

# zigbee alliance

1

2

## Cluster Library Specification

3

4

Document 07-5123 Revision 8

5

6

Chapter Document 14-0125

7

# dotdot

8

9

Zigbee Document	075123
Date of release	December 2019
Sponsored by	Zigbee Alliance
Accepted by	This document has been accepted for release by the Zigbee Alliance Board of Directors.
Abstract	This document defines the Zigbee Cluster Library.
Keywords	Zigbee, Application, Cluster, Library, ZCL, Dotdot, Dictionary, Data Model

10

Copyright © 2007-2020 by the Zigbee Alliance.  
<http://www.zigbee.org>  
All rights reserved.

Permission is granted to members of the Zigbee Alliance to reproduce this document for their own use or the use of other Zigbee Alliance members only, provided this notice is included. All other rights reserved. Duplication for sale, or for commercial or for-profit use is strictly prohibited without the prior written consent of the Zigbee Alliance.

## 11 **Notice of Use and Disclosure**

---

12 Copyright © Zigbee Alliance, Inc. (1996-2020). All rights Reserved. This information within this docu-  
13 ment is the property of the Zigbee Alliance and its use and disclosure are restricted.

14 Elements of Zigbee Alliance specifications may be subject to third party intellectual property rights, includ-  
15 ing without limitation, patent, copyright or trademark rights (such a third party may or may not be a mem-  
16 ber of Zigbee). Zigbee is not responsible and shall not be held responsible in any manner for identifying or  
17 failing to identify any or all such third party intellectual property rights.

18 No right to use any Zigbee name, logo or trademark is conferred herein. Use of any Zigbee name, logo or  
19 trademark requires membership in the Zigbee Alliance and compliance with the Zigbee Logo and Trade-  
20 mark Policy and related Zigbee policies.

21 This document and the information contained herein are provided on an “AS IS” basis and Zigbee DIS-  
22 CLAIMS ALL WARRANTIES EXPRESS OR IMPLIED, INCLUDING BUT NOT LIMITED TO (A)  
23 ANY WARRANTY THAT THE USE OF THE INFORMATION HEREIN WILL NOT INFRINGE ANY  
24 RIGHTS OF THIRD PARTIES (INCLUDING WITHOUT LIMITATION ANY INTELLECTUAL PROP-  
25 erty RIGHTS INCLUDING PATENT, COPYRIGHT OR TRADEMARK RIGHTS) OR (B) ANY IM-  
26 PLIED WARRANTIES OF MERCHANTABILITY, FITNESS FOR A PARTICULAR PURPOSE, TITLE  
27 OR NONINFRINGEMENT. IN NO EVENT WILL ZIGBEE BE LIABLE FOR ANY LOSS OF PROF-  
28 ITS, LOSS OF BUSINESS, LOSS OF USE OF DATA, INTERRUPTION OF BUSINESS, OR FOR ANY  
29 OTHER DIRECT, INDIRECT, SPECIAL OR EXEMPLARY, INCIDENTAL, PUNITIVE OR CONSE-  
30 QUENTIAL DAMAGES OF ANY KIND, IN CONTRACT OR IN TORT, IN CONNECTION WITH  
31 THIS DOCUMENT OR THE INFORMATION CONTAINED HEREIN, EVEN IF ADVISED OF THE  
32 POSSIBILITY OF SUCH LOSS OR DAMAGE. All Company, brand and product names may be trade-  
33 marks that are the sole property of their respective owners.

34 The above notice and this paragraph must be included on all copies of this document that are made.

## 35 **Participants**

---

36 The following is a list of Zigbee members who contributed to this document:

37 Cam Williams – Technical Editor

Rob Alexander	Ezra Hale	Zin Kyaw	Jonas Riska
Shane Almeida	Jesper Haee	Gary Lee	Zachary Smith
Casey Anderson	Robert Hall	Jared Lemke	Robby Simpson
Skip Ashton	Jon Harros	Christopher Leidigh	Sumit Singh
Arvind Asthana	Jim Hartman	Yingbo Li	David Smith
Wally Barnum	Arasch Honarbacht	Marco Naeve	Matt Smith
Alex Chu	Ted Humpal	Juan Agui Martin	Michael Stuber
Ettore Colicchio	Phil Jamieson	Christian P. Garcia	Don Sturek
Jeff Cooper	William Keith	Jeff Mathews	Mads Westergreen
Damon Corbin	Larry Kohrman	Tony Mauro	Urban Wicklander
Michael Cowan	Tom Klein	Leslie Mulder	Cam Williams
John Cowburn	John Knuth	Luca Negri	Ian Winterburn
Robert Cragie	Cristian Kuster	Ivan O’Neill	Kenny York
Jonathan Cressman	Wally Barnum	Isaac Pinhas	Walter Young
Tim Gillman		Andrea Ranalli	
Drew Gislason			

38

## 39 Document Control

---

40 The Zigbee Cluster Library is made of individual chapters such as this one. See Chapter 1 for the list of all  
41 chapters. References between chapters are made using a *X.Y* notation where *X* is the chapter and *Y* is the sub-  
42 section within that chapter. References to external documents are contained in Chapter 1 and are made using  
43 [*Rn*] notation.

44 An update to any of these chapters will be reflected in an update to the source document list below.

Chapter 1 – Introduction	Document 14-0125-14
Chapter 2 – Foundation	Document 14-0126-17
Chapter 3 – General	Document 14-0127-21
Chapter 4 – Measurement and Sensing	Document 14-0128-12
Chapter 5 – Lighting	Document 14-0129-16
Chapter 6 – HVAC	Document 14-0130-13
Chapter 7 – Closures	Document 14-0131-16
Chapter 8 – Security and Safety	Document 14-0132-14
Chapter 9 – Protocol Interfaces	Document 14-0133-09
Chapter 10 – Smart Energy	Document 14-0134-12
Chapter 11 – Over the Air Upgrades	Document 14-0135-16
Chapter 12 – Telecommunications	Document 14-0136-11
Chapter 13 – Commissioning	Document 14-0137-14
Chapter 14 – Retail Services	Document 14-0138-09
Chapter 15 – Appliances	Document 14-0139-13
Approved Errata for this ZCL revision	Document 19-2019
Source files for drawings in this ZCL revision	Document 14-0141-00

45

46 **Document History**

Rev	Date	Comments
00	11-Jul-2007	Document created
01	19-Oct2007	First release
02	29-May-2008	<p>Added Commissioning Cluster from 064699r12.</p> <ul style="list-style-type: none"> <li>Added material from annex of CBA Profile 053516r10</li> <li>Structured types (arrays etc) and structured R/W commands</li> <li>Input / Output / Value clusters (Basic)</li> <li>Input / Output / Value clusters (BACnet Regular &amp; Extended)</li> <li>Generic Tunnel cluster</li> <li>BACnet Protocol Tunnel cluster</li> </ul> <p>Made changes to the Color Control cluster re. CCB 870</p> <ul style="list-style-type: none"> <li>Added x,y control according to CIE 1931 Color Space</li> </ul> <p>Added long data types (as required by SE profile 075356r12 etc)</p> <ul style="list-style-type: none"> <li>40-64bit integers etc, long strings</li> </ul> <p>Made changes to time cluster (as required by CCBs 890, 914)</p> <ul style="list-style-type: none"> <li>Added time zone &amp; DST + UTCtime type</li> </ul> <p>Made minor changes as requested by the following CCBs</p> <ul style="list-style-type: none"> <li>627, 714, 781, 853, 854, 867, 878, 879, 880, 881, 883, 893, 897, 898, 919, 958</li> </ul>
03	18-Sep-2009	<p>The following changes were made to the Editor’s Copy of the ZCL, 095254r00.</p> <p>Made change to the Basic cluster, re CCB comment #606</p> <ul style="list-style-type: none"> <li>Added optional attribute <i>DisableLocalConfig</i>.</li> </ul> <p>Updated Pressure Measurement cluster re CCB comment #961</p> <ul style="list-style-type: none"> <li>Added extra attributes to allow wider range of pressure.</li> </ul> <p>Updated Color Control cluster re CCB comment #1006</p> <ul style="list-style-type: none"> <li>Clarification of stop commands, color mode switching etc.</li> </ul> <p>Made changes to RSSI Location cluster, re CCB comment #1053</p> <ul style="list-style-type: none"> <li>Added mechanism for centralized location.</li> </ul> <p>Made change to Generic Tunnel cluster, re CCB comment #1068</p> <ul style="list-style-type: none"> <li>Added extra fields to Match Protocol Address Response Command</li> </ul>
	24-Dec-2009	<p>Made minor changes and clarifications re the following CCBs</p> <ul style="list-style-type: none"> <li>960, 1001, 1004, 1061, 1097.</li> <li>Added Door Lock cluster.</li> </ul> <p>Updated Occupancy Sensor re CCB comments 1092, 1093, 1094</p>
04	2010	<p>CCB 1174: Fixed references</p> <p>CCB 1176: Added new status codes</p> <p>CCB 1202: Corrected default value in thermostat cluster</p>
	Apr-2012	<p>CCB 1381: Default Response clarification</p> <p>CCB 1260: Generic Tune 1 cluster clarification</p> <p>CCB 1377: Commissioning Cluster minor change</p>

Rev	Date	Comments
		CCB 1146: Report Attributes without Configuration CCB 1169: Dependencies on Optional Attributes CCB 1379: Generic Tunnel <i>ProtocolAddress</i> attribute ReadOnly Option CCB 1420: Time cluster ESI bit CCB 1390: Reporting destination clarification
05	18-Mar-2015	Move to individual chapters Added all approved Clusters from other Application Specifications Included CCBs Editorial cleanup of document
06	14-Jan-2016	Chapter 1: New terms for Zigbee 3.0 Chapter 2: Zigbee 3.0 & Application Architecture changes Broadcast Endpoint Rules Global discovery commands from ZHA 1.2 CCB 1277 1319 1444 1485 1505 1578 1923 2029 2092 Chapter 3: <i>ZCLVersion</i> attribute of Basic cluster is 0x02 CCB 1480 1555 1647 1745 1809 1815 1822 1833 2100 Chapter 4: CCB 2048 2049 2050 2055 Chapter 5: ZLL 1.0 errata CCB 2028 2106 Chapter 6: CCB 1485 1823 Chapter 7: CCB 1811 1812 1821 1994 1995 1996 1997 2086 2094 2095 2096 2097 Chapter 8: ZHA 1.2 & 1.2.1 & errata CCB 1977 2044 2045 Chapter 11: CCB 1374 1470 1477 1540 1594 2046 2056 Chapter 15: CCB 1893
07	Nov-2017	Removed the extraneous word “ZigBee” to describe items. CCB 2288 Chapter 1: reference for Manufacture Code database Chapter 2: clarified cluster Instance Model CCB 2327 2266 2338 2213 2318 Define Deprecation New data type: Fixed ASCII Chapter 3: Level Control cluster State Change Table New Basic attributes; <i>ZCLVersion</i> is 0x03 Transition time to Recall Scene NFR Quality of Goods clusters: PWM, Level ZLO 1.0 changes to Level Control for Lighting CCB 1499 1584 1775 2085 2147 2197 2211 2212 2229 2281 2289 CCB 2329 2330 2333 2309 2319 Chapter 4: NFR Quality of Goods Measurement clusters: Wind Speed, Concentration, pH, Electrical Conductivity Physical Contact Occupancy CCB 2167 2236 2241 2370

Rev	Date	Comments
		<p>Chapter 5: ZLO 1.0; <i>Options</i> Attribute;            CCB 2085 2104 2124 2193 2230 2393            Deprecate some attributes</p> <p>Chapter 6: CCB 1981 2186 2249 2250 2251            Thermostat Setback</p> <p>Chapter 7: CCB 2328 2340 2316</p> <p>Chapter 8: CCB 2341 2350 2352            Door-Window Position feature</p> <p>Chapter 10: alternative Image Activation Policies            128-bit Crypto suite, Smart Energy Profile 1.2a &amp; 1.2b            CCB 2219 2220 2221 2222 2223 2224 2225 2226 2227 2228 2296            CCB 2307 2315 2342 2398</p> <p>Chapter 11: new ECC curve; alternative Image Activation Policies            Smart Energy Profile 1.2a &amp; 1.2b            CCB 2019 2219 2220 2221 2222 2223 2224 2225 2226 2227 2228            CCB 2296 2307 2315 2339 2342 2398 2464</p> <p>Chapter 13: Touchlink Profile Interop bit; CCB 2115 2105</p> <p>Chapter 15: Cleaned up ranges to follow reserved value rules</p>
08	December-2019	<p>All: Status Code Cleanup (CCB 2477)            All: CCB 2474 2477 2550 2886</p> <p>Chapter 2: CCB 2477 2550 2543 2871 2874 2877 2885 2964 2965</p> <p>Chapter 3: CCB 2310 2425 2427 2454 2463 2477 2520 2521 2544            2550 2574 2605 2616 2618 2659 2675 2702 2704 2722 2808 2814            2817 2818 2819 2860 2871 2885 2893 2898 2899 3026</p> <p>Chapter 4: CCB 2369 2550 2817 2823 2882</p> <p>Chapter 5: CCB 2501 2550 2700 2814 2839 2840 2843 2861 2881</p> <p>Chapter 6: CCB 2550 2560 2773 2777 2815 2816 3029</p> <p>Chapter 7: New: Barrier Control            CCB 2477 2550 2555 2630 2845 2891 3028</p> <p>Chapter 8: CCB 2550 2745</p> <p>Chapter 9: CCB 2550</p> <p>Chapter 10: New: Prepayment, Calendar, Device Management, Events,            Sub-GHz            Updated: Key Establishment, Price, DRLC, Metering, Messaging            CCB 1291 1297 1511 1447 1513 1655 1679 1819 1886 1880 1939            1955 1999 2009 2010 2023 2052 2068 2081 2183 2199 2286 2287            2314 2550 2817 2860 2964 2965</p> <p>Chapter 11: CCB 2477 2519 2550 2873</p> <p>Chapter 12: CCB 2477 2550</p> <p>Chapter 13: CCB 2477 2550 2648 2862 2870</p>

# 48 TABLE OF CONTENTS

49	Cluster Library Specification .....	1
50	Notice of Use and Disclosure .....	2
51	Participants .....	3
52	Document Control .....	4
53	Document History .....	5
54	Table of Contents.....	8
55	List of Figures.....	19
56	List of Tables .....	31
57	Chapter 1 Introduction .....	1-1
58	1.1 Scope and Purpose.....	1-1
59	1.2 Acronyms and Abbreviations .....	1-1
60	1.3 Definitions .....	1-3
61	1.4 Conformance Levels.....	1-4
62	1.5 References .....	1-5
63	<b>1.5.1</b> Zigbee Alliance Documents .....	1-5
64	<b>1.5.2</b> International Standards Documents .....	1-5
65	<b>1.5.3</b> National Standards Documents .....	1-5
66	<b>1.5.4</b> IEEE Documents.....	1-6
67	<b>1.5.5</b> ASHRAE Documents .....	1-6
68	<b>1.5.6</b> Health Care Documents .....	1-6
69	<b>1.5.7</b> Other Documents .....	1-6
70	1.6 Conventions.....	1-7
71	<b>1.6.1</b> Enumerations and Reserved Values.....	1-7
72	<b>1.6.2</b> Reserved Bit Fields .....	1-7
73	<b>1.6.3</b> Number Format .....	1-7
74	Chapter 2 Foundation .....	2-1
75	2.1 Scope and Purpose.....	2-1
76	2.2 Cluster Library Overview .....	2-1
77	<b>2.2.1</b> Architecture and Data Model.....	2-1
78	<b>2.2.2</b> Client/Server Model.....	2-2
79	2.3 Functional Description .....	2-3
80	<b>2.3.1</b> Transmission .....	2-3
81	<b>2.3.2</b> Reception .....	2-4
82	<b>2.3.3</b> Manufacturer Specific Extensions .....	2-4
83	<b>2.3.4</b> Attribute, Command and Variable Data.....	2-5
84	<b>2.3.5</b> Persistent Data .....	2-7
85	2.4 Command Frame Formats .....	2-7
86	<b>2.4.1</b> General Frame Format .....	2-8
87	2.5 General Command Frames .....	2-9
88	<b>2.5.1</b> Read Attributes Command.....	2-11
89	<b>2.5.2</b> Read Attributes Response Command.....	2-12
90	<b>2.5.3</b> Write Attributes Command.....	2-14
91	<b>2.5.4</b> Write Attributes Undivided Command .....	2-16
92	<b>2.5.5</b> Write Attributes Response Command.....	2-16
93	<b>2.5.6</b> Write Attributes No Response Command.....	2-17
94	<b>2.5.7</b> Configure Reporting Command .....	2-18
95	<b>2.5.8</b> Configure Reporting Response Command.....	2-21
96	<b>2.5.9</b> Read Reporting Configuration Command.....	2-22



97	<b>2.5.10</b>	Read Reporting Configuration Response Command .....	2-23
98	<b>2.5.11</b>	Report Attributes Command .....	2-25
99	<b>2.5.12</b>	Default Response Command .....	2-28
100	<b>2.5.13</b>	Discover Attributes Command .....	2-29
101	<b>2.5.14</b>	Discover Attributes Response Command .....	2-30
102	<b>2.5.15</b>	Read Attributes Structured Command .....	2-31
103	<b>2.5.16</b>	Write Attributes Structured Command .....	2-33
104	<b>2.5.17</b>	Write Attributes Structured Response Command .....	2-36
105	<b>2.5.18</b>	Discover Commands Received Command .....	2-37
106	<b>2.5.19</b>	Discover Commands Received Response .....	2-38
107	<b>2.5.20</b>	Discover Commands Generated Command .....	2-39
108	<b>2.5.21</b>	Discover Commands Generated Response .....	2-39
109	<b>2.5.22</b>	Discover Attributes Extended Command .....	2-40
110	<b>2.5.23</b>	Discover Attributes Extended Response Command .....	2-41
111	2.6	Addressing, Types and Enumerations .....	2-42
112	<b>2.6.1</b>	Addressing .....	2-42
113	<b>2.6.2</b>	Data Types .....	2-44
114	<b>2.6.3</b>	Status Enumerations .....	2-55
115	Chapter 3	General .....	3-1
116	3.1	General Description .....	3-1
117	<b>3.1.1</b>	Introduction .....	3-1
118	<b>3.1.2</b>	Cluster List .....	3-1
119	3.2	Basic .....	3-6
120	<b>3.2.1</b>	Overview .....	3-6
121	<b>3.2.2</b>	Server .....	3-6
122	<b>3.2.3</b>	Client .....	3-17
123	3.3	Power Configuration .....	3-17
124	<b>3.3.1</b>	Overview .....	3-17
125	<b>3.3.2</b>	Server .....	3-18
126	<b>3.3.3</b>	Client .....	3-26
127	3.4	Device Temperature Configuration .....	3-26
128	<b>3.4.1</b>	Overview .....	3-26
129	<b>3.4.2</b>	Server .....	3-27
130	<b>3.4.3</b>	Client .....	3-30
131	3.5	Identify .....	3-30
132	<b>3.5.1</b>	Overview .....	3-30
133	<b>3.5.2</b>	Server .....	3-31
134	<b>3.5.3</b>	Client .....	3-34
135	3.6	Groups .....	3-34
136	<b>3.6.1</b>	Overview .....	3-34
137	<b>3.6.2</b>	Server .....	3-35
138	<b>3.6.3</b>	Client .....	3-44
139	3.7	Scenes .....	3-44
140	<b>3.7.1</b>	Overview .....	3-44
141	<b>3.7.2</b>	Server .....	3-44
142	<b>3.7.3</b>	Client .....	3-61
143	3.8	On/Off .....	3-61
144	<b>3.8.1</b>	Overview .....	3-61
145	<b>3.8.2</b>	Server .....	3-62
146	<b>3.8.3</b>	Client .....	3-69
147	3.9	On/Off Switch Configuration .....	3-69
148	<b>3.9.1</b>	Overview .....	3-69
149	<b>3.9.2</b>	Server .....	3-69
150	<b>3.9.3</b>	Client .....	3-71
151	3.10	Level .....	3-71

152	<b>3.10.1</b>	Overview.....	3-71
153	<b>3.10.2</b>	Server.....	3-72
154	<b>3.10.3</b>	Client.....	3-81
155	3.11	Alarms.....	3-82
156	<b>3.11.1</b>	Overview.....	3-82
157	<b>3.11.2</b>	Server.....	3-82
158	<b>3.11.3</b>	Client.....	3-86
159	3.12	Time.....	3-86
160	<b>3.12.1</b>	Overview.....	3-86
161	<b>3.12.2</b>	Server.....	3-86
162	<b>3.12.3</b>	Client.....	3-90
163	3.13	RSSI Location.....	3-90
164	<b>3.13.1</b>	Overview.....	3-90
165	<b>3.13.2</b>	Server.....	3-92
166	<b>3.13.3</b>	Client.....	3-105
167	3.14	Input, Output and Value Clusters.....	3-105
168	<b>3.14.1</b>	Overview.....	3-105
169	<b>3.14.2</b>	Analog Input (Basic).....	3-106
170	<b>3.14.3</b>	Analog Output (Basic).....	3-107
171	<b>3.14.4</b>	Analog Value (Basic).....	3-109
172	<b>3.14.5</b>	Binary Input (Basic).....	3-110
173	<b>3.14.6</b>	Binary Output (Basic).....	3-112
174	<b>3.14.7</b>	Binary Value (Basic).....	3-114
175	<b>3.14.8</b>	Multistate Input (Basic).....	3-115
176	<b>3.14.9</b>	Multistate Output (Basic).....	3-117
177	<b>3.14.10</b>	Multistate Value (Basic).....	3-118
178	<b>3.14.11</b>	Attribute Descriptions.....	3-120
179	3.15	Diagnostics.....	3-156
180	<b>3.15.1</b>	Overview.....	3-156
181	<b>3.15.2</b>	Server.....	3-157
182	<b>3.15.3</b>	Client.....	3-161
183	3.16	Poll Control.....	3-161
184	<b>3.16.1</b>	Overview.....	3-161
185	<b>3.16.2</b>	Terminology.....	3-162
186	<b>3.16.3</b>	Commissioning Process.....	3-163
187	<b>3.16.4</b>	Server.....	3-163
188	<b>3.16.5</b>	Client.....	3-166
189	<b>3.16.6</b>	Poll Control Cluster Sequence Diagram.....	3-168
190	3.17	Power Profile.....	3-170
191	<b>3.17.1</b>	Overview.....	3-170
192	<b>3.17.2</b>	References.....	3-171
193	<b>3.17.3</b>	General Description.....	3-171
194	<b>3.17.4</b>	Server Attributes.....	3-172
195	<b>3.17.5</b>	Server Commands Received.....	3-173
196	<b>3.17.6</b>	Server Commands Generated.....	3-181
197	<b>3.17.7</b>	Client Attributes.....	3-192
198	<b>3.17.8</b>	Client Commands Received.....	3-192
199	<b>3.17.9</b>	Client Commands Generated.....	3-192
200	<b>3.17.10</b>	Example of Device Interactions Using the Power Profile (Informative Section).....	3-192
201	3.18	Keep Alive.....	3-195
202	<b>3.18.1</b>	Overview.....	3-195
203	<b>3.18.2</b>	Server.....	3-196
204	<b>3.18.3</b>	Client.....	3-197
205	<b>3.18.4</b>	Application Guidelines.....	3-197
206	3.19	Level Control for Lighting.....	3-197
207	<b>3.19.1</b>	Overview.....	3-197

208	<b>3.19.2</b>	Server.....	3-198
209	<b>3.19.3</b>	Client .....	3-200
210	<b>3.19.4</b>	State Change Table for Lighting.....	3-200
211	3.20	Pulse Width Modulation.....	3-202
212	<b>3.20.1</b>	Overview .....	3-202
213	<b>3.20.2</b>	Server.....	3-202
214	<b>3.20.3</b>	Client .....	3-203
215	Chapter 4	Measurement and Sensing .....	4-1
216	4.1	General Description.....	4-1
217	<b>4.1.1</b>	Introduction .....	4-1
218	<b>4.1.2</b>	Cluster List .....	4-1
219	<b>4.1.3</b>	Measured Value .....	4-4
220	4.2	Illuminance Measurement .....	4-5
221	<b>4.2.1</b>	Overview .....	4-5
222	<b>4.2.2</b>	Server.....	4-5
223	<b>4.2.3</b>	Client .....	4-7
224	4.3	Illuminance Level Sensing .....	4-7
225	<b>4.3.1</b>	Overview .....	4-7
226	<b>4.3.2</b>	Server.....	4-8
227	<b>4.3.3</b>	Client .....	4-10
228	4.4	Temperature Measurement.....	4-10
229	<b>4.4.1</b>	Overview .....	4-10
230	<b>4.4.2</b>	Server.....	4-10
231	<b>4.4.3</b>	Client .....	4-12
232	4.5	Pressure Measurement.....	4-12
233	<b>4.5.1</b>	Overview .....	4-12
234	<b>4.5.2</b>	Server.....	4-13
235	<b>4.5.3</b>	Client .....	4-16
236	4.6	Flow Measurement.....	4-16
237	<b>4.6.1</b>	Overview .....	4-16
238	<b>4.6.2</b>	Server.....	4-16
239	<b>4.6.3</b>	Client .....	4-18
240	4.7	Water Content Measurement.....	4-18
241	<b>4.7.1</b>	Overview .....	4-18
242	<b>4.7.2</b>	Server.....	4-19
243	<b>4.7.3</b>	Client .....	4-19
244	4.8	Occupancy Sensing .....	4-20
245	<b>4.8.1</b>	Overview .....	4-20
246	<b>4.8.2</b>	Server.....	4-20
247	<b>4.8.3</b>	Client .....	4-24
248	4.9	Electrical Measurement.....	4-24
249	<b>4.9.1</b>	Overview .....	4-24
250	<b>4.9.2</b>	Server.....	4-25
251	4.10	Electrical Conductivity Measurement.....	4-47
252	<b>4.10.1</b>	Overview .....	4-47
253	<b>4.10.2</b>	Server.....	4-48
254	<b>4.10.3</b>	Client .....	4-49
255	4.11	pH Measurement .....	4-49
256	<b>4.11.1</b>	Overview .....	4-49
257	<b>4.11.2</b>	Server.....	4-50
258	<b>4.11.3</b>	Client .....	4-50
259	4.12	Wind Speed Measurement .....	4-51
260	<b>4.12.1</b>	Overview .....	4-51
261	<b>4.12.2</b>	Server.....	4-51
262	<b>4.12.3</b>	Client .....	4-52

263	4.13 Concentration Measurement.....	4-52
264	<b>4.13.1</b> Overview.....	4-52
265	<b>4.13.2</b> Server.....	4-54
266	<b>4.13.3</b> Client.....	4-55
267	Chapter 5 Lighting.....	5-1
268	5.1 General Description.....	5-1
269	<b>5.1.1</b> Introduction.....	5-1
270	<b>5.1.2</b> Terms.....	5-1
271	<b>5.1.3</b> Cluster List.....	5-1
272	5.2 Color Control Cluster.....	5-2
273	<b>5.2.1</b> Overview.....	5-2
274	<b>5.2.2</b> Server.....	5-3
275	<b>5.2.3</b> Client.....	5-36
276	5.3 Ballast Configuration Cluster.....	5-36
277	<b>5.3.1</b> Overview.....	5-36
278	<b>5.3.2</b> Server.....	5-37
279	<b>5.3.3</b> Client.....	5-41
280	<b>5.3.4</b> The Dimming Light Curve.....	5-41
281	Chapter 6 HVAC.....	6-1
282	6.1 General Description.....	6-1
283	<b>6.1.1</b> Introduction.....	6-1
284	<b>6.1.2</b> Terms.....	6-1
285	<b>6.1.3</b> Cluster List.....	6-1
286	6.2 Pump Configuration and Control.....	6-3
287	<b>6.2.1</b> Overview.....	6-3
288	<b>6.2.2</b> Server.....	6-3
289	<b>6.2.3</b> Client.....	6-13
290	6.3 Thermostat.....	6-13
291	<b>6.3.1</b> Overview.....	6-13
292	<b>6.3.2</b> Server.....	6-14
293	<b>6.3.3</b> Client.....	6-37
294	6.4 Fan Control.....	6-37
295	<b>6.4.1</b> Overview.....	6-37
296	<b>6.4.2</b> Server.....	6-38
297	<b>6.4.3</b> Client.....	6-39
298	6.5 Dehumidification Control.....	6-39
299	<b>6.5.1</b> Overview.....	6-39
300	<b>6.5.2</b> Server.....	6-40
301	<b>6.5.3</b> Client.....	6-42
302	6.6 Thermostat User Interface Configuration.....	6-42
303	<b>6.6.1</b> Overview.....	6-42
304	<b>6.6.2</b> Server.....	6-43
305	<b>6.6.3</b> Client.....	6-45
306	Chapter 7 Closures.....	7-1
307	7.1 General Description.....	7-1
308	<b>7.1.1</b> Introduction.....	7-1
309	<b>7.1.2</b> Cluster List.....	7-1
310	7.2 Shade Configuration.....	7-2
311	<b>7.2.1</b> Overview.....	7-2
312	<b>7.2.2</b> Server.....	7-3
313	<b>7.2.3</b> Client.....	7-5
314	7.3 Door Lock.....	7-5
315	<b>7.3.1</b> Overview.....	7-5

316	<b>7.3.2</b>	Server.....	7-5
317	<b>7.3.3</b>	Client .....	7-50
318	7.4	Window Covering .....	7-50
319	<b>7.4.1</b>	Overview .....	7-50
320	<b>7.4.2</b>	Server.....	7-50
321	<b>7.4.3</b>	Client .....	7-59
322	7.5	Barrier Control .....	7-59
323	<b>7.5.1</b>	Overview .....	7-59
324	<b>7.5.2</b>	Server.....	7-60
325	<b>7.5.3</b>	Client .....	7-64
326	Chapter 8	Security and Safety .....	8-1
327	8.1	General Description.....	8-1
328	<b>8.1.1</b>	Introduction .....	8-1
329	<b>8.1.2</b>	Cluster List .....	8-1
330	8.2	IAS Zone .....	8-2
331	<b>8.2.1</b>	Overview .....	8-2
332	<b>8.2.2</b>	Server.....	8-3
333	<b>8.2.3</b>	Client .....	8-13
334	8.3	IAS ACE .....	8-13
335	<b>8.3.1</b>	Overview .....	8-13
336	<b>8.3.2</b>	Server.....	8-14
337	<b>8.3.3</b>	Client .....	8-27
338	8.4	IAS WD.....	8-27
339	<b>8.4.1</b>	Overview .....	8-27
340	<b>8.4.2</b>	Server.....	8-28
341	<b>8.4.3</b>	Client .....	8-32
342	Chapter 9	Protocol Interfaces .....	9-1
343	9.1	General Description.....	9-1
344	<b>9.1.1</b>	Introduction .....	9-1
345	<b>9.1.2</b>	Cluster List .....	9-1
346	9.2	Generic Tunnel.....	9-3
347	<b>9.2.1</b>	Overview .....	9-3
348	<b>9.2.2</b>	Server.....	9-3
349	<b>9.2.3</b>	Client .....	9-6
350	9.3	BACnet Protocol Tunnel.....	9-6
351	<b>9.3.1</b>	Overview .....	9-6
352	<b>9.3.2</b>	Server.....	9-7
353	<b>9.3.3</b>	Client .....	9-8
354	9.4	BACnet Input, Output and Value Clusters .....	9-8
355	<b>9.4.1</b>	Overview .....	9-8
356	<b>9.4.2</b>	Analog Input (BACnet Regular).....	9-9
357	<b>9.4.3</b>	Analog Input (BACnet Extended) .....	9-10
358	<b>9.4.4</b>	Analog Output (BACnet Regular) .....	9-12
359	<b>9.4.5</b>	Analog Output (BACnet Extended).....	9-13
360	<b>9.4.6</b>	Analog Value (BACnet Regular).....	9-15
361	<b>9.4.7</b>	Analog Value (BACnet Extended) .....	9-16
362	<b>9.4.8</b>	Binary Input (BACnet Regular).....	9-18
363	<b>9.4.9</b>	Binary Input (BACnet Extended) .....	9-19
364	<b>9.4.10</b>	Binary Output (BACnet Regular) .....	9-21
365	<b>9.4.11</b>	Binary Output (BACnet Extended).....	9-23
366	<b>9.4.12</b>	Binary Value (BACnet Regular).....	9-24
367	<b>9.4.13</b>	Binary Value (BACnet Extended) .....	9-26
368	<b>9.4.14</b>	Multistate Input (BACnet Regular) .....	9-27
369	<b>9.4.15</b>	Multistate Input (BACnet Extended).....	9-29

370	<b>9.4.16</b>	Multistate Output (BACnet Regular).....	9-30
371	<b>9.4.17</b>	Multistate Output (BACnet Extended).....	9-32
372	<b>9.4.18</b>	Multistate Value (BACnet Regular).....	9-33
373	<b>9.4.19</b>	Multistate Value (BACnet Extended).....	9-34
374	<b>9.4.20</b>	Attributes of BACnet Regular Clusters.....	9-36
375	<b>9.4.21</b>	Attributes of BACnet Extended Clusters.....	9-38
376	9.5	ISO 7818 Protocol Tunnel.....	9-40
377	<b>9.5.1</b>	Scope and Purpose.....	9-40
378	<b>9.5.2</b>	Definitions.....	9-40
379	<b>9.5.3</b>	General Description.....	9-40
380	<b>9.5.4</b>	Overview.....	9-40
381	<b>9.5.5</b>	Server.....	9-41
382	<b>9.5.6</b>	Client.....	9-43
383	9.6	Partition.....	9-44
384	<b>9.6.1</b>	Scope and Purpose.....	9-44
385	<b>9.6.2</b>	Introduction.....	9-44
386	<b>9.6.3</b>	Server.....	9-47
387	<b>9.6.4</b>	Client.....	9-53
388	<b>9.6.5</b>	General Use of Partition Cluster.....	9-53
389	9.7	11073 Protocol Tunnel.....	9-55
390	<b>9.7.1</b>	Overview.....	9-55
391	<b>9.7.2</b>	Server.....	9-56
392	<b>9.7.3</b>	Client.....	9-62
393	Chapter 10	Smart Energy.....	10-1
394	10.1	General Description.....	10-1
395	<b>10.1.1</b>	Introduction.....	10-1
396	<b>10.1.2</b>	Cluster List.....	10-1
397	10.2	Price.....	10-2
398	<b>10.2.1</b>	Overview.....	10-2
399	<b>10.2.2</b>	Server.....	10-3
400	<b>10.2.3</b>	Client.....	10-63
401	<b>10.2.4</b>	Application Guidelines.....	10-64
402	10.3	Demand Response and Load Control.....	10-68
403	<b>10.3.1</b>	Overview.....	10-68
404	<b>10.3.2</b>	Server.....	10-69
405	<b>10.3.3</b>	Client.....	10-77
406	<b>10.3.4</b>	Application Guidelines.....	10-83
407	<b>10.3.5</b>	Rules and Guidelines for Overlapping Events.....	10-87
408	10.4	Metering.....	10-94
409	<b>10.4.1</b>	Overview.....	10-94
410	<b>10.4.2</b>	Server.....	10-98
411	<b>10.4.3</b>	Client.....	10-178
412	<b>10.4.4</b>	Metering Application Guidelines.....	10-196
413	10.5	Messaging.....	10-204
414	<b>10.5.1</b>	Overview.....	10-204
415	<b>10.5.2</b>	Server.....	10-205
416	<b>10.5.3</b>	Client.....	10-209
417	<b>10.5.4</b>	Application Guidelines.....	10-211
418	10.6	Tunneling.....	10-212
419	<b>10.6.1</b>	Overview.....	10-213
420	<b>10.6.2</b>	Server.....	10-216
421	<b>10.6.3</b>	Client.....	10-226
422	10.7	Key Establishment.....	10-227
423	<b>10.7.1</b>	Scope and Purpose.....	10-227
424	<b>10.7.2</b>	General Description.....	10-227

425	<b>10.7.3</b>	Overview .....	10-231
426	<b>10.7.4</b>	Server.....	10-233
427	<b>10.7.5</b>	Client .....	10-238
428	<b>10.7.6</b>	Application Implementation .....	10-243
429	<b>10.7.7</b>	Key Establishment Test Vectors for Cryptographic Suite 1 .....	10-251
430	<b>10.7.8</b>	Key Establishment Test Vectors for Cryptographic Suite 2 .....	10-263
431	10.8	Prepayment .....	10-274
432	<b>10.8.1</b>	Overview .....	10-274
433	<b>10.8.2</b>	Server.....	10-275
434	<b>10.8.3</b>	Client.....	10-313
435	<b>10.8.4</b>	Application Guidelines .....	10-313
436	10.9	Calendar .....	10-315
437	<b>10.9.1</b>	Overview .....	10-315
438	<b>10.9.2</b>	Server.....	10-319
439	<b>10.9.3</b>	Client .....	10-333
440	<b>10.9.4</b>	Application Guidelines .....	10-334
441	10.10	Device Management .....	10-334
442	<b>10.10.1</b>	Overview .....	10-334
443	<b>10.10.2</b>	Server.....	10-336
444	<b>10.10.3</b>	Client .....	10-351
445	<b>10.10.4</b>	Application Guidelines .....	10-373
446	10.11	Events .....	10-374
447	<b>10.11.1</b>	Overview .....	10-374
448	<b>10.11.2</b>	Server.....	10-376
449	<b>10.11.3</b>	Client .....	10-382
450	10.12	Sub-GHz .....	10-382
451	<b>10.12.1</b>	Overview .....	10-382
452	<b>10.12.2</b>	Server.....	10-383
453	<b>10.12.3</b>	Client .....	10-388
454	10.13	Meter Identification .....	10-389
455	<b>10.13.1</b>	Overview .....	10-389
456	<b>10.13.2</b>	Server.....	10-390
457	<b>10.13.3</b>	Client .....	10-393
458	Chapter 11	Over-The-Air Upgrade .....	11-1
459	11.1	Introduction .....	11-1
460	<b>11.1.1</b>	Purpose .....	11-1
461	<b>11.1.2</b>	Scope .....	11-1
462	<b>11.1.3</b>	Terminology .....	11-1
463	11.2	General Description.....	11-1
464	<b>11.2.1</b>	Introduction .....	11-1
465	<b>11.2.2</b>	Cluster List .....	11-2
466	11.3	OTA Upgrade.....	11-3
467	<b>11.3.1</b>	Overview .....	11-3
468	<b>11.3.2</b>	Security.....	11-4
469	<b>11.3.3</b>	Image Verification .....	11-5
470	<b>11.3.4</b>	Image Transport.....	11-6
471	<b>11.3.5</b>	Image Signature .....	11-6
472	<b>11.3.6</b>	Image Integrity Code .....	11-6
473	11.4	OTA File Format.....	11-6
474	<b>11.4.1</b>	General Structure .....	11-6
475	<b>11.4.2</b>	OTA Header Format .....	11-7
476	<b>11.4.3</b>	Sub-element Format.....	11-11
477	<b>11.4.4</b>	Tag Identifiers.....	11-12
478	<b>11.4.5</b>	Crypto Suites .....	11-12
479	<b>11.4.6</b>	ECDSA Signature Sub-element (Crypto Suite 1) .....	11-13

480	<b>11.4.7</b>	ECDSA Signing Certificate Sub-element .....	11-13
481	<b>11.4.8</b>	Image Integrity Code Sub-element .....	11-13
482	<b>11.4.9</b>	ECDSA Signature Sub-element (Crypto Suite 2) .....	11-14
483	<b>11.4.10</b>	ECDSA Signing Certificate Sub-element (Crypto Suite 2) .....	11-14
484	11.5	OTA File Naming .....	11-14
485	11.6	Signatures .....	11-15
486	11.7	ECDSA Signature Calculation .....	11-15
487	<b>11.7.1</b>	ECDSA Signature Verification .....	11-16
488	<b>11.7.2</b>	Image Integrity Code .....	11-17
489	11.8	Discovery of the Upgrade Server .....	11-18
490	<b>11.8.1</b>	Server and Client.....	11-18
491	<b>11.8.2</b>	Sleepy Devices.....	11-19
492	11.9	Dependencies.....	11-19
493	11.10	OTA Cluster Attributes .....	11-19
494	<b>11.10.1</b>	UpgradeServerID Attribute .....	11-20
495	<b>11.10.2</b>	<i>FileOffset</i> Attribute .....	11-20
496	<b>11.10.3</b>	CurrentFileVersion Attribute .....	11-21
497	<b>11.10.4</b>	CurrentZigBeeStackVersion Attribute.....	11-21
498	<b>11.10.5</b>	<i>DownloadedFileVersion</i> Attribute .....	11-21
499	<b>11.10.6</b>	DownloadedZigBeeStackVersion Attribute.....	11-21
500	<b>11.10.7</b>	ImageUpgradeStatus Attribute.....	11-21
501	<b>11.10.8</b>	Manufacturer ID Attribute .....	11-22
502	<b>11.10.9</b>	Image Type ID Attribute.....	11-22
503	<b>11.10.10</b>	<i>MinimumBlockPeriod</i> Attribute .....	11-22
504	<b>11.10.11</b>	Image Stamp Attribute .....	11-22
505	<b>11.10.12</b>	UpgradeActivationPolicy Attribute.....	11-22
506	<b>11.10.13</b>	UpgradeTimeoutPolicy Attribute .....	11-23
507	11.11	OTA Cluster Parameters .....	11-24
508	<b>11.11.1</b>	QueryJitter Parameter .....	11-24
509	<b>11.11.2</b>	<i>DataSize</i> Parameter .....	11-24
510	<b>11.11.3</b>	OTAImageData Parameter.....	11-24
511	<b>11.11.4</b>	CurrentTime and UpgradeTime/RequestTime Parameters .....	11-25
512	11.12	OTA Upgrade Diagram.....	11-26
513	11.13	Command Frames .....	11-27
514	<b>11.13.1</b>	OTA Cluster Command Identifiers .....	11-27
515	<b>11.13.2</b>	OTA Cluster Status Codes .....	11-28
516	<b>11.13.3</b>	Image Notify Command.....	11-28
517	<b>11.13.4</b>	Query Next Image Request Command.....	11-31
518	<b>11.13.5</b>	Query Next Image Response Command .....	11-33
519	<b>11.13.6</b>	Image Block Request Command.....	11-35
520	<b>11.13.7</b>	Image Page Request Command .....	11-37
521	<b>11.13.8</b>	Image Block Response Command .....	11-41
522	<b>11.13.9</b>	Upgrade End Request Command .....	11-45
523	<b>11.13.10</b>	Query Device Specific File Request Command .....	11-49
524	<b>11.13.11</b>	Query Device Specific File Response Command.....	11-50
525	11.14	Multiple Files Required for a Bootload.....	11-52
526	<b>11.14.1</b>	Single OTA File with multiple sub-elements.....	11-52
527	<b>11.14.2</b>	Separate OTA Files Upgraded Independently.....	11-52
528	<b>11.14.3</b>	Multiple OTA Files Dependent on Each Other.....	11-53
529	11.15	OTA Upgrade Cluster Management.....	11-53
530	<b>11.15.1</b>	Query Upgrade Status .....	11-53
531	<b>11.15.2</b>	Query Downloaded ZigBee Stack and File Versions.....	11-54
532	<b>11.15.3</b>	Rate Limiting .....	11-54
533	<b>11.15.4</b>	Current Time, Request Time, and MinimumBlockPeriod .....	11-55
534	11.16	OTA Upgrade Process.....	11-56
535	11.17	Application Standard Specific Decisions .....	11-56



536	<b>11.17.1</b>	SE Profile Standard: OTA Upgrade from SE 1.x to SE 2.0.....	11-57
537	11.18	OTA Upgrade Recovery .....	11-57
538	Chapter 12	Telecommunication .....	12-1
539	12.1	General Description.....	12-1
540	<b>12.1.1</b>	Introduction .....	12-1
541	<b>12.1.2</b>	Cluster List .....	12-1
542	12.2	Information.....	12-1
543	<b>12.2.1</b>	Scope and Purpose.....	12-1
544	<b>12.2.2</b>	Cluster List .....	12-2
545	<b>12.2.3</b>	Overview .....	12-3
546	<b>12.2.4</b>	Server.....	12-4
547	<b>12.2.5</b>	Client .....	12-21
548	<b>12.2.6</b>	Payload Formats for Contents Data .....	12-21
549	<b>12.2.7</b>	Introduction .....	12-24
550	<b>12.2.8</b>	Server.....	12-25
551	<b>12.2.9</b>	Client .....	12-35
552	12.3	Voice Over ZigBee.....	12-36
553	<b>12.3.1</b>	Scope and Purpose.....	12-36
554	<b>12.3.2</b>	Overview .....	12-36
555	<b>12.3.3</b>	Server.....	12-37
556	<b>12.3.4</b>	Client .....	12-44
557	Chapter 13	Commissioning.....	13-1
558	13.1	General Description.....	13-1
559	<b>13.1.1</b>	13.1.1 Introduction.....	13-1
560	<b>13.1.2</b>	13.1.2 Cluster List.....	13-1
561	13.2	Commissioning .....	13-1
562	<b>13.2.1</b>	Overview .....	13-1
563	<b>13.2.2</b>	Server.....	13-2
564	<b>13.2.3</b>	Client .....	13-16
565	<b>13.2.4</b>	Commissioning EUI-64s.....	13-17
566	13.3	Touchlink Commissioning .....	13-18
567	<b>13.3.1</b>	Overview .....	13-18
568	<b>13.3.2</b>	Server.....	13-19
569	<b>13.3.3</b>	Client .....	13-45
570	<b>13.3.4</b>	Functional Description.....	13-46
571	Chapter 14	Retail .....	14-1
572	14.1	General Description.....	14-1
573	<b>14.1.1</b>	Introduction .....	14-1
574	<b>14.1.2</b>	Cluster List .....	14-1
575	14.2	Retail Tunnel (MSP Tunnel).....	14-1
576	<b>14.2.1</b>	Overview .....	14-1
577	<b>14.2.2</b>	Server.....	14-2
578	<b>14.2.3</b>	Client .....	14-4
579	14.3	Mobile Device Configuration.....	14-4
580	<b>14.3.1</b>	Overview .....	14-4
581	<b>14.3.2</b>	Server.....	14-5
582	<b>14.3.3</b>	Client .....	14-7
583	14.4	Neighbor Cleaning .....	14-7
584	<b>14.4.1</b>	Overview .....	14-7
585	<b>14.4.2</b>	Server.....	14-8
586	<b>14.4.3</b>	Client .....	14-9
587	14.5	Nearest Gateway .....	14-10
588	<b>14.5.1</b>	Overview .....	14-10

589	<b>14.5.2</b>	Server .....	14-11
590	<b>14.5.3</b>	Client.....	14-11
591	<b>14.5.4</b>	Examples of Use .....	14-11
592	Chapter 15	Appliance.....	15-1
593	15.1	General Description.....	15-1
594	<b>15.1.1</b>	Introduction.....	15-1
595	<b>15.1.2</b>	Cluster List.....	15-1
596	15.2	EN50523 Appliance Control .....	15-1
597	<b>15.2.1</b>	Overview.....	15-1
598	<b>15.2.2</b>	General Description .....	15-2
599	<b>15.2.3</b>	Server Attributes .....	15-2
600	<b>15.2.4</b>	Server Commands Received .....	15-4
601	<b>15.2.5</b>	Server Commands Generated.....	15-8
602	<b>15.2.6</b>	Client.....	15-10
603	15.3	EN50523 Appliance Identification .....	15-11
604	<b>15.3.1</b>	Overview.....	15-11
605	<b>15.3.2</b>	Server .....	15-11
606	<b>15.3.3</b>	Client.....	15-15
607	15.4	EN50523 Appliance Events and Alerts .....	15-15
608	<b>15.4.1</b>	Overview.....	15-15
609	<b>15.4.2</b>	Server.....	15-17
610	<b>15.4.3</b>	Client.....	15-21
611	15.5	Appliance Statistics .....	15-21
612	<b>15.5.1</b>	Overview.....	15-21
613	<b>15.5.2</b>	Server .....	15-22
614	<b>15.5.3</b>	Client.....	15-25
615	<b>15.5.4</b>	Appliance Statistics Cluster Sequence Diagram .....	15-26
616			

617

## LIST OF FIGURES

618	Figure 2-1. Client Server Model.....	2-3
619	Figure 2-2. Format of the General ZCL Frame .....	2-8
620	Figure 2-3. Format of the Frame Control Field .....	2-8
621	Figure 2-4. Values of the Frame Type Sub-field .....	2-8
622	Figure 2-5. Format of the Read Attributes Command Frame .....	2-11
623	Figure 2-6. Format of Read Attributes Response Command Frame .....	2-12
624	Figure 2-7. Format of the Read Attributes Status Record Field .....	2-12
625	Figure 2-8. Format of the Attribute Value Field for an Array, Set or Bag .....	2-13
626	Figure 2-9. Format of the Attribute Value Field for a Structure.....	2-13
627	Figure 2-10. Format of the Write Attributes Command Frame .....	2-14
628	Figure 2-11. Format of the Write Attribute Record Field.....	2-14
629	Figure 2-12. Format of Write Attributes Response Command Frame.....	2-16
630	Figure 2-13. Format of the Write Attribute Status Record Field.....	2-16
631	Figure 2-14. Write Attributes No Response Command Frame .....	2-17
632	Figure 2-15. Format of the Configure Reporting Command Frame .....	2-18
633	Figure 2-16. Format of the Attribute Reporting Configuration Record.....	2-18
634	Figure 2-17. Format of the Configure Reporting Response Command Frame.....	2-21
635	Figure 2-18. Format of the Attribute Status Record Field.....	2-22
636	Figure 2-19. Read Reporting Configuration Command Frame .....	2-23
637	Figure 2-20. Format of the Attribute Status Record Field.....	2-23
638	Figure 2-21. Format of the Read Reporting Configuration Response Command Frame .....	2-24
639	Figure 2-22. Attribute Reporting Configuration Record Field.....	2-24
640	Figure 2-23. Format of the Report Attributes Command Frame .....	2-26
641	Figure 2-24. Format of the Attribute Report Fields.....	2-26
642	Figure 2-25. Format of the Default Response Command Frame.....	2-28
643	Figure 2-26. Format of the Discover Attributes Command Frame.....	2-29
644	Figure 2-27. Discover Attributes Response Command Frame .....	2-30
645	Figure 2-28. Format of the Attribute Report Fields.....	2-30
646	Figure 2-29. Format of Read Attributes Structured Command Frame .....	2-31
647	Figure 2-30. Format of the Selector Field .....	2-32
648	Figure 2-31. Write Attributes Structured Command Frame .....	2-33
649	Figure 2-32. Format of the Write Attribute Record Field.....	2-33
650	Figure 2-33. Format of the Selector Field .....	2-33
651	Figure 2-34. Write Attributes Structured Response Command Frame.....	2-36
652	Figure 2-35. Format of the Write Attribute Status Record Field.....	2-36
653	Figure 2-36. Format of the Discover Server Commands Command Frame .....	2-37
654	Figure 2-37. Format of the Discover Commands Received Response Frame .....	2-38
655	Figure 2-38. Format of the Discover Attributes Extended Command Frame.....	2-40
656	Figure 2-39. Format of the Discover Attributes Extended Response Command Frame .....	2-41
657	Figure 2-40. Format of the Extended Attribute Information Fields.....	2-41
658	Figure 2-41. Format of the Attribute Access Control Field.....	2-42
659	Figure 2-42. Format of the Semi-precision Number .....	2-49
660	Figure 2-43. Format of the Octet String Type .....	2-50
661	Figure 2-44. Format of the Character String Type .....	2-51
662	Figure 2-45. Format of the Long Octet String Type.....	2-51
663	Figure 2-46. Format of the Long Character String Type.....	2-52
664	Figure 2-47. Format of the Time of Day Type .....	2-53
665	Figure 2-48. Format of the Date Type.....	2-54
666	Figure 3-1. Typical Usage of Device Configuration and Installation Clusters.....	3-2
667	Figure 3-2. Typical Usage of On/Off and Level Clusters.....	3-3
668	Figure 3-3. Typical Usage of the Alarms Cluster.....	3-3
669	Figure 3-4. Typical Usage of the Location Cluster with Centralized Device.....	3-4
670	Figure 3-5. Example Usage of the Input, Output and Value Clusters .....	3-5
671	Figure 3-6. Format of the <i>ProductCode</i> attribute .....	3-11

672	Figure 3-7. Format of Identify Query Response Command Payload.....	3-32
673	Figure 3-8. Format of the Trigger Effect Command.....	3-32
674	Figure 3-9. Format of Identify Query Response Command Payload.....	3-34
675	Figure 3-10. Format of the Add Group Command Payload .....	3-37
676	Figure 3-11. Format of the View Group Command Payload.....	3-38
677	Figure 3-12. Format of Get Group Membership Command Payload .....	3-39
678	Figure 3-13. Format of the Remove Group Command Payload .....	3-39
679	Figure 3-14. Add Group If Identifying Command Payload.....	3-40
680	Figure 3-15. Format of the Add Group Response Command Payload .....	3-42
681	Figure 3-16. Format of the View Group Response Command Payload.....	3-42
682	Figure 3-17. Format of the Get Group Membership Response Command Payload .....	3-43
683	Figure 3-18. Format of Remove Group Response Command Payload.....	3-43
684	Figure 3-19. Format of the Add Scene Command Payload .....	3-48
685	Figure 3-20. Format of the View Scene Command Payload .....	3-49
686	Figure 3-21. Format of the Remove Scene Command Payload.....	3-49
687	Figure 3-22. Format of the Remove All Scenes Command Payload .....	3-50
688	Figure 3-23. Format of the Store Scene Command Payload.....	3-51
689	Figure 3-24. Format of the Recall Scene Command Payload.....	3-52
690	Figure 3-25. Format of Get Scene Membership Command Payload .....	3-53
691	Figure 3-26. Format of the Copy Scene Command .....	3-55
692	Figure 3-27. Format of the Mode Field of the Copy Scene Command.....	3-55
693	Figure 3-28. Format of the Add Scene Response Command Payload.....	3-57
694	Figure 3-29. Format of the View Scene Response Command Payload .....	3-57
695	Figure 3-30. Format of Remove Scene Response Command Payload .....	3-58
696	Figure 3-31. Format of the Remove All Scenes Response Command Payload .....	3-58
697	Figure 3-32. Format of the Store Scene Response Command Payload .....	3-59
698	Figure 3-33. Format of the Get Scene Membership Response CommandPayload .....	3-59
699	Figure 3-34. Format of the Copy Scene Response Command .....	3-60
700	Figure 3-35. State Behavior of Store and Recall Global Scene .....	3-63
701	Figure 3-36. Format of the Off With Effect Command .....	3-65
702	Figure 3-37. Format of the On With Timed Off Command.....	3-67
703	Figure 3-38. Format of the On/Off Control Field of the On With Timed Off Command.....	3-67
704	Figure 3-39. On/Off Cluster Operation State Machine.....	3-68
705	Figure 3-40. Format of the Move to Level Command Payload .....	3-77
706	Figure 3-41. Format of the Move Command Payload .....	3-78
707	Figure 3-42. Format of the Step Command Payload .....	3-79
708	Figure 3-43. Format of the Command Payload .....	3-80
709	Figure 3-44. Format of the Command Payload .....	3-81
710	Figure 3-45. Format of the Reset Alarm Command Payload.....	3-84
711	Figure 3-46. Format of the Alarm Command Payload .....	3-85
712	Figure 3-47. Format of the Get Alarm Response Command Payload .....	3-85
713	Figure 3-48. Example of Usage of RSSI Location Cluster.....	3-91
714	Figure 3-49. Format of the Set Absolute Location Command Payload .....	3-96
715	Figure 3-50. Format of the Set Device Configuration Payload .....	3-96
716	Figure 3-51. Format of the Get Device Configuration Payload.....	3-97
717	Figure 3-52. Format of the Get Location Data Payload.....	3-98
718	Figure 3-53. Format of the RSSI Response Command Payload.....	3-99
719	Figure 3-54. Format of the Send Pings Command Payload.....	3-100
720	Figure 3-55. Format of the Anchor Node Announce Command Payload.....	3-100
721	Figure 3-56. Format of the Device Configuration Response Payload .....	3-101
722	Figure 3-57. Format of the Location Data Response Payload .....	3-102
723	Figure 3-58. Format of the Location Data Notification Payload .....	3-103
724	Figure 3-59. Format of the RSSI Ping Command Payload.....	3-103
725	Figure 3-60. Format of the Report RSSI Measurements Command Payload.....	3-104
726	Figure 3-61. Neighbor Info Structure .....	3-104
727	Figure 3-62. Format of the Request Own Location Command Payload .....	3-105

728	Figure 3-63. Format of the Check-in Response Payload.....	3-167
729	Figure 3-64. Format of the Set Long Poll Interval Command Payload.....	3-168
730	Figure 3-65. Format of the Set Short Poll Interval Command Payload.....	3-168
731	Figure 3-66. Poll Control Cluster Sequence Diagram.....	3-169
732	Figure 3-67. Typical Usage of the Power Profile Cluster.....	3-171
733	Figure 3-68. Format of the <i>PowerProfileRequest</i> Command Payload.....	3-174
734	Figure 3-69. Format of the <i>GetPowerProfilePriceResponse</i> Command.....	3-175
735	Figure 3-70. Format of the <i>GetOverallSchedulePriceResponse</i> Command.....	3-176
736	Figure 3-71. Format of the <i>EnergyPhasesScheduleNotification</i> Command Payload.....	3-177
737	Figure 3-72. Format of the <i>PowerProfileNotification</i> Command Payload (1 of 2).....	3-182
738	Figure 3-73. Format of the <i>PowerProfileStateResponse</i> Command Frame.....	3-184
739	Figure 3-74. Format of the Power Profile Record Field.....	3-185
740	Figure 3-75. Power Profile States.....	3-186
741	Figure 3-76. Power Profile State Diagram.....	3-186
742	Figure 3-77. Format of <i>EnergyPhasesScheduleStateResponse</i> in Case of No Scheduled Phases.....	3-189
743	Figure 3-78. Format of the <i>PowerProfileScheduleConstraintsNotification</i> Command Frame.....	3-190
744	Figure 3-79. Format of the <i>GetPowerProfilePriceExtended</i> Command Payload.....	3-191
745	Figure 3-80. Visualization of Price Associated to a Power Profile.....	3-193
746	Figure 3-81. Energy Remote Disabled: Example of Sequence Diagram with User Interaction.....	3-194
747	Figure 3-82. Energy Remote Enabled: Example of Sequence Diagram with User Interaction.....	3-195
748	Figure 4-1. Typical Usage of Illuminance Measurement and Level Sensing Clusters.....	4-2
749	Figure 4-2. Typical Usage of Temperature, Pressure and Flow Measurement Clusters.....	4-3
750	Figure 4-3. Typical Usage of Occupancy Sensing Cluster.....	4-4
751	Figure 4-4. The DC Overload Alarm Mask.....	4-36
752	Figure 4-5. The <i>ACAlarmsMask</i> Attribute.....	4-37
753	Figure 4-6. Format of the Get Profile Info Response Command.....	4-44
754	Figure 4-7. <i>ProfileIntervalPeriod</i> .....	4-45
755	Figure 4-8. Format of the Get Measurement Profile Response Command.....	4-45
756	Figure 4-9. Format of the Get Measurement Profile Command.....	4-47
757	Figure 5-1. Typical Usage of Ballast Configuration and Color Control Clusters.....	5-2
758	Figure 5-2. Format of the Move to Hue Command Payload.....	5-16
759	Figure 5-3. Format of the Move Hue Command Payload.....	5-17
760	Figure 5-4. Format of the Step Hue Command Payload.....	5-19
761	Figure 5-5. Format of the Move to Saturation Command Payload.....	5-20
762	Figure 5-6. Format of the Move Saturation Command Payload.....	5-20
763	Figure 5-7. Format of the Step Saturation Command Payload.....	5-22
764	Figure 5-8. Move to Hue and Saturation Command Payload.....	5-23
765	Figure 5-9. Format of the Move to Color Command Payload.....	5-23
766	Figure 5-10. Format of the Move Color Command Payload.....	5-24
767	Figure 5-11. Format of the Step Color Command Payload.....	5-25
768	Figure 5-12. Move to Color Temperature Command Payload.....	5-25
769	Figure 5-13. Format of the Enhanced Move to Hue Command.....	5-26
770	Figure 5-14. Format of the Enhanced Move Hue Command.....	5-27
771	Figure 5-15. Format of the Enhanced Step Hue Command.....	5-28
772	Figure 5-16. Format of the Enhanced Move to Hue and Saturation Command.....	5-29
773	Figure 5-17. Format of the Color Loop Set Command.....	5-30
774	Figure 5-18. Format of the Update Flags Field of the Color Loop Set Command.....	5-30
775	Figure 5-19. Format of the Stop Move Step Command Payload.....	5-32
776	Figure 5-20. Format of the Move Color Temperature Command.....	5-33
777	Figure 5-21. Format of the Step Color Temperature Command.....	5-34
778	Figure 6-1. Typical Usage of Pump Configuration and Control Cluster.....	6-2
779	Figure 6-2. Example Usage of the Thermostat and Related Clusters.....	6-2
780	Figure 6-3. Priority Scheme of Pump Operation and Control.....	6-10
781	Figure 6-4. Format of the Setpoint Raise/Lower Command Payload.....	6-30
782	Figure 6-5. Set Weekly Schedule Command Payload Format (1 of 2).....	6-31
783	Figure 6-6. Set Weekly Schedule Command Payload Format (2 of 2).....	6-31

784	Figure 6-7. Set Heat Weekly Schedule Command Payload Format (1 of 2) .....	6-32
785	Figure 6-8. Set Heat Weekly Schedule Command Payload Format (2 of 2) .....	6-32
786	Figure 6-9. Set Cool Weekly Schedule Command Payload Format (1 of 2) .....	6-33
787	Figure 6-10. Set Cool Weekly Schedule Command Payload Format (2 of 2) .....	6-33
788	Figure 6-11. Set Heat & Cool Weekly Schedule Command Payload Format (1 of 2) .....	6-33
789	Figure 6-12. Set Heat & Cool Weekly Schedule Command Payload Format (2 of 2) .....	6-33
790	Figure 6-13. Format of the Get Weekly Schedule Command Payload .....	6-34
791	Figure 6-14. Format of the Relay Status Log Payload .....	6-36
792	Figure 7-1. Typical Usage of the Closures Clusters .....	7-2
793	Figure 7-2. Format of the Alarm Cluster .....	7-6
794	Figure 7-3. Format of the Lock Door Command .....	7-21
795	Figure 7-4. Format of the Unlock Door Command .....	7-21
796	Figure 7-5. Format of the Toggle Command .....	7-21
797	Figure 7-6. Format of the Unlock with Timeout Command .....	7-22
798	Figure 7-7. Format of the Get Log Record Command .....	7-22
799	Figure 7-8. Format of the Set PIN Code Command .....	7-23
800	Figure 7-9. Format of the Get PIN Code Command .....	7-24
801	Figure 7-10. Format of the Clear PIN Code Command .....	7-24
802	Figure 7-11. Format of the Set User Status Command .....	7-24
803	Figure 7-12. Format of the Get User Status Command .....	7-25
804	Figure 7-13. Format of the Set Week Day Schedule Command .....	7-25
805	Figure 7-14. Format of Days Mask Bits .....	7-25
806	Figure 7-15. Format of the Get Week Day Schedule Command .....	7-26
807	Figure 7-16. Format of the Clear Week Day Schedule Command .....	7-26
808	Figure 7-17. Format of the Set Year Day Schedule Command .....	7-26
809	Figure 7-18. Format of the Get Year Day Schedule Command .....	7-27
810	Figure 7-19. Format of the Clear Year Day Schedule Command .....	7-27
811	Figure 7-20. Format of the Set Holiday Schedule Command .....	7-27
812	Figure 7-21. Format of the Get Holiday Schedule Command .....	7-28
813	Figure 7-22. Format of the Clear Holiday Schedule Command .....	7-28
814	Figure 7-23. Format of the Set User Type Command .....	7-28
815	Figure 7-24. Format of the Get User Type Command .....	7-28
816	Figure 7-25. Format of the Set RFID Code Command .....	7-29
817	Figure 7-26. Format of the Get RFID Code Command .....	7-29
818	Figure 7-27. Format of the Clear RFID Code Command .....	7-30
819	Figure 7-28. Format of the Lock Door Response Command Payload .....	7-32
820	Figure 7-29. Format of the Unlock Door Response Command Payload .....	7-32
821	Figure 7-30. Format of the Get Log Record Response Command .....	7-33
822	Figure 7-31. Format of the Set PIN Code Response Command .....	7-34
823	Figure 7-32. Format of the Get PIN Code Response Command .....	7-34
824	Figure 7-33. Format of the Clear PIN Code Response Command .....	7-34
825	Figure 7-34. Format of the Clear All PIN Codes Response Command .....	7-35
826	Figure 7-35. Format of the Set User Status Response Command .....	7-35
827	Figure 7-36. Format of the Get User Status Response Command .....	7-35
828	Figure 7-37. Format of the Set Week Day Schedule Response Command .....	7-36
829	Figure 7-38. Format of the Get Week Day Schedule Response Command .....	7-36
830	Figure 7-39. Format of Days Mask Bits .....	7-36
831	Figure 7-40. Format of the Clear Week Day Schedule ID Response Command .....	7-37
832	Figure 7-41. Format of the Set Year Day Schedule Response Command .....	7-37
833	Figure 7-42. Format of the Get Year Day Schedule Response Command .....	7-38
834	Figure 7-43. Format of the Clear Year Day Schedule Response Command .....	7-38
835	Figure 7-44. Format of the Set Holiday Schedule Response Command .....	7-39
836	Figure 7-45. Format of the Get Holiday Schedule Response Command .....	7-39
837	Figure 7-46. Format of the Clear Holiday Schedule Response Command .....	7-40
838	Figure 7-47. Format of the Set User Type Response Command .....	7-40
839	Figure 7-48. Format of the Get User Type Response Command .....	7-40

840	Figure 7-49. Format of the Set RFID Code Response Command .....	7-41
841	Figure 7-50. Format of the Get RFID Code Response Command.....	7-41
842	Figure 7-51. Format of the Clear RFID Code Response Command.....	7-41
843	Figure 7-52. Format of the Clear All RFID Codes Response Command .....	7-42
844	Figure 7-53. Format of the Operation Event Notification Command.....	7-42
845	Figure 7-54. Format of the Programming Event Notification Command.....	7-46
846	Figure 7-55. Format of the Go To Lift Value Command .....	7-57
847	Figure 7-56. Format of the Go To Lift Percentage Command .....	7-57
848	Figure 7-57. Format of the Go To Tilt Value Command .....	7-58
849	Figure 7-58. Format of the Go To Lift Percentage Command .....	7-58
850	Figure 7-59. Format of the Go To Percent Command.....	7-63
851	Figure 8-1. Typical Usage of the IAS Clusters.....	8-2
852	Figure 8-2. Format of the Zone Enroll Response Command Payload.....	8-9
853	Figure 8-3. Payload format of Initiate Test Mode command .....	8-10
854	Figure 8-4. Format of the Zone Status Change Notification Command Payload.....	8-12
855	Figure 8-5. Format of the Zone Enroll Request Command Payload .....	8-12
856	Figure 8-6. Format of the Arm Command Payload.....	8-15
857	Figure 8-7. Format of the Bypass Command Payload.....	8-16
858	Figure 8-8. Format of the Get Zone Information Command Payload .....	8-17
859	Figure 8-9. Format of the Get Zone Status command .....	8-18
860	Figure 8-10. Format of the Arm Response Command Payload.....	8-19
861	Figure 8-11. Get Zone ID Map Response Command Payload .....	8-20
862	Figure 8-12. Format of the Get Zone Information Response Command Payload .....	8-20
863	Figure 8-13. Format of the Zone Status Changed Command Payload .....	8-21
864	Figure 8-14. Audible Notification field value .....	8-21
865	Figure 8-15. Format of the Panel Status Changed Command Payload.....	8-22
866	Figure 8-16. Alarm Status field value .....	8-23
867	Figure 8-17. Get Panel Status Response command.....	8-24
868	Figure 8-18. Set Bypassed Zone List Command payload format.....	8-25
869	Figure 8-19. Bypass Response command format .....	8-25
870	Figure 8-20. Format of the Get Zone Status Response command .....	8-26
871	Figure 8-21. Format of the Command Payload .....	8-29
872	Figure 8-22. Format of the Command Payload .....	8-31
873	Figure 9-1. Format of Match Protocol Address Command Payload .....	9-5
874	Figure 9-2. Match Protocol Address Response Command Payload .....	9-5
875	Figure 9-3. Advertise Protocol Address Command Payload.....	9-6
876	Figure 9-4. Format of the Transfer NPDU Command Payload.....	9-8
877	Figure 9-5. Format of the Transfer APDU command.....	9-42
878	Figure 9-6. Typical Usage of the Partition Cluster.....	9-45
879	Figure 9-7. Client and Server in Partition Cluster .....	9-46
880	Figure 9-8. Format of the <i>TransferPartitionedFrame</i> Command.....	9-50
881	Figure 9-9. Format of the <i>FragmentationOptions</i> Field.....	9-50
882	Figure 9-10. <i>ReadHandshakeParam</i> Frame .....	9-51
883	Figure 9-11. <i>WriteHandshakeParam</i> Frame .....	9-51
884	Figure 9-12. Format of Write Attribute Record Field .....	9-51
885	Figure 9-13. Format of the <i>MultipleACK</i> Command.....	9-52
886	Figure 9-14. Format of the <i>ACK Options</i> Field.....	9-52
887	Figure 9-15. <i>ReadHandshakeParamResponse</i> Frame .....	9-53
888	Figure 9-16. Format of Read Attribute Status Record Field.....	9-53
889	Figure 9-17. Example of Partition Cluster Use .....	9-54
890	Figure 9-18 Typical Usage of the 11073 Protocol Tunnel cluster.....	9-55
891	Figure 9-19 – Transfer APDU payload .....	9-59
892	Figure 9-20 – Connect Request command payload.....	9-59
893	Figure 9-21 – Connect control field format.....	9-59
894	Figure 9-22 – Disconnect Request command payload .....	9-60
895	Figure 9-23 – Connect Status Notification command payload.....	9-61

896	Figure 10-1. Price Cluster Client Server Example .....	10-2
897	Figure 10-2. Single Threshold Set applied to All Consumption.....	10-14
898	Figure 10-3. Threshold Set applied to Each Tier Consumption.....	10-14
899	Figure 10-4. The Format of the <i>Get Current Price</i> Command Payload.....	10-24
900	Figure 10-5. <i>Get Current Price</i> Command Options Field .....	10-25
901	Figure 10-6. Format of the <i>Get Scheduled Prices</i> Command Payload .....	10-25
902	Figure 10-7. Format of the <i>Price Acknowledgement</i> Command Payload.....	10-26
903	Figure 10-8. Format of the <i>Get Block Period(s)</i> Command Payload.....	10-27
904	Figure 10-9. Format of the <i>GetConversionFactor</i> Command Payload.....	10-28
905	Figure 10-10. Format of the <i>GetCalorificValue</i> Command Payload.....	10-28
906	Figure 10-11. Format of the <i>GetTariffInformation</i> Command Payload.....	10-29
907	Figure 10-12. Format of the <i>GetPriceMatrix</i> Command Payload.....	10-30
908	Figure 10-13. Format of the <i>GetBlockThresholds</i> Command Payload.....	10-30
909	Figure 10-14. Format of the <i>GetCO<sub>2</sub>Value</i> Command Payload.....	10-31
910	Figure 10-15. Format of the <i>GetTierLabels</i> Command Payload.....	10-31
911	Figure 10-16. Format of the <i>GetBillingPeriod</i> Command Payload .....	10-32
912	Figure 10-17. Format of the <i>GetConsolidatedBill</i> Command Payload.....	10-33
913	Figure 10-18. Format of the <i>CPPEventResponse</i> Command Payload .....	10-33
914	Figure 10-19. Format of the <i>GetCreditPayment</i> Command Payload.....	10-34
915	Figure 10-20. Format of the <i>Publish Price</i> Command Payload .....	10-36
916	Figure 10-21. Format of the <i>Publish Block Period</i> Command Payload.....	10-45
917	Figure 10-22. Format of the <i>PublishConversionFactor</i> Command Payload .....	10-47
918	Figure 10-23. Format of the <i>PublishCalorificValue</i> Command Payload.....	10-48
919	Figure 10-24. Format of the <i>PublishTariffInformation</i> Command Payload.....	10-48
920	Figure 10-25. Format of the <i>PublishPriceMatrix</i> Command Payload .....	10-51
921	Figure 10-26. Format of the <i>PriceMatrix</i> Command Sub-Payload.....	10-51
922	Figure 10-27. Format of the <i>PublishBlockThresholds</i> Command Payload.....	10-52
923	Figure 10-28. Format of the <i>BlockThreshold</i> Command Sub-Payload.....	10-53
924	Figure 10-29. Format of the <i>PublishCO<sub>2</sub>Value</i> Command Payload .....	10-54
925	Figure 10-30. Format of the <i>PublishTierLabels</i> Command Payload .....	10-55
926	Figure 10-31. Format of the <i>PublishBillingPeriod</i> Command Payload.....	10-56
927	Figure 10-32. Format of the <i>PublishConsolidatedBill</i> Command Payload.....	10-57
928	Figure 10-33. Format of the <i>PublishCPPEvent</i> Command Payload.....	10-58
929	Figure 10-34. CPP Event Flow .....	10-60
930	Figure 10-35. Format of the <i>PublishCreditPayment</i> Command Payload .....	10-60
931	Figure 10-36. Format of the <i>PublishCurrencyConversion</i> Command Payload .....	10-61
932	Figure 10-37. Format of the <i>CancelTariff</i> Command Payload .....	10-63
933	Figure 10-38. Demand Response/Load Control Cluster Client Server Example.....	10-68
934	Figure 10-39. Format of the <i>Load Control Event</i> Command Payload .....	10-70
935	Figure 10-40. Format of the <i>Cancel Load Control Event</i> Payload .....	10-75
936	Figure 10-41. Format of the <i>Report Event Status</i> Command Payload .....	10-80
937	Figure 10-42. Format of the <i>Get Scheduled Events</i> Command Payload .....	10-83
938	Figure 10-43. Example of Both a Successful and an Overridden Load Curtailment Event .....	10-86
939	Figure 10-44. Example of a Load Curtailment Superseded and Another Cancelled.....	10-87
940	Figure 10-45. Smart Energy Device Class Reference Example .....	10-90
941	Figure 10-46. Correctly Overlapping Events .....	10-90
942	Figure 10-47. Correct Superseding of Events .....	10-91
943	Figure 10-48. Superseded Event for a Subset of Device Classes.....	10-92
944	Figure 10-49. Ending Randomization Between Events .....	10-92
945	Figure 10-50. Start Randomization Between Events .....	10-93
946	Figure 10-51. Acceptable Gaps with Start and Stop Randomization .....	10-94
947	Figure 10-52. Standalone ESI Model with Mains Powered Metering Device .....	10-95
948	Figure 10-53. Standalone ESI Model with Battery Powered Metering Device .....	10-96
949	Figure 10-54. ESI Model with Integrated Metering Device .....	10-97
950	Figure 10-55. Format of the <i>Get Profile Response</i> Command Payload .....	10-157
951	Figure 10-56. Format of the <i>Request Fast Poll Mode Response</i> Command Payload.....	10-159



952	Figure 10-57. Format of the <i>ScheduleSnapshotResponse</i> Command Payload .....	10-160
953	Figure 10-58. Format of the Snapshot Response Payload Sub-Payload.....	10-160
954	Figure 10-59. Format of the <i>TakeSnapshotResponse</i> Command Payload .....	10-161
955	Figure 10-60. Format of the <i>Publish Snapshot</i> Command Payload.....	10-161
956	Figure 10-61. Snapshot Utilizing Multiple Commands.....	10-163
957	Figure 10-62. TOU Information Delivered Snapshot Sub-Payload .....	10-164
958	Figure 10-63. TOU Information Received Snapshot Sub-Payload .....	10-164
959	Figure 10-64. Block Information Delivered Snapshot Sub-Payload .....	10-165
960	Figure 10-65. Block Information Received Snapshot Sub-Payload .....	10-166
961	Figure 10-66. TOU Information Delivered (No Billing) Snapshot Sub-Payload.....	10-167
962	Figure 10-67. TOU Information Received (No Billing) Snapshot Sub-Payload.....	10-168
963	Figure 10-68. Block Information Delivered (No Billing) Snapshot Sub-Payload.....	10-168
964	Figure 10-69. Block Information Received (No Billing) Snapshot Sub-Payload.....	10-169
965	Figure 10-70. Format of the <i>GetSampledDataResponse</i> Command Payload .....	10-170
966	Figure 10-71. Format of the <i>ConfigureMirror</i> Command Payload .....	10-171
967	Figure 10-72. <i>MirrorReportAttributeResponse</i> Command Enabled.....	10-172
968	Figure 10-73. <i>MirrorReportAttributeResponse</i> Command Disabled.....	10-173
969	Figure 10-74. <i>NotificationScheme</i> Enumerations .....	10-173
970	Figure 10-75. Format of the <i>ConfigureNotificationScheme</i> Command Payload .....	10-174
971	Figure 10-76. Format of the <i>ConfigureNotificationFlags</i> Command Payload .....	10-175
972	Figure 10-77. Format of the <i>Bit Field Allocation</i> Command Sub Payload .....	10-176
973	Figure 10-78. Format of the <i>GetNotifiedMessage</i> Command Payload.....	10-176
974	Figure 10-79. Format of the <i>Supply Status Response</i> Command Payload.....	10-177
975	Figure 10-80. Format of the <i>StartSamplingResponse</i> Command Payload .....	10-178
976	Figure 10-81. Format of the <i>Get Profile</i> Command Payload.....	10-184
977	Figure 10-82. Format of the <i>Request Mirror Response</i> Command Payload.....	10-185
978	Figure 10-83. Format of the <i>Mirror Removed</i> Command Payload.....	10-185
979	Figure 10-84. Format of the <i>Request Fast Poll Mode</i> Command Payload .....	10-186
980	Figure 10-85. Format of the <i>ScheduleSnapshot</i> Command Payload .....	10-186
981	Figure 10-86. <i>SnapshotSchedulePayload</i> Format.....	10-187
982	Figure 10-87. Format of the <i>TakeSnapshot</i> Command Payload.....	10-187
983	Figure 10-88. Format of the <i>GetSnapshot</i> Command Payload.....	10-188
984	Figure 10-89. Format of the <i>StartSampling</i> Command Payload .....	10-189
985	Figure 10-90. Format of the <i>GetSampledData</i> Command Payload.....	10-190
986	Figure 10-91. Format of the <i>MirrorReportAttributeResponse</i> Command Payload .....	10-190
987	Figure 10-92. Format of the <i>ResetLoadLimitCounter</i> Command Payload .....	10-191
988	Figure 10-93. Format of the <i>Change Supply</i> Command Payload .....	10-191
989	Figure 10-94. Format of the <i>Local Change Supply</i> Command Payload.....	10-193
990	Figure 10-95. Format of the <i>SetSupplyStatus</i> Command Payload.....	10-194
991	Figure 10-96. Format of the <i>SetUncontrolledFlowThreshold</i> Command Payload.....	10-195
992	Figure 10-97. Example of Data flow from IHD to Gas meter .....	10-199
993	Figure 10-98. Messaging Cluster Client/Server Example .....	10-204
994	Figure 10-99. Format of the <i>Display Message</i> Command Payload .....	10-206
995	Figure 10-100. Format of the <i>Cancel Message</i> Command Payload .....	10-208
996	Figure 10-101. Format of the <i>Cancel All Messages</i> Command Payload.....	10-208
997	Figure 10-102. Format of the <i>Message Confirmation</i> Command Payload.....	10-210
998	Figure 10-103. Format of the <i>GetMessageCancellation</i> Command Payload .....	10-210
999	Figure 10-104. Client/Server Message Command Exchanges .....	10-212
1000	Figure 10-105. A Client Requests a Tunnel from a Server to Exchange Complex Data in Both Directions 10-	
1001	213	
1002	Figure 10-106. SE Device 1 (Client) Requests a Tunnel from SE Device 2 (Server) to Transfer Data	
1003	Without Flow Control (Default).....	10-214
1004	Figure 10-107. SE Device 1 (Client) Requests a Tunnel from SE Device 2 (Server) to Transfer Data with	
1005	Flow Control.....	10-215
1006	Figure 10-108. Format of the <i>RequestTunnel</i> Command Payload.....	10-217
1007	Figure 10-109. Format of the <i>CloseTunnel</i> Command Payload .....	10-218

1008	Figure 10-110. Format of the <i>TransferData</i> Command Payload.....	10-219
1009	Figure 10-111. Format of the <i>TransferDataError</i> Command Payload.....	10-220
1010	Figure 10-112. Format of the <i>AckTransferData</i> Command Payload.....	10-221
1011	Figure 10-113. Format of the <i>ReadyData</i> Command Payload.....	10-222
1012	Figure 10-114. Format of the <i>Get Supported Tunnel Protocols</i> Command Payload.....	10-222
1013	Figure 10-115. Format of the <i>RequestTunnelResponse</i> Command Payload.....	10-223
1014	Figure 10-116. Format of the <i>TransferData</i> Command Payload.....	10-224
1015	Figure 10-117. Format of the <i>Supported Tunnel Protocols Response</i> Command Payload.....	10-225
1016	Figure 10-118. Format of the Supported Tunnel Protocols Response Command Protocol Fields.....	10-225
1017	Figure 10-119. Format of the <i>TunnelClosureNotification</i> Command Payload.....	10-226
1018	Figure 10-120. Overview of General Exchange.....	10-229
1019	Figure 10-121. Typical Usage of the Key Establishment Cluster.....	10-231
1020	Figure 10-122. Key Establishment Command Exchange.....	10-232
1021	Figure 10-123. <i>Initiate Key Establishment Request</i> Command Payload.....	10-235
1022	Figure 10-124. <i>Ephemeral Data Request</i> Command Payload.....	10-236
1023	Figure 10-125. <i>Confirm Key Request</i> Command Payload.....	10-236
1024	Figure 10-126. <i>Terminate Key Establishment</i> Command Payload.....	10-237
1025	Figure 10-127. <i>Initiate Key Establishment Response</i> Command Payload.....	10-239
1026	Figure 10-128. <i>Ephemeral Data Response</i> Command Payload.....	10-241
1027	Figure 10-129. <i>Confirm Key Response</i> Command Payload.....	10-241
1028	Figure 10-130. <i>Terminate Key Establishment</i> Command Payload.....	10-242
1029	Figure 10-131. Key Establishment Command Exchange.....	10-254
1030	Figure 10-132. Key Establishment Command Exchange.....	10-265
1031	Figure 10-133. Prepayment Cluster Client Server Example.....	10-275
1032	Figure 10-134. Format of the <i>Select Available Emergency Credit</i> Command Payload.....	10-297
1033	Figure 10-135. Format of the <i>Change Debt</i> Command Payload.....	10-297
1034	Figure 10-136. Format of the <i>Emergency Credit Setup</i> Command Payload.....	10-299
1035	Figure 10-137. Format of the <i>Consumer Top Up</i> Command Payload.....	10-300
1036	Figure 10-138. Format of the <i>Credit Adjustment</i> Command Payload.....	10-300
1037	Figure 10-139. Format of the <i>Change Payment Mode</i> Command Payload.....	10-301
1038	Figure 10-140. Format of the <i>Get Prepay Snapshot</i> Command Payload.....	10-302
1039	Figure 10-141. Format of the <i>Get Top Up Log</i> Command Payload.....	10-303
1040	Figure 10-142. Format of the <i>Set Low Credit Warning Level</i> Command Payload.....	10-304
1041	Figure 10-143. Format of the <i>GetDebtRepaymentLog</i> Command Payload.....	10-304
1042	Figure 10-144. Format of the <i>Set Maximum Credit Level</i> Command Payload.....	10-305
1043	Figure 10-145. Format of the <i>Set Overall Debt Cap</i> Command Payload.....	10-306
1044	Figure 10-146. Format of the <i>Publish Prepay Snapshot</i> Command Payload.....	10-307
1045	Figure 10-147. Format of the <i>Debt/Credit Status SnapshotPayloadType</i> .....	10-308
1046	Figure 10-148. Format of the <i>Change Payment Mode Response</i> Command Payload.....	10-309
1047	Figure 10-149. Format of the <i>Consumer Top Up Response</i> Command Payload.....	10-310
1048	Figure 10-150. Format of the <i>Publish Top Up Log</i> Command Payload.....	10-311
1049	Figure 10-151. Format of the Top Up Payload.....	10-312
1050	Figure 10-152. Format of the <i>Publish Debt Log</i> Command Payload.....	10-312
1051	Figure 10-153. Format of a Debt Payload Record.....	10-312
1052	Figure 10-154. Prepayment Credit Status Attribute Explained.....	10-314
1053	Figure 10-155. Calendar Cluster Client Server Example.....	10-316
1054	Figure 10-156. Recommended Calendar Command Sequence.....	10-318
1055	Figure 10-157. Format of the <i>PublishCalendar</i> Command Payload.....	10-320
1056	Figure 10-158. Format of the <i>PublishDayProfile</i> Command Payload.....	10-322
1057	Figure 10-159. Schedule Entries for Rate Start Times Command Sub-Payload.....	10-324
1058	Figure 10-160. Schedule Entries for Friendly Credit Start Times Command Sub-Payload.....	10-324
1059	Figure 10-161. Schedule Entries for Auxilliary Load Start Times Command Sub-Payload.....	10-324
1060	Figure 10-162. Format of the <i>PublishWeekProfile</i> Command Payload.....	10-325
1061	Figure 10-163. Format of the <i>PublishSeasons</i> Command Payload.....	10-326
1062	Figure 10-164. Format of the Season Entry Sub-Payload.....	10-327
1063	Figure 10-165. Format of the <i>PublishSpecialDays</i> Command Payload.....	10-327

1064	Figure 10-166. Format of the <i>SpecialDayEntry</i> Sub-Payload .....	10-329
1065	Figure 10-167. Format of the <i>CancelCalendar</i> Command Payload .....	10-329
1066	Figure 10-168. Format of the <i>GetCalendar</i> Command Payload .....	10-330
1067	Figure 10-169. Format of the <i>GetDayProfiles</i> Command Payload .....	10-331
1068	Figure 10-170. Format of the <i>GetWeekProfiles</i> Command Payload .....	10-331
1069	Figure 10-171. Format of the <i>GetSeasons</i> Command Payload.....	10-332
1070	Figure 10-172. Format of the <i>GetSpecialDays</i> Command Payload.....	10-332
1071	Figure 10-173. Device Management Cluster Client/Server Example .....	10-335
1072	Figure 10-174. Format of the <i>RequestNewPassword</i> Command Payload.....	10-342
1073	Figure 10-175. Format of the <i>Report Event Configuration</i> Command Payload.....	10-343
1074	Figure 10-176. Format of the <i>Event Configuration</i> Sub-Payload.....	10-343
1075	Figure 10-177. Format of the <i>Publish Change of Tenancy</i> Command Payload .....	10-344
1076	Figure 10-178. Format of the <i>Publish Change of Supplier</i> Command Payload .....	10-345
1077	Figure 10-179. Format of the <i>RequestNewPasswordResponse</i> Command Payload.....	10-346
1078	Figure 10-180. Format of the <i>Update SiteID</i> Command Payload .....	10-347
1079	Figure 10-181. Format of the <i>Set Event Configuration</i> Command Payload.....	10-348
1080	Figure 10-182. Format of the ‘Apply by List’ Sub-Payload.....	10-348
1081	Figure 10-183. Format of the ‘Apply by Event Group’ Sub-Payload .....	10-349
1082	Figure 10-184. Format of the ‘Apply by Log Type’ Sub-Payload .....	10-349
1083	Figure 10-185. Format of the ‘Apply by Configuration Match’ Sub-Payload .....	10-349
1084	Figure 10-186. Format of the <i>Get Event Configuration</i> Command Payload.....	10-349
1085	Figure 10-187. Format of the <i>Update CIN</i> Command Payload.....	10-350
1086	Figure 10-188. Event Cluster Client/Server Example .....	10-374
1087	Figure 10-189. Mirrored BOMD Event Cluster Client/Server Example.....	10-375
1088	Figure 10-190. Format of the <i>Get Event Log</i> Command Payload .....	10-377
1089	Figure 10-191. Format of the <i>Clear Event Log Request</i> Command Payload .....	10-378
1090	Figure 10-192. Format of the <i>Publish Event</i> Command Payload .....	10-379
1091	Figure 10-193. Format of the <i>Publish Event Log</i> Command Payload.....	10-380
1092	Figure 10-194. Format of the <i>Publish Event Log</i> Command Log Sub-Payload .....	10-380
1093	Figure 10-195. Format of the <i>Clear Event Log Response</i> Command Payload .....	10-381
1094	Figure 10-196. Sub-GHz Cluster Client/Server Example .....	10-383
1095	Figure 10-197. Format of the <i>Suspend Cluster Messages</i> Command Payload.....	10-387
1096	Figure 10-198. Typical Usage of the Meter Identification Cluster.....	10-389
1097	Figure 11-1. Typical Usage of OTA Upgrade Cluster .....	11-2
1098	Figure 11-2. Sample OTA File.....	11-6
1099	Figure 11-3. Sub-element Format.....	11-11
1100	Figure 11-4. ECDSA Signature .....	11-13
1101	Figure 11-5. ECDSA Signing Certificate Sub-element.....	11-13
1102	Figure 11-6. Hash Value Sub-element .....	11-13
1103	Figure 11-7. ECDSA Signature.....	11-14
1104	Figure 11-8. ECDSA Signing Certificate Sub-element.....	11-14
1105	Figure 11-9. OTA Upgrade Message Diagram .....	11-26
1106	Figure 11-10. Format of Image Notify Command Payload.....	11-29
1107	Figure 11-11. Format of Query Next Image Request Command Payload.....	11-31
1108	Figure 11-12. Format of Query Next Image Response Command Payload .....	11-33
1109	Figure 11-13. Format of Image Block Request Command Payload.....	11-35
1110	Figure 11-14. Image Page Request Command Payload .....	11-37
1111	Figure 11-15. Image Block Response Command Payload with SUCCESS status .....	11-41
1112	Figure 11-16. Image Block Response Command Payload with WAIT_FOR_DATA status .....	11-41
1113	Figure 11-17. Image Block Response Command Payload with ABORT status.....	11-42
1114	Figure 11-18. Format of Upgrade End Request Command Payload .....	11-45
1115	Figure 11-19. Format of Upgrade End Response Command Payload.....	11-47
1116	Figure 11-20. Format of Query Device Specific File Request Command Payload .....	11-49
1117	Figure 11-21. Format of Query Device Specific File Response Command Payload.....	11-50
1118	Figure 11-22. Rate Limiting Exchange .....	11-55
1119	Figure 12-1. Typical Content Data Structure .....	12-2

1120	Figure 12-2. Typical Usage of the Information Cluster .....	12-3
1121	Figure 12-3. Typical Usage of the Information Cluster – with Proxy Function .....	12-3
1122	Figure 12-4. An Example Sequence .....	12-5
1123	Figure 12-5. Preference Scenarios (Triggered by the Client or by the Server).....	12-6
1124	Figure 12-6. Payload Format of Request Information Command.....	12-9
1125	Figure 12-7. Payload Format for Request a Content by a Content ID .....	12-10
1126	Figure 12-8. Request Information Payload for Request Contents by Multiple IDs .....	12-10
1127	Figure 12-9. Request Information Payload for Request by Depth.....	12-11
1128	Figure 12-10. Payload Format of Push Information Response Command .....	12-11
1129	Figure 12-11. Payload Format for Send Preference Command .....	12-11
1130	Figure 12-12. Payload Format for Preference Is Multiple Content ID (0x0000).....	12-12
1131	Figure 12-13. Payload Format for Preference Is Multiple Octet Strings (0x0001).....	12-12
1132	Figure 12-14. Payload Format of Request Preference Response Command .....	12-13
1133	Figure 12-15. Payload Format for Update Command.....	12-13
1134	Figure 12-16. Format for Redirection Control Field .....	12-14
1135	Figure 12-17. An Example Sequence of Forwarding Case.....	12-15
1136	Figure 12-18. An Example Sequence of Redirecting Case.....	12-16
1137	Figure 12-19. Payload Format for Delete Command.....	12-16
1138	Figure 12-20. Format for Deletion Option Field .....	12-17
1139	Figure 12-21. Payload Format for Configure Node Description Command.....	12-17
1140	Figure 12-22. Payload Format for Configure Delivery Enable Command.....	12-18
1141	Figure 12-23. Payload Format for Configure Push Information Timer Command.....	12-18
1142	Figure 12-24. Payload Format for Configure Set Root ID Command.....	12-18
1143	Figure 12-25. Payload Format of Request Information Response Command .....	12-19
1144	Figure 12-26. Payload Format of Push Information Command.....	12-19
1145	Figure 12-27. Payload Format for Send Preference Response Command and Request Preference	
1146	Confirmation Command .....	12-20
1147	Figure 12-28. Payload Format of Update Response and Delete Response command .....	12-21
1148	Figure 12-29. Payload Format for Multiple Contents.....	12-22
1149	Figure 12-30. Format for Single Content.....	12-22
1150	Figure 12-31. Format for Title String .....	12-23
1151	Figure 12-32. Format for Long Octet String.....	12-23
1152	Figure 12-33. Format for Long Character String.....	12-23
1153	Figure 12-34. Format for RSS Feed.....	12-23
1154	Figure 12-35. Typical Usage of the Chatting Cluster .....	12-25
1155	Figure 12-36. Format of the Join Chat Request Command .....	12-28
1156	Figure 12-37. Format of the Leave Chat Request Command .....	12-28
1157	Figure 12-38. Format of the Switch Chairman Response Command .....	12-29
1158	Figure 12-39. Format of the Start Chat Request Command .....	12-29
1159	Figure 12-40. Format of the ChatMessage Command.....	12-30
1160	Figure 12-41. Format of the Get Node Information Request Command .....	12-30
1161	Figure 12-42. Format of an Item of the Chatting Table.....	12-30
1162	Figure 12-43. Format of the Start Chat Response Command .....	12-31
1163	Figure 12-44. Format of the Join Chat Response Command.....	12-32
1164	Figure 12-45. Format of the User Left Command .....	12-32
1165	Figure 12-46. Format of the User Joined Command .....	12-33
1166	Figure 12-47. Format of the Search Chat Response command.....	12-33
1167	Figure 12-48. Format of the Switch Chairman Request Command.....	12-34
1168	Figure 12-49. Format of the Switch Chairman Confirm Command .....	12-34
1169	Figure 12-50. Format of the <i>NodeInformation</i> Field .....	12-34
1170	Figure 12-51. Format of the Switch Chairman Notification Command .....	12-35
1171	Figure 12-52. Format of the Get Node Information Response Command.....	12-35
1172	Figure 12-53. Typical Usage of the VoZ Cluster .....	12-36
1173	Figure 12-54. Format of the OptionFlags Attribute.....	12-39
1174	Figure 12-55. Format of the Establishment Request Command.....	12-40
1175	Figure 12-56. Format of the Flag.....	12-40

1176	Figure 12-57. Format of the Voice Transmission Command .....	12-41
1177	Figure 12-58. Format of the Voice Transmission Completion Command .....	12-41
1178	Figure 12-59. Format of the Control Response Command.....	12-41
1179	Figure 12-60. Format of the Voice Transmission Response Command.....	12-42
1180	Figure 12-61. Format of the Establishment Response Command .....	12-43
1181	Figure 12-62. Format of the Control Command.....	12-44
1182	Figure 13-1. Format of the Restart Device Command Payload.....	13-12
1183	Figure 13-2. Format of the Options Field.....	13-12
1184	Figure 13-3. Format of Save Startup Parameters Command Payload .....	13-14
1185	Figure 13-4. Restore Startup Parameters Command Payload.....	13-14
1186	Figure 13-5. Format of Reset Startup Parameters Command Payload .....	13-15
1187	Figure 13-6. Format of the Options Field.....	13-15
1188	Figure 13-7. Format of Reset Startup Parameters Command Payload .....	13-16
1189	Figure 13-8. Format of the Scan Request Command Frame .....	13-21
1190	Figure 13-9. Format of the ZigBee Information Field.....	13-21
1191	Figure 13-10. Format of the Scan Request Touchlink Information Field.....	13-21
1192	Figure 13-11. Format of the Device Information Request Command Frame .....	13-22
1193	Figure 13-12. Format of the Identify Request Command Frame .....	13-23
1194	Figure 13-13. Format of the Reset to Factory New Request Command Frame.....	13-24
1195	Figure 13-14. Format of the Network Start Request Command Frame.....	13-24
1196	Figure 13-15. Format of the Network Join Router Request Command Frame .....	13-27
1197	Figure 13-16. Format of the Network Join End Device Request Command Frame .....	13-29
1198	Figure 13-17. Format of the Network Update Request Command Frame.....	13-31
1199	Figure 13-18. Format of the Get Group Identifiers Request Command.....	13-32
1200	Figure 13-19. Format of the Get Endpoint List Request Command.....	13-32
1201	Figure 13-20. Format of the Scan Response Command Frame .....	13-33
1202	Figure 13-21. Format of the ZigBee Information Field.....	13-34
1203	Figure 13-22. Format of the Scan Response Touchlink Information Field .....	13-34
1204	Figure 13-23. Format of the Device Information Response Command Frame .....	13-37
1205	Figure 13-24. Format of the Device Information Record Field.....	13-37
1206	Figure 13-25. Format of the Network Start Response Command Frame .....	13-39
1207	Figure 13-26. Format of the Network Join Router Response Command Frame .....	13-40
1208	Figure 13-27. Format of the Network Join End Device Response Command Frame.....	13-41
1209	Figure 13-28. Format of the Endpoint Information Command .....	13-42
1210	Figure 13-29. Format of the Get Group Identifiers Response Command.....	13-43
1211	Figure 13-30. Format of a Group Information Record Entry .....	13-43
1212	Figure 13-31. Format of the Get Endpoint List Response Command .....	13-44
1213	Figure 13-32. Format of an Endpoint Information Record Entry .....	13-44
1214	Figure 13-33. Format of the device information table.....	13-48
1215	Figure 13-34. General format of an inter-PAN frame .....	13-50
1216	Figure 13-35. Scope of a touchlink commissioning inter-PAN transaction .....	13-51
1217	Figure 13-36. Overview of Touchlink Security.....	13-55
1218	Figure 13-37. Steps Required to Encrypt/Decrypt the Network Key .....	13-59
1219	Figure 14-1. Typical Usage of the Retail Tunnel Cluster.....	14-2
1220	Figure 14-2. Format of the Transfer APDU Command.....	14-3
1221	Figure 14-3. Typical Usage of the Mobile Device Configuration Cluster.....	14-5
1222	Figure 14-4. Format of the Keep Alive Notification Command.....	14-6
1223	Figure 14-5. Typical Usage of the Neighbor Cleaning Cluster .....	14-8
1224	Figure 14-6. Typical Usage of the Nearest Gateway Cluster .....	14-10
1225	Figure 14-7. Sequence Diagram .....	14-12
1226	Figure 15-1. Typical Usage of the Appliance Control Cluster .....	15-2
1227	Figure 15-2. Format of the Execution of a Command Payload .....	15-4
1228	Figure 15-3. Format of the Write Functions Command Frame .....	15-6
1229	Figure 15-4. Format of the Write Functions Record Field .....	15-6
1230	Figure 15-5. Format of the Overload Warning Payload .....	15-7
1231	Figure 15-6. Format of the Signal State Response Command Payload.....	15-8

1232	Figure 15-7. Typical Usage of the Appliance Events and Alerts Cluster .....	15-16
1233	Figure 15-8. Format of the Get Alerts Response Command Payload.....	15-18
1234	Figure 15-9. Format of the Alerts Notification Command Payload.....	15-20
1235	Figure 15-10. Format of the Event Notification Command Payload .....	15-20
1236	Figure 15-11. Format of the Log Notification Payload .....	15-23
1237	Figure 15-12. Format of the Log Queue Response Payload .....	15-24
1238	Figure 15-13. Format of the Log Request Payload.....	15-25
1239	Figure 15-14. Appliance Statistics Cluster Sequence Diagram .....	15-27
1240		

## LIST OF TABLES

1241

1242	Table 1-1. Acronyms and Abbreviations.....	1-1
1243	Table 2-1. Global Attributes.....	2-6
1244	Table 2-2. <i>AttributeReportingStatus</i> Enumerations.....	2-7
1245	Table 2-3. Commands .....	2-10
1246	Table 2-4. Destination of Reporting Based on Direction Field .....	2-19
1247	Table 2-5. Valid Profile Identifier Values .....	2-43
1248	Table 2-6. Valid Device Identifier Values.....	2-43
1249	Table 2-7. Valid Cluster Identifier Values .....	2-43
1250	Table 2-8. Attribute Identifier Value Ranges .....	2-44
1251	Table 2-9. Command Identifier Value Ranges.....	2-44
1252	Table 2-10. Nomenclature for Data Value Range & Default .....	2-45
1253	Table 2-11. Data Types .....	2-46
1254	Table 2-12. Enumerated Command Status Values .....	2-55
1255	Table 3-1. Device Configuration and Installation Clusters .....	3-1
1256	Table 3-2. Groups and Scenes Clusters .....	3-2
1257	Table 3-3. On/Off and Level Control Clusters .....	3-2
1258	Table 3-4. Alarms Cluster .....	3-3
1259	Table 3-5. Other Clusters .....	3-4
1260	Table 3-6. Generic Clusters.....	3-4
1261	Table 3-7. Attributes of the Basic Cluster .....	3-7
1262	Table 3-8. Values of the <i>PowerSource</i> Attribute.....	3-8
1263	Table 3-9. Values of the <i>GenericDeviceClass</i> attribute .....	3-9
1264	Table 3-10. Values of the <i>GenericDeviceType</i> attribute for the lighting class .....	3-9
1265	Table 3-11. Values of the <i>CodeId</i> field of the <i>ProductCode</i> attribute.....	3-11
1266	Table 3-12. Values of the <i>PhysicalEnvironment</i> Attribute.....	3-12
1267	Table 3-13. Values of the <i>DeviceEnable</i> Attribute.....	3-15
1268	Table 3-14. Values of the <i>AlarmMask</i> Attribute .....	3-16
1269	Table 3-15. Values of the <i>DisableLocalConfig</i> Attribute.....	3-16
1270	Table 3-16. Received Command IDs for the Basic Cluster.....	3-16
1271	Table 3-17. Power Configuration Attribute Sets .....	3-18
1272	Table 3-18. Attributes of the Mains Information Attribute Set .....	3-18
1273	Table 3-19. Attributes of the Mains Settings Attribute Set .....	3-19
1274	Table 3-20. Values of the <i>MainsAlarmMask</i> Attribute .....	3-19
1275	Table 3-21. Attributes of the Battery Information Attribute Set .....	3-20
1276	Table 3-22. Attributes of the Battery Settings Attribute Set.....	3-21
1277	Table 3-23. Values of the <i>BatterySize</i> Attribute.....	3-22
1278	Table 3-24. Values of the <i>BatteryAlarmMask</i> Attribute.....	3-22
1279	Table 3-25. Alarm Code Field Enumerations for Battery Alarms.....	3-23
1280	Table 3-26. <i>BatteryAlarmState</i> Enumerations.....	3-25
1281	Table 3-27. Device Temperature Configuration Attribute Sets.....	3-27
1282	Table 3-28. Device Temperature Information Attribute Set.....	3-28
1283	Table 3-29. Device Temperature Settings Attribute Set.....	3-28
1284	Table 3-30. Values of the <i>DeviceTempAlarmMask</i> Attribute.....	3-29
1285	Table 3-31. Attributes of the Identify Server Cluster .....	3-31
1286	Table 3-32. Received Command IDs for the Identify Cluster .....	3-31
1287	Table 3-33. Values of the Effect Identifier Field of the Trigger Effect Command .....	3-33
1288	Table 3-34. Values of the Effect Variant Field of the Trigger Effect Command .....	3-33
1289	Table 3-35. Generated Command IDs for the Identify Cluster .....	3-33
1290	Table 3-36. Attributes of the Groups Server Cluster.....	3-36
1291	Table 3-37. Received Command IDs for the Groups Cluster.....	3-36
1292	Table 3-38. Generated Command IDs for the Groups Cluster .....	3-41
1293	Table 3-39. Scenes Attribute Sets .....	3-45
1294	Table 3-40. Scene Management Information Attribute Set.....	3-45
1295	Table 3-41. Fields of a Scene Table Entry .....	3-46

1296	Table 3-42. Received Command IDs for the Scenes Cluster.....	3-47
1297	Table 3-43. Generated Command IDs for the Scenes Cluster .....	3-56
1298	Table 3-44. Values of the Status Field of the Copy Scene Response Command.....	3-61
1299	Table 3-45. Attributes of the On/Off Server Cluster .....	3-62
1300	Table 3-46. Values of the <i>StartUpOnOff</i> Attribute.....	3-64
1301	Table 3-47. Command IDs for the On/Off Cluster .....	3-64
1302	Table 3-48. Values of the Effect Identifier Field of the Off With Effect Command .....	3-65
1303	Table 3-49. Values of the Effect Variant Field of the Off With Effect Command .....	3-66
1304	Table 3-50. On/Off Switch Configuration Attribute Sets .....	3-70
1305	Table 3-51. Attributes of the Switch Information Attribute Set .....	3-70
1306	Table 3-52. Values of the <i>SwitchType</i> Attribute.....	3-70
1307	Table 3-53. Attributes of the Switch Settings Attribute Set .....	3-71
1308	Table 3-54. Values of the <i>SwitchActions</i> Attribute.....	3-71
1309	Table 3-55. Actions on Receipt for On/Off Commands, when Associated with Level Control .....	3-73
1310	Table 3-56. Attributes of the Level Control Server Cluster.....	3-74
1311	Table 3-57. <i>Options</i> Attribute.....	3-75
1312	Table 3-58. Values of the <i>StartUpCurrentLevel</i> attribute.....	3-76
1313	Table 3-59. Command IDs for the Level Control Cluster .....	3-77
1314	Table 3-60. Values of the Move Mode Field.....	3-78
1315	Table 3-61. Actions on Receipt for Move Command.....	3-79
1316	Table 3-62. Values of the Step Mode Field .....	3-79
1317	Table 3-63. Actions on Receipt for Step Command .....	3-80
1318	Table 3-64. Alarms Cluster Attribute Sets.....	3-83
1319	Table 3-65. Attributes of the Alarm Information Attribute Set .....	3-83
1320	Table 3-66. Format of the Alarm Table .....	3-83
1321	Table 3-67. Received Command IDs for the Alarms Cluster .....	3-84
1322	Table 3-68. Generated Command IDs for the Alarms Cluster.....	3-85
1323	Table 3-69. Attributes of the Time Server Cluster .....	3-87
1324	Table 3-70. Bit Values of the <i>TimeStatus</i> Attribute.....	3-88
1325	Table 3-71. Location Attribute Sets.....	3-92
1326	Table 3-72. Attributes of the Location Information Attribute Set .....	3-92
1327	Table 3-73. Bit Values of the <i>LocationType</i> Attribute.....	3-93
1328	Table 3-74. Values of the <i>LocationMethod</i> Attribute .....	3-93
1329	Table 3-75. Attributes of the Location Settings Attribute Set .....	3-94
1330	Table 3-76. Received Command IDs for the Location Cluster.....	3-95
1331	Table 3-77. Generated Command IDs for the RSSI Location Cluster.....	3-101
1332	Table 3-78. Attributes of the Analog Input (Basic) Server Cluster .....	3-106
1333	Table 3-79. Attributes of the Analog Output (Basic) Server Cluster.....	3-108
1334	Table 3-80. Attributes of the Analog Value (Basic) Server Cluster .....	3-110
1335	Table 3-81. Attributes of the Binary Input (Basic) Server Cluster .....	3-111
1336	Table 3-82. Attributes of the Binary Output (Basic) Server Cluster.....	3-113
1337	Table 3-83. Attributes of the Binary Value (Basic) Server Cluster .....	3-114
1338	Table 3-84. Attributes of the Multistate Input (Basic) Server Cluster.....	3-116
1339	Table 3-85. Attributes of the Multistate Output (Basic) Server Cluster .....	3-118
1340	Table 3-86. Attributes of the Multistate Value (Basic) Server Cluster.....	3-119
1341	Table 3-87. AI Types, Type = 0x00: Temperature in Degrees C .....	3-124
1342	Table 3-88. AI Types, Type = 0x01: Relative Humidity in %.....	3-127
1343	Table 3-89. AI Types, Type = 0x02: Pressure in Pascal.....	3-127
1344	Table 3-90. AI Types, Type = 0x03: Flow in Liters/Second .....	3-129
1345	Table 3-91. AI Types, Type = 0x04: Percentage % .....	3-130
1346	Table 3-92. AI types, Type = 0x05: Parts per Million PPM.....	3-130
1347	Table 3-93. AI Types, Type = 0x06: Rotational Speed in RPM.....	3-130
1348	Table 3-94. AI Types, Type = 0x07: Current in Amps.....	3-131
1349	Table 3-95. AI Types, Type = 0x08: Frequency in Hz.....	3-131
1350	Table 3-96. AI Types, Type = 0x09: Power in Watts .....	3-131
1351	Table 3-97. AI Types, Type = 0x0A: Power in kW.....	3-131



1352	Table 3-98. AI Types, Type = 0x0B: Energy in kWh .....	3-132
1353	Table 3-99. AI Types, Type = 0x0C: Count - Unitless .....	3-132
1354	Table 3-100. AI Types, Type = 0x0D: Enthalpy in KJoules/Kg .....	3-132
1355	Table 3-101. AI types, Type = 0x0E: Time in Seconds .....	3-133
1356	Table 3-102. AO Types, Type = 0x00: Temperature in Degrees C.....	3-133
1357	Table 3-103. AO Types, Type = 0x01: Relative Humidity in % .....	3-134
1358	Table 3-104. AO Types, Type = 0x02: Pressure Pascal.....	3-134
1359	Table 3-105. AO Types, Type = 0x03: Flow in Liters/Second .....	3-134
1360	Table 3-106. AO Types, Type = 0x04: Percentage % .....	3-134
1361	Table 3-107. AO Types, Type = 0x05: Parts per Million PPM.....	3-136
1362	Table 3-108. AO Types, Type = 0x06: Rotational Speed RPM.....	3-137
1363	Table 3-109. AO Types, Type = 0x07: Current in Amps.....	3-137
1364	Table 3-110. AO Types, Type = 0x08: Frequency in Hz .....	3-137
1365	Table 3-111. AO Types, Type = 0x09: Power in Watts .....	3-137
1366	Table 3-112. AO Types, Type = 0x0A: Power in kW .....	3-138
1367	Table 3-113. AO Types, Type = 0x0B: Energy in kWh.....	3-138
1368	Table 3-114. AO Types, Type = 0x0C: Count - Unitless.....	3-138
1369	Table 3-115. AO Types, Type = 0x0D: Enthalpy in KJoules/Kg.....	3-138
1370	Table 3-116. AO Types, Type = 0x0E: Time in Seconds .....	3-138
1371	Table 3-117. AV Types, Type = 0x00: Temperature in Degrees C.....	3-139
1372	Table 3-118. AV Types, Type = 0x01: Area in Square Metres.....	3-140
1373	Table 3-119. AV Types, Type = 0x02: Multiplier - Number .....	3-140
1374	Table 3-120. AV Types, Type = 0x03: Flow in Litres/Second .....	3-140
1375	Table 3-121. BI Types, Type = 0x00: Application Domain HVAC.....	3-141
1376	Table 3-122. BI Types, Type = 0x01: Application Domain Security.....	3-147
1377	Table 3-123. BO Types, Type = 0x00: Application Domain HVAC .....	3-148
1378	Table 3-124. BO Types, Type = 0x02: Application Domain Security .....	3-153
1379	Table 3-125. BV Types, Type = 0x00.....	3-153
1380	Table 3-126. MI Types, Type = 0x00: Application Domain HVAC.....	3-153
1381	Table 3-127. MO Types, Type = 0x00: Application Domain HVAC .....	3-154
1382	Table 3-128. MV Types, Type = 0x00: Application Domain HVAC .....	3-155
1383	Table 3-129. Server Attribute Sets of the Diagnostics Cluster.....	3-157
1384	Table 3-130. Hardware Information Attribute Set .....	3-157
1385	Table 3-131. Stack / Network Information Attribute Set .....	3-158
1386	Table 3-132. Server Attributes .....	3-163
1387	Table 3-133. Commands Generated by the Poll Control Server .....	3-165
1388	Table 3-134. Commands Generated by the Poll Control Client.....	3-166
1389	Table 3-135. Attributes of the Power Profile Cluster .....	3-172
1390	Table 3-136. <i>EnergyRemote</i> Attribute.....	3-173
1391	Table 3-137. <i>ScheduleMode</i> Attribute.....	3-173
1392	Table 3-138. Cluster-Specific Commands Received by the Server.....	3-173
1393	Table 3-139. Cluster-Specific Commands Sent by the Server .....	3-181
1394	Table 3-140. <i>PowerProfileState</i> Enumeration Field .....	3-185
1395	Table 3-141. Options Field.....	3-191
1396	Table 3-142. Keep-Alive Server Attributes.....	3-196
1397	Table 3-143. Attributes of the Level Control for Lighting server cluster.....	3-198
1398	Table 3-144. <i>Options</i> Attribute .....	3-199
1399	Table 3-145. Commands for the Pulse Width Modulation cluster .....	3-199
1400	Table 3-146. Lighting Device State Change .....	3-200
1401	Table 3-147. Attributes of the Pulse Width Modulation server cluster .....	3-202
1402	Table 3-148. Commands for the Pulse Width Modulation cluster .....	3-203
1403	Table 4-1. Illuminance Measurement and Level Sensing Clusters.....	4-1
1404	Table 4-2. Pressure and Flow Measurement Clusters .....	4-2
1405	Table 4-3. Occupancy Sensing Clusters .....	4-3
1406	Table 4-4. Electrical Measurement Clusters.....	4-4
1407	Table 4-5. Illuminance Measurement Attributes .....	4-5

1408	Table 4-6. Values of the <i>LightSensorType</i> Attribute .....	4-6
1409	Table 4-7. Illuminance Level Sensing Attribute Sets .....	4-8
1410	Table 4-8. Illuminance Level Sensing Information Attribute Set.....	4-8
1411	Table 4-9. Values of the <i>LevelStatus</i> Attribute .....	4-8
1412	Table 4-10. Values of the <i>LightSensorType</i> Attribute .....	4-9
1413	Table 4-11. Illuminance Level Sensing Settings Attribute Set .....	4-9
1414	Table 4-12. Temperature Measurement Attribute Sets .....	4-11
1415	Table 4-13. Temperature Measurement Information Attribute Set .....	4-11
1416	Table 4-14. Pressure Measurement Attribute Sets .....	4-13
1417	Table 4-15. Pressure Measurement Information Attribute Set .....	4-13
1418	Table 4-16. Extended Pressure Measurement Information Attribute Set .....	4-14
1419	Table 4-17. Flow Measurement Attribute Sets .....	4-17
1420	Table 4-18. Flow Measurement Information Attribute Set.....	4-17
1421	Table 4-19. Attributes of the Water Content cluster.....	4-19
1422	Table 4-20. Occupancy Sensor Attribute Sets .....	4-20
1423	Table 4-21. Occupancy Sensor Information Attribute Set.....	4-21
1424	Table 4-22. Values of the <i>OccupancySensorType</i> Attribute .....	4-21
1425	Table 4-23. The <i>OccupancySensorTypeBitmap</i> Attribute .....	4-21
1426	Table 4-24. Mapping between <i>OccupancySensorType</i> and <i>OccupancySensorTypeBitmap</i> Attributes .....	4-22
1427	Table 4-25. Attributes of the PIR Configuration Attribute Set .....	4-22
1428	Table 4-26. Attributes of the Ultrasonic Configuration Attribute Set .....	4-23
1429	Table 4-27. Attributes of the Physical Contact Configuration Attribute Set .....	4-23
1430	Table 4-28. Attributes of the Electrical Measurement Cluster .....	4-25
1431	Table 4-29. Electrical Measurement Cluster Basic Information.....	4-26
1432	Table 4-30. <i>MeasurementType</i> Attribute .....	4-27
1433	Table 4-31. DC Measurement Attributes.....	4-27
1434	Table 4-32. DC Formatting Attributes.....	4-28
1435	Table 4-33. AC (Non-phase Specific) Measurement Attributes.....	4-29
1436	Table 4-34. AC (Non-phase Specific) Formatting Attributes .....	4-31
1437	Table 4-35. AC (Single Phase or Phase A) Measurement Attributes .....	4-32
1438	Table 4-36. AC Formatting Attributes.....	4-35
1439	Table 4-37. DC Manufacturer Threshold Alarms Attributes.....	4-36
1440	Table 4-38. AC Manufacturer Threshold Alarms Attributes.....	4-36
1441	Table 4-39. AC Phase B Measurements Attributes .....	4-38
1442	Table 4-40. AC Phase C Measurements Attributes .....	4-41
1443	Table 4-41. Generated Command ID's for the Electrical Measurement Server .....	4-44
1444	Table 4-42. List of Status Valid Values.....	4-46
1445	Table 4-43. Generated Command IDs for the Electrical Measurement Client .....	4-46
1446	Table 4-44. Attributes of the Electrical Conductivity Measurement server cluster .....	4-48
1447	Table 4-45. Attributes of the pH Measurement server cluster .....	4-50
1448	Table 4-46. Attributes of the Wind Speed Measurement server cluster .....	4-51
1449	Table 4-47. Attributes of the Concentration Measurement server cluster .....	4-54
1450	Table 5.1. Clusters Specified for the Lighting Functional Domain .....	5-1
1451	Table 5.2. Hue Control Attribute Sets .....	5-3
1452	Table 5.3. Attributes of the Color Information Attribute Set.....	5-4
1453	Table 5.4. Values of the <i>DriftCompensation</i> Attribute.....	5-6
1454	Table 5.5. Values of the <i>ColorMode</i> Attribute .....	5-7
1455	Table 5.6. <i>Options</i> Attribute .....	5-8
1456	Table 5.7. Values of the <i>EnhancedColorMode</i> Attribute .....	5-8
1457	Table 5.8. Bit Values of the <i>ColorCapabilities</i> Attribute .....	5-9
1458	Table 5.9. Values of the <i>StartUpColorTemperatureMireds</i> attribute .....	5-11
1459	Table 5.10. Defined Primaries Information Attribute Set.....	5-11
1460	Table 5.11. Additional Defined Primaries Information Attribute Set.....	5-12
1461	Table 5.12. Defined Color Points Settings Attribute Set .....	5-13
1462	Table 5.13. Command IDs for the Color Control Cluster.....	5-14
1463	Table 5.14. Values of the Direction Field.....	5-17

1464	Table 5.15. Values of the Move Mode Field.....	5-18
1465	Table 5.16. Actions on Receipt for Move Hue Command.....	5-18
1466	Table 5.17. Values of the Step Mode Field.....	5-19
1467	Table 5.18. Actions on Receipt for Step Hue Command.....	5-19
1468	Table 5.19. Values of the Move Mode Field.....	5-21
1469	Table 5.20. Actions on Receipt for Move Saturation Command.....	5-21
1470	Table 5.21. Values of the Step Mode Field.....	5-22
1471	Table 5.22. Actions on Receipt for Step Saturation Command.....	5-22
1472	Table 5.23. Actions on Receipt of the Enhanced Move Hue Command.....	5-27
1473	Table 5.24. Actions on Receipt for the Enhanced Step Hue Command.....	5-28
1474	Table 5.25. Values of the Action Field of the Color Loop Set Command.....	5-30
1475	Table 5.26. Values of the Direction Field of the Color Loop Set Command.....	5-31
1476	Table 5.27. Actions on Receipt of the Move Color Temperature Command.....	5-34
1477	Table 5.28. Actions on Receipt of the Step Color Temperature Command.....	5-35
1478	Table 5.29. Ballast Configuration Attribute Sets.....	5-37
1479	Table 5.30. Attributes of the Ballast Information Attribute Set.....	5-38
1480	Table 5.31. Bit Usage of the <i>BallastStatus</i> Attribute.....	5-38
1481	Table 5.32. Attributes of the Ballast Settings Attribute Set.....	5-38
1482	Table 5.33. Attributes of the Lamp Information Attribute Set.....	5-39
1483	Table 5.34. Attributes of the Lamp Settings Attribute Set.....	5-40
1484	Table 5.35. Values of the <i>MainsAlarmMode</i> Attribute.....	5-41
1485	Table 5.36. Examples of The Dimming Light Curve.....	5-41
1486	Table 6-1. Clusters Specified in the HVAC Functional Domain.....	6-1
1487	Table 6-2. Pump Configuration Attribute Sets.....	6-4
1488	Table 6-3. Attributes of the Pump Information Attribute Set.....	6-4
1489	Table 6-4. Attributes of the Pump Dynamic Information Attribute Set.....	6-7
1490	Table 6-5. Values of the <i>PumpStatus</i> Attribute.....	6-7
1491	Table 6-6. Attributes of the Pump Settings Attribute Set.....	6-9
1492	Table 6-7. Values of the <i>OperationMode</i> Attribute.....	6-11
1493	Table 6-8. Values of the <i>ControlMode</i> Attribute.....	6-11
1494	Table 6-9. Alarm Codes.....	6-12
1495	Table 6-10. Currently Defined Thermostat Attribute Sets.....	6-14
1496	Table 6-11. Attributes of the Thermostat Information Attribute Set.....	6-14
1497	Table 6-12. HVAC System Type Configuration Values.....	6-16
1498	Table 6-13. Attributes of the Thermostat Settings Attribute Set.....	6-17
1499	Table 6-14. <i>RemoteSensing</i> Attribute Bit Values.....	6-19
1500	Table 6-15. <i>ControlSequenceOfOperation</i> Attribute Values.....	6-19
1501	Table 6-16. <i>SystemMode</i> Attribute Values.....	6-20
1502	Table 6-17. Interpretation of <i>SystemMode</i> Values.....	6-20
1503	Table 6-18. Alarm Codes.....	6-20
1504	Table 6.19 Thermostat Running Mode Attribute Values.....	6-21
1505	Table 6-20. Thermostat Schedule & HVAC Relay Attribute Set.....	6-21
1506	Table 6-21. <i>StartofWeek</i> Enumeration Values.....	6-21
1507	Table 6-22. <i>TemperatureSetpointHold</i> Attribute Values.....	6-22
1508	Table 6-23. <i>ThermostatProgrammingOperationMode</i> Attribute Values.....	6-23
1509	Table 6-24. HVAC Relay State Values.....	6-23
1510	Table 6-25. Thermostat Setpoint Change Tracking Attribute Set.....	6-23
1511	Table 6-26. <i>SetpointChangeSource</i> Values.....	6-24
1512	Table 6-27. <i>SetpointChangeAmount</i> Values.....	6-24
1513	Table 6-28. Attributes of the AC Information Attribute Set.....	6-27
1514	Table 6-29. <i>ACType</i> Enumeration.....	6-27
1515	Table 6-30. <i>ACRefrigerantType</i> Enumeration.....	6-28
1516	Table 6-31. <i>ACCompressorType</i> Enumeration.....	6-28
1517	Table 6-32. <i>ACErrorCode</i> Values.....	6-28
1518	Table 6-33. ACLouverPosition Values.....	6-29
1519	Table 6-34. ACCapacity Enumeration.....	6-29

1520	Table 6-35. Command IDs for the Thermostat Cluster .....	6-30
1521	Table 6-36. Mode Field Values for Setpoint Raise/Lower Command.....	6-30
1522	Table 6-37. Day Of Week for Sequence Values.....	6-31
1523	Table 6-38. Mode for Sequence Values.....	6-32
1524	Table 6-39. Server Commands Send Command ID.....	6-35
1525	Table 6-40. Attributes of the Fan Control Cluster .....	6-38
1526	Table 6-41. <i>FanMode</i> Attribute Values.....	6-38
1527	Table 6-42. <i>FanSequenceOperation</i> Attribute Values.....	6-38
1528	Table 6-43. Dehumidification Control Attribute Sets.....	6-40
1529	Table 6-44. Dehumidification Information Attribute Set .....	6-40
1530	Table 6-45. Dehumidification Settings Attribute Set.....	6-40
1531	Table 6-46. <i>RelativeHumidityMode</i> Attribute Values.....	6-41
1532	Table 6-47. <i>DehumidificationLockout</i> Attribute Values.....	6-41
1533	Table 6-48. <i>RelativeHumidityMode</i> Attribute Values.....	6-42
1534	Table 6-49. Thermostat User Interface Configuration Cluster .....	6-43
1535	Table 6-50. <i>DisplayMode</i> Attribute Values.....	6-43
1536	Table 6-51. <i>KeypadLockout</i> Attribute Values .....	6-43
1537	Table 6-52. <i>ScheduleProgrammingVisibility</i> Attribute Values .....	6-44
1538	Table 7-1. Clusters Specified in the Closures Functional Domain .....	7-1
1539	Table 7-2. Shade Configuration Attribute Sets.....	7-3
1540	Table 7-3. Attributes of the Shade Information Attribute Set.....	7-3
1541	Table 7-4. Bit Values for the <i>Status</i> Attribute .....	7-4
1542	Table 7-5. Attributes of the Shade Settings Attribute Set.....	7-4
1543	Table 7-6. Values of the Mode Attribute .....	7-4
1544	Table 7-7. Attribute Sets Description .....	7-8
1545	Table 7-8. Current Information Attribute Set .....	7-8
1546	Table 7-9. <i>LockState</i> Attribute Values.....	7-9
1547	Table 7-10. <i>LockType</i> Attribute Values.....	7-9
1548	Table 7-11. <i>ActuatorEnabled</i> Attribute Values .....	7-10
1549	Table 7-12. <i>DoorState</i> Attribute Values.....	7-10
1550	Table 7-13. User, PIN, Schedule, Log Information Attribute Set.....	7-11
1551	Table 7-14. Operational Settings Attribute Set.....	7-12
1552	Table 7-15. Operating Modes .....	7-13
1553	Table 7-16. Bit Values for the <i>SupportedOperatingModes</i> Attribute.....	7-14
1554	Table 7-17. Modes for the <i>LEDSettings</i> Attribute .....	7-14
1555	Table 7-18. Settings for the <i>SoundVolume</i> Attribute .....	7-15
1556	Table 7-19. <i>DefaultConfigurationRegister</i> Attribute.....	7-15
1557	Table 7-20. Security Settings Attribute Set .....	7-16
1558	Table 7-21. Alarm and Event Masks Attribute Set.....	7-17
1559	Table 7-22. Alarm Code Table .....	7-18
1560	Table 7-23. Commands Received by the Server Cluster .....	7-19
1561	Table 7-24. User Status Value .....	7-22
1562	Table 7-25. User Type Value.....	7-22
1563	Table 7-26. User Status Byte Values for Set RFID Code Command .....	7-29
1564	Table 7-27. Commands Generated by the Server Cluster.....	7-30
1565	Table 7-28. Operation Event Source Value .....	7-42
1566	Table 7-29. Operation Event Code Value.....	7-43
1567	Table 7-30. Keypad Operation Event Value.....	7-44
1568	Table 7-31. RF Operation Event Value .....	7-44
1569	Table 7-32. Manual Operation Event Value .....	7-45
1570	Table 7-33. RFID Operation Event Value .....	7-45
1571	Table 7-34. Operation Event Source Value .....	7-46
1572	Table 7-35. Programming Event Codes.....	7-46
1573	Table 7-36. Keypad Programming Event Value.....	7-47
1574	Table 7-37. RF Programming Event Value .....	7-48
1575	Table 7-38. RFID Programming Event Value .....	7-49

1576	Table 7-39. Window Covering Attribute Set.....	7-51
1577	Table 7-40. Window Covering Information Attribute Set.....	7-51
1578	Table 7-41. Window Covering Type.....	7-52
1579	Table 7-42. Bit Meanings for the Config/Status Attribute .....	7-53
1580	Table 7-43. Window Covering Settings Attribute Set.....	7-54
1581	Table 7-44. Bit Meanings for the Mode Attribute.....	7-55
1582	Table 7-45. Commands Received by the Window Covering Server Cluster.....	7-56
1583	Table 7-46. Attributes .....	7-60
1584	Table 7-47. <i>MovingState</i> .....	7-61
1585	Table 7-48. <i>SafetyStatus</i> .....	7-61
1586	Table 7-49. <i>Capabilities</i> .....	7-62
1587	Table 7-50. Commands Received.....	7-63
1588	Table 8-1. Clusters of the Security and Safety Functional Domain .....	8-1
1589	Table 8-2. Attribute Sets for the IAS Zone Cluster .....	8-3
1590	Table 8-3. Attributes of the Zone Information Attribute Set.....	8-3
1591	Table 8-4. Values of the <i>ZoneState</i> Attribute .....	8-3
1592	Table 8-5. Values of the <i>ZoneType</i> Attribute .....	8-4
1593	Table 8-6. Values of the <i>ZoneStatus</i> Attribute .....	8-5
1594	Table 8-7. Usage of alarm bits of <i>ZoneStatus</i> Attribute for <i>door/window handle</i> zone type (0x0016).....	8-5
1595	Table 8-8. Attributes of the Zone Settings Attribute Set .....	8-6
1596	Table 8-9. Received Command IDs for the IAS Zone Cluster .....	8-8
1597	Table 8-10. Values of the Enroll Response Code.....	8-9
1598	Table 8-11. Generated Command IDs for the IAS Zone Cluster .....	8-11
1599	Table 8-12. Format of the Zone Table.....	8-14
1600	Table 8-13. Received Command IDs for the IAS ACE Cluster .....	8-14
1601	Table 8-14. Arm Mode Field Values.....	8-15
1602	Table 8-15. Generated Command IDs for the IAS ACE Cluster.....	8-19
1603	Table 8-16. Arm Notification Values .....	8-19
1604	Table 8-17. <i>PanelStatus</i> Field Values .....	8-22
1605	Table 8-18. Values of Bypass Result Field .....	8-26
1606	Table 8-19. Attributes of the IAS WD (Server) Cluster.....	8-28
1607	Table 8-20. Received Command IDs for the IAS WD Server Cluster .....	8-28
1608	Table 8-21. Warning Modes.....	8-29
1609	Table 8-22. Values of the Strobe Field.....	8-29
1610	Table 8-23. Siren Level Field Values.....	8-30
1611	Table 8-24. Strobe Level Field Values.....	8-30
1612	Table 8-25. Squawk Mode Field .....	8-31
1613	Table 8-26. Strobe Bit .....	8-31
1614	Table 8-27. Squawk Level Field Values .....	8-31
1615	Table 9-1. Clusters of the Protocol Interfaces Functional .....	9-1
1616	Table 9-2. Attributes of the Generic Tunnel Cluster .....	9-4
1617	Table 9-3. Command IDs Received by the Generic Tunnel Cluster .....	9-4
1618	Table 9-4. Command IDs Generated by the Generic Tunnel Cluster.....	9-5
1619	Table 9-5. Command IDs for the BACnet Protocol Tunnel Cluster.....	9-7
1620	Table 9-6. Attributes of the Analog Input (BACnet Regular) Server.....	9-10
1621	Table 9-7. Attributes of the Analog Input (BACnet Extended) Server .....	9-11
1622	Table 9-8. Attributes of the Analog Output (BACnet Regular) Server .....	9-13
1623	Table 9-9. Attributes of the Analog Output (BACnet Extended) Server.....	9-14
1624	Table 9-10. Attributes of the Analog Value (BACnet Regular) Server.....	9-16
1625	Table 9-11. Attributes of the Analog Value (BACnet Extended) Server .....	9-17
1626	Table 9-12. Attributes of the Binary Input (BACnet Regular) Server.....	9-19
1627	Table 9-13. Attributes of the Binary Input (BACnet Extended) Server .....	9-20
1628	Table 9-14. Attributes of the Binary Output (BACnet Regular) Server .....	9-22
1629	Table 9-15. Attributes of the Binary Output (BACnet Extended) Server.....	9-23
1630	Table 9-16. Attributes of the Binary Value (BACnet Regular) Server.....	9-25
1631	Table 9-17. Attributes of the Binary Value (BACnet Extended) Server .....	9-26

1632	Table 9-18. Attributes of the Multistate Input (BACnet Regular) Server.....	9-28
1633	Table 9-19. Attributes of Multistate Input (BACnet Extended) Server .....	9-29
1634	Table 9-20. Attributes of Multistate Output (BACnet Regular) Server .....	9-31
1635	Table 9-21. Attributes of Multistate Output (BACnet Extended) Server .....	9-32
1636	Table 9-22. Attributes of Multistate Value (BACnet Regular) Server .....	9-34
1637	Table 9-23. Attributes of Multistate Value (BACnet Extended) Server .....	9-35
1638	Table 9-24. Definitions Used in ISO 7816 Protocol Tunnel Description .....	9-40
1639	Table 9-25. Attributes for the ISO7816 Tunnel Cluster .....	9-41
1640	Table 9-26. Status Values .....	9-42
1641	Table 9-27. Received Command IDs for the ISO7816 Tunnel Cluster .....	9-42
1642	Table 9-28. Generated Command IDs for the ISO7816 Tunnel Cluster.....	9-43
1643	Table 9-29. Attributes of the Partition Cluster.....	9-47
1644	Table 9-30. Server Received Command IDs for the Partition Cluster.....	9-49
1645	Table 9-31. Generated Command IDs for the Partition Cluster.....	9-51
1646	Table 9-32. Registration Table of Clusters Using the Partition Cluster.....	9-54
1647	Table 9-33 – Attributes of the 11073 Protocol Tunnel server cluster.....	9-56
1648	Table 9-34 – Command IDs for the 11073 protocol tunnel cluster .....	9-58
1649	Table 9-35 – Connect status values .....	9-61
1650	Table 10-1. Smart Energy Clusters.....	10-1
1651	Table 10-2. Price Cluster Attribute Sets .....	10-3
1652	Table 10-3. Tier Label Attribute Set.....	10-4
1653	Table 10-4. Block Threshold Attribute Set .....	10-5
1654	Table 10-5. Block Period Attribute Set .....	10-7
1655	Table 10-6. <i>Commodity</i> Attribute Set.....	10-8
1656	Table 10-7. Values and Descriptions for the <i>CalorificValueUnit</i> Attribute .....	10-9
1657	Table 10-8. Block Price Information Attribute Set .....	10-9
1658	Table 10-9. Extended Price Information Set (TOU charging only).....	10-11
1659	Table 10-10. Tariff Information Attribute Set .....	10-12
1660	Table 10-11. TierBlockMode Enumeration.....	10-13
1661	Table 10-12. CO <sub>2</sub> Unit Enumeration .....	10-15
1662	Table 10-13. Billing Information Attribute Set .....	10-16
1663	Table 10-14. Credit Payment Attribute Set.....	10-17
1664	Table 10-15. CreditPaymentStatus Enumeration.....	10-18
1665	Table 10-16. PaymentDiscountDuration Enumerations .....	10-18
1666	Table 10-17. Received Tier Label Attribute Set.....	10-19
1667	Table 10-18. Received Block Threshold Attribute Set.....	10-19
1668	Table 10-19. Received Block Period Attribute Set.....	10-19
1669	Table 10-20. Received Block Price Attribute Set.....	10-20
1670	Table 10-21. Received Extended Price Information Attribute Set (TOU charging only).....	10-21
1671	Table 10-22. Received Tariff Information Attribute Set .....	10-21
1672	Table 10-23. Received Billing Information Attribute Set.....	10-23
1673	Table 10-24. Received Command IDs for the Price Cluster .....	10-24
1674	Table 10-25. Generated Command IDs for the Price Cluster.....	10-35
1675	Table 10-26. Price Tier Sub-field Enumerations .....	10-38
1676	Table 10-27. Register Tier Sub-field Enumerations .....	10-39
1677	Table 10-28. Alternate Cost Unit Enumerations.....	10-40
1678	Table 10-29. Price Control Field BitMap .....	10-41
1679	Table 10-30. Generation Tier Enumerations .....	10-41
1680	Table 10-31. Extended Price Tier Field Enumerations.....	10-42
1681	Table 10-32. Extended Register Tier Field Enumerations.....	10-43
1682	Table 10-33. Block Period Control Field BitMap.....	10-46
1683	Table 10-34. Block Period DurationTimebase Enumeration.....	10-46
1684	Table 10-35. Block Period Duration Control Enumeration .....	10-46
1685	Table 10-36. Tariff Resolution Period Enumeration .....	10-47
1686	Table 10-37. Tariff Type Enumeration.....	10-49

1687	Table 10-38. Tariff Charging Scheme Enumeration .....	10-49
1688	Table 10-39. PublishPriceMatrix Sub-Payload Control Bitmap .....	10-51
1689	Table 10-40. PublishBlockThresholds Sub-Payload Control Bitmap .....	10-53
1690	Table 10-41. CPP Price Tier Enumeration .....	10-59
1691	Table 10-42. CPP Auth Enumeration .....	10-59
1692	Table 10-43. Currency Change Control .....	10-62
1693	Table 10-44. Price Client Cluster Attributes .....	10-63
1694	Table 10-45. Command IDs for the Demand Response and Load Control Server .....	10-70
1695	Table 10-46. Device Class Field BitMap/Encoding .....	10-71
1696	Table 10-47. Criticality Levels .....	10-72
1697	Table 10-48. Event Control Field BitMap .....	10-74
1698	Table 10-49. Cancel Control .....	10-75
1699	Table 10-50. Format of the <i>Cancel All Load Control Events</i> Command Payload .....	10-76
1700	Table 10-51. Cancel All Command Cancel Control Field .....	10-77
1701	Table 10-52. Demand Response Client Cluster Attributes .....	10-78
1702	Table 10-53. Generated Command IDs for the Demand Response and Load Control Client .....	10-79
1703	Table 10-54. Event Status Field Values .....	10-81
1704	Table 10-55. Enumerated Values of Signature Types .....	10-82
1705	Table 10-56. Metering Cluster Server Attribute Sets .....	10-98
1706	Table 10-57. Reading Information Attribute Set .....	10-99
1707	Table 10-58. Block Enumerations .....	10-103
1708	Table 10-59. Supply Status Attribute Enumerations .....	10-105
1709	Table 10-60. TOU Information Attribute Set .....	10-107
1710	Table 10-61. Meter Status Attribute Set .....	10-110
1711	Table 10-62. Mapping of the <i>Status</i> Attribute (Electricity) .....	10-110
1712	Table 10-63. Meter <i>Status</i> Attribute (Gas) .....	10-111
1713	Table 10-64. Meter <i>Status</i> Attribute (Water) .....	10-111
1714	Table 10-65. Meter <i>Status</i> Attribute (Heat and Cooling) .....	10-112
1715	Table 10-66. General Flags of the Extended Status BitMap .....	10-113
1716	Table 10-67. Electricity -Meter specific Flags of the Extended Status BitMap .....	10-114
1717	Table 10-68. Gas-Meter specific Flags of the Extended Status BitMap .....	10-114
1718	Table 10-69. LowMediumHighStatus Attribute .....	10-115
1719	Table 10-70. Formatting Examples .....	10-116
1720	Table 10-71. Formatting Attribute Set .....	10-116
1721	Table 10-72. <i>UnitOfMeasure</i> Attribute Enumerations .....	10-118
1722	Table 10-73. <i>MeteringDeviceType</i> Attribute .....	10-121
1723	Table 10-74. <i>TemperatureUnitOfMeasure</i> Enumeration .....	10-123
1724	Table 10-75. Historical Consumption Attribute Set .....	10-125
1725	Table 10-76. Load Profile Configuration Attribute Set .....	10-133
1726	Table 10-77. Supply Limit Attribute Set .....	10-133
1727	Table 10-78. Block Information Attribute Set (Delivered) .....	10-135
1728	Table 10-79. Alarm Attribute Set .....	10-138
1729	Table 10-80. Alarm Code Groups .....	10-139
1730	Table 10-81. Generic Alarm Group .....	10-139
1731	Table 10-82. Electricity Alarm Group .....	10-140
1732	Table 10-83. Generic Flow/Pressure Alarm Group .....	10-141
1733	Table 10-84. Water Specific Alarm Group .....	10-141
1734	Table 10-85. Heat and Cooling Specific Alarm Group .....	10-142
1735	Table 10-86. Gas Specific Alarm Group .....	10-142
1736	Table 10-87. Extended Generic Alarm Group .....	10-142
1737	Table 10-88. Manufacturer Specific Alarm Group .....	10-143
1738	Table 10-89. Block Information Attribute Set (Received) .....	10-144
1739	Table 10-90. Meter Billing Attribute Set .....	10-147
1740	Table 10-91. Supply Control Attribute Set .....	10-148
1741	Table 10-92. Alternative Historical Consumption Attribute Set .....	10-150

1742	Table 10-93. Generated Command IDs for the Metering Server.....	10-156
1743	Table 10-94. Status Field Values.....	10-157
1744	Table 10-95. ProfileIntervalPeriod Timeframes.....	10-158
1745	Table 10-96. Snapshot Schedule Confirmation.....	10-160
1746	Table 10-97. Snapshot Confirmation.....	10-161
1747	Table 10-98. Snapshot Cause BitMap.....	10-162
1748	Table 10-99. Snapshot Payload Type.....	10-162
1749	Table 10-100. Sample Type Enumerations.....	10-170
1750	Table 10-101. Notification Flags Order.....	10-174
1751	Table 10-102. Supply Status Field Enumerations.....	10-178
1752	Table 10-103. Metering Cluster Client Attribute Sets.....	10-179
1753	Table 10-104. Notification Attribute Set.....	10-179
1754	Table 10-105. Functional Notification Flags.....	10-180
1755	Table 10-106. Example Usage of Stay Awake Request Flags.....	10-181
1756	Table 10-107. Push Historical Metering Data Definition.....	10-181
1757	Table 10-108. Push Historical Payment Data Attribute Definition.....	10-182
1758	Table 10-109. Generated Command IDs for the Metering Client.....	10-183
1759	Table 10-110. Interval Channel Values.....	10-184
1760	Table 10-111. Snapshot Schedule BitMap.....	10-187
1761	Table 10-112. Supply Control Bits.....	10-192
1762	Table 10-113. Local Change Supply: Supply Status Field Enumerations.....	10-193
1763	Table 10-114. SetSupplyStatus: Field Enumerations.....	10-194
1764	Table 10-115. Notification Flags 2.....	10-201
1765	Table 10-116. Notification Flags 3.....	10-202
1766	Table 10-117. Notification Flags 4.....	10-202
1767	Table 10-118. Notification Flags 5.....	10-203
1768	Table 10-119. Generated Command IDs for the Messaging Server.....	10-205
1769	Table 10-120. Message Control Field Bit Map.....	10-206
1770	Table 10-121. Extended Message Control Field Bit Map.....	10-207
1771	Table 10-122. Messaging Client Commands.....	10-209
1772	Table 10-123. Message Confirmation Control.....	10-210
1773	Table 10-124. Tunneling Cluster Attributes.....	10-216
1774	Table 10-125. Cluster Parameters Passed Through Commands.....	10-216
1775	Table 10-126. Cluster-specific Commands Received by the Server.....	10-217
1776	Table 10-127. ProtocolID Enumerations.....	10-217
1777	Table 10-128. TransferDataStatus Values.....	10-221
1778	Table 10-129. Cluster-Specific Commands Sent by the Server.....	10-223
1779	Table 10-130. TunnelStatus Values.....	10-224
1780	Table 10-131. Key Establishment Attribute Sets.....	10-234
1781	Table 10-132. Information Attribute Sets.....	10-234
1782	Table 10-133. Values of the KeyEstablishmentSuite Attribute.....	10-234
1783	Table 10-134. Received Command IDs for the Key Establishment Cluster Server.....	10-234
1784	Table 10-135. Terminate Key Establishment Command Status Field.....	10-237
1785	Table 10-136. Key Establishment Attribute Sets.....	10-238
1786	Table 10-137. Attributes of the Information Attribute Set.....	10-238
1787	Table 10-138. Values of the KeyEstablishmentSuite Attribute.....	10-239
1788	Table 10-139. Received Command IDs for the Key Establishment Cluster Client.....	10-239
1789	Table 10-140. Terminate Key Establishment Command Status Field.....	10-242
1790	Table 10-141. Values of the KeyUsage Field.....	10-247
1791	Table 10-142. ECC Implicit Certificate format.....	10-247
1792	Table 10-143. Parameters Used by Methods of the CBKE Protocol.....	10-249
1793	Table 10-144. Prepayment Cluster Server Attribute Sets.....	10-276
1794	Table 10-145. Prepayment Information Attribute Set.....	10-276
1795	Table 10-146. Payment Control Configuration Attribute.....	10-278
1796	Table 10-147. Credit Status Attribute.....	10-280



1797	Table 10-148. OverallDebtCap Example .....	10-280
1798	Table 10-149. Top-up Attribute Set .....	10-282
1799	Table 10-150. Debt Attribute Set.....	10-284
1800	Table 10-151. Debt Recovery Method Enumerations .....	10-285
1801	Table 10-152. <i>Recovery Frequency</i> Field Enumerations.....	10-286
1802	Table 10-153. Alarm Attribute Set.....	10-286
1803	Table 10-154. Prepayment Alarm Status Indicators.....	10-287
1804	Table 10-155. Alarms Code Group .....	10-288
1805	Table 10-156. PrepayGenericAlarmGroup.....	10-288
1806	Table 10-157. PrepaySwitchAlarmGroup .....	10-288
1807	Table 10-158. PrepayEventAlarmGroup.....	10-289
1808	Table 10-159. Historical Cost Consumption Information Attribute Set.....	10-289
1809	Table 10-160. <i>CurrencyScalingFactor</i> Enumerations.....	10-294
1810	Table 10-161. Cluster -specific Commands Received by the Server.....	10-296
1811	Table 10-162. Originating Device Field Enumerations.....	10-297
1812	Table 10-163. Debt Amount Type Field Enumerations .....	10-298
1813	Table 10-164. Credit Type Field Enumerations .....	10-301
1814	Table 10-165. Debt Type Field Enumerations .....	10-304
1815	Table 10-166. Cluster -specific Commands Sent by the Server.....	10-306
1816	Table 10-167. Snapshot Payload Cause .....	10-307
1817	Table 10-168. Snapshot Payload Type.....	10-308
1818	Table 10-169. Friendly Credit BitMap.....	10-309
1819	Table 10-170. Result Type Field Enumerations.....	10-310
1820	Table 10-171. Calendar Data Structures.....	10-317
1821	Table 10-172. Calendar Cluster Server Attribute Sets .....	10-319
1822	Table 10-173. Auxiliary Switch Label Attribute Set.....	10-319
1823	Table 10-174. Cluster-specific Commands Sent by the Server.....	10-320
1824	Table 10-175. Calendar Type Enumeration .....	10-321
1825	Table 10-176. Calendar Time Reference Enumeration .....	10-321
1826	Table 10-177. Cluster -specific Commands Received by the Calendar Cluster Server .....	10-330
1827	Table 10-178. Device Management Cluster Server Attribute Sets.....	10-336
1828	Table 10-179. Supplier Control Attribute Set.....	10-336
1829	Table 10-180. Proposed Change Control BitMap .....	10-338
1830	Table 10-181. Meter Contactor State Bit Combinations .....	10-338
1831	Table 10-182. Tenancy Control Attribute Set .....	10-340
1832	Table 10-183. Backhaul Control Attribute Set .....	10-340
1833	Table 10-184. State of the WAN Connection.....	10-340
1834	Table 10-185. HAN Control Attribute Set.....	10-340
1835	Table 10-186. Cluster -specific Commands Received by the Device Management Cluster Server.....	10-341
1836	Table 10-187. Cluster-specific Commands Sent by the Server .....	10-343
1837	Table 10-188. Password Type Enumeration.....	10-347
1838	Table 10-189. Configuration Control Enumeration.....	10-348
1839	Table 10-190. Device Management Cluster Client Attribute Sets .....	10-351
1840	Table 10-191. Supplier Attribute Set.....	10-351
1841	Table 10-192. Price Event Configuration Attribute Set.....	10-352
1842	Table 10-193. Event Configuration Bitmaps.....	10-355
1843	Table 10-194. Metering Event Configuration Attribute Set .....	10-355
1844	Table 10-195. Messaging Event Configuration Attribute Set .....	10-363
1845	Table 10-196. Prepayment Event Configuration Attribute Set.....	10-364
1846	Table 10-197. Calendar Event Configuration Attribute Set .....	10-367
1847	Table 10-198. Device Management Event Configuration Attribute Set.....	10-368
1848	Table 10-199. Tunneling Event Configuration Attribute Set .....	10-370
1849	Table 10-200. OTA Event Configuration Attribute Set.....	10-372
1850	Table 10-201. Cluster -specific Commands Received by the Events Cluster Server.....	10-376
1851	Table 10-202. Log ID Enumeration .....	10-377

1852	Table 10-203. Event Control Bitmap.....	10-377
1853	Table 10-204. Cluster -specific Commands Generated by the Events Cluster Server .....	10-379
1854	Table 10-205. Event Action Control Bitmap.....	10-379
1855	Table 10-206. Log Payload Control Bitmap.....	10-381
1856	Table 10-207. ClearedEventsLogs Bitmap.....	10-381
1857	Table 10-208. Sub-GHz Cluster Server Attributes.....	10-384
1858	Table 10-209. Page 28 Channel Mask .....	10-384
1859	Table 10-210. Page 29 Channel Mask .....	10-385
1860	Table 10-211. Page 30 Channel Mask .....	10-385
1861	Table 10-212. Page 31 Channel Mask .....	10-386
1862	Table 10-213. Cluster-specific Commands Generated by the Sub-GHz Cluster Server .....	10-387
1863	Table 10-214. Cluster-specific Commands Generated by the Sub-GHz Cluster Client.....	10-388
1864	Table 10-215. Attributes of the Meter Identification Server Cluster.....	10-390
1865	Table 10-216. Meter Type IDs .....	10-391
1866	Table 10-217. Data Quality IDs.....	10-391
1867	Table 11-1. Clusters Specified in This Document .....	11-2
1868	Table 11-2. OTA Header Fields .....	11-7
1869	Table 11-3. OTA Header Field Control Bitmask.....	11-8
1870	Table 11-4. Image Type Values.....	11-8
1871	Table 11-5. Recommended File Version Definition.....	11-9
1872	Table 11-6. ZigBee Stack Version Values.....	11-10
1873	Table 11-7. Security Credential Version .....	11-10
1874	Table 11-8. Hardware Version Format.....	11-11
1875	Table 11-9. Tag Identifiers .....	11-12
1876	Table 11-10. Attributes of OTA Upgrade Cluster .....	11-20
1877	Table 11-11. Image Upgrade Status Attribute Values .....	11-21
1878	Table 11-12. UpgradeActivationPolicy Enumerations .....	11-23
1879	Table 11-13. UpgradeTimeoutPolicy Enumerations .....	11-23
1880	Table 11-14. Parameters of OTA Upgrade Cluster.....	11-24
1881	Table 11-15. Meaning of CurrentTime and UpgradeTime Parameters .....	11-25
1882	Table 11-16. OTA Upgrade Cluster Command Frames .....	11-27
1883	Table 11-17. Status Code Defined and Used by OTA Upgrade Cluster.....	11-28
1884	Table 11-18. Image Notify Command Payload Type.....	11-29
1885	Table 11-19. Query Next Image Request Field Control Bitmask.....	11-31
1886	Table 11-20. Image Block Request Field Control Bitmask .....	11-35
1887	Table 11-21. Image Page Request Field Control Bitmask.....	11-38
1888	Table 12-1. Telecom Cluster List .....	12-1
1889	Table 12-2. Clusters Specified for the Information Delivery .....	12-2
1890	Table 12-3. Information Cluster Attribute Sets .....	12-6
1891	Table 12-4. Node Information Attribute Set.....	12-7
1892	Table 12-5. Contents Information Attribute Set .....	12-7
1893	Table 12-6. Received Command IDs for the Information Cluster.....	12-8
1894	Table 12-7. Inquiry ID.....	12-9
1895	Table 12-8. Data Type IDs .....	12-9
1896	Table 12-9. Preference Type.....	12-11
1897	Table 12-10. Value of the Access Control Field.....	12-13
1898	Table 12-11. Generated Command IDs for the Information Cluster .....	12-18
1899	Table 12-12. Chatting Attributes Sets.....	12-26
1900	Table 12-13. Attributes of the User Related Attribute Set.....	12-26
1901	Table 12-14. Attributes of Chat Session Related Attribute Set .....	12-27
1902	Table 12-15. Command IDs for the Chatting Cluster.....	12-27
1903	Table 12-16. Generated Command IDs for the Chatting Cluster.....	12-31
1904	Table 12-17. VoZ Attribute Sets .....	12-37
1905	Table 12-18. Attributes of the Voice Information Attribute Set.....	12-37
1906	Table 12-19. Command IDs for the VoZ Cluster .....	12-39
1907	Table 12-20. Generated Command IDs for the VoZ Cluster.....	12-42

1908	Table 12-21. The Error Flag of Voice Transmission Response .....	12-43
1909	Table 13-1. Commissioning Attribute Sets .....	13-3
1910	Table 13-2. Attributes of the Startup Parameters Attribute Set.....	13-4
1911	Table 13-3. Stack Profile Compatibility for the <i>ShortAddress</i> Attribute.....	13-5
1912	Table 13-4. Stack Profile Compatibility for the <i>PANId</i> Attribute .....	13-5
1913	Table 13-5. <i>StartupControl</i> Attribute Usage .....	13-7
1914	Table 13-6. Stack Profile Compatibility for the <i>StartupControl</i> Attribute.....	13-8
1915	Table 13-7. Attributes of the Join Parameters Attribute Set.....	13-9
1916	Table 13-8. Attributes of the End Device Parameters Attribute Set.....	13-10
1917	Table 13-9. Attributes of the Concentrator Parameters Attribute Set.....	13-11
1918	Table 13-10. Commands Received by the Commissioning Cluster Server.....	13-12
1919	Table 13-11. Startup Mode Sub-field Values .....	13-13
1920	Table 13-12. Commands Generated by the Commissioning Cluster Server .....	13-16
1921	Table 13-13. Commands Received by the Server Side of the Touchlink Commissioning Cluster .....	13-20
1922	Table 13-14. Values of the Identify Duration Field .....	13-23
1923	Table 13-15. Commands Generated by the Server Side of the Touchlink Commissioning Cluster.....	13-32
1924	Table 13-16. Values of the Status Field of the Network Start Response Command Frame .....	13-39
1925	Table 13-17. Values of the Status Field of the Network Join Router Response Command Frame .....	13-40
1926	Table 13-18. Values of the Status Field of the Network Join End Device Response Command Frame ..	13-42
1927	Table 13-19. Commands Received by the Client Side of the ZLL Commissioning Cluster.....	13-45
1928	Table 13-20. Commands Generated by the Client Side of the ZLL Commissioning Cluster.....	13-46
1929	Table 13-21. Touchlink Commissioning Constants .....	13-46
1930	Table 13-22. Touchlink Commissioning Attributes .....	13-47
1931	Table 13-23. Key Encryption Algorithms .....	13-55
1932	Table 14-1. Clusters Specified in this Chapter.....	14-1
1933	Table 14-2. Attributes of the Retail Tunnel cluster .....	14-3
1934	Table 14-3. Cluster-specific Commands Received by the Server .....	14-3
1935	Table 14-4. Attributes of the Mobile Device Cleaning Cluster.....	14-6
1936	Table 14-5. Cluster-specific Commands Generated by the Server.....	14-6
1937	Table 14-6. Attributes of the Neighbor Cleaning Cluster.....	14-9
1938	Table 14-7. Cluster-specific Commands Generated by the Server.....	14-9
1939	Table 14-8. Attributes of the Nearest Gateway Cluster.....	14-11
1940	Table 15-1. Appliance Management Clusters .....	15-1
1941	Table 15-2. Appliance Control Attribute Set.....	15-3
1942	Table 15-3. Attributes of the Appliance Functions Attribute Set .....	15-3
1943	Table 15-4. Time Encoding.....	15-3
1944	Table 15-5. Cluster-specific Commands Received by the Server .....	15-4
1945	Table 15-6. Command Identification Values .....	15-5
1946	Table 15-7. Format of the Event ID Enumerator.....	15-7
1947	Table 15-8. Cluster-specific Commands Sent by the Server .....	15-8
1948	Table 15-9. Appliance Status Values .....	15-9
1949	Table 15-10. Remote Enable Flags Values .....	15-9
1950	Table 15-11. Appliance Identification Attribute Sets.....	15-11
1951	Table 15-12. Attributes of the Appliance Identification Attribute Set .....	15-12
1952	Table 15-13. Basic Appliance Identification Content Specification .....	15-12
1953	Table 15-14. Product Type IDs .....	15-12
1954	Table 15-15. Attributes of the Extended Appliance Identification Attribute Set .....	15-13
1955	Table 15-16. CECED Specification Version.....	15-15
1956	Table 15-17. Received Commands IDs for the Events and Alerts Cluster.....	15-17
1957	Table 15-18. Generated Commands IDs for the Appliance Events and Alerts Cluster.....	15-17
1958	Table 15-19. Alert Count Organization.....	15-18
1959	Table 15-20. Alerts Structure Organization .....	15-19
1960	Table 15-21. Event Identification.....	15-20
1961	Table 15-22. Server Attributes .....	15-22
1962	Table 15-23. Commands Generated by the Appliance Statistics Server .....	15-23
1963	Table 15-24. Commands Generated by the Appliance Statistics Client.....	15-25
1964		



# CHAPTER 1 INTRODUCTION

1965

1966 This library is made of individual chapters such as this one. See Document Control in the document header  
 1967 for a list of all chapters and documents. References between chapters are made using a *X.Y* notation where *X*  
 1968 is the chapter and *Y* is the sub-section within that chapter. References to external documents are contained in  
 1969 Chapter 1 and are made using [*Rn*] notation.

1970

## 1.1 Scope and Purpose

1971 Dotdot is a data model or language defined in Application Architecture [Z5]. Elements of the model include  
 1972 clusters and devices.

1973 The purpose of this library is to define object classes, called clusters, to be used as building blocks for devices  
 1974 that interoperate and perform functions as part of products in a market.

1975 This document is a repository and dictionary reference for cluster specifications , and is a working library  
 1976 with regular updates as new functionality is added.

1977 A developer constructing a new application should use this library to find relevant cluster functionality that  
 1978 can be incorporated into the new application. Correspondingly, new clusters that are defined for applications  
 1979 should be considered for inclusion in the library.

1980 The library is broken into chapters. Chapter 2 defines basic elements to the cluster model architecture that is  
 1981 described in Application Architecture [Z5]. Chapter 3 defines general application and utility clusters. The  
 1982 remaining chapters group clusters by application domain. The cluster name space is flat. No categorization  
 1983 or hierarchy is perfect, and the chapter grouping is not formalized by the model or name space.

1984

## 1.2 Acronyms and Abbreviations

1985

Table 1-1. Acronyms and Abbreviations

Acronym	Definition
Acc	Access
ACE	Ancillary Control Equipment
AES	Advanced Encryption Standard
AIB	Application support sub-layer Information Base
AP	Access Point
APS	Application support Sub-layer
CA	Certificate Authority
CBA	Commercial Building Automation
CBKE	Certificate-based Key Establishment
CIE	Control and Indicating Equipment
CT	Commissioning Tool
D	Deprecated
Def	Default

<b>Acronym</b>	<b>Definition</b>
ECDSA	Elliptic Curve Digital Signature Algorithm
ECMQV	Elliptic Curve Menezes-Qu-Vanstone
EMS	Energy Management System
EOF	End Of File
EPID	Extended PAN Identifier
ESI	Energy Service Interface
ESP	Energy Service Portal
EUI64	Extended Universal Identifier-64
HA	Home Automation (Application Profile)
HAN	Home Area Network
HVAC	Heating, Ventilation, Air Conditioning
IAS	Intruder Alarm System
ID	Identifier (or Id)
IHD	In-Home Display
IPD	In-Premises Display (Same as IHD) or Inter-PAN Device
M	Mandatory
M/O	Mandatory or Optional
MAC	Medium Access Control (referring to protocol stack sublayer)
MAC	Message Authentication Code (referring to cryptographic operation)
MAC PIB	Medium Access Control sub-layer PAN Information Base
MRD	Market Requirements Document
MT	Mobile Terminal
NIB	Network layer Information Base
NWK	Network layer
O	Optional
OTA	Over the Air or Over the Air Upgrade
P	Mandates that an attribute is reportable
PAN	Personal Area Network
PCT	Programmable Communicating Thermostat
PID	PAN Identifier
PIR	Pyroelectric Infra-Red (a type of motion detection sensor)
PKKE	Public Key Key Establishment
R	Readable (Read) or Read only if not also designated as Writable (W)
R*W	Readable and optionally writable

Acronym	Definition
RFD	Reduced Functionality Device
RSSI	Received Signal Strength Indication
R/W	Readable and Writable (same as RW)
S	Mandates that an attribute is part of a scene, if the Scene cluster is on the same endpoint
SAS	Startup Attribute Set
SE	Smart Energy (Application Profile)
SKKE	Symmetric Key Key Exchange
TC	Trust Center
TOU	Time of Use
TRD	Technical Requirements Document
UTF-8	8-bit Unicode Transformation Format
W	Writable (Write) or Write only if not also designated as Readable
WD	Warning Device
ZCL	Zigbee Cluster Library
ZCL <sub>n</sub>	A revision of the ZCL. For example: ZCL6 is the Zigbee Cluster Library revision 6
ZDO	Zigbee Device Object
ZDP	Zigbee Device Profile
ZED	Zigbee End Device (equivalent to IEEE’s RFD – Reduced Functionality Device)
ZR	Zigbee Router (equivalent to IEEE’s FFD – Full Functionality Device)

## 1986 1.3 Definitions

1987 Many of these terms are described in more detail in the core stack specification [Z1], or the Application  
 1988 Architecture specification [Z5].

1989 **Application Cluster:** An application cluster generates persistent functional application transactions between  
 1990 client and server.

1991 **Attribute:** A data entity which represents a physical quantity or state. This data is communicated to other  
 1992 devices using commands.

1993 **Binding:** A persistent mapping of a local cluster instance to one or more corresponding remote cluster in-  
 1994 stances. A binding can be broadcast, groupcast, or unicast. A unicast binding includes an address (IEEE or  
 1995 network) and endpoint.

1996 **Cluster:** A cluster is a specification defining one or more attributes, commands, behaviors and dependencies,  
 1997 that supports an independent utility or application function. The term may also be used for an implementation  
 1998 or instance of such a specification on an endpoint.

- 1999 **Cluster identifier:** The cluster identifier is a 16-bit number that maps to (identifies) a single cluster specification. More than one cluster identifier may map to a cluster specification, each defining a different scope and purpose. Cluster identifiers are designated as inputs or outputs in the simple descriptor for use in creating a binding table.
- 2000
- 2001
- 2002
- 2003 **Client:** A cluster interface which is listed in the output cluster list of the simple descriptor on an endpoint. Typically this interface sends commands that manipulate the attributes on the corresponding server cluster. A client cluster communicates with a corresponding remote server cluster with the same cluster identifier.
- 2004
- 2005
- 2006 **Corresponding cluster:** The opposite side of a cluster (client to a server, or server to a client).
- 2007
- 2008 **Device:** A specification which defines a unique device identifier and a set of mandatory and optional clusters to be implemented on a single endpoint. The term may also be used for an implementation or instance of the device specification on an endpoint.
- 2009
- 2010 **Node:** A Zigbee node (or node) is a single testable implementation of a Zigbee application on a single Zigbee stack, with a single network address, on a single network.
- 2011
- 2012 **Product:** A product is a node that is intended to be marketed.
- 2013
- 2014 **Server:** A cluster interface which is listed in the input cluster list of the simple descriptor on an endpoint. Typically, this interface supports all or most of the attributes of the cluster. A server cluster communicates with a corresponding remote client cluster with the same cluster identifier.
- 2015
- 2016 **Service discovery:** The ability of a device to locate services of interest.
- 2017 **Sleepy End Device:** A Zigbee End Device with rxOnWhenIdle set to FALSE.
- 2018
- 2019 **Utility Cluster:** A utility cluster is not part of the application function of the product. It may be used for commissioning, configuration, discovery, addressing, diagnostics, etc.
- 2020 **Type 1 Cluster:** A type 1 cluster's primary function is to initiate transactions from the client to the server.
- 2021 **Type 2 Cluster:** A type 2 cluster's primary function is to initiate transactions from the server to the client.
- 2022 **Zigbee Coordinator:** An IEEE 802.15.4-2003 PAN coordinator.
- 2023 **Zigbee End Device:** an IEEE 802.15.4-2003 RFD or FFD participating in a Zigbee network, which is neither the Zigbee coordinator nor a Zigbee router.
- 2024
- 2025 **Zigbee Router:** an IEEE 802.15.4-2003 FFD participating in a Zigbee network, which is not the Zigbee coordinator but may act as an IEEE 802.15.4-2003 coordinator within its personal operating space, that is capable of routing messages between devices and supporting associations.
- 2026
- 2027

## 2028 1.4 Conformance Levels

2029 The key words below are usually capitalized in the document to make the requirement clear.

Key Word	Description
<b>EXPECTED</b>	A key word used to describe the behavior of the hardware or software in the design models <i>assumed</i> by this Draft. Other hardware and software design models may also be implemented.
<b>MAY</b>	A key word that indicates flexibility of choice with <i>no implied preference</i> .
<b>NOT</b>	A key word that used to describe that the requirement is the inverse of the behavior specified (i.e. SHALL NOT, MAY NOT, etc)
<b>SHALL</b>	A key word indicating a mandatory requirement. Designers are <i>required</i> to implement all such mandatory requirements.



Key Word	Description
<b>SHOULD</b>	A key word indicating flexibility of choice with a strongly preferred alternative. Equivalent to the phrase <i>is recommended</i> .

2030 **1.5 References**

2031 The following standards and specifications contain provisions, which through reference in this document  
 2032 constitute provisions of this specification. All the standards and specifications listed are normative references.  
 2033 At the time of publication, the editions indicated were valid. All standards and specifications are subject to  
 2034 revision, and parties to agreements based on this specification are encouraged to investigate the possibility  
 2035 of applying the most recent editions of the standards and specifications indicated below.

2036 **1.5.1 Zigbee Alliance Documents**

- 2037 [Z1] Zigbee 053474, Zigbee Specification
- 2038 [Z2] Zigbee 064321, Zigbee Stack Profile
- 2039 [Z3] Zigbee 074855, Zigbee PRO Stack Profile
- 2040 [Z4] Zigbee 08006, Zigbee-2007 Layer PICs and Stack Profiles
- 2041 [Z5] Zigbee 130589, Application Architecture
- 2042 [Z6] Zigbee 130402, Base Device Behavior Specification
- 2043 [Z7] Zigbee 053298, Profile Identifier Database
- 2044 [Z8] Zigbee 106050, Zigbee Device internetworking, list of Device IDs
- 2045 [Z9] Zigbee 075356, Smart Energy Profile Specification
- 2046 [Z10] Zigbee 03084, Zigbee Key Establishment Proposal
- 2047 [Z11] Zigbee 095343, Installation Code Sample Source Code
- 2048 [Z12] Zigbee 053874 Manufacturer Code Database

2049 **1.5.2 International Standards Documents**

- 2050 [I1] CIE 1931 Color Space. Commission Internationale de l'Eclairage Proceedings. Cambridge Univer-  
 2051 sity Press, Cambridge
- 2052 [I2] ISO 7816 International Standard for Electronic Identification Cards with Contacts (Smart Cards)

2053 **1.5.3 National Standards Documents**

- 2054 [N1] EN 50131 European Standards Series for Intruder Alarm Systems
- 2055 [N2] BSI British Standards, document BS EN 50523-2:2009, “Household Appliances interworking –  
 2056 Part 2: Data Structures”. July 2009
- 2057 [N3] NIST Special Publication 800-38C, Recommendation for Block Cipher Modes of Operation:  
 2058 CCM Mode for Authentication and Confidentiality, May 2004
- 2059 [N4] FIPS Pub 197, Advanced Encryption Standard (AES), Processing Standards Publication 197, US  
 2060 Department of Commerce/NIST Springfield, Virginia, November 26, 2001

- 2061 [N5] FIPS Pub 198, The Keyed-Hash Message Authentication Code (HMAC), Federal Information,  
2062 Processing Standards Publication 198, US Department of Commerce/NIST Springfield, Virginia,  
2063 March 6, 2002

## 2064 **1.5.4 IEEE Documents**

- 2065 [E1] IEEE Standards 802, Part 15.4: Wireless Medium Access Control (MAC) and Physical Layer  
2066 (PHY) specifications for Low Rate Wireless Personal Area Networks (LR-WPANs), IEEE, Octo-  
2067 ber 2015.
- 2068 [E2] IEEE 754-1985, IEEE Standard for Binary Floating-Point Arithmetic, IEEE, 1985.

## 2069 **1.5.5 ASHRAE Documents**

- 2070 [A1] ASHRAE 135-2004 standard, Data Communication Protocol for Building Automation and Con-  
2071 trol Networks

## 2072 **1.5.6 Health Care Documents**

- 2073 [H1] ISO/IEEE 11073-20601: Health Informatics - Personal Health Device Communication - Applica-  
2074 tion Profile - Optimized Exchange Protocol - version 1.0 or later.
- 2075 [H2] ISO/IEEE P11073-10404, Health informatics – Personal health device communication – Device  
2076 specialization – Pulse oximeter.
- 2077 [H3] ISO/IEEE P11073-10407, Health informatics – Personal health device communication – Device  
2078 specialization – Blood pressure monitor.
- 2079 [H4] ISO/IEEE P11073-10408, Health informatics – Personal health device communication – Device  
2080 specialization – Thermometer.
- 2081 [H5] ISO/IEEE P11073-10415, Health informatics – Personal health device communication – Device  
2082 specialization – Weighing scale.
- 2083 [H6] ISO/IEEE P11073-10417, Health informatics – Personal health device communication – Device  
2084 specialization – Glucose meter.
- 2085 [H7] ISO/IEEE P11073-10419, Health informatics – Personal health device communication – Device  
2086 specialization – Insulin Pump
- 2087 [H8] ISO/IEEE P11073-10421, Health informatics – Personal health device communication – Device  
2088 specialization – Peak Expiratory Flow Monitor
- 2089 [H9] ISO/IEEE P11073-10441, Health informatics – Personal health device communication – Device  
2090 specialization – Cardiovascular Fitness and Activity Monitor.
- 2091 [H10] ISO/IEEE P11073-10442, Health informatics – Personal health device communication – Device  
2092 specialization – Strength Fitness Equipment.
- 2093 [H11] ISO/IEEE P11073-10471, Health informatics – Personal health device communication – Device  
2094 specialization – Independent living activity hub.
- 2095 [H12] ISO/IEEE P11073-10472, Health informatics – Personal health device communication – Device  
2096 specialization – Medication Monitor.

## 2097 **1.5.7 Other Documents**

- 2098 [O1] Standards for Efficient Cryptography: SEC 1 (working draft) ver 1.7: Elliptic Curve Cryptog-  
2099 raphy, Certicom Research, [www.secg.org](http://www.secg.org), November 13, 2006

2100 [O2] Standards for Efficient Cryptography: SEC 4 (draft) ver 1.0: Elliptic Curve Cryptography, Certi-  
2101 com Research, www.secg.org, January 24, 2013

## 2102 **1.6 Conventions**

---

2103 The following conventions are used in this document.

### 2104 **1.6.1 Enumerations and Reserved Values**

2105 An undefined value or range of an enumeration, field, or identifier SHALL be considered reserved for future  
2106 revisions of this standard and SHALL not be available for implementation.

2107 A value or range of an enumeration, field, or identifier that is available for non-standard implementation  
2108 SHALL be described as “manufacturer specific”, “ms”, or “MS”.

2109 A value or range of an enumeration, field, or identifier that is available for other parts of this standard SHALL  
2110 be described as such.

2111 A value or range of an enumeration, field, or identifier that is deprecated, and not available for implementa-  
2112 tion, SHALL be described as “Deprecated” or “D”.

### 2113 **1.6.2 Reserved Bit Fields**

2114 Each full or partial data field (e.g., message data field), of any bit length, that is undefined, SHALL be con-  
2115 sidered reserved for future revisions of this standard and SHALL not be available for implementation.

2116 Please see Section Chapter 2, Transmission and Reception, regarding rules for setting and interpreting re-  
2117 served fields.

### 2118 **1.6.3 Number Format**

2119 In this specification, hexadecimal numbers are prefixed with the designation “0x” and binary numbers are  
2120 prefixed with the designation “0b”. All other numbers are assumed to be decimal unless indicated otherwise  
2121 within the associated text.

2122 Binary numbers are specified as successive groups of 4 bits, separated by a space (“ ”) character from the  
2123 most significant bit (next to the 0b prefix and left most on the page) to the least significant bit (rightmost on  
2124 the page), e.g. the binary number 0b0000 1111 represents the decimal number 15. Where individual bits are  
2125 indicated (e.g. bit 3) the bit numbers are relative to the least significant bit which is bit 0.

2126 When a bit is specified as having a value of either 0 or 1 it is specified with an “x”, e.g. “0b0000 0xxx”  
2127 indicates that the lower 3 bits can take any value but the upper 5 bits must each be set to 0.



## CHAPTER 2 FOUNDATION

2128

2129 This library is made of individual chapters such as this one. See Document Control in the document header  
2130 for a list of all chapters and documents. References between chapters are made using a *X.Y* notation where *X*  
2131 is the chapter and *Y* is the sub-section within that chapter. References to external documents are contained in  
2132 Chapter 1 and are made using [*Rn*] notation.

### 2.1 Scope and Purpose

2133

2134 This chapter provides an entry point into the documentation for the Zigbee Cluster Library (ZCL) and spec-  
2135 ifies the elements that are general across the entire library.

2136 The Zigbee PRO [R1] frame structure is specified along with global commands used to manipulate attributes  
2137 from all the clusters. In addition, a set of data types is defined that can be used to represent attributes and a  
2138 common set of status values returned by commands.

2139 Frame formats and fields that are prefixed with ‘ZCL’ are particular to the Zigbee PRO message encoding of  
2140 cluster commands. In the future, it may be that such encodings will be moved to a separate document, and  
2141 this document will then only be a data model dictionary of abstract cluster specifications. As of now, the  
2142 concrete encodings for Zigbee PRO are included part of this document and can be ignored when this docu-  
2143 ment is referenced for other (non-Zigbee PRO) encodings.

### 2.2 Cluster Library Overview

2144

2145 This document is intended to act as a repository for cluster functionality and it is a working library with  
2146 regular updates as new functionality is added. A developer constructing a new application SHOULD use this  
2147 document to find relevant cluster functionality that can be incorporated into the new application so as not to  
2148 “re-invent the wheel”. This also allows applications to be developed with more of an object-oriented style  
2149 approach.

#### 2.2.1 Architecture and Data Model

2150

2151 Each cluster specification in this document defines an independent functional entity. Each cluster specifica-  
2152 tion is agnostic regarding functions beyond its purpose and scope, including overall requirements of the ap-  
2153 plication or device. An application cluster SHOULD have no dependencies outside its application domain.  
2154 A utility cluster MAY provide an interface to other layers (e.g. Groups cluster for group addressing).

2155 Please see [Z5] Application Architecture for more details.

##### 2.2.1.1 Cluster Identifier

2156

2157 A cluster identifier SHALL map to a single cluster specification. A cluster identifier also defines the purpose  
2158 of a cluster instance. More than one cluster identifier, each with a unique purpose, MAY map to a single  
2159 more abstract cluster specification. For example: A Concentration Measurement cluster specification MAY  
2160 be quite abstract but have many mapped cluster identifiers each with a more concrete purpose, such as CO<sub>2</sub>  
2161 measurement in air, by volume.

2162 Please see [Z5] Application Architecture for more details.

### 2163 **2.2.1.2 Extensibility Model**

2164 A cluster specification MAY be derived from a base cluster specification. A derived cluster specification  
2165 SHALL add specific requirements (attributes, commands, behavior, dependencies, etc) to the base specifica-  
2166 tion. A derived specification MAY reduce optionality by limiting the optional requirements from the base  
2167 specification.

2168 All new attribute and command definitions for the derived cluster SHALL be specified in the base cluster  
2169 specification as optional, to maintain, in one specification, the identifier name space and communication  
2170 behavior. Other behavior and dependencies that are specific to the derived cluster MAY also be specified in  
2171 the base cluster, if it is deemed reusable by future derived clusters.

2172 A derived cluster specification SHALL have the same mandatory requirements as the base cluster specifica-  
2173 tion. A derived specification MAY have mandatory requirements that are optional in the base specification.

2174 A derived cluster specification defines its own revision (*ClusterRevision* attribute) that is independent of the  
2175 base specification.

2176 Conversely, a base cluster may be defined from an original more specific cluster, which then becomes a  
2177 derived cluster.

2178 When considering the addition of one or more clusters to this specification, one SHALL explore the possi-  
2179 bility of either deriving a cluster from an existing cluster, or creating a base cluster to map or derive new and  
2180 existing cluster identifiers. This allows the reuse of approved and validated specifications and test plans.

2181 Please see [Z5] Application Architecture for more details.

### 2182 **2.2.1.3 Instance Model**

2183 If a device endpoint supports both a derived server cluster identifier and its base server cluster identifier, then  
2184 both SHALL represent a single instance and operate as a single entity. This makes it possible to deploy a  
2185 new device endpoint with both a base and derived cluster identifiers, which SHALL remain backward com-  
2186 patible to legacy devices that support only the original cluster identifier.

2187 Cluster identifiers that are mapped to a single base cluster specification, but are defined for distinctly different  
2188 purposes, MAY exist together on a device endpoint. If there is no base cluster identifier defined, or no base  
2189 cluster identifier exists on the same endpoint, then each cluster identifier SHALL represent a separate in-  
2190 stance.

2191 Please see [Z5] Application Architecture for more details.

### 2192 **2.2.1.4 Conformance Model**

2193 Specified behavior SHALL be Mandatory (M), Optional (O), or Deprecated (D). Mandatory behavior is usu-  
2194 ally dependent on other factors. For example: The mandatory behavior defined in a cluster server specifica-  
2195 tion, is only mandatory, if the cluster identifier is discoverable as a server on the device. Attributes and  
2196 commands MAY also be dependent on the support of other optional attributes. This is true when a feature of  
2197 a cluster requires a complete set of attributes and commands.

2198 Deprecated attributes and commands SHALL be noted as deprecated and description text SHALL be deleted.

## 2199 **2.2.2 Client/Server Model**

2200 For most clusters, a client/server model is employed. This model is illustrated in Figure 2-1.

2201

**Figure 2-1. Client Server Model**

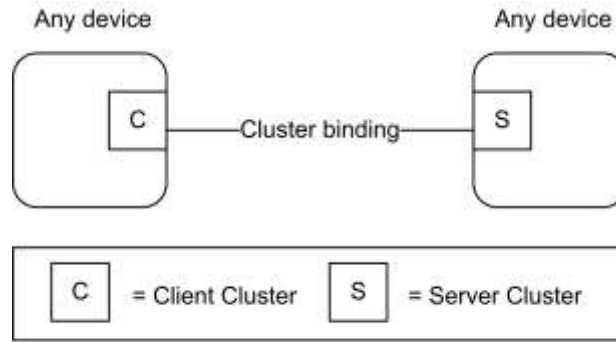

2202

*Note: Device names are examples for illustration purposes only*

2203  
 2204  
 2205  
 2206

A cluster is a related collection of commands and attributes, which together define an interface to specific functionality. Typically, the entity that stores the attributes of a cluster is referred to as the server of that cluster and an entity that affects or manipulates those attributes is referred to as the client of that cluster. However, if required, attributes MAY also be present on the client of a cluster.

2207  
 2208  
 2209  
 2210  
 2211

Commands that allow devices to manipulate attributes, e.g., in this document the read attribute (see 2.5.1) or write attribute (see 2.5.3) commands, are (typically) sent from a client device and received by the server device. Any response to those commands, e.g., in this document the read attribute response (see 2.5.2) or the write attribute response (see 2.5.5 commands), are sent from the server device and received by the client device.

2212  
 2213  
 2214

Conversely, the command that facilitates dynamic attribute reporting, i.e., the report attribute command (see 2.5.11) is (typically) sent from the server device (as typically this is where the attribute data itself is stored) and sent to the client device that has been bound to the server device.

2215  
 2216  
 2217  
 2218

A type 1 cluster’s primary function is to initiate transactions from the client to the server. For example: An On/Off client sends commands (data) to the On/Off server. A type 2 cluster’s primary function is to initiate transactions from the server to the client. For example: A Temperature Measurement server reports to the Temperature Measurement client. Please see [Z5] Application Architecture for more details.

2219  
 2220  
 2221  
 2222

The clusters supported by an application are identified through the simple descriptor (see [Z1] & [Z6]), specified on each active endpoint of a device. In the simple descriptor, the application input cluster list SHALL contain the list of server clusters supported on the device and the application output cluster list SHALL contain the list of client clusters supported on the device.

2223  
 2224

Methods and commands to discover and commission clusters are not defined in the document and are described in other documents such as [Z6] Zigbee PRO Base Device Specification.<sup>1</sup>

## 2225 **2.3 Functional Description**

2226

Global requirements for all clusters and commands are described here.

### 2227 **2.3.1 Transmission**

2228

ZCL frames are transmitted via the APS sub-layer by issuing the APSDE-DATA.request primitive.

2229  
 2230  
 2231

All sub-fields of ZCL frames, including individual bits, that are unspecified, or specified as reserved, SHALL be set to zero for transmission. This applies to all ZCL frames, including cluster-specific frames. Similarly, all reserved or unspecified bits of attributes of data type class Bitmap SHALL be set to zero for transmission.

<sup>1</sup> CCB 2874

## 2.3.2 Reception

2232 ZCL frames are received via the APS sub-layer by the reception of the APSDE-DATA.indication primitive.  
2233  
2234 On receipt of a command (including both general and cluster-specific commands) the device SHALL attempt  
2235 to parse and execute the command. During the parsing process for a non-manufacturer-specific command, it  
2236 SHALL ignore all reserved sub-fields of the ZCL frame, including individual reserved bits.  
2237 Note that, if any of these sub-fields are not set to zero, this MAY indicate that the format or interpretation of  
2238 the frame has been updated. However, it is the responsibility of the specifier of such an updated format that  
2239 it be backward compatible, i.e., any new format will result in the same functionality as before when parsed  
2240 by a device that supports the previous version of the cluster. Any additional octets found appended to the  
2241 frame SHALL also be ignored, as these MAY be added as part of such an updated frame format.  
2242 If the command is manufacturer-specific, handling of reserved sub-fields is determined by the manufacturer.  
2243 If required, the device SHALL then generate a response to the command. Responses are detailed in the spec-  
2244 ification of each command. If there is no response specified for a particular set of circumstances, (e.g., if the  
2245 command has been rejected or is not recognized, or the command has succeeded but there is no response  
2246 specified to indicate success), the Default Response command SHALL be generated, taking into account the  
2247 conditions in 2.5.12.2. The status code returned by the Default Response command SHALL be one of the  
2248 status enumerations listed in Table 2-12.

### 2.3.2.1 Broadcast Endpoint

2249 The device processing a message sent to the broadcast endpoint (0xff) SHALL:

- 2251 1. only deliver a copy of the message to the endpoints supporting the cluster indicated in the APS  
2252 Header.
- 2253 2. follow the Default Response command behavior described in section 2.5.12.2 (no response for non-  
2254 unicast messages).
- 2255 3. not generate error response messages, except when required by the Default Response command behav-  
2256 ior.

### 2.3.2.2 Broadcast Endpoint Recommendations

2257 Broadcast Endpoint Behavior Recommendations for Avoiding Network Congestion:

- 2258 1. A device SHOULD NOT send a broadcast message to the broadcast endpoint where a response is ex-  
2259 pected from every active endpoint. It is recommended to use discovery to determine the specific endpoint(s)  
2260 per device and then send individual messages that target those specific endpoints.  
2261
- 2262 2. A device processing a message sent to the broadcast endpoint SHOULD jitter messages that are sent in  
2263 response, especially when the nature of the message is such that it generates many responses (i.e. synchroni-  
2264 zation message).  
2265

2266 NOTE: Multicast group messages do not include an endpoint  
2267

## 2.3.3 Manufacturer Specific Extensions

2268 Manufacturers are free to extend the standard in the following ways:

- 2269 • Add manufacturer specific clusters to a standard device endpoint.
- 2270 • Add manufacturer specific commands to a standard cluster.
- 2271 • Add manufacturer specific attributes to a standard cluster.
- 2272



- 2273 All communications regarding manufacturer specific extensions SHALL be transmitted with the manufacturer specific sub-field of the frame control field set to 1 and the manufacturer code included in the frame.  
2274  
2275 If the manufacturer code in a command frame is not recognized, the command is not carried out.

## 2276 **2.3.4 Attribute, Command and Variable Data**

- 2277 This section defines terms (e.g. Variable) and rules for writing specification text, not for actual behavior.

### 2278 **2.3.4.1 Variable**

- 2279 A cluster variable (or variable) is a cluster data point with a defined value that is referenced in a cluster specification. A cluster attribute is a variable with a defined identifier, data type and access type. Optional  
2280 attributes MAY be referenced as variables in other attribute specifications within the same cluster specification.  
2281  
2282  
2283 A command field in a command payload is a variable with a defined data type.  
2284 A field within an attribute, such as one or more bits in a bitmap is a variable.  
2285 Cluster specifications also define variables that are not attributes or command fields, such as temporary calculated values, or persistent state values.  
2286  
2287 Any defined data value in a cluster specification is a variable.

### 2288 **2.3.4.2 Dependencies on Optional or Deprecated Variables**

- 2289  
2290 If the specification text of a cluster depends on the value of an optional or deprecated variable (e.g. attribute, command field, etc) of the same cluster, then the variable SHALL have a well-defined default value that  
2291 SHALL be used in place of the missing variable. This rule SHALL be recursive if there is a chain of dependencies. A deprecated attribute SHALL remain in a cluster's attribute table as a placeholder, with a default, if  
2292 required.  
2293  
2294  
2295 A fixed field in a command format definition SHALL always be present<sup>2</sup> and SHALL NOT be deprecated. However, the behavior associated with a field may be deprecated. It is good practice to define a default value  
2296 when deprecating a fixed field. See below for further default value requirements<sup>3</sup>  
2297

### 2298 **2.3.4.3 Default Value**

- 2299 If the default value of a variable is specified as “MS” or “ms”, then there is no default value and the application must return a manufacturer specific valid value that is in the valid range. A variable SHALL have a defined default value when:  
2300  
2301  
2302
  - the variable is new, and a default is required for backwards compatibility with legacy instances<sup>4</sup>  
2303
  - the variable is optional or deprecated (see 2.3.4.2)<sup>5</sup>  
2304
  - an initial value is needed before the application starts  
2305
  - the value cannot be determined by the application for the instance  
2306
  - the attribute is not implemented, but there is a dependency on the attribute value

<sup>2</sup> CCB 2287 for fixed fields in Energy commands that have defaults that mean fields is ignored

<sup>3</sup> CCB 2871 deprecating command fields and attributes

<sup>4</sup> CCB 2287 for fixed fields in Energy commands that have defaults that mean fields is ignored

<sup>5</sup> CCB 2877 command fields are variables with possible dependencies

2307 If the default value is not specified in this specification, then the default value is the Non-Value as specified  
 2308 in the data type specification, if defined. If no Non-Value is specified, then the default value SHALL be zero.  
 2309 See 2.6.2 for data types and definition of Non-Value

## 2310 2.3.4.4 Attribute Access

2311 Attributes MAY support these types of access that are listed in each cluster specification's attribute table for  
 2312 each attribute:

Access	Abrev	Description
Read	R	global commands that read the attribute value
Write	W	global commands that write a new value to the attribute
Read/Write	RW	Supports Read and Write access
Read*Write	R*W	Supports Read access. Write access as determined by the attribute implementation. If not writable, a returned status field SHALL be READ_ONLY, unless specified otherwise.
Report	P	global commands that report the value attribute or configure the attribute for reporting
Scene	S	if a Scenes server cluster instance is on the same endpoint, then the attribute is accessed through a scene as an extension field in the scenes table

2313 Local specific cluster commands for the cluster supporting the attribute MAY also access the attributes as  
 2314 defined in each cluster specification.

## 2315 2.3.4.5 Global Attributes

2316 Cluster global attributes (see 2.6.1.3) are either mandatory or optional. All cluster instances SHALL support  
 2317 mandatory global attributes.

2318 **Table 2-1. Global Attributes**

Id	Name	Type	Range	Access	Def	M/O
0xfffd	<i>ClusterRevision</i>	uint16	0x0001 - 0xfffe	R	0	M
0xfffe	<i>AttributeReportingStatus</i>	enum8	0x00 - 0xff	R	-	O

### 2319 2.3.4.5.1 ClusterRevision Attribute

2320 The *ClusterRevision* global attribute is mandatory for all cluster instances, client and server, conforming to  
 2321 ZCL revision 6 (ZCL6) and later ZCL revisions. A history of revision numbers for a cluster specification  
 2322 release is listed in the Revision History section for a cluster specification. Each new revision of a cluster  
 2323 specification SHALL specify a new revision number incremented (by 1) from the last. The latest, or last  
 2324 revision number in a cluster Revision History is the revision number for the cluster specification.<sup>6</sup> *ClusterRe-*  
 2325 *vision* SHALL represent the latest revision number of the cluster specification that has been implemented.

<sup>6</sup> CCB 2550 2885 clarify that Revision History table shows the latest valid ClusterRevision value,

- 2326 An implementation of a cluster specification before revision 6 of this Cluster Library SHALL have an assumed cluster revision of 0 (zero). For a new cluster specification, the initial value for the *ClusterRevision* attribute SHALL be 1 (not zero).
- 2327
- 2328
- 2329 An implementation of a new revision of a cluster specification SHALL interoperate with an implementation of an older revision of the cluster specification.
- 2330
- 2331 Interoperability with a cluster MAY require reading the *ClusterRevision* attribute. For example: If a new product application supporting revision 3 of cluster *X* wishes to take advantage of the new behavior that is mandated by revision 3, then the application SHOULD read the revision of the corresponding cluster *X* in each remote application. If a corresponding cluster *X* supports revision 3 or greater, then the behavior is supported. Conversely: Backward compatibility MAY require that a new cluster revision read the *ClusterRevision* of a corresponding cluster to support interoperability with legacy cluster revisions.
- 2332
- 2333
- 2334
- 2335
- 2336
- 2337 Please see [Z5] Application Architecture for more details.

### 2338 **2.3.4.5.2 AttributeReportingStatus Attribute**

- 2339 When reporting requires sending multiple *Report Attributes* commands, this attribute SHOULD be included in the last attribute record, to indicate that all required attributes have been reported, or that there are still attributes pending to be reported. The enumerated values for this attribute are outlined below:
- 2340
- 2341

2342 **Table 2-2. AttributeReportingStatus Enumerations**

Enumerated Value	Status
0x00	Pending
0x01	Attribute Reporting Complete

### 2343 **2.3.5 Persistent Data**

- 2344 Persistent data is persistent across a restart. A restart is a program restart (warm start) or power cycle (cold start), but not a factory reset.
- 2345
- 2346 Cluster attributes that represent configuration data SHALL be persistent data unless otherwise specified. For example: a writeable attribute that persistently changes the behavior (or mode) of the cluster. Examples of non-configuration data: data that is calculated or comes from an external source, such as a sensor value, a time value, etc.
- 2347
- 2348
- 2349
- 2350 Many clusters define persistent data that are not attributes. For example: The scene table that is part of a Scene cluster instance, or the Alarm Table in the Alarms cluster.
- 2351
- 2352 Commissioning or configuration data that is created to allow the cluster to perform its function is persistent data. For example: A reporting configuration for a cluster attribute.
- 2353
- 2354 An APS group table entry and an APS binding are both persistent data across a restart.
- 2355 A factory reset is a deliberate behavior to reset the above described persistent data back to its original state when the product left the factory.
- 2356

## 2357 **2.4 Command Frame Formats**

- 2358 All commands, defined in this specification, SHALL be transmitted to the stack using the message service.
- 2359 The transmission order for octets and bits of all ZCL elements is as specified in section 1.2.1.3 of the Zigbee Specification [Z1], i.e., least significant octet and bit first.
- 2360

2361 The command frame formats described in this document are not free-form and fields are positional. Some  
 2362 fields are dependent on a preceding field value (such as a length or format bitmap). All other fields are fixed  
 2363 and SHALL be present if a subsequent field is included in the frame. Optional fields at the end of a frame  
 2364 MAY be omitted, but also have requirements for defined default values (see 2.3.4.2 and 2.3.4.3).

## 2365 2.4.1 General Frame Format

2366 The ZCL frame format is composed of a ZCL header and a ZCL payload. The general ZCL frame SHALL  
 2367 be formatted as illustrated in Figure 2-2.

2368 **Figure 2-2. Format of the General ZCL Frame**

Bits: 8	0/16	8	8	Variable
Frame control	Manufacturer code	Transaction sequence number	Command identifier	Frame payload
ZCL header				ZCL payload

### 2369 2.4.1.1 Frame Control Field

2370 The frame control field is 8 bits in length and contains information defining the command type and other  
 2371 control flags. The frame control field SHALL be formatted as shown in Figure 2-3. Bits 5-7 are reserved for  
 2372 future use and SHALL be set to 0.

2373 **Figure 2-3. Format of the Frame Control Field**

Bits: 0-1	2	3	4	5-7
Frame type	Manufacturer specific	Direction	Disable Default Response	Reserved

#### 2374 2.4.1.1.1 Frame Type Sub-field

2375 The frame type sub-field is 2 bits in length and SHALL be set to one of the non-reserved values listed in  
 2376 Figure 2-4.

2377 **Figure 2-4. Values of the Frame Type Sub-field**

Frame Type	Description
00	Command is global for all clusters, including manufacturer specific clusters
01	Command is specific or local to a cluster

#### 2378 2.4.1.1.2 Manufacturer Specific Sub-field

2379 The manufacturer specific sub-field is 1 bit in length and specifies whether this command refers to a manu-  
 2380 facturer specific extension. If this value is set to 1, the manufacturer code field SHALL be present in the ZCL  
 2381 frame. If this value is set to 0, the manufacturer code field SHALL not be included in the ZCL frame. Man-  
 2382 ufacturer specific clusters SHALL support global commands (Frame Type 0b00).

2383 **2.4.1.1.3 Direction Sub-field**

2384 The direction sub-field specifies the client/server direction for this command. If this value is set to 1, the  
2385 command is being sent from the server side of a cluster to the client side of a cluster. If this value is set to 0,  
2386 the command is being sent from the client side of a cluster to the server side of a cluster.

2387 **2.4.1.1.4 Disable Default Response Sub-field**

2388 The disable Default Response sub-field is 1 bit in length. If it is set to 0, the Default Response command will  
2389 be returned, under the conditions specified in 2.5.12.2. If it is set to 1, the Default Response command will  
2390 only be returned if there is an error, also under the conditions specified in 2.5.12.2.

2391 This field SHALL be set to 1, for all response frames generated as the immediate and direct effect of a  
2392 previously received frame.

2393 **2.4.1.2 Manufacturer Code Field**

2394 The manufacturer code field is 16 bits in length and specifies the assigned manufacturer code for proprie-  
2395 tary extensions. This field SHALL only be included in the ZCL frame if the manufacturer specific sub-field  
2396 of the frame control field is set to 1. Please see [Z12] Manufacturer Code Database for a list of manufac-  
2397 turer codes.

2398

2399 **2.4.1.3 Transaction Sequence Number**

2400 The Transaction Sequence Number field is 8 bits in length and specifies an identification number for a single  
2401 transaction that includes one or more frames in both directions. Each time the first frame of a transaction is  
2402 generated, a new value SHALL be copied into the field. When a frame is generated as the specified effect on  
2403 receipt of a previous frame, then it is part of a transaction, and the Transaction Sequence Number SHALL be  
2404 copied from the previously received frame into the generated frame. This includes a frame that is generated  
2405 in response to request frame.

2406 The Transaction Sequence Number field can be used by a controlling device, which MAY have issued mul-  
2407 tiple commands, so that it can match the incoming responses to the relevant command.

2408 **2.4.1.4 Command Identifier Field**

2409 The Command Identifier field is 8 bits in length and specifies the cluster command being used. If the frame  
2410 type sub-field of the frame control field is set to 0b00, the command identifier corresponds to one of the non-  
2411 reserved values of Table 2-3. If the frame type sub-field of the frame control field is set to 0b01, the command  
2412 identifier corresponds to a cluster specific command. The cluster specific command identifiers can be found  
2413 in each individual document describing the clusters (see also 2.2.1.1).

2414 **2.4.1.5 Frame Payload Field**

2415 The frame payload field has a variable length and contains information specific to individual command types.  
2416 The maximum payload length for a given command is limited by the stack profile in use, in conjunction with  
2417 the applicable cluster specification and application profile. Fragmentation will be used where available.

2418 **2.5 General Command Frames**

---

2419 General command frames are used for manipulating attributes and other general tasks that are not specific to  
2420 an individual cluster.

2421 The command frames defined in this document are listed in Table 2-3. Each command frame SHALL be  
2422 constructed with the frame type sub-field of the frame control field set to 0b00.

2423 All clusters (server and client) SHALL support generation, reception and execution of the Default Response  
2424 command.

2425 Except for the optional Discover Attributes Extended commands and the optional Discover Commands com-  
2426 mands, each cluster (server or client) that implements attributes SHALL support reception of, execution of,  
2427 and response to all commands to discover, read, and write these attributes. However, if no attributes with  
2428 structured types are supported, it is not required to support the structured read and write commands.

2429 Implementation of commands to report, Configure Reporting of, and Read Reporting Configuration of at-  
2430 tributes is only mandatory if the cluster has attributes whose reportability is mandatory.

2431 Generation of request commands (e.g., Read Attributes, Write Attributes, etc), is application dependent.

2432

**Table 2-3. Commands**

<b>Command Identifier Field Value</b>	<b>Description</b>
0x00	Read Attributes
0x01	Read Attributes Response
0x02	Write Attributes
0x03	Write Attributes Undivided
0x04	Write Attributes Response
0x05	Write Attributes No Response
0x06	Configure Reporting
0x07	Configure Reporting Response
0x08	Read Reporting Configuration
0x09	Read Reporting Configuration Response
0x0a	Report attributes
0x0b	Default Response
0x0c	Discover Attributes
0x0d	Discover Attributes Response
0x0e	Read Attributes Structured
0x0f	Write Attributes Structured
0x10	Write Attributes Structured response
0x11	Discover Commands Received
0x12	Discover Commands Received Response
0x13	Discover Commands Generated
0x14	Discover Commands Generated Response

0x15	Discover Attributes Extended
0x16	Discover Attributes Extended Response

2433

## 2434 2.5.1 Read Attributes Command

### 2435 2.5.1.1 Read Attributes Command Frame Format

2436 The Read Attributes command frame SHALL be formatted as illustrated in Figure 2-5.

2437

Figure 2-5. Format of the Read Attributes Command Frame

Octets: Variable	2	2	...	2
ZCL header	Attribute identifier 1	Attribute identifier 2	...	Attribute identifier <i>n</i>

#### 2438 2.5.1.1.1 ZCL Header Fields

2439 The frame control field SHALL be specified as follows. The frame type sub-field SHALL be set to indicate  
 2440 a global command (0b00). The manufacturer specific sub-field SHALL be set to 0 if this command is being  
 2441 used to Read Attributes defined for any cluster in the ZCL or 1 if this command is being used to read manu-  
 2442 facturer specific attributes.

2443 The command identifier field SHALL be set to indicate the Read Attributes command (see Table 2-3).

#### 2444 2.5.1.1.2 Attribute Identifier Field

2445 The attribute identifier field is 16 bits in length and SHALL contain the identifier of the attribute that is to be  
 2446 read.

### 2447 2.5.1.2 When Generated

2448 The Read Attributes command is generated when a device wishes to determine the values of one or more  
 2449 attributes located on another device. Each attribute identifier field SHALL contain the identifier of the attrib-  
 2450 ute to be read.

### 2451 2.5.1.3 Effect on Receipt

2452 On receipt of this command, the device SHALL process each specified attribute identifier and generate a  
 2453 Read Attributes Response command. The Read Attributes Response command SHALL contain as many read  
 2454 attribute status records as attribute identifiers included in this command frame, subject to applicable space  
 2455 limitations. Each read attribute status record SHALL contain the corresponding attribute identifier from this  
 2456 command frame, a status value evaluated as described below, and, depending on the status value, the value  
 2457 of the attribute itself.

2458 For each attribute identifier included in the command frame, the device SHALL create an attribute status  
 2459 record as follows:

2460 If the attribute identifier does not correspond to an attribute that exists on this device, the device SHALL set  
 2461 the status field of the corresponding read attribute status record to UNSUPPORTED\_ATTRIBUTE and  
 2462 SHALL not include an attribute value field.

2463 If the attribute identified by the attribute identifier is supported, the device SHALL determine if the attribute  
 2464 status record carrying the attribute's current value fits into the remaining space available in the response  
 2465 frame. If the status record does not fit, the device SHALL set the status field of the corresponding read  
 2466 attribute status record to INSUFFICIENT\_SPACE and not include the data type and value fields. Otherwise  
 2467 the device SHALL set the status field of the corresponding read attribute status record to SUCCESS and  
 2468 SHALL set the attribute value field to its current value.

2469 If the resulting attribute status record does not fit into the response frame, the device SHALL transmit the  
 2470 response frame as assembled so far and terminate this process.

2471 Otherwise, the device SHALL then move on to the next attribute identifier.

## 2472 2.5.2 Read Attributes Response Command

### 2473 2.5.2.1 Read Attributes Response Command Frame 2474 Format

2475 The Read Attributes Response command frame SHALL be formatted as illustrated in Figure 2-6.

2476 **Figure 2-6. Format of Read Attributes Response Command Frame**

Octets: Variable	Variable	Variable	...	Variable
ZCL header	Read attribute status record 1	Read attribute status record 2	...	Read attribute status record <i>n</i>

2477 Each read attribute status record SHALL be formatted as illustrated in Figure 2-7.

2478 **Figure 2-7. Format of the Read Attributes Status Record Field**

Octets: 2	1	0 / 1	0 / Variable
Attribute identifier	Status	Attribute data type	Attribute value

#### 2479 2.5.2.1.1 ZCL Header Fields

2480 The frame control field SHALL be specified as follows. The frame type sub-field SHALL be set to indicate  
 2481 a global command (0b00). The manufacturer specific sub-field SHALL be set to 0 if this command is being  
 2482 used as a response to reading attributes defined for any cluster in the ZCL or 1 if this command is being used  
 2483 as a response to reading manufacturer specific attributes.

2484 The command identifier field SHALL be set to indicate the Read Attributes Response command (see Table  
 2485 2-3).

#### 2486 2.5.2.1.2 Attribute Identifier Field

2487 The attribute identifier field is 16 bits in length and SHALL contain the identifier of the attribute that has  
 2488 been read (or of which an element has been read). This field SHALL contain the same value that was included  
 2489 in the corresponding attribute identifier field of the original Read Attributes or Read Attributes Structured  
 2490 command.



2491 **2.5.2.1.3 Status Field**

2492 The status field is 8 bits in length and specifies the status of the read operation on this attribute. This field  
 2493 SHALL be set to SUCCESS, if the operation was successful, or an error code, as specified in 2.5.1.3, if the  
 2494 operation was not successful.

2495 **2.5.2.1.4 Attribute Data Type Field**

2496 The attribute data type field SHALL contain the data type of the attribute in the same Read Attributes status  
 2497 record (see 2.6.2). This field SHALL only be included if the associated status field contains a value of SUC-  
 2498 CESS.

2499 **2.5.2.1.5 Attribute Value Field**

2500 The attribute value field is variable in length and SHALL contain the current value of this attribute. This field  
 2501 SHALL only be included if the associated status field contains a value of SUCCESS.

2502 For an attribute or element of simple type (not array, structure, set or bag), this field has the format shown in  
 2503 the Table of Data Types (see 2.6.2). For an attribute or element of type array, set or bag, this field has the  
 2504 format shown in Figure 2-8.

2505 **Figure 2-8. Format of the Attribute Value Field for an Array, Set or Bag**

Octets: 1	2	Variable	...	Variable
Element type	Number of elements ( <i>m</i> )	Element value 1	...	Element value <i>m</i>

2506 (NB The reason that the Element type field is before the Number of elements field is so that the latter field is  
 2507 in the logical position for the zeroth element.)

2508 If the Number of elements field has the value 0xffff, this indicates that the attribute or element being read is  
 2509 invalid / undefined. In this case, or if the Number of elements field has the value 0, no Element value fields  
 2510 are included.

2511 For an attribute or element of type structure, this field has the format shown in Figure 2-9.

2512 **Figure 2-9. Format of the Attribute Value Field for a Structure**

Octets: 2	1	Variable	...	1	Variable
Number of elements ( <i>m</i> )	Element type 1	Element value 1	...	Element type <i>m</i>	Element value <i>m</i>

2513 In both figures, the Element value subfield follows the same format as that of the attribute value field. This  
 2514 format is thus recursive to any required depth (see Selector Field for limitations).

2515 If the Number of elements field has the value 0xffff, this indicates that the attribute or element being read is  
 2516 invalid / undefined. In this case, or if the Number of elements field has the value 0, no Element type or  
 2517 Element value fields are included.

2518 **2.5.2.2 When Generated**

2519 The Read Attributes Response command is generated in response to a Read Attributes or Read Attributes  
2520 Structured command. The command frame SHALL contain a read attribute status record for each attribute  
2521 identifier specified in the original Read Attributes or Read Attributes Structured command. For each read  
2522 attribute status record, the attribute identifier field SHALL contain the identifier specified in the original  
2523 Read Attributes or Read Attributes Structured command. The status field SHALL contain a suitable status  
2524 code, as detailed in 2.5.1.3.

2525 The attribute data type and attribute value field SHALL only be included in the read attribute status record if  
2526 the associated status field contains a value of SUCCESS and, where present, SHALL contain the data type  
2527 and current value, respectively, of the attribute, or element thereof, that was read.

2528 The length of this command may exceed a single frame, and thus fragmentation support may be needed to  
2529 return the entire response. If fragmentation is not supported, only as many read attribute status records as will  
2530 fit in the frame SHALL be returned.

2531 **2.5.2.3 Effect on Receipt**

2532 On receipt of this command, the originator is notified of the results of its original Read Attributes attempt  
2533 and, for each successful request, the value of the requested attribute.

2534 If fragmentation is not supported, and some trailing attribute status records have not been returned, due to  
2535 space limitations in the frame, the originator may issue an additional Read Attributes or Read Attributes  
2536 Structured command to obtain their values.

2537 **2.5.3 Write Attributes Command**2538 **2.5.3.1 Write Attributes Command Frame Format**

2539 The Write Attributes command frame SHALL be formatted as illustrated in Figure 2-10.

2540 **Figure 2-10. Format of the Write Attributes Command Frame**

Octets: Variable	Variable	Variable	...	Variable
ZCL header	Write attribute record 1	Write attribute record 2	...	Write attribute record <i>n</i>

2541 Each write attribute record SHALL be formatted as illustrated in Figure 2-11.

2542 **Figure 2-11. Format of the Write Attribute Record Field**

Octets: 2	1	Variable
Attribute identifier	Attribute data type	Attribute data

2543 **2.5.3.1.1 ZCL Header Fields**

2544 The frame control field SHALL be specified as follows. The frame type sub-field SHALL be set to indicate  
2545 a global command (0b00). The manufacturer specific sub-field SHALL be set to 0 if this command is being  
2546 used to Write Attributes defined for any cluster in the ZCL or 1 if this command is being used to write  
2547 manufacturer specific attributes.

2548 The command identifier field SHALL be set to indicate the Write Attributes command (see Table 2-3).

2549 **2.5.3.1.2 Attribute Identifier Field**

2550 The attribute identifier field is 16 bits in length and SHALL contain the identifier of the attribute that is to be  
2551 written.

2552 **2.5.3.1.3 Attribute Data Type Field**

2553 The attribute data type field SHALL contain the data type of the attribute that is to be written.

2554 **2.5.3.1.4 Attribute Data Field**

2555 The attribute data field is variable in length and SHALL contain the actual value of the attribute that is to be  
2556 written.

2557 **2.5.3.2 When Generated**

2558 The Write Attributes command is generated when a device wishes to change the values of one or more at-  
2559 tributes located on another device. Each write attribute record SHALL contain the identifier and the actual  
2560 value of the attribute to be written.

2561 **2.5.3.3 Effect on Receipt**

2562 On receipt of this command, the device SHALL attempt to process each specified write attribute record and  
2563 SHALL construct a write attribute response command (2.5.5). Each write attribute status record of the con-  
2564 structed command SHALL contain the identifier from the corresponding write attribute record and a status  
2565 value evaluated as described below.

2566 For each write attribute record included in the command frame, the device SHALL make the error checks  
2567 listed below, in the order shown. If an error is detected, a corresponding write attribute status record SHALL  
2568 be generated, the status SHALL be set according to the check below, and the device SHALL move on to the  
2569 next write attribute record.

- 2570 1. If the attribute is not supported on this device, the status field of the corresponding write attribute sta-  
2571 tus record SHALL be set to UNSUPPORTED\_ATTRIBUTE.
- 2572 2. If the attribute data type field is incorrect, the device SHALL set the status field of the corresponding  
2573 write attribute status record to INVALID\_DATA\_TYPE.
- 2574 3. If the attribute is designated as read only, the device SHALL set the status field of the corresponding  
2575 write attribute status record to READ\_ONLY.
- 2576 4. If the device is not currently accepting write attribute commands for the attribute, the status field of the  
2577 corresponding write attribute status record SHALL be set to NOT\_AUTHORIZED or READ\_ONLY.
- 2578 5. If the supplied value is not within the specified range of the attribute, the status field of the correspond-  
2579 ing write attribute status record SHALL be set to INVALID\_VALUE.
- 2580 6. If the device cannot support the supplied value, the status field of the corresponding write attribute sta-  
2581 tus record SHALL be set to INVALID\_VALUE.

2582 If the above error checks pass without generating a write attribute status record, the device SHALL write the  
2583 supplied value to the identified attribute, and SHALL move on to the next write attribute record.

2584 When all write attribute records have been processed, the device SHALL generate the constructed Write  
2585 Attributes Response command. If there are no write attribute status records in the constructed command,  
2586 indicating that all attributes were written successfully, a single write attribute status record SHALL be in-  
2587 cluded in the command, with the status field set to SUCCESS and the attribute identifier field omitted.

2588 **2.5.4 Write Attributes Undivided Command**

2589 The Write Attributes Undivided command is generated when a device wishes to change the values of one or  
2590 more attributes located on another device, in such a way that if any attribute cannot be written (e.g., if an  
2591 attribute is not implemented on the device, or a value to be written is outside its valid range), no attribute  
2592 values are changed.

2593 In all other respects, including generation of a Write Attributes Response command, the format and operation  
2594 of the command is the same as that of the Write Attributes Command, except that the command identifier  
2595 field SHALL be set to indicate the Write Attributes Undivided command (see Table 2-3).

2596 **2.5.5 Write Attributes Response Command**2597 **2.5.5.1 Write Attributes Response Command Frame  
2598 Format**

2599 The Write Attributes Response command frame SHALL be formatted as illustrated in Figure 2-12.

2600 **Figure 2-12. Format of Write Attributes Response Command Frame**

Octets: Variable	3	3	...	3
ZCL header	Write attribute status record 1	Write attribute status record 2	...	Write attribute status record <i>n</i>

2601

2602 Each write attribute status record SHALL be formatted as illustrated in Figure 2-13.

2603 **Figure 2-13. Format of the Write Attribute Status Record Field**

Octets: 1	2
Status	Attribute identifier

2604 **2.5.5.1.1 ZCL Header Fields**

2605 The frame control field SHALL be specified as follows. The frame type sub-field SHALL be set to indicate  
2606 a global command (0b00). The manufacturer specific sub-field SHALL be set to 0 if this command is being  
2607 used as a response to writing attributes defined for any cluster in the ZCL or 1 if this command is being used  
2608 as a response to writing manufacturer specific attributes.

2609 The command identifier field SHALL be set to indicate the Write Attributes Response command (see Table  
2610 2-3).

2611 **2.5.5.1.2 Status Field**

2612 The status field is 8 bits in length and specifies the status of the write operation attempted on this attribute,  
2613 as detailed in 2.5.3.3.

2614 Note that write attribute status records are not included for successfully written attributes, to save bandwidth.  
2615 In the case of successful writing of all attributes, only a single write attribute status record SHALL be in-  
2616 cluded in the command, with the status field set to SUCCESS and the attribute identifier field omitted.

2617 **2.5.5.1.3 Attribute Identifier Field**

2618 The attribute identifier field is 16 bits in length and SHALL contain the identifier of the attribute on which  
 2619 the write operation was attempted.

2620 **2.5.5.2 When Generated**

2621 The Write Attributes Response command is generated in response to a Write Attributes command.

2622 **2.5.5.3 Effect on Receipt**

2623 On receipt of this command, the device is notified of the results of its original Write Attributes command.

2624 **2.5.6 Write Attributes No Response Command**

2625 **2.5.6.1 Write Attributes No Response Command Frame**  
 2626 **Format**

2627 The Write Attributes No Response command frame SHALL be formatted as illustrated in Figure 2-14.

2628 **Figure 2-14. Write Attributes No Response Command Frame**

Octets: Variable	Variable	Variable	...	Variable
ZCL header	Write attribute record 1	Write attribute record 2	...	Write attribute record <i>n</i>

2629

2630 Each write attribute record SHALL be formatted as illustrated in Figure 2-11.

2631 **2.5.6.1.1 ZCL Header Fields**

2632 The frame control field SHALL be specified as follows. The frame type sub-field SHALL be set to indicate  
 2633 a global command (0b00). The manufacturer specific sub-field SHALL be set to 0 if this command is being  
 2634 used to Write Attributes defined for any cluster in the ZCL or 1 if this command is being used to write  
 2635 manufacturer specific attributes.

2636 The command identifier field SHALL be set to indicate the Write Attributes No Response command (see  
 2637 Table 2-3).

2638 **2.5.6.1.2 Write Attribute Records**

2639 Each write attribute record SHALL be formatted as illustrated in Figure 2-11. Its fields have the same mean-  
 2640 ing and contents as the corresponding fields of the Write Attributes command.

2641 **2.5.6.2 When Generated**

2642 The Write Attributes No Response command is generated when a device wishes to change the value of one  
 2643 or more attributes located on another device but does not require a response. Each write attribute record  
 2644 SHALL contain the identifier and the actual value of the attribute to be written.

2645 **2.5.6.3 Effect on Receipt**

2646 There SHALL NOT be any response, error response, or Default Response command, to this command.

2647 On receipt of this command, the device SHALL attempt to process each specified write attribute record.

2648 For each write attribute record included in the command frame, the device SHALL first check that it corresponds to an attribute that is implemented on this device. If it does not, the device SHALL ignore the attribute and move on to the next write attribute record.

2649

2650

2651 If the attribute identified by the attribute identifier is supported, the device SHALL check whether the attribute is writable. If the attribute is designated as read only, the device SHALL ignore the attribute and move on to the next write attribute record.

2652

2653

2654 If the attribute is writable, the device SHALL check that the supplied value in the attribute data field is within the specified range of the attribute. If the supplied value does not fall within the specified range of the attribute, the device SHALL ignore the attribute and move on to the next write attribute record.

2655

2656

2657 If the value supplied in the attribute data field is within the specified range of the attribute, the device SHALL write the supplied value to the identified attribute and move on to the next write attribute record.

2658

2659 **2.5.7 Configure Reporting Command**

2660 The Configure Reporting command is used to configure the reporting mechanism for one or more of the attributes of a cluster.

2661

2662 The individual cluster definitions specify which attributes SHALL be available to this reporting mechanism, however specific implementations of a cluster may make additional attributes available.

2663

2664 Note that attributes with data types of array, structure, set or bag cannot be reported.

2665 **2.5.7.1 Configure Reporting Command Frame Format**

2666 The Configure Reporting command frame SHALL be formatted as illustrated in Figure 2-15.

2667 **Figure 2-15. Format of the Configure Reporting Command Frame**

Octets: Variable	Variable	Variable	...	Variable
ZCL header	Attribute reporting configuration record 1	Attribute reporting configuration record 2	...	Attribute reporting configuration record <i>n</i>

2668 There SHALL be one attribute reporting configuration record for each attribute to be configured. Each such record SHALL be formatted as illustrated in Figure 2-16.

2670 **Figure 2-16. Format of the Attribute Reporting Configuration Record**

Octets: 1	2	0/1	0/2	0/2	0/Variable	0/2
Direction	Attribute identifier	Attribute data type	Minimum reporting interval	Maximum reporting interval	Reportable change	Timeout period

2671 **2.5.7.1.1 ZCL Header Fields**

2672 The frame control field SHALL be specified as follows. The frame type sub-field SHALL be set to indicate a global command (0b00). The manufacturer specific sub-field SHALL be set to 0 if this command is being used to configure attribute reports defined for any cluster in the ZCL or 1 if this command is being used to configure attribute reports for manufacturer specific attributes.

2673

2674

2675

2676 The command identifier field SHALL be set to indicate the report configuration command (see Table 2-3).

2677 **2.5.7.1.2 Direction Field**

2678 The direction field specifies whether values of the attribute are to be reported, or whether reports of the  
 2679 attribute are to be received.

2680 If this value is set to 0x00, then the attribute data type field, the minimum reporting interval field, the maxi-  
 2681 mum reporting interval field and the reportable change field are included in the payload, and the timeout  
 2682 period field is omitted. The record is sent to a cluster server (or client) to configure how it sends reports to a  
 2683 client (or server) of the same cluster.

2684 If this value is set to 0x01, then the timeout period field is included in the payload, and the attribute data type  
 2685 field, the minimum reporting interval field, the maximum reporting interval field and the reportable change  
 2686 field are omitted. The record is sent to a cluster client (or server) to configure how it SHOULD expect reports  
 2687 from a server (or client) of the same cluster.

2688 All other values of this field are reserved.

2689 **Table 2-4. Destination of Reporting Based on Direction Field**

Direction Field	Destinations
0x00	The receiver of the Configure Reporting command SHALL Configure Report- ing to send to each destination as resolved by the bindings for the cluster host- ing the attributes to be reported.
0x01	This indicates to the receiver of the Configure Reporting command that the sender has configured its reporting mechanism to transmit reports and that, based on the current state of the sender’s bindings, the sender will send re- ports to the receiver.

2690 **2.5.7.1.3 Attribute Identifier Field**

2691 If the direction field is 0x00, this field contains the identifier of the attribute that is to be reported. If instead  
 2692 the direction field is 0x01, the device SHALL expect reports of values of this attribute.

2693 **2.5.7.1.4 Attribute Data Type Field**

2694 The Attribute data type field contains the data type of the attribute that is to be reported.

2695 **2.5.7.1.5 Minimum Reporting Interval Field**

2696 The minimum reporting interval field is 16 bits in length and SHALL contain the minimum interval, in sec-  
 2697 onds, between issuing reports of the specified attribute.

2698 If this value is set to 0x0000, then there is no minimum limit, unless one is imposed by the specification of  
 2699 the cluster using this reporting mechanism or by the application.

2700 **2.5.7.1.6 Maximum Reporting Interval Field**

2701 The maximum reporting interval field is 16 bits in length and SHALL contain the maximum interval, in  
 2702 seconds, between issuing reports of the specified attribute.

2703 If this value is set to 0xffff, then the device SHALL not issue reports for the specified attribute, and the  
 2704 configuration information for that attribute need not be maintained. (**Note:** in an implementation using dy-  
 2705 namic memory allocation, the memory space for that information may then be reclaimed).

2706 If this value is set to 0x0000, and the minimum reporting interval field does not equal 0xffff there SHALL  
2707 be no periodic reporting, but change based reporting SHALL still be operational.

2708 If this value is set to 0x0000 and the Minimum Reporting Interval Field equals 0xffff, then the device SHALL  
2709 revert to its default reporting configuration. The reportable change field, if present, SHALL be set to zero.

2710

### 2711 **2.5.7.1.7 Reportable Change Field**

2712 The reportable change field SHALL contain the minimum change to the attribute that will result in a report  
2713 being issued. This field is of variable length. For attributes with 'analog' data type (see 2.6.2), the field has  
2714 the same data type as the attribute. The sign (if any) of the reportable change field is ignored.

2715 For attributes of 'discrete' data type (see 2.6.2), this field is omitted.

2716 If the Maximum Reporting Interval Field is set to 0xffff (terminate reporting configuration), or the Maximum  
2717 Reporting Interval Field is set to 0x0000 and the Minimum Reporting Interval Field equals 0xffff, indicating  
2718 a (default reporting configuration) then if this field is present, it SHALL be set to zero upon transmission and  
2719 ignored upon reception.

### 2720 **2.5.7.1.8 Timeout Period Field**

2721 The timeout period field is 16 bits in length and SHALL contain the maximum expected time, in seconds,  
2722 between received reports for the attribute specified in the attribute identifier field. If more time than this  
2723 elapses between reports, this may be an indication that there is a problem with reporting.

2724 If this value is set to 0x0000, reports of the attribute are not subject to timeout.

2725 Note that, for a server/client connection to work properly using automatic reporting, the timeout value set for  
2726 attribute reports to be received by the client (or server) cluster must be set somewhat higher than the maxi-  
2727 mum reporting interval set for the attribute on the server (or client) cluster.

## 2728 **2.5.7.2 When Generated**

2729 The report configuration command is generated when a device wishes to configure a device to automatically  
2730 report the values of one or more of its attributes, or to receive such reports.

## 2731 **2.5.7.3 Effect on Receipt**

2732 On receipt of this command, the device SHALL attempt to process each attribute reporting configuration  
2733 record and SHALL construct a Configure Reporting Response command. Each attribute status record of the  
2734 constructed command SHALL contain an identifier from an attribute reporting configuration record and a  
2735 status value evaluated as described below.

2736 If the direction field is 0x00, indicating that the reporting intervals and reportable change are being config-  
2737 ured, then

- 2738 • If the attribute specified in the attribute identifier field is not implemented on this device, the device  
2739 SHALL construct an attribute status record with the status field set to UNSUPPORTED\_ATTRIB-  
2740 UTE.
- 2741 • Else, if the attribute type is set to array, structure, set or bag the device SHALL construct an attribute  
2742 status record with the status field set to UNREPORTABLE\_ATTRIBUTE<sup>7</sup>.
- 2743 • Else, if the attribute identifier in this field cannot be reported (because it is not in the list of mandatory  
2744 reportable attributes in the relevant cluster specification, and support has also not been implemented as

---

<sup>7</sup> CCB 2543



2745 a manufacturer option), the device SHALL construct an attribute status record with the status field set  
 2746 to UNREPORTABLE\_ATTRIBUTE.

2747 • Else, if the attribute data type field is incorrect, the device SHALL construct an attribute status record  
 2748 with the status field set to INVALID\_DATA\_TYPE.

2749 • Else, if the minimum reporting interval field is less than any minimum set by the relevant cluster speci-  
 2750 fication or application, or the value of the maximum reporting interval field is non-zero and is less than  
 2751 that of the minimum reporting interval field, the device SHALL construct an attribute status record  
 2752 with the status field set to INVALID\_VALUE.

2753 • Else, if the value of the minimum or maximum reporting interval field is not supported by the product,  
 2754 the device SHALL construct an attribute status record with the status field set to INVALID\_VALUE.

2755 • Else the device SHALL set the minimum and maximum reporting intervals and the reportable change  
 2756 for the attribute to the values contained in the corresponding fields.

2757 Else the direction field is 0x01, indicating that the timeout period is being configured, then

2758 If reports of values of the attribute identifier specified in the attribute identifier field cannot be received  
 2759 (because it is not in the list of mandatory reportable attributes in the relevant cluster specification, and support  
 2760 has also not been implemented as a manufacturer option), or the timeout feature is not supported, the device  
 2761 SHALL construct an attribute status record with the status field set to UNREPORTABLE\_ATTRIBUTE<sup>8</sup>.

2762 Else the device SHALL set the timeout value for the attribute identifier specified in the attribute identifier  
 2763 field to the value of the timeout period field. Note that the action to be taken by the device if the timeout  
 2764 period is exceeded is cluster and device dependent, including optionally taking no action.

2765 When all attribute reporting configuration records have been processed, the device SHALL generate the con-  
 2766 structed Configure Reporting Response command. If there are no attribute status records in the constructed  
 2767 command, indicating that all attributes were configured successfully, a single attribute status record SHALL  
 2768 be included in the command, with the status field set to SUCCESS and the direction and attribute identifier  
 2769 fields omitted.

2770 The device SHALL then proceed to generate or receive attribute reports according the configuration just set  
 2771 up, by means of the Report Attributes command (see 2.5.11.2.1 through 2.5.11.2.4). See Table 2-4 to deter-  
 2772 mine the destination of the Report Attributes command.

## 2.5.8 Configure Reporting Response Command

2773 The Configure Reporting Response command is used to respond to a Configure Reporting command.

### 2.5.8.1 Configure Reporting Response Command Frame Format

2774 The Configure Reporting Response command frame SHALL be formatted as illustrated in Figure 2-17.

2775 **Figure 2-17. Format of the Configure Reporting Response Command Frame**

Octets: Variable	4	4	...	4
ZCL header	Attribute status record 1	Attribute status record 2	...	Attribute status record <i>n</i>

<sup>8</sup> CCB 2543 error code wrong

2779 Each attribute status record SHALL be formatted as illustrated in Figure 2-18.

2780 **Figure 2-18. Format of the Attribute Status Record Field**

Octets: 1	1	2
Status	Direction	Attribute identifier

### 2781 **2.5.8.1.1 ZCL Header Fields**

2782 The frame control field is specified as follows. The frame type sub-field SHALL be set to indicate a global  
2783 command (0b00). The manufacturer specific sub-field SHALL be set to 0 if this command is being used as  
2784 a response to configuring attribute reports defined for any cluster in the ZCL or 1 if this command is being  
2785 used as a response to configuring attribute reports for manufacturer specific attributes.

2786 The command identifier field SHALL be set to indicate the report configuration response command (see  
2787 Table 2-3).

### 2788 **2.5.8.1.2 Direction Field**

2789 The direction field specifies whether values of the attribute are reported (0x00), or whether reports of the  
2790 attribute are received (0x01).

2791 All other values of this field are reserved.

### 2792 **2.5.8.1.3 Status Field**

2793 The status field specifies the status of the Configure Reporting operation attempted on this attribute, as de-  
2794 tailed in 2.5.7.3.

2795 Note that attribute status records are not included for successfully configured attributes, to save bandwidth.  
2796 In the case of successful configuration of all attributes, only a single attribute status record SHALL be in-  
2797 cluded in the command, with the status field set to SUCCESS and the direction and attribute identifier fields  
2798 omitted.

## 2799 **2.5.8.2 When Generated**

2800 The Configure Reporting Response command is generated in response to a Configure Reporting command.

### 2801 **2.5.8.3 Effect on Receipt**

2802 On receipt of this command, the device is notified of the success (or otherwise) of its original Configure  
2803 Reporting command, for each attribute.

## 2804 **2.5.9 Read Reporting Configuration Command**

2805 The Read Reporting Configuration command is used to read the configuration details of the reporting mech-  
2806 anism for one or more of the attributes of a cluster.

2807 **2.5.9.1 Read Reporting Configuration Command Frame**  
 2808 **Format**

2809 The Read Reporting Configuration command frame SHALL be formatted as illustrated in Figure 2-19.

2810 **Figure 2-19. Read Reporting Configuration Command Frame**

<b>Octets: Variable</b>	<b>3</b>	<b>3</b>	<b>...</b>	<b>3</b>
ZCL header	Attribute record 1	Attribute record 2	...	Attribute record <i>n</i>

2811

2812 Each attribute record SHALL be formatted as illustrated in Figure 2-20.

2813 **Figure 2-20. Format of the Attribute Status Record Field**

<b>Octets: 1</b>	<b>2</b>
Direction	Attribute identifier

2814 **2.5.9.1.1 ZCL Header Fields**

2815 The frame control field SHALL be specified as follows. The frame type sub-field SHALL be set to indicate  
 2816 a global command (0b00). The manufacturer specific sub-field SHALL be set to 0 if this command is being  
 2817 used to read the reporting configuration of attributes defined for any cluster in the ZCL or 1 if this command  
 2818 is being used to read the reporting configuration of manufacturer specific attributes.

2819 The command identifier field SHALL be set to indicate the Read Reporting Configuration command (see  
 2820 Table 2-3).

2821 **2.5.9.1.2 Direction Field**

2822 The direction field specifies whether values of the attribute are reported (0x00), or whether reports of the  
 2823 attribute are received (0x01).

2824 All other values of this field are reserved.

2825 **2.5.9.1.3 Attribute Identifier Field**

2826 The attribute identifier field SHALL contain the identifier of the attribute whose reporting configuration  
 2827 details are to be read.

2828 **2.5.9.2 Effect on Receipt**

2829 On receipt of this command, a device SHALL generate a Read Reporting Configuration Response command  
 2830 containing the details of the reporting configuration for each of the attributes specified in the command (see  
 2831 2.5.10).

2832 **2.5.10 Read Reporting Configuration Response Com-**  
 2833 **mand**

2834 The Read Reporting Configuration Response command is used to respond to a Read Reporting Configuration  
 2835 command.

### 2836 **2.5.10.1 Read Reporting Configuration Response Com-** 2837 **mand Frame Format**

2838 The Read Reporting Configuration Response command frame SHALL be formatted as illustrated in Figure  
2839 2-21.

2840 **Figure 2-21. Format of the Read Reporting Configuration Response Command Frame**

Octets: Variable	Variable	Variable	...	Variable
ZCL header	Attribute reporting con- figuration record 1	Attribute reporting configuration record 2	...	Attribute reporting con- figuration record <i>n</i>

2841  
2842 There SHALL be one attribute reporting configuration record for each attribute record of the received Read  
2843 Reporting Configuration command. Each such record SHALL be formatted as illustrated in Figure 2-22.

2844 **Figure 2-22. Attribute Reporting Configuration Record Field**

Octets: 1	1	2	0/1	0/2	0/2	0/Variable	0/2
Status	Direction	Attribute identifier	Attribute data type	Minimum reporting interval	Maximum reporting in- terval	Reportable change	Timeout period

#### 2845 **2.5.10.1.1 ZCL Header Fields**

2846 The frame control field SHALL be specified as follows. The frame type sub-field SHALL be set to indicate  
2847 a global command (0b00). The manufacturer specific sub-field SHALL be set to 0 if this command is being  
2848 used to for attributes specified in the ZCL or 1 if this command is being used for manufacturer specific  
2849 attributes.

2850 The command identifier field SHALL be set to indicate the Read Reporting Configuration Response com-  
2851 mand (see Table 2-3).

#### 2852 **2.5.10.1.2 Status Field**

2853 If the attribute is not implemented on the sender or receiver of the command, whichever is relevant (depend-  
2854 ing on direction), this field SHALL be set to UNSUPPORTED\_ATTRIBUTE. If the attribute is supported,  
2855 but is not capable of being reported, this field SHALL be set to UNREPORTABLE\_ATTRIBUTE. If the  
2856 attribute is supported and reportable, but there is no report configuration, this field SHALL be set to  
2857 NOT\_FOUND. Otherwise, this field SHALL be set to SUCCESS.

2858 If the status field is not set to SUCCESS, all fields except the direction and attribute identifier fields SHALL  
2859 be omitted.

#### 2860 **2.5.10.1.3 Direction Field**

2861 The direction field specifies whether values of the attribute are reported (0x00), or whether reports of the  
2862 attribute are received (0x01).

2863 If this value is set to 0x00, then the attribute data type field, the minimum reporting interval field, the maxi-  
2864 mum reporting interval field and the reportable change field are included in the payload, and the timeout  
2865 period field is omitted. If this value is set to 0x01, then the timeout period field is included in the payload,  
2866 and the attribute data type field, the minimum reporting interval field, the maximum reporting interval field  
2867 and the reportable change field are omitted.

2868 All other values of this field are reserved.

#### 2869 **2.5.10.1.4 Attribute Identifier Field**

2870 The attribute identifier field is 16 bits in length and SHALL contain the identifier of the attribute that the  
2871 reporting configuration details apply to.

#### 2872 **2.5.10.1.5 Minimum Reporting Interval Field**

2873 The minimum reporting interval field is 16 bits in length and SHALL contain the minimum interval, in sec-  
2874 onds, between issuing reports for the attribute specified in the attribute identifier field. If the minimum re-  
2875 porting interval has not been configured, this field SHALL contain the value 0xffff.

#### 2876 **2.5.10.1.6 Maximum Reporting Interval Field**

2877 The maximum reporting interval field is 16 bits in length and SHALL contain the maximum interval, in  
2878 seconds, between issuing reports for the attribute specified in the attribute identifier field. If the maximum  
2879 reporting interval has not been configured, this field SHALL contain the value 0xffff.

#### 2880 **2.5.10.1.7 Reportable Change Field**

2881 The reportable change field SHALL contain the minimum change to the attribute that will result in a report  
2882 being issued. For attributes with Analog data type (see 2.6.2), the field has the same data type as the attribute.  
2883 If the reportable change has not been configured, this field SHALL contain the invalid value for the relevant  
2884 data type.

2885 For attributes of Discrete or Composite data (see 2.6.2), this field is omitted.

#### 2886 **2.5.10.1.8 Timeout Period Field**

2887 The timeout period field is 16 bits in length and SHALL contain the maximum expected time, in seconds,  
2888 between received reports for the attribute specified in the attribute identifier field. If the timeout period has  
2889 not been configured, this field SHALL contain the value 0xffff.

### 2890 **2.5.10.2 When Generated**

2891 The Read Reporting Configuration Response command is generated in response to a Read Reporting Con-  
2892 figuration command. Only as many attribute reporting configuration records as will fit in the frame SHALL  
2893 be returned.

### 2894 **2.5.10.3 Effect on Receipt**

2895 On receipt of this command, the originator is notified of the results of its original Read Reporting Configu-  
2896 ration command.

2897 If some trailing attribute reporting configuration records have not been returned, due to space limitations in  
2898 the frame, the originator may issue a further Read Reporting Configuration command to obtain their values.

## 2899 **2.5.11 Report Attributes Command**

2900 The Report Attributes command is used by a device to report the values of one or more of its attributes to  
2901 another device. Individual clusters, defined elsewhere in the ZCL, define which attributes are to be reported  
2902 and at what interval. See 2.5.7 to determine the destination of the Report Attributes command.

2903 **2.5.11.1 Report Attributes Command Frame Format**

2904 The Report Attributes command frame SHALL be formatted as illustrated in Figure 2-23.

2905 **Figure 2-23. Format of the Report Attributes Command Frame**

Octets: Variable	Variable	Variable	...	Variable
ZCL header	Attribute report 1	Attribute report 2	...	Attribute report <i>n</i>

2906 Each attribute report field SHALL be formatted as illustrated in Figure 2-24.

2907 **Figure 2-24. Format of the Attribute Report Fields**

Octets: 2	1	Variable
Attribute identifier	Attribute data type	Attribute data

2908 **2.5.11.1.1 ZCL Header Fields**

2909 The frame control field SHALL be specified as follows. The frame type sub-field SHALL be set to indicate  
2910 a global command (0b00). The manufacturer specific sub-field SHALL be set to 0 if this command is being  
2911 used to Report Attributes defined for any cluster in the ZCL or 1 if this command is being used to report  
2912 manufacturer specific attributes.

2913 The command identifier field SHALL be set to indicate the Report Attributes command (see Table 2-3).

2914 **2.5.11.1.2 Attribute Identifier Field**

2915 The attribute identifier field is 16 bits in length and SHALL contain the identifier of the attribute that is being  
2916 reported. When reporting requires sending multiple *Report Attributes* commands see 2.3.4.5.2.

2917 **2.5.11.1.3 Attribute Data Type Field**

2918 The attribute data type field contains the data type of the attribute that is being reported.

2919 **2.5.11.1.4 Attribute Data Field**

2920 The attribute data field is variable in length and SHALL contain the actual value of the attribute being re-  
2921 ported.

2922 **2.5.11.2 When Generated**

2923 The Report Attributes command is generated when a device has been configured to report the values of one  
2924 or more of its attributes to another device., and when the conditions that have been configured are satisfied.  
2925 These conditions are detailed in the following sections.

2926 A Report Attributes command may also be configured locally on a device at any time. Except for the source,  
2927 a locally created report configuration SHALL be no different than a configuration received externally. A  
2928 locally created report configuration SHALL support the same services as a configuration received externally.

2929 If the destination of the Report Attributes Command cannot be determined, then the command SHALL not  
2930 be generated. See 2.5.7 to determine the destination of the Report Attributes command.

2931 **2.5.11.2.1 Periodic Reporting**

2932 A report SHALL be generated when the time that has elapsed since the previous report of the same attribute  
2933 is equal to the Maximum Reporting Interval for that attribute (see 2.5.7.1.6). The time of the first report after  
2934 configuration is not specified.

2935 **2.5.11.2.2 Changes to 'Discrete' Attributes**

2936 If the attribute has a 'discrete' data type, a report SHALL be generated when the attribute undergoes any  
2937 change of value. Discrete types are general data types (which are often used as sets of bit fields), logical  
2938 types, bitmap types, enumerations, strings, identifiers, IEEE address and security key (see 2.6.2).

2939 Reporting is subject to the Minimum Reporting Interval for that attribute (see 2.5.7.1.5). After a report, no  
2940 further reports are sent during this interval.

2941 **2.5.11.2.3 Changes to 'Analog' Attributes**

2942 If the attribute has an 'analog' data type, a report SHALL be generated when the attribute undergoes a change  
2943 of value, in a positive or negative direction, equal to or greater than the Reportable Change for that attribute  
2944 (see 2.5.7.1.7). The change is measured from the value of the attribute when the Reportable Change is con-  
2945 figured, and thereafter from the previously reported value of the attribute.

2946 Analog types are signed and unsigned integer types, floating point types and time types (see 2.6.2).

2947 Reporting is subject to the Minimum Reporting Interval for that attribute (see 2.5.7.1.5). After a report, no  
2948 further reports are sent during this interval.

2949 **2.5.11.2.4 Cluster Specific Conditions**

2950 The specification for a cluster may add additional conditions for specific attributes of that cluster.

2951 **2.5.11.2.5 Consolidation of Attribute Reporting**

2952 To reduce the resources (such as the number of timers) required for attribute reporting, a device may adapt  
2953 the timing of reports by relaxing the configured minimum and maximum periods as described below. By  
2954 employing these techniques, a device may limit the number of timers required to any manufacturer specific  
2955 value, including use of only a single timer, though at the cost of some side effects, such as increased network  
2956 traffic in some cases.

2957 In consolidating timers, several principles apply:

- 2958 1. The maximum reporting interval of an attribute may be reduced, as it SHOULD not normally cause a  
2959 problem to devices to receive reports more frequently than expected – typical reporting intervals are  
2960 seconds to minutes. It may not be increased, as this may be incompatible with any timeout period set.
- 2961 2. The minimum reporting interval of an attribute may also be reduced. However, it may not be in-  
2962 creased, as an application may be relying on receiving reports of changes to an attribute within a given  
2963 delay time. Minimum values are generally used to reduce network traffic, but this is less important  
2964 than ensuring that the application timing needs are satisfied.
- 2965 3. From (1), when consolidating the maximum reporting periods of two or more attributes together, the  
2966 consolidated reporting period SHALL be equal to the lowest of the configured maximum intervals of  
2967 the attributes to be reported.
- 2968 4. Similarly, from (2), when consolidating the minimum reporting periods of two or more attributes to-  
2969 gether, the consolidated reporting period SHALL be equal to the lowest of the configured minimum  
2970 intervals of the attributes to be reported.

2971 As a first step, timers for attributes on the same cluster may be consolidated. Such adaptations SHOULD aim  
2972 to send attribute reports for different attributes of the same cluster at the same time, so that they can be  
2973 consolidated into fewer attribute reports, thus reducing network traffic.

2974 To reduce the number of timers further, timers may be consolidated across clusters and endpoints if needed.

2975 (Note that it is not generally possible to consolidate timeout values (see 2.5.7.1.8) of received attribute re-  
2976 ports.)

### 2977 **2.5.11.3 Effect on Receipt**

2978 On receipt of this command, a device is notified of the latest values of one or more of the attributes of another  
2979 device.

## 2980 **2.5.12 Default Response Command**

### 2981 **2.5.12.1 Default Response Command Frame Format**

2982 The Default Response command frame SHALL be formatted as illustrated in Figure 2-25.

2983 **Figure 2-25. Format of the Default Response Command Frame**

Octets: Variable	1	1
ZCL header	Command identifier	Status code

#### 2984 **2.5.12.1.1 ZCL Header Fields**

2985 The frame control field SHALL be specified as follows. The frame type sub-field SHALL be set to indicate  
2986 a global command (0b00). The manufacturer specific sub-field SHALL be set to 0 if this command is being  
2987 sent in response to a command defined for any cluster in the ZCL or 1 if this command is being sent in  
2988 response to a manufacturer specific command.

2989 The command identifier sub-field SHALL be set to indicate the Default Response command (see Table 2-3).

#### 2990 **2.5.12.1.2 Command Identifier Field**

2991 The command identifier field is 8 bits in length and specifies the identifier of the received command to which  
2992 this command is a response.

#### 2993 **2.5.12.1.3 Status Code Field**

2994 The status code field is 8 bits in length and specifies either SUCCESS or the nature of the error that was  
2995 detected in the received command. It SHALL be one of the status enumerations listed in Table 2-12.

### 2996 **2.5.12.2 When Generated**

2997 The Default Response command SHALL be generated when all 4 of these criteria are met:

- 2998 5. A device receives a unicast command that is not a Default Response command.
- 2999 6. No other command is sent in response to the received command, using the same Transaction sequence  
3000 number as the received command.



3001 7. The Disable Default Response bit of its Frame control field is set to 0 (see 2.4.1.1.4) or when an error  
 3002 results.

3003 8. The “Effect on Receipt” clause for the received command does not override the behavior of when a  
 3004 Default Response command is sent.

3005 If a device receives a command in error through a broadcast or multicast transmission, the command SHALL  
 3006 be discarded and the Default Response command SHALL not be generated.

3007 If the identifier of the received command is not supported on the device, it SHALL set the command identifier  
 3008 field to the value of the identifier of the command received in error. The status code field SHALL be set to  
 3009 UNSUP\_COMMAND<sup>9</sup>.  
 3010

3011 If the device receives a unicast cluster command to a particular endpoint, and the cluster does not exist on  
 3012 the endpoint, the status code field SHALL be set to UNSUPPORTED\_CLUSTER. Receiving devices  
 3013 SHOULD accept other error status codes, such as FAILURE, from devices certified before ZCL revision 6.

3014 The Default Response command SHALL be generated in response to reception of all commands, including  
 3015 response commands (such as the Write Attributes Response command), under the conditions specified above.  
 3016 However, the Default Response command SHALL not be generated in response to reception of another De-  
 3017 fault Response command.

3018 **2.5.12.3 Effect on Receipt**

3019 On receipt of this command, the device is notified of the success or otherwise of the generated command  
 3020 with the same transaction sequence number (see 2.4.1.3).

3021 **2.5.13 Discover Attributes Command**

3022 **2.5.13.1 Discover Attributes Command Frame Format**

3023 The Discover Attributes command frame SHALL be formatted as illustrated in Figure 2-26.

3024 **Figure 2-26. Format of the Discover Attributes Command Frame**

Octets: Variable	2	1
ZCL header	Start attribute identifier	Maximum attribute identifiers

3025 **2.5.13.1.1 ZCL Header Fields**

3026 The frame control field SHALL be specified as follows. The frame type sub-field SHALL be set to indicate  
 3027 a global command (0b00). The manufacturer specific sub-field SHALL be set to 0 to discover standard at-  
 3028 tributes in a cluster or 1 to discover manufacturer specific attributes in either a standard or a manufacturer  
 3029 specific cluster.

3030 The command identifier field SHALL be set to indicate the Discover Attributes command (see Table 2-3).

3031 **2.5.13.1.2 Start Attribute Identifier Field**

3032 The start attribute identifier field is 16 bits in length and specifies the value of the identifier at which to begin  
 3033 the attribute discovery.

<sup>9</sup> CCB 2477 Status Code Cleanup: UNSUP\_COMMAND is renamed UNSUP\_CLUSTER\_COMMAND

3034 **2.5.13.1.3 Maximum Attribute Identifiers Field**

3035 The maximum attribute identifiers field is 8 bits in length and specifies the maximum number of attribute  
3036 identifiers that are to be returned in the resulting Discover Attributes Response command.

3037 **2.5.13.2 When Generated**

3038 The Discover Attributes command is generated when a remote device wishes to discover the identifiers and  
3039 types of the attributes on a device which are supported within the cluster to which this command is directed.

3040 **2.5.13.3 Effect on Receipt**

3041 On receipt of this command, the device SHALL construct an ordered list of attribute information records,  
3042 each containing a discovered attribute identifier and its data type, in ascending order of attribute identifiers.  
3043 This list SHALL start with the first attribute that has an identifier that is equal to or greater than the identifier  
3044 specified in the start attribute identifier field. **The number of attribute identifiers included in the list**  
3045 **SHALL not exceed that specified in the maximum attribute identifiers field.**

3046 **The device SHALL then generate a Discover Attributes Response command containing the discovered**  
3047 **attributes and their types, and SHALL return it to the originator of the Discover Attributes command.**

3048 **2.5.14 Discover Attributes Response Command**3049 **2.5.14.1 Discover Attributes Response Command Frame**  
3050 **Format**

3051 The Discover Attributes Response command frame SHALL be formatted as illustrated in Figure 2-27.

3052 **Figure 2-27. Discover Attributes Response Command Frame**

<b>Octets: Variable</b>	<b>1</b>	<b>3</b>	<b>3</b>	<b>...</b>	<b>3</b>
ZCL header	Discovery complete	Attribute information 1	Attribute information 2	...	Attribute information <i>n</i>

3053

3054 Each attribute information field SHALL be formatted as illustrated in Figure 2-28.

3055 **Figure 2-28. Format of the Attribute Report Fields**

<b>Octets: 2</b>	<b>1</b>
Attribute identifier	Attribute data type

3056 **2.5.14.1.1 ZCL Header Fields**

3057 The frame control field SHALL be specified as follows. The frame type sub-field SHALL be set to indicate  
3058 a global command (0b00). The manufacturer specific sub-field SHALL be set to the same value included in  
3059 the original Discover Attributes command.

3060 The command identifier field SHALL be set to indicate the Discover Attributes Response command (see  
3061 Table 2-3).

3062 **2.5.14.1.2 Discovery Complete Field**

3063 The discovery complete field is a Boolean field. A value of 0 indicates that there are more attributes to be  
 3064 discovered that have an attribute identifier value greater than the last attribute identifier in the last attribute  
 3065 information field. A value of 1 indicates that there are no more attributes to be discovered.

3066 **2.5.14.1.3 Attribute Identifier Field**

3067 The attribute identifier field SHALL contain the identifier of a discovered attribute. Attributes SHALL be  
 3068 included in ascending order, starting with the lowest attribute identifier that is greater than or equal to the  
 3069 start attribute identifier field of the received Discover Attributes command.

3070 **2.5.14.1.4 Attribute Data Type Field**

3071 The attribute data type field SHALL contain the data type of the attribute in the same attribute report field  
 3072 (see 2.6.2).

3073 **2.5.14.2 When Generated**

3074 The Discover Attributes Response command is generated in response to a Discover Attributes command.

3075 **2.5.14.3 Effect on Receipt**

3076 On receipt of this command, the device is notified of the results of its attribute discovery request.  
 3077 Following the receipt of this command, if the discovery complete field indicates that there are more attributes  
 3078 to be discovered, the device may choose to send subsequent discover attribute request commands to obtain  
 3079 the rest of the attribute identifiers. In this case, the start attribute identifier specified in the next attribute  
 3080 discovery request command SHOULD be set equal to one plus the last attribute identifier received in the  
 3081 Discover Attributes Response command.

3082 **2.5.15 Read Attributes Structured Command**

3083 **2.5.15.1 Read Attributes Structured Command Frame**  
 3084 **Format**

3085 The Read Attributes Structured command frame SHALL be formatted as illustrated in Figure 2-29.

3086 **Figure 2-29. Format of Read Attributes Structured Command Frame**

<b>Octets: Variable</b>	<b>2</b>	<b>Variable</b>	<b>...</b>	<b>2</b>	<b>Variable</b>
ZCL header	Attribute identifier 1	Selector 1	...	Attribute identifier <i>n</i>	Selector <i>n</i>

3087 **2.5.15.1.1 ZCL Header Fields**

3088 The frame control field SHALL be specified as follows. The frame type sub-field SHALL be set to indicate  
 3089 a global command (0b00). The manufacturer specific sub-field SHALL be set to 0 if this command is being  
 3090 used to Read Attributes defined for any cluster in the ZCL or 1 if this command is being used to read manu-  
 3091 facturer specific attributes.

3092 The command identifier field SHALL be set to indicate the Read Attributes Structured command (see Table  
 3093 2-3).

3094 **2.5.15.1.2 Attribute Identifier Field**

3095 The attribute identifier field is 16 bits in length and SHALL contain the identifier of the attribute that is to be  
3096 read.

3097 **2.5.15.1.3 Selector Field**

3098 Each attribute identifier field is followed by a selector field, which specifies whether the whole of the attribute  
3099 value is to be read, or only an individual element of it. An individual element may only be read from attributes  
3100 with types of Array or Structure.

3101 The Selector field SHALL be formatted as illustrated in Figure 2-30.

3102 **Figure 2-30. Format of the Selector Field**

<b>Octets: 1</b>	<b>2</b>	<b>...</b>	<b>2</b>
Indicator ( <i>m</i> )	Index 1	...	Index <i>m</i>

3103  
3104 The Indicator subfield indicates the number of index fields that follow it. This number is limited to the range  
3105 0 - 15. It may be further limited by an application. All other values of this field are reserved.

3106 If this subfield is 0, there are no index fields, and the whole of the attribute value is to be read. For attributes  
3107 of type other than array or structure, this subfield SHALL have the value 0.

3108 If this subfield is 1 or greater, the index fields indicate which element is to be read, nested to a depth of *m*.  
3109 For example, if the attribute is an array of arrays (or structures), then if *m* = 2, index 1 = 5 and index 2 = 3,  
3110 the third element of the fifth element of the attribute will be read.

3111 Note that elements are numbered from 1 upwards for both arrays and structures. The zeroth element of an  
3112 array or structure is readable, always has type 16 bit unsigned integer, and returns the number of elements  
3113 contained in the array or structure.

3114 **2.5.15.2 When Generated**

3115 The Read Attributes command is generated when a device wishes to determine the values of one or more  
3116 attributes, or elements of attributes, located on another device. Each attribute identifier field SHALL contain  
3117 the identifier of the attribute to be read.

3118 **2.5.15.3 Effect on Receipt**

3119 On receipt of this command, the device SHALL process each specified attribute identifier and associated  
3120 selector, and SHALL generate a Read Attributes Response command. The Read Attributes Response com-  
3121 mand SHALL contain as many read attribute status records as there are attribute identifiers included in this  
3122 command frame. Each read attribute status record SHALL contain the corresponding attribute identifier from  
3123 this command frame, a status value evaluated as described below, and, depending on the status value, the  
3124 value of the attribute (or attribute element) itself.

3125 For each attribute identifier included in the command frame, the device SHALL first check that it corresponds  
3126 to an attribute that exists on this device, and that its associated selector field correctly indicates either the  
3127 whole of the attribute or an element of the attribute. If it does not, the device SHALL set the status field of  
3128 the corresponding read attribute status record to either UNSUPPORTED\_ATTRIBUTE or INVALID\_SE-  
3129 LECTOR as appropriate, and SHALL not include an attribute value field. The device SHALL then move on  
3130 to the next attribute identifier.

3131 If the attribute identified by the attribute identifier is supported, and its associated selector field is valid, the  
 3132 device SHALL set the status field of the corresponding read attribute status record to SUCCESS and SHALL  
 3133 set the attribute value field to the value of the attribute (or its selected element). The device SHALL then  
 3134 move on to the next attribute identifier.

## 3135 2.5.16 Write Attributes Structured Command

### 3136 2.5.16.1 Write Attributes Structured Command Frame 3137 Format

3138 The Write Attributes Structured command frame SHALL be formatted as illustrated in Figure 2-31.

3139 **Figure 2-31. Write Attributes Structured Command Frame**

Octets: Variable	Variable	Variable	...	Variable
ZCL header	Write attribute record 1	Write attribute record 2	...	Write attribute record <i>n</i>

3140 Each write attribute record SHALL be formatted as illustrated in Figure 2-32.

3141 **Figure 2-32. Format of the Write Attribute Record Field**

Octets: 2	Variable	1	Variable
Attribute identifier	Selector	Attribute data type	Attribute value

#### 3142 2.5.16.1.1 ZCL Header Fields

3143 The frame control field SHALL be specified as follows. The frame type sub-field SHALL be set to indicate  
 3144 a global command (0b00). The manufacturer specific sub-field SHALL be set to 0 if this command is being  
 3145 used to Write Attributes defined for any cluster in the ZCL or 1 if this command is being used to write  
 3146 manufacturer specific attributes.

3147 The command identifier field SHALL be set to indicate the Write Attributes Structured command (see Table  
 3148 2-3).

#### 3149 2.5.16.1.2 Attribute Identifier Field

3150 The attribute identifier field is 16 bits in length and SHALL contain the identifier of the attribute that is to be  
 3151 written (or an element of which is to be written).

#### 3152 2.5.16.1.3 Selector Field

3153 The selector field specifies whether the whole of the attribute value is to be written, or only an individual  
 3154 element of it. An individual element may only be written to attributes with types of Array, Structure, Set or  
 3155 Bag.

3156 The Selector field SHALL be formatted as illustrated in Figure 2-33.

3157 **Figure 2-33. Format of the Selector Field**

Octets: 1	2	...	2
Indicator ( <i>m</i> )	Index 1	...	Index <i>m</i>

#### 3158 **2.5.16.1.4 Writing an Element to an Array or Structure**

3159 When writing an element to an array or structure, the Indicator subfield indicates the number of index fields  
3160 that follow it. This number is limited to the range 0 - 15 (i.e., the upper 4 bits of the Indicator field are set to  
3161 zero). It may be further limited by an application.

3162 If the Indicator subfield is 0, there are no index fields, and the whole of the attribute value is to be written.

3163 If this subfield is 1 or greater, the index fields indicate which element is to be written, nested to a depth of m.  
3164 For example, if the attribute is an array of arrays (or structures), then if m = 2, index 1 = 5 and index 2 = 3,  
3165 the third element of the fifth element of the attribute will be written.

3166 Note that elements are numbered from 1 upwards for both arrays and structures.

3167 The zeroth element of an array or structure has type 16-bit unsigned integer, and holds the number of elements  
3168 in the array or structure. The zeroth element of an array may optionally be written (this is application depend-  
3169 ent) and has the effect of changing the number of elements of the array. If the number is reduced, the array  
3170 is truncated. If the number is increased, the content of new elements is application dependent.

3171 The zeroth element of a structure may not be written to. Writing to an element with an index greater than the  
3172 number of elements in an array or structure is always an error.

#### 3173 **2.5.16.1.5 Adding/Removing an Element to/from a Set or Bag**

3174 This command may also be used to add an element to a set or bag, or to remove an element from a set or bag.

3175 In this case, the lower 4 bits of the Indicator subfield still indicate the number of index fields that follow it,  
3176 as the set may be an element of an array or structure, which may itself be nested inside other arrays or struc-  
3177 tures.

3178 The upper 4 bits of the Indicator subfield have the following values:

3179	0b0000	Write whole set/bag
3180	0b0001	Add element to the set/bag
3181	0b0010	Remove element from the set/bag

3182 All other values are reserved.

#### 3183 **2.5.16.1.6 Attribute Data Type Field**

3184 The attribute data type field SHALL contain the data type of the attribute or element thereof that is to be  
3185 written.

#### 3186 **2.5.16.1.7 Attribute Value Field**

3187 The attribute value field is variable in length and SHALL contain the actual value of the attribute, or element  
3188 thereof, that is to be written. For an attribute or element of type array, structure, set or bag, this field has the  
3189 same format as for the Read Attributes Structured command (see Read Attributes Structured Command).

### 3190 **2.5.16.2 When Generated**

3191 The Write Attributes Structured command is generated when a device wishes to change the values of one or  
3192 more attributes located on another device. Each write attribute record SHALL contain the identifier and the  
3193 actual value of the attribute, or element thereof, to be written.

### 3194 2.5.16.3 Effect on Receipt

3195 On receipt of this command, the device SHALL attempt to process each specified write attribute record and  
3196 SHALL construct a write attribute structured response command. Each write attribute status record of the  
3197 constructed command SHALL contain the identifier from the corresponding write attribute record and a sta-  
3198 tus value evaluated as described below.

3199 For each write attribute record included in the command frame, the device SHALL first check that it corre-  
3200 sponds to an attribute that is implemented on this device and that its associated selector field correctly indi-  
3201 cates either the whole of the attribute or an element of the attribute. If it does not (e.g., an index is greater  
3202 than the number of elements of an array), the device SHALL set the status field of the corresponding write  
3203 attribute status record to either UNSUPPORTED\_ATTRIBUTE or INVALID\_SELECTOR as appropriate  
3204 and move on to the next write attribute record.

3205 If the attribute identified by the attribute identifier is supported, the device SHALL check whether the attrib-  
3206 ute data type field is correct. (**Note:** If the element being written is the zeroth element of an array (to change  
3207 the length of the array) the data type must be 16-bit unsigned integer). If not, the device SHALL set the status  
3208 field of the corresponding write attribute status record to INVALID\_DATA\_TYPE and move on to the next  
3209 write attribute record.

3210 If the attribute data type is correct, the device SHALL check whether the attribute is writable. If the attribute  
3211 is designated as read only, the device SHALL set the status field of the corresponding write attribute status  
3212 record to READ\_ONLY and move on to the next write attribute record. (**Note:** If an array may not have its  
3213 length changed, its zeroth element is read only).

3214 If the attribute is writable, the device SHALL check that all the supplied basic (e.g., integer, floating point)  
3215 values in the attribute value field are within the specified ranges of the elements they are to be written to. If  
3216 a supplied value does not fall within the specified range of its target element, the device SHALL set the status  
3217 field of the corresponding write attribute status record to INVALID\_VALUE, SHALL set the selector field  
3218 of that record to indicate that target element, and SHALL move on to the next write attribute record.

3219 The returned selector SHALL have the number of indices necessary to specify the specific low-level element  
3220 that failed, which will be the same as or greater than the number of indices in the selector of the write attribute  
3221 record. Note that if the element being written is the zeroth element of an array (to change the length of the  
3222 array) and the requested new length is not acceptable to the application, the value being written is considered  
3223 outside the specified range of the element.

3224 If the value supplied in the attribute value field is within the specified range of the attribute, the device  
3225 SHALL proceed as follows.

3226 • If an element is being added to a set, and there is an element of the set that has the same value as the  
3227 value to be added, the device SHALL set the status field of the corresponding write attribute status rec-  
3228 ord to DUPLICATE\_ENTRY and move on to the next write attribute record.

3229 • Else, if an element is being removed from a set or a bag, and there is no element of the set or bag that  
3230 has the same value as the value to be removed, the device SHALL set the status field of the corre-  
3231 sponding write attribute status record to NOT\_FOUND and move on to the next write attribute record.

3232 • Otherwise, the device SHALL write, add or remove the supplied value to/from the identified attribute  
3233 or element, as appropriate, and SHALL move on to the next write attribute record. In this (successful)  
3234 case, a write attribute status record SHALL not be generated. (**Note:** If the element being written is the  
3235 zeroth element of an array, the length of the array SHALL be changed. If the length is reduced, the ar-  
3236 ray is truncated. If the length is increased, the content of new elements is application dependent.)

3237 When all write attribute records have been processed, the device SHALL generate the constructed Write  
3238 Attributes Response command. If there are no write attribute status records in the constructed command,  
3239 because all attributes were written successfully, a single write attribute status record SHALL be included in  
3240 the command, with the status field set to SUCCESS and the attribute identifier field omitted.

3241 **2.5.17 Write Attributes Structured Response Command**3242 **2.5.17.1 Write Attributes Structured Response Command**  
3243 **Frame Format**

3244 The Write Attributes Response command frame SHALL be formatted as illustrated in Figure 2-34.

3245 **Figure 2-34. Write Attributes Structured Response Command Frame**

Octets: Variable	Variable	Variable	...	Variable
ZCL header	Write attribute status record 1	Write attribute status record 2	...	Write attribute status record <i>n</i>

3246  
3247 Each write attribute status record SHALL be formatted as illustrated in Figure 2-35.3248 **Figure 2-35. Format of the Write Attribute Status Record Field**

Octets: 1	2	Variable
Status	Attribute identifier	Selector

3249 **2.5.17.1.1 ZCL Header Fields**3250 The frame control field SHALL be specified as follows. The frame type sub-field SHALL be set to indicate  
3251 a global command (0b00). The manufacturer specific sub-field SHALL be set to 0 if this command is being  
3252 used to Write Attributes defined for any cluster in the ZCL or 1 if this command is being used to write  
3253 manufacturer specific attributes.3254 The command identifier field SHALL be set to indicate the Write Attributes Structured response command  
3255 (see Table 2-3).3256 **2.5.17.1.2 Status Field**3257 The status field is 8 bits in length and specifies the status of the write operation attempted on this attribute,  
3258 as detailed in Effect on Receipt 2.5.16.3.3259 Note that write attribute status records are not included for successfully written attributes, to save bandwidth.  
3260 In the case of successful writing of all attributes, only a single write attribute status record SHALL be included  
3261 in the command, with the status field set to SUCCESS and the attribute identifier and selector fields  
3262 omitted.3263 **2.5.17.1.3 Attribute Identifier Field**3264 The attribute identifier field is 16 bits in length and SHALL contain the identifier of the attribute on which  
3265 the write operation was attempted.3266 **2.5.17.1.4 Selector Field**3267 The selector field SHALL specify the element of the attribute on which the write operation that failed was  
3268 attempted. See Figure 2-33 for the structure of this field.



3269 From the structure shown in Figure 2-33, note that for all attribute data types other than array or structure  
 3270 this field consists of a single octet with value zero. For array or structure types, a single octet with value zero  
 3271 indicates that no information is available about which element of the attribute caused the failure.

### 3272 **2.5.17.2 When Generated**

3273 The Write Attributes Structured response command is generated in response to a Write Attributes Structured  
 3274 command.

### 3275 **2.5.17.3 Effect on Receipt**

3276 On receipt of this command, the device is notified of the results of its original Write Attributes Structured  
 3277 command.

## 3278 **2.5.18 Discover Commands Received Command**

3279 This command may be used to discover all commands processed (received) by this cluster, including op-  
 3280 tional or manufacturer-specific commands.

### 3281 **2.5.18.1 Discover Commands Received Command Frame 3282 Format**

3283 The discover server commands command frame SHALL be formatted as follows.

3284 **Figure 2-36. Format of the Discover Server Commands Command Frame**

<b>Octets:</b>	Variable	1	1
<b>Field:</b>	ZCL header	Start command identifier	Maximum command identifiers

3285

#### 3286 **2.5.18.1.1 ZCL Header Fields**

3287 The frame control field SHALL be specified as follows. The frame type sub-field SHALL be set to in-  
 3288 dicate a global command (0b00). The manufacturer-specific sub-field SHALL be set to 0 to discover stand-  
 3289 ard commands in a cluster or 1 to discover manufacturer-specific commands in either a standard or a  
 3290 manufacturer-specific cluster. A manufacturer ID in this field of 0xffff (wildcard) will discover any manu-  
 3291 facture-specific commands. The direction bit SHALL be 0 (client to server) to discover commands that  
 3292 the server can process. The direction bit SHALL be 1 (server to client) to discover commands that the client  
 3293 can process.

3294 The command identifier field SHALL be set to indicate the Discover Commands Received command.

#### 3295 **2.5.18.1.2 Start Command Identifier Field**

3296 The start command identifier field is 8-bits in length and specifies the value of the identifier at which to  
 3297 begin the command discovery.

#### 3298 **2.5.18.1.3 Maximum Command Identifiers Field**

3299 The maximum command identifiers field is 8-bits in length and specifies the maximum number of com-  
 3300 mand identifiers that are to be returned in the resulting Discover Commands Received Response.

3301 **2.5.18.2 When Generated**

3302 The Discover Commands Received command is generated when a remote device wishes to discover the  
3303 optional and mandatory commands the cluster to which this command is sent can process.

3304 **2.5.18.3 Effect on Receipt**

3305 On receipt of this command, the device SHALL construct an ordered list of command identifiers. This list  
3306 SHALL start with the first command that has an identifier that is equal to or greater than the identifier spec-  
3307 ified in the start command identifier field. The number of command identifiers included in the list SHALL  
3308 not exceed that specified in the maximum command identifiers field.

3309 **2.5.19 Discover Commands Received Response**

3310 The Discover Commands Received Response command is sent in response to a Discover Commands Re-  
3311 ceived command, and is used to discover which commands a cluster can process.

3312 **2.5.19.1 Discover Commands Received Response Frame**

3313 The Discover Commands Received Response command frame SHALL be formatted as shown below:

3314 **Figure 2-37. Format of the Discover Commands Received Response Frame**

<b>Octets:</b>	Variable	1	1	1	...	1
<b>Field:</b>	ZCL Header	Discovery complete	Command identifier 1	Command identifier 2	...	Command identifier n

3315

3316 **2.5.19.1.1 ZCL Header Fields**

3317 The frame control field SHALL be specified as follows. The frame type sub-field SHALL be set to indicate  
3318 a global command (0b00). The manufacturer-specific sub-field SHALL be set to the same value included in  
3319 the original discover commands command, with the exception that if the manufacture ID is 0xffff (wild-  
3320 card), then the response will contain the manufacture ID of the manufacturer-specific commands, or will  
3321 not be present if the cluster supports no manufacturer-specific extensions, or the manufacturer wishes to  
3322 hide the fact that it supports extensions. The command identifier field SHALL be set to indicate the Dis-  
3323 cover Commands Received Response command.

3324 **2.5.19.1.2 Discovery Complete Field**

3325 The discovery complete field is a boolean field. A value of 0 indicates that there are more commands to be  
3326 discovered. A value of 1 indicates that there are no more commands to be discovered.

3327 **2.5.19.1.3 Command Identifier Field**

3328 The command identifier field SHALL contain the identifier of a discovered command. Commands SHALL  
3329 be included in ascending order, starting with the lowest attribute identifier that is greater than or equal to  
3330 the start attribute identifier field of the received discover server commands command.

### 3331 **2.5.19.2 When Generated**

3332 The Discover Commands Received Response is generated in response to a Discover Commands Received  
3333 command.

### 3334 **2.5.19.3 Effect on Receipt**

3335 On receipt of this command, the device is notified of the results of its command discovery request. Follow-  
3336 ing the receipt of this command, if the discovery complete field indicates that there are more commands to  
3337 be discovered, the device may choose to send subsequent discover command request commands to obtain  
3338 the rest of the command identifiers. In this case, the start command identifier specified in the next com-  
3339 mand discovery request command SHOULD be set equal to one plus the last command identifier received  
3340 in the Discover Commands Received Response.

## 3341 **2.5.20 Discover Commands Generated Command**

3342 This command may be used to discover all commands which may be generated (sent) by the cluster, in-  
3343 cluding optional or manufacturer-specific commands.

### 3344 **2.5.20.1 Discover Commands Generated Command 3345 Frame Format**

3346 Except for the command ID in the ZCL header, the Discover Commands Generated command frame  
3347 SHALL be formatted as described in sub-clause 2.5.18 and its subsections.

### 3348 **2.5.20.2 When Generated**

3349 The Discover Commands Generated command is generated when a remote device wishes to discover the  
3350 commands that a cluster may generate on the device to which this command is directed.

### 3351 **2.5.20.3 Effect on Receipt**

3352 On receipt of this command, the device SHALL construct an ordered list of command identifiers. This list  
3353 SHALL start with the first command that has an identifier that is equal to or greater than the identifier spec-  
3354 ified in the start command identifier field. The number of command identifiers included in the list SHALL  
3355 not exceed that specified in the maximum command identifiers field.

## 3356 **2.5.21 Discover Commands Generated Response**

3357 The Discover Commands Generated Response command is sent in response to a Discover Commands Gen-  
3358 erated command, and is used to discover which commands a cluster supports.

### 3359 **2.5.21.1 Discover Commands Generated Response 3360 Frame**

3361 Except for the command ID in the ZCL header, the Discover Commands Generated Response command  
3362 frame SHALL be formatted as described in sub-clause 2.5.18 and its subsections.

### 3363 **2.5.21.2 When Generated**

3364 The Discover Commands Generated Response is generated in response to a Discover Commands Gener-  
3365 ated command.

3366 **2.5.21.3 Effect on Receipt**

3367 On receipt of this command, the device is notified of the results of its Discover Commands Generated com-  
3368 mand.

3369 Following the receipt of this command, if the discovery complete field indicates that there are more com-  
3370 mands to be discovered, the device may choose to send subsequent Discover Commands Generated com-  
3371 mands to obtain the rest of the command identifiers. In this case, the start command identifier specified in  
3372 the next Discover Commands Generated command SHOULD be set equal to one plus the last command  
3373 identifier received in the Discover Commands Generated Response.

3374 **2.5.22 Discover Attributes Extended Command**

3375 This command is similar to the discover attributes command, but also includes a field to indicate whether  
3376 the attribute is readable, writeable or reportable.

3377 **2.5.22.1 Discover Attributes Extended Command Frame  
3378 Format**

3379 The Discover Attributes Extended command frame SHALL be formatted as illustrated as follows.

3380 **Figure 2-38. Format of the Discover Attributes Extended Command Frame**

<b>Octets:</b>	Variable	2	1
<b>Field:</b>	ZCL Header	Start attribute identifier	Maximum attribute identifiers

3381

3382 **2.5.22.1.1 ZCL Header Fields**

3383 The frame control field SHALL be specified as follows. The frame type sub-field SHALL be set to indicate  
3384 a global command (0b00). The manufacturer-specific sub-field SHALL be set to 0 to discover standard at-  
3385 tributes in a cluster or 1 to discover manufacturer-specific attributes in either a standard or a manufacturer-  
3386 specific cluster. A manufacturer ID in this field of 0xffff (wildcard) will discover any manufacture-specific  
3387 attributes. The direction bit SHALL be 0 (client to server) to discover attributes that the server hosts. The  
3388 direction bit SHALL be 1 (server to client) to discover attributes that the client may host.

3389 The command identifier field SHALL be set to indicate the Discover Attributes Extended command.

3390 **2.5.22.1.2 Start Attribute Identifier Field**

3391 The start attribute identifier field is 16-bits in length and specifies the value of the identifier at which to  
3392 begin the attribute discovery.

3393 **2.5.22.1.3 Maximum Attribute Identifiers Field**

3394 The maximum attribute identifiers field is 8 bits in length and specifies the maximum number of attribute  
3395 identifiers that are to be returned in the resulting Discover Attributes Extended Response command.

3396 **2.5.22.2 When Generated**

3397 The Discover Attributes Extended command is generated when a remote device wishes to discover the  
3398 identifiers and types of the attributes on a device which are supported within the cluster to which this com-  
3399 mand is directed, including whether the attribute is readable, writeable or reportable.

3400 **2.5.22.3 Effect on Receipt**

3401 On receipt of this command, the device SHALL construct an ordered list of attribute information records,  
 3402 each containing a discovered attribute identifier and its data type, in ascending order of attribute identifiers.  
 3403 This list SHALL start with the first attribute that has an identifier that is equal to or greater than the identi-  
 3404 fier specified in the start attribute identifier field. The number of attribute identifiers included in the list  
 3405 SHALL not exceed that specified in the maximum attribute identifiers field.

3406 **2.5.23 Discover Attributes Extended Response Com-**  
 3407 **mand**

3408 This command is sent in response to a Discover Attributes Extended command, and is used to determine if  
 3409 attributes are readable, writable or reportable.

3410 **2.5.23.1 Discover Attributes Extended Response Com-**  
 3411 **mand Frame Format**

3412 The Discover Attributes Extended Response command frame SHALL be formatted as illustrated as fol-  
 3413 lows.

3414 **Figure 2-39. Format of the Discover Attributes Extended Response Command Frame**

<b>Octets:</b>	Variable	1	4	4	...	4
<b>Field:</b>	ZCL header	Discovery complete	Extended attribute information 1	Extended attribute information 2	...	Extended attribute information n

3415 Each extended attribute information field SHALL be formatted as follows.

3416 **Figure 2-40. Format of the Extended Attribute Information Fields**

<b>Octets:</b>	2	1	1
<b>Field:</b>	Attribute identifier	Attribute data type	Attribute access control

3417

3418 **2.5.23.1.1 ZCL Header Fields**

3419 The frame control field SHALL be specified as follows. The frame type sub-field SHALL be set to indicate  
 3420 a global command (0b00). The manufacturer-specific sub-field SHALL be set to the same value included in  
 3421 the original Discover Attributes Extended command, with the exception that if the manufacture ID is 0xffff  
 3422 (wildcard), then the response will contain the manufacture ID of the manufacturer-specific attributes, or  
 3423 will not be present if the cluster supports no manufacturer-specific extensions.

3424 The command identifier field SHALL be set to indicate the Discover Attributes Extended Response com-  
 3425 mand.

3426 **2.5.23.1.2 Discovery Complete Field**

3427 The discovery complete field is a boolean field. A value of 0 indicates that there are more attributes to be  
 3428 discovered. A value of 1 indicates that there are no more attributes to be discovered.

**3429 2.5.23.1.3 Attribute Identifier Field**

3430 The attribute identifier field SHALL contain the identifier of a discovered attribute. Attributes SHALL be  
3431 included in ascending order, starting with the lowest attribute identifier that is greater than or equal to the  
3432 start attribute identifier field of the received discover attributes command.

**3433 2.5.23.1.4 Attribute Data Type Field**

3434 The attribute data type field SHALL contain the data type of the attribute.

**3435 2.5.23.1.5 Attribute Access Control Field**

3436 The attribute access control field SHALL indicate whether the attribute is readable, writable, and/or report-  
3437 able. This is an 8-bit bitmask field as shown below: The bits are in little endian order (bit 0 is listed first).

3438 **Figure 2-41. Format of the Attribute Access Control Field**

<b>Bits:</b>	<b>1</b>	<b>1</b>	<b>1</b>
<b>Field:</b>	<b>Readable</b>	Writeable	Reportable

3439

**3440 2.5.23.2 When Generated**

3441 The Discover Attributes Extended Response command is generated in response to a Discover Attributes  
3442 Extended command.

**3443 2.5.23.3 Effect on Receipt**

3444 On receipt of this command, the device is notified of the results of its Discover Attributes Extended com-  
3445 mand.

3446 Following the receipt of this command, if the discovery complete field indicates that there are more attrib-  
3447 utes to be discovered, the device may choose to send subsequent Discover Attributes Extended commands  
3448 to obtain the rest of the attribute identifiers and access control. In this case, the start attribute identifier  
3449 specified in the next Discover Attributes Extended command SHOULD be set equal to one plus the last at-  
3450 tribute identifier received in the Discover Attributes Extended Response command.

**3451 2.6 Addressing, Types and Enumerations**

---

**3452 2.6.1 Addressing**

3453 The architecture uses a number of concepts to address applications, clusters, device descriptions, attributes  
3454 and commands, each with their own constraints. This sub-clause details these constraints.

**3455 2.6.1.1 Profile Identifier**

3456 A profile identifier is 16 bits in length and specifies the application profile being used. A profile identifier  
3457 SHALL be set to one of the non-reserved values listed in Table 2-5. Please see [Z5], Application Architec-  
3458 ture for more details.

3459

**Table 2-5. Valid Profile Identifier Values**

Profile Identifier	Description
0x0000 – 0x7fff	Standard application profile [Z7]
0xc000 – 0xffff	Manufacturer Specific application profile
<i>all other values</i>	Reserved

3460 **2.6.1.2 Device Identifier**

3461 A device identifier is 16 bits in length and specifies a specific device within a standard. A device identifier  
 3462 SHALL be set to one of the non-reserved values listed in Table 2-6. Please see [Z5], Application Architecture  
 3463 for more details.

3464

**Table 2-6. Valid Device Identifier Values**

Device Identifier	Description
0x0000 – 0xbfff	Standard device description.
<i>all other values</i>	Reserved

3465 **2.6.1.3 Cluster Identifier**

3466 A cluster identifier is 16 bits in length and identifies an instance of an implemented cluster specification (see  
 3467 2.2.1.1). It SHALL be set to one of the non-reserved values listed in Table 2-7. Please see [Z5], Application  
 3468 Architecture for more details.

3469

**Table 2-7. Valid Cluster Identifier Values**

Cluster Identifier	Description
0x0000 – 0x7fff	Standard cluster
0xfc00 – 0xffff	Manufacturer specific cluster
<i>all other values</i>	Reserved

### 3470 2.6.1.4 Attribute Identifier

3471 An attribute identifier is 16 bits in length and specifies a single attribute within a cluster. An attribute identifier SHALL be set to one of the non-reserved values listed in Table 2-8. Undefined cluster attributes are reserved for future cluster attributes. Global attributes are associated with all clusters (see 0).

3474 **Table 2-8. Attribute Identifier Value Ranges**

Attribute Identifier	Description
0x0000 – 0x4fff	Standard attribute
0xf000 – 0xffff	Global Attributes
<i>all other values</i>	Reserved

3475

3476 Manufacturer specific attributes within a standard cluster can be defined over the full 16-bit range. These may be manipulated using the global commands listed in Table 2-3, with the frame control field set to indicate a manufacturer specific command (see 2.4). (Note that, alternatively, the manufacturer may define his own cluster specific commands (see 2.4), re-using these command IDs if desired).

### 3480 2.6.1.5 Command Identifier

3481 A command identifier is 8 bits in length and specifies a global command or a cluster specific command. A command identifier SHALL be set to one of the non-reserved values listed in Table 2-9. Manufacturer specific commands within a standard cluster can be defined over the full 8-bit range but each SHALL use the appropriate manufacturer code.

3485 **Table 2-9. Command Identifier Value Ranges**

Command Identifier	Description
0x00 – 0x7f	Standard command or Manufacturer Specific command, depending on the Frame Control field in the ZCL Header
<i>all other values</i>	Reserved

## 3486 2.6.2 Data Types

3487 Each attribute, variable and command field in a cluster specification SHALL have a well-defined data type. Each attribute in a cluster specification SHALL map to a single data type identifier (data type ID), which describes the length and general properties of the data type.

3490 When a variable value is required to designate an unknown, invalid, null, or undefined data value and there is no obvious data value (e.g. zero), that is within the valid range, then the Non-Value in the data type table (see 2.6.2.2) MAY be used.<sup>10</sup>

<sup>10</sup> Moved from section 2.6.2.2



3493 **2.6.2.1 Value, Range and Default**

3494 The table below describes the nomenclature for describing the value, range and default values for a data value  
 3495 such as an attribute, variable, or command field where the data type is well defined (see 2.3.4). These names  
 3496 are used in the cluster attribute tables.

3497 **Table 2-10. Nomenclature for Data Value Range & Default**

Name	Description
0	The numeral zero is used for any data value to mean that no bits are set or that a composite data value, with a variable length, has length zero. This is also boolean FALSE.
1	This is used for any analog data type to mean that the value is 1. This is also boolean TRUE.
FF	This means that all bits are set in the data value. For example, this value for the data type uint16 is 0xffff.
FE	This means all bits are set in the data value except the lowest bit. For example, this value for the data type uint16 is 0xffffe.
NaS	Not a Signed number for any signed integer data type by having only the high bit set. See 2.6.2.8
NaN	Not a Number defined for semi-precision floating point values. See 2.6.2.10.
non	The value in the Data Type Table that is defined as the non-value (e.g. NaS is the non-value for the int8 data type).
value	When the non-value is used, this means the full data type range excluding the non-value. For example: an unsigned 16-bit integer counter with a range of 0-0xffffe excludes the non-value 0xffff as part of the range.
full-non	When the non-value is used, this means the full data type range including the non-value. For example: an unsigned 16-bit integer uses 0xffff as a non-value.
full	When the non-value is not used, this means the full range. For example: an unsigned 16-bit integer counter with a range of 0-0xffff includes 0xffff as part of the range and NOT a non-value.
min	The minimum data value that is not considered a non-value. For unsigned, this is zero.
max	The maximum data value that is not considered a non-value. For an unsigned with no non-value, this is FF, else with a non-value, this is FE.
desc	Item described in the description of the data value.

3498

3499 **2.6.2.2 Data Type Table**

3500 It is encouraged that commonly used cluster attribute and command field data types are added to this list and  
 3501 mapped to appropriate data type identifiers with a unique name. Such common data types can then be reused  
 3502 instead of redefined in each specification. For example: a percentage data type representing 0-100% with a  
 3503 unit size of .5 percent, would be mapped to data type identifier 0x20 (also unsigned 8-bit integer), and perhaps  
 3504 named ‘Percent 8-bit .5-unit’ (short named ‘percent8.5’). New data type identifiers SHALL NOT be added  
 3505 to this table.

3506 The table also indicates for each data type whether it defines an analog or discrete value. Values of analog  
 3507 types may be added to or subtracted from other values of the same type and are typically used to measure the  
 3508 value of properties in the real world that vary continuously over a range. Values of discrete data types only  
 3509 have meaning as individual values and may not be added or subtracted.

3510 Cluster specifications SHALL use the unique data type short name to reduce the text size of the specification.

3511

<sup>11</sup>Table 2-11. Data Types

Class	Data Type	Short	ID	Length (Octets)	Non-Value
Null	Unknown	unk	0xff	0	-
Null	No data	nodata	0x00	0	-
Discrete	8-bit data	data8	0x08	1	-
	16-bit data	data16	0x09	2	-
	24-bit data	data24	0x0a	3	-
	32-bit data	data32	0x0b	4	-
	40-bit data	data40	0x0c	5	-
	48-bit data	data48	0x0d	6	-
	56-bit data	data56	0x0e	7	-
	64-bit data	data64	0x0f	8	-
	Boolean	bool	0x10	1	FF
	8-bit bitmap	map8	0x18	1	-
	16-bit bitmap	map16	0x19	2	-
	24-bit bitmap	map24	0x1a	3	-
	32-bit bitmap	map32	0x1b	4	-
	40-bit bitmap	map40	0x1c	5	-
	48-bit bitmap	map48	0x1d	6	-
	56-bit bitmap	map56	0x1e	7	-
	64-bit bitmap	map64	0x1f	8	-
Analog	Unsigned 8-bit integer	uint8	0x20	1	FF
	Unsigned 16-bit integer	uint16	0x21	2	FF
	Unsigned 24-bit integer	uint24	0x22	3	FF

<sup>11</sup> Moved to section 2.6.2

Class	Data Type	Short	ID	Length (Octets)	Non-Value
Analog	Unsigned 32-bit integer	uint32	0x23	4	FF
	Unsigned 40-bit integer	uint40	0x24	5	FF
	Unsigned 48-bit integer	uint48	0x25	6	FF
	Unsigned 56-bit integer	uint56	0x26	7	FF
	Unsigned 64-bit integer	uint64	0x27	8	FF
	Signed 8-bit integer	int8	0x28	1	NaS
	Signed 16-bit integer	int16	0x29	2	NaS
	Signed 24-bit integer	int24	0x2a	3	NaS
	Signed 32-bit integer	int32	0x2b	4	NaS
	Signed 40-bit integer	int40	0x2c	5	NaS
	Signed 48-bit integer	int48	0x2d	6	NaS
	Signed 56-bit integer	int56	0x2e	7	NaS
	Signed 64-bit integer	int64	0x2f	8	NaS
Discrete	8-bit enumeration	enum8	0x30	1	FF
	16-bit enumeration	enum16	0x31	2	FF
Analog	Semi-precision	semi	0x38	2	NaN
	Single precision	single	0x39	4	NaN
	Double precision	double	0x3a	8	NaN
Composite	Octet string	octstr	0x41	<i>desc</i>	<i>desc</i>
	Character string	string	0x42	<i>desc</i>	<i>desc</i>
	Long octet string	octstr16	0x43	<i>desc</i>	<i>desc</i>
	Long character string	string16	0x44	<i>desc</i>	<i>desc</i>
	Fixed ASCII	ASCII	-	<i>desc</i>	<i>desc</i>
	Array	array	0x48	<i>desc</i>	<i>desc</i>
	Structure	struct	0x4c	<i>desc</i>	<i>desc</i>
	Set	set	0x50	<i>desc</i>	<i>desc</i>
Bag	bag	0x51	<i>desc</i>	<i>desc</i>	

Class	Data Type	Short	ID	Length (Octets)	Non-Value
Analog	Time of day	ToD	0xe0	4	FF
	Date	date	0xe1	4	FF
	UTCTime	UTC	0xe2	4	FF
Discrete	Cluster ID	clusterId	0xe8	2	FF
	Attribute ID	attribId	0xe9	2	FF
	BACnet OID	bacOID	0xea	4	FF
	IEEE address	EUI64	0xf0	8	FF
	128-bit security key	key128	0xf1	16	-
	Opaque	opaque	-	<i>desc</i>	-

### 3512 2.6.2.3 No Data Type

3513 The no data type is a special type to represent an attribute with no associated data.

### 3514 2.6.2.4 General Data (8, 16, 24, 32, 40, 48, 56 and 64-bit)

3516 This type has no rules about its use and may be used when a data element is needed but its use does not conform to any of the standard types.

### 3518 2.6.2.5 Boolean

3519 The Boolean type represents a logical value, either FALSE (0x00) or TRUE (0x01). The value 0xff represents a non-value of this type. All other values of this type are forbidden.

### 3521 2.6.2.6 Bitmap (8, 16, 24, 32, 40, 48, 56 and 64-bit)

3522 The Bitmap type holds 8, 16, 24, 32, 40, 48, 56 or 64 logical values, one per bit, depending on its length.  
3523 There is no value that represents a non-value of this type.

### 3524 2.6.2.7 Unsigned Integer (8, 16, 24, 32, 40, 48, 56 and 64-bit)

3526 This type represents an unsigned integer with a decimal range of 0 to  $2^8-1$ , 0 to  $2^{16}-1$ , 0 to  $2^{24}-1$ , 0 to  $2^{32}-1$ , 0  
3527 to  $2^{40}-1$ , 0 to  $2^{48}-1$ , 0 to  $2^{56}-1$ , or 0 to  $2^{64}-1$ , depending on its length.

3528 **2.6.2.8 Signed Integer (8, 16, 24, 32, 40, 48, 56 and 64-**  
 3529 **bit)**

3530 This type represents a signed integer with a decimal range of  $-(2^7-1)$  to  $2^7-1$ ,  $-(2^{15}-1)$  to  $2^{15}-1$ ,  $-(2^{23}-1)$  to  $2^{23}-$   
 3531  $1$ ,  $-(2^{31}-1)$  to  $2^{31}-1$ ,  $-(2^{39}-1)$  to  $2^{39}-1$ ,  $-(2^{47}-1)$  to  $2^{47}-1$ ,  $-(2^{55}-1)$  to  $2^{55}-1$ , or  $-(2^{63}-1)$  to  $2^{63}-1$ , depending on its  
 3532 length. The non-value of this type has only the high bit set (e.g. 0x80 for int8, 0x8000 for int16, etc).

3533 **2.6.2.9 Enumeration (8-bit, 16-bit)**

3534 The Enumeration type represents an index into a lookup table to determine the final value.

3535 **2.6.2.10 Semi-precision**

3536 The semi-precision number format is based on the IEEE 754 standard for binary floating-point arithmetic  
 3537 [E2]. This number format SHOULD be used very sparingly, when necessary, keeping in mind the code and  
 3538 processing required supporting it.

3539 The value is calculated as:

3540 
$$\text{Value} = -1^{\text{Sign}} * (\text{Hidden} + \text{Mantissa}/1024) * 2^{(\text{Exponent}-15)}$$

3541 **Figure 2-42. Format of the Semi-precision Number**

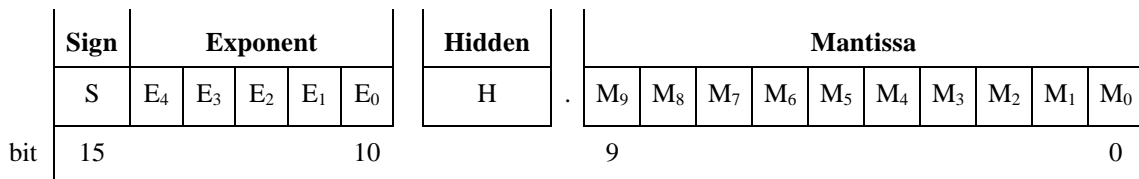

3542

3543 **Note:** The transmission order for the format in Figure 2-42 is bit 0 first.

3544 For normalized numbers ( $>2^{-14}$ ), the hidden bit = 1 and the resolution is constant at 11 bits (1 in 2048).

3545 For un-normalized numbers, the hidden bit = 0. Note that this does not maintain 11-bit resolution and that  
 3546 the resolution becomes coarser as the number gets smaller.

3547 The hidden bit is not sent over the link. It SHALL have the value ‘1’ (i.e., normalized) in order to be classified  
 3548 as a semi-precision number.

3549 The sign bit is set to 0 for positive values, 1 for negative.

3550 The exponent is 5 bits. The actual exponent of 2 is calculated as (exponent – 15).

3551 Certain values are reserved for specific purposes:

- 3552 • **Not a Number:** this is used for undefined values (e.g., at switch-on and before initialization) and is  
 3553 indicated by an exponent of 31 with a non-zero mantissa. Examples: 0xFFFF or 0x7801.
- 3554 • **Infinity:** this is indicated by an exponent of 31 and a zero mantissa. The sign bit indicates whether this  
 3555 represents + infinity or – infinity, the figure of 0x7c00 representing  $+\infty$  and 0xfc00 representing  $-\infty$ .
- 3556 • **Zero:** this is indicated by both a zero exponent and zero mantissa. The sign bit indicates whether this is  
 3557 + or – zero, the value 0x0000 representing +zero and 0x8000 representing –zero.
- 3558 • **Un-normalized numbers:** numbers  $< 2^{-14}$  are indicated by a value of 0 for the exponent. The hidden  
 3559 bit is set to zero.

3560 The maximum value represented by the mantissa is 0x3ff / 1024. The largest number that can be represented  
 3561 is therefore:

3562  $-1^{\text{Sign}} * (1 + 1023/1024) * 2^{(30-15)} = \pm 1.9990234 * 32768 = \pm 65504$

3563 Certain applications may choose to scale this value to allow representation of larger values (with a corre-  
3564 spondingly coarser resolution). For details, see the relevant device descriptions.

3565 For example, a value of +2 is represented by  $+2^{(16-15)} * 1.0 = 0x4000$ , while a value of -2 is represented by  
3566  $0xc000$ .

3567 Similarly, a value of +0.625 is represented by  $+2^{(17-15)} * 1.625 = 0x4680$ , while -0.625 is represented by  
3568  $0xc680$ .

### 3569 2.6.2.11 Single Precision

3570 The format of the single precision data type is based on the IEEE 754 standard for binary floating-point  
3571 arithmetic [E2]. This number format SHOULD be used very sparingly, when necessary, keeping in mind the  
3572 code and processing required supporting it.

3573 The format and interpretation of values of this data type follow the same rules as given for the semi-precision  
3574 data type, but with longer sub-fields, as follows.

3575 Length of mantissa = 23 bits, length of exponent = 8 bits

3576 For further details, see [E2].

### 3577 2.6.2.12 Double Precision

3578 The format of the double precision data type is based on the IEEE 754 standard for binary floating-point  
3579 arithmetic [E2]. This number format SHOULD be used very sparingly, when necessary, keeping in mind the  
3580 code and processing required supporting it.

3581 The format and interpretation of values of this data type follow the same rules as given for the semi-precision  
3582 data type, but with longer sub-fields, as follows.

3583 Length of mantissa = 52 bits, length of exponent = 11 bits

3584 For further details, see [E2].

### 3585 2.6.2.13 Octet String

3586 The octet string data type contains data in an application-defined format, not defined in this specification.  
3587 The octet string data type is formatted as illustrated in Figure 2-43.

3588 **Figure 2-43. Format of the Octet String Type**

Octets: 1	Variable
Octet count	Octet data

3589 The octet count sub-field is one octet in length and specifies the number of octets contained in the octet data  
3590 sub-field.

3591 Setting this sub-field to 0x00 represents an octet string with no octet data (an “empty string”). Setting this  
3592 sub-field to 0xff represents the non-value. In both cases the octet data sub-field has zero length.

3593 The octet data sub-field is  $n$  octets in length, where  $n$  is the value of the octet count sub-field. This sub-field  
3594 contains the application-defined data.

3595 **2.6.2.14 Character String**

3596 The character string data type contains data octets encoding characters according to the language and char-  
 3597 acter set field of the complex descriptor (see [Z1]). If not specified by the complex descriptor, the default  
 3598 character encoding SHALL be UTF-8. The character string data type SHALL be formatted as illustrated in  
 3599 Figure 2-44.

3600 **Figure 2-44. Format of the Character String Type**

Octets: 1	Variable
Character data length	Character data

3601 The character data length sub-field is one octet in length and specifies the length of the character data sub-  
 3602 field. (**Note:** for the ISO 646 ASCII character set, this is the same as the number of characters in the string.  
 3603 For other codings, this may not be the case.)

3604 Setting this sub-field to 0x00 represents a character string with no character data (an “empty string”). Setting  
 3605 this sub-field to 0xff represents the non-value. In both cases the character data sub-field has zero length.

3606 The character data sub-field contains the encoded characters that comprise the desired character string. Its  
 3607 length is the sum of the lengths of the characters as specified by the language and character set fields of the  
 3608 complex descriptor.

3609 A character string with no contents, i.e., with the character count sub-field equal to 0x00 and a zero length  
 3610 character data sub-field, SHALL be referred to as an 'empty string'.

3611 **2.6.2.15 Long Octet String**

3612 The long octet string data type contains data in an application-defined format, not defined in this specifica-  
 3613 tion. The long octet string data type is formatted as illustrated in Figure 2-45.

3614 **Figure 2-45. Format of the Long Octet String Type**

Octets: 2	Variable
Octet count	Octet data

3615

3616 The octet count sub-field is two octets in length and specifies the number of octets contained in the octet data  
 3617 sub-field. It has the same format as a 16-bit unsigned integer (see 2.6.2.7).

3618 Setting this sub-field to 0x0000 represents a long octet string with no octet data (an “empty string”). Setting  
 3619 this sub-field to 0xffff represents the non-value. In both cases the octet data sub-field has zero length.

3620 The octet data sub-field is *n* octets in length, where *n* is the value of the octet count sub-field. This sub-field  
 3621 contains the application-defined data.

3622 **2.6.2.16 Long Character String**

3623 The long character string data type contains data octets encoding characters according to the language and  
 3624 character set field of the complex descriptor (see [Z1]). If not specified by the complex descriptor, the default  
 3625 character encoding SHALL be UTF-8. The long character string data type is formatted as illustrated in Figure  
 3626 2-46.

3627

**Figure 2-46. Format of the Long Character String Type**

Octets: 2	Variable
Character count	Character data

3628

3629 The character count sub-field is two octets in length and specifies the length of the character data sub-field.  
3630 (**Note:** for the ISO 646 ASCII character set, this is the same as the number of characters in the string. For  
3631 other codings, this may not be the case.) It has the same format as a 16-bit unsigned integer (see 2.6.2.7).

3632 Setting this sub-field to 0x0000 represents a long character string with no character data (an “empty string”).  
3633 Setting this sub-field to 0xffff represents a non-value long character string value. In both cases the character  
3634 data sub-field has zero length.

3635 The character data sub-field contains the encoded characters that comprise the desired character string. Its  
3636 length is the sum of the lengths of the characters as specified by the language and character set fields of the  
3637 complex descriptor.

3638 A character string with no contents, i.e., with the character count sub-field equal to 0x0000 and a zero length  
3639 character data sub-field, SHALL be referred to as an 'empty string'.

### 3640 **2.6.2.17 Fixed ASCII**

3641 This data type is defined for legacy reasons, so that there is a data type to represent an ASCII display string  
3642 that has a fixed length as defined in the specification. The NUL ASCII character 0x00 shall terminate the  
3643 string, unless the string takes up the entire fixed length.

3644 This data type SHALL NOT be used as a data type for an attribute, because it does not have an associated  
3645 length, nor Data Type Id. It is not recommended to use this data type, when a more well-defined data type  
3646 exists.

### 3647 **2.6.2.18 Array**

3648 An array is an ordered sequence of zero or more elements, all of the same data type. This data type may be  
3649 any defined data type, including array, structure, bag or set. The total nesting depth is limited to 15, and may  
3650 be further limited by an application.

3651 Individual elements may be accessed by an index of type 16-bit unsigned integer. Elements are numbered  
3652 from 1 upwards. The zeroth element is readable, always has type uint16, and holds the number of elements  
3653 contained in the array, which may be zero. If the zeroth element contains 0xffff, the array is a non-value and  
3654 is considered undefined.

3655 The zeroth element may also, as an implementation option, be writable, to change the size of the array (see  
3656 2.5.16.1 for details).

3657 Arrays are 'packed', i.e., there is no concept of a 'null' element. However, if an element has a simple (unstruc-  
3658 tured) type, and that type has a non-value defined, then that value MAY indicate that the element is undefined.

### 3659 **2.6.2.19 Structure**

3660 A structure is an ordered sequence of elements, which may be of different data types. Each data type may be  
3661 any defined data type, including array, structure, bag or set. The total nesting depth is limited to 15, and may  
3662 be further limited by an application.



3663 Individual elements may be accessed by an index of type 16-bit unsigned integer. Elements are numbered  
 3664 from 1 upwards. The zeroth element is readable, always has type 16-bit unsigned integer, and holds the  
 3665 number of elements contained in the structure, which may be zero. If the zeroth element contains 0xffff, the  
 3666 array is considered a non-value and undefined. The zeroth element may not be written to.

3667 Structures are 'packed', i.e., there is no concept of a 'null' element. However, if an element has a simple  
 3668 (unstructured) type, and that type has the non-value defined, that value indicates that the element is undefined.

3669 **2.6.2.20 Set**

3670 A set is a collection of elements with no associated order. Each element has the same data type, which may  
 3671 be any defined data type, including array, structure, bag or set. The nesting depth is limited to 15, and may  
 3672 be further limited by an application.

3673 Elements of a set are not individually addressable, so may not be individually read or modified. Sets may  
 3674 only be read in their entirety. Individual elements may be added to a set or removed from a set; removal is  
 3675 done by value.

3676 The maximum number of elements in a set is 0xffff. If the number of elements is returned by a read command  
 3677 as 0xffff, this indicates that it is a non-value.

3678 No two elements of a set may have the same value.

3679 **2.6.2.21 Bag**

3680 A bag behaves the same as a set, except that the restriction that no two elements may have the same value is  
 3681 removed.

3682 **2.6.2.22 Time of Day**

3683 The Time of Day data type SHALL be formatted as illustrated in Figure 2-47.

3684 **Figure 2-47. Format of the Time of Day Type**

<b>Octets: 1</b>	<b>1</b>	<b>1</b>	<b>1</b>
Hours	Minutes	Seconds	Hundredths

3685

3686 The hours subfield represents hours according to a 24-hour clock. The range is from 0 to 23.

3687 The minutes subfield represents minutes of the current hour. The range is from 0 to 59.

3688 The seconds subfield represents seconds of the current minute. The range is from 0 to 59.

3689 The hundredths subfield represents 100ths of the current second. The range is from 0 to 99.

3690 A value of 0xff in any subfield indicates an unused subfield. If all subfields have the value 0xff, this indicates  
 3691 a non-value of the data type.

3692 **2.6.2.23 Date**

3693 The Date data type SHALL be formatted as illustrated in Figure 2-48.

3694

**Figure 2-48. Format of the Date Type**

Octets: 1	1	1	1
Year - 1900	Month	Day of month	Day of week

3695

3696 The year - 1900 subfield has a range of 0 to 255, representing years from 1900 to 2155.

3697 The month subfield has a range of 1 to 12, representing January to December.

3698 The day of month subfield has a range of 1 to 31. Note that values in the range 29 to 31 may be invalid,  
3699 depending on the month and year.

3700 The day of week subfield has a range of 1 to 7, representing Monday to Sunday.

3701 A value of 0xff in any subfield indicates an unused subfield. If all subfields have the value 0xff, this indicates  
3702 a non-value of the data type.

### 3703 **2.6.2.24 UTCTime**

3704 UTCTime is an unsigned 32-bit value representing the number of seconds since 0 hours, 0 minutes, 0 seconds,  
3705 on the 1st of January, 2000 UTC (Universal Coordinated Time).

3706 Note that UTCTime does not hold a standard textual representation of Universal Coordinated Time (UTC).  
3707 However, UTC (to a precision of one second) may be derived from it.

### 3708 **2.6.2.25 Cluster ID**

3709 This type represents a cluster identifier as defined in 2.6.1.3.

### 3710 **2.6.2.26 Attribute ID**

3711 This type represents an attribute identifier as defined in 2.6.1.4.

### 3712 **2.6.2.27 BACnet OID (Object Identifier)**

3713 The BACnet OID data type is included to allow interworking with BACnet (see [A1]). The format is de-  
3714 scribed in the referenced standard.

### 3715 **2.6.2.28 IEEE Address**

3716 The IEEE Address data type is a 64-bit IEEE address that is unique to every node. A value of 0xffffffffffffff  
3717 indicates that the address is unknown.

### 3718 **2.6.2.29 128-bit Security Key**

3719 The 128-bit Security Key data type may take any 128-bit value.

### 3720 **2.6.2.30 Opaque**

3721 Fixed block or series of octets where the length is determined separately. The length SHALL be fixed in the  
3722 specification or determined from information from another part of the protocol. The format of the data MAY  
3723 also be unknown. It is not recommended to use this data type, when a more well-defined data type exists.

3724 This data type SHALL NOT be used as a cluster attribute, or have a Data Type Id.

3725 **2.6.2.31 Unknown**

3726 This data type SHALL NOT be used for a cluster attribute or frame data field. This is not an actual data type.  
 3727 It is listed here for completeness and to reserve the data type identifier for use where one is required to  
 3728 designate that a data type is unknown. It SHALL never be used to identify actual data as unknown. If the  
 3729 structure, format, or length of data is unknown, or an existing data type cannot be used, then the Opaque data  
 3730 type SHALL be used.

3731 **2.6.3 Status Enumerations<sup>12</sup>**

3732 Where a command contains a status field, the actual value of the enumerated status values is listed in Table  
 3733 2-12. If a status value is deprecated, it SHALL not be used in a transmitted message. When a deprecated  
 3734 status value is received from a legacy device an error SHALL NOT result, and the value SHALL be processed  
 3735 as if the value were the replacement status value as described in the table below.

3736 **Table 2-12. Enumerated Command Status Values**

Enumerated Status	Val	Description
SUCCESS	0x00	Operation was successful.
FAILURE	0x01	Operation was not successful.
NOT_AUTHORIZED	0x7e	The sender of the command does not have authorization to carry out this command.
<i>reserved</i>	0x7f	
MALFORMED_COMMAND	0x80	The command appears to contain the wrong fields, as detected either by the presence of one or more invalid field entries or by there being missing fields. Command not carried out. Implementer has discretion as to whether to return this error or INVALID_FIELD.
UNSUP_CLUSTER_COMMAND name is DEPRECATED use new name: UNSUP_COMMAND <sup>13</sup>	0x81	The specified command is not supported on the device. Command not carried out.
UNSUP_GENERAL_COMMAND is DEPRECATED: use UNSUP_COMMAND	0x82	<del>The specified general ZCL command is not supported on the device.</del>
UNSUP_MANUF_CLUSTER_COMMAND is DEPRECATED: use UNSUP_COMMAND	0x83	<del>A manufacturer specific unicast, cluster specific command was received with an unknown manufacturer code, or the manufacturer code was recognized but the command is not supported.</del>
UNSUP_MANUF_GENERAL_COMMAND is DEPRECATED: use UNSUP_COMMAND	0x84	<del>A manufacturer specific unicast, ZCL specific command was received with an unknown manufacturer code, or the manufacturer code was recognized but the command is not supported.</del>

<sup>12</sup> CCB 2477 Status Code Cleanup: many deprecated here

<sup>13</sup> CCB 2477 Status Code Cleanup: UNSUP\_COMMAND is renamed UNSUP\_CLUSTER\_COMMAND

Enumerated Status	Val	Description
INVALID_FIELD	0x85	At least one field of the command contains an incorrect value, according to the specification the device is implemented to.
UNSUPPORTED_ATTRIBUTE	0x86	The specified attribute does not exist on the device.
INVALID_VALUE	0x87	Out of range error or set to a reserved value. Attribute keeps its old value. Note that an attribute value may be out of range if an attribute is related to another, e.g., with minimum and maximum attributes. See the individual attribute descriptions for specific details.
READ_ONLY	0x88	Attempt to write a read-only attribute.
INSUFFICIENT_SPACE	0x89	An operation failed due to an insufficient amount of free space available.
<del>DUPLICATE_EXISTS is DEPRECATED: use SUCCESS</del>	<del>0x8a</del>	<del>An attempt to create an entry in a table failed due to a duplicate entry already being present in the table.</del>
NOT_FOUND	0x8b	The requested information (e.g., table entry) could not be found.
UNREPORTABLE_ATTRIBUTE	0x8c	Periodic reports cannot be issued for this attribute.
INVALID_DATA_TYPE	0x8d	The data type given for an attribute is incorrect. Command not carried out.
INVALID_SELECTOR	0x8e	The selector for an attribute is incorrect.
<del>WRITE_ONLY is DEPRECATED: use NOT_AUTHORIZED</del>	<del>0x8f</del>	<del>A request has been made to read an attribute that the requestor is not authorized to read. No action taken.</del>
<del>INCONSISTENT_STARTUP_STATE is DEPRECATED: use FAILURE</del>	<del>0x90</del>	<del>Setting the requested values would put the device in an inconsistent state on startup. No action taken.</del>
<del>DEFINED_OUT_OF_BAND is DEPRECATED: use FAILURE</del>	<del>0x91</del>	<del>An attempt has been made to write an attribute that is present but is defined using an out-of-band method and not over the air.</del>
<i>reserved<sup>14</sup></i>	0x92	The supplied values (e.g., contents of table cells) are inconsistent.
<del>ACTION_DENIED is DEPRECATED: use FAILURE</del>	<del>0x93</del>	<del>The credentials presented by the device sending the command are not sufficient to perform this action.</del>
TIMEOUT	0x94	The exchange was aborted due to excessive response time.

<sup>14</sup> CCB 2477 Status Code Cleanup: never used

Enumerated Status	Val	Description
ABORT	0x95	Failed case when a client or a server decides to abort the upgrade process.
INVALID_IMAGE	0x96	Invalid OTA upgrade image (ex. failed signature validation or signer information check or CRC check).
WAIT_FOR_DATA	0x97	Server does not have data block available yet.
NO_IMAGE_AVAILABLE	0x98	No OTA upgrade image available for the client.
REQUIRE_MORE_IMAGE	0x99	The client still requires more OTA upgrade image files to successfully upgrade.
NOTIFICATION_PENDING	0x9a	The command has been received and is being processed.
<del>HARDWARE_FAILURE is DEPRECATED: use FAILURE</del>	<del>0xe0</del>	<del>An operation was unsuccessful due to a hardware failure.</del>
<del>SOFTWARE_FAILURE is DEPRECATED: use FAILURE</del>	<del>0xe1</del>	<del>An operation was unsuccessful due to a software failure.</del>
<i>reserved<sup>15</sup></i>	0xc2	An error occurred during calibration.
UNSUPPORTED_CLUSTER	0xc3	The cluster is not supported
<del>LIMIT_REACHED is DEPRECATED: use SUCCESS</del>	<del>0xe4</del>	<del>Limit of attribute range reached. Value is trimmed to closest limit (maximum or minimum).</del>

3737

<sup>15</sup> CCB 2477 Status Code Cleanup: never used



# CHAPTER 3 GENERAL

3738

3739 The Cluster Library is made of individual chapters such as this one. See Document Control in the Cluster  
 3740 Library for a list of all chapters and documents. References between chapters are made using a *X.Y* notation  
 3741 where *X* is the chapter and *Y* is the sub-section within that chapter. References to external documents are  
 3742 contained in Chapter 1 and are made using [*Rn*] notation.

## 3.1 General Description

3743

### 3.1.1 Introduction

3744

3745 The clusters specified in this document are generic interfaces that are sufficiently general to be of use across  
 3746 a wide range of application domains.

### 3.1.2 Cluster List

3747

3748 This section lists the clusters specified in this document and gives examples of typical usage.

3749

**Table 3-1. Device Configuration and Installation Clusters**

ID	Cluster Name	Description
0x0000	Basic	Attributes for determining basic information about a device, setting user device information such as description of location, and enabling a device.
0x0001	Power Configuration	Attributes for determining more detailed information about a device's power source(s), and for configuring under/over voltage alarms.
0x0002	Device Temperature Configuration	Attributes for determining information about a device's internal temperature, and for configuring under/over temperature alarms.
0x0003	Identify	Attributes and commands for putting a device into Identification mode (e.g., flashing a light)

3750

**Figure 3-1. Typical Usage of Device Configuration and Installation Clusters**

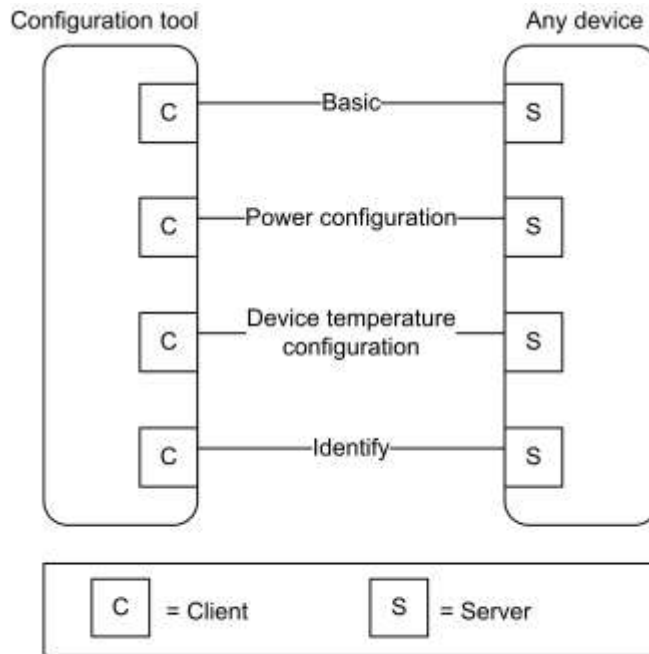

*Note: Device names are examples for illustration purposes only*

3751

3752

**Table 3-2. Groups and Scenes Clusters**

ID	Name	Description
0x0004	Groups	Attributes and commands for allocating a device to one or more of a number of groups of devices, where each group is addressable by a group address.
0x0005	Scenes	Attributes and commands for setting up and recalling a number of scenes for a device. Each scene corresponds to a set of stored values of specified device attributes.

3753

3754

**Table 3-3. On/Off and Level Control Clusters**

ID	Name	Description
0x0006	On/Off	Attributes and commands for switching devices between 'On' and 'Off' states.
0x0007	On/Off Switch Configuration	Attributes and commands for configuring on/off switching devices
0x0008	Level Level Control for Lighting	Attributes and commands for controlling a characteristic of devices that can be set to a level between fully 'On' and fully 'Off'.
0x001C	Pulse Width Modulation	Level also with frequency control

3755



3756

Figure 3-2. Typical Usage of On/Off and Level Clusters

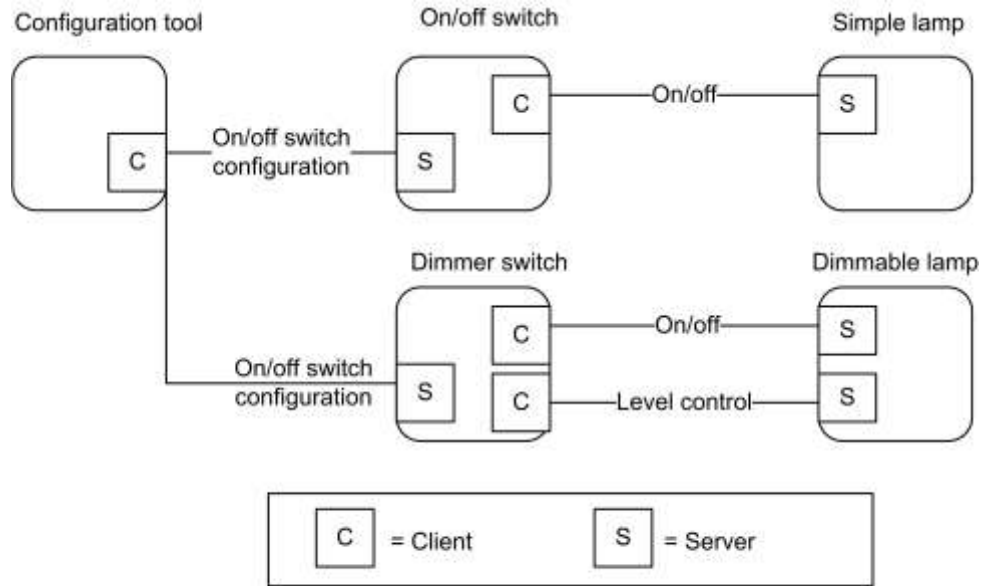

Note: Device names are examples for illustration purposes only

3757  
3758  
3759

Table 3-4. Alarms Cluster

ID	Name	Description
0x0009	Alarms	Attributes and commands for sending alarm notifications and configuring alarm functionality.

3760  
3761

Figure 3-3. Typical Usage of the Alarms Cluster

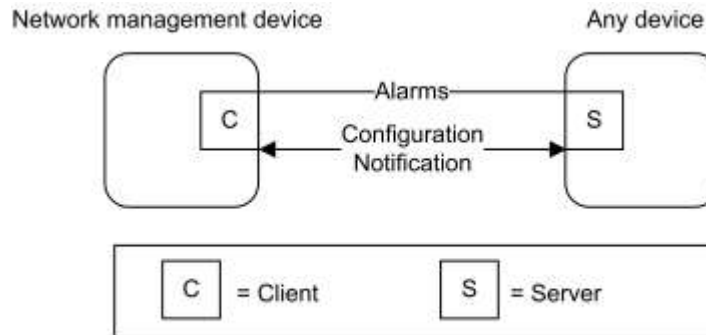

Note: Device names are examples for illustration purposes only

3762  
3763

3764

**Table 3-5. Other Clusters**

ID	Name	Description
0x000a	Time	Attributes and commands that provide an interface to a real-time clock.
0x000b	RSSI Location	Attributes and commands for exchanging location information and channel parameters among devices, and (optionally) reporting data to a centralized device that collects data from devices in the network and calculates their positions from the set of collected data.
0x0b05	Diagnostics	Attributes and commands that provide an interface to diagnostics of the stack
0x0020	Poll Control	Attributes and commands that provide an interface to control the polling of sleeping end device
0x001a	Power Profile	Attributes and commands that provide an interface to the power profile of a device
0x0025	Keep Alive	Provides services for devices to know that central device is active and for a central device to know that devices are active on the network

3765

3766

**Figure 3-4. Typical Usage of the Location Cluster with Centralized Device**

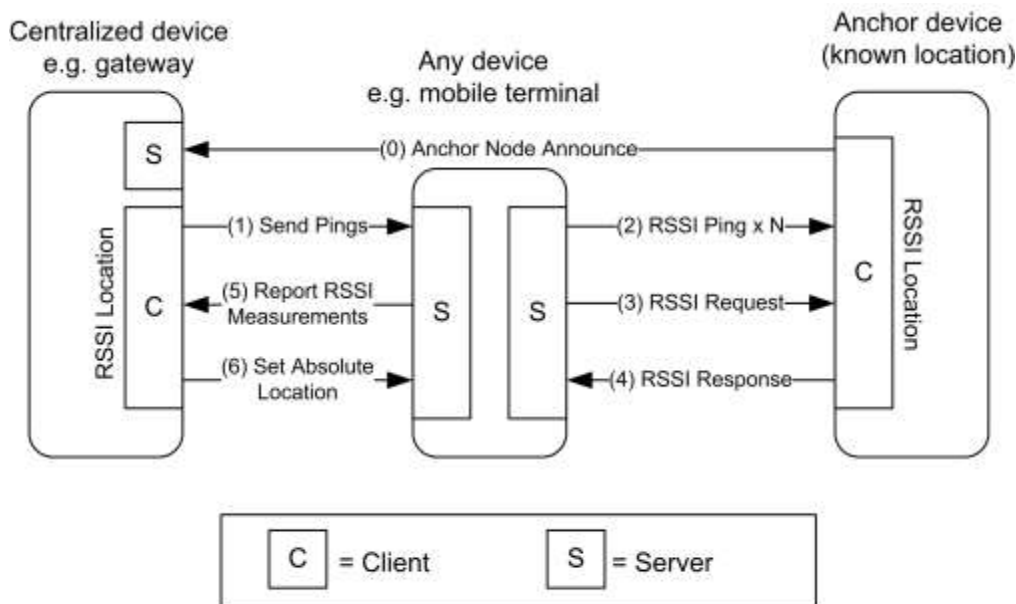

*Note: Device names are examples for illustration purposes only*

3767

3768

**Table 3-6. Generic Clusters**

ID	Cluster Name	Description
0x000c	Analog Input (basic)	An interface for reading the value of an analog measurement and accessing various characteristics of that measurement.

ID	Cluster Name	Description
0x000d	Analog Output (basic)	An interface for setting the value of an analog output (typically to the environment) and accessing various characteristics of that value.
0x000e	Analog Value (basic)	An interface for setting an analog value, typically used as a control system parameter, and accessing various characteristics of that value.
0x000f	Binary Input (basic)	An interface for reading the value of a binary measurement and accessing various characteristics of that measurement.
0x0010	Binary Output (basic)	An interface for setting the value of a binary output (typically to the environment) and accessing various characteristics of that value.
0x0011	Binary Value (basic)	An interface for setting a binary value, typically used as a control system parameter, and accessing various characteristics of that value.
0x0012	Multistate Input (basic)	An interface for reading the value of a multistate measurement and accessing various characteristics of that measurement.
0x0013	Multistate Output (basic)	An interface for setting the value of a multistate output (typically to the environment) and accessing various characteristics of that value.
0x0014	Multistate Value (basic)	An interface for setting a multistate value, typically used as a control system parameter, and accessing various characteristics of that value.

3769

3770

Figure 3-5. Example Usage of the Input, Output and Value Clusters

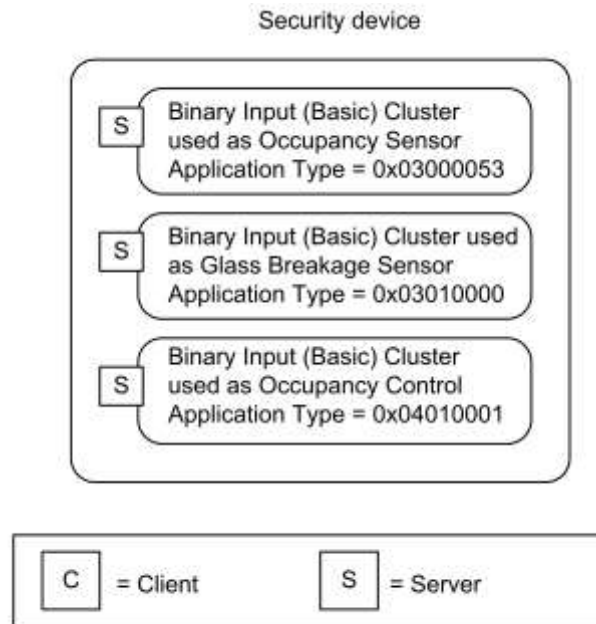

3771

Note: Device names are examples for illustration purposes only

## 3772 3.2 Basic

### 3773 3.2.1 Overview

3774 Please see Chapter 2 for a general cluster overview defining cluster architecture, revision, classification,  
3775 identification, etc.

3776 This cluster supports an interface to the node or physical device. It provides attributes and commands for  
3777 determining basic information, setting user information such as location, and resetting to factory defaults.

3778 **Note:** Where a node supports multiple endpoints, it will often be the case that many of these settings will  
3779 apply to the whole node, that is, they are the same for every endpoint on the node. In such cases, they can be  
3780 implemented once for the node, and mapped to each endpoint.

#### 3781 3.2.1.1 Revision History

3782 The global *ClusterRevision* attribute value SHALL be the highest revision number in the table below.

Rev	Description
1	mandatory global <i>ClusterRevision</i> attribute added; ZCLVersion set to 0x02
2	new attributes for manufacturer identification; CCB 1499 1584 2197 2229; ZCLVersion set to 0x03; ZLO 1.0
3	CCB 2722 2885

#### 3783 3.2.1.2 Classification

Hierarchy	Role	PICS Code
Base	Utility	B

#### 3784 3.2.1.3 Cluster Identifiers

Identifier	Name
0x0000	Basic

## 3785 3.2.2 Server

### 3786 3.2.2.1 Dependencies

3787 For the alarms functionality of this cluster to be operational, the Alarms cluster server SHALL be imple-  
3788 mented on the same endpoint.

### 3789 3.2.2.2 Attributes

3790 The Basic cluster attributes are summarized in Table 3-7.

3791

**Table 3-7. Attributes of the Basic Cluster**

Id	Name	Type	Range	Acc	Default	M/O
0x0000	<i>ZCLVersion</i>	uint8	0x00 to 0xff	R	8	M
0x0001	<i>ApplicationVersion</i>	uint8	0x00 to 0xff	R	0	O
0x0002	<i>StackVersion</i>	uint8	0x00 to 0xff	R	0	O
0x0003	<i>HWVersion</i>	uint8	0x00 to 0xff	R	0	O
0x0004	<i>ManufacturerName</i>	string	0 to 32 bytes	R	empty string	O
0x0005	<i>ModelIdentifier</i>	string	0 to 32 bytes	R	empty string	O
0x0006	<i>DateCode</i>	string	0 to 16 bytes	R	empty string	O
0x0007	<i>PowerSource</i>	enum8	0x00 to 0xff	R	0x00	M
0x0008	<i>GenericDevice-Class</i>	enum8	0x00 to 0xff	R	0xff	O
0x0009	<i>GenericDevice-Type</i>	enum8	0x00 to 0xff	R	0xff	O
0x000a	<i>ProductCode</i>	octstr		R	empty string	O
0x000b	<i>ProductURL</i>	string		R	empty string	O
0x000c	<i>ManufacturerVersionDetails</i>	string		R	empty string	O
0x000d	<i>SerialNumber</i>	string		R	empty string	O
0x000e	<i>ProductLabel</i>	string		R	empty string	O
0x0010	<i>LocationDescription</i>	string	0 to 16 bytes	RW	empty string	O
0x0011	<i>PhysicalEnvironment</i>	enum8	desc	RW	0	O
0x0012	<i>DeviceEnabled</i>	bool	0 or 1	RW	1	O
0x0013	<i>AlarmMask</i>	map8	000000xx	RW	0	O
0x0014	<i>DisableLocalConfig</i>	map8	000000xx	RW	0	O
0x4000	<i>SWBuildID</i>	string	0 to 16 bytes	R	empty string	O

3792 **3.2.2.2.1 ZCLVersion Attribute**

3793 The *ZCLVersion* attribute represents a published set of foundation items (in Chapter 2), such as global com-  
3794 mands and functional descriptions. **For this version of the ZCL (this document), this attribute SHALL**  
3795 **be set to 8. In the future, this value SHALL align with the release revision of the ZCL.**<sup>16</sup>

3796 **3.2.2.2.2 ApplicationVersion Attribute**

3797 The *ApplicationVersion* attribute is 8 bits in length and specifies the version number of the application soft-  
3798 ware contained in the device. The usage of this attribute is manufacturer dependent.

<sup>16</sup> CCB 2722

**3799 3.2.2.2.3 StackVersion Attribute**

3800 The *StackVersion* attribute is 8 bits in length and specifies the version number of the implementation of the  
3801 stack contained in the device. The usage of this attribute is manufacturer dependent.

**3802 3.2.2.2.4 HWVersion Attribute**

3803 The *HWVersion* attribute is 8 bits in length and specifies the version number of the hardware of the device.  
3804 The usage of this attribute is manufacturer dependent.

**3805 3.2.2.2.5 ManufacturerName Attribute**

3806 The *ManufacturerName* attribute is a maximum of 32 bytes in length and specifies the name of the manufac-  
3807 turer as a character string.

**3808 3.2.2.2.6 ModelIdentifier Attribute**

3809 The *ModelIdentifier* attribute is a maximum of 32 bytes in length and specifies the model number (or other  
3810 identifier) assigned by the manufacturer as a character string.

**3811 3.2.2.2.7 DateCode Attribute**

3812 The *DateCode* attribute is a character string with a maximum length of 16 bytes. The first 8 characters specify  
3813 the date of manufacturer of the device in international date notation according to ISO 8601, i.e.,  
3814 YYYYMMDD, e.g., 20060814.

3815 The final 8 characters MAY include country, factory, line, shift or other related information at the option of  
3816 the manufacturer. The format of this information is manufacturer dependent.

**3817 3.2.2.2.8 PowerSource Attribute**

3818 The *PowerSource* attribute is 8 bits in length and specifies the source(s) of power available to the device.  
3819 Bits  $b_0$ - $b_6$  of this attribute represent the primary power source of the device and bit  $b_7$  indicates whether the  
3820 device has a secondary power source in the form of a battery backup.

3821 This attribute SHALL be set to one of the non-reserved values listed in Table 3-8. Bit 7 of this attribute  
3822 SHALL be set to 1 if the device has a secondary power source in the form of a battery backup. Otherwise,  
3823 bit 7 SHALL be set to 0.

3824 **Table 3-8. Values of the *PowerSource* Attribute**

Value	Description
0x00	Unknown
0x01	Mains (single phase)
0x02	Mains (3 phase)
0x03	Battery
0x04	DC source
0x05	Emergency mains constantly powered
0x06	Emergency mains and transfer switch

Value	Description
<b>Bit 7 set denotes battery backup source</b>	
0x80	Unknown
0x81	Mains (single phase)
0x82	Mains (3 phase)
0x83	Battery
0x84	DC source
0x85	Emergency mains constantly powered
0x86	Emergency mains and transfer switch

3825 **3.2.2.2.9 GenericDeviceClass Attribute**

3826 The *GenericDeviceClass* attribute defines the field of application of the *GenericDeviceType* attribute. It  
3827 SHALL be set to one of the non-reserved values listed below:

3828

3829

**Table 3-9. Values of the *GenericDeviceClass* attribute**

<i>GenericDeviceClass</i> value	Description
0x00	Lighting

3830 **3.2.2.2.10 GenericDeviceType Attribute**

3831 The *GenericDeviceType* attribute allows an application to show an icon on a rich user interface (e.g.  
3832 smartphone app).

3833 Notes on the usage of the *GenericDeviceType* attribute:

- 3834 • lamps with integrated radio module SHALL have a proper value indicating the lamp type, accord-  
3835 ing to the table below;
- 3836 • devices that cannot be assigned to a proper category SHALL be set as “unspecified”;

3837

3838 When the *GenericDeviceClass* attribute is set to 0x00 (i.e. lighting) the *GenericDeviceType* attribute  
3839 SHALL be set to one of the non-reserved values listed below:

3840

3841

**Table 3-10. Values of the *GenericDeviceType* attribute for the lighting class**

Value	Description
0x00	Incandescent
0x01	Spotlight Halogen
0x02	Halogen bulb
0x03	CFL
0x04	Linear Fluorescent
0x05	LED bulb

Value	Description
0x06	Spotlight LED
0x07	LED strip
0x08	LED tube
0x09	Generic indoor luminaire/light fixture
0x0a	Generic outdoor luminaire/light fixture
0x0b	Pendant luminaire/light fixture
0x0c	Floor standing luminaire/light fixture
0xe0	Generic Controller (e.g. Remote controller)
0xe1	Wall Switch
0xe2	Portable remote controller
0xe3	Motion sensor / light sensor
0xe4 to 0xef	Reserved
0xf0	Generic actuator
0xf1	Wall socket
0xf2	Gateway/Bridge
0xf3	Plug-in unit
0xf4	Retrofit actuator
0xff	Unspecified

3842 **3.2.2.2.11 ProductCode Attribute**

3843 The *ProductCode* attribute allows an application to specify a code for the product. The *ProductCode* attrib-  
3844 ute SHALL have the format defined in Figure .

3845

Octets:1	1	Variable
Octet Count	CodeId (see Table )	The code represented as a sequence of ASCII characters
	Octet data	



3846

**Figure 3-6. Format of the *ProductCode* attribute**

3847

**Table 3-11. Values of the *CodeId* field of the *ProductCode* attribute**

Code ID	Code type
0x00	Manufacturer defined
0x01	International article number (EAN)
0x02	Global trade item number (GTIN)
0x03	Universal product code (UPC)
0x04	Stock keeping unit (SKU)

3848

3849

In case no code has been provided, the Octet Count field SHALL be set to 0 (i.e. the octet string is empty).

3850

### **3.2.2.2.12 ProductURL Attribute**

3851

The *ProductURL* attribute specifies a link to a web page containing specific product information.

3852

Notes on the usage of the *ProductURL* attribute:

3853

- The length of the URL SHALL be limited by the maximum number of bytes that can be transmitted from the application in a single frame. In most cases, such limit is around 50 bytes.

3854

3855

- In case no URL has been provided, the string SHALL be empty (i.e. the first byte is set to zero).

3856

### **3.2.2.2.13 Manufacturer VersionDetails Attribute**

3857

3858

Vendor specific human readable (displayable) string representing the versions of one of more program images supported on the device.

3859

### **3.2.2.2.14 SerialNumber Attribute**

3860

Vendor specific human readable (displayable) serial number.

3861

### **3.2.2.2.15 ProductLabel Attribute**

3862

Vendor specific human readable (displayable) product label.

3863

### **3.2.2.2.16 LocationDescription Attribute**

3864

3865

3866

The *LocationDescription* attribute is a maximum of 16 bytes in length and describes the physical location of the device as a character string. This location description MAY be added into the device during commissioning.

3867

### **3.2.2.2.17 PhysicalEnvironment Attribute**

3868

3869

3870

The *PhysicalEnvironment* attribute is 8 bits in length and specifies the type of physical environment in which the device will operate. This attribute SHALL be set to one of the non-reserved values listed in Table 3-12. All values are valid for endpoints supporting all profiles except when noted.

3871

**Table 3-12. Values of the *PhysicalEnvironment* Attribute**

<b>Value</b>	<b>Description</b>
0x00	Unspecified environment
0x01	Mirror Capacity Available – for 0x0109 Profile Id only; use 0x71 moving forward Atrium – defined for legacy devices with non-0x0109 Profile Id; use 0x70 moving forward Note: This value is deprecated for Profile Id 0x0104. The value 0x01 is maintained for historical purposes and SHOULD only be used for backwards compatibility with devices developed before this specification. The 0x01 value MUST be interpreted using the Profile Id of the endpoint upon which it is implemented. For endpoints with the Smart Energy Profile Id (0x0109) the value 0x01 has a meaning of Mirror. For endpoints with any other profile identifier, the value 0x01 has a meaning of Atrium.
0x02	Bar
0x03	Courtyard
0x04	Bathroom
0x05	Bedroom
0x06	Billiard Room
0x07	Utility Room
0x08	Cellar
0x09	Storage Closet
0x0a	Theater
0x0b	Office
0x0c	Deck
0x0d	Den
0x0e	Dining Room
0x0f	Electrical Room
0x10	Elevator
0x11	Entry
0x12	Family Room
0x13	Main Floor
0x14	Upstairs
0x15	Downstairs
0x16	Basement/Lower Level
0x17	Gallery
0x18	Game Room
0x19	Garage
0x1a	Gym
0x1b	Hallway

<b>Value</b>	<b>Description</b>
0x1c	House
0x1d	Kitchen
0x1e	Laundry Room
0x1f	Library
0x20	Master Bedroom
0x21	Mud Room (small room for coats and boots)
0x22	Nursery
0x23	Pantry
0x24	Office
0x25	Outside
0x26	Pool
0x27	Porch
0x28	Sewing Room
0x29	Sitting Room
0x2a	Stairway
0x2b	Yard
0x2c	Attic
0x2d	Hot Tub
0x2e	Living Room
0x2f	Sauna
0x30	Shop/Workshop
0x31	Guest Bedroom
0x32	Guest Bath
0x33	Powder Room (1/2 bath)
0x34	Back Yard
0x35	Front Yard
0x36	Patio
0x37	Driveway
0x38	Sun Room
0x39	Living Room
0x3a	Spa
0x3b	Whirlpool
0x3c	Shed

<b>Value</b>	<b>Description</b>
0x3d	Equipment Storage
0x3e	Hobby/Craft Room
0x3f	Fountain
0x40	Pond
0x41	Reception Room
0x42	Breakfast Room
0x43	Nook
0x44	Garden
0x45	Balcony
0x46	Panic Room
0x47	Terrace
0x48	Roof
0x49	Toilet
0x4a	Toilet Main
0x4b	Outside Toilet
0x4c	Shower room
0x4d	Study
0x4e	Front Garden
0x4f	Back Garden
0x50	Kettle
0x51	Television
0x52	Stove
0x53	Microwave
0x54	Toaster
0x55	Vacuum
0x56	Appliance
0x57	Front Door
0x58	Back Door
0x59	Fridge Door
0x60	Medication Cabinet Door
0x61	Wardrobe Door
0x62	Front Cupboard Door
0x63	Other Door

Value	Description
0x64	Waiting Room
0x65	Triage Room
0x66	Doctor’s Office
0x67	Patient’s Private Room
0x68	Consultation Room
0x69	Nurse Station
0x6a	Ward
0x6b	Corridor
0x6c	Operating Theatre
0x6d	Dental Surgery Room
0x6e	Medical Imaging Room
0x6f	Decontamination Room
0x70	Atrium
0x71	Mirror
0xff	Unknown environment

3872 **3.2.2.2.18 DeviceEnabled Attribute**

3873 The *DeviceEnabled* attribute is a Boolean and specifies whether the device is enabled or disabled. This at-  
3874 tribute SHALL be set to one of the non-reserved values listed in Table 3-13.

3875 **Table 3-13. Values of the *DeviceEnable* Attribute**

<i>DeviceEnable</i> Attribute Value	Description
0	Disabled
1	Enabled

3876

3877 ‘Disabled’ means that the device does not send or respond to application level commands, other than com-  
3878 mands to read or write attributes. Values of attributes which depend on the operation of the application MAY  
3879 be invalid, and any functionality triggered by writing to such attributes MAY be disabled. Networking func-  
3880 tionality remains operational.

3881 If implemented, the identify cluster cannot be disabled, i.e., it remains functional regardless of this setting.

3882 **3.2.2.2.19 AlarmMask Attribute**

3883 The *AlarmMask* attribute is 8 bits in length and specifies which of a number of general alarms MAY be  
3884 generated, as listed in Table 3-14. A ‘1’ in each bit position enables the associated alarm.

3885

**Table 3-14. Values of the *AlarmMask* Attribute**

Attribute Bit Number	Alarm Code	Alarm
0	0	General hardware fault
1	1	General software fault

3886

3887 These alarms are provided as basic alarms that a device MAY use even if no other clusters with alarms are  
3888 present on the device.

### 3889 **3.2.2.2.20 DisableLocalConfig Attribute**

3890 The *DisableLocalConfig* attribute allows a number of local device configuration functions to be disabled.

3891

**Table 3-15. Values of the *DisableLocalConfig* Attribute**

Attribute Bit Number	Description
0	0 = Reset (to factory defaults) enabled 1 = Reset (to factory defaults) disabled
1	0 = Device configuration enabled 1 = Device configuration disabled

3892

3893 The intention of this attribute is to allow disabling of any local configuration user interface, for example to  
3894 prevent reset or binding buttons being activated by non-authorized persons in a public building.

3895 Bit 0 of the *DisableLocalConfig* attribute disables any factory reset button (or equivalent) on the device. Bit  
3896 1 disables any device configuration button(s) (or equivalent)—for example, a bind button.

### 3897 **3.2.2.2.21 SWBuildID Attribute**

3898 The *SWBuildID* attribute represents a detailed, manufacturer-specific reference to the version of the software.

## 3899 **3.2.2.3 Commands Received**

3900 The command IDs for the Basic cluster are listed in Table 3-16.

3901

**Table 3-16. Received Command IDs for the Basic Cluster**

Command Identifier	Description	M/O
0x00	Reset to Factory Defaults	O

### 3902 **3.2.2.3.1 Reset to Factory Defaults Command**

3903 This command does not have a payload.

#### 3904 **3.2.2.3.1.1 Effect on Receipt**

3905 On receipt of this command, the device resets all the attributes of all its clusters to their factory defaults.

3906 Note that networking functionality, bindings, groups, or other persistent data are not affected by this com-  
3907 mand.

### 3908 **3.2.2.4 Commands Generated**

3909 No commands are generated by the server cluster.

### 3910 **3.2.3 Client**

3911 The client has no dependencies or attributes. No cluster specific commands are received by the client.

3912 The cluster specific commands generated by the client cluster are those received by the server, as required  
3913 by the application.

## 3914 **3.3 Power Configuration**

---

### 3915 **3.3.1 Overview**

3916 Please see Chapter 2 for a general cluster overview defining cluster architecture, revision, classification,  
3917 identification, etc.

3918 Attributes for determining detailed information about a device’s power source(s) and for configuring un-  
3919 der/over voltage alarms.

#### 3920 **3.3.1.1 Revision History**

3921 The global ClusterRevision attribute value SHALL be the highest revision number in the table below.

Rev	Description
1	global mandatory <i>ClusterRevision</i> attribute added; mains power lost alarm added to <i>Main- sAlarmMask</i> ; CCB 1809
2	CCB 2454 2463 2899 2885

#### 3922 **3.3.1.2 Classification**

Hierarchy	Role	PICS Code
Base	Utility	PC

#### 3923 **3.3.1.3 Cluster Identifiers**

Identifier	Name
0x0001	Power Configuration

3924 **3.3.2 Server**3925 **3.3.2.1 Dependencies**

3926 Any endpoint that implements this server cluster SHALL also implement the Basic server cluster.

3927 For the alarm functionality described in this cluster to be operational, any endpoint that implements the Power  
3928 Configuration server cluster must also implement the Alarms server cluster (see sub-clause Alarms).3929 **3.3.2.2 Attributes**3930 For convenience, the attributes defined in this specification are arranged into sets of related attributes; each  
3931 set can contain up to 16 attributes. Attribute identifiers are encoded such that the most significant three nib-  
3932 bles specify the attribute set and the least significant nibble specifies the attribute within the set. The currently  
3933 defined attribute sets are listed in Table 3-17.3934 **Table 3-17. Power Configuration Attribute Sets**

Attribute Set Identifier	Description
0x000	Mains Information
0x001	Mains Settings
0x002	Battery Information
0x003	Battery Settings
0x004	Battery Source 2 Information
0x005	Battery Source 2 Settings
0x006	Battery Source 3 Information
0x007	Battery Source 3 Settings

3935 **3.3.2.2.1 Mains Information Attribute Set**

3936 The Mains Information attribute set contains the attributes summarized in Table 3-18.

3937 **Table 3-18. Attributes of the Mains Information Attribute Set**

Identifier	Name	Type	Range	Acc	Def	M/O
0x0000	<i>MainsVoltage</i>	uint16	0x0000 to 0xffff	R	non	O
0x0001	<i>MainsFrequency</i>	uint8	0x00 to 0xff	R	non	O

3938 **3.3.2.2.1.1 MainsVoltage Attribute**3939 The *MainsVoltage* attribute is 16 bits in length and specifies the actual (measured) RMS voltage (or DC  
3940 voltage in the case of a DC supply) currently applied to the device, measured in units of 100mV.3941 **3.3.2.2.1.2 MainsFrequency Attribute**3942 The *MainsFrequency* attribute is 8 bits in length and represents the frequency, in Hertz, of the mains as  
3943 determined by the device as follows:



- 3944 *MainsFrequency* = 0.5 x measured frequency  
 3945 Where 2 Hz <= measured frequency <= 506 Hz, corresponding to a *MainsFrequency* in the range 1 to 0xfd.  
 3946 The maximum resolution this format allows is 2 Hz.  
 3947 The following special values of *MainsFrequency* apply.  
 3948       0x00 indicates a frequency that is too low to be measured.  
 3949       0xfe indicates a frequency that is too high to be measured.  
 3950       0xff indicates that the frequency could not be measured.  
 3951 In the case of a DC supply, this attribute SHALL also have the value zero.

3952 **3.3.2.2.2 Mains Settings Attribute Set**

3953 The Mains Settings attribute set contains the attributes summarized in Table 3-19.

3954 **Table 3-19. Attributes of the Mains Settings Attribute Set**

Identifier	Name	Type	Range	Acc	Default	M/O
0x0010	<i>MainsAlarmMask</i>	map8	0000 00xx	RW	0	O
0x0011	<i>MainsVoltageMinThreshold</i>	uint16	0x0000 to 0xffff	RW	0	O
0x0012	<i>MainsVoltageMaxThreshold</i>	uint16	0x0000 to 0xffff	RW	0xffff	O
0x0013	<i>MainsVoltageDwellTripPoint</i>	uint16	0x0000 to 0xffff	RW	0	O

- 3955  
 3956 The alarm settings in this table require the Alarms cluster to be implemented on the same device – see De-  
 3957 pendencies. If the Alarms cluster is not present on the same device they MAY be omitted.

3958 **3.3.2.2.2.1 MainsAlarmMask Attribute**

3959 The *MainsAlarmMask* attribute is 8 bits in length and specifies which mains alarms MAY be generated, as  
 3960 listed in Table 3-20. A ‘1’ in each bit position enables the alarm.

3961 **Table 3-20. Values of the MainsAlarmMask Attribute**

<i>MainsAlarmMask</i> Attribute Bit Number	Alarm	Rev
0	Mains Voltage too low (3.3.2.2.2.2)	0
1	Mains Voltage too high (3.3.2.2.2.3)	0
2	Mains power supply lost/unavailable (i.e., device is running on battery)	1

3962 **3.3.2.2.2.2 MainsVoltageMinThreshold Attribute**

3963 The *MainsVoltageMinThreshold* attribute is 16 bits in length and specifies the lower alarm threshold, meas-  
 3964 ured in units of 100mV, for the MainsVoltage attribute. The value of this attribute SHALL be less than  
 3965 MainsVoltageMaxThreshold.

3966 If the value of *MainsVoltage* drops below the threshold specified by *MainsVoltageMinThreshold*, the device  
3967 SHALL start a timer to expire after *MainsVoltageDwellTripPoint* seconds. If the value of this attribute in-  
3968 creases to greater than or equal to *MainsVoltageMinThreshold* before the timer expires, the device SHALL  
3969 stop and reset the timer. If the timer expires, an alarm SHALL be generated.

3970 The Alarm Code field (see 3.11.2.4.1) included in the generated alarm SHALL be 0x00.

3971 If this attribute takes the value 0xffff then this alarm SHALL NOT be generated.

### 3972 **3.3.2.2.2.3 MainsVoltageMaxThreshold Attribute**

3973 The *MainsVoltageMaxThreshold* attribute is 16 bits in length and specifies the upper alarm threshold, meas-  
3974 ured in units of 100mV, for the *MainsVoltage* attribute. The value of this attribute SHALL be greater than  
3975 *MainsVoltageMinThreshold*.

3976 If the value of *MainsVoltage* rises above the threshold specified by *MainsVoltageMaxThreshold*, the device  
3977 SHALL start a timer to expire after *MainsVoltageDwellTripPoint* seconds. If the value of this attribute drops  
3978 to lower than or equal to *MainsVoltageMaxThreshold* before the timer expires, the device SHALL stop and  
3979 reset the timer. If the timer expires, an alarm SHALL be generated.

3980 The Alarm Code field (see 3.11.2.4.1) included in the generated alarm SHALL be 0x01.

3981 If this attribute takes the value 0xffff then this alarm SHALL NOT be generated.

### 3982 **3.3.2.2.2.4 MainsVoltageDwellTripPoint Attribute**

3983 The *MainsVoltageDwellTripPoint* attribute is 16 bits in length and specifies the length of time, in seconds  
3984 that the value of *MainsVoltage* MAY exist beyond either of its thresholds before an alarm is generated. <sup>17</sup>

### 3985 **3.3.2.2.3 ~~48~~ Battery Information Attribute Set**

3986 The Battery Information attribute set contains the attributes summarized in Table 3-21.

3987 **Table 3-21. Attributes of the Battery Information Attribute Set**

Id	Name	Type	Range	Acc	Def	M/O
0x0020	<i>BatteryVoltage</i>	uint8	0x00 to 0xff	R	non	O
0x0021	<i>BatteryPercentageRemaining</i>	uint8	0x00 to 0xff	RP	0	O

3988

3989 Manufacturers SHOULD measure the battery voltage and capacity at a consistent moment (e.g., the moment  
3990 of radio transmission (i.e., peak demand)) in order to avoid unnecessary fluctuation in reporting the attribute,  
3991 which can confuse users and make them call into question the quality of the device.

3992 Manufacturers SHOULD employ a hysteresis algorithm appropriate for their battery type in order to smooth  
3993 battery reading fluctuations and avoid sending multiple battery warning messages when crossing the voltage  
3994 thresholds defined for warnings.

### 3995 **3.3.2.2.3.1 BatteryVoltage Attribute**

3996 The *BatteryVoltage* attribute specifies the current actual (measured) battery voltage, in units of 100mV.

3997 The value 0xff indicates an invalid or unknown reading.

### 3998 **3.3.2.2.3.2 BatteryPercentageRemaining Attribute**

<sup>17</sup> CCB 2899: *MainsVoltageDwellTripPoint* can't disable alarms, whether it is 0 or FFs. The Threshold attributes de-  
cide if alarms are sent.

<sup>19</sup> CCB 2454 description defines this as reportable

- 3999 Specifies the remaining battery life as a half integer percentage of the full battery capacity (e.g., 34.5%, 45%,  
4000 68.5%, 90%) with a range between zero and 100%, with 0x00 = 0%, 0x64 = 50%, and 0xC8 = 100%. This  
4001 is particularly suited for devices with rechargeable batteries.
- 4002 The value 0xff indicates an invalid or unknown reading.
- 4003 This attribute SHALL be configurable for attribute reporting.

4004 **3.3.2.2.4 Battery Settings Attribute Set**

4005 **Table 3-22. Attributes of the Battery Settings Attribute Set**

Id	Name	Type	Range	Acc	Default	M/O
0x0030	<i>BatteryManufacturer</i>	string	0 to 16 bytes	RW	empty string	O
0x0031	<i>BatterySize</i>	enum8	desc	RW	0xff	O
0x0032	<i>BatteryAhrRating</i>	uint16	0x0000 to 0xffff	RW	non	O
0x0033	<i>BatteryQuantity</i>	uint8	0x00 to 0xff	RW	non	O
0x0034	<i>BatteryRatedVoltage</i>	uint8	0x00 to 0xff	RW	non	O
0x0035	<i>BatteryAlarmMask</i>	map8	desc	RW	0	O
0x0036	<i>BatteryVoltageMinThreshold</i>	uint8	0x00 to 0xff	RW	0	O
0x0037	<i>BatteryVoltageThreshold1</i>	uint8	0x00 to 0xff	R*W	0	O
0x0038	<i>BatteryVoltageThreshold2</i>	uint8	0x00 to 0xff	R*W	0	O
0x0039	<i>BatteryVoltageThreshold3</i>	uint8	0x00 to 0xff	R*W	0	O
0x003a	<i>BatteryPercentageMinThreshold</i>	uint8	0x00 to 0xff	R*W	0	O
0x003b	<i>BatteryPercentageThreshold1</i>	uint8	0x00 to 0xff	R*W	0	O
0x003c	<i>BatteryPercentageThreshold2</i>	uint8	0x00 to 0xff	R*W	0	O
0x003d	<i>BatteryPercentageThreshold3</i>	uint8	0x00 to 0xff	R*W	0	O
0x003e	<i>BatteryAlarmState</i>	map32	descr	RP <sup>19</sup>	0	O

4006 **3.3.2.2.4.1 BatteryManufacturer Attribute**

4007 The *BatteryManufacturer* attribute is a maximum of 16 bytes in length and specifies the name of the battery  
4008 manufacturer as a character string.

4009 **3.3.2.2.4.2 BatterySize Attribute**

4010 The *BatterySize* attribute is an enumeration which specifies the type of battery being used by the device. This  
4011 attribute SHALL be set to one of the non-reserved values listed in Table 3-23.

<sup>19</sup> CCB 2454 description defines this as reportable

4012

**Table 3-23. Values of the *BatterySize* Attribute**

Attribute Value	Description
0x00	No battery
0x01	Built in
0x02	Other
0x03	AA
0x04	AAA
0x05	C
0x06	D
0x07	CR2 (IEC: CR17355 / ANSI: 5046LC)
0x08	CR123A (IEC: CR17345 / ANSI: 5018LC)
0xff	Unknown

4013 **3.3.2.2.4.3 *BatteryAHRRating* Attribute**

4014 The *BatteryAHRRating* attribute is 16 bits in length and specifies the Ampere-hour rating of the battery,  
4015 measured in units of 10mAh.

4016 **3.3.2.2.4.4 *BatteryQuantity* Attribute**

4017 The *BatteryQuantity* attribute is 8 bits in length and specifies the number of battery cells used to power the  
4018 device.

4019 **3.3.2.2.4.5 *BatteryRatedVoltage* Attribute**

4020 The *BatteryRatedVoltage* attribute is 8 bits in length and specifies the rated voltage of the battery being used  
4021 in the device, measured in units of 100mV.

4022 **3.3.2.2.4.6 *BatteryAlarmMask* Attribute**

4023 The *BatteryAlarmMask* attribute specifies which battery alarms must be generated, as listed in Table 3-24. A  
4024 '1' in each bit position enables the alarm.

4025 **Table 3-24. Values of the *BatteryAlarmMask* Attribute**

<i>BatteryAlarmMask</i> Attribute Bit Number*	Description
0	Battery voltage too low to continue operating the device's radio (i.e., <i>BatteryVoltageMinThreshold</i> value has been reached)
1	Battery Alarm 1 (i.e., <i>Battery Voltage Threshold 1</i> or <i>Battery Percentage Threshold 1</i> value has been reached)
2	Battery Alarm 2 (i.e., <i>Battery Voltage Threshold 2</i> or <i>Battery Percentage Threshold 2</i> value has been reached)

<i>BatteryAlarmMask</i> Attribute Bit Number*	Description
3	Battery Alarm 3 (i.e., Battery Voltage Threshold 3 or Battery Percentage Threshold 3 value has been reached)

4026 Manufacturers are responsible for determining the capability to sense and levels at which the alarms are  
4027 generated. See Section 10.3.2, References, for additional recommendations on measuring battery voltage.

4028 **3.3.2.2.4.7 BatteryVoltageMinThreshold Attribute**

4029

4030 Specifies the low battery voltage alarm threshold, measured in units of 100mV at which the device can no  
4031 longer operate or transmit via its radio (i.e., last gasp).

4032 If the value of *BatteryVoltage* drops below the threshold specified by *BatteryVoltageMinThreshold*, an ap-  
4033 propriate alarm SHALL be generated and/or the corresponding bit SHALL be updated in the *BatteryAlarm-*  
4034 *State* attribute.

4035 In order to report to Power Configuration clients, servers that implement *BatteryVoltageMinThreshold* at-  
4036 tribute SHALL implement alarming via the Alarm Cluster, attribute reporting via the *BatteryAlarmState* at-  
4037 tribute, or both.

4038 For servers that implement alarming via the Alarm Cluster, the appropriate alarm is specified in the Alarm  
4039 Code field (see 3.11.2.3.1) included in the generated alarm and SHALL be one of the values in Table 3-25.  
4040 The host determines which alarm code to populate based on the *BatteryAlarmMask* attribute and the *Bat-*  
4041 *teryVoltageMinThreshold* attribute reached. For example, when the *BatteryVoltage* attribute reaches the  
4042 value specified by the *BatteryVoltageMinThreshold* attribute, an alarm with the Alarm Code Field Enumer-  
4043 ation “0x10” SHALL be generated.

4044 For servers that implement battery alarm reporting via the *BatteryAlarmState* attribute, the bit corresponding  
4045 to the threshold level reached SHALL be set to TRUE. See the *BatteryAlarmState* attribute details for more  
4046 information.

4047

**Table 3-25. Alarm Code Field Enumerations for Battery Alarms**

Val	Description
0x10	<i>BatteryVoltageMinThreshold</i> or <i>BatteryPercentageMinThreshold</i> reached for Battery Source 1
0x11	<i>BatteryVoltageThreshold1</i> or <i>BatteryPercentageThreshold1</i> reached for Battery Source 1
0x12	<i>BatteryVoltageThreshold2</i> or <i>BatteryPercentageThreshold2</i> reached for Battery Source 1
0x13	<i>BatteryVoltageThreshold3</i> or <i>BatteryPercentageThreshold3</i> reached for Battery Source 1
0x20	<i>BatteryVoltageMinThreshold</i> or <i>BatteryPercentageMinThreshold</i> reached for Battery Source 2
0x21	<i>BatteryVoltageThreshold1</i> or <i>BatteryPercentageThreshold1</i> reached for Battery Source 2
0x22	<i>BatteryVoltageThreshold2</i> or <i>BatteryPercentageThreshold2</i> reached Battery Source 2
0x23	<i>BatteryVoltageThreshold3</i> or <i>BatteryPercentageThreshold3</i> reached Battery Source 2
0x30	<i>BatteryVoltageMinThreshold</i> or <i>BatteryPercentageMinThreshold</i> reached for Battery Source 3

Val	Description
0x31	<i>BatteryVoltageThreshold1</i> or <i>BatteryPercentageThreshold1</i> reached for Battery Source 3
0x32	<i>BatteryVoltageThreshold2</i> or <i>BatteryPercentageThreshold2</i> reached Battery Source 3
0x33	<i>BatteryVoltageThreshold3</i> or <i>BatteryPercentageThreshold3</i> reached Battery Source 3
0x3a	Mains power supply lost/unavailable (i.e., device is running on battery)
0xff	Alarm SHALL NOT be generated

#### 4048 **3.3.2.2.4.8 BatteryVoltageThreshold 1-3 Attributes**

4049 Specify the low voltage alarm thresholds, measured in units of 100mV, for the *BatteryVoltage* attribute.

4050 If the value of *BatteryVoltage* drops below the threshold specified by a *BatteryVoltageThreshold*, an appropriate alarm SHALL be generated and/or the corresponding bit SHALL be updated in the *BatteryAlarmState* attribute.  
4051  
4052

4053 The *BatteryVoltageThreshold1-3* attributes SHALL be ordered in ascending order such that the *BatteryVoltage* level specified to trigger:  
4054

- 4055 • *BatteryVoltageThreshold3* is higher than the level specified to trigger *BatteryVoltageThreshold2*
- 4056 • *BatteryVoltageThreshold2* is higher than the level specified to trigger *BatteryVoltageThreshold1*<sup>20</sup>
- 4057 • *BatteryVoltageThreshold1* is higher than the level specified to trigger *BatteryVoltageMinThreshold*

4058 The appropriate alarm is specified in the Alarm Code field (see 3.11.2.3.1) included in the generated alarm  
4059 and SHALL be one of the values in Table 3-25. The host determines which alarm code to populate based on  
4060 the *BatteryAlarmMask* attribute and the *BatteryVoltageThreshold1-3* attribute reached.

4061 If this attribute takes the non-value then this alarm SHALL NOT be generated.

#### 4062 **3.3.2.2.4.9 BatteryPercentageMinThreshold Attribute**

4063 Specifies the low battery percentage alarm threshold, measured in percentage (i.e., zero to 100%), for the  
4064 *BatteryPercentageRemaining* attribute (see sub-clause 3.3.2.2.3.2).

4065 If the value of *BatteryPercentageRemaining* drops below the threshold specified by a *BatteryPercentageThreshold*, an appropriate alarm SHALL be generated.  
4066

4067 The appropriate alarm is specified in the Alarm Code field (see 3.11.2.3.1) included in the generated alarm  
4068 and SHALL be the value in Table 3-25 that corresponds with this threshold being reached for a given battery  
4069 source. The host determines which alarm code to populate based on the *BatteryAlarmMask* attribute.

4070 If this attribute takes the non-value then this alarm SHALL NOT be generated.

#### 4071 **3.3.2.2.4.10 BatteryPercentageThreshold 1-3 Attributes**

4072 Specify the low battery percentage alarm thresholds, measured in percentage (i.e., zero to 100%), for the  
4073 *BatteryPercentageRemaining* attribute (see sub-clause 3.3.2.2.3.2).

4074 If the value of *BatteryPercentageRemaining* drops below the threshold specified by a *BatteryPercentageThreshold*, an appropriate alarm SHALL be generated.  
4075

4076 The *BatteryPercentageThreshold1-3* attributes SHALL be ordered in ascending order such that the *BatteryPercentageRemaining* level specified to trigger:  
4077

<sup>20</sup> CCB 2463

- 4078 • BatteryPercentageThreshold3 is higher than the level specified to trigger BatteryPercentageThreshold2
  - 4079 • BatteryPercentageThreshold2 is higher than the level specified to trigger BatteryPercentageThreshold
  - 4080 • BatteryPercentageThreshold1 is higher than the level specified to trigger BatteryPercent-
  - 4081 ageMinThreshold
- 4082 The appropriate alarm is specified in the Alarm Code field (see 3.11.2.3.1) included in the generated alarm  
 4083 and SHALL be one of the values in Table 3-25. The host determines which alarm code to populate based on  
 4084 the *BatteryAlarmMask* attribute and the *BatteryPercentageThreshold1-3* attribute reached.
- 4085 If this attribute takes the non-value then this alarm SHALL NOT be generated.

4086 **3.3.2.2.4.11 BatteryAlarmState Attribute**

4087 Specifies the current state of the device’s battery alarms. This attribute provides a persistent record of a  
 4088 device’s battery alarm conditions as well as a mechanism for reporting changes to those conditions, including  
 4089 the elimination of battery alarm states (e.g., when a battery is replaced).

4090 If implemented, the server SHALL support attribute reporting for *BatteryAlarmState* attribute. This provides  
 4091 clients with a mechanism for reading the current state in case they missed the initial attribute report and also  
 4092 reduces network and battery use due to repeated polling of this attribute when it has not changed. It also  
 4093 provides a way of notifying clients when battery alarm conditions no longer exist (e.g., when the batteries  
 4094 have been replaced).

4095 **Table 3-26. BatteryAlarmState Enumerations**

Bit	Description
0	<i>BatteryVoltageMinThreshold</i> or <i>BatteryPercentageMinThreshold</i> reached for Battery Source 1
1	<i>BatteryVoltageThreshold1</i> or <i>BatteryPercentageThreshold1</i> reached for Battery Source 1
2	<i>BatteryVoltageThreshold2</i> or <i>BatteryPercentageThreshold2</i> reached for Battery Source 1
3	<i>BatteryVoltageThreshold3</i> or <i>BatteryPercentageThreshold3</i> reached for Battery Source 1
10	<i>BatteryVoltageMinThreshold</i> or <i>BatteryPercentageMinThreshold</i> reached for Battery Source 2
11	<i>BatteryVoltageThreshold1</i> or <i>BatteryPercentageThreshold1</i> reached for Battery Source 2
12	<i>BatteryVoltageThreshold2</i> or <i>BatteryPercentageThreshold2</i> reached Battery Source 2
13	<i>BatteryVoltageThreshold3</i> or <i>BatteryPercentageThreshold3</i> reached Battery Source 2
20	<i>BatteryVoltageMinThreshold</i> or <i>BatteryPercentageMinThreshold</i> reached for Battery Source 3
21	<i>BatteryVoltageThreshold1</i> or <i>BatteryPercentageThreshold1</i> reached for Battery Source 3
22	<i>BatteryVoltageThreshold2</i> or <i>BatteryPercentageThreshold2</i> reached Battery Source 3
23	<i>BatteryVoltageThreshold3</i> or <i>BatteryPercentageThreshold3</i> reached Battery Source 3
30	Mains power supply lost/unavailable (i.e., device is running on battery)

4096

4097 Manufacturers are responsible for determining the capability to sense and levels at which the alarms are  
4098 generated. See 3.3.2.2.3 for additional recommendations on measuring battery voltage.

#### 4099 **3.3.2.2.5 Battery Information 2 Attribute Set**

4100 This attribute set is an exact replica of all the attributes, commands, and behaviors contained within the  
4101 Battery Information Attribute Set and provides a host with the ability to represent battery information for a  
4102 secondary battery bank or cell.

#### 4103 **3.3.2.2.6 Battery Settings 2 Attribute Set**

4104 This attribute set is an exact replica of all the attributes, commands, and behaviors contained within the  
4105 Battery Settings Attribute Set and provides a host with the ability to represent battery settings for a secondary  
4106 battery bank or cell.

#### 4107 **3.3.2.2.7 Battery Information 3 Attribute Set**

4108 This attribute set is an exact replica of all the attributes, commands, and behaviors contained within the  
4109 Battery Information Attribute Set and provides a host with the ability to represent battery information for a  
4110 tertiary battery bank or cell.

#### 4111 **3.3.2.2.8 Battery Settings 3 Attribute Set**

4112 This attribute set is an exact replica of all the attributes, commands, and behaviors contained within the  
4113 Battery Settings Attribute Set and provides a host with the ability to represent battery settings for a tertiary  
4114 battery bank or cell. Commands Received

### 4115 **3.3.2.3 Commands Received**

4116 No commands are received by the server.

### 4117 **3.3.2.4 Commands Generated**

4118 The server generates no commands.

## 4119 **3.3.3 Client**

4120 The client has no dependencies or cluster specific attributes. There are no cluster specific commands that are  
4121 generated or received by the client

## 4122 **3.4 Device Temperature Configuration**

---

### 4123 **3.4.1 Overview**

4124 Please see Chapter 2 for a general cluster overview defining cluster architecture, revision, classification,  
4125 identification, etc.

4126 Attributes for determining information about a device's internal temperature, and for configuring under/over  
4127 temperature alarms for temperatures that are outside the device's operating range.



4128 **3.4.1.1 Revision History**

4129 The global *ClusterRevision* attribute value SHALL be the highest revision number in the table below.

Rev	Description
1	global mandatory <i>Cluster Revision</i> attribute added

4130 **3.4.1.2 Classification**

Hierarchy	Role	PICS Code
Base	Utility	DTMP

4131 **3.4.1.3 Cluster Identifiers**

Identifier	Name
0x0002	Device Temperature Configuration

4132 **3.4.2 Server**

4133 **3.4.2.1 Dependencies**

4134 For the alarm functionality described in this cluster to be operational, any endpoint that implements the De-  
4135 vice Temperature Configuration server cluster SHALL also implement the Alarms server cluster (see 3.11).

4136 **3.4.2.2 Attributes**

4137 For convenience, the attributes defined in this specification are arranged into sets of related attributes; each  
4138 set can contain up to 16 attributes. Attribute identifiers are encoded such that the most significant three nib-  
4139 bles specify the attribute set and the least significant nibble specifies the attribute within the set. The currently  
4140 defined attribute sets are listed in Table 3-27.

4141 **Table 3-27. Device Temperature Configuration Attribute Sets**

Attribute Set Identifier	Description
0x000	Device Temperature Information
0x001	Device Temperature Settings

4142 **3.4.2.2.1 Device Temperature Information Attribute Set**

4143 The Device Temperature Information attribute set contains the attributes summarized in Table 3-28.

4144

**Table 3-28. Device Temperature Information Attribute Set**

<b>Id</b>	<b>Name</b>	<b>Type</b>	<b>Range</b>	<b>Acc</b>	<b>Def</b>	<b>M/O</b>
0x0000	<i>CurrentTemperature</i>	int16	-200 to +200	R	non	M
0x0001	<i>MinTempExperienced</i>	int16	-200 to +200	R	non	O
0x0002	<i>MaxTempExperienced</i>	int16	-200 to +200	R	non	O
0x0003	<i>OverTempTotalDwell</i>	uint16	0x0000 to 0xffff	R	0	O

**4145 3.4.2.2.1.1 CurrentTemperature Attribute**

4146 The *CurrentTemperature* attribute is 16 bits in length and specifies the current internal temperature, in de-  
4147 grees Celsius, of the device. This attribute SHALL be specified in the range –200 to +200.

4148 The non-value indicates an invalid reading.

**4149 3.4.2.2.1.2 MinTempExperienced Attribute**

4150 The *MinTempExperienced* attribute is 16 bits in length and specifies the minimum internal temperature, in  
4151 degrees Celsius, the device has experienced while powered. This attribute SHALL be specified in the range  
4152 –200 to +200.

4153 The non-value indicates an invalid reading.

**4154 3.4.2.2.1.3 MaxTempExperienced Attribute**

4155 The *MaxTempExperienced* attribute is 16 bits in length and specifies the maximum internal temperature, in  
4156 degrees Celsius, the device has experienced while powered. This attribute SHALL be specified in the range  
4157 –200 to +200.

4158 The non-value indicates an invalid reading.

**4159 3.4.2.2.1.4 OverTempTotalDwell Attribute**

4160 The *OverTempTotalDwell* attribute is 16 bits in length and specifies the length of time, in hours; the device  
4161 has spent above the temperature specified by the *HighTempThreshold* attribute 3.4.2.2.2.3, cumulative over  
4162 the lifetime of the device.

4163 The non-value indicates an invalid time.

**4164 3.4.2.2.2 Device Temperature Settings Attribute Set**

4165 The Device Temperature Settings attribute set contains the attributes summarized in Table 3-29.

4166

**Table 3-29. Device Temperature Settings Attribute Set**

<b>Id</b>	<b>Name</b>	<b>Type</b>	<b>Range</b>	<b>Acc</b>	<b>Default</b>	<b>M/O</b>
0x0010	<i>DeviceTempAlarmMask</i>	map8	0000 00xx	RW	0000 0000	O
0x0011	<i>LowTempThreshold</i>	int16	-200 to +200	RW	non	O
0x0012	<i>HighTempThreshold</i>	int16	-200 to +200	RW	non	O
0x0013	<i>LowTempDwellTripPoint</i>	uint24	0x000000 to 0xffffff	RW	non	O

Id	Name	Type	Range	Acc	Default	M/O
0x0014	<i>HighTempDwellTripPoint</i>	uint24	0x000000 to 0xffffffff	RW	non	O

4167

4168 All attributes in this table require the Alarms cluster to be implemented on the same device – see Dependenc-  
4169 cies. If the Alarms cluster is not present on the same device they MAY be omitted.

4170 **3.4.2.2.2.1 DeviceTempAlarmMask Attribute**

4171 The *DeviceTempAlarmMask* attribute is 8 bits in length and specifies which alarms MAY be generated, as  
4172 listed in Table 3-30. A ‘1’ in each bit position enables the corresponding alarm.

4173 **Table 3-30. Values of the *DeviceTempAlarmMask* Attribute**

Attribute Bit Number	Alarm
0	Device Temperature too low
1	Device Temperature too high

4174 **3.4.2.2.2.2 LowTempThreshold Attribute**

4175 The *LowTempThreshold* attribute is 16 bits in length and specifies the lower alarm threshold, measured in  
4176 degrees Celsius (range -200°C to 200°C), for the *CurrentTemperature* attribute. The value of this attribute  
4177 SHALL be less than *HighTempThreshold*.

4178 If the value of *CurrentTemperature* drops below the threshold specified by *LowTempThreshold*, the device  
4179 SHALL start a timer to expire after *LowTempDwellTripPoint* seconds. If the value of this attribute increases  
4180 to greater than or equal to *LowTempThreshold* before the timer expires, the device SHALL stop and reset the  
4181 timer. If the timer expires, an alarm SHALL be generated.

4182 The Alarm Code field (see 3.11.2.4.1) included in the generated alarm SHALL be 0x00.

4183 If this attribute takes the non-value then this alarm SHALL NOT be generated.

4184 **3.4.2.2.2.3 HighTempThreshold Attribute**

4185 The *HighTempThreshold* attribute is 16 bits in length and specifies the upper alarm threshold, measured in  
4186 degrees Celsius (range -200°C to 200°C), for the *CurrentTemperature* attribute. The value of this attribute  
4187 SHALL be greater than *LowTempThreshold*.

4188 If the value of *CurrentTemperature* rises above the threshold specified by *HighTempThreshold*, the device  
4189 SHALL start a timer to expire after *HighTempDwellTripPoint* seconds. If the value of this attribute drops to  
4190 lower than or equal to *HighTempThreshold* before the timer expires, the device SHALL stop and reset the  
4191 timer. If the timer expires, an alarm SHALL be generated.

4192 The Alarm Code field (see 3.11.2.4.1) included in the generated alarm SHALL be 0x01.

4193 If this attribute takes the non-value then this alarm SHALL NOT be generated.

4194 **3.4.2.2.2.4 LowTempDwellTripPoint Attribute**

4195 The *LowTempDwellTripPoint* attribute is 24 bits in length and specifies the length of time, in seconds, that  
4196 the value of *CurrentTemperature* MAY exist below *LowTempThreshold* before an alarm is generated.

4197 If this attribute takes the non-value then this alarm SHALL NOT be generated.

4198 **3.4.2.2.2.5 HighTempDwellTripPoint Attribute**4199 The *HighTempDwellTripPoint* attribute is 24 bits in length and specifies the length of time, in seconds, that  
4200 the value of *CurrentTemperature* MAY exist above *HighTempThreshold* before an alarm is generated.

4201 If this attribute takes the non-value then this alarm SHALL NOT be generated.

4202 **3.4.2.3 Commands**

4203 No commands are received or generated by the server.

4204 **3.4.3 Client**4205 The client has no dependencies or cluster specific attributes. There are no cluster specific commands that are  
4206 generated or received by the client.4207 **3.5 Identify**

---

4208 **3.5.1 Overview**4209 Please see Chapter 2 for a general cluster overview defining cluster architecture, revision, classification,  
4210 identification, etc.4211 Attributes and commands to put a device into an Identification mode (e.g., flashing a light), that indicates to  
4212 an observer – e.g., an installer – which of several devices it is, also to request any device that is identifying  
4213 itself to respond to the initiator.4214 Note that this cluster cannot be disabled, and remains functional regardless of the setting of the *DeviceEnable*  
4215 attribute in the Basic cluster.4216 **3.5.1.1 Revision History**4217 The global *ClusterRevision* attribute value SHALL be the highest revision number in the table below.

Rev	Description
1	global mandatory <i>Cluster Revision</i> attribute added
2	CCB 2808

4218 **3.5.1.2 Classification**

Hierarchy	Role	PICS Code
Base	Utility	I

4219 **3.5.1.3 Cluster Identifiers**

Identifier	Name
0x0003	Identify

4220 **3.5.2 Server**

4221 **3.5.2.1 Dependencies**

4222 None

4223 **3.5.2.2 Attributes**

4224 The server supports the attribute shown in Table 3-31.

4225 **Table 3-31. Attributes of the Identify Server Cluster**

Identifier	Name	Type	Range	Access	Default	M/O
0x0000	<i>IdentifyTime</i>	uint16	0x0000 to 0xffff	RW	0	M

4226 **3.5.2.2.1 IdentifyTime Attribute**

4227 The *IdentifyTime* attribute specifies the remaining length of time, in seconds, that the device will continue to  
4228 identify itself.

4229 If this attribute is set to a value other than 0x0000 then the device SHALL enter its identification procedure,  
4230 in order to indicate to an observer which of several devices it is. It is recommended that this procedure con-  
4231 sists of flashing a light with a period of 0.5 seconds. The *IdentifyTime* attribute SHALL be decremented every  
4232 second.

4233 If this attribute reaches or is set to the value 0x0000 then the device SHALL terminate its identification  
4234 procedure.

4235 **3.5.2.3 Commands Received**

4236 The server side of the identify cluster is capable of receiving the commands listed in Table 3-32.

4237 **Table 3-32. Received Command IDs for the Identify Cluster**

Command Identifier	Description	M/O
0x00	Identify	M
0x01	Identify Query	M
0x40	Trigger effect	O

4238 **3.5.2.3.1 Identify Command**

4239 The identify command starts or stops the receiving device identifying itself.

4240 **3.5.2.3.1.1 Payload Format**

4241 The identify query response command payload SHALL be formatted as illustrated in Figure 3-7.

4242 **Figure 3-7. Format of Identify Query Response Command Payload**

<b>Octets</b>	2
<b>Data Type</b>	uint16
<b>Field Name</b>	Identify Time

4243 **3.5.2.3.1.2 Effect on Receipt**4244 On receipt of this command, the device SHALL set the *IdentifyTime* attribute to the value of the Identify  
4245 Time field. This then starts, continues, or stops the device's identification procedure as detailed in 3.5.2.2.1.4246 **3.5.2.3.2 Identify Query Command**4247 The identify query command allows the sending device to request the target or targets to respond if they are  
4248 currently identifying themselves.

4249 This command has no payload.

4250 **3.5.2.3.2.1 Effect on Receipt**4251 On receipt of this command, if the device is currently identifying itself then it SHALL generate an appropriate  
4252 Identify Query Response command, see 3.5.2.4.1 and unicast it to the requestor. If the device is not currently  
4253 identifying itself it SHALL take no further action.4254 **3.5.2.3.3 Trigger Effect Command**4255 The *Trigger Effect* command allows the support of feedback to the user, such as a certain light effect. It is  
4256 used to allow an implementation to provide visual feedback to the user under certain circumstances such as  
4257 a color light turning green when it has successfully connected to a network. The use of this command and  
4258 the effects themselves are entirely up to the implementer to use whenever a visual feedback is useful but it is  
4259 not the same as and does not replace the identify mechanism used during commissioning.

4260 The payload of this command SHALL be formatted as illustrated in Figure 3-8.

4261 **Figure 3-8. Format of the Trigger Effect Command**

<b>Octets</b>	1	1
<b>Data Type</b>	enum8 <sup>21</sup>	enum8
<b>Field Name</b>	Effect identifier	Effect variant

4262 **3.5.2.3.3.1 Effect Identifier Field**4263 The *Effect Identifier* field is 8-bits in length and specifies the identify effect to use. This field SHALL contain  
4264 one of the nonreserved values listed in Table 3-33.<sup>21</sup> CCB 2808

4265

**Table 3-33. Values of the Effect Identifier Field of the Trigger Effect Command**

Effect Identifier Field Value	Effect <sup>22</sup>	Notes
0x00	Blink	e.g., Light is turned on/off once.
0x01	Breathe	e.g., Light turned on/off over 1 second and repeated 15 times.
0x02	Okay	e.g., Colored light turns green for 1 second; noncolored light flashes twice.
0x0b	Channel change	e.g., Colored light turns orange for 8 seconds; noncolored light switches to maximum brightness for 0.5s and then minimum brightness for 7.5s.
0xfe	Finish effect	Complete the current effect sequence before terminating. e.g., if in the middle of a breathe effect (as above), first complete the current 1s breathe effect and then terminate the effect.
0xff	Stop effect	Terminate the effect as soon as possible.

4266

4267 **3.5.2.3.3.2 Effect Variant Field**

4268 The *effect variant* field is 8-bits in length and is used to indicate which variant of the effect, indicated in the  
4269 *effect identifier* field, SHOULD be triggered. If a device does not support the given variant, it SHALL use  
4270 the default variant. This field SHALL contain one of the non-reserved values listed in Table 3-34.

4271 **Table 3-34. Values of the Effect Variant Field of the Trigger Effect Command**

Effect Variant Field Value	Description
0x00	Default

4272

4273 **3.5.2.3.3.3 Effect on Receipt**

4274 On receipt of this command, the device SHALL execute the trigger effect indicated in the *Effect Identifier*  
4275 and *Effect Variant* fields. If the *Effect Variant* field specifies a variant that is not supported on the device, it  
4276 SHALL execute the default variant.

4277 **3.5.2.4 Commands Generated**

4278 The server side of the identify cluster is capable of generating the commands listed in Table 3-35.

4279 **Table 3-35. Generated Command IDs for the Identify Cluster**

Command Identifier Field Value	Description	M/O
0x00	Identify Query Response	M

<sup>22</sup> Implementers SHOULD indicate during testing how they handle each effect.

### 4280 3.5.2.4.1 Identify Query Response Command

4281 The identify query response command is generated in response to receiving an Identify Query command, see  
4282 3.5.2.3.2, in the case that the device is currently identifying itself.

#### 4283 3.5.2.4.1.1 Payload Format

4284 The identify query response command payload SHALL be formatted as illustrated in Figure 3-9.

4285 **Figure 3-9. Format of Identify Query Response Command Payload**

<b>Octets</b>	2
<b>Data Type</b>	uint16
<b>Field Name</b>	Timeout

#### 4286 3.5.2.4.1.2 Timeout Field

4287 The Timeout field contains the current value of the *IdentifyTime* attribute, and specifies the length of time,  
4288 in seconds, that the device will continue to identify itself.

#### 4289 3.5.2.4.1.3 Effect on Receipt

4290 On receipt of this command, the device is informed of a device in the network which is currently identifying  
4291 itself. This information MAY be particularly beneficial in situations where there is no commissioning tool.  
4292 Note that there MAY be multiple responses.

## 4293 3.5.3 Client

4294 The client has no cluster specific attributes. The client generates the cluster specific commands detailed in  
4295 3.5.2.3, as required by the application. The client receives the cluster specific response commands detailed  
4296 in 3.5.2.4.

## 4297 3.6 Groups

---

### 4298 3.6.1 Overview

4299 Please see Chapter 2 for a general cluster overview defining cluster architecture, revision, classification,  
4300 identification, etc.

4301 The stack specification provides the capability for group addressing. That is, any endpoint on any device  
4302 MAY be assigned to one or more groups, each labeled with a 16-bit identifier (0x0001 to 0xffff), which acts  
4303 for all intents and purposes like a network address. Once a group is established, frames, sent using the  
4304 APSDE-DATA.request primitive and having a DstAddrMode of 0x01, denoting group addressing, will be  
4305 delivered to every endpoint assigned to the group address named in the DstAddr parameter of the outgoing  
4306 APSDE-DATA.request primitive on every device in the network for which there are such endpoints.

4307 Management of group membership on each device and endpoint is implemented by the APS, but the over-  
4308 the-air messages that allow for remote management and commissioning of groups are defined here in the  
4309 cluster library on the theory that, while the basic group addressing facilities are integral to the operation of  
4310 the stack, not every device will need or want to implement this management cluster. Furthermore, the place-  
4311 ment of the management commands here allows developers of proprietary profiles to avoid implementing  
4312 the library cluster but still exploit group addressing.



4313 Commands are defined here for discovering the group membership of a device, adding a group, removing a  
4314 group and removing all groups.

4315 Finally, the group cluster allows application entities to store a name string for each group to which they are  
4316 assigned and to report that name string in response to a client request.

4317 Note that configuration of group addresses for outgoing commands is achieved using the APS binding mech-  
4318 anisms, and is not part of this cluster.

4319 As Groupcasts are made on a broadcast to all devices for which macRxOnWhenIdle = TRUE, sleeping end  
4320 devices will not be able to benefit from the features of the Groups and Scenes server Cluster. For example, a  
4321 door lock which would typically be a sleeping end device would not be able to receive the datagrams required  
4322 to commission a scene or change for example, to a night scene. It is therefore not Mandatory but only optional  
4323 to support the Groups and Scenes Server cluster if the device is a Sleeping end device (even when listed as  
4324 Mandatory).

### 4325 3.6.1.1 Revision History

4326 The global *ClusterRevision* attribute value SHALL be the highest revision number in the table below.

Rev	Description
1	global mandatory <i>Cluster Revision</i> attribute added; CCB 1745 2100
2	CCB 2289
3	CCB 2310 2704

### 4327 3.6.1.2 Classification

Hierarchy	Role	PICS Code
Base	Utility	G

### 4328 3.6.1.3 Cluster Identifiers

Identifier	Name
0x0004	Groups

## 4329 3.6.2 Server

4330 Each device that implements this cluster MAY be thought of as a group management server in the sense that  
4331 it responds to information requests and configuration commands regarding the contents of its group table.

4332 Note that, since these commands are simply data frames sent using the APSDE\_SAP, they must be addressed  
4333 with respect to device and endpoint. In particular, the destination device and endpoint of a group management  
4334 command must be unambiguous at the time of the issuance of the primitive either because:

- 4335 1. They are explicitly spelled out in the DstAddr and DstEndpoint parameters of the primitive.
- 4336 2. They are not explicitly spelled out but MAY be derived from the binding table in the APS of the  
4337 sending device.
- 4338 3. Broadcast addressing is being employed, either with respect to the device address or the endpoint  
4339 identifier.

4340 4. Group addressing is being employed.

4341 On receipt of a group cluster command, the APS will, at least conceptually, deliver the frame to each destination endpoint spelled out in the addressing portion of the APS header and, again conceptually speaking, the application entity resident at that endpoint will process the command and respond as necessary. From an implementation standpoint, of course, this MAY be done in a more economical way that does not involve duplication and separate processing, e.g., by providing a hook in the APS whereby group cluster commands could be delivered to a special application entity without duplication.

### 4347 3.6.2.1 Dependencies

4348 For correct operation of the 'Add group if identifying' command, any endpoint that implements the Groups server cluster SHALL also implement the Identify server cluster.

### 4350 3.6.2.2 Attributes

4351 The server supports the attribute shown in Table 3-36.

4352 **Table 3-36. Attributes of the Groups Server Cluster**

Identifier	Name	Type	Range	Acc	Def	M/O
0x0000	<i>NameSupport</i>	map8	desc	R	0	M

#### 4353 3.6.2.2.1 NameSupport Attribute

4354 The most significant bit of the *NameSupport* attribute indicates whether or not group names are supported. A value of 1 indicates that they are supported, and a value of 0 indicates that they are not supported.

#### 4356 3.6.2.2.2 Group Names

4357 Group names are between 0 and 16 characters long. Support of group names is optional, and is indicated by the *NameSupport* attribute. Group names, if supported, must be stored in a separate data structure managed by the application in which the entries correspond to group table entries.

### 4360 3.6.2.3 Commands Received

4361 The groups cluster is concerned with management of the group table on a device. In practice, the group table is managed by the APS and the table itself is available to the next higher layer as an AIB attribute. A command set is defined here and the implementation details of that command set in terms of the facilities provided by the APS is left up to the implementer of the cluster library itself.

4365 The server side of the groups cluster is capable of receiving the commands listed in Table 3-37.

4366 **Table 3-37. Received Command IDs for the Groups Cluster**

Command Identifier	Description	M/O
0x00	Add group	M
0x01	View group	M

Command Identifier	Description	M/O
0x02	Get group membership	M
0x03	Remove group	M
0x04	Remove all groups	M
0x05	Add group if identifying	M

4367 **3.6.2.3.1 Generic Usage Notes**

4368 On receipt of the *Add Group*, *View Group*, or *Remove Group* command frames via the groupcast or broadcast  
4369 transmission service, no response SHALL be given.

4370 **3.6.2.3.2 Add Group Command**

4371 The Add Group command allows the sending device to add group membership in a particular group for one  
4372 or more endpoints on the receiving device.

4373 **3.6.2.3.2.1 Payload Format**

4374 The Add Group command payload SHALL be formatted as illustrated in Figure 3-10.

4375 **Figure 3-10. Format of the Add Group Command Payload**

<b>Octets</b>	2	Variable
<b>Data Type</b>	uint16	string
<b>Field Name</b>	Group ID	Group Name

4376 **3.6.2.3.2.2 Effect on Receipt<sup>23</sup>**

4377 If the device is unable to store the contents of the Group Name field, the Group Name field can be ignored.

4378 On receipt of the Add Group command, the device SHALL perform the following procedure:

- 4379 1. The device verifies that the Group ID field contains a valid group identifier in the range 0x0001 –  
4380 0xffff. If the Group ID field contains a group identifier outside this range, the status SHALL be  
4381 INVALID\_VALUE and the device continues from step 5.
- 4382 2. The device verifies that it does not already have an entry in its Group Table that corresponds to the  
4383 value of the Group ID field. If it already has the requested entry in its Group Table, the Group  
4384 Name SHALL be updated (if supported), the status SHALL be SUCCESS, and the device continues  
4385 from step 5.
- 4386 3. The device verifies that it has free entries in its Group Table. If the device has no free entries in its  
4387 Group Table, the status SHALL be INSUFFICIENT\_SPACE and the device continues from step 5.
- 4388 4. The device adds the values of the Group ID and Group Name (if supported) fields to its Group Table  
4389 and the status SHALL be SUCCESS.

<sup>23</sup> CCB 2310 clarify command process and response

4390 5. If the Add Group command was received as a unicast, the device SHALL generate an Add Group  
4391 Response command with the Status field set to the evaluated status and SHALL transmit it back to  
4392 the originator of the Add Group command.

4393 See 3.6.2.4.1 for a description of the Add Group Response command.

### 4394 3.6.2.3.3 View Group Command

4395 The view group command allows the sending device to request that the receiving entity or entities respond  
4396 with a view group response command containing the application name string for a particular group.

#### 4397 3.6.2.3.3.1 Payload Format

4398 The View Group command payload SHALL be formatted as illustrated in Figure 3-11:

4399 **Figure 3-11. Format of the View Group Command Payload**

<b>Octets</b>	2
<b>Data Type</b>	uint16
<b>Field Name</b>	Group ID

#### 4400 3.6.2.3.3.2 Effect on Receipt<sup>24</sup>

4401 On receipt of the View Group command, the device SHALL perform the following procedure:

- 4402 1. The device verifies that the Group ID field contains a valid group identifier in the range 0x0001 –  
4403 0xffff7. If the Group ID field contains a group identifier outside this range, the status SHALL be  
4404 INVALID\_VALUE and the device continues from step 4.
- 4405 2. The device attempts to retrieve the entry in its Group Table corresponding to the group identifier  
4406 contained in the Group ID field. If no such entry exists in the Group Table, the status SHALL be  
4407 NOT\_FOUND and the device continues from step 4.
- 4408 3. The device retrieves the requested entry from its Group Table and the status SHALL be SUCCESS.
- 4409 4. If the View Group command was received as a unicast, the device SHALL generate a View Group  
4410 Response command with the retrieved group entry and the Status field set to the evaluated status  
4411 and SHALL transmit it back to the originator of the View Group command.

4412 See 3.6.2.4.2 for a description of the View Group Response command.

### 4413 3.6.2.3.4 Get Group Membership Command

4414 The get group membership command allows the sending device to inquire about the group membership of  
4415 the receiving device and endpoint in a number of ways.

#### 4416 3.6.2.3.4.1 Payload Format

4417 The get group membership command payload SHALL be formatted as illustrated in Figure 3-12.

<sup>24</sup> CCB 2310 clarify command process and response

4418

**Figure 3-12. Format of Get Group Membership Command Payload**

<b>Octets</b>	1	Variable
<b>Data Type</b>	uint8	List of 16-bit integers
<b>Field Name</b>	Group count	Group list

4419 **3.6.2.3.4.2 Effect on Receipt**

4420 On receipt of the get group membership command, each receiving entity SHALL respond with group mem-  
4421 bership information using the get group membership response frame as follows:

4422 If the group count field of the command frame has a value of 0 indicating that the group list field is empty,  
4423 the entity SHALL respond with all group identifiers of which the entity is a member.

4424 If the group list field of the command frame contains at least one group of which the entity is a member, the  
4425 entity SHALL respond with each entity group identifier that match a group in the group list field.

4426 If the group count is non-zero, and the group list field of the command frame does not contain any group of  
4427 which the entity is a member, the entity SHALL only respond if the command is unicast. The response  
4428 SHALL return a group count of zero.

4429 **3.6.2.3.5 Remove Group Command**

4430 The remove group command allows the sender to request that the receiving entity or entities remove their  
4431 membership, if any, in a particular group.

4432 Note that if a group is removed the scenes associated with that group SHOULD be removed.

4433 **3.6.2.3.5.1 Payload Format**

4434 The Remove Group command payload SHALL be formatted as illustrated in Figure 3-13.

4435 **Figure 3-13. Format of the Remove Group Command Payload**

<b>Octets</b>	2
<b>Data Type</b>	uint16
<b>Field Name</b>	Group ID

4436 **3.6.2.3.5.2 Effect on Receipt<sup>25</sup>**

4437 On receipt of the Remove Group command, the device SHALL perform the following procedure:

- 4438 1. The device verifies that the Group ID field contains a valid group identifier in the range 0x0001 –  
4439 0xffff7. If the Group ID field contains a group identifier outside this range, the status SHALL be  
4440 INVALID\_VALUE and the device continues from step 4.
- 4441 2. The device attempts to remove the entry in its Group Table corresponding to the group identifier  
4442 contained in the Group Id field. If no such entry exists in the Group Table, the status SHALL be  
4443 NOT\_FOUND and the device continues from step 4.
- 4444 3. The device removes the requested entry from its Group Table and the status SHALL be SUCCESS.

<sup>25</sup> CCB 2310 clarify command process and response

4445 4. If the Remove Group command was received as a unicast, the device SHALL generate a Remove  
4446 Group Response command with the Status field set to the evaluated status and SHALL transmit it  
4447 back to the originator of the Remove Group command.

4448 See 3.6.2.4.4 for a description of the Remove Group Response command.

### 4449 3.6.2.3.6 Remove All Groups Command

4450 The remove all groups command allows the sending device to direct the receiving entity or entities to remove  
4451 all group associations.

4452 Note that removing all groups necessitates the removal of all associated scenes as well. (Note: scenes not  
4453 associated with a group need not be removed).

#### 4454 3.6.2.3.6.1 Payload Format

4455 The Remove All Groups command has no payload.

#### 4456 3.6.2.3.6.2 Effect on Receipt<sup>26</sup>

4457 On receipt of this command, the device SHALL remove all groups on this endpoint from its Group Table. If  
4458 the Remove All Groups command was received as unicast and a default response is requested, the device  
4459 SHALL generate a Default Response command with the Status field set to SUCCESS and SHALL transmit  
4460 it back to the originator of the Remove All Groups command.

### 4461 3.6.2.3.7 Add Group If Identifying Command

4462 The add group if identifying command allows the sending device to add group membership in a particular  
4463 group for one or more endpoints on the receiving device, on condition that it is identifying itself. Identifying  
4464 functionality is controlled using the identify cluster, (see 3.5).

4465 This command might be used to assist configuring group membership in the absence of a commissioning  
4466 tool.

#### 4467 3.6.2.3.7.1 Payload Format

4468 The Add Group If Identifying command payload SHALL be formatted as illustrated in Figure 3-14.

4469 **Figure 3-14. Add Group If Identifying Command Payload**

<b>Octets</b>	2	Variable
<b>Data Type</b>	uint16	string
<b>Field Name</b>	Group ID	Group Name

#### 4470 3.6.2.3.7.2 Effect on Receipt<sup>27</sup>

4471 If the device is unable to store the contents of the Group Name field, the Group Name field MAY be ignored.

4472 On receipt of the Add Group If Identifying command, the device SHALL perform the following procedure:

<sup>26</sup> CCB 2310 clarify command process and response

<sup>27</sup> CCB 2310 clarify command process and response

- 4473 1. The device verifies that it is currently identifying itself. If the device is not currently identifying  
4474 itself, the Add Group If Identifying command was received as unicast and a default response is  
4475 requested, the device SHALL generate a Default Response command with the Status field set to  
4476 SUCCESS and SHALL transmit it back to the originator of the Add Group If Identifying command.  
4477 If the device is not currently identifying itself and the Add Group If Identifying command was not  
4478 received as unicast, no further processing SHALL be performed.
- 4479 2. The device verifies that the Group ID field contains a valid group identifier in the range 0x0001 –  
4480 0xffff7. If the Group ID field contains a group identifier outside this range, the status SHALL be  
4481 INVALID\_VALUE and the device continues from step 6.
- 4482 3. The device verifies that it does not already have an entry in its Group Table that corresponds to the  
4483 value of the Group ID field. If it already has the requested entry in its Group Table, the status  
4484 SHALL be SUCCESS and the device continues from step 6.
- 4485 4. The device verifies that it has free entries in its Group Table. If the device has no free entries in its  
4486 Group Table, the status SHALL be INSUFFICIENT\_SPACE and the device continues from step 6.
- 4487 5. The device adds the values of the Group ID and Group Name (if supported) fields to its Group Table  
4488 and the status SHALL be SUCCESS.
- 4489 6. If the Add Group If Identifying command was received as unicast and the evaluated status is not  
4490 SUCCESS, the device SHALL generate a Default Response command with the Status field set to  
4491 the evaluated status and SHALL transmit it back to the originator of the Add Group If Identifying  
4492 command.
- 4493 No response is defined as this command is EXPECTED to be multicast or broadcast.
- 4494 If the command is unicast, with the Disable Default Response bit not set, and there is no error (or the endpoint  
4495 is not identifying), then there SHALL be a Default Response with a Status of SUCCESS.<sup>28</sup>

### 4496 3.6.2.4 Commands Generated

4497 The commands generated by the server side of the group cluster, as listed in Table 3-38, are responses to the  
4498 received commands listed in sub-clause 3.6.2.3.

4499 **Table 3-38. Generated Command IDs for the Groups Cluster**

Command Identifier	Description	M/O
0x00	Add group response	M
0x01	View group response	M
0x02	Get group membership response	M
0x03	Remove group response	M

4500

4501 **Note:** There is no need for a response to the Remove all Groups command, as, at an application level, this  
4502 command always succeeds.

<sup>28</sup> CCB 2704

4503 **3.6.2.4.1 Add Group Response Command**

4504 The add group response is sent by the groups cluster server in response to an add group command.

4505 **3.6.2.4.1.1 Payload Format**

4506 The Add Group Response command payload SHALL be formatted as illustrated in Figure 3-15.

4507 **Figure 3-15. Format of the Add Group Response Command Payload**

<b>Octets</b>	1	2
<b>Data Type</b>	enum8	uint16
<b>Field Name</b>	Status	Group ID

4508 **3.6.2.4.1.2 When Generated**

4509 This command is generated in response to a received Add Group command. The Status field is set according  
 4510 to the Effect on Receipt section of the Add Group command<sup>29</sup>. The Group ID field is set to the Group ID  
 4511 field of the received Add Group command.

4512 **3.6.2.4.2 View Group Response Command**

4513 The view group response command is sent by the groups cluster server in response to a view group command.

4514 **3.6.2.4.2.1 Payload Format**

4515 The View Group Response command payload SHALL be formatted as illustrated in Figure 3-16.

4516 **Figure 3-16. Format of the View Group Response Command Payload**

<b>Octets</b>	1	2	Variable
<b>Data Type</b>	enum8	uint16	string
<b>Field Name</b>	Status	Group ID	Group Name

4517 **3.6.2.4.2.2 When Generated**

4518 This command is generated in response to a received View Group command. The Status field is according  
 4519 to the Effect on Receipt section of the View Group command<sup>30</sup>. The Group ID field is set to the Group ID field  
 4520 of the received View Group command. If the status is SUCCESS, and group names are supported, the Group  
 4521 Name field is set to the Group Name associated with that Group ID in the Group Table; otherwise it is set to  
 4522 the null (empty) string, i.e., a single octet of value 0.

4523 **3.6.2.4.3 Get Group Membership Response Command**4524 The get group membership response command is sent by the groups cluster server in response to a get group  
4525 membership command.4526 **3.6.2.4.3.1 Payload Format**<sup>29</sup> CCB 2310 clarify command process and response<sup>30</sup> CCB 2310 clarify command process and response



4527 The payload of the get group membership response command is formatted as shown in Figure 3-17.

4528 **Figure 3-17. Format of the Get Group Membership Response Command Payload**

<b>Octets</b>	1	1	Variable
<b>Data Type</b>	uint8	uint8	List of 16-bit group ID
<b>Field Name</b>	Capacity	Group count	Group list

4529

4530 The fields of the get group membership response command have the following semantics:

4531 The Capacity field SHALL contain the remaining capacity of the group table of the device. The following  
4532 values apply:

4533	0	No further groups MAY be added.
4534	0 < Capacity < 0xfe	Capacity holds the number of groups that MAY be added
4535	0xfe	At least 1 further group MAY be added (exact number is unknown)
4536	0xff	It is unknown if any further groups MAY be added

4537 The Group count field SHALL contain the number of groups contained in the group list field.

4538 The Group list field SHALL contain the identifiers either of all the groups in the group table (in the case  
4539 where the group list field of the received get group membership command was empty) or all the groups from  
4540 the group list field of the received get group membership command which are in the group table. If the total  
4541 number of groups will cause the maximum payload length of a frame to be exceeded, then the Group list  
4542 field shall contain only as many groups as will fit.

4543 **3.6.2.4.3.2 When Generated**

4544 See Get Group Membership Command 3.6.2.3.4.2 Effect on Receipt.

4545 **3.6.2.4.4 Remove Group Response Command**

4546 The remove group response command is generated by an application entity in response to the receipt of a  
4547 remove group command.

4548 **3.6.2.4.4.1 Payload Format**

4549 The Remove Group Response command payload SHALL be formatted as illustrated in Figure 3-18.

4550 **Figure 3-18. Format of Remove Group Response Command Payload**

<b>Octets</b>	1	2
<b>Data Type</b>	enum8	uint16
<b>Field Name</b>	Status	Group ID

4551 **3.6.2.4.4.2 When Generated**

4552 This command is generated in response to a received Remove Group command. The Status field is according  
4553 to the Effect on Receipt section of the Remove Group command<sup>31</sup>. The Group ID field is set to the Group ID  
4554 field of the received Remove Group command.

<sup>31</sup> CCB 2310 clarify command process and response

4555 **3.6.3 Client**

4556 The Client cluster has no cluster specific attributes. The client generates the cluster specific commands de-  
4557 tailed in 3.6.2.3. The client receives the cluster specific response commands detailed in 3.6.2.4.

4558 **3.7 Scenes**4559 **3.7.1 Overview**

4560 Please see Chapter 2 for a general cluster overview defining cluster architecture, revision, classification,  
4561 identification, etc.

4562 The scenes cluster provides attributes and commands for setting up and recalling scenes. Each scene corre-  
4563 sponds to a set of stored values of specified attributes for one or more clusters on the same end point as the  
4564 scenes cluster.

4565 In most cases scenes are associated with a particular group ID. Scenes MAY also exist without a group, in  
4566 which case the value 0x0000 replaces the group ID. Note that extra care is required in these cases to avoid a  
4567 scene ID collision, and that commands related to scenes without a group MAY only be unicast, i.e., they  
4568 MAY not be multicast or broadcast.

4569 **3.7.1.1 Revision History**

4570 The global *ClusterRevision* attribute value SHALL be the highest revision number in the table below.

Rev	Description
1	global mandatory <i>ClusterRevision</i> attribute added; CCB 1745
2	Recall Scene Transition Time field
3	CCB 2427 3026

4571 **3.7.1.2 Classification**

Hierarchy	Role	PICS Code	Primary Transaction
Base	Application	S	Type 1 (client to server)

4572 **3.7.1.3 Cluster Identifiers**

Identifier	Name
0x0005	Scenes

4573 **3.7.2 Server**4574 **3.7.2.1 Dependencies**

4575 Any endpoint that implements the Scenes server cluster SHALL also implement the Groups server cluster.

4576 **3.7.2.2 Attributes**

4577 For convenience, the attributes defined in this specification are arranged into sets of related attributes; each  
4578 set can contain up to 16 attributes. Attribute identifiers are encoded such that the most significant three nib-  
4579 bles specify the attribute set and the least significant nibble specifies the attribute within the set. The currently  
4580 defined attribute sets are listed in Table 3-39.

4581 **Table 3-39. Scenes Attribute Sets**

Attribute Set Identifier	Description
0x000	Scene Management Information

4582 **3.7.2.2.1 Scene Management Information Attribute Set**

4583 The Scene Management Information attribute set contains the attributes summarized in Table 3-40.

4584 **Table 3-40. Scene Management Information Attribute Set**

Id	Name	Type	Range	Access	Default	M/O
0x0000	<i>SceneCount</i>	uint8	0x00 to 0xff (see 3.7.2.3.2)	R	0	M
0x0001	<i>CurrentScene</i>	uint8	0x00 to 0xff (see 3.7.2.3.2)	R	0	M
0x0002	<i>CurrentGroup</i>	uint16	0x0000 to 0xffff7	R	0	M
0x0003	<i>SceneValid</i>	bool	0 or 1	R	0	M
0x0004	<i>NameSupport</i>	map8	desc	R	0	M
0x0005	<i>LastConfiguredBy</i>	EUI64	-	R	non	O

4585 **3.7.2.2.1.1 SceneCount Attribute**

4586 The *SceneCount* attribute specifies the number of scenes currently in the device's scene table.

4587 **3.7.2.2.1.2 CurrentScene Attribute**

4588 The *CurrentScene* attribute holds the Scene ID of the scene last invoked.

4589 **3.7.2.2.1.3 CurrentGroup Attribute**

4590 The *CurrentGroup* attribute holds the Group ID of the scene last invoked, or 0 if the scene last invoked is  
4591 not associated with a group.

4592 **3.7.2.2.1.4 SceneValid Attribute**

4593 The *SceneValid* attribute indicates whether the state of the device corresponds to that associated with the  
4594 *CurrentScene* and *CurrentGroup* attributes. TRUE indicates that these attributes are valid, FALSE indicates  
4595 that they are not valid.

4596 Before a scene has been stored or recalled, this attribute is set to FALSE. After a successful Store Scene or  
4597 Recall Scene command it is set to TRUE. If, after a scene is stored or recalled, the state of the device is  
4598 modified, this attribute is set to FALSE.

4599 **3.7.2.2.1.5 NameSupport Attribute**

4600 The most significant bit of the *NameSupport* attribute indicates whether or not scene names are supported. A  
4601 value of 1 indicates that they are supported, and a value of 0 indicates that they are not supported.

#### 4602 **3.7.2.2.1.6 LastConfiguredBy Attribute**

4603 The *LastConfiguredBy* attribute is 64 bits in length and specifies the IEEE address of the device that last  
4604 configured the scene table.

4605 The non-value indicates that the device has not been configured, or that the address of the device that last  
4606 configured the scenes cluster is not known.

### 4607 **3.7.2.3 Scene Table**

4608 The scene table is used to store information for each scene capable of being invoked on a device. Each scene  
4609 is defined for a particular group.

4610 The fields of each scene table entry consist of a number of sets. The base set consists of the first four fields  
4611 of Table 3-41. A set of extension fields can be added by each additional cluster implemented on a device.

4612 **Table 3-41. Fields of a Scene Table Entry**

Field	Type	Valid Range	Description
Scene group ID	uint16	0 to 0xffff7	The group ID for which this scene applies, or 0 if the scene is not associated with a group.
Scene ID	uint8	0x00 to 0xff (see 3.7.2.3.2)	The identifier, unique within this group, which is used to identify this scene.
Scene name	string	0 to 16 characters	The name of the scene (optional)
Scene transition time	uint16	0x0000 to 0xffff	The amount of time, in seconds, it will take for the device to change from its current state to the requested scene.
Extension field sets	Variable	Variable	See the Scene Table Extensions subsections of individual clusters. Each extension field set holds a set of values of attributes for a cluster implemented on the device. The sum of all such sets defines a scene.
Transition-Time100ms	uint8	0x00 to 0x09	Together with the scene transition time element, this allows the transition time to be specified in tenths of a second.

#### 4613 **3.7.2.3.1 Scene Names**

4614 Scene names are between 0 and 16 characters long. Support of scene names is optional, and is indicated by  
4615 the *NameSupport* attribute. If scene names are not supported, any commands that write a scene name SHALL  
4616 simply discard the name, and any command that returns a scene names SHALL return the null string.

#### 4617 **3.7.2.3.2 Maximum Number of Scenes**

4618 The number of scenes capable of being stored in the table is defined by the profile in which this cluster is  
4619 used. The default maximum, in the absence of specification by the profile, is 16.

4620 **3.7.2.4 Commands Received**

4621 The received command IDs for the Scenes cluster are listed in Table 3-42.

4622 **Table 3-42. Received Command IDs for the Scenes Cluster**

Command Identifier Field Value	Description	M/O
0x00	Add Scene	M
0x01	View Scene	M
0x02	Remove Scene	M
0x03	Remove All Scenes	M
0x04	Store Scene	M
0x05	Recall Scene	M
0x06	Get Scene Membership	M
0x40	Enhanced Add Scene	O
0x41	Enhanced View Scene	O
0x42	Copy Scene	O

4623 **3.7.2.4.1 Generic Usage Notes**

4624 Scene identifier 0x00, along with group identifier 0x0000, is reserved for the global scene used by the *OnOff*  
4625 cluster.

4626 On receipt of the *Add Scene*, *View Scene*, *Remove Scene*, *Remove All Scenes*, *Store Scene*, *Enhanced Add*  
4627 *Scene*, *Enhanced View Scene* or *Copy Scene* command frames via the groupcast or broadcast transmission  
4628 service, no response SHALL be given.

4629 On receipt of the *Add Scene* command, the *Scene Transition Time* element of the scene table SHALL be  
4630 updated with the value of the *Transition Time* field and the *TransitionTime100ms* element SHALL be set to  
4631 zero.

4632 **3.7.2.4.2 Add Scene Command**

4633 **3.7.2.4.2.1 Payload Format**

4634 The payload SHALL be formatted as illustrated in Figure 3-19.

4635

**Figure 3-19. Format of the Add Scene Command Payload**

<b>Octets</b>	2	1	2	Variable	Variable
<b>Data Type</b>	uint16	uint8	uint16	string	Variable (multiple types)
<b>Field Name</b>	Group ID	Scene ID	Transition time	Scene Name	Extension field sets, one per cluster

4636

4637 The format of each extension field set is a 16 bit field carrying the cluster ID, followed by an 8 bit length  
4638 field and the set of scene extension fields specified in the relevant cluster. The length field holds the length  
4639 in octets of that extension field set.

4640 Extension field sets =

4641 {{clusterId 1, length 1, {extension field set 1}}, {clusterId 2, length 2, {extension field set 2}} ...}.

4642 The attributes included in the extension field set for each cluster are defined in the specification for that  
4643 cluster in this document (the Cluster Library). The field set consists of values for these attributes concatenated  
4644 together, in the order given in the cluster specification, with no attribute identifiers or data type indicators.

4645 For forward compatibility, reception of this command SHALL allow for the possible future addition of other  
4646 attributes to the trailing ends of the lists given in the cluster specifications (by ignoring them). Similarly, it  
4647 SHALL allow for one or more attributes to be omitted from the trailing ends of these lists (see 3.7.2.4.7.2).

4648 It is not mandatory for a field set to be included in the command for every cluster on that endpoint that has a  
4649 defined field set. Extension field sets MAY be omitted, including the case of no field sets at all.

#### 4650 **3.7.2.4.2.2 Effect on Receipt<sup>32</sup>**

4651 On receipt of the Add Scene command, the device SHALL perform the following procedure:

- 4652 1. The device verifies that the Group ID field contains a valid group identifier in the range 0x0000 –  
4653 0xffff. If the Group ID field contains a group identifier outside this range, the status SHALL be  
4654 INVALID\_VALUE and the device continues from step 5.
- 4655 2. If the value of the Group ID field is non-zero, the device verifies that it corresponds to an entry in  
4656 its Group Table. If there is no such entry in its Group Table, the status SHALL be INVA-  
4657 LID\_FIELD and the device continues from step 5.
- 4658 3. The device verifies that it has free entries in its Scene Table. If the device has no further free entries  
4659 in its Scene Table, the status SHALL be INSUFFICIENT\_SPACE and the device continues from  
4660 step 5.
- 4661 4. The device adds the scene entry into its Scene Table with fields copied from the Add Scene com-  
4662 mand payload and the status SHALL be SUCCESS. If there is already a scene in the Scene Table  
4663 with the same Scene ID and Group ID, it SHALL overwrite it.
- 4664 5. If the Add Scene command was received as a unicast, the device SHALL then generate an Add  
4665 Scene Response command with the Status field set to the evaluated status and SHALL transmit it  
4666 back to the originator of the Add Scene command.

4667 See 3.7.2.5.1 for a description of the Add Scene Response command.

#### 4668 **3.7.2.4.3 View Scene Command**

##### 4669 **3.7.2.4.3.1 Payload Format**

<sup>32</sup> CCB 2310 clarify command process and response

4670 The payload SHALL be formatted as illustrated in Figure 3-20.

4671

**Figure 3-20. Format of the View Scene Command Payload**

<b>Octets</b>	2	1
<b>Data Type</b>	uint16	uint8
<b>Field Name</b>	Group ID	Scene ID

4672 **3.7.2.4.3.2 Effect on Receipt<sup>33</sup>**

4673 On receipt of the View Scene command, the device SHALL perform the following procedure:

- 4674 1. The device verifies that the Group ID field contains a valid group identifier in the range 0x0000 –  
4675 0xffff. If the Group ID field contains a group identifier outside this range, the status SHALL be  
4676 INVALID\_VALUE and the device continues from step 5.
- 4677 2. If the value of the Group ID field is non-zero, the device verifies that it corresponds to an entry in  
4678 its Group Table. If there is no such entry in its Group Table, the status SHALL be INVA-  
4679 LID\_FIELD and the device continues from step 5.
- 4680 3. The device verifies that the scene entry corresponding to the Group ID and Scene ID fields exists in  
4681 its Scene Table. If there is no such entry in its Scene Table, the status SHALL be NOT\_FOUND  
4682 and the device continues from step 5.
- 4683 4. The device retrieves the requested scene entry from its Scene Table and the status SHALL be SUC-  
4684 CESS.
- 4685 5. If the View Scene command was received as a unicast, the device SHALL then generate a View  
4686 Scene Response command with the retrieved scene entry and the Status field set to the evaluated  
4687 status and SHALL transmit it back to the originator of the View Scene command.

4688 See 3.7.2.5.2 for a description of the View Scene Response command.

4689 **3.7.2.4.4 Remove Scene Command**

4690 **3.7.2.4.4.1 Payload Format**

4691 The Remove Scene command payload SHALL be formatted as illustrated in Figure 3-21.

4692

**Figure 3-21. Format of the Remove Scene Command Payload**

<b>Octets</b>	2	1
<b>Data Type</b>	uint16	uint8
<b>Field Name</b>	Group ID	Scene ID

4693 **3.7.2.4.4.2 Effect on Receipt<sup>34</sup>**

4694 On receipt of the Remove Scene command, the device SHALL perform the following procedure:

- 4695 1. The device verifies that the Group ID field contains a valid group identifier in the range 0x0000 –  
4696 0xffff. If the Group ID field contains a group identifier outside this range, the status SHALL be  
4697 INVALID\_VALUE and the device continues from step 5.

<sup>33</sup> CCB 2310 clarify command process and response

<sup>34</sup> CCB 2310 clarify command process and response

- 4698 2. If the value of the Group ID field is non-zero, the device verifies that it corresponds to an entry in  
4699 its Group Table. If there is no such entry in its Group Table, the status SHALL be INVA-  
4700 LID\_FIELD and the device continues from step 5.
- 4701 3. The device verifies that the scene entry corresponding to the Group ID and Scene ID fields exists in  
4702 its Scene Table. If there is no such entry in its Scene Table, the status SHALL be NOT\_FOUND  
4703 and the device continues from step 5.
- 4704 4. The device removes the requested scene entry from its Scene Table and the status SHALL be SUC-  
4705 CESS.
- 4706 5. If the Remove Scene command was received as a unicast, the device SHALL then generate a Re-  
4707 move Scene Response command with the Status field set to the evaluated status and SHALL trans-  
4708 mit it back to the originator of the Remove Scene command.
- 4709 See 3.7.2.5.3 for a description of the Remove Scene Response command.

### 4710 3.7.2.4.5 Remove All Scenes Command

#### 4711 3.7.2.4.5.1 Payload Format

4712 The Remove All Scenes command payload SHALL be formatted as illustrated in Figure 3-22.

4713 **Figure 3-22. Format of the Remove All Scenes Command Payload**

<b>Octets</b>	2
<b>Data Type</b>	uint16
<b>Field Name</b>	Group ID

#### 4714 3.7.2.4.5.2 Effect on Receipt<sup>35</sup>

4715 On receipt of the Remove All Scenes command, the device SHALL perform the following procedure:

- 4716 1. The device verifies that the Group ID field contains a valid group identifier in the range 0x0000 –  
4717 0xffff. If the Group ID field contains a group identifier outside this range, the status SHALL be  
4718 INVALID\_VALUE and the device continues from step 4.
- 4719 2. If the value of the Group ID field is non-zero, the device verifies that it corresponds to an entry in  
4720 its Group Table. If there is no such entry in its Group Table, the status SHALL be INVA-  
4721 LID\_FIELD and the device continues from step 4.
- 4722 3. The device SHALL remove all scenes, corresponding to the value of the Group ID field, from its  
4723 Scene Table and the status SHALL be SUCCESS.
- 4724 4. If the Remove All Scenes command was received as a unicast, the device SHALL then generate a  
4725 Remove All Scenes Response command with the Status field set to the evaluated status and SHALL  
4726 transmit it back to the originator of the Remove All Scenes command.

4727 See 3.7.2.5.4 for a description of the Remove All Scenes Response command.

### 4728 3.7.2.4.6 Store Scene Command

#### 4729 3.7.2.4.6.1 Payload Format

4730 The Store Scene command payload SHALL be formatted as illustrated in Figure 3-23.

<sup>35</sup> CCB 2310 clarify command process and response



4731

**Figure 3-23. Format of the Store Scene Command Payload**

<b>Octets</b>	2	1
<b>Data Type</b>	uint16	uint8
<b>Field Name</b>	Group ID	Scene ID

4732 **3.7.2.4.6.2 Effect on Receipt<sup>36</sup>**

4733 On receipt of the Store Scene command, the device SHALL perform the following procedure:

- 4734 1. The device verifies that the Group ID field contains a valid group identifier in the range 0x0000 –  
4735 0xff7. If the Group ID field contains a group identifier outside this range, the status SHALL be  
4736 INVALID\_VALUE and the device continues from step 5.
- 4737 2. If the value of the Group ID field is non-zero, the device verifies that it corresponds to an entry in  
4738 its Group Table. If there is no such entry in its Group Table, the status SHALL be INVA-  
4739 LID\_FIELD and the device continues from step 5.
- 4740 3. The device verifies that it has free entries in its Scene Table. If the device has no further free entries  
4741 in its Scene Table, the status SHALL be INSUFFICIENT\_SPACE and the device continues from  
4742 step 5.
- 4743 4. The device adds the scene entry into its Scene Table along with all extension field sets corresponding  
4744 to the current state of other clusters on the same endpoint on the device and the Transition Time and  
4745 Scene Name entries set to 0 and the null string, respectively. If there is already a scene in the Scene  
4746 Table with the same Scene ID and Group ID, it SHALL overwrite it, i.e., it SHALL first remove all  
4747 information included in the original scene entry except for the Transition Time and Scene Name  
4748 entries, which are left unaltered. The status SHALL be SUCCESS.
- 4749 5. If the Store Scene command was received as a unicast, the device SHALL then generate a Store  
4750 Scene Response command with the Status field set to the evaluated status and SHALL transmit it  
4751 back to the originator of the Store Scene command.

4752 Note that if a scene to be stored requires a transition time field and/ or a scene name field, these must be set  
4753 up by a prior Add Scene command, e.g., with no scene extension field sets.

4754 If the Group ID field is not zero, and the device is not a member of this group, the scene will not be added.

4755 See 3.7.2.5.5 for a description of the Store Scene Response command.

4756 **3.7.2.4.7 Recall Scene Command**

4757 **3.7.2.4.7.1 Payload Format**

4758 The Recall Scene command payload SHALL be formatted as illustrated in Figure 3-24.

<sup>36</sup> CCB 2310 clarify command process and response

4759

**Figure 3-24. Format of the Recall Scene Command Payload**

Octets	2	1	0/2
Data Type	uint16	uint8	uint16
Field Name	Group ID	Scene ID	Transition Time

4760 **3.7.2.4.7.2 Effect on Receipt<sup>37</sup>**

4761 On receipt of the Recall Scene command, the device SHALL perform the following procedure:

- 4762 1. The device verifies that the Group ID field contains a valid group identifier in the range 0x0000 –  
4763 0xffff. If the Group ID field contains a group identifier outside this range, the status SHALL be  
4764 INVALID\_VALUE and the device continues from step 5.
- 4765 2. If the value of the Group ID field is non-zero, the device verifies that it corresponds to an entry in  
4766 its Group Table. If there is no such entry in its Group Table, the status SHALL be INVA-  
4767 LID\_FIELD and the device continues from step 5.
- 4768 3. The device verifies that the scene entry corresponding to the Group ID and Scene ID fields exists in  
4769 its Scene Table. If there is no such entry in its Scene Table, the status SHALL be NOT\_FOUND  
4770 and the device continues from step 5.
- 4771 4. The device retrieves the requested scene entry from its Scene Table. For each other cluster on the  
4772 device, it SHALL retrieve any corresponding extension fields from the Scene Table and set the  
4773 attributes and corresponding state of the cluster accordingly. If there is no extension field set for a  
4774 cluster, the state of that cluster SHALL remain unchanged. If an extension field set omits the values  
4775 of any trailing attributes, the values of these attributes SHALL remain unchanged.
- 4776 5. This command does not result in a corresponding response command unless:  
4777 the command is unicast, and an error occurs during its processing, a Default Response SHALL be  
4778 generated with the Status code set to the error status.
- 4779 OR
- 4780 the command is unicast, no error occurs, and a Default Response is requested, a Default Response  
4781 command SHALL be generated with the Status code field set to SUCCESS.<sup>38</sup>

4782 If the Transition Time field is present in the command payload and its value is not equal to 0xffff, this field  
4783 SHALL indicate the transition time in 1/10ths of a second. In all other cases (command payload field not  
4784 present or value equal to 0xffff), the scene transition time field of the Scene Table entry SHALL indicate the  
4785 transition time. The transition time determines how long the transition takes from the old cluster state to the  
4786 new cluster state. It is recommended that, where possible (e.g., it is not possible for attributes with Boolean  
4787 data type), a gradual transition SHOULD take place from the old to the new state over this time. However,  
4788 the exact transition is manufacturer dependent.

4789 **3.7.2.4.8 Get Scene Membership Command**

4790 The Get Scene Membership command can be used to find an unused scene number within the group when  
4791 no commissioning tool is in the network, or for a commissioning tool to get used scenes for a group on a  
4792 single device or on all devices in the group.

4793 **3.7.2.4.8.1 Payload Format**

4794 The Get Scene Membership command payload SHALL be formatted as illustrated in Figure 3-25.

<sup>37</sup> CCB 2310 clarify command process and response<sup>38</sup> CCB 2427

4795

**Figure 3-25. Format of Get Scene Membership Command Payload**

<b>Octets</b>	2
<b>Data Type</b>	uint16
<b>Field Name</b>	Group ID

4796 **3.7.2.4.8.2 Effect on Receipt<sup>39</sup>**

4797 On receipt of the Get Scene Membership command, the device SHALL perform the following procedure:

- 4798 1. The device verifies that the Group ID field contains a valid group identifier in the range 0x0000 –  
 4799 0xffff. If the Group ID field contains a group identifier outside this range, the status SHALL be  
 4800 INVALID\_VALUE and the device continues from step 3.
- 4801 2. If the value of the Group ID field is non-zero, the device verifies that it corresponds to an entry in  
 4802 its Group Table. If there is no such entry in its Group Table, the status SHALL be INVA-  
 4803 LID\_FIELD and the device continues from step 3.
- 4804 3. If the Get Scene Membership command was received as a unicast, the device SHALL then generate  
 4805 a Get Scene Membership Response command with the Status field set to the evaluated status and  
 4806 SHALL transmit it back to the originator of the Get Scene Membership command. If the Get Scene  
 4807 Membership command was not received as a unicast, the device SHALL only generate a Get Scene  
 4808 Membership Response command with the Status field set to the evaluated status if an entry within  
 4809 the Scene Table corresponds to the Group ID; the device SHALL then transmit it back to the origi-  
 4810 nator of the Get Scene Membership command

4811 See 3.7.2.5.6 for a description of the Get Scene Membership Response command.

4812

4813 **3.7.2.4.9 Enhanced Add Scene Command**

4814 The *Enhanced Add Scene* command allows a scene to be added using a finer scene transition time than the  
 4815 *Add Scene* command.

4816 The payload of this command SHALL be formatted in the same way as the *Add Scene* command, specified  
 4817 in the ZCL *Scenes* cluster, with the following difference:

4818 The *Transition Time* field SHALL be measured in tenths of a second rather than in seconds.

4819 **3.7.2.4.9.1 Effect on Receipt<sup>40</sup>**

4820 On receipt of the Enhanced Add Scene command, the device SHALL perform the following procedure:

- 4821 1. The device verifies that the Group ID field contains a valid group identifier in the range 0x0000 –  
 4822 0xffff. If the Group ID field contains a group identifier outside this range, the status SHALL be  
 4823 INVALID\_VALUE and the device continues from step 5.
- 4824 2. If the value of the Group ID field is non-zero, the device verifies that it corresponds to an entry in  
 4825 its Group Table. If there is no such entry in its Group Table, the status SHALL be INVA-  
 4826 LID\_FIELD and the device continues from step 5.
- 4827 3. The device verifies that it has free entries in its Scene Table. If the device has no further free entries  
 4828 in its Scene Table, the status SHALL be INSUFFICIENT\_SPACE and the device continues from  
 4829 step 5.

<sup>39</sup> CCB 2310 clarify command process and response

<sup>40</sup> CCB 2310 clarify command process and response

- 4830 4. The device adds the scene entry into its Scene Table with fields copied from the Enhanced Add  
4831 Scene command payload and the status SHALL be SUCCESS. If there is already a scene in the  
4832 Scene Table with the same Scene ID and Group ID, it SHALL overwrite it, i.e., it SHALL first  
4833 remove all information included in the original scene entry. The *Transition Time* (measured in  
4834 tenths of a second) SHALL be separated into whole seconds for the standard *Transition Time* field  
4835 of the scene table entry and the new *TransitionTime100ms* field, as specified.
- 4836 5. If the Enhanced Add Scene command was received as a unicast, the device SHALL then generate  
4837 an Enhanced Add Scene Response command with the Status field set to the evaluated status and  
4838 SHALL transmit it back to the originator of the Enhanced Add Scene command.
- 4839 See 3.7.2.5.7 for a description of the Enhanced Add Scene Response command.

### 4840 3.7.2.4.10 Enhanced View Scene Command

4841 The *Enhanced View Scene* command allows a scene to be retrieved using a finer scene transition time than  
4842 the *View Scene* command.

4843 The payload of this command SHALL be formatted in the same way as the *View Scene* command.

#### 4844 3.7.2.4.10.1 Effect on Receipt<sup>41</sup>

4845 On receipt of the Enhanced View Scene command, the device SHALL perform the following procedure:

- 4846 1. The device verifies that the Group ID field contains a valid group identifier in the range 0x0000 –  
4847 0xffff7. If the Group ID field contains a group identifier outside this range, the status SHALL be  
4848 INVALID\_VALUE and the device continues from step 5.
- 4849 2. If the value of the Group ID field is non-zero, the device verifies that it corresponds to an entry in  
4850 its Group Table. If there is no such entry in its Group Table, the status SHALL be INVA-  
4851 LID\_FIELD and the device continues from step 5.
- 4852 3. The device verifies that the scene entry corresponding to the Group ID and Scene ID fields exists in  
4853 its Scene Table. If there is no such entry in its Scene Table, the status SHALL be NOT\_FOUND  
4854 and the device continues from step 5.
- 4855 4. The device retrieves the requested scene entry from its Scene Table and the status SHALL be SUC-  
4856 CESS.
- 4857 5. If the Enhanced View Scene command was received as a unicast, the device SHALL then generate  
4858 an Enhanced View Scene Response command with the Status field set to the evaluated status and  
4859 SHALL transmit it back to the originator of the Enhanced View Scene command.

4860 See 3.7.2.5.8 for a description of the Enhanced View Scene Response command.

### 4861 3.7.2.4.11 Copy Scene Command

4862 The *Copy Scene* command allows a device to efficiently copy scenes from one group/scene identifier pair to  
4863 another group/scene identifier pair.

4864 The payload of this command SHALL be formatted as illustrated in Figure 3-26.

---

<sup>41</sup> CCB 2310 clarify command process and response

4865

**Figure 3-26. Format of the Copy Scene Command**

<b>Octets</b>	1	2	1	2	1
<b>Data Type</b>	map8 <sup>42</sup>	uint16	uint8	uint16	uint8
<b>Field Name</b>	Mode	Group identifier from	Scene identifier from	Group identifier to	Scene identifier to

4866 **3.7.2.4.11.1 Mode Field**

4867 The *mode* field is 8-bits in length and contains information of how the scene copy is to proceed. This field  
4868 SHALL be formatted as illustrated in Figure 3-27.

4869

**Figure 3-27. Format of the Mode Field of the Copy Scene Command**

<b>Bits: 0</b>	<b>Bits: 1-7</b>
Copy All Scenes	Reserved

4870 The *Copy All Scenes* subfield is 1-bit in length and indicates whether all scenes are to be copied. If this value  
4871 is set to 1, all scenes are to be copied and the *Scene Identifier From* and *Scene Identifier To* fields SHALL  
4872 be ignored. Otherwise this field is set to 0.

4873 **3.7.2.4.11.2 Group Identifier From Field**

4874 The *Group Identifier From* field is 16-bits in length and specifies the identifier of the group from which the  
4875 scene is to be copied. Together with the *Scene Identifier From* field, this field uniquely identifies the scene  
4876 to copy from the scene table.

4877 **3.7.2.4.11.3 Scene Identifier From Field**

4878 The *Scene Identifier From* field is 8-bits in length and specifies the identifier of the scene from which the  
4879 scene is to be copied. Together with the *Group Identifier From* field, this field uniquely identifies the scene  
4880 to copy from the scene table.

4881 **3.7.2.4.11.4 Group Identifier To Field**

4882 The *Group Identifier To* field is 16-bits in length and specifies the identifier of the group to which the scene  
4883 is to be copied. Together with the *Scene Identifier To* field, this field uniquely identifies the scene to copy to  
4884 the scene table.

4885 **3.7.2.4.11.5 Scene Identifier To Field**

4886 The *Scene Identifier To* field is 8-bits in length and specifies the identifier of the scene to which the scene is  
4887 to be copied. Together with the *Group Identifier To* field, this field uniquely identifies the scene to copy to  
4888 the scene table.

4889 **3.7.2.4.11.6 Effect on Receipt<sup>43</sup>**

4890 On receipt of the Copy Scene command, the device SHALL perform the following procedure:

- 4891 1. The device verifies that the Group Identifier From and Group Identifier To fields contain a valid  
4892 group identifier in the range 0x0000 – 0xffff. If either the Group Identifier From field or the Group  
4893 Identifier To field contains a group identifier outside this range, the status SHALL be INVA-  
4894 LID\_VALUE and the device continues from step 6.

<sup>42</sup> CCB 3026 changed from uint8 to map8

<sup>43</sup> CCB 2310 clarify command process and response

- 4895 2. If the value of either the Group Identifier From field or the Group Identifier To field is non-zero,  
4896 the device verifies that it corresponds to an entry in its Group Table. If there is no such entry in its  
4897 Group Table, the status SHALL be INVALID\_FIELD and the device continues from step 6.
- 4898 3. The device verifies that the scene entry corresponding to the Group Identifier From and Scene Identifier  
4899 From fields exists in its Scene Table. If there is no such entry in its Scene Table, the status  
4900 SHALL be NOT\_FOUND and the device continues from step 6.
- 4901 4. If the *Copy All Scenes* sub-field of the *Mode* field is set to 1 or the scene entry corresponding to the  
4902 Group Identifier To and Scene Identifier To fields does not exist in the scene table and if the device  
4903 has no further free entries in its Scene Table, the status SHALL be INSUFFICIENT\_SPACE and  
4904 the device continues from step 6.
- 4905 5. The status SHALL be SUCCESS. If the *Copy All Scenes* sub-field of the *Mode* field is set to 1, the  
4906 device SHALL copy all its available scenes with group identifier equal to the *Group Identifier From*  
4907 field under the group identifier specified in the *Group Identifier To* field, leaving the scene identifier  
4908 s the same. In this case, the *Scene Identifier From* and *Scene Identifier To* fields are ignored. If  
4909 the *Copy All Scenes* sub-field of the *Mode* field is set to 0, the device SHALL copy the scene table  
4910 entry corresponding to the *Group Identifier From* and *Scene Identifier From* fields to the scene table  
4911 entry corresponding to the *Group Identifier To* and *Scene Identifier To* fields. If a scene already  
4912 exists under the same group/scene identifier pair, it SHALL be overwritten.
- 4913 6. If the Copy Scene command was received as a unicast, the device SHALL then generate a Copy  
4914 Scene Response command with the Status field set to the evaluated status and SHALL transmit it  
4915 back to the originator of the Copy Scene command.

4916 See 3.7.2.5.9 for a description of the Copy Scene Response command.

4917

### 4918 3.7.2.5 Commands Generated

4919 The generated command IDs for the Scenes cluster are listed in Table 3-43.

4920

Table 3-43. Generated Command IDs for the Scenes Cluster

Command Identifier Field Value	Description	M/O
0x00	Add Scene Response	M
0x01	View Scene Response	M
0x02	Remove Scene Response	M
0x03	Remove All Scenes Response	M
0x04	Store Scene Response	M
0x06	Get Scene Membership Response	M
0x40	Enhanced Add Scene Response	O
0x41	Enhanced View Scene Response	O
0x42	Copy Scene Response	O

4921 **3.7.2.5.1 Add Scene Response Command**

4922 **3.7.2.5.1.1 Payload Format**

4923 The Add Scene Response command payload SHALL be formatted as illustrated in Figure 3-28.

4924 **Figure 3-28. Format of the Add Scene Response Command Payload**

<b>Octets</b>	1	2	1
<b>Data Type</b>	enum8	uint16	uint8
<b>Field Name</b>	Status	Group ID	Scene ID

4925 **3.7.2.5.1.2 When Generated**

4926 This command is generated in response to a received Add Scene command 3.7.2.4.2. The Status field is set  
4927 according to the Effect on Receipt section for Add Scene<sup>44</sup>. The Group ID and Scene ID fields are set to the  
4928 corresponding fields of the received Add Scene command.

4929 **3.7.2.5.2 View Scene Response Command**

4930 **3.7.2.5.2.1 Payload Format**

4931 The View Scene Response command payload SHALL be formatted as illustrated in Figure 3-29.

4932 **Figure 3-29. Format of the View Scene Response Command Payload**

<b>Octets</b>	1	2	1	0 / 2	0 / Variable	0 / Variable
<b>Data Type</b>	enum8	uint16	uint8	uint16	string	Variable (multiple types)
<b>Field Name</b>	Status	Group ID	Scene ID	Transition time	Scene Name	Extension field sets, one per cluster

4933

4934 The format of each extension field set is a 16 bit field carrying the cluster ID, followed by an 8 bit data length  
4935 field and the set of scene extension fields specified in the relevant cluster. These fields are concatenated  
4936 together in the order given in the cluster.

4937 Extension field sets =

4938 {{clusterId 1, length 1, {extension field set 1}}, {clusterId 2, length 2, {extension field set 2}}},}

4939 **3.7.2.5.2.2 When Generated**

4940 This command is generated in response to a received View Scene command 3.7.2.4.3.

4941 The entry in the Scene Table with Scene ID and Group ID given in the received View Scene command is  
4942 located (if possible). The Status field is set according to the Effect on Receipt section for View Scene<sup>45</sup>. The  
4943 Group ID and Scene ID fields are set to the corresponding fields in the received View Scene command.

4944 If the status is SUCCESS, the Transition time, Scene Name and Extension field fields are copied from the  
4945 corresponding fields in the table entry, otherwise they are omitted.

<sup>44</sup> CCB 2310 clarify command process and response

<sup>45</sup> CCB 2310 clarify command process and response

4946 **3.7.2.5.3 Remove Scene Response Command**4947 **3.7.2.5.3.1 Payload Format**

4948 The Remove Scene Response command payload SHALL be formatted as illustrated in Figure 3-30.

4949 **Figure 3-30. Format of Remove Scene Response Command Payload**

<b>Octets</b>	1	2	1
<b>Data Type</b>	enum8	uint16	uint8
<b>Field Name</b>	Status	Group ID	Scene ID

4950 **3.7.2.5.3.2 When Generated**

4951 This command is generated in response to a received Remove Scene command 3.7.2.4.4. The Status field is  
 4952 set according to the Effect on Receipt section for Remove Scene<sup>46</sup>. The Group ID and Scene ID fields are set  
 4953 to the corresponding fields of the received Remove Scene command.

4954 **3.7.2.5.4 Remove All Scenes Response Command**4955 **3.7.2.5.4.1 Payload Format**

4956 The Remove All Scenes Response command payload SHALL be formatted as illustrated in Figure 3-31.

4957 **Figure 3-31. Format of the Remove All Scenes Response Command Payload**

<b>Octets</b>	1	2
<b>Data Type</b>	enum8	uint16
<b>Field Name</b>	Status	Group ID

4958 **3.7.2.5.4.2 When Generated**

4959 This command is generated in response to a received Remove All Scenes command, see 3.7.2.4.5. The Status  
 4960 field is according to the Effect on Receipt section for Remove All Scenes<sup>47</sup>. The Group ID field is set to the  
 4961 corresponding field of the received Remove All Scenes command.

4962 **3.7.2.5.5 Store Scene Response Command**4963 **3.7.2.5.5.1 Payload Format**

4964 The Store Scene Response command payload SHALL be formatted as illustrated in Figure 3-32.

---

<sup>46</sup> CCB 2310 clarify command process and response

<sup>47</sup> CCB 2310 clarify command process and response



4965

**Figure 3-32. Format of the Store Scene Response Command Payload**

<b>Octets</b>	1	2	1
<b>Data Type</b>	enum8	uint16	uint8
<b>Field Name</b>	Status	Group ID	Scene ID

4966 **3.7.2.5.5.2 When Generated**

4967 This command is generated in response to a received Store Scene command 3.7.2.4.6. The Status field is set  
4968 to SUCCESS, INSUFFICIENT\_SPACE or INVALID\_FIELD (the group is not present in the Group Table)  
4969 as appropriate. The Group ID and Scene ID fields are set to the corresponding fields of the received Store  
4970 Scene command.

4971 **3.7.2.5.6 Get Scene Membership Response Command**

4972 **3.7.2.5.6.1 Payload Format**

4973 The Get Scene Membership Response command payload SHALL be formatted as illustrated in Figure 3-33.

4974 **Figure 3-33. Format of the Get Scene Membership Response CommandPayload**

<b>Octets</b>	1	1	2	0/1	Variable
<b>Data Type</b>	enum8	uint8	uint16	uint8	uint8 x N
<b>Field Name</b>	Status	Capacity	Group ID	Scene count	Scene list

4975

4976 The fields of the get scene membership response command have the following semantics:

4977 The Capacity field SHALL contain the remaining capacity of the scene table of the device (for all groups).  
4978 The following values apply:

- 4979 0 No further scenes MAY be added.
- 4980 0 < Capacity < 0xfe Capacity holds the number of scenes that MAY be added
- 4981 0xfe At least 1 further scene MAY be added (exact number is unknown)
- 4982 0xff It is unknown if any further scenes MAY be added

4983 The Status field SHALL contain SUCCESS or INVALID\_FIELD (the group is not present in the Group  
4984 Table) as appropriate.

4985 The Group ID field SHALL be set to the corresponding field of the received Get Scene Membership com-  
4986 mand.

4987 If the status is not SUCCESS, then the Scene count and Scene list field are omitted, else

4988 The Scene count field SHALL contain the number of scenes contained in the Scene list field.

4989 The Scene list field SHALL contain the identifiers of all the scenes in the scene table with the corresponding  
4990 Group ID. If the total number of scenes associated with this Group ID will cause the maximum payload  
4991 length of a frame to be exceeded, then the Scene list field shall contain only as many scenes as will fit.

4992 **3.7.2.5.6.2 When Generated**

4993 This command is generated in response to a received Get Scene Membership command, 3.7.2.4.8.

4994 **3.7.2.5.7 Enhanced Add Scene Response Command**4995 The *Enhanced Add Scene Response* command allows a device to respond to an *Enhanced Add Scene* com-  
4996 mand.4997 The payload of this command SHALL be formatted in the same way as the *Add Scene Response* command,  
4998 specified in the ZCL scenes cluster.4999 **3.7.2.5.8 Enhanced View Scene Response Command**5000 The *Enhanced View Scene Response* command allows a device to respond to an *Enhanced View Scene* com-  
5001 mand using a finer scene transition time that was available in the ZCL.5002 The payload of this command SHALL be formatted in the same way as the *View Scene Response* command,  
5003 with the following difference:5004 The *Transition Time* field SHALL be measured in tenths of a second rather than in seconds.5005 **3.7.2.5.8.1 When Generated**5006 The *Enhanced View Scene Response* command is generated in response to a received *Enhanced View Scene*  
5007 command. The entry in the scene table with scene identifier and group identifier given in the received *En-*  
5008 *hanced View Scene* command is located (if possible). The *Status* field is set to SUCCESS, INVA-  
5009 LID\_VALUE (the Group ID is not in range)<sup>48</sup>, NOT\_FOUND (the scene is not present in the scene table) or  
5010 INVALID\_FIELD (the group is not present in the group table) as appropriate. The group identifier and scene  
5011 identifier fields are set to the corresponding fields in the received *Enhanced View Scene* command.5012 If the status is SUCCESS, the *Transition Time*, *Scene Name* and *Extension Field* fields are copied from the  
5013 corresponding fields in the table entry, otherwise they are omitted.5014 The *Transition Time* (measured in tenths of a second) SHALL be calculated from the standard transition time  
5015 field of the scene table entry (measured in seconds) and the new *TransitionTime100ms* field, as specified.5016 **3.7.2.5.9 Copy Scene Response Command**5017 The *Copy Scene Response* command allows a device to respond to a *Copy Scene* command.

5018 The payload of this command SHALL be formatted as illustrated in Figure 3-34.

5019 **Figure 3-34. Format of the Copy Scene Response Command**

<b>Octets</b>	1	2	1
<b>Data Type</b>	uint8	uint16	uint8
<b>Field Name</b>	Status	Group identifier from	Scene identifier from

5020 **3.7.2.5.9.1 3.7.2.5.9.1 Status field**5021 The *status* field is 8-bits in length and SHALL contain the status of the copy scene attempt. This field SHALL  
5022 be set to one of the non-reserved values listed in Table 3-44.<sup>48</sup> CCB 2310 clarify command process and response

5023

**Table 3-44. Values of the Status Field of the Copy Scene Response Command**

Status Field Value	Description
SUCCESS	Success
INVALID_FIELD	Invalid scene specified
INSUFFICIENT_SPACE	Insufficient space in the scene table

5024

### 3.7.2.5.9.2 Group Identifier From Field

5025

5026

5027

The *Group Identifier From* field is 16-bits in length and specifies the identifier of the group from which the scene was copied, as specified in the *Copy Scene* command. Together with the *Scene Identifier From* field, this field uniquely identifies the scene that was copied from the scene table.

5028

### 3.7.2.5.9.3 Scene Identifier From Field

5029

5030

5031

The *Scene Identifier From* field is 8-bits in length and specifies the identifier of the scene from which the scene was copied, as specified in the *Copy Scene* command. Together with the *Group Identifier From* field, this field uniquely identifies the scene that was copied from the scene table.

5032

### 3.7.2.5.9.4 When Generated

5033

5034

5035

5036

5037

5038

5039

5040

5041

The *Copy Scene Response* command is generated in response to a received *Copy Scene* command. If, during the copy, there is no more space in the scene table for the entire next scene to be copied, the *Status* field SHALL be set to *INSUFFICIENT\_SPACE* and the scenes already copied SHALL be kept. If either the group identifier from field or the group identifier to field are not in the correct range, the *Status* field SHALL be set to *INVALID\_VALUE*<sup>49</sup>. If the *Group Identifier From* and *Scene Identifier From* fields do not specify a scene that exists in the scene table, the *Status* field SHALL be set to *INVALID\_FIELD*. Otherwise, if the copy was successful, the *Status* field SHALL be set to *SUCCESS*. The *Group Identifier From* and *Scene Identifier From* fields SHALL be set to the same values as in the corresponding fields of the received *Copy Scene* command.

5042

## 3.7.3 Client

5043

5044

5045

The Client cluster has no cluster specific attributes. The client generates the cluster specific commands detailed in 3.7.2.4, as required by the application. The client receives the cluster specific response commands detailed in 3.7.2.5.

5046

## 3.8 On/Off

5047

### 3.8.1 Overview

5048

5049

5050

Please see Chapter 2 for a general cluster overview defining cluster architecture, revision, classification, identification, etc.

Attributes and commands for switching devices between ‘On’ and ‘Off’ states.

<sup>49</sup> CCB 2310 clarify command process and response

5051 **3.8.1.1 Revision History**

5052 The global *ClusterRevision* attribute value SHALL be the highest revision number in the table below.

Rev	Description
1	global mandatory <i>ClusterRevision</i> attribute added; CCB 1555
2	ZLO 1.0: <i>StartUpOnOff</i>

5053 **3.8.1.2 Classification**

Hierarchy	Role	PICS Code	Primary Transaction
Base	Application	OO	Type 1 (client to server)

5054 **3.8.1.3 Cluster Identifiers**

Identifier	PICS Code	Name
0x0006	OO	On/Off

5055 **3.8.2 Server**

5056 **3.8.2.1 Dependencies**

5057 None

5058 **3.8.2.1.1 Effect on Receipt of Level Control Cluster Com-**  
5059 **mands**

5060 On receipt of a *Level Control* cluster command that causes the *OnOff* attribute to be set to 0x00, the *OnTime*  
5061 attribute SHALL be set to 0x0000.

5062 On receipt of a *Level Control* cluster command that causes the *OnOff* attribute to be set to 0x01, if the value  
5063 of the *OnTime* attribute is equal to 0x0000, the device SHALL set the *OffWaitTime* attribute to 0x0000.

5064 **3.8.2.2 Attributes**

5065 The server supports the attributes shown in Table 3-45.

5066 **Table 3-45. Attributes of the On/Off Server Cluster**

Identifier	Name	Type	Range	Acc	Def	M
0x0000	<i>OnOff</i>	bool	value	RPS	0	M
0x4000	<i>GlobalSceneControl</i>	bool	value	R	1	O
0x4001	<i>OnTime</i>	uint16	full-non	RW	0	O
0x4002	<i>OffWaitTime</i>	uint16	full	RW	0	O

Identifier	Name	Type	Range	Acc	Def	M
0x4003	<i>StartUpOnOff</i>	enum8	desc	RW	<i>MS</i>	O

5067 **3.8.2.2.1 OnOff Attribute**

5068 The *OnOff* attribute has the following values: 0 = Off, 1 = On.

5069 **3.8.2.2.2 GlobalSceneControl Attribute**

5070 In order to support the use case where the user gets back the last setting of the devices (e.g. level settings for  
5071 lamps), a global scene is introduced which is stored when the devices are turned off and recalled when the  
5072 devices are turned on. The global scene is defined as the scene that is stored with group identifier 0 and scene  
5073 identifier 0.

5074 The *GlobalSceneControl* attribute is defined in order to prevent a second *off* command storing the all-devices-  
5075 off situation as a global scene, and to prevent a second *on* command destroying the current settings by going  
5076 back to the global scene.

5077 The *GlobalSceneControl* attribute SHALL be set to TRUE after the reception of a command which causes  
5078 the *OnOff* attribute to be set to TRUE, such as a standard *On* command, a *Move to level (with on/off)* com-  
5079 mand, a *Recall scene* command or a *On with recall global scene* command (see Section 3.8.2.3.5).

5080 The *GlobalSceneControl* attribute is set to FALSE after reception of a *Off with effect* command.

5081 These concepts are illustrated in Figure 3-35.

5082 **Figure 3-35. State Behavior of Store and Recall Global Scene**

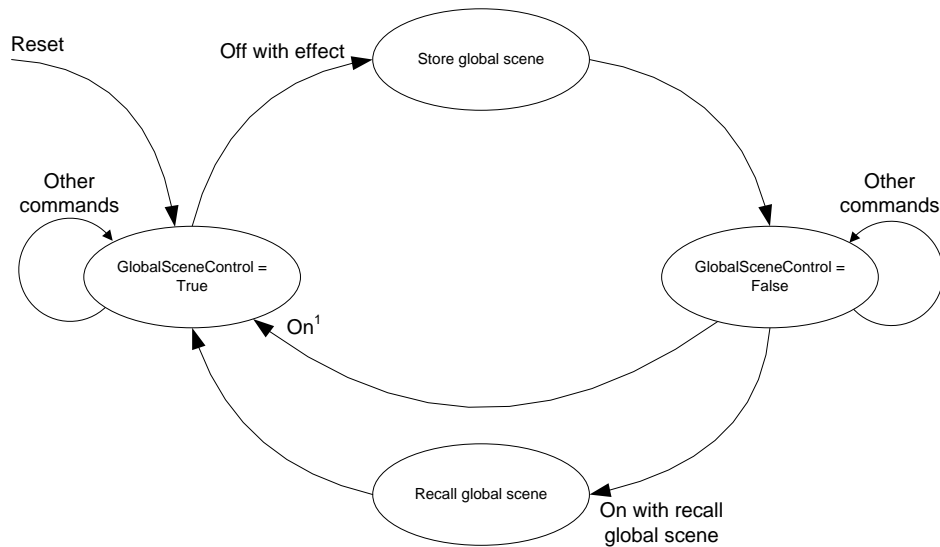

Note 1: Any command which causes the *OnOff* attribute to be set to 0x01 except On with recall global scene, e.g. On or Toggle.

5083

5084 **3.8.2.2.3 OnTime Attribute**

5085 The *OnTime* attribute specifies the length of time (in 1/10ths second) that the “on” state SHALL be main-  
5086 tained before automatically transitioning to the “off” state when using the *On with timed off* command. If this  
5087 attribute is set to 0x0000 or 0xffff, the device SHALL remain in its current state.

5088 **3.8.2.2.4 OffWaitTime Attribute**

5089 The *OffWaitTime* attribute specifies the length of time (in 1/10ths second) that the “off” state SHALL be  
5090 guarded to prevent an on command turning the device back to its “on” state (e.g., when leaving a room, the  
5091 lights are turned off but an occupancy sensor detects the leaving person and attempts to turn the lights back  
5092 on). If this attribute is set to 0x0000, the device SHALL remain in its current state.

5093 **3.8.2.2.5 StartUpOnOff Attribute**

5094 The *StartUpOnOff* attribute SHALL define the desired startup behavior of a<sup>50</sup> device when it is supplied with  
5095 power and this state SHALL be reflected in the *OnOff* attribute. The values of the *StartUpOnOff* attribute  
5096 are listed below.

5097 **Table 3-46. Values of the *StartUpOnOff* Attribute**

Value	Action on power up
0x00	Set the <i>OnOff</i> attribute to 0 (off).
0x01	Set the <i>OnOff</i> attribute to 1 (on).
0x02	If the previous value of the <i>OnOff</i> attribute is equal to 0, set the <i>OnOff</i> attribute to 1. If the previous value of the <i>OnOff</i> attribute is equal to 1, set the <i>OnOff</i> attribute to 0 (toggle).
0x03 to 0xfe	These values are reserved. No action.
0xff	Set the <i>OnOff</i> attribute to its previous value.

5098 **3.8.2.3 Commands Received**

5099 The command IDs for the *On/Off* cluster are listed below.

5100 **Table 3-47. Command IDs for the On/Off Cluster**

ID	Description	M/O
0x00	Off	M
0x01	On	M
0x02	Toggle	M
0x40	Off with effect	O
0x41	On with recall global scene	O
0x42	On with timed off	O

5101 **3.8.2.3.1 Off Command**

5102 This command does not have a payload.

<sup>50</sup> CCB 2605 remove ‘lamp’

5103 **3.8.2.3.1.1 Effect on Receipt**

5104 On receipt of this command, a device SHALL enter its ‘Off’ state. This state is device dependent, but it is  
5105 recommended that it is used for power off or similar functions. On receipt of the *Off* command, the *OnTime*  
5106 attribute SHALL be set to 0x0000.

5107 **3.8.2.3.2 On Command**

5108 This command does not have a payload.

5109 **3.8.2.3.2.1 Effect on Receipt**

5110 On receipt of this command, a device SHALL enter its ‘On’ state. This state is device dependent, but it is  
5111 recommended that it is used for power on or similar functions. On receipt of the *On* command, if the value  
5112 of the *OnTime* attribute is equal to 0x0000, the device SHALL set the *OffWaitTime* attribute to 0x0000.

5113 **3.8.2.3.3 Toggle Command**

5114 This command does not have a payload.

5115 **3.8.2.3.3.1 Effect on Receipt**

5116 On receipt of this command, if a device is in its ‘Off’ state it SHALL enter its ‘On’ state. Otherwise, if it is  
5117 in its ‘On’ state it SHALL enter its ‘Off’ state. On receipt of the *Toggle* command, if the value of the *OnOff*  
5118 attribute is equal to 0x00 and if the value of the *OnTime* attribute is equal to 0x0000, the device SHALL set  
5119 the *OffWaitTime* attribute to 0x0000. If the value of the *OnOff* attribute is equal to 0x01, the *OnTime* attribute  
5120 SHALL be set to 0x0000.

5121 **3.8.2.3.4 Off With Effect Command**

5122 The *Off With Effect* command allows devices to be turned off using enhanced ways of fading.

5123 The payload of this command SHALL be formatted as illustrated in Figure 3-36.

5124 **Figure 3-36. Format of the Off With Effect Command**

<b>Octets</b>	1	1
<b>Data Type</b>	uint8	uint8
<b>Field Name</b>	Effect identifier	Effect variant

5125 **3.8.2.3.4.1 Effect Identifier Field**

5126 The *Effect Identifier* field is 8-bits in length and specifies the fading effect to use when switching the device  
5127 off. This field SHALL contain one of the non-reserved values listed in Table 3-48.

5128 **Table 3-48. Values of the Effect Identifier Field of the Off With Effect Command**

<b>Effect Identifier Field Value</b>	<b>Description</b>
0x00	Delayed All Off
0x01	Dying Light
0x02 to 0xff	Reserved

5129

5130 **3.8.2.3.4.2 Effect Variant Field**

5131 The *Effect Variant* field is 8-bits in length and is used to indicate which variant of the effect, indicated in the  
5132 *Effect Identifier* field, SHOULD be triggered. If a device does not support the given variant, it SHALL use  
5133 the default variant. This field is dependent on the value of the *Effect Identifier* field and SHALL contain one  
5134 of the nonreserved values listed in Table 3-49.

5135 **Table 3-49. Values of the Effect Variant Field of the Off With Effect Command**

Effect Identifier Field Value	Effect Variant Field Value	Description
0x00	0x00 (default)	Fade to off in 0.8 seconds
	0x01	No fade
	0x02	50% dim down in 0.8 seconds then fade to off in 12 seconds
	0x03 to 0xff	Reserved
0x01	0x00 (default)	20% dim up in 0.5s then fade to off in 1 second
	0x01 to 0xff	Reserved
0x02 to 0xff	0x00 to 0xff	Reserved

5136 **3.8.2.3.4.3 Effect on Receipt**

5137 On receipt of the *Off With Effect* command and if the *GlobalSceneControl* attribute is equal to TRUE, the  
5138 application on the associated endpoint SHALL store its settings in its global scene then set the *GlobalScen-*  
5139 *eControl* attribute to FALSE. The application SHALL then enter its “off” state, update the *OnOff* attribute  
5140 accordingly and set the *OnTime* attribute to 0x0000.

5141 In all other cases, the application on the associated endpoint SHALL enter its “off” state and update the *OnOff*  
5142 attribute accordingly.

5143 **3.8.2.3.5 On With Recall Global Scene Command**

5144 The *On With Recall Global Scene* command allows the recall of the settings when the device was turned  
5145 off.

5146 The *On With Recall Global Scene* command SHALL have no parameters.

5147 **3.8.2.3.5.1 Effect on Receipt**

5148 On receipt of the *On With Recall Global Scene* command, if the *GlobalSceneControl* attribute is equal to  
5149 TRUE, the application on the associated endpoint SHALL discard the command.

5150 If the *GlobalSceneControl* attribute is equal to FALSE, the application on the associated endpoint SHALL  
5151 recall its global scene, entering the appropriate state and updating the *OnOff* attribute accordingly. It  
5152 SHALL then set the *GlobalSceneControl* attribute to TRUE. In Addition, if the value of the *OnTime* attrib-  
5153 ute is equal to 0x0000, the device SHALL then set the *OffWaitTime* attribute to 0x0000.  
5154

5155 **3.8.2.3.6 On With Timed Off Command**

5156 The *On With Timed Off* command allows devices to be turned on for a specific duration with a guarded off  
5157 duration so that SHOULD the device be subsequently switched off, further *On With Timed Off* commands,  
5158 received during this time, are prevented from turning the devices back on. Note that the device can be peri-  
5159 odically re-kicked by subsequent *On With Timed Off* commands, e.g., from an on/off sensor.



5160 The payload of this command SHALL be formatted as illustrated in Figure 3-37.

5161 **Figure 3-37. Format of the On With Timed Off Command**

<b>Octets</b>	1	2	2
<b>Data Type</b>	uint8	uint16	uint16
<b>Field Name</b>	On/off Control	On Time	Off Wait Time

5162 **3.8.2.3.6.1 On/Off Control Field**

5163 The *On/Off Control* field is 8-bits in length and contains information on how the device is to be operated.  
5164 This field SHALL be formatted as illustrated in Figure 3-38.

5165 **Figure 3-38. Format of the On/Off Control Field of the On With Timed Off Command**

<b>Bits: 0</b>	<b>1-7</b>
Accept Only When On	Reserved

5166

5167 The *Accept Only When On* sub-field is 1 bit in length and specifies whether the *On With Timed Off* command  
5168 is to be processed unconditionally or only when the *OnOff* attribute is equal to 0x01. If this sub-field is set to  
5169 1, the *On With Timed Off* command SHALL only be accepted if the *OnOff* attribute is equal to 0x01. If this  
5170 sub-field is set to 0, the *On With Timed Off* command SHALL be processed unconditionally.

5171 **3.8.2.3.6.2 On Time Field**

5172 The *On Time* field is 16 bits in length and specifies the length of time (in 1/10ths second) that the device is  
5173 to remain “on”, i.e., with its *OnOff* attribute equal to 0x01, before automatically turning “off”. This field  
5174 SHALL be specified in the range 0x0000 to 0xfffe.

5175 **3.8.2.3.6.3 Off Wait Time Field**

5176 The *Off Wait Time* field is 16 bits in length and specifies the length of time (in 1/10ths second) that the device  
5177 SHALL remain “off”, i.e., with its *OnOff* attribute equal to 0x00, and guarded to prevent an on command  
5178 turning the device back “on”. This field SHALL be specified in the range 0x0000 to 0xfffe.

5179 **3.8.2.3.6.4 Effect on Receipt**

5180 On receipt of this command, if the *accept only when on* sub-field of the on/off control field is set to 1 and the  
5181 value of the *OnOff* attribute is equal to 0x00 (off), the command SHALL be discarded.

5182 If the value of the *OffWaitTime* attribute is greater than zero and the value of the *OnOff* attribute is equal to  
5183 0x00, then the device SHALL set the *OffWaitTime* attribute to the minimum of the *OffWaitTime* attribute and  
5184 the value specified in the off wait time field.

5185 In all other cases, the device SHALL set the *OnTime* attribute to the maximum of the *OnTime* attribute and  
5186 the value specified in the on time field, set the *OffWaitTime* attribute to the value specified in the off wait  
5187 time field and set the *OnOff* attribute to 0x01 (on).

5188 If the values of the *OnTime* and *OffWaitTime* attributes are both less than 0xffff, the device SHALL then  
5189 update the device every 1/10<sup>th</sup> second until both the *OnTime* and *OffWaitTime* attributes are equal to 0x0000,  
5190 as follows:

- 5191 • If the value of the *OnOff* attribute is equal to 0x01 (on) and the value of the *OnTime* attribute is  
5192 greater than zero, the device SHALL decrement the value of the *OnTime* attribute. If the value of the  
5193 *OnTime* attribute reaches 0x0000, the device SHALL set the *OffWaitTime* and *OnOff* attributes to  
5194 0x0000 and 0x00, respectively.

- If the value of the *OnOff* attribute is equal to 0x00 (off) and the value of the *OffWaitTime* attribute is greater than zero, the device SHALL decrement the value of the *OffWaitTime* attribute. If the value of the *OffWaitTime* attribute reaches 0x0000, the device SHALL terminate the update.

### 3.8.2.4 State Description

The operation of the on/off cluster with respect to the on, off, and on with timed off commands is illustrated in Figure 3-39. In this diagram, the values X and Y correspond to the on time and off wait time fields, respectively, of the on with timed off command. In the “Timed On” state, the *OnTime* attribute is decremented every 1/10<sup>th</sup> second. Similarly, in the “Delayed Off” state, the *OffWaitTime* attribute is decremented every 1/10<sup>th</sup> second.

Figure 3-39. On/Off Cluster Operation State Machine

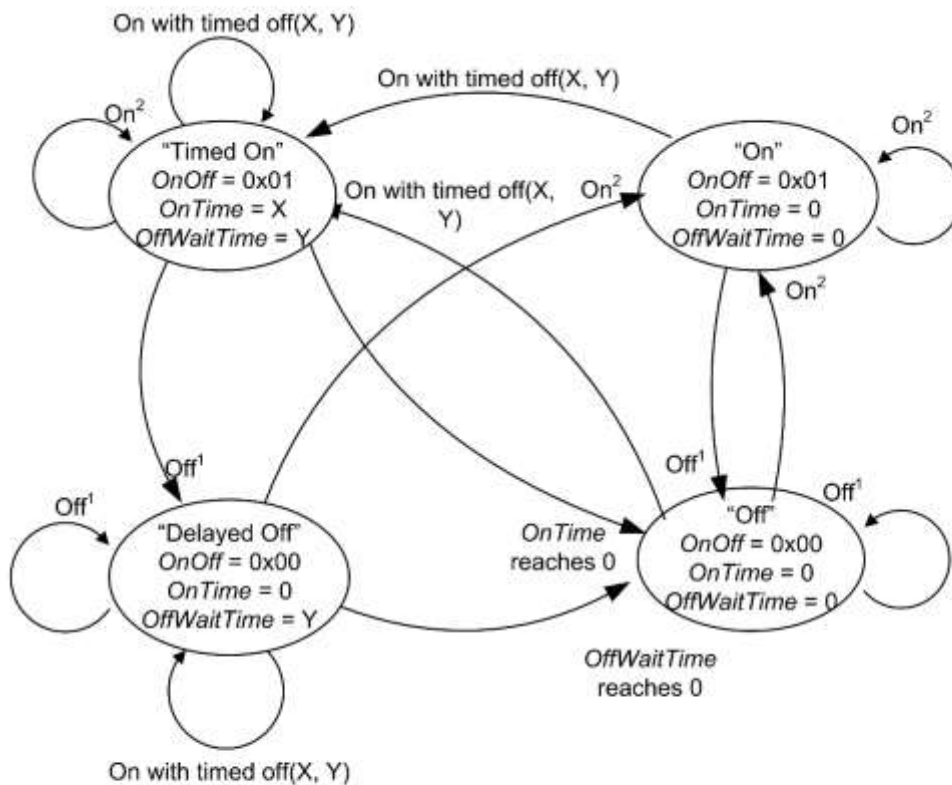

Note 1: Any command which causes the *OnOff* attribute to be set to 0x00, e.g. Off, Toggle or Off with effect.  
Note 2: Any command which causes the *OnOff* attribute to be set to 0x01, e.g. On, Toogle or On with recall global scene.

### 3.8.2.5 Commands Generated

The server generates no commands.

### 3.8.2.6 Scene Table Extensions

If the Scenes server cluster (11) is implemented, the following extension field is added to the Scenes table:

*OnOff*

5212 **3.8.2.7 Attribute Reporting**

5213 This cluster SHALL support attribute reporting using the Report Attributes command and according to the  
5214 minimum and maximum reporting interval settings described in Chapter 2, Foundation. The following attrib-  
5215 ute SHALL be reported:

5216 *OnOff*

5217 **3.8.3 Client**

5218 The client has no cluster specific attributes. The client generates the cluster specific commands received by  
5219 the server (see 3.8.2.3) , as required by the application. No cluster specific commands are received by the  
5220 client.

5221 **3.9 On/Off Switch Configuration**

---

5222 **3.9.1 Overview**

5223 Please see Chapter 2 for a general cluster overview defining cluster architecture, revision, classification,  
5224 identification, etc.

5225 Attributes and commands for configuring On/Off switching devices.

5226 **3.9.1.1 Revision History**

5227 The global *ClusterRevision* attribute value SHALL be the highest revision number in the table below.

.Rev	Description
1	global mandatory <i>ClusterRevision</i> attribute added

5228 **3.9.1.2 Classification**

Hierarchy	Role	PICS Code	Primary Transaction
Base	Application	OOSC	Type 2 (server to client)

5229 **3.9.1.3 Cluster Identifiers**

Identifier	Name
0x0007	On /Off Switch Configuration

5230 **3.9.2 Server**

5231 **3.9.2.1 Dependencies**

5232 Any endpoint that implements this server cluster SHALL also implement the On/Off client cluster.

5233 **3.9.2.2 Attributes**

5234 For convenience, the attributes defined in this specification are arranged into sets of related attributes; each  
 5235 set can contain up to 16 attributes. Attribute identifiers are encoded such that the most significant three nib-  
 5236 bles specify the attribute set and the least significant nibble specifies the attribute within the set. The currently  
 5237 defined attribute sets are listed in Table 3-50.

5238 **Table 3-50. On/Off Switch Configuration Attribute Sets**

Attribute Set Identifier	Description
0x000	Switch Information
0x001	Switch Settings

5239 **3.9.2.2.1 Switch Information Attribute Set**

5240 The switch information attribute set contains the attributes summarized in Table 3-51.

5241 **Table 3-51. Attributes of the Switch Information Attribute Set**

Identifier	Name	Type	Range	Access	Default	M/O
0x0000	<i>SwitchType</i>	enum8	0x00 to 0x01	R	-	M

5242 **3.9.2.2.2 SwitchType Attribute**

5243 The *SwitchType* attribute specifies the basic functionality of the On/Off switching device. This attribute  
 5244 SHALL be set to one of the nonreserved values listed in Table 3-52.

5245 **Table 3-52. Values of the *SwitchType* Attribute**

Attribute Value	Description	Details
0x00	Toggle	A switch with two physical states. An action by the user (e.g., toggling a rocker switch) moves the switch from state 1 to state 2. The switch then remains in that state until another action from the user returns it to state 1.
0x01	Momentary	A switch with two physical states. An action by the user (e.g., pressing a button) moves the switch from state 1 to state 2. When the user ends his action (e.g., releases the button) the switch returns to state 1.
0x02	Multifunction	A switch that behaves differently depending on user input. Under some conditions it MAY send a toggle or in some other conditions a move command. The behavior of the switch is application-specific but the nature of the switch is clear: it is a multifunction switch.

5246 **3.9.2.2.3 Switch Settings Attribute Set**

5247 The switch settings attribute set contains the attributes summarized in Table 3-53.

5248

**Table 3-53. Attributes of the Switch Settings Attribute Set**

Identifier	Name	Type	Range	Access	Default	M/O
0x0010	<i>SwitchActions</i>	enum8	0 to 2	RW	0	M

5249

### **3.9.2.2.3.1 *SwitchActions* Attribute**

5250

The *SwitchActions* attribute is 8 bits in length and specifies the commands of the On/Off cluster (see 3.8) to be generated when the switch moves between its two states, as detailed in Table 3-54.

5251

5252

**Table 3-54. Values of the *SwitchActions* Attribute**

Attribute Value	Command Generated When Arriving at State 2 From State 1	Command Generated When Arriving at State 1 From State 2
0x00	On	Off
0x01	Off	On
0x02	Toggle	Toggle

5253

### **3.9.2.3 Commands Received**

5254

No commands are received by the server.

5255

### **3.9.2.4 Commands Generated**

5256

The server generates no commands.

5257

## **3.9.3 Client**

5258

The client has no cluster specific attributes. No cluster specific commands are generated or received by the client.

5259

5260

## **3.10 Level**

---

5261

### **3.10.1 Overview**

5262

Please see Chapter 2 for a general cluster overview defining cluster architecture, revision, classification, identification, etc.

5263

5264

This cluster provides an interface for controlling a characteristic of a device that can be set to a level, for example the brightness of a light, the degree of closure of a door, or the power output of a heater.

5265

5266

NOTE: This cluster specification is a base cluster for generic level control. Also, in this document, is the Level Control for Lighting cluster specification, formerly just Level Control. Level Control for Lighting is derived from this cluster specification, and has further requirements for the lighting application. Please see section 3.18 for the Level Control for Lighting.

5267

5268

5269

5270 **3.10.1.1 Revision History**5271 The global *ClusterRevision* attribute value SHALL be the highest revision number in the table below.

Rev	Description
1	global mandatory <i>ClusterRevision</i> attribute added
2	added <i>Options</i> attribute, state change table; ZLO 1.0; Base cluster (no change) CCB 2085 1775 2281 2147
3	CCB 2574 2616 2659 2702 2814 2818 2819 2898

5272 **3.10.1.2 Classification**

Hierarchy	Role	PICS Code	Primary Transaction
Base	Application	LVL	Type 1 (client to server)

5273 **3.10.1.3 Cluster Identifiers**

5274 Derived cluster specifications are defined elsewhere. This base cluster specification MAY be used for generic  
5275 level control; however, it is recommended to derive another cluster to better define the application and do-  
5276 main requirements. If one of more derived cluster identifiers and the base identifier exists on a device end-  
5277 point, then they SHALL all represent a single instance of the device level control. See Chapter 2 – Instance  
5278 Model for more information.

Identifier	Hierarchy	Name
0x0008	Base	Level (this cluster specification)
0x0008	Derived	Level Control for Lighting (3.19)
0x001c	Derived	Pulse Width Modulation (3.20)

5279 **3.10.2 Server**5280 **3.10.2.1 Dependencies**

5281 For many applications, a close relationship between this cluster and the On/Off cluster is needed. This section  
5282 describes the dependencies that are required when an endpoint that implements this server cluster and also  
5283 implements the On/Off server cluster.

5284 The *OnOff* attribute of the On/Off cluster and the *CurrentLevel* attribute of the Level Control cluster are  
5285 intrinsically independent variables, as they are on different clusters. However, when both clusters are imple-  
5286 mented on the same endpoint, dependencies MAY be introduced between them. Facilities are provided to  
5287 introduce dependencies if required.

5288 **3.10.2.1.1 Effect of On/Off Commands on the *CurrentLevel* At-**  
5289 **tribute**

5290 The attribute *OnLevel* (see 3.10.2.2.10) determines whether commands of the On/Off cluster have a perma-  
5291 nent effect on the *CurrentLevel* attribute or not. If this attribute is defined (i.e., implemented and not 0xff)  
5292 they do have a permanent effect, otherwise they do not. There is always a temporary effect, due to fading up  
5293 / down.

5294 The effect on the Level Control cluster on receipt of the various commands of the On/Off cluster are as  
5295 detailed in Table 3-55. In this table, and throughout this cluster specification, 'level' means the value of the  
5296 *CurrentLevel* attribute.

5297 **Table 3-55. Actions on Receipt for On/Off Commands, when Associated with Level Control**

Command	Action On Receipt
On	Temporarily store <i>CurrentLevel</i> . Set <i>CurrentLevel</i> to the minimum level allowed for the device. Change <i>CurrentLevel</i> to <i>OnLevel</i> , or to the stored level if <i>OnLevel</i> is not defined, over the time period <i>OnOffTransitionTime</i> .
Off	Temporarily store <i>CurrentLevel</i> . Change <i>CurrentLevel</i> to the minimum level allowed for the device over the time period <i>OnOffTransitionTime</i> . If <i>OnLevel</i> is not defined, set the <i>CurrentLevel</i> to the stored level.
Toggle	If the <i>OnOff</i> attribute has the value Off, proceed as for the On command. Otherwise proceed as for the Off command.

5298 Intention of the actions described in the table above is that *CurrentLevel*, which was in effect before any of  
5299 the On, Off or Toggle commands were issued, shall be restored, after the transition is completed. If another  
5300 of these commands is received, before the transition is completed, the originally stored *CurrentLevel* shall  
5301 be preserved and restored.

5302 **3.10.2.1.2 Effect of Level Control Commands on the *OnOff* At-**  
5303 **tribute**

5304 There are two sets of commands provided in the Level Control cluster. These are identical, except that the  
5305 first set (Move to Level, Move and Step) SHALL NOT affect the *OnOff* attribute, whereas the second set  
5306 ('with On/Off' variants) SHALL.

5307 The first set is used to maintain independence between the *CurrentLevel* and *OnOff* attributes, so changing  
5308 *CurrentLevel* has no effect on the *OnOff* attribute. As examples, this represents the behavior of a volume  
5309 control with a mute button, or a 'turn to set level and press to turn on/off' light dimmer.

5310 The second set is used to link the *CurrentLevel* and *OnOff* attributes. When the level is reduced to its mini-  
5311 mum the *OnOff* attribute is automatically turned to Off, and when the level is increased above its minimum  
5312 the *OnOff* attribute is automatically turned to On. As an example, this represents the behavior of a light  
5313 dimmer with no independent on/off switch.

5314

5315 **3.10.2.1.3 GlobalSceneControl and Commands with On/Off**

5316 If a *Move to Level (with On/off)*, *Move (with on/Off)* or *Step (with On/Off)* command is received that causes  
5317 a change to the value of the *OnOff* attribute of the On/Off cluster, the value of the *GlobalSceneControl* at-  
5318 tribute of the On/Off cluster SHALL be updated according to section 3.8.2.2.2.

5319

5320 **3.10.2.2 Attributes**

5321 The attributes of the Level Control server cluster are summarized in Table 3-56.

5322 **Table 3-56. Attributes of the Level Control Server Cluster**

Id	Name	Type	Range	Acc	Default	M/O
0x0000	<i>CurrentLevel</i>	uint8	<i>MinLevel</i> to <i>MaxLevel</i>	RPS	0xff	M
0x0001	<i>RemainingTime</i>	uint16	0x0000 to 0xffff	R	0	O
0x0002	<i>MinLevel</i>	uint8	0 to <i>MaxLevel</i>	R	0	O
0x0003	<i>MaxLevel</i>	uint8	<i>MinLevel</i> to 0xff	R	0xff	O
0x0004	<i>CurrentFrequency</i>	uint16	<i>MinFrequency</i> to <i>MaxFrequency</i>	RPS	0	O
0x0005	<i>MinFrequency</i>	uint16	0 to <i>MaxFrequency</i>	R	0	O
0x0006	<i>MaxFrequency</i>	uint16	<i>MinFrequency</i> to 0xffff	R	0	O
0x0010	<i>OnOffTransitionTime</i>	uint16	0x0000 to 0xffff	RW	0	O
0x0011	<i>OnLevel</i>	uint8	<i>MinLevel</i> to <i>MaxLevel</i>	RW	0xff	O
0x0012	<i>OnTransitionTime</i>	uint16	0x0000 to 0xfffe	RW	0xffff	O
0x0013	<i>OffTransitionTime</i>	uint16	0x0000 to 0xfffe	RW	0xffff	O
0x0014	<i>DefaultMoveRate</i>	uint8 <sup>51</sup>	0x00 to 0xfe	RW	MS	O
0x000F	<i>Options</i>	map8	descr	RW	0	O
0x4000	<i>StartUpCurrentLevel</i>	uint8	0x00 to 0xff	RW	MS	O

5323 **3.10.2.2.1 CurrentLevel Attribute**5324 The *CurrentLevel* attribute represents the current level of this device. The meaning of 'level' is device dependent.  
53255326 **3.10.2.2.2 RemainingTime Attribute**5327 The *RemainingTime* attribute represents the time remaining until the current command is complete - it is  
5328 specified in 1/10ths of a second.5329 **3.10.2.2.3 MinLevel Attribute**5330 The *MinLevel* attribute indicates the minimum value of *CurrentLevel* that is capable of being assigned.<sup>51</sup> CCB 2574 all other text and scripts treat as an unsigned 8-bit integer



5331 **3.10.2.2.4 MaxLevel Attribute**

5332 The *MaxLevel* attribute indicates the maximum value of *CurrentLevel* that is capable of being assigned.

5333 **3.10.2.2.5 CurrentFrequency Attribute**

5334 The *CurrentFrequency* attribute represents the frequency that the devices is at *CurrentLevel*. A *CurrentFrequency* of 0 is unknown.

5336 **3.10.2.2.6 MinFrequency Attribute**

5337 The *MinFrequency* attribute indicates the minimum value of *CurrentFrequency* that is capable of being assigned. *MinFrequency* shall be less than or equal to *MaxFrequency*. A value of 0 indicates undefined.

5339 **3.10.2.2.7 MaxFrequency Attribute**

5340 The *MaxFrequency* attribute indicates the maximum value of *CurrentFrequency* that is capable of being assigned. *MaxFrequency* shall be greater than or equal to *MinFrequency*. A value of 0 indicates undefined.

5342 **3.10.2.2.8 Options Attribute**

5343 The *Options* attribute is meant to be changed only during commissioning. The *Options* attribute is a bitmap that determines the default behavior of some cluster commands. Each command that is dependent on the *Options* attribute SHALL first construct a temporary Options bitmap that is in effect during the command processing. The temporary Options bitmap has the same format and meaning as the *Options* attribute, but includes any bits that may be overridden by command fields.

5348 Below is the format and description of the *Options* attribute and temporary Options bitmap and the effect on dependent commands.

5350

**Table 3-57. Options Attribute**

Bit	Name	Values & Summary
0	ExecuteIfOff	0 – Do not execute command if OnOff is 0x00 (FALSE) 1 – Execute command if OnOff is 0x00 (FALSE)
1	<i>Reserved for Derived Clusters</i>	This bit has been defined in these derived clusters for a specific application: Level Control for Lighting

5351

5352 **3.10.2.2.8.1 ExecutelfOff Options Bit**

5353 Command execution SHALL NOT continue beyond the *Options* processing if all of these criteria are true:

- 5354
- The command is one of the ‘without On/Off’ commands: Move, Move to Level, Stop, or Step.
  - 5355 • The On/Off cluster exists on the same endpoint as this cluster.
  - 5356 • The *OnOff* attribute of the On/Off cluster, on this endpoint, is 0x00 (FALSE).
  - 5357 • The value of the ExecutelfOff bit is 0.

5358

5359 **3.10.2.2.9 OnOffTransitionTime Attribute**

5360 The *OnOffTransitionTime* attribute represents the time taken to move to or from the target level when On of  
5361 Off commands are received by an On/Off cluster on the same endpoint. It is specified in 1/10ths of a second.

5362 The actual time taken SHOULD be as close to *OnOffTransitionTime* as the device is able. N.B. If the device  
5363 is not able to move at a variable rate, the *OnOffTransitionTime* attribute SHOULD NOT be implemented.

5364 **3.10.2.2.10 OnLevel Attribute**

5365 The *OnLevel* attribute determines the value that the *CurrentLevel* attribute is set to when the *OnOff* attribute  
5366 of an On/Off cluster on the same endpoint is set to On, as a result of processing an On/Off cluster command.  
5367 If the *OnLevel* attribute is not implemented, or is set to the non-value, it has no effect. For more details see  
5368 3.10.2.1.1.

5369 **3.10.2.2.11 OnTransitionTime Attribute**

5370 The *OnTransitionTime* attribute represents the time taken to move the current level from the minimum level  
5371 to the maximum level when an On command is received by an On/Off cluster on the same endpoint. It is  
5372 specified in 10ths of a second. If this command is not implemented, or contains a non-value, the *On/OffTran-*  
5373 *sitionTime* will be used instead.

5374 **3.10.2.2.12 OffTransitionTime Attribute**

5375 The *OffTransitionTime* attribute represents the time taken to move the current level from the maximum level  
5376 to the minimum level when an Off command is received by an On/Off cluster on the same endpoint. It is  
5377 specified in 10ths of a second. If this command is not implemented, or contains a non-value, the *On/OffTran-*  
5378 *sitionTime* will be used instead.

5379 **3.10.2.2.13 DefaultMoveRate Attribute**

5380 The *DefaultMoveRate* attribute determines the movement rate, in units per second, when a Move command  
5381 is received with a non-value Rate parameter.

5382 **3.10.2.2.14 StartUpCurrentLevel Attribute**

5383 The *StartUpCurrentLevel* attribute SHALL define the desired startup level for a device when it is supplied  
5384 with power and this level SHALL be reflected in the *CurrentLevel* attribute. The values of the *StartUpCur-*  
5385 *rentLevel* attribute are listed below:

5386 **Table 3-58. Values of the *StartUpCurrentLevel* attribute**

Value	Action on power up
0x00	Set the <i>CurrentLevel</i> attribute to the minimum value permitted on the device
0xff	Set the <i>CurrentLevel</i> attribute to its previous value
<i>other values</i>	Set the <i>CurrentLevel</i> attribute to this value

5387

5388 **3.10.2.3 Commands Received**

5389 The command IDs for the Level Control cluster are listed below.

5390 **Table 3-59. Command IDs for the Level Control Cluster**

ID	Description	M/O
0x00	Move to Level	M
0x01	Move	M
0x02	Step	M
0x03	Stop	M
0x04	Move to Level (with On/Off)	M
0x05	Move (with On/Off)	M
0x06	Step (with On/Off)	M
0x07	Stop	M
0x08	Move to Closest Frequency	M:CurrentFrequency attribute supported

5391 **3.10.2.3.1 Move to Level Command**

5392 **3.10.2.3.1.1 Payload Format**

5393 The Move to Level command payload SHALL be formatted as illustrated in Figure 3-40.

5394 **Figure 3-40. Format of the Move to Level Command Payload**

<b>Octets</b>	1	2	1	1
<b>Data Type</b>	uint8	uint16	map8	map8
<b>Field Name</b>	Level	Transition time	OptionsMask	OptionsOverride
<b>Default</b>	n/a	n/a	0	0 <sup>52</sup>

5395 **3.10.2.3.1.2 Effect on Receipt**

5396 The OptionsMask & OptionsOverride fields SHALL both be present<sup>53</sup>. Default values are provided to interpret missing fields from legacy devices. A temporary Options bitmap SHALL be created from the Options attribute, using the OptionsMask & OptionsOverride fields. Each bit of the temporary Options bitmap SHALL be determined as follows:

5400 Each bit in the Options attribute SHALL determine the corresponding bit in the temporary Options bitmap, unless the OptionsMask field is present and has the corresponding bit set to 1, in which case the corresponding bit in the OptionsOverride field SHALL determine the corresponding bit in the temporary Options bitmap.

<sup>52</sup> CCB 2814 defaults for legacy devices

<sup>53</sup> CCB 2814 fields are mandatory because fields may follow

- 5404 The resulting temporary Options bitmap SHALL then be processed as defined in section 3.10.2.2.8<sup>54</sup>.
- 5405 On receipt of this command, a device SHALL move from its current level to the value given in the Level  
5406 field. The meaning of ‘level’ is device dependent – e.g., for a light it MAY mean brightness level.
- 5407 The movement SHALL be as continuous as technically practical, i.e., not a step function, and the time taken  
5408 to move to the new level SHALL be equal to the value of the Transition time field, in tenths of a second, or  
5409 as close to this as the device is able.
- 5410 If the Transition time field takes the value 0xffff then the time taken to move to the new level SHALL instead  
5411 be determined by the *OnOffTransitionTime* attribute. If *OnOffTransitionTime*, which is an optional attribute,  
5412 is not present, the device SHALL move to its new level as fast as it is able.
- 5413 If the device is not able to move at a variable rate, the Transition time field MAY be disregarded.

### 5414 3.10.2.3.2 Move Command

#### 5415 3.10.2.3.2.1 Payload Format

5416 The Move command payload SHALL be formatted as illustrated in Figure 3-41.

5417 **Figure 3-41. Format of the Move Command Payload**

<b>Octets</b>	1	1	1	1
<b>Data Type</b>	enum8	uint8	map8	map8
<b>Field Name</b>	Move mode	Rate	OptionsMask	OptionsOverride
<b>Default</b>	n/a	n/a	0	0 <sup>55</sup>

#### 5418 3.10.2.3.2.2 Move Mode Field

5419 The Move mode field SHALL be one of the non-reserved values in Table 3-60.

5420 **Table 3-60. Values of the Move Mode Field**

Fade Mode Value	Description
0x00	Up
0x01	Down

#### 5421 3.10.2.3.2.3 Rate Field

5422

5423 The Rate field specifies the rate of movement in units per second. The actual rate of movement SHOULD be  
5424 as close to this rate as the device is able. If the Rate field is 0xFF, then the value in *DefaultMoveRate* attribute  
5425 SHALL be used. If the Rate field is 0xFF and the *DefaultMoveRate* attribute is not supported, then the device  
5426 SHOULD move as fast as it is able. If the device is not able to move at a variable rate, this field MAY be  
5427 disregarded.

#### 5428 3.10.2.3.2.4 Effect on Receipt

<sup>54</sup> CCB 2702

<sup>55</sup> CCB 2814 defaults for legacy devices

5429 On receipt of this command, a device SHALL first create and process a temporary Options bitmap as de-  
5430 scribed in section 3.10.2.3.1.2.

5431 On receipt of this command, a device SHALL move from its current level in an up or down direction in a  
5432 continuous fashion, as detailed in Table 3-61.

5433 **Table 3-61. Actions on Receipt for Move Command**

Fade Mode	Action on Receipt
Up	Increase the device’s level at the rate given in the Rate field. If the level reaches the maximum allowed for the device, stop.
Down	Decrease the device’s level at the rate given in the Rate field. If the level reaches the minimum allowed for the device, stop.

5434 **3.10.2.3.3 Step Command**

5435 **3.10.2.3.3.1 Payload Format**

5436 The Step command payload SHALL be formatted as illustrated in Figure 3-42.

5437 **Figure 3-42. Format of the Step Command Payload**

Octets	1	1	2	1	1
Data Type	enum8	uint8	uint16	map8	map8
Field Name	Step mode	Step size	Transition time	OptionsMask	OptionsOverride
Default	n/a	n/a	n/a	0	0 <sup>56</sup>

5438

5439 The Step mode field SHALL be one of the non-reserved values in Table 3-62.

5440 **Table 3-62. Values of the Step Mode Field**

Fade Mode Value	Description
0x00	Up
0x01	Down

5441

5442 The Transition time field specifies the time that SHALL be taken to perform the step, in tenths of a second.  
5443 A step is a change in the *CurrentLevel* of 'Step size' units. The actual time taken SHOULD be as close to this  
5444 as the device is able. If the Transition time field is 0xffff the device SHOULD move as fast as it is able.

5445 If the device is not able to move at a variable rate, the Transition time field MAY be disregarded.

5446 **3.10.2.3.3.2 Effect on Receipt**

5447 On receipt of this command, a device SHALL first create and process a temporary Options bitmap as de-  
5448 scribed in section 3.10.2.3.1.2.

<sup>56</sup> CCB 2814 defaults for legacy devices

5449 On receipt of this command, a device SHALL move from its current level in an up or down direction as  
5450 detailed in Table 3-63.

5451 **Table 3-63. Actions on Receipt for Step Command**

Fade Mode	Action on Receipt
Up	Increase <i>CurrentLevel</i> by 'Step size' units, or until it reaches the maximum level allowed for the device if this reached in the process. In the latter case, the transition time SHALL be proportionally reduced.
Down	Decrease <i>CurrentLevel</i> by 'Step size' units, or until it reaches the minimum level allowed for the device if this reached in the process. In the latter case, the transition time SHALL be proportionally reduced.

### 5452 3.10.2.3.4 Stop Command

#### 5453 3.10.2.3.4.1 Payload Format

5454 The command payload SHALL be formatted as illustrated below.

5455 **Figure 3-43. Format of the Command Payload**

Octets	1	1
Data Type	map8	map8
Field Name	OptionsMask	OptionsOverride
Default	0	0 <sup>57</sup>

5456

#### 5457 3.10.2.3.4.2 Effect of Receipt

5458 On receipt of this command, a device SHALL first create and process a temporary Options bitmap as de-  
5459 scribed in section 3.10.2.3.1.2.

5460 Upon receipt of this command, any Move to Level, Move or Step command (and their 'with On/Off' variants)  
5461 currently in process SHALL be terminated. The value of *CurrentLevel* SHALL be left at its value upon  
5462 receipt of the Stop command, and *RemainingTime* SHALL be set to zero.

5463 This command has two entries in Table 3-5, one for the Move to Level, Move and Set commands, and one  
5464 for their 'with On/Off' counterparts. This is solely for symmetry, to allow easy choice of one or other set of  
5465 commands – the Stop commands are identical, because the dependency on On/Off is determined by the orig-  
5466 inal command that is being stopped<sup>58</sup>.

### 5467 3.10.2.3.5 Move to Closest Frequency Command

5468 This command shall be mandatory if the CurrentFrequency attribute is supported.

5469

#### 5470 3.10.2.3.5.1 Payload Format

<sup>57</sup> CCB 2814 defaults for legacy devices

<sup>58</sup> CCB 2819

5471 The command payload SHALL be formatted as illustrated below.

5472 **Figure 3-44. Format of the Command Payload**

<b>Octets</b>	2 <sup>59</sup>
<b>Data Type</b>	uint16
<b>Field Name</b>	Frequency

5473

5474 **3.10.2.3.5.2 Effect of Receipt**

5475 Upon receipt of this command, the device shall change its current frequency to the requested frequency, or  
5476 to the closest frequency that it can generate. If the device cannot approximate the frequency, then it shall  
5477 return a default response with an error code of INVALID\_VALUE. Determining if a requested frequency  
5478 can be approximated by a supported frequency is a manufacturer-specific decision.

5479 **3.10.2.3.6 'With On/Off' Commands**

5480 The Move to Level (with On/Off), Move (with On/Off) and Step (with On/Off) commands have identical  
5481 payloads to the Move to Level, Move and Step commands respectively<sup>60</sup>. They also have the same effects,  
5482 except for the following additions.

5483 Before commencing any command that has the effect of setting the *CurrentLevel* above the minimum level  
5484 allowed by the device, the OnOff attribute of the On/Off cluster on the same endpoint, if implemented,  
5485 SHALL be set to On.

5486 If any command that has the effect of setting the CurrentLevel to the minimum level allowed by the device,  
5487 the OnOff attribute of the On/Off cluster on the same endpoint, if implemented, SHALL be set to Off.

5488 **3.10.2.4 Commands Generated**

5489 The server generates no commands.

5490 **3.10.2.5 Scene Table Extensions<sup>61</sup>**

5491 If the Scenes server cluster is implemented, the following extension field is added to the Scenes table:

5492 *CurrentLevel*

5493 **3.10.3 Client**

5494 The client has no cluster specific attributes. The client generates the cluster specific commands received by  
5495 the server<sup>62</sup>, as required by the application. No cluster specific commands are received by the client.

<sup>59</sup> CCB 2898 explain duplicate Stop command

<sup>60</sup> CCB 2818 'with On/Off commands are the same, including Options processing

<sup>61</sup> CCB 2659

<sup>62</sup> CCB 2616

5496 

## 3.11 Alarms

5497 

### 3.11.1 Overview

5498 Please see Chapter 2 for a general cluster overview defining cluster architecture, revision, classification,  
5499 identification, etc.

5500 Attributes and commands for sending alarm notifications and configuring alarm functionality.

5501 Alarm conditions and their respective alarm codes are described in individual clusters, along with an alarm  
5502 mask field. Alarm notifications are reported to subscribed targets using binding.

5503 Where an alarm table is implemented, all alarms, masked or otherwise, are recorded and MAY be retrieved  
5504 on demand.

5505 Alarms MAY either reset automatically when the conditions that cause are no longer active, or MAY need  
5506 to be explicitly reset.

5507 

#### 3.11.1.1 Revision History

5508 The global *ClusterRevision* attribute value SHALL be the highest revision number in the table below.

Rev	Description
1	global mandatory <i>ClusterRevision</i> attribute added

5509 

#### 3.11.1.2 Classification

Hierarchy	Role	PICS Code	Primary Transaction
Base	Application	ALM	Type 2 (server to client)

5510 

#### 3.11.1.3 Cluster Identifiers

Identifier	Name
0x0009	Alarms

5511 

### 3.11.2 Server

5512 

#### 3.11.2.1 Dependencies

5513 Any endpoint which implements time stamping SHALL also implement the Time server cluster.

5514 

#### 3.11.2.2 Attributes

5515 For convenience, the attributes defined in this specification are arranged into sets of related attributes; each  
5516 set can contain up to 16 attributes. Attribute identifiers are encoded such that the most significant three nib-  
5517 bles specify the attribute set and the least significant nibble specifies the attribute within the set. The currently  
5518 defined attribute sets are listed in Table 3-64.



5519

**Table 3-64. Alarms Cluster Attribute Sets**

Attribute Set Identifier	Description
0x000	Alarm Information

5520

### 3.11.2.2.1 Alarm Information Attribute Set

5521

The Alarm Information attribute set contains the attributes summarized in Table 3-65.

5522

**Table 3-65. Attributes of the Alarm Information Attribute Set**

Identifier	Name	Type	Range	Access	Default	M/O
0x0000	<i>AlarmCount</i>	uint16	0x00 to 0xff	R	0	O

5523

#### 3.11.2.2.1.1 AlarmCount Attribute

5524

The *AlarmCount* attribute is 16 bits in length and specifies the number of entries currently in the alarm table.

5525

If alarm logging is not implemented this attribute SHALL always take the value 0.

5526

### 3.11.2.3 Alarm Table

5527

The alarm table is used to store details of alarms generated within the devices. Alarms are requested by clusters which have alarm functionality, e.g., when attributes take on values that are outside ‘safe’ ranges.

5528

5529

The maximum number of entries in the table is device dependent.

5530

When an alarm is generated, a corresponding entry is placed in the table. If the table is full, the earliest entry is replaced by the new entry.

5531

5532

Once an alarm condition has been reported the corresponding entry in the table is removed.

5533

#### 3.11.2.3.1 Alarm Table Format

5534

The format of an alarm table entry is illustrated in Table 3-66Format of the Alarm Table.

5535

**Table 3-66. Format of the Alarm Table**

Field	Type	Valid Range	Description
Alarm code	enum8	0x00 to 0xff	Identifying code for the cause of the alarm, as given in the specification of the cluster whose attribute generated this alarm.
Cluster identifier	clusterId	0x0000 to 0xffff	The identifier of the cluster whose attribute generated this alarm.
Time stamp	uint32	0x00000000 to 0xffffffff	The time at which the alarm occurred or 0xffffffff if no time information is available. This time is taken from a Time server cluster, which must be present on the same endpoint.

5536 **3.11.2.4 Commands Received**

5537 The received command IDs for the Alarms cluster are listed in Table 3-67.

5538 **Table 3-67. Received Command IDs for the Alarms Cluster**

Command Identifier Field Value	Description	M/O
0x00	Reset Alarm	M
0x01	Reset all alarms	M
0x02	Get Alarm	O
0x03	Reset alarm log	O

5539 **3.11.2.4.1 Reset Alarm Command**

5540 This command resets a specific alarm. This is needed for some alarms that do not reset automatically. If the  
5541 alarm condition being reset was in fact still active then a new notification will be generated and, where im-  
5542 plemented, a new record added to the alarm log.

5543 **3.11.2.4.1.1 Payload Format**

5544 The Reset Alarm command payload SHALL be formatted as illustrated in Figure 3-45.

5545 **Figure 3-45. Format of the Reset Alarm Command Payload**

Octets	1	2
Data Type	enum8	clusterId
Field Name	Alarm code	Cluster identifier

5546 **3.11.2.4.2 Reset All Alarms Command**

5547 This command resets all alarms. Any alarm conditions that were in fact still active will cause a new notifica-  
5548 tion to be generated and, where implemented, a new record added to the alarm log.

5549 **3.11.2.4.3 Get Alarm Command**

5550 This command causes the alarm with the earliest generated alarm entry in the alarm table to be reported in a  
5551 get alarm response command 3.11.2.5.2. This command enables the reading of logged alarm conditions from  
5552 the alarm table. Once an alarm condition has been reported the corresponding entry in the table is removed.

5553 This command does not have a payload.

5554 **3.11.2.4.4 Reset Alarm Log Command**

5555 This command causes the alarm table to be cleared, and does not have a payload.

5556 **3.11.2.5 Commands Generated**

5557 The generated command IDs for the Alarms cluster are listed in Table 3-68.

5558

**Table 3-68. Generated Command IDs for the Alarms Cluster**

Command Identifier Field Value	Description	M/O
0x00	Alarm	M
0x01	Get alarm response	O

5559 **3.11.2.5.1 Alarm Command**

5560 The alarm command signals an alarm situation on the sending device.

5561 An alarm command is generated when a cluster which has alarm functionality detects an alarm condition,  
5562 e.g., an attribute has taken on a value that is outside a ‘safe’ range. The details are given by individual cluster  
5563 specifications.

5564 **3.11.2.5.1.1 Payload Format**

5565 The alarm command payload SHALL be formatted as illustrated in Figure 3-46.

5566 **Figure 3-46. Format of the Alarm Command Payload**

Octets	1	2
Data Type	enum8	clusterId
Field Name	Alarm code	Cluster identifier

5567 **3.11.2.5.2 Get Alarm Response Command**

5568 The get alarm response command returns the results of a request to retrieve information from the alarm log,  
5569 along with a time stamp indicating when the alarm situation was detected.

5570 **3.11.2.5.2.1 Payload Format**

5571 The get alarm response command payload SHALL be formatted as illustrated in Figure 3-47.

5572 **Figure 3-47. Format of the Get Alarm Response Command Payload**

Octets	1	0/1	0/2	0/4
Data Type	enum8	enum8	clusterId	uint32
Field Name	Status	Alarm code	Cluster identifier	Time stamp

5573

5574 If there is at least one alarm record in the alarm table then the status field is set to SUCCESS. The alarm  
5575 code, cluster identifier and time stamp fields SHALL all be present and SHALL take their values from the  
5576 item in the alarm table that they are reporting.

5577 If there are no more alarms logged in the alarm table then the status field is set to NOT\_FOUND and the  
5578 alarm code, cluster identifier and time stamp fields SHALL be omitted.

5579 **3.11.3 Client**

5580 The client has no cluster specific attributes. The client generates the cluster specific commands received by  
 5581 the server (see 3.11.2.4), as required by the application. The client receives the cluster specific commands  
 5582 generated by the server (see 3.11.2.5).

5583 **3.12 Time**5584 **3.12.1 Overview**

5585 Please see Chapter 2 for a general cluster overview defining cluster architecture, revision, classification,  
 5586 identification, etc.

5587 This cluster provides a basic interface to a real-time clock. The clock time MAY be read and also written, in  
 5588 order to synchronize the clock (as close as practical) to a time standard. This time standard is the number of  
 5589 seconds since 0 hrs 0 mins 0 sec on 1<sup>st</sup> January 2000 UTC (Universal Coordinated Time).

5590 The cluster also includes basic functionality for local time zone and daylight saving time.

5591 **3.12.1.1 Revision History**

5592 The global *ClusterRevision* attribute value SHALL be the highest revision number in the table below.

Rev	Description
1	global mandatory <i>ClusterRevision</i> attribute added
2	CCB 2544 2983

5593 **3.12.1.2 Classification**

Hierarchy	Role	PICS Code
Base	Application	T

5594 **3.12.1.3 Cluster Identifiers**

Identifier	Name
0x000a	Time

5595 **3.12.2 Server**5596 **3.12.2.1 Dependencies**

5597 None

5598 **3.12.2.2 Attributes**

5599 The server supports the attributes shown in Table 3-69.

5600

**Table 3-69. Attributes of the Time Server Cluster**

Identifier	Name	Type	Range	Access	Default	M/O
0x0000	<i>Time</i>	UTC	0x00000000 to 0xfffffffffe	R*W <sup>63</sup>	0xffffffff	M
0x0001	<i>TimeStatus</i>	map8	desc	R*W	0	M
0x0002	<i>TimeZone</i>	int32	-86400 to +86400	RW	0	O
0x0003	<i>DstStart</i>	uint32	0x00000000 to 0xfffffffffe	RW	0xffffffff	O
0x0004	<i>DstEnd</i>	uint32	0x00000000 to 0xfffffffffe	RW	0xffffffff	O
0x0005	<i>DstShift</i>	int32	-86400 to +86400	RW	0	O
0x0006	<i>StandardTime</i>	uint32	0x00000000 to 0xfffffffffe	R	0xffffffff	O
0x0007	<i>LocalTime</i>	uint32	0x00000000 to 0xfffffffffe	R	0xffffffff	O
0x0008	<i>LastSetTime</i>	UTC	0x00000000 to 0xffffffff	R	0xffffffff	O
0x0009	<i>ValidUntilTime</i>	UTC	0x00000000 to 0xffffffff	RW	0xffffffff	O

5601 **3.12.2.2.1 Time Attribute**

5602 The *Time* attribute is 32 bits in length and holds the time value of a real time clock. This attribute has data  
5603 type UTCTime, but note that it MAY not actually be synchronized to UTC - see discussion of the *TimeStatus*  
5604 attribute.

5605 If the Master bit of the *TimeStatus* attribute has a value of 0, writing to this attribute SHALL set the real time  
5606 clock to the written value, otherwise it cannot be written. Attempting to write to this attribute while the master  
5607 bit of the *TimeStatus* attribute is 1, SHOULD return a response of status READ\_ONLY.<sup>64</sup>

5608 The non-value indicates an invalid time.

5609 **3.12.2.2.2 TimeStatus Attribute**

5610 The *TimeStatus* attribute holds a number of bit fields, as detailed in Table 3-70.

<sup>63</sup> CCB 2544 Time & TimeStatus are not always writable

<sup>64</sup> CCB 2893

5611

**Table 3-70. Bit Values of the *TimeStatus* Attribute**

Attribute Bit Number	Meaning	Values
0	Master	1 – master clock 0 – not master clock
1	Synchronized	1 – synchronized 0 – not synchronized
2	MasterZoneDst	1 – master for Time Zone and DST 0 – not master for Time Zone and DST
3	Superseding	1 – time synchronization SHOULD be superseded 0 – time synchronization SHOULD not be superseded

5612

5613 The Master and Synchronized bits together provide information on how closely the *Time* attribute conforms  
5614 to the time standard.

5615 The Master bit specifies whether the real time clock corresponding to the *Time* attribute is internally set to  
5616 the time standard. This bit is not writeable – if a value is written to the *TimeStatus* attribute, this bit does not  
5617 change.

5618 The Synchronized bit specifies whether *Time* has been set over the network to synchronize it (as close as  
5619 MAY be practical) to the time standard (see 3.12.1). This bit must be explicitly written to indicate this – i.e.,  
5620 it is not set automatically on writing to the *Time* attribute. If the Master bit is 1, the value of this bit is 0.

5621 If both the Master and Synchronized bits are 0, the real time clock has no defined relationship to the time  
5622 standard (e.g., it MAY record the number of seconds since the device was initialized).

5623 The MasterZoneDst bit specifies whether the *TimeZone*, *DstStart*, *DstEnd* and *DstShift* attributes are set in-  
5624 ternally to correct values for the location of the clock. If not, these attributes need to be set over the network.  
5625 This bit is not writeable – if a value is written to the *TimeStatus* attribute, this bit does not change.

5626 Devices SHALL synchronize to a Time server with the highest rank according to the following rules, listed  
5627 in order of precedence:

- 5628 • A server with the Superseding bit set SHALL be chosen over a server without the bit set.
- 5629 • A server with the Master bit SHALL be chosen over a server without the bit set.
- 5630 • The server with the lower short address SHALL be chosen (note that this means a coordinator with the  
5631 Superseding and Master bit set will always be chosen as the network time server).
- 5632 • A Time server with neither the Master nor Synchronized bits set SHOULD not be chosen as the net-  
5633 work time server.

### 5634 3.12.2.2.3 *TimeZone* Attribute

5635 The *TimeZone* attribute indicates the local time zone, as a signed offset in seconds from the *Time* attribute  
5636 value. The non-value indicates an invalid time zone.

5637 The local Standard Time, i.e., the time adjusted for the time zone, but not adjusted for Daylight Saving Time  
5638 (DST) is given by

5639  $\text{Standard Time} = \text{Time} + \text{TimeZone}$

5640 The range of this attribute is +/- one day. Note that the actual range of physical time zones on the globe is  
5641 much smaller than this, so the manufacturer has the option to impose a smaller range.

5642 If the MasterZoneDst bit of the *TimeStatus* attribute has a value of 1, this attribute cannot be written.

#### 5643 **3.12.2.2.4 DstStart Attribute**

5644 The *DstStart* attribute indicates the DST start time in seconds. The non-value indicates an invalid DST start  
5645 time. For semantic purposes *DstStart* and *DstEnd* are actually type UTCTime.

5646 The Local Time, i.e., the time adjusted for both the time zone and DST, is given by

5647  $\text{Local Time} = \text{Standard Time} + \text{DstShift}$  (if  $\text{DstStart} \leq \text{Time} \leq \text{DstEnd}$ )

5648  $\text{Local Time} = \text{Standard Time}$  (if  $\text{Time} < \text{DstStart}$  or  $\text{Time} > \text{DstEnd}$ )

5649 Note that the three attributes DstStart, DstEnd and DstShift are optional, but if any one of them is imple-  
5650 mented the other two must also be implemented.

5651 Note that this attribute SHOULD be set to a new value once every year.

5652 If the MasterZoneDst bit of the *TimeStatus* attribute has a value of 1, this attribute cannot be written.

#### 5653 **3.12.2.2.5 DstEnd Attribute**

5654 The *DstEnd* attribute indicates the DST end time in seconds. The non-value indicates an invalid DST end  
5655 time. For semantic purposes *DstStart* and *DstEnd* are actually type UTCTime.

5656 Note that this attribute SHOULD be set to a new value once every year, and SHOULD be written synchro-  
5657 nously with the *DstStart* attribute.

5658 If the MasterZoneDst bit of the *TimeStatus* attribute has a value of 1, this attribute cannot be written.

#### 5659 **3.12.2.2.6 DstShift Attribute**

5660 The *DstShift* attribute represents a signed offset in seconds from the standard time, to be applied between the  
5661 times *DstStart* and *DstEnd* to calculate the Local Time (see 3.12.2.2.4). The non-value indicates an invalid  
5662 DST shift.

5663 The range of this attribute is +/- one day. Note that the actual range of DST values employed by countries is  
5664 much smaller than this, so the manufacturer has the option to impose a smaller range.

5665 If the MasterZoneDst bit of the *TimeStatus* attribute has a value of 1, this attribute cannot be written.

#### 5666 **3.12.2.2.7 StandardTime Attribute**

5667 The local Standard Time is given by the equation in 3.12.2.2.3. Another device on the network MAY calcu-  
5668 late this time by reading the *Time* and *TimeZone* attributes and adding them together. If implemented how-  
5669 ever, the optional StandardTime attribute indicates this time directly. The non-value indicates an invalid  
5670 Standard Time.

#### 5671 **3.12.2.2.8 LocalTime Attribute**

5672 The Local Time is given by the equation in 3.12.2.2.4. Another device on the network MAY calculate this  
5673 time by reading the *Time*, *TimeZone*, *DstStart*, *DstEnd* and *DstShift* attributes and performing the calculation.  
5674 If implemented however, the optional LocalTime attribute indicates this time directly. The non-value indi-  
5675 cates an invalid Local Time.

#### 5676 **3.12.2.2.9 LastSetTime Attribute**

5677 The LastSetTime attribute indicates the most recent time that the *Time* attribute was set, either internally or  
5678 over the network (thus it holds a copy of the last value that *Time* was set to). This attribute is set automatically,  
5679 so is Read Only. The non-value indicates an invalid LastSetTime.

#### 5680 **3.12.2.2.10 ValidUntilTime Attribute**

5681 The ValidUntilTime attribute indicates a time, later than LastSetTime, up to which the Time attribute MAY  
5682 be trusted. ‘Trusted’ means that the difference between the Time attribute and the true UTC time is less than  
5683 an acceptable error. The acceptable error is not defined by this cluster specification, but MAY be defined by  
5684 the application profile in which devices that use this cluster are specified.

5685 **Note:** The value that the ValidUntilTime attribute SHOULD be set to depends both on the acceptable error  
5686 and the drift characteristics of the real time clock in the device that implements this cluster, which must  
5687 therefore be known by the application entity that sets this value.

5688 The non-value indicates an invalid ValidUntilTime.

### 5689 **3.12.2.3 Commands Received**

5690 The server receives no commands except those to read and write attributes.

### 5691 **3.12.2.4 Commands Generated**

5692 The server generates no cluster specific commands.

## 5693 **3.12.3 Client**

5694 The client has no cluster specific attributes. No cluster specific commands are generated or received by the  
5695 client.

## 5696 **3.13 RSSI Location**

---

### 5697 **3.13.1 Overview**

5698 Please see Chapter 2 for a general cluster overview defining cluster architecture, revision, classification,  
5699 identification, etc.

5700 This cluster provides a means for exchanging Received Signal Strength Indication (RSSI) information among  
5701 one hop devices as well as messages to report RSSI data to a centralized device that collects all the RSSI data  
5702 in the network. An example of the usage of RSSI location cluster is shown in Figure 3-48.



5703

Figure 3-48. Example of Usage of RSSI Location Cluster

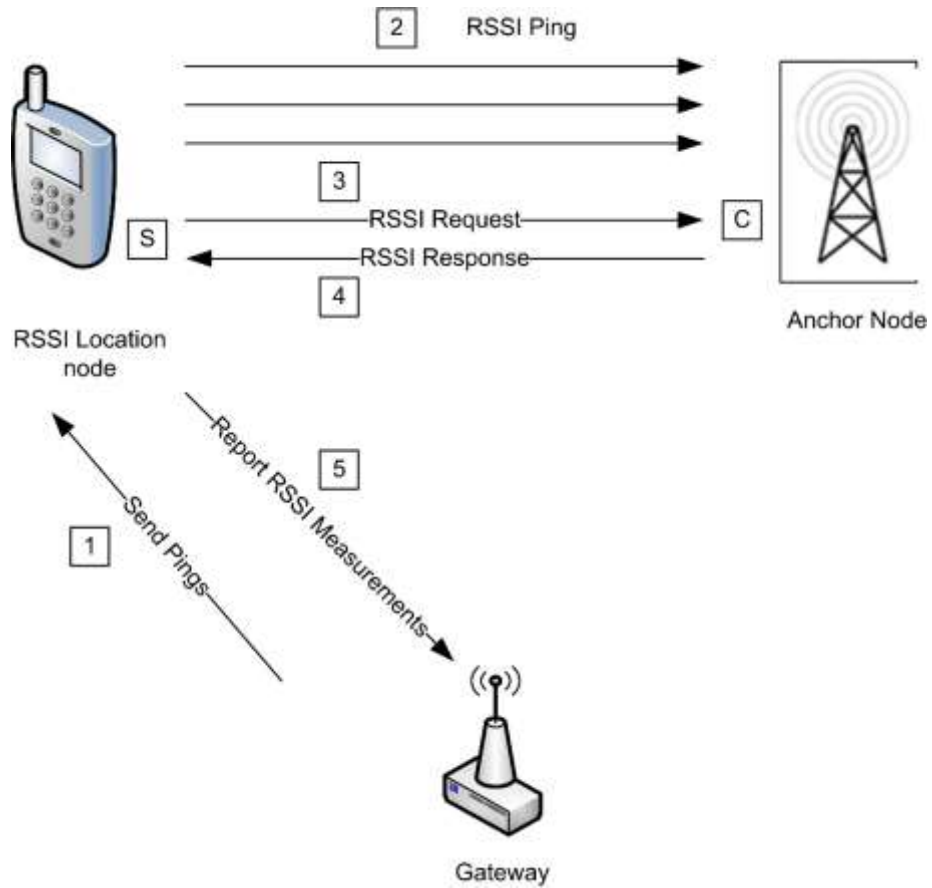

5704

### 5705 3.13.1.1 Revision History

5706 The global *ClusterRevision* attribute value SHALL be the highest revision number in the table below.

Rev	Description
1	global mandatory <i>ClusterRevision</i> attribute added

### 5707 3.13.1.2 Classification

Hierarchy	Role	PICS Code
Base	Utility	RSSI

5708 **3.13.1.3 Cluster Identifiers**

Identifier	Name
0x000b	RSSI

5709 **3.13.2 Server**5710 **3.13.2.1 Dependencies**

5711 None

5712 **3.13.2.2 Attributes**

5713 For convenience, the attributes defined in this specification are arranged into sets of related attributes; each  
 5714 set can contain up to 16 attributes. Attribute identifiers are encoded such that the most significant three nib-  
 5715 bles specify the attribute set and the least significant nibble specifies the attribute within the set. The currently  
 5716 defined attribute sets are listed in Table 3-71.

5717 **Table 3-71. Location Attribute Sets**

Attribute Set Identifier	Description
0x000	Location Information
0x001	Location Settings

5718 **3.13.2.2.1 Location Information Attribute Set**

5719 The Location Information attribute set contains the attributes summarized in Table 3-72.

5720 **Table 3-72. Attributes of the Location Information Attribute Set**

Identifier	Name	Type	Range	Access	Def	M/O
0x0000	<i>LocationType</i>	data8	desc	RW	-	M
0x0001	<i>LocationMethod</i>	enum8	desc	RW	-	M
0x0002	<i>LocationAge</i>	uint16	0x0000 to 0xffff	R	-	O
0x0003	<i>QualityMeasure</i>	uint8	0x00 to 0x64	R	-	O
0x0004	<i>NumberOfDevices</i>	uint8	0x00 to 0xff	R	-	O

5721 **3.13.2.2.1.1 LocationType Attribute**

5722 The *LocationType* attribute is 8 bits long and is divided into bit fields. The meanings of the individual bit  
 5723 fields are detailed in Table 3-73.

5724

**Table 3-73. Bit Values of the *LocationType* Attribute**

Bit Field (Bit Numbers)	Meaning	Values
0	Absolute	1 – Absolute location 0 – Measured location
1	2-D	1 – Two dimensional 0 – Three dimensional
2-3	Coordinate System	0 – Rectangular (installation-specific origin and orientation)

5725 The Absolute bit field indicates whether the location is a known absolute location or is calculated.

5726 The 2-D bit field indicates whether the location information is two- or three-dimensional. If the location  
5727 information is two-dimensional, Coordinate 3 is unknown and SHALL be set to 0x8000.

5728 The Coordinate System bit field indicates the geometry of the system used to express the location coordinates.  
5729 If the field is set to zero, the location coordinates are expressed using the rectangular coordinate system. All  
5730 other values are reserved.

5731 **3.13.2.2.1.2 *LocationMethod* Attribute**

5732 The *LocationMethod* attribute SHALL be set to one of the non-reserved values in Table 3-74.

5733

**Table 3-74. Values of the *LocationMethod* Attribute**

Value	Method	Description
0x00	Lateration	A method based on RSSI measurements from three or more sources.
0x01	Signposting	The location reported is the location of the neighboring device with the strongest received signal.
0x02	RF fingerprinting	RSSI signatures are collected into a database at commissioning time. The location reported is the location taken from the RSSI signature database that most closely matches the device's own RSSI signature.
0x03	Out of band	The location is obtained by accessing an out-of-band device (that is, the device providing the location is not part of the network).
0x04	Centralized	The location is performed in a centralized way (e.g., by the GW) by a device on the network. Different from the above because the device performing the localization is part of the network.
0x40 to 0xff	-	Reserved for manufacturer specific location methods.

5734 **3.13.2.2.1.3 *LocationAge* Attribute**

5735 The *LocationAge* attribute indicates the amount of time, measured in seconds, that has transpired since the  
5736 location information was last calculated. This attribute is not valid if the Absolute bit of the *LocationType*  
5737 attribute is set to one.

5738 **3.13.2.2.1.4 *QualityMeasure* Attribute**

5739 The *QualityMeasure* attribute is a measure of confidence in the corresponding location information. The  
5740 higher the value, the more confident the transmitting device is in the location information. A value of 0x64  
5741 indicates complete (100%) confidence and a value of 0x00 indicates zero confidence. (Note: no fixed confi-  
5742 dence metric is mandated – the metric MAY be application and manufacturer dependent.)

5743 This field is not valid if the Absolute bit of the *LocationType* attribute is set to one.

#### 5744 **3.13.2.2.1.5      *NumberOfDevices* Attribute**

5745 The *NumberOfDevices* attribute is the number of devices whose location data were used to calculate the last  
5746 location value. This attribute is related to the *QualityMeasure* attribute.

### 5747 **3.13.2.2.2      Location Settings Attribute Set**

5748 The Location Settings attribute set contains the attributes summarized in Table 3-75.

5749 **Table 3-75. Attributes of the Location Settings Attribute Set**

Identifier	Name	Type	Range	Acc	Def	M
0x0010	<i>Coordinate1</i>	int16	0x8000 to 0x7fff	RW	non	M
0x0011	<i>Coordinate2</i>	int16	0x8000 to 0x7fff	RW	non	M
0x0012	<i>Coordinate3</i>	int16	0x8000 to 0x7fff	RW	non	O
0x0013	<i>Power</i>	int16	0x8000 to 0x7fff	RW	non	M
0x0014	<i>PathLossExponent</i>	uint16	0x0000 to 0xffff	RW	non	M
0x0015	<i>ReportingPeriod</i>	uint16	0x0000 to 0xffff	RW	MS	O
0x0016	<i>CalculationPeriod</i>	uint16	0x0000 to 0xffff	RW	MS	O
0x0017	<i>NumberRSSIMeasurements</i>	uint8	0x01 to 0xff	RW	MS	M

#### 5750 **3.13.2.2.2.1      *Coordinate 1,2,3* Attributes**

5751 The *Coordinate1*, *Coordinate2* and *Coordinate3* attributes are signed 16-bit integers, and represent orthog-  
5752 onal linear coordinates x, y, z in meters as follows.

$$5753 \quad x = \text{Coordinate1} / 10, \quad y = \text{Coordinate2} / 10, \quad z = \text{Coordinate3} / 10$$

5754 The range of x is -3276.7 to 3276.7 meters, corresponding to *Coordinate1* between 0x8001 and 0x7fff. The  
5755 same range applies to y and z. A non-value for any of the coordinates indicates that the coordinate is un-  
5756 known.

#### 5757 **3.13.2.2.2.2      *Power* Attribute**

5758 The *Power* attribute specifies the value of the average power  $P_0$ , measured in dBm, received at a reference  
5759 distance of one meter from the transmitter.

$$5760 \quad P_0 = \text{Power} / 100$$

5761 A value of 0x8000 indicates that *Power* is unknown.

#### 5762 **3.13.2.2.2.3      *PathLossExponent* Attribute**

5763 The *PathLossExponent* attribute specifies the value of the Path Loss Exponent n, an exponent that describes  
5764 the rate at which the signal power decays with increasing distance from the transmitter.

5765  $n = PathLossExponent / 100$

5766 A non-value indicates that *PathLossExponent* is unknown.

5767 The signal strength in dBm at a distance d meters from the transmitter is given by

5768  $P = P_0 - 10n \times \log_{10}(d)$

5769 where

5770 P is the power in dBm at the receiving device.

5771 P0 is the average power in dBm received at a reference distance of 1meter from the transmitter.

5772 n is the path loss exponent.

5773 d is the distance in meters between the transmitting device and the receiving device.

5774 **3.13.2.2.2.4 ReportingPeriod Attribute**

5775 The *ReportingPeriod* attribute specifies the time in seconds between successive reports of the device's loca-  
5776 tion by means of the Location Data Notification command. If *ReportingPeriod* is zero, the device does not  
5777 automatically report its location. Note that location information can always be polled at any time.

5778 **3.13.2.2.2.5 CalculationPeriod Attribute**

5779 The *CalculationPeriod* attribute specifies the time in milliseconds between successive calculations of the  
5780 device's location. If *CalculationPeriod* is less than the physically possible minimum period that the calcula-  
5781 tion can be performed, the calculation will be repeated as frequently as possible. In case of centralized loca-  
5782 tion (*LocationMethod* attribute equal to Centralized) the *CalculationPeriod* attribute specifies the period be-  
5783 tween successive RSSI ping commands.

5784 **3.13.2.2.2.6 NumberRSSIMeasurements Attribute**

5785 The *NumberRSSIMeasurements* attribute specifies the number of RSSI measurements to be used to generate  
5786 one location estimate. The measurements are averaged to improve accuracy. *NumberRSSIMeasurements*  
5787 must be greater than or equal to 1. In the case of centralized location (*LocationMethod* attribute equal to  
5788 Centralized) the *NumberRSSIMeasurements* attribute specifies the number of successive RSSI Ping com-  
5789 mands to be sent by the server side of location cluster.

5790 **3.13.2.3 Commands Received**

5791 The received command IDs for the Location cluster are listed in Table 3-76.

5792 **Table 3-76. Received Command IDs for the Location Cluster**

Command Identifier Field Value	Description	M/O
0x00	Set Absolute Location	M
0x01	Set Device Configuration	M
0x02	Get Device Configuration	M
0x03	Get Location Data	M
0x04	RSSI Response	O
0x05	Send Pings	O

Command Identifier Field Value	Description	M/O
0x06	Anchor Node Announce	O

### 5793 3.13.2.3.1 Set Absolute Location Command

5794 This command is used to set a device's absolute (known, not calculated) location and the channel parameters  
5795 corresponding to that location.

#### 5796 3.13.2.3.1.1 Payload Format

5797 The Set Absolute Location command payload SHALL be formatted as illustrated in Figure 3-49.

5798 **Figure 3-49. Format of the Set Absolute Location Command Payload**

Octets	2	2	2	2	2
Data Type	int16	int16	int16	int16	uint16
Field Name	Coordinate 1	Coordinate 2	Coordinate 3	Power	Path Loss Exponent

5799 The fields of the payload correspond directly to the attributes with the same names. For details of their mean-  
5800 ing and ranges see the descriptions of the individual attributes.

5801 The three coordinate fields SHALL contain the absolute location (known, not calculated) of the destination  
5802 device. If any coordinate field(s) is not known, the value(s) SHALL be set to 0x8000.

#### 5803 3.13.2.3.1.2 Effect on Receipt

5804 On receipt of this command, the device SHALL update the attributes corresponding to (i.e., with the same  
5805 names as) the payload fields.

### 5806 3.13.2.3.2 Set Device Configuration Command

5807 This command is used to set a device's location parameters, which will be used for calculating and reporting  
5808 measured location. This command is invalid unless the Absolute bit of the *LocationType* attribute has a value  
5809 of 0.

#### 5810 3.13.2.3.2.1 Payload Format

5811 The Set Device Configuration command payload SHALL be formatted as illustrated in Figure 3-50.

5812 **Figure 3-50. Format of the Set Device Configuration Payload**

Octets	2	2	2	1	2
Data Type	int16	uint16	uint16	uint8	uint16
Field Name	Power	Path Loss Exponent	Calculation Period	Number RSSI Measurements	Reporting Period

5813

5814 The fields of the payload correspond directly to the attributes with the same names. For details of their mean-  
5815 ing and ranges see the descriptions of the individual attributes.

#### 5816 3.13.2.3.2.2 Effect on Receipt

5817 On receipt of this command, the device SHALL update the attributes corresponding to (i.e., with the same  
 5818 names as) the payload fields.

5819 **3.13.2.3.3 Get Device Configuration Command**

5820 This command is used to request the location parameters of a device. The location parameters are used for  
 5821 calculating and reporting measured location.

5822 **3.13.2.3.3.1 Payload Format**

5823 The Get Device Configuration command payload SHALL be formatted as illustrated in Figure 3-51.

5824 **Figure 3-51. Format of the Get Device Configuration Payload**

<b>Octets</b>	8
<b>Data Type</b>	EUI64
<b>Field Name</b>	Target Address

5825

5826 The Target Address field contains the 64-bit IEEE address of the device for which the location parameters  
 5827 are being requested. This field MAY contain the address of the sending device, the address of the receiving  
 5828 device or the address of a third device.

5829 **Note:** one reason a device MAY request its own configuration is that there MAY be a designated device  
 5830 which holds the configurations of other devices for distribution at commissioning time. It is also possible that  
 5831 the device MAY lose its configuration settings for some other reason (loss of power, reset). In the case of a  
 5832 third device, that device MAY sleep a lot and not be easily accessible.

5833 **3.13.2.3.3.2 Effect on Receipt**

5834 On receipt of this command, the device SHALL generate a Device Configuration Response command  
 5835 (3.13.2.4.1).

5836 **3.13.2.3.4 Get Location Data Command**

5837 This command is used to request a device’s location information and channel parameters. It MAY be sent as  
 5838 a unicast, multicast or broadcast frame. When sent as a broadcast frame, care SHOULD be taken to minimize  
 5839 the risk of a broadcast 'storm' - in particular, it is recommended that the broadcast radius is set to 1.

5840 (**Note:** devices MAY or MAY not acquire and store information on other devices' locations such that this  
 5841 information MAY be requested by another device. This is application dependent.)

5842 **3.13.2.3.4.1 Payload Format**

5843 The Get Location Data command payload SHALL be formatted as illustrated in Figure 3-52.

5844

**Figure 3-52. Format of the Get Location Data Payload**

<b>Bits</b>	3	1	1	1	1	1	8	0 / 64
<b>Data Type</b>	map8						uint8	EUI64
<b>Field Name</b>	Re-served	Compact Re-sponse	Broadcast Response	Broadcast Indicator	Recal-culate	Abso-lute Only	Number Responses	Target Ad-dress

5845

5846 The highest 3 bits of the first octet are reserved and SHALL be set to zero.

5847 The Absolute Only field (bit 0 of the first octet) specifies the type of location information being requested. If  
5848 the Absolute Only field is set to one, the device is only requesting absolute location information (a device  
5849 MAY want to gather absolute node locations for use in its own location calculations, and MAY not be inter-  
5850 ested in neighbors with calculated values). Otherwise, if the field is set to zero, the device is requesting all  
5851 location information (absolute and calculated).

5852 The Recalculate field (bit 1 of the first octet) indicates whether the device is requesting that a new location  
5853 calculation be performed. If the field is set to zero, the device is requesting the currently stored location  
5854 information. Otherwise, if the field is set to one, the device is requesting that a new calculation be performed.  
5855 This field is only valid if the Absolute Only field is set to zero.

5856 The Broadcast Indicator field (bit 2 of the first octet) indicates whether the command is being sent as a  
5857 unicast, multicast or broadcast frame. If the field is set to one, the command is sent as a broadcast or multicast,  
5858 else it is sent as a unicast.

5859 The Broadcast Response field (bit 3 of the first octet) indicates whether subsequent responses after the first  
5860 (where the Number Responses field is greater than one) SHALL be unicast or broadcast. Broadcast responses  
5861 can be used as a 'location beacon'.

5862 The Compact Response field (bit 4 of the first octet) indicates whether subsequent responses after the first  
5863 (where the Number Responses field is greater than one) SHALL be sent using the Location Data Notification  
5864 or the Compact Location Data Notification command.

5865 The Number Responses field indicates the number of location responses to be returned. The information to  
5866 be returned is evaluated this number of times, with a period equal to the value of the *ReportingPeriod* attrib-  
5867 ute, and a separate response is sent for each evaluation. This field SHALL have a minimum value of one.  
5868 Values greater than one are typically used for situations where locations are changing.

5869 The Target Address field contains the 64-bit IEEE address of the device for which the location information  
5870 and channel parameters are being requested. If the Broadcast Indicator field is set to zero (i.e., the command  
5871 is sent as a unicast) this field MAY contain the address of the receiving device, the address of the sending  
5872 device or the address of any other device. If the Broadcast Indicator field is set to one (i.e., the command is  
5873 sent as a broadcast or multicast) the target address is implicitly that of the receiving device, so this field  
5874 SHALL be omitted.

#### 5875 **3.13.2.3.4.2 Effect on Receipt**

5876 On receipt of this command, if the Location Type field is set to zero, only a receiving device(s) that knows  
5877 its absolute location SHALL respond by generating a Location Data Response command. If the Location  
5878 Type field is set to one, all devices receiving this command SHALL respond by generating a Location Data  
5879 Response command.



5880 If the command is sent as a unicast, information for the device specified in the Target Address field SHALL  
 5881 be returned, if the receiving device has or can obtain the information for that device. If the information is not  
 5882 available, the Status field of the Location Data Response command SHALL be set to NOT\_FOUND.

5883 If the command is sent as a broadcast or multicast, receiving devices SHALL send back their own information  
 5884 (there is no IEEE target address in this case).

5885 If the Number Responses field is greater than one, the subsequent location readings/calculations SHALL be  
 5886 sent using the Location Data Notification or the Compact Location Data Notification command, depending  
 5887 on the value of the Reduced Response field.

5888 **3.13.2.3.5 RSSI Response Command**

5889 This command is sent by a device in response to an RSSI Request command.

5890 **3.13.2.3.5.1 Payload Format**

5891 The command payload SHALL be formatted as illustrated in Figure 3-53.

5892 **Figure 3-53. Format of the RSSI Response Command Payload**

<b>Octets</b>	8	2	2	2	1	1
<b>Data Type</b>	EUI64	int16	int16	int16	int8	uint8
<b>Field Name</b>	Replying Device	X	Y	Z	RSSI	<i>NumberRSSIMeasurements</i>

5893

5894 The fields of the payload have the following meanings:

5895 Replying Device: The IEEE address of the neighbor that replies to the RSSI request

5896 X, Y, Z: The coordinates of the replying node

5897 RSSI: The RSSI registered by the replying node that refers to the radio link, expressed in dBm, between itself  
 5898 and the neighbor that performed the RSSI request

5899 *NumberRSSIMeasurements*: How many packets were considered to give the RSSI value (=1 meaning no  
 5900 mean is supported)

5901 **3.13.2.3.5.2 Effect on Receipt**

5902 On receipt of this command, the server side of the location cluster will wait for *CalculationPeriod* time and  
 5903 generate a Report RSSI Measurement command.

5904 **3.13.2.3.6 Send Pings Command**

5905 This command is used to alert a node to start sending multiple packets so that all its one-hop neighbors can  
 5906 calculate the mean RSSI value of the radio link.

5907 **3.13.2.3.6.1 Payload Format**

5908 Send Pings command SHALL be formatted as illustrated in Figure 3-54. The address field contains the IEEE  
 5909 address of the node that have to perform the blasting (the destination node of this command) and the other  
 5910 fields of the payload correspond directly to the attributes with the same names. For details of their meaning  
 5911 and ranges see the descriptions of the individual attributes.

5912

**Figure 3-54. Format of the Send Pings Command Payload**

<b>Octets</b>	8	1	2
<b>Data Type</b>	EUI64	uint8	uint16
<b>Field Name</b>	Target Address	<i>NumberRSSIMeasurements</i>	<i>CalculationPeriod</i>

5913

5914 The Target Address field contains the IEEE address of the intended target node. This is included because  
5915 there can be cases when the sender does not definitely know the short address of the intended target (see  
5916 below for effect on receipt). The other fields of the payload correspond directly to the attributes with the  
5917 same names. For details of their meaning and ranges see the descriptions of the individual attributes.

### 5918 3.13.2.3.6.2 Effect on Receipt

5919 On receipt of this command, the device SHALL update the attributes corresponding to (i.e., with the same  
5920 names as) the payload fields and generate a number of RSSI Ping commands equal to *NumberRSSIMeasure-*  
5921 *ments* waiting for *CalculationPeriod* time between successive transmission of pings.

### 5922 3.13.2.3.7 Anchor Node Announce Command

5923 This command is sent by an anchor node when it joins the network, if it is already commissioned with the  
5924 coordinates, to announce itself so that the central device knows the exact position of that device. This message  
5925 SHOULD be either unicast to the central node or broadcast in the case that of unknown destination address.

#### 5926 3.13.2.3.7.1 Payload Format

5927 Into the payload there are both the short and long addresses of the joining node as well as the coordinates of  
5928 the node itself. 0xffff SHOULD be used if coordinates are not known.

5929 The command payload SHALL be formatted as in Figure 3-55.

5930

**Figure 3-55. Format of the Anchor Node Announce Command Payload**

<b>Octets</b>	8	2	2	2
<b>Data Type</b>	EUI64	int16	int16	int16
<b>Field Name</b>	Anchor Node IEEE Ad- dress	X	Y	Z

5931

5932 The Anchor Node Address field contains the IEEE address of the anchor node. The other fields of the payload  
5933 correspond directly to the attributes with the same names. For details of their meaning and ranges see the  
5934 descriptions of the individual attributes. If any coordinate is unknown, it SHOULD be set to 0x8000.

5935 **3.13.2.4 Commands Generated**

5936 **Table 3-77. Generated Command IDs for the RSSI Location Cluster**

Command Identifier Field Value	Description	M/O
0x00	Device configuration response	M
0x01	Location data response	M
0x02	Location data notification	M
0x03	Compact location data notification	M
0x04	RSSI Ping	M
0x05	RSSI Request	O
0x06	Report RSSI Measurements	O
0x07	Request Own Location	O

5937 **3.13.2.4.1 Device Configuration Response Command**

5938 This command is sent by a device in response to a Get Device Configuration command (3.13.2.3.3).

5939 **3.13.2.4.1.1 Payload Format**

5940 The Device Configuration Response command payload SHALL be formatted as illustrated in Figure 3-56.  
5941 All payload fields are relevant to the device for which the location parameters have been requested.

5942 **Figure 3-56. Format of the Device Configuration Response Payload**

<b>Octets</b>	1	0 / 2	0 / 2	0 / 2	0 / 1	0 / 2
<b>Data Type</b>	enum8	int16	uint16	uint16	uint8	uint16
<b>Field Name</b>	Status	Power	Path Loss Exponent	Calculation Period	Number RSSI Measurements	Reporting Period

5943  
5944 The fields of the payload (other than Status) correspond directly to the attributes with the same names. For  
5945 details of their meaning and ranges see the descriptions of the individual attributes.

5946 The Status field indicates whether the response to the request was successful or not. If the field is set to  
5947 SUCCESS, the response was successful. If the field is set to NOT\_FOUND, the receiving device was unable  
5948 to provide the location parameters of the device for which the location parameters were requested. If the field  
5949 is set to NOT\_FOUND, all other payload fields SHALL NOT be sent.

5950 **3.13.2.4.2 Location Data Response Command**

5951 This command is sent by a device in response to a request for location information and channel parameters.

5952 **3.13.2.4.2.1 Payload Format**5953 The Location Data Response command payload SHALL be formatted as illustrated in Figure 3-57. All pay-  
5954 load fields are relevant to the device for which the location parameters have been requested.5955 **Figure 3-57. Format of the Location Data Response Payload**

<b>Oc- tets</b>	1	0 / 1	0 / 2	0 / 2	0 / 2	0 / 2	0 / 2	0 / 1	0 / 1	0 / 2
<b>Data Type</b>	enum8	data8	int16	int16	int16	int16	uint16	enum8	uint8	uint16
<b>Field Name</b>	Status	Loca- tion Type	Coordi- nate 1	Coordi- nate 2	Coordi- nate 3	Power	Path Loss Exponent	Loca- tion Method	Qual- ity Mea- sure	Loca- tion Age

5956

5957 The fields of the payload correspond directly to the attributes with the same names. For details of their mean-  
5958 ing and ranges see the descriptions of the individual attributes.5959 If the Absolute bit of the Location Type field is set to 1, the Location Method, Quality Measure and Location  
5960 Age fields are not applicable and SHALL NOT be sent.

5961 If the 2-D bit of the Location Type field is set to 1, the Coordinate 3 field SHALL NOT be sent.

5962 The Status field indicates whether the response to the request was successful or not. If the field is set to  
5963 SUCCESS, the response was successful. If the field is set to NOT\_FOUND, the receiving device was unable  
5964 to provide the location parameters of the device for which the location parameters were requested. If the field  
5965 is set to NOT\_FOUND, all other payload fields SHALL NOT be sent.5966 **3.13.2.4.3 Location Data Notification Command**5967 This command is sent periodically by a device to announce its location information and channel parameters.  
5968 The period is equal to the value of the *ReportingPeriod* attribute.5969 The location data notification command MAY be sent as a unicast or as a broadcast frame. When sent as a  
5970 broadcast frame, it is recommended that the broadcast radius is set to 1.5971 **3.13.2.4.3.1 Payload Format**

5972 The Location Data Notification command payload SHALL be formatted as illustrated in Figure 3-58.

5973

**Figure 3-58. Format of the Location Data Notification Payload**

<b>Octets</b>	1	2	2	0/2	2	2	0/1	0/1	0/2
<b>Data Type</b>	data8	int16	int16	int16	int16	uint16	enum8	uint8	uint16
<b>Field Name</b>	Location Type	Coordinate 1	Coordinate 2	Coordinate 3	Power	Path Loss Exponent	Location Method	Quality Measure	Location Age

5974

5975 The fields of the payload correspond directly to the attributes with the same names. For details of their meaning and ranges see the descriptions of the individual attributes.  
5976

5977 If the 2-D bit of the Location Type field is set to 1, the Coordinate 3 field SHALL NOT be sent.

5978 If the Absolute bit of the Location Type field is set to 1, the Location Method, Quality Measure and Location Age fields are not applicable and SHALL NOT be sent.  
5979

#### 5980 **3.13.2.4.4 Compact Location Data Notification Command**

5981 This command is identical in format and use to the Location Data Notification command, except that the  
5982 Power, Path Loss Exponent and Location Method fields are not included.

#### 5983 **3.13.2.4.5 RSSI Ping Command**

5984 This command is sent periodically by a device to enable listening devices to measure the received signal  
5985 strength in the absence of other transmissions from that device. The period is given by the *ReportingPeriod*  
5986 attribute.

5987 The RSSI Ping command MAY be sent as a unicast or as a broadcast frame. When sent as a broadcast frame,  
5988 it is recommended that the broadcast radius is set to 1.

#### 5989 **3.13.2.4.5.1 Payload Format**

5990 The RSSI Ping command payload SHALL be formatted as illustrated in Figure 3-59.

5991

**Figure 3-59. Format of the RSSI Ping Command Payload**

<b>Octets</b>	1
<b>Data Type</b>	data8
<b>Field Name</b>	Location Type

5992

5993 The Location Type field holds the value of the *LocationType* attribute.

5994 **3.13.2.4.6 RSSI Request Command**

5995 A device uses this command to ask one, more, or all its one-hop neighbors for the (mean) RSSI value they  
5996 hear from itself.

5997 **3.13.2.4.6.1 Payload Format**

5998 The message is empty and MAY be used in broadcast (typical usage is broadcast with radius equal to one).

5999 **3.13.2.4.6.2 Effect on Receipt**

6000 On receipt of this command, the device SHALL respond by generating an RSSI Response command back to  
6001 the sender of this request.

6002 **3.13.2.4.7 Report RSSI Measurements Command**

6003 This command is sent by a device to report its measurements of the link between itself and one or more  
6004 neighbors. In a centralized location scenario, the device that sends this command is the device that needs to  
6005 be localized.

6006 **3.13.2.4.7.1 Payload Format**

6007 The Report RSSI measurement command SHALL be formatted as in Figure 3-60.

6008 **Figure 3-60. Format of the Report RSSI Measurements Command Payload**

Octets	8	1	N
Data Type	EUI64	uint8	Variable [E1]
Field Name	Measuring De- vice	N Neighbors	NeighborsInfo

6009

6010 NeighborsInfo structure is reported in Figure 3-61.

6011 **Figure 3-61. Neighbor Info Structure**

Octets	8	2	2	2	1	1
Data Type	EUI64	int16	int16	int16	int8	uint8
Field Name	Neighbor	X	Y	Z	RSSI	NumberRSSI Measurements

6012

6013 The fields in the payload have the following meanings:

6014 N Neighbors: Numbers of one-hop neighbours that reported the RSSI; indicates how many *NeighborsInfo*  
6015 fields are present in the message.

6016 Measuring Device: IEEE address of the device that report the measurements (i.e., the one that started the  
6017 blast procedure)

6018 Neighbors information:

- 6019 X,Y,Z: Coordinates (if present) of the neighbor
- 6020 Neighbor: IEEE address of the neighbor used to identify it if coordinates are either not present or not
- 6021 valid
- 6022 RSSI: RSSI value registered by the neighbor that refer to the radio link between itself and measuring
- 6023 device
- 6024 NumberRSSIMeasurements: How many packets were considered to give the RSSI value (=1 meaning
- 6025 is that no mean is supported)

6026 **3.13.2.4.8 Request Own Location Command**

6027 This command is sent by a node wishing to know its own location and it is sent to the device that performs  
6028 the centralized localization algorithm.

6029 **3.13.2.4.8.1 Payload Format**

6030 The Request Own Location command payload SHALL be formatted as illustrated in Figure 3-62. The only  
6031 field in the payload contains the IEEE address of the blind node, i.e., the node that wishes to know about its  
6032 own location.

6033 **Figure 3-62. Format of the Request Own Location Command Payload**

<b>Octets</b>	8
<b>Data Type</b>	EUI64
<b>Field Name</b>	IEEE Address of the Blind Node

6034

6035 **3.13.2.4.8.2 Effect On Receipt**

6036 The node receiving the Request Own Location command will then reply with a Set Absolute Location com-  
6037 mand, telling the requesting entity its location.

6038 **3.13.3 Client**

6039 The client has no cluster specific attributes. The client generates the cluster-specific commands received by  
6040 the server (see 3.13.2.3), as required by the application. The client receives the cluster-specific commands  
6041 generated by the server (see 3.13.2.4).

6042 **3.14 Input, Output and Value Clusters**

---

6043 **3.14.1 Overview**

6044 Please see Chapter 2 for a general cluster overview defining cluster architecture, revision, classification,  
6045 identification, etc.

6046 This section specifies a number of clusters which are based on ‘Basic’ properties of the Input, Output and  
6047 Value objects specified by BACnet (see [A1]).

6048 The clusters specified herein are for use typically in Commercial Building applications, but MAY be used in  
6049 any application domain.

6050 **3.14.2 Analog Input (Basic)**

6051 The Analog Input (Basic) cluster provides an interface for reading the value of an analog measurement and  
6052 accessing various characteristics of that measurement. The cluster is typically used to implement a sensor  
6053 that measures an analog physical quantity.

6054 **3.14.2.1 Revision History**

6055 The global *ClusterRevision* attribute value SHALL be the highest revision number in the table below.

Rev	Description
1	mandatory global <i>ClusterRevision</i> attribute added

6056 **3.14.2.2 Classification**

Hierarchy	Role	PICS Code	Primary Transaction
Base	Application	AI	Type 2 (server to client)

6057 **3.14.2.3 Cluster Identifiers**

Identifier	Name
0x000c	Analog Input

6058 **3.14.2.4 Server**6059 **3.14.2.4.1 Dependencies**

6060 None

6061 **3.14.2.4.2 Attributes**

6062 The attributes of this cluster are detailed in Table 3-78.

6063 **Table 3-78. Attributes of the Analog Input (Basic) Server Cluster**

ID	Name	Type	Range	Access	Default	M/O
0x001C	<i>Description</i>	string	-	R*W	Null string	O
0x0041	<i>MaxPresentValue</i>	single	-	R*W	-	O
0x0045	<i>MinPresentValue</i>	single	-	R*W	-	O
0x0051	<i>OutOfService</i>	bool	False (0) or True (1)	R*W	False (0)	M
0x0055	<i>PresentValue</i>	single	-	RWP	-	M
0x0067	<i>Reliability</i>	enum8	-	R*W	0x00	O



ID	Name	Type	Range	Access	Default	M/O
0x006A	<i>Resolution</i>	single	-	R*W	-	O
0x006F	<i>StatusFlags</i>	map8	0x00 to 0x0f	RP	0	M
0x0075	<i>EngineeringUnits</i>	enum1 6	See section 3.14.11.10	R*W	-	O
0x0100	<i>ApplicationType</i>	uint32	0 to 0xffffffff	R	-	O

6064

6065 For an explanation of the attributes, see section 3.14.11.

6066 **3.14.2.4.2.1 Commands**

6067 No cluster specific commands are received or generated.

6068 **3.14.2.4.2.2 Attribute Reporting**

6069 This cluster SHALL support attribute reporting using the Report Attributes and Configure Reporting commands, according to the minimum and maximum reporting interval, value and timeout settings.

6071 The following attributes SHALL be reported: *StatusFlags*, *PresentValue*

6072 **3.14.2.4.3 Client**

6073 The client has no dependencies and no cluster specific attributes. The client does not receive or generate any cluster specific commands.

6075 **3.14.3 Analog Output (Basic)**

6076 The Analog Output (Basic) cluster provides an interface for setting the value of an analog output (typically to the environment) and accessing various characteristics of that value.

6078 **3.14.3.1 Revision History**

6079 The global *ClusterRevision* attribute value SHALL be the highest revision number in the table below.

Rev	Description
1	mandatory global <i>ClusterRevision</i> attribute added

6080 **3.14.3.2 Classification**

Hierarchy	Role	PICS Code	Primary Transaction
Base	Application	AO	Type 2 (server to client)

6081 **3.14.3.3 Cluster Identifiers**

Identifier	Name
0x000d	Analog Output

6082 **3.14.3.4 Server**6083 **3.14.3.4.1 Dependencies**

6084 None

6085 **3.14.3.4.2 Attributes**

6086 The attributes of this cluster are detailed in Table 3-79.

6087 **Table 3-79. Attributes of the Analog Output (Basic) Server Cluster**

Identifier	Name	Type	Range	Access	Default	M/O
0x001C	<i>Description</i>	string	-	R*W	Null string	O
0x0041	<i>MaxPresentValue</i>	single	-	R*W	-	O
0x0045	<i>MinPresentValue</i>	single	-	R*W	-	O
0x0051	<i>OutOfService</i>	bool	False (0) or True (1)	R*W	False (0)	M
0x0055	<i>PresentValue</i>	single	-	RWP	-	M
0x0057	<i>PriorityArray</i>	Array of 16 structures of (bool, single)	-	RW	16 x (0, 0.0)	O
0x0067	<i>Reliability</i>	enum8	-	R*W	0x00	O
0x0068	<i>RelinquishDefault</i>	single	-	R*W	-	O
0x006A	<i>Resolution</i>	single	-	R*W	-	O
0x006F	<i>StatusFlags</i>	map8	0x00 to 0x0f	RP	0	M
0x0075	<i>EngineeringUnits</i>	enum16	See section 3.14.11.10	R*W	-	O
0x0100	<i>ApplicationType</i>	uint32	0 to 0xffffffff	R	-	O

6088

6089 For an explanation of the attributes, see section 0.

6090 **3.14.3.4.3 Commands**

6091 No cluster specific commands are received or generated.

6092 **3.14.3.4.4 Attribute Reporting**

6093 This cluster SHALL support attribute reporting using the Report Attributes and Configure Reporting com-  
6094 mands, according to the minimum and maximum reporting interval, value and timeout settings.

6095 The following attributes SHALL be reported: *StatusFlags*, *PresentValue*

6096 **3.14.3.5 Client**

6097 The client has no dependencies and no cluster specific attributes. The client does not receive or generate any  
6098 cluster specific commands.

6099 **3.14.4 Analog Value (Basic)**

6100 The Analog Value (Basic) cluster provides an interface for setting an analog value, typically used as a control  
6101 system parameter, and accessing various characteristics of that value.

6102 **3.14.4.1 Revision History**

6103 The global *ClusterRevision* attribute value SHALL be the highest revision number in the table below.

Rev	Description
1	mandatory global <i>ClusterRevision</i> attribute added

6104 **3.14.4.2 Classification**

Hierarchy	Role	PICS Code	Primary Transaction
Base	Application	AV	Type 2 (server to client)

6105 **3.14.4.3 Cluster Identifiers**

Identifier	Name
0x000e	Analog Value

6106 **3.14.4.4 Server**

6107 **3.14.4.4.1 Dependencies**

6108 None

6109 **3.14.4.4.2 Attributes**

6110 The attributes of this cluster are detailed in Table 3-80.

6111

**Table 3-80. Attributes of the Analog Value (Basic) Server Cluster**

Identifier	Name	Type	Range	Access	Default	M/O
0x001C	<i>Description</i>	string	-	R*W	Null string	O
0x0051	<i>OutOfService</i>	bool	False (0) or True (1)	R*W	False (0)	M
0x0055	<i>PresentValue</i>	single	-	R/W	-	M
0x0057	<i>PriorityArray</i>	Array of 16 structures of (bool, single)	-	R/W	16 x (0, 0.0)	O
0x0067	<i>Reliability</i>	enum8	-	R*W	0x00	O
0x0068	<i>RelinquishDefault</i>	single	-	R*W	-	O
0x006F	<i>StatusFlags</i>	map8	0x00 to 0x0f	R	0	M
0x0075	<i>EngineeringUnits</i>	enum16	See section 3.14.11.10	R*W	-	O
0x0100	<i>ApplicationType</i>	uint32	0 to 0xffffffff	R	-	O

6112

6113 For an explanation of the attributes, see section 3.14.11.

6114 **3.14.4.4.3 Commands**

6115 No cluster specific commands are received or generated.

6116 **3.14.4.4.4 Attribute Reporting**

6117 This cluster SHALL support attribute reporting using the Report Attributes and Configure Reporting commands, according to the minimum and maximum reporting interval, value and timeout settings.

6118  
6119 The following attributes SHALL be reported: *StatusFlags*, *PresentValue*6120 **3.14.4.5 Client**

6121 The client has no dependencies and no cluster specific attributes. The client does not receive or generate any cluster specific commands.

6123 **3.14.5 Binary Input (Basic)**

6124 The Binary Input (Basic) cluster provides an interface for reading the value of a binary measurement and accessing various characteristics of that measurement. The cluster is typically used to implement a sensor that measures a two-state physical quantity.

6125  
6126

6127 **3.14.5.1 Revision History**

6128 The global *ClusterRevision* attribute value SHALL be the highest revision number in the table below.

Rev	Description
1	mandatory global <i>ClusterRevision</i> attribute added

6129 **3.14.5.2 Classification**

Hierarchy	Role	PICS Code	Primary Transaction
Base	Application	BI	Type 2 (server to client)

6130 **3.14.5.3 Cluster Identifiers**

Identifier	Name
0x000f	Binary Input

6131 **3.14.5.4 Server**

6132 **3.14.5.4.1 Dependencies**

6133 None

6134 **3.14.5.4.2 Attributes**

6135 The attributes of this cluster are detailed in Table 3-81.

6136 **Table 3-81. Attributes of the Binary Input (Basic) Server Cluster**

Identifier	Name	Type	Range	Access	Default	M/O
0x0004	<i>ActiveText</i>	string	-	R*W	Null string	O
0x001C	<i>Description</i>	string	-	R*W	Null string	O
0x002E	<i>InactiveText</i>	string	-	R*W	Null string	O
0x0051	<i>OutOfService</i>	bool	False (0) or True (1)	R*W	False (0)	M
0x0054	<i>Polarity</i>	enum8	-	R	0	O
0x0055	<i>PresentValue</i>	bool	-	R*W	-	M
0x0067	<i>Reliability</i>	enum8	-	R*W	0x00	O
0x006F	<i>StatusFlags</i>	map8	0x00 to 0x0f	R	0	M

Identifier	Name	Type	Range	Access	Default	M/O
0x0100	<i>Application-Type</i>	uint32	0 to 0xffffffff	R	-	O

6137

6138 For an explanation of the attributes, see section 3.14.11.

### 6139 **3.14.5.4.3 Commands**

6140 No cluster specific commands are received or generated.

### 6141 **3.14.5.4.4 Attribute Reporting**

6142 This cluster SHALL support attribute reporting using the Report Attributes and Configure Reporting commands, according to the minimum and maximum reporting interval, value and timeout settings.

6144 The following attributes SHALL be reported: *StatusFlags*, *PresentValue*

### 6145 **3.14.5.5 Client**

6146 The client has no dependencies and no cluster specific attributes. The client does not receive or generate any cluster specific commands.

## 6148 **3.14.6 Binary Output (Basic)**

6149 The Binary Output (Basic) cluster provides an interface for setting the value of a binary output, and accessing various characteristics of that value.

### 6151 **3.14.6.1 Revision History**

6152 The global *ClusterRevision* attribute value SHALL be the highest revision number in the table below.

Rev	Description
1	mandatory global <i>ClusterRevision</i> attribute added

### 6153 **3.14.6.2 Classification**

Hierarchy	Role	PICS Code	Primary Transaction
Base	Application	BO	Type 2 (server to client)

### 6154 **3.14.6.3 Cluster Identifiers**

Identifier	Name
0x0010	Binary Output

6155 **3.14.6.4 Server**

6156 **3.14.6.4.1 Dependencies**

6157 None

6158 **3.14.6.4.2 Attributes**

6159 The attributes of this cluster are detailed in Table 3-82.

6160 **Table 3-82. Attributes of the Binary Output (Basic) Server Cluster**

ID	Name	Type	Range	Access	Default	MO
0x0004	<i>ActiveText</i>	string	-	R*W	Null string	O
0x001C	<i>Description</i>	string	-	R*W	Null string	O
0x002E	<i>InactiveText</i>	string	-	R*W	Null string	O
0x0042	<i>MinimumOffTime</i>	uint32	-	R*W	0xffffffff	O
0x0043	<i>MinimumOnTime</i>	uint32	-	R*W	0xffffffff	O
0x0051	<i>OutOfService</i>	bool	False (0) or True (1)	R*W	False (0)	M
0x0054	<i>Polarity</i>	enum8	-	R	0	O
0x0055	<i>PresentValue</i>	bool	-	R*W	-	M
0x0057	<i>PriorityArray</i>	Array of 16 structures of (bool, bool)	-	R/W	16 x (0, 0)	O
0x0067	<i>Reliability</i>	enum8	-	R*W	0x00	O
0x0068	<i>RelinquishDefault</i>	bool	-	R*W	-	O
0x006F	<i>StatusFlags</i>	map8	0x00 to 0x0f	R	0	M
0x0100	<i>ApplicationType</i>	uint32	0 to 0xffffffff	R	-	O

6161 For an explanation of the attributes, see section 3.14.11.

6162 **3.14.6.4.3 Commands**

6163 No cluster specific commands are received or generated.

6164 **3.14.6.4.4 Attribute Reporting**

6165 This cluster SHALL support attribute reporting using the Report Attributes and Configure Reporting commands, according to the minimum and maximum reporting interval, value and timeout settings.

6167 The following attributes SHALL be reported: *StatusFlags*, *PresentValue*

6168 **3.14.6.5 Client**

6169 The client has no dependencies, no attributes, and receives or generates no cluster specific commands.

6170 **3.14.7 Binary Value (Basic)**6171 The Binary Value (Basic) cluster provides an interface for setting a binary value, typically used as a control  
6172 system parameter, and accessing various characteristics of that value.6173 **3.14.7.1 Revision History**6174 The global *ClusterRevision* attribute value SHALL be the highest revision number in the table below.

Rev	Description
1	mandatory global <i>ClusterRevision</i> attribute added

6175 **3.14.7.2 Classification**

Hierarchy	Role	PICS Code	Primary Transaction
Base	Application	BV	Type 2 (server to client)

6176 **3.14.7.3 Cluster Identifiers**

Identifier	Name
0x0011	Binary Value

6177 **3.14.7.4 Server**6178 **3.14.7.4.1 Dependencies**

6179 None

6180 **3.14.7.4.2 Attributes**

6181 The attributes of this cluster are detailed in Table 3-83.

6182 **Table 3-83. Attributes of the Binary Value (Basic) Server Cluster**

ID	Name	Type	Range	Access	Default	M/O
0x0004	<i>ActiveText</i>	string	-	R*W	Null string	O
0x001C	<i>Description</i>	string	-	R*W	Null string	O
0x002E	<i>InactiveText</i>	string	-	R*W	Null string	O
0x0042	<i>MinimumOffTime</i>	uint32	-	R*W	0xffffffff	O
0x0043	<i>MinimumOnTime</i>	uint32	-	R*W	0xffffffff	O



ID	Name	Type	Range	Access	Default	M/O
0x0051	<i>OutOfService</i>	bool	False (0) or True (1)	R*W	False (0)	M
0x0055	<i>PresentValue</i>	bool	-	R*W	-	M
0x0057	<i>PriorityArray</i>	Array of 16 structures of (bool, bool)	-	R/W	16 x (0, 0)	O
0x0067	<i>Reliability</i>	enum8	-	R*W	0x00	O
0x0068	<i>RelinquishDefault</i>	bool	-	R*W	-	O
0x006F	<i>StatusFlags</i>	map8	0x00 to 0x0f	R	0	M
0x0100	<i>ApplicationType</i>	uint32	0 to 0xffffffff	R	-	O

6183 For an explanation of the attributes, see section 3.14.11.

### 6184 **3.14.7.4.3 Commands**

6185 No cluster specific commands are received or generated.

### 6186 **3.14.7.4.4 Attribute Reporting**

6187 This cluster SHALL support attribute reporting using the Report Attributes and Configure Reporting commands, according to the minimum and maximum reporting interval, value and timeout settings.

6189 The following attributes SHALL be reported: *StatusFlags*, *PresentValue*

### 6190 **3.14.7.5 Client**

6191 The client has no dependencies and no cluster specific attributes. The client does not receive or generate any cluster specific commands.

## 6193 **3.14.8 Multistate Input (Basic)**

6194 The Multistate Input (Basic) cluster provides an interface for reading the value of a multistate measurement and accessing various characteristics of that measurement. The cluster is typically used to implement a sensor that measures a physical quantity that can take on one of a number of discrete states.

6197 **3.14.8.1 Revision History**

6198 The global *ClusterRevision* attribute value SHALL be the highest revision number in the table below.

Rev	Description
1	mandatory global <i>ClusterRevision</i> attribute added

6199 **3.14.8.2 Classification**

Hierarchy	Role	PICS Code	Primary Transaction
Base	Application	MI	Type 2 (server to client)

6200 **3.14.8.3 Cluster Identifiers**

Identifier	Name
0x0012	Multistate Input

6201 **3.14.8.4 Server**

6202 **3.14.8.4.1 Dependencies**

6203 None

6204 **3.14.8.4.2 Attributes**

6205 The attributes of this cluster are detailed in Table 3-84.

6206 **Table 3-84. Attributes of the Multistate Input (Basic) Server Cluster**

Identifier	Name	Type	Range	Acc	Default	MO
0x000E	<i>StateText</i>	Array of character string	-	R*W	Null	O
0x001C	<i>Description</i>	string	-	R*W	Null string	O
0x004A	<i>NumberOfStates</i>	uint16	1 to 0xffff	R*W	0	M
0x0051	<i>OutOfService</i>	bool	False (0) or True (1)	R*W	False (0)	M
0x0055	<i>PresentValue</i>	uint16	-	R*W	-	M
0x0067	<i>Reliability</i>	enum8	-	R*W	0x00	O
0x006F	<i>StatusFlags</i>	map8	0x00 to 0x0f	R	0	M
0x0100	<i>ApplicationType</i>	uint32	0 to 0xffffffff	R	-	O

6207 For an explanation of the attributes, see section 3.14.11.

6208 **3.14.8.4.3 Commands**

6209 No cluster specific commands are received or generated.

6210 **3.14.8.4.4 Attribute Reporting**

6211 This cluster SHALL support attribute reporting using the Report Attributes and Configure Reporting commands, according to the minimum and maximum reporting interval, value and timeout settings.

6213 The following attributes SHALL be reported: *StatusFlags*, *PresentValue*

6214 **3.14.8.5 Client**

6215 The client has no dependencies and no cluster specific attributes. The client does not receive or generate any cluster specific commands.

6217 **3.14.9 Multistate Output (Basic)**

6218 The Multistate Output (Basic) cluster provides an interface for setting the value of an output that can take one of a number of discrete values, and accessing characteristics of that value.

6220 **3.14.9.1 Revision History**

6221 The global *ClusterRevision* attribute value SHALL be the highest revision number in the table below.

Rev	Description
1	mandatory global <i>ClusterRevision</i> attribute added

6222 **3.14.9.2 Classification**

Hierarchy	Role	PICS Code	Primary Transaction
Base	Application	MO	Type 2 (server to client)

6223 **3.14.9.3 Cluster Identifiers**

Identifier	Name
0x0013	Multistate Output

6224 **3.14.9.4 Server**

6225 **3.14.9.4.1 Dependencies**

6226 None

6227 **3.14.9.4.2 Attributes**

6228 The attributes of this cluster are detailed in Table 3-85.

6229

**Table 3-85. Attributes of the Multistate Output (Basic) Server Cluster**

Identifier	Name	Type	Range	Access	Default	M/O
0x000E	<i>StateText</i>	Array of character string	-	R*W	Null	O
0x001C	<i>Description</i>	string	-	R*W	Null string	O
0x004A	<i>NumberOfStates</i>	uint16	1 to 0xffff	R*W	0	M
0x0051	<i>OutOfService</i>	bool	False (0) or True (1)	R*W	False (0)	M
0x0055	<i>PresentValue</i>	uint16	-	R/W	-	M
0x0057	<i>PriorityArray</i>	Array of 16 structures of (bool, uint16)	-	R/W	16 x (0, 0)	O
0x0067	<i>Reliability</i>	enum8	-	R*W	0x00	O
0x0068	<i>RelinquishDefault</i>	uint16	-	R*W	-	O
0x006F	<i>StatusFlags</i>	map8	0x00 to 0x0f	R	0	M
0x0100	<i>ApplicationType</i>	uint32	0 to 0xffffffff	R	-	O

6230 For an explanation of the attributes, see section 3.14.11.

6231 **3.14.9.4.3 Commands**

6232 No cluster specific commands are received or generated.

6233 **3.14.9.4.4 Attribute Reporting**

6234 This cluster SHALL support attribute reporting using the Report Attributes and Configure Reporting commands, according to the minimum and maximum reporting interval, value and timeout settings.

6236 The following attributes SHALL be reported: *StatusFlags*, *PresentValue*6237 **3.14.9.5 Client**6238 The client has no dependencies and no cluster specific attributes. The client does not receive or generate any cluster specific commands.  
62396240 **3.14.10 Multistate Value (Basic)**6241 The Multistate Value (Basic) cluster provides an interface for setting a multistate value, typically used as a control system parameter, and accessing characteristics of that value.  
6242

6243 **3.14.10.1 Revision History**

6244 The global *ClusterRevision* attribute value SHALL be the highest revision number in the table below.

Rev	Description
1	mandatory global <i>ClusterRevision</i> attribute added

6245 **3.14.10.2 Classification**

Hierarchy	Role	PICS Code	Primary Transaction
Base	Application	MV	Type 2 (server to client)

6246 **3.14.10.3 Cluster Identifiers**

Identifier	Name
0x0014	Multistate Value

6247 **3.14.10.4 Server**

6248 **3.14.10.5 Dependencies**

6249 None

6250 **3.14.10.5.1 Attributes**

6251 The attributes of this cluster are detailed in Table 3-86.

6252 **Table 3-86. Attributes of the Multistate Value (Basic) Server Cluster**

Identifier	Name	Type	Range	Access	Default	M/O
0x000E	<i>StateText</i>	Array of character string	-	R*W	Null	O
0x001C	<i>Description</i>	string	-	R*W	Null string	O
0x004A	<i>NumberOfStates</i>	uint16	1 to 0xffff	R*W	0	M
0x0051	<i>OutOfService</i>	bool	False (0) or True (1)	R*W	False (0)	M
0x0055	<i>PresentValue</i>	uint16	-	R/W	-	M
0x0057	<i>PriorityArray</i>	Array of 16 structures of (bool, uint16)	-	R/W	16 x (0, 0)	O
0x0067	<i>Reliability</i>	enum8	-	R*W	0x00	O
0x0068	<i>RelinquishDefault</i>	uint16	-	R*W	-	O

Identifier	Name	Type	Range	Access	Default	M/O
0x006F	<i>StatusFlags</i>	map8	0x00 to 0x0f	R	0	M
0x0100	<i>ApplicationType</i>	uint32	0 to 0xffffffff	R	-	O

6253 For an explanation of the attributes, see section 3.14.11.

### 6254 3.14.10.5.2 Commands

6255 No cluster specific commands are received or generated.

### 6256 3.14.10.5.3 Attribute Reporting

6257 This cluster SHALL support attribute reporting using the Report Attributes and Configure Reporting com-  
6258 mands, according to the minimum and maximum reporting interval, value and timeout settings.

6259 The following attributes SHALL be reported: *StatusFlags*, *PresentValue*

### 6260 3.14.10.6 Client

6261 The client has no dependencies and no cluster specific attributes. The client does not receive or generate any  
6262 cluster specific commands.

## 6263 3.14.11 Attribute Descriptions

6264 Note: These attributes are based on BACnet properties with the same names. For more information, refer to  
6265 the BACnet reference manual [A1].

### 6266 3.14.11.1 OutOfService Attribute

6267 The *OutOfService* attribute, of type Boolean, indicates whether (TRUE) or not (FALSE) the physical input,  
6268 output or value that the cluster represents is not in service. For an Input cluster, when *OutOfService* is TRUE  
6269 the *PresentValue* attribute is decoupled from the physical input and will not track changes to the physical  
6270 input. For an Output cluster, when *OutOfService* is TRUE the *PresentValue* attribute is decoupled from the  
6271 physical output, so changes to *PresentValue* will not affect the physical output. For a Value cluster, when  
6272 *OutOfService* is TRUE the *PresentValue* attribute MAY be written to freely by software local to the device  
6273 that the cluster resides on.

### 6274 3.14.11.2 PresentValue Attribute

6275 The *PresentValue* attribute indicates the current value of the input, output or value, as appropriate for the  
6276 cluster. For Analog clusters it is of type single precision, for Binary clusters it is of type Boolean, and for  
6277 multistate clusters it is of type Unsigned 16-bit integer.

6278 The *PresentValue* attribute of an input cluster SHALL be writable when *OutOfService* is TRUE.

6279 When the *PriorityArray* attribute is implemented, writing to *PresentValue* SHALL be equivalent to writing  
6280 to element 16 of *PriorityArray*, i.e., with a priority of 16.

### 6281 **3.14.11.3 StatusFlags Attribute**

6282 This attribute, of type bitmap, represents four Boolean flags that indicate the general “health” of the analog  
6283 sensor. Three of the flags are associated with the values of other optional attributes of this cluster. A more  
6284 detailed status could be determined by reading the optional attributes (if supported) that are linked to these  
6285 flags. The relationship between individual flags is not defined. The four flags are

6286 Bit 0 = IN ALARM, Bit 1 = FAULT, Bit 2 = OVERRIDDEN, Bit 3 = OUT OF SERVICE

6287 where:

6288 IN ALARM - Logical FALSE (0) if the *EventState* attribute has a value of NORMAL, otherwise logical  
6289 TRUE (1). This bit is always 0 unless the cluster implementing the *EventState* attribute is implemented on  
6290 the same endpoint.

6291 FAULT - Logical TRUE (1) if the *Reliability* attribute is present and does not have a value of NO FAULT  
6292 DETECTED, otherwise logical FALSE (0).

6293 OVERRIDDEN - Logical TRUE (1) if the cluster has been overridden by some mechanism local to the  
6294 device. Otherwise, the value is logical FALSE (0).

6295 In this context, for an input cluster, “overridden” is taken to mean that the *PresentValue* and *Reliability*  
6296 (optional) attributes are no longer tracking changes to the physical input. For an Output cluster, “overridden”  
6297 is taken to mean that the physical output is no longer tracking changes to the *PresentValue* attribute and the  
6298 *Reliability* attribute is no longer a reflection of the physical output. For a Value cluster, “overridden” is taken  
6299 to mean that the *PresentValue* attribute is not writeable.

6300 OUT OF SERVICE - Logical TRUE (1) if the *OutOfService* attribute has a value of TRUE, otherwise logical  
6301 FALSE (0).

### 6302 **3.14.11.4 Description Attribute**

6303 The *Description* attribute, of type Character string, MAY be used to hold a description of the usage of the  
6304 input, output or value, as appropriate to the cluster. The character set used SHALL be ASCII, and the attribute  
6305 SHALL contain a maximum of 16 characters, which SHALL be printable but are otherwise unrestricted.

### 6306 **3.14.11.5 MaxPresentValue Attribute**

6307 The *MaxPresentValue* attribute, of type Single precision, indicates the highest value that can be reliably  
6308 obtained for the *PresentValue* attribute of an Analog Input cluster, or which can reliably be used for the  
6309 *PresentValue* attribute of an Analog Output or Analog Value cluster.

### 6310 **3.14.11.6 PriorityArray Attribute**

6311 The *PriorityArray* attribute is an array of 16 structures. The first element of each structure is a Boolean, and  
6312 the second element is of the same type as the *PresentValue* attribute of the corresponding cluster.

6313 *PriorityArray* holds potential values for the *PresentValue* attribute of the corresponding cluster, in order of  
6314 decreasing priority. The first value in the array corresponds to priority 1 (highest), the second value corre-  
6315 sponds to priority 2, and so on, to the sixteenth value that corresponds to priority 16 (lowest).

6316 The Boolean value in each element of the array indicates whether (TRUE) or not (FALSE) there is a valid  
6317 value at that priority. All entries within the priority table are continuously monitored in order to locate the  
6318 entry with the highest priority valid value, and *PresentValue* is set to this value.

6319 When *PriorityArray* is supported, *PresentValue* MAY be written to indirectly by writing to the *PriorityArray*,  
6320 as described above. If *PresentValue* is written to directly, a default priority of 16 (the lowest priority) SHALL  
6321 be assumed, and the value is entered into the 16th element of *PriorityArray*.

6322 When a value at a given priority is marked as invalid, by writing FALSE to its corresponding Boolean value,  
6323 it is said to be relinquished.

6324 **(Informative note:** In BACnet, each element of *PriorityArray* consists of a single value, which MAY be  
6325 either of the same type as *PresentValue* or MAY be of type NULL to indicate that a value is not present. An  
6326 attribute cannot have a variable data type; thus, an extra Boolean value is associated with each element of the  
6327 array to indicate whether or not it is null).

### 6328 **3.14.11.7 RelinquishDefault Attribute**

6329 The *RelinquishDefault* attribute is the default value to be used for the *PresentValue* attribute when all ele-  
6330 ments of the *PriorityArray* attribute are marked as invalid.

### 6331 **3.14.11.8 MinPresentValue Attribute**

6332 The *MinPresentValue* attribute, of type Single precision, indicates the lowest value that can be reliably ob-  
6333 tained for the *PresentValue* attribute of an Analog Input cluster, or which can reliably be used for the  
6334 *PresentValue* attribute of an Analog Output or Analog Value cluster.

### 6335 **3.14.11.9 Reliability Attribute**

6336 The *Reliability* attribute, of type 8-bit enumeration, provides an indication of whether the *PresentValue* or  
6337 the operation of the physical input, output or value in question (as appropriate for the cluster) is “reliable” as  
6338 far as can be determined and, if not, why not. The *Reliability* attribute MAY have any of the following values:

6339 NO-FAULT-DETECTED (0)

6340 NO-SENSOR (1) - for input clusters only

6341 OVER-RANGE (2)

6342 UNDER-RANGE (3)

6343 OPEN-LOOP (4)

6344 SHORTED-LOOP (5)

6345 NO-OUTPUT (6) - for input clusters only

6346 UNRELIABLE-OTHER (7)

6347 PROCESS-ERROR (8)

6348 MULTI-STATE-FAULT (9) - for multistate clusters only

6349 CONFIGURATION-ERROR (10)

### 6350 **3.14.11.10 EngineeringUnits Attribute**

6351 The *EngineeringUnits* attribute indicates the physical units associated with the value of the *PresentValue*  
6352 attribute of an Analog cluster.

6353 Values 0x0000 to 0x00fe are reserved for the list of engineering units with corresponding values specified in  
6354 Clause 21 of the BACnet standard [A1]. 0x00ff represents 'other'. Values 0x0100 to 0xffff are available for  
6355 proprietary use.

6356 If the *ApplicationType* attribute is implemented, and is set to a value with a defined physical unit, the physical  
6357 unit defined in *ApplicationType* takes priority over *EngineeringUnits*.



6358 This attribute is defined to be Read Only, but a vendor can decide to allow this to be written to if *ApplicationType*  
6359 is also supported. If this attribute is written to, how the device handles invalid units (e.g., changing  
6360 Deg F to Cubic Feet per Minute), any local display or other vendor-specific operation (upon the change) is a  
6361 local matter.

### 6362 **3.14.11.11 Resolution Attribute**

6363 This attribute, of type Single precision, indicates the smallest recognizable change to *PresentValue*.

### 6364 **3.14.11.12 ActiveText Attribute**

6365 This attribute, of type Character string, MAY be used to hold a human readable description of the ACTIVE  
6366 state of a binary *PresentValue*. For example, for a Binary Input cluster, if the physical input is a switch  
6367 contact, then the *ActiveText* attribute might be assigned a value such as “Fan 1 On”. If either the *ActiveText*  
6368 attribute or the *InactiveText* attribute are present, then both of them SHALL be present.

6369 The character set used SHALL be ASCII, and the attribute SHALL contain a maximum of 16 characters,  
6370 which SHALL be printable but are otherwise unrestricted.

### 6371 **3.14.11.13 InactiveText Attribute**

6372 This attribute, of type Character string, MAY be used to hold a human readable description of the INACTIVE  
6373 state of a binary *PresentValue*. For example, for a Binary Input cluster, if the physical input is a switch  
6374 contact, then the *InactiveText* attribute might be assigned a value such as “Fan 1 Off”. If either the *InactiveText*  
6375 attribute or the *ActiveText* attribute are present, then both of them SHALL be present.

6376 The character set used SHALL be ASCII, and the attribute SHALL contain a maximum of 16 characters,  
6377 which SHALL be printable but are otherwise unrestricted.

### 6378 **3.14.11.14 MinimumOffTime Attribute**

6379 This property, of type 32-bit unsigned integer, represents the minimum number of seconds that a binary  
6380 *PresentValue* SHALL remain in the INACTIVE (0) state after a write to *PresentValue* causes it to assume  
6381 the INACTIVE state.

### 6382 **3.14.11.15 MinimumOnTime Attribute**

6383 This property, of type 32-bit unsigned integer, represents the minimum number of seconds that a binary  
6384 *PresentValue* SHALL remain in the ACTIVE (1) state after a write to *PresentValue* causes it to assume the  
6385 ACTIVE state.

### 6386 **3.14.11.16 Polarity Attribute**

6387 This attribute, of type enumeration, indicates the relationship between the physical state of the input (or  
6388 output as appropriate for the cluster) and the logical state represented by a binary *PresentValue* attribute,  
6389 when *OutOfService* is FALSE. If the *Polarity* attribute is NORMAL (0), then the ACTIVE (1) state of the  
6390 *PresentValue* attribute is also the ACTIVE or ON state of the physical input (or output). If the *Polarity*  
6391 attribute is REVERSE (1), then the ACTIVE (1) state of the *PresentValue* attribute is the INACTIVE or OFF  
6392 state of the physical input (or output).

6393 Thus, when *OutOfService* is FALSE, for a constant physical input state a change in the *Polarity* attribute  
6394 SHALL produce a change in the *PresentValue* attribute. If *OutOfService* is TRUE, then the *Polarity* attribute  
6395 SHALL have no effect on the *PresentValue* attribute.

### 6396 3.14.11.17 NumberOfStates Attribute

6397 This attribute, of type Unsigned 16-bit integer, defines the number of states that a multistate *PresentValue*  
6398 MAY have. The *NumberOfStates* property SHALL always have a value greater than zero. If the value of this  
6399 property is changed, the size of the *StateText* array, if present, SHALL also be changed to the same value.  
6400 The states are numbered consecutively, starting with 1.

### 6401 3.14.11.18 StateText Attribute

6402 This attribute, of type Array of Character strings, holds descriptions of all possible states of a multistate  
6403 *PresentValue*. The number of descriptions matches the number of states defined in the *NumberOfStates* prop-  
6404 erty. The *PresentValue*, interpreted as an integer, serves as an index into the array. If the size of this array is  
6405 changed, the *NumberOfStates* property SHALL also be changed to the same value.

6406 The character set used SHALL be ASCII, and the attribute SHALL contain a maximum of 16 characters,  
6407 which SHALL be printable but are otherwise unrestricted.

### 6408 3.14.11.19 ApplicationType Attribute

6409 The *ApplicationType* attribute is an unsigned 32 bit integer that indicates the specific application usage for  
6410 this cluster. (**Note:** This attribute has no BACnet equivalent.)

6411 *ApplicationType* is subdivided into Group, Type and an Index number, as follows.

6412 Group = Bits 24 to 31

6413 An indication of the cluster this attribute is part of.

6414 Type = Bits 16 to 23

6415 For Analog clusters, the physical quantity that the Present Value attribute of the cluster represents.

6416 For Binary and Multistate clusters, the application usage domain.

6417 Index = Bits 0 to 15

6418 The specific application usage of the cluster.

#### 6419 3.14.11.19.1 Analog Input (AI) Types

6420 Group = 0x00.

6421 The following sub-clauses describe the values when Type = 0x00 to 0x0E. Types 0x0F to 0xFE are reserved,  
6422 Type = 0xFF indicates other.

##### 6423 3.14.11.19.1.1 Type = 0x00: Temperature in degrees C

6424 **Table 3-87. AI Types, Type = 0x00: Temperature in Degrees C**

Index	Application Usage
0x0000	2 Pipe Entering Water Temperature AI
0x0001	2 Pipe Leaving Water Temperature AI
0x0002	Boiler Entering Temperature AI
0x0003	Boiler Leaving Temperature AI
0x0004	Chiller Chilled Water Entering Temp AI

<b>Index</b>	<b>Application Usage</b>
0x0005	Chiller Chilled Water Leaving Temp AI
0x0006	Chiller Condenser Water Entering Temp AI
0x0007	Chiller Condenser Water Leaving Temp AI
0x0008	Cold Deck Temperature AI
0x0009	Cooling Coil Discharge Temperature AI
0x000A	Cooling Entering Water Temperature AI
0x000B	Cooling Leaving Water Temperature AI
0x000C	Condenser Water Return Temperature AI
0x000D	Condenser Water Supply Temperature AI
0x000E	Decouple Loop Temperature AI
0x000F	Building Load AI
0x0010	Decouple Loop Temperature AI
0x0011	Dew Point Temperature AI
0x0012	Discharge Air Temperature AI
0x0013	Discharge Temperature AI
0x0014	Exhaust Air Temperature After Heat Recovery AI
0x0015	Exhaust Air Temperature AI
0x0016	Glycol Temperature AI
0x0017	Heat Recovery Air Temperature AI
0x0018	Hot Deck Temperature AI
0x0019	Heat Exchanger Bypass Temp AI
0x001A	Heat Exchanger Entering Temp AI
0x001B	Heat Exchanger Leaving Temp AI
0x001C	Mechanical Room Temperature AI
0x001D	Mixed Air Temperature AI
0x001E	Mixed Air Temperature AI
0x001F	Outdoor Air Dewpoint Temp AI

<b>Index</b>	<b>Application Usage</b>
0x0020	Outdoor Air Temperature AI
0x0021	Preheat Air Temperature AI
0x0022	Preheat Entering Water Temperature AI
0x0023	Preheat Leaving Water Temperature AI
0x0024	Primary Chilled Water Return Temp AI
0x0025	Primary Chilled Water Supply Temp AI
0x0026	Primary Hot Water Return Temp AI
0x0027	Primary Hot Water Supply Temp AI
0x0028	Reheat Coil Discharge Temperature AI
0x0029	Reheat Entering Water Temperature AI
0x002A	Reheat Leaving Water Temperature AI
0x002B	Return Air Temperature AI
0x002C	Secondary Chilled Water Return Temp AI
0x002D	Secondary Chilled Water Supply Temp AI
0x002E	Secondary HW Return Temp AI
0x002F	Secondary HW Supply Temp AI
0x0030	Sideloop Reset Temperature AI
0x0031	Sideloop Temperature Setpoint AI
0x0032	Sideloop Temperature AI
0x0033	Source Temperature
0x0034	Supply Air Temperature AI
0x0035	Supply Low Limit Temperature AI
0x0036	Tower Basin Temp AI
0x0037	Two Pipe Leaving Water Temp AI
0x0038	Reserved
0x0039	Zone Dewpoint Temperature AI
0x003A	Zone Sensor Setpoint AI

Index	Application Usage
0x003B	Zone Sensor Setpoint Offset AI
0x003C	Zone Temperature AI
0x0200 to 0xFFFFE	Vendor defined
0xFFFF	Other

6425 **3.14.11.19.1.2 Type = 0x01: Relative Humidity in %**

6426 **Table 3-88. AI Types, Type = 0x01: Relative Humidity in %**

Index	Application Usage
0x0000	Discharge Humidity AI
0x0001	Exhaust Humidity AI
0x0002	Hot Deck Humidity AI
0x0003	Mixed Air Humidity AI
0x0004	Outdoor Air Humidity AI
0x0005	Return Humidity AI
0x0006	Sideloop Humidity AI
0x0007	Space Humidity AI
0x0008	Zone Humidity AI
0x0200 to 0xFFFFE	Vendor defined
0xFFFF	Other

6427 **3.14.11.19.1.3 Type = 0x02: Pressure in Pascal**

6428 **Table 3-89. AI Types, Type = 0x02: Pressure in Pascal**

Index	Application Usage
0x0000	Boiler Pump Differential Pressure AI
0x0001	Building Static Pressure AI
0x0002	Cold Deck Differential Pressure Sensor AI
0x0003	Chilled Water Building Differential Pressure AI
0x0004	Cold Deck Differential Pressure AI

<b>Index</b>	<b>Application Usage</b>
0x0005	Cold Deck Static Pressure AI
0x0006	Condenser Water Pump Differential Pressure AI
0x0007	Discharge Differential Pressure AI
0x0008	Discharge Static Pressure 1 AI
0x0009	Discharge Static Pressure 2 AI
0x000A	Exhaust Air Differential Pressure AI
0x000B	Exhaust Air Static Pressure AI
0x000C	Exhaust Differential Pressure AI
0x000D	Exhaust Differential Pressure AI
0x000E	Hot Deck Differential Pressure AI
0x000F	Hot Deck Differential Pressure AI
0x0010	Hot Deck Static Pressure AI
0x0011	Hot Water Bldg Diff Pressure AI
0x0012	Heat Exchanger Steam Pressure AI
0x0013	Minimum Outdoor Air Differential Pressure AI
0x0014	Outdoor Air Differential Pressure AI
0x0015	Primary Chilled Water Pump Differential Pressure AI
0x0016	Primary Hot water Pump Differential Pressure AI
0x0017	Relief Differential Pressure AI
0x0018	Return Air Static Pressure AI
0x0019	Return Differential Pressure AI
0x001A	Secondary Chilled Water Pump Differential Pressure AI
0x001B	Secondary Hot water Pump Differential Pressure AI
0x001C	Sideloop Pressure AI
0x001D	Steam Pressure AI
0x001E	Supply Differential Pressure Sensor AI
0x0200 to 0xFFFFE	Vendor defined

Index	Application Usage
0xFFFF	Other

6429 **3.14.11.19.1.4 Type = 0x03: Flow in Liters/Second**

6430

**Table 3-90. AI Types, Type = 0x03: Flow in Liters/Second**

Index	Application Usage
0x0000	Chilled Water Flow AI
0x0001	Chiller Chilled Water Flow AI
0x0002	Chiller Condenser Water Flow AI
0x0003	Cold Deck Flow AI
0x0004	Decouple Loop Flow AI
0x0005	Discharge Flow AI
0x0006	Exhaust Fan Flow AI
0x0007	Exhaust Flow AI
0x0008	Fan Flow AI
0x0009	Hot Deck Flow AI
0x000A	Hot Water Flow AI
0x000B	Minimum Outdoor Air Fan Flow AI
0x000C	Minimum Outdoor Air Flow AI
0x000D	Outdoor Air Flow AI
0x000E	Primary Chilled Water Flow AI
0X000F	Relief Fan Flow AI
0x0010	Relief Flow AI
0x0011	Return Fan Flow AI
0x0012	Return Flow AI
0x0013	Secondary Chilled Water Flow AI
0x0014	Supply Fan Flow AI
0x0015	Tower Fan Flow AI
0x0200 to 0xFFFFE	Vendor defined

Index	Application Usage
0xFFFF	Other

6431 **3.14.11.19.1.5 Type = 0x04: Percentage %**

6432 **Table 3-91. AI Types, Type = 0x04: Percentage %**

Index	Application Usage
0x0000	Chiller % Full Load Amperage AI
0x0200 to 0xFFFFE	Vendor defined
0xFFFF	Other

6433 **3.14.11.19.1.6 Type = 0x05: Parts per Million PPM**

6434 **Table 3-92. AI types, Type = 0x05: Parts per Million PPM**

Index	Application Usage
0x0000	Return Carbon Dioxide AI
0x0001	Zone Carbon Dioxide AI
0x0200 to 0xFFFFE	Vendor defined
0xFFFF	Other

6435 **3.14.11.19.1.7 Type = 0x06: Rotational Speed in RPM**

6436 **Table 3-93. AI Types, Type = 0x06: Rotational Speed in RPM**

Index	Application Usage
0x0000	Exhaust Fan Remote Speed AI
0x0001	Heat Recovery Wheel Remote Speed AI
0x0002	Min Outdoor Air Fan Remote Speed AI
0x0003	Relief Fan Remote Speed AI
0x0004	Return Fan Remote Speed AI
0x0005	Supply Fan Remote Speed AI
0x0006	Variable Speed Drive Motor Speed AI
0x0007	Variable Speed Drive Speed Setpoint AI



Index	Application Usage
0x0200- 0xFFFFE	Vendor defined
0xFFFF	Other

6437 **3.14.11.19.1.8 Type = 0x07: Current in Amps**

6438

Table 3-94. AI Types, Type = 0x07: Current in Amps

Index	Application Usage
0x0000	Chiller Amps AI
0x0200 to 0xFFFFE	Vendor defined
0xFFFF	Other

6439 **3.14.11.19.1.9 Type = 0x08: Frequency in Hz**

6440

Table 3-95. AI Types, Type = 0x08: Frequency in Hz

Index	Application Usage
0x0000	Variable Speed Drive Output Frequency AI
0x0200- 0xFFFFE	Vendor defined
0xFFFF	Other

6441 **3.14.11.19.1.10 Type = 0x09: Power in Watts**

6442

Table 3-96. AI Types, Type = 0x09: Power in Watts

Index	Application Usage
0x0000	Power Consumption AI
0x0200- FFFE	Vendor defined
0xFFFF	Other

6443 **3.14.11.19.1.11 Type = 0x0A: Power in kW**

6444

Table 3-97. AI Types, Type = 0x0A: Power in kW

Index	Application Usage
0x0000	Absolute Power AI

Index	Application Usage
0x0001	Power Consumption AI
0x0200 to 0xFFFE	Vendor defined
0xFFFF	Other

6445 **3.14.11.19.1.12 Type = 0x0B: Energy in kWh**

6446 **Table 3-98. AI Types, Type = 0x0B: Energy in kWh**

Index	Application Usage
0x0000	Variable Speed Drive Kilowatt Hours AI
0x0200- FFFE	Vendor defined
0xFFFF	Other

6447 **3.14.11.19.1.13 Type = 0x0C: Count – Unitless**

6448 **Table 3-99. AI Types, Type = 0x0C: Count - Unitless**

Index	Application Usage
0x0000	Count
0x0200 to 0xFFFE	Vendor defined
0xFFFF	Other

6449 **3.14.11.19.1.14 Type = 0x0D: Enthalpy in KJoules/Kg**

6450 **Table 3-100. AI Types, Type = 0x0D: Enthalpy in KJoules/Kg**

Index	Application Usage
0x0000	Outdoor Air Enthalpy AI
0x0001	Return Air Enthalpy AI
0x0002	Space Enthalpy
0x0200 to 0xFFFE	Vendor defined
0xFFFF	Other

6451 **3.14.11.19.1.15 Type = 0x0E: Time in Seconds**

6452

**Table 3-101. AI types, Type = 0x0E: Time in Seconds**

Index	Application Usage
0x0000	Relative time AI
0x0200 to 0xFFFFE	Vendor defined
0xFFFF	Other

6453 **3.14.11.19.2 Analog Output (AO) types**

6454 Group = 0x01.

6455 The following sub-clauses describe the values when Type = 0x00 to 0x0E. Types 0x0F to 0xFE are reserved,  
6456 Type = 0xFF indicates other.

6457 **3.14.11.19.2.1 Type = 0x00: Temperature in Degrees C**

6458 **Table 3-102. AO Types, Type = 0x00: Temperature in Degrees C**

Index	Application Usage
0x0000	Boiler AO
0x0001	Boiler Setpoint AO
0x0002	Cold Deck AO
0x0003	Chiller Setpoint AO
0x0004	Chiller Setpoint AO
0x0005	Hot Deck AO
0x0006	Cooling Valve AO
0x0007	Zone Temperature Setpoint AO
0x0008	Setpoint Offset AO
0x0009	Setpoint Shift AO
0x0200 to 0xFFFFE	Vendor defined
0xFFFF	Other

6459 **3.14.11.19.2.2 Type = 0x01: Relative Humidity in %**

6460

**Table 3-103. AO Types, Type = 0x01: Relative Humidity in %**

Index	Application Usage
0x0000	Humidification AO
0x0001	Zone Relative Humidity Setpoint AO
0x0200 to 0xFFFFE	Vendor defined
0xFFFF	Other

6461 **3.14.11.19.2.3 Type = 0x02: Pressure Pascal**

6462

**Table 3-104. AO Types, Type = 0x02: Pressure Pascal**

Index	Application Usage
0x0200 to 0xFFFFE	Vendor defined
0xFFFF	Other

6463 **3.14.11.19.2.4 Type = 0x03: Flow in Liters/Second**

6464

**Table 3-105. AO Types, Type = 0x03: Flow in Liters/Second**

Index	Application Usage
0x0200 to 0xFFFFE	Vendor defined
0xFFFF	Other

6465 **3.14.11.19.2.5 Type = 0x04: Percentage %**

6466

**Table 3-106. AO Types, Type = 0x04: Percentage %**

Index	Application Usage
0x0000	Face & Bypass Damper AO
0x0001	Heat Recovery Valve AO
0x0002	Heat Recovery Wheel AO
0x0003	Heating Valve AO
0x0004	Hot Deck Damper AO
0x0005	2 Pipe Damper AO
0x0006	2 Pipe Valve AO

<b>Index</b>	<b>Application Usage</b>
0x0007	Boiler Mixing Valve AO
0x0008	Box Cooling Valve AO
0x0009	Box Heating Valve AO
0x000A	Chilled Water Bypass Valve AO
0x000B	Cold Deck Damper AO
0x000C	Cooling Damper AO
0x000D	Cooling Valve AO
0x000E	Damper AO
0x000F	Exhaust Air Damper AO
0x0010	Exhaust Damper AO
0x0011	Hot Water Bypass Valve AO
0x0012	Hot Water Mixing Valve AO
0x0013	Minimum Outside Air Damper AO
0x0014	Minimum Outside Air Fan AO
0x0015	Mixed Air Damper AO
0x0016	Mixing Valve AO
0x0017	Outside Air Damper AO
0x0018	Primary Chilled Water Pump AO
0x0019	Primary Hot Water Pump AO
0x001A	Primary Heat Exchange Pump AO
0x001B	Preheat Damper AO
0x001C	Preheat Valve AO
0x001D	Reheat Valve 1 AO
0x001E	Reheat Valve AO
0x001F	Return Air Damper AO

Index	Application Usage
0x0020	Secondary Chilled Water Pump AO
0x0021	Sequenced Valves AO
0x0022	Secondary Hot Water Pump AO
0x0023	Secondary Heat Exchange Pump AO
0x0024	Sideloop AO
0x0025	Supply Heating Valve AO
0x0026	Supply Damper AO
0x0027	Tower Bypass Valve AO
0x0028	Tower Fan AO
0x0029	Valve AO
0x002A	Zone 1 Damper AO
0x002B	Zone 1 Heating Valve AO
0x002C	Heat Recovery Exhaust Bypass Damper AO
0x002D	Heat Recovery Outside Air Bypass Damper AO
0x0200 to 0xFFFE	Vendor defined
0xFFFF	Other

6467 **3.14.11.19.2.6 Type = 0x05: Parts per Million PPM**

6468 **Table 3-107. AO Types, Type = 0x05: Parts per Million PPM**

Index	Application Usage
0x0000	Space Carbon Dioxide limit AO
0x0200 to 0xFFFE	Vendor defined
0xFFFF	Other

6469 **3.14.11.19.2.7 Type = 0x06: Rotational Speed RPM**

6470

**Table 3-108. AO Types, Type = 0x06: Rotational Speed RPM**

Index	Application Usage
0x0000	Exhaust Fan Speed AO
0x0001	Fan Speed AO
0x0002	Relief Fan Speed AO
0x0003	Return Fan Speed AO
0x0004	Supply Fan Speed AO
0x0200- 0xFFFFE	Vendor defined
0xFFFF	Other

6471

**3.14.11.19.2.8 Type = 0x07: Current in Amps**

6472

**Table 3-109. AO Types, Type = 0x07: Current in Amps**

Index	Application Usage
0x0200- 0xFFFFE	Vendor defined
0xFFFF	Other

6473

**3.14.11.19.2.9 Type = 0x08: Frequency in Hz**

6474

**Table 3-110. AO Types, Type = 0x08: Frequency in Hz**

Index	Application Usage
0x0000 to 0x01FF	Reserved
0x0200- 0xFFFFE	Vendor defined
0xFFFF	Other

6475

**3.14.11.19.2.10 Type = 0x09: Power in Watts**

6476

**Table 3-111. AO Types, Type = 0x09: Power in Watts**

Index	Application Usage
0x0200- 0xFFFFE	Vendor defined
0xFFFF	Other

6477

**3.14.11.19.2.11 Type = 0x0A: Power in kW**

6478

**Table 3-112. AO Types, Type = 0x0A: Power in kW**

Index	Application Usage
0x0200- 0xFFFFE	Vendor defined
0xFFFF	Other

6479 **3.14.11.19.2.12 Type = 0x0B: Energy in kWh**

6480

**Table 3-113. AO Types, Type = 0x0B: Energy in kWh**

Index	Application Usage
0x0200- 0xFFFFE	Vendor defined
0xFFFF	Other

6481 **3.14.11.19.2.13 Type = 0x0C: Count – Unitless**

6482

**Table 3-114. AO Types, Type = 0x0C: Count - Unitless**

Index	Application Usage
0x0200- 0xFFFFE	Vendor defined
0xFFFF	Other

6483 **3.14.11.19.2.14 Type = 0x0D: Enthalpy in KJoules/Kg**

6484

**Table 3-115. AO Types, Type = 0x0D: Enthalpy in KJoules/Kg**

Index	Application Usage
0x0200- 0xFFFFE	Vendor defined
0xFFFF	Other

6485 **3.14.11.19.2.15 Type = 0x0E: Time in Seconds**

6486

**Table 3-116. AO Types, Type = 0x0E: Time in Seconds**

Index	Application Usage
0x0000	Relative time AO
0x0200- 0xFFFFE	Vendor defined
0xFFFF	Other



6487 **3.14.11.19.3 Analog Value (AV) Types**

6488 Group = 0x02.

6489 The following sub-clauses describe the values when Type = 0x00 to 0x03. Types 0x04 to 0xFE are reserved,  
6490 Type = 0xFF indicates other.

6491 **3.14.11.19.3.1 Type = 0x00: Temperature in Degrees C**

6492 **Table 3-117. AV Types, Type = 0x00: Temperature in Degrees C**

Index	Application Usage
0x0000	Setpoint Offset AV
0x0001	Temp Deadband AV
0x0002	Occupied Heating Setpoint AV
0x0003	Unoccupied Heating Setpoint AV
0x0004	Occupied Cooling Setpoint AV
0x0005	Unoccupied Cooling Setpoint AV
0x0006	Standby Heat Setpoint AV
0x0007	Standby Cooling Setpoint AV
0x0008	Effective Occupied Heating Setpoint AV
0x0009	Effective Unoccupied Heating Setpoint AV
0x000a	Effective Occupied Cooling Setpoint AV
0x000b	Effective Unoccupied Cooling Setpoint AV
0x000c	Effective Standby Heat Setpoint AV
0x000d	Effective Standby Cooling Setpoint AV
0x000e	Setpoint Offset AV
0x000f	Setpoint Shift AV
0x0200 to fffe	Vendor defined
0xffff	Other

6493 **3.14.11.19.3.2 Type = 0x01: Area in Square Metres**

6494

**Table 3-118. AV Types, Type = 0x01: Area in Square Metres**

Index	Application Usage
0x0000	Duct Area AV
0x0200- 0xFFFE	Vendor defined
0xFFFF	Other

6495

**3.14.11.19.3.3 Type = 0x02: Multiplier - Number**

6496

**Table 3-119. AV Types, Type = 0x02: Multiplier - Number**

Index	Application Usage
0x0000	Gain multiplier AV
0x0200 to 0xfffe	Vendor defined
0xffff	Other

6497

**3.14.11.19.3.4 Type 0x03: Flow in Litres/Second**

6498

**Table 3-120. AV Types, Type = 0x03: Flow in Litres/Second**

Index	Application Usage
0x0000	Minimum Air Flow AV
0x0001	Maximum Air Flow AV
0x0002	Heating Minimum Air Flow AV
0x0003	Heating Maximum Air Flow AV
0x0004	Standby Minimum Air Flow AV
0x0005	Standby Maximum Air Flow AV
0x0200 to 0xfffe	Vendor defined
0xffff	Other

6499

**3.14.11.19.4 Binary Inputs (BI) Types**

6500

Group = 0x03.

6501

The following sub-clauses describe the values when Type = 0x00 to 0x01. Types 0x02 to 0xFE are reserved,

6502

Type = 0xFF indicates other.

6503

Present Value = 0 represents False, Off, Normal

6504 Present Value = 1 represents True, On, Alarm

6505 **3.14.11.19.4.1 Type = 0x00: Application Domain HVAC**

6506 **Table 3-121. BI Types, Type = 0x00: Application Domain HVAC**

Index	Application Usage
0x0000	2 Pipe Pump Status BI
0x0001	Air Proving Switch BI
0x0002	Alarm Reset BI
0x0003	Boiler Status BI
0x0004	Boiler Flow Status BI
0x0005	Boiler General Alarm BI
0x0006	Boiler High Temperature Alarm BI
0x0007	Boiler Isolation Valve Status BI
0x0008	Boiler Maintenance Switch BI
0x0009	Boiler Pump Overload BI
0x000A	Boiler Pump Status BI
0x000B	Boiler Status BI
0x000C	Box Heating Alarm BI
0x000D	Chiller Alarm BI
0x000E	Chiller Chilled Water Flow Status BI
0x000F	Chiller Chilled Water Isolation Valve Status BI
0x0010	Chiller Condenser Water Flow Status BI
0x0011	Chiller Condenser Water Isolation Valve Status BI
0x0012	Chiller Maintenance Switch BI
0x0013	Chiller Status BI
0x0014	Chilled Water Expansion Tank Alarm BI
0x0015	Chilled Water Expansion Tank High Pressure Alarm BI
0x0016	Chilled Water Expansion Tank Low Pressure Alarm BI

<b>Index</b>	<b>Application Usage</b>
0x0017	Chilled Water Expansion Tank Status BI
0x0018	Combustion Damper Status BI
0x0019	Cooling Alarm BI
0x001A	Cooling Pump Maintenance Switch BI
0x001B	Cooling Pump Overload BI
0x001C	Cooling Pump Status BI
0x001D	Condenser Water Expansion Tank Alarm BI
0x001E	Condenser Water Expansion Tank High Pressure Alarm BI
0x001F	Condenser Water Expansion Tank Low Pressure Alarm BI
0x0020	Condenser Water Expansion Tank Status BI
0x0021	Condenser Water Pump Maintenance Switch BI
0x0022	Condenser Water Pump Overload BI
0x0023	Condenser Water Pump Status BI
0x0024	Decouple Loop Flow Direction BI
0x0025	Discharge Smoke BI
0x0026	Door Status BI
0x0027	Economizer Command BI
0x0028	Emergency Shutdown BI
0x0029	Equipment Tamper BI
0x002A	Energy Hold Off BI
0x002B	Exhaust Fan Maintenance Switch BI
0x002C	Exhaust Fan Overload BI
0x002D	Exhaust Fan Status BI
0x002E	Exhaust Filter Status BI
0x002F	Exhaust Smoke BI

<b>Index</b>	<b>Application Usage</b>
0x0030	Expansion Tank Alarm BI
0x0031	Expansion Tank High Pressure Alarm BI
0x0032	Expansion Tank Low Pressure Alarm BI
0x0033	Expansion Tank Status BI
0x0034	Fan Control By Others BI
0x0035	Fan Overload BI
0x0036	Filter Monitoring BI
0x0037	Final Filter Status BI
0x0038	Free Cooling Availability BI
0x0039	Heat Recovery Pump Status BI
0x003A	Heat Recovery Wheel Alarm BI
0x003B	Heat Recovery Wheel Maintenance Switch BI
0x003C	Heat Recovery Wheel Overload BI
0x003D	Heat Recovery Wheel Status BI
0x003E	Heating Alarm BI
0x003F	Heating/Cooling Pump Maintenance Switch BI
0x0040	Heating/Cooling Pump Overload BI
0x0041	High Humidity Limit BI
0x0042	High Static Pressure Fault BI
0x0043	High Temperature Limit Fault BI
0x0044	Humidifier Alarm BI
0x0045	Humidifier Maintenance Switch BI
0x0046	Humidifier Overload BI
0x0047	Humidifier Status BI
0x0048	Heat Exchanger Alarm BI

Index	Application Usage
0x0049	Heat Exchanger Isolation Valve Status BI
0x004A	Heat Exchanger Maintenance Switch BI
0x004B	Lighting Status BI
0x004C	Low Static Pressure Fault BI
0x004D	Low Temperature Limit Fault BI
0x004E	Minimum Outdoor Air Damper End Switch BI
0x004F	Minimum Outdoor Air Fan Maintenance Switch BI
0x0050	Minimum Outdoor Air Fan Overload BI
0x0051	Minimum Outdoor Air Fan Status BI
0x0052	Minimum Outdoor Air Fan Variable Frequency Drive Fault BI
0x0053	Occupancy BI
0x0054	Occupancy Sensor BI
0x0055	Primary Chilled Water Pump Maintenance Switch BI
0x0056	Primary Chilled Water Pump Overload BI
0x0057	Primary Chilled Water Pump Status BI
0x0058	Primary Chilled Water Pump Maintenance Switch BI
0x0059	Primary Chilled Water Pump Overload BI
0x005A	Primary Chilled Water Pump Status BI
0x005B	Pre-Filter Status BI
0x005C	Preheat Alarm BI
0x005D	Preheat Bonnet Switch BI
0x005E	Preheat Pump Maintenance Switch BI
0x005F	Preheat Pump Overload BI
0x0060	Preheat Pump Status BI
0x0061	Refrigerant Alarm BI

<b>Index</b>	<b>Application Usage</b>
0x0062	Reheat Alarm BI
0x0063	Reheat Bonnet Switch BI
0x0064	Reheat Pump Maintenance Switch BI
0x0065	Reheat Pump Overload BI
0x0066	Reheat Pump Status BI
0x0067	Relief Fan Maintenance Switch BI
0x0068	Relief Fan Overload BI
0x0069	Relief Fan Status BI
0x006A	Relief Fan Variable Frequency Drive Fault BI
0x006B	Return Air Smoke BI
0x006C	Return Fan Maintenance Switch BI
0x006D	Return Fan Overload BI
0x006E	Return Fan Status BI
0x006F	Return Fan VFD Fault BI
0x0070	Return Smoke BI
0x0071	Secondary Chilled Water Pump 1 Maintenance Switch BI
0x0072	Secondary Chilled Water Pump 1 Overload BI
0x0073	Secondary Chilled Water Pump 1 Status BI
0x0074	Secondary Chilled Water Pump 1 Maintenance Switch BI
0x0075	Secondary Chilled Water Pump 1 Overload BI
0x0076	Secondary Chilled Water Pump 1 Status BI
0x0077	Sideloop BI
0x0078	Generic Status BI
0x0079	Summer Winter BI
0x007A	Supplemental Heating Alarm BI

<b>Index</b>	<b>Application Usage</b>
0x007B	Supplemental Heating Pump Maintenance Switch BI
0x007C	Supplemental Heating Pump Overload BI
0x007D	Supplemental Heating Pump Status BI
0x007E	Supply Fan Maintenance Switch BI
0x007F	Supply Fan Overload BI
0x0080	Supply Fan Status BI
0x0081	Supply Fan Variable Frequency Drive Fault BI
0x0082	Temporary Occupancy BI
0x0083	Tower Level Alarm BI
0x0084	Tower Level Status BI
0x0085	Tower Temp BI
0x0086	Tower Vibration Alarm Status BI
0x0087	Tower Level Alarm BI
0x0088	Tower Level Switch BI
0x0089	Tower Temp Switch BI
0x008A	Tower Fan Isolation Valve Status BI
0x008B	Tower Fan Maintenance Switch BI
0x008C	Tower Fan Overload BI
0x008D	Tower Fan Status BI
0x008E	Unit Enable BI
0x008F	Unit Reset BI
0x0090	Window Status BI
0x0091	Zone Sensor Temporary Occupancy BI
0x0092	Air Proving Switch BI
0x0093	Primary Heating Status BI



Index	Application Usage
0x0094	Primary Cooling Status BI
0x0200 to 0xFFFE	Vendor defined
0xFFFF	Other

6507 **3.14.11.19.4.2 Type = 0x01: Application Domain Security**

6508 **Table 3-122. BI Types, Type = 0x01: Application Domain Security**

Index	Application Usage
0x0000	Glass Breakage Detection
0x0001	Intrusion Detection
0x0002	Motion Detection
0x0003	Glass Breakage Detection
0x0004	Zone Armed
0x0005	Glass Breakage Detection
0x0006	Smoke Detection
0x0007	Carbon Dioxide Detection
0x0008	Heat Detection
0x0200 to 0xFFFE	Vendor defined
0xFFFF	Other

6509 **3.14.11.19.5 Binary Output (BO) Types**

6510 Group = 0x04.

6511 The following sub-clauses describe the values when Type = 0x00 to 0x01. Types 0x02 to 0xFE are reserved,  
6512 Type = 0xFF indicates other.

6513 Present Value = 0 represents False, Off, Normal

6514 Present Value = 1 represents True, On, Alarm

6515 **3.14.11.19.5.1 Type = 0x00: Application Domain HVAC**

6516

**Table 3-123. BO Types, Type = 0x00: Application Domain HVAC**

<b>Index</b>	<b>Application Usage</b>
0x0000	2 Pipe Circulation Pump BO
0x0001	2 Pipe Valve BO
0x0002	2 Pipe Valve Command BO
0x0003	Boiler BO
0x0004	Boiler Isolation Valve BO
0x0005	Boiler Pump BO
0x0006	Box Cooling 2 Position BO
0x0007	Box Heating 2 Position BO
0x0008	Box Heating Enable BO
0x0009	Box Heating Stage 1 BO
0x000A	Box Heating Stage 2 BO
0x000B	Box Heating Stage 3 BO
0x000C	Chiller 1 Isolation Valve BO
0x000D	Chiller BO
0x000E	Chiller Chilled Water Isolation Valve BO
0x000F	Chiller Condenser Water Isolation Valve BO
0x0010	Combustion Damper BO
0x0011	Compressor Stage 1 BO
0x0012	Compressor Stage 2 BO
0x0013	Cooling Circulation Pump BO
0x0014	Cooling Stage 1 BO
0x0015	Cooling Stage 2 BO
0x0016	Cooling Stage 3 BO
0x0017	Cooling Stage 4 BO

<b>Index</b>	<b>Application Usage</b>
0x0018	Cooling Stage 5 BO
0x0019	Cooling Stage 6 BO
0x001A	Cooling Stage 7 BO
0x001B	Cooling Stage 8 BO
0x001C	Cooling Valve BO
0x001D	Cooling Valve Command BO
0x001E	Chilled Water Pump BO
0x001F	Economizer Enable BO
0x0020	Exhaust Air Damper BO
0x0021	Exhaust Fan BO
0x0022	Fan BO
0x0023	Fan Speed 1 BO
0x0024	Fan Speed 2 BO
0x0025	Fan Speed 3 BO
0x0026	Heat Recovery Pump BO
0x0027	Heat Recovery Valve BO
0x0028	Heat Recovery Wheel BO
0x0029	Heating Stage 1 BO
0x002A	Heating Stage 2 BO
0x002B	Heating Stage 3 BO
0x002C	Heating Valve BO
0x002D	Heating Valve Command BO
0x002E	Hot Gas Bypass Valve BO
0x002F	Humidification Stage 1 BO
0x0030	Humidification Stage 2 BO

<b>Index</b>	<b>Application Usage</b>
0x0031	Humidification Stage 3 BO
0x0032	Humidification Stage 4 BO
0x0033	Humidifier Enable BO
0x0034	Heat Exchanger Isolation Valve BO
0x0035	Lighting BO
0x0036	Minimum Outside Air Damper BO
0x0037	Minimum Outside Air Fan BO
0x0038	Outside Air Damper BO
0x0039	Primary Chilled Water Pump 1 BO
0x003A	Plate-and-Frame Heat Exchanger Isolation Valve BO
0x003B	Primary Hot Water Pump BO
0x003C	Primary Heat Exchange Pump BO
0x003D	Preheat Circulation Pump BO
0x003E	Preheat Enable BO
0x003F	Preheat Stage 1 BO
0x0040	Preheat Stage 2 BO
0x0041	Preheat Stage 3 BO
0x0042	Preheat Stage 4 BO
0x0043	Preheat Stage 5 BO
0x0044	Preheat Stage 6 BO
0x0045	Preheat Stage 7 BO
0x0046	Preheat Stage 8 BO
0x0047	Preheat Valve BO
0x0048	Reheat Circulation Pump BO
0x0049	Reheat Enable BO

<b>Index</b>	<b>Application Usage</b>
0x004A	Reheat Stage 1 BO
0x004B	Reheat Stage 2 BO
0x004C	Reheat Stage 3 BO
0x004D	Reheat Stage 4 BO
0x004E	Reheat Stage 5 BO
0x004F	Reheat Stage 6 BO
0x0050	Reheat Stage 7 BO
0x0051	Reheat Stage 8 BO
0x0052	Relief Fan BO
0x0053	Return Fan BO
0x0054	Reversing Valve 1 BO
0x0055	Reversing Valve 2 BO
0x0056	Secondary Chilled Water Pump BO
0x0057	Secondary Hot Water Pump BO
0x0058	Secondary Heat Exchange Pump BO
0x0059	Sideloop BO
0x005A	Sideloop Stage 1 BO
0x005B	Sideloop Stage 2 BO
0x005C	Sideloop Stage 3 BO
0x005D	Sideloop Stage 4 BO
0x005E	Sideloop Stage 5 BO
0x005F	Sideloop Stage 6 BO
0x0060	Sideloop Stage 7 BO
0x0061	Sideloop Stage 8 BO
0x0062	Steam Isolation Valve BO

<b>Index</b>	<b>Application Usage</b>
0x0063	Supplemental Heating 2 Position BO
0x0064	Supplemental Heating Stage 1 BO
0x0065	Supplemental Heating Valve BO
0x0066	Supplemental Heating Enable BO
0x0067	Supplemental Heating Pump BO
0x0068	Supply Fan BO
0x0069	Tower Basin Heater BO
0x006A	Tower Basin Makeup BO
0x006B	Tower Basin Heater BO
0x006C	Tower Basin Makeup BO
0x006D	Tower Isolation Valve BO
0x006E	Tower Fan BO
0x006F	Tower Fan Speed 1 BO
0x0070	Tower Fan Speed 2 BO
0x0071	Tower Fan Speed 3 BO
0x0072	Zone Heating Stage 1 BO
0x0073	Zone Heating Stage 2 BO
0x0074	Zone Heating Stage 3 BO
0x0075	Zone Heating Valve BO
0x0076	2 Pipe Circulation Pump BO
0x0200 to 0xFFFFE	Vendor defined
0xFFFF	Other

6517 **3.14.11.19.5.2 Type = 0x02: Application Domain Security**

6518

**Table 3-124. BO Types, Type = 0x02: Application Domain Security**

Index	Application Usage
0x0000	Arm Disarm Command BO
0x0001	Occupancy Control BO
0x0002	Enable Control BO
0x0003	Access Control BO
0x0200 to 0xFFFFE	Vendor defined
0xFFFF	Other

6519 **3.14.11.19.6 Binary Value (BV) Types**

6520 Group = 0x05.

6521 The following sub-clauses describe the values when Type = 0x00. Types 0x01 to 0xFE are reserved, Type =  
6522 0xFF indicates other.

6523 Present Value = 0 represents False, Off, Normal

6524 Present Value = 1 represents True, On, Alarm

6525 **3.14.11.19.6.1 Type = 0x00**

6526

**Table 3-125. BV Types, Type = 0x00**

Index	Application Usage
0x0200- 0xFFFFE	Vendor defined
0xFFFF	Other

6527 **3.14.11.19.7 Multistate Input (MI) Types**

6528 Group = 0x0D.

6529 The following sub-clauses describe the values when Type = 0x00. Types 0x01 to 0xFE are reserved, Type =  
6530 0xFF indicates other.

6531 **3.14.11.19.7.1 Type = 0x00: Application Domain HVAC**

6532

**Table 3-126. MI Types, Type = 0x00: Application Domain HVAC**

Index	Application Usage [Number of States] States
0x0000	[3] Off, On, Auto
0x0001	[4] Off, Low, Medium, High

Index	Application Usage [Number of States] States
0x0002	[7] Auto, Heat, Cool, Off, Emergency Heat, Fan Only, Max Heat
0x0003	[4] Occupied, Unoccupied, Standby, Bypass
0x0004	[3] Inactive, Active, Hold
0x0005	[8] Auto, Warm-up, Water Flush, Autocalibration, Shutdown Open, Shutdown Closed, Low Limit, Test and Balance
0x0006	[6] Off, Auto, Heat Cool, Heat Only, Cool Only, Fan Only
0x0007	[3] High, Normal, Low
0x0008	[4] Occupied, Unoccupied, Startup, Shutdown
0x0009	[3] Night, Day, Hold
0x000A	[5] Off, Cool, Heat, Auto, Emergency Heat
0x000B	[7] Shutdown Closed, Shutdown Open, Satisfied, Mixing, Cooling, Heating, Supplemental Heat
0x0200- 0xFFFE	Vendor defined
0xFFFF	Other

6533 **3.14.11.19.8 Multistate Output (MO) Types**

6534 Group = 0x0E.

6535 The following sub-clauses describe the values when Type = 0x00. Types 0x01 to 0xFE are reserved, Type =  
6536 0xFF indicates other.

6537 **3.14.11.19.8.1 Type = 0x00: Application Domain HVAC**

6538 **Table 3-127. MO Types, Type = 0x00: Application Domain HVAC**

Index	Application Usage [Number of States] States
0x0000	[3] Off, On, Auto
0x0001	[4] Off, Low, Medium, High
0x0002	[7] Auto, Heat, Cool, Off, Emerg Heat, Fan Only, Max Heat



<b>Index</b>	<b>Application Usage [Number of States] States</b>
0x0003	[4] Occupied, Unoccupied, Standby, Bypass
0x0004	[3] Inactive, Active, Hold
0x0005	[8] Auto, Warm-up, Water Flush, Autocalibration, Shutdown Open, Shutdown Closed, Low Limit, Test and Balance
0x0006	[6] Off, Auto, Heat Cool, Heat Only, Cool Only, Fan Only
0x0007	[3] High, Normal, Low
0x0008	[4] Occupied, Unoccupied, Startup, Shutdown
0x0009	[3] Night, Day, Hold
0x000A	[5] Off, Cool, Heat, Auto, Emergency Heat
0x000B	[7] Shutdown Closed, Shutdown Open, Satisfied, Mixing, Cooling, Heating, Suppl Heat
0x0200- 0xFFFE	Vendor defined
0xFFFF	Other

6539 **3.14.11.19.9 Multistate Value (MV) Types**

6540 Group = 0x13.

6541 The following sub-clauses describe the values when Type = 0x00. Types 0x01 to 0xFE are reserved, Type =  
6542 0xFF indicates other.

6543 **3.14.11.19.9.1 Type = 0x00: Application Domain HVAC**

6544 **Table 3-128. MV Types, Type = 0x00: Application Domain HVAC**

<b>Index</b>	<b>Application Usage [Number of States] States</b>
0x0000	[3] Off, On, Auto
0x0001	[4] Off, Low, Medium, High
0x0002	[7] Auto, Heat, Cool, Off, Emerg Heat, Fan Only, Max Heat
0x0003	[4] Occupied, Unoccupied, Standby, Bypass

<b>Index</b>	<b>Application Usage [Number of States] States</b>
0x0004	[3] Inactive, Active, Hold
0x0005	[8] Auto, Warm-up, Water Flush, Autocalibration, Shutdown Open, Shutdown Closed, Low Limit, Test and Balance
0x0006	[6] Off, Auto, Heat Cool, Heat Only, Cool Only, Fan Only
0x0007	[3] High, Normal, Low
0x0008	[4] Occupied, Unoccupied, Startup, Shutdown
0x0009	[3] Night, Day, Hold
0x000A	[5] Off, Cool, Heat, Auto, Emergency Heat
0x000B	[7] Shutdown Closed, Shutdown Open, Satisfied, Mixing, Cooling, Heating, Suppl Heat
0x0200- 0xFFFFE	Vendor defined
0xFFFF	Other

6545

6546 All other group values are currently reserved

6547 

## 3.15 Diagnostics

---

6548 

### 3.15.1 Overview

6549 Please see Chapter 2 for a general cluster overview defining cluster architecture, revision, classification,  
6550 identification, etc.6551 The diagnostics cluster provides access to information regarding the operation of the stack over time. This  
6552 information is useful to installers and other network administrators who wish to know how a particular device  
6553 is functioning on the network.6554 The Diagnostics Cluster needs to understand the performance of the network over time in order to isolate  
6555 network routing issues.6556 While it is not absolutely essential, it is recommended that server attributes be stored in persistent memory.  
6557 This especially makes sense if for instance some stack behavior were causing a device to reset. Without  
6558 storing the associated server attributes in persistent memory there would be no way to analyze what was  
6559 causing the reset behavior.

6560 **3.15.1.1 Revision History**

6561 The global *ClusterRevision* attribute value SHALL be the highest revision number in the table below.

Rev	Description
1	global mandatory <i>ClusterRevision</i> attribute added
2	CCB 2309 2212 2333
3	CCB 2425 2520 2521

6562 **3.15.1.2 Classification**

Hierarchy	Role	PICS Code
Base	Utility	DIAG

6563 **3.15.1.3 Cluster Identifiers**

Identifier	Name
0x0b05	Diagnostics

6564 **3.15.2 Server**

6565 **3.15.2.1 Dependencies**

6566 **3.15.2.2 Attributes**

6567 The server attributes in the diagnostics cluster are broken up into several attribute sets listed in Table 3-129.

6568 **Table 3-129. Server Attribute Sets of the Diagnostics Cluster**

Attribute Set Identifier	Description
0x0000	Hardware Information
0x0100	Stack/Network Information

6569 **3.15.2.2.1 Hardware Information Attribute Set**

6570 **Table 3-130. Hardware Information Attribute Set**

Identifier	Name	Type	Range	Access	Default	M/O
0x0000	<i>NumberOfResets</i>	uint16	0x0000 to 0xffff	R	0x00000000	O
0x0001	<i>PersistentMemoryWrites</i>	uint16	0x0000 to 0xffff	R	0x00000000	O

6571 **3.15.2.2.1.1 NumberOfResets Attribute**

6572 An attribute that is incremented each time the device resets. A reset is defined as any time the device restarts.  
6573 This is not the same as a reset to factory defaults, which SHOULD clear this and all values.

### 6574 3.15.2.2.1.2 *PersistentMemoryWrites Attribute*

6575 This attribute keeps track of the number of writes to persistent memory. Each time that the device stores a  
6576 token in persistent memory it will increment this value.

### 6577 3.15.2.2.2 *Stack / Network Information Attribute Set*

6578 Note that many of the counters in this attribute set (Table 3-131) will wrap quickly. They SHOULD be read  
6579 frequently during periods of network interrogation in order to avoid missing points where the counters roll  
6580 over.

6581 **Table 3-131. Stack / Network Information Attribute Set**

Id	Name	Type	Range	Acc	Def	MO
0x0100	<i>MacRxBcast</i>	uint32	0x00000000 to 0xffffffff	R	0	O
0x0101	<i>MacTxBcast</i>	uint32	0x00000000 to 0xffffffff	R	0	O
0x0102	<i>MacRxUcast</i>	uint32	0x00000000 to 0xffffffff	R	0	O
0x0103	<i>MacTxUcast</i>	uint32	0x00000000 to 0xffffffff	R	0	O
0x0104	<i>MacTxUcastRetry</i>	uint16	0x0000 to 0xffff	R	0	O
0x0105	<i>MacTxUcastFail</i>	uint16	0x0000 to 0xffff	R	0	O
0x0106	<i>APSRxBcast</i>	uint16	0x0000 to 0xffff	R	0	O
0x0107	<i>APSTxBcast</i>	uint16	0x0000 to 0xffff	R	0	O
0x0108	<i>APSRxUcast</i>	uint16	0x0000 to 0xffff	R	0	O
0x0109	<i>APSTxUcastSuccess</i>	uint16	0x0000 to 0xffff	R	0	O
0x010A	<i>APSTxUcastRetry</i>	uint16	0x0000 to 0xffff	R	0	O
0x010B	<i>APSTxUcastFail</i>	uint16	0x0000 to 0xffff	R	0	O
0x010C	<i>RouteDisInitiated</i>	uint16	0x0000 to 0xffff	R	0	O
0x010D	<i>NeighborAdded</i>	uint16	0x0000 to 0xffff	R	0	O
0x010E	<i>NeighborRemoved</i>	uint16	0x0000 to 0xffff	R	0	O
0x010F	<i>NeighborStale</i>	uint16	0x0000 to 0xffff	R	0	O
0x0110	<i>JoinIndication</i>	uint16	0x0000 to 0xffff	R	0	O
0x0111	<i>ChildMoved</i>	uint16	0x0000 to 0xffff	R	0	O
0x0112	<i>NWKFCFailure</i>	uint16	0x0000 to 0xffff	R	0	O
0x0113	<i>APSFCEFailure</i>	uint16	0x0000 to 0xffff	R	0	O
0x0114	<i>APSUnauthorizedKey</i>	uint16	0x0000 to 0xffff	R	0	O
0x0115	<i>NWKDecryptFailures</i>	uint16	0x0000 to 0xffff	R	0	O
0x0116	<i>APSDDecryptFailures</i>	uint16	0x0000 to 0xffff	R	0	O
0x0117	<i>PacketBufferAllocateFailures</i>	uint16	0x0000 to 0xffff	R	0	O
0x0118	<i>RelayedUcast</i>	uint16	0x0000 to 0xffff	R	0	O
0x0119	<i>PhytoMACQueueLimitReached</i>	uint16	0x0000 to 0xffff	R	0	O
0x011A	<i>PacketValidatedDropcount</i>	uint16	0x0000 to 0xffff	R	0	O
0x011B	<i>AverageMACRetry-PerAPSMMessageSent</i>	uint16	0x0000 to 0xffff	R	0	O

0x011C	<i>LastMessageLQI</i>	uint8	0x00 to 0xff	R	0	O
0x011D	<i>LastMessageRSSI</i>	int8	-127 to 127	R	0	O

6582 **3.15.2.2.2.1 *MacRxBcast Attribute***

6583 A counter that is incremented each time the MAC layer receives a broadcast.

6584 **3.15.2.2.2.2 *MacTxBcast Attribute***

6585 A counter that is incremented each time the MAC layer transmits a broadcast.

6586 **3.15.2.2.2.3 *MacRxUcast Attribute***

6587 A counter that is incremented each time the MAC layer receives a unicast.

6588 **3.15.2.2.2.4 *MacTxUcast Attribute***

6589 A counter that is incremented each time the MAC layer transmits a unicast.

6590 **3.15.2.2.2.5 *MacTxUcastRetry Attribute***

6591 A counter that is incremented each time the MAC layer retries a unicast.

6592 **3.15.2.2.2.6 *MacTxUcastFail Attribute***

6593 A counter that is incremented each time the MAC layer fails to send a unicast.

6594 **3.15.2.2.2.7 *APSRxBcast Attribute***

6595 A counter that is incremented each time the APS layer receives a broadcast.

6596 **3.15.2.2.2.8 *APSTxBcast Attribute***

6597 A counter that is incremented each time the APS layer transmits a broadcast.

6598 **3.15.2.2.2.9 *APSRxUcast Attribute***

6599 A counter that is incremented each time the APS layer receives a unicast.

6600 **3.15.2.2.2.10 *APSTxUcastSuccess Attribute***

6601 A counter that is incremented each time the APS layer successfully transmits a unicast.

6602 **3.15.2.2.2.11 *APSTxUcastRetry Attribute***

6603 A counter that is incremented each time the APS layer retries the sending of a unicast.

6604 **3.15.2.2.2.12 *APSTxUcastFail Attribute***

6605 A counter that is incremented each time the APS layer fails to send a unicast.

6606 **3.15.2.2.2.13 *RouteDisclnitiated Attribute***

6607 A counter that is incremented each time a route request is initiated.

6608 **3.15.2.2.2.14 *NeighborAdded Attribute***

6609 A counter that is incremented each time an entry is added to the neighbor table.

6610 **3.15.2.2.2.15 *NeighborRemoved Attribute***

6611 A counter that is incremented each time an entry is removed from the neighbor table.

- 6612 **3.15.2.2.2.16**     *NeighborStale Attribute*
- 6613     A counter that is incremented each time a neighbor table entry becomes stale because the neighbor has not  
6614     been heard from.
- 6615 **3.15.2.2.2.17**     *JoinIndication Attribute*
- 6616     A counter that is incremented each time a node joins or rejoins the network via this node.
- 6617 **3.15.2.2.2.18**     *ChildMoved Attribute*
- 6618     A counter that is incremented each time an entry is removed from the child table.
- 6619 **3.15.2.2.2.19**     *NWKFCFailure Attribute*
- 6620     A counter that is incremented each time a message is dropped at the network layer because the network  
6621     security<sup>65</sup> frame counter was not higher than the last message seen from that source.
- 6622 **3.15.2.2.2.20**     *APSFCEFailure Attribute*
- 6623     A counter that is incremented each time a message is dropped at the APS layer because the APS frame counter  
6624     was not higher than the last message seen from that source.
- 6625 **3.15.2.2.2.21**     *APSUnauthorizedKey Attribute*
- 6626     A counter that is incremented each time a message is dropped at the APS layer because it had APS encryption  
6627     but the key associated with the sender has not been authenticated, and thus the key is not authorized for use  
6628     in APS data messages.
- 6629 **3.15.2.2.2.22**     *NWKDecryptFailures Attribute*
- 6630     A counter that is incremented each time a NWK encrypted message was received but dropped because de-  
6631     cryption failed.
- 6632 **3.15.2.2.2.23**     *APSDDecryptFailures Attribute*
- 6633     A counter that is incremented each time an APS encrypted message was received but dropped because de-  
6634     cryption failed.
- 6635 **3.15.2.2.2.24**     *PacketBufferAllocateFailures Attribute*
- 6636     A counter that is incremented each time the stack failed to allocate a packet buffers. This doesn't necessarily  
6637     mean that the packet buffer count was 0 at the time, but that the number requested was greater than the  
6638     number free.
- 6639 **3.15.2.2.2.25**     *RelayedUcast Attribute*
- 6640     A counter that is incremented each time a unicast packet is relayed.
- 6641 **3.15.2.2.2.26**     *PacketValidateDropCount Attribute*
- 6642     A counter that is incremented each time a packet is dropped because the PHY to MAC queue was exhausted.<sup>66</sup>
- 6643 **3.15.2.2.2.27**     *PacketValidateDropCount Attribute*
- 6644     A counter that is incremented each time a packet was dropped due to a packet validation error. This could be  
6645     due to length or other formatting problems in the packet.

---

<sup>65</sup> CCB 2521

<sup>66</sup> CCB 2425 2520

6646 **3.15.2.2.2.28** *AverageMACRetryPerAPSMessagesent* Attribute

6647 A counter that is equal to the average number of MAC retries needed to send an APS message.

6648 **3.15.2.2.2.29** *LastMessageLQI* Attribute

6649 This is the Link Quality Indicator for the last message received. There is no current agreed upon standard for  
6650 calculating the LQI. For some implementations LQI is related directly to RSSI for others it is a function of  
6651 the number of errors received over a fixed number of bytes in a given message. The one thing that has been  
6652 agreed is that the Link Quality Indicator is a value between 0 and 255 where 0 indicates the worst possible  
6653 link and 255 indicates the best possible link. Note that for a device reading the Last Message LQI the returned  
6654 value SHALL be the LQI for the read attribute message used to read the attribute itself.

6655 **3.15.2.2.2.30** *LastMessageRSSI* Attribute

6656 This is the receive signal strength indication for the last message received. As with Last Message LQI, a  
6657 device reading the Last Message RSSI, the returned value SHALL be the RSSI of the read attribute message  
6658 used to read the attribute itself.

6659 **3.15.2.3 Commands**

6660 There are no commands received by the server side of the diagnostics cluster.

6661 **3.15.3 Client**

6662 The client has no dependencies and no cluster specific attributes. The client does not receive or generate any  
6663 cluster specific commands.

6664 **3.16 Poll Control**

---

6665 **3.16.1 Overview**

6666 Please see Chapter 2 for a general cluster overview defining cluster architecture, revision, classification,  
6667 identification, etc.

6668 This cluster provides a mechanism for the management of an end device's MAC Data Request rate. For the  
6669 purposes of this cluster, the term "poll" always refers to the sending of a MAC Data Request from the end  
6670 device to the end device's parent.

6671 This cluster can be used for instance by a configuration device to make an end device responsive for a certain  
6672 period of time so that the device can be managed by the controller.

6673 This cluster is composed of a client and server. The end device implements the server side of this cluster.  
6674 The server side contains several attributes related to the MAC Data Request rate for the device. The client  
6675 side implements commands used to manage the poll rate for the device.

6676 The end device which implements the server side of this cluster sends a query to the client on a predetermined  
6677 interval to see if the client would like to manage the poll period of the end device in question. When the client  
6678 side of the cluster hears from the server it has the opportunity to respond with configuration data to either put  
6679 the end device in a short poll mode or let the end device continue to function normally.

6680 **3.16.1.1 Revision History**6681 The global *ClusterRevision* attribute value SHALL be the highest revision number in the table below.

Rev	Description
1	global mandatory <i>ClusterRevision</i> attribute added;CCB 1815 1822 1833
2	CCB 2319 2329
3	CCB 2477 Status Code cleanup

6682 **3.16.1.2 Classification**

Hierarchy	Role	PICS Code
Base	Utility	POLL

6683 **3.16.1.3 Cluster Identifiers**

Identifier	Name
0x0020	Poll Control

6684 **3.16.2 Terminology**

6685 MAC Data Request Rate: The MAC Data Request rate or simply “poll rate” is the frequency with which an  
 6686 end device sends a MAC Data Request to its parent. A parent device is only required to store a single message  
 6687 for its child for 7.68 seconds. Therefore if an end device wants to retrieve messages from its parent, it must  
 6688 send a MAC Data Request every 7.68 seconds.

6689 Generally, end devices have two different rates at which they send MAC Data Polls to their parents. A slower  
 6690 rate for when the device is not expecting data (Long Poll Interval) and a faster rate (Short Poll Interval) for  
 6691 when the device is expecting data.

6692 End devices only know that they are expecting data when they have initiated some sort of transaction. This  
 6693 cluster provides a mechanism for forcing this state to make the end device responsive to asynchronous mes-  
 6694 saging.

6695 Long Poll Interval: The amount of time between MAC Data Requests when the device is in its normal oper-  
 6696 ating state and not expecting any messages.

6697 Short Poll Interval: The amount of time between MAC Data Requests when the device is either expecting  
 6698 data or has been put into “Fast Poll Mode” by the controlling device.

6699 Fast Poll Mode: When the device is polling frequently to retrieve data from its parent we say that the device  
 6700 is in “Fast Poll Mode”. The entire purpose of this cluster is to provide a means of managing when an end  
 6701 device goes into and out of Fast Poll Mode so that it can be made responsive for a controlling device.



6702 **3.16.3 Commissioning Process**

6703 Poll Control Cluster Clients SHALL configure bindings on the device implementing the Poll Control Cluster  
6704 Server so that they will receive the regular check-in command on the configured *Check-In Interval*. This can  
6705 be done during the configuration period on the end device implementing the Poll Control Cluster Server  
6706 during which it is in fast poll mode. The device that implements the Poll Control Cluster Server SHALL  
6707 check its bindings on the configured check-in Interval. If it has any bindings related to any endpoint and the  
6708 Poll Control Cluster, it will send a check-in command out on that binding.

6709 **3.16.4 Server**

6710 **3.16.4.1 Attributes**

6711 The server side of this cluster contains certain attributes (Table 3-132) associated with the poll period.  
6712 *CheckInIntervalMin*, *LongPollIntervalMin*, *FastPollTimeoutMaximum* attributes are optional; however, if  
6713 they are not supported, you could end up with a lot of chatter on the network as clients and servers attempt  
6714 to negotiate the poll period. It is therefore recommended that these attributes be supported.

6715 **Table 3-132. Server Attributes**

Identifier	Name	Type	Range	Acc	Default	M/O
0x0000	<i>Check-inInterval</i>	uint32	0x0 to 0x6E0000	RW	0x3840 (1 hr.)	M
0x0001	<i>LongPoll Interval</i>	uint32	0x04 to 0x6E0000	R	0x14 (5 sec)	M
0x0002	<i>ShortPollInterval</i>	uint16	0x01 to 0xffff	R	0x02 (2 qs)	M
0x0003	<i>FastPollTimeout</i>	uint16	0x01 to 0xffff	RW	0x28 (10 sec.)	M
0x0004	<i>Check-inIntervalMin</i>	uint32	-	R	0	O
0x0005	<i>LongPollIntervalMin</i>	uint32	-	R	0	O
0x0006	<i>FastPollTimeoutMax</i>	uint16	-	R	0	O

6716 **3.16.4.1.1 Check-inInterval Attribute**

6717 The Poll Control server is responsible for checking in with the poll control client periodically to see if the  
6718 poll control client wants to modify the poll rate of the poll control server. This is due to the fact that the Poll  
6719 Control server is implemented on an end device that MAY have an unpredictable sleep-wake cycle.

6720 The *Check-inInterval* represents the default amount of time between check-ins by the poll control server with  
6721 the poll control client. The *Check-inInterval* is measured in quarterseconds. A value of 0 indicates that the  
6722 Poll Control Server is turned off and the poll control server will not check-in with the poll control client.

6723 The Poll Control Server checks in with the Poll Control Client by sending a Check-in command to the Client.  
6724 This value SHOULD be longer than the *LongPoll Interval* attribute. If the Client writes an invalid attribute  
6725 value (Example: Out of Range as defined in Table 3-132 or a value smaller than the optional *Check-inInter-*  
6726 *valMin* attribute value or a value smaller than the *LongPollInterval* attribute value), the Server SHOULD  
6727 return Write Attributes Response with an error status not equal to SUCCESS(0x00).

6728 The Poll Control Client will hold onto the actions or messages for the Poll Control Server at the application  
6729 level until the Poll Control Server checks in with the Poll Control Client.

#### 6730 **3.16.4.1.2 LongPollInterval Attribute**

6731 An end device that implements the Poll Control server MAY optionally expose a *LongPollInterval* attribute.  
6732 The Long Poll Interval represents the maximum amount of time in quarterseconds between MAC Data Re-  
6733 quests from the end device to its parent.

6734 The *LongPollInterval* defines the frequency of polling that an end device does when it is NOT in fast poll  
6735 mode. The *LongPollInterval* SHOULD be longer than the *ShortPollInterval* attribute but shorter than the  
6736 *Check-inInterval* attribute.

6737 A value of 0xffffffff is reserved to indicate that the device does not have or does not know its long poll  
6738 interval.

#### 6739 **3.16.4.1.3 ShortPollInterval Attribute**

6740 An end device that implements the Poll Control server MAY optionally expose the *ShortPollInterval* attrib-  
6741 ute. The *ShortPollInterval* represents the number of quarterseconds that an end device waits between MAC  
6742 Data Requests to its parent when it is expecting data (i.e., in fast poll mode).

#### 6743 **3.16.4.1.4 FastPollTimeout Attribute**

6744 The *FastPollTimeout* attribute represents the number of quarterseconds that an end device will stay in fast  
6745 poll mode by default. It is suggested that the *FastPollTimeout* attribute value be greater than 7.68 seconds  
6746 (see Zigbee Specification [R1]).

6747 The Poll Control Cluster Client MAY override this value by indicating a different value in the Fast Poll  
6748 Duration argument in the Check-in Response command. If the Client writes a value out of range as defined  
6749 in Table 3-132 or greater than the optional *FastPollTimeoutMax* attribute value if supported, the Server  
6750 SHOULD return a Write Attributes Response with a status of INVALID\_VALUE. An end device that im-  
6751 plements the Poll Control server can be put into a fast poll mode during which it will send MAC Data Re-  
6752 quests to its parent at the frequency of its configured *ShortPollInterval* attribute. During this period of time,  
6753 fast polling is considered active. When the device goes into fast poll mode, it is required to send MAC Data  
6754 Requests to its parent at an accelerated rate and is thus more responsive on the network and can receive data  
6755 asynchronously from the device implementing the Poll Control Cluster Client.

#### 6756 **3.16.4.1.5 Check-inIntervalMin Attribute**

6757 The Poll Control Server MAY optionally provide its own minimum value for the *Check-inInterval* to protect  
6758 against the *Check-inInterval* being set too low and draining the battery on the end device implementing the  
6759 Poll Control Server.

#### 6760 **3.16.4.1.6 LongPollIntervalMin Attribute**

6761 The Poll Control Server MAY optionally provide its own minimum value for the *LongPollInterval* to protect  
6762 against another device setting the value to too short a time resulting in an inadvertent power drain on the  
6763 device.

#### 6764 **3.16.4.1.7 FastPollTimeoutMax Attribute**

6765 The Poll Control Server MAY optionally provide its own maximum value for the *FastPollTimeout* to avoid  
6766 it being set to too high a value resulting in an inadvertent power drain on the device.

6767 **3.16.4.2 Attribute Settings and Battery Life Considerations**  
6768

6769 The Poll Control Cluster is used on end devices that MAY be battery powered. In order to conserve battery  
6770 life, it is important that the Poll Control Server maintain certain boundaries for the setting of the *Check-*  
6771 *inInterval*, *LongPollInterval* and the *ShortPollInterval*. Therefore, while these attributes are all Readable and  
6772 Writeable, it is possible that a battery-powered device might maintain its own boundary for the min and max  
6773 of each of these attributes. The end device implementing the Poll Control Cluster Server MAY define its own  
6774 boundaries for these attributes in order to protect itself against a power drain due to improper configuration.

6775 For instance, a battery powered device MAY not allow another device to set its *Check-inInterval* to too short  
6776 a value or its *FastPollTimeout* to too long an interval because it might cause the device to send too frequent  
6777 check-in messages on the network and stay in fast poll mode for too long a time resulting in a drain on the  
6778 battery.

6779 The Check-inInterval, LongPollInterval and ShortPollInterval SHOULD be set such that:

6780 **Check-in Interval >= Long Poll Interval >= Short Poll Interval**

6781 The default values chosen for this cluster are:

6782 **Check-in Interval = 1 hour = 0x3840 quarterseconds**

6783 **Long Poll Interval = 5 seconds = 0x14 quarterseconds**

6784 **Short Poll Interval = 2 quarterseconds = 0x02 quarterseconds**

6785 **Fast Poll Timeout = 10 seconds = 0x28 quarterseconds**

6786 Note that for the Check-in Interval, 0 is a special value and does not apply to this equation.

6787 **3.16.4.3 Commands**  
6788

Table 3-133. Commands Generated by the Poll Control Server

Command ID	Description	Mandatory/Optional
0x00	Check-in	M

6789 **3.16.4.4 Check-in Command**

6790 The Poll Control Cluster server sends out a Check-in command to the devices to which it is paired based on  
6791 the server’s *Check-inInterval* attribute. It does this to find out if any of the Poll Control Cluster Clients with  
6792 which it is paired are interested in having it enter fast poll mode so that it can be managed. This request is  
6793 sent out based on either the *Check-inInterval*, or the next Check-in value in the Fast Poll Stop Request gen-  
6794 erated by the Poll Control Cluster Client.

6795 The Check-in command expects a Check-in Response command to be sent back from the Poll Control Client.  
6796 If the Poll Control Server does not receive a Check-in response back from the Poll Control Client up to 7.68  
6797 seconds it is free to return to polling according to the *LongPollInterval*.

6798 **3.16.4.4.1 Payload Format**  
6799

There is no payload for this command.

#### 6800 **3.16.4.4.2 Effect on Receipt**

6801 Upon receipt of the Check-in command, the Poll Control Cluster client will respond with a Check-in Re-  
6802 sponse command indicating that the server SHOULD or SHOULD not begin fast poll mode.

### 6803 **3.16.5 Client**

#### 6804 **3.16.5.1 Attributes**

6805 There are no attributes on the client side of the Poll Control Cluster.

#### 6806 **3.16.5.2 Commands**

6807 **Table 3-134. Commands Generated by the Poll Control Client**

Command ID	Description	Mandatory/Optional
0x00	Check-in Response	M
0x01	Fast Poll Stop	M
0x02	Set Long Poll Interval	O
0x03	Set Short Poll Interval	O

6808

#### 6809 **3.16.5.3 Check-in Response Command**

6810 The Check-in Response is sent in response to the receipt of a Check-in command. The Check-in Response is  
6811 used by the Poll Control Client to indicate whether it would like the device implementing the Poll Control  
6812 Cluster Server to go into a fast poll mode and for how long. If the Poll Control Cluster Client indicates that  
6813 it would like the device to go into a fast poll mode, it is responsible for telling the device to stop fast polling  
6814 when it is done sending messages to the fast polling device.

6815 If the Poll Control Server receives a Check-In Response from a client for which there is no binding (unbound),  
6816 it SHOULD respond with a Default Response with a status value indicating FAILURE<sup>67</sup>.

6817 If the Poll Control Server receives a Check-In Response from a client for which there is a binding (bound)  
6818 with an invalid fast poll timeout, it SHOULD respond with a Default Response with status INVA-  
6819 LID\_VALUE.

6820 If the Poll Control Server receives a Check-In Response from a bound client after temporary fast poll mode  
6821 is completed it SHOULD respond with a Default Response with a status value indicating FAILURE<sup>68</sup>.

6822 In all of the above cases, the Server SHALL respond with a Default Response not equal to SUCCESS.

<sup>67</sup> CCB 2477 status code cleanup

<sup>68</sup> CCB 2477 status code cleanup

6823 **3.16.5.3.1 Payload Format**

6824

Figure 3-63. Format of the Check-in Response Payload

Octets	1	2
Data Type	bool	uint16
Field Name	Start Fast Polling	Fast Poll Timeout

6825 **3.16.5.3.1.1 Start Fast Polling**

6826 This Boolean value indicates whether or not the Poll Control Server device SHOULD begin fast polling or  
6827 not. If the Start Fast Polling value is true, the server device is EXPECTED to begin fast polling until the Fast  
6828 Poll Timeout has expired. If the Start Fast Polling argument is false, the Poll Control Server MAY continue  
6829 in normal operation and is not required to go into fast poll mode.

6830 **3.16.5.3.1.2 Fast Poll Timeout**

6831 The Fast Poll Timeout value indicates the number of quarterseconds during which the device SHOULD con-  
6832 tinue fast polling. If the Fast Poll Timeout value is 0, the device is EXPECTED to continue fast polling until  
6833 the amount of time indicated in the *FastPollTimeout* attribute has elapsed or it receives a Fast Poll Stop  
6834 command. If the Start Fast Polling argument is false, the Poll Control Server MAY ignore the Fast Poll  
6835 Timeout argument.

6836 The Fast Poll Timeout argument temporarily overrides the *FastPollTimeout* attribute on the Poll Control  
6837 Cluster Server for the fast poll mode induced by the Check-in Response command. This value is not EX-  
6838 PECTED to overwrite the stored value in the *FastPollTimeout* attribute.

6839 If the *FastPollTimeout* parameter in the *CheckInResponse* command is greater than the *FastPollTimeoutMax*  
6840 attribute value, the Server Device SHALL respond with a default response of error status not equal to SUC-  
6841 CESS. It is suggested to use the Error Status of *ZCL\_INVALID\_FIELD* (0x85).

6842 **3.16.5.4 Fast Poll Stop Command**

6843 The Fast Poll Stop command is used to stop the fast poll mode initiated by the Check-in response. The Fast  
6844 Poll Stop command has no payload.

6845 If the Poll Control Server receives a Fast Poll Stop from an unbound client it SHOULD send back a De-  
6846 faultResponse with a value field indicating FAILURE<sup>69</sup>. The Server SHALL respond with a De-  
6847 faultResponse not equal to SUCCESS.

6848 If the Poll Control Server receives a Fast Poll Stop command from a bound client but it is unable to stop  
6849 fast polling due to the fact that there is another bound client which has requested that polling continue it  
6850 SHOULD respond with a Default Response with a status of FAILURE<sup>70</sup>.

6851 If a Poll Control Server receives a Fast Poll Stop command from a bound client but it is not FastPolling it  
6852 SHOULD respond with a Default Response with a status of FAILURE<sup>71</sup>.

6853 **3.16.5.5 Set Long Poll Interval Command**

6854 The Set Long Poll Interval command is used to set the Read Only *LongPollInterval* attribute.

<sup>69</sup> CCB 2477 status code cleanup

<sup>70</sup> CCB 2477 status code cleanup

<sup>71</sup> CCB 2477 status code cleanup

6855 When the Poll Control Server receives the Set Long Poll Interval Command, it SHOULD check its internal  
6856 minimal limit and the attributes relationship defined in 3.16.4.2 if the new Long Poll Interval is acceptable.  
6857 If the new value is acceptable, the new value SHALL be saved to the *LongPollInterval* attribute. If the new  
6858 value is not acceptable, the Poll Control Server SHALL send a default response of INVALID\_VALUE  
6859 (0x87) and the *LongPollInterval* attribute value is not updated.

### 6860 3.16.5.5.1 Payload Format

6861 **Figure 3-64. Format of the Set Long Poll Interval Command Payload**

<b>Octets</b>	4
<b>Data Type</b>	uint32
<b>Field Name</b>	NewLongPollInterval

### 6862 3.16.5.6 Set Short Poll Interval Command

6863 The Set Short Poll Interval command is used to set the Read Only *ShortPollInterval* attribute.

6864 When the Poll Control Server receives the Set Short Poll Interval Command, it SHOULD check its internal  
6865 minimal limit and the attributes relationship defined in 3.16.4.2 if the new Short Poll Interval is acceptable.  
6866 If the new value is acceptable, the new value SHALL be saved to the *ShortPollInterval* attribute. If the new  
6867 value is not acceptable, the Poll Control Server SHALL send a default response of INVALID\_VALUE  
6868 (0x87) and the *ShortPollInterval* attribute value is not updated.

### 6869 3.16.5.6.1 Payload Format

6870 **Figure 3-65. Format of the Set Short Poll Interval Command Payload**

<b>Octets</b>	2
<b>Data Type</b>	uint16
<b>Field Name</b>	New Short Poll Interval

## 6871 3.16.6 Poll Control Cluster Sequence Diagram

6872 What follows is a typical sequence interaction between the client and server sides of the Poll Control Cluster.

6873

Figure 3-66. Poll Control Cluster Sequence Diagram

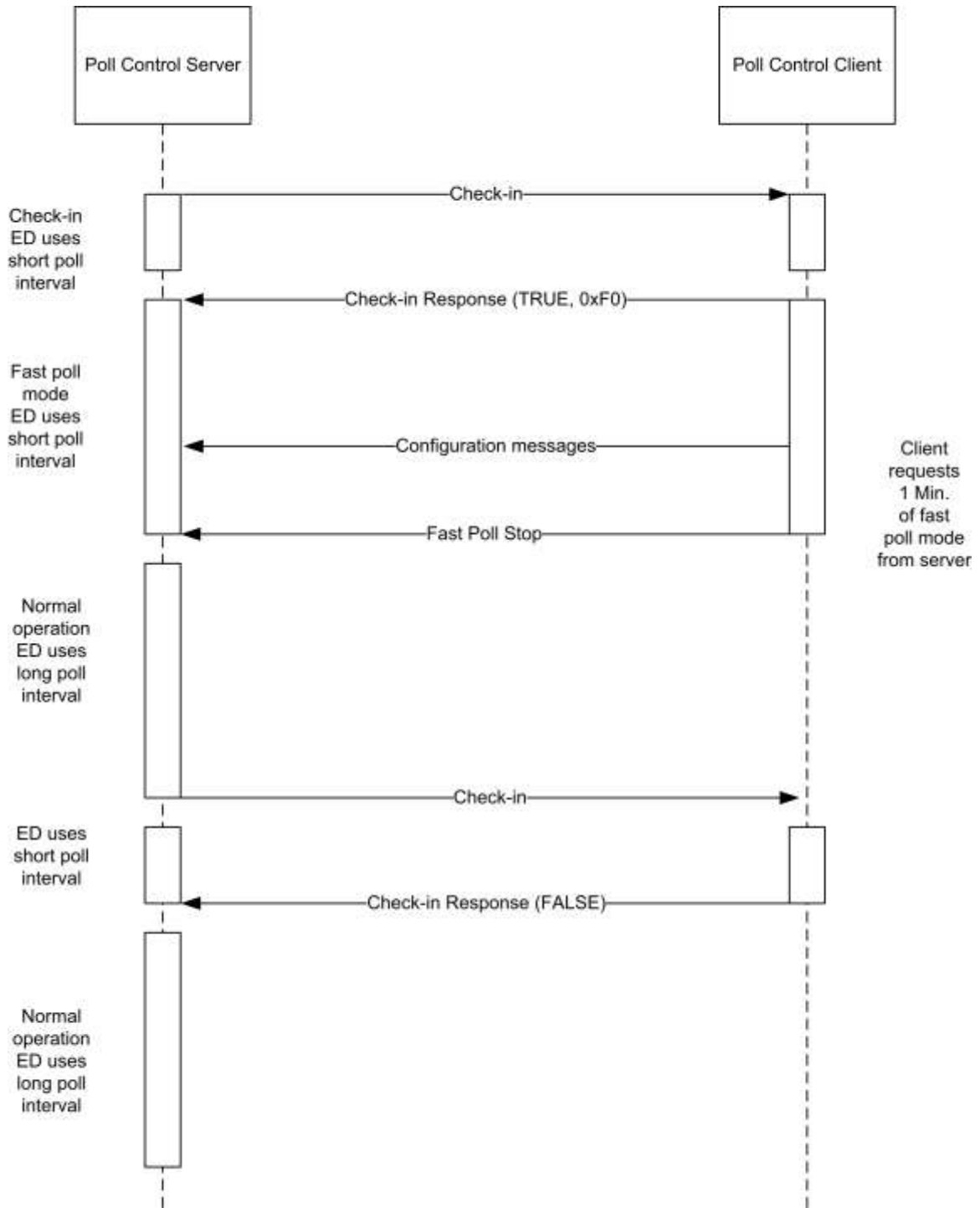

6874

6875 **3.16.6.1 Guaranteed Consistent Check-In Interval**

6876 Provided that the *Check-inInterval* attribute value stays constant, the interval between two Check In com-  
 6877 mands is guaranteed. The *Check-inInterval* SHOULD be kept independent regardless of when the Check-In  
 6878 Response or Fast Poll Stop command is received.

### 6879 **3.16.6.2 Multiple Poll Control Client**

6880 When the *Check-inInterval* expires, the Server SHOULD send parallel Check-In commands to all paired  
6881 client devices.

6882 The server SHOULD then enter a temporary Fast Poll Mode, with a fixed manufacturer-specific predefined  
6883 check in timeout duration ( $t_1$ ), to wait for the Check-In Response Messages from all paired device.

6884 Once the server received all the Check-In Response or if the temporary Fast Poll Mode timeout ( $t_1$ ), the  
6885 server SHOULD then gather the information from all Check-In Response messages and determine the longest  
6886 Fast Poll Timeout ( $t_2$ ) duration.

6887 The Server device SHALL stay in the Fast Poll Mode for the longest Fast Poll Timeout ( $t_2$ ) duration. The  
6888 server device MAY end fast poll mode before the longest fast poll timeout if it is able to determine that every  
6889 start request from the paired device has been stopped explicitly by the Fast Poll Stop command or implicitly  
6890 by a timeout.

6891 For example:

6892 Device A implements a poll control server, devices B and C implement poll control clients. Device A sends  
6893 a check-in command to both B and C. Both B and C respond with check-in response command requesting a  
6894 fast poll start. Assume B requests fast polling for 5 minutes and C requests fast polling for 10 minutes. If C  
6895 sends a fast poll stop command after 7 minutes, device A MAY immediately end fast polling upon receipt of  
6896 this command since the fast poll period requested by B would have expired after only 5 minutes (before the  
6897 command from C was received).

### 6898 **3.16.6.3 Check-in Interval Attribute Changed**

6899 When the *Check-inInterval* attribute is changed (provided that the new value is valid and within acceptable  
6900 range), the device SHOULD reset the internal check-in interval timer and send a check-in command  
6901 according to the new *Check-inInterval* value.

## 6902 **3.17 Power Profile**

---

6903 This section describes the Power Profile cluster.

### 6904 **3.17.1 Overview**

6905 Please see Chapter 2 for a general cluster overview defining cluster architecture, revision, classification,  
6906 identification, etc.

6907 This cluster provides an interface for transferring power profile information from a device (e.g., White  
6908 Goods) to a controller (e.g., the Home Gateway). The Power Profile can be solicited by client side (request  
6909 command) or can be notified directly from the device (server side). The Power Profile represents a forecast  
6910 of the energy that a device is able to predict. It is split in multiple energy phases with a specific set of param-  
6911 eters representing the estimated “energy footprint” of an appliance. The data carried in the Power Profile can  
6912 be updated during the different states of a Power Profile; since it represents a forecast of energy, duration  
6913 and peak power of energy phases, it SHALL be considered as an estimation and not derived by measurements.

6914 The Power Profile MAY also be used by an energy management system, together with other specific inter-  
6915 faces supported by the device, in order to schedule and control the device operation and to perform energy  
6916 management within a home network. For more informative examples on how the Power Profile cluster might  
6917 be used, see Chapter 15 Appliance Management, section 3.



6918

**Figure 3-67. Typical Usage of the Power Profile Cluster**

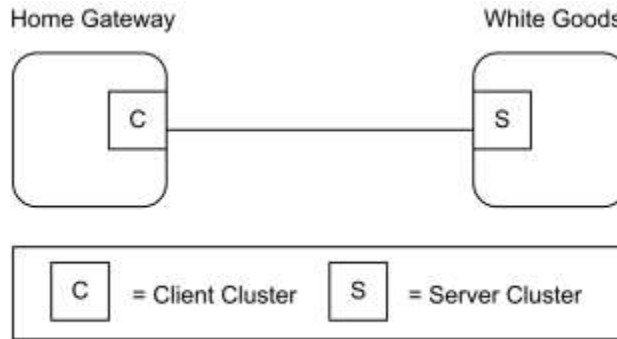

6919

*Note: Device names are examples for illustration purposes only*

6920

### 3.17.1.1 Revision History

6921

The global *ClusterRevision* attribute value SHALL be the highest revision number in the table below.

Rev	Description
1	global mandatory <i>ClusterRevision</i> attribute added

6922

### 3.17.1.2 Classification

Hierarchy	Role	PICS Code
Base	Utility	PWR

6923

### 3.17.1.3 Cluster Identifiers

Identifier	Name
0x001a	Power Profile

6924

## 3.17.2 References

6925

The following standards and specifications contain provisions, which through reference in this document constitute provisions of this specification. All the standards and specifications listed are normative references. At the time of publication, the editions indicated were valid. All standards and specifications are subject to revision, and parties to agreements based on this specification are encouraged to investigate the possibility of applying the most recent editions of the standards and specifications indicated below.

6926

6927

6928

6929

6930

## 3.17.3 General Description

6931

### 3.17.3.1 Dependencies

6932

6933

6934

6935

The Power Profile Cluster is dependent upon the Appliance Control Cluster for the parts regarding the status notification and power management commands. Other specific clusters for actuation for devices different than Smart Appliances. Due to the possible length of the Power Profile commands, the devices supporting the Power Profile cluster MAY leverage on Partitioning if required by the application.

6936 

## 3.17.4 Server Attributes

6937 . The following attributes represent the parameters for each Power Profile's phases.

6938 **Table 3-135. Attributes of the Power Profile Cluster**

Id	Name	Type	Range	Acc	Default	M
0x0000	<i>TotalProfileNum</i>	uint8	1 to FE	R	1	M
0x0001	<i>MultipleScheduling</i>	bool	0 or 1	R	0	M
0x0002	<i>EnergyFormatting</i>	map8	desc	R	1*	M
0x0003	<i>EnergyRemote</i>	bool	0 or 1	R	0	M
0x0004	<i>ScheduleMode</i>	map8	desc	RWP	0x00	M

6939

6940 \* 1/10 of Watt Hours represented

6941 

### 3.17.4.1 TotalProfileNum Attribute

6942 The *TotalProfileNum* attribute represents the total number of profiles supported by the device. The minimum  
6943 value for this attribute SHALL be 1.6944 

### 3.17.4.2 MultipleScheduling Attribute

6945 The *MultipleScheduling* attribute specifies if the server side of the Power Profile cluster supports the sched-  
6946 uling of multiple Energy Phases or it does support the scheduling of a single energy phase of the Power  
6947 Profile at a time. If more than a single energy phases MAY be scheduled simultaneously the *MultipleSched-*  
6948 *uling* attribute SHALL be set to TRUE. In this case the device supporting the Power Profile server SHALL  
6949 be able to process and manage scheduling commands carrying the schedule of more than one energy phase.6950 If the *MultipleScheduling* attribute is FALSE the device supporting the Power Profile client (e.g., EMS)  
6951 SHALL be allowed to schedule just a single energy phase.6952 

### 3.17.4.3 EnergyFormatting Attribute

6953 The *EnergyFormatting* attribute provides a method to properly decipher the number of digits and the decimal  
6954 location of the values found in the Energy Fields carried by the Power Profile Notification and Power Profile  
6955 Response commands. This attribute is to be decoded as follows:

- 6956 • Bits 0 to 2: Number of Digits to the right of the Decimal Point.
- 6957 • Bits 3 to 6: Number of Digits to the left of the Decimal Point.
- 6958 • Bit 7: If set, suppress leading zeros.

6959 This attribute SHALL be used against the Energy fields.

6960 

### 3.17.4.4 EnergyRemote Attribute

6961 The *EnergyRemote* attribute indicates whether the power profile server (e.g., appliance) is configured for  
6962 remote control (e.g., by an energy management system). This refers to the selection chosen by the user on the  
6963 remote control feature of the device. If the value is FALSE, the remote energy management is disabled,  
6964 otherwise it is enabled. If the *EnergyRemote* is equal to FALSE all the supported PowerProfile SHALL set  
6965 the Power Profile Remote Control field in the PowerProfile record equal to FALSE.

6966 If the *EnergyRemote* attribute value is equal to TRUE, at least one PowerProfile SHALL be remotely con-  
6967 trollable setting the Power Profile Remote Control field in the PowerProfile record to TRUE.

6968

**Table 3-136. EnergyRemote Attribute**

Energy Remote Value	Description
0x00	FALSE = Remote Energy Management disabled
0x01	TRUE = Remote Energy Management enabled

6969 **3.17.4.5 ScheduleMode Attribute**

6970 The *ScheduleMode* attribute describes the criteria that SHOULD be used by the Power Profile cluster client  
6971 side (e.g., energy management system) to schedule the power profiles.

6972 **3.17.4.5.1 Schedule Mode Field BitMap**

6973

**Table 3-137. ScheduleMode Attribute**

Bit	Description
bit0	bit0=1 : Schedule Mode Cheapest
bit1	bit1 =1: Schedule Mode Greenest
bit2 to bit7	Reserved

6974 If the *ScheduleMode* attribute is set to the value 0x00, the scheduling criteria is demanded to the Power  
6975 Profile cluster client side, which means that no specific preferences on the schedule mode are requested by  
6976 the device supporting the server side of the power Profile cluster.

6977 If “Schedule Mode Cheapest” is selected then the energy management system SHALL try to schedule the  
6978 Power Profile to minimize the user’s energy bill.

6979 If “Schedule Mode Greenest” is selected then the energy management system SHALL try to schedule the  
6980 Power Profile to provide the highest availability of renewable energy sources.

6981 Please note that how the energy management system MAY obtain “cheapest” or “greenest” information and  
6982 estimate scheduling times is out of scope of this specification.

6983 If more than a single bit is selected in the *ScheduleMode* bitmask, the Power Profile client SHALL try to  
6984 calculate the schedule following all the selected criteria.

6985 If all the bits are set to zero not specific optimization metrics preferences are requested by the device sup-  
6986 porting the Power Profile server.

6987 **3.17.5 Server Commands Received**

6988 The command IDs for the commands received by the server side of the Power Profile Cluster are listed in  
6989 Table 3-138.

6990

**Table 3-138. Cluster-Specific Commands Received by the Server**

Command Identifier Field Value	Description	M/O
0x00	<i>PowerProfileRequest</i>	M

Command Identifier Field Value	Description	M/O
0x01	<i>PowerProfileStateRequest</i>	M
0x02	<i>GetPowerProfilePriceResponse</i>	M
0x03	<i>GetOverallSchedulePriceResponse</i>	M
0x04	<i>EnergyPhasesScheduleNotification</i>	M
0x05	<i>EnergyPhasesScheduleResponse</i>	M
0x06	<i>PowerProfileScheduleConstraintsRequest</i>	M
0x07	<i>EnergyPhasesScheduleStateRequest</i>	M
0x08	<i>GetPowerProfilePriceExtendedResponse</i>	M

6991 **3.17.5.1 PowerProfileRequest Command**

6992 The *PowerProfileRequest* Command is generated by a device supporting the client side of the Power Profile  
6993 cluster in order to request the Power Profile of a server device. It is possible to request all profiles (without  
6994 knowing how many Power Profiles the server has) or to request a specific *PowerProfileID*.

6995 In the case of multiple profiles the server SHOULD send multiple messages, one for each Power Profile.

6996 Although the profile is in a Power Profile running state (see *PowerProfileState*), the Power Profile Response  
6997 transmitted as a reply to a *PowerProfileRequest* command SHALL carry all the energy phases of the esti-  
6998 mated Power Profile, including the previous energy phases and the current energy phase which is running.  
6999 The parameters of the Power Profile (e.g., the *ExpectedDuration* or the *Energy* fields of all the energy phases)  
7000 MAY be updated for the same Power Profile due to a tuning in the forecast.

7001 **3.17.5.1.1 Payload Format**

7002 The *PowerProfileRequest* Command payload SHALL be formatted as illustrated in Figure 3-68.

7003 **Figure 3-68. Format of the *PowerProfileRequest* Command Payload**

Octets	1
Data Type	uint8
Field Name	PowerProfileID

7004 **3.17.5.1.1.1 Payload Details**

7005 The payload of the *PowerProfileRequest* command carries the fields defined in Figure 3-68.

7006 The *PowerProfileID* field specifies which profile (in the range 1 to *TotalProfileNum*) is requested. The special  
7007 value 0x00 of this field does not refer to a particular profile; if 0x00 value is received the device SHOULD  
7008 send details related to all the available profiles.

7009 The *PowerProfileID* field SHALL NOT be greater than *TotalProfileNum*.

7010 **3.17.5.1.2 When Generated**

7011 This command is generated when the client side of the Power Profile cluster (e.g., a Home gateway device),  
7012 needs to request the power profile to a device supporting the Power Profile cluster server side (e.g., White  
7013 Good).

7014 **3.17.5.1.3 Effect on Receipt**

7015 The device that receives the Power Profile Request command SHALL reply with a *PowerProfileResponse* if  
7016 supported. If the command is not supported the device SHALL reply with a standard ZCL Default response  
7017 with status UNSUP\_COMMAND<sup>72</sup>.

7018 If the requested profile data are not available, the device SHALL reply with a standard ZCL response  
7019 NOT\_FOUND.

7020 **3.17.5.2 PowerProfileStateRequest Command**

7021 The *PowerProfileStateRequest* command is generated in order to retrieve the identifiers of current Power  
7022 Profiles. This command does not have a payload.

7023 **3.17.5.2.1 Effect on Receipt**

7024 On receipt of this command, the device SHALL generate a *PowerProfileStateResponse* command.

7025 **3.17.5.3 GetPowerProfilePriceResponse Command**

7026 The *GetPowerProfilePriceResponse* command allows a device (client) to communicate the cost associated  
7027 with a defined Power Profile to another device (server) requesting it. If the Price information requested re-  
7028 lated to the Power Profile is not available yet the response SHALL be a ZCL default response with "NOT  
7029 FOUND" Status.

7030 **3.17.5.3.1 Payload Format**

7031 The *GetPowerProfilePriceResponse* command payload SHALL be formatted as illustrated in Figure 3-69.

7032 **Figure 3-69. Format of the *GetPowerProfilePriceResponse* Command**

<b>Octets</b>	1	2	4	1
<b>Data Type</b>	uint8	uint16	uint32	uint8
<b>Field Name</b>	Power Profile ID	Currency	Price	Price Trailing Digit

7033 **3.17.5.3.1.1 Payload Details**

7034 **PowerProfileID**

7035 The PowerProfileID field represents the identifier of the specific profile described by the Power Profile.

<sup>72</sup> CCB 2477 status code cleanup

7036 This is typically a sequential and contiguous number ranging from 1 to *TotalProfileNum*.

### 7037 **Currency**

7038 The Currency field identifies the local unit of currency used in the price field. This field is thought to be  
7039 useful for displaying the appropriate symbol for a currency (i.e., \$, €). The value of the currency field  
7040 SHOULD match the values defined by ISO 4217.

### 7041 **Price**

7042 The Price field contains the price of the energy of a specific Power Profile measured in base unit of Currency  
7043 per Unit of Measure (as described in the Metering Cluster, see SE specification) with the decimal point lo-  
7044 cated as indicated by the PriceTrailingDigit field when the energy is delivered to the premise.

### 7045 **Price Trailing Digit**

7046 The PriceTrailingDigit field determines where the decimal point is located in the price field. The PriceTrail-  
7047 ingDigit indicates the number of digits to the right of the decimal point.

## 7048 **3.17.5.3.2 When Generated**

7049 This command is generated when the command Get Power Profile Price is received. Please refer to Get Power  
7050 Profile Price command description.

## 7051 **3.17.5.3.3 Effect on Receipt**

7052 On receipt of this command, the originator (server) is notified of the associated cost of the requested Power  
7053 Profile, calculated by the client side of the Power Profile (see 9.7.10.1 for sequence diagrams and exam-  
7054 ples).

## 7055 **3.17.5.4 GetOverallSchedulePriceResponse Command**

7056 The *GetOverallSchedulePriceResponse* command allows a client to communicate the overall cost associated  
7057 to all Power Profiles scheduled to a server requesting it. If the Price information requested is not available  
7058 the response SHALL be a ZCL default response with “NOT FOUND” Status. The overall cost provided by  
7059 the Power Profile Client side (e.g., energy management system) is intended as the cost of all the scheduled  
7060 power profiles. This information MAY be helpful to assess the overall benefit provided by the scheduler,  
7061 since a change in the scheduling of a specific device might -in some cases-increase its associated Power  
7062 Profile cost. In fact in that case the schedule SHALL provide a global optimization by reducing the overall  
7063 cost of all the scheduled power profiles, then reducing the energy bill for the user.

### 7064 **3.17.5.4.1 Payload Format**

7065 The Get Overall Schedule Price Response command payload SHALL be formatted as illustrated in Figure  
7066 3-70.

7067 **Figure 3-70. Format of the *GetOverallSchedulePriceResponse* Command**

<b>Octets</b>	2	4	1
<b>Data Type</b>	uint16	uint32	uint8
<b>Field Name</b>	Currency	Price	Price Trailing Digit

### 7068 **3.17.5.4.2 Payload Details**

7069 See *GetPowerProfilePriceResponse* command payload details.

7070 **3.17.5.4.3 When Generated**

7071 This command is generated when the command *GetOverallSchedulePriceRequest* is received.

7072 **3.17.5.4.4 Effect on Receipt**

7073 On receipt of this command, the originator is notified of the overall cost of the scheduled Power Profiles,  
7074 calculated by the Power Profile cluster client side. This information MAY be used to assess the overall benefit  
7075 provided by the scheduler, which might be dependent on the schedule constraints. For more information, see  
7076 Chapter 15 Appliance Management, section 3.

7077 **3.17.5.5 Energy Phases Schedule Notification Command**

7078 The Energy Phases Schedule Notification command is generated by a device supporting the client side of the  
7079 Power Profile cluster in order to schedule the start of a Power Profile and its energy phases (they MAY be  
7080 more than one in case of *MultipleScheduling* attribute equal to TRUE) on a the device supporting the server  
7081 side of the Power Profile cluster, which did not solicit the schedule (“un-solicited” schedule). That happens  
7082 when the Power Profile State carries a *PowerProfileRemoteControl* field equal to TRUE and the Energy  
7083 Phase has a *MaxActivationDelay* different than 0x0000 (please note that changes on an already scheduled  
7084 energy phase or power profile are possible but SHOULD be applied just in case of sensible advantages). The  
7085 mechanisms designed to find the proper schedule are not part of the description of this command.

7086 Please consider that, in case the *MultipleScheduling* attribute is FALSE (which means that the server side of  
7087 the Power Profile cluster SHALL support the schedule of only a single energy phase at once), the Energy  
7088 Phases Schedule Notification command SHOULD also be used to set a pause between two energy phases  
7089 (energy pause behavior). In this case the Power Profile State MAY have any values but the command SHALL  
7090 be issued only if the *PowerProfileRemoteControl* is set to TRUE and the Energy Phase has a *MaxActiva-  
7091 tionDelay* different than 0x0000.

7092 **3.17.5.5.1 Payload Format**

7093 The Energy Phases Schedule Notification command payload SHALL be formatted as illustrated in Figure  
7094 3-71.

7095 **Figure 3-71. Format of the *EnergyPhasesScheduleNotification* Command Payload**

<b>Octets</b>	1	1	1	2	...	1	2
<b>Data Type</b>	uint8	uint8	uint8	uint16	...	uint8	uint16
<b>Field Name</b>	Power ProfileID	Num of Scheduled Phases	Energy PhaseID <sub>n</sub>	Scheduled Time <sub>n</sub>	...	Energy PhaseID <sub>n</sub>	Scheduled Time <sub>n</sub>

7096 **3.17.5.5.1.1 Payload Details**

7097 The payload of the *EnergyPhasesScheduleNotification* command carries the fields defined in Figure 3-71.  
7098 Each *EnergyPhasesScheduleNotification* message SHALL include only one Power Profile and the energy  
7099 phases of that Power Profile that needs to be scheduled. In case this command needs to be sent to a device  
7100 supporting the server side of the power Profile Cluster with the *MultipleScheduling* attribute set to false, the  
7101 payload of *EnergyPhasesScheduleNotification* command SHALL carry just one phase and the Scheduled  
7102 Time field SHALL indicate the time scheduled for the whole Power Profile to start (in case the Power Profile  
7103 is not started yet). If the Power Profile is in ENERGY\_PHASE\_RUNNING state and the server side of the  
7104 cluster has the *MultipleScheduling* attribute set to false, the *EnergyPhasesScheduleNotification* command  
7105 SHALL carry the scheduled time of the next energy phase.

**7106 PowerProfileID**

7107 See definition in *PowerProfileNotification* command.

**7108 Num of Scheduled Phases**

7109 The Num of Scheduled Phases field represents the total number of the energy phases of the Power Profile  
7110 that need to be scheduled by this command.

7111 The Energy phases that are not required to be scheduled SHALL NOT be counted in Num of Scheduled  
7112 Phases field. The Num of Scheduled Phases SHALL be equal to 1 in case the *MultipleScheduling* attribute  
7113 set to FALSE (only one energy phase SHALL be scheduled at a time). The *Num of Scheduled Phases* MAY  
7114 be greater than 1 in case the *MultipleScheduling* attribute set to TRUE (scheduling of multiple energy phases  
7115 at the same time).

**7116 EnergyPhaseID**

7117 See definition in *PowerProfileNotification* command.

**7118 Scheduled Time**

7119 The Scheduled Time field represents the relative time scheduled in respect to the end of the previous energy  
7120 phase. The unit is the minute. The Scheduled Time for the first Energy phase represents the scheduled time  
7121 (expressed in relative encoding in respect to the current time) for the start of the Power Profile. The Scheduled  
7122 Time fields for the subsequent Energy phases represent the relative time in minutes in respect to the previous  
7123 scheduled Energy phase. The Energy phases that are not required to be scheduled will not be included in the  
7124 commands and not be counted in Num of Scheduled Phases field. Only the Power Profile carrying a Power  
7125 Profile Remote Control field equal to TRUE (as indicated in Power Profile State Notification command) and  
7126 the Energy Phases supporting *MaxActivationDelay* different than 0x0000 SHALL be schedulable (as indi-  
7127 cated in Power Profile Notification command).

**7128 3.17.5.5.2 When Generated**

7129 This command is generated when the client side of the Power Profile cluster (e.g., a Home gateway device),  
7130 has calculated a specific schedule for a Power Profile and needs to send the schedule (i.e., “unsolicited”  
7131 schedule) to a device supporting the Power Profile cluster server side (e.g., White Goods). This command  
7132 SHALL be generated only if the recipient devices support schedulable Power Profiles (i.e., only if the Power  
7133 Profile carries the first Energy Phase with a *MaxActivationDelay* different than 0x0000).

**7134 3.17.5.5.3 Effect on Receipt**

7135 The device that receives the *EnergyPhasesScheduleNotification* command SHALL reply with a standard De-  
7136 fault response only if requested in the ZCL header of the *EnergyPhasesScheduleNotification* command or  
7137 there is an error (as from ZCL specification).

7138 If the device that receives the *EnergyPhasesScheduleNotification* command cannot schedule the energy  
7139 phases because the activation delay of any of carried phases is equal to zero, it SHALL reply with a standard  
7140 Default response with the error code NOT\_AUTHORIZED (0x7e).

7141 In case the scheduling state of the recipient entity changes after the reception of this command, the recipient  
7142 will issue an Energy Phases Schedule State Notification.

**7143 3.17.5.6 EnergyPhasesScheduleResponse Command**

7144 This command is generated by the client side of Power Profile cluster as a reply to the *EnergyPhasesSched-*  
7145 *uleRequest* command.



### 7146 3.17.5.6.1 Payload Format

7147 The *EnergyPhasesScheduleResponse* command payload SHALL have the same payload as *EnergyPhasesS-*  
7148 *cheduleNotification* command (*EnergyPhasesScheduleNotification* command, but “solicited” schedule be-  
7149 cause it is triggered by the *EnergyPhasesScheduleRequest* command). For more information, see Chapter 15,  
7150 Appliance Management, section 3.

#### 7151 3.17.5.6.1.1 Payload Details

7152 The payload of the *EnergyPhasesScheduleResponse* command carries the same fields as the *EnergyPhasesS-*  
7153 *cheduleNotification* command. (*EnergyPhasesScheduleNotification* command, but “solicited” schedule be-  
7154 cause it is triggered by the *EnergyPhasesScheduleRequest* command)

### 7155 3.17.5.6.2 When Generated

7156 This command is generated when the server side of the Power Profile cluster (e.g., a White Goods device),  
7157 has requested, using the *EnergyPhasesScheduleRequest*, the schedule of a specific power profile to a device  
7158 supporting the Power Profile cluster client side (e.g., Home gateway) which SHALL calculate the schedules  
7159 (“solicited” schedule) and reply with the *EnergyPhasesScheduleResponse*.

### 7160 3.17.5.6.3 Effect on Receipt

7161 The device that receives the *EnergyPhasesScheduleResponse* command SHALL reply with a standard De-  
7162 fault response only if requested in the ZCL header of the *EnergyPhasesScheduleResponse* command. If the  
7163 reception of *EnergyPhasesScheduleResponse* command is not supported the device SHALL reply with a  
7164 standard ZCL Default response with status UNSUP\_COMMAND<sup>73</sup>.

7165 In case the scheduling state of the recipient entity changes after the reception of this command, the recipient  
7166 will issue an *EnergyPhasesScheduleStateNotification*.

## 7167 3.17.5.7 PowerProfileScheduleConstraintsRequest Com- 7168 mand

7169 The *PowerProfileScheduleConstraintsRequest* command is generated by client side of the Power Profile  
7170 cluster in order to request the constraints of the Power Profile of a server, in order to set the proper boundaries  
7171 for the scheduling when calculating the schedules.

### 7172 3.17.5.7.1 Payload Format

7173 The *PowerProfileScheduleConstraintsRequest* command payload is the same as the one used for *PowerPro-*  
7174 *fileRequest* command. For more information, see Chapter 15, Appliance Management, section 3.

#### 7175 3.17.5.7.1.1 Payload Details

7176 The payload of the *PowerProfileScheduleConstraintsRequest* command carries the fields defined in *Power-*  
7177 *ProfileRequest* command.

7178 The Power Profile ID field specifies which profile (among *TotalProfileNum* total profiles number) the con-  
7179 straints are referring to.

---

<sup>73</sup> CCB 2477 status code cleanup

### 7180 3.17.5.7.2 When Generated

7181 This command is generated when the client side of the Power Profile cluster (e.g., a Home gateway device),  
7182 needs to request the constraints of the power profile to a device supporting the Power Profile cluster server  
7183 side (e.g., Whitegood).

### 7184 3.17.5.7.3 Effect on Receipt

7185 The device that receives the Power Profile Schedule Constraints Request command SHALL reply with a  
7186 Power Profile Schedule Constraints Response if supported. If the command is not supported, the device  
7187 SHALL reply with a standard ZCL Default response with status UNSUP\_COMMAND<sup>74</sup>.

7188 If the requested profile data are not available, the device SHALL reply with a standard ZCL response  
7189 NOT\_FOUND.

## 7190 3.17.5.8 EnergyPhasesScheduleStateRequest Command

7191 The *EnergyPhasesScheduleStateRequest* command is generated by a device supporting the client side of the  
7192 Power Profile cluster to check the states of the scheduling of a power profile, which is supported in the device  
7193 implementing the server side of Power Profile cluster. This command can be used to re-align the schedules  
7194 between server and client (e.g., after a client reset).

### 7195 3.17.5.8.1 Payload Format

7196 The *EnergyPhasesScheduleStateRequest* command payload is the same as the one used for *PowerProfile-*  
7197 *Request* command. For more information, see Chapter 15, Appliance Management, section 3.

#### 7198 3.17.5.8.1.1 Payload Details

7199 The payload of the *EnergyPhasesScheduleStateRequest* command carries the same fields defined in the *PowerProfileRequest* command. For more information, see Chapter 15, Appliance Management, section 3.

7201 The Power Profile ID field specifies which profile (among *TotalProfileNum* total profiles number) the con-  
7202 straints are referring to.

### 7203 3.17.5.8.2 When Generated

7204 This command is generated when the client side of the Power Profile cluster (e.g., a Home gateway device),  
7205 needs to check the schedules of the Power Profile to a device supporting the Power Profile cluster server side  
7206 (e.g., White Good).

### 7207 3.17.5.8.3 Effect on Receipt

7208 The server that receives the *EnergyPhasesScheduleStateRequest* command SHALL reply to the client with  
7209 an *EnergyPhasesScheduleStateResponse*, if supported. If the command is not supported, the servers SHALL  
7210 reply with a standard ZCL Default response with status UNSUP\_COMMAND<sup>75</sup>.

7211 If the requested profile data are not available (e.g., invalid Power Profile ID), the server SHALL reply with  
7212 a standard ZCL response NOT\_FOUND.

7213 If the server does not have any schedules set, it SHALL reply with a *EnergyPhasesScheduleStateResponse*  
7214 carrying *NumofScheduledPhases* equal to zero (see Format of the *EnergyPhasesScheduleStateResponse* in  
7215 case of no scheduled phases).

---

<sup>74</sup> CCB 2477 status code cleanup

<sup>75</sup> CCB 2477 status code cleanup

7216 **3.17.5.9 GetPowerProfilePriceExtendedResponse Command**  
7217

7218 The *GetPowerProfilePriceExtendedResponse* command allows a device (client) to communicate the cost  
7219 associated to all Power Profiles scheduled to another device (server) requesting it according to the specific  
7220 options contained in the *EnergyPhasesScheduleStateResponse*. If the Price information requested is not avail-  
7221 able, the response SHALL be a ZCL default response with "NOT FOUND" Status.

7222 **3.17.5.9.1 Payload Format**

7223 The *EnergyPhasesScheduleStateResponse* command payload SHALL be formatted as the *GetPowerProfile-*  
7224 *PriceResponse* command.

7225 **3.17.5.9.2 Payload Details**

7226 See *GetPowerProfilePriceResponse* command payload details.

7227 **3.17.5.9.3 When Generated**

7228 This command is generated when the command *GetPowerProfilePriceExtendedResponse* is received.

7229 **3.17.5.9.4 Effect on Receipt**

7230 On receipt of this command, the originator is notified of cost of the scheduled Power Profiles, calculated by  
7231 the Power Profile cluster server side according to the specific option transmitted in the *EnergyPhasesSched-*  
7232 *uleStateResponse* command (e.g., cost at specific *PowerProfileStartTime*). For more information, see Chap-  
7233 ter 15, Appliance Management, section 3.

7234 **3.17.6 Server Commands Generated**

7235 Cluster-specific commands are generated by the server, as shown in Table 3-139.

7236 **Table 3-139. Cluster-Specific Commands Sent by the Server**

Command Identifier Field Value	Description	M/O
0x00	<i>PowerProfileNotification</i>	M
0x01	<i>PowerProfileResponse</i>	M
0x02	<i>PowerProfileStateResponse</i>	M
0x03	<i>GetPowerProfilePrice</i>	O
0x04	<i>PowerProfilesStateNotification</i>	M
0x05	<i>GetOverallSchedulePrice</i>	O
0x06	<i>EnergyPhasesScheduleRequest</i>	M
0x07	<i>EnergyPhasesScheduleStateResponse</i>	M
0x08	<i>EnergyPhasesScheduleStateNotification</i>	M
0x09	<i>PowerProfileScheduleConstraintsNotification</i>	M
0x0A	<i>PowerProfileScheduleConstraintsResponse</i>	M

Command Identifier Field Value	Description	M/O
0x0B	<i>GetPowerProfilePriceExtended</i>	O

7237

### 7238 3.17.6.1 PowerProfileNotification Command

7239 The *PowerProfileNotification* command is generated by a device supporting the server side of the Power  
7240 Profile cluster in order to send the information of the specific parameters (such as Peak power and others)  
7241 belonging to each phase.

#### 7242 3.17.6.1.1 Payload Format

7243 The *PowerProfileNotification* command payload SHALL be formatted as illustrated in Figure 3-72.

7244 **Figure 3-72. Format of the *PowerProfileNotification* Command Payload (1 of 2)**

<b>Octets</b>	1	1	1	1	1	2	2	2
<b>Data Type</b>	uint8	uint8	uint8	uint8	uint8	uint16	uint16	uint16
<b>Field Name</b>	Total Profile Num	Power ProfileID	Num of Transferred Phases	Energy PhaseID <sub>1</sub>	Macro PhaseID <sub>1</sub>	Expected-Duration <sub>1</sub>	Peak Power <sub>1</sub>	Energy <sub>1</sub>

7245

<b>Octets</b>	2	...	1	1	2	2	2	2
<b>Data Type</b>	uint16	...	uint8	uint8	uint16	uint16	uint16	uint16
<b>Field Name</b>	MaxActivationDelay <sub>1</sub>	...	Energy PhaseID <sub>n</sub>	Macro PhaseID <sub>n</sub>	Expected Duration <sub>n</sub>	Peak Power <sub>n</sub>	Energy <sub>n</sub>	MaxActivationDelay <sub>n</sub>

#### 7246 3.17.6.1.1.1 Payload Details

7247 The payload of the *PowerProfileNotification* command carries the fields defined in Figure 3-72. Each *PowerProfileNotification*  
7248 message SHALL include only one Power Profile.

7249 If multiple phases are transferred within a single *PowerProfileNotification* command (i.e., *Number of Transferred Phases*  
7250 greater than 1), the parameters of the other phases (*PhaseID*, *ExpectedDuration*, etc.)  
7251 SHOULD be carried in the payload. Each phase has a fixed number of parameters and the total length is 10  
7252 octets, so that the total length of the payload could be calculated with the following formula:

7253  $Total\ Payload\ Length = 1 + 1 + 1 + (Num\ of\ Transferred\ Phases * 10)$

#### 7254 **TotalProfileNum**

7255 For more information, see Chapter 15, Appliance Management, section 3.

7256 **PowerProfileID**

7257 The PowerProfileID field represents the identifier of the specific profile described by the Power Profile.

7258 This field contains a sequential and contiguous number ranging from 1 to *TotalProfileNum*.

7259 **Num of Transferred Phases**

7260 This field represents the number of the energy phases of the Power Profile.

7261 **MacroPhaseID**

7262 The MacroPhaseID field represents the identifier of the specific phase (operational-displayed) described by  
7263 the Power Profile.

7264 This reference could be used in conjunction with a table of ASCII strings, describing the label of the func-  
7265 tional phase. This table is not described in the contest of the Power Profile because it MAY be not functionally  
7266 linked with energy management.

7267 **EnergyPhaseID**

7268 The EnergyPhaseID field indicates the identifier of the specific energy phase described by the Power Profile.

7269 This is a sequential and contiguous number ranging from 1 to the maximum number of phases belonging to  
7270 the Power Profile.

7271 The value 0xFF SHALL be used to specify invalid energy phase (e.g., for a Power Profile in IDLE state).

7272 **ExpectedDuration**

7273 The ExpectedDuration field represents the estimated duration of the specific phase. Each unit is a minute.

7274 **PeakPower**

7275 The PeakPower field represents the estimated power for the specific phase. Each unit is a Watt.

7276 **Energy**

7277 The Energy field represents the estimated energy consumption for the accounted phase. Each unit is Watt per  
7278 hours, according to the formatting specified in the *EnergyFormatting* attribute. For more information, see  
7279 Chapter 15, Appliance Management, section 3. The Energy value fulfills the following equation:

7280  $Energy \leq PeakPower(Watt) * ExpectedDuration(sec)$

7281 **MaxActivationDelay**

7282 The MaxActivationDelay field indicates the maximum interruption time between the end of the previous  
7283 phase and the beginning of the specific phase. Each unit is a minute.

7284 The special value 0x0000 means that it is not possible to insert a pause between the two consecutive phases.

7285 The MaxActivationDelay field of the first energy phase of a Power Profile SHALL be set to the value  
7286 0xFFFF.

7287 **3.17.6.1.2 When Generated**

7288 This command is generated when the server side of the Power Profile cluster (e.g., a White Good device),  
7289 need to send the representation of its power profile to a controller device supporting the Power Profile cluster  
7290 client side (e.g., Home Gateway).

7291 **3.17.6.1.3 Effect on Receipt**

7292 The device that receives the *PowerProfileNotification* command SHALL reply with a standard Default re-  
7293 sponse if requested in the ZCL header of the *PowerProfileNotification* command.

7294 **3.17.6.2 PowerProfileResponse Command**

7295 This command is generated by the server side of Power Profile cluster as a reply to the *PowerProfileRequest*  
7296 command. If the reception of *PowerProfileRequest* command is not supported the device SHALL reply with  
7297 a standard ZCL Default response with status UNSUP\_COMMAND<sup>76</sup>.

7298 If the profile data requested are not available, the device SHALL reply with a standard ZCL response INVA-  
7299 LID\_VALUE.

7300 **3.17.6.2.1 Payload Format**

7301 The *PowerProfileResponse* Command payload SHALL be formatted as illustrated in Figure 3-72 (same as  
7302 *PowerProfileNotification* command).

7303 **3.17.6.2.1.1 Payload Details**

7304 The payload of the *PowerProfileResponse* command carries the fields defined in Figure 3-72 (the same as  
7305 *PowerProfileNotification* command).

7306 **3.17.6.2.2 When Generated**

7307 This command is generated by the server side of Power Profile cluster (e.g., White Good) as a reply to the  
7308 *PowerProfileRequest* command sent by the client side (e.g., a Home gateway device).

7309 **3.17.6.2.3 Effect on Receipt**

7310 The device that receives the *PowerProfileResponse* command SHALL reply with a standard Default response  
7311 if requested in the ZCL header of the *PowerProfileResponse* command.

7312 The device that receives the *PowerProfileResponse* command SHALL reply with a standard ZCL Default  
7313 response with status UNSUP\_COMMAND<sup>77</sup> if the reception of this command is not supported.

7314 If the profile data requested are not available, the device SHALL reply with a standard ZCL response INVA-  
7315 LID\_VALUE.

7316 **3.17.6.3 PowerProfileStateResponse Command**

7317 The *PowerProfileStateResponse* command allows a device (server) to communicate its current Power Pro-  
7318 file(s) to another device (client) that previously requested them.

7319 **3.17.6.3.1 Payload Format**

7320 The *PowerProfileStateResponse* command payload SHALL be formatted as illustrated in Figure 3-73.

7321 **Figure 3-73. Format of the *PowerProfileStateResponse* Command Frame**

<b>Octets</b>	1	4	4	...	4
<b>Field Name</b>	Power Profile Count	Power Profile Record 1	Power Profile Record 2	...	Power Profile Record <i>n</i>

7322

<sup>76</sup> CCB 2477 status code cleanup

<sup>77</sup> CCB 2477 status code cleanup

7323 Each Power Profile record SHALL be formatted as illustrated in Figure 3-74.

7324

**Figure 3-74. Format of the Power Profile Record Field**

<b>Octets</b>	1	1	1	1
<b>Data Type</b>	uint8	uint8	bool	enum8
<b>Field Name</b>	Power Profile ID	Energy Phase ID	PowerProfile RemoteControl	PowerProfile State

7325 **3.17.6.3.1.1 Payload Details**

7326 **Power Profile Count**

7327 The Power Profile Count is the number of Power Profile Records that follow in the message.

7328 **Power Profile Record**

7329 The Power Profile record supports the following fields:

- 7330 • **Power Profile ID:** The identifier of the Power Profile as requested.
- 7331 • **Energy Phase ID:** The current Energy Phase ID of the specific Profile ID; this value SHALL be set to  
7332 invalid 0xFF when PowerProfileState indicates a Power Profile in POWER\_PROFILE\_IDLE state.
- 7333 • **PowerProfileRemoteControl:** It indicates if the PowerProfile is currently remotely controllable or  
7334 not; if the Power Profile is not remotely controllable it cannot be scheduled by a Power Profile client.
- 7335 • **PowerProfileState:** An enumeration field representing the current state of the Power Profile (see Ta-  
7336 ble 3-140).

7337

**Table 3-140. PowerProfileState Enumeration Field**

Enumeration	Value	Description
POWER_PROFILE_IDLE	0x00	The PP is not defined in its parameters.
POWER_PROFILE_PROGRAMMED	0x01	The PP is defined in its parameters but without a scheduled time reference
ENERGY_PHASE_RUNNING	0x03	An energy phase is running
ENERGY_PHASE_PAUSED	0x04	The current energy phase is paused
ENERGY_PHASE_WAITING_TO_START	0x05	The Power Profile is in between two energy phases (one ended, the other not yet started). If the first Energy Phase is considered, this state indicates that the whole power profile is not yet started, but it has been already programmed to start
ENERGY_PHASE_WAITING_PAUSED	0x06	The Power Profile is set to Pause when being in the ENERGY_PHASE_WAITING_TO_START state.
POWER_PROFILE_ENDED	0x07	The whole Power Profile is terminated

7338

7339

Figure 3-75. Power Profile States

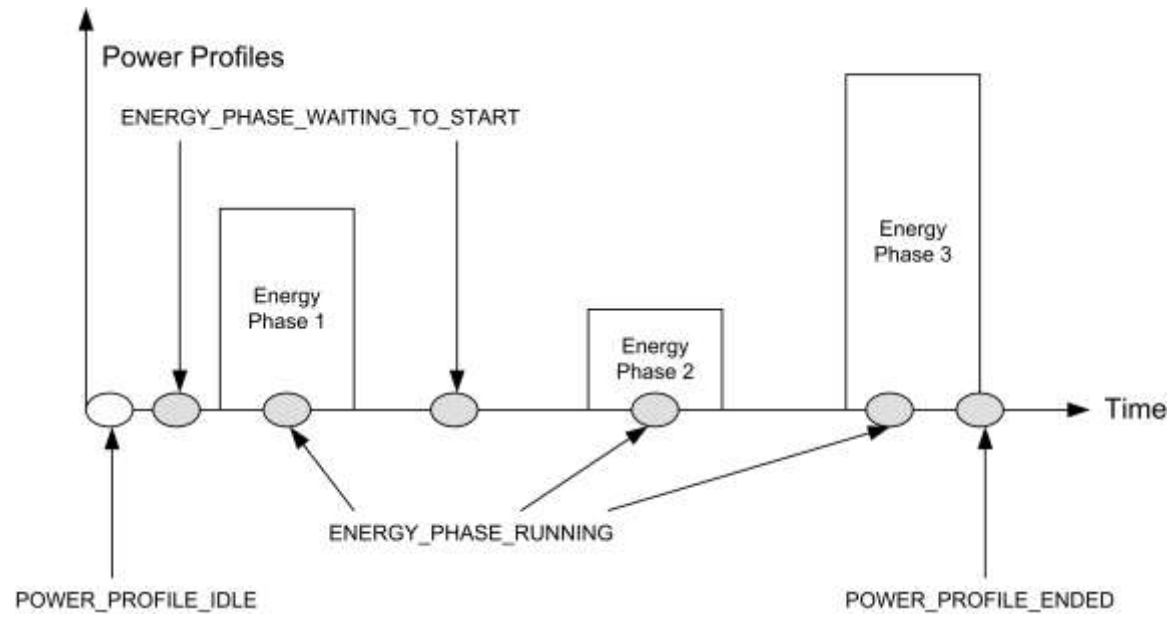

7340

7341

Figure 3-76. Power Profile State Diagram



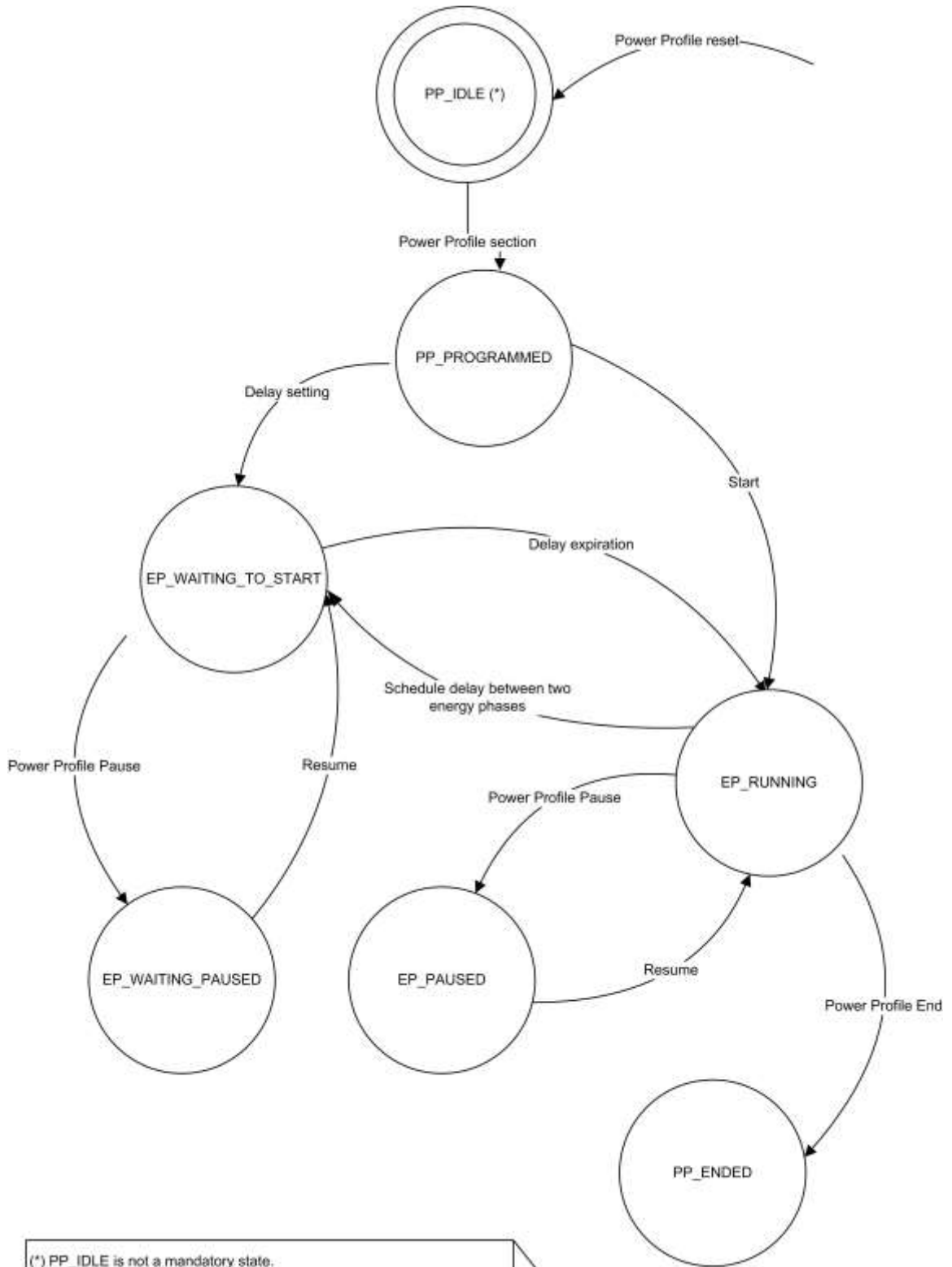

(\*) PP\_IDLE is not a mandatory state. Some machine could not have this state; in this case the state machine automatically starts with PP\_PROGRAMMED.

7342

7343 **3.17.6.3.2 When Generated**

7344 This command is generated when the command *PowerProfileStateRequest* is received. For more information,  
7345 see Chapter 15, Appliance Management, section 3.

### 7346 **3.17.6.3.3 Effect on Receipt**

7347 On receipt of this command, the originator is notified of the results of its Read Current Power Profiles attempt  
7348 (i.e., receives the Power Profiles currently running in the server device).

## 7349 **3.17.6.4 GetPowerProfilePrice Command**

7350 The *GetPowerProfilePrice* command is generated by the server (e.g., White Goods) in order to retrieve the  
7351 cost associated to a specific Power Profile. This command has the same payload as the Power Profile Request  
7352 command. For more information, see Chapter 15, Appliance Management, section 3.

### 7353 **3.17.6.4.1 Effect on Receipt**

7354 On receipt of this command, the recipient device SHALL generate a *GetPowerProfilePriceResponse* com-  
7355 mand. For more information, see Chapter 15, Appliance Management, section 3.

## 7356 **3.17.6.5 PowerProfileStateNotification Command**

7357 The *PowerProfileStateNotification* command is generated by the server (e.g., White Goods) in order to up-  
7358 date the state of the power profile and the current energy phase. It has the same payload as the *PowerPro-  
7359 fileStateResponse* command but it is an unsolicited command.

### 7360 **3.17.6.5.1 Effect on Receipt**

7361 On receipt of this command, the recipient device will update its information related to the PowerProfile of  
7362 the device (e.g., it will update the forecasts of the durations of the Power Profile's energy phases with the  
7363 actual data).

## 7364 **3.17.6.6 GetOverallSchedulePrice Command**

7365 The *GetOverallSchedulePrice* command is generated by the server (e.g., White Goods) in order to retrieve  
7366 the overall cost associated to all the Power Profiles scheduled by the scheduler (the device supporting the  
7367 Power Profile cluster client side) for the next 24 hours. This command has no payload.

### 7368 **3.17.6.6.1 Effect on Receipt**

7369 On receipt of this command, the recipient device SHALL generate a *GetOverallSchedulePriceResponse* com-  
7370 mand. For more information, see Chapter 15, Appliance Management, section 3.

## 7371 **3.17.6.7 EnergyPhasesScheduleRequest Command**

7372 The *EnergyPhasesScheduleRequest* Command is generated by the server (e.g., White Goods) in order to  
7373 retrieve from the scheduler (e.g., Home Gateway) the schedule (if available) associated to the specific Power  
7374 Profile carried in the payload. This command has the same payload as the Power Profile Request. For more  
7375 information, see Chapter 15, Appliance Management, section 3.

7376 **3.17.6.7.1 Effect on Receipt**

7377 On receipt of this command, the recipient device SHALL generate an *EnergyPhasesScheduleResponse* com-  
7378 mand in order to notify the proper scheduling to the server side of the Power Profile cluster (“solicited”  
7379 schedule). For more information, see Chapter 15, Appliance Management, section 3. If the schedule is ac-  
7380 cepted by the PowerProfile server side (e.g., the appliance) the PowerProfile SHALL have the state EN-  
7381 ERGY\_PHASE\_WAITING\_TO\_START (delay start set for the first energy phase of the power profile). If  
7382 the device receiving the *EnergyPhasesScheduleResponse* command cannot accept the schedule of the energy  
7383 phases because the activation delay related to any of carried phases is equal to zero, it SHALL reply with a  
7384 standard Default response with the error code NOT\_AUTHORIZED (0x7e).

7385 **3.17.6.8 EnergyPhasesScheduleStateResponse Com-**  
7386 **mand**

7387 The *EnergyPhasesScheduleStateResponse* command is generated by the server (e.g., White Goods) in order  
7388 to reply to an *EnergyPhasesScheduleStateRequest* command about the scheduling states that are set in the  
7389 server side. For more information, see Chapter 15, Appliance Management, section 3. The payload of this  
7390 command is the same as *EnergyPhasesScheduleNotification*. In case of no scheduled energy phases, the pay-  
7391 load shown in Figure 3-77 SHALL be used.

7392 **Figure 3-77. Format of *EnergyPhasesScheduleStateResponse* in Case of No Scheduled Phases**

<b>Octets</b>	1	1
<b>Data Type</b>	uint8	uint8
<b>Field Name</b>	PowerProfileID	Num of Scheduled Energy Phases=0x00

7393 **3.17.6.8.1 Effect on Receipt**

7394 On receipt of this command, the recipient device will be notified about the scheduling activity of the server  
7395 side of the Power Profile Cluster.

7396 Please note that the schedules MAY be set by the scheduling commands listed in this cluster or by the users  
7397 (e.g., delay start of an appliance).

7398 **3.17.6.9 EnergyPhasesScheduleStateNotification Com-**  
7399 **mand**

7400 The *EnergyPhasesScheduleStateNotification* command is generated by the server (e.g., White Goods) in or-  
7401 der to notify (un-solicited command) a client side about the scheduling states that are set in the server side.  
7402 The payload of this command is the same as *EnergyPhasesScheduleStateResponse*.

7403 **3.17.6.9.1 Effect on Receipt**

7404 On receipt of this command, the recipient devices will be notified about the scheduling activity of the server  
7405 side of the Power Profile Cluster.

### 7406 3.17.6.10 PowerProfileScheduleConstraintsNotification 7407 Command

7408 The *PowerProfileScheduleConstraintsNotification* command is generated by a device supporting the server  
7409 side of the Power Profile cluster to notify the client side of this cluster about the imposed constraints and let  
7410 the scheduler (i.e., the entity supporting the Power Profile cluster client side) to set the proper boundaries for  
7411 the scheduling.

#### 7412 3.17.6.10.1 Payload Format

7413 The *PowerProfileScheduleConstraintsNotification* command payload is reported in Figure 3-78.

7414 **Figure 3-78. Format of the *PowerProfileScheduleConstraintsNotification* Command Frame**

Octets	1	2	2
Data Type	uint8	uint16	uint16
Field Name	PowerProfileID	Start After	Stop Before

#### 7415 3.17.6.10.1.1 Payload Details

7416 The payload of the *PowerProfileScheduleConstraintsNotification* command carries the following fields:

- 7417 • The Power Profile ID field specifies which profile (among *TotalProfileNum* total profiles number) the  
7418 constraints are referring to.
- 7419 • The *StartAfter* parameter represents the relative time in minutes (in respect to the time of the reception  
7420 of this command), that limits the start of the Power Profile; it means that the Power Profile SHOULD  
7421 be scheduled to start after a period of time equal to *StartAfter*; if this value is not specified by the de-  
7422 vice the value SHALL be 0x0000;
- 7423 • The *StopBefore* parameter represents the relative time in minutes (in respect to the time of the recep-  
7424 tion of this command), that limits the end of the Power Profile; it means that the Power Profile  
7425 SHOULD be scheduled to end before a period of time equal to *StopBefore*; if this value is not specified  
7426 by the device the value SHALL be 0xFFFF.

#### 7427 3.17.6.10.2 When Generated

7428 This command is generated when the server side of the Power Profile cluster (e.g., a White Goods device),  
7429 needs to notify a change in the constraints of the Power Profile (e.g., the user selected boundaries for the  
7430 specific behavior of the device).

#### 7431 3.17.6.10.3 Effect on Receipt

7432 The device that receives the *PowerProfileScheduleConstraintsNotification* command SHALL use the infor-  
7433 mation carried in the payload of this command to refine the proper schedule of the specific Power Profile  
7434 indicated in the Power Profile ID field in order to meet the constraints.

7435 **3.17.6.11 PowerProfileScheduleConstraintsResponse**  
7436 **Command**

7437 The *PowerProfileScheduleConstraintsResponse* command is generated by a device supporting the server side  
7438 of the Power Profile cluster to reply to a client side of this cluster which sent a *PowerProfileScheduleCon-*  
7439 *straintsRequest*. The payload carries the selected constraints to let the scheduler (i.e., the entity supporting  
7440 the Power Profile client cluster) to set the proper boundaries for completing or refining the scheduling.

7441 **3.17.6.11.1 Payload Format**

7442 Same as *PowerProfileScheduleConstraintsNotification* command. For more information, see Chapter 15,  
7443 Appliance Management, section 3.

7444 **3.17.6.11.2 When Generated**

7445 This command is generated as a reply to the Power Profile Schedule Constraints Request.

7446 **3.17.6.11.3 Effect on Receipt**

7447 The device that receives the Power Profile Schedule ConstraintsResponse command SHALL use the infor-  
7448 mation carried in the payload of this command to refine the proper schedule of the specific Power Profile  
7449 indicated in the Power ProfileID field.

7450 **3.17.6.12 GetPowerProfilePriceExtended Command**

7451 The *GetPowerProfilePriceExtended* command is generated by the server (e.g., White Goods) in order to  
7452 retrieve the cost associated to a specific Power Profile considering specific conditions described in the option  
7453 field (e.g., a specific time).

7454 **3.17.6.12.1 Payload Format**

7455 The *GetPowerProfilePriceExtended* command payload SHALL be formatted as illustrated in Figure 3-79.

7456 **Figure 3-79. Format of the *GetPowerProfilePriceExtended* Command Payload**

<b>Octets</b>	1	1	0/2
<b>Data Type</b>	map8	uint8	uint16
<b>Field Name</b>	Options	PowerProfileID	PowerProfileStartTime

7457

7458 **Table 3-141. Options Field**

<b>Bit</b>	<b>Description</b>
0	Bit0=1 : PowerProfileStartTime Field Present
1	Bit1=0 : provide an estimation of the price considering the power profile with contiguous energy phases

Bit	Description
	Bit1=1 : provide an estimation of the price considering the power profile as scheduled (i.e., taking in account delays between Energy phases set by the EMS)

7459

**Options**

7461 The Options field represents the type of request of extended price is requested to the client side of the power  
7462 profile cluster (e.g., to an energy management system).

**PowerProfileStartTime**

7464 The PowerProfileStartTime field represents the relative time (expressed in relative encoding in respect to the  
7465 current time) when the overall Power Profile can potentially start. The unit is the minute.

**3.17.6.12.2 Effect on Receipt**

7467 On receipt of this command, the recipient device SHALL generate a *GetPowerProfilePriceExtendedResponse*  
7468 command. For more information, see Chapter 15, Appliance Management, section 3.

**3.17.7 Client Attributes**

7470 The client has no cluster specific attributes.

**3.17.8 Client Commands Received**

7472 Description is in server side commands generated (sent) description.

**3.17.9 Client Commands Generated**

7474 Description is in server side commands received description.

**3.17.10 Example of Device Interactions Using the Power Profile (Informative Section)****3.17.10.1 Price Information Retrieved by the White Goods**

7478 The price of a specific appliance program is estimated by the Home gateway/EMS, calculated using the  
7479 Power Profile forecast provided by the appliance and the *PowerProfileStartTime* contained in the *GetPowerProfilePriceExtended*  
7480 which indicates when the appliance program will start. How the Home Gateway/EMS retrieves from the utility the information related to tariff schemes and price changes over time is  
7481 out of scope of this specification.  
7482

7483 The appliance MAY then show to the user on the display the price associated to a specific cycle set (e.g., a  
7484 washing machine program “Cotton 90 °C” will cost you “1.15€”).

7485

**Figure 3-80. Visualization of Price Associated to a Power Profile**

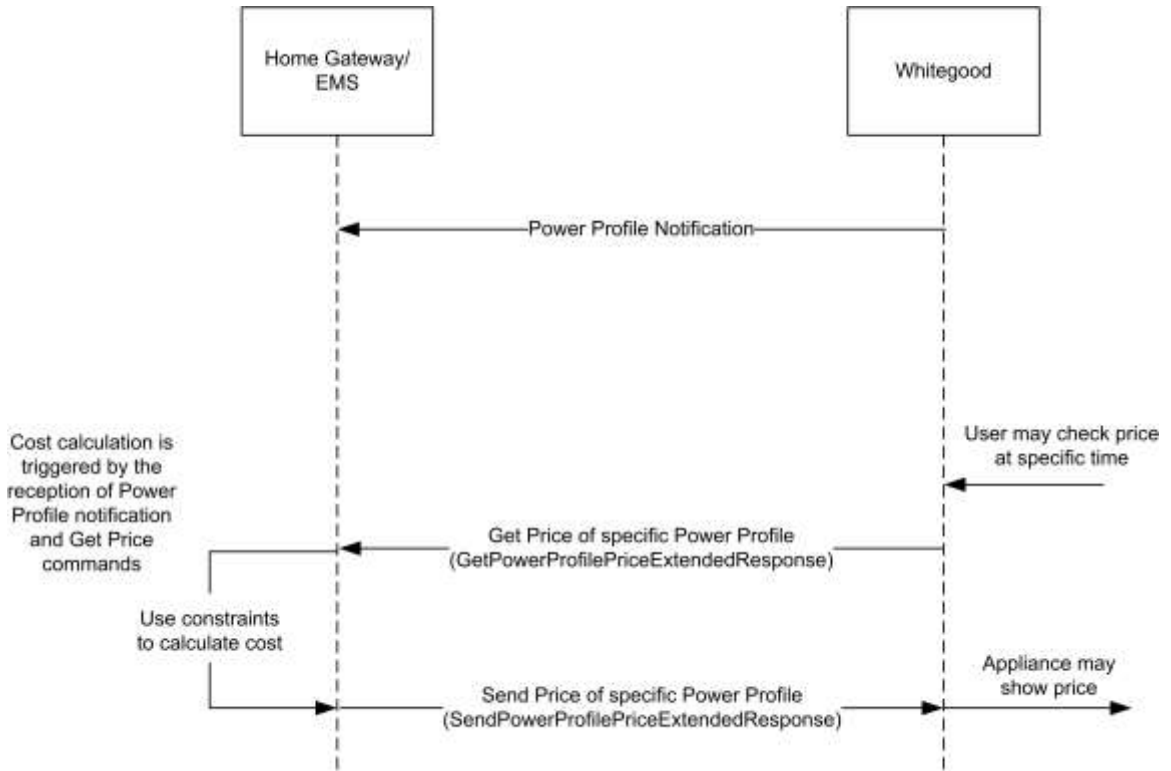

7486

7487 **3.17.10.2 Interaction with Power Profile Cluster When Appliance Is Not Remotely Controllable**  
7488

7489 **Figure 3-81. Energy Remote Disabled: Example of Sequence Diagram with User Interaction**

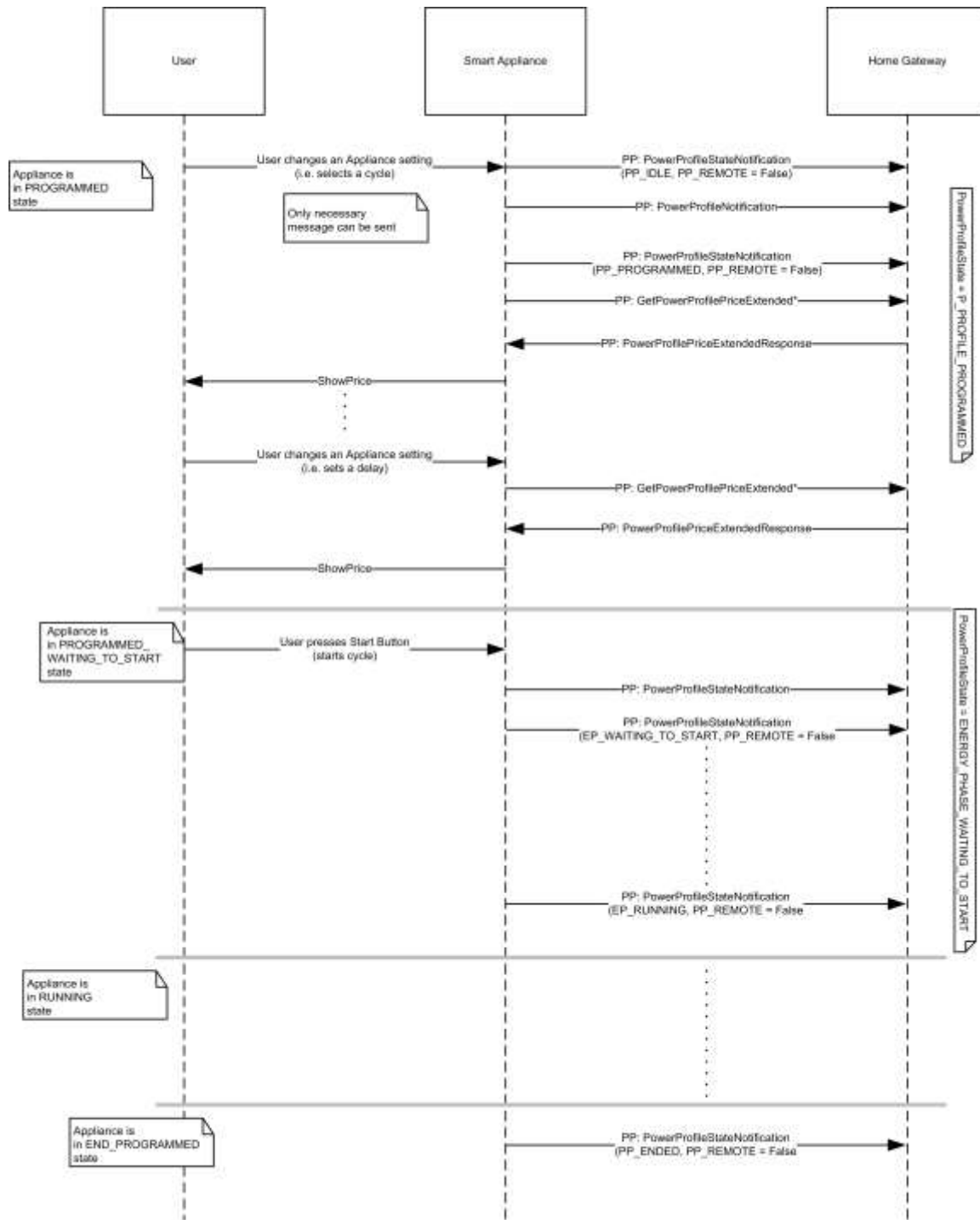

\*GetPowerProfilePriceExtended payload includes delay time to start

7490  
7491



7492  
7493  
7494  
7495

### 3.17.10.3 Interaction with Power Profile Cluster When Appliance Is Remotely Controllable (Scheduling of Appliance)

Figure 3-82. Energy Remote Enabled: Example of Sequence Diagram with User Interaction

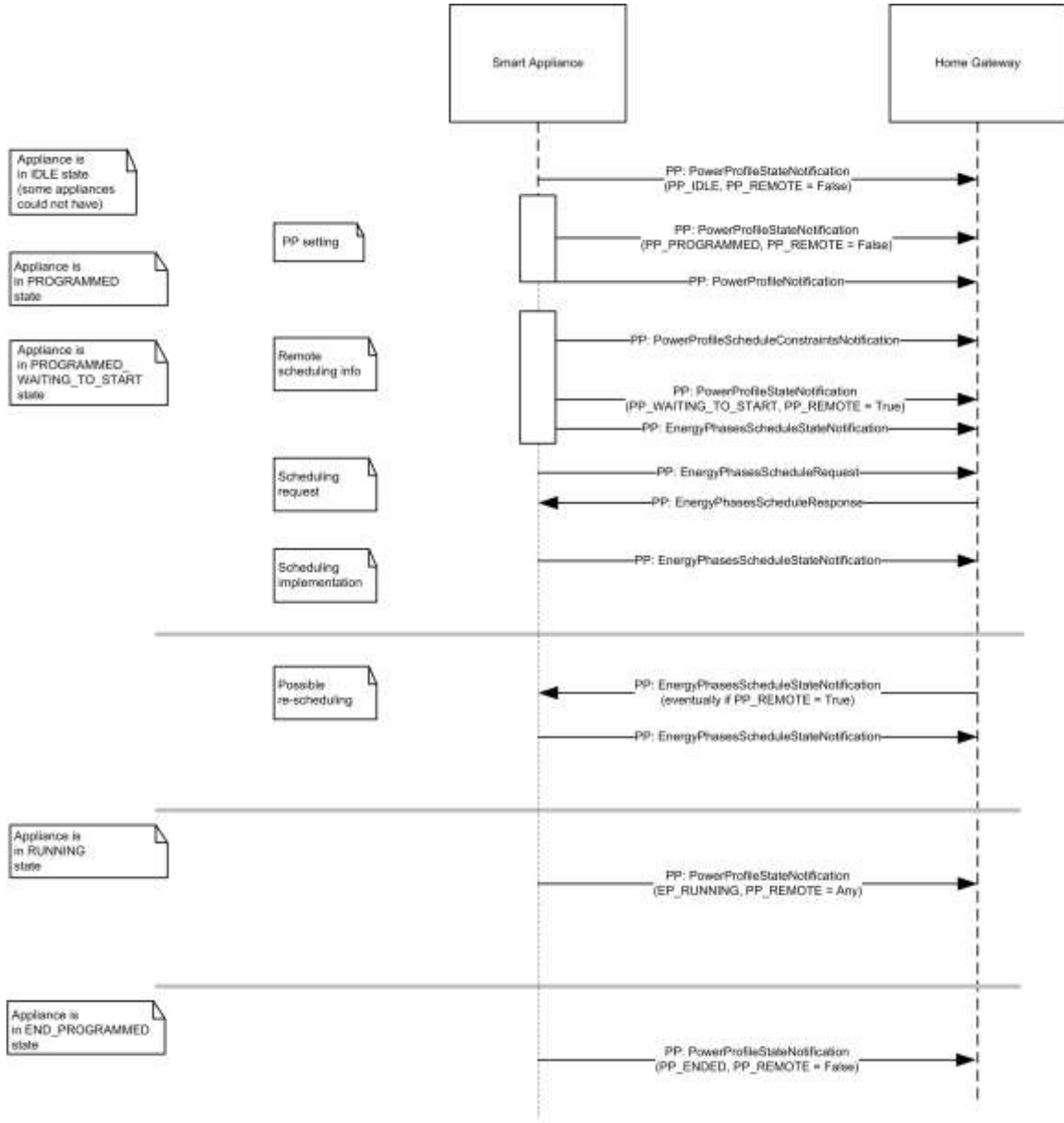

7496

\*GetPowerProfilePriceExtended can be generated any time by SA if a PP is active

7497

## 3.18 Keep Alive<sup>78</sup>

7498

### 3.18.1 Overview

7499  
7500

This cluster supports the commands and attributes directed to the network Trust Center in order to determine whether communication with the Trust Center is still available.

7501 **3.18.1.1 Revision History**

Rev	Description
1	Added from SE1.4

7502 **3.18.1.2 Classification**

Hierarchy	Role	PICS Code
Base	Utility	KA

7503 **3.18.1.3 Cluster Identifiers**

Identifier	Name
0x0025	Keep-Alive

7504 **3.18.2 Server**7505 **3.18.2.1 Attributes**

7506 The currently defined attributes are listed in the following table:

7507 **Table 3-142. Keep-Alive Server Attributes**

Id	Name	Type	Range	Access	Default	M/O
0x0000	<i>TC Keep-Alive Base</i>	uint8	0x00 to 0xFF	R	0x0A	M
0x0001	<i>TC Keep-Alive Jitter</i>	uint16	0x0000 to 0xFFFF	R	0x012C	M

7508 **3.18.2.1.1 TC Keep-Alive Base Attribute**

7509 *TC Keep-Alive Base* represents the base time (**in minutes**) used for calculating each interval used by the  
 7510 keep-alive mechanism to determine whether contact with the Trust Center is still available. Each interval is  
 7511 ‘jittered’ by adding a random value in the range defined by the *TC Keep-Alive Jitter* attribute. A value of  
 7512 0x00 is not allowed. Following power-up or reboot, a client device should utilize the default times until  
 7513 required values are fetched from the cluster attributes.

7514 **3.18.2.1.2 TC Keep-Alive Jitter Attribute**

7515 *TC Keep-Alive Jitter* indicates the range (**in seconds**) for the random element added to value of the *TC Keep-  
 7516 Alive Base* attribute when calculating each interval for the keep-alive mechanism that determines whether  
 7517 contact with the Trust Center is still available.

7518 **3.18.2.2 Commands Generated**

7519 There are no commands generated by the cluster server.

7520 **3.18.3 Client**

7521 There are no cluster specific attributes or commands received or generated for the cluster client.

7522 **3.18.4 Application Guidelines**

7523 **Routers:**

7524 In order to detect when a TC is no longer available, all routers shall implement a keep-alive mechanism  
7525 with the TC. The *Keep-Alive* cluster is mandatory when supporting Trust Center Swap-out. Presence of the  
7526 *Keep-Alive* cluster attributes shall indicate support of the keep-alive mechanism by the device providing the  
7527 *Keep-Alive* cluster server. The routers shall send an APS encrypted *Read Attributes* command to the *Keep-*  
7528 *Alive* cluster on a periodic interval defined by the cluster’s *TC Keep-Alive Base* and *TC Keep-Alive Jitter*  
7529 attributes. Each interval shall be calculated by adding a different random value, in the range defined by the  
7530 *TC Keep-Alive Jitter* attribute, to the base time defined by the *TC Keep-Alive Base* attribute. Each *Read*  
7531 *Attributes* command shall request both the *TC Keep-Alive Base* and *TC Keep-Alive Jitter* attributes. Failure  
7532 to receive an APS-encrypted *Read Attribute Response* command shall indicate the TC is no longer avail-  
7533 able. If the device fails to read the *Keep-Alive* cluster attributes on 3 successive attempts it shall consider  
7534 the TC no longer accessible and initiate a search for it. Failure of the encryption or frame counter shall  
7535 constitute a failure of the keep-alive.

7536 **End Devices:**

7537 End devices should ensure that they can still communicate with the TC by exchanging messages at a rate  
7538 suitable for their particular implementation. End devices MAY utilize the *Keep-Alive* cluster for this pur-  
7539 pose

7540 **3.19 Level Control for Lighting**

---

7541 **3.19.1 Overview**

7542 Please see Chapter 2 for a general cluster overview defining cluster architecture, revision, classification,  
7543 identification, etc.

7544 This cluster provides an interface for controlling the level of a light source.

7545 All requirements and dependencies are derived from the base cluster. Additional or extended requirements  
7546 and dependencies are listed in this cluster specification.

7547  
7548 NOTE: This cluster specification is derived from the Level cluster specification (generic level control also  
7549 defined in this document). This cluster specifies further requirements for the lighting application. Please see  
7550 section 3.10 for the generic Level cluster specification.

7551 **3.19.1.1 Revision History**

7552 The global *ClusterRevision* attribute value SHALL be the highest revision number in the table below.

Rev	Description
1	global mandatory <i>ClusterRevision</i> attribute added
2	added <i>Options</i> attribute, state change table; ZLO 1.0; Derived from base Level (no change) CCB 2085 1775 2281 2147

7553 **3.19.1.2 Classification**

Hierarchy	Base	Role	PICS Code	Primary Transaction
Derived	Level (3.10)	Application	LC	Type 1 (client to server)

7554 **3.19.1.3 Cluster Identifiers**

Identifier	Name
0x0008	Level Control for Lighting

7555 **3.19.2 Server**7556 **3.19.2.1 Dependencies**

7557 Please see examples of state changes with regards to the On/Off server cluster in section 3.19.4.

7558

7559 **3.19.2.2 Attributes**7560 The Level Control for Lighting server cluster supports the base attributes below. See the base cluster for  
7561 details. Additional requirements are defined here.

7562

7563

7564

Table 3-143. Attributes of the Level Control for Lighting server cluster

Name	Range	Default	M/O
<i>CurrentLevel</i>	1 to FE	0xff	M
<i>RemainingTime</i>	<i>base</i> <sup>79</sup>	<i>base</i>	O
<i>CurrentFrequency</i>	<i>base</i>	<i>base</i>	O
<i>MinFrequency</i>	<i>base</i>	<i>base</i>	M: <i>CurrentFrequency</i> <sup>80</sup>
<i>MaxFrequency</i>	<i>base</i>	<i>base</i>	M: <i>CurrentFrequency</i>
<i>OnOffTransitionTime</i>	<i>base</i>	<i>base</i>	O
<i>OnLevel</i>	<i>base</i>	<i>base</i>	O
<i>OnTransitionTime</i>	<i>base</i>	<i>base</i>	O
<i>OffTransitionTime</i>	<i>base</i>	<i>base</i>	O
<i>DefaultMoveRate</i>	<i>base</i>	<i>base</i>	O
<i>Options</i>	<i>base</i>	<i>base</i>	M

<sup>79</sup> see base cluster for definition<sup>80</sup> Mandatory if *CurrentFrequency* supported

Name	Range	Default	M/O
<i>StartUpCurrentLevel</i>	<i>base</i>	<i>base</i>	O

7565 **3.19.2.2.1 CurrentLevel Attribute for Lighting**

- 7566 A value of 0 SHALL not be used.
- 7567 A value of 1 SHALL indicate the minimum level that can be attained on a device.
- 7568 A value of 0xfe SHALL indicate the maximum level that can be attained on a device.
- 7569 A non-value of 0xff SHALL represent an undefined value.
- 7570 All other values are application specific gradations from the minimum to the maximum level.

7571 **3.19.2.2.2 CurrentFrequency Attribute**

- 7572 The *CurrentFrequency* attribute represents the frequency in 10Hz (hertz) increments up to 655.34 kHz. A
- 7573 value of 0 is unknown.

7574 **3.19.2.2.3 Options Attribute for Lighting**

- 7575 Below describes the lighting specific bits of the *Options* attribute. All other bits are defined, or reserved by
- 7576 the base cluster.

7577 **Table 3-144. Options Attribute**

Bit	Name	Values & Summary
1	CoupleColorTempToLevel (See Color Control cluster)	0 - Do not couple changes to the <i>CurrentLevel</i> attribute with the color temperature. 1 - Couple changes to the <i>CurrentLevel</i> attribute with the color temperature.

7578 **3.19.2.3 Commands Received**

- 7579 The command IDs for the cluster are listed below:

7580 **Table 3-145. Commands for the Pulse Width Modulation cluster**

ID	Description	M/O
0x00	Move to Level	M
0x01	Move	M
0x02	Step	M
0x03	Stop	M
0x04	Move to Level (with On/Off)	M

ID	Description	M/O
0x05	Move (with On/Off)	M
0x06	Step (with On/Off)	M
0x07	Stop	M
0x08	Move to Closest Frequency	<i>M:CurrentFrequency</i>

7581 **3.19.2.4 Commands Generated**

7582 There are no commands generated by the server.

7583 **3.19.3 Client**

7584 The client has no cluster specific attributes. The client generates the cluster specific commands received by  
7585 the server, as required by the application. No cluster specific commands are received by the client.

7586 **3.19.4 State Change Table for Lighting**

7587 Below is a table of examples of state changes when Level Control for Lighting and On/Off clusters are on  
7588 the same endpoint.

7589 *EiO* - *ExecuteIfOff* field in the *Options* attribute

7590 *OnOff* – attribute value of On/Off cluster 0=Off, 1=On

7591 *MIN* - *MinLevel*

7592 *MAX* - *MaxLevel*

7593 *MID* – midpoint between *MinLevel* and *MaxLevel*

7594 **Table 3-146. Lighting Device State Change**

<i>Current Level</i>	<i>EiO</i>	<i>OnOff</i>	<i>Physical Device</i>	<b>Command</b> ← Before After →	<i>Current Level</i>	<i>OnOff</i>	<i>Physical Device</i>	<b>Device Output Result</b>
<i>any</i>	0	0	Off	Move to level <i>MID</i> over 2 sec	<i>same</i>	0	Off	stays off
<i>any</i>	0	0	Off	Move with On/Off to level <i>MID</i> over 2 sec	<i>MID</i>	1	On (mid-point brightness)	turns on and output level adjusts or stays at half

<i>Current Level</i>	<i>EiO</i>	<i>OnOff</i>	<b>Physical Device</b>	<b>Command</b> ← Before After →	<i>Current Level</i>	<i>OnOff</i>	<b>Physical Device</b>	<b>Device Output Result</b>
<i>any</i>	1	0	Off	Move to level <i>MID</i> over 2 sec	<i>MID</i>	0	Off	stays off
<i>any</i>	1	0	Off	Move with On/Off to level <i>MID</i> over 2 sec	<i>MID</i>	1	On	turns on and output level adjusts to or stays at half
<i>any</i>	1	0	Off	Move rate = up 64 per second	<i>MAX</i>	0	Off	stays off
<i>any</i>	1	0	Off	Move with On/Off rate = up 64 per second	<i>MAX</i>	1	On	turn on and output level adjusts to or stays at full
<i>any</i>	1	0	Off	Move (with On/Off) rate = down 64 per second	<i>MIN</i>	0	Off	stays off
<i>any</i>	<i>any</i>	1	On (any brightness)	Move (with On/Off) to level <i>MID</i> over 2 sec	<i>MID</i>	1	On (mid-point brightness)	output level adjusts to or stays at half
<i>any</i>	<i>any</i>	1	On (any brightness)	Move (with On/Off) rate = up 64 per second	<i>MAX</i>	1	On (full brightness)	output level adjusts to or stays at full
<i>any</i>	<i>any</i>	1	On (any brightness)	Move rate = down 64 per second	<i>MIN</i>	0	On (at minimum brightness)	output level adjusts to minimum
<i>any</i>	<i>any</i>	1	On (any brightness)	Move with On/Off rate = down 64 per second	<i>MIN</i>	0	Off	output level adjusts to off

7595

7596 

## 3.20 Pulse Width Modulation

7597 

### 3.20.1 Overview

7598 Please see Chapter 2 for a general cluster overview defining cluster architecture, revision, classification,  
7599 identification, etc.

7600 This cluster provides an interface for controlling the Pulse Width Modulation (PWM) characteristics of a  
7601 device. Typical applications include heating element and fan control (10-100Hz), DC electric motors and  
7602 power efficient LED control (5-10kHz), and switching power supplies (>20kHz). For the purposes of PWM,  
7603 the value of level is effectively a duty cycle. The frequency and level (duty cycle) values are reportable and  
7604 may be configured for reporting.

7605 

#### 3.20.1.1 Revision History

7606 The global *ClusterRevision* attribute value SHALL be the highest revision number in the table below.

Rev	Description
1	global mandatory <i>ClusterRevision</i> attribute added

7607 

#### 3.20.1.2 Classification

Hierarchy	Base	Role	PICS Code	Primary Transaction
Derived	Level (3.10)	Application	PWM	Type 1 (client to server)

7608 

#### 3.20.1.3 Cluster Identifiers

Identifier	Name
0x001c	Pulse Width Modulation

7609 

### 3.20.2 Server

7610 The server requirements and dependencies are derived from the base cluster. Additional requirements are  
7611 listed in this section below.

7612 

#### 3.20.2.1 Attributes

7613 The Pulse Width Modulation server cluster supports the base attributes below. See the base cluster for details.  
7614 Additional requirements are defined here.

7615 **Table 3-147. Attributes of the Pulse Width Modulation server cluster**

Name	Range	Default	M/O
<i>CurrentLevel</i>	<i>MinLevel</i> to <i>MaxLevel</i>	0xff	M
<i>MinLevel</i>	0 to <i>MaxLevel</i>	0	M
<i>MaxLevel</i>	<i>MinLevel</i> to 100	100	M



Name	Range	Default	M/O
<i>CurrentFrequency</i>	<i>MinFrequency</i> to <i>MaxFrequency</i>	0	M
<i>MinFrequency</i>	0 to <i>MaxFrequency</i>	0	M
<i>MaxFrequency</i>	<i>MinFrequency</i> to 0xffff	0	M

7616 **3.20.2.1.1 CurrentLevel Attribute**

7617 The *CurrentLevel* attribute represents a duty cycle as a percentage. A non-value means the level is unknown.

7618 **3.20.2.1.2 CurrentFrequency Attribute**

7619 The *CurrentFrequency* attribute represents the frequency in 10Hz (hertz) increments up to 655.34 kHz. A  
7620 value of 0 is unknown.

7621 **3.20.2.2 Commands Received**

7622 The command IDs for the cluster are listed below:

7623 **Table 3-148. Commands for the Pulse Width Modulation cluster**

ID	Description	M/O
0x00	Move to Level	M
0x01	Move	M
0x02	Step	M
0x03	Stop	M
0x04	Move to Level (with On/Off)	M
0x05	Move (with On/Off)	M
0x06	Step (with On/Off)	M
0x07	Stop	M
0x08	Move to Closest Frequency	M

7624 **3.20.2.3 Commands Generated**

7625 There are no commands generated by the server.

7626 **3.20.3 Client**

7627 The client has no cluster specific attributes. The client generates the cluster specific commands received by  
7628 the server, as required by the application. No cluster specific commands are received by the client.



7629

## CHAPTER 4 MEASUREMENT AND SENSING

7630

The Cluster Library is made of individual chapters such as this one. See Document Control in the Cluster

7631

Library for a list of all chapters and documents. References between chapters are made using a *X.Y* notation

7632

where *X* is the chapter and *Y* is the sub-section within that chapter. References to external documents are

7633

contained in Chapter 1 and are made using [*Rn*] notation.

7634

### 4.1 General Description

7635

#### 4.1.1 Introduction

7636

The clusters specified in this document are generic measurement and sensing interfaces that are sufficiently

7637

general to be of use across a wide range of application domains.

7638

#### 4.1.2 Cluster List

7639

This section lists the clusters specified in this document and gives examples of typical usage.

7640

##### 4.1.2.1 Illuminance Measurement and Level Sensing

7641

Table 4-1. Illuminance Measurement and Level Sensing Clusters

Cluster ID	Cluster Name	Description
0x0400	Illuminance Measurement	Attributes and commands for configuring the measurement of illuminance, and reporting illuminance measurements
0x0401	Illuminance Level Sensing	Attributes and commands for configuring the sensing of illuminance levels, and reporting whether illuminance is above, below, or on target

7642

7643

**Figure 4-1. Typical Usage of Illuminance Measurement and Level Sensing Clusters**

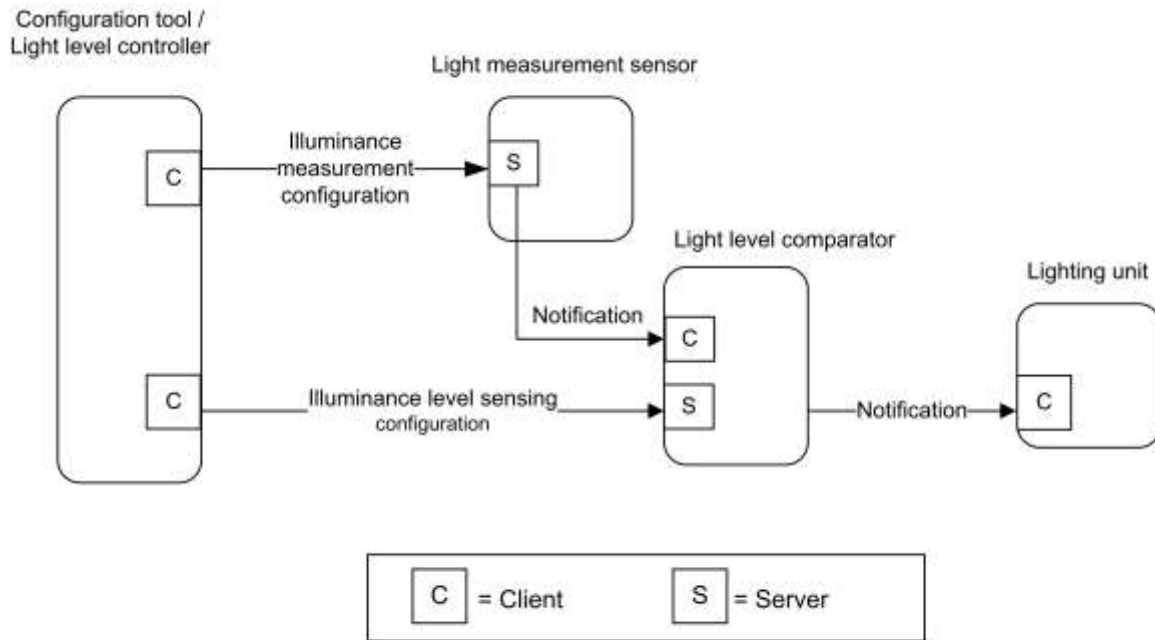

7644

*Note: Device names are examples for illustration purposes only*

#### 4.1.2.2 Temperature, Pressure and Flow Measurement

7645

7646

**Table 4-2. Pressure and Flow Measurement Clusters**

ID	Cluster Name	Description
0x0402	Temperature Measurement	Attributes and commands for configuring the measurement of temperature, and reporting temperature measurements
0x0403	Pressure Measurement	Attributes and commands for configuring the measurement of pressure, and reporting pressure measurements
0x0404	Flow Measurement	Attributes and commands for configuring the measurement of flow, and reporting flow rates
0x0405	Relative Humidity Measurement	Attributes and commands for configuring the measurement of relative humidity, and reporting relative humidity measurements

7647

7648

**Figure 4-2. Typical Usage of Temperature, Pressure and Flow Measurement Clusters**

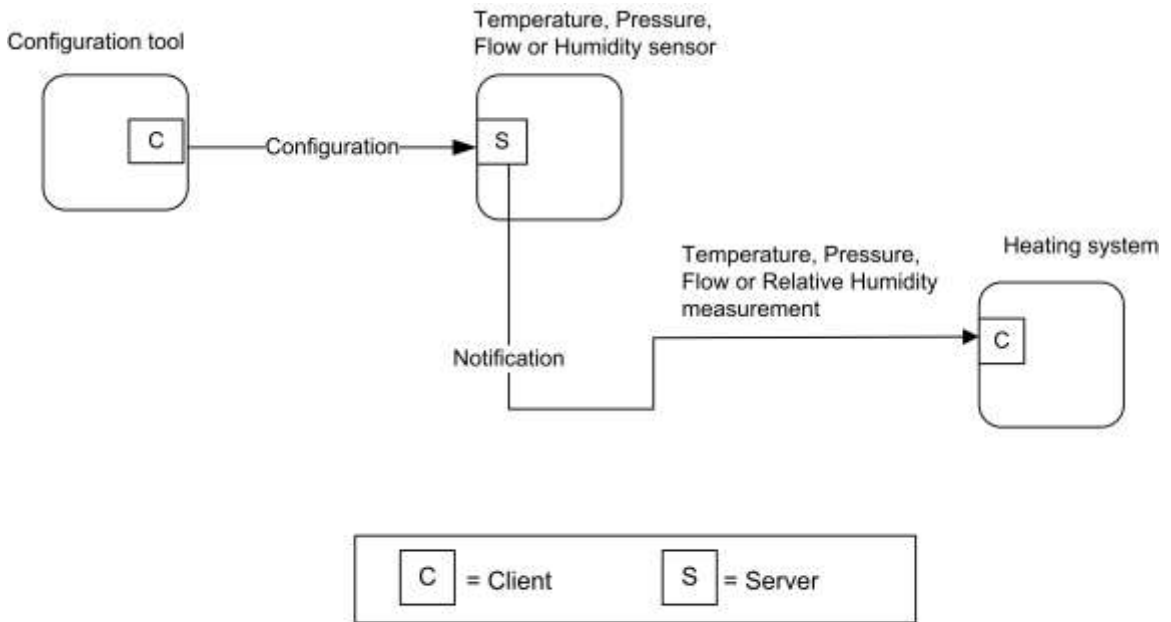

7649

*Note: Device names are examples for illustration purposes only*

7650

### 4.1.2.3 Occupancy Sensing

7651

**Table 4-3. Occupancy Sensing Clusters**

ID	Cluster Name	Description
0x0406	Occupancy Sensing	Attributes and commands for configuring occupancy sensing, and reporting occupancy status

7652

7653 **Figure 4-3. Typical Usage of Occupancy Sensing Cluster**

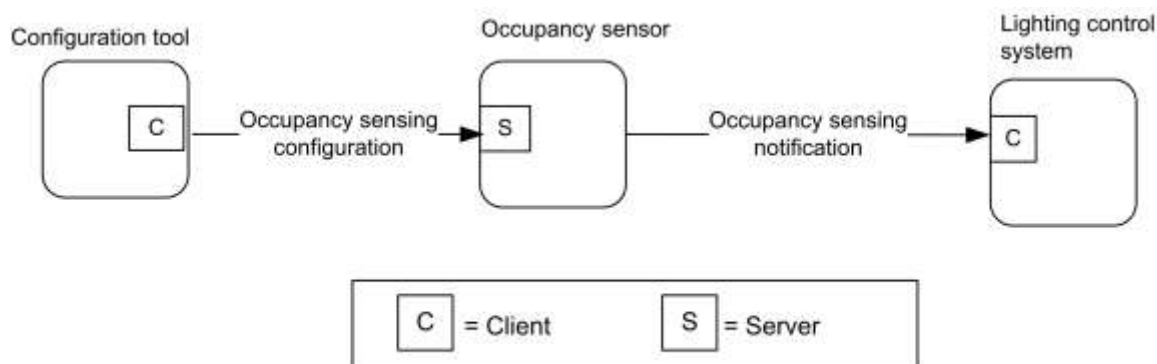

7654 *Note: Device names are examples for illustration purposes only*

### 7655 4.1.2.4 Electrical Measurement

7656 **Table 4-4. Electrical Measurement Clusters**

Cluster ID	Cluster Name	Description
0x0b04	Electrical Measurement	Attributes and commands for measuring electrical usage

## 7657 4.1.3 Measured Value

### 7658 4.1.3.1 Range

7659 For any measurement cluster with *MeasuredValue*, *MinMeasuredValue* and *MaxMeasuredValue* attributes,  
7660 the following SHALL be always be true:

- 7661
- 7662 • If both are defined, then *MaxMeasuredValue* SHALL be greater than *MinMeasuredValue*.
- 7663 • If *MaxMeasuredValue* is known, then *MeasuredValue* SHALL be less than or equal to *Max-*  
7664 *MeasuredValue*.
- 7665 • If *MinMeasuredValue* is known, then *MeasuredValue* SHALL be greater than or equal to *MinMeas-*  
7666 *uredValue*.

### 7667 4.1.3.2 Tolerance

7668 For any measurement cluster with a *MeasuredValue* and *Tolerance* attribute, the following SHALL always  
7669 be true:

7670 The *Tolerance* attribute SHALL indicate the magnitude of the possible error that is associated with  
7671 *MeasuredValue*, using the same units and resolution. The true value SHALL be in the range (*Meas-*  
7672 *uredValue* – *Tolerance*) to (*MeasuredValue* + *Tolerance*).

7673 If known, the true value SHALL never be outside the possible physical range. Some examples:

- 7674 • a temperature SHALL NOT be below absolute zero
- 7675 • a concentration SHALL NOT be negative

7676 **4.2 Illuminance Measurement**

7677 **4.2.1 Overview**

7678 Please see Chapter 2 for a general cluster overview defining cluster architecture, revision, classification,  
 7679 identification, etc.

7680 The server cluster provides an interface to illuminance measurement functionality, including configuration  
 7681 and provision of notifications of illuminance measurements.

7682 **4.2.1.1 Revision History**

7683 The global *ClusterRevision* attribute value SHALL be the highest revision number in the table below.

Rev	Description
1	mandatory global <i>ClusterRevision</i> attribute added; CCB 2048 2049 2050
2	CCB 2167

7684 **4.2.1.2 Classification**

Hierarchy	Role	PICS Code	Primary Transaction
Base	Application	ILL	Type 2 (server to client)

7685 **4.2.1.3 Cluster Identifiers**

Identifier	Name
0x0400	Illuminance Measurement

7686 **4.2.2 Server**

7687 **4.2.2.1 Dependencies**

7688 None

7689 **4.2.2.2 Attributes**

7690 The Illuminance Measurement attributes summarized in Table 4-5.

7691 **Table 4-5. Illuminance Measurement Attributes**

Id	Name	Type	Range	Acc	Def	MO
0x0000	<i>MeasuredValue</i>	uint16	0x0000 to 0xffff	RP	0x0000	M
0x0001	<i>MinMeasuredValue</i>	uint16	0x0001 – 0xfffd	R	ms	M
0x0002	<i>Max-MeasuredValue</i>	uint16	2 to 0xfffe	R	ms	M

0x0003	<i>Tolerance</i>	uint16	0x0000 – 0x0800	R	ms	O
0x0004	<i>LightSensorType</i>	enum8	0x00 – 0xff	R	0xff	O

7692 **4.2.2.2.1 MeasuredValue Attribute**

7693 *MeasuredValue* represents the Illuminance in Lux (symbol lx) as follows:

7694  $MeasuredValue = 10,000 \times \log_{10} \text{Illuminance} + 1$

7695 Where  $1 \text{ lx} \leq \text{Illuminance} \leq 3.576 \text{ Mlx}$ , corresponding to a *MeasuredValue* in the range 1 to 0xffffe.

7696 The *MeasuredValue* attribute can take the following values.

- 7697 • 0x0000 indicates a value of Illuminance that is too low to be measured.
- 7698 •  $MinMeasuredValue \leq MeasuredValue \leq MaxMeasuredValue$  under normal circumstances.
- 7699 • 0xffff indicates that the Illuminance measurement is invalid.

7700 *MeasuredValue* is updated continuously as new measurements are made.

7701 **4.2.2.2.2 MinMeasuredValue Attribute**

7702 The *MinMeasuredValue* attribute indicates the minimum value of *MeasuredValue* that can be measured. A  
7703 value of 0xffff indicates that this attribute is not defined. See 4.1.3 for more details.

7704 **4.2.2.2.3 MaxMeasuredValue Attribute**

7705 The *MaxMeasuredValue* attribute indicates the maximum value of *MeasuredValue* that can be measured. A  
7706 value of 0xffff indicates that this attribute is not defined. See 4.1.3 for more details.

7707 **4.2.2.2.4 Tolerance Attribute**

7708 See 4.1.3.

7709 **4.2.2.2.5 LightSensorType Attribute**

7710 The *LightSensorType* attribute specifies the electronic type of the light sensor. This attribute shall be set to  
7711 one of the non-reserved values listed in Table 4-6.

7712 **Table 4-6. Values of the *LightSensorType* Attribute**

Attribute Value	Description
0x00	Photodiode
0x01	CMOS
0x40 – 0xfe	Reserved for manufacturer specific light sensor types
0xff	Unknown

7713 **4.2.2.3 Commands Received**

7714 No cluster specific commands are received by the server cluster.



7715 **4.2.2.4 Commands Generated**

7716 No cluster specific commands are generated by the server cluster.

7717 **4.2.2.5 Attribute Reporting**

7718 This cluster shall support attribute reporting using the Report Attributes command and according to the minimum and maximum reporting intervals and reportable change settings described in the ZCL Foundation specification (see 2.4.7). The following attributes shall be reported:

7721 *MeasuredValue*

7722 **4.2.3 Client**

7723 The client cluster has no dependencies, cluster specific attributes nor specific commands generated or received.  
 7724

7725 **4.3 Illuminance Level Sensing**

---

7726 **4.3.1 Overview**

7727 Please see Chapter 2 for a general cluster overview defining cluster architecture, revision, classification, identification, etc.  
 7728

7729 The server cluster provides an interface to illuminance level sensing functionality, including configuration and provision of notifications of whether the illuminance is within, above or below a target band.  
 7730

7731 **4.3.1.1 Revision History**

7732 The global *ClusterRevision* attribute value SHALL be the highest revision number in the table below.

Rev	Description
1	mandatory global <i>ClusterRevision</i> attribute added

7733 **4.3.1.2 Classification**

Hierarchy	Role	PICS Code	Primary Transaction
Base	Application	ILLVL	Type 2 (server to client)

7734 **4.3.1.3 Cluster Identifiers**

Identifier	Name
0x0401	Illuminance Level Sensing

7735 **4.3.2 Server**

7736 **4.3.2.1 Dependencies**

7737 None

7738 **4.3.2.2 Attributes**

7739 For convenience, the attributes defined in this specification are arranged into sets of related attributes; each  
7740 set can contain up to 16 attributes. Attribute identifiers are encoded such that the most significant three nib-  
7741 bles specify the attribute set and the least significant nibble specifies the attribute within the set. The currently  
7742 defined attribute sets are listed in Table 4-7.

7743 **Table 4-7. Illuminance Level Sensing Attribute Sets**

Attribute Set Identifier	Description
0x000	Illuminance Level Sensing Information
0x001	Illuminance Level Sensing Settings

7744 **4.3.2.3 Illuminance Level Sensing Information Attribute**  
7745 **Set**

7746 The light sensor configuration attribute set contains the attributes summarized in Table 4-8.

7747 **Table 4-8. Illuminance Level Sensing Information Attribute Set**

Id	Name	Type	Range	Access	Default	M/O
0x0000	<i>LevelStatus</i>	enum8	0x00 – 0xfe	RP	-	M
0x0001	<i>LightSensorType</i>	enum8	0x00 – 0xfe	R	-	O

7748 **4.3.2.3.1 LevelStatus Attribute**

7749 The *LevelStatus* attribute indicates whether the measured illuminance is above, below, or within a band  
7750 around *IlluminanceTargetLevel* (see 4.3.2.4.1). It may have any non-reserved value shown in Table 4-9.

7751 **Table 4-9. Values of the LevelStatus Attribute**

Attribute Value	Description
0x00	Illuminance on target
0x01	Illuminance below target
0x02	Illuminance above target

7752 **4.3.2.3.2 LightSensorType Attribute**

7753 The *LightSensorType* attribute specifies the electronic type of the light sensor. This attribute shall be set to  
 7754 one of the non-reserved values listed in Table 4-10.

7755 **Table 4-10. Values of the *LightSensorType* Attribute**

Attribute Value	Description
0x00	Photodiode
0x01	CMOS
0x40 – 0xfe	Reserved for manufacturer specific light sensor types
0xff	Unknown

7756 **4.3.2.4 Illuminance Level Sensing Settings Attribute Set**  
 7757

7758 The light sensor configuration attribute set contains the attributes summarized in Table 4-11  
 7759 Illuminance Level Sensing Settings Attribute Set.

7760 **Table 4-11. Illuminance Level Sensing Settings Attribute Set**

Id	Name	Type	Range	Access	Def	M/O
0x0010	<i>IlluminanceTargetLevel</i>	uint16	0x0000 – 0xfffe	RW	-	M

7761 **4.3.2.4.1 IlluminanceTargetLevel Attribute**

7762 The *IlluminanceTargetLevel* attribute specifies the target illuminance level. This target level is taken as the  
 7763 centre of a ‘dead band’, which must be sufficient in width, with hysteresis bands at both top and bottom, to  
 7764 provide reliable notifications without ‘chatter’. Such a dead band and hysteresis bands must be provided by  
 7765 any implementation of this cluster. (N.B. Manufacturer specific attributes may be provided to configure  
 7766 these).

7767 *IlluminanceTargetLevel* represents illuminance in Lux (symbol lx) as follows:

7768 
$$IlluminanceTargetLevel = 10,000 \times \log_{10} \text{Illuminance}$$

7769 Where  $1 \text{ lx} \leq \text{Illuminance} \leq 3.576 \text{ Mlx}$ , corresponding to a *MeasuredValue* in the range 0 to 0xfffe.

7770 A value of 0xffff indicates that this attribute is not valid.

7771 **4.3.2.5 Commands Received**

7772 No cluster specific commands are received by the server.

7773 **4.3.2.6 Commands Generated**

7774 No cluster specific commands are generated by the server cluster.

7775 **4.3.2.7 Attribute Reporting**

7776 This cluster shall support attribute reporting using the Report Attributes command and according to the minimum and maximum reporting interval settings described in the ZCL Foundation Specification (see 2.4.7).  
7777  
7778 The following attribute shall be reported:

7779 *LevelStatus*

7780 **4.3.3 Client**

7781 The client cluster has no dependencies, specific attributes nor specific commands generated or received.

7782 **4.4 Temperature Measurement**

---

7783 **4.4.1 Overview**

7784 Please see Chapter 2 for a general cluster overview defining cluster architecture, revision, classification, identification, etc.  
7785

7786 The server cluster provides an interface to temperature measurement functionality, including configuration and provision of notifications of temperature measurements.  
7787

7788 **4.4.1.1 Revision History**

7789 The global *ClusterRevision* attribute value SHALL be the highest revision number in the table below.

Rev	Description
1	mandatory global <i>ClusterRevision</i> attribute added
2	CCB 2241 2370
3	CCB 2823

7790 **4.4.1.2 Classification**

Hierarchy	Role	PICS Code	Primary Transaction
Base	Application	TMP	Type 2 (server to client)

7791 **4.4.1.3 Cluster Identifiers**

Identifier	Name
0x0402	Temperature Measurement

7792 **4.4.2 Server**

7793 **4.4.2.1 Dependencies**

7794 None

7795 **4.4.2.2 Attributes**

7796 For convenience, the attributes defined in this specification are arranged into sets of related attributes; each  
 7797 set can contain up to 16 attributes. Attribute identifiers are encoded such that the most significant nibble  
 7798 specifies the attribute set and the least significant nibble specifies the attribute within the set. The currently  
 7799 defined attribute sets are listed in Table 4-12.

7800 **Table 4-12. Temperature Measurement Attribute Sets**

Attribute Set Identifier	Description
0x000	Temperature Measurement Information

7801 **4.4.2.2.1 Temperature Measurement Information Attribute Set**

7802 The Temperature Measurement Information attribute set contains the attributes summarized in Table 4-13.

7803 **Table 4-13. Temperature Measurement Information Attribute Set**

Id	Name	Type	Range	Acc	Def	M
0x0000	<i>MeasuredValue</i>	int16	<i>MinMeasuredValue</i> – <i>MaxMeasuredValue</i>	RP	non <sup>81</sup>	M
0x0001	<i>MinMeasuredValue</i>	int16	0x954d – 0x7ffe	R	non	M
0x0002	<i>MaxMeasuredValue</i>	int16	0x954e – 0x7fff	R	non	M
0x0003	<i>Tolerance</i>	uint16	0x0000 – 0x0800	R	-	O

7804 **4.4.2.2.1.1 MeasuredValue Attribute**

7805 *MeasuredValue* represents the temperature in degrees Celsius as follows:

7806 *MeasuredValue* = 100 x temperature in degrees Celsius.

7807 Where -273.15°C <= temperature <= 327.67 °C, corresponding to a *MeasuredValue* in the range 0x954d to  
 7808 0x7fff. The maximum resolution this format allows is 0.01 °C.

7809 A *MeasuredValue* of 0x8000 indicates that the temperature measurement is unknown, otherwise the range  
 7810 SHALL be as described in 4.1.3.

7811 *MeasuredValue* is updated continuously as new measurements are made. *MinMeasuredValue* and *Max-*  
 7812 *MeasuredValue* define the range of the sensor.

7813 **4.4.2.2.1.2 MinMeasuredValue Attribute**

7814 The *MinMeasuredValue* attribute indicates the minimum value of *MeasuredValue* that is capable of being  
 7815 measured. A *MinMeasuredValue* of 0x8000 indicates that the minimum value is unknown. See 4.1.3 for more  
 7816 details.

7817 **4.4.2.2.1.3 MaxMeasuredValue Attribute**

<sup>81</sup> CCB 2823 0xffff is in the valid range and means -0.1 °C, so use non-value to mean unknown (see Chapter 2: Data Types).

7818 The *MaxMeasuredValue* attribute indicates the maximum value of *MeasuredValue* that is capable of being  
7819 measured. See 4.1.3 for more details. A *MaxMeasuredValue* of 0x8000 indicates that the maximum value is  
7820 unknown.

#### 7821 **4.4.2.2.1.4 Tolerance Attribute**

7822 See 4.1.3.

### 7823 **4.4.2.3 Commands Received**

7824 No cluster specific commands are received by the server cluster.

### 7825 **4.4.2.4 Commands Generated**

7826 No cluster specific commands are generated by the server cluster.

### 7827 **4.4.2.5 Attribute Reporting**

7828 This cluster shall support attribute reporting using the Report Attributes command and according to the min-  
7829 imum and maximum reporting interval and reportable change settings described in the ZCL Foundation spec-  
7830 ification (see 2.4.7). The following attributes shall be reported:

7831 *MeasuredValue*

## 7832 **4.4.3 Client**

7833 The client cluster has no dependencies, cluster specific attributes nor specific commands generated or re-  
7834 ceived.

## 7835 **4.5 Pressure Measurement**

---

### 7836 **4.5.1 Overview**

7837 Please see Chapter 2 for a general cluster overview defining cluster architecture, revision, classification,  
7838 identification, etc.

7839 The server cluster provides an interface to pressure measurement functionality, including configuration and  
7840 provision of notifications of pressure measurements.

#### 7841 **4.5.1.1 Revision History**

7842 The global *ClusterRevision* attribute value SHALL be the highest revision number in the table below.

Rev	Description
1	mandatory global <i>ClusterRevision</i> attribute added
2	CCB 2241 2370

7843 **4.5.1.2 Classification**

Hierarchy	Role	PICS Code	Primary Transaction
Base	Application	PRS	Type 2 (server to client)

7844 **4.5.1.3 Cluster Identifiers**

Identifier	Name
0x0403	Pressure Measurement

7845 **4.5.2 Server**

7846 **4.5.2.1 Dependencies**

7847 None

7848 **4.5.2.2 Attributes**

7849 For convenience, the attributes defined in this specification are arranged into sets of related attributes; each  
 7850 set can contain up to 16 attributes. Attribute identifiers are encoded such that the most significant three nib-  
 7851 bles specify the attribute set and the least significant nibble specifies the attribute within the set. The currently  
 7852 defined attribute sets are listed in Table 4-14 Pressure Measurement Attribute Sets.

7853 **Table 4-14. Pressure Measurement Attribute Sets**

Attribute Set Identifier	Description
0x000	Pressure Measurement Information
0x001	Extended Pressure Measurement Information

7854 **4.5.2.2.1 Pressure Measurement Information Attribute Set**

7855 The Pressure Measurement Information attribute set contains the attributes summarized in Table 4-15.

7856 **Table 4-15. Pressure Measurement Information Attribute Set**

Id	Name	Type	Range	Acc	Def	MO
0x0000	<i>MeasuredValue</i>	int16	<i>MinMeasuredValue</i> – <i>MaxMeasuredValue</i>	RP	0x8000	M
0x0001	<i>MinMeasuredValue</i>	int16	0x8001– 0x7ffe	R	0x8000	M

0x0002	<i>MaxMeasuredValue</i>	int16	0x8002– 0x7fff	R	0x8000	M
0x0003	<i>Tolerance</i>	uint16	0x0000 – 0x0800	R	-	O

7857

7858 This set provides for measurements with a fixed maximum resolution of 0.1 kPa.

7859 **4.5.2.2.1.1 MeasuredValue Attribute**

7860 *MeasuredValue* represents the pressure in kPa as follows:

7861  $MeasuredValue = 10 \times Pressure$

7862 Where  $-3276.7 \text{ kPa} \leq Pressure \leq 3276.7 \text{ kPa}$ , corresponding to a *MeasuredValue* in the range 0x8001 to  
7863 0x7fff.

7864 *MinMeasuredValue* and *MaxMeasuredValue* define the range of the sensor.

7865 A *MeasuredValue* of 0x8000 indicates that the pressure measurement is unknown, otherwise the range  
7866 SHALL be as described in 4.1.3.

7867 *MeasuredValue* is updated continuously as new measurements are made.

7868 **4.5.2.2.1.2 MinMeasuredValue Attribute**

7869 The *MinMeasuredValue* attribute indicates the minimum value of *MeasuredValue* that can be measured. A  
7870 value of 0x8000 means this attribute is not defined. See 4.1.3 for more details.

7871 **4.5.2.2.1.3 MaxMeasuredValue Attribute**

7872 The *MaxMeasuredValue* attribute indicates the maximum value of *MeasuredValue* that can be measured. A  
7873 value of 0x8000 means this attribute is not defined. See 4.1.3 for more details.

7874 **4.5.2.2.1.4 Tolerance Attribute**

7875 See 4.1.3.

7876 **4.5.2.2.2 Extended Pressure Measurement Information Attribute Set**  
7877

7878 The Extended Pressure Measurement Information attribute set contains the attributes summarized in Table  
7879 4-16.

7880 **Table 4-16. Extended Pressure Measurement Information Attribute Set**

Id	Name	Type	Range	Acc	Def	M/O
0x0010	<i>ScaledValue</i>	int16	<i>MinScaledValue</i> – <i>MaxScaledValue</i>	R	0	O Note 1
0x0011	<i>MinScaledValue</i>	int16	0x8001-0x7ffe	R	0x8000	O Note 1
0x0012	<i>MaxScaledValue</i>	int16	0x8002-0x7fff	R	0x8000	O Note 1
0x0013	<i>ScaledTolerance</i>	uint16	0x0000 – 0x0800	R	-	O Note 2
0x0014	<i>Scale</i>	int8	0x81 – 0x7f	R	-	O Note 1

7881 **Note 1:** If any one of these attributes is supported, all four shall be supported.

7882 **Note 2:** If this attribute is supported, all attributes in this set shall be supported.



7883 This attribute set is optional, and allows the range and resolution of measured pressures to be extended beyond those catered for by the Pressure Measurement Information Attribute Set, in a way fully backward compatible with devices that implement (or can read) only that attribute set.  
7884  
7885

#### 7886 **4.5.2.2.2.1 ScaledValue Attribute**

7887 *ScaledValue* represents the pressure in Pascals as follows:

7888  $ScaledValue = 10^{Scale} \times \text{Pressure in Pa}$

7889 Where  $-3276.7 \times 10^{Scale} \text{ Pa} \leq \text{Pressure} \leq 3276.7 \times 10^{Scale} \text{ Pa}$  corresponding to a *ScaledValue* in the range  
7890  $0x8001$  to  $0x7fff$ .

7891 A *ScaledValue* of  $0x8000$  indicates that the pressure measurement is invalid.

7892 *ScaledValue* is updated continuously as new measurements are made.

#### 7893 **4.5.2.2.2.2 MinScaledValue Attribute**

7894 The *MinScaledValue* attribute indicates the minimum value of *ScaledValue* that can be measured. A value of  
7895  $0x8000$  means this attribute is not defined

#### 7896 **4.5.2.2.2.3 MaxScaledValue Attribute**

7897 The *MaxScaledValue* attribute indicates the maximum value of *ScaledValue* that can be measured. A value  
7898 of  $0x8000$  means this attribute is not defined.

7899 *MaxScaledValue* shall be greater than *MinScaledValue*.

7900 *MinScaledValue* and *MaxScaledValue* define the range of the sensor.

#### 7901 **4.5.2.2.2.4 ScaledTolerance Attribute**

7902 The *ScaledTolerance* attribute indicates the magnitude of the possible error that is associated with  
7903 *ScaledValue*. The true value is located in the range

7904  $(ScaledValue - ScaledTolerance)$  to  $(ScaledValue + ScaledTolerance)$ .

#### 7905 **4.5.2.2.2.5 Scale Attribute**

7906 The *Scale* attribute indicates the base 10 exponent used to obtain *ScaledValue* (see 4.5.2.2.2.1).

### 7907 **4.5.2.3 Commands**

7908 No cluster specific commands are received by the server cluster. No cluster specific commands are generated  
7909 by the server cluster.

### 7910 **4.5.2.4 Attribute Reporting**

7911 This cluster shall support attribute reporting using the Report Attributes command and according to the minimum and maximum reporting interval and reportable change settings described in the ZCL Foundation specification (see 2.4.7). The following attributes shall be reportable:

7914 *MeasuredValue*

7915 If the Extended Pressure Measurement Information attribute set is implemented, it is recommended that the following attributes are also reportable:

7917 *ScaledValue*

7918 *ScaledTolerance*

7919 **4.5.3 Client**

7920 The client cluster has no dependencies, cluster specific attributes nor specific commands generated or re-  
7921 ceived.

7922 **4.6 Flow Measurement**

---

7923 **4.6.1 Overview**

7924 Please see Chapter 2 for a general cluster overview defining cluster architecture, revision, classification,  
7925 identification, etc.

7926 The server cluster provides an interface to flow measurement functionality, including configuration and pro-  
7927 vision of notifications of flow measurements.

7928 **4.6.1.1 Revision History**

7929 The global *ClusterRevision* attribute value SHALL be the highest revision number in the table below.

Rev	Description
1	mandatory global <i>ClusterRevision</i> attribute added
2	CCB 2241 2370

7930 **4.6.1.2 Classification**

Hierarchy	Role	PICS Code	Primary Transaction
Base	Application	FLW	Type 2 (server to client)

7931 **4.6.1.3 Cluster Identifiers**

Identifier	Name
0x0404	Flow Measurement

7932 **4.6.2 Server**

7933 **4.6.2.1 Dependencies**

7934 None

7935 **4.6.2.2 Attributes**

7936 For convenience, the attributes defined in this specification are arranged into sets of related attributes; each  
7937 set can contain up to 16 attributes. Attribute identifiers are encoded such that the most significant three nib-  
7938 bles specify the attribute set and the least significant nibble specifies the attribute within the set. The currently  
7939 defined attribute sets for are listed in Table 4-17.

7940

**Table 4-17. Flow Measurement Attribute Sets**

Attribute Set Identifier	Description
0x000	Flow Measurement Information

7941

#### 4.6.2.2.1 Flow Measurement Information Attribute Set

7942

The Flow Measurement Information attribute set contains the attributes summarized in Table 4-18.

7943

**Table 4-18. Flow Measurement Information Attribute Set**

Id	Name	Type	Range	Acc	Def	MO
0x0000	<i>MeasuredValue</i>	uint16	<i>MinMeasuredValue</i> – <i>MaxMeasuredValue</i>	RP	0xffff	M
0x0001	<i>MinMeasuredValue</i>	uint16	0x0000 – 0xfffd	R	0xffff	M
0x0002	<i>Max-MeasuredValue</i>	uint16	0x0001 – 0xfffe	R	0xffff	M
0x0003	<i>Tolerance</i>	uint16	0x0000 – 0x0800	R		O

7944

##### 4.6.2.2.1.1 *MeasuredValue* Attribute

7945

*MeasuredValue* represents the flow in m<sup>3</sup>/h as follows:

7946

*MeasuredValue* = 10 x Flow

7947

Where 0 m<sup>3</sup>/h <= Flow <= 6,553.4 m<sup>3</sup>/h, corresponding to a *MeasuredValue* in the range 0 to 0xfffe.

7948

The maximum resolution this format allows is 0.1 m<sup>3</sup>/h.

7949

*MinMeasuredValue* and *MaxMeasuredValue* define the range of the sensor.

7950

A *MeasuredValue* of 0xffff indicates that the pressure measurement is unknown, otherwise the range SHALL be as described in 4.1.3.

7952

*MeasuredValue* is updated continuously as new measurements are made.

7953

##### 4.6.2.2.1.2 *MinMeasuredValue* Attribute

7954

The *MinMeasuredValue* attribute indicates the minimum value of *MeasuredValue* that can be measured. A value of 0xffff means this attribute is not defined. See 4.1.3 for more details.

7956

##### 4.6.2.2.1.3 *MaxMeasuredValue* Attribute

7957

The *MaxMeasuredValue* attribute indicates the maximum value of *MeasuredValue* that can be measured. A value of 0xffff means this attribute is not defined. See 4.1.3 for more details.

7959

##### 4.6.2.2.1.4 *Tolerance* Attribute

7960

See 4.1.3.

7961

#### 4.6.2.3 Commands Received

7962

No cluster specific commands are received by the server cluster.

7963 **4.6.2.4 Commands Generated**

7964 No cluster specific commands are generated by the server cluster.

7965 **4.6.2.5 Attribute Reporting**

7966 This cluster shall support attribute reporting using the Report Attributes command and according to the minimum and maximum reporting interval and reportable change settings described in the ZCL Foundation specification (see 2.4.7). The following attributes shall be reported:

7969 *MeasuredValue*

7970 **4.6.3 Client**

7971 The client cluster has no dependencies, cluster specific attributes nor specific commands generated or received.  
7972

7973 **4.7 Water Content Measurement**

---

7974 **4.7.1 Overview**

7975 Please see Chapter 2 for a general cluster overview defining cluster architecture, revision, classification, identification, etc.  
7976

7977 This is a base cluster. The server cluster provides an interface to water content measurement functionality. The measurement is reportable and may be configured for reporting. Water content measurements include, but are not limited to, leaf wetness, relative humidity, and soil moisture.  
7978  
7979

7980 **4.7.1.1 Revision History**

7981 The global *ClusterRevision* attribute value SHALL be the highest revision number in the table below.

Rev	Description
1	mandatory global <i>ClusterRevision</i> attribute added
2	CCB 2241

7982 **4.7.1.2 Classification**

Hierarchy	Role	PICS Code	Primary Transaction
Base	Application	RH	Type 2 (server to client)

7983 **4.7.1.3 Cluster Identifiers**

Identifier	Name	Description
0x0405	Relative Humidity	Percentage of water in the air
0x0407	Leaf Wetness	Percentage of water on the leaves of plants
0x0408	Soil Moisture	Percentage of water in the soil

7984 **4.7.2 Server**

7985 **4.7.2.1 Attributes**

7986 **Table 4-19. Attributes of the Water Content cluster**

Id	Name	Type	Range	Acc	Def	MO
0x0000	<i>MeasuredValue</i>	uint16	<i>MinMeasuredValue</i> – <i>MaxMeasuredValue</i>	RP	0xffff	M
0x0001	<i>MinMeasuredValue</i>	uint16	0x0000 – 0x270f	R	0xffff	M
0x0002	<i>MaxMeasuredValue</i>	uint16	0x0001 – 0x2710	R	0xffff	M
0x0003	<i>Tolerance</i>	uint16	0x0000 – 0x0800	R		O

7987 **4.7.2.1.1 *MeasuredValue* Attribute**

7988 *MeasuredValue* represents the water content in % as follows:

7989  $MeasuredValue = 100 \times \text{water content}$

7990 Where  $0\% \leq \text{water content} \leq 100\%$ , corresponding to a *MeasuredValue* in the range 0 to 0x2710.

7991 The maximum resolution this format allows is 0.01%.

7992 *MinMeasuredValue* and *MaxMeasuredValue* define the range of the sensor.

7993 A *MeasuredValue* of 0xffff indicates that the measurement is unknown, otherwise the range SHALL be as described in 4.1.3.

7995 *MeasuredValue* is updated continuously as new measurements are made.

7996 **4.7.2.1.2 *MinMeasuredValue* Attribute**

7997 The *MinMeasuredValue* attribute indicates the minimum value of *MeasuredValue* that can be measured. A value of 0xffff means this attribute is not defined. See 4.1.3 for more details.

7999 **4.7.2.1.3 *MaxMeasuredValue* Attribute**

8000 The *MaxMeasuredValue* attribute indicates the maximum value of *MeasuredValue* that can be measured. A value of 0xffff means this attribute is not defined. See 4.1.3 for more details.

8002 **4.7.2.1.4 *Tolerance* Attribute**

8003 See 4.1.3.

8004 **4.7.2.2 Commands**

8005 No cluster specific commands are received or generated by the server cluster.

8006 **4.7.3 Client**

8007 The client cluster has no dependencies, cluster specific attributes nor specific commands generated or received.

## 8009 4.8 Occupancy Sensing

### 8010 4.8.1 Overview

8011 Please see Chapter 2 for a general cluster overview defining cluster architecture, revision, classification,  
8012 identification, etc.

8013 The server cluster provides an interface to occupancy sensing functionality, including configuration and pro-  
8014 vision of notifications of occupancy status.

#### 8015 4.8.1.1 Revision History

8016 The global *ClusterRevision* attribute value SHALL be the highest revision number in the table below.

Rev	Description
1	mandatory global <i>ClusterRevision</i> attribute added
2	Physical Contact Occupancy feature with mandatory <i>OccupancySensorTypeBitmap</i>

#### 8017 4.8.1.2 Classification

Hierarchy	Role	PICS Code	Primary Transaction
Base	Application	OCC	Type 2 (server to client)

#### 8018 4.8.1.3 Cluster Identifiers

Identifier	Name
0x0406	Occupancy Sensing

### 8019 4.8.2 Server

#### 8020 4.8.2.1 Dependencies

8021 None

#### 8022 4.8.2.2 Attributes

8023 For convenience, the attributes defined in this specification are arranged into sets of related attributes; each  
8024 set can contain up to 16 attributes. Attribute identifiers are encoded such that the most significant three nib-  
8025 bles specify the attribute set and the least significant nibble specifies the attribute within the set. The currently  
8026 defined attribute sets are listed in Table 4-20.

8027 **Table 4-20. Occupancy Sensor Attribute Sets**

Attribute Set Identifier	Description
0x000	Occupancy sensor information
0x001	PIR configuration

0x002	Ultrasonic configuration
0x003	Physical contact configuration

8028 **4.8.2.2.1 Occupancy Sensor Information Set**

8029 The occupancy sensor information attribute set contains the attributes summarized in Table 4-21.

8030 **Table 4-21. Occupancy Sensor Information Attribute Set**

Id	Name	Type	Range	Access	Def	M/O
0x0000	<i>Occupancy</i>	map8	0b0000 000x	RP	-	M
0x0001	<i>OccupancySensorType</i>	enum8		R	MS	M
0x0002	<i>OccupancySensorTypeBitmap</i>	map8	0000 0xxx	R	-	M

8031 **4.8.2.2.1.1 Occupancy Attribute**

8032 The *Occupancy* attribute is a bitmap.

8033 Bit 0 specifies the sensed occupancy as follows: 1 = occupied, 0 = unoccupied.

8034 All other bits are reserved.

8035 **4.8.2.2.1.2 OccupancySensorType Attribute**

8036 The *OccupancySensorType* attribute specifies the type of the occupancy sensor. This attribute shall be set to  
 8037 one of the non-reserved values listed in Table 4-22.

8038 **Table 4-22. Values of the *OccupancySensorType* Attribute**

Attribute Value	Description
0x00	PIR
0x01	Ultrasonic
0x02	PIR and ultrasonic
0x03	Physical contact

8039 **4.8.2.2.1.3 OccupancySensorTypeBitmap Attribute**

8040 The *OccupancySensorTypeBitmap* attribute specifies the types of the occupancy sensor, as listed below; a  
 8041 ‘1’ in each bit position indicates this type is implemented.

8042 **Table 4-23. The *OccupancySensorTypeBitmap* Attribute**

Bit	Description
Bit0	PIR
Bit1	Ultrasonic

Bit	Description
Bit2	Physical contact

8043 The value of the *OccupancySensorTypeBitmap* attribute and the *OccupancySensorType* attribute SHALL be  
8044 aligned as defined below.

8045 **Table 4-24. Mapping between *OccupancySensorType* and *OccupancySensorTypeBitmap* Attributes**

Description	<i>OccupancySensorType</i> attribute	<i>OccupancySensorTypeBitmap</i> attribute
PIR	0x00	0000 0001
Ultrasonic	0x01	0000 0010
PIR and ultrasonic	0x02	0000 0011
Physical contact and PIR	0x00	0000 0101
Physical contact and ultrasonic	0x01	0000 0110
Physical contact and PIR and ultrasonic	0x02	0000 0111

8046

#### 8047 **4.8.2.2.2 PIR Configuration Set**

8048 The PIR sensor configuration attribute set contains the attributes summarized in Table 4-25.

8049 **Table 4-25. Attributes of the PIR Configuration Attribute Set**

Id	Name	Type	Range	Access	Def	M/O
0x0010	<i>PIROccupiedToUnoccupiedDelay</i>	uint16	0x00 – 0xfffe	RW	0x00	O
0x0011	<i>PIRUnoccupiedToOccupiedDelay</i>	uint16	0x00 – 0xfffe	RW	0x00	O
0x0012	<i>PIRUnoccupiedToOccupiedThreshold</i>	uint8	0x01 – 0xfe	RW	0x01	O

##### 8050 **4.8.2.2.2.1 *PIROccupiedToUnoccupiedDelay* Attribute**

8051 The *PIROccupiedToUnoccupiedDelay* attribute is 16 bits in length and specifies the time delay, in seconds,  
8052 before the PIR sensor changes to its unoccupied state after the last detection of movement in the sensed area.

##### 8053 **4.8.2.2.2.2 *PIRUnoccupiedToOccupiedDelay* Attribute**

8054 The *PIRUnoccupiedToOccupiedDelay* attribute is 16 bits in length and specifies the time delay, in seconds,  
8055 before the PIR sensor changes to its occupied state after the detection of movement in the sensed area. This  
8056 attribute is mandatory if the *PIRUnoccupiedToOccupiedThreshold* attribute is implemented.

##### 8057 **4.8.2.2.2.3 *PIRUnoccupiedToOccupiedThreshold* Attribute**



8058 The *PIRUnoccupiedToOccupiedThreshold* attribute is 8 bits in length and specifies the number of movement  
 8059 detection events that must occur in the period *PIRUnoccupiedToOccupiedDelay*, before the PIR sensor  
 8060 changes to its occupied state. This attribute is mandatory if the *PIRUnoccupiedToOccupiedDelay* attribute is  
 8061 implemented.

8062 **4.8.2.2.3 Ultrasonic Configuration Set**

8063 The ultrasonic sensor configuration attribute set contains the attributes summarized in Table 4-26.

8064 **Table 4-26. Attributes of the Ultrasonic Configuration Attribute Set**

<b>Id</b>	<b>Name</b>	<b>Type</b>	<b>Range</b>	<b>Acc</b>	<b>Def</b>	<b>MO</b>
0x0020	<i>UltrasonicOccupiedToUnoccupiedDelay</i>	uint16	0x0000 – 0xffffe	RW	0x00	O
0x0021	<i>UltrasonicUnoccupiedToOccupiedDelay</i>	uint16	0x0000 – 0xffffe	RW	0x00	O
0x0022	<i>UltrasonicUnoccupiedToOccupiedThreshold</i>	uint8	0x01 – 0xfe	RW	0x01	O

8065 **4.8.2.2.3.1 UltrasonicOccupiedToUnoccupiedDelay Attribute**

8066 The *UltrasonicOccupiedToUnoccupiedDelay* attribute is 16 bits in length and specifies the time delay, in  
 8067 seconds, before the Ultrasonic sensor changes to its unoccupied state after the last detection of movement in  
 8068 the sensed area.

8069 **4.8.2.2.3.2 UltrasonicUnoccupiedToOccupiedDelay Attribute**

8070 The *UltrasonicUnoccupiedToOccupiedDelay* attribute is 16 bits in length and specifies the time delay, in  
 8071 seconds, before the Ultrasonic sensor changes to its occupied state after the detection of movement in the  
 8072 sensed area. This attribute is mandatory if the *UltrasonicUnoccupiedToOccupiedThreshold* attribute is im-  
 8073 plemented.

8074 **4.8.2.2.3.3 UltrasonicUnoccupiedToOccupiedThreshold Attribute**

8075 The *UltrasonicUnoccupiedToOccupiedThreshold* attribute is 8 bits in length and specifies the number of  
 8076 movement detection events that must occur in the period *UltrasonicUnoccupiedToOccupiedDelay*, before  
 8077 the Ultrasonic sensor changes to its occupied state. This attribute is mandatory if the *UltrasonicUnoccu-  
 8078 piredToOccupiedDelay* attribute is implemented.

8079 **4.8.2.2.4 Physical Contact Configuration Set**

8080 The physical contact configuration attribute set contains the attributes summarized below.

8081 **Table 4-27. Attributes of the Physical Contact Configuration Attribute Set**

<b>Id</b>	<b>Name</b>	<b>Type</b>	<b>Range</b>	<b>Acc</b>	<b>Def</b>	<b>MO</b>
0x0030	<i>PhysicalContactOccupiedToUnoccupiedDelay</i>	uint16	0x0000 to 0xffffe	RW	0x0000	O
0x0031	<i>PhysicalContactUnoccupiedToOccupiedDelay</i>	uint16	0x0000 to 0xffffe	RW	0x0000	O
0x0032	<i>PhysicalContactUnoccupiedToOccupiedThreshold</i>	uint8	0x01 to 0xfe	RW	0x01	O

8082 **4.8.2.2.4.1 PhysicalContactOccupiedToUnoccupiedDelay Attribute**

8083 The *PhysicalContactOccupiedToUnoccupiedDelay* attribute is 16 bits in length and specifies the time delay,  
8084 in seconds, before the physical contact occupancy sensor changes to its unoccupied state after detecting the  
8085 unoccupied event. The value of 0xffff indicates the sensor does not report occupied to unoccupied transition.

8086 **4.8.2.2.4.2 PhysicalContactUnoccupiedToOccupiedDelay Attribute**

8087 The *PhysicalContactUnoccupiedToOccupiedDelay* attribute is 16 bits in length and specifies the time delay,  
8088 in seconds, before the physical contact sensor changes to its occupied state after the detection of the occupied  
8089 event.

8090 The value of 0xffff indicates the sensor does not report unoccupied to occupied transition.

8091 **4.8.2.2.4.3 PhysicalContactUnoccupiedToOccupiedThreshold Attribute**  
8092

8093 The *PhysicalContactUnoccupiedToOccupiedThreshold* attribute is 8 bits in length and specifies the number  
8094 of movement detection events that must occur in the period *PhysicalContactUnoccupiedToOccupiedDelay*,  
8095 before the PIR sensor changes to its occupied state. This attribute is mandatory if the *PhysicalContactUnoc-*  
8096 *cupiedToOccupiedDelay* attribute is implemented.

8097 **4.8.2.3 Commands**

8098 No cluster specific commands are received by the server cluster. No cluster specific commands are generated  
8099 by the server cluster.

8100 **4.8.3 Client**

8101 The client cluster has no dependencies, cluster specific attributes nor specific commands generated or re-  
8102 ceived.

8103 **4.9 Electrical Measurement**

---

8104 **4.9.1 Overview**

8105 Please see Chapter 2 for a general cluster overview defining cluster architecture, revision, classification,  
8106 identification, etc.

8107 This cluster provides a mechanism for querying data about the electrical properties as measured by the device.  
8108 This cluster may be implemented on any device type and be implemented on a per-endpoint basis. For ex-  
8109 ample, a power strip device could represent each outlet on a different endpoint and report electrical infor-  
8110 mation for each individual outlet. The only caveat is that if you implement an attribute that has an associated  
8111 multiplier and divisor, then you must implement the associated multiplier and divisor attributes. For example  
8112 if you implement DCVoltage, you must also implement DCVoltageMultiplier and DCVoltageDivisor.

8113 If you are interested in reading information about the power supply or battery level on the device, please see  
8114 the Power Configuration cluster.

8115 **4.9.1.1 Revision History**

8116 The global *ClusterRevision* attribute value SHALL be the highest revision number in the table below.

Rev	Description
1	mandatory global <i>ClusterRevision</i> attribute added
2	CCB 2236

3	CCB 2369 2817
---	---------------

8117 **4.9.1.2 Classification**

Hierarchy	Role	PICS Code	Primary Transaction
Base	Application	EMR	Type 1 (client to server)

8118 **4.9.1.3 Cluster Identifiers**

Identifier	Name
0x0b04	Electrical Measurement

8119 **4.9.1.4 Formatting**

8120 Most measurement values have an associated multiplier and divisor attribute. Multiplier attributes provide a  
 8121 value to be multiplied against a raw or uncompensated measurement value. Divisor attributes provide a value  
 8122 to divide the results of applying a multiplier attribute against a raw or uncompensated measurement value. If  
 8123 a multiplier or divisor attribute is present, its corresponding divisor or multiplier attribute shall be imple-  
 8124 mented as well.

8125 **4.9.2 Server**

8126 **4.9.2.1 Dependencies**

8127 For the alarm functionality in this cluster to be operational, any endpoint that implements the Electrical  
 8128 Measurement server cluster shall also implement the Alarms server cluster.

8129 **4.9.2.2 Attributes**

8130 The server side of this cluster contains certain attributes associated with the electrical properties and config-  
 8131 uration, as shown in Table 4-28.

8132 **Table 4-28. Attributes of the Electrical Measurement Cluster**

Attribute Set Identifier	Description
0x00	Basic Information
0x01	DC Measurement
0x02	DC Formatting
0x03	AC (Non-phase Specific) Measurements
0x04	AC (Non-phase Specific) Formatting
0x05	AC (Single Phase or Phase A) Measurements
0x06	AC Formatting
0x07	DC Manufacturer Threshold Alarms

Attribute Set Identifier	Description
0x08	AC Manufacturer Threshold Alarms
0x09	AC Phase B Measurements
0x0a	AC Phase C Measurements

8133 **4.9.2.2.1 Basic Information**

8134 **Table 4-29. Electrical Measurement Cluster Basic Information**

Id	Name	Type	Range	Acc	Def	MO
0x0000	<i>MeasurementType</i>	map32	0x00000000 – 0xffffffff	R	0x00000000	M

8135 **4.9.2.2.1.1 MeasurementType**

8136 This attribute indicates a device’s measurement capabilities. This will be indicated by setting the desire  
 8137 measurement bits to 1, as mentioned in Table 4-30 and DC Measurement  
 8138 Table 4-31. This attribute will be used client devices to determine what all attribute is supported by the me-  
 8139 ter. Unused bits should be set to zero.

8140

**Table 4-30. MeasurementType Attribute**

Bit	Flag Name / Description
0	Active measurement (AC)
1	Reactive measurement (AC)
2	Apparent measurement (AC)
3	Phase A measurement
4	Phase B measurement
5	Phase C measurement
6	DC measurement
7	Harmonics measurement
8	Power quality measurement

8141 **4.9.2.2.2 DC Measurement**

8142

**Table 4-31. DC Measurement Attributes**

Id	Name	Type	Range	Acc	Default	M/O
0x0100	<i>DCVoltage</i>	int16	-32767 – 32767	RP	0x8000	O
0x0101	<i>DCVoltageMin</i>	int16	-32767 – 32767	R	0x8000	O
0x0102	<i>DCVoltageMax</i>	int16	-32767 – 32767	R	0x8000	O
0x0103	<i>DCCurrent</i>	int16	-32767 – 32767	RP	0x8000	O
0x0104	<i>DCCurrentMin</i>	int16	-32767 – 32767	R	0x8000	O
0x0105	<i>DCCurrentMax</i>	int16	-32767 – 32767	R	0x8000	O
0x0106	<i>DCPower</i>	int16	-32767 – 32767	RP	0x8000	O
0x0107	<i>DCPowerMin</i>	int16	-32767 – 32767	R	0x8000	O
0x0108	<i>DCPowerMax</i>	int16	-32767 – 32767	R	0x8000	O
0x0109 – 0x01FF	Reserved					

8143 **4.9.2.2.2.1 DCVoltage**

8144 The DCVoltage attribute represents the most recent DC voltage reading in Volts (V). If the voltage cannot  
 8145 be measured, a value of 0x8000 is returned.

8146 **4.9.2.2.2.2 DCVoltageMin**

8147 The DCVoltageMin attribute represents the lowest DC voltage value measured in Volts (V). After resetting,  
8148 this attribute will return a value of 0x8000 until a measurement is made.

8149 **4.9.2.2.2.3 DCVoltageMax**

8150 The DCVoltageMax attribute represents the highest DC voltage value measured in Volts (V). After resetting,  
8151 this attribute will return a value of 0x8000 until a measurement is made.

8152 **4.9.2.2.2.4 DCCurrent**

8153 The DCCurrent attribute represents the most recent DC current reading in Amps (A). If the current cannot be  
8154 measured, a value of 0x8000 is returned.

8155 **4.9.2.2.2.5 DCCurrentMin**

8156 The DCCurrentMin attribute represents the lowest DC current value measured in Amps (A). After resetting,  
8157 this attribute will return a value of 0x8000 until a measurement is made.

8158 **4.9.2.2.2.6 DCCurrentMax**

8159 The DCCurrentMax attribute represents the highest DC current value measured in Amps (A). After resetting,  
8160 this attribute will return a value of 0x8000 until a measurement is made.

8161 **4.9.2.2.2.7 DCPower**

8162 The DCPower attribute represents the most recent DC power reading in Watts (W). If the power cannot be  
8163 measured, a value of 0x8000 is returned.

8164 **4.9.2.2.2.8 DCPowerMin**

8165 The DCPowerMin attribute represents the lowest DC power value measured in Watts (W). After resetting,  
8166 this attribute will return a value of 0x8000 until a measurement is made.

8167 **4.9.2.2.2.9 DCPowerMax**

8168 The DCPowerMax attribute represents the highest DC power value measured in Watts (W). After resetting,  
8169 this attribute will return a value of 0x8000 until a measurement is made.

8170 **4.9.2.2.3 DC Formatting**

8171 **Table 4-32. DC Formatting Attributes**

<b>Id</b>	<b>Name</b>	<b>Type</b>	<b>Range</b>	<b>Access</b>	<b>Default</b>	<b>M/O</b>
0x0200	<i>DCVoltageMultiplier</i>	uint16	0x0001 – 0xffff	RP	0x0001	O
0x0201	<i>DCVoltageDivisor</i>	uint16	0x0001 – 0xffff	RP	0x0001	O
0x0202	<i>DCCurrentMultiplier</i>	uint16	0x0001 – 0xffff	RP	0x0001	O
0x0203	<i>DCCurrentDivisor</i>	uint16	0x0001 – 0xffff	RP	0x0001	O
0x0204	<i>DCPowerMultiplier</i>	uint16	0x0001 – 0xffff	RP	0x0001	O
0x0205	<i>DCPowerDivisor</i>	uint16	0x0001 – 0xffff	RP	0x0001	O

8172 **4.9.2.2.3.1 DCVoltageMultiplier**

8173 The *DCVoltageMultiplier* provides a value to be multiplied against the *DCVoltage*, *DCVoltageMin*, and  
 8174 *DCVoltageMax* attributes. This attribute must be used in conjunction with the *DCVoltageDivisor* attribute.  
 8175 0x0000 is an invalid value for this attribute.

8176 **4.9.2.2.3.2 DCVoltageDivisor**

8177 The *DCVoltageDivisor* provides a value to be divided against the *DCVoltage*, *DCVoltageMin*, and *DCVoltageMax*  
 8178 attributes. This attribute must be used in conjunction with the *DCVoltageMultiplier* attribute. 0x0000  
 8179 is an invalid value for this attribute.

8180 **4.9.2.2.3.3 DCCurrentMultiplier**

8181 The *DCCurrentMultiplier* provides a value to be multiplied against the *DCCurrent*, *DCCurrentMin*, and  
 8182 *DCCurrentMax* attributes. This attribute must be used in conjunction with the *DCCurrentDivisor* attribute.  
 8183 0x0000 is an invalid value for this attribute.

8184 **4.9.2.2.3.4 DCCurrentDivisor**

8185 The *DCCurrentDivisor* provides a value to be divided against the *DCCurrent*, *DCCurrentMin*, and *DCCurrentMax*  
 8186 attributes. This attribute must be used in conjunction with the *DCCurrentMultiplier* attribute.  
 8187 0x0000 is an invalid value for this attribute.

8188 **4.9.2.2.3.5 DCPowerMultiplier**

8189 The *DCPowerMultiplier* provides a value to be multiplied against the *DCPower*, *DCPowerMin*, and  
 8190 *DCPowerMax* attributes. This attribute must be used in conjunction with the *DCPowerDivisor* attribute.  
 8191 0x0000 is an invalid value for this attribute.

8192 **4.9.2.2.3.6 DCPowerDivisor**

8193 The *DCPowerDivisor* provides a value to be divided against the *DCPower*, *DCPowerMin*, and *DCPowerMax*  
 8194 attributes. This attribute must be used in conjunction with the *DCPowerMultiplier* attribute. 0x0000 is an  
 8195 invalid value for this attribute.

8196 **4.9.2.2.4 AC (Non-phase Specific) Measurements**

8197 **Table 4-33. AC (Non-phase Specific) Measurement Attributes**

Id	Name	Type	Range	Acc	Default	M/O
0x0300	<i>ACFrequency</i>	uint16	0x0000 – 0xffff	RP	0xffff	O
0x0301	<i>ACFrequencyMin</i>	uint16	0x0000 – 0xffff	R	0xffff	O
0x0302	<i>ACFrequencyMax</i>	uint16	0x0000 – 0xffff	R	0xffff	O
0x0303	<i>NeutralCurrent</i>	uint16	0x0000 – 0xffff	RP	0xffff	O
0x0304	<i>TotalActivePower</i>	int32	-8,388,607–8,388,607	RP	-	O
0x0305	<i>TotalReactivePower</i>	int32	-8,388,607–8,388,607	RP	-	O
0x0306	<i>TotalApparentPower</i>	uint32	0x000000–0xffffFF	RP	-	O
0x0307	<i>Measured1stHarmonicCurrent</i>	int16	-32768 – 32767	RP	0x8000	O

Id	Name	Type	Range	Acc	Default	M/O
0x0308	<i>Measured3rdHarmonicCurrent</i>	int16	-32768 – 32767	RP	0x8000	O
0x0309	<i>Measured5thHarmonicCurrent</i>	int16	-32768 – 32767	RP	0x8000	O
0x030a	<i>Measured7thHarmonicCurrent</i>	int16	-32768 – 32767	RP	0x8000	O
0x030b	<i>Measured9thHarmonicCurrent</i>	int16	-32768 – 32767	RP	0x8000	O
0x030c	<i>Measured11thHarmonicCurrent</i>	int16	-32768 – 32767	RP	0x8000	O
0x030d	<i>MeasuredPhase1stHarmonicCurrent</i>	int16	-32768 – 32767	RP	0x8000	O
0x030e	<i>MeasuredPhase3rdHarmonicCurrent</i>	int16	-32768 – 32767	RP	0x8000	O
0x030f	<i>MeasuredPhase5thHarmonicCurrent</i>	int16	-32768 – 32767	RP	0x8000	O
0x0310	<i>MeasuredPhase7thHarmonicCurrent</i>	int16	-32768 – 32767	RP	0x8000	O
0x0311	<i>MeasuredPhase9thHarmonicCurrent</i>	int16	-32768 – 32767	RP	0x8000	O
0x0312	<i>MeasuredPhase11thHarmonicCurrent</i>	int16	-32768 – 32767	RP	0x8000	O

8198 **4.9.2.2.4.1 ACFrequency**

8199 The *ACFrequency* attribute represents the most recent AC Frequency reading in Hertz (Hz). If the frequency  
8200 cannot be measured, a value of 0xffff is returned.

8201 **4.9.2.2.4.2 ACFrequencyMin**

8202 The *ACFrequencyMin* attribute represents the lowest AC Frequency value measured in Hertz (Hz). After  
8203 resetting, this attribute will return a value of 0xffff until a measurement is made.

8204 **4.9.2.2.4.3 ACFrequencyMax**

8205 The *ACFrequencyMax* attribute represents the highest AC Frequency value measured in Hertz (Hz). After  
8206 resetting, this attribute will return a value of 0xffff until a measurement is made.

8207 **4.9.2.2.4.4 NeutralCurrent**

8208 The *NeutralCurrent* attribute represents the magnitude of the most recent AC neutral current in Amps. Typ-  
8209 ically this is a derived value, taking the magnitude of the vector sum of phase current(s). If the neutral current  
8210 cannot be measured or derived, a value of 0xffff is returned.<sup>82</sup>

8211 **4.9.2.2.4.5 TotalActivePower**

8212 Active power represents the current demand of active power delivered or received at the premises, in kW.  
8213 Positive values indicate power delivered to the premises where negative values indicate power received from  
8214 the premises. In case if device is capable of measuring multi elements or phases then this will be net active  
8215 power value.

8216 **4.9.2.2.4.6 TotalReactivePower**

<sup>82</sup> CCB 2369



8217 Reactive power represents the current demand of reactive power delivered or received at the premises, in  
 8218 kVAr. Positive values indicate power delivered to the premises where negative values indicate power re-  
 8219 ceived from the premises. In case if device is capable of measuring multi elements or phases then this will  
 8220 be net reactive power value.

8221 **4.9.2.2.4.7 TotalApparentPower**

8222 Represents the current demand of apparent power, in kVA. In case if device is capable of measuring multi  
 8223 elements or phases then this will be net apparent power value.

8224 **4.9.2.2.4.8 MeasuredNthHarmonicCurrent Attributes**

8225 The *Measured1stHarmonicCurrent* through *MeasuredNthHarmonicCurrent* attributes represent the most re-  
 8226 cent N<sup>th</sup> harmonic current reading in an AC frequency. The unit for this measurement is  $10^{NthHarmonic-}$   
 8227 *CurrentMultiplier* amperes. If *NthHarmonicCurrentMultiplier* is not implemented the unit is in amperes. If  
 8228 the N<sup>th</sup> harmonic current cannot be measured a value of 0x8000 is returned. A positive value indicates the  
 8229 measured N<sup>th</sup> harmonic current is positive, and a negative value indicates that the measured N<sup>th</sup> harmonic  
 8230 current is negative.

8231 **4.9.2.2.4.9 MeasuredPhaseNthHarmonicCurrent Attributes**

8232 The *MeasuredPhase1stHarmonicCurrent* through *MeasuredPhaseNthHarmonicCurrent* attributes represent  
 8233 the most recent phase of the N<sup>th</sup> harmonic current reading in an AC frequency. The unit for this measurement  
 8234 is  $10^{PhaseNthHarmonicCurrentMultiplier}$  degree. If *PhaseNthHarmonicCurrentMultiplier* is not imple-  
 8235 mented the unit is in degree. If the phase of the N<sup>th</sup> harmonic current cannot be measured a value of 0x8000  
 8236 is returned. A positive value indicates the measured phase of the N<sup>th</sup> harmonic current is prehurry, and a  
 8237 negative value indicates that the measured phase of the N<sup>th</sup> harmonic current is lagging.

8238 **4.9.2.2.5 AC (Non-phase Specific) Formatting**

8239 **Table 4-34. AC (Non-phase Specific) Formatting Attributes**

Id	Name	Type	Range	Acc	Default	M/O
0x0400	<i>ACFrequencyMultiplier</i>	uint16	0x0001 – 0xffff	RP	0x0001	O
0x0401	<i>ACFrequencyDivisor</i>	uint16	0x0001 – 0xffff	RP	0x0001	O
0x0402	<i>PowerMultiplier</i>	uint32	0x000000 – 0xffffFF	RP	0x000001	O
0x0403	<i>PowerDivisor</i>	uint32	0x000000 – 0xffffFF	RP	0x000001	O
0x0404	<i>HarmonicCurrentMultiplier</i>	int8	-127 – 127	RP	0x00	O
0x0405	<i>PhaseHarmonicCurrentMultiplier</i>	int8	-127 – 127	RP	0x00	O

8240 **4.9.2.2.5.1 ACFrequencyMultiplier**

8241 Provides a value to be multiplied against the *ACFrequency* attribute. This attribute must be used in conjunc-  
 8242 tion with the *ACFrequencyDivisor* attribute. 0x0000 is an invalid value for this attribute.

8243 **4.9.2.2.5.2 ACFrequencyDivisor**

8244 Provides a value to be divided against the *ACFrequency* attribute. This attribute must be used in conjunction  
 8245 with the *ACFrequencyMultiplier* attribute. 0x0000 is an invalid value for this attribute.

8246 **4.9.2.2.5.3 PowerMultiplier**

8247 Provides a value to be multiplied against a raw or uncompensated sensor count of power being measured by  
8248 the metering device. If present, this attribute must be applied against all power/demand values to derive the  
8249 delivered and received values expressed in the specified units. This attribute must be used in conjunction  
8250 with the *PowerDivisor* attribute.

8251 **4.9.2.2.5.4 PowerDivisor**

8252 Provides a value to divide against the results of applying the *Multiplier* attribute against a raw or uncompen-  
8253 sated sensor count of power being measured by the metering device. If present, this attribute must be applied  
8254 against all demand/power values to derive the delivered and received values expressed in the specified units.  
8255 This attribute must be used in conjunction with the *PowerMultiplier* attribute.

8256 **4.9.2.2.5.5 HarmonicCurrentMultiplier**

8257 Represents the unit value for the *MeasuredNthHarmonicCurrent* attribute in the format *MeasuredNthHar-*  
8258 *monicCurrent* \* 10 ^ *HarmonicCurrentMultiplier* amperes.

8259 **4.9.2.2.5.6 PhaseHarmonicCurrentMultiplier**

8260 Represents the unit value for the *MeasuredPhaseNthHarmonicCurrent* attribute in the format *Meas-*  
8261 *uredPhaseNthHarmonicCurrent* \* 10 ^ *PhaseHarmonicCurrentMultiplier* degrees.

8262 **4.9.2.2.6 AC (Single Phase or Phase A) Measurements**

8263 **Table 4-35. AC (Single Phase or Phase A) Measurement Attributes**

Id	Name	Type	Range	Acc	Default	M/O
0x0501	<i>LineCurrent</i>	uint16	0x0000 – 0xffff	RP	0xffff	O
0x0502	<i>ActiveCurrent</i>	int16	-32768 – 32767	RP	0x8000	O
0x0503	<i>ReactiveCurrent</i>	int16	-32768 – 32767	RP	0x8000	O
0x0505	<i>RMSVoltage</i>	uint16	0x0000 – 0xffff	RP	0xffff	O
0x0506	<i>RMSVoltageMin</i>	uint16	0x0000 – 0xffff	R	0xffff	O
0x0507	<i>RMSVoltageMax</i>	uint16	0x0000 – 0xffff	R	0xffff	O
0x0508	<i>RMSCurrent</i>	uint16	0x0000 – 0xffff	RP	0xffff	O
0x0509	<i>RMSCurrentMin</i>	uint16	0x0000 – 0xffff	R	0xffff	O
0x050a	<i>RMSCurrentMax</i>	uint16	0x0000 – 0xffff	R	0xffff	O
0x050b	<i>ActivePower</i>	int16	-32768 – 32767	RP	0x8000	O
0x050c	<i>ActivePowerMin</i>	int16	-32768 – 32767	R	0x8000	O
0x050d	<i>ActivePowerMax</i>	int16	-32768 – 32767	R	0x8000	O
0x050e	<i>ReactivePower</i>	int16	-32768 – 32767	RP	0x8000	O
0x050f	<i>ApparentPower</i>	uint16	0x0000 – 0xffff	RP	0xffff	O
0x0510	<i>PowerFactor</i>	int8	-100 to +100	R	0x00	O
0x0511	<i>AverageRMSVoltageMeasurementPeriod</i>	uint16	0x0000 – 0xffff	RW	0x0000	O

<b>Id</b>	<b>Name</b>	<b>Type</b>	<b>Range</b>	<b>Acc</b>	<b>Default</b>	<b>M/O</b>
0x0512	<i>AverageRMSOverVoltageCounter</i>	uint16	0x0000 – 0xffff	RW	0x0000	O
0x0513	<i>AverageRMSUnderVoltageCounter</i>	uint16	0x0000 – 0xffff	RW	0x0000	O
0x0514	<i>RMSExtremeOverVoltagePeriod</i>	uint16	0x0000 – 0xffff	RW	0x0000	O
0x0515	<i>RMSExtremeUnderVoltagePeriod</i>	uint16	0x0000 – 0xffff	RW	0x0000	O
0x0516	<i>RMSVoltageSagPeriod</i>	uint16	0x0000 – 0xffff	RW	0x0000	O
0x0517	<i>RMSVoltageSwellPeriod</i>	uint16	0x0000 – 0xffff	RW	0x0000	O

8264 **4.9.2.2.6.1 LineCurrent**

8265 Represents the single phase or Phase A, AC line current (Square root of active and reactive current) value at  
 8266 the moment in time the attribute is read, in Amps (A). If the instantaneous current cannot be measured, a  
 8267 value of 0x8000 is returned.

8268 **4.9.2.2.6.2 ActiveCurrent**

8269 Represents the single phase or Phase A, AC active/resistive current value at the moment in time the attribute  
 8270 is read, in Amps (A). Positive values indicate power delivered to the premises where negative values indicate  
 8271 power received from the premises.

8272 **4.9.2.2.6.3 ReactiveCurrent**

8273 Represents the single phase or Phase A, AC reactive current value at the moment in time the attribute is read,  
 8274 in Amps (A). Positive values indicate power delivered to the premises where negative values indicate power  
 8275 received from the premises.

8276 **4.9.2.2.6.4 RMSVoltage**

8277 Represents the most recent RMS voltage reading in Volts (V). If the RMS voltage cannot be measured, a  
 8278 value of 0xffff is returned.

8279 **4.9.2.2.6.5 RMSVoltageMin**

8280 Represents the lowest RMS voltage value measured in Volts (V). After resetting, this attribute will return a  
 8281 value of 0xffff until a measurement is made.

8282 **4.9.2.2.6.6 RMSVoltageMax**

8283 Represents the highest RMS voltage value measured in Volts (V). After resetting, this attribute will return a  
 8284 value of 0xffff until a measurement is made.

8285 **4.9.2.2.6.7 RMSCurrent**

8286 Represents the most recent RMS current reading in Amps (A). If the power cannot be measured, a value of  
 8287 0xffff is returned.

8288 **4.9.2.2.6.8 RMSCurrentMin**

8289 Represents the lowest RMS current value measured in Amps (A). After resetting, this attribute will return a  
 8290 value of 0xffff until a measurement is made.

8291 **4.9.2.2.6.9 RMSCurrentMax**

8292 Represents the highest RMS current value measured in Amps (A). After resetting, this attribute will return a  
8293 value of 0xffff until a measurement is made.

8294 **4.9.2.2.6.10      *ActivePower***

8295 Represents the single phase or Phase A, current demand of active power delivered or received at the premises,  
8296 in Watts (W). Positive values indicate power delivered to the premises where negative values indicate power  
8297 received from the premises.

8298 **4.9.2.2.6.11      *ActivePowerMin***

8299 Represents the lowest AC power value measured in Watts (W). After resetting, this attribute will return a  
8300 value of 0x8000 until a measurement is made.

8301 **4.9.2.2.6.12      *ActivePowerMax***

8302 Represents the highest AC power value measured in Watts (W). After resetting, this attribute will return a  
8303 value of 0x8000 until a measurement is made.

8304 **4.9.2.2.6.13      *ReactivePower***

8305 Represents the single phase or Phase A, current demand of reactive power delivered or received at the prem-  
8306 ises, in VAR. Positive values indicate power delivered to the premises where negative values indicate power  
8307 received from the premises.

8308 **4.9.2.2.6.14      *ApparentPower***

8309 Represents the single phase or Phase A, current demand of apparent (Square root of active and reactive  
8310 power) power, in VA.

8311 **4.9.2.2.6.15      *PowerFactor***

8312 Contains the single phase or PhaseA, Power Factor ratio in 1/100ths.

8313 **4.9.2.2.6.16      *AverageRMSVoltageMeasurementPeriod***

8314 The Period in seconds that the RMS voltage is averaged over.

8315 **4.9.2.2.6.17      *AverageRMSOverVoltageCounter***

8316 The number of times the average RMS voltage, has been above the *AverageRMS OverVoltage* threshold since  
8317 last reset. This counter may be reset by writing zero to the attribute.

8318 **4.9.2.2.6.18      *AverageRMSUnderVoltageCounter***

8319 The number of times the average RMS voltage, has been below the *AverageRMS underVoltage* threshold  
8320 since last reset. This counter may be reset by writing zero to the attribute.

8321 **4.9.2.2.6.19      *RMSExtremeOverVoltagePeriod***

8322 The duration in seconds used to measure an extreme over voltage condition.

8323 **4.9.2.2.6.20      *RMSExtremeUnderVoltagePeriod***

8324 The duration in seconds used to measure an extreme under voltage condition.

8325 **4.9.2.2.6.21      *RMSVoltageSagPeriod***

8326 The duration in seconds used to measure a voltage sag condition.

8327 **4.9.2.2.6.22      *RMSVoltageSwellPeriod***

8328 The duration in seconds used to measure a voltage swell condition.

8329 **4.9.2.2.7 AC Formatting**

8330 **Table 4-36. AC Formatting Attributes**

Id	Name	Type	Range	Acc	Default	M/O
0x0600	<i>ACVoltageMultiplier</i>	uint16	0x0001 – 0xffff	RP	0x0001	O
0x0601	<i>ACVoltageDivisor</i>	uint16	0x0001 – 0xffff	RP	0x0001	O
0x0602	<i>ACCurrentMultiplier</i>	uint16	0x0001 – 0xffff	RP	0x0001	O
0x0603	<i>ACCurrentDivisor</i>	uint16	0x0001 – 0xffff	RP	0x0001	O
0x0604	<i>ACPowerMultiplier</i>	uint16	0x0001 – 0xffff	RP	0x0001	O
0x0605	<i>ACPowerDivisor</i>	uint16	0x0001 – 0xffff	RP	0x0001	O

8331 **4.9.2.2.7.1 ACVoltageMultiplier**

8332 Provides a value to be multiplied against the *InstantaneousVoltage* and *RMSVoltage* attributes. This attribute  
 8333 must be used in conjunction with the *ACVoltageDivisor* attribute. 0x0000 is an invalid value for this attribute.

8334 **4.9.2.2.7.2 ACVoltageDivisor**

8335 Provides a value to be divided against the *InstantaneousVoltage* and *RMSVoltage* attributes. This attribute  
 8336 must be used in conjunction with the *ACVoltageMultiplier* attribute. 0x0000 is an invalid value for this at-  
 8337 tribute.

8338 **4.9.2.2.7.3 ACCurrentMultiplier**

8339 Provides a value to be multiplied against the *InstantaneousCurrent* and *RMSCurrent* attributes. This attribute  
 8340 must be used in conjunction with the *ACCurrentDivisor* attribute. 0x0000 is an invalid value for this attribute.

8341 **4.9.2.2.7.4 ACCurrentDivisor**

8342 Provides a value to be divided against the *ACCurrent*, *InstantaneousCurrent* and *RMSCurrent* attributes. This  
 8343 attribute must be used in conjunction with the *ACCurrentMultiplier* attribute. 0x0000 is an invalid value for  
 8344 this attribute.

8345 **4.9.2.2.7.5 ACPowerMultiplier**

8346 Provides a value to be multiplied against the *InstantaneousPower* and *ActivePower* attributes. This attribute  
 8347 must be used in conjunction with the *ACPowerDivisor* attribute. 0x0000 is an invalid value for this attribute.

8348 **4.9.2.2.7.6 ACPowerDivisor**

8349 Provides a value to be divided against the *InstantaneousPower* and *ActivePower* attributes. This attribute  
 8350 must be used in conjunction with the *ACPowerMultiplier* attribute. 0x0000 is an invalid value for this attrib-  
 8351 ute.

8352 **4.9.2.2.8 DC Manufacturer Threshold Alarms**

8353 **Table 4-37. DC Manufacturer Threshold Alarms Attributes**

Id	Name	Type	Range	Access	Default	M/O
0x0700	<i>DCOverloadAlarmsMask</i>	map8	0000 00xx	RW	0000 0000	O
0x0701	<i>DCVoltageOverload</i>	int16	-32768 – 32767	R	0xffff	O
0x0702	<i>DCCurrentOverload</i>	int16	-32768 – 32767	R	0xffff	O

8354 **4.9.2.2.8.1 DCOverloadAlarmsMask**

8355 Specifies which configurable alarms may be generated, as listed in Figure 4-4. A ‘1’ in each bit position  
8356 enables the alarm.

8357 **Figure 4-4. The DC Overload Alarm Mask**

Bit	Description
Bit0	Voltage Overload
Bit1	Current Overload

8358 **4.9.2.2.8.2 DCVoltageOverload**

8359 Specifies the alarm threshold, set by the manufacturer, for the maximum output voltage supported by device.  
8360 The value is multiplied and divided by the *DCVoltageMultiplier* the *DCVoltageDivisor* respectively.

8361 **4.9.2.2.8.3 DCCurrentOverload**

8362 Specifies the alarm threshold, set by the manufacturer, for the maximum output current supported by device.  
8363 The value is multiplied and divided by the *DCCurrentMultiplier* and *DCCurrentDivider* respectively.

8364 **4.9.2.2.9 AC Manufacturer Threshold Alarms**

8365 **Table 4-38. AC Manufacturer Threshold Alarms Attributes**

Id	Name	Type	Range	Access	Default	MO
0x0800	<i>ACAlarmsMask</i>	map16	0000 xxxx	RW	0000 0000	O
0x0801	<i>ACVoltageOverload</i>	int16	-32768 – 32767	R	0xffff	O
0x0802	<i>ACCCurrentOverload</i>	int16	-32768 – 32767	R	0xffff	O
0x0803	<i>ACActivePowerOverload</i>	int16	-32768 – 32767	R	0xffff	O
0x0804	<i>ACReactivePowerOverload</i>	int16	-32768 – 32767	R	0xffff	O
0x0805	<i>AverageRMSOverVoltage</i>	int16	-32768 – 32767	R		O

Id	Name	Type	Range	Access	Default	MO
0x0806	<i>AverageRMSUnderVoltage</i>	int16	-32768 – 32767	R		O
0x0807	<i>RMSExtremeOverVoltage</i>	int16	-32768 – 32767	RW		O
0x0808	<i>RMSExtremeUnderVoltage</i>	int16	-32768 – 32767	RW		O
0x0809	<i>RMSVoltageSag</i>	int16	-32768 – 32767	RW		O
0x080a	<i>RMSVoltageSwell</i>	int16	-32768 – 32767	RW		O

8366 **4.9.2.2.9.1 ACAlarmsMask**

8367 Specifies which configurable alarms may be generated, as listed in Figure 4-5. A ‘1’ in each bit position  
 8368 enables the alarm.

8369 **Figure 4-5. The ACAlarmsMask Attribute**

Bit	Description
Bit0	Voltage Overload
Bit1	Current Overload
Bit2	Active Power Overload
Bit3	Reactive Power Overload
Bit4	Average RMS Over Voltage
Bit5	Average RMS Under Voltage
Bit6	RMS Extreme Over Voltage
Bit7	RMS Extreme Under Voltage
Bit8	RMS Voltage Sag
Bit9	RMS Voltage Swell

8370 **4.9.2.2.9.2 ACVoltageOverload**

8371 Specifies the alarm threshold, set by the manufacturer, for the maximum output voltage supported by device.  
 8372 The value is multiplied and divided by the *ACVoltageMultiplier* the *ACVoltageDivisor*, respectively. The  
 8373 value is voltage RMS.

8374 **4.9.2.2.9.3 ACCurrentOverload**

8375 Specifies the alarm threshold, set by the manufacturer, for the maximum output current supported by device.  
 8376 The value is multiplied and divided by the *ACCurrentMultiplier* and *ACCurrentDivider*, respectively. The  
 8377 value is current RMS.

8378 **4.9.2.2.9.4 ACActivePowerOverload**

8379 Specifies the alarm threshold, set by the manufacturer, for the maximum output active power supported by  
8380 device. The value is multiplied and divided by the *ACPowerMultiplier* and *ACPowerDivisor*, respectively.

8381 **4.9.2.2.9.5 ACReactivePowerOverload**

8382 Specifies the alarm threshold, set by the manufacturer, for the maximum output reactive power supported by  
8383 device. The value is multiplied and divided by the *ACPowerMultiplier* and *ACPowerDivisor*, respectively.

8384 **4.9.2.2.9.6 AverageRMSOverVoltage**

8385 The average RMS voltage above which an over voltage condition is reported. The threshold shall be config-  
8386 urable within the specified operating range of the electricity meter. The value is multiplied and divided by  
8387 the *ACVoltageMultiplier* and *ACVoltageDivisor*, respectively.

8388 **4.9.2.2.9.7 AverageRMSUnderVoltage**

8389 The average RMS voltage below which an under voltage condition is reported. The threshold shall be con-  
8390 figurable within the specified operating range of the electricity meter. The value is multiplied and divided by  
8391 the *ACVoltageMultiplier* and *ACVoltageDivisor*, respectively.

8392 **4.9.2.2.9.8 RMSExtremeOverVoltage**

8393 The RMS voltage above which an extreme under voltage condition is reported. The threshold shall be con-  
8394 figurable within the specified operating range of the electricity meter. The value is multiplied and divided by  
8395 the *ACVoltageMultiplier* and *ACVoltageDivisor*, respectively.

8396 **4.9.2.2.9.9 RMSExtremeUnderVoltage**

8397 The RMS voltage below which an extreme under voltage condition is reported. The threshold shall be con-  
8398 figurable within the specified operating range of the electricity meter. The value is multiplied and divided by  
8399 the *ACVoltageMultiplier* and *ACVoltageDivisor*, respectively.

8400 **4.9.2.2.9.10 RMSVoltageSag**

8401 The RMS voltage below which a sag condition is reported. The threshold shall be configurable within the  
8402 specified operating range of the electricity meter. The value is multiplied and divided by the *ACVoltageMul-*  
8403 *tiplier* and *ACVoltageDivisor*, respectively.

8404 **4.9.2.2.9.11 RMSVoltageSwell**

8405 The RMS voltage above which a swell condition is reported. The threshold shall be configurable within the  
8406 specified operating range of the electricity meter. The value is multiplied and divided by the *ACVoltageMul-*  
8407 *tiplier* and *ACVoltageDivisor*, respectively.

8408 **4.9.2.2.10 AC Phase B Measurements**

8409 **Table 4-39. AC Phase B Measurements Attributes**

Id	Name	Type	Range	Acc	Def	M/O
0x0901	<i>LineCurrentPhB</i>	uint16	0x0000 – 0xffff	RP	0xffff	O
0x0902	<i>ActiveCurrentPhB</i>	int16	-32768 – 32767	RP	0x8000	O
0x0903	<i>ReactiveCurrentPhB</i>	int16	-32768 – 32767	RP	0x8000	O



<b>Id</b>	<b>Name</b>	<b>Type</b>	<b>Range</b>	<b>Acc</b>	<b>Def</b>	<b>M/O</b>
0x0905	<i>RMSVoltagePhB</i>	uint16	0x0000 – 0xffff	RP	0xffff	O
0x0906	<i>RMSVoltageMinPhB</i>	uint16	0x0000 – 0xffff	R	0x8000	O
0x0907	<i>RMSVoltageMaxPhB</i>	uint16	0x0000 – 0xffff	R	0x8000	O
0x0908	<i>RMSCurrentPhB</i>	uint16	0x0000 – 0xffff	RP	0xffff	O
0x0909	<i>RMSCurrentMinPhB</i>	uint16	0x0000 – 0xffff	R	0xffff	O
0x090a	<i>RMSCurrentMaxPhB</i>	uint16	0x0000 – 0xffff	R	0xffff	O
0x090b	<i>ActivePowerPhB</i>	int16	-32768 – 32767	RP	0x8000	O
0x090c	<i>ActivePowerMinPhB</i>	int16	-32768 – 32767	R	0x8000	O
0x090d	<i>ActivePowerMaxPhB</i>	int16	-32768 – 32767	R	0x8000	O
0x090e	<i>ReactivePowerPhB</i>	int16	-32768 – 32767	RP	0x8000	O
0x090f	<i>ApparentPowerPhB</i>	uint16	0x0000 – 0xffff	RP	0xffff	O
0x0910	<i>PowerFactorPhB</i>	int8	-100 to +100	R	0x00	O
0x0911	<i>AverageRMSVoltageMeasurementPeriod-PhB</i>	uint16	0x0000 – 0xffff	RW	0x0000	O
0x0912	<i>AverageRMSOverVoltageCounterPhB</i>	uint16	0x0000 – 0xffff	RW	0x0000	O
0x0913	<i>AverageRMSUnderVoltageCounterPhB</i>	uint16	0x0000 – 0xffff	RW	0x0000	O
0x0914	<i>RMSExtremeOverVoltagePeriodPhB</i>	uint16	0x0000 – 0xffff	RW	0x0000	O
0x0915	<i>RMSExtremeUnderVoltagePeriodPhB</i>	uint16	0x0000 – 0xffff	RW	0x0000	O
0x0916	<i>RMSVoltageSagPeriodPhB</i>	uint16	0x0000 – 0xffff	RW	0x0000	O
0x0917	<i>RMSVoltageSwellPeriodPhB</i>	uint16	0x0000 – 0xffff	RW	0x0000	O

8410 **4.9.2.2.10.1 LineCurrentPhB**

8411 Represents the Phase B, AC line current (Square root sum of active and reactive currents) value at the moment  
 8412 in time the attribute is read, in Amps (A). If the instantaneous current cannot be measured, a value of 0x8000  
 8413 is returned.

8414 **4.9.2.2.10.2 ActiveCurrentPhB**

8415 Represents the Phase B, AC active/resistive current value at the moment in time the attribute is read, in Amps  
 8416 (A). Positive values indicate power delivered to the premises where negative values indicate power received  
 8417 from the premises.

8418 **4.9.2.2.10.3 ReactiveCurrentPhB**

8419 Represents the Phase B, AC reactive current value at the moment in time the attribute is read, in Amps (A).  
8420 Positive values indicate power delivered to the premises where negative values indicate power received from  
8421 the premises.

8422 **4.9.2.2.10.4**      ***RMSVoltagePhB***

8423 Represents the most recent RMS voltage reading in Volts (V). If the RMS voltage cannot be measured, a  
8424 value of 0xffff is returned.

8425 **4.9.2.2.10.5**      ***RMSVoltageMinPhB***

8426 Represents the lowest RMS voltage value measured in Volts (V). After resetting, this attribute will return a  
8427 value of 0xffff until a measurement is made.

8428 **4.9.2.2.10.6**      ***RMSVoltageMaxPhB***

8429 Represents the highest RMS voltage value measured in Volts (V). After resetting, this attribute will return a  
8430 value of 0xffff until a measurement is made.

8431 **4.9.2.2.10.7**      ***RMSCurrentPhB***

8432 Represents the most recent RMS current reading in Amps (A). If the power cannot be measured, a value of  
8433 0xffff is returned.

8434 **4.9.2.2.10.8**      ***RMSCurrentMinPhB***

8435 Represents the lowest RMS current value measured in Amps (A). After resetting, this attribute will return a  
8436 value of 0x8000 until a measurement is made.

8437 **4.9.2.2.10.9**      ***RMSCurrentMaxPhB***

8438 Represents the highest RMS current value measured in Amps (A). After resetting, this attribute will return a  
8439 value of 0x8000 until a measurement is made.

8440 **4.9.2.2.10.10**     ***ActivePowerPhB***

8441 Represents the Phase B, current demand of active power delivered or received at the premises, in Watts (W).  
8442 Positive values indicate power delivered to the premises where negative values indicate power received from  
8443 the premises.

8444 **4.9.2.2.10.11**     ***ActivePowerMinPhB***

8445 Represents the lowest AC power value measured in Watts (W). After resetting, this attribute will return a  
8446 value of 0x8000 until a measurement is made.

8447 **4.9.2.2.10.12**     ***ActivePowerMaxPhB***

8448 Represents the highest AC power value measured in Watts (W). After resetting, this attribute will return a  
8449 value of 0x8000 until a measurement is made.

8450 **4.9.2.2.10.13**     ***ReactivePowerPhB***

8451 Represents the Phase B, current demand of reactive power delivered or received at the premises, in VAR.  
8452 Positive values indicate power delivered to the premises where negative values indicate power received from  
8453 the premises.

8454 **4.9.2.2.10.14**     ***ApparentPowerPhB***

8455 Represents the Phase B, current demand of apparent (Square root of active and reactive power) power, in  
8456 VA.

- 8457 **4.9.2.2.10.15** *PowerFactorPhB*
- 8458 Contains the PhaseB, Power Factor ratio in 1/100ths.
- 8459 **4.9.2.2.10.16** *AverageRMSVoltageMeasurementPeriodPhB*
- 8460 The Period in seconds that the RMS voltage is averaged over.
- 8461 **4.9.2.2.10.17** *AverageRMSOverVoltageCounterPhB*
- 8462 The number of times the average RMS voltage, has been above the *AverageRMS OverVoltage* threshold since  
 8463 last reset. This counter may be reset by writing zero to the attribute.
- 8464 **4.9.2.2.10.18** *AverageRMSUnderVoltageCounterPhB*
- 8465 The number of times the average RMS voltage, has been below the *AverageRMS underVoltage* threshold  
 8466 since last reset. This counter may be reset by writing zero to the attribute.
- 8467 **4.9.2.2.10.19** *RMSExtremeOverVoltagePeriodPhB*
- 8468 The duration in seconds used to measure an extreme over voltage condition.
- 8469 **4.9.2.2.10.20** *RMSExtremeUnderVoltagePeriodPhB*
- 8470 The duration in seconds used to measure an extreme under voltage condition.
- 8471 **4.9.2.2.10.21** *RMSVoltageSagPeriodPhB*
- 8472 The duration in seconds used to measure a voltage sag condition.
- 8473 **4.9.2.2.10.22** *RMSVoltageSwellPeriodPhB*
- 8474 The duration in seconds used to measure a voltage swell condition.

8475 **4.9.2.2.11 AC Phase C Measurements**

8476 **Table 4-40. AC Phase C Measurements Attributes**

Id	Name	Type	Range	Acc	Def	M/O
0x0a01	<i>LineCurrentPhC</i>	uint16	0x0000 – 0xffff	RP	0xffff	O
0x0a02	<i>ActiveCurrentPhC</i>	int16	-32768 – 32767	RP	0x8000	O
0x0a03	<i>ReactiveCurrentPhC</i>	int16	-32768 – 32767	RP	0x8000	O
0x0a05	<i>RMSVoltagePhC</i>	uint16	0x0000 – 0xffff	RP	0xffff	O
0x0a06	<i>RMSVoltageMinPhC</i>	uint16	0x0000 – 0xffff	R	0x8000	O
0x0a07	<i>RMSVoltageMaxPhC</i>	uint16	0x0000 – 0xffff	R	0x8000	O
0x0a08	<i>RMSCurrentPhC</i>	uint16	0x0000 – 0xffff	RP	0xffff	O
0x0a09	<i>RMSCurrentMinPhC</i>	uint16	0x0000 – 0xffff	R	0xffff	O
0x0a0a	<i>RMSCurrentMaxPhC</i>	uint16	0x0000 – 0xffff	R	0xffff	O

Id	Name	Type	Range	Acc	Def	M/O
0x0a0b	<i>ActivePowerPhC</i>	int16	-32768 – 32767	RP	0x8000	O
0x0a0c	<i>ActivePowerMinPhC</i>	int16	-32768 – 32767	R	0x8000	O
0x0a0d	<i>ActivePowerMaxPhC</i>	int16	-32768 – 32767	R	0x8000	O
0x0a0e	<i>ReactivePowerPhC</i>	int16	-32768 – 32767	RP	0x8000	O
0x0a0f	<i>ApparentPowerPhC</i>	uint16	0x0000 – 0xffff	RP	0xffff	O
0x0a10	<i>PowerFactorPhC</i>	int8	-100 to +100	R	0x00	O
0x0a11	<i>AverageRMSVoltageMeasurementPeriod-PhC</i>	uint16	0x0000 – 0xffff	RW	0x0000	O
0x0a12	<i>AverageRMSOverVoltageCounterPhC</i>	uint16	0x0000 – 0xffff	RW	0x0000	O
0x0a13	<i>AverageRMSUnderVoltageCounterPhC</i>	uint16	0x0000 – 0xffff	RW	0x0000	O
0x0a14	<i>RMSExtremeOverVoltagePeriodPhC</i>	uint16	0x0000 – 0xffff	RW	0x0000	O
0x0a15	<i>RMSExtremeUnderVoltagePeriodPhC</i>	uint16	0x0000 – 0xffff	RW	0x0000	O
0x0a16	<i>RMSVoltageSagPeriodPhC</i>	uint16	0x0000 – 0xffff	RW	0x0000	O
0x0a17	<i>RMSVoltageSwellPeriodPhC</i>	uint16	0x0000 – 0xffff	RW	0x0000	O

8477 **4.9.2.2.11.1** *LineCurrentPhC*

8478 Represents the Phase C, AC line current (Square root of active and reactive current) value at the moment in  
8479 time the attribute is read, in Amps (A). If the instantaneous current cannot be measured, a value of 0x8000 is  
8480 returned.

8481 **4.9.2.2.11.2** *ActiveCurrentPhC*

8482 Represents the Phase C, AC active/resistive current value at the moment in time the attribute is read, in Amps  
8483 (A). Positive values indicate power delivered to the premises where negative values indicate power received  
8484 from the premises.

8485 **4.9.2.2.11.3** *ReactiveCurrentPhC*

8486 Represents the Phase C, AC reactive current value at the moment in time the attribute is read, in Amps (A).  
8487 Positive values indicate power delivered to the premises where negative values indicate power received from  
8488 the premises.

8489 **4.9.2.2.11.4** *RMSVoltagePhC*

8490 Represents the most recent RMS voltage reading in Volts (V). If the RMS voltage cannot be measured, a  
8491 value of 0xffff is returned.

8492 **4.9.2.2.11.5** *RMSVoltageMinPhC*

- 8493 Represents the lowest RMS voltage value measured in Volts (V). After resetting, this attribute will return a  
8494 value of 0xffff until a measurement is made.
- 8495 **4.9.2.2.11.6**      ***RMSVoltageMaxPhC***
- 8496 Represents the highest RMS voltage value measured in Volts (V). After resetting, this attribute will return a  
8497 value of 0xffff until a measurement is made.
- 8498 **4.9.2.2.11.7**      ***RMSCurrentPhC***
- 8499 Represents the most recent RMS current reading in Amps (A). If the power cannot be measured, a value of  
8500 0xffff is returned.
- 8501 **4.9.2.2.11.8**      ***RMSCurrentMinPhC***
- 8502 Represents the lowest RMS current value measured in Amps (A). After resetting, this attribute will return a  
8503 value of 0x8000 until a measurement is made.
- 8504 **4.9.2.2.11.9**      ***RMSCurrentMaxPhC***
- 8505 Represents the highest RMS current value measured in Amps (A). After resetting, this attribute will return a  
8506 value of 0x8000 until a measurement is made.
- 8507 **4.9.2.2.11.10**     ***ActivePowerPhC***
- 8508 Represents the Phase C, current demand of active power delivered or received at the premises, in Watts (W).  
8509 Positive values indicate power delivered to the premises where negative values indicate power received from  
8510 the premises.
- 8511 **4.9.2.2.11.11**     ***ActivePowerMinPhC***
- 8512 Represents the lowest AC power value measured in Watts (W). After resetting, this attribute will return a  
8513 value of 0x8000 until a measurement is made.
- 8514 **4.9.2.2.11.12**     ***ActivePowerMaxPhC***
- 8515 Represents the highest AC power value measured in Watts (W). After resetting, this attribute will return a  
8516 value of 0x8000 until a measurement is made.
- 8517 **4.9.2.2.11.13**     ***ReactivePowerPhC***
- 8518 Represents the Phase C, current demand of reactive power delivered or received at the premises, in VAR.  
8519 Positive values indicate power delivered to the premises where negative values indicate power received from  
8520 the premises.
- 8521 **4.9.2.2.11.14**     ***ApparentPowerPhC***
- 8522 Represents the Phase C, current demand of apparent (Square root of active and reactive power) power, in  
8523 VA.
- 8524 **4.9.2.2.11.15**     ***PowerFactorPhC***
- 8525 Contains the Phase C, Power Factor ratio in 1/100ths.
- 8526 **4.9.2.2.11.16**     ***AverageRMSVoltageMeasurementPeriodPhC***
- 8527 The Period in seconds that the RMS voltage is averaged over
- 8528 **4.9.2.2.11.17**     ***AverageRMSOverVoltageCounterPhC***

8529 The number of times the average RMS voltage, has been above the *AverageRMS OverVoltage* threshold since  
8530 last reset. This counter may be reset by writing zero to the attribute.

8531 **4.9.2.2.11.18 *AverageRMSUnderVoltageCounterPhC***

8532 The number of times the average RMS voltage, has been below the *AverageRMS underVoltage* threshold  
8533 since last reset. This counter may be reset by writing zero to the attribute.

8534 **4.9.2.2.11.19 *RMSExtremeOverVoltagePeriodPhC***

8535 The duration in seconds used to measure an extreme over voltage condition.

8536 **4.9.2.2.11.20 *RMSExtremeUnderVoltagePeriodPhC***

8537 The duration in seconds used to measure an extreme under voltage condition.

8538 **4.9.2.2.11.21 *RMSVoltageSagPeriodPhC***

8539 The duration in seconds used to measure a voltage sag condition.

8540 **4.9.2.2.11.22 *RMSVoltageSwellPeriodPhC***

8541 The duration in seconds used to measure a voltage swell condition.

8542 **4.9.2.3 Server Commands**

8543 **4.9.2.3.1 Commands Generated**

8544 The command IDs generated by the electrical measurement server cluster are listed in Table 4-41.

8545 **Table 4-41. Generated Command ID's for the Electrical Measurement Server**

Command Identifier	Description	M/O
0x00	Get Profile Info Response Command	O
0x01	Get Measurement Profile Response Command	O

8546 **4.9.2.3.1.1 Get Profile Info Response Command**

8547 The Get Profile Info Response Command shall be formatted as illustrated in Figure 4-6.

8548 **Figure 4-6. Format of the Get Profile Info Response Command**

Octets	1	1	1	Variable
Data Type	uint8	enum8	uint8	Array of attribute IDs (two-byte unsigned values)
Field Name	Profile Count	ProfileIntervalPeriod	MaxNumberOfIntervals	ListOfAttributes

8549 **4.9.2.3.1.1.1 Payload Details**

8550 **Profile Count:** Total number of supported profile.

8551 **ProfileIntervalPeriod:** Represents the interval or time frame used to capture parameter for profiling pur-  
 8552 poses. ProfileIntervalPeriod is an enumerated field representing the timeframes listed in Figure 4-7.

8553

**Figure 4-7. ProfileIntervalPeriod**

Enumerated Value	Time Frame
0	Daily
1	60 minutes
2	30 minutes
3	15 minutes
4	10 minutes
5	7.5 minutes
6	5 minutes
7	2.5 minutes

8554 **MaxNumberOfIntervals:** Represents the maximum number of intervals the device is capable of returning  
 8555 in one Get Measurement Profile Response command. It is required MaxNumberOfIntervals fit within the  
 8556 default Fragmentation ASDU size of 128 bytes, or an optionally agreed upon larger Fragmentation ASDU  
 8557 size supported by both devices as per the application profile supported by the devices.

8558 **ListOfAttributes:** Represents the list of attributes being profiled.

8559 **4.9.2.3.1.2 When Generated**

8560 This command is generated when the Client command GetProfileInfo is received.

8561 **4.9.2.3.1.3 Get Measurement Profile Response Command**

8562 The Get Measurement Profile Response Command shall be formatted as illustrated in Figure 4-8.

8563

**Figure 4-8. Format of the Get Measurement Profile Response Command**

<b>Octets</b>	4	1	1	1	1	Variable
<b>Data Type</b>	UTC	enum8	enum8	uint8	attribId	Array of Attribute values
<b>Field Name</b>	StartTime	Status	ProfileIn-ter-valPeriod	NumberOf IntervalsDelivered	Attribute Id	Intervals

8564 **4.9.2.3.1.3.1 Payload Details**

8565 **StartTime:** 32-bit value (in UTC) representing the end time of the most chronologically recent interval being  
 8566 requested. Example: Data collected from 2:00 PM to 3:00 PM would be specified as a 3:00 PM interval (end  
 8567 time).

8568 **Status:** Table status enumeration in Table 4-42 lists the valid values returned in the Status field.

8569

**Table 4-42. List of Status Valid Values**

Status Value	Description
0x00	Success
0x01	Attribute Profile not supported
0x02	Invalid Start Time
0x03	More intervals requested than can be returned
0x04	No intervals available for the requested time

8570

8571 **ProfileIntervalPeriod:** Represents the interval or time frame used to capture parameter for profiling purposes. Refer to table “ProfileIntervalPeriod”.

8573 **NumberOfIntervalsDelivered:** Represents the number of intervals the device is returning. Please note the number of intervals returned in the Get Measurement Profile Response command can be calculated when the packets are received and can replace the usage of this field. The intent is to provide this information as a convenience.

8577 **AttributeID:** The attribute that has been profiled by the application.

8578 **Intervals:** Series of interval data captured using the period specified by the ProfileIntervalPeriod field. The content of the interval data depend of the type of information requested using the **AttributeID** field in the Get Measurement Profile Command. Data is organized in a reverse chronological order, the oldest intervals are transmitted first and the newest interval is transmitted last. Invalid intervals should be marked as 0xffff. For scaling and data type use the respective attribute set as defined above in attribute sets.

8583 **4.9.2.3.1.3.2 When Generated**

8584 This command is generated when the Client command GetMeasurementProfile is received.

8585 **4.9.2.4 Client Commands**

8586 **4.9.2.4.1 Commands Generated**

8587 The command ID’s generated by the electrical measurement client cluster are listed in Table 4-43.

8588 **Table 4-43. Generated Command IDs for the Electrical Measurement Client**

Command Identifier	Description	M/O
0x00	Get Profile Info Command	O
0x01	Get Measurement Profile Command	O

8589 **4.9.2.4.1.1 Get Profile Info Command**

8590 This command has no payload.

8591 **4.9.2.4.1.1.1 Effect on Receipt**



8592 On receipt of this command, the device shall send a Get Profile Info Response Command. A Default Re-  
 8593 sponse with status UNSUP\_COMMAND<sup>83</sup> shall be returned if command is not supported on the device.

8594 **4.9.2.4.1.2 Get Measurement Profile Command**

8595 The Get Measurement Profile Command shall be formatted as illustrated in Figure 4-9.

8596 **Figure 4-9. Format of the Get Measurement Profile Command**

<b>Octets</b>	2	4 <sup>84</sup>	1
<b>Data Type</b>	attribId	UTC	uint8
<b>Field Name</b>	Attribute ID	Start Time	NumberOfIntervals

8597 **4.9.2.4.1.2.1 Payload Details**

8598 **Attribute ID:** The electricity measurement attribute being profiled.

8599 **StartTime:** 32-bit value (in UTCtime) used to select an Intervals block from all the Intervals blocks avail-  
 8600 able. The Intervals block returned is the most recent block with its StartTime equal or greater to the one  
 8601 provided.

8602 **NumberOfIntervals:** Represents the number of intervals being requested. This value can't exceed the size  
 8603 stipulated in the MaxNumberOfIntervals field of Get Profile Info Response Command. If more intervals are  
 8604 requested than can be delivered, the GetMeasurementProfileResponse will return the number of intervals  
 8605 equal to MaxNumberOfIntervals. If fewer intervals available for the time period then only those available  
 8606 are returned.

8607 **4.9.2.4.1.2.2 Effect on Receipt**

8608 On receipt of this command, the device shall send a Get Measurement Profile Response Command. A ZCL  
 8609 default response with status UNSUP\_COMMAND<sup>85</sup> shall be returned if command is not supported on the  
 8610 device.

8611 **4.10 Electrical Conductivity Measurement**

---

8612 **4.10.1 Overview**

8613 Please see Chapter 2 for a general cluster overview defining cluster architecture, revision, classification,  
 8614 identification, etc.

8615 The server cluster provides an interface to Electrical Conductivity measurement functionality.

8616 **4.10.1.1 Revision History**

8617 The global *ClusterRevision* attribute value SHALL be the highest revision number in the table below.

---

<sup>83</sup> CCB 2477 status code cleanup

<sup>84</sup> CCB 2817 UTC is 4 octets

<sup>85</sup> CCB 2477 status code cleanup

Rev	Description
1	mandatory global <i>ClusterRevision</i> attribute added

8618 **4.10.1.2 Classification**

Hierarchy	Role	PICS Code	Primary Transaction
Base	Application	EC	Type 2 (server to client)

8619 **4.10.1.3 Cluster Identifiers**

Identifier	Name
0x040A	Electrical Conductivity

8620 **4.10.2 Server**

8621 **4.10.2.1 Attributes**

8622 **Table 4-44. Attributes of the Electrical Conductivity Measurement server cluster**

Id	Name	Type	Range	Acc	Def	MO
0x0000	<i>MeasuredValue</i>	uint16	<i>MinMeasuredValue</i> to <i>MaxMeasuredValue</i>	RP	0xffff	M
0x0001	<i>MinMeasuredValue</i>	uint16	0x0000 to <i>MaxMeasuredValue</i> -1	R	0xffff	M
0x0002	<i>MaxMeasuredValue</i>	uint16	<i>MinMeasuredValue</i> +1 to 0xfffe	R	0xffff	M
0x0003	<i>Tolerance</i>	uint16	0x0000 to 0x0064	R		O

8623 **4.10.2.1.1.1 *MeasuredValue* Attribute**

8624 *MeasuredValue* represents the Electrical Conductivity in EC or mS/m (milli-Siemens per meter) as follows:

8625  $MeasuredValue = 10 \times$  Electrical Conductivity in mS/m. The maximum resolution this format allows is 0.1.

8626 A *MeasuredValue* of 0xffff SHALL indicate an unknown value, otherwise the range SHALL be as described  
8627 in 4.1.3.

8628 *MeasuredValue* is updated continuously as new measurements are made.

8629 **4.10.2.1.1.2 *MinMeasuredValue* Attribute**

8630 The *MinMeasuredValue* attribute indicates the minimum value of *MeasuredValue* that is capable of being  
8631 measured. A *MinMeasuredValue* of 0xffff indicates that the minimum value is not defined. See 4.1.3 for  
8632 more details.

8633 **4.10.2.1.1.3 *MaxMeasuredValue* Attribute**

8634 The *MaxMeasuredValue* attribute indicates the maximum value of *MeasuredValue* that is capable of being  
8635 measured. A *MaxMeasuredValue* of 0xffff indicates that the maximum value is not defined. See 4.1.3 for  
8636 more details.

8637 **4.10.2.1.1.4 Tolerance Attribute**

8638 See 4.1.3.

8639 **4.10.2.2 Commands**

8640 No cluster specific commands are generated or received by the server cluster.

8641 **4.10.3 Client**

8642 The client cluster has no dependencies, cluster specific attributes nor specific commands generated or re-  
 8643 ceived.

8644

8645 **4.11 pH Measurement**

---

8646 **4.11.1 Overview**

8647 Please see Chapter 2 for a general cluster overview defining cluster architecture, revision, classification,  
 8648 identification, etc.

8649 The server cluster provides an interface to pH measurement functionality.

8650 **4.11.1.1 Revision History**

8651 The global *ClusterRevision* attribute value SHALL be the highest revision number in the table below.

Rev	Description
1	mandatory global <i>ClusterRevision</i> attribute added

8652 **4.11.1.2 Classification**

Hierarchy	Role	PICS Code	Primary Transaction
Base	Application	PH	Type 2 (server to client)

8653 **4.11.1.3 Cluster Identifiers**

Identifier	Name
0x0409	pH Measurement

## 8654 4.11.2 Server

### 8655 4.11.2.1 Attributes

8656 **Table 4-45. Attributes of the pH Measurement server cluster**

Id	Name	Type	Range	Acc	Def	M/O
0x0000	<i>MeasuredValue</i>	uint16	<i>MinMeasuredValue</i> to <i>MaxMeasuredValue</i>	RP	0xffff	M
0x0001	<i>MinMeasuredValue</i>	uint16	0x0000 to <i>MaxMeasuredValue</i> -1	R	0xffff	M
0x0002	<i>MaxMeasuredValue</i>	uint16	<i>MinMeasuredValue</i> +1 to 0x0578	R	0xffff	M
0x0003	<i>Tolerance</i>	uint16	0x0000 to 0x00c8	R		O

#### 8657 4.11.2.1.1.1 *MeasuredValue* Attribute

8658 *MeasuredValue* represents the pH with no units as follows:  $MeasuredValue = 100 \times pH$ .

8659 Where  $0.00 \leq pH \leq 14.00$ , corresponding to a *MeasuredValue* in the range 0x0000 to 0x0578. The maximum resolution this format allows is 0.01, this is to accommodate certain applications where such resolution is necessary.

8662 A *MeasuredValue* of 0xffff SHALL indicate an unknown value, otherwise the range SHALL be as described in 4.1.3.

8664 *MeasuredValue* is updated continuously as new measurements are made.

#### 8665 4.11.2.1.1.2 *MinMeasuredValue* Attribute

8666 The *MinMeasuredValue* attribute indicates the minimum value of *MeasuredValue* that is capable of being measured. A *MinMeasuredValue* of 0xffff indicates that the minimum value is not defined. See 4.1.3 for more details.

#### 8669 4.11.2.1.1.3 *MaxMeasuredValue* Attribute

8670 The *MaxMeasuredValue* attribute indicates the maximum value of *MeasuredValue* that is capable of being measured. A *MaxMeasuredValue* of 0xffff indicates that the maximum value is not defined. See 4.1.3 for more details.

#### 8673 4.11.2.1.1.4 *Tolerance* Attribute

8674 See 4.1.3.

## 8675 4.11.2.2 Commands

8676 No cluster specific commands are generated or received by the server cluster.

## 8677 4.11.3 Client

8678 The client cluster has no dependencies, cluster specific attributes nor specific commands generated or received.

## 8680 4.12 Wind Speed Measurement

### 8681 4.12.1 Overview

8682 Please see Chapter 2 for a general cluster overview defining cluster architecture, revision, classification,  
 8683 identification, etc.

8684 The server cluster provides an interface to Wind Speed measurement functionality.

#### 8685 4.12.1.1 Revision History

8686 The global *ClusterRevision* attribute value SHALL be the highest revision number in the table below.

Rev	Description
1	mandatory global <i>ClusterRevision</i> attribute added

#### 8687 4.12.1.2 Classification

Hierarchy	Role	PICS Code	Primary Transaction
Base	Application	WSPD	Type 2 (server to client)

#### 8688 4.12.1.3 Cluster Identifiers

Identifier	Name
0x040b	Wind Speed Measurement

## 8689 4.12.2 Server

### 8690 4.12.2.1 Attributes

8691 Table 4-46. Attributes of the Wind Speed Measurement server cluster

Id	Name	Type	Range	Acc	Def	M/O
0x0000	<i>MeasuredValue</i>	uint16	<i>MinMeasuredValue</i> to <i>MaxMeasuredValue</i>	RP	0xffff	M
0x0001	<i>MinMeasuredValue</i>	uint16	0x0000 to <i>MaxMeasuredValue</i> -1	R	0xffff	M
0x0002	<i>MaxMeasuredValue</i>	uint16	<i>MinMeasuredValue</i> +1 to 0xfffe	R	0xffff	M
0x0003	<i>Tolerance</i>	uint16	0x0000 to 0x0308	R		O

8692

#### 8693 4.12.2.1.1.1 *MeasuredValue* Attribute

8694 *MeasuredValue* represents the Wind Speed in m/s (meters per second) as follows:

8695  $MeasuredValue = 100 \times \text{Wind Speed in m/s}$ . The maximum resolution this format allows is 0.01.

8696 A *MeasuredValue* of 0xffff SHALL indicate an unknown value, otherwise the range SHALL be as described  
8697 in 4.1.3.

8698 *MeasuredValue* is updated continuously as new measurements are made.

#### 8699 **4.12.2.1.1.2 *MinMeasuredValue* Attribute**

8700 The *MinMeasuredValue* attribute indicates the minimum value of *MeasuredValue* that is capable of being  
8701 measured. A *MinMeasuredValue* of 0xffff indicates that the minimum value is not defined. See 4.1.3 for  
8702 more details.

#### 8703 **4.12.2.1.1.3 *MaxMeasuredValue* Attribute**

8704 The *MaxMeasuredValue* attribute indicates the maximum value of *MeasuredValue* that is capable of being  
8705 measured. A *MaxMeasuredValue* of 0xffff indicates that the maximum value is not defined. See 4.1.3 for  
8706 more details.

#### 8707 **4.12.2.1.1.4 *Tolerance* Attribute**

8708 See 4.1.3.

### 8709 **4.12.2.2 Commands**

8710 No cluster specific commands are generated or received by the server cluster.

### 8711 **4.12.3 Client**

8712 The client cluster has no dependencies, cluster specific attributes nor specific commands generated or re-  
8713 ceived.

## 8714 **4.13 Concentration Measurement**

---

### 8715 **4.13.1 Overview**

8716 Please see Chapter 2 for a general cluster overview defining cluster architecture, revision, classification,  
8717 identification, etc.

8718 The server cluster provides an interface to concentration measurement functionality. The measurement is  
8719 reportable and may be configured for reporting. Concentration measurements include, but are not limited  
8720 to, levels in gases, such as CO, CO<sub>2</sub>, and ethylene, or in fluids and solids, such as dissolved oxygen, chemi-  
8721 cals & pesticides.

#### 8722 **4.13.1.1 Revision History**

8723 The global *ClusterRevision* attribute value SHALL be the highest revision number in the table below.

Rev	Description
1	mandatory global <i>ClusterRevision</i> attribute added
2	CCB 2882

8724

### 4.13.1.2 Classification

Hierarchy	Role	PICS Code	Primary Transaction
Base	Application	CONC	Type 2 (server to client)

8725

### 4.13.1.3 Cluster Identifiers

8726  
 8727  
 8728  
 8729  
 8730  
 8731

The table below is a list of Cluster Ids that conform to this specification. More than one ambient substance may be supported by the same Cluster Id (e.g. Water and Alcohol). This would make the Cluster Id generic to the ambient substance. A new Cluster Id may also be added that is limited to a single ambient substance to provide more specific self-description. If both generic and specific Cluster Ids appear on an endpoint, then a single instance of the cluster exists on the endpoint, and either Cluster Id can be used to access the cluster interface.

Cluster Id	Substance Measured	Ambient Substance	Units	Notes (not normative or prescribed)
0x040c	Carbon Monoxide (CO)	Air	Volume	
0x040d	Carbon Dioxide (CO2)	Air	Volume	
0x040e	Ethylene (CH2)	Air	Volume	
0x040f	Ethylene Oxide (C2H4O)	Air	Volume	
0x0410	Hydrogen (H)	Air	Volume	
0x0411	Hydrogen Sulfide (H2S)	Air	Volume	
0x0412	Nitric Oxide (NO)	Air	Volume	
0x0413	Nitrogen Dioxide (NO2)	Air	Volume	
0x0414	Oxygen (O2)	Air	Volume	
0x0415	Ozone (O3)	Air	Volume	
0x0416	Sulfur Dioxide (SO2)	Air	Volume	
0x0417	Dissolved Oxygen (DO)	Water	Mass	
0x0418	Bromate	Drinking Water	Volume	typical range example: not detected to 3.6 PPB typical value example: 1.79 PPB
0x0419	Chloramines	Drinking Water	Volume	typical range example: 0.9 to 3.8 PPM typical value example: 2.87 PPM
0x041a	Chlorine	Drinking Water	Volume	typical range example: 0.1 to 2.4 PPM typical value example: 1.28 PPM
0x041b	Fecal coliform & E. Coli	Drinking Water	Volume	Percent of positive samples typical value example: 0
0x041c <sup>86</sup>	Fluoride	Drinking Water	Volume	typical range example: 0 to 100 PPM typical value example: 0.72 PPM

<sup>86</sup> CCB 2882 wrong id

0x041d	Haloacetic Acids	Drinking Water	Volume	typical range example: Not Detected to 20 PPB typical value example: 14 PPB
0x041e	Total Trihalomethanes	Drinking Water	Volume	typical range example: 0 to 100 PPB typical value example: 44 PPB
0x041f	Total Coliform Bacteria	Drinking Water	Volume	Percent of positive samples typical range example: 0 to 100% typical value example: 1.33%
0x0420	Turbidity	Drinking Water	Volume	Cloudiness of particles in water where an average person would notice a 5 or higher typical range example: 0 to 10 typical value example: 0.18
0x0421	Copper	Drinking Water	Volume	typical range example: 0 to 10 PPM typical value example: 0.191 PPM
0x0422	Lead	Drinking Water	Volume	typical range example: 0 to 10 PPB typical value example: 3.2 PPB
0x0423	Manganese	Drinking Water	Volume	typical range example: 0 to 1000 PPB typical value example: 31PPB
0x0424	Sulfate	Drinking Water	Volume	typical range example: 0 to 1000 PPM typical value example: 36 PPM
0x0425	Bromodichloromethane	Drinking Water	Volume	typical range example: 0 to 1000 PPB typical value example: 9.6 PPB
0x0426	Bromoform	Drinking Water	Volume	typical range example: 0 to 1000 PPB typical value example: 1.1 PPB
0x0427	Chlorodibromomethane	Drinking Water	Volume	typical range example: 0 to 1000 PPB typical value example: 6.4 PPB
0x0428	Chloroform	Drinking Water	Volume	typical range example: 0 to 1000 PPB typical value example: 8.0 PPB
0x0429	Sodium	Drinking Water	Volume	typical range example: 0 to 1000 PPM typical value example: 27 PPM
0x042A	PM2.5	Air	Volume	Particulate Matter 2.5 microns or less
0x042B	Formaldehyde	Air	Volume	

8732 **4.13.2 Server**

8733 **4.13.2.1 Attributes**

8734 **Table 4-47. Attributes of the Concentration Measurement server cluster**

Id	Name	Type	Range	Acc	Def	MO
0x0000	<i>MeasuredValue</i>	single	<i>MinMeasuredValue</i> to <i>MaxMeasuredValue</i>	RP	NaN*	M
0x0001	<i>MinMeasuredValue</i>	single	$0 \leq \text{value} < \text{MaxMeasuredValue}$	R	NaN*	M
0x0002	<i>MaxMeasuredValue</i>	single	$\text{MinMeasuredValue} < \text{value} \leq 1$	R	NaN*	M



Id	Name	Type	Range	Acc	Def	MO
0x0003	<i>Tolerance</i>	single	<i>MS</i>	R	<i>MS</i>	O

8735 \* see Not a Number: Chapter 2 for data type default and invalid values  
 8736

8737 **4.13.2.1.1.1 *MeasuredValue* Attribute**

8738 *MeasuredValue* represents the concentration as a fraction of 1 (one).

8739 A value of NaN indicates that the concentration measurement is unknown or outside the valid range.

8740 *MinMeasuredValue* and *MaxMeasuredValue* define the valid range for *MeasuredValue*.

8741 *MeasuredValue* is updated continuously as new measurements are made.

8742 **4.13.2.1.1.2 *MinMeasuredValue* Attribute**

8743 The *MinMeasuredValue* attribute indicates the minimum value of *MeasuredValue* that is capable of being  
 8744 measured. A *MinMeasuredValue* of NaN indicates that the *MinMeasuredValue* is not defined. See 4.1.3 for  
 8745 more details.

8746 **4.13.2.1.1.3 *MaxMeasuredValue* Attribute**

8747 The *MaxMeasuredValue* attribute indicates the maximum value of *MeasuredValue* that is capable of being  
 8748 measured. A *MaxMeasuredValue* of NaN indicates that the *MaxMeasuredValue* is not defined. See 4.1.3 for  
 8749 more details.

8750 **4.13.2.1.1.4 *Tolerance* Attribute**

8751 See 4.1.3.

8752 **4.13.2.2 Commands**

8753 No cluster specific commands are generated or received by the server cluster.

8754 **4.13.3 Client**

8755 The client cluster has no dependencies, cluster specific attributes nor specific commands generated or re-  
 8756 ceived.



## CHAPTER 5 LIGHTING

8757

8758 The Cluster Library is made of individual chapters such as this one. See Document Control in the Cluster  
8759 Library for a list of all chapters and documents. References between chapters are made using a *X.Y* notation  
8760 where *X* is the chapter and *Y* is the sub-section within that chapter. References to external documents are  
8761 contained in Chapter 1 and are made using [*Rn*] notation.

### 5.1 General Description

8762

#### 5.1.1 Introduction

8763

8764 The clusters specified in this document are for use typically in lighting applications, but MAY be used in any  
8765 application domain.

#### 5.1.2 Terms

8766

8767 **Ballast Factor:** A measure of the light output (lumens) of a ballast and lamp combination in comparison to  
8768 an ANSI standard ballast operated with the same lamp. Multiply the ballast factor by the rated lumens of the  
8769 lamp to get the light output of the lamp/ballast combination.

8770 **HSV:** Hue, Saturation, Value. A color space, also known as HSB (Hue, Saturation, Brightness). This is a  
8771 well-known transformation of the RGB (Red, Green, Blue) color space. For more information see e.g.,  
8772 [http://en.wikipedia.org/wiki/HSV\\_color\\_space](http://en.wikipedia.org/wiki/HSV_color_space).

8773 **Illuminance:** The density of incident luminous flux on a surface. Illuminance is the standard metric for  
8774 lighting levels, and is measured in lux (lx).

#### 5.1.3 Cluster List

8775

8776 This section lists the clusters specified in this document and gives examples of typical usage for the purpose  
8777 of clarification. The clusters specified in this document are listed in Table 5.1.

8778

Table 5.1. Clusters Specified for the Lighting Functional Domain

ID	Cluster Name	Description
0x0300	Color Control	Attributes and commands for controlling the color of a color-capable light.
0x0301	Ballast Configuration	Attributes and commands for configuring a lighting ballast

8779

8780

Figure 5-1. Typical Usage of Ballast Configuration and Color Control Clusters

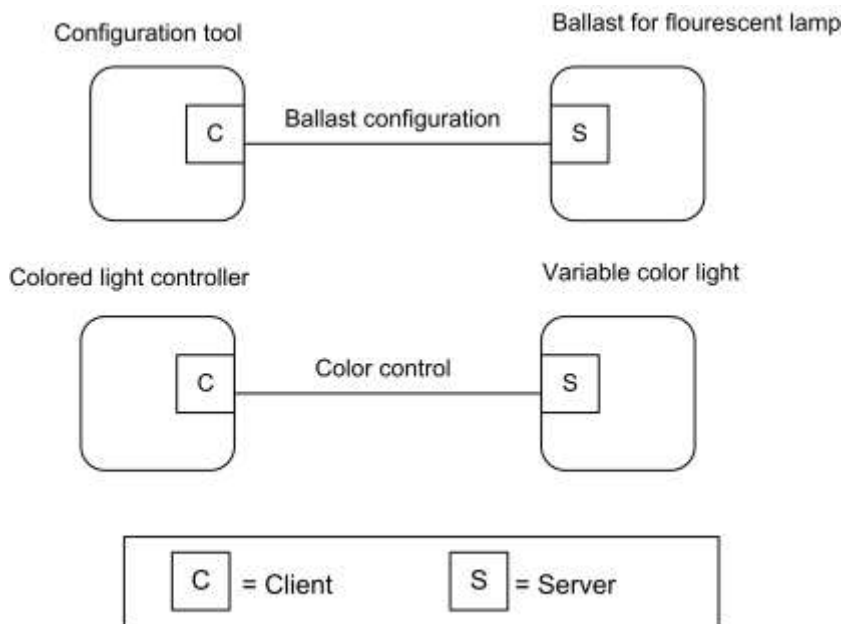

8781

*Note: Device names are examples for illustration purposes only*

8782

## 5.2 Color Control Cluster

8783

### 5.2.1 Overview

8784  
8785

Please see Chapter 2 for a general cluster overview defining cluster architecture, revision, classification, identification, etc.

8786  
8787  
8788

This cluster provides an interface for changing the color of a light. Color is specified according to the Commission Internationale de l'Éclairage (CIE) specification CIE 1931 Color Space, [I1]. Color control is carried out in terms of x,y values, as defined by this specification.

8789  
8790  
8791

Additionally, color MAY optionally be controlled in terms of color temperature, or as hue and saturation values based on optionally variable RGB and W color points. It is recommended that the hue and saturation are interpreted according to the HSV (aka HSB) color model.

8792  
8793  
8794

Control over luminance is not included, as this is provided by means of the Level Control for Lighting cluster of the General library (see Chapter 3). It is recommended that the level provided by this cluster be interpreted as representing a proportion of the maximum intensity achievable at the current color.

8795

#### 5.2.1.1 Revision History

8796

The global *ClusterRevision* attribute value SHALL be the highest revision number in the table below.

Rev	Description
1	mandatory global <i>ClusterRevision</i> attribute added; CCB 2028
2	added <i>Options</i> attribute, CCB 2085 2104 2124 2230; ZLO 1.0
3	CCB 2501 2814 2839 2840 2843 2861

8797 **5.2.1.2 Classification**

Hierarchy	Role	PICS Code	Primary Transaction
Base	Application	CC	Type 1 (client to server)

8798 **5.2.1.3 Cluster Identifiers**

Identifier	Name
0x0300	Color Control

8799 **5.2.2 Server**

8800 **5.2.2.1 Dependencies**

8801 **5.2.2.1.1 Coupling color temperature to Level Control**

8802 If the *Level Control for Lighting* cluster identifier 0x0008 is supported on the same endpoint as the *Color*  
 8803 *Control* cluster and color temperature is supported, it is possible to couple changes in the current level to the  
 8804 color temperature.

8805 The *CoupleColorTempToLevel* bit of the *Options* attribute of the *Level Control* cluster indicates whether the  
 8806 color temperature is to be linked with the *CurrentLevel* attribute in the *Level Control* cluster.

8807 If the *CoupleColorTempToLevel* bit of the *Options* attribute of the *Level Control* cluster is equal to 1 and the  
 8808 *ColorMode* or *EnhancedColorMode* attribute is set to 0x02 (*color temperature*) then a change in the *Cur-*  
 8809 *rentLevel* attribute SHALL affect the *ColorTemperatureMireds* attribute. This relationship is manufacturer  
 8810 specific, with the qualification that the maximum value of the *CurrentLevel* attribute SHALL correspond to  
 8811 a *ColorTemperatureMired* attribute value equal to the *CoupleColorTempToLevelMinMireds* attribute. This  
 8812 relationship is one-way so a change to the *ColorTemperatureMireds* attribute SHALL NOT have any effect  
 8813 on the *CurrentLevel* attribute.

8814 In order to simulate the behavior of an incandescent bulb, a low value of the *CurrentLevel* attribute SHALL  
 8815 be associated with a high value of the *ColorTemperatureMireds* attribute (i.e., a low value of color tempera-  
 8816 ture in kelvins).

8817 If the *CoupleColorTempToLevel* bit of the *Options* attribute of the *Level Control* cluster is equal to 0, there  
 8818 SHALL be no link between color temperature and current level.

8819 **5.2.2.2 Attributes**

8820 For convenience, the attributes defined in this specification are arranged into sets of related attributes; each  
 8821 set can contain up to 16 attributes. Attribute identifiers are encoded such that the most significant three nib-  
 8822 bles specify the attribute set and the least significant nibble specifies the attribute within the set. The currently  
 8823 defined attribute sets are listed in Table 5.2.

8824 **Table 5.2. Hue Control Attribute Sets**

Attribute Set Identifier	Description
0x000, 0x400	Color Information

0x001	Defined Primaries Information
0x002	Additional Defined Primaries Information
0x003	Defined Color Point Settings

8825 **5.2.2.2.1 Color Information Attribute Set**

8826 The Color Information attribute set contains the attributes summarized below.

8827 **Table 5.3. Attributes of the Color Information Attribute Set**

<b>Id</b>	<b>Name</b>	<b>Type</b>	<b>Range</b>	<b>Acc</b>	<b>Def</b>	<b>M/O</b>
0x0000	CurrentHue	uint8	0x00 – 0xfe	RP	0x00	M <sup>0</sup>
0x0001	CurrentSaturation	uint8	0x00 – 0xfe	RPS	0x00	M <sup>0</sup>
0x0002	RemainingTime	uint16	0x0000 – 0xfffe	R	0x00	O
0x0003	CurrentX	uint16	0x0000 - 0xfeff	RPS	0x616b (0.381)	M <sup>3</sup>
0x0004	CurrentY	uint16	0x0000 - 0xfeff	RPS	0x607d (0.377)	M <sup>3</sup>
0x0005	DriftCompensation	enum8	0x00 – 0x04	R	-	O
0x0006	CompensationText	string	0 to 254 chars	R	-	O
0x0007	ColorTemperatureMireds	uint16	0x0000 - 0xfeff	RPS	0x00fa (4000K)	M <sup>4</sup>
0x0008	ColorMode	enum8	0x00 – 0x02	R	0x01	M
0x000f	Options	map8		RW	0x00	M
0x4000	<i>EnhancedCurrentHue</i>	uint16	0x0000 – 0xffff	RS	0x0000	M <sup>1</sup>
0x4001	<i>EnhancedColorMode</i>	enum8	0x00 – 0xff	R	0x01	M
0x4002	<i>ColorLoopActive</i>	uint8	0x00 – 0xff	RS	0x00	M <sup>2</sup>
0x4003	<i>ColorLoopDirection</i>	uint8	0x00 – 0xff	RS	0x00	M <sup>2</sup>
0x4004	<i>ColorLoopTime</i>	uint16	0x0000 – 0xffff	RS	0x0019	M <sup>2</sup>
0x4005	<i>ColorLoopStartEnhancedHue</i>	uint16	0x0000 – 0xffff	R	0x2300	M <sup>2</sup>
0x4006	<i>ColorLoopStoredEnhancedHue</i>	uint16	0x0000 – 0xffff	R	0x0000	M <sup>2</sup>
0x400a	<i>ColorCapabilities</i>	map16	0x0000 – 0x001f	R	0x0000	M
0x400b	<i>ColorTempPhysicalMinMireds</i>	uint16	0x0000 – 0xfeff	R	0x0000	M <sup>4</sup>
0x400c	<i>ColorTempPhysicalMaxMireds</i>	uint16	0x0000 – 0xfeff	R	0xfeff	M <sup>4</sup>
0x400d	<i>CoupleColorTempToLevelMinMireds</i>	uint16	<i>ColorTempPhysicalMinMireds</i> to <i>ColorTemperatureMired</i> <sup>87</sup>	R	MS	M <sup>4*</sup>
0x4010	<i>StartUpColorTemperatureMireds</i>	uint16	0x0000-0xfeff <sup>88</sup>	RW	MS	M <sup>4*</sup>

8828 M<sup>i</sup> = Mandatory if bit *i* of the *ColorCapabilities* attribute is equal to 1, otherwise optional.

<sup>87</sup> CCB 2840

<sup>88</sup> CCB 2843

8829 \* Mandatory if *ColorTemperatureMireds* is supported.

#### 8830 **5.2.2.2.1.1 CurrentHue Attribute**

8831 The *CurrentHue* attribute contains the current hue value of the light. It is updated as fast as practical during  
8832 commands that change the hue.

8833 The hue in degrees SHALL be related to the *CurrentHue* attribute by the relationship  
8834  $\text{Hue} = \text{CurrentHue} \times 360 / 254$  (CurrentHue in the range 0 - 254 inclusive)

8835 If this attribute is implemented then the *CurrentSaturation* and *ColorMode* attributes SHALL also be imple-  
8836 mented.

#### 8837 **5.2.2.2.1.2 CurrentSaturation Attribute**

8838 The *CurrentSaturation* attribute holds the current saturation value of the light. It is updated as fast as practical  
8839 during commands that change the saturation.

8840 The saturation SHALL be related to the *CurrentSaturation* attribute by the relationship  
8841  $\text{Saturation} = \text{CurrentSaturation} / 254$  (CurrentSaturation in the range 0 - 254 inclusive)

8842 If this attribute is implemented then the *CurrentHue* and *ColorMode* attributes SHALL also be implemented.

#### 8843 **5.2.2.2.1.3 RemainingTime Attribute**

8844 The *RemainingTime* attribute holds the time remaining, in 1/10ths of a second, until the currently active  
8845 command will be complete.

#### 8846 **5.2.2.2.1.4 CurrentX Attribute**

8847 The *CurrentX* attribute contains the current value of the normalized chromaticity value x, as defined in the  
8848 CIE xyY Color Space. It is updated as fast as practical during commands that change the color.

8849 The value of x SHALL be related to the *CurrentX* attribute by the relationship

8850  $x = \text{CurrentX} / 65536$  (CurrentX in the range 0 to 65279 inclusive)

#### 8851 **5.2.2.2.1.5 CurrentY Attribute**

8852 The *CurrentY* attribute contains the current value of the normalized chromaticity value y, as defined in the  
8853 CIE xyY Color Space. It is updated as fast as practical during commands that change the color.

8854 The value of y SHALL be related to the *CurrentY* attribute by the relationship

8855  $y = \text{CurrentY} / 65536$  (CurrentY in the range 0 to 65279 inclusive)

#### 8856 **5.2.2.2.1.6 DriftCompensation Attribute**

8857 The *DriftCompensation* attribute indicates what mechanism, if any, is in use for compensation for color/in-  
8858 tensity drift over time. It SHALL be one of the non-reserved values in Table 5.4.

8859 **Table 5.4. Values of the *DriftCompensation* Attribute**

Attribute Value	Description
0x00	None
0x01	Other / Unknown
0x02	Temperature monitoring
0x03	Optical luminance monitoring and feedback



0x04	Optical color monitoring and feedback
------	---------------------------------------

8860 **5.2.2.2.1.7 CompensationText Attribute**

8861 The *CompensationText* attribute holds a textual indication of what mechanism, if any, is in use to compensate  
 8862 for color/intensity drift over time.

8863 **5.2.2.2.1.8 ColorTemperatureMireds Attribute**

8864 The *ColorTemperatureMireds* attribute contains a scaled inverse of the current value of the color tempera-  
 8865 ture. The unit of *ColorTemperatureMireds* is the mired (micro reciprocal degree), AKA mirek (micro recip-  
 8866 rocal kelvin). It is updated as fast as practical during commands that change the color.

8867 The color temperature value in kelvins SHALL be related to the *ColorTemperatureMireds* attribute in mireds  
 8868 by the relationship

8869 Color temperature in kelvins = 1,000,000 / *ColorTemperatureMireds*, where *ColorTemperatureMireds* is in  
 8870 the range 1 to 65279 mireds inclusive, giving a color temperature range from 1,000,000 kelvins to 15.32  
 8871 kelvins.

8872 The value *ColorTemperatureMireds* = 0x0000 indicates an undefined value. The value *ColorTemperature-*  
 8873 *Mireds* = 0xffff indicates an invalid value.

8874 If this attribute is implemented then the *ColorMode* attribute SHALL also be implemented.

8875 **5.2.2.2.1.9 ColorMode Attribute**

8876 The *ColorMode* attribute indicates which attributes are currently determining the color of the device. If either  
 8877 the *CurrentHue* or *CurrentSaturation* attribute is implemented, this attribute SHALL also be implemented,  
 8878 otherwise it is optional.

8879 The value of the *ColorMode* attribute cannot be written directly - it is set upon reception of any command in  
 8880 section 5.2.2.3 to the appropriate mode for that command.

8881 **Table 5.5. Values of the ColorMode Attribute**

Attribute Value	Attributes that Determine the Color
0x00	<i>CurrentHue</i> and <i>CurrentSaturation</i>
0x01	<i>CurrentX</i> and <i>CurrentY</i>
0x02	<i>ColorTemperatureMireds</i>

8882 **5.2.2.2.1.10 Options Attribute**

8883 The *Options* attribute is meant to be changed only during commissioning. The *Options* attribute is a bitmap  
 8884 that determines the default behavior of some cluster commands. Each command that is dependent on the  
 8885 *Options* attribute SHALL first construct a temporary Options bitmap that is in effect during the command  
 8886 processing. The temporary Options bitmap has the same format and meaning as the *Options* attribute, but  
 8887 includes any bits that may be overridden by command fields.

8888 Below is the format and description of the *Options* attribute and temporary Options bitmap and the effect on  
 8889 dependent commands.

8890

**Table 5.6. Options Attribute**

Bit	Name	Values & Summary
0	ExecuteIfOff	0 – Do not execute command if the On/Off cluster, OnOff attribute is 0x00 (FALSE) 1 – Execute command if the On/Off cluster, OnOff attribute is 0x00 (FALSE)

8891

8892 **ExecuteIfOff:** Command execution SHALL NOT continue beyond the *Options* processing if all of these  
8893 criteria are true:

- 8894 • The On/Off cluster exists on the same endpoint as this cluster.
- 8895 • The *OnOff* attribute of the On/Off cluster, on this endpoint, is 0x00 (FALSE).
- 8896 • The value of the ExecuteIfOff bit is 0.

#### 8897 **5.2.2.2.1.11 EnhancedCurrentHue Attribute**

8898 The EnhancedCurrentHue attribute represents non-equidistant steps along the CIE 1931 color triangle, and  
8899 it provides 16-bits precision.

8900 The upper 8 bits of this attribute SHALL be used as an index in the implementation specific XY lookup table  
8901 to provide the non-equidistance steps (see the ZLL test specification for an example). The lower 8 bits  
8902 SHALL be used to interpolate between these steps in a linear way in order to provide color zoom for the user.

8903 To provide compatibility with standard ZCL, the CurrentHue attribute SHALL contain a hue value in the  
8904 range 0 to 254, calculated from the EnhancedCurrentHue attribute.

#### 8905 **5.2.2.2.1.12 EnhancedColorMode Attribute**

8906 The EnhancedColorMode attribute specifies which attributes are currently determining the color of the de-  
8907 vice, as detailed in Table 5.7.

8908 **Table 5.7. Values of the EnhancedColorMode Attribute**

Attribute Value	Attributes That Determine the Color
0x00	CurrentHue and CurrentSaturation
0x01	<i>CurrentX</i> and <i>CurrentY</i>
0x02	<i>ColorTemperatureMireds</i>
0x03	<i>EnhancedCurrentHue</i> and <i>CurrentSaturation</i>

8909

8910 To provide compatibility with standard ZCL, the original ColorMode attribute SHALL indicate ‘CurrentHue  
8911 and CurrentSaturation’ when the light uses the EnhancedCurrentHue attribute. If the ColorMode attribute is  
8912 changed, e.g., due to one of the standard color control cluster commands defined in the ZCL, its new value  
8913 SHALL be copied to the EnhancedColorMode attribute.

#### 8914 **5.2.2.2.1.13 ColorLoopActive Attribute**

8915 The ColorLoopActive attribute specifies the current active status of the color loop. If this attribute has the  
 8916 value 0x00, the color loop SHALL not be active. If this attribute has the value 0x01, the color loop SHALL  
 8917 be active. All other values (0x02 – 0xff) are reserved.

8918 **5.2.2.2.1.14 ColorLoopDirection Attribute**

8919 The ColorLoopDirection attribute specifies the current direction of the color loop. If this attribute has the  
 8920 value 0x00, the EnhancedCurrentHue attribute SHALL be decremented. If this attribute has the value 0x01,  
 8921 the EnhancedCurrentHue attribute SHALL be incremented. All other values (0x02 – 0xff) are reserved.

8922 **5.2.2.2.1.15 ColorLoopTime Attribute**

8923 The ColorLoopTime attribute specifies the number of seconds it SHALL take to perform a full color loop,  
 8924 i.e., to cycle all values of the EnhancedCurrentHue attribute (between 0x0000 and 0xffff).

8925 **5.2.2.2.1.16 ColorLoopStartEnhancedHue Attribute**

8926 The ColorLoopStartEnhancedHue attribute specifies the value of the EnhancedCurrentHue attribute from  
 8927 which the color loop SHALL be started.

8928 **5.2.2.2.1.17 ColorLoopStoredEnhancedHue Attribute**

8929 The ColorLoopStoredEnhancedHue attribute specifies the value of the EnhancedCurrentHue attribute before  
 8930 the color loop was started. Once the color loop is complete, the EnhancedCurrentHue attribute SHALL be  
 8931 restored to this value.

8932 **5.2.2.2.1.18 ColorCapabilities Attribute**

8933 The ColorCapabilities attribute specifies the color capabilities of the device supporting the color control clus-  
 8934 ter, as illustrated in Table 5.8. If a bit is set to 1, the corresponding attributes and commands SHALL become  
 8935 mandatory. If a bit is set to 0, the corresponding attributes and commands need not be implemented.

8936 **Table 5.8. Bit Values of the ColorCapabilities Attribute**

Value	Description	Related Attributes	Mandatory Commands
0	Hue/saturation supported	<i>CurrentHue</i> <i>CurrentSaturation</i>	<i>Move to hue</i> <i>Move hue</i> <i>Step hue</i> <i>Move to saturation</i> <i>Move saturation</i> <i>Step saturation</i> <i>Move to hue and saturation</i> <i>Stop move step</i>
1	Enhanced hue supported <b>Note:</b> hue/saturation must also be supported.	<i>EnhancedCurrentHue</i>	<i>Enhanced move to hue</i> <i>Enhanced move hue</i> <i>Enhanced step hue</i> <i>Enhanced move to hue and saturation</i> <i>Stop move step</i>
2	Color loop supported <b>Note:</b> enhanced hue must also be supported.	<i>ColorLoopActive</i> <i>ColorLoopDirection</i> <i>ColorLoopTime</i> <i>ColorLoopStartEnhancedHue</i> <i>ColorLoopStoredEnhancedHue</i>	<i>Color loop set</i>

Value	Description	Related Attributes	Mandatory Commands
3	XY attributes supported	<i>CurrentX</i> <i>CurrentY</i>	<i>Move to color</i> <i>Move color</i> <i>Step color</i> <i>Stop move step</i>
4	Color temperature supported	<i>ColorTemperatureMireds</i> <i>ColorTempPhysicalMinMireds</i> <i>ColorTempPhysicalMaxMireds</i>	<i>Move to color temperature</i> <i>Move color temperature</i> <i>Step color temperature</i> <i>Stop move step</i>

8937 <sup>89</sup>

8938 On receipt of a unicast color control cluster command that is not supported or a general command which  
8939 affects a color control cluster attribute that is not supported, the device SHALL respond with a default re-  
8940 sponse command with a status indicating an unsupported cluster command or unsupported attribute, respec-  
8941 tively.

#### 8942 **5.2.2.2.1.19 ColorTempPhysicalMinMireds Attribute**

8943 The *ColorTempPhysicalMinMireds* attribute indicates the minimum mired value supported by the hardware.  
8944 *ColorTempPhysicalMinMireds* corresponds to the maximum color temperature in kelvins supported by the  
8945 hardware.  $\text{ColorTempPhysicalMinMireds} \leq \text{ColorTemperatureMireds}$ .

#### 8946 **5.2.2.2.1.20 ColorTempPhysicalMaxMireds Attribute**

8947 The *ColorTempPhysicalMaxMireds* attribute indicates the maximum mired value supported by the hardware.  
8948 *ColorTempPhysicalMaxMireds* corresponds to the minimum color temperature in kelvins supported by the  
8949 hardware.  $\text{ColorTemperatureMireds} \leq \text{ColorTempPhysicalMaxMireds}$ .

#### 8950 **5.2.2.2.1.21 CoupleColorTempToLevelMinMireds Attribute**

8951 The *CoupleColorTempToLevelMinMireds* attribute specifies a lower bound on the value of the *ColorTemp-*  
8952 *eratureMireds* attribute for the purposes of coupling the *ColorTemperatureMireds* attribute to the *CurrentLevel*  
8953 attribute when the *CoupleColorTempToLevel* bit of the *Options* attribute of the *Level Control* cluster is equal  
8954 to 1. When coupling the *ColorTemperatureMireds* attribute to the *CurrentLevel* attribute, this value SHALL  
8955 correspond to a *CurrentLevel* value of 0xfe (100%).

8956 This attribute SHALL be set such that the following relationship exists:

8957 
$$\text{ColorTempPhysicalMinMireds} \leq \text{CoupleColorTempToLevelMinMireds} \leq \text{ColorTemperatureMireds}$$

8958 Note that since this attribute is stored as a micro reciprocal degree (mired) value (i.e. color temperature in  
8959 kelvins =  $1,000,000 / \text{CoupleColorTempToLevelMinMireds}$ ), the *CoupleColorTempToLevel-MinMireds* at-  
8960 tribute corresponds to an upper bound on the value of the color temperature in kelvins supported by the device.

#### 8961 **5.2.2.2.1.22 StartUpColorTemperatureMireds Attribute**

8962 The *StartUpColorTemperatureMireds* attribute SHALL define the desired startup color temperature value a  
8963 lamp SHALL use when it is supplied with power and this value SHALL be reflected in the *ColorTemp-*  
8964 *eratureMireds* attribute. In addition, the *ColorMode* and *EnhancedColorMode* attributes SHALL be set to  
8965 0x02 (*color temperature*). The values of the *StartUpColorTemperatureMireds* attribute are listed in the ta-  
8966 ble below,

<sup>89</sup> CCB 2861 deleted text for mandatory CurrentX/Y support

8967

**Table 5.9. Values of the *StartUpColorTemperatureMireds* attribute**

Value	Action on power up
0x0000 – 0xffef	Set the <i>ColorTemperatureMireds</i> attribute to this value.
0xffff	Set the <i>ColorTemperatureMireds</i> attribute to its previous value.

8968

### 5.2.2.2.2 Defined Primaries Information Attribute Set

8969

The Defined Primaries Information attribute set contains the attributes summarized in Table 5.10.

8970

**Table 5.10. Defined Primaries Information Attribute Set**

Id	Name	Type	Range	Access	Def	M/O
0x0010	NumberOfPrimaries	uint8	0x00 – 0x06	R	-	M
0x0011	Primary1X	uint16	0x0000 – 0xfeff	R	-	M <sup>0</sup>
0x0012	Primary1Y	uint16	0x0000 – 0xfeff	R	-	M <sup>0</sup>
0x0013	Primary1Intensity	uint8	0x00 - 0xff	R	-	M <sup>0</sup>
0x0014	Reserved	-	-	-	-	-
0x0015	Primary2X	uint16	0x0000 – 0xfeff	R	-	M <sup>1</sup>
0x0016	Primary2Y	uint16	0x0000 – 0xfeff	R	-	M <sup>1</sup>
0x0017	Primary2Intensity	uint8	0x0000- 0xff	R	-	M <sup>1</sup>
0x0018	Reserved	-	-	-	-	-
0x0019	Primary3X	uint16	0x0000 – 0xfeff	R	-	M <sup>2</sup>
0x001a	Primary3Y	uint16	0x0000 – 0xfeff	R	-	M <sup>2</sup>
0x001b	Primary3Intensity	uint8	0x00 - 0xff	R	-	M <sup>2</sup>

8971

8972

M<sup>i</sup> = Mandatory if the value of the *NumberOfPrimaries* attribute is greater than *i*, otherwise optional.

8973

8974

#### 5.2.2.2.2.1 *NumberOfPrimaries* Attribute

8975

The *NumberOfPrimaries* attribute contains the number of color primaries implemented on this device. A value of 0xff SHALL indicate that the number of primaries is unknown.

8976

8977

Where this attribute is implemented, the attributes below for indicating the “x” and “y” color values of the primaries SHALL also be implemented for each of the primaries from 1 to *NumberOfPrimaries*, without leaving gaps. Implementation of the *Primary1Intensity* attribute and subsequent intensity attributes is optional.

8978

8979

8980

8981

#### 5.2.2.2.2.2 *Primary1X* Attribute

8982 The *Primary1X* attribute contains the normalized chromaticity value x for this primary, as defined in the CIE  
8983 xyY Color Space.

8984 The value of x SHALL be related to the *Primary1X* attribute by the relationship

8985  $x = \text{Primary1X} / 65536$  (*Primary1X* in the range 0 to 65279 inclusive)

#### 8986 **5.2.2.2.3 Primary1Y Attribute**

8987 The *Primary1Y* attribute contains the normalized chromaticity value y for this primary, as defined in the CIE  
8988 xyY Color Space.

8989 The value of y SHALL be related to the *Primary1Y* attribute by the relationship

8990  $y = \text{Primary1Y} / 65536$  (*Primary1Y* in the range 0 to 65279 inclusive)

#### 8991 **5.2.2.2.4 Primary1Intensity Attribute**

8992 The *Primary1intensity* attribute contains a representation of the maximum intensity of this primary as defined  
8993 in the Dimming Light Curve in the Ballast Configuration cluster (see 5.3), normalized such that the primary  
8994 with the highest maximum intensity contains the value 0xfe.

8995 A value of 0xff SHALL indicate that this primary is not available.

#### 8996 **5.2.2.2.5 Remaining Attributes**

8997 The *Primary2X*, *Primary2Y*, *Primary2Intensity*, *Primary3X*, *Primary3Y* and *Primary3Intensity* attributes are  
8998 used to represent the capabilities of the 2<sup>nd</sup> and 3<sup>rd</sup> primaries, where present, in the same way as for the  
8999 *Primary1X*, *Primary1Y* and *Primary1Intensity* attributes.

### 9000 **5.2.2.2.3 Additional Defined Primaries Information Attribute** 9001 **Set**

9002 The Additional Defined Primaries Information attribute set contains the attributes summarized in Table 5.11.

9003 **Table 5.11. Additional Defined Primaries Information Attribute Set**

Id	Name	Type	Range	Access	Def	M/O
0x0020	Primary4X	uint16	0x0000 – 0xfeff	R	-	M <sup>3</sup>
0x0021	Primary4Y	uint16	0x0000 – 0xfeff	R	-	M <sup>3</sup>
0x0022	Primary4Intensity	uint8	0x00 – 0xff	R	-	M <sup>3</sup>
0x0023	Reserved	-	-	-	-	-
0x0024	Primary5X	uint16	0x0000 – 0xfeff	R	-	M <sup>4</sup>
0x0025	Primary5Y	uint16	0x0000 – 0xfeff	R	-	M <sup>4</sup>
0x0026	Primary5Intensity	uint8	0x00 – 0xff	R	-	M <sup>4</sup>
0x0027	Reserved	-	-	-	-	-
0x0028	Primary6X	uint16	0x0000 – 0xfeff	R	-	M <sup>5</sup>
0x0029	Primary6Y	uint16	0x0000 – 0xfeff	R	-	M <sup>5</sup>

<b>Id</b>	<b>Name</b>	<b>Type</b>	<b>Range</b>	<b>Access</b>	<b>Def</b>	<b>M/O</b>
0x002a	Primary6Intensity	uint8	0x00 – 0xff	R	-	M <sup>5</sup>

9004

9005 M<sup>i</sup> = Mandatory if the value of the *NumberOfPrimaries* attribute is greater than *i*, otherwise optional.

9006

9007 **5.2.2.2.3.1 Attributes**

9008 The *Primary4X*, *Primary4Y*, *Primary4Intensity*, *Primary5X*, *Primary5Y*, *Primary5Intensity*, *Primary6X*, *Primary6Y* and *Primary6Intensity* attributes represent the capabilities of the 4<sup>th</sup>, 5<sup>th</sup> and 6<sup>th</sup> primaries, where  
 9009 present, in the same way as the *Primary1X*, *Primary1Y* and *Primary1Intensity* attributes.  
 9010

9011 **5.2.2.2.4 Defined Color Points Settings Attribute Set**

9012 The Defined Color Points Settings attribute set contains the attributes summarized in Table 5.12.

9013

**Table 5.12. Defined Color Points Settings Attribute Set**

<b>Id</b>	<b>Name</b>	<b>Type</b>	<b>Range</b>	<b>Access</b>	<b>Def</b>	<b>M/O</b>
0x0030	WhitePointX	uint16	0x0000 – 0xfeff	RW	-	O
0x0031	WhitePointY	uint16	0x0000 – 0xfeff	RW	-	O
0x0032	ColorPointRX	uint16	0x0000 – 0xfeff	RW	-	O
0x0033	ColorPointRY	uint16	0x0000 – 0xfeff	RW	-	O
0x0034	ColorPointRIntensity	uint8	0x00 – 0xff	RW	-	O
0x0035	Reserved	-	-	-	-	-
0x0036	ColorPointGX	uint16	0x0000 – 0xfeff	RW	-	O
0x0037	ColorPointGY	uint16	0x0000 – 0xfeff	RW	-	O
0x0038	ColorPointGIntensity	uint8	0x00 – 0xff	RW	-	O
0x0039	Reserved	-	-	-	-	-
0x003a	ColorPointBX	uint16	0x0000 – 0xfeff	RW	-	O
0x003b	ColorPointBY	uint16	0x0000 – 0xfeff	RW	-	O
0x003c	ColorPointBIntensity	uint8	0x00 – 0xff	RW	-	O

9014 **5.2.2.2.4.1 WhitePointX Attribute**

9015 The *WhitePointX* attribute contains the normalized chromaticity value x, as defined in the CIE xyY Color  
9016 Space, of the current white point of the device.

9017 The value of x SHALL be related to the *WhitePointX* attribute by the relationship

$$9018 \quad x = \text{WhitePointX} / 65536 \quad (\text{WhitePointX in the range 0 to 65279 inclusive})$$

#### 9019 **5.2.2.2.4.2 WhitePointY Attribute**

9020 The *WhitePointY* attribute contains the normalized chromaticity value y, as defined in the CIE xyY Color  
9021 Space, of the current white point of the device.

9022 The value of y SHALL be related to the *WhitePointY* attribute by the relationship

$$9023 \quad y = \text{WhitePointY} / 65536 \quad (\text{WhitePointY in the range 0 to 65279 inclusive})$$

#### 9024 **5.2.2.2.4.3 ColorPointRX Attribute**

9025 The *ColorPointRX* attribute contains the normalized chromaticity value x, as defined in the CIE xyY Color  
9026 Space, of the red color point of the device.

9027 The value of x SHALL be related to the *ColorPointRX* attribute by the relationship

$$9028 \quad x = \text{ColorPointRX} / 65536 \quad (\text{ColorPointRX in the range 0 to 65279 inclusive})$$

#### 9029 **5.2.2.2.4.4 ColorPointRY Attribute**

9030 The *ColorPointRY* attribute contains the normalized chromaticity value y, as defined in the CIE xyY Color  
9031 Space, of the red color point of the device.

9032 The value of y SHALL be related to the *ColorPointRY* attribute by the relationship

$$9033 \quad y = \text{ColorPointRY} / 65536 \quad (\text{ColorPointRY in the range 0 to 65279 inclusive})$$

#### 9034 **5.2.2.2.4.5 ColorPointRIntensity Attribute**

9035 The *ColorPointRIntensity* attribute contains a representation of the relative intensity of the red color point as  
9036 defined in the Dimming Light Curve in the Ballast Configuration cluster (see 5.3), normalized such that the  
9037 color point with the highest relative intensity contains the value 0xfe.

9038 A value of 0xff SHALL indicate an invalid value.

#### 9039 **5.2.2.2.4.6 Remaining Attributes**

9040 The *ColorPointGX*, *ColorPointGY*, *ColorPointGIntensity*, *ColorPointBX*, *ColorPointBY* and, *ColorPoint-*  
9041 *BIntensity* attributes are used to represent the chromaticity values and intensities of the green and blue color  
9042 points, in the same way as for the *ColorPointRX*, *ColorPointRY* and *ColorPointRIntensity* attributes.

9043 If any one of these red, green or blue color point attributes is implemented then they SHALL all be imple-  
9044 mented.

### 9045 **5.2.2.3 Commands Received**

9046 The command IDs for the Color Control cluster are listed in Table 5.13.

9047 **Table 5.13. Command IDs for the Color Control Cluster**

Command Identifier	Description	M/O
0x00	Move to Hue	M <sup>0</sup>
0x01	Move Hue	M <sup>0</sup>



Command Identifier	Description	M/O
0x02	Step Hue	M <sup>0</sup>
0x03	Move to Saturation	M <sup>0</sup>
0x04	Move Saturation	M <sup>0</sup>
0x05	Step Saturation	M <sup>0</sup>
0x06	Move to Hue and Saturation	M <sup>0</sup>
0x07	Move to Color	M <sup>3</sup>
0x08	Move Color	M <sup>3</sup>
0x09	Step Color	M <sup>3</sup>
0x0a	Move to Color Temperature	M <sup>4</sup>
0x40	Enhanced Move to Hue	M <sup>1</sup>
0x41	Enhanced Move Hue	M <sup>1</sup>
0x42	Enhanced Step Hue	M <sup>1</sup>
0x43	Enhanced Move to Hue and Saturation	M <sup>1</sup>
0x44	Color Loop Set	M <sup>2</sup>
0x47	Stop Move Step	M <sup>0,1,3,4</sup>
0x4b	Move Color Temperature	M <sup>4</sup>
0x4c	Step Color Temperature	M <sup>4</sup>

9048

9049 M<sup>i</sup> = Mandatory if bit *i* of the *ColorCapabilities* attribute is equal to 1, otherwise optional.

9050

### 9051 5.2.2.3.1 Generic Usage Notes

9052 If one of these commands is received while the device is in its off state, i.e., the OnOff attribute of the on/off  
 9053 cluster is equal to 0x00, the command SHALL be ignored.

9054 When asked to change color via one of these commands, the implementation SHALL select a color, within  
 9055 the limits of the hardware of the device, which is as close as possible to that requested. The determination as  
 9056 to the true representations of color is out of the scope of this specification.

9057 If a color loop is active (i.e., the ColorLoopActive attribute is equal to 0x01), it SHALL only be stopped by  
 9058 sending a specific color loop set command frame with a request to deactivate the color loop (i.e., the color  
 9059 loop SHALL not be stopped on receipt of another command such as the enhanced move to hue command).  
 9060 In addition, while a color loop is active, a manufacturer MAY choose to ignore incoming color commands  
 9061 which affect a change in hue.

9062 For the move hue command, the Rate field specifies the rate of movement in steps per second. A step is a  
 9063 change in the device's hue of one unit. If the move mode field is equal to 0x01 (Up) or 0x03 (Down) and the  
 9064 Rate field has a value of zero, the command has no effect and a default response command (see 2.4.12) is  
 9065 sent in response, with the status code set to INVALID\_FIELD.

9066 For the move to color temperature command, if the target color specified is not achievable by the hardware  
 9067 then the color temperature SHALL be clipped at the physical minimum or maximum achievable, depending  
 9068 on the color temperature transition, when the device reaches that color temperature (which MAY be before  
 9069 the requested transition time), and a ZCL default response command SHALL be generated, where not disa-  
 9070 bled, with a status code equal to SUCCESS.

### 9071 5.2.2.3.2 Note on Change of ColorMode

9072 The first action taken when any one of these commands is received is to change the *ColorMode* attribute to  
 9073 the appropriate value for the command (see individual commands). Note that, when moving from one color  
 9074 mode to another (e.g., *CurrentX/CurrentY* to *CurrentHue/CurrentSaturation*), the starting color for the com-  
 9075 mand is formed by calculating the values of the new attributes (in this case *CurrentHue*, *CurrentSaturation*)  
 9076 from those of the old attributes (in this case *CurrentX* and *CurrentY*).

9077 When moving from a mode to another mode that has a more restricted color range (e.g., *CurrentX/CurrentY*  
 9078 to *CurrentHue/CurrentSaturation*, or *CurrentHue/CurrentSaturation* to *ColorTemperatureMireds*) it is pos-  
 9079 sible for the current color value to have no equivalent in the new mode. The behavior in such cases is manu-  
 9080 facturer dependent, and therefore it is recommended to avoid color mode changes of this kind during usage.

### 9081 5.2.2.3.3 Use of the OptionsMask & OptionsOverride fields

9082 The OptionsMask & OptionsOverride fields SHALL both be present.<sup>90</sup> Default values are provided to inter-  
 9083 pret missing fields from legacy devices. A temporary Options bitmap SHALL be created from the *Options*  
 9084 attribute, using the OptionsMask & OptionsOverride fields. Each bit of the temporary Options bitmap  
 9085 SHALL be determined as follows:

9086 Each bit in the *Options* attribute SHALL determine the corresponding bit in the temporary Options bitmap,  
 9087 unless the OptionsMask field is present and has the corresponding bit set to 1, in which case the correspond-  
 9088 ing bit in the OptionsOverride field SHALL determine the corresponding bit in the temporary Options bit-  
 9089 map.

9090 The resulting temporary Options bitmap SHALL then be processed as defined in section 5.2.2.2.1.10.

### 9091 5.2.2.3.4 Move to Hue Command

#### 9092 5.2.2.3.4.1 Payload Format

9093 The Move to Hue command payload SHALL be formatted as illustrated in Figure 5-2.

9094 **Figure 5-2. Format of the Move to Hue Command Payload**

<b>Octets</b>	1	1	2	1	1
<b>Data Type</b>	uint8	enum8	uint16	map8	map8
<b>Field Name</b>	Hue	Direction	Transition Time	OptionsMask	OptionsOverride
<b>Default</b>	n/a	n/a	n/a	0	0 <sup>91</sup>

#### 9095 5.2.2.3.4.2 Hue Field

9096 The Hue field specifies the hue to be moved to.

<sup>90</sup> CCB 2814 fields are mandatory because fields may follow

<sup>91</sup> CCB 2814 defaults for legacy devices

9097 **5.2.2.3.4.3 Direction Field**

9098 The Direction field SHALL be one of the non-reserved values in Table 5.14.

9099 **Table 5.14. Values of the Direction Field**

Fade Mode Value	Description
0x00	Shortest distance
0x01	Longest distance
0x02	Up
0x03	Down

9100 **5.2.2.3.4.4 Transition Time Field**

9101 The Transition Time field specifies, in 1/10ths of a second, the time that SHALL be taken to move to the  
 9102 new hue.

9103 **5.2.2.3.4.5 OptionsMask and OptionsOverride fields**

9104 The OptionsMask and OptionsOverride fields SHALL be processed according to section 5.2.2.3.3.

9105 **5.2.2.3.4.6 Effect on Receipt**

9106 On receipt of this command, a device SHALL also set the *ColorMode* attribute to the value 0x00 and then  
 9107 SHALL move from its current hue to the value given in the Hue field.

9108 The movement SHALL be continuous, i.e., not a step function, and the time taken to move to the new hue  
 9109 SHALL be equal to the Transition Time field.

9110 As hue is effectively measured on a circle, the new hue MAY be moved to in either direction. The direction  
 9111 of hue change is given by the Direction field. If Direction is 'Shortest distance', the direction is taken that  
 9112 involves the shortest path round the circle. This case corresponds to expected normal usage. If Direction is  
 9113 'Longest distance', the direction is taken that involves the longest path round the circle. This case can be used  
 9114 for 'rainbow effects'. In both cases, if both distances are the same, the Up direction SHALL be taken.

9115 **5.2.2.3.5 Move Hue Command**

9116 **5.2.2.3.5.1 Payload Format**

9117 The Move Hue command payload SHALL be formatted as illustrated in Figure 5-3.

9118 **Figure 5-3. Format of the Move Hue Command Payload**

<b>Octets</b>	1	1	1	1
<b>Data Type</b>	enum8	uint8	map8	map8
<b>Field Name</b>	Move Mode	Rate	OptionsMask	OptionsOverride
<b>Default</b>	n/a	n/a	0	0 <sup>92</sup>

9119 **5.2.2.3.5.2 Move Mode Field**

<sup>92</sup> CCB 2814 defaults for legacy devices

9120 The Move Mode field SHALL be one of the non-reserved values in Table 5.15. If the Move Mode field is  
9121 equal to 0x00 (Stop), the Rate field SHALL be ignored.<sup>93</sup>

9122

9123

**Table 5.15. Values of the Move Mode Field**

Move Mode Value	Description
0x00	Stop
0x01	Up
0x02	Reserved
0x03	Down

#### 9124 **5.2.2.3.5.3 Rate Field**

9125 The Rate field specifies the rate of movement in steps per second. A step is a change in the device's hue of  
9126 one unit. If the Move Mode field is set to 0x01 (up) or 0x03 (down) and the Rate field has a value of zero,  
9127 the command has no effect and a Default Response command (see Chapter 2) SHALL be sent in response,  
9128 with the status code set to INVALID\_FIELD. If the Move Mode field is set to 0x00 (stop) the Rate field SHALL  
9129 be ignored.<sup>94</sup>

#### 9130 **5.2.2.3.5.4 OptionsMask and OptionsOverride field**

9131 The OptionsMask and OptionsOverride fields SHALL be processed according to section 5.2.2.3.3.

#### 9132 **5.2.2.3.5.5 Effect on Receipt**

9133 On receipt of this command, a device SHALL set the *ColorMode* attribute to the value 0x00 and SHALL  
9134 then move from its current hue in an up or down direction in a continuous fashion, as detailed in Table 5.16.

9135

**Table 5.16. Actions on Receipt for Move Hue Command**

Fade Mode	Action on Receipt
Stop	If moving, stop, else ignore the command (i.e., the command is accepted but has no effect). NB This MAY also be used to stop a Move to Hue command, a Move to Saturation command, or a Move to Hue and Saturation command.
Up	Increase the device's hue at the rate given in the Rate field. If the hue reaches the maximum allowed for the device, then proceed to its minimum allowed value.
Down	Decrease the device's hue at the rate given in the Rate field. If the hue reaches the minimum allowed for the device, then proceed to its maximum allowed value.

#### 9136 **5.2.2.3.6 Step Hue Command**

##### 9137 **5.2.2.3.6.1 Payload Format**

<sup>93</sup> CCB 2501

<sup>94</sup> CCB 2501

9138 The Step Hue command payload SHALL be formatted as illustrated in Figure 5-4.

9139 **Figure 5-4. Format of the Step Hue Command Payload**

<b>Octets</b>	1	1	1	1	1
<b>Data Type</b>	enum8	uint8	uint8	map8	map8
<b>Field Name</b>	Step Mode	Step Size	Transition Time	OptionsMask	OptionsOverride
<b>Default</b>	n/a	n/a	n/a	0	0 <sup>95</sup>

9140 **5.2.2.3.6.2 Step Mode Field**

9141 The Step Mode field SHALL be one of the non-reserved values in Table 5.17.

9142 **Table 5.17. Values of the Step Mode Field**

Fade Mode Value	Description
0x00	Reserved
0x01	Up
0x02	Reserved
0x03	Down

9143 **5.2.2.3.6.3 Step Size Field**

9144 The change to be added to (or subtracted from) the current value of the device’s hue.

9145 **5.2.2.3.6.4 Transition Time Field**

9146 The Transition Time field specifies, in 1/10ths of a second, the time that SHALL be taken to perform the  
 9147 step. A step is a change in the device’s hue of ‘Step size’ units.

9148 **5.2.2.3.6.5 OptionsMask and OptionsOverride fields**

9149 The OptionsMask and OptionsOverride fields SHALL be processed according to section 5.2.2.3.3.

9150 **5.2.2.3.6.6 Effect on Receipt**

9151 On receipt of this command, a device SHALL set the *ColorMode* attribute to the value 0x00 and SHALL  
 9152 then move from its current hue in an up or down direction by one step, as detailed in Table 5.18.

9153 **Table 5.18. Actions on Receipt for Step Hue Command**

Fade Mode	Action on Receipt
Up	Increase the device’s hue by one step, in a continuous fashion. If the hue value reaches the maximum value then proceed to the minimum allowed value.

<sup>95</sup> CCB 2814 defaults for legacy devices

Down	Decrease the device’s hue by one step, in a continuous fashion. If the hue value reaches the minimum value then proceed to the maximum allowed value.
------	---

9154 **5.2.2.3.7 Move to Saturation Command**

9155 **5.2.2.3.7.1 Payload Format**

9156 The Move to Saturation command payload SHALL be formatted as illustrated in Figure 5-5.

9157 **Figure 5-5. Format of the Move to Saturation Command Payload**

<b>Octets</b>	1	2	1	1
<b>Data Type</b>	uint8	uint16	map8	map8
<b>Field Name</b>	Saturation	Transition Time	OptionsMask	OptionsOverride
<b>Default</b>	n/a	n/a	0	0 <sup>96</sup>

9158 **5.2.2.3.7.2 OptionsMask and OptionsOverride fields**

9159 The OptionsMask and OptionsOverride fields SHALL be processed according to section 5.2.2.3.3.

9160 **5.2.2.3.7.3 Effect on Receipt**

9161 On receipt of this command, a device set the *ColorMode* attribute to the value 0x00 and SHALL then move  
9162 from its current saturation to the value given in the Saturation field.

9163 The movement SHALL be continuous, i.e., not a step function, and the time taken to move to the new satu-  
9164 ration SHALL be equal to the Transition Time field, in 1/10ths of a second.

9165 **5.2.2.3.8 Move Saturation Command**

9166 **5.2.2.3.8.1 Payload Format**

9167 The Move Saturation command payload SHALL be formatted as illustrated in Figure 5-6.

9168 **Figure 5-6. Format of the Move Saturation Command Payload**

<b>Octets</b>	1	1	1	1
<b>Data Type</b>	enum8	uint8	map8	map8
<b>Field Name</b>	Move Mode	Rate	OptionsMask	OptionsOverride
<b>Default</b>	n/a	n/a	0	0 <sup>97</sup>

9169 **5.2.2.3.8.2 Move Mode Field**

<sup>96</sup> CCB 2814 defaults for legacy devices

<sup>97</sup> CCB 2814 defaults for legacy devices

9170 The Move Mode field SHALL be one of the non-reserved values in Table 5.19. If the Move Mode field is  
 9171 equal to 0x00 (Stop), the Rate field SHALL be ignored.<sup>98</sup>

9172

**Table 5.19. Values of the Move Mode Field**

Move Mode Value	Description
0x00	Stop
0x01	Up
0x02	Reserved
0x03	Down

9173 **5.2.2.3.8.3 Rate Field**

9174 The Rate field specifies the rate of movement in steps per second. A step is a change in the device’s saturation  
 9175 of one unit. If the Move Mode field is set to 0x01 (up) or 0x03 (down) and the Rate field has a value of zero,  
 9176 the command has no effect and a Default Response command (see Chapter 2) SHALL be sent in response,  
 9177 with the status code set to INVALID\_FIELD. If the Move Mode field is set to 0x00 (stop) the Rate field  
 9178 SHALL be ignored.<sup>99</sup>OptionsMask and OptionsOverride fields

9179 The OptionsMask and OptionsOverride fields SHALL be processed according to section 5.2.2.3.3.

9180 **5.2.2.3.8.4 Effect on Receipt**

9181 On receipt of this command, a device SHALL set the *ColorMode* attribute to the value 0x00 and SHALL  
 9182 then move from its current saturation in an up or down direction in a continuous fashion, as detailed in Table  
 9183 5.20.

9184

**Table 5.20. Actions on Receipt for Move Saturation Command**

Fade Mode	Action on Receipt
Stop	If moving, stop, else ignore the command (i.e., the command is accepted but has no affect). NB This MAY also be used to stop a Move to Saturation command, a Move to Hue command, or a Move to Hue and Saturation command.
Up	Increase the device’s saturation at the rate given in the Rate field. If the saturation reaches the maximum allowed for the device, stop.
Down	Decrease the device’s saturation at the rate given in the Rate field. If the saturation reaches the minimum allowed for the device, stop.

9185 **5.2.2.3.9 Step Saturation Command**

9186 **5.2.2.3.9.1 Payload Format**

9187 The Step Saturation command payload SHALL be formatted as illustrated in Figure 5-7.

<sup>98</sup> CCB 2501

<sup>99</sup> CCB 2501

9188

**Figure 5-7. Format of the Step Saturation Command Payload**

<b>Octets</b>	1	1	1	1	1
<b>Data Type</b>	enum8	uint8	uint8	map8	map8
<b>Field Name</b>	Step Mode	Step Size	Transition Time	OptionsMask	OptionsOverride
<b>Default</b>	n/a	n/a	n/a	0	0 <sup>100</sup>

9189 **5.2.2.3.9.2 Step Mode Field**

9190 The Step Mode field SHALL be one of the non-reserved values in Table 5.21.

9191 **Table 5.21. Values of the Step Mode Field**

Step Mode Value	Description
0x00	Reserved
0x01	Up
0x02	Reserved
0x03	Down

9192 **5.2.2.3.9.3 Step Size Field**

9193 The change to be added to (or subtracted from) the current value of the device's saturation.

9194 **5.2.2.3.9.4 Transition Time Field**9195 The Transition Time field specifies, in 1/10ths of a second, the time that SHALL be taken to perform the  
9196 step. A step is a change in the device's saturation of 'Step size' units.9197 **5.2.2.3.9.5 OptionsMask and OptionsOverride fields**

9198 The OptionsMask and OptionsOverride fields SHALL be processed according to section 5.2.2.3.3.

9199 **5.2.2.3.9.6 Effect on Receipt**9200 On receipt of this command, a device SHALL set the *ColorMode* attribute to the value 0x00 and SHALL  
9201 then move from its current saturation in an up or down direction by one step, as detailed in Table 5.22.9202 **Table 5.22. Actions on Receipt for Step Saturation Command**

Step Mode	Action on Receipt
Up	Increase the device's saturation by one step, in a continuous fashion. However, if the saturation value is already the maximum value then do nothing.
Down	Decrease the device's saturation by one step, in a continuous fashion. However, if the saturation value is already the minimum value then do nothing.

<sup>100</sup> CCB 2814 defaults for legacy devices



9203 **5.2.2.3.10 Move to Hue and Saturation Command**

9204 **5.2.2.3.10.1 Payload Format**

9205 The Move to Hue and Saturation command payload SHALL be formatted as illustrated in Figure 5-8.

9206 **Figure 5-8. Move to Hue and Saturation Command Payload**

<b>Octets</b>	1	1	2	1	1
<b>Data Type</b>	uint8	uint8	uint16	map8	map8
<b>Field Name</b>	Hue	Saturation	Transition Time	OptionsMask	OptionsOverride
<b>Default</b>	n/a	n/a	n/a	0	0 <sup>101</sup>

9207 **5.2.2.3.10.2 OptionsMask and OptionsOverride fields**

9208 The OptionsMask and OptionsOverride fields SHALL be processed according to section 5.2.2.3.3.

9209 **5.2.2.3.10.3 Effect on Receipt**

9210 On receipt of this command, a device SHALL set the *ColorMode* attribute to the value 0x00 and SHALL  
 9211 then move from its current hue and saturation to the values given in the Hue and Saturation fields.

9212 The movement SHALL be continuous, i.e., not a step function, and the time taken to move to the new color  
 9213 SHALL be equal to the Transition Time field, in 1/10ths of a second.

9214 The path through color space taken during the transition is not specified, but it is recommended that the  
 9215 shortest path is taken though hue/saturation space, i.e., movement is ‘in a straight line’ across the hue/satu-  
 9216 ration disk.

9217 **5.2.2.3.11 Move to Color Command**

9218 **5.2.2.3.11.1 Payload Format**

9219 The Move to Color command payload SHALL be formatted as illustrated in Figure 5-9.

9220 **Figure 5-9. Format of the Move to Color Command Payload**

<b>Octets</b>	2	2	2	1	1
<b>Data Type</b>	uint16	uint16	uint16	map8	map8
<b>Field Name</b>	ColorX	ColorY	Transition Time	OptionsMask	OptionsOverride
<b>Default</b>	n/a	n/a	n/a	0	0 <sup>102</sup>

9221 **5.2.2.3.11.2 OptionsMask and OptionsOverride fields**

9222 The OptionsMask and OptionsOverride fields SHALL be processed according to section 5.2.2.3.3.

9223 **5.2.2.3.11.3 Effect on Receipt**

<sup>101</sup> CCB 2814 defaults for legacy devices

<sup>102</sup> CCB 2814 defaults for legacy devices

9224 On receipt of this command, a device SHALL set the value of the *ColorMode* attribute, where implemented,  
9225 to 0x01, and SHALL then move from its current color to the color given in the ColorX and ColorY fields.

9226 The movement SHALL be continuous, i.e., not a step function, and the time taken to move to the new color  
9227 SHALL be equal to the Transition Time field, in 1/10ths of a second.

9228 The path through color space taken during the transition is not specified, but it is recommended that the  
9229 shortest path is taken though color space, i.e., movement is 'in a straight line' across the CIE xyY Color Space.

### 9230 **5.2.2.3.12 Move Color Command**

#### 9231 **5.2.2.3.12.1 Payload Format**

9232 The Move Color command payload SHALL be formatted as illustrated in Figure 5-10.

9233 **Figure 5-10. Format of the Move Color Command Payload**

<b>Octets</b>	2	2	1	1
<b>Data Type</b>	int16	int16	map8	map8
<b>Field Name</b>	RateX	RateY	OptionsMask	OptionsOverride
<b>Default</b>	n/a	n/a	0	0 <sup>103</sup>

#### 9234 **5.2.2.3.12.2 RateX Field**

9235 The RateX field specifies the rate of movement in steps per second. A step is a change in the device's Cur-  
9236 rentX attribute of one unit.

#### 9237 **5.2.2.3.12.3 RateY Field**

9238 The RateY field specifies the rate of movement in steps per second. A step is a change in the device's Cur-  
9239 rentY attribute of one unit.

#### 9240 **5.2.2.3.12.4 OptionsMask and OptionsOverride fields**

9241 The OptionsMask and OptionsOverride fields SHALL be processed according to section 5.2.2.3.3.

#### 9242 **5.2.2.3.12.5 Effect on Receipt**

9243 On receipt of this command, a device SHALL set the value of the *ColorMode* attribute, where implemented,  
9244 to 0x01, and SHALL then move from its current color in a continuous fashion according to the rates specified.  
9245 This movement SHALL continue until the target color for the next step cannot be implemented on this device.

9246 If both the RateX and RateY fields contain a value of zero, no movement SHALL be carried out, and the  
9247 command execution SHALL have no effect other than stopping the operation of any previously received  
9248 command of this cluster. This command can thus be used to stop the operation of any other command of this  
9249 cluster.

### 9250 **5.2.2.3.13 Step Color Command**

#### 9251 **5.2.2.3.13.1 Payload Format**

9252 The Step Color command payload SHALL be formatted as illustrated in Figure 5-11.

<sup>103</sup> CCB 2814 defaults for legacy devices

9253

**Figure 5-11. Format of the Step Color Command Payload**

<b>Octets</b>	2	2	2	1	1
<b>Data Type</b>	int16	int16	uint16	map8	map8
<b>Field Name</b>	StepX	StepY	Transition Time	OptionsMask	OptionsOverride
<b>Default</b>	n/a	n/a	n/a	0	0 <sup>104</sup>

9254 **5.2.2.3.13.2 StepX and StepY Fields**

9255 The StepX and StepY fields specify the change to be added to the device's CurrentX attribute and CurrentY  
 9256 attribute respectively.

9257 **5.2.2.3.13.3 Transition Time Field**

9258 The Transition Time field specifies, in 1/10ths of a second, the time that SHALL be taken to perform the  
 9259 color change. 9999

9260 **5.2.2.3.13.4 OptionsMask and OptionsOverride fields**

9261 The OptionsMask and OptionsOverride fields SHALL be processed according to section 5.2.2.3.3.

9262 **5.2.2.3.13.5 Effect on Receipt**

9263 On receipt of this command, a device SHALL set the value of the *ColorMode* attribute, where implemented,  
 9264 to 0x01, and SHALL then move from its current color by the color step indicated.

9265 The movement SHALL be continuous, i.e., not a step function, and the time taken to move to the new color  
 9266 SHALL be equal to the Transition Time field, in 1/10ths of a second.

9267 The path through color space taken during the transition is not specified, but it is recommended that the  
 9268 shortest path is taken though color space, i.e., movement is 'in a straight line' across the CIE xyY Color Space.

9269 Note also that if the required step is larger than can be represented by signed 16-bit integers then more than  
 9270 one step command SHOULD be issued.

9271 **5.2.2.3.14 Move to Color Temperature Command**

9272 **5.2.2.3.14.1 Payload Format**

9273 The Move to Color Temperature command payload SHALL be formatted as illustrated in Figure 5-12.

9274 **Figure 5-12. Move to Color Temperature Command Payload**

<b>Octets</b>	2	2	1	1
<b>Data Type</b>	uint16	uint16	map8	map8
<b>Field Name</b>	Color Temperature Mireds	Transition Time	OptionsMask	OptionsOverride
<b>Default</b>	n/a	n/a	0	0 <sup>105</sup>

9275 **5.2.2.3.14.2 OptionsMask and OptionsOverride fields**

<sup>104</sup> CCB 2814 defaults for legacy devices

<sup>105</sup> CCB 2814 defaults for legacy devices

9276 The OptionsMask and OptionsOverride fields SHALL be processed according to section 5.2.2.3.3.

#### 9277 **5.2.2.3.14.3 Effect on Receipt**

9278 On receipt of this command, a device SHALL set the value of the *ColorMode* attribute, where implemented,  
9279 to 0x02, and SHALL then move from its current color to the color given by the Color Temperature Mireds  
9280 field.

9281 The movement SHALL be continuous, i.e., not a step function, and the time taken to move to the new color  
9282 SHALL be equal to the Transition Time field, in 1/10ths of a second.

9283 By definition of this color mode, the path through color space taken during the transition is along the 'Black  
9284 Body Line'.

#### 9285 **5.2.2.3.15 Enhanced Move to Hue Command**

9286 The Enhanced Move to Hue command allows lamps to be moved in a smooth continuous transition from  
9287 their current hue to a target hue.

9288 The payload of this command SHALL be formatted as illustrated in Figure 5-13.

9289 **Figure 5-13. Format of the Enhanced Move to Hue Command**

<b>Octets</b>	2	1	2	1	1
<b>Data Type</b>	uint16	enum8	uint16	map8	map8
<b>Field Name</b>	Enhanced Hue	Direction	Transition Time	OptionsMask	OptionsOverride
<b>Default</b>	n/a	n/a	n/s	0	0 <sup>106</sup>

#### 9290 **5.2.2.3.15.1 Enhanced Hue Field**

9291 The Enhanced Hue field is 16-bits in length and specifies the target extended hue for the lamp.

#### 9292 **5.2.2.3.15.2 Direction Field**

9293 This field is identical to the Direction field of the Move to Hue command of the Color Control cluster (see  
9294 sub-clause 5.2.2.3.3).

#### 9295 **5.2.2.3.15.3 Transition Time Field**

9296 This field is identical to the Transition Time field of the Move to Hue command of the Color Control cluster  
9297 (see sub-clause 5.2.2.3.3).

#### 9298 **5.2.2.3.15.4 OptionsMask and OptionsOverride fields**

9299 The OptionsMask and OptionsOverride fields SHALL be processed according to section 5.2.2.3.3.

#### 9300 **5.2.2.3.15.5 Effect on Receipt**

9301 On receipt of this command, a device SHALL set the ColorMode attribute to 0x00 and set the EnhancedCol-  
9302 orMode attribute to the value 0x03. The device SHALL then move from its current enhanced hue to the value  
9303 given in the Enhanced Hue field.

9304 The movement SHALL be continuous, i.e., not a step function, and the time taken to move to the new en-  
9305 hanced hue SHALL be equal to the Transition Time field.

<sup>106</sup> CCB 2814 defaults for legacy devices

9306 **5.2.2.3.16 Enhanced Move Hue Command**

9307 The Enhanced Move Hue command allows lamps to be moved in a continuous stepped transition from their  
 9308 current hue to a target hue.

9309 The payload of this command SHALL be formatted as illustrated in Figure 5-14.

9310 **Figure 5-14. Format of the Enhanced Move Hue Command**

<b>Octets</b>	1	2	1	1
<b>Data Type</b>	enum8	uint16	map8	map8
<b>Field Name</b>	Move Mode	Rate	OptionsMask	OptionsOverride
<b>Default</b>	n/a	n/a	0	0 <sup>107</sup>

9311 **5.2.2.3.16.1 Move Mode Field**

9312 This field is identical to the Move Mode field of the Move Hue command of the Color Control cluster (see  
 9313 sub-clause 5.2.2.3.5). If the Move Mode field is equal to 0x00 (Stop), the Rate field SHALL be ignored.<sup>108</sup>

9314 **5.2.2.3.16.2 Rate field**

9315 The Rate field is 16-bits in length and specifies the rate of movement in steps per second. A step is a change  
 9316 in the extended hue of a device by one unit. If the Move Mode field is set to 0x01 (up) or 0x03 (down) and  
 9317 the Rate field has a value of zero, the command has no effect and a ZCL Default Response command SHALL  
 9318 be sent in response, with the status code set to INVALID\_FIELD. If the Move Mode field is set to 0x00 (stop)  
 9319 the Rate field SHALL be ignored.

9320 **5.2.2.3.16.3 OptionsMask and OptionsOverride fields**

9321 The OptionsMask and OptionsOverride fields SHALL be processed according to section 5.2.2.3.3.

9322 **5.2.2.3.16.4 Effect on receipt**

9323 On receipt of this command, a device SHALL set the ColorMode attribute to 0x00 and set the EnhancedCol-  
 9324 orMode attribute to the value 0x03. The device SHALL then move from its current enhanced hue in an up or  
 9325 down direction in a continuous fashion, as detailed in Table 5.23.

9326 **Table 5.23. Actions on Receipt of the Enhanced Move Hue Command**

<b>Move Mode</b>	<b>Action on Receipt</b>
Stop	If moving, stop, else ignore the command (i.e., the command is accepted but has no effect). NB This MAY also be used to stop an Enhanced Move to Hue command or an enhanced Move to Hue and Saturation command.
Up	Increase the device’s enhanced hue at the rate given in the Rate field. If the enhanced hue reaches the maximum allowed for the device, proceed to its minimum allowed value.
Down	Decrease the device’s enhanced hue at the rate given in the Rate field. If the hue reaches the minimum allowed for the device, proceed to its maximum allowed value.

<sup>107</sup> CCB 2814 defaults for legacy devices

<sup>108</sup> CCB 2501

9327 **5.2.2.3.17 Enhanced Step Hue Command**9328 The Enhanced Step Hue command allows lamps to be moved in a stepped transition from their current hue  
9329 to a target hue, resulting in a linear transition through XY space.

9330 The payload of this command SHALL be formatted as illustrated in Figure 5-15.

9331 **Figure 5-15. Format of the Enhanced Step Hue Command**

<b>Octets</b>	1	2	2	1	1
<b>Data Type</b>	enum8	uint16	uint16	map8	map8
<b>Field Name</b>	Step Mode	Step Size	Transition Time	OptionsMask	OptionsOverride
<b>Default</b>	n/a	n/a	n/a	0	0 <sup>109</sup>

9332 **5.2.2.3.17.1 Step Mode Field**9333 This field is identical to the Step Mode field of the Step Hue command of the Color Control cluster (see sub-  
9334 clause 5.2.2.3.6).9335 **5.2.2.3.17.2 Step Size Field**9336 The Step Size field is 16-bits in length and specifies the change to be added to (or subtracted from) the current  
9337 value of the device's enhanced hue.9338 **5.2.2.3.17.3 Transition Time Field**9339 The Transition Time field is 16-bits in length and specifies, in units of 1/10ths of a second, the time that  
9340 SHALL be taken to perform the step. A step is a change to the device's enhanced hue of a magnitude corre-  
9341 sponding to the Step Size field.9342 **5.2.2.3.17.4 OptionsMask and OptionsOverride fields**

9343 The OptionsMask and OptionsOverride fields SHALL be processed according to section 5.2.2.3.3.

9344 **5.2.2.3.17.5 Effect on Receipt**9345 On receipt of this command, a device SHALL set the *ColorMode* attribute to 0x00 and the *EnhancedColor-*  
9346 *Mode* attribute to the value 0x03. The device SHALL then move from its current enhanced hue in an up or  
9347 down direction by one step, as detailed in Table 5.24.9348 **Table 5.24. Actions on Receipt for the Enhanced Step Hue Command**

<b>Move Mode</b>	<b>Action on Receipt</b>
Up	Increase the device's enhanced hue by one step. If the enhanced hue reaches the maximum allowed for the device, proceed to its minimum allowed value.
Down	Decrease the device's enhanced hue by one step. If the hue reaches the minimum allowed for the device, proceed to its maximum allowed value.

<sup>109</sup> CCB 2814 defaults for legacy devices

9349 **5.2.2.3.18 Enhanced Move to Hue and Saturation Command**

9350 The Enhanced Move to Hue and Saturation command allows lamps to be moved in a smooth continuous  
 9351 transition from their current hue to a target hue and from their current saturation to a target saturation.

9352 The payload of this command SHALL be formatted as illustrated in Figure 5-16.

9353 **Figure 5-16. Format of the Enhanced Move to Hue and Saturation Command**

<b>Octets</b>	2	1	2	1	1
<b>Data Type</b>	uint16	uint8	uint16	map8	map8
<b>Field Name</b>	Enhanced Hue	Saturation	Transition Time	OptionsMask	OptionsOverride
<b>Default</b>	n/a	n/a	n/a	0	0 <sup>110</sup>

9354 **5.2.2.3.18.1 Enhanced Hue Field**

9355 The Enhanced Hue field is 16-bits in length and specifies the target extended hue for the lamp.

9356 **5.2.2.3.18.2 Saturation Field**

9357 This field is identical to the Saturation field of the Move to Hue and Saturation command of the Color Control  
 9358 cluster (see sub-clause 5.2.2.3.10).

9359 **5.2.2.3.18.3 Transition Time Field**

9360 This field is identical to the Transition Time field of the Move to Hue command of the Color Control cluster  
 9361 (see sub-clause 5.2.2.3.10).

9362 **5.2.2.3.18.4 OptionsMask and OptionsOverride fields**

9363 The OptionsMask and OptionsOverride fields SHALL be processed according to section 5.2.2.3.3.

9364 **5.2.2.3.18.5 Effect on Receipt**

9365 On receipt of this command, a device SHALL set the ColorMode attribute to the value 0x00 and set the  
 9366 EnhancedColorMode attribute to the value 0x03. The device SHALL then move from its current enhanced  
 9367 hue and saturation to the values given in the enhanced hue and saturation fields.

9368 The movement SHALL be continuous, i.e., not a step function, and the time taken to move to the new color  
 9369 SHALL be equal to the Transition Time field, in 1/10ths of a second.

9370 The path through color space taken during the transition is not specified, but it is recommended that the  
 9371 shortest path is taken though XY space, i.e., movement is 'in a straight line' across the hue/saturation disk.

9372 **5.2.2.3.19 Color Loop Set Command**

9373 The Color Loop Set command allows a color loop to be activated such that the color lamp cycles through its  
 9374 range of hues.

9375 The payload of this command SHALL be formatted as illustrated in Figure 5-17.

<sup>110</sup> CCB 2814 defaults for legacy devices

9376

**Figure 5-17. Format of the Color Loop Set Command**

<b>Octets</b>	1	1	1	2	2	1	1
<b>Data Type</b>	map8	enum8	enum8	uint16	uint16	map8	map8
<b>Field Name</b>	Update Flags	Action	Direction	Time	Start Hue	OptionsMask	OptionsOverride
<b>Default</b>	n/a	n/a	n/a	n/a	n/a	0	0 <sup>111</sup>

9377 **5.2.2.3.19.1 Update Flags Field**

9378 The Update Flags field is 8 bits in length and specifies which color loop attributes to update before the color  
9379 loop is started. This field SHALL be formatted as illustrated in Figure 5-18.

9380 **Figure 5-18. Format of the Update Flags Field of the Color Loop Set Command**

<b>Bits: 0</b>	<b>1</b>	<b>2</b>	<b>3</b>	<b>4-7</b>
Update Action	Update Direction	Update Time	Update Start Hue	Reserved

9381

9382 The Update Action sub-field is 1 bit in length and specifies whether the device SHALL adhere to the action  
9383 field in order to process the command. If this sub-field is set to 1, the device SHALL adhere to the action  
9384 field. If this sub-field is set to 0, the device SHALL ignore the action field.

9385 The Update Direction sub-field is 1 bit in length and specifies whether the device SHALL update the Color-  
9386 LoopDirection attribute with the Direction field. If this sub-field is set to 1, the device SHALL update the  
9387 value of the ColorLoopDirection attribute with the value of the Direction field. If this sub-field is set to 0,  
9388 the device SHALL ignore the Direction field.

9389 The Update Time sub-field is 1 bit in length and specifies whether the device SHALL update the ColorLoop-  
9390 Time attribute with the Time field. If this sub-field is set to 1, the device SHALL update the value of the  
9391 ColorLoopTime attribute with the value of the Time field. If this sub-field is set to 0, the device SHALL  
9392 ignore the Time field.

9393 The Update Start Hue sub-field is 1 bit in length and specifies whether the device SHALL update the Color-  
9394 LoopStartEnhancedHue attribute with the Start Hue field. If this sub-field is set to 1, the device SHALL  
9395 update the value of the ColorLoopStartEnhancedHue attribute with the value of the Start Hue field. If this  
9396 sub-field is set to 0, the device SHALL ignore the Start Hue field.

9397 **5.2.2.3.19.2 Action Field**

9398 The Action field is 8 bits in length and specifies the action to take for the color loop if the Update Action  
9399 sub-field of the Update Flags field is set to 1. This field SHALL be set to one of the non-reserved values  
9400 listed in Table 5.25.

9401 **Table 5.25. Values of the Action Field of the Color Loop Set Command**

<b>Value</b>	<b>Description</b>
0x00	De-activate the color loop.
0x01	Activate the color loop from the value in the <i>ColorLoopStartEnhancedHue</i> field.

<sup>111</sup> CCB 2814 defaults for legacy devices



Value	Description
0x02	Activate the color loop from the value of the <i>EnhancedCurrentHue</i> attribute.

9402 **5.2.2.3.19.3 Direction Field**

9403 The Direction field is 8 bits in length and specifies the direction for the color loop if the Update Direction  
 9404 field of the Update Flags field is set to 1. This field SHALL be set to one of the non-reserved values listed in  
 9405 Table 5.26.

9406 **Table 5.26. Values of the Direction Field of the Color Loop Set Command**

Direction Field Value	Description
0x00	Decrement the hue in the color loop.
0x01	Increment the hue in the color loop.

9407 **5.2.2.3.19.4 Time Field**

9408 The Time field is 16 bits in length and specifies the number of seconds over which to perform a full color  
 9409 loop if the Update Time field of the Update Flags field is set to 1.

9410 **5.2.2.3.19.5 Start Hue Field**

9411 The Start Hue field is 16 bits in length and specifies the starting hue to use for the color loop if the Update  
 9412 Start Hue field of the Update Flags field is set to 1.

9413 **5.2.2.3.19.6 OptionsMask and OptionsOverride fields**

9414 The OptionsMask and OptionsOverride fields SHALL be processed according to section 5.2.2.3.3.

9415 **5.2.2.3.19.7 Effect on Receipt**

9416 On receipt of this command, the device SHALL first update its color loop attributes according to the value  
 9417 of the Update Flags field, as follows. If the Update Direction sub-field is set to 1, the device SHALL set the  
 9418 ColorLoopDirection attribute to the value of the Direction field. If the Update Time sub-field is set to 1, the  
 9419 device SHALL set the ColorLoopTime attribute to the value of the Time field. If the Update Start Hue sub-  
 9420 field is set to 1, the device SHALL set the ColorLoopStartEnhancedHue attribute to the value of the Start  
 9421 Hue field. If the color loop is active (and stays active), the device SHALL immediately react on updates of  
 9422 the ColorLoopDirection and ColorLoopTime attributes.

9423 If the Update Action sub-field of the Update Flags field is set to 1, the device SHALL adhere to the action  
 9424 specified in the Action field, as follows. If the value of the Action field is set to 0x00 and the color loop is  
 9425 active, i.e. the ColorLoopActive attribute is set to 0x01, the device SHALL de-active the color loop, set the  
 9426 ColorLoopActive attribute to 0x00 and set the EnhancedCurrentHue attribute to the value of the ColorLoop-  
 9427 StoredEnhancedHue attribute. If the value of the Action field is set to 0x00 and the color loop is inactive,  
 9428 i.e. the ColorLoopActive attribute is set to 0x00, the device SHALL ignore the action update component of  
 9429 the command. If the value of the action field is set to 0x01, the device SHALL set the ColorLoopStoredEn-  
 9430 hancedHue attribute to the value of the EnhancedCurrentHue attribute, set the ColorLoopActive attribute to  
 9431 0x01 and activate the color loop, starting from the value of the ColorLoopStartEnhancedHue attribute. If the  
 9432 value of the Action field is set to 0x02, the device SHALL set the ColorLoopStoredEnhancedHue attribute  
 9433 to the value of the EnhancedCurrentHue attribute, set the ColorLoopActive attribute to 0x01 and activate the  
 9434 color loop, starting from the value of the EnhancedCurrentHue attribute.

9435 If the color loop is active, the device SHALL cycle over the complete range of values of the EnhancedCur-  
9436 rentHue attribute in the direction of the ColorLoopDirection attribute over the time specified in the Color-  
9437 LoopTime attribute. The level of increments/decrements is application specific.

#### 9438 **5.2.2.3.20 Stop Move Step Command**

9439 The Stop Move Step command is provided to allow Move to and Step commands to be stopped. (Note this  
9440 automatically provides symmetry to the Level Control cluster.)

9441 Note: the Stop Move Step command has no effect on an active color loop.

9442 The Stop Move Step command payload SHALL be formatted as illustrated in Figure 5-19.

9443 **Figure 5-19. Format of the Stop Move Step Command Payload**

<b>Octets</b>	1	1
<b>Data Type</b>	map8	map8
<b>Field Name</b>	OptionsMask	OptionsOverride
<b>Default</b>	0	0 <sup>112</sup>

#### 9444 **5.2.2.3.20.1 OptionsMask and OptionsOverride fields**

9445 The OptionsMask and OptionsOverride fields SHALL be processed according to section 5.2.2.3.3.

#### 9446 **5.2.2.3.20.2 Effect on Receipt**

9447 Upon receipt of this command, any Move to, Move or Step command currently in process SHALL be termi-  
9448 nated. The values of the CurrentHue, EnhancedCurrentHue and CurrentSaturation attributes SHALL be left  
9449 at their present value upon receipt of the Stop Move Step command, and the RemainingTime attribute  
9450 SHALL be set to zero.

#### 9451 **5.2.2.3.21 Move Color Temperature Command**

9452 The Move Color Temperature command allows the color temperature of a lamp to be moved at a specified  
9453 rate.

9454 The payload of this command SHALL be formatted as illustrated in Figure 5-20.

---

<sup>112</sup> CCB 2814 defaults for legacy devices

9455

**Figure 5-20. Format of the Move Color Temperature Command**

<b>Octets</b>	1	2	2	2	1	1
<b>Data Type</b>	map8	uint16	uint16	uint16	map8	map8
<b>Field Name</b>	Move Mode	Rate	Color Temperature Minimum Mireds	Color Temperature Maximum Mireds	OptionsMask	OptionsOverride
<b>Default</b>	n/a	n/a	n/a	n/a	0	0 <sup>113</sup>

9456 **5.2.2.3.21.1 Move Mode Field**

9457 This field is identical to the Move Mode field of the Move Hue command of the Color Control cluster (see  
 9458 sub-clause 5.2.2.3.5). If the Move Mode field is equal to 0x00 (Stop), the Rate field SHALL be ignored.<sup>114</sup>

9459 **5.2.2.3.21.2 Rate Field**

9460 The Rate field is 16-bits in length and specifies the rate of movement in steps per second. A step is a  
 9461 change in the color temperature of a device by one unit. If the Move Mode field is set to 0x01 (up) or 0x03  
 9462 (down) and the Rate field has a value of zero, the command has no effect and a Default Response command  
 9463 SHALL be sent in response, with the status code set to INVALID\_FIELD. If the Move Mode field is set to  
 9464 0x00 (stop) the Rate field SHALL be ignored.<sup>115</sup>

9465 **5.2.2.3.21.3 Color Temperature Minimum Mireds Field**

9466 The Color Temperature Minimum Mireds field is 16-bits in length and specifies a lower bound on the *Color-*  
 9467 *TemperatureMireds* attribute ( $\equiv$  an upper bound on the color temperature in kelvins) for the current move  
 9468 operation such that:

9469  $ColorTempPhysicalMinMireds \leq Color\ Temperature\ Minimum\ Mireds\ field \leq ColorTemperatureMireds$

9470 As such if the move operation takes the *ColorTemperatureMireds* attribute towards the value of the Color  
 9471 Temperature Minimum Mireds field it SHALL be clipped so that the above invariant is satisfied. If the Color  
 9472 Temperature Minimum Mireds field is set to 0x0000, *ColorTempPhysicalMinMireds* SHALL be used as the  
 9473 lower bound for the *ColorTemperatureMireds* attribute.

9474 **5.2.2.3.21.4 Color Temperature Maximum Mireds Field**

9475 The Color Temperature Maximum Mireds field is 16-bits in length and specifies an upper bound on the  
 9476 *ColorTemperatureMireds* attribute ( $\equiv$  a lower bound on the color temperature in kelvins) for the current move  
 9477 operation such that:

9478  $ColorTemperatureMireds \leq Color\ Temperature\ Maximum\ Mireds\ field \leq ColorTempPhysicalMaxMireds$

9479 As such if the move operation takes the *ColorTemperatureMireds* attribute towards the value of the Color  
 9480 Temperature Maximum Mireds field it SHALL be clipped so that the above invariant is satisfied. If the Color  
 9481 Temperature Maximum Mireds field is set to 0x0000, *ColorTempPhysicalMaxMireds* SHALL be used as the  
 9482 upper bound for the *ColorTemperatureMireds* attribute.

9483 **5.2.2.3.21.5 OptionsMask and OptionsOverride fields**

9484 The OptionsMask and OptionsOverride fields SHALL be processed according to section 5.2.2.3.3.

<sup>113</sup> CCB 2814 defaults for legacy devices

<sup>114</sup> CCB 2501

<sup>115</sup> CCB 2501

9485 **5.2.2.3.21.6 Effect on Receipt**

9486 On receipt of this command, a device SHALL set both the *ColorMode* and *EnhancedColorMode* attributes  
9487 to 0x02. The device SHALL then move from its current color temperature in an up or down direction in a  
9488 continuous fashion, as detailed in Table 5.27.

9489 **Table 5.27. Actions on Receipt of the Move Color Temperature Command**

Move Mode	Action on Receipt
Stop	If moving, stop the operation, else ignore the command (i.e., the command is accepted but has no effect).
Up	Increase the <i>ColorTemperatureMireds</i> attribute ( $\equiv$ decrease the color temperature in kelvins) at the rate given in the Rate field. If the <i>ColorTemperatureMireds</i> attribute reaches the maximum allowed for the device (via either the Color Temperature Maximum Mireds field or the <i>ColorTempPhysicalMaxMireds</i> attribute), the move operation SHALL be stopped.
Down	Decrease the <i>ColorTemperatureMireds</i> attribute ( $\equiv$ increase the color temperature in kelvins) at the rate given in the Rate field. If the <i>ColorTemperatureMireds</i> attribute reaches the minimum allowed for the device (via either the Color Temperature Minimum Mireds field or the <i>ColorTempPhysicalMinMireds</i> attribute), the move operation SHALL be stopped.

9490 **5.2.2.3.22 Step Color Temperature Command**

9491 The Step Color Temperature command allows the color temperature of a lamp to be stepped with a specified  
9492 step size.

9493 The payload of this command SHALL be formatted as illustrated in Figure 5-21.

9494 **Figure 5-21. Format of the Step Color Temperature Command**

Octets	1	2	2	2	2	1	1
Data Type	map8	uint16	uint16	uint16	uint16	map8	map8
Field Name	Step Mode	Step Size	Transition Time	Color Temperature Minimum Mireds	Color Temperature Maximum Mireds	Options Mask	Options Override
Default	n/a	n/a	n/a	n/a	n/a	0	0 <sup>116</sup>

9495 **5.2.2.3.22.1 Step Mode Field**

9496 This field is identical to the Step Mode field of the Step Hue command of the Color Control cluster (see sub-  
9497 clause 5.2.2.3.6).

9498 **5.2.2.3.22.2 Step Size Field**

9499 The Step Size field is 16-bits in length and specifies the change to be added to (or subtracted from) the current  
9500 value of the device's color temperature.

<sup>116</sup> CCB 2814 defaults for legacy devices

9501 **5.2.2.3.22.3 Transition Time Field**

9502 The Transition Time field is 16-bits in length and specifies, in units of 1/10ths of a second, the time that  
 9503 SHALL be taken to perform the step. A step is a change to the device’s color temperature of a magnitude  
 9504 corresponding to the Step Size field.

9505 **5.2.2.3.22.4 Color Temperature Minimum Mireds Field**

9506 The Color Temperature Minimum Mireds field is 16-bits in length and specifies a lower bound on the *Color-*  
 9507 *TemperatureMireds* attribute ( $\equiv$  an upper bound on the color temperature in kelvins) for the current step  
 9508 operation such that:

9509  $ColorTempPhysicalMinMireds \leq Color\ Temperature\ Minimum\ Mireds\ field \leq ColorTemperatureMireds$

9510 As such if the step operation takes the *ColorTemperatureMireds* attribute towards the value of the Color  
 9511 Temperature Minimum Mireds field it SHALL be clipped so that the above invariant is satisfied. If the Color  
 9512 Temperature Minimum Mireds field is set to 0x0000, *ColorTempPhysicalMinMireds* SHALL be used as the  
 9513 lower bound for the *ColorTemperatureMireds* attribute.

9514 **5.2.2.3.22.5 Color Temperature Maximum Mireds Field**

9515 The Color Temperature Maximum Mireds field is 16-bits in length and specifies an upper bound on the  
 9516 *ColorTemperatureMireds* attribute ( $\equiv$  a lower bound on the color temperature in kelvins) for the current step  
 9517 operation such that:

9518  $ColorTemperatureMireds \leq Color\ Temperature\ Maximum\ Mireds\ field \leq ColorTempPhysicalMaxMireds$

9519 As such if the step operation takes the *ColorTemperatureMireds* attribute towards the value of the Color  
 9520 Temperature Maximum Mireds field it SHALL be clipped so that the above invariant is satisfied. If the Color  
 9521 Temperature Maximum Mireds field is set to 0x0000, *ColorTempPhysicalMaxMireds* SHALL be used as the  
 9522 upper bound for the *ColorTemperatureMireds* attribute.

9523 **5.2.2.3.22.6 OptionsMask and OptionsOverride fields**

9524 The OptionsMask and OptionsOverride fields SHALL be processed according to section 5.2.2.3.3.

9525 **5.2.2.3.22.7 Effect on Receipt**

9526 On receipt of this command, a device SHALL set both the *ColorMode* and *EnhancedColorMode* attributes  
 9527 to 0x02. The device SHALL then move from its current color temperature in an up or down direction by one  
 9528 step, as detailed in Table 5.28.

9529 **Table 5.28. Actions on Receipt of the Step Color Temperature Command**

Move Mode	Action on Receipt
Up	Increase the <i>ColorTemperatureMireds</i> attribute ( $\equiv$ decrease the color temperature in kelvins) by one step. If the <i>ColorTemperatureMireds</i> attribute reaches the maximum allowed for the device (via either the Color Temperature Maximum Mireds field or the <i>ColorTempPhysicalMaxMireds</i> attribute), the step operation SHALL be stopped.
Down	Decrease the <i>ColorTemperatureMireds</i> attribute ( $\equiv$ increase the color temperature in kelvins) by one step. If the <i>ColorTemperatureMireds</i> attribute reaches the minimum allowed for the device (via either the Color Temperature Minimum Mireds field or the <i>ColorTempPhysicalMinMireds</i> attribute), the step operation SHALL be stopped.

9530 **5.2.2.4 Commands Generated**

9531 The server generates no cluster specific commands

9532 **5.2.2.5 Scene Table Extensions**

9533 If the Scenes server cluster (see 3.7) is implemented, the following extension fields SHALL be added to the  
9534 Scenes table in the given order, i.e., the attribute listed as 1 is added first:

- 9535 1. *CurrentX*  
9536 2. *CurrentY*  
9537 3. *EnhancedCurrentHue*  
9538 4. *CurrentSaturation*  
9539 5. *ColorLoopActive*  
9540 6. *ColorLoopDirection*  
9541 7. *ColorLoopTime*  
9542 8. *ColorTemperatureMireds*

9543 Since there is a direct relation between *ColorTemperatureMireds* and XY, color temperature, if supported, is  
9544 stored as XY in the scenes table.

9545 Attributes in the scene table that are not supported by the device (according to the *ColorCapabilities* attribute)  
9546 SHALL be present but ignored.

9547 **5.2.2.6 Attribute Reporting**

9548 This cluster SHALL support attribute reporting using the Report Attributes command and according to the  
9549 minimum and maximum reporting interval and reportable change settings described in the Chapter 2, Foun-  
9550 dation. The following attributes SHALL be reportable:

- 9551 *CurrentX*, *CurrentY*  
9552 *CurrentHue* (if implemented), *CurrentSaturation* (if implemented), *ColorTemperatureMireds* (if imple-  
9553 mented)

9554 **5.2.3 Client**

9555 The client has no specific dependencies, no specific attributes, and receives no cluster specific commands.  
9556 The client generates the cluster specific commands detailed in 5.2.2.3, as required by the application.

9557 **5.3 Ballast Configuration Cluster**9558 **5.3.1 Overview**

9559 Please see Chapter 2 for a general cluster overview defining cluster architecture, revision, classification,  
9560 identification, etc.

9561 This cluster is used for configuring a lighting ballast.

9562 **5.3.1.1 Revision History**

9563 The global *ClusterRevision* attribute value SHALL be the highest revision number in the table below.

Rev	Description
1	mandatory global <i>ClusterRevision</i> attribute added

2	CCB 2104 2193 2230 2393 Deprecated some attributes
3	CCB 2881

9564 **5.3.1.2 Classification**

Hierarchy	Role	PICS Code	Primary Transaction
Base	Application	BC <sup>117</sup>	Type 1 (client to server)

9565 **5.3.1.3 Cluster Identifiers**

Identifier	Name
0x0301	Ballast Configuration

9566 **5.3.2 Server**

9567 **5.3.2.1 Dependencies**

9568 For the alarm functionality specified by this cluster to be operational, the Alarms server cluster SHALL be  
 9569 implemented on the same endpoint.

9570 **5.3.2.2 Attributes**

9571 For convenience, the attributes defined in this specification are arranged into sets of related attributes; each  
 9572 set can contain up to 16 attributes. Attribute identifiers are encoded such that the most significant three nib-  
 9573 bles specify the attribute set and the least significant nibble specifies the attribute within the set. The currently  
 9574 defined attribute sets are listed in Table 5.29.

9575 **Table 5.29. Ballast Configuration Attribute Sets**

Attribute Set Identifier	Description
0x000	Ballast information
0x001	Ballast settings
0x002	Lamp information
0x003	Lamp settings

9576

9577 **5.3.2.2.1 Ballast Information Attribute Set**

9578 The Ballast Information attribute set contains the attributes summarized in Table 5.30.

<sup>117</sup> CCB 2700

9579

**Table 5.30. Attributes of the Ballast Information Attribute Set**

<b>Id</b>	<b>Name</b>	<b>Type</b>	<b>Range</b>	<b>Access</b>	<b>Default</b>	<b>M/O</b>
0x0000	PhysicalMinLevel	uint8	0x01 – 0xfe	R	0x01	M
0x0001	PhysicalMaxLevel	uint8	0x01 – 0xfe	R	0xfe	M
0x0002	BallastStatus	map8	0000 00xx	R	0000 0000	O

9580 **5.3.2.2.1.1 PhysicalMinLevel Attribute**

9581 The *PhysicalMinLevel* attribute is 8 bits in length and specifies the minimum light output the ballast can  
 9582 achieve. This attribute SHALL be specified in the range 0x01 to 0xfe, and specifies the light output of the  
 9583 ballast according to the dimming light curve (see 5.3.4).

9584 **5.3.2.2.1.2 PhysicalMaxLevel Attribute**

9585 The *PhysicalMaxLevel* attribute is 8 bits in length and specifies the maximum light output the ballast can  
 9586 achieve according to the dimming light curve (see 5.3.4).

9587 **5.3.2.2.1.3 BallastStatus Attribute**

9588 The *BallastStatus* attribute is 8 bits in length and specifies the activity status of the ballast functions. The  
 9589 usage of the bits is specified in Table 5.31. Where a function is active, the corresponding bit SHALL be set  
 9590 to 1. Where a function is not active, the corresponding bit SHALL be set to 0.

9591

**Table 5.31. Bit Usage of the BallastStatus Attribute**

<b>Bit</b>	<b>Function</b>	<b>Details</b>
0	Ballast Non-operational	0 = The ballast is fully operational 1 = The ballast is not fully operational
1	Lamp Failure	0 = All lamps are operational 1 = One or more lamp is not in its socket or is faulty

9592 **5.3.2.2.2 Ballast Settings Attribute Set**

9593 The Ballast Settings attribute set contains the attributes summarized in Table 5.32.

9594

**Table 5.32. Attributes of the Ballast Settings Attribute Set**

<b>Id</b>	<b>Name</b>	<b>Type</b>	<b>Range</b>	<b>Acc</b>	<b>Default</b>	<b>M/O</b>
0x0010	MinLevel	uint8	0x01 – 0xfe	RW	<i>PhysicalMinLevel</i>	M
0x0011	MaxLevel	uint8	0x01 – 0xfe	RW	<i>PhysicalMaxLevel</i>	M
0x0012	PowerOnLevel	uint8	0x00 – 0xfe	RW	<i>PhysicalMaxLevel</i>	D
0x0013	PowerOnFadeTime	uint16	0x0000 – 0xfffe	RW	0x0000	D
0x0014	IntrinsicBallastFactor	uint8	0x00 – 0xfe	RW	-	O
0x0015	BallastFactorAdjustment	uint8	0x64 – MS	RW	0xff	O



9595 **5.3.2.2.2.1 MinLevel Attribute**

9596 The *MinLevel* attribute is 8 bits in length and specifies the light output of the ballast according to the dimming  
 9597 light curve (see 5.3.4) when the Level Control Cluster’s CurrentLevel attribute equals to 0x01 (1) (and the  
 9598 On/Off Clusters’s OnOff attribute equals to 0x01).

9599 The value of this attribute SHALL be both greater than or equal to *PhysicalMinLevel* and less than or equal  
 9600 to *MaxLevel*. If an attempt is made to set this attribute to a level where these conditions are not met, a default  
 9601 response command SHALL be returned with status code set to INVALID\_VALUE, and the level SHALL  
 9602 not be set.

9603 **5.3.2.2.2.2 MaxLevel Attribute**

9604 The *MaxLevel* attribute is 8 bits in length and specifies the light output of the ballast according to the dimming  
 9605 light curve (see 5.3.4) when the Level Control Cluster’s CurrentLevel attribute equals to 0xfe (254) (and the  
 9606 On/Off Cluster’s OnOff attribute equals to 0x01).

9607 The value of this attribute SHALL be both less than or equal to *PhysicalMaxLevel* and greater than or equal  
 9608 to *MinLevel*. If an attempt is made to set this attribute to a level where these conditions are not met, a default  
 9609 response command SHALL be returned with status code set to INVALID\_VALUE, and the level SHALL  
 9610 not be set.

9611 **5.3.2.2.2.3 IntrinsicBallastFactor Attribute**

9612 The *IntrinsicBallastFactor* attribute is 8 bits in length and specifies as a percentage the ballast factor of the  
 9613 ballast/lamp combination (see also 5.3), prior to any adjustment.

9614 A value of 0xff indicates in invalid value.

9615 **5.3.2.2.2.4 BallastFactorAdjustment Attribute**

9616 The *BallastFactorAdjustment* attribute is 8 bits in length and specifies the multiplication factor, as a percent-  
 9617 age, to be applied to the configured light output of the lamps (see also Overview5.3). A typical usage of this  
 9618 mechanism is to compensate for reduction in efficiency over the lifetime of a lamp.

9619 The light output is given by

9620  $Actual\ light\ output = configured\ light\ output \times BallastFactorAdjustment / 100\%$

9621 The range for this attribute is manufacturer dependent. If an attempt is made to set this attribute to a level  
 9622 that cannot be supported, a default response command SHALL be returned with status code set to INVA-  
 9623 LID\_VALUE, and the level SHALL not be set. The value 0xff indicates that ballast factor scaling is not in  
 9624 use.

9625 **5.3.2.2.3 Lamp Information Attribute Set**

9626 The lamp information attribute set contains the attributes summarized in Table 5.33.

9627 **Table 5.33. Attributes of the Lamp Information Attribute Set**

Identifier	Name	Type	Range	Access	Default	M/O
0x0020	LampQuantity	uint8	0x00 – 0xfe	R	-	O

9628 **5.3.2.2.3.1 LampQuantity Attribute**

9629 The *LampQuantity* attribute is 8 bits in length and specifies the number of lamps connected to this ballast.  
 9630 (**Note 1:** this number does not take into account whether lamps are actually in their sockets or not).

9631 **5.3.2.2.4 Lamp Settings Attribute Set**

9632 The Lamp Settings attribute set contains the attributes summarized in Table 5.34. If *LampQuantity* is greater  
9633 than one, each of these attributes is taken to apply to the lamps as a set. For example, all lamps are taken to  
9634 be of the same *LampType* with the same *LampBurnHours*.

9635 **Table 5.34. Attributes of the Lamp Settings Attribute Set**

Id	Name	Type	Range	Acc	Default	M/O
0x0030	LampType	string	-	RW	empty string	O
0x0031	LampManufacturer	string	-	RW	empty string	O
0x0032	LampRatedHours	uint24	0x000000 – 0xfffffe	RW	0xffffff	O
0x0033	LampBurnHours	uint24	0x000000 – 0xfffffe	RW	0x000000	O
0x0034	LampAlarmMode	map8	0000 000x	RW	0000 0000	O
0x0035	LampBurnHoursTripPoint	uint24	0x000000 – 0xfffffe	RW	0xffffff	O

9636 **5.3.2.2.4.1 LampType Attribute**

9637 The *LampType* attribute is a character string of up to 16 bytes in length. It specifies the type of lamps (in-  
9638 cluding their wattage) connected to the ballast.

9639 **5.3.2.2.4.2 LampManufacturer Attribute**

9640 The *LampManufacturer* attribute is a character string of up to 16 bytes in length. It specifies the name of the  
9641 manufacturer of the currently connected lamps.

9642 **5.3.2.2.4.3 LampRatedHours Attribute**

9643 The *LampRatedHours* attribute is 24 bits in length and specifies the number of hours of use the lamps are  
9644 rated for by the manufacturer.

9645 A value of 0xffffff indicates an invalid or unknown time.

9646 **5.3.2.2.4.4 LampBurnHours Attribute**

9647 The *LampBurnHours* attribute is 24 bits in length and specifies the length of time, in hours, the currently  
9648 connected lamps have been operated, cumulative since the last re-lamping. Burn hours SHALL not be accu-  
9649 mulated if the lamps are off.

9650 This attribute SHOULD be reset to zero (e.g., remotely) when the lamp(s) are changed. If partially used  
9651 lamps are connected, *LampBurnHours* SHOULD be updated to reflect the burn hours of the lamps.

9652 A value of 0xffffff indicates an invalid or unknown time.

9653 **5.3.2.2.4.5 LampAlarmMode Attribute**

9654 The *LampsAlarmMode* attribute is 8 bits in length and specifies which attributes MAY cause an alarm noti-  
9655 fication to be generated, as listed in Table 5.35. A ‘1’ in each bit position causes its associated attribute to be  
9656 able to generate an alarm. (**Note:** All alarms are also logged in the alarm table – see Alarms cluster 3.11).

9657

**Table 5.35. Values of the *MainsAlarmMode* Attribute**

Attribute Bit Number	Attribute
0	LampBurnHours

9658

**5.3.2.2.4.6 *LampBurnHoursTripPoint* Attribute**

9659

The *LampBurnHoursTripPoint* attribute is 24 bits in length and specifies the number of hours the LampBurnHours attribute MAY reach before an alarm is generated.

9660

9661

If the Alarms cluster is not present on the same device this attribute is not used and thus MAY be omitted (see 5.3.2.1).

9662

9663

The Alarm Code field included in the generated alarm SHALL be 0x01.

9664

If this attribute takes the value 0xfffff then this alarm SHALL not be generated.

9665

**5.3.2.3 Commands**

9666

No cluster specific commands are received or generated by the server.

9667

**5.3.3 Client**

9668

The client has no attributes. No cluster specific commands are received by the client. No cluster specific commands are generated by the client.

9669

9670

**5.3.4 The Dimming Light Curve**

9671

The dimming curve is recommended to be logarithmic, as defined by the following equation:

$$\%Light = 10 \left( \frac{Level-1}{\left(\frac{253}{3}\right)} \right)^{-1}$$

9672

9673

Where: %Light is the percent light output of the ballast and

9674

Level is an 8-bit integer between 1 (0.1% light output) and 254 (100% output) that is adjusted for MinLevel and MaxLevel using the following equation:

9675

9676

$$Level = (MaxLevel - MinLevel) * CurrentLevel / 253 + (254 * MinLevel - MaxLevel) / 253.$$

9677

**Note 1:** Value 255 is not used.

9678

**Note 2:** The light output is determined by this curve together with the *IntrinsicBallastFactor* and *BallastFactorAdjustment* Attributes.

9679

9680

The table below gives a couple of examples of the dimming light curve for different values of MinLevel, MaxLevel and CurrentLevel.

9681

9682

**Table 5.36. Examples of The Dimming Light Curve**

MinLevel	MaxLevel	CurrentLevel	Level	%Light
1	254	1	1	0.10%

1	254	10	10	0.13%
1	254	100	100	1.49%
1	254	254 <sup>118</sup>	254	100%
170	254	1	170	10.1%
170	254	10	173	11.0%
170	254	100	203	24.8%
170	254	254	254	100%
170	230	1	170	10.1%
170	230	10	172	10.7%
170	230	100	193	19.2%
170	230	254	230	51.9%

9683

<sup>118</sup> CCB 2881 – editorial: was “154”

## CHAPTER 6 HVAC

9684

9685 The Cluster Library is made of individual chapters such as this one. See Document Control in the Cluster  
 9686 Library for a list of all chapters and documents. References between chapters are made using a *X.Y* notation  
 9687 where *X* is the chapter and *Y* is the sub-section within that chapter. References to external documents are  
 9688 contained in Chapter 1 and are made using [*Rn*] notation.

### 6.1 General Description

9689

#### 6.1.1 Introduction

9690

9691 The clusters specified in this document are for use typically in HVAC applications, but MAY be used in any  
 9692 application domain.

#### 6.1.2 Terms

9693

9694 **4-pipes:** In a 4-pipe HVAC fan coil system, heated and chilled water each have their own supply and return  
 9695 pipes, while in a 2 pipe system they share the same supply and return. With a 4-pipes system, heating and  
 9696 cooling can take place at the same time in different locations of a building. With a 2-pipes system, only  
 9697 heating or cooling can take place in the whole building.

9698 **Precooling:** Cooling a building in the early (cooler) part of the day, so that the thermal mass of the building  
 9699 decreases cooling needs in the later (hotter) part of the day.

#### 6.1.3 Cluster List

9700

9701 This section lists the clusters specified in this document and gives examples of typical usage for the purpose  
 9702 of clarification. The clusters defined in this document are listed in Table 6-1:

9703

**Table 6-1. Clusters Specified in the HVAC Functional Domain**

ID	Cluster Name	Description
0x0200	Pump Configuration and Control	An interface for configuring and controlling pumps.
0x0201	Thermostat	An interface for configuring and controlling the functionality of a thermostat
0x0202	Fan Control	An interface for controlling a fan in a heating / cooling system
0x0203	Dehumidification Control	An interface for controlling dehumidification
0x0204	Thermostat User Interface Configuration	An interface for configuring the user interface of a thermostat (which MAY be remote from the thermostat)

9704

9705

**Figure 6-1. Typical Usage of Pump Configuration and Control Cluster**

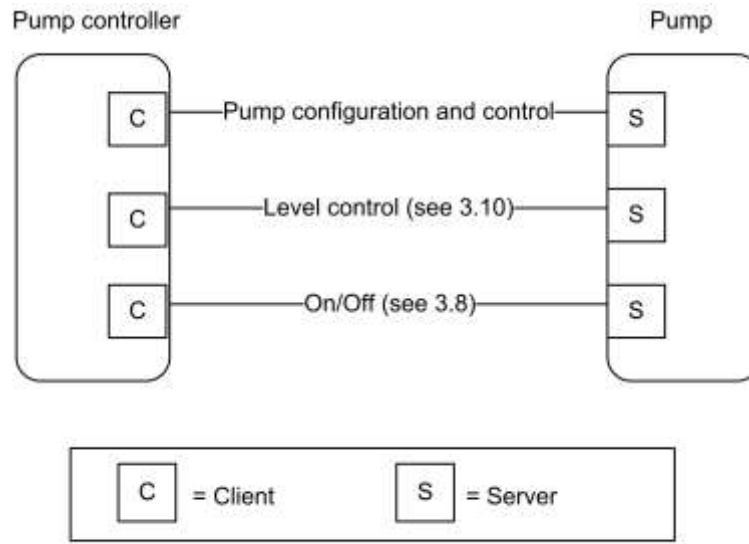

*Note: Device names are examples for illustration purposes only*

9706

9707

9708

**Figure 6-2. Example Usage of the Thermostat and Related Clusters**

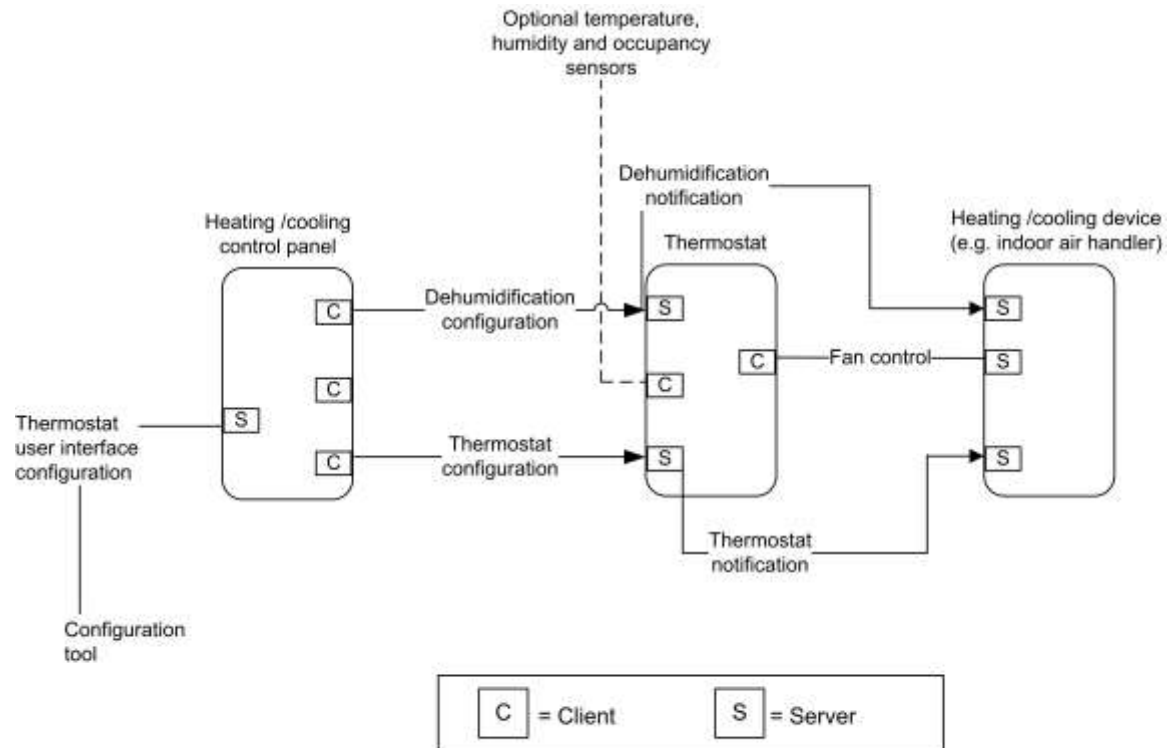

*Note: Device names are examples for illustration purposes only*

9709

## 9710 6.2 Pump Configuration and Control

### 9711 6.2.1 Overview

9712 Please see Chapter 2 for a general cluster overview defining cluster architecture, revision, classification,  
 9713 identification, etc.

9714 The Pump Configuration and Control cluster provides an interface for the setup and control of pump devices,  
 9715 and the automatic reporting of pump status information. Note that control of pump speed is not included –  
 9716 speed is controlled by the On/Off and Level Control clusters.

#### 9717 6.2.1.1 Revision History

9718 The global *ClusterRevision* attribute value SHALL be the highest revision number in the table below.

Rev	Description
1	mandatory global <i>ClusterRevision</i> attribute added

#### 9719 6.2.1.2 Classification

Hierarchy	Role	PICS Code	Primary Transaction
Base	Application	PCC	Type 2 (server to client)

#### 9720 6.2.1.3 Cluster Identifiers

Identifier	Name
0x0200	Pump Configuration and Control

## 9721 6.2.2 Server

### 9722 6.2.2.1 Dependencies

9723 Where external pressure, flow, and temperature measurements are processed by this cluster (see Table 6-8),  
 9724 these are provided by a Pressure Measurement cluster (4.5), a Flow Measurement cluster (4.6), and a Tem-  
 9725 perature Measurement client cluster (4.4), respectively. These 3 client clusters are used for connection to a  
 9726 remote sensor device. The pump is able to use the sensor measurement provided by a remote sensor for  
 9727 regulation of the pump speed.

9728 For the alarms, described in Table 6-9, to be operational, the Alarms server cluster (3.11) SHALL be imple-  
 9729 mented on the same endpoint.

9730 Note that control of the pump setpoint is not included in this cluster – the On/Off and Level Control clusters  
 9731 (see Figure 6-1) MAY be used by a pump device to turn it on and off and control its setpoint. Note that the  
 9732 Pump Configuration and Control Cluster MAY override on/off/setpoint settings for specific operation modes  
 9733 (See section 6.2.2.2.3.1 for detailed description of the operation and control of the pump.).

9734 **6.2.2.2 Attributes**

9735 For convenience, the attributes defined in this specification are arranged into sets of related attributes; each  
 9736 set can contain up to 16 attributes. Attribute identifiers are encoded such that the most significant three nib-  
 9737 bles specify the attribute set and the least significant nibble specifies the attribute within the set. The currently  
 9738 defined attribute sets are listed in Table 6-2.

9739 **Table 6-2. Pump Configuration Attribute Sets**

Attribute Set Identifier	Description
0x000	Pump Information
0x001	Pump Dynamic Information
0x002	Pump Settings

9740 **6.2.2.2.1 Pump Information Attribute Set**

9741 The pump information attribute set contains the attributes summarized in Table 6-3:

9742 **Table 6-3. Attributes of the Pump Information Attribute Set**

Id	Name	Type	Range	Access	Def	M/O
0x0000	<i>MaxPressure</i>	int16	0x8001-0x7fff	R	-	M
0x0001	<i>MaxSpeed</i>	uint16	0x0000 – 0xfffe	R	-	M
0x0002	<i>MaxFlow</i>	uint16	0x0000 – 0xfffe	R	-	M
0x0003	<i>MinConstPressure</i>	int16	0x8001-0x7fff	R	-	O
0x0004	<i>MaxConstPressure</i>	int16	0x8001-0x7fff	R	-	O
0x0005	<i>MinCompPressure</i>	int16	0x8001-0x7fff	R	-	O
0x0006	<i>MaxCompPressure</i>	int16	0x8001-0x7fff	R	-	O
0x0007	<i>MinConstSpeed</i>	uint16	0x0000 – 0xfffe	R	-	O
0x0008	<i>MaxConstSpeed</i>	uint16	0x0000 – 0xfffe	R	-	O
0x0009	<i>MinConstFlow</i>	uint16	0x0000 – 0xfffe	R	-	O
0x000a	<i>MaxConstFlow</i>	uint16	0x0000 – 0xfffe	R	-	O
0x000b	<i>MinConstTemp</i>	int16	0x954d – 0x7fff	R	-	O
0x000c	<i>MaxConstTemp</i>	int16	0x954d – 0x7fff	R	-	O

9743 **6.2.2.2.1.1 MaxPressure Attribute**

9744 The *MaxPressure* attribute specifies the maximum pressure the pump can achieve. It is a physical limit, and  
 9745 does not apply to any specific control mode or operation mode.

9746 This attribute is read only, and can only be set by the manufacturer. If the value is not available, this attribute  
 9747 will display the invalid value.

9748 Valid range is -3,276.7 kPa to 3,276.7 kPa (steps of 0.1 kPa).

9749 The value -3,276.8 kPa (0x8000) indicates that this value is invalid.



9750 **6.2.2.2.1.2 MaxSpeed Attribute**

9751 The *MaxSpeed* attribute specifies the maximum speed the pump can achieve. It is a physical limit, and does  
9752 not apply to any specific control mode or operation mode.

9753 This attribute is read only, and can only be set by the manufacturer. If the value is not available, this attribute  
9754 will display the invalid value.

9755 Valid range is 0 to 65,534 RPM (steps of 1 RPM).

9756 The value 65,535 RPM (0xffff) indicates that this value is invalid.

9757 **6.2.2.2.1.3 MaxFlow Attribute**

9758 The *MaxFlow* attribute specifies the maximum flow the pump can achieve. It is a physical limit, and does  
9759 not apply to any specific control mode or operation mode.

9760 This attribute is read only, and can only be set by the manufacturer. If the value is not available, this attribute  
9761 will display the invalid value.

9762 Valid range is 0 m<sup>3</sup>/h to 6,553.4 m<sup>3</sup>/h (steps of 0.1 m<sup>3</sup>/h).

9763 The value 6,553.5 m<sup>3</sup>/h (0xffff) indicates that this value is invalid.

9764 **6.2.2.2.1.4 MinConstPressure Attribute**

9765 The *MinConstPressure* attribute specifies the minimum pressure the pump can achieve when it is running  
9766 and working in control mode constant pressure (*ControlMode* attribute of the Pump settings attribute set is  
9767 set to Constant pressure).

9768 This attribute is read only, and can only be set by the manufacturer. If the value is not available, this attribute  
9769 will display the invalid value.

9770 Valid range is –3,276.7 kPa to 3,276.7 kPa (steps of 0.1 kPa).

9771 The value -3,276.8 kPa (0x8000) indicates that this value is invalid.

9772 **6.2.2.2.1.5 MaxConstPressure Attribute**

9773 The *MaxConstPressure* attribute specifies the maximum pressure the pump can achieve when it is working  
9774 in control mode constant pressure (*ControlMode* attribute of the Pump settings attribute set is set to Constant  
9775 pressure).

9776 This attribute is read only, and can only be set by the manufacturer. If the value is not available, this attribute  
9777 will display the invalid value.

9778 Valid range is –3,276.7 kPa to 3,276.7 kPa (steps of 0.1 kPa).

9779 The value -3,276.8 kPa (0x8000) indicates that this value is invalid.

9780 **6.2.2.2.1.6 MinCompPressure Attribute**

9781 The *MinCompPressure* attribute specifies the minimum compensated pressure the pump can achieve when  
9782 it is running and working in control mode Proportional pressure (*ControlMode* attribute of the Pump settings  
9783 attribute set is set to Proportional pressure).

9784 This attribute is read only, and can only be set by the manufacturer. If the value is not available, this attribute  
9785 will display the invalid value.

9786 Valid range is –3,276.7 kPa to 3,276.7 kPa (steps of 0.1 kPa).

9787 The value -3,276.8 kPa (0x8000) indicates that this value is invalid.

9788 **6.2.2.2.1.7 MaxCompPressure Attribute**

9789 The *MaxCompPressure* attribute specifies the maximum compensated pressure the pump can achieve when  
9790 it is working in control mode Proportional pressure (*ControlMode* attribute of the Pump settings attribute set  
9791 is set to Proportional pressure).

9792 This attribute is read only, and can only be set by the manufacturer. If the value is not available, this attribute  
9793 will display the invalid value.

9794 Valid range is  $-3,276.7$  kPa to  $3,276.7$  kPa (steps of  $0.1$  kPa).  
9795 The value  $-3,276.8$  kPa (0x8000) indicates that this value is invalid.

#### 9796 **6.2.2.2.1.8 *MinConstSpeed* Attribute**

9797 The *MinConstSpeed* attribute specifies the minimum speed the pump can achieve when it is running and  
9798 working in control mode Constant speed (*ControlMode* attribute of the Pump settings attribute set is set to  
9799 Constant speed).

9800 This attribute is read only, and can only be set by the manufacturer. If the value is not available, this attribute  
9801 will display the invalid value.

9802 Valid range is 0 to  $65,534$  RPM (steps of  $1$  RPM).  
9803 The value  $65,535$  RPM (0xffff) indicates that this value is invalid.

#### 9804 **6.2.2.2.1.9 *MaxConstSpeed* Attribute**

9805 The *MaxConstSpeed* attribute specifies the maximum speed the pump can achieve when it is working in  
9806 control mode Constant speed (*ControlMode* attribute of the Pump settings attribute set is set to Constant  
9807 speed).

9808 This attribute is read only, and can only be set by the manufacturer. If the value is not available, this attribute  
9809 will display the invalid value.

9810 Valid range is 0 to  $65,534$  RPM (steps of  $1$  RPM).  
9811 The value  $65,535$  RPM (0xffff) indicates that this value is invalid.

#### 9812 **6.2.2.2.1.10 *MinConstFlow* Attribute**

9813 The *MinConstFlow* attribute specifies the minimum flow the pump can achieve when it is running and work-  
9814 ing in control mode Constant flow (*ControlMode* attribute of the Pump settings attribute set is set to Constant  
9815 flow).

9816 This attribute is read only, and can only be set by the manufacturer. If the value is not available, this attribute  
9817 will display the invalid value.

9818 Valid range is  $0$  m<sup>3</sup>/h to  $6,553.4$  m<sup>3</sup>/h (steps of  $0.1$  m<sup>3</sup>/h).  
9819 The value  $6,553.5$  m<sup>3</sup>/h (0xffff) indicates that this value is invalid.

#### 9820 **6.2.2.2.1.11 *MaxConstFlow* Attribute**

9821 The *MaxConstFlow* attribute specifies the maximum flow the pump can achieve when it is running and work-  
9822 ing in control mode Constant flow (*ControlMode* attribute of the Pump settings attribute set is set to Constant  
9823 flow).

9824 This attribute is read only, and can only be set by the manufacturer. If the value is not available, this attribute  
9825 will display the invalid value.

9826 Valid range is  $0$  m<sup>3</sup>/h to  $6,553.4$  m<sup>3</sup>/h (steps of  $0.1$  m<sup>3</sup>/h).  
9827 The value  $6,553.5$  m<sup>3</sup>/h (0xffff) indicates that this value is invalid.

#### 9828 **6.2.2.2.1.12 *MinConstTemp* Attribute**

9829 The *MinConstTemp* attribute specifies the minimum temperature the pump can maintain in the system when  
9830 it is running and working in control mode Constant temperature (*ControlMode* attribute of the Pump settings  
9831 attribute set is set to Constant temperature).

9832 This attribute is read only, and can only be set by the manufacturer. If the value is not available, this attribute  
9833 will display the invalid value.

9834 Valid range is  $-273.15\text{ }^{\circ}\text{C}$  to  $327.67\text{ }^{\circ}\text{C}$  (steps of  $0.01\text{ }^{\circ}\text{C}$ ).  
 9835 The value  $-327.68\text{ }^{\circ}\text{C}$  (0x8000) indicates that this value is invalid.

9836 **6.2.2.2.1.13 MaxConstTemp Attribute**

9837 The *MaxConstTemp* attribute specifies the maximum temperature the pump can maintain in the system when  
 9838 it is running and working in control mode Constant temperature (*ControlMode* attribute of the Pump settings  
 9839 attribute set is set to Constant temperature).

9840 This attribute is read only, and can only be set by the manufacturer. If the value is not available, this attribute  
 9841 will display the invalid value. *MaxConstTemp* SHALL be greater than or equal to *MinConstTemp*

9842 Valid range is  $-273.15\text{ }^{\circ}\text{C}$  to  $327.67\text{ }^{\circ}\text{C}$  (steps of  $0.01\text{ }^{\circ}\text{C}$ ).  
 9843 The value  $-327.68\text{ }^{\circ}\text{C}$  (0x8000) indicates that this value is invalid.

9844 **6.2.2.2.2 Pump Dynamic Information Attribute Set**

9845 The pump dynamic information attribute set contains the attributes summarized in Table 6-4:

9846 **Table 6-4. Attributes of the Pump Dynamic Information Attribute Set**

Id	Name	Type	Range	Access	Def	M/O
0x0010	<i>PumpStatus</i>	map16	-	RP	-	O
0x0011	<i>EffectiveOperationMode</i>	enum8	0x00 – 0xfe	R	-	M
0x0012	<i>EffectiveControlMode</i>	enum8	0x00 – 0xfe	R	-	M
0x0013	<i>Capacity</i>	int16	0x0000-0x7fff	RP	-	M
0x0014	<i>Speed</i>	uint16	0x0000 - 0xffffe	R	-	O
0x0015	<i>LifetimeRunningHours</i>	uint24	0x000000 - 0xfffffe	RW	0	O
0x0016	<i>Power</i>	uint24	0x000000 - 0xfffffe	RW	-	O
0x0017	<i>LifetimeEnergyConsumed</i>	uint32	0x00000000 - 0xffffffe	R	0	O

9847 **6.2.2.2.2.1 PumpStatus Attribute**

9848 The *PumpStatus* attribute specifies the activity status of the pump functions listed in Table 6-5. Where a  
 9849 pump controller function is active, the corresponding bit SHALL be set to 1. Where a pump controller func-  
 9850 tion is not active, the corresponding bit SHALL be set to 0.

9851 **Table 6-5. Values of the PumpStatus Attribute**

Bit	Function	Remarks
0	Device fault	A fault related to the pump device is detected (Corresponds to a Alarm code in the range 6-13, see Table 6-9)
1	Supply fault	A fault related to the supply to the pump is detected (Corresponds to a Alarm code in the range 0-5 or 13, see Table 6-9)
2	Speed low	Setpoint is too low to achieve
3	Speed high	Setpoint is too high to achieve
4	Local override	The pump is overridden by local control

Bit	Function	Remarks
5	Running	Pump is currently running
6	Remote Pressure	A remote pressure sensor is used as the sensor for the regulation of the pump. <i>EffectiveControlMode</i> is Constant pressure, and the setpoint for the pump is interpreted as a percentage of the range of the remote sensor ( $[MinMeasuredValue - MaxMeasuredValue]$ )
7	Remote Flow	A remote flow sensor is used as the sensor for the regulation of the pump. <i>EffectiveControlModeI</i> is Constant flow, and the setpoint for the pump is interpreted as a percentage of the range of the remote sensor ( $[MinMeasuredValue - MaxMeasuredValue]$ )
8	Remote Temperature	A remote temperature sensor is used as the sensor for the regulation of the pump. <i>EffectiveControlModeI</i> is Constant temperature, and setpoint is interpreted as a percentage of the range of the remote sensor ( $[MinMeasuredValue - MaxMeasuredValue]$ )

#### 9852 **6.2.2.2.2.2 EffectiveOperationMode Attribute**

9853 The *EffectiveOperationMode* attribute specifies current effective operation mode of the pump. The value of  
9854 the *EffectiveOperationMode* attribute is the same as the *OperationMode* attribute of the Pump settings attrib-  
9855 ute set, except when it is overridden locally. See section 6.2.2.2.3.1 for a detailed description of the operation  
9856 and control of the pump.

9857 This attribute is read only.

9858 Valid range is defined by the operation modes listed in Table 6-1.

#### 9859 **6.2.2.2.2.3 EffectiveControlMode Attribute**

9860 The *EffectiveControlMode* attribute specifies the current effective control mode of the pump.

9861 The *EffectiveControlMode* attribute contains the control mode that currently applies to the pump. It will have  
9862 the value of the *ControlMode* attribute, unless a remote sensor is used as the sensor for regulation of the  
9863 pump. In this case, *EffectiveControlMode* will display Constant pressure, Constant flow or Constant temper-  
9864 ature if the remote sensor is a pressure sensor, a flow sensor or a temperature sensor respectively, regardless  
9865 of the value of the *ControlMode* attribute.

9866 See section 6.2.2.2.3.1 for detailed description of the operation and control of the pump. This attribute is read  
9867 only.

9868 Valid range is defined by the control modes listed in Table 6-8.

#### 9869 **6.2.2.2.2.4 Capacity Attribute**

9870 The *Capacity* attribute specifies the actual capacity of the pump as a percentage of the effective maximum  
9871 setpoint value. It is updated dynamically as the speed of the pump changes.

9872 This attribute is read only. If the value is not available (the measurement or estimation of the speed is done  
9873 in the pump), this attribute will contain the invalid value.

9874 Valid range is 0 % to 163.835% (0.005 % granularity). Although the *Capacity* attribute is a signed value,  
9875 values of capacity less than zero have no physical meaning.

9876 The value -163.840 % (0x8000) indicates that this value is invalid.

#### 9877 **6.2.2.2.2.5 Speed Attribute**

9878 The *Speed* attribute specifies the actual speed of the pump measured in RPM. It is updated dynamically as  
9879 the speed of the pump changes.

9880 This attribute is read only. If the value is not available (the measurement or estimation of the speed is done  
 9881 in the pump), this attribute will contain the invalid value.

9882 Valid range is 0 to 65.534 RPM.  
 9883 The value 65.535 RPM (0xffff) indicates that this value is invalid.

9884 **6.2.2.2.6 LifetimeRunningHours Attribute**

9885 The *LifetimeRunningHours* attribute specifies the accumulated number of hours that the pump has been pow-  
 9886 ered and the motor has been running. It is updated dynamically as it increases. It is preserved over power  
 9887 cycles of the pump. if *LifeTimeRunningHours* rises above maximum value it “rolls over” and starts at 0  
 9888 (zero).

9889 This attribute is writeable, in order to allow setting to an appropriate value after maintenance. If the value is  
 9890 not available, this attribute will contain the invalid value.

9891 Valid range is 0 to 16,777,214 hrs.  
 9892 The value 16,777,215 (0xfffff) indicates that this value is unknown.

9893 **6.2.2.2.7 Power Attribute**

9894 The *Power* attribute specifies the actual power consumption of the pump in Watts. The value of the *Power*  
 9895 attribute is updated dynamically as the power consumption of the pump changes.

9896 This attribute is read only. If the value is not available (the measurement of power consumption is not done  
 9897 in the pump), this attribute will display the invalid value.

9898 Valid range is 0 to 16,777,214 Watts.  
 9899 The value 16,777,215 (0xfffff) indicates that this value is unknown.

9900 **6.2.2.2.8 LifetimeEnergyConsumed Attribute**

9901 The *LifetimeEnergyConsumed* attribute specifies the accumulated energy consumption of the pump through  
 9902 the entire lifetime of the pump in kWh. The value of the *LifetimeEnergyConsumed* attribute is updated dy-  
 9903 namicly as the energy consumption of the pump increases. If *LifetimeEnergyConsumed* rises above maxi-  
 9904 mum value it “rolls over” and starts at 0 (zero).

9905 This attribute is writeable, in order to allow setting to an appropriate value after maintenance.

9906 Valid range is 0 kWh to 4,294,967,294 kWh.  
 9907 The value 4,294,967,295 (0xfffffff) indicates that this value is unknown.

9908 **6.2.2.2.3 Pump Settings Attribute Set**

9909 The pump settings attribute set contains the attributes summarized in Table 6-6:

9910 **Table 6-6. Attributes of the Pump Settings Attribute Set**

Identifi- fier	Name	Type	Range	Access	Def	M/O
0x0020	<i>OperationMode</i>	enum8	0x00 – 0xfe	RW	0x00	M
0x0021	<i>ControlMode</i>	enum8	0x00 – 0xfe	RW	0x00	O
0x0022	<i>AlarmMask</i>	map16	-	R	-	O

9911 **6.2.2.2.3.1 OperationMode Attribute**

9912 The *OperationMode* attribute specifies the operation mode of the pump. This attribute SHALL have one of  
 9913 the values listed in Table 6-7Values of the .

9914 The actual operating mode of the pump is a result of the setting of the attributes *OperationMode*, *ControlMode* and the optional connection of a remote sensor. The operation and control is prioritized as shown  
9915 in the scheme in Figure 6-3:  
9916

9917 **Figure 6-3. Priority Scheme of Pump Operation and Control**

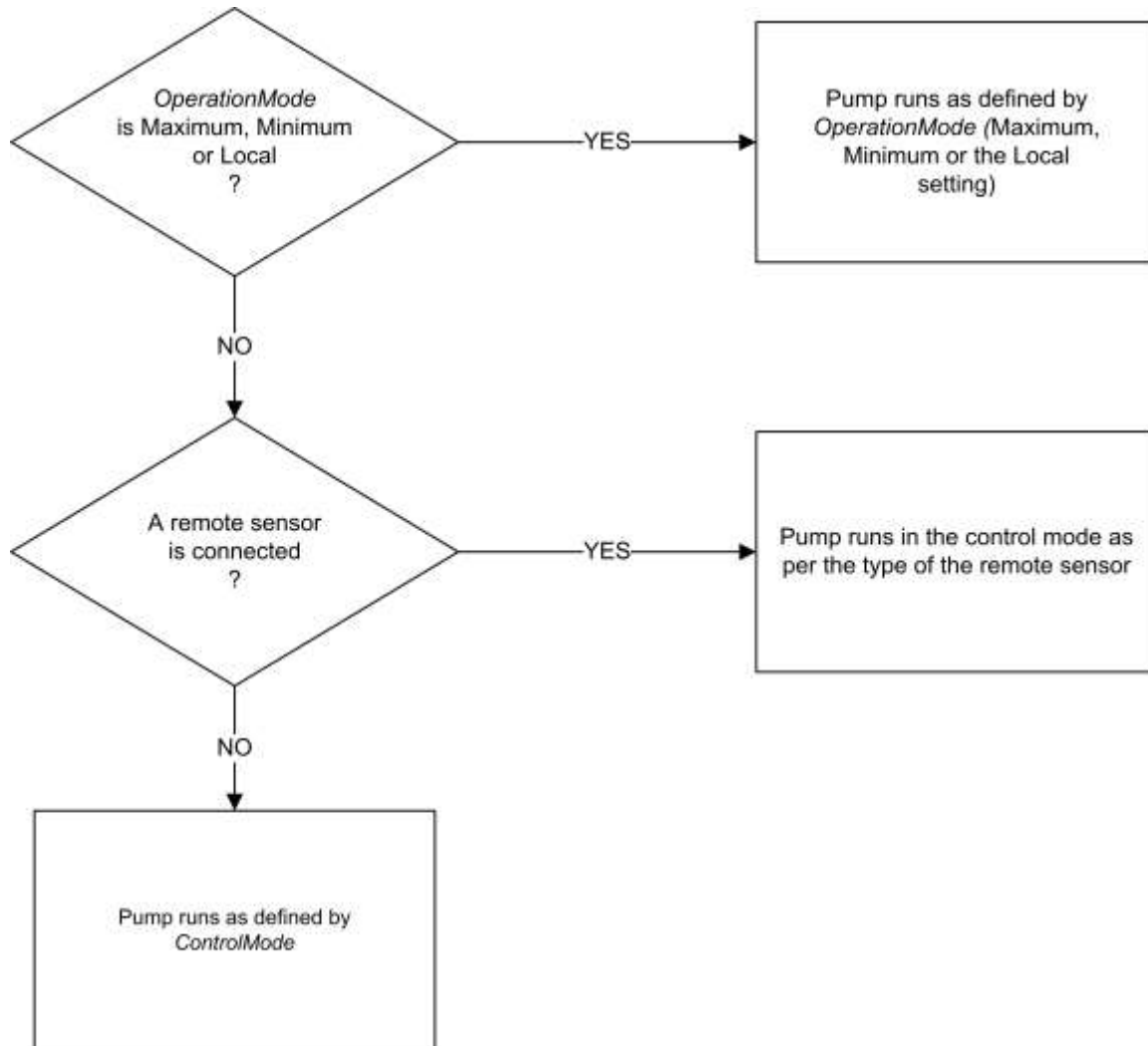

9918  
9919  
9920 If the *OperationMode* attribute is Maximum, Minimum or Local, the *OperationMode* attribute decides how  
9921 the pump is operated.

9922 If the *OperationMode* attribute is Normal and a remote sensor is connected to the pump, the type of the  
9923 remote sensor decides the control mode of the pump. A connected remote pressure sensor will make the  
9924 pump run in control mode Constant pressure and vice versa for flow and temperature type sensors. This is  
9925 regardless of the setting of the *ControlMode* attribute.

9926 If the *OperationMode* attribute is Normal and no remote sensor is connected, the control mode of the pump  
9927 is decided by the *ControlMode* attribute.

9928 *OperationMode* MAY be changed at any time, even when the pump is running. The behavior of the pump at  
9929 the point of changing the value of the *OperationMode* attribute is vendor-specific.

9930

**Table 6-7. Values of the *OperationMode* Attribute**

Value	Name	Explanation
0	Normal	The pump is controlled by a setpoint, as defined by a connected remote sensor or by the <i>ControlMode</i> attribute. (N.B. The setpoint is an internal variable which MAY be controlled between 0% and 100%, e.g., by means of the Level Control cluster 3.10)
1	Minimum	This value sets the pump to run at the minimum possible speed it can without being stopped
2	Maximum	This value sets the pump to run at its maximum possible speed
3	Local	This value sets the pump to run with the local settings of the pump, regardless of what these are

9931 **6.2.2.2.3.2 ControlMode Attribute**

9932 The *ControlMode* attribute specifies the control mode of the pump. This attribute SHALL have one of the  
 9933 values listed in Table 6-8 Values of the .

9934 See section 6.2.2.2.3.1 for detailed description of the operation and control of the pump.

9935 *ControlMode* MAY be changed at any time, even when the pump is running. The behavior of the pump at  
 9936 the point of changing is vendor-specific.

9937

**Table 6-8. Values of the *ControlMode* Attribute**

Value	Name	Explanation
0	Constant speed	The pump is running at a constant speed. The setpoint is interpreted as a percentage of the <i>MaxSpeed</i> attribute
1	Constant pressure	The pump will regulate its speed to maintain a constant differential pressure over its flanges. The setpoint is interpreted as a percentage of the range of the sensor used for this control mode. In case of the internal pressure sensor, this will be the range derived from the [ <i>MinConstPressure</i> - <i>MaxConstPressure</i> ] attributes. In case of a remote pressure sensor, this will be the range derived from the [ <i>MinMeasuredValue</i> - <i>MaxMeasuredValue</i> ] attributes of the remote pressure sensor.
2	Proportional pressure	The pump will regulate its speed to maintain a constant differential pressure over its flanges. The setpoint is interpreted as a percentage of the range derived of the [ <i>MinCompPressure</i> - <i>MaxCompPressure</i> ] attributes. The internal setpoint will be lowered (compensated) dependant on the flow in the pump (lower flow => lower internal setpoint)
3	Constant flow	The pump will regulate its speed to maintain a constant flow through the pump. The setpoint is interpreted as a percentage of the range of the sensor used for this control mode. In case of the internal flow sensor, this will be the range derived from the [ <i>MinConstFlow</i> - <i>MaxConstFlow</i> ] attributes. In case of a remote flow sensor, this will be the range derived from the [ <i>MinMeasuredValue</i> - <i>MaxMeasuredValue</i> ] attributes of the remote flow sensor.

Value	Name	Explanation
5	Constant temperature	The pump will regulate its speed to maintain a constant temperature. The setpoint is interpreted as a percentage of the range of the sensor used for this control mode. In case of the internal temperature sensor, this will be the range derived from the <i>[MinConstTemp - MaxConstTemp]</i> attributes. In case of a remote temperature sensor, this will be the range derived from the <i>[MinMeasuredValue - MaxMeasuredValue]</i> attributes of the remote temperature sensor.
7	Automatic	The operation of the pump is automatically optimized to provide the most suitable performance with respect to comfort and energy savings. This behavior is manufacturer defined. The pump can be stopped by setting the setpoint of the level control cluster to 0 or by using the On/Off cluster. If the pump is started (at any setpoint), the speed of the pump is entirely determined by the pump.

9938 **6.2.2.2.3.3 AlarmMask Attribute**

9939 The *AlarmMask* attribute specifies whether each of the alarms listed in Table 6-9 is enabled. When the bit  
 9940 number corresponding to the alarm code is set to 1, the alarm is enabled, else it is disabled. Bits not corre-  
 9941 sponding to a code in the table (bits 14, 15) are reserved.

9942 When the Alarms cluster is implemented on a device, and one of the alarm conditions included in this table  
 9943 occurs, an alarm notification is generated, with the alarm code field set as listed in the table.

9944 **Table 6-9. Alarm Codes**

Alarm Code	Alarm Condition
0	Supply voltage too low
1	Supply voltage too high
2	Power missing phase
3	System pressure too low
4	System pressure too high
5	Dry running
6	Motor temperature too high
7	Pump motor has fatal failure
8	Electronic temperature too high
9	Pump blocked
10	Sensor failure
11	Electronic non fatal failure
12	Electronic fatal failure
13	General fault

9945 **6.2.2.3 Commands**

9946 The server does not receive or generate cluster specific commands.



9947 **6.2.2.4 Attribute Reporting**

9948 This cluster SHALL support attribute reporting using the Report Attributes command, according to the min-  
 9949 imum and maximum reporting interval, reportable change, and timeout period settings described in the ZCL  
 9950 Foundation Specification (see 2.4.7).

9951 The following attributes SHALL be reported:

- 9952 *PumpStatus*
- 9953 *Capacity*

9954 **6.2.3 Client**

9955 The client supports no specific attributes. The client does not receive or generate cluster specific commands.

9956 **6.3 Thermostat**

---

9957 **6.3.1 Overview**

9958 Please see Chapter 2 for a general cluster overview defining cluster architecture, revision, classification,  
 9959 identification, etc.

9960 This cluster provides an interface to the functionality of a thermostat.

9961 **6.3.1.1 Revision History**

9962 The global *ClusterRevision* attribute value SHALL be the highest revision number in the table below.

Rev	Description
1	mandatory global <i>ClusterRevision</i> attribute added; fixed some defaults; CCB 1823, 1480
2	CCB 1981 2186 2249 2250 2251; NFR Thermostat Setback
3	CCB 2477 2560 2773 2777 2815 2816 3029

9963 **6.3.1.2 Classification**

Hierarchy	Role	PICS Code	Primary Transaction
Base	Application	TSTAT	Type 2 (server to client)

9964 **6.3.1.3 Cluster Identifiers**

Identifier	Name
0x0201	Thermostat

9965 **6.3.1.4 Thermostat Temperature Conversion**

9966 Many Thermostats store internally or have the capability to display the temperature in degree Fahrenheit  
 9967 format. The Thermostat cluster standardizes temperature representation in degree Celsius format when trans-  
 9968 ferred over the air. Sample code has been provided (see 6.6.2.3). Manufacturers SHOULD use the conversion  
 9969 algorithm provided to convert temperature from Fahrenheit to Celsius and vice versa.

### 9970 6.3.1.5 Thermostat Schedule Feature Mandatory Re- 9971 requirement

9972 The *StartOfWeek* Attribute is the indicator to show that the Weekly schedule extension is supported. If the  
9973 Weekly schedule extension feature is supported, it is mandatory to also support the *StartOfWeek* Attribute,  
9974 *NumberOfWeeklyTransitions* Attribute, *NumberOfDailyTransitions* Attribute, Set Weekly Schedule Com-  
9975 mand and Get Weekly Schedule Command.

## 9976 6.3.2 Server

### 9977 6.3.2.1 Dependencies

9978 For alarms to be generated by this cluster, the Alarms server cluster (see 3.11) SHALL be included on the  
9979 same endpoint. For remote temperature sensing, the Temperature Measurement client cluster (see 4.4) MAY  
9980 be included on the same endpoint. For occupancy sensing, the Occupancy Sensing client cluster (see 4.8)  
9981 MAY be included on the same endpoint.

### 9982 6.3.2.2 Attributes

9983 For convenience, the attributes defined in this specification are arranged into sets of related attributes; each  
9984 set can contain up to 16 attributes. Attribute identifiers are encoded such that the most significant three nib-  
9985 bles specify the attribute set and the least significant nibble specifies the attribute within the set. The currently  
9986 defined attribute sets for Thermostat are listed in Table 6-10.

9987 **Table 6-10. Currently Defined Thermostat Attribute Sets**

Attribute Set Identifier	Description
0x000	Thermostat Information
0x001	Thermostat Settings
0x002	Thermostat Schedule & HVAC Relay Attribute Set
0x003	Thermostat Setpoint Change Tracking Attribute Set
0x004	AC Information Attribute Set
0x400 – 0xfff	Reserved for vendor specific attributes

#### 9988 6.3.2.2.1 Thermostat Information Attribute Set

9989 The Thermostat Information attribute set contains the attributes summarized in Table 6-11.

9990 **Table 6-11. Attributes of the Thermostat Information Attribute Set**

Id	Name	Type	Range	Acc	Default	M
0x0000	<i>LocalTemperature</i>	int16	0x954d – 0x7fff	RP	FF	M
0x0001	<i>OutdoorTemperature</i>	int16	0x954d – 0x7fff	R	FF	O
0x0002	<i>Occupancy</i>	map8	desc	R	1 <sup>119</sup>	O

<sup>119</sup> CCB 2560 default to occupied because occupied setpoints are mandatory

Id	Name	Type	Range	Acc	Default	M
0x0003	<i>AbsMinHeatSetpointLimit</i>	int16	0x954d – 0x7fff	R	0x02bc (7°C)	O
0x0004	<i>AbsMaxHeatSetpointLimit</i>	int16	0x954d – 0x7fff	R	0x0bb8 (30°C)	O
0x0005	<i>AbsMinCoolSetpointLimit</i>	int16	0x954d – 0x7fff	R	0x0640 (16°C)	O
0x0006	<i>AbsMaxCoolSetpointLimit</i>	int16	0x954d – 0x7fff	R	0x0c80 (32°C)	O
0x0007	<i>PICoolingDemand</i>	uint8	0x00 – 0x64	RP	-	O
0x0008	<i>PIHeatingDemand</i>	uint8	0x00 – 0x64	RP	-	O
0x0009	<i>HVACSystemTypeConfiguration</i>	map8	desc	R* <sup>120</sup> W	0	O

9991 **6.3.2.2.1.1 LocalTemperature Attribute**

9992 *LocalTemperature* represents the temperature in degrees Celsius, as measured locally or remotely (over the  
 9993 network), including any adjustments applied by *LocalTemperatureCalibration* attribute (if any) as follows:

9994  $LocalTemperature = 100 \times (\text{temperature in degrees Celsius} + LocalTemperatureCalibration)$ .

9995 Where  $-273.15^{\circ}\text{C} \leq \text{temperature} \leq 327.67^{\circ}\text{C}$ , corresponding to a *LocalTemperature* in the range 0x954d  
 9996 to 0x7fff.

9997 The maximum resolution this format allows is 0.01 °C.

9998 A *LocalTemperature* non-value indicates that the temperature measurement is invalid.

9999 All setpoint attributes in the Thermostat cluster SHALL be triggered based off the *LocalTemperature* attribute  
 10000 (i.e., measured temperature and any calibration offset).

10001 **6.3.2.2.1.2 OutdoorTemperature Attribute**

10002 *OutdoorTemperature* represents the outdoor temperature in degrees Celsius, as measured locally or remotely  
 10003 (over the network). It is measured as described for *LocalTemperature*.

10004 **6.3.2.2.1.3 Occupancy Attribute**

10005 *Occupancy* specifies whether the heated/cooled space is occupied or not, as measured locally or remotely  
 10006 (over the network). If bit 0 = 1, the space is occupied, else it is unoccupied. All other bits are reserved.

10007 **6.3.2.2.1.4 AbsMinHeatSetpointLimit Attribute**

10008 The *MinHeatSetpointLimit* attribute specifies the absolute minimum level that the heating setpoint MAY be  
 10009 set to. This is a limitation imposed by the manufacturer. The value is calculated as described in the Local-  
 10010 Temperature attribute.

10011 **6.3.2.2.1.5 AbsMaxHeatSetpointLimit Attribute**

10012 The *MaxHeatSetpointLimit* attribute specifies the absolute maximum level that the heating setpoint MAY be  
 10013 set to. This is a limitation imposed by the manufacturer. The value is calculated as described in the Local-  
 10014 Temperature attribute.

10015 **6.3.2.2.1.6 AbsMinCoolSetpointLimit Attribute**

<sup>120</sup> CCB 2773 application may not allow remote change

10016 The *MinCoolSetpointLimit* attribute specifies the absolute minimum level that the cooling setpoint MAY be  
10017 set to. This is a limitation imposed by the manufacturer. The value is calculated as described in the Local-  
10018 Temperature attribute.

#### 10019 **6.3.2.2.1.7 AbsMaxCoolSetpointLimit Attribute**

10020 The *MaxCoolSetpointLimit* attribute specifies the absolute maximum level that the cooling setpoint MAY be  
10021 set to. This is a limitation imposed by the manufacturer. The value is calculated as described in the Local-  
10022 Temperature attribute.

#### 10023 **6.3.2.2.1.8 PICoolingDemand Attribute**

10024 The *PICoolingDemand* attribute is 8 bits in length and specifies the level of cooling demanded by the PI  
10025 (proportional integral) control loop in use by the thermostat (if any), in percent. This value is 0 when the  
10026 thermostat is in “off” or “heating” mode.

10027 This attribute is reported regularly and MAY be used to control a heating device.

#### 10028 **6.3.2.2.1.9 PIHeatingDemand Attribute**

10029 The *PIHeatingDemand* attribute is 8 bits in length and specifies the level of heating demanded by the PI loop  
10030 in percent. This value is 0 when the thermostat is in “off” or “cooling” mode.

10031 This attribute is reported regularly and MAY be used to control a cooling device.

#### 10032 **6.3.2.2.1.10 HVACSystemTypeConfiguration Attribute**

10033 The *HVACSystemTypeConfiguration* attribute specifies the HVAC system type controlled by the thermostat.  
10034 If the thermostat uses physical DIP switches to set these parameters, this information SHALL be available  
10035 read-only from the DIP switches. If these parameters are set via software, there SHALL be read/write access  
10036 in order to provide remote programming capability. The meanings of individual bits are detailed in Table  
10037 6-12. Each bit represents a type of system configuration.

10038 **Table 6-12. HVAC System Type Configuration Values**

Bit Number	Description
0 – 1	<b>Cooling System Stage</b> 00 – Cool Stage 1 01 – Cool Stage 2 10 – Cool Stage 3 11 – Reserved
2 – 3	<b>Heating System Stage</b> 00 – Heat Stage 1 01 – Heat Stage 2 10 – Heat Stage 3 11 – Reserved
4	<b>Heating System Type</b> 0 – Conventional 1 – Heat Pump
5	<b>Heating Fuel Source</b> 0 – Electric / B 1 – Gas / O

#### 10039 **6.3.2.2.2 Thermostat Settings Attribute Set**

10040 The Thermostat settings attribute set contains the attributes summarized in Table 6-13:

10041

**Table 6-13. Attributes of the Thermostat Settings Attribute Set**

<b>Id</b>	<b>Name</b>	<b>Type</b>	<b>Range</b>	<b>Acc</b>	<b>Def</b>	<b>MO</b>
0x0010	<i>LocalTemperatureCalibration</i>	int8	0xE7 – 0x19	RW	0x00 (0°C)	O
0x0011	<i>OccupiedCoolingSetpoint</i>	int16	<i>MinCoolSetpointLimit</i> to <i>MaxCoolSetpointLimit</i>	RWS	0x0a28 (26°C)	M*
0x0012	<i>OccupiedHeatingSetpoint</i>	int16	<i>MinHeatSetpointLimit</i> to <i>MaxHeatSetpointLimit</i>	RWS	0x07d0 (20°C)	M*
0x0013	<i>UnoccupiedCoolingSetpoint</i>	int16	<i>MinCoolSetpointLimit</i> to <i>MaxCoolSetpointLimit</i>	RW	0x0a28 (26°C)	O
0x0014	<i>UnoccupiedHeatingSetpoint</i>	int16	<i>MinHeatSetpointLimit</i> to <i>MaxHeatSetpointLimit</i>	RW	0x07d0 (20°C)	O
0x0015	<i>MinHeatSetpointLimit</i>	int16	0x954d – 0x7fff	RW	0x02bc (7°C)	O
0x0016	<i>MaxHeatSetpointLimit</i>	int16	0x954d – 0x7fff	RW	0x0bb8 (30°C)	O
0x0017	<i>MinCoolSetpointLimit</i>	int16	0x954d – 0x7fff	RW	0x0640 (16°C)	O
0x0018	<i>MaxCoolSetpointLimit</i>	int16	0x954d – 0x7fff	RW	0x0c80 (32°C)	O
0x0019	<i>MinSetpointDeadBand</i>	int8	0– 0x19	R*W <sup>121</sup>	0x19 (2.5°C)	O
0x001a	<i>RemoteSensing</i>	map8	00000xxx	RW	0	O
0x001b	<i>ControlSequenceOfOperation</i>	enum8	desc	RW	4	M
0x001c	<i>SystemMode</i>	enum8	See Table 6-16	RWS	1	M
0x001d	<i>AlarmMask</i>	map8	desc	R	0	O
0x001e	<i>ThermostatRunningMode</i>	enum8	desc	R	0	O

10042 **\*Note:** "M\*" designates that a server SHALL implement at least one of the attributes designated "M\*." For  
 10043 example, a radiator valve implementing the Thermostat Cluster server would only implement the Occu-  
 10044 piedHeatingSetpoint attribute. Thermostats SHOULD implement both OccupiedCoolingSetpoint and Occu-  
 10045 piedHeatingSetpoint attributes. The "M\*" designation allows HVAC devices to implement the portions of  
 10046 Thermostat cluster germane to their operation.

10047 **6.3.2.2.2.1 LocalTemperatureCalibration Attribute**

10048 Specifies the offset the Thermostat server SHALL make to the measured temperature (locally or remotely)  
 10049 before calculating, displaying, or communicating the *LocalTemperature* attribute, in steps of 0.1°C.

10050 The purpose of this attribute is to adjust the calibration of the Thermostat server per the user’s preferences  
 10051 (e.g., to match if there are multiple servers displaying different values for the same HVAC area) or compen-  
 10052 sate for variability amongst temperature sensors.

<sup>121</sup> CCB 2777 RW to R\*W and allow zero deadband for Thermostats that are just a UI

10053 If a Thermostat client attempts to write *LocalTemperatureCalibration* attribute to an unsupported value (e.g.,  
10054 out of the range supported by the Thermostat server), the Thermostat server SHALL respond with a Write  
10055 Attribute Response Command with a status of SUCCESS<sup>122</sup> and set the value of *LocalTemperatureCalibra-*  
10056 *tion* to the upper or lower limit reached.

10057

#### 10058 **6.3.2.2.2.2 OccupiedCoolingSetpoint Attribute**

10059 The *OccupiedCoolingSetpoint* attribute specifies the cooling mode setpoint when the room is occupied

10060 The *OccupiedHeatingSetpoint* attribute SHALL always be below the value specified in the *OccupiedCooling*  
10061 *Setpoint* by at least *MinSetpointDeadband*. If an attempt is made to set it such that this condition is violated,  
10062 a response command with the status code INVALID\_VALUE (see 2.5.3) SHALL be returned. If the occu-  
10063 pancy status of the room is unknown, this attribute SHALL be used as the cooling mode setpoint.

#### 10064 **6.3.2.2.2.3 OccupiedHeatingSetpoint Attribute**

10065 The *OccupiedHeatingSetpoint* attribute specifies the heating mode setpoint when the room is occupied. The  
10066 *OccupiedCoolingSetpoint* attribute SHALL always be above the value specified in the *OccupiedHeatingSet-*  
10067 *point* by at least *MinSetpointDeadband*.

10068 If the occupancy status of the room is unknown, this attribute SHALL be used as the heating mode setpoint.

#### 10069 **6.3.2.2.2.4 UnoccupiedCoolingSetpoint Attribute**

10070 The *UnoccupiedCoolingSetpoint* attribute and specifies the cooling mode setpoint when the room is unoccu-  
10071 pied. The *UnoccupiedHeatingSetpoint* attribute SHALL always be below the value specified in the *Unoccu-*  
10072 *piedCoolingSetpoint* by at least *MinSetpointDeadband*.

10073 If the occupancy status of the room is unknown, this attribute SHALL not be used.

#### 10074 **6.3.2.2.2.5 UnoccupiedHeatingSetpoint Attribute**

10075 The *UnoccupiedHeatingSetpoint* attribute specifies the heating mode setpoint when the room is unoccu-  
10076 piedThe *UnoccupiedCoolingSetpoint* attribute SHALL always be above the value specified in the *Unoccu-*  
10077 *piedHeatingSetpoint* by at least *MinSetpointDeadband*.

10078 If the occupancy status of the room is unknown, this attribute SHALL not be used.

#### 10079 **6.3.2.2.2.6 MinHeatSetpointLimit Attribute**

10080 The *MinHeatSetpointLimit* attribute specifies the minimum level that the heating setpoint MAY be set to. If  
10081 this attribute is not present, it SHALL be taken as equal to *AbsMinHeatSetpointLimit*.

10082 This attribute, and the following three attributes, allow the user to define setpoint limits more constrictive  
10083 than the manufacturer imposed ones. Limiting users (e.g., in a commercial building) to such setpoint limits  
10084 can help conserve power.

#### 10085 **6.3.2.2.2.7 MaxHeatSetpointLimit Attribute**

10086 The *MaxHeatSetpointLimit* attribute specifies the maximum level that the heating setpoint MAY be set to. It  
10087 must be less than or equal to *AbsMaxHeatSetpointLimit*. If this attribute is not present, it SHALL be taken as  
10088 equal to *AbsMaxHeatSetpointLimit*.

#### 10089 **6.3.2.2.2.8 MinCoolSetpointLimit Attribute**

---

<sup>122</sup> CCB 2477

10090 The *MinCoolSetpointLimit* attribute specifies the minimum level that the cooling setpoint MAY be set to. It  
 10091 must be greater than or equal to *AbsMinCoolSetpointLimit*. If this attribute is not present, it SHALL be taken  
 10092 as equal to *AbsMinCoolSetpointLimit*.

10093 **6.3.2.2.2.9 MaxCoolSetpointLimit Attribute**

10094 The *MaxCoolSetpointLimit* attribute specifies the maximum level that the cooling setpoint MAY be set to.  
 10095 . It must be less than or equal to *AbsMaxCoolSetpointLimit*. If this attribute is not present, it SHALL be taken  
 10096 as equal to *AbsMaxCoolSetpointLimit*.

10097 **6.3.2.2.2.10 MinSetpointDeadBand Attribute**

10098 The *MinSetpointDeadBand* attribute specifies the minimum difference between the Heat Setpoint and the  
 10099 Cool SetPoint, in steps of 0.1°C. Its range is 0x0a to 0x19 (1°C to 2.5°C).

10100 **6.3.2.2.2.11 RemoteSensing Attribute**

10101 The RemoteSensing attribute is an 8-bit bitmap that specifies whether the local temperature, outdoor temper-  
 10102 ature and occupancy are being sensed by internal sensors or remote networked sensors. The meanings of  
 10103 individual bits are detailed in Table 6-14.

10104 **Table 6-14. RemoteSensing Attribute Bit Values**

Bit Number	Description
0	0 – local temperature sensed internally 1 – local temperature sensed remotely
1	0 – outdoor temperature sensed internally 1 – outdoor temperature sensed remotely
2	0 – occupancy sensed internally 1 – occupancy sensed remotely

10105 **6.3.2.2.2.12 ControlSequenceOfOperation Attribute**

10106 The *ControlSequenceOfOperation* attribute specifies the overall operating environment of the thermostat,  
 10107 and thus the possible system modes that the thermostat can operate in. It SHALL be set to one of the non-  
 10108 reserved values in Table 6-15. (**Note:** it is not mandatory to support all values).

10109 **Table 6-15. ControlSequenceOfOperation Attribute Values**

Value	Description	Possible Values of <i>SystemMode</i>
0x00	Cooling Only	Heat and Emergency are not possible
0x01	Cooling With Reheat	Heat and Emergency are not possible
0x02	Heating Only	Cool and precooling (see 6.1.2) are not possible
0x03	Heating With Reheat	Cool and precooling are not possible
0x04	Cooling and Heating 4-pipes (see 1.3.2)	All modes are possible
0x05	Cooling and Heating 4-pipes with Reheat	All modes are possible

10110 **6.3.2.2.2.13 SystemMode Attribute**

10111 The *SystemMode* attribute specifies the current operating mode of the thermostat, It SHALL be set to one of  
 10112 the non-reserved values in Table 6-16, as limited by Table 6-17. (**Note:** It is not mandatory to support all  
 10113 values).

10114

**Table 6-16. SystemMode Attribute Values**

Attribute Value	Description
0x00	Off
0x01	Auto
0x03	Cool
0x04	Heat
0x05	Emergency heating
0x06	Precooling (see 6.1.2)
0x07	Fan only
0x08	Dry
0x09	Sleep

10115 The interpretation of the Heat, Cool and Auto values of *SystemMode* is shown in Table 6-17.

10116

**Table 6-17. Interpretation of SystemMode Values**

Attribute Values	Temperature Below Heat Setpoint	Temperature Between Heat Setpoint and Cool Setpoint	Temperature Above Cool Setpoint
Heat	Temperature below target	Temperature on target	Temperature on target
Cool	Temperature on target	Temperature on target	Temperature above target
Auto	Temperature below target	Temperature on target	Temperature above target

#### 10117 **6.3.2.2.2.14 AlarmMask Attribute**

10118 The *AlarmMask* attribute specifies whether each of the alarms listed in Table 6-18 Alarm Codes is enabled.  
 10119 When the bit number corresponding to the alarm code is set to 1, the alarm is enabled, else it is disabled. Bits  
 10120 not corresponding to a code in the table are reserved.

10121 When the Alarms cluster is implemented on a device, and one of the alarm conditions included in this table  
 10122 occurs, an alarm notification is generated, with the alarm code field set as listed in the table.

10123

**Table 6-18. Alarm Codes**

Alarm Code	Alarm Condition
0	Initialization failure. The device failed to complete initialization at power-up.
1	Hardware failure
2	Self-calibration failure

#### 10124 **6.3.2.2.2.15 Thermostat Running Mode Attribute**



10125 *ThermostatRunningMode* represents the running mode of the thermostat. The thermostat running mode can  
 10126 only be Off, Cool or Heat. This attribute is intended to provide additional information when the thermo-  
 10127 stat’s system mode is in auto mode. The attribute value is maintained to have the same value as the Sys-  
 10128 *temMode* attribute.  
 10129

**Table 6.19 Thermostat Running Mode Attribute Values**

Value	Description
0x00	Off
0x03	Cool
0x04	Heat

10130 **6.3.2.2.3 Thermostat Schedule & HVAC Relay Attribute Set**

10131

**Table 6-20. Thermostat Schedule & HVAC Relay Attribute Set**

Id	Name	Type	Range	Acc	Def	M
Schedule Attribute Set 0x0020 – 0x0028						
x0020	<i>StartOfWeek</i>	enum8	desc	R	–	O
x0021	<i>NumberOfWeeklyTransitions</i>	uint8	0x00 – 0xff	R	0	O
x0022	<i>NumberOfDailyTransitions</i>	uint8	0x00 – 0xff	R	0	O
x0023	<i>TemperatureSetpointHold</i>	enum8	desc	RW	0	O
x0024	<i>TemperatureSetpointHoldDuration</i>	uint16	0 - 0x05a0	RW	0xffff	O
x0025	<i>ThermostatProgrammingOperationMode</i>	map8	desc	RWP	0	O
HVAC Relay Attribute Set 0x0029 – 0x002F						
x0029	<i>ThermostatRunningState</i>	map16	desc	R	-	O

10132 **6.3.2.2.3.1 StartOfWeek Attribute**

10133 *StartOfWeek* represents the day of the week that this thermostat considers to be the start of week for weekly  
 10134 set point scheduling. The possible values are given in Table 6-21:

10135

**Table 6-21. StartofWeek Enumeration Values**

Enumeration Field	Value Description
0x00	Sunday
0x01	Monday
0x02	Tuesday
0x03	Wednesday
0x04	Thursday
0x05	Friday
0x06	Saturday

10136 If the Weekly schedule extension is supported this attribute SHALL be supported.

10137 This attribute MAY be able to be used as the base to determine if the device supports weekly scheduling by  
10138 reading the attribute. Successful response means that the weekly scheduling is supported.

#### 10139 **6.3.2.2.3.2      NumberOfWeeklyTransitions Attribute**

10140 *NumberOfWeeklyTransitions* attribute determines how many weekly schedule transitions the thermostat is  
10141 capable of handling.

#### 10142 **6.3.2.2.3.3      NumberOfDailyTransitions Attribute**

10143 *NumberOfDailyTransitions* attribute determines how many daily schedule transitions the thermostat is capa-  
10144 ble of handling.

#### 10145 **6.3.2.2.3.4      TemperatureSetpointHold Attribute**

10146 *TemperatureSetpointHold* specifies the temperature hold status on the thermostat, as shown in Table 6-22. If  
10147 hold status is on, the thermostat SHOULD maintain the temperature set point for the current mode until a  
10148 system mode change. If hold status is off, the thermostat SHOULD follow the setpoint transitions specified  
10149 by its internal scheduling program. If the thermostat supports setpoint hold for a specific duration, it  
10150 SHOULD also implement the *TemperatureSetpointHoldDuration* attribute.

10151 **Table 6-22. *TemperatureSetpointHold* Attribute Values**

Enumeration Field	Value Description
0x00	Setpoint Hold Off
0x01	Setpoint Hold On

#### 10152 **6.3.2.2.3.5      TemperatureSetpointHoldDuration Attribute**

10153 *TemperatureSetpointHoldDuration* sets the period in minutes for which a setpoint hold is active. Thermostats  
10154 that support hold for a specified duration SHOULD implement this attribute. The valid range is from 0x0000  
10155 – 0x05A0 (1440 minutes within a day). A non-value indicates the field is unused. All other values are re-  
10156 served.

#### 10157 **6.3.2.2.3.6      ThermostatProgrammingOperationMode Attribute**

10158 The *ThermostatProgrammingOperationMode* attribute determines the operational state of the thermostat's  
10159 programming. The thermostat SHALL modify its programming operation when this attribute is modified by  
10160 a client and update this attribute when its programming operation is modified locally by a user. The thermo-  
10161 stat MAY support more than one active *ThermostatProgrammingOperationMode*. For example, the thermo-  
10162 stat MAY operate simultaneously in Schedule Programming Mode and Recovery Mode. If a thermostat sup-  
10163 ports Thermostat Programming Operation Mode attribute, it SHALL support attribute reporting for this at-  
10164 tribute. Any locally-initiated changes to the *ThermostatProgrammingOperationMode* SHALL be updated  
10165 and reported to all clients configured to receive such reports. The meanings of individual bits are detailed in  
10166 Table 6-23. Each bit represents a type of operation.

10167

**Table 6-23. ThermostatProgrammingOperationMode Attribute Values**

Bit Num <sup>123</sup>	Description
0	0 – Simple/setpoint mode. This mode means the thermostat setpoint is altered only by manual up/down changes at the thermostat or remotely, not by internal schedule programming. 1 – Schedule programming mode. This enables or disables any programmed weekly schedule configurations. <i>Note: It does not clear or delete previous weekly schedule programming configurations.</i>
1	0 - Auto/recovery mode set to OFF 1 – Auto/recovery mode set to ON
2	0 – Economy/EnergyStar mode set to OFF 1 – Economy/EnergyStar mode set to ON

10168

**6.3.2.2.3.7 ThermostatRunningState Attribute**

10169

*ThermostatRunningState* represents the current relay state of the heat, cool, and fan relays, whose values are shown in Table 6-24.

10170

10171

**Table 6-24. HVAC Relay State Values**

Bit Number	Description
0	Heat State On
1	Cool State On
2	Fan State On
3	Heat 2 <sup>nd</sup> Stage State On
4	Cool 2 <sup>nd</sup> Stage State On
5	Fan 2 <sup>nd</sup> Stage State On
6	Fan 3 <sup>rd</sup> Stage State On

10172

**6.3.2.2.4 Thermostat Setpoint ChangeTracking Attribute Set**

10173

**Table 6-25. Thermostat Setpoint Change Tracking Attribute Set**

Id	Name	Type	Range	Acc	Def	MO
0x0030	<i>SetpointChangeSource</i>	enum8	0x00 – 0xff	R	0x00	O
0x0031	<i>SetpointChangeAmount</i>	int16	0x0000 – 0xffff	R	0x8000	O
0x0032	<i>SetpointChangeSourceTimestamp</i>	UTC	0x00000000 – 0xffffffe	R	0x00000000	O
0x0034	<i>OccupiedSetback</i>	uint8	<i>OccupiedSetbackMin</i> – <i>OccupiedSetbackMax</i>	RW	0xff	O

<sup>123</sup> CCB 2816

<b>Id</b>	<b>Name</b>	<b>Type</b>	<b>Range</b>	<b>Acc</b>	<b>Def</b>	<b>MO</b>
0x0035	<i>OccupiedSetbackMin</i>	uint8	0x00 – <i>OccupiedSetbackMax</i>	R	0xff	O
0x0036	<i>OccupiedSetbackMax</i>	uint8	<i>OccupiedSetbackMin</i> – 0xff	R	0xff	O
0x0037	<i>UnoccupiedSetback</i>	uint8	<i>UnoccupiedSetbackMin</i> – <i>OccupiedSetbackMax</i>	RW	0xff	O
0x0038	<i>UnoccupiedSetbackMin</i>	uint8	0x00 – <i>OccupiedSetbackMax</i>	R	0xff	O
0x0039	<i>UnoccupiedSetbackMax</i>	uint8	<i>OccupiedSetbackMin</i> – 0xff	R	0xff	O
0x003a	<i>EmergencyHeatDelta</i>	uint8	0x00 – 0xff	RW	0xff	O

10174

10175 **6.3.2.2.4.1 SetpointChangeSource Attribute**

10176 The *SetpointChangeSource* attribute specifies the source of the current active *OccupiedCoolingSetpoint* or  
 10177 *OccupiedHeatingSetpoint* (i.e., who or what determined the current setpoint).

10178 *SetpointChangeSource* attribute enables service providers to determine whether changes to setpoints were  
 10179 initiated due to occupant comfort, scheduled programming or some other source (e.g., electric utility or other  
 10180 service provider). Because automation services MAY initiate frequent setpoint changes, this attribute clearly  
 10181 differentiates the source of setpoint changes made at the thermostat.

10182

**Table 6-26. SetpointChangeSource Values**

<b>SetpointChangeSource Attribute</b>	<b>Description</b>
0x00	Manual, user-initiated setpoint change via the thermostat
0x01	Schedule/internal programming-initiated setpoint change
0x02	Externally-initiated setpoint change (e.g., DRLC cluster command, attribute write)

10183 **6.3.2.2.4.2 SetpointChangeAmount Attribute**

10184 The *SetpointChangeAmount* attribute specifies the delta between the current active *OccupiedCoolingSetpoint*  
 10185 or *OccupiedHeatingSetpoint* and the previous active setpoint. This attribute is meant to accompany the *Set-*  
 10186 *pointChangeSource* attribute; devices implementing *SetpointChangeAmount* SHOULD also implement *Set-*  
 10187 *pointChangeSource*.

10188

**Table 6-27. SetpointChangeAmount Values**

<b>SetpointChangeAmount Attribute</b>	<b>Description</b>
0x0000 – 0xffff	The signed difference in 0.01 degrees Celsius between the previous temperature setpoint and the new temperature setpoint.

10189 **6.3.2.2.4.3 SetpointChangeSourceTimestamp Attribute**

10190 The *SetpointChangeSourceTimestamp* attribute specifies the time in UTC at which the *SetpointChang-*  
 10191 *eSourceAmount* attribute change was recorded.

10192 **6.3.2.2.4.4 OccupiedSetback Attribute**

10193 Specifies the degrees Celsius, in 0.1 degree increments, the Thermostat server will allow the *LocalTemperature*  
10194 attribute to float above the *OccupiedCooling* setpoint (i.e., *OccupiedCooling* + *OccupiedSetback*) or  
10195 below the *OccupiedHeating* setpoint (i.e., *OccupiedHeating* – *OccupiedSetback*) before initiating a state  
10196 change to bring the temperature back to the user’s desired setpoint. This attribute is sometimes also referred  
10197 to as the “span.”

10198 The purpose of this attribute is to allow remote configuration of the span between the desired setpoint and  
10199 the measured temperature to help prevent over-cycling and reduce energy bills, though this may result in  
10200 lower comfort on the part of some users.

10201 A value of 0xff indicates the attribute is unused.

10202 If *OccupiedSetback* is implemented, then the Thermostat server SHALL also implement *OccupiedSetback-*  
10203 *Min* and *OccupiedSetbackMax* attributes.

10204 If the Thermostat client attempts to write *OccupiedSetback* to a value greater than *OccupiedSetbackMax*, the  
10205 Thermostat server SHALL set its *OccupiedSetback* value to *OccupiedSetbackMax* and SHALL send a Write  
10206 Attribute Response command with a Status Code field enumeration of SUCCESS<sup>124</sup> response.

10207 If the Thermostat client attempts to write *OccupiedSetback* to a value less than *OccupiedSetbackMin*, the  
10208 Thermostat server SHALL set its *OccupiedSetback* value to *OccupiedSetbackMin* and SHALL send a Write  
10209 Attribute Response command with a Status Code field enumeration of SUCCESS<sup>125</sup> response.

10210 **6.3.2.2.4.5 OccupiedSetbackMin Attribute**

10211 Specifies the minimum degrees Celsius, in 0.1 degree increments, the Thermostat server will allow the *Oc-*  
10212 *cupiedSetback* attribute to be configured by a user.

10213 A value of 0xff indicates the attribute is unused.

10214 *OccupiedSetbackMin* attribute value SHALL be less than *OccupiedSetbackMax* attribute value. Attempts  
10215 to configure *OccupiedSetbackMin* with a value greater than or equal to the value of the *OccupiedSetbackMax*  
10216 attribute SHALL cause the Thermostat server to respond with a Write Attribute Response Command con-  
10217 taining the status INVALID\_VALUE and SHALL revert back to the previous *OccupiedSetbackMin* attribute  
10218 value.

10219 If *OccupiedSetbackMin* is configured to a value greater than the value of *OccupiedSetback*, then the Ther-  
10220 mostat server SHALL update the value of *OccupiedSetback* to equal the new value of *OccupiedSetbackMin*.

10221 **6.3.2.2.4.6 OccupiedSetbackMax Attribute**

10222 Specifies the maximum degrees Celsius, in 0.1 degree increments, the Thermostat server will allow the *Oc-*  
10223 *cupiedSetback* attribute to be configured by a user.

10224 A value of 0xff indicates the attribute is unused.

10225 *OccupiedSetbackMax* attribute value SHALL be greater than *OccupiedSetbackMin* attribute value. At-  
10226 tempts to configure *OccupiedSetbackMax* with a value less than or equal to the value of the *OccupiedSet-*  
10227 *backMin* attribute SHALL cause the Thermostat server to respond with a Write Attribute Response Command  
10228 containing the status INVALID\_VALUE and SHALL revert back to the previous *OccupiedSetbackMax* at-  
10229 tribute value.

10230 If *OccupiedSetbackMax* is configured to a value less than the value of *OccupiedSetback*, then the Thermostat  
10231 server SHALL update the value of *OccupiedSetback* to equal the new value of *OccupiedSetbackMax*.

10232 **6.3.2.2.4.7 UnoccupiedSetback Attribute**

---

<sup>124</sup> CCB 2477

<sup>125</sup> CCB 2477

10233 Specifies the degrees Celsius, in 0.1 degree increments, the Thermostat server will allow the LocalTemperature attribute to float above the UnoccupiedCooling setpoint (i.e., UnoccupiedCooling + UnoccupiedSetback) or below the UnoccupiedHeating setpoint (i.e., UnoccupiedHeating - UnoccupiedSetback) before initiating a state change to bring the temperature back to the user’s desired setpoint. This attribute is sometimes also referred to as the “span.”

10238 The purpose of this attribute is to allow remote configuration of the span between the desired setpoint and the measured temperature to help prevent over-cycling and reduce energy bills, though this may result in lower comfort on the part of some users.

10241 A value of 0xff indicates the attribute is unused.

10242 If UnoccupiedSetback is implemented, then the Thermostat server SHALL also implement UnoccupiedSetbackMin and UnoccupiedSetbackMax attributes.

10244 If the Thermostat client attempts to write UnoccupiedSetback to a value greater than UnoccupiedSetbackMax, the Thermostat server SHALL set its UnoccupiedSetback value to UnoccupiedSetbackMax and SHALL send a Write Attribute Response command with a Status Code field enumeration of SUCCESS<sup>126</sup> response.

10248 If the Thermostat client attempts to write UnoccupiedSetback to a value less than UnoccupiedSetbackMin, the Thermostat server SHALL set its UnoccupiedSetback value to UnoccupiedSetbackMin and SHALL send a Write Attribute Response command with a Status Code field enumeration of SUCCESS<sup>127</sup> response.

#### 10251 **6.3.2.2.4.8 UnoccupiedSetbackMin Attribute**

10252 Specifies the minimum degrees Celsius, in 0.1 degree increments, the Thermostat server will allow the *UnoccupiedSetback* attribute to be configured by a user.

10254 A value of 0xff indicates the attribute is unused.

10255 *UnoccupiedSetbackMin* attribute value SHALL be less than *UnoccupiedSetbackMax* attribute value. Attempts to configure *UnoccupiedSetbackMin* with a value greater than or equal to the value of the *UnoccupiedSetbackMax* attribute SHALL cause the Thermostat server to respond with a Write Attribute Response Command containing the status INVALID\_VALUE and SHALL revert back to the previous *UnoccupiedSetbackMin* attribute value.

10260 If *UnoccupiedSetbackMin* is configured to a value greater than the value of *UnoccupiedSetback*, then the Thermostat server SHALL update the value of *UnoccupiedSetback* to equal the new value of *UnoccupiedSetbackMin*.

#### 10263 **6.3.2.2.4.9 UnoccupiedSetbackMax Attribute**

10264 Specifies the maximum degrees Celsius, in 0.1 degree increments, the Thermostat server will allow the *UnoccupiedSetback* attribute to be configured by a user.

10266 A value of 0xff indicates the attribute is unused.

10267 *UnoccupiedSetbackMax* attribute value SHALL be greater than *UnoccupiedSetbackMin* attribute value. Attempts to configure *UnoccupiedSetbackMax* with a value less than or equal to the value of the *UnoccupiedSetbackMin* attribute SHALL cause the Thermostat server to respond with a Write Attribute Response Command containing the status INVALID\_VALUE and SHALL revert back to the previous *UnoccupiedSetbackMax* attribute value.

10272 If *UnoccupiedSetbackMax* is configured to a value less than the value of *UnoccupiedSetback*, then the Thermostat server SHALL update the value of *UnoccupiedSetback* to equal the new value of *UnoccupiedSetbackMax*.

#### 10275 **6.3.2.2.4.10 EmergencyHeatDelta Attribute**

---

<sup>126</sup> CCB 2477

<sup>127</sup> CCB 2477

10276 Specifies the delta, in 0.1 degrees Celsius, between *LocalTemperature* and the *OccupiedHeatingSetpoint* or  
 10277 *UnoccupiedHeatingSetpoint* attributes at which the Thermostat server will operate in emergency heat mode.

10278 If the difference between *LocalTemperature* and *Un/OccupiedHeatingSetpoint* is greater than or equal to the  
 10279 *EmergencyHeatDelta* and the Thermostat server's *SystemMode* attribute is in a heating-related mode, then  
 10280 the Thermostat server SHALL immediately switch to the *SystemMode* attribute value that provides the high-  
 10281 est stage of heating (e.g., emergency heat) and continue operating in that running state until the *Occu-  
 10282 piedHeatingSetpoint* value is reached. For example:

- 10283 • *LocalTemperature* = 10.0 degrees Celsius
- 10284 • *OccupiedHeatingSetpoint* = 16.0 degrees Celsius
- 10285 • *EmergencyHeatDelta* = 2.0 degrees Celsius

10286 =>  $OccupiedHeatingSetpoint - LocalTemperature \geq EmergencyHeatDelta$   
 10287 =>  $16 - 10 \geq 2$

10288 => TRUE >>> Thermostat server changes its *SystemMode* to operate in 2<sup>nd</sup> stage or emergency heat mode

10289 The purpose of this attribute is to provide Thermostat clients the ability to configure rapid heating when a  
 10290 setpoint is of a specified amount greater than the measured temperature. This allows the heated space to be  
 10291 quickly heated to the desired level set by the user.

10292 **6.3.2.2.5 AC Information Attribute Set**

10293 **Table 6-28. Attributes of the AC Information Attribute Set**

<b>Id</b>	<b>Name</b>	<b>Type</b>	<b>Range</b>	<b>Access</b>	<b>Default</b>	<b>M/O</b>
0x0040	<i>ACType</i>	enum8	desc	RW	0	O
0x0041	<i>ACCapacity</i>	uint16	0x0000 – 0xffff	RW	0	O
0x0042	<i>ACRefrigerantType</i>	enum8	desc	RW	0	O
0x0043	<i>ACCompressorType</i>	enum8	desc	RW	0	O
0x0044	<i>ACErrorCode</i>	map32	0x00000000 – 0xffffffff	RW	0	O
0x0045	<i>ACLouverPosition</i>	enum8	desc	RW	0	O
0x0046	<i>ACCoilTemperature</i>	int16	0x954d – 0x7fff	R	FF	O
0x0047	<i>ACCapacityFormat</i>	enum8	desc	RW	0	O

10294 **6.3.2.2.5.1 ACType Attribute**

10295 Indicates the type of Mini Split *ACType* of Mini Split AC is defined depending on how Cooling and Heating  
 10296 condition is achieved by Mini Split AC.

10297 **Table 6-29. ACType Enumeration**

<b>Enumeration Field Value</b>	<b>Description</b>
0x00	Unknown <sup>128</sup>
0x01	Cooling and Fixed Speed

<sup>128</sup> CCB 2815

Enumeration Field Value	Description
0x02	Heat Pump and Fixed Speed
0x03	Cooling and Inverter
0x04	Heat Pump and Inverter

10298 **6.3.2.2.5.2 ACCapacity Attribute**

10299 Indicates capacity of Mini Split AC in terms of the format defined by the *ACCapacityFormat* attribute

10300 **6.3.2.2.5.3 ACRefrigerantType Attribute**

10301 Indicates type of refrigerant used within the Mini Split AC.

10302 **Table 6-30. ACRefrigerantType Enumeration**

Enumeration Field Value	Description
0x00	Unknown <sup>129</sup>
0x01	R22
0x02	R410a
0x03	R407c

10303

10304 **6.3.2.2.5.4 ACCompressorType Attribute**

10305 This indicates type of Compressor used within the Mini Split AC.

10306 **Table 6-31. ACCompressorType Enumeration**

Enumeration Field Value	Description
0x00	Unknown <sup>130</sup>
0x01	T1, Max working ambient 43 °C
0x02	T2, Max working ambient 35 °C
0x03	T3, Max working ambient 52 °C

10307 **6.3.2.2.5.5 ACErrorCode Attribute**

10308 This indicates the type of errors encountered within the Mini Split AC. Error values are reported with four  
10309 bytes values. Each bit within the four bytes indicates the unique error.

10310 **Table 6-32. ACErrorCode Values**

Bit	Value
0	Compressor Failure or Refrigerant Leakage

<sup>129</sup> CCB 2815

<sup>130</sup> CCB 2815



Bit	Value
1	Room Temperature Sensor Failure
2	Outdoor Temperature Sensor Failure
3	Indoor Coil Temperature Sensor Failure
4	Fan Failure

10311 **6.3.2.2.5.6 ACLouverPosition Attribute**

10312 This indicates the position of Louver on the AC. Attribute values are listed in Table 6-33.

10313 **Table 6-33. ACLouverPosition Values**

Louver Position Byte	Value
Fully Closed	0x01
Fully Open	0x02
Quarter Open	0x03
Half Open	0x04
Three Quarters Open	0x05

10314 **6.3.2.2.5.7 ACCoilTemperature Attribute**

10315 *ACCoilTemperature* represents the temperature in degrees Celsius, as measured locally or remotely (over the  
 10316 network) as follows:

- 10317 • *ACCoilTemperature* = 100 x temperature in degrees Celsius.
- 10318 • Where  $-273.15^{\circ}\text{C} \leq \text{temperature} \leq 327.67^{\circ}\text{C}$ , corresponding to an *ACCoilTemperature* in the range  
 10319 0x954d to 0x7fff.
- 10320 • The maximum resolution this format allows is 0.01 °C.
- 10321 • *ACCoilTemperature* of FFff indicates that the temperature measurement is invalid.

10322 **6.3.2.2.5.8 ACCapacityFormat Attribute**

10323 This is the format for the *ACCapacity* attribute.

10324 **Table 6-34. ACCapacity Enumeration**

Enumeration Field Value	Description
0x00	BTUh

10325 **6.3.2.3 Server Commands Received**

10326 The command IDs for the Thermostat cluster are listed in Table 6-35:

10327

**Table 6-35. Command IDs for the Thermostat Cluster**

Command Identifier Field Value	Description	M/O
0x00	Setpoint Raise/Lower	M
0x01	Set Weekly Schedule	O
0x02	Get Weekly Schedule	O
0x03	Clear Weekly Schedule	O
0x04	Get Relay Status Log	O

10328 **6.3.2.3.1 Setpoint Raise/Lower Command**10329 **6.3.2.3.1.1 Payload Format**

10330 The Setpoint Raise/Lower command payload SHALL be formatted as illustrated in Figure 6-4Format of the  
10331 Setpoint Raise/Lower Command Payload.

10332 **Figure 6-4. Format of the Setpoint Raise/Lower Command Payload**

<b>Bits</b>	8	8
<b>Data Type</b>	enum8	int8
<b>Field Name</b>	Mode	Amount

10333 **6.3.2.3.1.2 Mode Field**

10334 The mode field SHALL be set to one of the non-reserved values in Table 6-36. It specifies which setpoint is  
10335 to be configured. If it is set to auto, then both setpoints SHALL be adjusted.

10336 **Table 6-36. Mode Field Values for Setpoint Raise/Lower Command**

Mode Field Value	Description
0x00	Heat (adjust Heat Setpoint)
0x01	Cool (adjust Cool Setpoint)
0x02	Both (adjust Heat Setpoint and Cool Setpoint)

10337 **6.3.2.3.1.3 Amount Field**

10338 The amount field is a signed 8-bit integer that specifies the amount the setpoint(s) are to be increased (or  
10339 decreased) by, in steps of 0.1°C.

10340 **6.3.2.3.1.4 Effect on Receipt**

10341 The attributes for the indicated setpoint(s) SHALL be increased by the amount specified in the Amount field.

10342 **6.3.2.3.2 Set Weekly Schedule Command**10343 **6.3.2.3.2.1 Payload Format**

10344 The set weekly schedule command payload SHALL be formatted as shown in Figure 6-5 and Figure 6-6.

10345 **Figure 6-5. Set Weekly Schedule Command Payload Format (1 of 2)**

<b>Octets</b>	1(Header)	1(Header)	1(Header)	2	2/0	2/0
<b>Data Type</b>	uint8 <sup>131</sup>	map8	map8	uint16	int16	int16
<b>Field Name</b>	Number of Transitions for Sequence	Day of Week for Sequence	Mode for Sequence	Transition Time 1	Heat Set Point 1	Cool Set Point 1

10346 **Figure 6-6. Set Weekly Schedule Command Payload Format (2 of 2)**

<b>Octets</b>	Variable	2	2/0	2/0
<b>Data Type</b>	--	uint16	int16	int16
<b>Field Name</b>	--	Transition Time 10	Heat Set Point 10	Cool Set Point 10

10348 The set weekly schedule command is used to update the thermostat weekly set point schedule from a management system. If the thermostat already has a weekly set point schedule programmed then it SHOULD replace each daily set point set as it receives the updates from the management system. For example if the thermostat has 4 set points for every day of the week and is sent a Set Weekly Schedule command with one set point for Saturday then the thermostat SHOULD remove all 4 set points for Saturday and replace those with the updated set point but leave all other days unchanged. If the schedule is larger than what fits in one frame or contains more than 10 transitions, the schedule SHALL then be sent using multiple Set Weekly Schedule Commands.

10356 Each Set Weekly Schedule Command has 3 header bytes – Number of Transitions for Sequence, Day of Week for Sequence, and Mode for Sequence. The application SHALL decode the payload according to what has specified in the 3 header bytes.

10359 **6.3.2.3.2.2 Number of Transitions for Sequence**

10360 The Number of Transitions for Sequence field indicates how many individual transitions to expect for this sequence of commands. If a device supports more than 10 transitions in its schedule they can send this by sending more than 1 “Set Weekly Schedule” command, each containing the separate information that the device needs to set.

10364 **6.3.2.3.2.3 Day of Week for Sequence**

10365 This field represents the day of the week at which all the transitions within the payload of the command SHOULD be associated to. This field is a bitmap and therefore the associated set point could overlap onto multiple days (you could set one transition time for all “week days” or whatever combination of days the implementation requests). Table 6-37 displays the bitmap values.

10369 **Table 6-37. Day Of Week for Sequence Values**

Bit Number	Description
0	Sunday
1	Monday
2	Tuesday

<sup>131</sup> CCB 3029

Bit Number	Description
3	Wednesday
4	Thursday
5	Friday
6	Saturday
7	Away or Vacation

10370

10371 Each set point transition will begin with the day of week for this transition. There can be up to 10 transitions  
10372 for each command.

10373 **6.3.2.3.2.4 Mode for Sequence**

10374 This field determines how the application SHALL decode the Set Point Fields of each transition for the  
10375 remaining of the command. This field is a bitmap and the values are presented in Table 6-38.

10376

**Table 6-38. Mode for Sequence Values**

Bit Number	Description
0	Heat Setpoint Field Present in Payload
1	Cool Setpoint Field Present in Payload

10377 If the Heat Bit is On and the Cool Bit is Off, the Command SHALL be represented as in Figure 6-7 and  
10378 Figure 6-8.

10379

**Figure 6-7. Set Heat Weekly Schedule Command Payload Format (1 of 2)**

Octets	1(Header)	1(Header)	1(Header)	2	2
Data Type	enum8	map8	map8	uint16	int16
Field Name	Number of Transitions for Sequence	Day of Week for Sequence	0x01 (Heat)	Transition Time 1	Heat Set Point 1

10380  
10381

**Figure 6-8. Set Heat Weekly Schedule Command Payload Format (2 of 2)**

Octets	Variable	2	2
Data Type	--	uint16	int16
Field Name	--	Transition Time 10	Heat Set Point 10

10382

10383 If the Heat Bit is Off and the Cool Bit is On, the Command SHALL be represented as in Figure 6-9 and  
10384 Figure 6-10.

10385

**Figure 6-9. Set Cool Weekly Schedule Command Payload Format (1 of 2)**

<b>Octets</b>	1(Header)	1(Header)	1(Header)	2	2
<b>Data Type</b>	enum8	map8	map8	uint16	int16
<b>Field Name</b>	Number of Transitions for Sequence	Day of Week for Sequence	0x02 (Cool)	Transition Time 1	Cool Set Point 1

10386  
 10387

**Figure 6-10. Set Cool Weekly Schedule Command Payload Format (2 of 2)**

<b>Octets</b>	Variable	2	2
<b>Data Type</b>	--	uint16	int16
<b>Field Name</b>	--	Transition Time 10	Cool Set Point 10

10388

10389 If both the Heat Bit and the Cool Bit are On, the Command SHALL be represented as in Figure 6-11 and  
 10390 Figure 6-12.

10391

**Figure 6-11. Set Heat & Cool Weekly Schedule Command Payload Format (1 of 2)**

<b>Octets</b>	1(Header)	1(Header)	1(Header)	2	2	2
<b>Data Type</b>	enum8	map8	map8	uint16	int16	int16
<b>Field Name</b>	Number of Transitions for Sequence	Day of Week for Sequence	0x03 (Heat & Cool)	Transition Time 1	Heat Set Point 1	Cool Set Point 1

10392  
 10393

**Figure 6-12. Set Heat & Cool Weekly Schedule Command Payload Format (2 of 2)**

<b>Octets</b>	Variable	2	2	2
<b>Data Type</b>	--	uint16	int16	int16
<b>Field Name</b>	--	Transition Time 10	Heat Set Point 10	Cool Set Point 10

10394

10395 At least one of the bits in the Mode For Sequence byte SHALL be on.

10396 **6.3.2.3.2.5 Transition Time Field**

10397 This field represents the start time of the schedule transition during the associated day. The time will be  
 10398 represented by a 16 bits unsigned integer to designate the minutes since midnight. For example, 6am will be  
 10399 represented by 0x0168 (360 minutes since midnight) and 11:30pm will be represented by 0x0582 (1410  
 10400 minutes since midnight)

10401 **6.3.2.3.2.6 Heat Set Point Field**

10402 If the heat bit is enabled in the *Mode For Sequence* byte, this field represents the heat setpoint to be applied  
 10403 at this associated transition start time. The format of this attribute represents the temperature in degrees Cel-  
 10404 sium with 0.01 deg C resolution.

10405 **6.3.2.3.2.7 Cool Set Point Field**

10406 If the cool bit is enabled in the *Mode For Sequence* byte, this field represents the cool setpoint to be applied  
 10407 at this associated transition start time. The format of this attribute represents the temperature in degrees Cel-  
 10408 sius with 0.01 deg C resolution.

#### 10409 **6.3.2.3.2.8 Effect on Receipt**

10410 The weekly schedule for updating set points SHALL be stored in the thermostat and SHOULD begin at the  
 10411 time of receipt. A default response SHALL always be sent as a response. If the total number of transitions  
 10412 sent is greater than what the thermostat supports a default response of INSUFFICIENT\_SPACE (0x89)  
 10413 SHALL be sent in response to the last command sent for that transition sequence. If any of the set points sent  
 10414 in the entire sequence is out of range of what the thermostat supports (AbsMin/MaxSetPointLimit) then a  
 10415 default response of INVALID\_VALUE (0x87) SHALL be sent in return and the no set points from the entire  
 10416 sequence SHOULD be used. If the transitions could be added successfully a default response of SUC-  
 10417 CESS(0x00) SHALL be sent. Overlapping transitions is not allowed. If an overlap is detected and a default  
 10418 response of FAILURE(0x01) SHALL be sent. The Day of Week for Sequence and Mode for Sequence fields  
 10419 are defined as bitmask for the flexibility to support multiple days and multiple modes within one command.  
 10420 If thermostat cannot handle incoming command with multiple days and/or multiple modes within one com-  
 10421 mand, it SHALL send default response of INVALID\_FIELD (0x85) in return.

### 10422 **6.3.2.3.3 Get Weekly Schedule**

10423 **Figure 6-13. Format of the Get Weekly Schedule Command Payload**

<b>Octets</b>	1	1
<b>Data Type</b>	map8	map8
<b>Field Name</b>	Days To Return	Mode To Return

#### 10424 **6.3.2.3.3.1 Days To Return**

10425 This field indicates the number of days the client would like to return the set point values for and could be  
 10426 any combination of single days or the entire week. This field has the same format as the Day of Week for  
 10427 Sequence field in the **Set Weekly Schedule command**.

#### 10428 **6.3.2.3.3.2 Mode To Return**

10429 This field indicates the mode the client would like to return the set point values for and could be any combi-  
 10430 nation of heat only, cool only or heat&cool. This field has the same format as the Mode for Sequence field  
 10431 in the **Set Weekly Schedule command**.

#### 10432 **6.3.2.3.3.3 Effect on Receipt**

10433 When this command is received the unit SHOULD send in return the Get Weekly Schedule Response com-  
 10434 mand. The Days to Return and Mode to Return fields are defined as bitmask for the flexibility to support  
 10435 multiple days and multiple modes within one command. If thermostat cannot handle incoming command  
 10436 with multiple days and/or multiple modes within one command, it SHALL send default response of INVA-  
 10437 LID\_FIELD (0x85) in return.

### 10438 **6.3.2.3.4 Clear Weekly Schedule**

10439 The Clear Weekly Schedule command is used to clear the weekly schedule. The Clear weekly schedule has  
 10440 no payload.

#### 10441 **6.3.2.3.4.1 Effect on Receipt**

10442 When this command is received, all transitions currently stored SHALL be cleared and a default response of  
10443 SUCCESS (0x00) SHALL be sent in response. There are no error responses to this command.

### 10444 **6.3.2.3.5 Get Relay Status Log**

10445 The Get Relay Status Log command is used to query the thermostat internal relay status log. This command  
10446 has no payload.

10447 The log storing order is First in First Out (FIFO) when the log is generated and stored into the Queue.

10448 The first record in the log (i.e., the oldest) one, is the first to be replaced when there is a new record and there  
10449 is no more space in the log. Thus, the newest record will overwrite the oldest one if there is no space left.

10450 The log storing order is Last In First Out (LIFO) when the log is being retrieved from the Queue by a client  
10451 device.

10452 Once the "Get Relay Status Log Response" frame is sent by the Server, the "Unread Entries" attribute  
10453 SHOULD be decremented to indicate the number of unread records that remain in the queue.

10454 If the "Unread Entries" attribute reaches zero and the Client sends a new "Get Relay Status Log Request",  
10455 the Server MAY send one of the following items as a response:

10456 i) resend the last Get Relay Status Log Response

10457 or

10458 ii) generate new log record at the time of request and send Get Relay Status Log Response with the  
10459 new data

10460 For both cases, the "Unread Entries" attribute will remain zero.

10461

### 10462 **6.3.2.3.5.1 Effect on Receipt**

10463 When this command is received, the unit SHALL respond with Relay Status Log command if the relay status  
10464 log feature is supported on the unit.

## 10465 **6.3.2.4 Server Commands Sent**

10466 Table 6-39 shows the command sent by the server (received by the client).

10467

**Table 6-39. Server Commands Send Command ID**

<b>Command Identifier Field Value</b>	<b>Description</b>
0x00	Get Weekly Schedule Response
0x01	Get Relay Status Log Response

### 10468 **6.3.2.4.1 Get Weekly Schedule Response**

10469 This command has the same payload format as the Set Weekly Schedule. Please refer to the payload detail  
10470 in Section Set Weekly Schedule Command, Set Weekly Schedule Command, in this chapter.

10471 **6.3.2.4.2 Get Relay Status Log Response**

10472 This command is sent from the thermostat cluster server in response to the Get Relay Status Log. After the  
10473 Relay Status Entry is sent over the air to the requesting client, the specific entry will be cleared from the  
10474 thermostat internal log.

10475 **6.3.2.4.2.1 Payload Format**

10476 The relay status log command payload SHALL be formatted as shown in Figure 6-14.

10477 **Figure 6-14. Format of the Relay Status Log Payload**

<b>Octets</b>	2	2	2	1	2	2
<b>Data Type</b>	uint16	map8	int16	uint8	int16	uint16
<b>Field Name</b>	Time of Day	Relay Status	Local Temperature	Humidity in Percentage	Set Point	Unread Entries

10478 **6.3.2.4.2.2 Time of Day Field**

10479 Represents the sample time of the day, in minutes since midnight, when the relay status was captured for this  
10480 associated log entry. For example, 6am will be represented by 0x0168 (360 minutes since midnight) and  
10481 11:30pm will be represented by 0x0582 (1410 minutes since midnight).

10482 **6.3.2.4.2.3 Relay Status Field**

10483 Presents the relay status for thermostat when the log is captured. Each bit represents one relay used by the  
10484 thermostat. If the bit is on, the associated relay is on and active. Each thermostat manufacturer can create its  
10485 own mapping between the bitmask and the associated relay.

10486 **6.3.2.4.2.4 Local Temperature Field**

10487 Presents the local temperature when the log is captured. The format of this attribute represents the tempera-  
10488 ture in degrees Celsius with 0.01 deg C resolution.

10489 **6.3.2.4.2.5 Humidity Field**

10490 This field presents the humidity as a percentage when the log was captured.

10491 **6.3.2.4.2.6 Setpoint Field**

10492 Presents the target setpoint temperature when the log is captured. The format of this attribute represents the  
10493 temperature in degrees Celsius with 0.01 deg C resolution.

10494 **6.3.2.4.2.7 Unread Entries Field**

10495 This field presents the number of unread entries within the thermostat internal log system.

10496 **6.3.2.5 Attribute Reporting**

10497 This cluster SHALL support attribute reporting using the Report Attributes command and according to the  
10498 minimum and maximum reporting interval and reportable change settings described in Chapter 2, Foundation  
10499 and whenever they change. The following attributes SHALL be reported:

- 10500 • *LocalTemperature*
- 10501 • *PICoolingDemand*
- 10502 • *PIHeatingDemand*



10503 Other attributes MAY optionally be reported.

10504 **6.3.2.6 Scene Table Extensions**

10505 If the Scenes server cluster (see 3.7) is implemented, the following extension fields SHALL be added to the  
 10506 Scenes table in the given order, i.e., the attribute listed as 1 is added first:

- 10507 1) *OccupiedCoolingSetpoint*
- 10508 2) *OccupiedHeatingSetpoint*
- 10509 3) *SystemMode*

10510 **6.3.3 Client**

10511 The client has no specific dependencies nor specific attributes. The client cluster generates the commands  
 10512 received by the server cluster, as required by the application.

10513 **6.4 Fan Control**

---

10514 **6.4.1 Overview**

10515 Please see Chapter 2 for a general cluster overview defining cluster architecture, revision, classification,  
 10516 identification, etc.

10517 This cluster specifies an interface to control the speed of a fan as part of a heating / cooling system.

10518 **6.4.1.1 Revision History**

10519 The global *ClusterRevision* attribute value SHALL be the highest revision number in the table below.

Rev	Description
1	global mandatory <i>ClusterRevision</i> attribute added

10520 **6.4.1.2 Classification**

Hierarchy	Role	PICS Code	Primary Transaction
Base	Application	FAN	Type 1 (client to server)

10521 **6.4.1.3 Cluster Identifiers**

Identifier	Name
0x0202	Fan Control

10522 

## 6.4.2 Server

10523 

### 6.4.2.1 Attributes

10524 The Fan Control Status attribute set contains the attributes summarized in Table 6-40 Attributes of the Fan  
10525 Control Cluster.

10526 **Table 6-40. Attributes of the Fan Control Cluster**

Identifier	Name	Type	Range	Access	Default	M/O
0x0000	<i>FanMode</i>	enum8	0x00 – 0x06	RW	0x05 (auto)	M
0x0001	<i>FanModeSequence</i>	enum8	0x00 – 0x04	RW	0x02	M

10527 

#### 6.4.2.1.1 *FanMode* Attribute

10528 The *FanMode* attribute is an 8-bit value that specifies the current speed of the fan. It SHALL be set to one of  
10529 the nonreserved values in Table 6-41:

10530

10531

**Table 6-41. *FanMode* Attribute Values**

Value	Description
0x00	Off
0x01	Low
0x02	Medium
0x03	High
0x04	On
0x05	Auto (the fan speed is self-regulated)
0x06	Smart (when the heated/cooled space is occupied, the fan is always on)

10532 Note that for Smart mode, information must be available as to whether the heated/cooled space is occupied.  
10533 This MAY be accomplished by use of the Occupancy Sensing cluster (see 4.8).

10534 

#### 6.4.2.1.2 *FanModeSequence* Attribute

10535 The *FanModeSequence* attribute is an 8-bit value that specifies the possible fan speeds that the thermostat  
10536 can set. It SHALL be set to one of the non-reserved values in Table 6-42 *FanSequenceOperatio*. (**Note:**  
10537 'Smart' is not in this table, as this mode resolves to one of the other modes depending on occupancy).

10538

**Table 6-42. *FanSequenceOperation* Attribute Values**

Attribute Value	Description
0x00	Low/Med/High
0x01	Low/High

Attribute Value	Description
0x02	Low/Med/High/Auto
0x03	Low/High/Auto
0x04	On/Auto

10539 **6.4.2.2 Commands**

10540 No cluster specific commands are generated or received by the server.

10541 **6.4.3 Client**

10542 The Client cluster has no specific attributes. No cluster specific commands are received by the server. No  
 10543 cluster specific commands are generated by the server.

10544 **6.5 Dehumidification Control**

---

10545 **6.5.1 Overview**

10546 This cluster provides an interface to dehumidification functionality.

10547 **6.5.1.1 Revision History**

10548 The global *ClusterRevision* attribute value SHALL be the highest revision number in the table below.

Rev	Description
1	global mandatory <i>ClusterRevision</i> attribute added

10549 **6.5.1.2 Classification**

Hierarchy	Role	PICS Code	Primary Transaction
Base	Application	DHUM	Type 1 (client to server)

10550 **6.5.1.3 Cluster Identifiers**

Identifier	Name
0x0203	Dehumidification Control

10551 **6.5.2 Server**10552 **6.5.2.1 Attributes**

10553 For convenience, the attributes defined in this specification are arranged into sets of related attributes; each  
 10554 set can contain up to 16 attributes. Attribute identifiers are encoded such that the most significant nibble  
 10555 specifies the attribute set and the least significant nibble specifies the attribute within the set. The currently  
 10556 defined attribute set for the dehumidification control cluster is listed in Table 6-43.

10557 **Table 6-43. Dehumidification Control Attribute Sets**

Attribute Set Identifier	Description
0x000	Dehumidification Information
0x001	Dehumidification Settings

10558 **6.5.2.1.1 Dehumidification Information Attribute Set**

10559 The Dehumidification Information attribute set contains the attributes summarized in Table  
 10560 6-44 Dehumidification Information Attribute Set.

10561 **Table 6-44. Dehumidification Information Attribute Set**

Id	Name	Type	Range	Acc	Def	M/O
0x0000	<i>RelativeHumidity</i>	uint8	0x00 – 0x64	R	-	O
0x0001	<i>DehumidificationCooling</i>	uint8	0 - <i>DehumidificationMaxCool</i>	RP	-	M

10562 **6.5.2.1.1.1 RelativeHumidity Attribute**

10563 The *RelativeHumidity* attribute is an 8-bit value that represents the current relative humidity (in %) measured  
 10564 by a local or remote sensor. The valid range is 0x00 – 0x64 (0% to 100%).

10565 **6.5.2.1.1.2 DehumidificationCooling Attribute**

10566 The *DehumidificationCooling* attribute is an 8-bit value that specifies the current dehumidification cooling  
 10567 output (in %). The valid range is 0 to *DehumidificationMaxCool*.

10568 **6.5.2.1.2 Dehumidification Settings Attribute Set**

10569 The Dehumidification Settings attribute set contains the attributes summarized in the table below:

10570 **Table 6-45. Dehumidification Settings Attribute Set**

Identifier	Name	Type	Range	Access	Default	M/O
0x0010	<i>RHDehumidificationSet-point</i>	uint8	0x1E – 0x64	RW	0x32	M
0x0011	<i>RelativeHumidityMode</i>	enum8	0x00 – 0x01	RW	0x00	O
0x0012	<i>DehumidificationLockout</i>	enum8	0x00 – 0x01	RW	0x01	O

Identifier	Name	Type	Range	Access	Default	M/O
0x0013	<i>DehumidificationHysteresis</i>	uint8	0x02 – 0x14	RW	0x02	M
0x0014	<i>DehumidificationMaxCool</i>	uint8	0x14 – 0x64	RW	0x14	M
0x0015	<i>RelativeHumidityDisplay</i>	enum8	0x00 – 0x01	RW	0x00	O

10571 **6.5.2.1.2.1 RHDehumidificationSetpoint Attribute**

10572 The *RHDehumidificationSetpoint* attribute is an 8-bit value that represents the relative humidity (in %) at  
 10573 which dehumidification occurs. The valid range is 0x1E – 0x64 (30% to 100%).

10574 **6.5.2.1.2.2 RelativeHumidityMode Attribute**

10575 The *RelativeHumidityMode* attribute is an 8-bit value that specifies how the *RelativeHumidity* value is being  
 10576 updated. It SHALL be set to one of the values below:

10577 **Table 6-46. RelativeHumidityMode Attribute Values**

Attribute Value	Description
0x00	<i>RelativeHumidity</i> measured locally
0x01	<i>RelativeHumidity</i> updated over the network

10578 **6.5.2.1.2.3 DehumidificationLockout Attribute**

10579 The *DehumidificationLockout* attribute is an 8-bit value that specifies whether dehumidification is allowed  
 10580 or not. It SHALL be set to one of the values below:

10581 **Table 6-47. DehumidificationLockout Attribute Values**

Attribute Value	Description
0x00	Dehumidification is not allowed.
0x01	Dehumidification is allowed.

10582 **6.5.2.1.2.4 DehumidificationHysteresis Attribute**

10583 The *DehumidificationHysteresis* attribute is an 8-bit value that specifies the hysteresis (in %) associated with  
 10584 *RelativeHumidity* value. The valid range is 0x02 – 0x14 (2% to 20%).

10585 **6.5.2.1.2.5 DehumidificationMaxCool Attribute**

10586 The *DehumidificationMaxCool* attribute is an 8-bit value that specifies the maximum dehumidification cool-  
 10587 ing output (in %). The valid range is 0x14 – 0x64 (20% to 100%).

10588 **6.5.2.1.2.6 RelativeHumidityDisplay Attribute**

10589 The *RelativeHumidityDisplay* attribute is an 8-bit value that specifies whether the *RelativeHumidity* value is  
 10590 displayed to the user or not. It SHALL be set to one of the non-reserved values in Table 6-48.

10591

**Table 6-48. *RelativeHumidityMode* Attribute Values**

Attribute Value	Description
0x00	<i>RelativeHumidity</i> is not displayed
0x01	<i>RelativeHumidity</i> is displayed

10592 **6.5.2.2 Commands**

10593 No cluster specific commands are generated or received by the server.

10594 **6.5.2.3 Attribute Reporting**

10595 This cluster SHALL support attribute reporting using the Report Attributes command and according to the  
10596 minimum and maximum reporting interval settings described in the ZCL Foundation specification.

10597 The following attribute SHALL be reported: *DehumidificationCooling*

10598 This attribute SHALL also be reported whenever it changes (a minimum change is 1%).

10599 Reports of this attribute MAY be used to control a remote dehumidifier device.

10600 **6.5.3 Client**

10601 The client has no dependencies or attributes and there are no cluster specific commands defined.

10602 **6.6 Thermostat User Interface Configuration**

---

10603 **6.6.1 Overview**

10604 Please see Chapter 2 for a general cluster overview defining cluster architecture, revision, classification,  
10605 identification, etc.

10606 This cluster provides an interface to allow configuration of the user interface for a thermostat, or a thermostat  
10607 controller device, that supports a keypad and LCD screen.

10608 **6.6.1.1 Revision History**

10609 The global *ClusterRevision* attribute value SHALL be the highest revision number in the table below.

Rev	Description
1	global mandatory <i>ClusterRevision</i> attribute added

10610 **6.6.1.2 Classification**

Hierarchy	Role	PICS Code	Primary Transaction
Base	Application	TSUIC	Type 1 (client to server)

10611 **6.6.1.3 Cluster Identifiers**

Identifier	Name
0x0204	Thermostat User Interface Configuration

10612 **6.6.2 Server**

10613 **6.6.2.1 Attributes**

10614 The attributes of this cluster are summarized in Table 6-49.

10615 **Table 6-49. Thermostat User Interface Configuration Cluster**

Id	Name	Type	Range	Access	Default	M/O
0x0000	<i>TemperatureDisplayMode</i>	enum8	0x00 – 0x01	RW	0x00 (Celsius)	M
0x0001	<i>KeypadLockout</i>	enum8	0x00 – 0x05	RW	0x00 (no lockout)	M
0x0002	<i>ScheduleProgrammingVisibility</i>	enum8	0x00 – 0x01	RW	0x00	O

10616 **6.6.2.1.1 TemperatureDisplayMode Attribute**

10617 The *TemperatureDisplayMode* attribute specifies the units of the temperature displayed on the thermostat  
 10618 screen. This attribute SHALL be set to one of the non-reserved values in Table 6-50.

10619 **Table 6-50. DisplayMode Attribute Values**

Attribute Value	Description
0x00	Temperature in °C
0x01	Temperature in °F

10620 **6.6.2.1.2 KeypadLockout Attribute**

10621 The *KeypadLockout* attribute specifies the level of functionality that is available to the user via the keypad.  
 10622 This attribute SHALL be set to one of the non-reserved values Table 6-51*KeypadLockout*.

10623 **Table 6-51. KeypadLockout Attribute Values**

Attribute Value	Description
0x00	No lockout
0x01	Level 1 lockout
0x02	Level 2 lockout
0x03	Level 3 lockout
0x04	Level 4 lockout

Attribute Value	Description
0x05	Level 5 lockout (least functionality available to the user)

10624  
10625 The interpretation of the various levels is device-dependent.

### 10626 6.6.2.1.3 ScheduleProgrammingVisibility Attribute

10627 The *ScheduleProgrammingVisibility* attribute is used to hide the weekly schedule programming functionality  
10628 or menu on a thermostat from a user to prevent local user programming of the weekly schedule. The schedule  
10629 programming MAY still be performed via a remote interface, and the thermostat MAY operate in schedule  
10630 programming mode.

10631 This command is designed to prevent local tampering with or disabling of schedules that MAY have been  
10632 programmed by users or service providers via a more capable remote interface. The programming schedule  
10633 SHALL continue to run even though it is not visible to the user locally at the thermostat.

10634 It SHALL be set to one of the non-reserved values in Table 6-52.

10635 **Table 6-52. ScheduleProgrammingVisibility Attribute Values**

<i>ScheduleProgrammingVisibility</i> Attribute Value	Description
0x00	Local schedule programming functionality is enabled at the thermostat
0x01	Local schedule programming functionality is disabled at the thermostat

### 10636 6.6.2.2 Commands

10637 No cluster specific commands are generated or received by the server.

### 10638 6.6.2.3 Sample Conversion Code

10639 Sample code provided to ensure consistent Fahrenheit to Celsius and vice-versa conversion between devices  
10640 and across vendors.

```

10641 For degF: the value is a int8u representing 2x temperature
10642 value in Farenheit (to get 0.5 resolution).
10643 For degC: the value is a int16s representing Celsius in
10644 0.01 resolution as expected by the ZCL format.
10645 /*
10646  * Function : translateZclTemp()
10647  * Description : Converts the temperature setpoints in ZCL
10648  * to the half degF format.
10649  * The half degF format is 8-bit unsigned,
10650  * and represents 2x temperature value in
10651  * Farenheit (to get 0.5 resolution).
10652  * The format used in ZCL is 16-bit signed
10653  * in Celsius and multiplied by 100
10654  * to get 0.01 resolution.
10655  * e.g. 2500(25.00 deg C) ---> 0x9A (77 deg F)
10656  * Input Para : Temperature in ZCL (degC)format
10657  * Output Para: Temperature in half DegF format

```



```

10658  */
10659  int8u translateZclTemp(int16s temperature)
10660  {
10661      int32s x = temperature;
10662      //rearrangement of
10663      // = (x * (9/5) / 100 + 32) * 2;
10664      // the added 250 is for proper rounding.
10665      // a rounding technique that only works
10666      // with positive numbers
10667
10668      return (int8u) ((x*9*2 + 250)/ (5*100) + 64);
10669  }
10670
10671  /*
10672  * Function   : translateDegFTemp
10673  * Description : Converts the temperature in DegF
10674  * protocol to the format
10675  * expected by the cluster attribute
10676  * Measured Value in the
10677  * Temperature Measurement
10678  * Information Attribute Set.
10679  * The half deg F format is 8-bit
10680  * unsigned, and represents
10681  * 2x temperature value in
10682  * Farenheit (to get 0.5 resolution).
10683  * The format expected by cluster
10684  * is 16-bit signed in Celsius and
10685  * multiplied by 100 to get
10686  * 0.01 resolution.
10687  * e.g. 0x9A(77 deg F) ---> 2500 (25.00 deg C)
10688  * Input Para : temperature in DegF format
10689  * Output Para: temperature in ZCL format
10690  */
10691  int16s translateDegFTemp(int8u temperature)
10692  {
10693      int32s x = temperature;
10694
10695      // rearrangement of
10696      // = 100 * (x/2 - 32) * 5/9
10697      // *1000 (should be 100), +90, then /10,
10698      // is for rounding.
10699
10700      return (int16s) (((x - 64)*5*1000 + 90) / (10*2*9));
10701  }

```

### 10702 **6.6.3 Client**

10703 The client has no dependencies or cluster specific attributes and there are no cluster specific commands de-  
 10704 fined.



10705

## CHAPTER 7 CLOSURES

10706  
10707  
10708  
10709

The Cluster Library is made of individual chapters such as this one. See Document Control in the Cluster Library for a list of all chapters and documents. References between chapters are made using a *X.Y* notation where *X* is the chapter and *Y* is the sub-section within that chapter. References to external documents are contained in Chapter 1 and are made using [*Rn*] notation.

10710

### 7.1 General Description

10711

#### 7.1.1 Introduction

10712  
10713

The clusters specified in this document are for use typically in applications involving closures (e.g., shades, windows, doors), but MAY be used in any application domain.

10714

#### 7.1.2 Cluster List

10715  
10716

This section lists the clusters specified in this document, and gives examples of typical usage for the purpose of clarification.

10717

The clusters defined in this document are listed in Table 7-1.

10718

**Table 7-1. Clusters Specified in the Closures Functional Domain**

Cluster ID	Cluster Name	Description
0x0100	Shade Configuration	Attributes and commands for configuring a shade
0x0101	Door Lock	An interface to a generic way to secure a door
0x0102	Window Covering	Commands and attributes for controlling a window covering

10719

10720

Figure 7-1. Typical Usage of the Closures Clusters

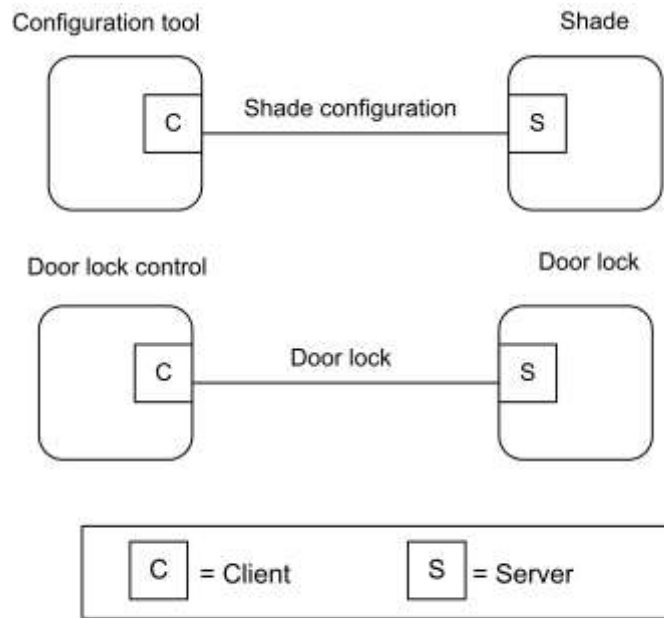

10721

*Note: Device names are examples for illustration purposes only*

10722

## 7.2 Shade Configuration

10723

### 7.2.1 Overview

10724 Please see Chapter 2 for a general cluster overview defining cluster architecture, revision, classification,  
10725 identification, etc.

10726 This cluster provides an interface for reading information about a shade, and configuring its open and closed  
10727 limits.

10728

#### 7.2.1.1 Revision History

10729 The global *ClusterRevision* attribute value SHALL be the highest revision number in the table below.

Rev	Description
1	mandatory global <i>ClusterRevision</i> attribute added

10730

#### 7.2.1.2 Classification

Hierarchy	Role	PICS Code	Primary Transaction
Base	Application	SHDCFG	Type 2 (server to client)

10731 **7.2.1.3 Cluster Identifiers**

Identifier	Name
0x0100	Shade Configuration

10732 **7.2.2 Server**

10733 **7.2.2.1 Attributes**

10734 For convenience, the attributes defined in this specification are arranged into sets of related attributes; each  
 10735 set can contain up to 16 attributes. Attribute identifiers are encoded such that the most significant three nib-  
 10736 bles specify the attribute set and the least significant nibble specifies the attribute within the set. The currently  
 10737 defined attribute sets are listed in Table 7-2.

Table 7-2. Shade Configuration Attribute Sets

Attribute Set Identifier	Description
0x000	Shade information
0x001	Shade settings

10739 **7.2.2.1.1 Shade Information Attribute Set**

10740 The Shade Information attribute set contains the attributes summarized in Table 7-3.

Table 7-3. Attributes of the Shade Information Attribute Set

Id	Name	Type	Range	Access	Default	M/O
0x0000	<i>PhysicalClosedLimit</i>	uint16	0x0001 – 0xffff	R	-	O
0x0001	<i>MotorStepSize</i>	uint8	0x00 – 0xfe	R	-	O
0x0002	<i>Status</i>	map8	0000 xxxx	RW	0000 0000	M

10742 **7.2.2.1.1.1 PhysicalClosedLimit Attribute**

10743 The *PhysicalClosedLimit* attribute indicates the most closed (numerically lowest) position that the shade can  
 10744 physically move to. This position is measured in terms of steps of the motor, taking the physical most open  
 10745 position of the shade as zero.

10746 This attribute is for installation informational purposes only.

10747 The value 0xffff indicates an invalid or unknown *PhysicalClosedLimit*.

10748 **7.2.2.1.1.2 MotorStepSize Attribute**

10749 The *MotorStepSize* attribute indicates the angle the shade motor moves for one step, measured in 1/10ths of  
 10750 a degree.

10751 This attribute is for installation informational purposes only.

10752 The value 0xff indicates an invalid or unknown step size.

10753 **7.2.2.1.1.3 Status Attribute**

10754 The *Status* attribute indicates the status of a number of shade functions, as shown in Table 7-4. Writing a  
10755 value to this attribute only affects those bits with Read/Write access.

10756 **Table 7-4. Bit Values for the *Status* Attribute**

Bit Number	Meaning	Access
0	Shade operational 0 = no 1 = yes	R
1	Shade adjusting 0 = no 1 = yes	R
2	Shade direction 0 = closing 1 = opening	R
3	Direction corresponding to forward direction of motor 0 = closing 1 = opening	RW

10757 **7.2.2.1.2 Shade Settings Attribute Set**

10758 The Shade Settings attribute set contains the attributes summarized in Table 7-5.

10759 **Table 7-5. Attributes of the Shade Settings Attribute Set**

Id	Name	Type	Range	Access	Default	M/O
0x0010	<i>ClosedLimit</i>	uint16	0x0001 – 0xfffe	RW	0x0001	M
0x0011	<i>Mode</i>	enum8	0x00 – 0xfe	RW	0x00	M

10760 **7.2.2.1.2.1 ClosedLimit Attribute**

10761 The *ClosedLimit* attribute indicates the most closed position that the shade can move to. This position is  
10762 measured in terms of steps of the motor, taking the physical most open position of the shade as zero. This  
10763 attribute is set either by directly writing it, or by the following method.

10764 When the Mode attribute is set to Configure, the shade is opening, and either the shade is stopped or it reaches  
10765 its physical most open limit (if there is one – the motor MAY continue to turn at the top), the zero point for  
10766 the motor-step measurement system is set to the current position of the shade.

10767 When the Mode attribute is set to Configure, the shade is closing, and either the shade is stopped or it reaches  
10768 its physical closed limit, the *ClosedLimit* attribute is set to the current position of the shade, relative to the  
10769 zero point set as described above.

10770 **7.2.2.1.2.2 Mode Attribute**

10771 The *Mode* attribute indicates the current operating mode of the shade, as shown in Table 7-6. The value 0xff  
10772 indicates an invalid or unknown mode.

10773 **Table 7-6. Values of the Mode Attribute**

Attribute Value	Meaning
0x00	Normal
0x01	Configure

10774 In configure mode, the *ClosedLimit* attribute MAY be set as described above.

### 10775 **7.2.2.2 Commands**

10776 No cluster specific commands are generated or received by the server.

### 10777 **7.2.3 Client**

10778 The client has no specific attributes and there are no cluster specific commands to receive or generate.

## 10779 **7.3 Door Lock**

---

### 10780 **7.3.1 Overview**

10781 Please see Chapter 2 for a general cluster overview defining cluster architecture, revision, classification,  
 10782 identification, etc.

10783 The door lock cluster provides an interface to a generic way to secure a door. The physical object that pro-  
 10784 vides the locking functionality is abstracted from the cluster. The cluster has a small list of mandatory attrib-  
 10785 utes and functions and a list of optional features.

#### 10786 **7.3.1.1 Revision History**

10787 The global *ClusterRevision* attribute value SHALL be the highest revision number in the table below.

Rev	Description
1	mandatory global <i>ClusterRevision</i> attribute added; CCB 1811 1812 1821
2	CCB 2430
3	CCB 2629 2630

#### 10788 **7.3.1.2 Classification**

Hierarchy	Role	PICS Code	Primary Transaction
Base	Application	DRLK	Type 2 (server to client)

#### 10789 **7.3.1.3 Cluster Identifiers**

Identifier	Name
0x0101	Door Lock

### 10790 **7.3.2 Server**

10791 Generally the door lock itself implements the server side of this cluster. The attributes and commands listed  
 10792 in this cluster were developed to be implemented by a door lock which has the ability to keep track of multiple  
 10793 users and schedules.

## 10794 7.3.2.1 Alarms, Reports, and Events

10795 A door lock implementing all of the optional features provided in this cluster has the ability to push data to a  
10796 controller in three different forms, Alarms, Reports and Events. Alarms are used to report critical states on  
10797 the door lock. Reports are used to inform a subscribed device of changes of state in specific attributes on the  
10798 lock. Events are used to inform a bound device about changes in state related to the operation and program-  
10799 ming of the door lock. Event commands are sent to a binding. Examples of events are locking and unlocking  
10800 the lock and adding or deleting a user on the lock.

### 10801 7.3.2.1.1 Alarms

10802 The door lock cluster provides several alarms which can be sent when there is a critical state on the door  
10803 lock. The alarms available for the door lock cluster are listed in the section below outlining the alarm mask  
10804 attribute. The Alarm cluster is used to generate the actual alarms.

10805 **Alarm example:** If the first bit of the attribute Alarm Mask is set, any device that is bound to the alarm  
10806 cluster will be informed each time the deadbolt becomes jammed. If for some reason the door lock became  
10807 jammed, the door lock would send an alarm command from the alarms cluster with the payload illustrated in  
10808 Figure 7-2.

10809 **Figure 7-2. Format of the Alarm Cluster**

Octets	1	2
Data Type	enum8	Cluster ID
Field Name	Alarm Code	Cluster Identifier
Field Value	0x00	0x0101

### 10810 7.3.2.1.2 Reports

10811 The reporting mechanism within the ZCL can be used to subscribe to changes in a specific attribute within  
10812 the door lock.

10813 **Report example:** If an application wants to know each time a programming change is made on the door lock,  
10814 it can use the reporting mechanism to be informed of changes to the Operating Mode attribute. Each time the  
10815 Operating Mode changes to programming mode, the application will be informed and can then sync its  
10816 knowledge of user data to make sure that it has an up to date record of user the users supported on the door  
10817 lock.

### 10818 7.3.2.1.3 Events

10819 The event mechanism described within this document is unique to the Door Lock Cluster and was designed  
10820 specifically for this cluster and no other. It is in part modeled on similar mechanisms in other clusters such  
10821 as the load control events in the Demand Response and Load Control cluster in Smart Energy (DRLC).

10822 The event mechanism in the door lock centers on the transmission of two commands autonomously generated  
10823 by the server and sent to a bound device. The assumption is that the binding mechanism will be used to  
10824 commission the server to send these commands.

10825 There are two types of events on the door lock, operational and programmatic. Operational events relate to  
10826 the general operation of the door lock, when it locks and unlocks for instance. The programmatic events  
10827 relate to the programming of the door lock, for example when users are added or modified via the keypad.

10828 Events are transmitted using two server commands, the Operation Event Notification Command and Pro-  
10829 gramming Event Notification Command.



10830 A primary key uniquely identifies each event. The key consists of the event’s type (operation, programming  
10831 etc...), source (keypad, RF, manual, etc...) and event code. The event mask bit that matches its type, source  
10832 and event code controls the generation of each event. A complete list of events is included in the description  
10833 of their commands along with the specific attribute and bit that control their generation.

### 10834 **7.3.2.2 Door Lock Security**

10835 *The following functionality has not been validated at a Specification Validation Event and is therefore con-*  
10836 *sidered provisional.*

10837 Door locks have the ability to require the use of APS encryption for sending and receiving of all cluster  
10838 messages. The Security Level attribute is used to specify the type of encryption required by the door lock.

10839 The APS key MUST be unique to the door lock device to provide the enhanced security needed. Therefore,  
10840 if APS security setting is selected, the device SHALL use a randomly generated install code to generate the  
10841 unique APS link key to join to the network and use this unique APS link key to encryption all Door Lock  
10842 Cluster, Group Cluster, Scene Cluster messages.

10843 The hashing method used to convert install code into APS link key is AES-MMO.

10844 It SHOULD be noted that for the device with unique APS link key to join successfully to the network, the  
10845 Trust Center will need to have a method for the user/installer to input the unique install code for the device.

10846 Note that the security setting will only take effect when the device is not part of a network. If the user modifies  
10847 the Security Level setting while the device is part of a network, the setting will not be applied until the device  
10848 leaves the network and commissions to a network again.

### 10849 **7.3.2.3 Time**

10850 There are various references to the LocalTime within this cluster specification.

10851 LocalTime (32-bit unsigned integer) represents the number of seconds since January 1 2000, in the local zone  
10852 with time saving adjusted.

### 10853 **7.3.2.4 PIN/RFID Code Format**

10854 The PIN/RFID codes defined in this specification are all in ZCL OCTET STRING format. The first octet in  
10855 the string specifies the number of octets contained in the remaining of the data field not including itself.

10856 All value in the PIN/RFID code SHALL be ASCII encoded regardless if the PIN/RFID codes are number or  
10857 characters. For example, code of “1, 2, 3, 4” SHALL be represented as 0x31, 0x32, 0x33, 0x34.

### 10858 **7.3.2.5 Process for Creating a New User with Schedule**

10859 The following is the process that the client device SHALL follow for creating a new user with weekday  
10860 schedule or yearday schedule.<sup>132</sup>

10861 9. Set Pin Code

10862 10. Set Weekday Schedule or Set Yearday Schedule

10863 11. Set User Type to the desired schedule user type.

---

<sup>132</sup> CCB 2629 removed that this multi-message client process be atomic

10864 **7.3.2.6 Process for Clearing All Schedules for a User**

10865 The following is the process that the client device SHALL follow for clearing all weekday schedule or all  
10866 yearday schedule for a user. <sup>133</sup>

10867 12. Clear All Weekday Schedule or Clear All Yearday Schedule

10868 13. Set User Type to the Unrestricted User Type

10869 **Note:** If the User Type is not reset to Unrestricted User, the associated user Code (ex: PIN/RFID) will not  
10870 have access.

10871 **7.3.2.7 Clarification of Changing the User Type**

10872 When the user type is changed from a scheduled user to some other user type, the door lock server MAY  
10873 remove the user's schedule.

10874 **7.3.2.8 Clarification for Changing the User Code**

10875 When changing the user code, the server SHALL not require that the user code be removed first.

10876 **7.3.2.9 Server Attributes**

10877 For convenience, the attributes defined in this specification are arranged into sets of related attributes; each  
10878 set can contain up to 16 attributes. Attribute identifiers are encoded such that the most significant three nib-  
10879 bles specify the attribute set and the least significant nibble specifies the attribute within the set. The currently  
10880 defined attribute sets for Door Lock Cluster Server are listed in Table 7-7.

10881

Table 7-7. Attribute Sets Description

Attribute Set	Identifier Description
0x0000 – 0x000F	Basic Information Attribute Set
0x0010 – 0x001F	User, PIN, Schedule Information Attribute Set
0x0020 – 0x002F	Operational Settings Attribute Set
0x0030 – 0x003F	Security Settings Attribute Set
0x0040 – 0x004F	Alarm and Event Masks Attribute Set

10882 **7.3.2.10 Basic Information Attribute Set**

10883

Table 7-8. Current Information Attribute Set

Identifier	Name	Type	Access	Def	M/O
0x0000	<i>LockState</i>	enum8	RP	-	M
0x0001	<i>LockType</i>	enum8	R	-	M
0x0002	<i>ActuatorEnabled</i>	bool	R	-	M

<sup>133</sup> CCB 2629 removed that this multi-message client process be atomic

Identifier	Name	Type	Access	Def	M/O
0x0003	<i>DoorState</i>	enum8	RP	-	O
0x0004	<i>DoorOpenEvents</i>	uint32	RW	-	O
0x0005	<i>DoorClosedEvents</i>	uint32	RW	-	O
0x0006	<i>OpenPeriod</i>	uint16	RW	-	O

10884 **7.3.2.10.1 LockState Attribute**

10885 This attribute has the following possible values:

10886

**Table 7-9. LockState Attribute Values**

Value	Definition
0x00	Not fully locked
0x01	Locked
0x02	Unlocked
0xFF	Undefined

10887

10888 **7.3.2.10.2 LockType Attribute**

10889 The *LockType* attribute is indicated by an enumeration:

10890

**Table 7-10. LockType Attribute Values**

Value	Definition
0x00	Dead bolt
0x01	Magnetic
0x02	Other
0x03	Mortise
0x04	Rim
0x05	Latch Bolt
0x06	Cylindrical Lock
0x07	Tubular Lock
0x08	Interconnected Lock
0x09	Dead Latch

Value	Definition
0x0A	Door Furniture

10891 **7.3.2.10.3 ActuatorEnabled Attribute**

10892 The ActuatorEnabled attribute indicates if the lock is currently able to (Enabled) or not able to (Disabled)  
10893 process remote Lock, Unlock, or Unlock with Timeout commands.<sup>134</sup>

10894 This attribute has the following possible values:

10895 **Table 7-11. ActuatorEnabled Attribute Values**

Boolean Value	Definition
0	Disabled
1	Enabled

10896 **7.3.2.10.4 DoorState Attribute**

10897 This attribute has the following possible values:

10898 **Table 7-12. DoorState Attribute Values**

Value	Definition
0x00	Open
0x01	Closed
0x02	Error (jammed)
0x03	Error (forced open)
0x04	Error (unspecified)
0xFF	Undefined

10899 **7.3.2.10.5 DoorOpenEvents Attribute**

10900 This attribute holds the number of door open events that have occurred since it was last zeroed.

10901 **7.3.2.10.6 DoorClosedEvents Attribute**

10902 This attribute holds the number of door closed events that have occurred since it was last zeroed.

<sup>134</sup> CCB 2630

10903 **7.3.2.10.7 OpenPeriod Attribute**

10904 This attribute holds the number of minutes the door has been open since the last time it transitioned from  
 10905 closed to open.

10906 **7.3.2.11 User, PIN, Schedule, Log Information Attribute**  
 10907 **Set**

10908 **Table 7-13. User, PIN, Schedule, Log Information Attribute Set**

<b>Id</b>	<b>Description</b>	<b>Type</b>	<b>Access</b>	<b>Def</b>	<b>M/O</b>
0x0010	<i>NumberOfLogRecordsSupported</i>	uint16	R	0	O
0x0011	<i>NumberOfTotalUsersSupported</i>	uint16	R	0	O
0x0012	<i>NumberOfPINUsersSupported</i>	uint16	R	0	O
0x0013	<i>NumberOfRFIDUsersSupported</i>	uint16	R	0	O
0x0014	<i>NumberOfWeekDaySchedulesSupportedPerUser</i>	uint8	R	0	O
0x0015	<i>NumberOfYearDaySchedulesSupportedPerUser</i>	uint8	R	0	O
0x0016	<i>NumberOfHolidaySchedulesSupported</i>	uint8	R	0	O
0x0017	<i>MaxPINCodeLength</i>	uint8	R	0x08	O
0x0018	<i>MinPINCodeLength</i>	uint8	R	0x04	O
0x0019	<i>MaxRFIDCodeLength</i>	uint8	R	0x14	O
0x001A	<i>MinRFIDCodeLength</i>	uint8	R	0x08	O

10909 **7.3.2.11.1 NumberOfLogRecordsSupported Attribute**

10910 The number of available log records.

10911 **7.3.2.11.2 NumberOfTotalUsersSupported Attribute**

10912 Number of total users supported by the lock. This value is equal to the higher one of [# of PIN Users Sup-  
 10913 ported] and [# of RFID Users Supported]

10914 **7.3.2.11.3 NumberOfPINUsersSupported Attribute**

10915 The number of PIN users supported.

10916 **7.3.2.11.4 NumberOfRFIDUsersSupported Attribute**

10917 The number of RFID users supported.

10918 **7.3.2.11.5 NumberOfWeekDaySchedulesSupportedPerUser Attribute**  
10919

10920 The number of configurable week day schedule supported per user.

10921 **7.3.2.11.6 NumberOfYearDaySchedulesSupportedPerUser Attribute**  
10922

10923 The number of configurable year day schedule supported per user.

10924 **7.3.2.11.7 NumberOfHolidaySchedulesSupported Attribute**

10925 The number of holiday schedules supported for the entire door lock device.

10926 **7.3.2.11.8 MaxPINCodeLength Attribute**

10927 An 8 bit value indicates the maximum length in bytes of a PIN Code on this device. The default is set to 8  
10928 since most lock manufacturers currently allow PIN Codes of 8 bytes or less.

10929 **7.3.2.11.9 MinPINCodeLength Attribute**

10930 An 8 bit value indicates the minimum length in bytes of a PIN Code on this device. The default is set to 4  
10931 since most lock manufacturers do not support PIN Codes that are shorter than 4 bytes.

10932 **7.3.2.11.10 MaxRFIDCodeLength Attribute**

10933 An 8 bit value indicates the maximum length in bytes of a RFID Code on this device. The value depends on  
10934 the RFID code range specified by the manufacturer, if media anti-collision identifiers (UID) are used as RFID  
10935 code, a value of 20 (equals 10 Byte ISO 14443A UID) is recommended.

10936 **7.3.2.11.11 MinRFIDCodeLength Attribute**

10937 An 8 bit value indicates the minimum length in bytes of a RFID Code on this device. The value depends on  
10938 the RFID code range specified by the manufacturer, if media anti-collision identifiers (UID) are used as RFID  
10939 code, a value of 8 (equals 4 Byte ISO 14443A UID) is recommended.

10940 **7.3.2.12 Operational Settings Attribute Set**

10941 The attributes within this attribute set affect the physical behavior on the server device. Some of the setting  
10942 might not be applicable to the specific device. When the client sends the write attribute request with values  
10943 that are not applicable to the server device, the server SHALL send back a Write Attribute Response with  
10944 error status not equal to ZCL\_SUCCESS(0x00). It is suggested that it SHOULD respond with an error status  
10945 of ZCL\_INVALID\_VALUE (0x87).

10946 **Table 7-14. Operational Settings Attribute Set**

<b>Id</b>	<b>Description</b>	<b>Type</b>	<b>Access</b>	<b>Def</b>	<b>M/O</b>
0x0020	<i>EnableLogging</i>	bool	R*W P	0	O
0x0021	<i>Language</i>	string (3bytes)	R*W P	0	O
0x0022	<i>LEDSettings</i>	uint8	R*W P	0	O

<b>Id</b>	<b>Description</b>	<b>Type</b>	<b>Access</b>	<b>Def</b>	<b>M/O</b>
0x0023	<i>AutoRelockTime</i>	uint32	R*W P	0	O
0x0024	<i>SoundVolume</i>	uint8	R*W P	0	O
0x0025	<i>OperatingMode</i>	enum8	R*W P	0	O
0x0026	<i>SupportedOperatingModes</i>	map16	R	0x0001	O
0x0027	<i>DefaultConfigurationRegister</i>	map16	RP	0x0000	O
0x0028	<i>EnableLocalProgramming</i>	bool	R*W P	0x01	O
0x0029	<i>EnableOneTouchLocking</i>	bool	RWP	0	O
0x002A	<i>EnableInsideStatusLED</i>	bool	RWP	0	O
0x002B	<i>EnablePrivacyModeButton</i>	bool	RWP	0	O

10947 **7.3.2.12.1 EnableLogging Attribute**

10948 Enable/disable event logging. When event logging is enabled, all event messages are stored on the lock for  
 10949 retrieval. Logging events can be but not limited to Tamper Alarm, Lock, Unlock, Autolock, User Code  
 10950 Added, User Code Deleted, Schedule Added, and Schedule Deleted. For a full detail of all the possible alarms  
 10951 and events, please refer to the full list in the Alarm and Event Masks Attribute Set.

10952 **7.3.2.12.2 Language Attribute**

10953 Modifies the language for the on-screen or audible user interface using three bytes from ISO-639-1. It con-  
 10954 sists of one byte of length and two bytes for the language code. For example if the language is set to English,  
 10955 the value would be "02 65 6E" for the language code "en".

10956 **7.3.2.12.3 OperatingMode Attribute**

10957 Table 7-15 shows the current operating mode and which interfaces are enabled during each of the operating  
 10958 mode.

Table 7-15. Operating Modes

<b>Enum</b>	<b>Operating Mode</b>	<b>Interface (E = Enabled; D = Disabled)</b>		
		<b>Keypad</b>	<b>RF</b>	<b>RFID</b>
0x00	Normal	E	E	E
0x01	Vacation	D	E	E
0x02	Privacy	D	D	D
0x03	No RF Lock/Unlock	E	D	E
0x04	Passage	N/A	N/A	N/A

10960

- 10961 **Normal Mode:** The lock operates normally. All interfaces are enabled.
- 10962 **Vacation Mode:** Only RF interaction is enabled. The keypad cannot be operated.
- 10963 **Privacy Mode:** All external interaction with the door lock is disabled. This is intended so that users presumably inside the property will have control over the entrance. Privacy mode assumes that the lock can only be operated from inside by operating the thumb turn or some other means of ending privacy mode.
- 10964
- 10965
- 10966 **No RF Lock or Unlock:** This mode only disables RF interaction with the lock. It specifically applies to the Lock, Unlock, Toggle, and Unlock with Timeout Commands.
- 10967
- 10968 **Passage Mode:** The lock is open or can be open or closed at will without the use of a Keypad or other means of user validation.
- 10969
- 10970 **Note:** For modes that disable the RF interface, the door lock SHALL respond to Lock, Unlock, Toggle, and Unlock with Timeout commands with a ZCL response with status FAILURE (0x01) and not take the action requested by those commands. The door lock SHALL NOT disable the radio or otherwise unbind or leave the network. It SHALL still respond to all other commands and requests.
- 10971
- 10972
- 10973

#### 10974 7.3.2.12.4 SupportedOperatingModes Attribute

- 10975 This bitmap contains all operating bits of the Operating Mode Attribute supported by the lock. The value of the enumeration in “Operating Mode” defines the related bit to be set, as shown in Table 7-16. All bits supported by a lock SHALL be set to zero.
- 10976
- 10977

10978 **Table 7-16. Bit Values for the *SupportedOperatingModes* Attribute**

Bitmap Number	Description
0	Normal Mode Supported
1	Vacation Mode Supported
2	Privacy Mode Supported
3	No RF Lock or Unlock Mode Supported
4	Passage Mode Supported

10979

#### 10980 7.3.2.12.5 LEDSettings Attribute

- 10981 The settings for the LED support three different modes, shown in Table 7-17:

10982 **Table 7-17. Modes for the *LEDSettings* Attribute**

Attribute Identifier	Definition
0x00	Never use LED for signalization
0x01	Use LED signalization except for access allowed events
0x02	Use LED signalization for all events



10983 **7.3.2.12.6 AutoRelockTime Attribute**

10984 The number of seconds to wait after unlocking a lock before it automatically locks again. 0=disabled. If set,  
 10985 unlock operations from any source will be timed. For one time unlock with timeout use the specific command.

10986 **7.3.2.12.7 SoundVolume Attribute**

10987 The sound volume on a door lock has three possible settings: silent, low and high volumes, shown in Table  
 10988 7-18.

10989 **Table 7-18. Settings for the SoundVolume Attribute**

Attribute Identifier	Definition
0x00	Silent Mode
0x01	Low Volume
0x02	High Volume

10990 **7.3.2.12.8 DefaultConfigurationRegister Attribute**

10991 This attribute represents the default configurations as they are physically set on the device (example: hard-  
 10992 ware dip switch setting, etc...) and represents the default setting for some of the attributes within this Oper-  
 10993 ational Setting Attribute Set (for example: LED, Auto Lock, Sound Volume, and Operating Mode attributes),  
 10994 as in Table 7-19.

10995 This is a read-only attribute and is intended to allow clients to determine what changes MAY need to be made  
 10996 without having to query all the included attributes. It MAY be beneficial for the clients to know what the  
 10997 device’s original settings were in the event that the device needs to be restored to factory default settings.

10998 If the Client device would like to query and modify the door lock server’s operating settings, it SHOULD  
 10999 send read and write attribute request to the specific attributes.

11000 For example, the Buzzer bitmap within this attribute is off. It represents the hardware dip switch Buzzer  
 11001 setting (original default setting) is off and the Sound Volume attribute default value is in Silent Mode. How-  
 11002 ever, it is possible that the current Sound Volume is in High Volume. Therefore, if the client wants to  
 11003 query/modify the current Sound Volume setting on the server, the client SHOULD read/write to the Sound  
 11004 Volume attribute.

11005 **Table 7-19. DefaultConfigurationRegister Attribute**

Bitmap Number	Description
0	0 - Enable Local Programming Attribute default value is 0 (disabled) 1 - Enable Local Programming Attribute default value is 1 (enabled)
1	0 –Keypad Interface default access is disabled 1 - Keypad Interface default access is enabled
2	0 - RF Interface default access is disabled 1 - RF Interface default access is enabled

Bitmap Number	Description
5	0 – Sound Volume attribute default value is 0 (Slight Mode) 1 – Sound Volume attribute default value is equal to something other than 0x00
6	0 – Auto Relock Time attribute default value = 0x00 1 – Auto Relock Time attribute default value is equal to something other than 0x00
7	0 – Led Settings attribute default value = 0x00 1 – Led Settings attribute default value is equal to something other than 0x00

### 11006 7.3.2.12.9 EnableLocalProgramming Attribute

11007 Enable/disable local programming on the door lock. The local programming features includes but not limited  
11008 to adding new user codes, deleting existing user codes, add new schedule, deleting existing schedule on the  
11009 local door lock interfaces. If this value is set to 0x01 or TRUE then local programming is enabled on the door  
11010 lock. If it is set to 0x00 or FALSE then local programming is disabled on the door lock. Local programming  
11011 is enabled by default.

### 11012 7.3.2.12.10 EnableOneTouchLocking Attribute

11013 Enable/disable the ability to lock the door lock with a single touch on the door lock.

### 11014 7.3.2.12.11 EnableInsideStatusLED Attribute

11015 Enable/disable an inside LED that allows the user to see at a glance if the door is locked.

### 11016 7.3.2.12.12 EnablePrivacyModeButton Attribute

11017 Enable/disable a button inside the door that is used to put the lock into privacy mode. When the lock is in  
11018 privacy mode it cannot be manipulated from the outside.

## 11019 7.3.2.13 Security Settings Attribute Set

11020 **Table 7-20. Security Settings Attribute Set**

Id	Description	Type	Access	Def	M/O
0x0030	<i>WrongCodeEntryLimit</i>	uint8	R*W P	0	O
0x0031	<i>UserCodeTemporaryDisableTime</i>	uint8	R*W P	0	O
0x0032	<i>SendPINOverTheAir</i>	bool	R*W P	0	O
0x0033	<i>RequirePINforRFOperation</i>	bool	R*W P	0	O
0x0034	<i>SecurityLevel</i>	enum8	RP	0	O

11021 **7.3.2.13.1 WrongCodeEntryLimit Attribute**

11022 The number of incorrect codes or RFID presentment attempts a user is allowed to enter before the door will  
 11023 enter a lockout state. The lockout state will be for the duration of *UserCodeTemporaryDisableTime*.

11024 **7.3.2.13.2 UserCodeTemporaryDisableTime Attribute**

11025 The number of seconds that the lock shuts down following wrong code entry. 1-255 seconds. Device can shut  
 11026 down to lock user out for specified amount of time. (Makes it difficult to try and guess a PIN for the device.)

11027 **7.3.2.13.3 SendPINOverTheAir Attribute**

11028 Boolean set to True if it is ok for the door lock server to send PINs over the air. This attribute determines the  
 11029 behavior of the server’s TX operation. If it is false, then it is not ok for the device to send PIN in any messages  
 11030 over the air.

11031 The PIN field within any door lock cluster message SHALL keep the first octet unchanged and masks the  
 11032 actual code by replacing with 0xFF. For example (PIN "1234" ): If the attribute value is True, 0x04 0x31  
 11033 0x32 0x33 0x34 SHALL be used in the PIN field in any door lock cluster message payload. If the attribute  
 11034 value is False, 0x04 0xFF 0xFF 0xFF SHALL be used.

11035 **7.3.2.13.4 RequirePINForRFOperation Attribute**

11036 Boolean set to True if the door lock server requires that an optional PINs be included in the payload of RF  
 11037 lock operation events like Lock, Unlock and Toggle in order to function.

11038 **7.3.2.13.5 SecurityLevel Attribute**

11039 Door locks MAY sometimes wish to implement a higher level of security within the application protocol in  
 11040 addition to the default network security. For instance, a door lock MAY wish to use additional APS security  
 11041 for cluster transactions. This protects the door lock against being controlled by any other devices which have  
 11042 access to the network key.

11043 The Security Level attribute allows the door lock manufacturer to indicate what level of security the door  
 11044 lock requires.

11045 There are two levels of security possible within this cluster:

- 11046 • 0 = Network Security (default)
- 11047 • 1 = APS Security

11048 This attribute is read only over the network to protect security method defined by each manufacturer.

11049 However, manufacturer can provide method to modify the security setting locally on the device. The security  
 11050 setting modification will not take effect when the device is in a network.

11051 **7.3.2.14 Alarm and Event Masks Attribute Set**

11052 **Table 7-21. Alarm and Event Masks Attribute Set**

<b>Id</b>	<b>Description</b>	<b>Type</b>	<b>Access</b>	<b>Default</b>	<b>M/O</b>
0x0040	<i>AlarmMask</i>	map16	RWP	0x0000	O
0x0041	<i>KeypadOperationEventMask</i>	map16	RWP	0x0000	O
0x0042	<i>RFOperationEventMask</i>	map16	RWP	0x0000	O

<b>Id</b>	<b>Description</b>	<b>Type</b>	<b>Access</b>	<b>Default</b>	<b>M/O</b>
0x0043	<i>ManualOperationEventMask</i>	map16	RWP	0x0000	O
0x0044	<i>RFIDOperationEventMask</i>	map16	RWP	0x0000	O
0x0045	<i>KeypadProgrammingEventMask</i>	map16	RWP	0x0000	O
0x0046	<i>RFProgrammingEventMask</i>	map16	RWP	0x0000	O
0x0047	<i>RFIDProgrammingEventMask</i>	map16	RWP	0x0000	O

### 11053 **7.3.2.14.1 AlarmMask Attribute**

11054 The alarm mask is used to turn on/off alarms for particular functions, as shown in Table 7-22. Alarms for an  
11055 alarm group are enabled if the associated alarm mask bit is set. Each bit represents a group of alarms. Entire  
11056 alarm groups can be turned on or off by setting or clearing the associated bit in the alarm mask.

11057 **Table 7-22. Alarm Code Table**

<b>Alarm Code</b>	<b>Bitmap Number</b>	<b>Alarm Condition</b>
0x00	0	Deadbolt Jammed
0x01	1	Lock Reset to Factory Defaults
0x02	2	Reserved
0x03	3	RF Module Power Cycled
0x04	4	Tamper Alarm – wrong code entry limit
0x05	5	Tamper Alarm - front escutcheon removed from main
0x06	6	Forced Door Open under Door Locked Condition

### 11058 **7.3.2.14.2 KeypadOperationEventMask Attribute**

11059 Event mask used to turn on and off the transmission of keypad operation events. This mask DOES NOT  
11060 apply to the storing of events in the report table.

11061 For detail event mask value, please refer to Table 7-30.

### 11062 **7.3.2.14.3 RFOperationEventMask Attribute**

11063 Event mask used to turn on and off the transmission of RF operation events. This mask DOES NOT apply to  
11064 the storing of events in the report table.

11065 For detail event mask value, please refer to Table 7-31.

### 11066 **7.3.2.14.4 ManualOperationEventMask Attribute**

11067 Event mask used to turn on and off manual operation events. This mask DOES NOT apply to the storing of  
11068 events in the report table.

11069 For detail event mask value, please refer to Table 7-32.

11070 **7.3.2.14.5 RFIDOperationEventMask Attribute**

11071 Event mask used to turn on and off RFID operation events. This mask DOES NOT apply to the storing of  
 11072 events in the report table.

11073 For detail event mask value, please refer to Table 7-33.

11074 **7.3.2.14.6 KeypadProgrammingEventMask Attribute**

11075 Event mask used to turn on and off keypad programming events. This mask DOES NOT apply to the storing  
 11076 of events in the report table.

11077 For detail event mask value, please refer to Table 7-36.

11078 **7.3.2.14.7 RFProgrammingEventMask Attribute**

11079 Event mask used to turn on and off RF programming events. This mask DOES NOT apply to the storing of  
 11080 events in the report table.

11081 For detail event mask value, please refer to Table 7-37.

11082 **7.3.2.14.8 RFIDProgrammingEventMask Attribute**

11083 Event mask used to turn on and off RFID programming events. This mask DOES NOT apply to the storing  
 11084 of events in the report table.

11085 For detail event mask value, please refer to Table 7-38.

11086 **7.3.2.15 Server Commands Received**

11087 The commands received by the server are listed in Table 7-23.

11088 **Table 7-23. Commands Received by the Server Cluster**

Command ID	Description	M/O
0x00	Lock Door	M
0x01	Unlock Door	M
0x02	Toggle	O
0x03	Unlock with Timeout	O
0x04	Get Log Record	O
0x05	Set PIN Code	O
0x06	Get PIN Code	O
0x07	Clear PIN Code	O
0x08	Clear All PIN Codes	O

Command ID	Description	M/O
0x09	Set User Status	O
0x0A	Get User Status	O
0x0B	Set Weekday Schedule	O
0x0C	Get Weekday Schedule	O
0x0D	Clear Weekday Schedule	O
0x0E	Set Year Day Schedule	O
0x0F	Get Year Day Schedule	O
0x10	Clear Year Day Schedule	O
0x11	Set Holiday Schedule	O
0x12	Get Holiday Schedule	O
0x13	Clear Holiday Schedule	O
0x14	Set User Type	O
0x15	Get User Type	O
0x16	Set RFID Code	O
0x17	Get RFID Code	O
0x18	Clear RFID Code	O
0x19	Clear All RFID Codes	O

### 11089 7.3.2.15.1 Lock Door Command

11090 This command causes the lock device to lock the door. As of HA 1.2, this command includes an optional  
11091 code for the lock. The door lock MAY require a PIN depending on the value of the [Require PIN for RF  
11092 Operation attribute].

11093

**Figure 7-3. Format of the Lock Door Command**

<b>Octets</b>	Variable
<b>Data Type</b>	octstr
<b>Field Name</b>	PIN/RFID Code

11094 **7.3.2.15.2 Unlock Door Command**

11095 This command causes the lock device to unlock the door. As of HA 1.2, this command includes an optional  
 11096 code for the lock. The door lock MAY require a code depending on the value of the [Require PIN for RF  
 11097 Operation attribute].

11098 **Note:** If the attribute *AutoRelockTime* is supported the lock will close when the auto relock time has expired.

11099

**Figure 7-4. Format of the Unlock Door Command**

<b>Octets</b>	Variable
<b>Data Type</b>	octstr
<b>Field Name</b>	PIN/RFID Code

11100 **7.3.2.15.3 Toggle Command**

11101 Request the status of the lock. As of HA 1.2, this command includes an optional code for the lock. The door  
 11102 lock MAY require a code depending on the value of the [Require PIN for RF Operation attribute].

11103

**Figure 7-5. Format of the Toggle Command**

<b>Octets</b>	Variable
<b>Data Type</b>	octstr
<b>Field Name</b>	PIN/RFID Code

11104 **7.3.2.15.4 Unlock with Timeout Command**

11105 This command causes the lock device to unlock the door with a timeout parameter. After the time in seconds  
 11106 specified in the timeout field, the lock device will relock itself automatically. This timeout parameter is only  
 11107 temporary for this message transition only and overrides the default relock time as specified in the [Auto  
 11108 Relock Time attribute] attribute. If the door lock device is not capable of or does not want to support tempo-  
 11109 rary Relock Timeout, it SHOULD not support this optional command.

11110

**Figure 7-6. Format of the Unlock with Timeout Command**

<b>Octets</b>	1	Variable
<b>Data Type</b>	uint16	octstr
<b>Field Name</b>	Timeout in seconds	PIN/RFID Code

11111 **7.3.2.15.5 Get Log Record Command**

11112 Request a log record. Log number is between 1 – [Number of Log Records Supported attribute]. If log number  
11113 0 is requested then the most recent log entry is returned.

11114

**Figure 7-7. Format of the Get Log Record Command**

<b>Octets</b>	2
<b>Data Type</b>	uint16
<b>Field Name</b>	Log Index

11115

11116 **Log record format:** The log record format is defined in the description of the Get Log Record Response  
11117 command.

11118 **7.3.2.15.6 User Status and User Type Values**

11119 The following User Status and User Type values are used in the payload of multiple commands:

11120 **User Status:** Used to indicate what the status is for a specific user ID.

11121

**Table 7-24. User Status Value**

Enum	Description
0	Available
1	Occupied / Enabled
3	Occupied / Disabled
0xff	Not Supported

11122

11123 **User Type:** Used to indicate what the type is for a specific user ID.

11124

**Table 7-25. User Type Value**

Enum	Description
0	Unrestricted User (default)



Enum	Description
1	Year Day Schedule User
2	Week Day Schedule User
3	Master User
4	Non Access User
0xff	Not Supported

11125

11126 **Unrestricted:** User has access 24/7 provided proper PIN is supplied (e.g., owner). Unrestricted user type is  
 11127 the default user type.

11128 **Year Day Schedule User:** User has ability to open lock within a specific time period (e.g., guest).

11129 **Week Day Schedule User:** User has ability to open lock based on specific time period within a reoccurring  
 11130 weekly schedule (e.g., cleaning worker).

11131 **Master User:** User has ability to both program and operate the door lock. This user can manage the users  
 11132 and user schedules. In all other respects this user matches the unrestricted (default) user. Master user is the  
 11133 only user that can disable the user interface (keypad, RF, etc...).

11134 **Non Access User:** User is recognized by the lock but does not have the ability to open the lock. This user  
 11135 will only cause the lock to generate the appropriate event notification to any bound devices.

11136 **7.3.2.15.7 Set PIN Code Command**

11137 Set a PIN into the lock.

11138

**Figure 7-8. Format of the Set PIN Code Command**

<b>Octets</b>	2	1	1	Variable
<b>Data Type</b>	uint16	uint8	enum8	octstr
<b>Field Name</b>	User ID	User Status	User Type	PIN

11139

11140 User ID is between 0 - [# of PIN Users Supported attribute]. Only the values 1 (Occupied/Enabled) and 3  
 11141 (Occupied/Disabled) are allowed for User Status.

11142 **7.3.2.15.8 Get PIN Code Command**

11143 Retrieve a PIN Code. User ID is between 0 - [# of PIN Users Supported attribute].

11144

**Figure 7-9. Format of the Get PIN Code Command**

<b>Octets</b>	2
<b>Data Type</b>	uint16
<b>Field Name</b>	User ID

### 11145 7.3.2.15.9 Clear PIN Code Command

11146 Delete a PIN. User ID is between 0 - [# of PIN Users Supported attribute].

11147

**Figure 7-10. Format of the Clear PIN Code Command**

<b>Octets</b>	2
<b>Data Type</b>	uint16
<b>Field Name</b>	User ID

11148 Note: **If you delete a PIN Code and this user didn't have a RFID Code, the user status is set to "0**  
11149 **Available"**, the user type is set to the default value and all schedules are also set to the default values.

### 11150 7.3.2.15.10 Clear All PIN Codes Command

11151 Clear out all PINs on the lock.

11152 **Note:** *On the server, the clear all PIN codes command SHOULD have the same effect as the Clear PIN Code*  
11153 *command with respect to the setting of user status, user type and schedules.*

### 11154 7.3.2.15.11 Set User Status Command

11155 Set the status of a user ID. User Status value of 0x00 is not allowed. In order to clear a user id, the Clear ID  
11156 Command SHALL be used. For user status value please refer to User Status Value.

11157

**Figure 7-11. Format of the Set User Status Command**

<b>Octets</b>	2	1
<b>Data Type</b>	uint16	uint8
<b>Field Name</b>	User ID	User Status

### 11158 7.3.2.15.12 Get User Status Command

11159 Get the status of a user.

11160

**Figure 7-12. Format of the Get User Status Command**

<b>Octets</b>	2
<b>Data Type</b>	uint16
<b>Field Name</b>	User ID

11161

### 7.3.2.15.13 Set Week Day Schedule Command

11162

Set a weekly repeating schedule for a specified user.

11163

**Figure 7-13. Format of the Set Week Day Schedule Command**

<b>Octets</b>	1	2	1	1	1	1	1
<b>Data Type</b>	uint8	uint16	map8	uint8	uint8	uint8	uint8
<b>Field Name</b>	Schedule ID #	User ID	Days Mask	Start Hour	Start Minute	End Hour	End Minute

11164

11165

**Schedule ID:** number is between 0 – [# of Week Day Schedules Per User attribute].

11166

**User ID:** is between 0 – [# of Total Users Supported attribute].

11167

**Days Mask:** bitmask of the effective days in the order XSFTWTMS.

11168

**Figure 7-14. Format of Days Mask Bits**

<b>7</b>	<b>6</b>	<b>5</b>	<b>4</b>	<b>3</b>	<b>2</b>	<b>1</b>	<b>0</b>
Reserved	Sat	Fri	Thur	Wed	Tue	Mon	Sun

11169

Days mask is listed as bitmask for flexibility to set same schedule across multiple days. For the door lock that does not support setting schedule across multiple days within one command, it SHOULD respond with ZCL\_INVALID\_FIELD (0x85) status when received the set schedule command days bitmask field has multiple days selected.

11173

**Start Hour:** in decimal format represented by 0x00 – 0x17 (00 to 23 hours).

11174

**Start Minute:** in decimal format represented by 0x00 – 0x3B (00 to 59 mins).

11175

**End Hour:** in decimal format represented by 0x00 – 0x17 (00 to 23 hours). End Hour SHALL be equal or greater than Start Hour.

11176

11177

**End Minute:** in decimal format represented by 0x00 – 0x3B (00 to 59 mins).

11178

If End Hour is equal with Start Hour, End Minute SHALL be greater than Start Minute.

11179

When the Server Device receives the command, the Server Device MAY change the user type to the specific schedule user type. Please refer to section 7.3.2.5, Process for Creating a New User with Schedule, at the beginning of this cluster.

11180

11181

11182

### 7.3.2.15.14 Get Week Day Schedule Command

11183

Retrieve the specific weekly schedule for the specific user.

11184

**Figure 7-15. Format of the Get Week Day Schedule Command**

<b>Octets</b>	1	2
<b>Data Type</b>	uint8	uint16
<b>Field Name</b>	Schedule ID	User ID

### 11185 7.3.2.15.15 Clear Week Day Schedule Command

11186 Clear the specific weekly schedule for the specific user.

11187

**Figure 7-16. Format of the Clear Week Day Schedule Command**

<b>Octets</b>	1	2
<b>Data Type</b>	uint8	uint16
<b>Field Name</b>	Schedule ID	User ID

### 11188 7.3.2.15.16 Set Year Day Schedule Command

11189 Set a time-specific schedule ID for a specified user.

11190

**Figure 7-17. Format of the Set Year Day Schedule Command**

<b>Octets</b>	1	2	4	4
<b>Data Type</b>	uint8	uint16	uint32	uint32
<b>Field Name</b>	Schedule ID	User ID	Local Start Time	Local End Time

11191

11192 Schedule ID number is between 0 – [# of Year Day Schedules Supported Per User attribute]. User ID is  
11193 between 0 – [# of Total Users Supported attribute].

11194 Start time and end time are given in LocalTime. End time must be greater than the start time.

11195 When the Server Device receives the command, the Server Device MAY change the user type to the specific  
11196 schedule user type. Please refer to Process for Creating a New User with Schedule at the beginning of this  
11197 cluster.

### 11198 7.3.2.15.17 Get Year Day Schedule Command

11199 Retrieve the specific year day schedule for the specific user.

11200

**Figure 7-18. Format of the Get Year Day Schedule Command**

<b>Octets</b>	1	2
<b>Data Type</b>	uint8	uint16
<b>Field Name</b>	Schedule ID	User ID

11201

### 7.3.2.15.18 Clear Year Day Schedule Command

11202

Clears the specific year day schedule for the specific user.

11203

**Figure 7-19. Format of the Clear Year Day Schedule Command**

<b>Octets</b>	1	2
<b>Data Type</b>	uint8	uint16
<b>Field Name</b>	Schedule ID	User ID

11204

### 7.3.2.15.19 Set Holiday Schedule Command

11205

Set the holiday Schedule by specifying local start time and local end time with respect to any Lock Operating Mode.

11206

11207

**Figure 7-20. Format of the Set Holiday Schedule Command**

<b>Octets</b>	1	4	4	1
<b>Data Type</b>	uint8	uint32	uint32	enum8
<b>Field Name</b>	Holiday Schedule ID	Local Start Time	Local End Time	Operating Mode During Holiday

11208

11209

Holiday Schedule ID number is between 0 – [# of Holiday Schedules Supported attribute].

11210

Start time and end time are given in LocalTime. End time must be greater than the start time.

11211

Operating Mode is valid enumeration value as listed in operating mode attribute.

11212

### 7.3.2.15.20 Get Holiday Schedule Command

11213

Get the holiday Schedule by specifying Holiday ID.

11214

**Figure 7-21. Format of the Get Holiday Schedule Command**

<b>Octets</b>	1
<b>Data Type</b>	uint8
<b>Field Name</b>	Holiday Schedule ID

11215 **7.3.2.15.21 Clear Holiday Schedule Command**

11216 Clear the holiday Schedule by specifying Holiday ID.

11217

**Figure 7-22. Format of the Clear Holiday Schedule Command**

<b>Octets</b>	1
<b>Data Type</b>	uint8
<b>Field Name</b>	Holiday Schedule ID

11218 **7.3.2.15.22 Set User Type Command**

11219 Set the type byte for a specified user.

11220 For user type value please refer to User Type Value.

11221

**Figure 7-23. Format of the Set User Type Command**

<b>Octets</b>	2	1
<b>Data Type</b>	uint16	enum8
<b>Field Name</b>	User ID	User Type

11222 **7.3.2.15.23 Get User Type Command**

11223 Retrieve the type byte for a specific user.

11224

**Figure 7-24. Format of the Get User Type Command**

<b>Octets</b>	2
<b>Data Type</b>	uint16
<b>Field Name</b>	User ID

11225 **7.3.2.15.24 Set RFID Code Command**

11226 Set an ID for RFID access into the lock.

11227

**Figure 7-25. Format of the Set RFID Code Command**

<b>Octets</b>	2	1	1	Variable
<b>Data Type</b>	uint16	uint8	enum8	octstr
<b>Field Name</b>	User ID	User Status	User Type	RFID Code

11228

11229 **User ID:** Between 0 - [# of RFID Users Supported attribute]. Only the values 1 (Occupied/Enabled) and 3  
 11230 (Occupied/Disabled) are allowed for User Status.

11231 **User Status:** Used to indicate what the status is for a specific user ID. The values are according to “Set PIN”  
 11232 while not all are supported.

11233

**Table 7-26. User Status Byte Values for Set RFID Code Command**

User Status Byte	Value
Occupied / Enabled (Access Given)	1
Occupied / Disabled	3
Not Supported	0xff

11234

11235 **User Type:** The values are the same as used for “Set PIN Code.”

11236 **7.3.2.15.25 Get RFID Code Command**

11237 Retrieve an ID. User ID is between 0 - [# of RFID Users Supported attribute].

11238

**Figure 7-26. Format of the Get RFID Code Command**

<b>Octets</b>	2
<b>Data Type</b>	uint16
<b>Field Name</b>	User ID

11239 **7.3.2.15.26 Clear RFID Code Command**

11240 Delete an ID. User ID is between 0 - [# of RFID Users Supported attribute]. If you delete a RFID code and  
 11241 this user didn't have a PIN code, the user status has to be set to "0 Available", the user type has to be set to  
 11242 the default value, and all schedules which are supported have to be set to the default values.

11243

**Figure 7-27. Format of the Clear RFID Code Command**

<b>Octets</b>	2
<b>Data Type</b>	uint16
<b>Field Name</b>	User ID

11244 **7.3.2.15.27 Clear All RFID Codes Command**

11245 Clear out all RFIDs on the lock. If you delete all RFID codes and this user didn't have a PIN code, the user  
 11246 status has to be set to "0 Available", the user type has to be set to the default value, and all schedules which  
 11247 are supported have to be set to the default values.

11248 **7.3.2.16 Server Commands Generated**

11249 The commands generated by the server are listed in Table 7-27.

11250 **Table 7-27. Commands Generated by the Server Cluster**

Command ID	Description	M/O
0x00	Lock Door Response	M
0x01	Unlock Door Response	M
0x02	Toggle Response	O
0x03	Unlock with Timeout Response	O
0x04	Get Log Record Response	O
0x05	Set PIN Code Response	O
0x06	Get PIN Code Response	O
0x07	Clear PIN Code Response	O
0x08	Clear All PIN Codes Response	O
0x09	Set User Status Response	O
0x0A	Get User Status Response	O
0x0B	Set Weekday Schedule Response	O
0x0C	Get Weekday Schedule Response	O
0x0D	Clear Weekday Schedule Response	O



Command ID	Description	M/O
0x0E	Set Year Day Schedule Response	O
0x0F	Get Year Day Schedule Response	O
0x10	Clear Year Day Schedule Response	O
0x11	Set Holiday Schedule Response	O
0x12	Get Holiday Schedule Response	O
0x13	Clear Holiday Schedule Response	O
0x14	Set User Type Response	O
0x15	Get User Type Response	O
0x16	Set RFID Code Response	O
0x17	Get RFID Code Response	O
0x18	Clear RFID Code Response	O
0x19	Clear All RFID Codes Response	O
0x20	Operating Event Notification	O
0x21	Programming Event Notification	O

11251 **7.3.2.16.1 Lock Door Response Command**

11252 This command is sent in response to a Lock command with one status byte payload. The Status field SHALL  
 11253 be set to SUCCESS or FAILURE (see 2.5).

11254 The status byte only indicates if the message has received successfully. To determine the lock and/or door  
 11255 status, the client SHOULD query to [Lock State attribute] and [Door State attribute].

11256

**Figure 7-28. Format of the Lock Door Response Command Payload**

<b>Bits</b>	8
<b>Data Type</b>	enum8
<b>Field Name</b>	Status

**11257 7.3.2.16.2 Unlock Door Response Command**

11258 This command is sent in response to a Toggle command with one status byte payload. The Status field  
11259 SHALL be set to SUCCESS or FAILURE (see 2.5).

11260 The status byte only indicates if the message has received successfully. To determine the lock and/or door  
11261 status, the client SHOULD query to [Lock State attribute] and [Door State attribute].

11262

**Figure 7-29. Format of the Unlock Door Response Command Payload**

<b>Bits</b>	8
<b>Data Type</b>	enum8
<b>Field Name</b>	Status

**11263 7.3.2.16.3 Toggle Response Command**

11264 This command is sent in response to a Toggle command with one status byte payload. The Status field  
11265 SHALL be set to SUCCESS or FAILURE (see 2.5).

11266 The status byte only indicates if the message has received successfully. To determine the lock and/or door  
11267 status, the client SHOULD query to [Lock State attribute] and [Door State attribute].

**11268 7.3.2.16.4 Unlock with Timeout Response Command**

11269 This command is sent in response to an Unlock with Timeout command with one status byte payload. The  
11270 Status field SHALL be set to SUCCESS or FAILURE (see 2.5).

11271 The status byte only indicates if the message has received successfully. To determine the lock and/or door  
11272 status, the client SHOULD query to [Lock State attribute] and [Door State attribute].

**11273 7.3.2.16.5 Get Log Record Response Command**

11274 Returns the specified log record. If an invalid log entry ID was requested, it is set to 0 and the most recent  
11275 log entry will be returned.

11276

**Figure 7-30. Format of the Get Log Record Response Command**

Octets	2	4	1	1	1	2	Variable
Data Type	uint16	uint32	enum8	uint8	uint8	uint16	octstr
Field Name	Log Entry ID	Timestamp	Event Type	Source (see Operation Event Sources)	Event ID/Alarm Code (see Operation Event Codes)	User ID	PIN

11277

11278 **Log Entry ID:** the index into the log table where this log entry is stored. If the log entry requested is 0, the  
 11279 most recent log is returned with the appropriate log entry ID.

11280 **Timestamp:** A LocalTime used to timestamp all events and alarms on the door lock.

11281 **Event Type:** Indicates the type of event that took place on the door lock.

11282 0x00 = Operation

11283 0x01 = Programming

11284 0x02 = Alarm

11285 **Source:** A source value where available sources are:

11286 0x00 = Keypad

11287 0x01 = RF

11288 0x02 = Manual

11289 0x03 = RFID

11290 0xff = Indeterminate

11291 If the Event type is 0x02 (Alarm) then the source SHOULD be but does not have to be 0xff (Indeterminate).

11292 **Event ID:** A one byte value indicating the type of event that took place on the door lock depending on the  
 11293 event code table provided for a given event type and source.

11294 **User ID:** A two byte value indicating the ID of the user who generated the event on the door lock if one is  
 11295 available. If none is available, 0xffff has to be used.

11296 **PIN / ID:** A string indicating the PIN code or RFID code that was used to create the event on the door lock  
 11297 if one is available.

### 11298 **7.3.2.16.6 Set PIN Code Response Command**

11299 Returns status of the PIN set command. Possible values are:

11300 0 = Success

11301 1 = General failure

11302 2 = Memory full

11303 3 = Duplicate Code error

11304

**Figure 7-31. Format of the Set PIN Code Response Command**

<b>Octets</b>	1
<b>Data Type</b>	uint8
<b>Field Name</b>	Status

11305 **7.3.2.16.7 Get PIN Code Response Command**

11306 Returns the PIN for the specified user ID.

11307

**Figure 7-32. Format of the Get PIN Code Response Command**

<b>Octets</b>	2	1	1	Variable
<b>Data Type</b>	uint16	uint8	enum8	octstr
<b>Field Name</b>	User ID	User Status	User Type	Code

11308 If the requested UserId is valid and the Code doesn't exist, Get RFID Code Response SHALL have the fol-  
11309 lowing format:

11310 UserId = requested UserId

11311 UserStatus = 0 (available)

11312 UserType = 0xFF (not supported)

11313 RFID = 0 (zero length)

11314 If the requested UserId is invalid, send Default Response with an error status not equal to ZCL\_SUC-  
11315 CESS(0x00).

11316 **7.3.2.16.8 Clear PIN Code Response Command**

11317 Returns pass/fail of the command.

11318

**Figure 7-33. Format of the Clear PIN Code Response Command**

<b>Octets</b>	1
<b>Data Type</b>	uint8
<b>Field Name</b>	Status
<b>Field Value</b>	0=pass 1=fail

11319 **7.3.2.16.9 Clear All PIN Codes Response Command**

11320 Returns pass/fail of the command.

11321

**Figure 7-34. Format of the Clear All PIN Codes Response Command**

<b>Octets</b>	1
<b>Data Type</b>	uint8
<b>Field Name</b>	Status
<b>Field Value</b>	0=pass 1=fail

11322 **7.3.2.16.10 Set User Status Response Command**

11323 Returns the pass or fail value for the setting of the user status.

11324

**Figure 7-35. Format of the Set User Status Response Command**

<b>Octets</b>	1
<b>Data Type</b>	uint8
<b>Field Name</b>	Status
<b>Field Value</b>	0=pass 1=fail

11325 **7.3.2.16.11 Get User Status Response Command**

11326 Returns the user status for the specified user ID.

11327

**Figure 7-36. Format of the Get User Status Response Command**

<b>Octets</b>	2	1
<b>Data Type</b>	uint16	uint8
<b>Field Name</b>	User ID	User Status

11328 **7.3.2.16.12 Set Week Day Schedule Response Command**

11329 Returns pass/fail of the command.

11330

**Figure 7-37. Format of the Set Week Day Schedule Response Command**

<b>Octets</b>	1
<b>Data Type</b>	uint8
<b>Field Name</b>	Status
<b>Field Value</b>	0=pass 1=fail

11331 **7.3.2.16.13 Get Week Day Schedule Response Command**

11332 Returns the weekly repeating schedule data for the specified schedule ID.

11333 **Figure 7-38. Format of the Get Week Day Schedule Response Command**

<b>Octets</b>	1	2	1	0/1	0/1	0/1	0/1	0/1
<b>Data Type</b>	uint8	uint16	uint8	uint8	uint8	uint8	uint8	uint8
<b>Field Name</b>	Schedule ID	User ID	Status	Days Mask	Start Hour	Start Minute	End Hour	End Minute

11334 **7.3.2.16.13.1 Schedule ID Field**

11335 The requested Schedule ID.

11336 **7.3.2.16.13.2 User ID Field**

11337 The requested User ID.

11338 **7.3.2.16.13.3 Status**

11339 ZCL SUCCESS (0x00) if both Schedule ID and User ID are valid and there is a corresponding schedule entry.

11341 ZCL INVALID\_FIELD (0x85) if either Schedule ID and/or User ID values are not within valid range

11342 ZCL NOT\_FOUND (0x8B) if both Schedule ID and User ID are within the valid range, however, there is not corresponding schedule entry found.

11344 Only if the status is ZCL SUCCESS that other remaining fields are included. For other (error) status values, only the fields up to the status field SHALL be present.

11346 **7.3.2.16.13.4 Days Mask**

11347 Days mask is a bitmask of the effective days in the order [E]SMT WTFS. Bit 7 indicates the enabled status of the schedule ID, with the lower 7 bits indicating the effective days mask.

11349 **Figure 7-39. Format of Days Mask Bits**

<b>7</b>	<b>0</b>	<b>1</b>	<b>2</b>	<b>3</b>	<b>4</b>	<b>5</b>	<b>6</b>
EN	Sun	Mon	Tue	Wed	Thu	Fri	Sat

11350 Bit 7: Enabled status: 1=enabled, 0=disabled

11351 **7.3.2.16.13.5 Start Hour**

11352 The Start Hour of the Week Day Schedule: 0-23

11353 **7.3.2.16.13.6 Start Minute**

11354 The Start Min of the Week Day Schedule: 0-59

11355 **7.3.2.16.13.7 End Hour**

11356 The End Hour of the Week Day Schedule: 0-23, must be greater than Start Hour

11357 **7.3.2.16.13.8 End Minute**

11358 The End Min of the Week Day Schedule: 0-59

11359 **7.3.2.16.14 Clear Week Day Schedule ID Response Command**

11360 Returns pass/fail of the command.

11361 **Figure 7-40. Format of the Clear Week Day Schedule ID Response Command**

<b>Octets</b>	1
<b>Data Type</b>	uint8
<b>Field Name</b>	Status
<b>Field Value</b>	0=pass 1=fail

11362 **7.3.2.16.15 Set Year Day Schedule Response Command**

11363 Returns pass/fail of the command.

11364 **Figure 7-41. Format of the Set Year Day Schedule Response Command**

<b>Octets</b>	1
<b>Data Type</b>	uint8
<b>Field Name</b>	Status
<b>Field Value</b>	0=pass 1=fail

11365 **7.3.2.16.16 Get Year Day Schedule Response Command**

11366 Returns the weekly repeating schedule data for the specified schedule ID.

11367

**Figure 7-42. Format of the Get Year Day Schedule Response Command**

<b>Octets</b>	1	2	1	0/4	0/4
<b>Data Type</b>	uint8	uint16	uint8	uint32	uint32
<b>Field Name</b>	Schedule ID	User ID	Status	Local Start Time	Local End Time

11368 **7.3.2.16.16.1 Schedule ID Field**

11369 The requested Schedule ID.

11370 **7.3.2.16.16.2 User ID Field**

11371 The requested User ID.

11372 **7.3.2.16.16.3 Status**11373 ZCL SUCCESS (0x00) if both Schedule ID and User ID are valid and there is a corresponding schedule  
11374 entry.

11375 ZCL INVALID\_FIELD (0x85) if either Schedule ID and/or User ID values are not within valid range

11376 ZCL NOT\_FOUND (0x8B) if both Schedule ID and User ID are within the valid range, however, there is  
11377 not corresponding schedule entry found.11378 Only if the status is ZCL SUCCESS that other remaining fields are included. For other (error) status values,  
11379 only the fields up to the status field SHALL be present.11380 **7.3.2.16.16.4 Local Start Time**

11381 Start Time of the Year Day Schedule representing by LocalTime.

11382 **7.3.2.16.16.5 Local End Time**

11383 End Time of the Year Day Schedule representing by LocalTime.

11384 **7.3.2.16.17 Clear Year Day Schedule Response Command**

11385 Returns pass/fail of the command.

11386 **Figure 7-43. Format of the Clear Year Day Schedule Response Command**

<b>Octets</b>	1
<b>Data Type</b>	uint8
<b>Field Name</b>	Status
<b>Field Value</b>	0=pass 1=fail

11387 **7.3.2.16.18 Set Holiday Schedule Response Command**

11388 Returns pass/fail of the command.



11389

**Figure 7-44. Format of the Set Holiday Schedule Response Command**

<b>Octets</b>	1
<b>Data Type</b>	uint8
<b>Field Name</b>	Status
<b>Field Value</b>	0=pass 1=fail

11390 **7.3.2.16.19 Get Holiday Schedule Response Command**

11391 Returns the Holiday Schedule Entry for the specified Holiday ID.

11392 **Figure 7-45. Format of the Get Holiday Schedule Response Command**

<b>Octets</b>	1	1	0/4	0/4	0/1
<b>Data Type</b>	uint8	uint8	uint32	uint32	enum8
<b>Field Name</b>	Holiday Schedule ID	Status	Local Start Time	Local End Time	Operating Mode During Holiday

11393 **7.3.2.16.19.1 Holiday Schedule ID**

11394 The requested Holiday Schedule ID

11395 **7.3.2.16.19.2 Status**

11396 ZCL SUCCESS (0x00) if both Schedule ID and User ID are valid and there is a corresponding schedule  
 11397 entry.

11398 ZCL INVALID\_FIELD (0x85) if either Schedule ID and/or User ID values are not within valid range

11399 ZCL NOT\_FOUND (0x8B) if both Schedule ID and User ID are within the valid range, however, there is  
 11400 not corresponding schedule entry found.

11401 Only if the status is ZCL SUCCESS that other remaining fields are included. For other (error) status values,  
 11402 only the fields up to the status field SHALL be present.

11403 **7.3.2.16.19.3 Local Start Time**

11404 Start Time of the Year Day Schedule representing by LocalTime.

11405 **7.3.2.16.19.4 Local End Time**

11406 End Time of the Year Day Schedule representing by LocalTime.

11407 **7.3.2.16.19.5 Operating Mode**

11408 Operating Mode is valid enumeration value as listed in operating mode attribute.

11409 **7.3.2.16.20 Clear Holiday Schedule Response Command**

11410 Returns pass/fail of the command.

11411

**Figure 7-46. Format of the Clear Holiday Schedule Response Command**

<b>Octets</b>	1
<b>Data Type</b>	uint8
<b>Field Name</b>	Status
<b>Field Value</b>	0=pass 1=fail

**11412 7.3.2.16.21 Set User Type Response Command**

11413 Returns the pass or fail value for the setting of the user type.

11414

**Figure 7-47. Format of the Set User Type Response Command**

<b>Octets</b>	1
<b>Data Type</b>	uint8
<b>Field Name</b>	Status
<b>Field Value</b>	0=pass 1=fail

**11415 7.3.2.16.22 Get User Type Response Command**

11416 Returns the user type for the specified user ID.

11417

**Figure 7-48. Format of the Get User Type Response Command**

<b>Octets</b>	2	1
<b>Data Type</b>	uint16	enum8
<b>Field Name</b>	User ID	User Type

**11418 7.3.2.16.23 Set RFID Code Response Command**

11419 Returns status of the Set RFID Code command. Possible values are:

11420 0 = Success

11421 1 = General failure

11422 2 = Memory full

11423 3 = Duplicate ID error

11424

**Figure 7-49. Format of the Set RFID Code Response Command**

<b>Octets</b>	1
<b>Data Type</b>	uint8
<b>Field Name</b>	Status

11425

### 7.3.2.16.24 Get RFID Code Response Command

11426

Returns the RFID code for the specified user ID.

11427

**Figure 7-50. Format of the Get RFID Code Response Command**

<b>Octets</b>	2	1	1	Variable
<b>Data Type</b>	uint16	uint8	enum8	octstr
<b>Field Name</b>	User ID	User Status	User Type	RFID Code

11428

11429 If the requested UserId is valid and the Code doesn't exist, Get RFID Code Response SHALL have the fol-  
 11430 lowing format:

11431

UserId = requested UserId

11432

UserStatus = 0 (available)

11433

UserType = 0xFF (not supported)

11434

RFID = 0 (zero length)

11435

If requested UserId is invalid, send Default Response with an error status not equal to ZCL\_SUCCESS(0x00).

11436

### 7.3.2.16.25 Clear RFID Code Response Command

11437

Returns pass/fail of the command.

11438

**Figure 7-51. Format of the Clear RFID Code Response Command**

<b>Octets</b>	1
<b>Data Type</b>	uint8
<b>Field Name</b>	Status
<b>Field Value</b>	0=pass 1=fail

11439

### 7.3.2.16.26 Clear All RFID Codes Response Command

11440

Returns pass/fail of the command.

11441

**Figure 7-52. Format of the Clear All RFID Codes Response Command**

<b>Octets</b>	1
<b>Data Type</b>	uint8
<b>Field Name</b>	Status
<b>Field Value</b>	0=pass 1=fail

### 11442 7.3.2.16.27 Operation Event Notification Command

11443 The door lock server sends out operation event notification when the event is triggered by the various event  
11444 sources. The specific operation event will only be sent out if the associated bitmask is enabled in the various  
11445 attributes in the Event Masks Attribute Set.

11446 All events are optional.

11447

**Figure 7-53. Format of the Operation Event Notification Command**

<b>Octets</b>	1	1	2	1	4	Variable/0
<b>Data Type</b>	uint8	uint8	uint16	octstr	uint32	string
<b>Field Name</b>	Operation Event Source	Operation Event Code	User ID	PIN	LocalTime	Data

### 11448 7.3.2.16.27.1 Operation Event Sources

11449 This field indicates where the event was triggered from.

11450

**Table 7-28. Operation Event Source Value**

<b>Value</b>	<b>Source</b>
0x00	Keypad
0x01	RF
0x02	Manual
0x03	RFID
0xFF	Indeterminate

### 11451 7.3.2.16.27.2 Operation Event Codes

11452 The door lock optionally sends out notifications (if they are enabled) whenever there is a significant opera-  
11453 tional event on the lock. When combined with a source from the Event Source table above, the following  
11454 operational event codes constitute an event on the door lock that can be both logged and sent to a bound  
11455 device using the Operation Event Notification command.

11456 Not all operation event codes are applicable to each of the event source. Table 7-29 marks each event code  
11457 with “A” if the event code is applicable to the event source.

11458

**Table 7-29. Operation Event Code Value**

Value	Operation Event Code	Keypad	RF	Manual	RFID
0x00	UnknownOrMfgSpecific	A	A	A	A
0x01	Lock	A	A	A	A
0x02	Unlock	A	A	A	A
0x03	LockFailureInvalidPINorID	A	A		A
0x04	LockFailureInvalidSchedule	A	A		A
0x05	UnlockFailureInvalidPINorID	A	A		A
0x06	UnlockFailureInvalidSchedule	A	A		A
0x07	OneTouchLock			A	
0x08	KeyLock			A	
0x09	KeyUnlock			A	
0x0A	AutoLock			A	
0x0B	ScheduleLock			A	
0x0C	ScheduleUnlock			A	
0x0D	Manual Lock (Key or Thumbturn)			A	
0x0E	Manual Unlock (Key or Thumbturn)			A	
0x0F	Non-Access User Operational Event	A			

11459 **7.3.2.16.27.3 User ID**

11460 The User ID who performed the event.

11461 **7.3.2.16.27.4 PIN**

11462 The PIN that is associated with the User ID who performed the event.

11463 **7.3.2.16.27.5 LocalTime**

11464 The LocalTime that indicates when the event is triggered. If time is not supported, the field SHALL be populated with default not used value 0xFFFFFFFF.  
 11465

11466 **7.3.2.16.27.6 Data**

11467 The operation event notification command contains a variable string, which can be used to pass data associated with a particular event. Generally this field will be left empty. However, manufacturer can choose to use this field to store/display manufacturer-specific information.  
 11468  
 11469

11470 **7.3.2.16.27.7 Keypad Operation Event Notification**

11471 Keypad Operation Event Notification feature is enabled by setting the associated bitmasks in the [Keypad  
11472 Operation Event Mask attribute].

11473 **Table 7-30. Keypad Operation Event Value**

Event Source	Operation Event Code	Attribute Bitmask	Event Description
0x00	0x00	BIT(0)	Unknown or manufacturer-specific keypad operation event
0x00	0x01	BIT(1)	Lock, source: keypad
0x00	0x02	BIT(2)	Unlock, source: keypad
0x00	0x03	BIT(3)	Lock, source: keypad, error: invalid PIN
0x00	0x04	BIT(4)	Lock, source: keypad, error: invalid schedule
0x00	0x05	BIT(5)	Unlock, source: keypad, error: invalid code
0x00	0x06	BIT(6)	Unlock, source: keypad, error: invalid schedule
0x00	0x0F	BIT(7)	Non-Access User operation event, source keypad.

11474 **7.3.2.16.27.8 RF Operation Event Notification**

11475 RF Operation Event Notification feature is enabled by setting the associated bitmasks in the [RF Operation  
11476 Event Mask attribute].

11477 **Table 7-31. RF Operation Event Value**

Event Source	Operation Event Code	Attribute Bitmask	Event Description
0x01	0x00	BIT(0)	Unknown or manufacturer-specific RF operation event
0x01	0x01	BIT(1)	Lock, source: RF
0x01	0x02	BIT(2)	Unlock, source: RF
0x01	0x03	BIT(3)	Lock, source: RF, error: invalid code
0x01	0x04	BIT(4)	Lock, source: RF, error: invalid schedule
0x01	0x05	BIT(5)	Unlock, source: RF, error: invalid code
0x01	0x06	BIT(6)	Unlock, source: RF, error: invalid schedule

11478 **7.3.2.16.27.9 Manual Operation Event Notification**

11479 Manual Operation Event Notification feature is enabled by setting the associated bitmasks in the [Manual  
11480 Operation Event Mask attribute].

11481

**Table 7-32. Manual Operation Event Value**

Event Source	Operation Event Code	Attribute Bitmask	Event Description
0x02	0x00	BIT(0)	Unknown or manufacturer-specific manual operation event
0x02	0x01	BIT(1)	Thumbturn Lock
0x02	0x02	BIT(2)	Thumbturn Unlock
0x02	0x07	BIT(3)	One touch lock
0x02	0x08	BIT(4)	Key Lock
0x02	0x09	BIT(5)	Key Unlock
0x02	0x0A	BIT(6)	Auto lock
0x02	0x0B	BIT(7)	Schedule Lock
0x02	0x0C	BIT(8)	Schedule Unlock
0x02	0x0D	BIT(9)	Manual Lock (Key or Thumbturn)
0x02	0x0E	BIT(10)	Manual Unlock (Key or Thumbturn)

11482

**7.3.2.16.27.10 RFID Operation Event Notification**

11483

RFID Operation Event Notification feature is enabled by setting the associated bitmasks in the [RFID Operation Event Mask attribute].

11484

11485

**Table 7-33. RFID Operation Event Value**

Event Source	Operation Event Code	Attribute Bitmask	Event Description
0x03	0x00	BIT(0)	Unknown or manufacturer-specific keypad operation event
0x03	0x01	BIT(1)	Lock, source: RFID
0x03	0x02	BIT(2)	Unlock, source: RFID
0x03	0x03	BIT(3)	Lock, source: RFID, error: invalid RFID ID
0x03	0x04	BIT(4)	Lock, source: RFID, error: invalid schedule
0x03	0x05	BIT(5)	Unlock, source: RFID, error: invalid RFID ID
0x03	0x06	BIT(6)	Unlock, source: RFID, error: invalid schedule

11486 **7.3.2.16.28 Programming Event Notification Command**

11487 The door lock server sends out a programming event notification whenever a programming event takes place  
11488 on the door lock.

11489 As with operational events, all programming events can be turned on and off by flipping bits in the associated  
11490 event mask.

11491 The programming event notification command includes an optional string of data that can be used by the  
11492 manufacturer to pass some manufacturer-specific information if that is required.

11493 **Figure 7-54. Format of the Programming Event Notification Command**

<b>Octets</b>	1	1	2	1	1	1	4	Variable/0
<b>Data Type</b>	uint8	uint8	uint16	octstr	enum8	uint8	uint32	string
<b>Field Name</b>	Program Event Source	Program Event Code	User ID	PIN	User Type	User Status	Local-Time	Data

11494 **7.3.2.16.28.1 Operation Event Sources**

11495 This field indicates where the event was triggered from.

11496 **Table 7-34. Operation Event Source Value**

<b>Value</b>	<b>Source</b>
0x00	Keypad
0x01	RF
0x02	Reserved (Manual in Operation Event)
0x03	RFID
0xFF	Indeterminate

11497 **7.3.2.16.28.2 Programming Event Codes**

11498 The door lock optionally sends out notifications (if they are enabled) whenever there is a significant pro-  
11499 gramming event on the lock. When combined with a source from the Event Source table above, the following  
11500 programming event codes constitute an event on the door lock that can be both logged and sent to a bound  
11501 device using the Programming Event Notification command.

11502 Not all event codes are applicable to each of the event source. Table 7-35 marks each event code with “A” if  
11503 the event code is applicable to the event source.

11504 **Table 7-35. Programming Event Codes**

<b>Value</b>	<b>Programming Event Code</b>	<b>Keypad</b>	<b>RF</b>	<b>RFID</b>
0x00	UnknownOrMfgSpecific	A	A	A



Value	Programming Event Code	Keypad	RF	RFID
0x01	MasterCodeChanged	A		
0x02	PINCodeAdded	A	A	
0x03	PINCodeDeleted	A	A	
0x04	PINCodeChanged	A	A	
0x05	RFIDCodeAdded			A
0x06	RFIDCodeDeleted			A

11505 **7.3.2.16.28.3 User ID**

11506 The User ID who performed the event

11507 **7.3.2.16.28.4 PIN**

11508 The PIN that is associated with the User ID who performed the event

11509 **7.3.2.16.28.5 User Type**

11510 The User Type that is associated with the User ID who performed the event

11511 **7.3.2.16.28.6 User Status**

11512 The User Status that is associated with the User ID who performed the event

11513 **7.3.2.16.28.7 LocalTime**

11514 The LocalTime that indicates when the event is triggered. If time is not supported, the field SHALL be pop-  
 11515 ulated with default not used value 0xFFFFFFFF.

11516 **7.3.2.16.28.8 Data**

11517 The programming event notification command contains a variable string, which can be used to pass data  
 11518 associated with a particular event. Generally this field will be left empty. However, manufacturer can choose  
 11519 to use this field to store/display manufacturer-specific information.

11520 **7.3.2.16.28.9 Keypad Programming Event Notification**

11521 Keypad Programming Event Notification feature is enabled by setting the associated bitmasks in the [Keypad  
 11522 Programming Event Mask attribute].

11523 **Table 7-36. Keypad Programming Event Value**

Event Source	Program Event Code	Attribute Bitmask	Event Description
0x00	0x00	BIT(0)	Unknown or manufacturer-specific keypad programming event

Event Source	Program Event Code	Attribute Bitmask	Event Description
0x00	0x01	BIT(1)	Master code changed, source: keypad User ID: master user ID. PIN: default or master code if codes can be sent over the air per attribute. User type: default User Status: default
0x00	0x02	BIT(2)	PIN added, source: keypad User ID: user ID that was added. PIN: code that was added (if codes can be sent over the air per attribute.) User type: default or type added. User Status: default or status added.
0x00	0x03	BIT(3)	PIN deleted, source: keypad User ID: user ID that was deleted. PIN: code that was deleted (if codes can be sent over the air per attribute.) User type: default or type deleted. User Status: default or status deleted.
0x00	0x04	BIT(4)	PIN changed Source: keypad User ID: user ID that was changed PIN: code that was changed (if codes can be sent over the air per attribute.) User type: default or type changed. User Status: default or status changed.

11524 **7.3.2.16.28.10 RF Programming Event Notification**

11525 RF Programming Event Notification feature is enabled by setting the associated bitmasks in the [RF Programming Event Mask attribute].  
11526

11527 **Table 7-37. RF Programming Event Value**

Event Source	Program Event Code	Attribute Bitmask	Event Description
0x01	0x00	BIT(0)	Unknown or manufacturer-specific RF programming event.
0x01	0x02	BIT(2)	PIN added, source RF Same as keypad source above
0x01	0x03	BIT(3)	PIN deleted, source RF Same as keypad source above.

Event Source	Program Event Code	Attribute Bitmask	Event Description
0x01	0x04	BIT(4)	PIN changed Source RF Same as keypad source above
0x01	0x05	BIT(5)	RFID code added, Source RF
0x01	0x06	BIT(6)	RFID code deleted, Source RF

11528 **7.3.2.16.28.11 RFID Programming Event Notification**

11529 RFID Programming Event Notification feature is enabled by setting the associated bitmasks in the [RFID  
 11530 Programming Event Mask attribute].

11531 **Table 7-38. RFID Programming Event Value**

Event Source	Program Event Code	Attribute Bitmask	Event Description
0x03	0x00	BIT(0)	Unknown or manufacturer-specific keypad programming event
0x03	0x05	BIT(5)	ID Added, Source: RFID User ID: user ID that was added. ID: ID that was added (if codes can be sent over the air per attribute.) User Type: default or type added. User Status: default or status added.
0x03	0x06	BIT(6)	ID Deleted, Source: RFID User ID: user ID that was deleted. ID: ID that was deleted (if codes can be sent over the air per attribute.) User Type: default or type deleted. User Status: default or status deleted.

11532 **7.3.2.17 Scene Table Extension**

11533 If the Scene server cluster is implemented, the following extension field is added to the Scene table:

11534 • **LockState**

11535 When the *LockState* attribute is part of a Scene table, the attribute is treated as a writable command;  
 11536 that is, setting the *LockState* to lock will command the lock to lock, and setting the *LockState* to unlock  
 11537 will command the lock to unlock. Setting the *LockState* attribute to “not fully locked” is not supported.

11538 The Transition Time field in the Scene table will be treated as a delay before setting the *LockState* at-  
 11539 tribute; that is, it is possible to activate a scene with the lock actuation some seconds later.

11540 Locks that do not have an actuation mechanism SHOULD not support the Scene table extension.

11541 **7.3.3 Client**

11542 The client supports no cluster specific attributes. The client receives the cluster-specific commands generated  
 11543 by the server, as shown in Table 7-27. The client generates the cluster-specific commands that will be re-  
 11544 ceived by the server, as shown in Table 7-23.

11545 **7.4 Window Covering**11546 **7.4.1 Overview**

11547 Please see Chapter 2 for a general cluster overview defining cluster architecture, revision, classification,  
 11548 identification, etc.

11549 The window covering cluster provides an interface for controlling and adjusting automatic window coverings  
 11550 such as drapery motors, automatic shades, and blinds.

11551 **7.4.1.1 Revision History**

11552 The global *ClusterRevision* attribute value SHALL be the highest revision number in the table below.

Rev	Description
1	mandatory global <i>ClusterRevision</i> attribute added; CCB 1994 1995 1996 1997 2086 2094 2095 2096 2097
2	CCB 2328
3	CCB 2477 2555 2845 3028

11553 **7.4.1.2 Classification**

Hierarchy	Role	PICS Code	Primary Transaction
Base	Application	WNCV	Type 1 (client to server)

11554 **7.4.1.3 Cluster Identifiers**

Identifier	Name
0x0102	Window Covering

11555 **7.4.2 Server**11556 **7.4.2.1 Attributes**

11557 For convenience, the attributes defined in this cluster are arranged into sets of related attributes; each set can  
 11558 contain up to 16 attributes. Attribute identifiers are encoded such that the most significant three nibbles spec-  
 11559 ify the attribute set and the least significant nibble specifies the attribute within the set. The currently defined  
 11560 attribute sets are listed in Table 7-39.

11561

**Table 7-39. Window Covering Attribute Set**

Attribute Set Identifier	Description
0x000 <sup>135</sup>	Window Covering Information
0x001	Window Covering Settings

11562 **7.4.2.1.1 Window Covering Information Attribute Set**

11563 The Window Covering Information attribute set contains the attributes summarized in Table 7-40.

11564

**Table 7-40. Window Covering Information Attribute Set**

Id	Name	Type	Range	Acc	Default	M/O
0x0000	<i>WindowCoveringType</i>	enum8	desc	R	0	M
0x0001	<i>PhysicalClosedLimit – Lift</i>	uint16	0x0000 – 0xffff	R	0	O
0x0002	<i>PhysicalClosedLimit – Tilt</i>	uint16	0x0000 – 0xffff	R	0	O
0x0003	<i>CurrentPosition – Lift</i>	uint16	0x0000 – 0xffff	R	0	O
0x0004	<i>Current Position – Tilt</i>	uint16	0x0000 – 0xffff	R	0	O
0x0005	<i>Number of Actuations – Lift</i>	uint16	0x0000 – 0xffff	R	0	O
0x0006	<i>Number of Actuations – Tilt</i>	uint16	0x0000 – 0xffff	R	0	O
0x0007	<i>Config/Status</i>	map8	desc	R	desc	M
0x0008	<i>Current Position Lift Percentage</i>	uint8	0-100	RSP	FF <sup>136</sup>	<b>M*</b>
0x0009	<i>Current Position Tilt Percentage</i>	uint8	0-100	RSP	FF	<b>M*</b>

11565

11566 **\*Note:** "M\*" designates that the related attributes are required to be mandatory only if Closed Loop control is enabled and Lift/Tilt actions are correspondingly supported, i.e. the *CurrentPositionLiftPercentage*  
 11567 attribute SHALL be mandatory only if Closed Loop control and Lift actions are supported; and the *Cur-*  
 11568 *rentPositionTiltPercentage* attribute SHALL be mandatory only if Closed Loop control and Tilt actions are  
 11569 supported.  
 11570

11571 **7.4.2.1.2 WindowCoveringType Attribute**

11572 The *WindowCoveringType* attribute identifies the type of window covering being controlled by this endpoint  
 11573 and SHALL be set to one of the non-reserved values in Table 7-41.

<sup>135</sup> CCB 3028 added '0' for 3 digits to represent 3 nibbles

<sup>136</sup> CCB 2555 zero is a valid value, so use non-value (Tilt also) if unknown

11574

Table 7-41. Window Covering Type

Value	Window Covering Type	Supported Actions
0x00	Rollershade	Lift
0x01	Rollershade - 2 Motor	Lift
0x02	Rollershade – Exterior	Lift
0x03	Rollershade - Exterior - 2 Motor	Lift
0x04	Drapery	Lift
0x05	Awning	Lift
0x06	Shutter	Tilt
0x07	Tilt Blind - Tilt Only	Tilt
0x08	Tilt Blind - Lift and Tilt	Lift, Tilt
0x09	Projector Screen	Lift

11575 **7.4.2.1.2.1 PhysicalClosedLimit - Lift Attribute**

11576 The *PhysicalClosedLimitLift* attribute identifies the maximum possible encoder position possible (in centi-  
11577 meters) to position the height of the window covering – this is ignored if the device is running in Open Loop  
11578 Control.

11579 **7.4.2.1.2.2 PhysicalClosedLimit - Tilt Attribute**

11580 The *PhysicalClosedLimitTilt* attribute identifies the maximum possible encoder position possible (tenth of a  
11581 degrees) to position the angle of the window covering – this is ignored if the device is running in Open Loop  
11582 Control.

11583 **7.4.2.1.2.3 CurrentPosition - Lift Attribute**

11584 The *CurrentPositionLift* attribute identifies the actual position (in centimeters) of the window covering from  
11585 the top of the shade if Closed Loop Control is enabled. This attribute is ignored if the device is running in  
11586 Open Loop Control.

11587 **7.4.2.1.2.4 Current Position - Tilt Attribute**

11588 The *CurrentPositionTilt* attribute identifies the actual tilt position (in tenth of an degree) of the window cov-  
11589 ering from Open if Closed Loop Control is enabled. This attribute is ignored if the device is running in Open  
11590 Loop Control.

11591 **7.4.2.1.2.5 Number of Actuations - Lift Attribute**

11592 The *NumberOfActuationsLift* attribute identifies the total number of lift actuations applied to the Window  
11593 Covering since the device was installed.

11594 **7.4.2.1.2.6 Number of Actuations - Tilt Attribute**

11595 The *NumberOfActuationsTilt* attribute identifies the total number of tilt actuations applied to the Window  
 11596 Covering since the device was installed.

11597 **7.4.2.1.2.7 Config/Status Attribute**

11598 The *ConfigStatus* attribute makes configuration and status information available. To change settings, devices  
 11599 SHALL write to the Mode attribute of the Window Covering Settings Attribute Set. The behavior causing  
 11600 the setting or clearing of each bit is vendor specific. See Table 7-42 for details on each bit.

11601 **Table 7-42. Bit Meanings for the Config/Status Attribute**

Bit	Meaning	Description
bit0	0 = Not Operational 1 = Operational	Operational: This status bit defines if the Window Covering is operational.
bit1	0 = Not Online 1 = Online	Online: This status bit defines if the Window Covering is enabled for transmitting over the network.
bit2	0 = Commands are normal 1 = Open/Up Commands have been reversed	Reversal – Lift commands: This status bit identifies if the direction of rotation for the Window Covering has been reversed in order for Open/Up commands to match the physical installation condition.
bit3	0 = Lift control is Open Loop 1 = Lift control is Closed Loop	Control – Lift: This status bit identifies if the window covering supports Open Loop or Closed Loop Lift Control
bit4	0 = Tilt control is Open Loop 1 = Tilt control is Closed Loop	Control – Tilt: This status bit identifies if the window covering supports Open Loop or Closed Loop Tilt Control
bit5	0 = Timer Controlled 1 = Encoder Controlled This bit is Ignored if running Lift in Open Loop Control.	Encoder – Lift: This status bit identifies if a Closed Loop Controlled Window Covering is employing an encoder for positioning the height of the window covering.
bit6	0 = Timer Controlled 1 = Encoder Controlled This bit is Ignored if running Tilt in Open Loop Control.	Encoder – Tilt: This status bit identifies if a Closed Loop Controlled Window Covering is employing an encoder for tilting the window covering.

11602 **7.4.2.1.2.8 Current Position Lift Percentage Attribute**

11603 The *CurrentPositionLiftPercentage* attribute identifies the actual position as a percentage between the *In-*  
 11604 *stalledOpenLimitLift* attribute and the *InstalledClosedLimitLift* attribute of the window covering from the  
 11605 up/open position if Closed Loop Control is enabled. If the device is running in Open Loop Control or the  
 11606 device only supports Tilt actions, this attribute is not required as an attribute but has a special interpretation  
 11607 when received as part of a scene command (see “Scene Table Extensions” below).

11608 **7.4.2.1.2.9 Current Position Tilt Percentage Attribute**

11609 The *CurrentPositionTiltPercentage* attribute identifies the actual position as a percentage between the *InstalledOpenLimitTilt* attribute and the *InstalledClosedLimitTilt* attribute of the window covering from the  
 11610 up/open position if Closed Loop Control is enabled. If the device is running in Open Loop Control or the  
 11611 device only support Lift actions, this attribute is not required as an attribute but has a special interpretation  
 11612 when received as part of a scene command (see “Scene Table Extensions” below).  
 11613

### 11614 7.4.2.1.3 Window Covering Settings Attribute Set

11615 The *WindowCoveringSettings* attribute set contains the attributes summarized in Table 7-43.

11616 **Table 7-43. Window Covering Settings Attribute Set**

Id	Name	Unit	Type	Range	Acc	Default	M/O
0x0010 <sup>137</sup>	<i>InstalledOpenLimit – Lift</i>	cm	uint16	0x0000 – 0xffff	R	0x0000	M*
0x0011	<i>InstalledClosedLimit – Lift</i>	cm	uint16	0x0000 – 0xffff	R	0xffff	M*
0x0012	<i>InstalledOpenLimit – Tilt</i>	0.1°	uint16	0x0000 – 0xffff	R	0x0000	M*
0x0013	<i>InstalledClosedLimit – Tilt</i>	0.1°	uint16	0x0000 – 0xffff	R	0xffff	M*
0x0014	<i>Velocity – Lift</i>	cm/sec	uint16	0x0000 – 0xffff	RW	0x0000	O
0x0015	<i>Acceleration Time – Lift</i>	0.1sec	uint16	0x0000 – 0xffff	RW	0x0000	O
0x0016	<i>Deceleration Time – Lift</i>	0.1sec	uint16	0x0000 – 0xffff	RW	0x0000	O
0x0017	<i>Mode</i>		map8		RW	0000 0100	M
0x0018	<i>Intermediate Setpoints – Lift</i>		octstr	-	RW	“1,0x0000”	O
0x0019	<i>Intermediate Setpoints – Tilt</i>		octstr	-	RW	“1,0x0000”	O

11617  
 11618 **\*Note:** “M\*” designates that the related attributes are required to be mandatory only if Closed Loop control  
 11619 is enabled and Lift/Tilt actions are correspondingly supported, i.e. the *InstalledOpenLimitLift* and *InstalledClosedLimitLift* attributes SHALL be mandatory only if Closed Loop control and Lift actions are  
 11620 supported; and the *InstalledOpenLimitTilt* and *InstalledClosedLimitTilt* attributes SHALL be mandatory  
 11621 only if Closed Loop control and Tilt actions are supported.  
 11622

#### 11623 7.4.2.1.3.1 InstalledOpenLimit – Lift

11624 The *InstalledOpenLimitLift* attribute identifies the Open Limit for Lifting the Window Covering whether  
 11625 position (in centimeters) is encoded or timed. This attribute is ignored if the device is running in Open Loop  
 11626 Control or only supports Tilt actions.

#### 11627 7.4.2.1.3.2 InstalledClosedLimit – Lift

11628 The *InstalledClosedLimitLift* attribute identifies the Closed Limit for Lifting the Window Covering whether  
 11629 position (in centimeters) is encoded or timed. This attribute is ignored if the device is running in Open Loop  
 11630 Control or only supports Tilt actions.

#### 11631 7.4.2.1.3.3 InstalledOpenLimit – Tilt

<sup>137</sup> CCB 2845 used complete attribute ids for this set



11632 The *InstalledOpenLimitTilt* attribute identifies the Open Limit for Tilting the Window Covering whether  
 11633 position (in tenth of a degree) is encoded or timed. This attribute is ignored if the device is running in Open  
 11634 Loop Control or only supports Lift actions.

11635 **7.4.2.1.3.4 InstalledClosedLimit – Tilt**

11636 The *InstalledClosedLimitTilt* attribute identifies the Closed Limit for Tilting the Window Covering whether  
 11637 position (in tenth of a degree) is encoded or timed. This attribute is ignored if the device is running in Open  
 11638 Loop Control or only supports Lift actions.

11639 **7.4.2.1.3.5 Velocity – Lift**

11640 The *VelocityLift* attribute identifies the velocity (in centimeters per second) associated with Lifting the Win-  
 11641 dows Covering.

11642 **7.4.2.1.3.6 Acceleration Time – Lift**

11643 The *AccelerationTimeLift* attribute identifies any ramp up times to reaching the velocity setting (in tenth of  
 11644 a second) for positioning the Window Covering.

11645 **7.4.2.1.3.7 Deceleration Time – Lift**

11646 The *DecelerationTimeLift* attribute identifies any ramp down times associated with stopping the positioning  
 11647 (in tenth of a second) of the Window Covering.

11648 **7.4.2.1.3.8 Mode**

11649 The *Mode* attribute allows configuration of the Window Covering, such as: reversing the motor direction,  
 11650 placing the Window Covering into calibration mode, placing the motor into maintenance mode, disabling the  
 11651 network, and disabling status LEDs. See Table 7-44 for details.

11652 **Table 7-44. Bit Meanings for the Mode Attribute**

Bit	Meaning	Description
bit0	0 = motor direction is normal 1 = motor direction is reversed	Disables (0) or Enables (1) the reversal of the motor rotating direction associated with an UP/OPEN command. Should be set so that an UP/OPEN command matches moving the Window Covering physically in that direction.
bit1	0 = run in normal mode 1 = run in calibration mode	Disables (0) or Enables (1) placing the Window Covering into Calibration Mode where limits are either setup using physical tools or limits are learned by the controller based on physical setup of the Window Covering by an installer.
bit2	0 = motor is running normally 1 = motor is running in maintenance mode	Disables (0) or Enables (1) placing the motor into Maintenance Mode where the motor cannot be moved over the network or by a switch connected to a Local Switch Input.
bit3	0 = LEDs are off 1 = LEDs will display feedback	Disables (0) or Enables (1) the display of any feedback LEDs resident especially on the packaging of an endpoint where they may cause distraction to the occupant.

11653 **7.4.2.1.3.9 Intermediate Setpoints – Lift**

11654 Identifies the number of Intermediate Setpoints supported by the Window Covering for Lift and then identifies the position settings for those Intermediate Setpoints if Closed Loop Control is supported. This is a comma delimited ASCII character string. For example: “2,0x0013, 0x0030”  
11655  
11656

#### 11657 **7.4.2.1.3.10 Intermediate Setpoints – Tilt**

11658 Identifies the number of Intermediate Setpoints supported by the Window Covering for Tilt and then identifies the position settings for those Intermediate Setpoints if Closed Loop Control is supported. This is a comma delimited ASCII character string. For example: “2,0x0013, 0x0030”  
11659  
11660

11661

## 11662 **7.4.2.2 Commands Received**

11663 **Table 7-45. Commands Received by the Window Covering Server Cluster**

Command ID	Description	M/O
0x00	Up / Open	M
0x01	Down / Close	M
0x02	Stop	M
0x04	Go To Lift Value	O
0x05	Go to Lift Percentage	O
0x07	Go to Tilt Value	O
0x08	Go to Tilt Percentage	O

### 11664 **7.4.2.2.1 Up / Open Command**

#### 11665 **7.4.2.2.1.1 Payload Format**

11666 This command has no payload.

#### 11667 **7.4.2.2.1.2 Effect on Receipt**

11668 Upon receipt of this command, the Window Covering will adjust the window so the physical lift is at the *InstalledOpenLimit – Lift* and the tilt is at the *InstalledOpenLimit – Tilt*. This will happen as fast as possible.  
11669

### 11670 **7.4.2.2.2 Down / Close Command**

#### 11671 **7.4.2.2.2.1 Payload Format**

11672 This command has no payload.

#### 11673 **7.4.2.2.2.2 Effect on Receipt**

11674 Upon receipt of this command, the Window Covering will adjust the window so the physical lift is at the *InstalledClosedLimit – Lift* and the tilt is at the *InstalledClosedLimit – Tilt*. This will happen as fast as possible.  
11675  
11676

11677 **7.4.2.2.3 Stop Command**

11678 **7.4.2.2.3.1 Payload Format**

11679 This command has no payload.

11680 **7.4.2.2.3.2 Effect on Receipt**

11681 Upon receipt of this command, the Window Covering will stop any adjusting to the physical tilt and lift that  
 11682 is currently occurring.

11683 **7.4.2.2.4 Go To Lift Value**

11684 **7.4.2.2.4.1 Payload Format**

11685 The Go To Lift Value command payload SHALL be formatted as illustrated in Figure 7-55.

11686 **Figure 7-55. Format of the Go To Lift Value Command**

<b>Octets</b>	2
<b>Data Type</b>	uint16
<b>Field Name</b>	Lift Value

11687 **7.4.2.2.4.2 Effect on Receipt**

11688 Upon receipt of this command, the Window Covering will adjust the window so the physical lift is at the lift  
 11689 value specified in the payload of this command as long as that value is not larger than *InstalledOpenLimit* –  
 11690 *Lift* and not smaller than *InstalledClosedLimit* – *Lift*. If the lift value is out of bounds a default response  
 11691 containing the status of INVALID\_VALUE will be returned.

11692 **7.4.2.2.5 Go to Lift Percentage**

11693 **7.4.2.2.5.1 Payload Format**

11694 The Go To Lift Percentage command payload SHALL be formatted as illustrated in Figure 7-56.

11695 **Figure 7-56. Format of the Go To Lift Percentage Command**

<b>Octets</b>	1
<b>Data Type</b>	uint8
<b>Field Name</b>	Percentage Lift Value

11696 **7.4.2.2.5.2 Effect on Receipt**

11697 Upon receipt of this command, the Window Covering will adjust the window so the physical lift is at the lift  
 11698 percentage specified in the payload of this command. The percentage value will be mapped to a 8-bit unsigned  
 11699 integer value between *InstalledOpenLimit* and *InstalledClosedLimit*. If the percentage lift value is larger than  
 11700 100, no physical action will be taken and a default response containing the status of INVALID\_VALUE will  
 11701 be returned. If the device only supports open loop lift action then a zero percentage SHOULD be treated as  
 11702 a down/close command and a non-zero percentage SHOULD be treated as an up/open command. If the device  
 11703 is only a tilt control device, then the command SHOULD be ignored and a UNSUPPORTED\_COMMAND  
 11704 status SHOULD be returned. The device must support either the Go To Lift Percentage or the Go To Tilt  
 11705 Percentage command.

11706 **7.4.2.2.6 Go to Tilt Value**11707 **7.4.2.2.6.1 Payload Format**

11708 The Go To Tilt Value command payload SHALL be formatted as illustrated in Figure 7-57.

11709 **Figure 7-57. Format of the Go To Tilt Value Command**

<b>Octets</b>	2
<b>Data Type</b>	uint16
<b>Field Name</b>	Tilt Value

11710 **7.4.2.2.6.2 Effect on Receipt**

11711 Upon receipt of this command, the Window Covering will adjust the window so the physical tilt is at the tilt  
 11712 value specified in the payload of this command as long as that value is not larger than *InstalledOpenLimit –*  
 11713 *Tilt* and not smaller than *InstalledClosedLimit – Tilt*. If the tilt value is out of bounds a default response  
 11714 containing the status of INVALID\_VALUE will be returned.

11715 **7.4.2.2.7 Go to Tilt Percentage**11716 **7.4.2.2.7.1 Payload Format**

11717 The Go To Tilt Percentage command payload SHALL be formatted as illustrated below.

11718 **Figure 7-58. Format of the Go To Lift Percentage Command**

<b>Octets</b>	1
<b>Data Type</b>	uint8
<b>Field Name</b>	Percentage Tilt Value

11719 **7.4.2.2.7.2 Effect on Receipt**

11720 Upon receipt of this command, the Window Covering will adjust the window so the physical tilt is at the tilt  
 11721 percentage specified in the payload of this command. The percentage value will be mapped to a 8-bit un-  
 11722 signed integer value between *InstalledOpenLimit-Tilt* and *InstalledClosedLimit-Tilt*. If the percentage tilt  
 11723 value is larger than 100, no physical action will be taken and a default response containing the status of  
 11724 INVALID\_VALUE will be returned. If the device only supports open loop tilt action then a zero percentage  
 11725 SHOULD be treated as a down/close command and a non-zero percentage SHOULD be treated as an up/open  
 11726 command. If the device is only a lift control device, then the command SHOULD be ignored and a UNSUP-  
 11727 PORTED\_COMMAND status SHOULD be returned. The device must support either the Go To Lift Per-  
 11728 centage or the Go To Tilt Percentage command.

11729 **7.4.2.3 Commands Generated**

11730 This cluster uses the standard Default Response command defined in the ZCL specification for responding  
 11731 to received commands. Possible status values that can be returned are: SUCCESS, NOT\_FOUND, NOT\_AU-  
 11732 THORIZED, INSUFFICIENT\_SPACE, UNSUP\_COMMAND<sup>138</sup>, INVALID\_FIELD, INVALID\_VALUE,  
 11733 FAILURE<sup>139</sup>.

<sup>138</sup> CCB 2477 renamed status<sup>139</sup> CCB 2477 deprecate HARDWARE\_FAILURE

## 11734 7.4.2.4 Scene Table Extensions

11735 If the Window Covering server cluster is implemented, the following extension field is added to the Scene  
11736 table:

- 11737 • **CurrentPositionLiftPercentage**

11738 When the *CurrentPositionLiftPercentage* attribute is part of a Scene table, the attribute is treated as a  
11739 writeable command, that is, setting the lift percentage of the covering device to the value specified in  
11740 the scene table extension over the specified transition time. The device MAY treat the command as a  
11741 linear transition if appropriate or MAY accelerate and decelerate as it deems necessary. If the device is  
11742 only a tilt controlling device this scene table extension is ignored. If the device is an open loop con-  
11743 trolled lift device, then a percentage of 0 is treated as a close command and a non zero percentage is  
11744 treated as an open command and the device will ignore the transition time and transition as fast as ap-  
11745 propriate for that device.

- 11746 • **CurrentPositionTiltPercentage**

11747 When the *CurrentPositionTiltPercentage* attribute is part of a Scene table, the attribute is treated as a  
11748 writeable command, that is, setting the tilt percentage of the covering device to the value specified in  
11749 the scene table extension over the specified transition time. The device MAY treat the command as a  
11750 linear transition if appropriate or MAY accelerate and decelerate as it deems necessary. If the device is  
11751 only a lift controlling device this scene table extension is ignored. If the device is an open loop con-  
11752 trolled tilt device, then a percentage of 0 is treated as a close command and a non zero percentage is  
11753 treated as an open command and the device will ignore the transition time and transition as fast as ap-  
11754 propriate for that device.

## 11755 7.4.2.5 Attribute Reporting

11756 This cluster SHALL support attribute reporting using the Report Attributes command and according to the  
11757 minimum and maximum reporting interval settings described in the ZCL. The following attributes SHALL  
11758 be reported:

11759 *Current Position - Lift Percentage*

11760 *Current Position - Tilt Percentage*

## 11761 7.4.3 Client

11762 The client has no cluster specific attributes. No cluster specific commands are received by the client. The  
11763 client generates the cluster specific commands detailed in sub-clause 7.4.2.2.

# 11764 7.5 Barrier Control

---

## 11765 7.5.1 Overview

11766 Please see Chapter 2 for a general cluster overview defining cluster architecture, revision, classification,  
11767 identification, etc.

11768 This cluster defines an interface for barrier control, which allows for remote operation of barrier devices  
11769 such as garage doors, gate operators, and automatic doors. The cluster provides the current position of the  
11770 barrier, operational information, and device status. The cluster accepts commands to operate the barrier and  
11771 provide remote configuration of the device.

11772 This cluster supports a safety mechanism that may lockout remote operation until the local condition has  
11773 been addressed.

11774 **7.5.1.1 Revision History**11775 The global *ClusterRevision* attribute value SHALL be the highest revision number in the table below.

Rev	Description
1	Initial Revision

11776 **7.5.1.2 Classification**

Hierarchy	Role	PICS Code	Primary Transaction
Base	Application	BAR	Type 1 (client to server)

11777 **7.5.1.3 Cluster Identifiers**

Identifier	Name
0x0103	Barrier Control

11778 **7.5.2 Server**11779 **7.5.2.1 Attributes**

11780 The attributes defined for the server cluster are listed below:

11781 **Table 7-46. Attributes**

Id	Name	Type	Range	Acc	Def	M
0x0001	MovingState	enum8	desc	RP	-	M
0x0002	SafetyStatus	map16	desc	RP	-	M
0x0003	Capabilities	map8	desc	R	ms	M
0x0004	OpenEvents	uint16	0x0000 – 0xfffe	RW	0	O
0x0005	CloseEvents	uint16	0x0000 – 0xfffe	RW	0	O
0x0006	CommandOpenEvents	uint16	0x0000 – 0xfffe	RW	0	O
0x0007	CommandCloseEvents	uint16	0x0000 – 0xfffe	RW	0	O
0x0008	OpenPeriod	uint16	0x0000 – 0xfffe	RW	ms	O
0x0009	ClosePeriod	uint16	0x0000 – 0xfffe	RW	ms	O
0x000A	BarrierPosition	uint8	0 – 100	RPS	FF	M

11782

11783 **7.5.2.1.1 MovingState Attribute**

11784 The *MovingState* attribute identifies whether the barrier is stopped or which direction it is moving. This is  
 11785 the current condition, not the commanded condition. The expected sequence of events SHOULD be as fol-  
 11786 lows:

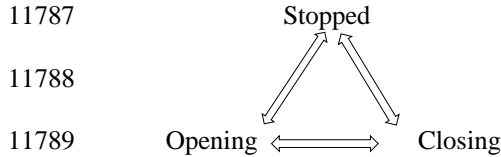

11790 **Table 7-47. MovingState**

Value	Name	Description
0x00	<i>Stopped</i>	The barrier is stopped
0x01	<i>Closing</i>	The barrier is moving toward the fully closed position. If supported, <i>BarrierPosition</i> is decreasing.
0x02	<i>Opening</i>	The barrier is moving toward the fully open position. If supported, <i>BarrierPosition</i> is increasing.

11791

11792 **7.5.2.1.2 SafetyStatus Attribute**

11793 The *SafetyStatus* attribute identifies the current status of the barrier safety mechanisms The Alarm Code,  
 11794 defined below, is used by the Alarms cluster, if it is supported on the same endpoint.

11795 **Table 7-48. SafetyStatus**

Bit	Alarm Code	Name	Description
0	0	Remote Lockout	Commands that change the position of the barrier are ignored (locked out).
1	1	Tamper Detected	Tampering detected on sensors or any other safety equipment
2	2	Failed Communication	Communication failure to sensors or other safety equipment
3	3	Position Failure	Barrier failed to reach desired position

11796 **7.5.2.1.2.1 Remote Lockout**

11797 This bit indicates that a critical error has occurred and the cluster commands to change the barrier position  
 11798 SHALL NOT function. The barrier MAY be actuated by the local physical user interface.

11799 **7.5.2.1.2.2 Other Bits**

11800 The remaining bits give detailed information on why the Remote Lockout state was entered.

11801

11802 **7.5.2.1.3 Capabilities Attribute**

11803 Each bit of this attribute indicates the support of a capability.

11804 **Table 7-49. Capabilities**

Bit	Capability	Description
0	PartialBarrier	The <i>BarrierPosition</i> attribute supports values between fully open (100), and fully closed (0). The barrier also supports commands (and/or a scene) to cause the <i>BarrierPosition</i> to move to a position between fully open (100) and fully closed (0).

11805

11806 **7.5.2.1.4 OpenEvents Attribute**

11807 The *OpenEvents* attribute provides a count of the number of times the barrier has been opened either remotely  
11808 with a command, or locally to the controller. The value SHALL increment when the *BarrierPosition* attribute  
11809 changes from a value of zero to non-zero. This value SHALL NOT roll over. If the number of events exceeds  
11810 the range, the value SHALL be set to 0xffff until it is modified by the controller. It MAY be cleared by  
11811 writing zero to the attribute.

11812 **7.5.2.1.5 CloseEvents Attribute**

11813 The *CloseEvents* attribute provides a count of the number of times the barrier has been closed either remotely  
11814 with a command, or locally to the controller. The value SHALL increment when the *BarrierPosition* attribute  
11815 changes from a value of non-zero to zero. This value SHALL NOT roll over. If the number of events exceeds  
11816 the range, the value SHALL be set to 0xffff until it is modified by the controller. It MAY be cleared by  
11817 writing zero to the attribute.

11818 **7.5.2.1.6 CommandOpenEvents Attribute**

11819 The *CommandOpenEvents* attribute provides a count of the number of times the barrier has been opened  
11820 remotely with a command. The value SHALL increment when the *BarrierPosition* attribute changes from a  
11821 lower value to a higher value. This value SHALL NOT roll over. If the number of events exceeds the range,  
11822 the value SHALL be set to 0xffff until it is modified by the controller. It MAY be cleared by writing zero to  
11823 the attribute.

11824 **7.5.2.1.7 CommandCloseEvents Attribute**

11825 The *CommandCloseEvents* attribute provides a count of the number of times the barrier has been closed  
11826 remotely with a command. The value SHALL increment when the *BarrierPosition* attribute changes from a  
11827 higher value to a lower value. This value SHALL NOT roll over. If the number of events exceeds the range,  
11828 the value SHALL be set to 0xffff until it is modified by the controller. It MAY be cleared by writing zero to  
11829 the attribute.

11830 **7.5.2.1.8 OpenPeriod Attribute**

11831 The *OpenPeriod* attribute indicates the maximum time in tenths of a second that the barrier is expected to  
11832 take to move from a fully closed to a fully opened position. This attribute SHALL be persistent.



11833 This value is used by the application to determine if the barrier has some problem reaching the desired position.  
 11834 If the barrier does not reach the desired position within this period, the application SHOULD take safety  
 11835 steps which MAY include Remote Lockout (see SafetyStatus attribute).

11836 **7.5.2.1.9 ClosePeriod Attribute**

11837 The *ClosePeriod* attribute indicates the maximum time in tenths of a second that the barrier is expected to  
 11838 take to move from a fully opened to a fully closed position. This attribute SHALL be persistent.

11839 This value is used by the application to determine if the barrier has some problem reaching the desired position.  
 11840 If the barrier does not reach the desired position within this period, the application SHOULD take safety  
 11841 steps which MAY include Remote Lockout (see SafetyStatus attribute).

11842 **7.5.2.1.10 BarrierPosition Attribute**

11843 The *BarrierPosition* attribute indicates the current barrier position as a percentage open value. A value of  
 11844 0xff SHALL be returned if the position is unknown. A value of 0 indicates the barrier is fully closed. A value  
 11845 of 100 (0x64) indicates the barrier is fully open. If the barrier is moving and the *PartialBarrier* in the *Capa-*  
 11846 *bilities* attribute Capability is true, then this value SHALL return the position of the barrier, else this value  
 11847 SHALL return 0xff.

11848

11849 **7.5.2.2 Commands Received**

11850

Table 7-50. Commands Received

Command ID	Description	M/O
0x00	Go To Percent	M
0x01	Stop	M

11851 **7.5.2.2.1 Go To Percent Command**

11852 **7.5.2.2.1.1 Payload Format**

11853 The Go To Percent command payload SHALL be formatted as illustrated below:

11854

Figure 7-59. Format of the Go To Percent Command

<b>Octets</b>	1
<b>Data Type</b>	uint8
<b>Field Name</b>	Percent Open
<b>Valid Range</b>	0 to 100

11855 **7.5.2.2.1.1.1 Effect on Receipt**

11856 The Go To Percent command causes the barrier to move to the requested percentage open. If the PartialBar-  
 11857 rier Capability, of the *Capabilities* attribute, is false, then the only valid values SHALL be 0 and 100. If the  
 11858 value is out of bounds, a default response containing the status of INVALID\_VALUE will be returned.

11859 **7.5.2.2.2 Stop Command**

11860 **7.5.2.2.2.1 Payload Format**

11861 The Stop command SHALL NOT have any payload.

11862 **7.5.2.2.2.2 Effect on Receipt**

11863 The Stop command causes the current movement of the barrier to halt. The Stop command has no effect, if  
11864 the barrier is already stopped. The command has no payload.

11865 **7.5.2.3 Commands Generated**

11866 No commands are generated by this cluster.

11867 **7.5.2.4 Scene Table Extensions**

11868 If the Scenes server cluster (see 3.7) is implemented, the following extension fields SHALL be added to the  
11869 Scenes table in the given order, i.e., the attribute listed as 1 is added first:

11870  
11871 1) *BarrierPosition*

11872 **7.5.2.5 Attribute Reporting**

11873 This cluster SHALL support attribute reporting using the Report Attributes command and according to the  
11874 minimum and maximum reporting interval settings described in the ZCL. The following attributes SHALL  
11875 be reported:

11876 *Moving State*

11877 *Barrier Position*

11878 *Safety Status*

11879 **7.5.3 Client**

11880 The client has no cluster specific attributes. No cluster specific commands are received by the client. The  
11881 client generates the cluster specific commands detailed in sub-clause 7.5.2.2.

11882

## CHAPTER 8 SECURITY AND SAFETY

11883

The Cluster Library is made of individual chapters such as this one. See Document Control in the Cluster Library for a list of all chapters and documents. References between chapters are made using a *X.Y* notation where *X* is the chapter and *Y* is the sub-section within that chapter. References to external documents are contained in Chapter 1 and are made using [*Rn*] notation.

11884

11885

11886

11887

### 8.1 General Description

11888

#### 8.1.1 Introduction

11889

The clusters specified in this document are for use in security and safety related applications.

11890

11891

11892

The clusters currently defined are those that are used by wireless Intruder Alarm Systems (IAS). Intruder Alarm systems include functions for the detection of intruders and/or triggering, processing of information, notification of alarms and the means to operate the IAS.

11893

11894

11895

Functions additional to those MAY be included in IAS providing they do not influence the correct operation of the mandatory functions. Components of other applications MAY be combined or integrated with a IAS, providing the performance of the IAS components is not adversely influenced.

11896

#### 8.1.2 Cluster List

11897

11898

This section lists the clusters specified in this document, and gives examples of typical usage for the purpose of clarification.

11899

The clusters defined in this document are listed in Table 8-1.

11900

**Table 8-1. Clusters of the Security and Safety Functional Domain**

Cluster ID	Cluster Name	Description
0x500	IAS Zone	Attributes and commands for IAS security zone devices.
0x501	IAS ACE	Attributes and commands for IAS Ancillary Control Equipment.
0x502	IAS WD	Attributes and commands for IAS Warning Devices

11901

11902

**Figure 8-1. Typical Usage of the IAS Clusters**

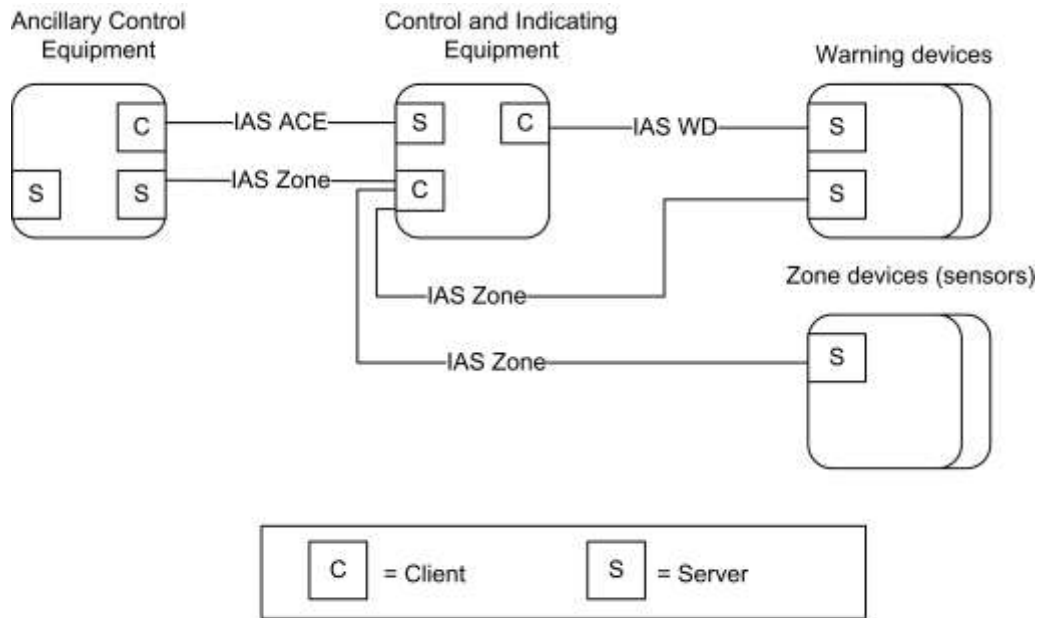

*Note: Device names are examples for illustration purposes only*

11903

## 11904 8.2 IAS Zone

### 11905 8.2.1 Overview

11906 Please see Chapter 2 for a general cluster overview defining cluster architecture, revision, classification,  
11907 identification, etc.

11908 The IAS Zone cluster defines an interface to the functionality of an IAS security zone device. IAS Zone  
11909 supports up to two alarm types per zone, low battery reports and supervision of the IAS network.

#### 11910 8.2.1.1 Revision History

11911 The global *ClusterRevision* attribute value SHALL be the highest revision number in the table below.

Rev	Description
1	mandatory global <i>ClusterRevision</i> attribute added; ZHA 1.2 and 1.2.1 features; CCB 2044 2045
2	CCB 2352

#### 11912 8.2.1.2 Classification

Hierarchy	Role	PICS Code	Primary Transaction
-----------	------	-----------	---------------------

Base	Application	IASZ	Type 2 (server to client)
------	-------------	------	---------------------------

11913 **8.2.1.3 Cluster Identifiers**

Identifier	Name
0x0500	IAS Zone

11914 **8.2.2 Server**

11915 **8.2.2.1 Attributes**

11916 For convenience, the attributes defined in this specification are arranged into sets of related attributes; each  
 11917 set can contain up to 16 attributes. Attribute identifiers are encoded such that the most significant three nib-  
 11918 bles specify the attribute set and the least significant nibble specifies the attribute within the set. The currently  
 11919 defined attribute sets are listed in Table 8-2.

11920 **Table 8-2. Attribute Sets for the IAS Zone Cluster**

Attribute Set Identifier	Description
0x000	Zone information
0x001	Zone settings

11921 **8.2.2.1.1 Zone Information Attribute Set**

11922 The Zone Information attribute set contains the attributes summarized in Table 8-3.

11923 **Table 8-3. Attributes of the Zone Information Attribute Set**

Id	Name	Type	Range	Access	Default	M/O
0x0000	<i>ZoneState</i>	enum8	<i>All</i>	R	0x00	M
0x0001	<i>ZoneType</i>	enum16	<i>All</i>	R	-	M
0x0002	<i>ZoneStatus</i>	map16	<i>All</i>	R	0x00	M

11924 **8.2.2.1.1.1 ZoneState Attribute**

11925 The *ZoneState* attribute contains the values summarized in Table 8-4.

11926 **Table 8-4. Values of the ZoneState Attribute**

Attribute Value	Meaning
0x00	Not enrolled

Attribute Value	Meaning
0x01	Enrolled (the client will react to Zone State Change Notification commands from the server)

11927 **8.2.2.1.1.2 ZoneType Attribute**

11928 The *ZoneType* attribute values are summarized in Table 8-5. The Zone Type dictates the meaning of Alarm1  
11929 and Alarm2 bits of the *ZoneStatus* attribute, as also indicated in this table.

11930 **Table 8-5. Values of the ZoneType Attribute**

Value	Zone Type	Alarm1	Alarm2
0x0000	Standard CIE	System Alarm	-
0x000d	Motion sensor	Intrusion indication	Presence indication
0x0015	Contact switch	1 <sup>st</sup> portal Open-Close	2 <sup>nd</sup> portal Open-Close
0x0016	Door/Window handle	See Table 8-7	See Table 8-7
0x0028	Fire sensor	Fire indication	-
0x002a	Water sensor	Water overflow indication	-
0x002b	Carbon Monoxide (CO) sensor	CO indication	Cooking indication
0x002c	Personal emergency device	Fall/Concussion	Emergency button
0x002d	Vibration/Movement sensor	Movement indication	Vibration
0x010f	Remote Control	Panic	Emergency
0x0115	Key fob	Panic	Emergency
0x021d	Keypad	Panic	Emergency
0x0225	Standard Warning Device (see [N1] part 4)	-	-
0x0226	Glass break sensor	Glass breakage detected	-
0x0229	Security repeater*	-	-
0x8000-0xfffe	manufacturer specific types	-	-
0xffff	Invalid Zone Type	-	-

11931 \* For example: a repeater for security devices that needs to be supervised by the alarm panel/IAS  
11932 CIE to ensure a reliable security sensor network

11933 **8.2.2.1.1.3 ZoneStatus Attribute**

11934 The *ZoneStatus* attribute is a bit map. The meaning of each bit is summarized in Table 8-6.

11935

**Table 8-6. Values of the *ZoneStatus* Attribute**

Bit	Meaning	Values
0	Alarm1	1 – opened or alarmed 0 – closed or not alarmed
1	Alarm2	1 – opened or alarmed 0 – closed or not alarmed
2	Tamper	1 – Tampered 0 – Not tampered
3	Battery	1 – Low battery 0 – Battery OK
4	Supervision Notify	1 – Notify 0 – Does not notify
5	Restore Notify	1 – Notify restore 0 – Does not notify of restore
6	Trouble	1 – Trouble/Failure 0 – OK
7	AC (mains)	1 – AC/Mains fault 0 – AC/Mains OK
8	Test	1 – Sensor is in test mode 0 – Sensor is in operation mode
9	Battery Defect	1 – Sensor detects a defective battery 0 – Sensor battery is functioning normally

11936  
 11937  
 11938  
 11939  
 11940

For the door/window handle zone type (0x0016), the Alarm1 and Alarm2 bits of the of the *ZoneStatus* attribute are to be interpreted as indicated below.

**Table 8-7. Usage of alarm bits of *ZoneStatus* Attribute for door/window handle zone type (0x0016)**

Alarm1	Alarm2	Description
0b0	0b0	(Door/window) closed
0b1	0b0	(Door/window) tilted (partly open)
0b1	0b1	(Door/window) open

11941

**8.2.2.1.1.3.1 Supervision Notify**

11942  
 11943  
 11944  
 11945

This bit indicates whether the Zone issues periodic Zone Status Change Notification commands. The CIE device MAY use these periodic notifications as an indication that a zone is operational. Zones that do not implement periodic notifications are required to set this bit to zero (the CIE will know not to interpret the lack of reports as a problem).

11946  
 11947  
 11948

The notification interval is not configurable. It is manufacturer specific and is typically determined by local regulations (e.g. UL requires a minimum of 28 minutes). The Poll Control cluster SHOULD be used for sleeping end devices.

11949 **8.2.2.1.1.3.2 Restore Notify**

11950 This bit indicates whether or not a Zone Status Change Notification command will be sent to indicate that an  
11951 alarm is no longer present. Some Zones do not have the ability to detect that alarm condition is no longer  
11952 present, they only can tell that an alarm has occurred. These Zones must set the “Restore” bit to zero, indi-  
11953 cating to the CIE not to look for alarm-restore notifications.

11954 **8.2.2.1.2 Zone Settings Attribute Set**

11955 The Zone Settings attribute set contains the attributes summarized in Table 8-8.

11956 **Table 8-8. Attributes of the Zone Settings Attribute Set**

Id	Name	Type	Range	Access	Def	M/O
0x0010	<i>IAS_CIE_Address</i>	EUI64	-	RW	-	M
0x0011	<i>ZoneID</i>	uint8	0x00 – 0xFF	R	0xFF	M
0x0012	<i>NumberOfZoneSensitivityLevelsSupported</i>	uint8	0x02 – 0xff	R	0x02	O*
0x0013	<i>CurrentZoneSensitivityLevel</i>	uint8	0x00 – 0xff	RW	0x00	O*

11957 \* *These attributes depend on each other and if one is supported than both SHALL be supported.*

11958 **8.2.2.1.2.1 IAS\_CIE\_Address Attribute**

11959 The *IAS\_CIE\_Address* attribute specifies the address that commands generated by the server SHALL be sent  
11960 to. All commands received by the server must also come from this address.

11961 It is up to the zone's specific implementation to permit or deny change (write) of this attribute at specific  
11962 times.

11963 See section 8.2.2.1.3 for more information on setting this attribute.

11964 **8.2.2.1.2.2 ZoneID Attribute**

11965 A unique reference number allocated by the CIE at zone enrollment time.

11966 Used by IAS devices to reference specific zones when communicating with the CIE. The *ZoneID* of each  
11967 zone stays fixed until that zone is unenrolled.

11968 **8.2.2.1.2.3 NumberOfZoneSensitivityLevelsSupported Attribute**

11969 Provides the total number of sensitivity levels supported by the IAS Zone server. The purpose of this attrib-  
11970 ute is to support devices that can be configured to be more or less sensitive (e.g., motion sensor). It provides  
11971 IAS Zone clients with the range of sensitivity levels that are supported so they MAY be presented to the user  
11972 for configuration.

11973 The values 0x00 and 0x01 are reserved because a device that has zero or one sensitivity level SHOULD NOT  
11974 support this attribute because no configuration of the IAS Zone server's sensitivity level is possible.

11975 The meaning of each sensitivity level is manufacturer-specific. However, the sensitivity level of the IAS  
11976 Zone server SHALL become more sensitive as they ascend. For example, if the server supports three sen-  
11977 sitivity levels, then the value of this attribute would be 0x03 where 0x03 is more sensitive than 0x02, which  
11978 is more sensitive than 0x01.

11979 **8.2.2.1.2.4 CurrentZoneSensitivityLevel Attribute**

11980 Allows an IAS Zone client to query and configure the IAS Zone server's sensitivity level. Please see Section  
11981 *NumberOfZoneSensitivityLevelsSupported* Attribute for more detail on how to interpret this attribute.



11982 The default value 0x00 is the device’s default sensitivity level as configured by the manufacturer. It MAY  
11983 correspond to the same sensitivity as another value in the *NumberOfZoneSensitivityLevelsSupported*, but this  
11984 is the default sensitivity to be used if the *CurrentZoneSensitivityLevel* attribute is not otherwise configured  
11985 by an IAS Zone client.

### 11986 **8.2.2.1.3 Implementation Guidelines**

11987 Use of the *IAS\_CIE\_Address* and *ZoneID* attributes functions as an additional enrollment step that is not  
11988 employed by other devices. The reason for this is to provide an extra layer of security due to the nature of  
11989 these devices in protecting premises from physical intrusion and attack.

11990 There are three methods for enrolling IAS Zone server to an IAS CIE (i.e., IAS Zone client):

- 11991 • Trip-to-pair
- 11992 • Auto-Enroll-Response
- 11993 • Auto-Enroll-Request

11994 IAS Zone servers SHALL support either:

- 11995 • Trip-to-pair AND Auto-Enroll-Response, OR
- 11996 • Auto-Enroll-Request

11997 An IAS Zone client SHALL support either:

- 11998 • Trip-to-pair AND Auto-Enroll-Response, OR
- 11999 • Auto-Enroll-Request

12000 An IAS Zone client MAY support all enrollment methods. The Trip-to-Pair enrollment method is primarily  
12001 intended to be used when there is a desire for an explicit enrollment method (e.g., when a GUI wizard or  
12002 other commissioning tool is used by a user or installer to add multiple IAS Zone servers in an orderly fashion,  
12003 assign names to them, configure them in the system).

12004 A commissioning tool MAY act as an agent, on behalf of an IAS CIE device for either commissioning  
12005 method. A commissioning tool MAY perform any of the actions that are defined below for the IAS CIE.

12006 The following requirements are intended to ensure a timely and interoperable commissioning process:

- 12007 • After joining a network, an IAS Zone server implemented as a Sleepy End Device SHALL data  
12008 poll at least once every seven seconds until its *ZoneState* attribute has been updated to “enrolled”  
12009 (i.e., until it receives a Zone Enroll Response command from an IAS Zone client).
- 12010 • After joining a network, an IAS Zone server SHOULD data poll at least once every two seconds  
12011 until its *ZoneState* attribute has been updated to “enrolled” (i.e., until it receives a Zone Enroll Re-  
12012 sponse command from an IAS Zone client).
- 12013 • If the IAS Zone server supports Poll Control cluster, it SHOULD continue data polling at this rate  
12014 until its Poll Control cluster parameters are configured otherwise.
- 12015 • The *IAS\_CIE\_Address* attribute of the IAS Zone server to be enrolled SHALL be configured only  
12016 by the IAS CIE (or an agent of an IAS CIE). A self-configuration based on any kind of auto-detect  
12017 approach triggered by the IAS Zone server itself SHALL be prohibited.

12018 The detailed requirements for each commissioning method follow:

#### 12019 **Trip-to-Pair**

- 12020 1. After an IAS Zone server is commissioned to a network, the IAS CIE MAY perform service dis-  
12021 covery.
- 12022 2. If the IAS CIE determines it wants to enroll the IAS Zone server, it SHALL send a Write Attribute  
12023 command on the IAS Zone server’s *IAS\_CIE\_Address* attribute with its IEEE address.
- 12024 3. The IAS Zone server MAY configure a binding table entry for the IAS CIE’s address because all  
12025 of its communication will be directed to the IAS CIE.

- 12026 4. Upon a user input determined by the manufacturer (e.g., a button, change to device’s *ZoneStatus*  
12027 attribute that would result in a Zone Status Change Notification command) and the IAS Zone  
12028 server’s *ZoneState* attribute equal to 0x00 (unenrolled), the IAS Zone server SHALL send a Zone  
12029 Enroll Request command.  
12030 5. The IAS CIE SHALL send a Zone Enroll Response command, which assigns the IAS Zone  
12031 server’s *ZoneID* attribute.  
12032 6. The IAS Zone server SHALL change its *ZoneState* attribute to 0x01 (enrolled).

12033 **Auto-Enroll-Response**

- 12034 1. After an IAS Zone server is commissioned to a network, the IAS CIE MAY perform service dis-  
12035covery.  
12036 2. If the IAS CIE determines it wants to enroll the IAS Zone server, it SHALL send a Write Attribute  
12037command on the IAS Zone server’s *CIE\_IAS\_Address* attribute with its IEEE address.  
12038 3. The IAS Zone server MAY configure a binding table entry for the IAS CIE’s address because all  
12039of its communication will be directed to the IAS CIE.  
12040 4. The IAS CIE SHALL send a Zone Enroll Response, which assigns the IAS Zone server’s *ZoneID*  
12041attribute.  
12042 5. The IAS Zone server SHALL change its *ZoneState* attribute to 0x01 (enrolled).

12043 **Auto-Enroll-Request**

- 12044 1. After an IAS Zone server is commissioned to a network, the IAS CIE MAY perform service dis-  
12045covery.  
12046 2. If the IAS CIE determines it wants to enroll the IAS Zone server, it SHALL send a Write Attribute  
12047command on the IAS Zone server’s *IAS\_CIE\_Address* attribute with its IEEE address.  
12048 3. The IAS Zone server MAY configure a binding table entry for the IAS CIE’s address because all  
12049of its communication will be directed to the IAS CIE.  
12050 4. The IAS Zone server SHALL send a Zone Enroll Request command.  
12051 5. The IAS CIE SHALL send a Zone Enroll Response command, which assigns the IAS Zone  
12052server’s *ZoneID* attribute.  
12053 6. The IAS Zone server SHALL change its *ZoneState* attribute to 0x01 (enrolled).

12054 Once the *IAS\_CIE\_Address* attribute has been written on an IAS Zone server, the IAS Zone server SHALL  
12055only act upon commands received from an initiator that matches the *IAS\_CIE\_Address* attribute.

12056 Any attempt via the ZDO bind or unbind request to create, modify or remove binding table entry on a device  
12057embodying the IAS Zone server SHALL be rejected and responded with the status NOT\_AUTHORIZED, if  
12058the subjected binding table entry is related to an IAS Zone server cluster and the ZDP request does not come  
12059from the paired IAS CIE.

12060 **8.2.2.2 Commands Received**

12061 The command IDs received by the IAS Zone server cluster are listed in Table 8-9Received Command IDs  
12062for the IAS Zone Cluster.

Table 8-9. Received Command IDs for the IAS Zone Cluster

Command Id	Description	M/O
0x00	Zone Enroll Response	M
0x01	Initiate Normal Operation Mode	O
0x02	Initiate Test Mode	O

12064 **8.2.2.2.1 Zone Enroll Response Command**

12065 **8.2.2.2.1.1 Payload Format**

12066 The Zone Enroll Response command payload SHALL be formatted as illustrated in Figure 8-2Format of the  
 12067 Zone Enroll Response Command Payload.

12068 **Figure 8-2. Format of the Zone Enroll Response Command Payload**

<b>Bits</b>	8	8
<b>Data Type</b>	enum8	uint8
<b>Field Name</b>	Enroll response code	Zone ID

12069

12070 The permitted values of the Enroll Response Code are shown in Table 8-10 Values of the Enroll Response  
 12071 Code.

12072 **Table 8-10. Values of the Enroll Response Code**

<b>Code</b>	<b>Meaning</b>	<b>Details</b>
0x00	Success	Success
0x01	Not supported	This specific Zone type is not known to the CIE and is not supported.
0x02	No enroll permit	CIE does not permit new zones to enroll at this time.
0x03	Too many zones	CIE reached its limit of number of enrolled zones

12073

12074 The Zone ID field is the index into the zone table of the CIE (Table 8-12Format of the Zone Table). This  
 12075 field is only relevant if the response code is success.

12076 **8.2.2.2.1.2 Effect on Receipt**

12077 On receipt, the device embodying the Zone server is notified that it is now enrolled as an active alarm device

12078 The device embodying the Zone server must authenticate received messages by checking the address of their  
 12079 sender against *IAS\_CIE\_Address*. This is to ensure that only messages from the correct CIE are accepted.

12080 **8.2.2.2.2 Initiate Normal Operation Mode Command**

12081 Used to tell the IAS Zone server to commence normal operation mode.

12082 **8.2.2.2.2.1 Payload Format**

12083 This command has no payload.

12084 **8.2.2.2.2.2 Effect on Receipt**

12085 Upon receipt, the IAS Zone server SHALL commence normal operational mode.

12086 Any configurations and changes made (e.g., *CurrentZoneSensitivityLevel* attribute) to the IAS Zone server  
 12087 SHALL be retained.

12088 Upon commencing normal operation mode, the IAS Zone server SHALL send a Zone Status Change Notifi-  
12089 cation command updating the *ZoneStatus* attribute Test bit to zero (i.e., “operation mode”).

12090 **8.2.2.2.2.3 Initiate Test Mode Command**

12091 Certain IAS Zone servers MAY have operational configurations that could be configured OTA or locally on  
12092 the device. This command enables them to be remotely placed into a test mode so that the user or installer  
12093 MAY configure their field of view, sensitivity, and other operational parameters. They MAY also verify  
12094 the placement and proper operation of the IAS Zone server, which MAY have been placed in a difficult to  
12095 reach location (i.e., making a physical input on the device impractical to trigger).

12096 Another use case for this command is large deployments, especially commercial and industrial, where placing  
12097 the entire IAS system into test mode instead of a single IAS Zone server is infeasible due to the vulnerabilities  
12098 that might arise. This command enables only a single IAS Zone server to be placed into test mode.

12099 The biggest limitation of this command is that most IAS Zone servers today are battery-powered sleepy nodes  
12100 that cannot reliably receive commands. However, implementers MAY decide to program an IAS Zone  
12101 server by factory default to maintain a limited duration of normal polling upon initialization/joining to a new  
12102 network. Some IAS Zone servers MAY also have AC mains power and are able to receive commands.  
12103 Some types of IAS Zone servers that MAY benefit from this command are: motion sensors and fire sen-  
12104 sor/smoke alarm listeners (i.e., a device that listens for a non-communicating fire sensor to alarm and com-  
12105 municates this to the IAS CIE).

12106 **8.2.2.2.2.4 Payload Format**

12107 The Initiate Test Mode command SHALL be formatted as illustrated below:

12108 **Figure 8-3. Payload format of Initiate Test Mode command**

<b>Octets</b>	1	1
<b>Data Type</b>	uint8	uint8
<b>Field Name</b>	Test Mode Duration	Current Zone Sensitivity Level

12109

12110 **8.2.2.2.2.5 Test Mode Duration Field**

12111 Specifies the duration, in seconds, for which the IAS Zone server SHALL operate in its test mode.

12112 **8.2.2.2.2.6 Current Zone Sensitivity Level Field**

12113 Specifies the sensitivity level the IAS Zone server SHALL use for the duration of the Test Mode and with  
12114 which it must update its *CurrentZoneSensitivityLevel* attribute.

12115 The permitted values of Current Zone Sensitivity Level are shown defined for the *CurrentZoneSensitiv-*  
12116 *ityLevel* Attribute in Section 8.2.2.1.2.4.

12117 **8.2.2.2.2.7 Effect on Receipt**

12118 Upon receipt, the IAS Zone server SHALL commence test mode for the duration specified in the command  
12119 and update its *CurrentZoneSensitivityLevel* attribute to match the value specified in the command.

12120 The IAS Zone server SHALL send a Zone Status Change Notification command updating the *ZoneStatus*  
12121 attribute Test bit to one (i.e., “test mode”).

12122 While in test mode, the IAS Zone server SHALL send Zone Status Change Notification commands with the  
12123 appropriate payload to signal that the node is successfully detecting test events.

12124 Upon completing the allotted test mode duration time, the IAS Zone server SHALL resume normal operation  
 12125 mode and SHALL send a Zone Status Change Notification command updating the *ZoneStatus* attribute Test  
 12126 bit to zero (i.e., “normal operation mode”).

12127 At any time, the IAS Zone client MAY send an Initiate Normal Operation Mode command.

12128 The behavior of the IAS Zone server while in test mode is manufacturer specific. The below devices  
 12129 SHOULD behave in the following manner:

- 12130 • Motion sensor
  - 12131 ○ Suspend battery saving features designed to reduce the frequency of motion detection
  - 12132 events sent to the IAS CIE.
  - 12133 ○ Reduce the “blackout period” (i.e., the period the sensor waits before sending a second
  - 12134 motion detection event) so that the IAS Zone server restores an existing motion event and
  - 12135 is ready to send another motion event notification within ten seconds. This is some-
  - 12136 times known as “walk test” mode.
  - 12137 ○ Support manufacturer specific profile extensions to allow a user to configure additional
  - 12138 operational parameters that can be tested while in test mode.
- 12139 • Fire sensor
  - 12140 ○ Begin listening for the user to initiate a test mode on the non-communicating fire sensor
  - 12141 or smoke detector
  - 12142 ○ Generate a Zone Status Change Notification command upon detecting an audible test
  - 12143 alarm
- 12144 • Carbon monoxide sensor
  - 12145 ○ Begin listening for the user to initiate a test mode on the non-communicating carbon
  - 12146 monoxide detector
  - 12147 ○ Generate a Zone Status Change Notification command upon detecting an audible test
  - 12148 alarm

12149 The above guidelines are intended as guidelines for the devices likely to implement test mode. Any IAS  
 12150 Zone server MAY implement test mode features and commands.

12151 Future revisions to this section MAY include additional commands germane to the operational behavior of a  
 12152 given IAS Zone server.

### 12153 8.2.2.3 Commands Generated

12154 The generated command IDs for the IAS Zone server cluster are listed in Table 8-11 Generated Command  
 12155 IDs for the IAS Zone Cluster.

12156 **Table 8-11. Generated Command IDs for the IAS Zone Cluster**

Command Identifier	Description	M/O
0x00	Zone Status Change Notification	M
0x01	Zone Enroll Request	M

#### 12157 8.2.2.3.1 Zone Status Change Notification Command

##### 12158 8.2.2.3.1.1 Payload Format

12159 The Zone Status Change Notification command payload SHALL be formatted as illustrated in Figure  
12160 8-4Format of the Zone Status Change Notification Command Payload.

12161 **Figure 8-4. Format of the Zone Status Change Notification Command Payload**

<b>Bits</b>	16	8	8	16
<b>Data Type</b>	map16	map8	uint8	uint16
<b>Field Name</b>	Zone Status	Extended Status	Zone ID	Delay

12162 **8.2.2.3.1.2 Zone Status Parameter**

12163 The Zone Status field SHALL be the current value of the *ZoneStatus* attribute.

12164 **8.2.2.3.1.3 Extended Status Parameter**

12165 The Extended Status field is reserved for additional status information and SHALL be set to zero.

12166 **8.2.2.3.1.4 Zone ID Parameter**

12167 Zone ID is the index of the Zone in the CIE's zone table (Table 8-12). If none is programmed, the Zone ID  
12168 default value SHALL be indicated in this field.

12169 **8.2.2.3.1.5 Delay Parameter**

12170 The Delay field is defined as the amount of time, in quarter-seconds, from the moment when a change takes  
12171 place in one or more bits of the Zone Status attribute and the successful transmission of the Zone Status  
12172 Change Notification. This is designed to help congested networks or offline servers quantify the amount of  
12173 time from when an event was detected and when it could be reported to the client.

12174 **8.2.2.3.1.6 When Generated**

12175 The Zone Status Change Notification command is generated when a change takes place in one or more bits  
12176 of the *ZoneStatus* attribute.

12177 **8.2.2.3.2 Zone Enroll Request Command**

12178 **8.2.2.3.2.1 Payload Format**

12179 The Zone Enroll Request command payload SHALL be formatted as illustrated in Figure 8-5Format of the  
12180 Zone Enroll Request Command Payload.

12181 **Figure 8-5. Format of the Zone Enroll Request Command Payload**

<b>Bits</b>	16	16
<b>Data Type</b>	enum16	uint16
<b>Field Name</b>	Zone Type	Manufacturer Code

12182  
12183 The Zone Type field SHALL be the current value of the *ZoneType* attribute.

12184 The Manufacturer Code field SHALL be the manufacturer code as held in the node descriptor for the device.  
12185 See [Z12] Manufacturer Code Database.

12186 **8.2.2.3.2.2 When Generated**

12187 The Zone Enroll Request command is generated when a device embodying the Zone server cluster wishes to  
 12188 be enrolled as an active alarm device. It must do this immediately it has joined the network (during commis-  
 12189 sioning).

12190 **8.2.3 Client**

12191 No dependencies or cluster specific attributes are defined for the client. The client receives the cluster specific  
 12192 commands detailed in 8.2.2.3. The client generates the cluster specific commands detailed in 8.2.2.2, as re-  
 12193 quired by the application.

12194 **8.3 IAS ACE**

---

12195 **8.3.1 Overview**

12196 Please see Chapter 2 for a general cluster overview defining cluster architecture, revision, classification,  
 12197 identification, etc.

12198 The IAS ACE cluster defines an interface to the functionality of any Ancillary Control Equipment of the IAS  
 12199 system. Using this cluster, an ACE device can access a IAS CIE device and manipulate the IAS system, on  
 12200 behalf of a level-2 user (see [N1]).

12201 The client is usually implemented by the IAS ACE device. It allows the IAS ACE device to control the IAS  
 12202 CIE device, which typically implements the server side.

12203 **8.3.1.1 Revision History**

12204 The global *ClusterRevision* attribute value SHALL be the highest revision number in the table below.

Rev	Description
1	mandatory global <i>ClusterRevision</i> attribute added; ZHA 1.2 and 1.2.1 features; CCB 1977

12205 **8.3.1.2 Classification**

Hierarchy	Role	PICS Code	Primary Transaction
Base	Application	IASACE	Type 1 (client to server)

12206 **8.3.1.3 Cluster Identifiers**

Ident- fier	Name
0x0501	IAS ACE

12207 **8.3.2 Server**12208 **8.3.2.1 Attributes**

12209 No attributes are currently defined for this cluster.

12210 **8.3.2.2 Zone Table**12211 The Zone Table is used to store information for each Zone enrolled by the CIE. The maximum number of  
12212 entries in the table is 255.

12213 The format of a group table entry is illustrated in Table 8-12.

12214 **Table 8-12. Format of the Zone Table**

Field	Type	Valid Range	Description
Zone ID	uint8	0x00 – 0xfe	The unique identifier of the zone
Zone Type	enum16	0x0000 – 0xfffe	See Table 8-5.
Zone Address	EUI64	Valid 64-bit IEEE address	Device address

12215 The Zone ID is a unique reference number allocated by the CIE at zone enrollment time.

12216 The Zone ID is used by IAS devices to reference specific zones when communicating with the CIE. The  
12217 Zone ID of each zone stays fixed until that zone is unenrolled.12218 **8.3.2.3 Commands Received**12219 The received command IDs for the IAS ACE server cluster are listed in Table 8-13Received Command IDs  
12220 for the IAS ACE Cluster.12221 **Table 8-13. Received Command IDs for the IAS ACE Cluster**

Command Identifier	Description	M/O
0x00	Arm	M
0x01	Bypass	M
0x02	Emergency	M
0x03	Fire	M
0x04	Panic	M
0x05	Get Zone ID Map	M
0x06	Get Zone Information	M
0x07	Get Panel Status	M



Command Identifier	Description	M/O
0x08	Get Bypassed Zone List	M
0x09	Get Zone Status	M

12222 **8.3.2.3.1 Arm Command**

12223 **8.3.2.3.1.1 Payload Format**

12224 The Arm command payload SHALL be formatted as illustrated in Figure 8-6.

12225 **Figure 8-6. Format of the Arm Command Payload**

Bits	8	Varies	8
Data Type	enum8	string	uint8
Field Name	Arm Mode	Arm/Disarm Code	Zone ID

12226 **8.3.2.3.1.2 Arm Mode Field**

12227 The Arm Mode field SHALL have one of the values shown in Table 8-14 Arm Mode Field Values.

12228 **Table 8-14. Arm Mode Field Values**

Value	Meaning
0x00	Disarm
0x01	Arm Day/Home Zones Only
0x02	Arm Night/Sleep Zones Only
0x03	Arm All Zones

12229 **8.3.2.3.1.3 Arm/Disarm Code Field**

12230 The Arm/Disarm Code SHALL be a code entered into the ACE client (e.g., security keypad) or system by  
 12231 the user upon arming/disarming. The server MAY validate the Arm/Disarm Code received from the IAS  
 12232 ACE client in Arm command payload before arming or disarming the system. If the client does not have the  
 12233 capability to input an Arm/Disarm Code (e.g., key-fob), or the system does not require one, the client SHALL  
 12234 a transmit a string with a length of zero.

12235 There is no minimum or maximum length to the Arm/Disarm Code; however, the Arm/Disarm Code  
 12236 SHOULD be between four and eight alphanumeric characters in length.

12237 The string encoding SHALL be UTF-8.

12238 **8.3.2.3.1.4 Zone ID Field**

12239 Zone ID is the index of the Zone in the CIE's zone table (Table 8-12). If none is programmed, the Zone ID  
 12240 default value SHALL be indicated in this field.

12241 **8.3.2.3.1.5 Effect on Receipt**

12242 On receipt of this command, the receiving device sets its arm mode according to the value of the Arm Mode  
12243 field, as detailed in Table 8-14. It is not guaranteed that an Arm command will succeed. Based on the current  
12244 state of the IAS CIE, and its related devices, the command can be rejected. The device SHALL generate an  
12245 Arm Response command (see 8.3.2.4.1) to indicate the resulting armed state.

12246 **8.3.2.3.2 Bypass Command**

12247 Provides IAS ACE clients with a method to send zone bypass requests to the IAS ACE server. Bypassed  
12248 zones MAY be faulted or in alarm but will not trigger the security system to go into alarm. For example, a  
12249 user MAY wish to allow certain windows in his premises protected by an IAS Zone server to be left open  
12250 while the user leaves the premises. The user could bypass the IAS Zone server protecting the window on  
12251 his IAS ACE client (e.g., security keypad), and if the IAS ACE server indicates that zone is successfully  
12252 bypassed, arm his security system while he is away.

12253 **8.3.2.3.2.1 Payload Format**

12254 The Bypass command payload SHALL be formatted as illustrated in Figure 8-7For.

12255 **Figure 8-7. Format of the Bypass Command Payload**

<b>Bits</b>	8	8	...	8	Varies
<b>Data Type</b>	uint8	uint8	...	uint8	string
<b>Field Name</b>	Number of Zones	Zone ID	...	Zone ID	Arm/Disarm Code

12256 **8.3.2.3.2.2 Number of Zones Field**

12257 This is the number of Zone IDs included in the payload.

12258 **8.3.2.3.2.3 Zone ID Field**

12259 Zone ID is the index of the Zone in the CIE's zone table (Table 8-12Format of the Zone Table).

12260 **8.3.2.3.2.4 Arm/Disarm Code Field**

12261 This field is the same as the Arm/Disarm Code field defined in Section 8.3.2.3.1.3.

12262 **8.3.2.3.2.5 Effect of Receipt**

12263 On receipt of this command, the IAS ACE server SHALL process this bypass request and generate a single  
12264 Bypass Response command for the zones requested in the Bypass command payload

12265 **8.3.2.3.3 Emergency, Fire and Panic Commands**

12266 These commands indicate the emergency situations inherent in their names. They have no payload.

12267 **8.3.2.3.4 Get Zone ID Map Command**

12268 **8.3.2.3.4.1 Payload Format**

12269 This command has no payload.

12270 **8.3.2.3.4.2 Effect on Receipt**

12271 On receipt of this command, the device SHALL generate a Get Zone ID Map Response command. See  
12272 8.3.2.4.2.

### 12273 **8.3.2.3.5 Get Zone Information Command**

#### 12274 **8.3.2.3.5.1 Payload Format**

12275 The Get Zone Information command payload SHALL be formatted as illustrated in Figure 8-8.  
12276

**Figure 8-8. Format of the Get Zone Information Command Payload**

<b>Bits</b>	8
<b>Data Type</b>	uint8
<b>Field Name</b>	Zone ID

#### 12277 **8.3.2.3.5.2 Effect on Receipt**

12278 On receipt of this command, the device SHALL generate a Get Zone Information Response command. See  
12279 8.3.2.4.3.

### 12280 **8.3.2.3.6 Get Panel Status Command**

12281 This command is used by ACE clients to request an update to the status (e.g., security system arm state) of  
12282 the ACE server (i.e., the IAS CIE). This command is useful for battery-powered ACE clients with polling  
12283 rates longer than the standard check-in rate.

#### 12284 **8.3.2.3.6.1 Payload Format**

12285 There is no payload for the Get Panel Status command.

#### 12286 **8.3.2.3.6.2 Effect on Receipt**

12287 On receipt of this command, the ACE server responds with the status of the security system. The IAS  
12288 ACE server SHALL generate a Get Panel Status Response command.

### 12289 **8.3.2.3.7 Get Bypassed Zone List Command**

12290 Provides IAS ACE clients with a way to retrieve the list of zones to be bypassed. This provides them with  
12291 the ability to provide greater local functionality (i.e., at the IAS ACE client) for users to modify the Bypassed  
12292 Zone List and reduce communications to the IAS ACE server when trying to arm the CIE security system.

#### 12293 **8.3.2.3.7.1 Payload Format**

12294 This command has no payload.

#### 12295 **8.3.2.3.7.2 Effect on Receipt**

12296 Upon receipt, the IAS ACE server sends a Set Bypassed Zone List command.

### 12297 **8.3.2.3.8 Get Zone Status Command**

12298 This command is used by ACE clients to request an update of the status of the IAS Zone devices managed  
12299 by the ACE server (i.e., the IAS CIE). This command is useful for battery-powered ACE clients with polling  
12300 rates longer than the standard check-in rate. The command is similar to the Get Attributes Supported com-  
12301 mand in that it specifies a starting Zone ID and a number of Zone IDs for which information is requested.

12302 Depending on the number of IAS Zone devices managed by the IAS ACE server, sending the Zone Status of  
 12303 all zones MAY not fit into a single Get Zone Status Response command. IAS ACE clients MAY need to  
 12304 send multiple Get Zone Status commands in order to get the information they seek.

#### 12305 **8.3.2.3.8.1 Payload Format**

12306 The Get Zone Status command SHALL be formatted as illustrated below.

12307 **Figure 8-9. Format of the Get Zone Status command**

<b>Bits</b>	8	8	8	16
<b>Data Type</b>	uint8	uint8	bool	map16
<b>Field Name</b>	Starting Zone ID	Max Number of Zone IDs	Zone Status Mask Flag	Zone Status Mask

12308

#### 12309 **8.3.2.3.8.2 Starting Zone ID Field**

12310 Specifies the starting Zone ID at which the IAS Client would like to obtain zone status information.

#### 12311 **8.3.2.3.8.3 Max Number of Zone IDs Requested Field**

12312 Specifies the maximum number of Zone IDs and corresponding Zone Statuses that are to be returned by the  
 12313 IAS ACE server when it responds with a Get Zone Status Response command.

#### 12314 **8.3.2.3.8.4 Zone Status Mask Flag Field**

12315 Functions as a query operand with the Zone Status Mask field. If set to zero (i.e., FALSE), the IAS ACE  
 12316 server SHALL include all Zone IDs and their status, regardless of their Zone Status when it responds with a  
 12317 Get Zone Status Response command.

12318 If set to one (i.e., TRUE), the IAS ACE server SHALL include only those Zone IDs whose *Zone Status*  
 12319 attribute is equal to one or more of the Zone Statuses requested in the Zone Status Mask field of the Get Zone  
 12320 Status command.

12321 Use of Zone Status Mask Flag and Zone Status Mask fields allow a client to obtain updated information for  
 12322 the subset of Zone IDs they're interested in, which is beneficial when the number of IAS Zone devices in a  
 12323 system is large.

#### 12324 **8.3.2.3.8.5 Zone Status Mask Field**

12325 Coupled with the Zone Status Mask Flag field, functions as a mask to enable IAS ACE clients to get infor-  
 12326 mation about the Zone IDs whose *ZoneStatus* attribute is equal to any of the bits indicated by the IAS ACE  
 12327 client in the Zone Status Mask field. The format of this field is the same as the *ZoneStatus* attribute in the  
 12328 IAS Zone cluster. Per the Zone Status Mask Flag field, IAS ACE servers SHALL respond with only the  
 12329 Zone IDs whose *ZoneStatus* attributes are equal to at least one of the Zone Status bits set in the Zone Status  
 12330 Mask field requested by the IAS ACE client.

12331 For example, if the Zone Status Mask field set to “0x0003” would match IAS Zones whose *ZoneStatus* at-  
 12332 tributes are 0x0001, 0x0002, and 0x0003. In other words, if a logical 'AND' between the Zone Status Mask  
 12333 field and the IAS Zone's *ZoneStatus* attribute yields a non-zero result, the IAS ACE server SHALL include  
 12334 that IAS Zone in the Get Zone Status Response command.

#### 12335 **8.3.2.3.8.6 Effect on Receipt**

12336 On receipt of this command, the IAS ACE server responds with the status of the zones it manages that meet  
 12337 those requested in the Get Zone Status command. The IAS ACE server SHALL generate a Get Zone Status  
 12338 Response command.

12339 **8.3.2.4 Commands Generated**

12340 The generated command IDs for the IAS ACE server cluster are listed in Table 8-15.

12341 **Table 8-15. Generated Command IDs for the IAS ACE Cluster**

Command Identifier	Description	M/O
0x00	Arm Response	M
0x01	Get Zone ID Map Response	M
0x02	Get Zone Information Response	M
0x03	Zone Status Changed	M
0x04	Panel Status Changed	M
0x05	Get Panel Status Response	M
0x06	Set Bypassed Zone List	M
0x07	Bypass Response	M
0x08	Get Zone Status Response	M

12342 **8.3.2.4.1 Arm Response Command**

12343 **8.3.2.4.1.1 Payload Format**

12344 The Arm Response command payload SHALL be formatted as illustrated in Figure 8-10.

12345 **Figure 8-10. Format of the Arm Response Command Payload**

<b>Bits</b>	8
<b>Data Type</b>	enum8
<b>Field Name</b>	Arm Notification

12346 **8.3.2.4.1.2 Arm Notification Field**

12347 The Arm Notification field SHALL have one of the values shown in Table 8-16.

12348 **Table 8-16. Arm Notification Values**

Value	Meaning
0x00	All Zones Disarmed

Value	Meaning
0x01	Only Day/Home Zones Armed
0x02	Only Night/Sleep Zones Armed
0x03	All Zones Armed
0x04	Invalid Arm/Disarm Code
0x05	Not ready to arm*
0x06	Already disarmed

12349 \* NOTE: reasons for not being ready to arm are determined by the IAS ACE server manufacturer

### 12350 8.3.2.4.2 Get Zone ID Map Response Command

#### 12351 8.3.2.4.2.1 Payload Format

12352 The Get Zone ID Map Response command payload SHALL be formatted as illustrated in Figure 8-11.

12353 **Figure 8-11. Get Zone ID Map Response Command Payload**

<b>Bits</b>	16	...	16
<b>Data Type</b>	map16	...	map16
<b>Field Name</b>	Zone ID Map section 0	...	Zone ID Map section 15

12354  
12355 The 16 fields of the payload indicate whether each of the Zone IDs from 0 to 0xff is allocated or not. If bit n  
12356 of Zone ID Map section N is set to 1, then Zone ID (16 x N + n) is allocated, else it is not allocated.

### 12357 8.3.2.4.3 Get Zone Information Response Command

#### 12358 8.3.2.4.3.1 Payload Format

12359 The Get Zone Information Response command payload SHALL be formatted as illustrated in Figure 8-12.

12360 **Figure 8-12. Format of the Get Zone Information Response Command Payload**

<b>Bits</b>	8	16	64	Varies
<b>Data Type</b>	uint8	enum16	EUI64	string
<b>Field Name</b>	Zone ID	Zone Type	IEEE address	Zone Label

12361  
12362 The first 3 fields of the payload are equal to the fields of the Zone Table entry corresponding to the ZoneID  
12363 field of the Get Zone Information command to which this command is a response.

12364 If the Zone ID is unallocated, this SHALL be indicated by setting the Zone Type and IEEE Address fields to  
12365 0xffff (see Table 8-5 Values of the ) and 0xffffffffffffffff respectively.

12366 **8.3.2.4.3.2 Zone Label Field**

12367 Provides the Zone Label stored in the IAS CIE. If none is programmed, the IAS ACE server SHALL transmit  
 12368 a string with a length of zero.

12369 There is no minimum or maximum length to the Zone Label field; however, the Zone Label SHOULD be  
 12370 between 16 to 24 alphanumeric characters in length.

12371 The string encoding SHALL be UTF-8.

12372 **8.3.2.4.4 Zone Status Changed Command**

12373 This command updates ACE clients in the system of changes to zone status recorded by the ACE server (e.g.,  
 12374 IAS CIE device).

12375 An IAS ACE server SHOULD send a Zone Status Changed command upon a change to an IAS Zone device’s  
 12376 *ZoneStatus* that it manages (i.e., IAS ACE server SHOULD send a Zone Status Changed command upon  
 12377 receipt of a Zone Status Change Notification command).

12378 **8.3.2.4.4.1 Payload Format**

12379 The Zone Status Changed Command SHALL be formatted as illustrated in Figure 8-13.

12380 **Figure 8-13. Format of the Zone Status Changed Command Payload**

Bits	8	16	8	Varies
Data Type	uint8	enum16	enum8	string
Field Name	Zone ID	Zone Status	Audible Notification	Zone Label

12381 **8.3.2.4.4.2 Zone ID Field**

12382 The index of the Zone in the CIE’s zone table (Table 8-12). If none is programmed, the ZoneID attribute  
 12383 default value SHALL be indicated in this field.

12384 **8.3.2.4.4.3 Zone Status Field**

12385 The current value of the ZoneStatus attribute.

12386 **8.3.2.4.4.4 Audible Notification Field**

12387 Provide the ACE client with information on which type of audible notification it SHOULD make for the zone  
 12388 status change. This field is useful for telling the ACE client to play a standard chime or other audio indica-  
 12389 tion or to mute and not sound an audible notification at all. This field also allows manufacturers to create  
 12390 additional audible alert types (e.g., dog barking, wind chimes, conga drums) to enable users to customize  
 12391 their system.

12392 The Audible Notification field SHALL be formatted as illustrated below:

12393 **Figure 8-14. Audible Notification field value**

Enumeration	Description
0x00	Mute (i.e., no audible notification)
0x01	Default sound
0x80-0xff	Manufacturer specific

12394 The default value SHALL be 0x01.

12395 **8.3.2.4.4.5 Zone Label Field**

12396 Provides the Zone Label stored in the IAS CIE. If none is programmed, the IAS ACE server SHALL transmit  
12397 a string with a length of zero.

12398 There is no minimum or maximum length to the Zone Label field; however, the Zone Label SHOULD be  
12399 between 16 to 24 alphanumeric characters in length.

12400 The string encoding SHALL be UTF-8.

12401 **8.3.2.4.5 Panel Status Changed Command**

12402 This command updates ACE clients in the system of changes to panel status recorded by the ACE server  
12403 (e.g., IAS CIE device).

12404 Sending the Panel Status Changed command (vs. the Get Panel Status and Get Panel Status Response method)  
12405 is generally useful only when there are IAS ACE clients that data poll within the retry timeout of the network  
12406 (e.g., less than 7.68 seconds).

12407 An IAS ACE server SHALL send a Panel Status Changed command upon a change to the IAS CIE’s panel  
12408 status (e.g., Disarmed to Arming Away/Stay/Night, Arming Away/Stay/Night to Armed, Armed to Dis-  
12409 armed) as defined in the Panel Status field.

12410 When Panel Status is Arming Away/Stay/Night, an IAS ACE server SHOULD send Panel Status Changed  
12411 commands every second in order to update the Seconds Remaining. In some markets (e.g., North America),  
12412 the final 10 seconds of the Arming Away/Stay/Night sequence requires a separate audible notification (e.g.,  
12413 a double tone).

12414 **8.3.2.4.5.1 Payload Format**

12415 The Panel Status Changed Command SHALL be formatted as illustrated in Figure 8-15.

12416 **Figure 8-15. Format of the Panel Status Changed Command Payload**

<b>Bits</b>	8	8	8	8
<b>Data Type</b>	enum8	uint8	enum8	enum8
<b>Field Name</b>	Panel Status	Seconds Remaining	Audible Notification	Alarm Status

12417 **8.3.2.4.5.2 PanelStatus Parameter**

12418 The Panel Status parameter SHALL be formatted as illustrated in Table 8-17.

12419 **Table 8-17. PanelStatus Field Values**

<b>Panel Status Enumerations</b>	<b>Description</b>
0x00	Panel disarmed (all zones disarmed) and ready to arm
0x01	Armed stay
0x02	Armed night
0x03	Armed away



Panel Status Enumerations	Description
0x04	Exit delay
0x05	Entry delay
0x06	Not ready to arm
0x07	In alarm
0x08	Arming Stay
0x09	Arming Night
0x0a	Arming Away

12420 **8.3.2.4.5.3 Audible Notification Field**

12421 See 8.3.2.4.4.4 for a description of this field.

12422 **8.3.2.4.5.4 Alarm Status Field**

12423 Provides the ACE client with information on the type of alarm the panel is in if its Panel Status field indicates it is “in alarm.” This field MAY be useful for ACE clients to display or otherwise initiate notification for users.

12426 The Alarm Status field SHALL be formatted as illustrated below. Note: this is the same as the Warning Mode field in the IAS WD cluster.

12428 **Figure 8-16. Alarm Status field value**

Enumeration	Description
0x00	No alarm
0x01	Burglar
0x02	Fire
0x03	Emergency
0x04	Police Panic
0x05	Fire Panic
0x06	Emergency Panic (i.e., medical issue)

12429

12430 The default value SHALL be 0x00.

12431 **8.3.2.4.5.5 Seconds Remaining Parameter**

12432 Indicates the number of seconds remaining for the server to be in the state indicated in the Panel Status  
12433 parameter.

12434 The Seconds Remaining parameter SHALL be provided if the Panel Status parameter has a value of 0x04  
12435 (Exit delay) or 0x05 (Entry delay).

12436 The default value SHALL be 0x00.

12437 **8.3.2.4.6 Get Panel Status Response Command**

12438 This command updates requesting IAS ACE clients in the system of changes to the security panel status  
12439 recorded by the ACE server (e.g., IAS CIE device).

12440 **8.3.2.4.6.1 Payload Format**

12441 The Get Panel Status Response command SHALL be formatted as illustrated below.

12442 **Figure 8-17. Get Panel Status Response command**

<b>Bits</b>	8	8	8	8
<b>Data Type</b>	enum8	uint8	enum8	enum8
<b>Field Name</b>	Panel Status	Seconds Remaining	Audible Notification	Alarm Status

12443

12444 **8.3.2.4.6.2 Panel Status Field**

12445 See 8.3.2.4.5.2 for a description of this field.

12446 **8.3.2.4.6.3 Seconds Remaining Field**

12447 Indicates the number of seconds remaining for the server to be in the state indicated in the Panel Status field.  
12448 The Seconds Remaining field SHALL be provided if the Panel Status field has a value of 0x04 (Exit delay)  
12449 or 0x05 (Entry delay).

12450 The default value SHALL be 0x00.

12451 **8.3.2.4.6.4 Audible Notification Field**

12452 See 8.3.2.4.4.4 for a description of this field.

12453 **8.3.2.4.6.5 Alarm Status Field**

12454 See 8.3.2.4.5.4 for a description of this field.

12455 **8.3.2.4.7 Set Bypassed Zone List Command**

12456 Sets the list of bypassed zones on the IAS ACE client. This command can be sent either as a response to  
12457 the Get Bypassed Zone List command or unsolicited when the list of bypassed zones changes on the ACE  
12458 server.

12459 **8.3.2.4.7.1 Payload Format**

12460 The Set Bypassed Zone List command SHALL be formatted as illustrated below.

12461

**Figure 8-18. Set Bypassed Zone List Command payload format**

<b>Bits</b>	8	8	8	...	8
<b>Data Type</b>	uint8	uint8	uint8	...	uint8
<b>Field Name</b>	Number of Zones	Zone ID 1	Zone ID 2	...	Zone ID <i>n</i>

12462

12463 **8.3.2.4.7.2 Number of Zones Field**

12464 This is the number of Zone IDs included in the payload.

12465 If no zones are bypassed, the IAS ACE server SHALL send the Set Bypassed Zone List command with a  
 12466 Number of Zones field set to “0” (zero).

12467 **8.3.2.4.7.3 Zone ID 1...X Field**

12468 Zone ID is the index of the Zone in the CIE's zone table and is an array of Zone IDs for each zone that is  
 12469 bypassed where X is equal to the value of the Number of Zones field. There is no order imposed by the  
 12470 numbering of the Zone ID field in this command payload. IAS ACE servers SHOULD provide the array of  
 12471 Zone IDs in ascending order.

12472 **8.3.2.4.7.4 Implementation Guidelines**

12473 The IAS ACE server SHALL reset (i.e., set to be “not bypassed”) all previously bypassed zones each time  
 12474 the security system is disarmed unless certain zones are programmed by the user to be bypassed on a perma-  
 12475 nent basis.

12476 **8.3.2.4.8 Bypass Response Command**

12477 Provides the response of the security panel to the request from the IAS ACE client to bypass zones via a  
 12478 Bypass command.

12479 **8.3.2.4.8.1 Payload Format**

12480 The Bypass Response command SHALL be formatted as illustrated below:

12481

**Figure 8-19. Bypass Response command format**

<b>Bits</b>	8	8	8	...	8
<b>Data Type</b>	uint8	uint8	uint8	...	uint8
<b>Field Name</b>	Number of Zones	Bypass Result for Zone ID 1	Bypass Result for Zone ID 2	...	Bypass Result for Zone ID <i>n</i>

12482

12483 **8.3.2.4.8.2 Number of Zones Field**

12484 This is the number of Zone IDs for which a bypass result is provided in the payload.

12485 **8.3.2.4.8.3 Bypass Result Field**

12486 An array of Zone IDs for each zone requested to be bypassed via the Bypass command where X is equal to  
12487 the value of the Number of Zones field. The order of results for Zone IDs SHALL be the same as the order  
12488 of Zone IDs sent in the Bypass command by the IAS ACE client.

12489 The permitted values of Bypass Result are shown below:

12490 **Table 8-18. Values of Bypass Result Field**

Value	Meaning	Description
0x00	Zone bypassed	The Zone ID requested to be bypassed is successful. Zone is bypassed.
0x01	Zone not bypassed	The Zone ID requested to be bypassed is unsuccessful. Zone is not bypassed.
0x02	Not allowed	The Zone ID requested to be bypassed is not eligible to be bypassed per the policy or user configurations on the IAS ACE server. Zone is not bypassed.
0x03	Invalid Zone ID	The Zone ID requested to be bypassed is not in the valid range of Zone IDs.
0x04	Unknown Zone ID	The Zone ID requested to be bypassed is in the valid range of Zone IDs, but the IAS ACE server does not have a record of the Zone ID requested.
0x05	Invalid Arm/Disarm Code	A value returned indicating that the Arm/Disarm Code was entered incorrectly.

12491 **8.3.2.4.9 Get Zone Status Response Command**

12492 This command updates requesting IAS ACE clients in the system of changes to the IAS Zone server statuses  
12493 recorded by the ACE server (e.g., IAS CIE device).

12494 **8.3.2.4.9.1 Payload Format**

12495 The Get Zone Status Response command SHALL be formatted as illustrated below.

12496 **Figure 8-20. Format of the Get Zone Status Response command**

<b>Bits</b>	8	8	8	16
<b>Data Type</b>	Boolean	uint8	uint8	map16
<b>Field Name</b>	Zone Status Complete	Number of Zones	Zone ID 1	Zone ID 1 Zone Status

12497

<b>Bits</b>	8	16	...	8	16
<b>Data Type</b>	uint8	map16	...	uint8	map16

<b>Field Name</b>	Zone ID 2	Zone ID 2 Zone Status	...	Zone ID N	Zone ID n Zone Status
-------------------	-----------	-----------------------	-----	-----------	-----------------------

12498 **8.3.2.4.9.2 Zone Status Complete Field**

12499 Indicates whether there are additional Zone IDs managed by the IAS ACE Server with Zone Status infor-  
 12500 mation to be obtained. A value of zero (i.e., FALSE) indicates there are additional Zone IDs for which Zone  
 12501 Status information is available and that the IAS ACE client SHOULD send another Get Zone Status com-  
 12502 mand.

12503 A value of one (i.e., TRUE) indicates there are no more Zone IDs for the IAS ACE client to query and the  
 12504 IAS ACE client has received all the Zone Status information for all IAS Zones managed by the IAS ACE  
 12505 server. The IAS ACE client SHOULD NOT typically send another Get Zone Status command.

12506 **8.3.2.4.9.3 Number of Zones Field**

12507 This is the number of Zone IDs for which a zone status result is provided in the payload.

12508 **8.3.2.4.9.4 Zone ID Field**

12509 The index of the Zone in the CIE’s zone table. If none is programmed, the *ZoneID* attribute default value  
 12510 SHALL be indicated in this field.

12511 **8.3.2.4.9.5 Zone Status Field**

12512 The current value of the *ZoneStatus* attribute for the indicated Zone ID.

12513 **8.3.3 Client**

12514 The client supports no cluster specific attributes. The client receives the cluster specific commands detailed  
 12515 in 8.3.2.4. The client cluster generates the commands detailed in 8.3.2.3, as required by the application.

12516 **8.4 IAS WD**

---

12517 **8.4.1 Overview**

12518 Please see Chapter 2 for a general cluster overview defining cluster architecture, revision, classification,  
 12519 identification, etc.

12520 The IAS WD cluster provides an interface to the functionality of any Warning Device equipment of the IAS  
 12521 system. Using this cluster, a CIE device can access an IAS WD device and issue alarm warning indications  
 12522 (siren, strobe lighting, etc.) when a system alarm condition is detected (according to [N1]).

12523 **8.4.1.1 Revision History**

12524 The global *ClusterRevision* attribute value SHALL be the highest revision number in the table below.

Rev	Description
1	mandatory global <i>ClusterRevision</i> attribute added
2	CCB 2350 2341

12525 **8.4.1.2 Classification**

Hierarchy	Role	PICS Code	Primary Transaction
Base	Application	IASWD	Type 1 (client to server)

12526 **8.4.1.3 Cluster Identifiers**

Identifier	Name
0x0502	IAS WD

12527 **8.4.2 Server**

12528 **8.4.2.1 Attributes**

12529 The attributes defined for the server cluster are detailed in Table 8-19.

12530 **Table 8-19. Attributes of the IAS WD (Server) Cluster**

Identifier	Name	Type	Range	Access	Default	M/O
0x0000	<i>MaxDuration</i>	uint16	0x0000 – 0ffff	RW	240	M

12531 **8.4.2.1.1 MaxDuration Attribute**

12532 The *MaxDuration* attribute specifies the maximum time in seconds that the siren will sound continuously,  
12533 regardless of start/stop commands.

12534 **8.4.2.2 Commands Received**

12535 The received command IDs are listed in Table 8-20.

12536 **Table 8-20. Received Command IDs for the IAS WD Server Cluster**

Command Identifier	Description	M/O
0x00	Start warning	M
0x01	Squawk	M

12537 **8.4.2.2.1 Start Warning Command**

12538 This command starts the WD operation. The WD alerts the surrounding area by audible (siren) and visual  
12539 (strobe) signals.

12540 A Start Warning command SHALL always terminate the effect of any previous IAS WD cluster command  
 12541 that is still current.

12542 **8.4.2.2.1.1 Payload Format**

12543 The Start Warning command payload SHALL be formatted as illustrated in Figure 8-21.  
 12544

**Figure 8-21. Format of the Command Payload**

<b>Bits</b>	4	2	2	16	8	8
<b>Data Type</b>	map8			uint16	uint8	enum8
<b>Field Name</b>	Warning Mode	Strobe	Siren Level	Warning Duration	Strobe Duty Cycle	Strobe Level

12545

12546 The Warning Mode and Strobe subfields are concatenated together to a single 8-bit bitmap field. The groups  
 12547 of bits these subfields occupy are used as described below.

12548 **8.4.2.2.1.2 Warning Mode Field**

12549 The Warning Mode field is used as an 4-bit enumeration, can have one of the values defined below. The  
 12550 exact behavior of the WD device in each mode is according to the relevant security standards.

12551

**Table 8-21. Warning Modes**

Warning Mode	Meaning
0	Stop (no warning)
1	Burglar
2	Fire
3	Emergency
4	Police panic
5	Fire panic
6	Emergency Panic (i.e., medical issue)

12552 **8.4.2.2.1.3 Strobe Field**

12553 The Strobe field is used as a 2-bit enumeration, and determines if the visual indication is required in addition  
 12554 to the audible siren, as indicated in Table 8-22. If the strobe field is “1” and the Warning Mode is “0” (“Stop”)  
 12555 then only the strobe is activated.

12556

**Table 8-22. Values of the Strobe Field**

Value	Meaning
0	No strobe
1	Use strobe in parallel to warning

12557 **8.4.2.2.1.4 Siren Level Field**

12558 The Siren Level field is used as a 2-bit enumeration, and indicates the intensity of audible squawk sound as  
12559 shown in the following table. At least one level of sound SHALL be supported.

12560 **Table 8-23. Siren Level Field Values**

<i>SirenLevel</i> Value	Description
0	Low level sound
1	Medium level sound
2	High level sound
3	Very high level sound

12561 **8.4.2.2.1.5 Warning Duration Field**

12562 Requested duration of warning, in seconds. If both Strobe and Warning Mode are "0" this field SHALL be  
12563 ignored.

12564 **8.4.2.2.1.6 Strobe Duty Cycle Field**

12565 Indicates the length of the flash cycle. This provides a means of varying the flash duration for different alarm  
12566 types (e.g., fire, police, burglar). Valid range is 0-100 in increments of 10. All other values SHALL be  
12567 rounded to the nearest valid value. Strobe SHALL calculate duty cycle over a duration of one second. The  
12568 ON state SHALL precede the OFF state. For example, if Strobe Duty Cycle Field specifies "40," then the  
12569 strobe SHALL flash ON for 4/10ths of a second and then turn OFF for 6/10ths of a second.

12570 The default value for this field SHALL be 0x00.

12571 **8.4.2.2.1.7 Strobe Level Field**

12572 Indicates the intensity of the strobe as shown in the table below. This attribute is designed to vary the output  
12573 of the strobe (i.e., brightness) and not its frequency, which is detailed in 8.4.2.2.1.6. At least one level of  
12574 strobe SHALL be supported.

12575 **Table 8-24. Strobe Level Field Values**

<i>StrobeLevel</i> Enumerations	Description
0x00	Low level strobe
0x01	Medium level strobe
0x02	High level strobe
0x03	Very high level strobe

12576 **8.4.2.2.2 Squawk Command**

12577 This command uses the WD capabilities to emit a quick audible/visible pulse called a "squawk". The squawk  
12578 command has no effect if the WD is currently active (warning in progress).

12579 **8.4.2.2.2.1 Payload Format**

12580 The Squawk command payload SHALL be formatted as illustrated in Figure 8-22.



12581

**Figure 8-22. Format of the Command Payload**

<b>Bits</b>	4	1	1	2
<b>Data Type</b>	map8			
<b>Field Name</b>	Squawk mode	Strobe	Reserved	Squawk level

12582 **8.4.2.2.2 Squawk Mode Field**

12583 The Squawk Mode field is used as a 4-bit enumeration, and can have one of the values shown in Table 8-25  
 12584 Squawk Mode Field. The exact operation of each mode (how the WD “squawks”) is implementation specific.

12585 **Table 8-25. Squawk Mode Field**

Warning Mode	Meaning
0	Notification sound for “System is armed”
1	Notification sound for "System is disarmed"

12586 **8.4.2.2.3 Strobe Field**

12587 The strobe field is used as a Boolean, and determines if the visual indication is also required in addition to  
 12588 the audible squawk, as shown in Table 8-26 Strobe Bit.

12589 **Table 8-26. Strobe Bit**

Value	Meaning
0	No strobe
1	Use strobe blink in parallel to squawk

12590 **8.4.2.2.4 Squawk Level Field**

12591 The squawk level field is used as a 2-bit enumeration, and determines the intensity of audible squawk sound  
 12592 as shown in Table 8-27 Squawk Level Field Values.

12593 **Table 8-27. Squawk Level Field Values**

Value	Meaning
0	Low level sound
1	Medium level sound
2	High level sound
3	Very High level sound

12594 **8.4.2.3 Commands Generated**

12595 No cluster specific commands are generated by the server cluster.

12596

### 8.4.3 Client

12597

The client side is implemented by the CIE. The CIE is a client of the warning service provided by this cluster.

12598

Usually a WD would implement an IAS WD cluster server and an IAS Zone cluster server.

12599

There are no cluster specific attributes defined for the client cluster. The client receives no cluster specific

12600

commands. The client cluster generates the cluster specific commands detailed in 8.4.2.2, as required by the

12601

application.

12602

## CHAPTER 9 PROTOCOL INTERFACES

12603  
 12604  
 12605  
 12606

The Cluster Library is made of individual chapters such as this one. See Document Control in the Cluster Library for a list of all chapters and documents. References between chapters are made using a *X.Y* notation where *X* is the chapter and *Y* is the sub-section within that chapter. References to external documents are contained in Chapter 1 and are made using [*Rn*] notation.

12607

### 9.1 General Description

12608

#### 9.1.1 Introduction

12609

The clusters specified in this document are for use in applications which interface to external protocols.

12610

#### 9.1.2 Cluster List

12611  
 12612

This section lists the clusters specified in this document and gives examples of typical usage for the purpose of clarification.

12613

The clusters defined in this document are listed in Table 9-1.

12614

**Table 9-1. Clusters of the Protocol Interfaces Functional**

Cluster ID	Cluster Name	Description
0x0016	Partition	The commands and attributes for enabling partitioning of a large frame between devices
0x0600	Generic tunnel	The minimum common commands and attributes required to tunnel any protocol.
0x0601	BACnet protocol tunnel	Commands and attributes required to tunnel the BACnet protocol.
0x0602	Analog input (BACnet regular)	An interface for accessing a number of commonly used BACnet based attributes of an analog measurement.
0x0603	Analog input (BACnet extended)	An interface for accessing a number of BACnet based attributes of an analog measurement.
0x0604	Analog output (BACnet regular)	An interface for accessing a number of commonly used BACnet based attributes of an analog output.
0x0605	Analog output (BACnet extended)	An interface for accessing a number of BACnet based attributes of an analog output.
0x0606	Analog value(BACnet regular)	An interface for accessing a number of commonly used BACnet based attributes of an analog value, typically used as a control system parameter.

Cluster ID	Cluster Name	Description
0x0607	Analog value(BACnet extended)	An interface for accessing a number of BACnet based attributes of an analog value, typically used as a control system parameter.
0x0608	Binary input (BACnet regular)	An interface for accessing a number of commonly used BACnet based attributes of a binary measurement.
0x0609	Binary input (BACnet extended)	An interface for accessing a number of BACnet based attributes of a binary measurement.
0x060a	Binary output (BACnet regular)	An interface for accessing a number of commonly used BACnet based attributes of a binary output.
0x060b	Binary output (BACnet extended)	An interface for accessing a number of BACnet based attributes of a binary output.
0x060c	Binary value (BACnet regular)	An interface for accessing a number of commonly used BACnet based attributes of a binary value, typically used as a control system parameter.
0x060d	Binary value (BACnet extended)	An interface for accessing a number of BACnet based attributes of a binary value, typically used as a control system parameter.
0x060e	Multistate input (BACnet regular)	An interface for accessing a number of commonly used BACnet based attributes of a multistate measurement.
0x060f	Multistate input (BACnet extended)	An interface for accessing a number of BACnet based attributes of a multistate measurement.
0x0610	Multistate output (BACnet regular)	An interface for accessing a number of commonly used BACnet based attributes of a multistate output.
0x0611	Multistate output (BACnet extended)	An interface for accessing a number of BACnet based attributes of a multistate output.
0x0612	Multistate value (BACnet regular)	An interface for accessing a number of commonly used BACnet based attributes of a multistate value, typically used as a control system parameter.
0x0613	Multistate value (BACnet extended)	An interface for accessing a number of BACnet based attributes of a multistate value, typically used as a control system parameter.
0x0614	11073 Protocol Tunnel	Interface for 11073 Protocol Tunnel used in health care applications
0x0615	ISO7816 Tunnel	Commands and attributes for mobile office solutions using devices.

## 12615 9.2 Generic Tunnel

### 12616 9.2.1 Overview

12617 Please see Chapter 2 for a general cluster overview defining cluster architecture, revision, classification,  
 12618 identification, etc.

12619 The generic cluster provides the minimum common commands and attributes required to discover protocol  
 12620 tunnelling devices. A protocol cluster specific to the protocol being tunneled shall be implemented on the  
 12621 same endpoint as the Generic Tunnel cluster.

12622 **Note:** The reverse is not true, as there may be tunnel clusters that do not require the Generic Tunnel cluster.

#### 12623 9.2.1.1 Revision History

12624 The global *ClusterRevision* attribute value SHALL be the highest revision number in the table below.

Rev	Description
1	mandatory global <i>ClusterRevision</i> attribute added

#### 12625 9.2.1.2 Classification

Hierarchy	Role	PICS Code	Primary Transaction
Base	Application	TUN	Type 1 (client to server)

#### 12626 9.2.1.3 Cluster Identifiers

Identifier	Name
0x0600	Generic Tunnel

## 12627 9.2.2 Server

### 12628 9.2.2.1 Dependencies

12629 The maximum size of the *ProtocolAddress* attribute is dependent on the protocol supported by any associated  
 12630 specific protocol tunnel cluster supported on the same endpoint (see 9.2.2.2.3, ProtocolAddress Attribute).

### 12631 9.2.2.2 Attributes

12632 The Generic Tunnel contains the attributes summarized in Table 9-2.

12633

**Table 9-2. Attributes of the Generic Tunnel Cluster**

Id	Name	Type	Range	Acc	Default	M/O
0x0001	MaximumIncomingTransferSize	uint16	0x0000 - 0xffff	R	0x0000	M
0x0002	MaximumOutgoingTransferSize	uint16	0x0000 - 0xffff	R	0x0000	M
0x0003	ProtocolAddress	octstr	0 - 255 octets	RW	Null string	M

### 12634 9.2.2.2.1 MaximumIncomingTransferSize Attribute

12635 The *MaximumIncomingTransferSize* attribute specifies the maximum size, in octets, of the application ser-  
12636 vice data unit (ASDU) that can be transferred to this node in one single message transfer. The ASDU referred  
12637 to is the ZCL frame, including header and payload, of any command received by a protocol specific tunnel  
12638 cluster on the same endpoint.

12639 This value cannot exceed the Maximum Incoming Transfer Size field of the node descriptor on the device  
12640 supporting this cluster.

### 12641 9.2.2.2.2 MaximumOutgoingTransferSize Attribute

12642 The *MaximumOutgoingTransferSize* attribute specifies the maximum size, in octets, of the application sub-  
12643 layer data unit (ASDU) that can be transferred from this node in one single message transfer. The ASDU  
12644 referred to is the ZCL frame, including header and payload, of any command sent by a protocol specific  
12645 tunnel cluster on the same endpoint.

12646 This value cannot exceed the Maximum Outgoing Transfer Size field of the node descriptor on the device  
12647 supporting this cluster.

### 12648 9.2.2.2.3 ProtocolAddress Attribute

12649 The *ProtocolAddress* attribute contains an octet string that is interpreted as a device address by the protocol  
12650 being tunneled by an associated protocol specific tunnel cluster (if any). The overall maximum size of the  
12651 string is 255 octets, but devices need only support the actual maximum size required by that protocol

## 12652 9.2.2.3 Commands Received

12653 The cluster specific commands received by the Generic Tunnel server cluster are listed in Table 9-3.

12654 **Table 9-3. Command IDs Received by the Generic Tunnel Cluster**

Identifier	Description	M/O
0x00	Match Protocol Address	M

### 12655 9.2.2.3.1 Match Protocol Address Command

12656 The Match Protocol Address command payload shall be formatted as illustrated in Figure 9-1.

12657

**Figure 9-1. Format of Match Protocol Address Command Payload**

<b>octets</b>	Variable
<b>Data Type</b>	octstr
<b>Field Name</b>	Protocol Address

12658 **9.2.2.3.2 When Generated**

12659 This command is generated when an associated protocol specific tunnel cluster wishes to find the address  
 12660 (node, endpoint) of the Generic Tunnel server cluster representing a protocol-specific device with a given  
 12661 protocol address. The command is typically multicast to a group of inter-communicating Generic Tunnel  
 12662 clusters.

12663 **9.2.2.3.3 Effect on Receipt**

12664 On receipt of this command, a device shall match the Protocol Address field of the received command to the  
 12665 ProtocolAddress attribute. If they are equal, it shall return the Match Protocol Address Response command  
 12666 (see 9.2.2.4.1), otherwise it shall do nothing.

12667 **9.2.2.4 Commands Generated**

12668 The cluster specific commands generated by the Generic Tunnel server cluster are listed in Table 9-4. Com-  
 12669 mand IDs Generated by the Generic Tunnel Cluster.

12670

**Table 9-4. Command IDs Generated by the Generic Tunnel Cluster**

<b>Identifier</b>	<b>Description</b>	<b>M/O</b>
0x00	Match Protocol Address Response	M
0x01	Advertise Protocol Address	O

12671

12672 **9.2.2.4.1 Match Protocol Address Response Command**

12673 The Match Protocol Address Response command payload shall be formatted as illustrated in Figure 9-2.

12674

**Figure 9-2. Match Protocol Address Response Command Payload**

<b>octets</b>	8	Variable
<b>Data Type</b>	EUI64	octstr
<b>Field Name</b>	Device IEEE Address	Protocol Address

12675

12676 The Device IEEE Address field shall be set equal to the IEEE address of the responding device. The Protocol  
 12677 Address field shall be set equal to the matched Protocol Address.

12678 **9.2.2.4.2 When Generated**

12679 This command is generated upon receipt of a Match Protocol Address command (see 9.2.2.3.1), to indicate  
 12680 that the Protocol Address was successfully matched by the responding device.

12681 **9.2.2.4.3 Advertise Protocol Address Command**

12682 The Advertise Protocol Address command payload shall be formatted as illustrated in Figure 9-3.

12683 **Figure 9-3. Advertise Protocol Address Command Payload**

<b>octets</b>	Variable
<b>Data Type</b>	octstr
<b>Field Name</b>	Protocol Address

12684  
12685 The Protocol Address field shall be set to the value of the *ProtocolAddress* attribute.

12686 **9.2.2.4.4 When Generated**

12687 This command is typically sent upon startup, and whenever the *ProtocolAddress* attribute changes. It is typ-  
12688 ically multicast to a group of inter-communicating Generic Tunnel clusters.

12689 **9.2.3 Client**

12690 The client cluster has no specific attributes or dependencies. The client cluster receives the cluster specific  
12691 commands detailed in Commands Generated. The client cluster generates the cluster specific commands de-  
12692 tailed in 9.2.2.3.

12693 **9.3 BACnet Protocol Tunnel**

---

12694 **9.3.1 Overview**

12695 Please see Chapter 2 for a general cluster overview defining cluster architecture, revision, classification,  
12696 identification, etc.

12697 The BACnet Protocol Tunnel cluster provides the commands and attributes required to tunnel the BACnet  
12698 protocol (see [A1]). The server cluster receives BACnet NPDUs and the client cluster generates BACnet  
12699 NPDUs, thus it is necessary to have both server and client on an endpoint to tunnel BACnet messages in both  
12700 directions.

12701 **9.3.1.1 Revision History**

12702 The global *ClusterRevision* attribute value SHALL be the highest revision number in the table below.

Rev	Description
1	mandatory global <i>ClusterRevision</i> attribute added

12703 **9.3.1.2 Classification**

Hierarchy	Role	PICS Code	Primary Transaction



Base	Application	BACTUN	Type 1 (client to server)
------	-------------	--------	---------------------------

12704 **9.3.1.3 Cluster Identifiers**

Identifier	Name
0x0601	BACnet Protocol Tunnel

12705 **9.3.2 Server**

12706 **9.3.2.1 Dependencies**

12707 Any endpoint that supports the BACnet Protocol Tunnel server cluster shall also support the Generic Tunnel  
 12708 server cluster.

12709 The associated Generic Tunnel server cluster shall have its *ProtocolAddress* attribute equal to the device  
 12710 identifier of the BACnet device represented on that endpoint, expressed as an octet string (i.e., with identical  
 12711 format as a BACnet OID data type, but interpreted as an octet string). The special three octet value 0x3FFFFFF  
 12712 of the *ProtocolAddress* attribute indicates that the associated BACnet device is not commissioned.

12713 The associated Generic Tunnel server cluster shall also have its *MaximumIncomingTransferSize* attribute and  
 12714 *MaximumOutgoingTransferSize* attribute equal to or greater than 504 octets. Accordingly, this cluster re-  
 12715 quires fragmentation to be implemented, with maximum transfer sizes given by these attributes.

12716 **9.3.2.2 Attributes**

12717 The BACnet Protocol Tunnel cluster does not contain any attributes.

12718 **9.3.2.3 Commands Received**

12719 The cluster specific commands received by the BACnet Protocol Tunnel server cluster are listed in Table  
 12720 9-5.

12721 **Table 9-5. Command IDs for the BACnet Protocol Tunnel Cluster**

Identifier	Description	M/O
0x00	Transfer NPDU	M

12722 **9.3.2.3.1 Transfer NPDU Command**

12723 **9.3.2.3.1.1 Payload Format**

12724 The Transfer NPDU command payload shall be formatted as illustrated in Figure 9-4.

12725

**Figure 9-4. Format of the Transfer NPDU Command Payload**

<b>octets</b>	Variable
<b>Data Type</b>	Sequence of data8
<b>Field Name</b>	NPDU

**12726 9.3.2.3.1.2 NPDU Field**

12727 The NPDU field is of variable length and is a BACnet NPDU as defined in the BACnet standard [A1]. Its  
12728 format is a sequence of 8-bit data (see General Data section of Chapter 2 of arbitrary length.

**12729 9.3.2.3.1.3 When Generated**

12730 This command is generated when a BACnet network layer wishes to transfer a BACnet NPDU across a tunnel  
12731 to another BACnet network layer.

**12732 9.3.2.3.1.4 Effect on Receipt**

12733 On receipt of this command, a device shall process the BACnet NPDU as specified in the BACnet standard  
12734 [A1].

**12735 9.3.2.4 Commands Generated**

12736 No cluster specific commands are generated by the server cluster.

**12737 9.3.3 Client**

12738 The client cluster has no specific attributes or dependencies. The client does not receive any cluster specific  
12739 commands. The cluster specific commands generated by the client cluster are listed in 9.3.2.3.

**12740 9.4 BACnet Input, Output and Value Clusters**

---

**12741 9.4.1 Overview**

12742 Please see Chapter 2 for a general cluster overview defining cluster architecture, revision, classification,  
12743 identification, etc.

12744 This section specifies a number of clusters which are based on the Input, Output and Value objects specified  
12745 by BACnet (see [A1]).

12746 Each of these three objects is specified by BACnet in three different forms - Analog, Binary and Multistate.  
12747 clusters are specified here based on all nine such BACnet objects.

12748 Each such BACnet object is represented in the ZCL by three related clusters – a BACnet Basic cluster , a  
12749 BACnet Regular cluster and a BACnet Extended cluster. The properties of each BACnet object are imple-  
12750 mented as attributes, and are divided into three sets, which are allocated to the clusters as follows.

12751 BACnet Basic clusters implement attributes and functionality that can be readily employed either via inter-  
12752 working with a BACnet system, or by a non-BACnet system. Accordingly, these clusters are included in the  
12753 ZCL General functional domain.

12754 BACnet Regular and BACnet Extended clusters implement attributes and functionality that are specifically  
12755 intended for interworking with a BACnet system (through a BACnet gateway). Accordingly, these clusters  
12756 are included in the ZCL Protocol Interface functional domain.

12757 A BACnet Regular cluster may only be implemented on an endpoint that also implements its associated Basic  
 12758 cluster. Similarly, a BACnet Extended cluster may only be implemented on an endpoint that also implements  
 12759 both its associated BACnet Regular cluster and its associated Basic cluster.

12760 The clusters specified herein are for use typically in Commercial Building applications, but may be used in  
 12761 any application domain.

## 12762 **9.4.2 Analog Input (BACnet Regular)**

12763 The Analog Input (BACnet Regular) cluster provides an interface for accessing a number of commonly used  
 12764 BACnet based attributes of an analog measurement. It is used principally for interworking with BACnet  
 12765 systems.

### 12766 **9.4.2.1 Revision History**

12767 The global *ClusterRevision* attribute value SHALL be the highest revision number in the table below.

Rev	Description
1	mandatory global <i>ClusterRevision</i> attribute added

### 12768 **9.4.2.2 Classification**

Hierarchy	Role	PICS Code	Primary Transaction
Base	Application	BAI	Type 2 (server to client)

### 12769 **9.4.2.3 Cluster Identifiers**

Identifier	Name
0x0602	Analog Input (BACnet Regular)

### 12770 **9.4.2.4 Server**

#### 12771 **9.4.2.4.1 Dependencies**

12772 Any endpoint that supports this cluster must support the Analog Input (Basic) cluster.

#### 12773 **9.4.2.4.2 Attributes**

12774 The attributes of this cluster are detailed in Table 9-6.

12775

**Table 9-6. Attributes of the Analog Input (BACnet Regular) Server**

Identifier	Name	Type	Range	Acc	Default	M/O
0x0016	<i>COVIncrement</i>	single	-	R*W	0	O
0x001F	<i>DeviceType</i>	string	-	R	Null string	O
0x004B	<i>ObjectIdentifier</i>	bacOID	0x00000000-0xffffffff	R	-	M
0x004D	<i>ObjectName</i>	string	-	R	Null string	M
0x004F	<i>ObjectType</i>	enum16	-	R	-	M
0x0076	<i>UpdateInterval</i>	uint8	-	R*W	0	O
0x00A8	<i>ProfileName</i>	string	-	R*W	Null string	O

12776

12777 For an explanation of the attributes, see section 9.4.20.

12778 **9.4.2.4.3 Commands**

12779 No cluster specific commands are received or generated.

12780 **9.4.2.4.4 Attribute Reporting**

12781 No attribute reporting is mandated for this cluster.

12782 **9.4.2.5 Client**

12783 The client has no dependencies, no attributes, and receives or generates no cluster specific commands.

12784 **9.4.3 Analog Input (BACnet Extended)**

12785 The Analog Input (BACnet Extended) cluster provides an interface for accessing a number of BACnet based  
12786 attributes of an analog measurement. It is used principally for interworking with BACnet systems.

12787 **9.4.3.1 Revision History**

12788 The global *ClusterRevision* attribute value SHALL be the highest revision number in the table below.

Rev	Description
1	mandatory global <i>ClusterRevision</i> attribute added

12789 **9.4.3.2 Classification**

Hierarchy	Role	PICS Code	Primary Transaction

Base	Application	AIBE	Type 2 (server to client)
------	-------------	------	---------------------------

12790 **9.4.3.3 Cluster Identifiers**

Identifier	Name
0x0603	Analog Input (BACnet Extended)

12791 **9.4.3.4 Server**

12792 **9.4.3.4.1 Dependencies**

12793 Any endpoint that supports this cluster must support the Analog Input (Basic) cluster and the Analog Input  
 12794 (BACnet Regular) cluster.

12795 **9.4.3.4.2 Attributes**

12796 The attributes of this cluster are detailed in Table 9-7.

12797 **Table 9-7. Attributes of the Analog Input (BACnet Extended) Server**

<b>Id</b>	<b>Name</b>	<b>Type</b>	<b>Range</b>	<b>Acc</b>	<b>Def</b>	<b>M/O</b>
0x0000	<i>AckedTransitions</i>	map8	-	R*W	0	M
0x0011	<i>NotificationClass</i>	uint16	0x0000 - 0xffff	R*W	0	M
0x0019	<i>Deadband</i>	single	-	R*W	0	M
0x0023	<i>EventEnable</i>	map8	-	R*W	0	M
0x0024	<i>EventState</i>	enum8	-	R	0	O
0x002D	<i>HighLimit</i>	single	-	R*W	0	M
0x0034	<i>LimitEnable</i>	map8	0x00 - 0x11	R*W	0x00	M
0x003B	<i>LowLimit</i>	single	-	R*W	0	M
0x0048	<i>NotifyType</i>	enum8	-	R*W	0	M
0x0071	<i>TimeDelay</i>	uint8	-	R*W	0	M
0x0082	<i>EventTimeStamps</i>	array[3] of (uint16, ToD, or struct of (date, ToD))	-	R	-	M

12798

12799 For an explanation of the attributes, see section 9.4.20 and 9.4.21.

12800 **9.4.3.4.3 Commands**

12801 No cluster specific commands are received or generated.

12802 **9.4.3.4.4 Attribute Reporting**

12803 No attribute reporting is mandated for this cluster.

12804 **9.4.3.5 Client**

12805 The client has no dependencies, no attributes, and receives or generates no cluster specific commands.

12806 **9.4.4 Analog Output (BACnet Regular)**

12807 The Analog Output (BACnet Regular) cluster provides an interface for accessing a number of commonly  
12808 used BACnet based attributes of an analog output. It is used principally for interworking with BACnet sys-  
12809 tems.

12810 **9.4.4.1 Revision History**

12811 The global *ClusterRevision* attribute value SHALL be the highest revision number in the table below.

Rev	Description
1	mandatory global <i>ClusterRevision</i> attribute added

12812 **9.4.4.2 Classification**

Hierarchy	Role	PICS Code	Primary Transaction
Base	Application	AOB	Type 2 (server to client)

12813 **9.4.4.3 Cluster Identifiers**

Identifier	Name
0x0604	Analog Output (BACnet Regular)

12814 **9.4.4.4 Server**

12815 **9.4.4.4.1 Dependencies**

12816 Any endpoint that supports this cluster shall also support the Analog Output (Basic) cluster, and this cluster  
12817 shall support the *PriorityArray* and *RelinquishDefault* attributes.

12818 **9.4.4.4.2 Attributes**

12819 The attributes of this cluster are detailed in Table 9-8.

12820 **Table 9-8. Attributes of the Analog Output (BACnet Regular) Server**

<b>Id</b>	<b>Name</b>	<b>Type</b>	<b>Range</b>	<b>Acc</b>	<b>Default</b>	<b>M/O</b>
0x0016	<i>COVIncrement</i>	single	-	R*W	0	O
0x001F	<i>DeviceType</i>	string	-	R	Null string	O
0x004B	<i>ObjectIdentifier</i>	bacOID	0x00000000 - 0xffffffff	R	-	M
0x004D	<i>ObjectName</i>	string	-	R	Null string	M
0x004F	<i>ObjectType</i>	enum16	-	R	-	M
0x00A8	<i>ProfileName</i>	string	-	R*W	Null string	O

12821

12822 For an explanation of the attributes, see section 9.4.20.

12823 **9.4.4.4.3 Commands**

12824 No cluster specific commands are received or generated.

12825 **9.4.4.4.4 Attribute Reporting**

12826 No attribute reporting is mandated for this cluster.

12827 **9.4.4.5 Client**

12828 The client has no dependencies, no specific attributes, and receives or generates no cluster specific commands.  
 12829

12830 **9.4.5 Analog Output (BACnet Extended)**

12831 The Analog Output (BACnet Extended) cluster provides an interface for accessing a number of BACnet based attributes of an analog output. It is used principally for interworking with BACnet systems.  
 12832

12833 **9.4.5.1 Revision History**

12834 The global *ClusterRevision* attribute value SHALL be the highest revision number in the table below.

<b>Rev</b>	<b>Description</b>
1	mandatory global <i>ClusterRevision</i> attribute added

12835 **9.4.5.2 Classification**

<b>Hierarchy</b>	<b>Role</b>	<b>PICS Code</b>	<b>Primary Transaction</b>

Base	Application	AOBE	Type 2 (server to client)
------	-------------	------	---------------------------

12836 **9.4.5.3 Cluster Identifiers**

Identifier	Name
0x0605	Analog Output (BACnet Extended)

12837 **9.4.5.4 Server**

12838 **9.4.5.4.1 Dependencies**

12839 Any endpoint that supports this cluster must support the Analog Output (Basic) cluster and the Analog Output  
12840 (BACnet Regular) cluster.

12841 **9.4.5.4.2 Attributes**

12842 The attributes of this cluster are detailed in Table 9-9.

12843 **Table 9-9. Attributes of the Analog Output (BACnet Extended) Server**

Id	Name	Type	Range	Acc	Def	M/O
0x0000	<i>AckedTransitions</i>	map8	-	R*W	0	M
0x0011	<i>NotificationClass</i>	uint16	0x0000 - 0xffff	R*W	0	M
0x0019	<i>Deadband</i>	single	-	R*W	0	M
0x0023	<i>EventEnable</i>	map8	-	R*W	0	M
0x0024	<i>EventState</i>	enum8	-	R	0	O
0x002D	<i>HighLimit</i>	single	-	R*W	0	M
0x0034	<i>LimitEnable</i>	map8	0x00 - 0x11	R*W	0x00	M
0x003B	<i>LowLimit</i>	single	-	R*W	0	M
0x0048	<i>NotifyType</i>	enum8	-	R*W	0	M
0x0071	<i>TimeDelay</i>	uint8	-	R*W	0	M
0x0082	<i>EventTimeStamps</i>	array[3] of (uint16, ToD, or struct of (date, ToD))	-	R	-	M

12844

12845 For an explanation of the attributes, see sections 9.4.20 and 9.4.21.



12846 **9.4.5.4.3 Commands**

12847 No cluster specific commands are received or generated.

12848 **9.4.5.4.4 Attribute Reporting**

12849 No attribute reporting is mandated for this cluster.

12850 **9.4.5.5 Client**

12851 The client has no dependencies, no attributes, and receives or generates no cluster specific commands.

12852 **9.4.6 Analog Value (BACnet Regular)**

12853 The Analog Value (BACnet Regular) cluster provides an interface for accessing commonly used BACnet  
 12854 based characteristics of an analog value, typically used as a control system parameter. It is principally used  
 12855 for interworking with BACnet systems.

12856 **9.4.6.1 Revision History**

12857 The global *ClusterRevision* attribute value SHALL be the highest revision number in the table below.

Rev	Description
1	mandatory global <i>ClusterRevision</i> attribute added

12858 **9.4.6.2 Classification**

Hierarchy	Role	PICS Code	Primary Transaction
Base	Application	AVB	Type 2 (server to client)

12859 **9.4.6.3 Cluster Identifiers**

Identifier	Name
0x0606	Analog Value (BACnet Regular)

12860 **9.4.6.4 Server**

12861 **9.4.6.4.1 Dependencies**

12862 Any endpoint that supports this cluster must support the Analog Value (Basic) cluster.

12863 **9.4.6.4.2 Attributes**

12864 The attributes of this cluster are detailed in Table 9-10.

12865 **Table 9-10. Attributes of the Analog Value (BACnet Regular) Server**

Id	Name	Type	Range	Acc	Default	M/O
0x0016	<i>COVIncrement</i>	single	-	R*W	0	O
0x004B	<i>ObjectIdentifier</i>	bacOID	0x00000000 - 0xffffffff	R	-	M
0x004D	<i>ObjectName</i>	string	-	R	Null string	M
0x004F	<i>ObjectType</i>	enum16	-	R	-	M
0x00A8	<i>ProfileName</i>	string	-	R*W	Null string	O

12866

12867 For an explanation of the attributes, see section 9.4.20.

12868 **9.4.6.4.3 Commands**

12869 No cluster specific commands are received or generated.

12870 **9.4.6.4.4 Attribute Reporting**

12871 No attribute reporting is mandated for this cluster.

12872 **9.4.6.5 Client**

12873 The client has no dependencies, no attributes, and receives or generates no cluster specific commands.

12874 **9.4.7 Analog Value (BACnet Extended)**

12875 The Analog Value (BACnet Extended) cluster provides an interface for accessing BACnet based characteristics of an analog value, typically used as a control system parameter. It is principally used for interworking with BACnet systems.

12878 **9.4.7.1 Revision History**12879 The global *ClusterRevision* attribute value SHALL be the highest revision number in the table below.

Rev	Description
1	mandatory global <i>ClusterRevision</i> attribute added

12880 **9.4.7.2 Classification**

Hierarchy	Role	PICS Code	Primary Transaction
Base	Application	AVBE	Type 2 (server to client)

12881 **9.4.7.3 Cluster Identifiers**

Identifier	Name
0x0607	Analog Value (BACnet Extended)

12882 **9.4.7.4 Server**

12883 **9.4.7.4.1 Dependencies**

12884 Any endpoint that supports this cluster must support the Analog Value (Basic) cluster and the Analog Value  
 12885 (BACnet Regular) cluster.

12886 **9.4.7.4.2 Attributes**

12887 The attributes of this cluster are detailed in Table 9-11.

12888 **Table 9-11. Attributes of the Analog Value (BACnet Extended) Server**

Id	Name	Type	Range	Acc	Def	M/O
0x0000	<i>AckedTransitions</i>	map8	-	R*W	0	M
0x0011	<i>NotificationClass</i>	uint16	0x0000 - 0xffff	R*W	0	M
0x0019	<i>Deadband</i>	single	-	R*W	0	M
0x0023	<i>EventEnable</i>	map8	-	R*W	0	M
0x0024	<i>EventState</i>	enum8	-	R	0	O
0x002D	<i>HighLimit</i>	single	-	R*W	0	M
0x0034	<i>LimitEnable</i>	map8	0x00 - 0x11	R*W	0x00	M
0x003B	<i>LowLimit</i>	single	-	R*W	0	M
0x0048	<i>NotifyType</i>	enum8	-	R*W	0	M
0x0071	<i>TimeDelay</i>	uint8	-	R*W	0	M
0x0082	<i>EventTimeStamps</i>	array[3] of (uint16, ToD, or struct of (date, ToD))	-	R	-	M

12889

12890 For an explanation of the attributes, see sections 9.4.20 and 9.4.21.

#### 12891 **9.4.7.4.3 Commands**

12892 No cluster specific commands are received or generated.

#### 12893 **9.4.7.4.4 Attribute Reporting**

12894 No attribute reporting is mandated for this cluster.

#### 12895 **9.4.7.5 Client**

12896 The client has no dependencies, no attributes, and receives or generates no cluster specific commands.

### 12897 **9.4.8 Binary Input (BACnet Regular)**

12898 The Binary Input (BACnet Regular) cluster provides an interface for accessing a number of commonly used  
12899 BACnet based attributes of a binary measurement. It is used principally for interworking with BACnet sys-  
12900 tems.

#### 12901 **9.4.8.1 Revision History**

12902 The global *ClusterRevision* attribute value SHALL be the highest revision number in the table below.

Rev	Description
1	mandatory global <i>ClusterRevision</i> attribute added

#### 12903 **9.4.8.2 Classification**

Hierarchy	Role	PICS Code	Primary Transaction
Base	Application	BIB	Type 2 (server to client)

#### 12904 **9.4.8.3 Cluster Identifiers**

Identifier	Name
0x0608	Binary Input (BACnet Regular)

#### 12905 **9.4.8.4 Server**

##### 12906 **9.4.8.4.1 Dependencies**

12907 Any endpoint that supports this cluster must support the Binary Input (Basic) cluster.

12908 **9.4.8.4.2 Attributes**

12909 The attributes of this cluster are detailed in Table 9-12.

12910 **Table 9-12. Attributes of the Binary Input (BACnet Regular) Server**

Id	Name	Type	Range	Acc	Default	MO
0x000F	<i>ChangeOfStateCount</i>	uint32	-	R*W	0xffffffff	O
0x0010	<i>ChangeOfStateTime</i>	struct (date, ToD)	-	R	0xffffffff 0xffffffff	O
0x001F	<i>DeviceType</i>	string	-	R	Null string	O
0x0021	<i>ElapsedActiveTime</i>	uint32	-	R*W	0xffffffff	O
0x004B	<i>ObjectIdentifier</i>	bacOID	0x00000000 - 0xffffffff	R	-	M
0x004D	<i>ObjectName</i>	string	-	R	Null string	M
0x004F	<i>ObjectType</i>	enum16	-	R	-	M
0x0072	<i>TimeOfATReset</i>	struct (date, ToD)	-	R	0xffffffff 0xffffffff	O
0x0073	<i>TimeOfSCReset</i>	struct (date, ToD)	-	R	0xffffffff 0xffffffff	O
0x00A8	<i>ProfileName</i>	string	-	R*W	Null string	O

12911

12912 For an explanation of the attributes, see section 9.4.20.

12913 **9.4.8.4.3 Commands**

12914 No cluster specific commands are received or generated.

12915 **9.4.8.4.4 Attribute Reporting**

12916 No attribute reporting is mandated for this cluster.

12917 **9.4.8.5 Client**

12918 The client has no dependencies, no attributes, and receives or generates no cluster specific commands.

12919 **9.4.9 Binary Input (BACnet Extended)**

12920 The Binary Input (BACnet Extended) cluster provides an interface for accessing a number of BACnet based  
 12921 attributes of a binary measurement. It is used principally for interworking with BACnet systems.

12922 **9.4.9.1 Revision History**

12923 The global *ClusterRevision* attribute value SHALL be the highest revision number in the table below.

Rev	Description
1	mandatory global <i>ClusterRevision</i> attribute added

12924 **9.4.9.2 Classification**

Hierarchy	Role	PICS Code	Primary Transaction
Base	Application	BIBE	Type 2 (server to client)

12925 **9.4.9.3 Cluster Identifiers**

Identifier	Name
0x0609	Binary Input (BACnet Extended)

12926 **9.4.9.4 Server**

12927 **9.4.9.4.1 Dependencies**

12928 Any endpoint that supports this cluster must support the Binary Input (Basic) cluster and the Binary Input  
12929 (BACnet Regular) cluster.

12930 **9.4.9.4.2 Attributes**

12931 The attributes of this cluster are detailed in Table 9-13.

12932 **Table 9-13. Attributes of the Binary Input (BACnet Extended) Server**

Id	Name	Type	Range	Access	Def	M/O
0x0000	<i>AckedTransitions</i>	map8	-	R*W	0	M
0x0006	<i>AlarmValue</i>	bool	0 - 1	R*W	-	M
0x0011	<i>NotificationClass</i>	uint16	0x0000 - 0xffff	R*W	0	M
0x0023	<i>EventEnable</i>	map8	-	R*W	0	M
0x0024	<i>EventState</i>	enum8	-	R	0	O
0x0048	<i>NotifyType</i>	enum8	-	R*W	0	M
0x0071	<i>TimeDelay</i>	uint8	-	R*W	0	M

Id	Name	Type	Range	Access	Def	M/O
0x0082	<i>EventTimeStamps</i>	array[3] of (uint16, ToD, or struct of (date, ToD))	-	R	-	M

12933

12934 For an explanation of the attributes, see sections 9.4.20 and 9.4.21.

12935 **9.4.9.4.3 Commands**

12936 No cluster specific commands are received or generated.

12937 **9.4.9.4.4 Attribute Reporting**

12938 No attribute reporting is mandated for this cluster.

12939 **9.4.9.5 Client**

12940 The client has no dependencies, no attributes, and receives or generates no cluster specific commands.

12941 **9.4.10 Binary Output (BACnet Regular)**

12942 The Analog Output (BACnet Regular) cluster provides an interface for accessing a number of commonly  
 12943 used BACnet based attributes of a binary output. It is used principally for interworking with BACnet systems.

12944 **9.4.10.1 Revision History**

12945 The global *ClusterRevision* attribute value SHALL be the highest revision number in the table below.

Rev	Description
1	mandatory global <i>ClusterRevision</i> attribute added

12946 **9.4.10.2 Classification**

Hierarchy	Role	PICS Code	Primary Transaction
Base	Application	BOB	Type 2 (server to client)

12947 **9.4.10.3 Cluster Identifiers**

Identifier	Name
0x060a	Binary Output (BACnet Regular)

12948 **9.4.10.4 Server**12949 **9.4.10.4.1 Dependencies**

12950 Any endpoint that supports this cluster shall also support the Binary Output (Basic) cluster, and this cluster  
12951 shall support the PriorityArray and RelinquishDefault attributes.

12952 **9.4.10.4.2 Attributes**

12953 The attributes of this cluster are detailed in Table 9-14.

12954 **Table 9-14. Attributes of the Binary Output (BACnet Regular) Server**

<b>Id</b>	<b>Name</b>	<b>Type</b>	<b>Range</b>	<b>Acc</b>	<b>Default</b>	<b>MO</b>
0x000F	<i>ChangeOfStateCount</i>	uint32	-	R*W	0xffffffff	O
0x0010	<i>ChangeOfStateTime</i>	struct (date, ToD)	-	R	0xffffffff 0xffffffff	O
0x001F	<i>DeviceType</i>	string	-	R	Null string	O
0x0021	<i>ElapsedActiveTime</i>	uint32	-	R*W	0xffffffff	O
0x0028	<i>FeedBackValue</i>	enum8	0 - 1	R*W	0	O
0x004B	<i>ObjectIdentifier</i>	bacOID	0x00000000 - 0xffffffff	R	-	M
0x004D	<i>ObjectName</i>	string	-	R	Null string	M
0x004F	<i>ObjectType</i>	enum16	-	R	-	M
0x0072	<i>TimeOfATReset</i>	struct (date, ToD)	-	R	0xffffffff 0xffffffff	O
0x0073	<i>TimeOfSCReset</i>	struct (date, ToD)	-	R	0xffffffff 0xffffffff	O
0x00A8	<i>ProfileName</i>	string	-	R*W	Null string	O

12955

12956 For an explanation of the attributes, see section 9.4.20.

12957 **9.4.10.4.3 Commands**

12958 No cluster specific commands are received or generated.

12959 **9.4.10.4.4 Attribute Reporting**

12960 No attribute reporting is mandated for this cluster.



12961 **9.4.10.5 Client**

12962 The client has no dependencies, no attributes, and receives or generates no cluster specific commands.

12963 **9.4.11 Binary Output (BACnet Extended)**

12964 The Binary Output (BACnet Extended) cluster provides an interface for accessing a number of BACnet based  
 12965 attributes of a binary output. It is used principally for interworking with BACnet systems.

12966 **9.4.11.1 Revision History**

12967 The global *ClusterRevision* attribute value SHALL be the highest revision number in the table below.

Rev	Description
1	mandatory global <i>ClusterRevision</i> attribute added

12968 **9.4.11.2 Classification**

Hierarchy	Role	PICS Code	Primary Transaction
Base	Application	BOBE	Type 2 (server to client)

12969 **9.4.11.3 Cluster Identifiers**

Identifier	Name
0x060b	Binary Output (BACnet Extended)

12970 **9.4.11.4 Server**

12971 **9.4.11.4.1 Dependencies**

12972 Any endpoint that supports this cluster must support the Binary Output (Basic) cluster and the Binary Output  
 12973 (BACnet Regular) cluster.

12974 **9.4.11.4.2 Attributes**

12975 The attributes of this cluster are detailed in Table 9-15.

12976 **Table 9-15. Attributes of the Binary Output (BACnet Extended) Server**

Id	Name	Type	Range	Acc	Def	M/O
0x0000	<i>AckedTransitions</i>	map8	-	R*W	0	M

Id	Name	Type	Range	Acc	Def	M/O
0x0011	<i>NotificationClass</i>	uint16	0x0000 - 0xffff	R*W	0	M
0x0023	<i>EventEnable</i>	map8	-	R*W	0	M
0x0024	<i>EventState</i>	enum8	-	R	0	O
0x0048	<i>NotifyType</i>	enum8	-	R*W	0	M
0x0071	<i>TimeDelay</i>	uint8	-	R*W	0	M
0x0082	<i>EventTimeStamps</i>	array[3] of (uint16, ToD, or struct of (date, ToD))	-	R	-	M

12977

12978 For an explanation of the attributes, see sections 9.4.20 and 9.4.21.

### 12979 9.4.11.4.3 Commands

12980 No cluster specific commands are received or generated.

### 12981 9.4.11.4.4 Attribute Reporting

12982 No attribute reporting is mandated for this cluster.

### 12983 9.4.11.5 Client

12984 The client has no dependencies, no attributes, and receives or generates no cluster specific commands.

## 12985 9.4.12 Binary Value (BACnet Regular)

12986 The Binary Value (BACnet Regular) cluster provides an interface for accessing commonly used BACnet  
12987 based characteristics of a binary value, typically used as a control system parameter. It is principally used for  
12988 interworking with BACnet systems.

### 12989 9.4.12.1 Revision History

12990 The global *ClusterRevision* attribute value SHALL be the highest revision number in the table below.

Rev	Description
1	mandatory global <i>ClusterRevision</i> attribute added

### 12991 9.4.12.2 Classification

Hierarchy	Role	PICS Code	Primary Transaction
Base	Application	BVB	Type 2 (server to client)

12992 **9.4.12.3 Cluster Identifiers**

Identifier	Name
0x060c	Binary Value (BACnet Regular)

12993 **9.4.12.4 Server**

12994 **9.4.12.4.1 Dependencies**

12995 Any endpoint that supports this cluster must support the Binary Value (Basic) cluster.

12996 **9.4.12.4.2 Attributes**

12997 The attributes of this cluster are detailed in Table 9-16.

12998 **Table 9-16. Attributes of the Binary Value (BACnet Regular) Server**

Id	Name	Type	Range	Acc	Default	M/O
0x000F	<i>ChangeOfStateCount</i>	uint32	-	R*W	0xffffffff	O
0x0010	<i>ChangeOfStateTime</i>	struct (date, ToD)	-	R	0xffffffff 0xffffffff	O
0x0021	<i>ElapsedActiveTime</i>	uint32	-	R*W	0xffffffff	O
0x004B	<i>ObjectIdentifier</i>	bacOID	0- 0xffffffff	R	-	M
0x004D	<i>ObjectName</i>	string	-	R	Null string	M
0x004F	<i>ObjectType</i>	enum16	-	R	-	M
0x0072	<i>TimeOfATReset</i>	struct (date, ToD)	-	R	0xffffffff 0xffffffff	O
0x0073	<i>TimeOfSCReset</i>	struct (date, ToD)	-	R	0xffffffff 0xffffffff	O
0x00A8	<i>ProfileName</i>	string	-	R*W	Null string	O

12999  
 13000 For an explanation of the attributes, see section 9.4.20.

13001 **9.4.12.4.3 Commands**

13002 No cluster specific commands are received or generated.

13003 **9.4.12.4.4 Attribute Reporting**

13004 No attribute reporting is mandated for this cluster.

13005 **9.4.12.5 Client**

13006 The client has no dependencies, no attributes, and receives or generates no cluster specific commands.

13007 **9.4.13 Binary Value (BACnet Extended)**13008 The Binary Value (BACnet Extended) cluster provides an interface for accessing BACnet based characteris-  
13009 tics of a binary value, typically used as a control system parameter. It is principally used for interworking  
13010 with BACnet systems.13011 **9.4.13.1 Revision History**13012 The global *ClusterRevision* attribute value SHALL be the highest revision number in the table below.

Rev	Description
1	mandatory global <i>ClusterRevision</i> attribute added

13013 **9.4.13.2 Classification**

Hierarchy	Role	PICS Code	Primary Transaction
Base	Application	BVBE	Type 2 (server to client)

13014 **9.4.13.3 Cluster Identifiers**

Identifier	Name
0x060d	Binary Value (BACnet Extended)

13015 **9.4.13.4 Server**13016 **9.4.13.4.1 Dependencies**13017 Any endpoint that supports this cluster must support the Binary Value (Basic) cluster and the Binary Value  
13018 (BACnet Regular) cluster.13019 **9.4.13.4.2 Attributes**

13020 The attributes of this cluster are detailed in Table 9-17.

13021 **Table 9-17. Attributes of the Binary Value (BACnet Extended) Server**

Id	Name	Type	Range	Acc	Def	M/O
0x0000	<i>AckedTransitions</i>	map8	-	R*W	0	M

Id	Name	Type	Range	Acc	Def	M/O
0x0006	<i>AlarmValue</i>	bool	0 - 1	R*W	-	M
0x0011	<i>NotificationClass</i>	uint16	0x0000 - 0xffff	R*W	0	M
0x0023	<i>EventEnable</i>	map8	-	R*W	0	M
0x0024	<i>EventState</i>	enum8	-	R	0	O
0x0048	<i>NotifyType</i>	enum8	-	R*W	0	M
0x0071	<i>TimeDelay</i>	uint8	-	R*W	0	M
0x0082	<i>EventTimeStamps</i>	array[3] of (uint16, ToD, or struct of (date, ToD))	-	R	-	M

13022

13023 For an explanation of the attributes, see sections 9.4.20 and 9.4.21.

13024 **9.4.13.4.3 Commands**

13025 No cluster specific commands are received or generated.

13026 **9.4.13.4.4 Attribute Reporting**

13027 No attribute reporting is mandated for this cluster.

13028 **9.4.13.5 Client**

13029 The client has no dependencies, no attributes, and receives or generates no cluster specific commands.

13030 **9.4.14 Multistate Input (BACnet Regular)**

13031 The Multistate Input (BACnet Regular) cluster provides an interface for accessing a number of commonly  
 13032 used BACnet based attributes of a multistate measurement. It is used principally for interworking with BAC-  
 13033 net systems.

13034 **9.4.14.1 Revision History**

13035 The global *ClusterRevision* attribute value SHALL be the highest revision number in the table below.

Rev	Description
1	mandatory global <i>ClusterRevision</i> attribute added

13036 **9.4.14.2 Classification**

Hierarchy	Role	PICS Code	Primary Transaction

Base	Application	MIB	Type 2 (server to client)
------	-------------	-----	---------------------------

13037 **9.4.14.3 Cluster Identifiers**

Identifier	Name
0x060e	Multistate Input (BACnet Regular)

13038 **9.4.14.4 Server**

13039 **9.4.14.4.1 Dependencies**

13040 Any endpoint that supports this cluster must support the Multistate Input (Basic) cluster.

13041 **9.4.14.4.2 Attributes**

13042 The attributes of this cluster are detailed in Table 9-18.

13043 **Table 9-18. Attributes of the Multistate Input (BACnet Regular) Server**

Id	Name	Type	Range	Acc	Default	M/O
0x001F	<i>DeviceType</i>	string	-	R	Null string	O
0x004B	<i>ObjectIdentifier</i>	bacOID	0-0xffffffff	R	-	M
0x004D	<i>ObjectName</i>	string	-	R	Null string	M
0x004F	<i>ObjectType</i>	enum16	-	R	-	M
0x00A8	<i>ProfileName</i>	string	-	R*W	Null string	O

13044  
13045 For an explanation of the attributes, see section 9.4.20.

13046 **9.4.14.4.3 Commands**

13047 No cluster specific commands are received or generated.

13048 **9.4.14.4.4 Attribute Reporting**

13049 No attribute reporting is mandated for this cluster.

13050 **9.4.14.5 Client**

13051 The client has no dependencies, no attributes, and receives or generates no cluster specific commands.

13052 **9.4.15 Multistate Input (BACnet Extended)**

13053 The Multistate Input (BACnet Extended) cluster provides an interface for accessing a number of BACnet  
 13054 based attributes of a multistate measurement. It is used principally for interworking with BACnet systems.

13055 **9.4.15.1 Revision History**

13056 The global *ClusterRevision* attribute value SHALL be the highest revision number in the table below.

Rev	Description
1	mandatory global <i>ClusterRevision</i> attribute added

13057 **9.4.15.2 Classification**

Hierarchy	Role	PICS Code	Primary Transaction
Base	Application	MIBE	Type 2 (server to client)

13058 **9.4.15.3 Cluster Identifiers**

Identifier	Name
0x060f	Multistate Input (BACnet Extended)

13059 **9.4.15.4 Server**

13060 **9.4.15.4.1 Dependencies**

13061 Any endpoint that supports this cluster must support the Multistate Input (Basic) cluster and the Multistate  
 13062 Input (BACnet Regular) cluster.

13063 **9.4.15.4.2 Attributes**

13064 The attributes of this cluster are detailed in Table 9-19.

13065 **Table 9-19. Attributes of Multistate Input (BACnet Extended) Server**

Id	Name	Type	Range	Acc	Def	M/O
0x0000	<i>AckedTransitions</i>	map8	-	R*W	0	M
0x0006	<i>AlarmValues</i>	Set of uint16	0 - 0xffff	R*W	-	M

Id	Name	Type	Range	Acc	Def	M/O
0x0011	<i>NotificationClass</i>	uint16	0x0000 - 0xffff	R*W	0	M
0x0023	<i>EventEnable</i>	map8	-	R*W	0	M
0x0024	<i>EventState</i>	enum8	-	R	0	O
0x0025	<i>FaultValues</i>	Set of uint16	0 - 0xffff	R*W	0	M
0x0048	<i>NotifyType</i>	enum8	-	R*W	0	M
0x0071	<i>TimeDelay</i>	uint8	-	R*W	0	M
0x0082	<i>EventTimeStamps</i>	array[3] of (uint16, ToD, or struct of (date, ToD))	-	R	-	M

13066

13067 For an explanation of the attributes, see sections 9.4.20 and 9.4.21.

### 13068 **9.4.15.4.3 Commands**

13069 No cluster specific commands are received or generated.

### 13070 **9.4.15.4.4 Attribute Reporting**

13071 No attribute reporting is mandated for this cluster.

### 13072 **9.4.15.5 Client**

13073 The client has no dependencies, no attributes, and receives or generates no cluster specific commands.

## 13074 **9.4.16 Multistate Output (BACnet Regular)**

13075 The Multistate Output (BACnet Regular) cluster provides an interface for accessing a number of commonly  
13076 used BACnet based attributes of a multistate output. It is used principally for interworking with BACnet  
13077 systems.

### 13078 **9.4.16.1 Revision History**

13079 The global *ClusterRevision* attribute value SHALL be the highest revision number in the table below.

Rev	Description
1	mandatory global <i>ClusterRevision</i> attribute added

### 13080 **9.4.16.2 Classification**

Hierarchy	Role	PICS Code	Primary Transaction



Base	Application	MOB	Type 2 (server to client)
------	-------------	-----	---------------------------

13081 **9.4.16.3 Cluster Identifiers**

Identifier	Name
0x0610	Multistate Output (BACnet Regular)

13082 **9.4.16.4 Server**

13083 **9.4.16.4.1 Dependencies**

13084 Any endpoint that supports this cluster shall also support the Multistate Output (Basic) cluster, and this cluster  
 13085 shall support the PriorityArray and RelinquishDefault attributes.

13086 **9.4.16.4.2 Attributes**

13087 The attributes of this cluster are detailed in Table 9-20.

13088 **Table 9-20. Attributes of Multistate Output (BACnet Regular) Server**

Id	Name	Type	Range	Access	Default	M/O
0x001F	<i>DeviceType</i>	string	-	R	Null string	O
0x0028	<i>FeedBackValue</i>	enum8	0 - 1	R*W	0	O
0x004B	<i>ObjectIdentifier</i>	bacOID	0x00000000 - 0xffffffff	R	-	M
0x004D	<i>ObjectName</i>	string	-	R	Null string	M
0x004F	<i>ObjectType</i>	enum16	-	R	-	M
0x00A8	<i>ProfileName</i>	string	-	R*W	Null string	O

13089

13090 For an explanation of the attributes, see section 9.4.20.

13091 **9.4.16.4.3 Commands**

13092 No cluster specific commands are received or generated.

13093 **9.4.16.4.4 Attribute Reporting**

13094 No attribute reporting is mandated for this cluster.

13095 **9.4.16.5 Client**

13096 The client has no dependencies, no attributes, and receives or generates no cluster specific commands.

13097 **9.4.17 Multistate Output (BACnet Extended)**

13098 The Multistate Output (BACnet Extended) cluster provides an interface for accessing a number of BACnet  
13099 based attributes of a multistate output. It is used principally for interworking with BACnet systems.

13100 **9.4.17.1 Revision History**

13101 The global *ClusterRevision* attribute value SHALL be the highest revision number in the table below.

Rev	Description
1	mandatory global <i>ClusterRevision</i> attribute added

13102 **9.4.17.2 Classification**

Hierarchy	Role	PICS Code	Primary Transaction
Base	Application	MOBE	Type 2 (server to client)

13103 **9.4.17.3 Cluster Identifiers**

Identifier	Name
0x0611	Multistate Output (BACnet Extended)

13104 **9.4.17.4 Server**13105 **9.4.17.4.1 Dependencies**

13106 Any endpoint that supports this cluster must support the Multistate Output (Basic) cluster and the Multistate  
13107 Output (BACnet Regular) cluster.

13108 **9.4.17.4.2 Attributes**

13109 The attributes of this cluster are detailed in Table 9-21.

13110 **Table 9-21. Attributes of Multistate Output (BACnet Extended) Server**

Id	Name	Type	Range	Acc	Def	M/O
0x0000	<i>AckedTransitions</i>	map8	-	R*W	0	M
0x0011	<i>NotificationClass</i>	uint16	0x0000 - 0xffff	R*W	0	M
0x0023	<i>EventEnable</i>	map8	-	R*W	0	M
0x0024	<i>EventState</i>	enum8	-	R	0	O

Id	Name	Type	Range	Acc	Def	M/O
0x0048	<i>NotifyType</i>	enum8	-	R*W	0	M
0x0071	<i>TimeDelay</i>	uint8	-	R*W	0	M
0x0082	<i>EventTimeStamps</i>	array[3] of (uint16, ToD, or struct of (date, ToD))	-	R	-	M

13111

13112 For an explanation of the attributes, see sections 9.4.20 and 9.4.21.

13113 **9.4.17.4.3 Commands**

13114 No cluster specific commands are received or generated.

13115 **9.4.17.4.4 Attribute Reporting**

13116 No attribute reporting is mandated for this cluster.

13117 **9.4.17.5 Client**

13118 The client has no dependencies, no attributes, and receives or generates no cluster specific commands.

13119 **9.4.18 Multistate Value (BACnet Regular)**

13120 The Multistate Value (BACnet Regular) cluster provides an interface for accessing commonly used BACnet based characteristics of a multistate value, typically used as a control system parameter. It is principally used for interworking with BACnet systems.

13123 **9.4.18.1 Revision History**

13124 The global *ClusterRevision* attribute value SHALL be the highest revision number in the table below.

Rev	Description
1	mandatory global <i>ClusterRevision</i> attribute added

13125 **9.4.18.2 Classification**

Hierarchy	Role	PICS Code	Primary Transaction
Base	Application	MVB	Type 2 (server to client)

13126 **9.4.18.3 Cluster Identifiers**

Identifier	Name
0x0612	Multistate Value (BACnet Regular)

13127 **9.4.18.4 Server**

13128 **9.4.18.4.1 Dependencies**

13129 Any endpoint that supports this cluster must support the Multistate Value (Basic) cluster.

13130 **9.4.18.4.2 Attributes**

13131 The attributes of this cluster are detailed in Table 9-22.

13132 **Table 9-22. Attributes of Multistate Value (BACnet Regular) Server**

Id	Name	Type	Range	Acc	Default	M/O
0x004B	<i>ObjectIdentifier</i>	bacOID	0 -0xffffffff	R	-	M
0x004D	<i>ObjectName</i>	string	-	R	Null string	M
0x004F	<i>ObjectType</i>	enum16	-	R	-	M
0x00A8	<i>ProfileName</i>	string	-	R*W	Null string	O

13133  
13134 For an explanation of the attributes, see section 9.4.20.

13135 **9.4.18.4.3 Commands**

13136 No cluster specific commands are received or generated.

13137 **9.4.18.4.4 Attribute Reporting**

13138 No attribute reporting is mandated for this cluster.

13139 **9.4.18.5 Client**

13140 The client has no dependencies, no attributes, and receives or generates no cluster specific commands.

13141 **9.4.19 Multistate Value (BACnet Extended)**

13142 The Multistate Value (BACnet Extended) cluster provides an interface for accessing BACnet based characteristics of a multistate value, typically used as a control system parameter. It is principally used for interworking with BACnet systems.  
13143  
13144

13145 **9.4.19.1 Revision History**

13146 The global *ClusterRevision* attribute value SHALL be the highest revision number in the table below.

Rev	Description
1	mandatory global <i>ClusterRevision</i> attribute added

13147 **9.4.19.2 Classification**

Hierarchy	Role	PICS Code	Primary Transaction
Base	Application	MVBE	Type 2 (server to client)

13148 **9.4.19.3 Cluster Identifiers**

Identifier	Name
0x0613	Multistate Value (BACnet Extended)

13149 **9.4.19.4 Server**

13150 **9.4.19.4.1 Dependencies**

13151 Any endpoint that supports this cluster must support the Multistate Value (Basic) cluster and the Multistate  
 13152 Value (BACnet Regular) cluster.

13153 **9.4.19.4.2 Attributes**

13154 The attributes of this cluster are detailed in Table 9-23.

13155 **Table 9-23. Attributes of Multistate Value (BACnet Extended) Server**

Id	Name	Type	Range	Acc	Def	M/O
0x0000	<i>AckedTransitions</i>	map8	-	R*W	0	M
0x0006	<i>AlarmValues</i>	set of uint16	0 - 0xffff	R*W	-	M
0x0011	<i>NotificationClass</i>	uint16	0x0000 - xffff	R*W	0	M
0x0023	<i>EventEnable</i>	map8	-	R*W	0	M
0x0024	<i>EventState</i>	enum8	-	R	0	O
0x0025	<i>FaultValues</i>	set of uint16	0 - 0xffff	R*W	0	M
0x0048	<i>NotifyType</i>	enum8	-	R*W	0	M
0x0071	<i>TimeDelay</i>	uint8	-	R*W	0	M

Id	Name	Type	Range	Acc	Def	M/O
0x0082	<i>EventTimeStamps</i>	array[3] of (uint16, ToD, or struct of (date, ToD))	-	R	-	M

13156

13157 For an explanation of the attributes, see sections 9.4.20 and 9.4.21.

### 13158 **9.4.19.4.3 Commands**

13159 No cluster specific commands are received or generated.

### 13160 **9.4.19.4.4 Attribute Reporting**

13161 No attribute reporting is mandated for this cluster.

### 13162 **9.4.19.5 Client**

13163 The client has no dependencies, no attributes, and receives or generates no cluster specific commands.

## 13164 **9.4.20 Attributes of BACnet Regular Clusters**

13165 The attributes of BACnet Regular and BACnet Extended clusters are specifically intended for interworking  
13166 with BACnet systems (via a BACnet gateway). They are based on BACnet properties with the same names.  
13167 See the BACnet Reference Manual [A1] for detailed descriptions of these properties.

13168 References to reports in this section refer to BACnet intrinsic reporting. Note that attribute reporting may be  
13169 used to send reports as well.

### 13170 **9.4.20.1 ObjectIdentifier Attribute**

13171 This attribute, of type BACnet OID, is a numeric code that is used to identify the object. It shall be unique  
13172 within the BACnet Device that maintains it.

### 13173 **9.4.20.2 ObjectName Attribute**

13174 This attribute, of type Character String, shall represent a name for the object that is unique within the BACnet  
13175 Device that maintains it. The minimum length of the string shall be one character. The set of characters used  
13176 in the *ObjectName* shall be restricted to printable characters.

### 13177 **9.4.20.3 ObjectType Attribute**

13178 This attribute, of type enumeration, is set to the ID of the corresponding BACnet object type from which the  
13179 cluster was derived.

### 13180 **9.4.20.4 COVIncrement Attribute**

13181 This attribute, of type single, specifies the minimum change in *PresentValue* that will cause a value change  
13182 report to be initiated to bound report recipient clients. This value is the same as the Reportable Change value  
13183 for the *PresentValue* attribute.

### 13184 **9.4.20.5 DeviceType Attribute**

13185 This attribute, of type Character String, is a text description of the physical device connected to the input,  
13186 output or value.

### 13187 **9.4.20.6 UpdateInterval Attribute**

13188 This attribute indicates the maximum period of time between updates to the *PresentValue* of an Analog Input  
13189 cluster, in hundredths of a second, when the input is not overridden and not out-of-service.

### 13190 **9.4.20.7 ChangeOfStateCount Attribute**

13191 This attribute, of type Unsigned 32-bit integer, represents the number of times that the *PresentValue* attribute  
13192 of a Binary Input, Output or Value cluster has changed state (from 0 to 1, or from 1 to 0) since the *ChangeOf-*  
13193 *StateCount* attribute was most recently set to a zero value. The *ChangeOfStateCount* attribute shall have a  
13194 range of 0-65535 or greater.

13195 When *OutOfService* is FALSE, a change to the *Polarity* attribute shall alter *PresentValue* and thus be con-  
13196 sidered a change of state. When *OutOfService* is TRUE, changes to *Polarity* shall not cause changes of state.  
13197 If one of the optional attributes *ChangeOfStateTime*, *ChangeOfStateCount*, or *TimeOfStateCountReset* is  
13198 present, then all of these attributes shall be present.

### 13199 **9.4.20.8 ChangeOfStateTime Attribute**

13200 This attribute, of type Structure (Date, Time of Day), represents the most recent date and time at which the  
13201 *PresentValue* attribute of a Binary Input, Output or Value cluster changed state (from 0 to 1, or from 1 to 0)

13202 When *OutOfService* is FALSE, a change to the *Polarity* attribute shall alter *PresentValue* and thus be con-  
13203 sidered a change of state. When *OutOfService* is TRUE, changes to *Polarity* shall not cause changes of state.  
13204 If one of the optional attributes *ChangeOfStateTime*, *ChangeOfStateCount*, or *TimeOfSCReset* is present,  
13205 then all of these attributes shall be present.

### 13206 **9.4.20.9 ElapsedActiveTime Attribute**

13207 This attribute, of type Unsigned 32-bit integer, represents the accumulated number of seconds that the  
13208 *PresentValue* attribute of a Binary Input, Output or Value cluster has had the value ACTIVE (1) since the  
13209 *ElapsedActiveTime* attribute was most recently set to a zero value. If one of the optional properties  
13210 *ElapsedActiveTime* or *TimeOfATReset* is present, then both of these attributes shall be present.

### 13211 **9.4.20.10 TimeOfATReset Attribute**

13212 This attribute, of type Structure (Date, Time of Day), represents the date and time at which the *ElapsedAc-*  
13213 *tiveTime* attribute of a Binary Input, Output or Value cluster was most recently set to a zero value. If one of  
13214 the optional properties *ElapsedActiveTime* or *TimeOfATReset* is present, then both of these attributes shall  
13215 be present.

### 13216 **9.4.20.11 TimeOfSCReset Attribute**

13217 This attribute, of type Structure (Date, Time of Day), represents the date and time at which the *ChangeOf-*  
13218 *StateCount* attribute of a Binary Input, Output or Value cluster was most recently set to a zero value. If one  
13219 of the optional properties *ChangeOfStateTime*, *ChangeOfStateCount*, or *TimeOfSCReset* is present, then all  
13220 of these attributes shall be present.

### 13221 **9.4.20.12 FeedbackValue Attribute**

13222 This property, of type enumeration, indicates a feedback value from which *PresentValue* must differ before  
13223 an OFFNORMAL event is generated, and to which *PresentValue* must return before a TONORMAL event  
13224 is generated. The manner by which the *FeedbackValue* is determined shall be a local matter.

### 13225 **9.4.20.13 ProfileName Attribute**

13226 This attribute, of type Character string, is the name of a BACnet object profile to which its associated cluster  
13227 conforms. A profile defines a set of additional attributes, behavior, and/or requirements for the cluster beyond  
13228 those specified here.

13229 To ensure uniqueness, a profile name must begin with a vendor identifier code (see Clause 23 of [A1]) in  
13230 base-10 integer format, followed by a dash. All subsequent characters are administered by the organization  
13231 registered with that vendor identifier code. The vendor identifier code that prefixes the profile name shall  
13232 indicate the organization that publishes and maintains the profile document named by the remainder of the  
13233 profile name. This vendor identifier need not have any relationship to the vendor identifier of the device  
13234 within which the object resides.

## 13235 **9.4.21 Attributes of BACnet Extended Clusters**

13236 The attributes of BACnet Extended clusters are specifically intended for interworking with BACnet systems  
13237 (via a BACnet gateway). They are based on BACnet properties with the same names. See the BACnet Ref-  
13238 erence Manual [A1] for detailed descriptions of these properties.

13239 References to events and alarms in this section refer to BACnet intrinsic reporting. Note that attribute report-  
13240 ing may be used to send reports as well.

### 13241 **9.4.21.1 AckedTransitions Attribute**

13242 This attribute, of type bitmap, holds three one-bit flags (b0, b1, b2) that respectively indicate the receipt of  
13243 acknowledgments for TO-OFFNORMAL, TO-FAULT, and TO-NORMAL events

### 13244 **9.4.21.2 AlarmValue Attribute**

13245 This attribute, of type Boolean, specifies the value that the *PresentValue* attribute must have before a TO-  
13246 OFFNORMAL event is generated.

### 13247 **9.4.21.3 AlarmValues Attribute**

13248 This attribute, of type Set of uint16, specifies any values that the *PresentValue* attribute must equal before a  
13249 TO-OFFNORMAL event is generated.

### 13250 **9.4.21.4 FaultValues Attribute**

13251 This attribute, of type Set of uint16, specifies any values that the *PresentValue* attribute must equal before a  
13252 TO-FAULT event is generated.

### 13253 **9.4.21.5 NotificationClass Attribute**

13254 This attribute, of type uint16, specifies the notification class to be used when handling and generating event  
13255 notifications for this object (over a BACnet gateway).



### 13256 **9.4.21.6 Deadband Attribute**

13257 This attribute, of type single, specifies a range (from *LowLimit + Deadband* to *HighLimit - Deadband*) which  
13258 the *PresentValue* must return within for a TO-NORMAL event to be generated.

### 13259 **9.4.21.7 EventEnable Attribute**

13260 This attribute, of type bitmap, holds three one-bit flags (b0, b1, b2) that respectively enable (1) and disable  
13261 (0) reporting of TO-OFFNORMAL, TO-FAULT, and TO-NORMAL events.

### 13262 **9.4.21.8 EventState Attribute**

13263 The *EventState* attribute, of type 8-bit enumeration, is included in order to provide a way to determine if this  
13264 object has an active event state associated with it. The allowed values are:

- 13265 • NORMAL (0)
- 13266 • FAULT (1)
- 13267 • OFFNORMAL (2)
- 13268 • HIGH-LIMIT (3)
- 13269 • LOW-LIMIT (4)

### 13270 **9.4.21.9 HighLimit Attribute**

13271 This attribute, of type single, specifies a limit that *PresentValue* must exceed before an OFF-NORMAL  
13272 (HIGH-LIMIT) event is generated.

### 13273 **9.4.21.10 LimitEnable Attribute**

13274 This attribute, of type map8, holds two one-bit flags. The flag in bit position 0 enables reporting of low limit  
13275 off-normal and return-to-normal events if it has the value 1, and disables reporting of these events if it has  
13276 the value 0. The flag in bit position 1 enables reporting of high limit off-normal and return-to-normal events  
13277 if it has the value 1, and disables reporting of these events if it has the value 0.

### 13278 **9.4.21.11 LowLimit Attribute**

13279 This attribute, of type single, shall specify a limit that *PresentValue* must fall below before an OFF-NOR-  
13280 MAL (LOW-LIMIT) event is generated.

### 13281 **9.4.21.12 NotifyType Attribute**

13282 This attribute, of type enumeration, indicates whether the notifications generated by the cluster should be  
13283 Events (0) or Alarms (1).

### 13284 **9.4.21.13 TimeDelay Attribute**

13285 This attribute, of type Unsigned 8-bit integer, specifies the minimum period of time in seconds that  
13286 *PresentValue* must remain outside the band defined by the *HighLimit* and *LowLimit* attributes before a TO-  
13287 OFFNORMAL event is generated, or within the band (from *LowLimit + Deadband* to *HighLimit - Deadband*)  
13288 before a TO-NORMAL event is generated.

### 13289 **9.4.21.14 EventTimeStamps Attribute**

13290 This optional read-only attribute is of type Array[3]. The three elements each have a type which is one of:

- 13291 • 16-bit unsigned integer - a sequence number
- 13292 • Time of day
- 13293 • Structure of (date, time of day)

13294 The elements of the array hold the times (or sequence numbers) of the last event notifications for TO-  
13295 OFFNORMAL, TO-FAULT, and TO-NORMAL events, respectively. The type of the elements is discovered  
13296 by reading the attribute.

## 13297 **9.5 ISO 7818 Protocol Tunnel**

### 13298 **9.5.1 Scope and Purpose**

13299 This section specifies a single cluster, the ISO7816 Tunnel cluster, which provides commands and attributes  
13300 for mobile office solutions.

13301 This cluster is to provide a standardized interface to enable a scenario of authorization management on mobile  
13302 office devices (e.g., access to PC resources)

### 13303 **9.5.2 Definitions**

13304 The definitions used in the ISO 7816 Protocol Tunnel are shown in Table 9-24.

13305 **Table 9-24. Definitions Used in ISO 7816 Protocol Tunnel Description**

Term	Definition
Target Device	A Computer System on which User has to perform authentication in order to access to information services
User Token	A device used by a Target Device to authenticate and authorize User
Virtual SmartCard	A SmartCard that is a node on the network

### 13306 **9.5.3 General Description**

13307 The cluster specified in this document is typically used for telecom applications, but may be used in any other  
13308 application domains.

### 13309 **9.5.4 Overview**

13310 Please see Chapter 2 for a general cluster overview defining cluster architecture, revision, classification,  
13311 identification, etc.

13312 This cluster provides attributes and commands to tunnel ISO7816 APDUs, enabling solution such as Mobile  
13313 Office, i.e., a mechanism to authenticate and authorize Users on shared Computer System (said Target De-  
13314 vice) by means of a Virtual Smartcard (generically said User Token).

13315 A Target Device, enabled by the server side of this cluster, and a User Token (supporting a client side of this  
13316 cluster) can establish a connection and exchange information by means of ISO7816 APDU messages over  
13317 network.

13318 **9.5.4.1 Revision History**

13319 The global *ClusterRevision* attribute value SHALL be the highest revision number in the table below.

Rev	Description
1	mandatory global <i>ClusterRevision</i> attribute added

13320 **9.5.4.2 Classification**

Hierarchy	Role	PICS Code	Primary Transaction
Base	Application	T7816	Type 1 (client to server)

13321 **9.5.4.3 Cluster Identifiers**

Identifier	Name
0x0615	ISO 7818 Protocol Tunnel

13322 **9.5.5 Server**

13323 **9.5.5.1 Dependencies**

13324 Since ISO7816 protocol may use APDU frames larger than typical payload, stack fragmentation or Partition  
 13325 cluster shall be supported by the devices supporting this cluster.

13326 **9.5.5.2 Attributes**

13327 The ISO7816 Tunnel cluster contains the attribute shown in Table 9-25.

13328 **Table 9-25. Attributes for the ISO7816 Tunnel Cluster**

Id	Name	Type	Range	Access	Default	M/O
0x0001	<i>Status</i>	uint8	0x00-0x01	R	0x00	M

13329 **9.5.5.2.1 Status Attribute**

13330 The *Status* attribute specifies the Server internal state.

13331 Values and usage of this attribute are application dependent, e.g., server busy (client connected). Server sup-  
 13332 ports only one client connection at a time.

13333 The *Status* values are shown in Table 9-26.

13334

**Table 9-26. Status Values**

Meaning	Values
0x00	FREE
0x01	BUSY

13335 **9.5.5.3 Commands Received**

13336 The cluster specific commands received by the ISO7816 Tunnel server cluster are listed in Table 9-27.

13337 **Table 9-27. Received Command IDs for the ISO7816 Tunnel Cluster**

Command Identifier Field Value	Description	M/O
0x00	Transfer APDU	M
0x01	Insert SmartCard	M
0x02	Extract SmartCard	M

13338 **9.5.5.3.1 Transfer APDU Command**13339 **9.5.5.3.1.1 Payload Format**

13340 The Transfer APDU command shall be formatted as illustrated in Figure 9-5.

13341 **Figure 9-5. Format of the Transfer APDU command**

Bits	Variable
Data Type	octstr
Field Name	APDU

13342 **9.5.5.3.1.2 APDU Field**

13343 The APDU field is of variable length and is an ISO7816 APDU as defined in the ISO7816 standard [I2]

13344 **9.5.5.3.1.3 When Generated**

13345 This command is generated when an ISO7816 APDU has to be transferred across a tunnel.

13346 **9.5.5.3.1.4 Effect on Receipt**

13347 On receipt of this command, a device shall process the ISO7816 APDU as specified in the ISO7816 standard.

13348 **9.5.5.3.2 Insert Smart Card**13349 **9.5.5.3.2.1 Payload Format**

13350 No payload needed for Insert Smart Card command.

13351 **9.5.5.3.2.2 When Generated**

13352 This command is generated when a User Token insertion has to be sent to Server.

13353 **9.5.5.3.2.3 Effect on Receipt**

- 13354 On receipt of this command:
- 13355     • If the *Status* attribute is equal to BUSY, the Server shall send a Default Response with status  
 13356         FAILURE.
- 13357     • If the *Status* attribute is equal to FREE and the bit ‘Disable Default Response’ of the Frame control  
 13358         field of the ZCL Header is set to zero, the Server shall send respond with status SUCCESS. It also  
 13359         shall set its Status Attributes to BUSY and it can start to exchange APDUs with Client over ISO7816  
 13360         Tunnel.

13361 **9.5.5.3.3 Extract Smart Card**

13362 **9.5.5.3.3.1 Payload Format**

13363 No payload needed for Insert Smart Card command.

13364 **9.5.5.3.3.2 When Generated**

13365 This command is generated when a User Token extraction has to be sent to Server.

13366 **9.5.5.3.3.3 Effect on Receipt**

- 13367 On receipt of this command:
- 13368     • If the *Status* attribute is equal to FREE, the Server shall send a Default Response with status  
 13369         FAILURE.
- 13370     • If the *Status* attribute is equal to BUSY and the bit ‘Disable Default Response’ of the of the Frame  
 13371         control field of the ZCL Header is set to zero, the Server shall send respond with status SUCCESS. It  
 13372         shall also set its Status Attributes to FREE and after this, Server shall not be able to exchange APDUs  
 13373         with Client over ISO7816 Tunnel.

13374 **9.5.5.4 Commands Generated**

13375 The cluster specific commands generated by the ISO7816 Tunnel server cluster are listed in Table 9-28.

13376 **Table 9-28. Generated Command IDs for the ISO7816 Tunnel Cluster**

Command Identifier Field Value	Description	M/O
0x00	Transfer APDU	M

13377 **9.5.5.5 Transfer APDU**

13378 **9.5.5.5.1.1 Payload Format**

13379 The Transfer APDU command shall be formatted using the same command “Transfer APDU” in paragraph  
 13380 9.5.5.3.1. The effect on receipt is the same as reported in 9.5.5.3.1.4.

13381 **9.5.6 Client**

13382 **9.5.6.1 Dependencies**

13383 None

13384 **9.5.6.2 Attributes**

13385 The client cluster has no attributes.

13386 **9.5.6.3 Command Received**

13387 The client receives the cluster specific commands detailed in 9.5.5.4 as required by application profiles

13388 **9.5.6.4 Command Generated**

13389 The client generates the cluster specific commands detailed in 9.5.5.3 as required by application profiles.

13390 **9.6 Partition**

---

13391 **9.6.1 Scope and Purpose**

13392 This section specifies a single cluster, the Partition cluster, which provides commands and attributes for en-  
13393 abling partitioning of large frame to be carried from other clusters. This cluster is designed to provide a  
13394 standardized interface for the applications to manage extended size frame format, up to 100KB long. The  
13395 Partition cluster can be used in different application scenarios that requires extended frame for services pro-  
13396 vided by particular clusters.

13397 **9.6.2 Introduction**

13398 Please see Chapter 2 for a general cluster overview defining cluster architecture, revision, classification,  
13399 identification, etc.

13400 The cluster specified in this may be used in different application domains. The Partition cluster provides the  
13401 attributes and commands required for enabling and managing the transmission of extended frames over a  
13402 network.

13403

Figure 9-6. Typical Usage of the Partition Cluster

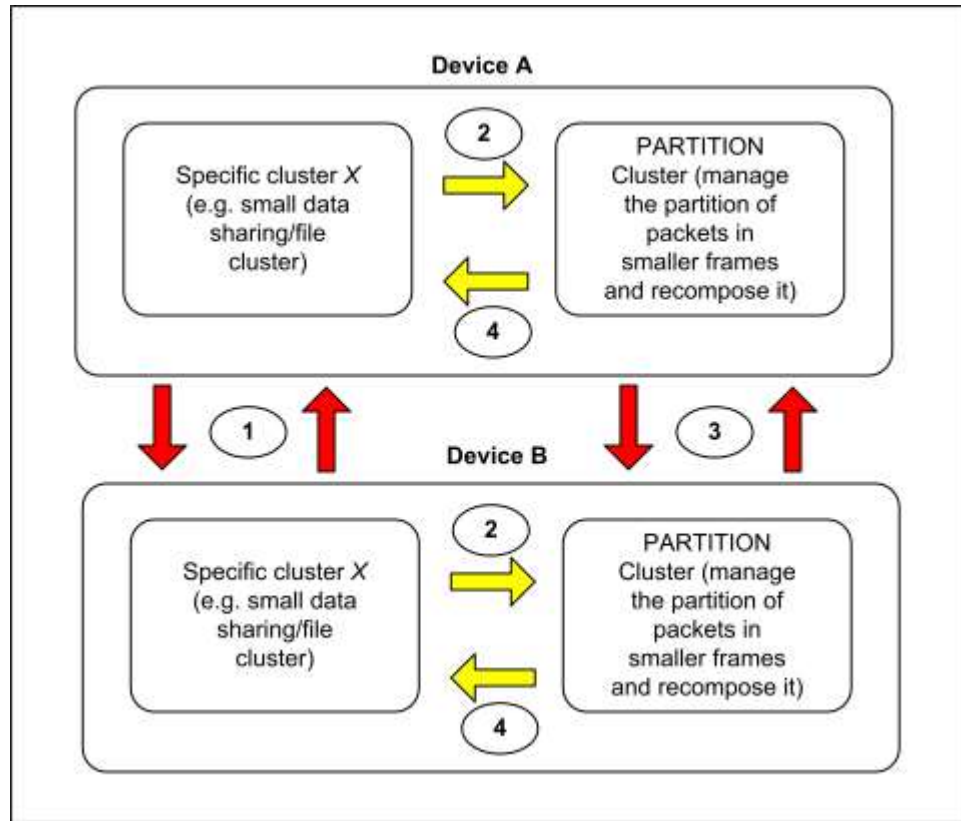

13404

13405

13406 The typical usage of Partition cluster is shown in Figure 9-6 and can be represented by the following phases:

13407 14. Cluster based Discovery (e.g., performing Match\_Desc\_Req) can be operated to the specific cluster X  
13408 that needs to transfer information to a matching cluster (e.g., File Cluster); moreover cluster based dis-  
13409covery should be used in order to check the support of the Partition Cluster by a recipient device.

13410 15. If the application entity requires transmission of large frames (e.g., an application willing to use data  
13411sharing/file cluster, generic tunnel cluster) the specific application entity shall subscribe to the Partition  
13412cluster; registration or subscription phase is described in 9.6.5.

13413 16. The Partition clusters will perform and manage the “fragmentation” and send the rebuilt frame to the  
13414registered specific cluster.

13415 17. The Partition Cluster will forward the recomposed packet to the specific clusters that registered to the  
13416Partitioning Cluster (e.g., Cluster X).

13417 The application object implementing and using the Partition Cluster should have enough memory to manage  
13418the incoming frames; the Partition cluster is designed for devices like Mobile Phones or other gateways that  
13419have extended computing capabilities in comparison with typical devices.

13420 Since the Partition cluster performs a handshake phase between the devices using Partition cluster (reading  
13421and writing the proper defined attributes) as described with more details in 9.6.5, both client and server should  
13422be used in order to guarantee a full bidirectional link in the communication (see Figure 9-7).

13423

Figure 9-7. Client and Server in Partition Cluster

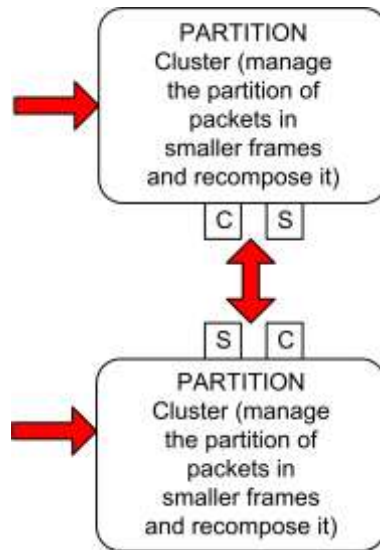

13424

13425

13426 A simple way to enable the use of the partition cluster should be to define a specific API that would support  
 13427 the sending/receive functionalities through the use of *Partition Cluster*. Partition should be considered like a  
 13428 specific tunnel cluster: Commands exposed to the application objects (general API to be used by the appli-  
 13429 cation) should be the following ones:

- 13430 • *TransferFrameUsingPartitionCluster* (send/receive) → the max size for the carried data is typically  
 13431 25KB<x<100KB as from discussed requirements. This command may pass a handler to the sequence  
 13432 of bytes corresponding to the ZCL message of the specific cluster using the Partition Cluster. In order  
 13433 to operate using the Partition Cluster the application may want to manage the transmission and  
 13434 reception of large frames running the handshake phase described in 9.6.5.

13435 Rather than pushing the large frame to the application, the Partition Cluster may only inform the  
 13436 application that a packet has arrived (very short packet that can be fed through the stack). The application  
 13437 will then read the frame from the Partitioning Cluster. The detailed mechanism to perform this opera-  
 13438 tion is out of scope of this specification

- 13439 • *RW handshake commands*

13440 Partition cluster related commands should be sent transparently between the application objects managing  
 13441 the fragmentation to guarantee the reconstruction of the received frame; these commands are described in the  
 13442 following sections:

- 13443 • *Transfer partitioned frame* (max dimension<max size carried by the ZCL standard frame ~80B)
- 13444 • *Multiple ACKs*

13445 In the Partition Cluster attributes a list of registered clusters should be inserted in order to manage possible  
 13446 sharing and re-use of it by multiple clusters.

### 13447 9.6.2.1 Revision History

13448 The global *ClusterRevision* attribute value SHALL be the highest revision number in the table below.

Rev	Description



1	mandatory global <i>ClusterRevision</i> attribute added
---	---

13449 **9.6.2.2 Classification**

Hierarchy	Role	PICS Code	Primary Transaction
Base	Application	PART	Type 1 (client to server)

13450 **9.6.2.3 Cluster Identifiers**

Identifier	Name
0x0016	Partition

13451 **9.6.3 Server**

13452 **9.6.3.1 Dependencies**

13453 None

13454 **9.6.3.2 Attributes**

13455 The attributes are used in the Partition Cluster summarized in Table 9-29.

13456 **Table 9-29. Attributes of the Partition Cluster**

Id	Name	Type	Range	Acc	Default	M/O
0x0000	<i>MaximumIncomingTransferSize</i>	uint16	0x0000-0xffff	R	0x0500	M
0x0001	<i>MaximumOutgoingTransferSize</i>	uint16	0x0000-0xffff	R	0x0500	M
0x0002	<i>PartitionedFrameSize</i>	uint8	0x00-0xff	RW	0x50	M
0x0003	<i>LargeFrameSize</i>	uint16	0x0000-0xffff	RW	0x0500	M
0x0004	<i>NumberOfACKFrame</i>	uint8	0x00-0xff	RW	0x64	M
0x0005	<i>NACKTimeout</i>	uint16	0x0000-0xffff	R	<i>apsAckWaitDuration + InterframeDelay * NumberOfACKFrames</i>	M
0x0006	<i>InterframeDelay</i>	uint8	Default-0xff	RW	<i>apsInterFrameDelay</i>	M

<b>Id</b>	<b>Name</b>	<b>Type</b>	<b>Range</b>	<b>Acc</b>	<b>Default</b>	<b>M/O</b>
0x0007	<i>NumberOfSendRetries</i>	uint8	0x00-0xff	R	0x03	M
0x0008	<i>SenderTimeout</i>	uint16	Default-0xffff	R	$2 * \text{apsAckWaitDuration} + \text{InterframeDelay} * \text{NumberOfACKFrames}$	M
0x0009	<i>ReceiverTimeout</i>	uint16	Default-0xffff	R	$\text{apsAckWaitDuration} + \text{InterframeDelay} + \text{NumberOfSendRetries} * \text{NACKTimeout}$	M

#### 13457 **9.6.3.2.1.1 MaximumIncomingTransferSize Attribute**

13458 The *MaximumIncomingTransferSize* attribute specifies the maximum size, as multiple of *PartitionedFrame-*  
13459 *Size*, of the application service data unit (ASDU) that can be transferred to this node in one single message  
13460 transfer. The ASDU referred to is the ZCL frame, including header and payload, of any command received  
13461 by a Partition cluster on the same endpoint.

#### 13462 **9.6.3.2.1.2 MaximumOutgoingTransferSize Attribute**

13463 The *MaximumOutgoingTransferSize* attribute specifies the maximum size, as multiple of *PartitionedFrame-*  
13464 *Size*, of the application service data unit (ASDU) that can be transferred from this node in one single message  
13465 transfer. The ASDU referred to is the ZCL frame, including header and payload, of any command received  
13466 by a Partition cluster on the same endpoint.

#### 13467 **9.6.3.2.1.3 PartitionedFrameSize Attribute**

13468 The *PartitionedFrameSize* attribute specifies the size in bytes of a partitioned frame transferred using *Trans-*  
13469 *ferPartitionedFrame* command. The default value for this attribute is equal to 80 bytes (0x50) because a  
13470 “large frame” to be transferred using the Partition Cluster shall be partitioned into smaller *PartitionedFrame-*  
13471 *Size* frame size.

#### 13472 **9.6.3.2.1.4 LargeFrameSize Attribute**

13473 The *LargeFrameSize* attribute specifies the size, in multiple of *PartitionedFrameSize*, of a large frame to be  
13474 partitioned using the Partition cluster into *PartitionedFrameSize* bytes carried by *TransferPartitionedFrame*  
13475 commands. The default value of this attribute should be set equal to 0x0500 (so that, given the default *Par-*  
13476 *titionedFrameSize* attribute equal to 80bytes the default large frame would be 100KB). The length in byte of  
13477 the large frame to be partitioned is equal to  $\text{PartitionedFrameSize} * \text{LargeFrameSize}$ . In case the frame to be  
13478 partitioned is not multiple of  $\text{PartitionedFrameSize} * \text{LargeFrameSize}$ , the last *TransferPartitionedFrame* com-  
13479 mand shall be padded with zeros in order to fit in *PartitionedFrameSize* length of the last *TransferPar-*  
13480 *titionedFrame* command.

#### 13481 **9.6.3.2.1.5 NumberOfACKFrame Attribute**

13482 The *NumberOfACKFrame* attribute specifies the number of partitioned frames to be received before sending  
13483 a multiple acknowledge command. The proper setting of this attribute guarantee the reduction of  
13484 acknowledge packet to be transmitted over the network. If *NumberOfAckFrame* attribute is set to 0x00, it  
13485 indicates a non-ACK transmission. In this case, the sender would ignore the sender timeout and send the  
13486 blocks continuously with *InterframeDelay* interval between each partitioned frame. In this case the receiver  
13487 shall not return the *MultipleACK* after receiving the block, and the *ReceiverTimeout* and *NACKTimeout* at-  
13488 tributes (set to the receiver) shall be also ignored.

13489 **9.6.3.2.1.6 NACKTimeout Attribute**

13490 *NACKTimeout* attribute specifies the maximum time, expressed in milliseconds, the receiver entity should  
 13491 wait after having received the last *NumberOfAckFrame* partitioned frames, before sending a *MultipleACK*  
 13492 command to the sender. The receiver shall transmit immediately if it receives all the partitioned frames cor-  
 13493 rectly.

13494 **9.6.3.2.1.7 InterFrameDelay Attribute**

13495 The *InterFrameDelay* attribute specifies the delay in milliseconds between successive transmissions of  
 13496 *TransferPartitionedFrame* commands. Default value for this attributes is given by the *apsInterFrameDelay*.  
 13497 0x00 is not a valid value for this attribute. If the device doesn't support APS fragmentation but supports the  
 13498 Partition Cluster, this value shall be set to 10ms.

13499 **9.6.3.2.1.8 NumberOfSendRetries Attribute**

13500 The *NumberOfSendRetries* specifies the maximum number of retries the sender should perform in case no  
 13501 *MultipleACK* have been received in *SenderTimeout* time period. This attribute should be reset to the default  
 13502 value when a *MultipleACK* command is received.

13503 **9.6.3.2.1.9 SenderTimeout Attribute**

13504 The *SenderTimeout* attribute specifies is the time that the sender should wait for the *MultipleACK* before  
 13505 sending a number of *NumberOfACKFrame* of *TransferPartitionedFrame* commands again. This attribute  
 13506 should be reset to the default value when a *MultipleACK* command is received and started with the first block  
 13507 sent to the receiver.

13508 **9.6.3.2.1.10 ReceiverTimeout Attribute**

13509 The *ReceiverTimeout* attribute specifies the maximum time the receiver need to wait for a *TransferParti-*  
 13510 *tionedFrame* command after the reception the first frame of the large frame to be transferred. If there will be  
 13511 no frames received after *ReceiverTimeout*, the receiver will exit the Partition procedure.

13512 **9.6.3.3 Commands Received**

13513 The received command IDs for the Partition cluster are listed in Table 9-30.

13514 **Table 9-30. Server Received Command IDs for the Partition Cluster**

Command Identifier Field Value	Description	M/O
0x00	TransferPartitionedFrame	M
0x01	ReadHandshakeParam	M
0x02	WriteHandshakeParam	M

13515 **9.6.3.3.1 TransferPartitionedFrame Command**

13516 The *TransferPartitionedFrame* command is used to send a partitioned frame to another Partition cluster. It  
 13517 shall be originated by the sender device and sent to the recipient device which is expected to answer with a  
 13518 *MultipleACK* (as defined in 9.6.3.4.1). When the sender composes and sends to the receiver the first *Trans-*  
 13519 *ferPartitionedFrame* command, a timer on the sender is started; this timer shall be used to check if the sender  
 13520 received a *MultipleACK* before *SenderTimeout* time period. The sender may wait for a *MultipleACK* after  
 13521 every *NumberOfACKFrame* blocks transmission. In that case the value *NumberOfACKFrame* should be set  
 13522 in a handshake phase. The sender will consider a successful transmission of a *NumberOfACKFrame* number  
 13523 of blocks if no *NACKIds* are carried by the *MultipleACK* command payload.

13524 The *TransferPartitionedFrame* command shall be formatted as illustrated in Figure 9-8.

13525

**Figure 9-8. Format of the *TransferPartitionedFrame* Command**

octets	1	1-2	Variable
Data Types	map8	uint8 or uint16	octstr
Field Name	<i>Fragmentation Options</i>	<i>PartitionIndicator</i>	<i>PartitionedFrame</i>

13526 The *Fragmentation Options* field shall be formatted as in Figure 9-9.

13527

**Figure 9-9. Format of the *FragmentationOptions* Field**

b0: 1 bit	b1: 1 bit	b2-b7: 6 bit
<i>First block</i>	<i>Indicator length</i>	Reserved

13528 *First Block* field  $b0=1$  indicates that the *TransferPartitionedFrame* command carries the first block of *Num-*  
 13529 *berOfACKFrame* while  $b0=0$  indicates that the *TransferPartitionedFrame* command doesn't carry a first  
 13530 block. *Indicator length* field specifies if the *PartitionIndicator* field is 1 or 2-bytes long:  $b1=0$  indicates that  
 13531 the *PartitionIndicator* is 1-byte long,  $b1 = 1$  indicates that the *PartitionIndicator* is 2-bytes long.

13532 *PartitionIndicator* field specifies the overall number of blocks for the 1st partitioned frame (fragment), and  
 13533 the block index for the other fragments starting from 0x01 or 0x0001 (respectively for  $b1=0$  or  $b1 = 1$ ).

13534 The address mechanism used for the *TransferPartitionedFrame* command should not use broadcasting and  
 13535 it should not use multicasting.

#### 13536 **9.6.3.3.1 Effect on Receipt**

13537 The receiver will start receiving *TransferPartitionedFrame* commands and start the *NACKTimeout* and *Re-*  
 13538 *ceiverTimeout* timers after the reception of the first frame related to the transaction registered by the hand-  
 13539 shake phase (*WriteHandshakeParam* command); if *NumberOfACKFrames* have been received, the Partition  
 13540 Cluster of the receiver will send a *MultipleACK* command with no *NACKId*. The block indexes of expected  
 13541 *TransferPartitionedFrame* commands that have not been received in *NACKTimeout* (*NACKIds*) will be in-  
 13542 serted in the *MultipleACK* command returned to the sender. If there are no frames received after *Receiver-*  
 13543 *Timeout*, the receiver will exit the partition procedure. In case the receiver receives a number equal to *Num-*  
 13544 *berOfACKFrame* partitioned frames it shall send the *MultipleACK* command without waiting for a *NACK-*  
 13545 *Timeout* time. The receiver will also reset the *ReceiverTimeout* timer after reception of a *TransferParti-*  
 13546 *tionedFrame* command.

#### 13547 **9.6.3.3.2 ReadHandshakeParam Command**

13548 The *ReadHandshakeParam* command is used in order to read the appropriate set of parameters for each  
 13549 transaction to be performed by the Partition Cluster. The *ReadHandshakeParam* Frame shall be formatted as  
 13550 shown below. The *Partitioned ClusterID* field identifies the specific cluster referred to the large frame that  
 13551 is going to be partitioned by the Partition Cluster itself. The transaction number of the specific frame to be  
 13552 partitioned shall be carried directly in the ZCL header.

13553

Figure 9-10. *ReadHandshakeParam* Frame

<b>Octets</b>	2	2	...	2
<b>Data Types</b>	ClusterID	AttributeID	...	AttributeID
<b>Field Name</b>	Partitioned ClusterID	Attribute identifier 1	...	Attribute identifier <i>n</i>

13554

### 9.6.3.3.3 WriteHandshakeParam Command

13555  
 13556  
 13557  
 13558  
 13559  
 13560  
 13561

The *WriteHandshakeParam* command is used during the handshake phase in order to write the appropriate parameters for each transaction to be performed by the Partition Cluster. The *WriteHandshakeParam* Frame shall be formatted as shown below. The *Partitioned ClusterID* field identifies the specific cluster referred to the frames that is going to be partitioned by the Partition Cluster itself. The transaction number of the specific frame to be partitioned shall be carried in the ZCL header. See 2.4.3 for write attribute record format. By using the *WriteHandshakeParam* command report it is possible to write Partition Cluster attributes related to the specific large frame to be transferred using partitioning.

13562

Figure 9-11. *WriteHandshakeParam* Frame

<b>Octets</b>	2	2	...	2
<b>Data Types</b>	ClusterID	See 2.4.3	...	See 2.4.3
<b>Field Name</b>	Partitioned ClusterID	Write Attribute Record 1		Write Attribute Record <i>n</i>

13563

The Write Attribute Record Field shall be formatted as shown below.

13564

Figure 9-12. Format of Write Attribute Record Field

<b>octets: 2</b>	<b>1</b>	<b>Variable</b>
Attribute Identifier	Attribute Data Type	Attribute Data

13565

### 9.6.3.4 Commands Generated

13566

The generated command IDs for the server Partition cluster are listed in Table 9-31.

13567

Table 9-31. Generated Command IDs for the Partition Cluster

Command Identifier Field Value	Description	M/O
0x00	<i>MultipleACK</i>	M
0x01	<i>ReadHandshakeParamResponse</i>	M

13568

#### 9.6.3.4.1 MultipleACK Command

13569  
 13570  
 13571  
 13572  
 13573

The receiver shall return the *MultipleACK* command when receiving a number equal to *NumberOfACKFrame TransferPartitionedFrame* commands (partitioned frames) or when *NACKTimeout* expires. The *MultipleACK* command will carry no *NACKId* in the payload if *NumberOfACKFrame TransferPartitionedFrame* commands are received. The sender may wait for a *MultipleACK* command after every *NumberOfACKFrame* blocks transmission. The *MultipleACK* command shall be formatted as illustrated in Figure 9-13.

13574

**Figure 9-13. Format of the *MultipleACK* Command**

<b>Octets</b>	1	1-2	1-2	1-2	1-2
<b>Data Types</b>	map8	uint8 or uint16	uint8 or uint16		uint8 or uint16
<b>Field Name</b>	<i>ACK Options</i>	<i>FirstFrameID</i>	<i>NACKId</i>	...	<i>NACKId</i>

13575

13576 The *ACKOptions* payload fields shall be formatted as illustrated in Figure 9-14.

13577

**Figure 9-14. Format of the *ACK Options* Field**

<b>b0: 1 bit</b>	<b>b1-b7: 7 bit</b>
<i>NACKId length</i>	Reserved

13578 *NACKId length* specifies if the *NACKId*, corresponding to the *PartitionIndicator* (*NACKIds* carried in this  
13579 command are the values of the "PartitionIndicator" field), and the *FirstFrameID* are 1 or 2 bytes long: *b0=0*  
13580 indicates that the *NACKIds* and the *FirstFrameID*, are 1-byte long, *b0 = 1* indicates that the *NACKIds* and  
13581 the *FirstFrameID*, are 2-bytes long.

13582 *FirstFrameID* field indicates the first partition frame (block) index of the current overall *NumberOfACK-*  
13583 *Frame* blocks the *MultipleACK* refers to. It is used in order to identify the set of *NumberOfACKFrame* the  
13584 *MultipleACK* command refers to.

13585 *NACKId* fields represent the ID of partitioned frame that have not been received yet after *NACKTimeout*.

#### 13586 **9.6.3.4.1.1 Effect on Receipt**

13587 After sending a number of *TransferPartitionedFrame* commands equal to *NumberOfACKFrame* (Number of  
13588 acknowledged frames) the sender will wait for a *MultipleACK*: a successful transmission is indicated by a  
13589 *MultipleACK* command with no *NACKId* fields carried. The sender shall stop sending the next *Number-*  
13590 *OfACKFrame* blocks until it receives a *MultipleACK* command reporting a successful transmission.

13591 When the sender successfully sends the current *NumberOfACKFrame* blocks and receives a *MultipleACK*  
13592 command with no *NACKId* fields, the Partition Cluster should proceed to send the next *NumberOfACKFrame*  
13593 set of blocks of the, large frame to be transmitted, until all the set of blocks have been sent out. The partition  
13594 parameters such as *NumberOfACKFrame* may be tuned after sending out the current *NumberOfACKFrame*,  
13595 set of blocks (e.g., the value of *NumberOfACKFrame* may be decreased after retransmissions of many *Trans-*  
13596 *ferPartitionedFrame* commands of a previous transaction).

13597 In case the receiver does need to send out several *MultipleACKs* to the sender, it should not send out a next  
13598 one until completing the reception of all blocks indicated in the *NACKId* fields of the previous *MultipleACK*.  
13599 The sender should receive *MultipleACK* command by sender timeout (this timeout specifies how long to wait  
13600 for a *MultipleACK*); if no *MultipleACK* command is received the sender will retransmit the *TransferParti-*  
13601 *tionedFrame* commands up to a maximum number of retries (in order to optimize the protocol the sender  
13602 may reduce also the *NumberOfACKFrame* value by using the writing command defined in the handshake  
13603 phase); if the sender doesn't receive any *MultipleACK* after maximum number of retries it will exit the par-  
13604 tition procedure and the *TransferFrameUsingPartitionCluster* response will notify the error in the partition  
13605 procedure; otherwise, if *MultipleACK* is received carrying some *NACK IDs*, the sender will reset the sender  
13606 timeout and the max number of retries and resend the no acknowledged *TransferPartitionedFrame* com-  
13607 mands up to max number of retries until a *MultipleACK* with no *NACK* is received (success in the partition  
13608 transaction) or the *SenderTimeout* expires (in case no *MultipleACK* commands are received) or max number  
13609 of retries reached (in case *MultipleACK* commands are received but still with *NACKIds*).

13610 The *SenderTimeout* is equal to  $2 * apcAckWaitDuration + InterframeDelay * NumberOfACKFrames$ .

13611 **9.6.3.4.2 ReadHandshakeParamResponse Command**

13612 The *ReadHandshakeParamResponse* command is used in order to response to the corresponding *ReadHand-*  
 13613 *shakeParam* command in order to communicate the appropriate set of parameters configured for each trans-  
 13614 action to be performed by the Partition Cluster. The *ReadHandshakeParamResponse* Frame shall be format-  
 13615 ted as shown below. The *Partitioned ClusterID* field identifies the specific cluster referred to the large frame  
 13616 that is going to be partitioned by the Partition Cluster itself. The transaction number of the specific frame to  
 13617 be partitioned shall be carried directly in the ZCL header. The Read Attribute status record field is the same  
 13618 as defined for the ZCL (see 2.4.2.1 ).

13619 **Figure 9-15. ReadHandshakeParamResponse Frame**

<b>octets</b>	2	Variable	...	Variable
<b>Data Types</b>	ClusterID	See 2.4.2.1	...	See 2.4.2.1
<b>Field Name</b>	Partitioned ClusterID	Read attribute sta- tus record 1	...	Read attribute status record <i>n</i>

13620 The Read Attribute Status Record Field shall be formatted as shown below.

13621 **Figure 9-16. Format of Read Attribute Status Record Field**

<b>octets: 2</b>	2	0/1	0/Variable
Attribute Identifier	Status	Attribute Data Type	Attribute Data

13622 **9.6.4 Client**

13623 **9.6.4.1 Attributes**

13624 None

13625 **9.6.4.2 Command Received**

13626 The client receives the cluster specific commands detailed in 9.6.3.4, as required by application profiles.

13627 **9.6.4.3 Command Generated**

13628 The client generates the cluster specific commands detailed in 9.6.3.3 as required by application profiles.

13629 **9.6.5 General Use of Partition Cluster**

13630 The Partition cluster may be used by multiple clusters defined in a single application object. In order to  
 13631 perform the recognition of multiple partitioned frames associated to a specific cluster and reconstruct a par-  
 13632 titioned large frame the Partition cluster shall maintain an internal table similar to the one presented in Table  
 13633 9-32: Each large frame to be partitioned can be identified by the ClusterID and the ZCL transaction sequence  
 13634 number.

13635 The specific clusters using the Partition cluster to transfer large frame shall subscribe to the registration table  
 13636 writing an entry for each frame to be partitioned with the Partition Cluster attributes fields specified in 9.6.3.2.  
 13637 This entry shall be cancelled by the Partition Cluster when the frame is correctly transferred or the partition-  
 13638 ing procedure exited with errors. The entries of this table should be inserted during the handshake phase, i.e.,  
 13639 in the sender when the *WriteHandshakeParam* command is generated and in the receiver when the  
 13640 *WriteHandshakeParam* command is received.

13641 The partitioned frames generated from the partitioning of a large frame shall use the ZCL transaction se-  
 13642 quence number inserted in the ZCL header of the large frame for each small partitioned frame (transferred  
 13643 using the *TransferPartitionedFrame* commands) in order to identify the proper fragment if multiple partitions  
 13644 are running on the same endpoint with large frames carrying the same ClusterIDs.

13645 **Table 9-32. Registration Table of Clusters Using the Partition Cluster**

ClusterID	Transaction sequence number	Partition Cluster attributes
Registered cluster ID	Transaction sequence number (of the packet to be partitioned) through the Partition cluster	Attributes that are written using the <i>WriteHandshakeParam</i> command

13646  
13647

**Figure 9-17. Example of Partition Cluster Use**

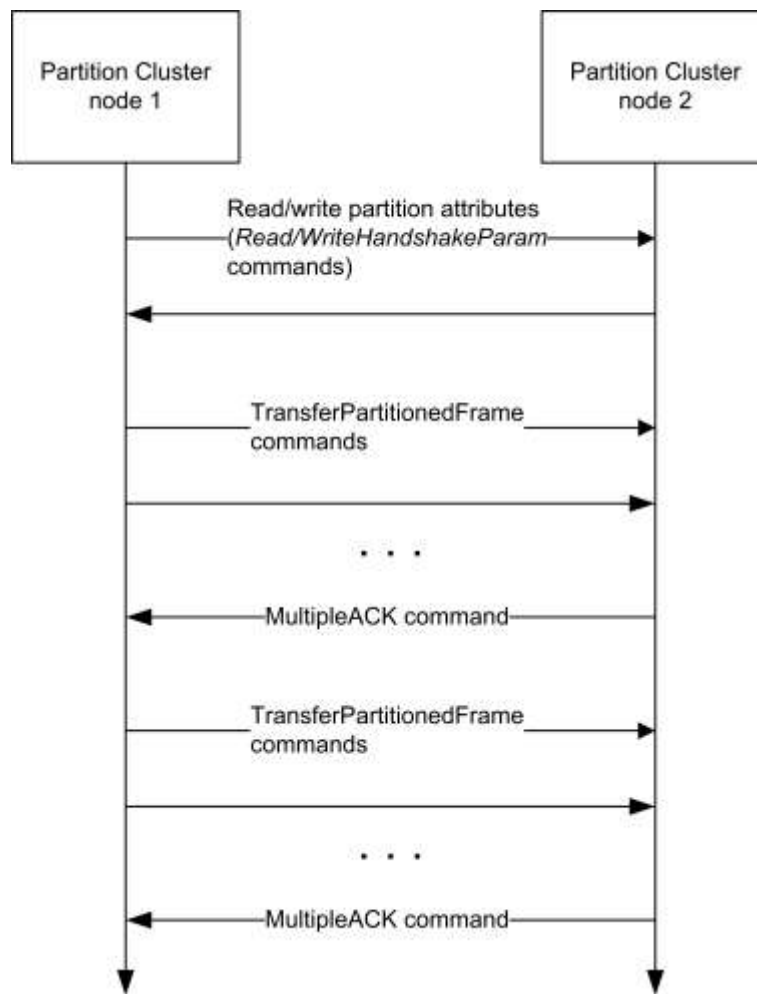

13648  
13649



## 13650 9.7 11073 Protocol Tunnel

### 13651 9.7.1 Overview

13652 Please see Chapter 2 for a general cluster overview defining cluster architecture, revision, classification,  
 13653 identification, etc.

13654 The 11073 Protocol Tunnel cluster provides the commands and attributes required to tunnel the 11073 pro-  
 13655 tocol. The server cluster receives 11073 APDUs and the client cluster generates 11073 APDUs, thus it is  
 13656 necessary to have both server and client on an endpoint to tunnel 11073 messages in both directions.

13657 Commands and attributes are provided for establishing, querying the status of, and removing an 11073 tunnel  
 13658 connection between two devices.

13659 Devices that support this cluster shall also comply with the ISO/IEEE 11073-20601 standard for Personal  
 13660 Health Device Communication [H1] and the applicable ISO/IEEE 11073 device specialization documents  
 13661 [H2] – [H12].

13662 Typical usage of the 11073 Protocol Tunnel cluster is illustrated in Figure 9-18.

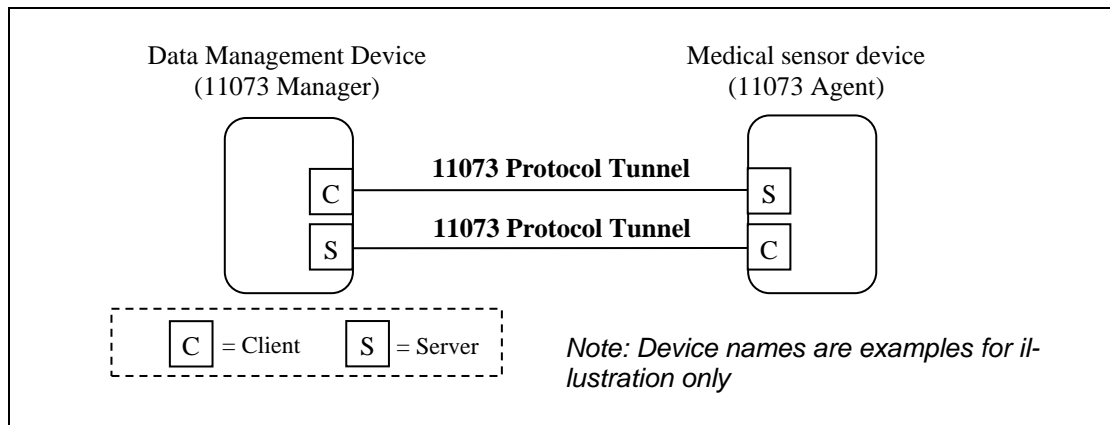

13663 **Figure 9-18 Typical Usage of the 11073 Protocol Tunnel cluster**

13664 Note that all 11073 protocol tunnel cluster specific commands are generated by the client and received by  
 13665 the server. A typical sequence of events to initiate an 11073 interaction might be:

- 13666 - DMD transmits Connect Request command to sensor (client→server)
- 13667 - Sensor responds with a Connect Status Notification command with status CONNECTED (cli-  
 13668 ent→server)
- 13669 - Sensor and DMD carry out an 11073 layer interaction by exchanging Transfer APDU commands in each  
 13670 direction (client→server in each case)

#### 13671 9.7.1.1 Revision History

13672 The global *ClusterRevision* attribute value SHALL be the highest revision number in the table below.

Rev	Description
1	mandatory global <i>ClusterRevision</i> attribute added

13673 **9.7.1.2 Classification**

Hierarchy	Role	PICS Code	Primary Transaction
Base	Application	T11073	Type 1 (client to server)

13674 **9.7.1.3 Cluster Identifiers**

Identifier	Name
0x0614	11073 Protocol Tunnel

13675 **9.7.2 Server**

13676 **9.7.2.1 Dependencies**

13677 Any endpoint that supports the 11073 Protocol Tunnel server cluster shall also support the Generic Tunnel  
13678 server cluster (see 9.2).

13679 The value of the *ProtocolAddress* attribute of the associated Generic Tunnel server cluster shall be set equal  
13680 to the system ID of the 11073 device represented on that endpoint (see [H1]). The system ID, represented as  
13681 a octet string, shall be 8 octets in Big Endian order.

13682 The value of the *MaximumIncomingTransferSize* attribute and the value of the *MaximumOutgoingTransfer-*  
13683 *Size* attribute of the associated Generic Tunnel server cluster shall be set equal to or greater than the maximum  
13684 APDU size specified in the applicable ISO/IEEE 11073 device specialization document ([H2] – [H12]).

13685 **9.7.2.2 Attributes**

13686 The 11073 Protocol Tunnel server cluster contains the attributes shown in Table 9-33:

13687 **Table 9-33 – Attributes of the 11073 Protocol Tunnel server cluster**

ID	Name	Type	Range	Acc	Default	M/O
0x0000	<i>DeviceIDList</i>	array of uint16	Any valid	R	0xffff	O
0x0001	<i>ManagerTarget</i>	IEEE address	Any valid IEEE address	R	-	O
0x0002	<i>ManagerEndpoint</i>	uint8	0x01-0xff	R	-	O
0x0003	<i>Connected</i>	bool	TRUE / FALSE	R	FALSE	O
0x0004	<i>Preemptible</i>	bool	TRUE / FALSE	R	TRUE	O

0x0005	<i>IdleTimeout</i>	uint16	0x0001 – 0xffff	R	0x0000	O
--------	--------------------	--------	-----------------	---	--------	---

13688

13689 Although the *ManagerTarget*, *ManagerEndpoint*, *Connected*, *Preemptible* and *IdleTimeout* attributes are  
 13690 listed above as optional, if any one of them is implemented then all of them shall be implemented, and also  
 13691 reception of the connect and disconnect request commands shall be implemented, and the 11073 Protocol  
 13692 Tunnel client cluster implemented on the same endpoint shall implement transmission of the connect status  
 13693 notification command.

13694 **9.7.2.2.1 DeviceIDList attribute**

13695 The *DeviceIDList* attribute specifies all devices supported behind a single instance of the 11073 tunnel, on a  
 13696 single endpoint. It allows for discovering the functionality of 11073 devices, e.g. prior to establishment of an  
 13697 11073 tunnel. The *DeviceIDList* attribute can be read using generic ZCL commands.

13698 For a multifunction device as defined in [Z6], the *DeviceIDList* attribute is mandatory and shall contain a  
 13699 complete list of supported Device IDs (as defined in [Z6]) supported by the single instance of the *11073*  
 13700 *Protocol Tunnel* on this particular endpoint. The DeviceID contained in the Simple Descriptor of the multi-  
 13701 function sensor shall contain the value corresponding to the multifunction device itself (see [Z6]).

13702 For all other devices types, the *DeviceIDList* attribute is optional. If implemented, it shall contain the single  
 13703 DeviceID allocated to that device (see [Z6]).

13704 **9.7.2.2.2 ManagerTarget attribute**

13705 The *ManagerTarget* attribute specifies the IEEE address of the currently or most recently connected Data  
 13706 Management device.

13707 **9.7.2.2.3 ManagerEndpoint attribute**

13708 The *ManagerEndpoint* attribute specifies the endpoint used by the currently or most recently connected Data  
 13709 Management device.

13710 **9.7.2.2.4 Connected attribute**

13711 The *Connected* attribute specifies whether or not the 11073 tunnel on this endpoint is currently connected.

13712 If this attribute takes the value TRUE, then the tunnel is currently connected.

13713 If this attribute takes the value FALSE, then the tunnel is not currently connected.

13714 Whenever the value of this attribute changes the 11073 layer shall be informed via the transport connected  
 13715 and transport disconnected indications.

13716 **9.7.2.2.5 Preemptible attribute**

13717 The *Preemptible* attribute specifies whether or not the current connection can be disconnected by a Data  
 13718 Management device other than by the one currently connected.

13719 If this attribute takes the value TRUE, then a disconnect request from a device other than the Data Manage-  
 13720 ment device indicated by the *ManagerTarget* attribute shall be accepted and if the 11073 tunnel on this end-  
 13721 point is currently connected then it shall become disconnected, and a connect status notification command  
 13722 with status DISCONNECTED shall be sent to the currently connected Data Management device.

13723 If this attribute takes the value FALSE, then a disconnect request from a device other than the Data Manage-  
13724 ment device indicated by the *ManagerTarget* attribute shall be rejected and a connect status notification  
13725 command with status NOT\_AUTHORIZED sent to the requester.

#### 13726 9.7.2.2.6 Idle timeout attribute

13727 The *Idle Timeout* attribute specifies the inactivity time in minutes which the Data Management device will  
13728 wait without transmitting or receiving any tunneled frames to or from the connected target, before it discon-  
13729 nects the connection.

13730 If the Data Management device does not intend to timeout this connection after a specific idle period then  
13731 this attribute shall take the value 0xffff.

13732 If the indicated timeout period passes with no data on the 11073 tunnel, then the agent device shall set its  
13733 *Connected* attribute to FALSE and a connect status notification command with status DISCONNECTED  
13734 shall be sent to the currently connected Data Management device. In order to continue to use the tunnel, the  
13735 agent device shall send the Data Management device a further connect status notification command with  
13736 status RECONNECT\_REQUEST, and wait for the Data Management device to respond.

### 13737 9.7.2.3 Commands Received

13738 The cluster specific commands received by the 11073 Protocol Tunnel server cluster are listed in Table 9-34:  
13739

13740 **Table 9-34 – Command IDs for the 11073 protocol tunnel cluster**

Command identifier field value	Description	Mandatory/Optional
0x00	Transfer APDU	M
0x01	Connect request	O
0x02	Disconnect request	O
0x03	Connect status notification	O

13741  
13742 Although the connect request and disconnect commands are listed above as optional, if reception of either of  
13743 them is implemented then reception of both of them shall be implemented, and also the *ManagerTarget*,  
13744 *ManagerEndpoint*, *Connected*, *Preemptible* and *IdleTimeout* attributes shall be implemented, and the 11073  
13745 Protocol Tunnel client cluster implemented on the same endpoint shall implement transmission of the connect  
13746 status notification command.

13747 Although reception of the connect status notification command is listed above as optional, if reception of this  
13748 command is implemented then also the connect request command shall be implemented by the 11073 Proto-  
13749 col Tunnel server on the same endpoint.

#### 13750 9.7.2.3.1 Transfer APDU Command

13751 The Transfer APDU command payload shall be formatted as illustrated in Figure 9-19:

<b>Bits</b>	Variable
<b>Data Type</b>	long octet string
<b>Field Name</b>	APDU

13752 **Figure 9-19 – Transfer APDU payload**

13753 The APDU field is of variable length and is a 11073 APDU as defined in the ISO/IEEE 11073 standard  
 13754 [H1].

13755 **9.7.2.3.1.1 When generated**

13756 This command is generated when an 11073 network layer wishes to transfer an 11073 APDU across a tunnel  
 13757 to another 11073 network layer.

13758 The most stringent reliability characteristic of a given transport technology is “Best” reliability. Note - For  
 13759 ZigBee, this corresponds to use of APS-ACKs.

13760 The least stringent reliability characteristic of a given transport technology is “Good” reliability. Note - For  
 13761 ZigBee, this corresponds to no use of APS-ACKs.

13762 The application is responsible for transmitting at a reliability level appropriate for each frame.

13763 This command shall always be transmitted with the disable default response bit in the ZCL frame control  
 13764 field set to 1.

13765 **9.7.2.3.1.2 Effect on Receipt**

13766 On receipt of this command, a device shall process the 11073 APDU as specified in [H1] and the applicable  
 13767 device specialization [H2] to [H12]

13768 **9.7.2.3.2 Connect Request Command**

13769 The Connect Request command payload shall be formatted as illustrated below:

<b>Octets</b>	1	2	8	1
<b>Data Type</b>	map8	uint16	IEEE address	uint8
<b>Field Name</b>	Connect control	Idle timeout	Manager target	Manager end-point

13770 **Figure 9-20 – Connect Request command payload**

13771 **9.7.2.3.2.1 Connect control**

13772 The *connect control* field shall be formatted as illustrated below:

<b>Bit</b>	0	1-7
<b>Field Name</b>	Preemptible	Reserved

13773 **Figure 9-21 – Connect control field format**

13774 The *Preemptible* bit shall indicate whether or not this connection can be removed by a different Data Man-  
 13775 agement device.

13776 **9.7.2.3.2.2 Idle timeout**

13777 The *idle timeout* field shall indicate the inactivity time in minutes which the Data Management device will  
 13778 wait without receiving any tunneled frames from the connected target, before it disconnects the connection.

13779 **9.7.2.3.2.3 Manager target**

13780 The *Manager target* field shall indicate the IEEE address of the Data Management device transmitting this  
13781 frame.

#### 13782 **9.7.2.3.2.4 Manager endpoint**

13783 The *Manager endpoint* field shall indicate the source endpoint from which the Data Management device is  
13784 transmitting this frame.

#### 13785 **9.7.2.3.2.5 When generated**

13786 This command is generated when a Data Management device wishes to connect to an 11073 agent device.

13787 This may be in response to receiving a connect status notification command from that agent device with the  
13788 connect status field set to RECONNECT\_REQUEST.

#### 13789 **9.7.2.3.2.6 Effect on Receipt**

13790 On receipt of this command, a device shall first check if it is already connected by examining its *Connected*  
13791 attribute.

13792 If the tunnel is already connected then the device shall generate a connect status notification command with  
13793 status set to ALREADY\_CONNECTED and transmit it to the sender of this connect request frame. No  
13794 other attributes shall be affected, and no further processing shall be carried out.

13795 If the tunnel is not currently connected then the device shall copy the preemptible bit of connect control field  
13796 into the preemptible attribute, the idle timeout value into the idle timeout attribute, the manager target value  
13797 into the *ManagerTarget* attribute and the manager endpoint value into the *ManagerEndpoint* attribute.

13798 It shall set the connected attribute to TRUE, and generate a connect status notification command with status  
13799 set to CONNECTED and transmit it to the sender of this connect request frame.

13800 Finally, if the idle timeout field is set to a value other than 0xffff, the device shall set a timer for the timeout  
13801 time indicated. This timer shall be restarted at any time that data is transmitted or received over the tunnel.  
13802 If the timer expires then the device shall set the *Connected* attribute to FALSE and a connect status notifica-  
13803 tion command with status DISCONNECTED shall be sent to the currently connected Data Management  
13804 device. In order to continue to use the tunnel, the agent device shall send the Data Management device a  
13805 further connect status notification command with status RECONNECT\_REQUEST, and wait for the Data  
13806 Management device to respond.

### 13807 **9.7.2.3.3 Disconnect Request Command**

13808 The Disconnect Request command payload shall be formatted as illustrated in Figure 9-22.

<b>Octets</b>	8
<b>Data Type</b>	IEEE address
<b>Field Name</b>	Manager IEEE address

13809 **Figure 9-22 – Disconnect Request command payload**

#### 13810 **9.7.2.3.3.1 Manager IEEE address**

13811 The *Manager IEEE address* field shall indicate the IEEE address of the Data Management device transmit-  
13812 ting this frame.

#### 13813 **9.7.2.3.3.2 When generated**

13814 This command is generated when a Data Management device wishes to disconnect a tunnel connection ex-  
13815 isting on an agent device.

#### 13816 **9.7.2.3.3.3 Effect on Receipt**

13817 On receipt of this command, a device shall first check if it is already connected by examining its *Connected*  
13818 attribute.

13819 If it is not currently connected then the device shall generate a connect status notification command with  
 13820 status set to DISCONNECTED and transmit it to the sender of this disconnect request frame. No other  
 13821 attributes shall be affected, and no further processing shall be carried out.

13822 If it is currently connected then the device shall check whether the requesting device is authorized to remove  
 13823 this connection. A device is authorized to remove the connection if the value of the manager IEEE address  
 13824 field is the same as the value in the *ManagerTarget* attribute or if the *Preemptible* attribute is set to TRUE.

13825 If the requester is not authorized then the device shall generate a connect status notification command with  
 13826 status set to NOT\_AUTHORIZED and transmit it to the sender of this disconnect request frame. No other  
 13827 attributes shall be affected, and no further processing shall be carried out.

13828 If the requester is authorized then the device shall initiate disconnection. A short period of time is permitted  
 13829 in order to allow the higher layer to finalize its activities, but within 12 seconds the device shall generate a  
 13830 connect status notification command with status set to DISCONNECTED and transmit it to the target indi-  
 13831 cated in the *ManagerTarget* attribute. The *Connected* attribute shall be set to FALSE and the tunnel shall  
 13832 be disconnected. The device shall now generate a further connect status notification command with status  
 13833 set to DISCONNECTED and transmit it to the sender of this disconnect request frame.

13834 **9.7.2.3.4 Connect Status Notification Command**

13835 The Connect Status Notification command payload shall be formatted as illustrated in Figure 9-23.

<b>Octets</b>	1
<b>Data Type</b>	enum8
<b>Field Name</b>	Connect status

13836 **Figure 9-23 – Connect Status Notification command payload**

13837 **9.7.2.3.4.1 Connect Status**

13838 The *connect status* field shall be set to one of the values in Table 9-35:

13839 **Table 9-35 – Connect status values**

Value	Designation	Description
0x00	DISCONNECTED	Indicates that this agent device has been disconnected from the tunnel.
0x01	CONNECTED	Indicates that this agent device has been connected to the tunnel.
0x02	NOT_AUTHORIZED	Indicates that a request to disconnect the tunnel is not authorized from this requester at this time.
0x03	RECONNECT_REQUEST	Indicates that the agent device wishes the Data Management device to reconnect the tunnel.
0x04	ALREADY_CONNECTED	Indicates that the request to connect this tunnel has failed as the agent device is already connected.

13840 **9.7.2.3.4.2 When generated**

13841 This command is generated by an agent device in response to a connect request command, disconnect com-  
 13842 mand, or in response to some other event that causes the tunnel to become connected or disconnected.

13843 It is also sent by the agent device to request the Data Management device to reconnect a tunnel.

13844 **9.7.2.3.4.3 Effect on Receipt**

13845 On receipt of this command, a device shall be informed of the new status of the tunnel connection or of its  
13846 attempt to modify the status of the connection.

13847 If the connect status field takes the value RECONNECT\_REQUEST then, depending on available resources  
13848 being available, the Data Management device should attempt to reconnect the tunnel by generating a connect  
13849 request command and transmitting it to the agent device sending this connect status notification command.

13850 **9.7.2.4 Commands Generated**

13851 No cluster specific commands are generated by the server cluster.

13852 **9.7.3 Client**

13853 **9.7.3.1 Dependencies**

13854 Any endpoint that supports the 11073 Protocol Tunnel client cluster shall also support the Generic Tunnel  
13855 client cluster (see 9.2).

13856 **9.7.3.2 Attributes**

13857 The client cluster has no attributes.

13858 **9.7.3.3 Commands Received**

13859 The client does not receive any cluster specific commands.

13860 **9.7.3.4 Commands Generated**

13861 The cluster specific commands generated by the client cluster are listed in 9.7.2.3.

13862 In order to reduce the burden on implementations, some commands and attributes are conditionally mandated,  
13863 as follows:

- 13864 • Transmission of the transfer APDU command is mandatory.
- 13865 • Transmission of the connect request and disconnect request commands is optional unless specified  
13866 otherwise.
- 13867 • If the 11073 Protocol Tunnel server cluster implemented on the same endpoint implements any of  
13868 the *ManagerTarget*, *ManagerEndpoint*, *Connected*, *Preemptible* and *IdleTimeout* attributes, or im-  
13869 plements reception of the connect request or disconnect request commands, then transmission of  
13870 the connect status notification command is mandatory.
- 13871 • Transmission of non-cluster specific commands to manipulate attributes is optional unless speci-  
13872 fied otherwise.



13873

# CHAPTER 10 SMART ENERGY

13874  
 13875  
 13876  
 13877

The ZigBee Cluster Library is made of individual chapters such as this one. See Document Control in the ZigBee Cluster Library for a list of all chapters and documents. References between chapters are made using a *X.Y* notation where *X* is the chapter and *Y* is the sub-section within that chapter. References to external documents are contained in Chapter 1 and are made using [*Rn*] notation.

13878

## 10.1 General Description

13879

### 10.1.1 Introduction

13880  
 13881

The clusters specified in this chapter are for use typically in ZigBee Smart Energy applications with associated security controls at the application layer. These clusters may be used in any application domain.

13882

### 10.1.2 Cluster List

13883  
 13884  
 13885

This section lists the clusters specified in this chapter and gives examples of typical usage for the purpose of clarification. The clusters specified in this chapter are listed in Table 10-1.

**Table 10-1. Smart Energy Clusters**

Cluster ID	Cluster Name	Description
0x0700	Price	Commands and attributes for reporting price
0x0701	Demand Response and Load Control	Commands and attributes for providing demand response and load control of devices
0x0702	Metering	Commands and attributes for reporting metering data
0x0703	Messaging	Commands and attributes for sending messages to devices
0x0704	Tunneling	Commands and attributes for establishing and using a tunnel between two devices
0x0705	Prepayment	Commands and attributes for reporting and controlling Prepayment
0x0707	Calendar	Commands and attributes for controlling calendar information
0x0708	Device Management	Commands and attributes allowing management of Smart Energy devices within a network
0x0709	Events	Commands allowing the passing of event information between devices
0x070B	Sub-GHz	Commands and attributes specific to the use of Sub-GHz frequencies and operation
0x0800	Key Establishment	Commands and attributes for application level security establishment
0x0b01	Meter Identification	Attributes and commands that provide an interface to meter identification

13886 **10.2 Price**

13887 **10.2.1 Overview**

13888 Please see Chapter 2 for a general cluster overview defining cluster architecture, revision, classification,  
13889 identification, etc.

13890 The Price Cluster provides the mechanism for communicating Gas, Energy, or Water pricing information  
13891 within the premises. This pricing information is distributed to the ESI from either the utilities or from regional  
13892 energy providers. The ESI conveys the information (via the Price Cluster mechanisms) to Smart Energy de-  
13893 vices.

13894 **Figure 10-1. Price Cluster Client Server Example**

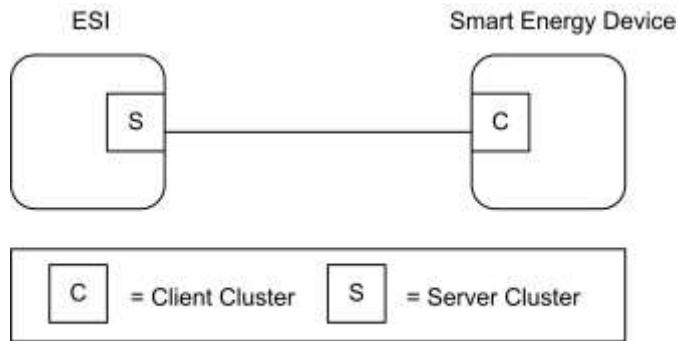

*Note: Device names are examples for illustration purposes only*

13895  
13896 Please note the ESI is defined as the Server due to its role in acting as the proxy for upstream price management  
13897 systems and subsequent data stores.

13898 **10.2.1.1 Revision History**

13899 The global *ClusterRevision* attribute value SHALL be the highest revision number in the table below.

Rev	Description
1	mandatory global <i>ClusterRevision</i> attribute added
2	Updated from SE1.4 version; CCB 1447 2964 2965

13900 **10.2.1.2 Classification**

Hierarchy	Role	PICS Code	Primary Transaction
Base	Application	SEPR	Type 1 (client to server)

13901 **10.2.1.3 Cluster Identifiers**

Identifier	Name
0x0700	Price

13902 **10.2.2 Server**

13903 **10.2.2.1 Dependencies**

- 13904       • Events carried using this cluster include a timestamp with the assumption that target devices main-  
 13905       tain a real time clock. Devices can acquire and synchronize their internal clocks via the Time clus-  
 13906       ter server.
- 13907       • If a device does not support a real time clock it is assumed that the device will interpret and utilize  
 13908       the “Start Now” value within the Time field.

13909 **10.2.2.2 Attributes**

13910 For convenience, the attributes defined in this cluster are arranged into sets of related attributes; each set  
 13911 can contain up to 256 attributes. Attribute identifiers are encoded such that the most significant octet spec-  
 13912 ifies the attribute set and the least significant octet specifies the attribute within the set. The currently defined  
 13913 attribute sets are listed in Table 3-142. The Price Cluster is broken down in to Delivered attribute sets 0x00  
 13914 to 0x7F and Received attribute sets 0x80 to 0xFF.

13915

**Table 10-2. Price Cluster Attribute Sets**

Attribute Set Identifier	Description
0x00	Tier Label (Delivered)
0x01	Block Threshold (Delivered)
0x02	Block Period (Delivered)
0x03	Commodity
0x04	Block Price Information (Delivered)
0x05	Extended Price Information (Delivered)
0x06	Tariff Information Set (Delivered)
0x07	Billing Information Set (Delivered)
0x08	Credit Payment Attribute Set
0x80	Received Tier Label
0x81	Received Block Threshold
0x82	Received Block Period
0x83	Reserved
0x84	Received Block Price Information
0x85	Received Extended Price Information
0x86	Received Tariff Information Set
0x87	Received Billing Information Set

13916

13917 **10.2.2.2.1 Tier Label (Delivered) Set**

13918

13919

**Table 10-3. Tier Label Attribute Set**

<b>Id</b>	<b>Name</b>	<b>Type</b>	<b>Length</b>	<b>Access</b>	<b>Default</b>	<b>M</b>
0x0000	<i>Tier1PriceLabel</i>	octstr	1 to 13 Octets	RW	“Tier 1”	O
0x0001	<i>Tier2PriceLabel</i>	octstr	1 to 13 Octets	RW	“Tier 2”	O
0x0002	<i>Tier3PriceLabel</i>	octstr	1 to 13 Octets	RW	“Tier 3”	O
0x0003	<i>Tier4PriceLabel</i>	octstr	1 to 13 Octets	RW	“Tier 4”	O
0x0004	<i>Tier5PriceLabel</i>	octstr	1 to 13 Octets	RW	“Tier 5”	O
0x0005	<i>Tier6PriceLabel</i>	octstr	1 to 13 Octets	RW	“Tier 6”	O
0x0006	<i>Tier7PriceLabel</i>	octstr	1 to 13 Octets	R	“Tier 7”	O
0x0007	<i>Tier8PriceLabel</i>	octstr	1 to 13 Octets	R	“Tier 8”	O
0x0008	<i>Tier9PriceLabel</i>	octstr	1 to 13 Octets	R	“Tier 9”	O
0x0009	<i>Tier10PriceLabel</i>	octstr	1 to 13 Octets	R	“Tier 10”	O
0x000A	<i>Tier11PriceLabel</i>	octstr	1 to 13 Octets	R	“Tier 11”	O
0x000B	<i>Tier12PriceLabel</i>	octstr	1 to 13 Octets	R	“Tier 12”	O
0x000C	<i>Tier13PriceLabel</i>	octstr	1 to 13 Octets	R	“Tier 13”	O
0x000D	<i>Tier14PriceLabel</i>	octstr	1 to 13 Octets	R	“Tier 14”	O
0x000E	<i>Tier15PriceLabel</i>	octstr	1 to 13 Octets	R	“Tier 15”	O
0x000F	<i>Tier16PriceLabel</i>	octstr	1 to 13 Octets	R	“Tier 16”	O
0x0010	<i>Tier17PriceLabel</i>	octstr	1 to 13 Octets	R	“Tier 17”	O
0x001n	<i>TierwxPriceLabel</i>	octstr	1 to 13 Octets	R	“Tier wx”	O
0x002n	<i>TieryzPriceLabel</i>	octstr	1 to 13 Octets	R	“Tier yz”	O
0x002F	<i>Tier48PriceLabel</i>	octstr	1 to 13 Octets	R	“Tier 48”	O

13920 **10.2.2.2.1.1 TierNPriceLabel Attributes**

13921 The TierNPriceLabel attributes provide a method for utilities to assign a label to the Price Tier declared  
 13922 within the Publish Price command. The TierNPriceLabel attributes are an Octet String field capable of storing  
 13923 a 12 character string (the first octet indicates length) encoded in the UTF-8 format. Example Tier Price  
 13924 Labels are “Normal”, “Shoulder”, “Peak”, “Real Time,” and “Critical”. There are 48 Tier Labels.

13925 Although not prohibited, it is likely (and allowed) that a server will reject an attempt to write to these attrib-  
 13926 utes; if rejected, the server shall return a Default Response with a status of either NOT\_AUTHORIZED or  
 13927 READ\_ONLY. A client should make provision for a write attempt to be rejected.

13928

13929 **10.2.2.2.2 Block Threshold (Delivered) Set**

13930 The set of attributes shown in Table 10-4 provides remote access to the Price server Block Thresholds. Block  
13931 Threshold values are crossed when the CurrentBlockPeriodConsumptionDelivered attribute value is greater  
13932 than a BlockNThreshold attribute. The number of block thresholds is indicated by the Number of Block  
13933 Thresholds field in the associated Publish Price command. The number of blocks is one greater than the  
13934 number of thresholds.

13935 **Table 10-4. Block Threshold Attribute Set**

<b>Id</b>	<b>Name</b>	<b>Type</b>	<b>Range</b>	<b>Acc</b>	<b>Def</b>	<b>M</b>
0x0100	<i>Block1Threshold</i>	uint48	0x000000000000 to 0xFFFFFFFFFFFFFFF	R	-	O
0x0101	<i>Block2Threshold</i>	uint48	0x000000000000 to 0xFFFFFFFFFFFFFFF	R	-	O
0x0102	<i>Block3Threshold</i>	uint48	0x000000000000 to 0xFFFFFFFFFFFFFFF	R	-	O
0x0103	<i>Block4Threshold</i>	uint48	0x000000000000 to 0xFFFFFFFFFFFFFFF	R	-	O
0x0104	<i>Block5Threshold</i>	uint48	0x000000000000 to 0xFFFFFFFFFFFFFFF	R	-	O
0x0105	<i>Block6Threshold</i>	uint48	0x000000000000 to 0xFFFFFFFFFFFFFFF	R	-	O
0x0106	<i>Block7Threshold</i>	uint48	0x000000000000 to 0xFFFFFFFFFFFFFFF	R	-	O
0x0107	<i>Block8Threshold</i>	uint48	0x000000000000 to 0xFFFFFFFFFFFFFFF	R	-	O
0x0108	<i>Block9Threshold</i>	uint48	0x000000000000 to 0xFFFFFFFFFFFFFFF	R	-	O
0x0109	<i>Block10Threshold</i>	uint48	0x000000000000 to 0xFFFFFFFFFFFFFFF	R	-	O
0x010A	<i>Block11Threshold</i>	uint48	0x000000000000 to 0xFFFFFFFFFFFFFFF	R	-	O
0x010B	<i>Block12Threshold</i>	uint48	0x000000000000 to 0xFFFFFFFFFFFFFFF	R	-	O
0x010C	<i>Block13Threshold</i>	uint48	0x000000000000 to 0xFFFFFFFFFFFFFFF	R	-	O
0x010D	<i>Block14Threshold</i>	uint48	0x000000000000 to 0xFFFFFFFFFFFFFFF	R	-	O
0x010E	<i>Block15Threshold</i>	uint48	0x000000000000 to 0xFFFFFFFFFFFFFFF	R	-	O
0x010F	<i>BlockThresholdCount</i>	uint8	0x00 to 0xFF	R	-	O
0x0110	<i>Tier1Block1Threshold</i>	uint48	0x000000000000 to 0xFFFFFFFFFFFFFFF	R	-	O
0x0111	<i>Tier1Block2Threshold</i>	uint48	0x000000000000 to 0xFFFFFFFFFFFFFFF	R	-	O
--	--	--	--	--	--	--
0x011E	<i>Tier1Block15Threshold</i>	uint48	0x000000000000 to 0xFFFFFFFFFFFFFFF	R	-	O
0x011F	<i>Tier1BlockThreshold Count</i>	uint8	0x00 to 0xFF	R	-	O
0x0120	<i>Tier2Block1Threshold</i>	uint48	0x000000000000 to 0xFFFFFFFFFFFFFFF	R	-	O
0x0121	<i>Tier2Block2Threshold</i>	uint48	0x000000000000 to 0xFFFFFFFFFFFFFFF	R	-	O
--	--	--	--	--	--	--
0x012E	<i>Tier2Block15Threshold</i>	uint48	0x000000000000 to 0xFFFFFFFFFFFFFFF	R	-	O
0x012F	<i>Tier2BlockThreshold Count</i>	uint8	0x00 to 0xFF	R	-	O
--	--	--	--	--	--	--
--	--	--	--	--	--	--
0x01FE	<i>Tier15Block15Threshold</i>	uint48	0x000000000000 to 0xFFFFFFFFFFFFFFF	R	-	O
0x01FF	<i>Tier15BlockThreshold Count</i>	uint8	0x00 to 0xFF	R	-	O

13936 **10.2.2.2.2.1 BlockNThreshold**

13937 Attributes *Block1Threshold* through *Block15Threshold* represent the block threshold values for a given pe-  
 13938 riod (typically the billing cycle). These values may be updated by the utility on a seasonal or annual basis.  
 13939 The thresholds are established such that crossing the threshold of energy consumption for the present block  
 13940 activates the next higher block, which can affect the energy rate in a positive or negative manner. The values  
 13941 are absolute and always increasing. The values represent the threshold at the end of a block. The Unit of  
 13942 Measure will be based on the fields defined in the *Publish Price* command, the formatting being defined by  
 13943 attributes within the *Block Period* attribute set.

13944 **10.2.2.2.2 BlockThresholdCount Attribute**

13945 Where a single set of thresholds is used, the *BlockThresholdCount* attribute indicates the number of appli-  
 13946 cable *BlockNThresholds*. Where more than one set of thresholds is used, each set will be accompanied by  
 13947 an appropriate *TierNBlockThresholdCount* attribute (see 10.2.2.2.2.4).

13948 **10.2.2.2.3 TierNBlockMThreshold Attributes**

13949 Attributes *Tier1Block1Threshold* through *Tier15Block15Threshold* represent the block threshold values ap-  
 13950 plicable to a specific TOU tier for a given period (typically the billing cycle). These values may be updated  
 13951 by the utility on a seasonal or annual basis. The thresholds are established such that crossing the threshold  
 13952 of energy consumption for the present block activates the next higher block, which can affect the energy  
 13953 rate in a positive or negative manner. The values are absolute and always increasing. The values represent  
 13954 threshold at the end of a block. The Unit of Measure will be based on the fields defined in the *Publish Price*  
 13955 command, the formatting being defined by attributes within the *Block Period* attribute set.

13956 **10.2.2.2.4 TierNBlockThresholdCount Attributes**

13957 The *TierNBlockThresholdCount* attributes hold the number of block thresholds applicable to a given tier.  
 13958 These attributes are used in the case when a combination (TOU/Hybrid) tariff has a separate set of thresh-  
 13959 olds for each TOU tier. Unused *TierNBlockThresholdCount* attributes shall be set to zero.

13960

13961 **10.2.2.2.3 Block Period (Delivered) Set**

13962 The set of attributes shown in Table 10-5 provides remote access to the Price server Block Threshold  
 13963 period (typically the billing cycle) information.

13964

**Table 10-5. Block Period Attribute Set**

<b>Id</b>	<b>Name</b>	<b>Type</b>	<b>Range</b>	<b>Acc</b>	<b>Def</b>	<b>M</b>
0x0200	<i>StartofBlockPeriod</i>	UTC	-	R	-	O
0x0201	<i>BlockPeriodDuration</i>	uint24	0x000000 to 0xFFFFFFFF	R	-	O
0x0202	<i>ThresholdMultiplier</i>	uint24	0x000000 to 0xFFFFFFFF	R	-	O
0x0203	<i>ThresholdDivisor</i>	uint24	0x000000 to 0xFFFFFFFF	R	-	O
0x0204	<i>BlockPeriod Duration- Type</i>	map8		R	0x00	O

13965 **10.2.2.2.3.1 StartofBlockPeriod Attribute**

13966 The *StartofBlockPeriod* attribute represents the start time of the current block tariff period. A change  
 13967 indicates that a new Block Period is in effect (see sub-clause 10.2.4.3 for further details).

13968 **10.2.2.2.3.2 BlockPeriodDuration Attribute**

13969 The *BlockPeriodDuration* attribute represents the current block tariff period duration in units defined by the  
13970 *BlockPeriodDurationType* attribute. A change indicates that only the duration of the current Block Period  
13971 has been modified. A client device shall expect a new Block Period following the expiration of the new  
13972 duration.

13973 **10.2.2.2.3.3 ThresholdMultiplier Attribute**

13974 *ThresholdMultiplier* provides a value to be multiplied against *Threshold* attributes. If present, this attribute  
13975 must be applied to all Block *Threshold* values to derive values that can be compared against the *Cur-*  
13976 *rentBlockPeriodConsumptionDelivered* attribute within the Metering cluster (see 10.4.2.2.1.13). This attri-  
13977 bute must be used in conjunction with the *ThresholdDivisor* attribute. An attribute value of zero shall result  
13978 in a unitary multiplier (0x000001).

13979 **10.2.2.2.3.4 ThresholdDivisor Attribute**

13980 *ThresholdDivisor* provides a value to divide the result of applying the *ThresholdMultiplier* attribute to Block  
13981 *Threshold* values to derive values that can be compared against the *CurrentBlockPeriodConsumptionDeliv-*  
13982 *ered* attribute within the Metering cluster (see 10.4.2.2.1.13). This attribute must be used in conjunction  
13983 with the *ThresholdMultiplier* attribute. An attribute value of zero shall result in a unitary divisor  
13984 (0x000001).

13985 **10.2.2.2.3.5 BlockPeriodDurationType Attribute**

13986 The *BlockPeriodDurationType* attribute indicates the timebase used for the *BlockPeriodDuration* attribute.  
13987 Enumerated values for this attribute are shown in Table 10-34. A default value of 0x00 (Minutes) shall be  
13988 assumed if this attribute is not present.

13989

13990 **10.2.2.2.4 Commodity Set**

13991 The set of attributes shown in Table 10-6 represents items that are associated with a particular commodity.

13992

13993

**Table 10-6. Commodity Attribute Set**

<b>Id</b>	<b>Name</b>	<b>Type</b>	<b>Range</b>	<b>Acc</b>	<b>Default</b>	<b>M</b>
0x0300	<i>CommodityType</i>	enum8	0x00 to 0xFF	R	-	O
0x0301	<i>StandingCharge</i>	uint32	0x00000000 to 0xFFFFFFFF	R	-	O
0x0302	<i>ConversionFactor</i>	uint32	0x00000000 to 0xFFFFFFFF	R	0x10000000	O
0x0303	<i>ConversionFactorTrailing-Digit</i>	map8		R	0x70	O
0x0304	<i>CalorificValue</i>	uint32	0x00000000 to 0xFFFFFFFF	R	0x2625A00	O
0x0305	<i>CalorificValueUnit</i>	enum8		R	0x1	O
0x0306	<i>CalorificValueTrailingDigit</i>	map8		R	0x60	O

13994 **10.2.2.2.4.1 CommodityType Attribute**



13995 CommodityType provides a label for identifying the type of pricing server present. The attribute is an enumerated value representing the commodity. The defined values are represented by the non-mirrored values (0-127) in the MeteringDeviceType attribute enumerations (refer to Table 10-73).

13998 **10.2.2.2.4.2 Standing Charge Attribute**

13999 The value of the Standing Charge is a daily fixed charge associated with supplying the commodity, measured in base unit of Currency with the decimal point located as indicated by the Trailing Digits field of a Publish Price command (see sub-clause 0). A value of 0xFFFFFFFF indicates field not used.

14002 **10.2.2.2.4.3 ConversionFactor Attribute**

14003 The conversion factor is used for gas meter and takes into account changes in the volume of gas based on temperature and pressure. The ConversionFactor attribute represents the current active value. The ConversionFactor is dimensionless. The default value for the ConversionFactor is 1, which means no conversion is applied. A price server can advertise a new/different value at any time.

14007 **10.2.2.2.4.4 ConversionFactorTrailingDigit Attribute**

14008 An 8-bit bitmap used to determine where the decimal point is located in the ConversionFactor attribute. The most significant nibble indicates the number of digits to the right of the decimal point. The least significant nibble is reserved. The ConversionFactorTrailingDigit attribute represents the current active value.

14011 **10.2.2.2.4.5 CalorificValue Attribute**

14012 The amount of heat generated when a given mass of fuel is completely burned. The CalorificValue is used to convert the measured volume or mass of gas into kWh. The CalorificValue attribute represents the current active value.

14015 **10.2.2.2.4.6 CalorificValueUnit Attribute**

14016 This attribute defines the unit for the CalorificValue. This attribute is an 8-bit enumerated field. The values and descriptions for this attribute are listed in Table 10-7 below. The CalorificValueUnit attribute represents the current active value.

**Table 10-7. Values and Descriptions for the *CalorificValueUnit* Attribute**

Values	Description
0x01	MJ/m3
0x02	MJ/kg

14020 **10.2.2.2.4.7 CalorificValueTrailingDigit Attribute**

14021 An 8-bit bitmap used to determine where the decimal point is located in the CalorificValue attribute. The most significant nibble indicates the number of digits to the right of the decimal point. The least significant nibble is reserved. The CalorificValueTrailingDigit attribute represents the current active value.

14024 **10.2.2.2.5 Block Price Information (Delivered) Set**

14025 The set of attributes shown in Table 10-8 provide remote access to the block prices. The Block Price Information attribute set supports Block and combined Tier-Block pricing, the number of blocks is one greater than the number of block thresholds defined in the Pricing cluster.

**Table 10-8. Block Price Information Attribute Set**

<b>Id</b>	<b>Name</b>	<b>Type</b>	<b>Range</b>	<b>Acc</b>	<b>Def</b>	<b>M</b>
0x0400	<i>NoTierBlock1Price</i>	uint32	0x00000000 to 0xFFFFFFFF	R	-	O
0x0401	<i>NoTierBlock2Price</i>	uint32	0x00000000 to 0xFFFFFFFF	R	-	O
0x0402	<i>NoTierBlock3Price</i>	uint32	0x00000000 to 0xFFFFFFFF	R	-	O
0x040N	<i>NoTierBlockN+1Price...</i>	uint32	0x00000000 to 0xFFFFFFFF	R	-	O
0x040F	<i>NoTierBlock16Price</i>	uint32	0x00000000 to 0xFFFFFFFF	R	-	O
0x0410	<i>Tier1Block1Price</i>	uint32	0x00000000 to 0xFFFFFFFF	R	-	O
0x0411	<i>Tier1Block2Price</i>	uint32	0x00000000 to 0xFFFFFFFF	R	-	O
0x0412	<i>Tier1Block3Price</i>	uint32	0x00000000 to 0xFFFFFFFF	R	-	O
0x041N	<i>Tier1BlockN+1Price...</i>	uint32	0x00000000 to 0xFFFFFFFF	R	-	O
0x041F	<i>Tier1Block16Price</i>	uint32	0x00000000 to 0xFFFFFFFF	R	-	O
0x0420	<i>Tier2Block1Price</i>	uint32	0x00000000 to 0xFFFFFFFF	R	-	O
0x042N	<i>Tier2BlockN+1Price...</i>	uint32	0x00000000 to 0xFFFFFFFF	R	-	O
0x042F	<i>Tier2Block16Price</i>	uint32	0x00000000 to 0xFFFFFFFF	R	-	O
0x0430	<i>Tier3Block1Price</i>	uint32	0x00000000 to 0xFFFFFFFF	R	-	O
0x043N	<i>Tier3BlockN+1Price...</i>	uint32	0x00000000 to 0xFFFFFFFF	R	-	O
0x043F	<i>Tier3Block16Price</i>	uint32	0x00000000 to 0xFFFFFFFF	R	-	O
0x0440	<i>Tier4Block1Price</i>	uint32	0x00000000 to 0xFFFFFFFF	R	-	O
0x044N	<i>Tier4BlockN+1Price...</i>	uint32	0x00000000 to 0xFFFFFFFF	R	-	O
0x044F	<i>Tier4Block16Price</i>	uint32	0x00000000 to 0xFFFFFFFF	R	-	O
0x0450	<i>Tier5Block1Price</i>	uint32	0x00000000 to 0xFFFFFFFF	R	-	O
0x045N	<i>Tier5BlockN+1Price...</i>	uint32	0x00000000 to 0xFFFFFFFF	R	-	O
0x045F	<i>Tier5Block16Price</i>	uint32	0x00000000 to 0xFFFFFFFF	R	-	O
0x0460	<i>Tier6Block1Price</i>	uint32	0x00000000 to 0xFFFFFFFF	R	-	O
0x046N	<i>Tier6BlockN+1Price...</i>	uint32	0x00000000 to 0xFFFFFFFF	R	-	O
0x046F	<i>Tier6Block16Price</i>	uint32	0x00000000 to 0xFFFFFFFF	R	-	O
0x0470	<i>Tier7Block1Price</i>	uint32	0x00000000 to 0xFFFFFFFF	R	-	O
0x047N	<i>Tier7BlockN+1Price...</i>	uint32	0x00000000 to 0xFFFFFFFF	R	-	O
0x047F	<i>Tier7Block16Price</i>	uint32	0x00000000 to 0xFFFFFFFF	R	-	O
0x0480	<i>Tier8Block1Price</i>	uint32	0x00000000 to 0xFFFFFFFF	R	-	O
0x048N	<i>Tier8BlockN+1Price...</i>	uint32	0x00000000 to 0xFFFFFFFF	R	-	O
0x048F	<i>Tier8Block16Price</i>	uint32	0x00000000 to 0xFFFFFFFF	R	-	O
0x0490	<i>Tier9Block1Price</i>	uint32	0x00000000 to 0xFFFFFFFF	R	-	O
0x049N	<i>Tier9BlockN+1Price ...</i>	uint32	0x00000000 to 0xFFFFFFFF	R	-	O
0x049F	<i>Tier9Block16Price</i>	uint32	0x00000000 to 0xFFFFFFFF	R	-	O

0x04A0	<i>Tier10Block1Price</i>	uint32	0x00000000 to 0xFFFFFFFF	R	-	O
0x04AN	<i>Tier10BlockN+1Price...</i>	uint32	0x00000000 to 0xFFFFFFFF	R	-	O
0x04AF	<i>Tier10Block16Price</i>	uint32	0x00000000 to 0xFFFFFFFF	R	-	O
0x04B0	<i>Tier11Block1Price</i>	uint32	0x00000000 to 0xFFFFFFFF	R	-	O
0x04BN	<i>Tier11BlockN+1Price...</i>	uint32	0x00000000 to 0xFFFFFFFF	R	-	O
0x04BF	<i>Tier11Block16Price</i>	uint32	0x00000000 to 0xFFFFFFFF	R	-	O
0x04C0	<i>Tier12Block1Price</i>	uint32	0x00000000 to 0xFFFFFFFF	R	-	O
0x04CN	<i>Tier12BlockN+1Price...</i>	uint32	0x00000000 to 0xFFFFFFFF	R	-	O
0x04CF	<i>Tier12Block16Price</i>	uint32	0x00000000 to 0xFFFFFFFF	R	-	O
0x04D0	<i>Tier13Block1Price</i>	uint32	0x00000000 to 0xFFFFFFFF	R	-	O
0x04DN	<i>Tier13BlockN+1Price...</i>	uint32	0x00000000 to 0xFFFFFFFF	R	-	O
0x04DF	<i>Tier13Block16Price</i>	uint32	0x00000000 to 0xFFFFFFFF	R	-	O
0x04E0	<i>Tier14Block1Price</i>	uint32	0x00000000 to 0xFFFFFFFF	R	-	O
0x04EN	<i>Tier14BlockN+1Price...</i>	uint32	0x00000000 to 0xFFFFFFFF	R	-	O
0x04EF	<i>Tier14Block16Price</i>	uint32	0x00000000 to 0xFFFFFFFF	R	-	O
0x04F0	<i>Tier15Block1Price</i>	uint32	0x00000000 to 0xFFFFFFFF	R	-	O
0x04FN	<i>Tier15BlockN+1Price...</i>	uint32	0x00000000 to 0xFFFFFFFF	R	-	O
0x04FF	<i>Tier15Block16Price</i>	uint32	0x00000000 to 0xFFFFFFFF	R	-	O

14029 **10.2.2.2.5.1 TierNBlockNPrice Attributes**

14030 Attributes PriceNoTierBlock1 through PriceTier15Block16 represent the price of Energy, Gas, or Water  
 14031 delivered to the premises (i.e. delivered to the customer from the utility) at a specific price tier as defined  
 14032 by a TOU schedule, Block Threshold or a real time pricing period. If optionally provided, attributes shall  
 14033 be initialized prior to the issuance of associated Publish Price commands (see sub-clause 0). The expected  
 14034 practical limit for the number of PriceTierNBlockN attributes supported is 32. The Unit of Measure, Currency  
 14035 and Trailing Digits that apply to this attribute should be obtained from the appropriate fields in a Publish  
 14036 Price command.

14037 **10.2.2.2.6 Extended Price Information (Delivered) Set**

14038 In case of TOU charging only, the price server allows support for up to 48 TOU rates. To reduce the number  
 14039 of attributes, *Tier1Block1Price* through *Tier15Block1Price* attributes are reused to represent rates for tiers 1  
 14040 to 15. Rates for tiers 16 to 48 are provided in the extended price information set.

14041 **Table 10-9. Extended Price Information Set (TOU charging only)**

<b>Id</b>	<b>Name</b>	<b>Type</b>	<b>Range</b>	<b>Acc</b>	<b>Def</b>	<b>M</b>
0x0500-0x050E	<i>Reserved</i>					
0x050F	PriceTier16	uint32	0x00000000 to 0xFFFFFFFF	R	-	O
...	PriceTierN	uint32	0x00000000 to 0xFFFFFFFF	R	-	O

Id	Name	Type	Range	Acc	Def	M
0x052F	PriceTier48	uint32	0x00000000 to 0xFFFFFFFF	R	-	O
0x0530-0x05FD	<i>Reserved</i>					
0x05FE	CPP1 Price	uint32	0x00000000 to 0xFFFFFFFF	R	-	O
0x05FF	CPP2 Price	uint32	0x00000000 to 0xFFFFFFFF	R	-	O

14042 **10.2.2.2.6.1 PriceTierN Attributes**

14043 Attributes *PriceTier16* through *PriceTier48* represent the price of Energy, Gas, or Water delivered to the  
14044 premises (i.e. delivered to the customer from the utility) at a specific price tier.

14045 **10.2.2.2.6.2 CPP1 Price Attribute**

14046 Attribute *CPP1 Price* represents the price of Energy, Gas, or Water delivered to the premises (i.e. delivered  
14047 to the customer from the utility) while Critical Peak Pricing ‘CPP1’ is being applied.

14048 **10.2.2.2.6.3 CPP2 Price Attribute**

14049 Attribute *CPP2 Price* represents the price of Energy, Gas, or Water delivered to the premises (i.e. delivered  
14050 to the customer from the utility) while Critical Peak Pricing ‘CPP2’ is being applied.

14051 **10.2.2.2.7 Tariff Information (Delivered) Attribute Set**

14052 The following set of attributes represents items that are associated with a particular Price Tariff. Please note  
14053 that the terms tier and rate are used interchangeably here, but do define the same thing.

14054 **Table 10-10. Tariff Information Attribute Set**

Id	Name	Type	Range	Acc	Def	M
0x0610	TariffLabel	octstr	1 to 25 Octets	R	0	O
0x0611	NumberOfPrice TiersInUse	uint8	0 to 15	R	0	O
0x0612	NumberOfBlock ThresholdsInUse	uint8	0 to 15	R	0	O
0x0613	TierBlockMode	enum8	0x00 to 0xFF	R	0xFF	O
0x0614	<i>Reserved</i>					
0x0615	Unit of Measure	enum8	0x00 to 0xFF	R	0	O
0x0616	Currency	uint16	0x0000 to 0xFFFF	R	-	O
0x0617	Price Trailing Digit	map8		R	0x00	O
0x0618	<i>Reserved</i>					
0x0619	TariffResolutionPeriod	enum8		R	0	O
0x0620	CO <sub>2</sub>	uint32	0x00000000 to 0xFFFFFFFF	R	185	O
0x0621	CO <sub>2</sub> Unit	enum8		R	1	O

Id	Name	Type	Range	Acc	Def	M
0x0622	CO <sub>2</sub> TrailingDigit	map8		R	0	O

14055 **10.2.2.2.7.1 TariffLabel Attribute**

14056 The TariffLabel attribute provides a method for utilities to assign a label to an entire set of tariff information.  
 14057 The TariffLabel attribute is an Octet String capable of storing a 24 character string (the first Octet indicates  
 14058 length) encoded in the UTF-8 format. This attribute is thought of be useful when a commodity supplier may  
 14059 have multiple tariffs. The TariffLabel attribute represents the current active value.

14060 **10.2.2.2.7.2 NumberofPriceTiersInUse Attribute**

14061 An 8-bit integer which indicates the number of price tiers used while this tariff is active. Valid values are  
 14062 from 0 to 48 reflecting block charging only (no price tiers in use) (0) to 48 price tiers available (48). The  
 14063 NumberofPriceTiersInUse attribute represents the current active value.

14064 **10.2.2.2.7.3 NumberofBlockThresholdsInUse Attribute**

14065 An 8-bit integer which indicates the total number of block thresholds used in the currently active tariff.

14066 When utilizing TOU charging only, the attribute shall be set to 0 (no thresholds employed).

14067 Where a single set of thresholds is employed, valid values are from 1 to 15 reflecting 1 to 15 block thresholds  
 14068 available. The number of blocks is one greater than the number of block thresholds.

14069 Where the TierBlockMode is set to 2, this attribute indicates the sum of all thresholds employed for all tiers  
 14070 within the currently active tariff.

14071 **10.2.2.2.7.4 TierBlockMode Attribute**

14072 An 8-bit enumeration indicating how the mixed TOU / Block charging is to be applied. The value stored in  
 14073 this attribute is applicable only in the case where NumberofPriceTiersInUse is greater than one and Number-  
 14074 ofBlockThresholdsInUse is greater than zero. Table 10-11 shows possible values.

14075

**Table 10-11. TierBlockMode Enumeration**

Values	Description
0x00	This tariff employs a single set of thresholds. All commodity consumption within a block period is summed and the result compared against the thresholds to determine the Current Block. Each TOU tier will have prices for each block, the current TOU price being dependant on the value of the Current Block. See Figure 10-2.
0x01	This tariff employs a single set of thresholds common across all TOU tiers. During a block period, commodity consumption whilst in each TOU tier is individually summed. The summation for a particular TOU tier is compared against the common thresholds to determine the current block. See Figure 10-3.
0x02	This combination tariff employs an individual set of Thresholds for each TOU tier. During a block period, commodity consumption whilst in each TOU tier is individually summed. The summation for a particular TOU tier is compared against the thresholds for that tier to determine the current block. This is similar in operation to that shown in Figure 10-3 with the exception that the thresholds used can vary from tier to tier.
0xFF	Not Used

14076  
14077

**Figure 10-2. Single Threshold Set applied to All Consumption**

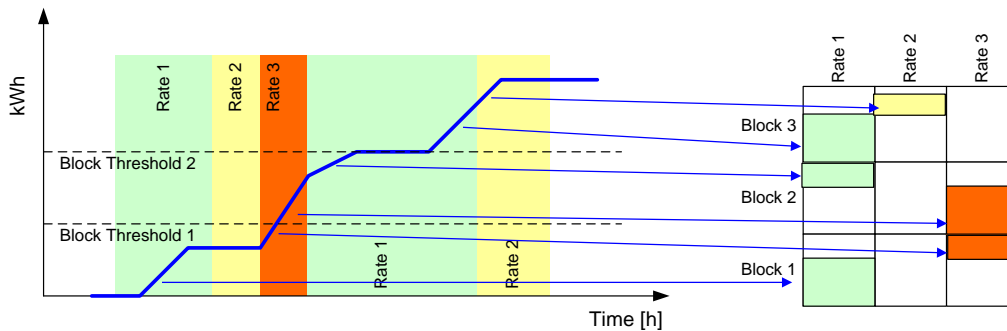

14078  
14079  
14080

**Figure 10-3. Threshold Set applied to Each Tier Consumption**

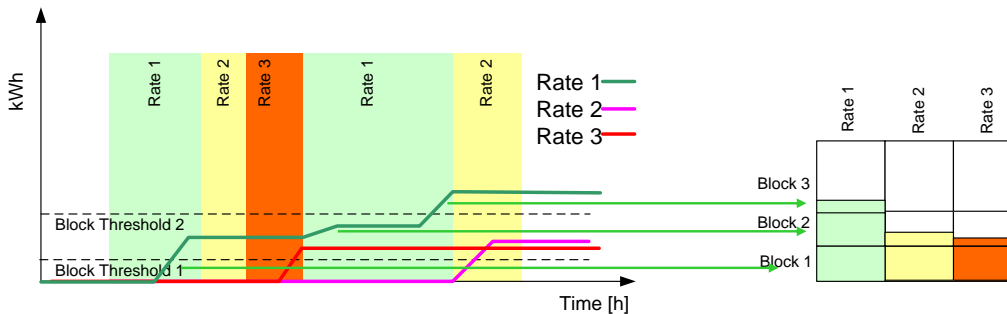

14081  
14082  
14083  
14084  
14085

**Note:** Tiers 1-15 ONLY are available for hybrid Tier/Block tariffing ... Tiers 16-48 are for TOU tariffing only.

14086 **10.2.2.2.7.5 Unit of Measure Attribute**

14087 An 8-bit enumeration identifying the base unit of measure. The enumeration used for this attribute shall match  
14088 one of the UnitOfMeasure values using a pure Binary format, as defined in the Metering cluster.

14089 **10.2.2.2.7.6 Currency Attribute**

14090 An unsigned 16-bit integer containing identifying information concerning the local unit of currency used in  
14091 the Price cluster. The *Currency* attribute shall correspond to the *Currency* field within the *PublishPrice* com-  
14092 mand.

14093 The value of the currency attribute should match the values defined by ISO 4217.

14094 **10.2.2.2.7.7 PriceTrailingDigit Attribute**

14095 An 8-bit BitMap used to determine where the decimal point is located for prices provided in the Standing  
14096 Charge attribute and the Price Matrix command. The most significant nibble is the Trailing Digit sub-field  
14097 which indicates the number of digits to the right of the decimal point. The least significant nibble is reserved  
14098 and shall be 0. The Price Trailing Digit attribute represents the current active value.

14099 **10.2.2.2.7.8 TariffResolutionPeriod Attribute**

14100 An 8 bit enumeration identifying the resolution period for Block Tariff, Table 10-36 shows all available  
14101 options.

14102 **10.2.2.2.7.9 CO<sub>2</sub> Attribute**

14103 Used to calculate the amount of carbon dioxide (CO<sub>2</sub>) produced from energy use. Natural gas has a conver-  
14104 sion factor of about 0.185, e.g. 1,000 kWh of gas used is responsible for the production of 185kg CO<sub>2</sub> (0.185  
14105 x 1000 kWh). The CO<sub>2</sub> attribute represents the current active value.

14106 **10.2.2.2.7.10 CO<sub>2</sub>Unit Attribute**

14107 This attribute is an 8-bit enumeration which defines the unit for the CO<sub>2</sub> attribute. The values and descrip-  
14108 tions for this attribute are listed in Table 10-12 below. The *CO<sub>2</sub>Unit* attribute represents the current active  
14109 value.  
14110  
14111

**Table 10-12. CO<sub>2</sub>Unit Enumeration**

Values	Description
0x00	Reserved for future use
0x01	kg per kWh
0x02	kg per Gallon of Gasoline
0x03	kg per Therm of Natural Gas

14112

14113 **10.2.2.2.7.11 CO<sub>2</sub>TrailingDigit Attribute**

14114 An 8-bit Bit-Map used to determine where the decimal point is located in the CO<sub>2</sub> attribute. The most signif-  
14115 icant nibble indicates the number of digits to the right of the decimal point. The least significant nibble is  
14116 reserved. The CO<sub>2</sub>TrailingDigit attribute represents the current active value.  
14117

14118 **10.2.2.2.8 Billing Information (Delivered) Attribute Set**

14119 The set of attributes shown in Table 10-13 provides remote access to the Price server Billing information.

14120

**Table 10-13. Billing Information Attribute Set**

Id	Name	Type	Range	Acc	Def	M
0x0700	<i>CurrentBillingPeriodStart</i>	UTC	0x00000000 to 0xFFFFFFFF	R	-	O
0x0701	<i>CurrentBillingPeriodDuration</i>	uint24	0x000000 to 0xFFFFFF	R	-	O
0x0702	<i>LastBillingPeriodStart</i>	UTC	0x00000000 to 0xFFFFFFFF	R	-	O
0x0703	<i>LastBillingPeriodDuration</i>	uint24	0x000000 to 0xFFFFFF	R	-	O
0x0704	<i>LastBillingPeriodConsolidatedBill</i>	uint32	0x00000000 to 0xFFFFFFFF	R	-	O

14121 **10.2.2.2.8.1 CurrentBillingPeriodStart Attribute**

14122 The CurrentBillingPeriodStart attribute represents the start time of the current billing period.

14123 **10.2.2.2.8.2 CurrentBillingPeriodDuration Attribute**

14124 The CurrentBillingPeriodDuration attribute represents the current billing period duration in minutes.

14125 **10.2.2.2.8.3 LastBillingPeriodStart Attribute**

14126 The LastBillingPeriodStart attribute represents the start time of the last billing period.

14127 **10.2.2.2.8.4 LastBillingPeriodDuration Attribute**

14128 The LastBillingPeriodDuration attribute is the duration of the last billing period in minutes (start to end of  
14129 last billing period).

14130 **10.2.2.2.8.5 LastBillingPeriodConsolidatedBill Attribute**

14131 The LastBillingPeriodConsolidatedBill attribute is an amount for the cost of the energy supplied from the  
14132 date of the LastBillingPeriodStart attribute and until the duration of the LastBillingPeriodDuration attribute  
14133 expires, measured in base unit of Currency with the decimal point located as indicated by the Trailing Digits  
14134 attribute.

14135

14136 **10.2.2.2.9 Credit Payment Attribute Set**

14137 The Credit Payments Attribute set provides a method for the HAN (IHD) to understand the current status of  
14138 the credit-only payment made to the energy supplier. These payments are for a credit meter only and do not  
14139 cover any Prepayment Top up or payment. This attribute set is used to display the bill on the IHD should this  
14140 service be required. Devices that require this information should use standard commands to read this infor-  
14141 mation.



14142

**Table 10-14. Credit Payment Attribute Set**

<b>Id</b>	<b>Name</b>	<b>Type</b>	<b>Range</b>	<b>Acc</b>	<b>Def</b>	<b>M</b>
0x0800	CreditPaymentDueDate	UTC		R	-	O
0x0801	CreditPaymentStatus	enum8	0x00 to 0xFF	R	-	O
0x0802	CreditPayment Over-DueAmount	int32	-2147483647 to 2147483647	R	0	O
0x080A	PaymentDiscount	int32	-2147483647 to 2147483647	R	-	O
0x080B	PaymentDiscountPeriod	enum8	0x00 to 0xFF	R	-	O
0x0810	CreditPayment#1	uint32	0x00000000 to 0xFFFFFFFF	R	-	O
0x0811	CreditPaymentDate#1	UTC		R	-	O
0x0812	CreditPaymentRef#1	Octstr	1-21	R	-	O
0x0820	CreditPayment#2	uint32	0x00000000 to 0xFFFFFFFF	R	-	O
0x0821	CreditPaymentDate#2	UTC		R	-	O
0x0822	CreditPaymentRef#2	Octstr	1-21	R	-	O
0x0830	CreditPayment#3	uint32	0x00000000 to 0xFFFFFFFF	R	-	O
0x0831	CreditPaymentDate#3	UTC		R	-	O
0x0832	CreditPaymentRef#3	Octstr	1-21	R	-	O
0x0840	CreditPayment#4	uint32	0x00000000 to 0xFFFFFFFF	R	-	O
0x0841	CreditPaymentDate#4	UTC		R	-	O
0x0842	CreditPaymentRef#4	Octstr	1-21	R	-	O
0x0850	CreditPayment#5	uint32	0x00000000 to 0xFFFFFFFF	R	-	O
0x0851	CreditPaymentDate#5	UTC		R	-	O
0x0852	CreditPaymentRef#5	Octstr	1-21	R	-	O

14143 **10.2.2.2.9.1 CreditPaymentDueDate Attribute**

14144 The CreditPaymentDueDate attribute indicates the date and time when the next credit payment is due to be  
 14145 paid by the consumer to the supplier.

14146 **10.2.2.2.9.2 CreditPaymentStatus Attribute**

14147 The CreditPaymentStatus attribute indicates the current status of the last payment. Table 10-15 defines the  
 14148 enumeration values for this attribute.

14149

**Table 10-15. CreditPaymentStatus Enumeration**

Value	Status
0x00	Pending
0x01	Received / Paid
0x02	Overdue
0x03	2 payments overdue
0x04	3 payments overdue

14150 **10.2.2.2.9.3 CreditPaymentOverDueAmount Attribute**

14151 This is the total of the consolidated bill amounts accumulated since the last payment.

14152 **10.2.2.2.9.4 PaymentDiscount Attribute**

14153 The PaymentDiscount attribute indicates the discount that the energy supplier has applied to the consolidated  
14154 bill.

14155 **10.2.2.2.9.5 PaymentDiscountPeriod Attribute**

14156 The PaymentDiscountPeriod attribute indicates the period for which this discount shall be applied for. Table  
14157 10-16 shows the enumeration values for this attribute.

14158

**Table 10-16. PaymentDiscountDuration Enumerations**

Value	Status
0x00	Current Billing Period
0x01	Current Consolidated bill
0x02	One Month
0x03	One Quarter
0x04	One Year

14159 **10.2.2.2.9.6 CreditPayment Attribute**

14160 The CreditPayment attributes indicate the amount paid by the consumer to the energy supplier. The last 5  
14161 values are shown with #1 meaning the most recent. Measured in base unit of Currency with the decimal point  
14162 located as indicated by the Trailing Digits attribute.

14163 **10.2.2.2.9.7 CreditPaymentDate Attribute**

14164 The CreditPaymentDate attributes indicate the last time the consumer made a payment to the energy supplier.  
14165 The last 5 values are shown with #1 meaning the most recent.

14166 **10.2.2.2.9.8 CreditPaymentRef Attribute**

14167 The CreditPaymentRef attributes indicate the reference number given to the payment by the energy supplier.  
14168 The last 5 values are shown with #1 meaning the most recent.

14169

14170 **10.2.2.2.10 Received Tier Label Attribute Set**

14171

**Table 10-17. Received Tier Label Attribute Set**

<b>Id</b>	<b>Name</b>	<b>Type</b>	<b>Range</b>	<b>Acc</b>	<b>Def</b>	<b>M</b>
0x8000	ReceivedTier1PriceLabel	octstr	1 to 13 Octets	RW	“Tier 1”	O
0x800n	ReceivedTierNPriceLabel	octstr	1 to 13 Octets	RW	“Tier N”	O
0x802F	ReceivedTier48PriceLabel	octstr	1 to 13 Octets	RW	“Tier 48”	O

14172 **10.2.2.2.10.1 ReceivedTierNPriceLabel Attributes**

14173 The ReceivedTierNPriceLabel attributes provide a method for utilities to assign a label to Received Price  
 14174 Tiers. There are 48 Tier Labels. The format and use of these attributes is the same as for the ‘Delivered’ Price  
 14175 Labels defined in 10.2.2.2.1.

14176

14177 **10.2.2.2.11 Received Block Threshold Attribute Set**

14178 The following set of attributes provides remote access to the Price server ReceivedBlockThresholds. The  
 14179 number of block thresholds is indicated by the NumberOfBlockThresholds field in the associated Publish-  
 14180 TariffInformation command. The number of blocks is one greater than the number of thresholds.

14181

**Table 10-18. Received Block Threshold Attribute Set**

<b>Id</b>	<b>Name</b>	<b>Type</b>	<b>Range</b>	<b>Acc</b>	<b>Def</b>	<b>M</b>
0x8100	ReceivedBlock1Threshold	uint48	0x000000000000 to 0xFFFFFFFFFFFF	R	-	O
0x810n	ReceivedBlockNThreshold	uint48	0x000000000000 to 0xFFFFFFFFFFFF	R	-	O
0x810E	ReceivedBlock15Threshold	uint48	0x000000000000 to 0xFFFFFFFFFFFF	R	-	O

14182 **10.2.2.2.11.1 ReceivedBlockNThreshold Attributes**

14183 The format of these attributes is the same as for the ‘Delivered’ Block Thresholds defined in 10.2.2.2.2.1.

14184

14185 **10.2.2.2.12 Received Block Period Attribute Set**

14186 The following set of attributes provides remote access to the Price server Received Block Threshold period  
 14187 (typically the billing cycle) information.

14188

**Table 10-19. Received Block Period Attribute Set**

<b>Id</b>	<b>Name</b>	<b>Type</b>	<b>Range</b>	<b>Acc</b>	<b>Def</b>	<b>M</b>
0x8200	ReceivedStartofBlockPeriod	UTC	-	R	-	O
0x8201	ReceivedBlockPeriodDuration	uint24	0x000000 to 0xFFFFFF	R	-	O
0x8202	ReceivedThresholdMultiplier	uint24	0x000000 to 0xFFFFFF	R	-	O

Id	Name	Type	Range	Acc	Def	M
0x8203	ReceivedThresholdDivisor	uint24	0x000000 to 0xFFFFF	R	-	O

14189 **10.2.2.2.12.1 ReceivedStartofBlockPeriod Attribute**

14190 The format of this attribute is the same as for the ‘Delivered’ StartofBlockPeriod attribute defined in  
14191 10.2.2.2.3.1.

14192 **10.2.2.2.12.2 ReceivedBlockPeriodDuration Attribute**

14193 The format of this attribute is the same as for the ‘Delivered’ BlockPeriodDuration attribute defined in  
14194 10.2.2.2.3.2.

14195 **10.2.2.2.12.3 ReceivedThresholdMultiplier Attribute**

14196 The format of this attribute is the same as for the ‘Delivered’ ThresholdMultiplier attribute defined in  
14197 10.2.2.2.3.3.

14198 **10.2.2.2.12.4 ReceivedThresholdDivisor Attribute**

14199 The format of this attribute is the same as for the ‘Delivered’ ThresholdDivisor attribute defined in  
14200 10.2.2.2.3.4.

14201

14202 **10.2.2.2.13 Received Block Price Information Attribute Set**

14203

Table 10-20. Received Block Price Attribute Set

Id	Name	Type	Range	Acc	Def	M
0x8400	RxNoTierBlock1Price	uint32	0x00000000 to 0xFFFFFFFF	R	-	O
0x8401	RxNoTierBlock2Price	uint32	0x00000000 to 0xFFFFFFFF	R	-	O
0x8402	RxNoTierBlock3Price	uint32	0x00000000 to 0xFFFFFFFF	R	-	O
0x840N	RxNoTierBlockN+1Price ...	uint32	0x00000000 to 0xFFFFFFFF	R	-	O
0x840F	RxNoTierBlock16Price	uint32	0x00000000 to 0xFFFFFFFF	R	-	O
0x8410	RxTier1Block1Price	uint32	0x00000000 to 0xFFFFFFFF	R	-	O
...	...	...	...	...	...	...
0x84FF	RxTier15Block16Price	uint32	0x00000000 to 0xFFFFFFFF	R	-	O

14204 **10.2.2.2.13.1 RxTierNBlockNPrice Attributes**

14205 The format and use of these attributes is the same as for the ‘Delivered’ TierNBlockNPrice attributes defined  
 14206 in 10.2.2.2.5.1.

14207

14208 **10.2.2.2.14 Received Extended Price Information Attribute Set**

14209 In case of TOU charging only, the price server shall support up to 48 TOU rates. To reduce the number of  
 14210 attributes, RxTierNBlock1Price attributes are reused to represent rates for tiers 1 to 15. Rates for tiers 16 to  
 14211 48 are provided in the Received Extended Price Information Set.

14212

14213

**Table 10-21. Received Extended Price Information Attribute Set (TOU charging only)**

<b>Id</b>	<b>Name</b>	<b>Type</b>	<b>Range</b>	<b>Acc</b>	<b>Def</b>	<b>M</b>
0x850F	ReceivedPriceTier16	uint32	0x00000000 to 0xFFFFFFFF	R	-	O
0x8510	ReceivedPriceTier17	uint32	0x00000000 to 0xFFFFFFFF	R	-	O
0x8511	ReceivedPriceTier18	uint32	0x00000000 to 0xFFFFFFFF	R	-	O
...	ReceivedPriceTierN	uint32	0x00000000 to 0xFFFFFFFF	R	-	O
0x852F	ReceivedPriceTier48	uint32	0x00000000 to 0xFFFFFFFF	R	-	O

14214 **10.2.2.2.14.1 ReceivedPriceTierN Attributes**

14215 The format and use of these attributes is the same as for the ‘Delivered’ PriceTierN attributes defined in  
 14216 10.2.2.2.6.1.

14217

14218 **10.2.2.2.15 Received Tariff Information Attribute Set**

14219 The following set of attributes represents items that are associated with a particular Received Price Tariff.

14220

**Table 10-22. Received Tariff Information Attribute Set**

<b>Id</b>	<b>Name</b>	<b>Type</b>	<b>Range</b>	<b>Acc</b>	<b>Def</b>	<b>M</b>
0x8610	ReceivedTariffLabel	Octstr	1 to 25 Octets	R	0	O
0x8611	ReceivedNumberofPriceTiersInUse	uint8	0 to 15	R	0	O
0x8612	ReceivedNumberofBlockThresholdsInUse	uint8	0 to 15	R	0	O
0x8613	ReceivedTierBlockMode	uint8	0 to 1	R	0xFF	O
0x8614	Reserved					

Id	Name	Type	Range	Acc	Def	M
0x8615	ReceivedTariffResolutionPeriod	enum8	0x00 to 0xFF	R	0x00	O
0x8625	ReceivedCO <sub>2</sub>	uint32	0x00000000 to 0xFFFFFFFF	R	185	O
0x8626	ReceivedCO <sub>2</sub> Unit	enum8		R	1	O
0x8627	ReceivedCO <sub>2</sub> TrailingDigit	map8		R	0	O

14221 **10.2.2.2.15.1 ReceivedTariffLabel Attribute**

14222 The format and use of this attribute is the same as for the ‘Delivered’ TariffLabel attribute defined in  
14223 10.2.2.2.7.1.

14224 **10.2.2.2.15.2 ReceivedNumberOfPriceTiersInUse Attribute**

14225 The format and use of this attribute is the same as for the ‘Delivered’ NumberOfPriceTiersInUse attribute  
14226 defined in 10.2.2.2.7.2.

14227 **10.2.2.2.15.3 ReceivedNumberOfBlockThresholdsInUse Attribute**

14228 The format and use of this attribute is the same as for the ‘Delivered’ NumberOfBlockThresholdsInUse at-  
14229 tribute defined in 10.2.2.2.7.3.

14230 **10.2.2.2.15.4 ReceivedTierBlockMode Attribute**

14231 The format and use of this attribute is the same as for the ‘Delivered’ TierBlockMode attribute defined in  
14232 10.2.2.2.7.4.

14233 **10.2.2.2.15.5 ReceivedTariffResolutionPeriod Attribute**

14234 An 8 bit enumeration identifying the resolution period for Block Tariff, Table 10-36 shows all available  
14235 options.

14236 **10.2.2.2.15.6 ReceivedCO<sub>2</sub> Attribute**

14237 The format and use of this attribute is the same as for the ‘Delivered’ CO<sub>2</sub> attribute defined in 10.2.2.2.7.9.

14238 **10.2.2.2.15.7 ReceivedCO<sub>2</sub>Unit Attribute**

14239 The format and use of this attribute is the same as for the ‘Delivered’ CO<sub>2</sub>Unit attribute defined in  
14240 10.2.2.2.7.10.

14241 **10.2.2.2.15.8 ReceivedCO<sub>2</sub>TrailingDigit Attribute**

14242 The format and use of this attribute is the same as for the ‘Delivered’ CO<sub>2</sub>TrailingDigit attribute defined in  
14243 10.2.2.2.7.11.

14244

14245 **10.2.2.2.16 Received Billing Information Attribute Set**

14246 The following set of attributes represents items that are associated with particular Received Billing infor-  
14247 mation.

14248

**Table 10-23. Received Billing Information Attribute Set**

Id	Name	Type	Range	Acc	Def	M
0x8700	ReceivedCurrentBillingPeriodStart	UTC	0x00000000 to 0xFFFFFFFF	R	-	O
0x8701	ReceivedCurrentBillingPeriodDuration	uint24	0x000000 to 0xFFFFFF	R	-	O
0x8702	ReceivedLastBillingPeriodStart	UTC	0x00000000 to 0xFFFFFFFF	R	-	O
0x8703	ReceivedLastBillingPeriodDuration	uint24	0x000000 to 0xFFFFFF	R	-	O
0x8704	ReceivedLastBillingPeriodConsolidatedBill	uint32	0x00000000 to 0xFFFFFFFF	R	-	O

14249 **10.2.2.2.16.1 ReceivedCurrentBillingPeriodStart Attribute**

14250 The format and use of this attribute is the same as for the ‘Delivered’ CurrentBillingPeriodStart attribute  
 14251 defined in 10.2.2.2.8.1.

14252 **10.2.2.2.16.2 ReceivedCurrentBillingPeriodDuration Attribute**

14253 The format and use of this attribute is the same as for the ‘Delivered’ CurrentBillingPeriodDuration attribute  
 14254 defined in 10.2.2.2.8.2.

14255 **10.2.2.2.16.3 ReceivedLastBillingPeriodStart Attribute**

14256 The format and use of this attribute is the same as for the ‘Delivered’ LastBillingPeriodStart attribute defined  
 14257 in 10.2.2.2.8.3.

14258 **10.2.2.2.16.4 ReceivedLastBillingPeriodDuration Attribute**

14259 The format and use of this attribute is the same as for the ‘Delivered’ LastBillingPeriodDuration attribute  
 14260 defined in 10.2.2.2.8.4.

14261 **10.2.2.2.16.5 ReceivedLastBillingPeriodConsolidatedBill Attribute**

14262 The format and use of this attribute is the same as for the ‘Delivered’ LastBillingPeriodConsolidatedBill  
 14263 attribute defined in 10.2.2.2.8.5.

14264

14265 **10.2.2.3 Commands Received**

14266 The server side of the Price cluster is capable of receiving the commands listed in Table 10-24.

14267

**Table 10-24. Received Command IDs for the Price Cluster**

Command Identifier Field Value	Description	M
0x00	<i>Get Current Price</i>	M
0x01	<i>Get Scheduled Prices</i>	O
0x02	<i>Price Acknowledgement</i>	M for SE1.1 and later devices
0x03	<i>Get Block Period(s)</i>	O
0x04	<i>GetConversionFactor</i>	O
0x05	<i>GetCalorificValue</i>	O
0x06	<i>GetTariffInformation</i>	O
0x07	<i>GetPriceMatrix</i>	O
0x08	<i>GetBlockThresholds</i>	O
0x09	<i>GetCO<sub>2</sub>Value</i>	O
0x0A	<i>GetTierLabels</i>	O
0x0B	<i>GetBillingPeriod</i>	O
0x0C	<i>GetConsolidatedBill</i>	O
0x0D	<i>CPPEventResponse</i>	O
0x0E	<i>GetCreditPayment</i>	O
0x0F	<i>GetCurrencyConversion</i>	O
0x10	<i>GetTariffCancellation</i>	O

14268 **10.2.2.3.1 Error Handling**

14269 If the response to a ‘Get’ command has no data available, then the device should respond using a Default  
14270 Response with a status of NOT\_FOUND.

14271

14272 **10.2.2.3.2 Get Current Price Command**

14273 This command initiates a Publish Price command (see sub-clause 0) for the current time.

14274 **10.2.2.3.2.1 Payload Format**

14275 The payload of the Get Current Price command is formatted as shown in Figure 10-4.

14276

**Figure 10-4. The Format of the *Get Current Price* Command Payload**

<b>Octets</b>	1
<b>Data Type</b>	uint8
<b>Field Name</b>	Command Options

14277 **10.2.2.3.2.1.1 Payload Details**



14278 **The Command Options Field:** The command options field is 8 Bits in length and is formatted as a bit field  
 14279 as shown in Figure 10-5.

14280

**Figure 10-5. Get Current Price Command Options Field**

<b>Bits</b>	0	1 to 7
<b>Field Name</b>	Requestor Rx On When Idle	Reserved

14281

14282 **The Requestor Rx On When Idle Sub-field:** The Requestor Rx On When Idle sub-field has a value of  
 14283 1 if the requestor’s receiver may be, for all practical purposes, enabled when the device is not actively  
 14284 transmitting, thereby making it very likely that regular broadcasts of pricing information will be received by  
 14285 this device, and 0 otherwise.

14286 A device that publishes price information may use the value of this bit, as received from requestors in its neigh-  
 14287 borhood, to determine publishing policy. For example, if a device makes a request for current pricing infor-  
 14288 mation and the requestor Rx on when idle sub-field of the GetCurrentPrice command payload has a value of  
 14289 1 (indicating that the device will be likely to receive regular price messages), then the receiving device may  
 14290 store information about the requestor and use it in future publishing operations.

14291 **10.2.2.3.2 Effect on Receipt**

14292 On receipt of this command, the device shall send a Publish Price command (sub-clause 0) for the currently  
 14293 scheduled time.

14294

14295 **10.2.2.3.3 Get Scheduled Prices Command**

14296 This command initiates a Publish Price command (see sub-clause 0) for available price events. A server  
 14297 device shall be capable of storing five price events at a minimum.

14298 **10.2.2.3.3.1 Payload Details**

14299 The Get Scheduled Prices command payload shall be formatted as illustrated in Figure 10-6.

14300

**Figure 10-6. Format of the Get Scheduled Prices Command Payload**

<b>Octets</b>	4	1
<b>Data Type</b>	UTC	uint8
<b>Field Name</b>	Start Time (M)	Number of Events (M)

14301

14302 **Start Time (mandatory):** UTC Timestamp representing the minimum ending time for any scheduled or  
 14303 currently active pricing events to be resent. If a command has a Start Time of 0x00000000, replace that  
 14304 Start Time with the current time stamp.

14305 **Number of Events (mandatory):** Represents the maximum number of events to be sent. A value of 0  
 14306 indicates no maximum limit<sup>140</sup>. Example: Number of Events = 1 would return the first event with an  
 14307 EndTime greater than or equal to the value of Start Time field in the Get Scheduled Prices command.  
 14308 (EndTime would be StartTime plus Duration of the event listed in the device’s event table).

14309 **10.2.2.3.3.2 When Generated**

<sup>140</sup> CCB 1447

14310 This command is generated when the client device wishes to verify the available Price Events or after a loss  
14311 of power/reset occurs and the client device needs to recover currently active, scheduled, or expired Price  
14312 Events.

14313 A Default Response with status NOT\_FOUND shall be returned if there are no events available.

14314 **10.2.2.3.3 Effect on Receipt**

14315 On receipt of this command, the device shall send a Publish Price command (see sub-clause 0) for all  
14316 currently scheduled price events.

14317

14318 **10.2.2.3.4 Price Acknowledgement Command**

14319 The Price Acknowledgement command described in Figure 10-7 provides the ability to acknowledge a  
14320 previously sent Publish Price command. It is mandatory for SE1.1 and later devices. For SE 1.0 devices, the  
14321 command is optional.

14322 **10.2.2.3.4.1 Payload Format**

Figure 10-7. Format of the *Price Acknowledgement Command Payload*

<b>Octets</b>	4	4	4	1
<b>Data Type</b>	uint32	uint32	UTC	map8
<b>Field Name</b>	Provider ID (M)	Issuer Event ID (M)	Price Ack Time (M)	Control (M)

14324 **10.2.2.3.4.1.1 Payload Details**

14325 **Provider ID (mandatory):** An unsigned 32-bit field containing a unique identifier for the commodity pro-  
14326 vider.

14327 **Issuer Event ID (mandatory):** Unique identifier generated by the commodity provider.

14328 **Price Ack Time (mandatory):** Time price acknowledgement generated.

14329 **Control (mandatory):** Identifies the Price Control or Block Period Control options for the event. The  
14330 values for this field are described in Table 10-29 and Table 10-33.

14331 **10.2.2.3.4.2 When Generated**

14332 This command is generated on receipt of a Publish Price command when the Price Control field of that  
14333 Publish Price command indicates that a Price Acknowledgement is required (see sub-clause 0 for further  
14334 details).

14335

14336 **10.2.2.3.5 Get Block Period(s) Command**

14337 This command initiates a Publish Block Period command (see sub-clause 10.2.2.4.2) for the currently sched-  
14338 uled block periods. A server device shall be capable of storing at least two commands, the current period and  
14339 a period to be activated in the near future.

14340 **10.2.2.3.5.1 Payload Format**

14341

**Figure 10-8. Format of the *Get Block Period(s)* Command Payload**

<b>Octets</b>	4	1	1
<b>Data Type</b>	UTC	uint8	map8
<b>Field Name</b>	Start Time (M)	Number of Events (M)	Tariff Type (O)

14342 **10.2.2.3.5.1.1 Payload Details**

14343 **Start Time (mandatory):** UTC Timestamp representing the minimum ending time for any scheduled or  
 14344 current block period events to be resent. If a command has a Start Time of 0x00000000, replace that  
 14345 Start Time with the current time stamp.

14346 **Number of Events (mandatory):** An 8 bit integer which indicates the maximum number of Publish Block  
 14347 Period commands that can be sent. Example: Number of Events = 1 would return the first event with an  
 14348 EndTime greater than or equal to the value of Start Time field in the GetBlockPeriod(s) command. (EndTime  
 14349 would be StartTime plus Duration of the event listed in the device’s event table). Number of Events = 0 indi-  
 14350 cates no maximum limit<sup>141</sup>.

14351 **Tariff Type (mandatory):** An 8-bit bitmap identifying the type of tariff published in this command. The  
 14352 least significant nibble represents an enumeration of the tariff type as detailed in Table 10-37 (Generation  
 14353 Meters shall use the ‘Received’ Tariff.). If the TariffType is not specified, the server shall assume that the  
 14354 request is for the ‘Delivered’ Tariff. The most significant nibble is reserved.

14355 **10.2.2.3.5.2 When Generated**

14356 This command is generated when the client device wishes to verify the available Block Period events or  
 14357 after a loss of power/reset occurs and the client device needs to recover currently active or scheduled Block  
 14358 Periods.

14359 A Default response with status NOT\_FOUND shall be returned if there are no events available.

14360 **10.2.2.3.5.3 Effect on Receipt**

14361 On receipt of this command, the device shall send a Publish Block Period command (sub-clause 10.2.2.4.2)  
 14362 for all currently scheduled periods, up to the maximum number of commands specified.

14363

14364 **10.2.2.3.6 GetConversionFactor Command**

14365 This command initiates a PublishConversionFactor command(s) for the scheduled conversion factor updates.  
 14366 A server device shall be capable of storing at least two instances, the current and (if available) next instance  
 14367 to be activated in the near future.

14368 **10.2.2.3.6.1 Payload Format**

<sup>141</sup> CCB 1447

14369

**Figure 10-9. Format of the *GetConversionFactor* Command Payload**

<b>Octets</b>	4	4	1
<b>Data Type</b>	UTC	uint32	uint8
<b>Field Name</b>	Earliest Start Time (M)	Min. Issuer Event ID (M)	Number of Commands (M)

14370 **10.2.2.3.6.2 Payload Details**

14371 **Earliest Start Time (mandatory):** UTC Timestamp indicating the earliest start time of values to be returned  
 14372 by the corresponding PublishConversionFactor command. The first returned PublishConversionFactor com-  
 14373 mand shall be the instance which is active or becomes active at or after the stated Earliest Start Time. If  
 14374 more than one instance is requested, the active and scheduled instances shall be sent with ascending  
 14375 ordered StartTime.

14376 **Min. Issuer Event ID (mandatory):** A 32-bit integer representing the minimum Issuer Event ID of values  
 14377 to be returned by the corresponding PublishConversionFactor command. A value of 0xFFFFFFFF means not  
 14378 specified; the server shall return values irrespective of the value of the Issuer Event ID.

14379 **Number of Commands (mandatory):** An 8-bit integer which represents the maximum number of Publish-  
 14380 ConversionFactor commands that the client is willing to receive in response to this command. A value of 0  
 14381 would indicate A value of 0 indicates no maximum limit<sup>142</sup>.

14382 **10.2.2.3.6.3 Effect on Receipt**

14383 A Default response with status NOT\_FOUND shall be returned if there are no conversion factor updates  
 14384 available.

14385

14386 **10.2.2.3.7 GetCalorificValue Command**

14387 This command initiates a PublishCalorificValue command for the scheduled calorific value updates. A  
 14388 server device shall be capable of storing at least two instances, the current and (if available) next instance  
 14389 to be activated in the near future.

14390 Payload Format

14391

**Figure 10-10. Format of the *GetCalorificValue* Command Payload**

<b>Octets</b>	4	4	1
<b>Data Type</b>	UTC	uint32	uint8
<b>Field Name</b>	Earliest Start Time (M)	Min. Issuer Event ID (M)	Number of Commands (M)

14392 **10.2.2.3.7.1 Payload Details**

14393 **Earliest Start Time (mandatory):** UTC Timestamp indicating the earliest start time of values to be returned  
 14394 by the corresponding PublishCalorificValue command. The first returned PublishCalorificValue command  
 14395 shall be the instance which is active or becomes active at or after the stated Earliest Start Time. If more than  
 14396 one instance is requested, the active and scheduled instances shall be sent with ascending ordered Start Time.

<sup>142</sup> CCB 1447

14397 **Min. Issuer Event ID (mandatory):** A 32-bit integer representing the minimum Issuer Event ID of values  
 14398 to be returned by the corresponding PublishCalorificValue command. A value of 0xFFFFFFFF means not  
 14399 specified; the server shall return values irrespective of the value of the Issuer Event ID.

14400 **Number of Commands (mandatory):** An 8-bit integer which represents the maximum number of Pub-  
 14401 lishCalorificValue commands that the client is willing to receive in response to this command. A value of 0  
 14402 indicates no maximum limit<sup>143</sup>.

14403 **10.2.2.3.7.2 Effect on Receipt**

14404 A Default Response with status NOT\_FOUND shall be returned if there are no calorific value updates  
 14405 available.

14406

14407 **10.2.2.3.8 GetTariffInformation Command**

14408 This command initiates PublishTariffInformation command(s) for scheduled tariff updates. A server device  
 14409 shall be capable of storing at least **two** instances, current and the next instance to be activated in the future.

14410 One or more PublishTariffInformation commands are sent in response to this command.

14411 To obtain the complete tariff details, further GetPriceMatrix and GetBlockThesholds commands must be sent  
 14412 using the start time and IssuerTariffID obtained from the appropriate PublishTariffInformation command.

14413 **10.2.2.3.8.1 Payload Format**

14414

Figure 10-11. Format of the GetTariffInformation Command Payload

<b>Octets</b>	<b>4</b>	<b>4</b>	<b>1</b>	<b>1</b>
<b>Data Type</b>	UTC	uint32	uint8	map8
<b>Field Name</b>	Earliest Start Time (M)	Min. Issuer Event ID (M)	Number of Commands (M)	Tariff Type (M)

14415 **10.2.2.3.8.2 Payload Details**

14416 **Earliest Start Time (mandatory):** UTC Timestamp indicating the earliest start time of tariffs to be returned  
 14417 by the corresponding PublishTariffInformation command. The first returned PublishTariffInformation com-  
 14418 mand shall be the instance which is active or becomes active at or after the stated EarliestStartTime. If more  
 14419 than one command is requested, the active and scheduled commands shall be sent with ascending ordered  
 14420 StartTime.

14421 **Min. Issuer Event ID (mandatory):** A 32-bit integer representing the minimum Issuer Event ID of tariffs  
 14422 to be returned by the corresponding PublishTariffInformation command. A value of 0xFFFFFFFF means not  
 14423 specified; the server shall return tariffs irrespective of the value of the Issuer Event ID.

14424 **Number of Commands (mandatory):** An 8-bit integer which represents the maximum number of Publish-  
 14425 TariffInformation commands that the client is willing to receive in response to this command. A value of 0  
 14426 would indicate all available PublishTariffInformation commands shall be returned.

14427 **Tariff Type (mandatory):** An 8-bit bitmap identifying the type of tariff published in this command. The  
 14428 least significant nibble represents an enumeration of the tariff type as detailed in Table 10-37 (Generation  
 14429 Meters shall use the ‘Received’ Tariff.). The most significant nibble is reserved.

14430 **10.2.2.3.8.3 Effect on Receipt**

<sup>143</sup> CCB 1447

14431 A Default response with status NOT\_FOUND shall be returned if there are no tariff updates available.

14432

### 14433 **10.2.2.3.9 GetPriceMatrix Command**

14434 This command initiates a PublishPriceMatrix command for the scheduled Price Matrix updates. A server  
14435 device shall be capable of storing at least **two** instances, current and next instance to be activated in the future.

#### 14436 **10.2.2.3.9.1 Payload Format**

14437 **Figure 10-12. Format of the GetPriceMatrix Command Payload**

<b>Octets</b>	<b>4</b>
<b>Data Type</b>	uint32
<b>Field Name</b>	Issuer Tariff ID (M)

#### 14438 **10.2.2.3.9.2 Payload Details**

14439 **Issuer Tariff ID (mandatory):** *IssuerTariffID* indicates the tariff to which the requested Price Matrix belongs.  
14440

14441 **Note:** A Price Matrix instance may require multiple PublishPriceMatrix commands to be transmitted to the  
14442 client device.

#### 14443 **10.2.2.3.9.3 Effect on Receipt**

14444 A Default response with status NOT\_FOUND shall be returned if there are no Price Matrix updates available.  
14445

14446

### 14447 **10.2.2.3.10 GetBlockThresholds Command**

14448 This command initiates a PublishBlockThreshold command for the scheduled Block Threshold updates. A  
14449 server device shall be capable of storing at least **two** instances, current and next instance to be activated in  
14450 the future.

#### 14451 **10.2.2.3.10.1 Payload Format**

14452 **Figure 10-13. Format of the GetBlockThresholds Command Payload**

<b>Octets</b>	<b>4</b>
<b>Data Type</b>	uint32
<b>Field Name</b>	Issuer Tariff ID (M)

#### 14453 **10.2.2.3.10.2 Payload Details**

14454 **Issuer Tariff ID (mandatory):** Issuer Tariff ID indicates the tariff to which the requested Block Thresholds belong.  
14455

14456 **Note:** A Block Threshold instance may require multiple PublishBlockThreshold commands to be transmitted  
14457 to the client device.

#### 14458 **10.2.2.3.10.3 Effect on Receipt**

14459 A Default response with status NOT\_FOUND shall be returned if there are no Block Threshold updates  
14460 available.

14461

14462 **10.2.2.3.11 GetCO<sub>2</sub>Value Command**

14463 This command initiates PublishCO<sub>2</sub>Value command(s) for scheduled CO<sub>2</sub> conversion factor updates. A  
 14464 server device shall be capable of storing at least **two** instances, current and (if available) next instance to be  
 14465 activated in the future.

14466 **10.2.2.3.11.1 Payload Format**

14467 **Figure 10-14. Format of the GetCO<sub>2</sub>Value Command Payload**

<b>Octets</b>	<b>4</b>	<b>4</b>	<b>1</b>	<b>1</b>
<b>Data Type</b>	UTC	uint32	uint8	map8
<b>Field Name</b>	Earliest Start Time (M)	Min. Issuer Event ID (M)	Number of Commands (M)	Tariff Type (O)

14468 **10.2.2.3.11.2 Payload Details**

14469 **Earliest Start Time (mandatory):** UTC Timestamp indicating the earliest start time of values to be returned  
 14470 by the corresponding *PublishCO<sub>2</sub>Value* command. The first returned *PublishCO<sub>2</sub>Value* command shall be  
 14471 the instance which is active or becomes active at or after the stated *EarliestStartTime*. If more than one  
 14472 instance is requested, the active and scheduled instances shall be sent with ascending ordered *StartTime*.

14473 **Min. Issuer Event ID (mandatory):** A 32-bit integer representing the minimum *Issuer Event ID* of values  
 14474 to be returned by the corresponding *PublishCO<sub>2</sub>Value* command. A value of 0xFFFFFFFF means not speci-  
 14475 fied; the server shall return values irrespective of the value of the *Issuer Event ID*.

14476 **Number of Commands (mandatory):** An 8-bit Integer which represents the maximum number of *Pub-*  
 14477 *lishCO<sub>2</sub>Value* commands that the client is willing to receive in response to this command. A value of 0 would  
 14478 indicate all available *PublishCO<sub>2</sub>Value* commands shall be returned.

14479 **Tariff Type (Optional):** An 8-bit bitmap identifying the type of tariff published in this command. The least  
 14480 significant nibble represents an enumeration of the tariff type as detailed in Table 10-37 (Generation Meters  
 14481 shall use the ‘Received’ Tariff). A value of 0xFF means not specified. If the *TariffType* is not specified, the  
 14482 server shall return all CO<sub>2</sub> values regardless of tariff type. The most significant nibble is reserved.

14483 **10.2.2.3.11.3 Effect on Receipt**

14484 A Default response with status NOT\_FOUND shall be returned if there are no CO<sub>2</sub> conversion factor updates  
 14485 available.

14486

14487 **10.2.2.3.12 GetTierLabels Command**

14488 This command allows a client to retrieve the tier labels associated with a given tariff; this command initiates  
 14489 a PublishTierLabels command from the server.

14490 **10.2.2.3.12.1 Payload Format**

14491 **Figure 10-15. Format of the GetTierLabels Command Payload**

<b>Octets</b>	<b>4</b>
<b>Data Type</b>	uint32
<b>Field Name</b>	Issuer Tariff ID (M)

14492 **10.2.2.3.12.2 Payload Details**

14493 **Issuer Tariff ID (mandatory):** Unique identifier generated by the commodity supplier. This is used to identify the tariff that the labels apply to.  
14494

14495 **10.2.2.3.12.3 Effect on Receipt**

14496 A Default response with status NOT\_FOUND shall be returned if there are no tier label updates available.  
14497

14498 **10.2.2.3.13 GetBillingPeriod Command**

14499 This command initiates one or more PublishBillingPeriod commands for currently scheduled billing periods.

14500 **10.2.2.3.13.1 Payload Format**

14501 **Figure 10-16. Format of the GetBillingPeriod Command Payload**

<b>Octets</b>	<b>4</b>	<b>4</b>	<b>1</b>	<b>1</b>
<b>Data Type</b>	UTC	uint32	uint8	map8
<b>Field Name</b>	Earliest Start Time (M)	Min. Issuer Event ID (M)	Number of Commands (M)	Tariff Type (O)

14502 **10.2.2.3.13.2 Payload Details**

14503 **Earliest Start Time (mandatory):** UTC Timestamp indicating the earliest start time of billing periods to be returned by the corresponding *PublishBillingPeriod* command. The first returned *PublishBillingPeriod* command shall be the instance which is active or becomes active at or after the stated *EarliestStartTime*. If more than one instance is requested, the active and scheduled instances shall be sent with ascending ordered *StartTime*.  
14504  
14505  
14506  
14507

14508 **Min. Issuer Event ID (mandatory):** A 32-bit integer representing the minimum *Issuer Event ID* of billing periods to be returned by the corresponding *PublishBillingPeriod* command. A value of 0xFFFFFFFF means not specified; the server shall return periods irrespective of the value of the *Issuer Event ID*.  
14509  
14510

14511 **Number of Commands (mandatory):** An 8 bit Integer which indicates the maximum number of *PublishBillingPeriod* commands that the client is willing to receive in response to this command. A value of 0 would indicate all available *PublishBillingPeriod* commands shall be returned.  
14512  
14513

14514 **Tariff Type (optional):** An 8-bit bitmap identifying the *TariffType* of the requested Billing Period information. The least significant nibble represents an enumeration of the tariff type as detailed in Table 10-37 (Generation Meters shall use the ‘Received’ Tariff). A value of 0xFF means not specified. If the *TariffType* is not specified, the server shall return Billing Period information regardless of its type. The most significant nibble is reserved.  
14515  
14516  
14517  
14518

14519 **10.2.2.3.13.3 Effect on Receipt**

14520 A Default response with status NOT\_FOUND shall be returned if there are no scheduled billing periods available.  
14521  
14522

14523 **10.2.2.3.14 GetConsolidatedBill Command**

14524 This command initiates one or more PublishConsolidatedBill commands with the requested billing information.  
14525

14526 **10.2.2.3.14.1 Payload Format**



14527

**Figure 10-17. Format of the GetConsolidatedBill Command Payload**

<b>Octets</b>	<b>4</b>	<b>4</b>	<b>1</b>	<b>1</b>
<b>Data Type</b>	UTC	uint32	uint8	map8
<b>Field Name</b>	Earliest Start Time (M)	Min. Issuer Event ID (M)	Number of Commands (M)	Tariff Type (O)

14528 **10.2.2.3.14.2 Payload Details**

14529 **Earliest Start Time (mandatory):** UTC Timestamp indicating the earliest start time of billing information  
 14530 to be returned by the corresponding *PublishConsolidatedBill* command. The first returned *PublishConsoli-*  
 14531 *datedBill* command shall be the instance which is active or becomes active at or after the stated *EarliestStart-*  
 14532 *Time*. If more than one instance is requested, the active and scheduled instances shall be sent with ascending  
 14533 ordered *StartTime*.

14534 **Min. Issuer Event ID (mandatory):** A 32-bit integer representing the minimum *Issuer Event ID* of billing  
 14535 information to be returned by the corresponding *PublishConsolidatedBill* command. A value of 0xFFFFFFFF  
 14536 means not specified; the server shall return information irrespective of the value of the *Issuer Event ID*.

14537 **Number of Commands (mandatory):** An 8 bit Integer which indicates the maximum number of Publish-  
 14538 ConsolidatedBill commands that can be sent. A value of 0 would indicate all available PublishConsolidated-  
 14539 Bill commands shall be returned.

14540 **Tariff Type (Optional):** An 8-bit bitmap identifying the type of tariff published in this command. The least  
 14541 significant nibble represents an enumeration of the tariff type as detailed in Table 10-37 (Generation Meters  
 14542 shall use the ‘Received’ Tariff). A value of 0xFF means not specified. If the *TariffType* is not specified, the  
 14543 server shall return all billing information regardless of tariff type. The most significant nibble is reserved.

14544 **10.2.2.3.14.3 Effect on Receipt**

14545 A Default response with status NOT\_FOUND shall be returned if there is no billing information available.

14546

14547 **10.2.2.3.15 CPPEventResponse Command**

14548 **Note:** The *CPPEventResponse* command in this revision of this specification is provisional and not certifi-  
 14549 able. This feature may change before reaching certifiable status in a future revision of this specification.

14550 The *CPPEventResponse* command is sent from a Client (IHD) to the ESI to notify it of a Critical Peak Pricing  
 14551 event authorization.

14552 **10.2.2.3.15.1 Payload Format**

14553 **Figure 10-18. Format of the CPPEventResponse Command Payload**

<b>Octets</b>	<b>4</b>	<b>1</b>
<b>Data Type</b>	uint32	enum8
<b>Field Name</b>	Issuer Event ID (M)	CPP Auth (M)

14554 **10.2.2.3.15.2 Payload Details**

14555 **Issuer Event ID (mandatory):** Unique identifier generated by the commodity provider. When new infor-  
 14556 mation is provided that replaces older information for the same time period, this field allows devices to de-  
 14557 termine which information is newer. The value contained in this field is a unique number managed by up-  
 14558 stream servers or a UTC based time stamp (UTCTime data type) identifying when the Publish command was  
 14559 issued. Thus, newer information will have a value in the *Issuer Event ID* field that is larger than older infor-  
 14560 mation.

14561 **CPP Auth (mandatory):** An 8-bit enumeration identifying the status of the CPP event. This field shall con-  
14562 tain the ‘Accepted’ or ‘Rejected’ values defined in Table 10-42.

14563 **10.2.2.3.15.3 When Generated**

14564 The CPPEventResponse command is sent in response to the PublishCPPEvent command, for either the Meter  
14565 or the IHD, as acceptance or rejection of the CPP event.

14566 **10.2.2.3.15.4 Effect on Receipt**

14567 When the *CPPEventResponse* is received by the ESI, it will look at the *CPPAuth* parameter to determine  
14568 what action shall be taken next.

14569 The ESI shall resend the PublishCPPEvent command, but with the CPPAuth field now set to the value re-  
14570 ceived in the CPPEventResponse command.

14571

14572 **10.2.2.3.16 GetCreditPayment Command**

14573 This command initiates PublishCreditPayment commands for the requested credit payment information.

14574 **10.2.2.3.16.1 Payload Format**

14575 **Figure 10-19. Format of the *GetCreditPayment* Command Payload**

<b>Octets</b>	<b>4</b>	<b>1</b>
<b>Data Type</b>	UTC	uint8
<b>Field Name</b>	Latest End Time (M)	NumberOf Records (M)

14576 **10.2.2.3.16.2 Payload Details**

14577 **Latest End Time (mandatory):** UTC timestamp indicating the latest *CreditPaymentDate* of rec-  
14578 ords to be returned by the corresponding *PublishCreditPayment* commands. The first returned  
14579 *PublishCreditPayment* command shall be the most recent record with its *CreditPaymentDate* equal to  
14580 or older than the *Latest End Time* provided.

14581 **NumberofRecords (mandatory):** An 8-bit integer that represents the maximum number of PublishCredit-  
14582 Payment commands that the client is willing to receive in response to this command. A value of 0 would  
14583 indicate all available PublishCreditPayment commands shall be returned. If more than one record is re-  
14584 quested, the PublishCreditPayment commands should be returned with descending ordered CreditPay-  
14585 mentDate. If fewer records are available than are being requested, only those available are returned.

14586 **10.2.2.3.16.3 Effect on Receipt**

14587 A Default response with status NOT\_FOUND shall be returned if there is no credit payment information  
14588 available.

14589

14590 **10.2.2.3.17 GetCurrencyConversion Command**

14591 This command initiates a PublishCurrencyConversion command for the currency conversion factor updates.  
14592 A server shall be capable of storing both the old and the new currencies.

14593 **10.2.2.3.17.1 Payload Details**

14594 This command has no payload.

14595 **10.2.2.3.17.2 Effect on Receipt**

14596 A Default response with status NOT\_FOUND shall be returned if there are no currency conversion factor  
 14597 updates available.

14598

14599 **10.2.2.3.18 GetTariffCancellation Command**

14600 This command initiates the return of the last CancelTariff command held on the associated server.

14601 **10.2.2.3.18.1 Payload Details**

14602 This command has no payload.

14603 **10.2.2.3.18.2 When Generated**

14604 This command is generated when the client device wishes to fetch any pending *CancelTariff* command from  
 14605 the server (see 10.2.2.4.15 for further details). In the case of a BOMD, this may be as a result of the associated  
 14606 Notification flag.

14607 A Default response with status NOT\_FOUND shall be returned if there is no CancelTariff command avail-  
 14608 able.

14609

14610

14611 **10.2.2.4 Commands Generated**

14612 The server side of the Price cluster is capable of generating the commands listed in Table 10-25.

14613

**Table 10-25. Generated Command IDs for the Price Cluster**

Command Identifier Field Value	Description	M
0x00	<i>Publish Price</i>	M
0x01	<i>Publish Block Period</i>	O
0x02	<i>Publish Conversion Factor</i>	O
0x03	<i>Publish Calorific Value</i>	O
0x04	<i>PublishTariffInformation</i>	O
0x05	<i>PublishPriceMatrix</i>	O
0x06	<i>PublishBlockThresholds</i>	O
0x07	<i>PublishCO<sub>2</sub>Value</i>	O
0x08	<i>PublishTierLabels</i>	O
0x09	<i>PublishBillingPeriod</i>	O
0x0A	<i>PublishConsolidatedBill</i>	O
0x0B	<i>PublishCPPEvent</i>	O
0x0C	<i>PublishCreditPayment</i>	O
0x0D	<i>PublishCurrencyConversion</i>	O

Command Identifier Field Value	Description	M
0x0E	<i>CancelTariff</i>	O

14614

14615 **10.2.2.4.1 Publish Price Command**

14616 The Publish Price command is generated in response to receiving a Get Current Price command (see sub-  
14617 clause 10.2.2.3.2), in response to a Get Scheduled Prices command (see sub-clause 10.2.2.3.3), and when an  
14618 update to the pricing information is available from the commodity provider, either before or when a TOU  
14619 price becomes active. Additionally the Publish Price Command is generated as specified in sub-clause  
14620 10.2.4.3 when Block Pricing is in effect.

14621 When a Get Current Price or Get Scheduled Prices command is received over a ZigBee Smart Energy  
14622 network, the Publish Price command should be sent unicast to the requester. In the case of an update to  
14623 the pricing information from the commodity provider, the Publish Price command should be unicast to all  
14624 individually registered devices implementing the Price Cluster on the ZigBee Smart Energy network.

14625 Devices capable of receiving this command must be capable of storing and supporting at least two pricing  
14626 information instances, the current active price and the next price. By supporting at least two pricing infor-  
14627 mation instances, receiving devices will allow the Publish Price command generator to publish the next  
14628 pricing information during the current pricing period.

14629 Nested and overlapping Publish Price commands are not allowed. The current active price will be replaced  
14630 if new price information is received by the ESI. In the case of overlapping events, the event with the newer  
14631 Issuer Event ID takes priority over all nested and overlapping events. All existing events that overlap, even  
14632 partially, should be removed. The only exception to this is that if an event with a newer Issuer Event ID over-  
14633 laps with the end of the current active price but is not yet active, the active price is not deleted but its  
14634 duration is modified to 0xFFFF (until changed) so that the active price ends when the new event begins.

14635 **10.2.2.4.1.1 Payload Format**

14636 The PublishPrice command payload shall be formatted as illustrated in Figure 10-20.

14637 **Figure 10-20. Format of the Publish Price Command Payload**

<b>Octets</b>	4	1-13	4	4	1	2	1
<b>Data Type</b>	uint32	octstr	uint32	UTC	enum8	uint16	map8
<b>Field Name</b>	Provider ID (M)	Rate Label (M)	Issuer Event ID (M)	Current Time (M)	Unit of Measure (M)	Currency (M)	Price Trailing Digit & Price Tier (M)

14638

<b>Octets</b>	1	4	2	4	1	4	1
<b>Data Type</b>	map8	UTC	uint16	uint32	uint8	uint32	uint8
<b>Field Name</b>	Number of Price Tiers & Register Tier (M)	Start Time (M)	Duration In Minutes (M)	Price (M)	Price Ratio (O)	Generation Price (O)	Generation Price Ratio (O)

14639

<b>Octets</b>	4	1	1	1 <sup>b</sup>	1 <sup>c</sup>
<b>Data Type</b>	uint32	enum8	map8	8 bit integer	map8
<b>Field Name</b>	Alternate Cost Delivered (O)	Alternate Cost Unit (O)	Alternate Cost Trailing Digit(O)	Number of Block Thresholds (O)	Price Control (O)

14640

<b>Octets</b>	4	1	1	1	1
<b>Data Type</b>	8 bit integer	enum8	enum8	enum8	enum8
<b>Field Name</b>	Number of Generation Tiers(O)	Generation Tier(O)	Extended Number of Price Tiers (O)	Extended Price Tier (O)	Extended Register Tier (O)

14641

14642 **Note:** M = Mandatory field, O = Optional field. An optional field SHALL define a value to indicate that  
 14643 it is to be ignored.<sup>144</sup>

14644 **Provider ID (mandatory):** An unsigned 32-bit field containing a unique identifier for the commodity pro-  
 14645 vider. This field is thought to be useful in deregulated markets where multiple commodity providers may be  
 14646 available.

14647 **Rate Label (mandatory):** An Octet String field capable of storing a 12 character string (the first octet  
 14648 indicates length) containing commodity provider- specific information regarding the current billing rate. The  
 14649 String shall be encoded in the UTF-8 format. This field allows differentiation when a commodity provider  
 14650 may have multiple pricing plans.

14651 **Issuer Event ID (mandatory):** Unique identifier generated by the commodity provider. When new pricing  
 14652 information is provided that replaces older pricing information for the same time period, this field allows  
 14653 devices to determine which information is newer. It is expected that the value contained in this field is  
 14654 a unique number managed by upstream servers or a UTC based time stamp (UTC data type) identifying  
 14655 when the Publish Price command was issued. Thus, newer pricing information will have a value in the Issuer  
 14656 Event ID field that is larger than older pricing information.

14657 **Current Time (mandatory):** A UTC field containing the current time as determined by the device. This  
 14658 field provides an extra value-added feature for the broadcast price signals.

14659 **Unit of Measure (mandatory):** An 8-bit enumeration field identifying the commodity as well as its base  
 14660 unit of measure. The enumeration used for this field shall match one of the UnitOfMeasure values using a  
 14661 pure binary format as defined in the Metering cluster (see sub-clause 10.4.2.2.4.1).

14662 **Currency (mandatory):** An unsigned 16-bit field containing identifying information concerning the local  
 14663 unit of currency used in the price field. This field allows the displaying of the appropriate symbol for a currency  
 14664 (e.g.: \$).

14665 The value of the currency field should match the values defined by ISO 4217.

14666 **Price Trailing Digit and Price Tier (mandatory):** An 8-bit field used to determine where the decimal point  
 14667 is located in the price field and to indicate the current pricing tier as chosen by the commodity provider. The  
 14668 most significant nibble is the Trailing Digit sub-field which indicates the number of digits to the right of the  
 14669 decimal point. The least significant nibble is an enumerated field containing the current Price Tier.

<sup>144</sup> CCB 2287 2964 2965 (see 2.3.4 & 2.4 for more information)

14670 Valid values for the Price Tier sub-field are from 1 to 15 reflecting the least expensive tier (1) to the most ex-  
 14671 pensive tiers (15). A value of zero indicates no price tier is in use. This parameter also references the associ-  
 14672 ated *TierNPriceLabel* attribute assigned to the Price Tier. Table 10-26 depicts the assignments. The meaning  
 14673 of value 0xF is dependant on the value of the optional Extended Price Tier field. Absence of this field, or a  
 14674 value of 0x00 in this field, indicates that the current Price Tier is fifteen, and references the *Tier15PriceLa-*  
 14675 *bel* attribute.. Where the Extended Price Tier field contains a non-zero value, the current Price Tier and  
 14676 *TierNPriceLabel* attribute are determined by the sum of the values of the Price Tier sub-field and the Extended  
 14677 Price Tier field.

14678  
14679

**Table 10-26. Price Tier Sub-field Enumerations**

Enumerated Value	Price Tier
0x0	No Tier Related
0x1	Reference <i>Tier1PriceLabel</i>
0x2	Reference <i>Tier2PriceLabel</i>
0x3	Reference <i>Tier3PriceLabel</i>
0x4	Reference <i>Tier4PriceLabel</i>
0x5	Reference <i>Tier5PriceLabel</i>
0x6	Reference <i>Tier6PriceLabel</i>
0x7	Reference <i>Tier7PriceLabel</i>
0x8	Reference <i>Tier8PriceLabel</i>
0x9	Reference <i>Tier9PriceLabel</i>
0xA	Reference <i>Tier10PriceLabel</i>
0xB	Reference <i>Tier11PriceLabel</i>
0xC	Reference <i>Tier12PriceLabel</i>
0xD	Reference <i>Tier13PriceLabel</i>
0xE	Reference <i>Tier14PriceLabel</i>
0xF	Dependant on the value of the <i>Extended Price Tier</i> field

14680

14681 **Number of Price Tiers & Register Tier (mandatory):** An 8-bit bitmap where the most significant nibble  
 14682 is an enumerated sub-field representing the maximum number of price tiers available, and the least signifi-  
 14683 cant nibble is an enumerated sub-field indicating the register tier used with the current Price Tier.

14684 Valid values for the Number of Price Tiers sub-field are from 0 to 15 reflecting no tiers in use (0) to fifteen  
 14685 or more tiers available (15). The meaning of value 0xF is dependant on the value of the optional Extended  
 14686 Number of Price Tiers field. Absence of this field, or a value of 0x00 in this field, indicates that maximum  
 14687 number of tiers available is fifteen. Where the Extended Number of Price Tiers field contains a non-zero  
 14688 value, the maximum number of tiers available is determined by the sum of the values of the Number of Price  
 14689 Tiers sub-field and the Extended Number of Price Tiers field.

14690 The Register Tier values correlate which *CurrentTierNSummationDelivered* attribute, found in sub-clause  
 14691 10.4.2.2.2 is accumulating usage information. Register Tier enumerated values are listed in Table 10-27. The  
 14692 meaning of value 0xF is dependant on the value of the optional *Extended Register Tier* field. Absence of this

14693 field, or a value of 0x00 in this field, indicates that usage information is being accumulated in the *CurrentTier15SummationDelivered* attribute. Where the *Extended Register Tier* field contains a non-zero value,  
 14694 the *CurrentTierNSummationDelivered* attribute currently accumulating usage information by the sum of the  
 14695 values of the *Register Tier* sub-field and the *Extended Register Tier* field.  
 14696

14697 Both attributes can be used to calculate and display usage and subsequent costs..

14698 Table 10-27. Register Tier Sub-field Enumerations

Enumerated Value	Register Tier
0x0	No Tier Related
0x1	Usage accumulating in <i>CurrentTier1SummationDelivered</i> attribute
0x2	Usage accumulating in <i>CurrentTier2SummationDelivered</i> attribute
0x3	Usage accumulating in <i>CurrentTier3SummationDelivered</i> attribute
0x4	Usage accumulating in <i>CurrentTier4SummationDelivered</i> attribute
0x5	Usage accumulating in <i>CurrentTier5SummationDelivered</i> attribute
0x6	Usage accumulating in <i>CurrentTier6SummationDelivered</i> attribute
0x7	Usage accumulating in <i>CurrentTier7SummationDelivered</i> attribute
0x8	Usage accumulating in <i>CurrentTier8SummationDelivered</i> attribute
0x9	Usage accumulating in <i>CurrentTier9SummationDelivered</i> attribute
0xA	Usage accumulating in <i>CurrentTier10SummationDelivered</i> attribute
0xB	Usage accumulating in <i>CurrentTier11SummationDelivered</i> attribute
0xC	Usage accumulating in <i>CurrentTier12SummationDelivered</i> attribute
0xD	Usage accumulating in <i>CurrentTier13SummationDelivered</i> attribute
0xE	Usage accumulating in <i>CurrentTier14SummationDelivered</i> attribute
0xF	Dependant on the value of the <i>Extended Register Tier</i> field

14699

14700 **Start Time (mandatory):** A UTC field to denote the time at which the price signal becomes valid. A Start  
 14701 Time of 0x00000000 is a special time denoting “now.”

14702 If the device would send a price with a Start Time of now, adjust the Duration In Minutes field to correspond  
 14703 to the remainder of the price.

14704 **Duration In Minutes (mandatory):** An unsigned 16-bit field used to denote the amount of time in minutes  
 14705 after the Start Time during which the price signal is valid. Maximum value means “until changed”. If Block  
 14706 Charging only is in use (see sub-clause 10.2.4.3 for further details), the Duration in Minutes field of the  
 14707 Publish Price command shall be set to 0xFFFF indicating the price is valid “until changed”.

14708 **Price (mandatory):** An unsigned 32-bit field containing the price of the commodity measured in base unit  
 14709 of Currency per Unit of Measure with the decimal point located as indicated by the Price Trailing Digit  
 14710 field when the commodity is delivered to the premises.

14711 **Price Ratio (optional):** An unsigned 8-bit field that gives the ratio of the price denoted in the Price field  
 14712 to the “normal” price chosen by the commodity provider. This field is thought to be useful in situations  
 14713 where client devices may simply be interested in pricing levels or ratios. The value in this field should be  
 14714 scaled by a factor of 0.1, giving a range of ratios from 0.1 to 25.4. A value of 0xFF indicates the field is not  
 14715 used and 0x00 is an invalid value.

14716 **Generation Price (optional):** An unsigned 32-bit field containing the price of the commodity measured in  
 14717 base unit of Currency per Unit of Measure with the decimal point located as indicated by the Price Trailing  
 14718 Digit field when the commodity is received from the premises. An example use of this field is in energy  
 14719 markets where the price of electricity from the grid is different than the price of electricity placed on the  
 14720 grid. A value of 0xFFFFFFFF indicates the field is not used.

14721 **Generation Price Ratio (optional):** An unsigned 8-bit field that gives the ratio of the price denoted in the  
 14722 Generation Price field to the “normal” price chosen by the commodity provider. This field is thought to be  
 14723 useful in situations where client devices may simply be interested in pricing levels or ratios. The value in this  
 14724 field should be scaled by a factor of 0.1, giving a range of ratios from 0.1 to 25.4. A value of 0xFF  
 14725 indicates the field is not used and 0x00 is an invalid value.

14726 **Alternate Cost Delivered (optional):** An unsigned 32 Integer field that provides a mechanism to describe  
 14727 an alternative measure of the cost of the energy consumed. An example of an Alternate Cost might be the  
 14728 emissions of CO<sub>2</sub> for each kWh of electricity consumed providing a measure of the environmental cost.  
 14729 Another example is the emissions of CO<sub>2</sub> for each cubic meter of gas consumed (for gas metering). A differ-  
 14730 ent value for each price tier may be provided which can be used to reflect the different mix of generation that  
 14731 is associated with different TOU rates. A value of 0xFFFFFFFF indicates the field is not used.

14732 **Alternate Cost Unit (optional):** An 8-bit enumeration identifying the for the Alternate Cost Delivered  
 14733 field. A value of 0xFF indicates the field is not used.

14734

**Table 10-28. Alternate Cost Unit Enumerations**

Values	Description
0x01	Kg of CO <sub>2</sub> per unit of measure

14735

14736 **Alternate Cost Trailing Digit (optional):** An 8-bit bitmap field used to determine where the decimal point  
 14737 is located in the alternate cost field. The most significant nibble indicates the number of digits to the right  
 14738 of the decimal point. The least significant nibble is reserved. A value of 0xFF indicates the field is not used.

14739 **Number of Block Thresholds (optional):** An 8-bit integer which indicates the number of block thresholds  
 14740 available. Valid values are from 0 to 15 reflecting no blocks in use (0) to 15 block thresholds available (15).  
 14741 A value of 0xFF indicates field not used. Any value between 1 and 15 indicates that Block Pricing shall be  
 14742 used, see sub-clause 10.2.4.3 for further details.

14743 For combined Block/TOU charging, where multiple sets of Block Thresholds are being utilized, the field  
 14744 shall indicate the number of block thresholds available in the current price tier.

14745 **Price Control (optional):** Identifies additional control options for the price event. A value of 0x00 indicates  
 14746 field not used. Note that for ZigBee SE 1.1 and later devices, the Price Acknowledgement command is  
 14747 mandatory, but for SE 1.0 devices, it was optional, so the sender of the Publish Price command should  
 14748 not rely on receiving a Price Acknowledgment command even if the Price Acknowledgement bit in the Price  
 14749 Control Field is set.

14750 If Bit 1 is set, this indicates that the total number of tiers exceeds the 15 specified in the command; this shall  
 14751 indicate to a client complying with this specification that it should read the total number of tiers using the  
 14752 GetTariffInformation command.

14753 The BitMap for this field is described in Table 10-29.



14754

**Table 10-29. Price Control Field BitMap**

Bit	Description
0	0=Price Acknowledgement not required 1=Price Acknowledgement required
1	0=Total Tiers DOES NOT exceed 15 1= Total Tiers exceeds the 15 specified in the com-

14755

14756 **Number of Generation Tiers (optional):** Specifies the total number of generation tiers applicable in the  
 14757 current tariff, valid values are 0-48.

14758 **Generation Tier (optional):** An 8-bit enumerated value specifying the current generation tier. See Table  
 14759 10-30.

14760

**Table 10-30. Generation Tier Enumerations**

Enumerated Value	Description
0x01	Usage accumulating in <i>CurrentTier1SummationReceived</i> attribute
0x02	Usage accumulating in <i>CurrentTier2SummationReceived</i> attribute
0x03	Usage accumulating in <i>CurrentTier3SummationReceived</i> attribute
0x04	Usage accumulating in <i>CurrentTier4SummationReceived</i> attribute
0x05	Usage accumulating in <i>CurrentTier5SummationReceived</i> attribute
0x06	Usage accumulating in <i>CurrentTier6SummationReceived</i> attribute
0x07	Usage accumulating in <i>CurrentTier7SummationReceived</i> attribute
0x08	Usage accumulating in <i>CurrentTier8SummationReceived</i> attribute
0x09	Usage accumulating in <i>CurrentTier9SummationReceived</i> attribute
0x0A	Usage accumulating in <i>CurrentTier10SummationReceived</i> attribute
0x0B	Usage accumulating in <i>CurrentTier11SummationReceived</i> attribute
0x0C	Usage accumulating in <i>CurrentTier12SummationReceived</i> attribute
0x0D	Usage accumulating in <i>CurrentTier13SummationReceived</i> attribute
0x0E	Usage accumulating in <i>CurrentTier14SummationReceived</i> attribute
0x0F	Usage accumulating in <i>CurrentTier15SummationReceived</i> attribute
0x10	Usage accumulating in <i>CurrentTier16SummationReceived</i> attribute
0x11	Usage accumulating in <i>CurrentTier17SummationReceived</i> attribute
0x12	Usage accumulating in <i>CurrentTier18SummationReceived</i> attribute
0x13	Usage accumulating in <i>CurrentTier19SummationReceived</i> attribute
0x14	Usage accumulating in <i>CurrentTier20SummationReceived</i> attribute
0x15	Usage accumulating in <i>CurrentTier21SummationReceived</i> attribute
0x16	Usage accumulating in <i>CurrentTier22SummationReceived</i> attribute
0x17	Usage accumulating in <i>CurrentTier23SummationReceived</i> attribute
0x18	Usage accumulating in <i>CurrentTier24SummationReceived</i> attribute
0x19	Usage accumulating in <i>CurrentTier25SummationReceived</i> attribute
0x1A	Usage accumulating in <i>CurrentTier26SummationReceived</i> attribute
0x1B	Usage accumulating in <i>CurrentTier27SummationReceived</i> attribute
0x1C	Usage accumulating in <i>CurrentTier28SummationReceived</i> attribute

0x1D	Usage accumulating in <i>CurrentTier29SummationReceived</i> attribute
0x1E	Usage accumulating in <i>CurrentTier30SummationReceived</i> attribute
0x1F	Usage accumulating in <i>CurrentTier31SummationReceived</i> attribute
0x20	Usage accumulating in <i>CurrentTier32SummationReceived</i> attribute
0x21	Usage accumulating in <i>CurrentTier33SummationReceived</i> attribute
0x22	Usage accumulating in <i>CurrentTier34SummationReceived</i> attribute
0x23	Usage accumulating in <i>CurrentTier35SummationReceived</i> attribute
0x24	Usage accumulating in <i>CurrentTier36SummationReceived</i> attribute
0x25	Usage accumulating in <i>CurrentTier37SummationReceived</i> attribute
0x26	Usage accumulating in <i>CurrentTier38SummationReceived</i> attribute
0x27	Usage accumulating in <i>CurrentTier39SummationReceived</i> attribute
0x28	Usage accumulating in <i>CurrentTier40SummationReceived</i> attribute
0x29	Usage accumulating in <i>CurrentTier41SummationReceived</i> attribute
0x2A	Usage accumulating in <i>CurrentTier42SummationReceived</i> attribute
0x2B	Usage accumulating in <i>CurrentTier43SummationReceived</i> attribute
0x2C	Usage accumulating in <i>CurrentTier44SummationReceived</i> attribute
0x2D	Usage accumulating in <i>CurrentTier45SummationReceived</i> attribute
0x2E	Usage accumulating in <i>CurrentTier46SummationReceived</i> attribute
0x2F	Usage accumulating in <i>CurrentTier47SummationReceived</i> attribute
0x30	Usage accumulating in <i>CurrentTier48SummationReceived</i> attribute

14761  
14762  
14763  
14764  
14765  
14766  
14767

**Extended Number of Price Tiers (optional):** Where the the maximum number of price tiers available exceeds the value of 15 supported by the *Number of Price Tiers* sub-field, this enumerated field is used in conjunction with the *Number of Price Tiers* sub-field to indicate the maximum number of price tiers available. Valid values for the *Extended Number of Price Tiers* field are from 1 to 33, indicating a maximum number of tiers available from 16 to 48 respectively. A value of zero indicates that the maximum number of price tiers available is indicated by the *Number of Price Tiers* sub-field alone.

14768  
14769  
14770  
14771  
14772

**Extended Price Tier (optional):** Where the current Price Tier exceeds the value of 15 supported by the *Price Tier* sub-field, this enumerated field is used in conjunction with the *Price Tier* sub-field to indicate the current Price Tier. Valid values for the *Extended Price Tier* field are from 1 to 33, indicating a current Price Tier of 16 to 48 respectively as shown in Table 10-31. A value of zero indicates that the current status of the Price Tier is indicated by the *Price Tier* sub-field alone.

14773

**Table 10-31. Extended Price Tier Field Enumerations**

Enumerated Value	Price Tier
0x00	Refer to <i>Price Tier</i> sub-field
0x01	Reference <i>Tier16PriceLabel</i>
0x02	Reference <i>Tier17PriceLabel</i>
0x03	Reference <i>Tier18PriceLabel</i>
0x04	Reference <i>Tier19PriceLabel</i>
0x05	Reference <i>Tier20PriceLabel</i>
0x06	Reference <i>Tier21PriceLabel</i>
0x07	Reference <i>Tier22PriceLabel</i>
0x08	Reference <i>Tier23PriceLabel</i>
0x09	Reference <i>Tier24PriceLabel</i>
0x0A	Reference <i>Tier25PriceLabel</i>

0x0B	Reference <i>Tier26PriceLabel</i>
0x0C	Reference <i>Tier27PriceLabel</i>
0x0D	Reference <i>Tier28PriceLabel</i>
0x0E	Reference <i>Tier29PriceLabel</i>
0x0F	Reference <i>Tier30PriceLabel</i>
0x10	Reference <i>Tier31PriceLabel</i>
0x11	Reference <i>Tier32PriceLabel</i>
0x12	Reference <i>Tier33PriceLabel</i>
0x13	Reference <i>Tier34PriceLabel</i>
0x14	Reference <i>Tier35PriceLabel</i>
0x15	Reference <i>Tier36PriceLabel</i>
0x16	Reference <i>Tier37PriceLabel</i>
0x17	Reference <i>Tier38PriceLabel</i>
0x18	Reference <i>Tier39PriceLabel</i>
0x19	Reference <i>Tier40PriceLabel</i>
0x1A	Reference <i>Tier41PriceLabel</i>
0x1B	Reference <i>Tier42PriceLabel</i>
0x1C	Reference <i>Tier43PriceLabel</i>
0x1D	Reference <i>Tier44PriceLabel</i>
0x1E	Reference <i>Tier45PriceLabel</i>
0x1F	Reference <i>Tier46PriceLabel</i>
0x20	Reference <i>Tier47PriceLabel</i>
0x21	Reference <i>Tier48PriceLabel</i>

14774

14775 **Extended Register Tier (mandatory):** Where the current Register Tier exceeds the value of 15 supported  
 14776 by the *Register Tier* sub-field, this enumerated field is used in conjunction with the *Register Tier* sub-field to  
 14777 indicate which *CurrentTierNSummationDelivered* attribute, found in sub-clause 10.4.2.2.2, is accumulating  
 14778 usage information. Valid values for the *Extended Register Tier* field are from 1 to 33, indicating a current  
 14779 Register Tier of 16 to 48 respectively as shown in Table 10-32. A value of zero indicates that the current  
 14780 status of the Register Tier is indicated by the *Register Tier* sub-field alone.

14781

**Table 10-32. Extended Register Tier Field Enumerations**

Enumerated Value	Register Tier
0x00	Refer to <i>Register Tier</i> sub-field
0x01	Usage accumulating in <i>CurrentTier16SummationDelivered</i> attribute
0x02	Usage accumulating in <i>CurrentTier17SummationDelivered</i> attribute
0x03	Usage accumulating in <i>CurrentTier18SummationDelivered</i> attribute
0x04	Usage accumulating in <i>CurrentTier19SummationDelivered</i> attribute
0x05	Usage accumulating in <i>CurrentTier20SummationDelivered</i> attribute
0x06	Usage accumulating in <i>CurrentTier21SummationDelivered</i> attribute
0x07	Usage accumulating in <i>CurrentTier22SummationDelivered</i> attribute
0x08	Usage accumulating in <i>CurrentTier23SummationDelivered</i> attribute
0x09	Usage accumulating in <i>CurrentTier24SummationDelivered</i> attribute

0x0A	Usage accumulating in <i>CurrentTier25SummationDelivered</i> attribute
0x0B	Usage accumulating in <i>CurrentTier26SummationDelivered</i> attribute
0x0C	Usage accumulating in <i>CurrentTier27SummationDelivered</i> attribute
0x0D	Usage accumulating in <i>CurrentTier28SummationDelivered</i> attribute
0x0E	Usage accumulating in <i>CurrentTier29SummationDelivered</i> attribute
0x0F	Usage accumulating in <i>CurrentTier30SummationDelivered</i> attribute
0x10	Usage accumulating in <i>CurrentTier31SummationDelivered</i> attribute
0x11	Usage accumulating in <i>CurrentTier32SummationDelivered</i> attribute
0x12	Usage accumulating in <i>CurrentTier33SummationDelivered</i> attribute
0x13	Usage accumulating in <i>CurrentTier34SummationDelivered</i> attribute
0x14	Usage accumulating in <i>CurrentTier35SummationDelivered</i> attribute
0x15	Usage accumulating in <i>CurrentTier36SummationDelivered</i> attribute
0x16	Usage accumulating in <i>CurrentTier37SummationDelivered</i> attribute
0x17	Usage accumulating in <i>CurrentTier38SummationDelivered</i> attribute
0x18	Usage accumulating in <i>CurrentTier39SummationDelivered</i> attribute
0x19	Usage accumulating in <i>CurrentTier40SummationDelivered</i> attribute
0x1A	Usage accumulating in <i>CurrentTier41SummationDelivered</i> attribute
0x1B	Usage accumulating in <i>CurrentTier42SummationDelivered</i> attribute
0x1C	Usage accumulating in <i>CurrentTier43SummationDelivered</i> attribute
0x1D	Usage accumulating in <i>CurrentTier44SummationDelivered</i> attribute
0x1E	Usage accumulating in <i>CurrentTier45SummationDelivered</i> attribute
0x1F	Usage accumulating in <i>CurrentTier46SummationDelivered</i> attribute
0x20	Usage accumulating in <i>CurrentTier47SummationDelivered</i> attribute
0x21	Usage accumulating in <i>CurrentTier48SummationDelivered</i> attribute

14782

14783 **10.2.2.4.1.2 Effect on Receipt**

14784 On receipt of this command, the device is informed of a price event for the specific provider, commodity,  
14785 and currency indicated.

14786 Should the device choose to change behavior based on the price event, the change of behavior should occur  
14787 after a random delay between 0 and 5 minutes, to avoid potential spikes that could occur as a result of  
14788 coordinated behavior changes. Likewise, should a device choose to change behavior based on the expira-  
14789 tion of the price event, the change in behavior should occur after a random delay between 0 and 5 minutes.

14790

14791 **10.2.2.4.2 Publish Block Period Command**

14792 The Publish Block Period command is generated in response to receiving a Get Block Period(s) command  
 14793 (see sub-clause 10.2.2.3.5) or when an update to the block tariff schedule is available from the commodity  
 14794 provider. When the Get Block Period(s) command is received over the ZigBee Smart Energy network, the  
 14795 Publish Block Period command(s) should be sent unicast to the requestor. In the case of an update to the  
 14796 block tariff schedule from the commodity provider, the Publish Block Period command should be unicast  
 14797 to all individually registered devices implementing the Price Cluster on the ZigBee Smart Energy network.

14798 Devices capable of receiving this command must be capable of storing and supporting two block periods,  
 14799 the current active block and the next block. By supporting two block periods, receiving devices will  
 14800 allow the Publish Block Period command generator to publish the next block information during the  
 14801 current block period.

14802 Payload Format

14803 **Figure 10-21. Format of the Publish Block Period Command Payload**

Oc-tets	4	4	4	3	1	1	1	1
Data Type	uint32	uint32	UTC	uint24	map8	map8	map8	enum8
Field Name	Provider ID (M)	Issuer Event ID (M)	Block Period Start Time (M)	Block Period Duration (M)	Block Period Control (M)	Block Period Duration Type (M)	Tariff Type (M)	Tariff Resolution Period (M)

14804

14805 **Provider ID (mandatory):** An unsigned 32-bit field containing a unique identifier for the commodity pro-  
 14806 vider. This field allows differentiation in deregulated markets where multiple commodity providers may be  
 14807 available.

14808 **Issuer Event ID (mandatory):** Unique identifier generated by the commodity provider. When new block  
 14809 period information is provided that replaces older information for the same period, this field allows  
 14810 devices to determine which information is newer. It is expected that the value contained in this field is  
 14811 a unique number managed by upstream servers or a UTC based time stamp (UTC data type) identifying  
 14812 when the Publish Block Period command was issued. Thus, newer block period information will have a  
 14813 value in the Issuer Event ID field that is larger than older block information.

14814 **Block Period Start Time (mandatory):** A UTC field to denote the time at which the block tariff period  
 14815 starts. A start time of 0x00000000 is a special time denoting “now”. If the device would send an event  
 14816 with a Start Time of now, adjust the Duration In Minutes field to correspond to the remainder of the event.  
 14817 A start date/time of 0xFFFFFFFF shall cause an existing PublishBlockPeriod command with the same Pro-  
 14818 vider ID and Issuer Event ID to be cancelled (note that, in markets where permanently active price infor-  
 14819 mation is required for billing purposes, it is recommended that a replacement/superseding Publish Block  
 14820 Period command is used in place of this cancellation mechanism).

14821 Where the Duration Timebase is set to a value other than Minutes, the Duration Control sub-field provides  
 14822 further clarification; where Duration Control is set to Start of Timebase, the Block Period Start Time shall be  
 14823 set to 00:00:00 on the applicable date, and where Duration Control is set to End of Timebase, the Block  
 14824 Period Start Time shall be set to 23:59:59 on the applicable date.

14825 **Block Period Duration (mandatory):** An unsigned 24-bit field to denote the block tariff period. The  
 14826 duration units are defined by the Block Period Duration Type field. Maximum value (0xFFFFFF) means  
 14827 'until changed'.

14828 **Block Period Control (mandatory):** Identifies additional control options for the block period event. A  
14829 value of 0x00 indicates field not used.

14830 The BitMap for this field is described in Table 10-33.

14831 **Table 10-33. Block Period Control Field BitMap**

Bit	Description
0	1=Price Acknowledgement required 0=Price Acknowledgement not required
1	1=Repeating Block 0=Non Repeating Block

14832

14833 **Price Acknowledgement:** Indicates whether a Price Acknowledgment command shall be returned on receipt  
14834 of this Publish Block Period command.

14835 **Repeating Block:** Indicates whether a block period repeats on expiry. Note that the interaction between Block  
14836 and Billing periods is out of scope of this specification.

14837 **Block Period Duration Type (mandatory):** An 8-bit bitmap where the least significant nibble is an enu-  
14838 merated sub-field indicating the time base used for the duration and the most significant nibble is an enumer-  
14839 ated sub-field providing duration control.

14840 Enumerated values for the Duration Timebase are shown in Table 10-34:

14841 **Table 10-34. Block Period DurationTimebase Enumeration**

Value	Description
0x0	Minutes (default)
0x1	Days
0x2	Weeks
0x3	Months

14842

14843 Enumerated values for the Duration Control are shown in Table 10-35:

14844 **Table 10-35. Block Period Duration Control Enumeration**

Value	Description
0x0	Start of Timebase
0x1	End of Timebase
0x2	Not Specified

14845

14846 Where the Duration Timebase is set to a value other than Minutes, the Duration Control sub-field provides  
14847 further clarification; Start of Timebase indicates that the duration shall run from the START of the respective  
14848 day, week or month, whereas End of Timebase shall indicate that the duration runs from the END of the  
14849 respective day, week or month. The Duration Control sub-field shall be set to Not Specified when a timebase  
14850 of Minutes is in use.

14851 **Tariff Type (mandatory):** An 8-bit bitmap identifying the type of tariff published in this command. The  
14852 least significant nibble represents an enumeration of the tariff type as detailed in Table 10-37 (Generation  
14853 Meters shall use the ‘Received’ Tariff). The most significant nibble is reserved.

14854 **Tariff Resolution Period (mandatory):** An 8 bit enumeration identifying the resolution period for the block  
14855 tariff. See Table 10-36:

14856

**Table 10-36. Tariff Resolution Period Enumeration**

Value	Description
0x00	Not Defined
0x01	Block Period
0x02	1 Day

14857

14858 The Tariff Resolution of *Block Period* means that the Block Tariff is applied based on calculations to the  
 14859 Block Thresholds defined in the command set without smoothing.

14860 The Tariff resolution period of *1 Day* means that the application should apply “daily resolution”, with recal-  
 14861 culation of the thresholds through the Block Period to achieve the same result for the end of the Block Period  
 14862 but smoothing out the tariff application for the customer. This is described as follows:

14863 Daily resolution of block tariffs is a method by which customers on a block tariff are charged on the basis of  
 14864 assigning the block thresholds on a day in proportion to the period through the block period. For example,  
 14865 if the Block Period is 90 days and the day is number 45 in the period, then the thresholds which determine  
 14866 the cost to date on that day will be 50% of the thresholds defined for the whole Block period. This creates  
 14867 an averaging effect on the block tariff and prevents the customer from being exposed to one or more poten-  
 14868 tially large cost changes for many days during the billing period which can create customer concern, particu-  
 14869 larly in prepayment applications, and replacing these with cost changes during each day which are less  
 14870 apparent, but create the same total charges.

14871

14872 **10.2.2.4.3 PublishConversionFactor Command**

14873 The PublishConversionFactor command is sent in response to a GetConversionFactor command or if a new  
 14874 conversion factor is available.

14875 Clients shall be capable of storing at least two instances of the Calorific Value, the currently active one and  
 14876 the next one.

14877 Payload Format

14878

**Figure 10-22. Format of the *PublishConversionFactor* Command Payload**

<b>Octets</b>	4	4	4	1
<b>Data Type</b>	uint32	UTC	uint32	map8
<b>Field Name</b>	Issuer Event ID (M)	Start Time (M)	Conversion Factor (M)	Conversion Factor Trailing Digit (M)

14879 **10.2.2.4.3.1 Payload Details**

14880 **Issuer Event ID (mandatory):** Unique identifier generated by the commodity provider.

14881 **Start Time (mandatory):** A UTC field to denote the time at which the value becomes valid. The value re-  
 14882 mains valid until replaced by a newer one.

14883 **Conversion Factor (mandatory):** See Price Cluster Commodity attributes (see sub-clause 10.2.2.2.4.3).

14884 **Conversion Factor Trailing Digit (mandatory):** See Price Cluster Commodity attributes (see sub-clause  
 14885 10.2.2.2.4.4).

14886

14887 **10.2.2.4.4 PublishCalorificValue Command**

14888 The PublishCalorificValue command is sent in response to a GetCalorificValue command or if a new  
14889 calorific value is available. Clients shall be capable of storing at least two instances of the Calorific  
14890 Value, the currently active one and the next one.

14891 Payload Format

14892 **Figure 10-23. Format of the PublishCalorificValue Command Payload**

<b>Octets</b>	4	4	4	1	1
<b>Data Type</b>	uint32	UTC	uint32	enum8	map8
<b>Field Name</b>	Issuer Event ID (M)	Start Time (M)	Calorific Value (M)	Calorific Value Unit (M)	Calorific Value Trailing Digit (M)

14893 **10.2.2.4.4.1 Payload Details**

14894 **Issuer Event ID (mandatory):** Unique identifier generated by the commodity provider.

14895 **Start Time (mandatory):** A UTC field to denote the time at which the value becomes valid. The value re-  
14896 mains valid until replaced by a newer one.

14897 **Calorific Value (mandatory):** See Price Cluster Commodity attributes (see sub- clause 10.2.2.2.4.5).

14898 **Calorific Value Unit (mandatory):** See Price Cluster Commodity attributes (see sub-clause 10.2.2.2.4.6).

14899 **Calorific Value Trailing Digit (mandatory):** See Price Cluster Commodity attributes (see sub-clause  
14900 10.2.2.2.4.7).

14901

14902 **10.2.2.4.5 PublishTariffInformation Command**

14903 The PublishTariffInformation command is sent in response to a GetTariffInformation command or if new  
14904 tariff information is available (including Price Matrix and Block Thresholds).

14905 Clients should be capable of storing at least **two** instances of the Tariff Information, the currently active and  
14906 the next one. Note that there may be separate tariff information for consumption delivered and received.

14907 Note that the payload for this command could be up to 61 bytes in length, therefore fragmentation may be  
14908 required.

14909 **10.2.2.4.5.1 Payload Format**

14910 **Figure 10-24. Format of the PublishTariffInformation Command Payload**

<b>Octets</b>	<b>4</b>	<b>4</b>	<b>4</b>	<b>4</b>	<b>1</b>	<b>1..25</b>	<b>1</b>	<b>1</b>
<b>Data Type</b>	uint32	uint32	uint32	UTC	map8	octstr	uint8	uint8
<b>Field Name</b>	Pro- vider ID (M)	Issuer Event ID (M)	Issuer Tariff ID (M)	Start Time (M)	Tariff Type / Charging Scheme (M)	Tariff Label (M)	Number of Price Tiers in Use(M)	Number of Block Thresholds in Use(M)

14911

<b>1</b>	<b>2</b>	<b>1</b>	<b>4</b>	<b>1</b>	<b>3</b>	<b>3</b>
enum8	uint16	map8	uint32	uint8	uint24	uint24



Unit of Measure (M)	Currency (M)	Price Trailing Digit (M)	Standing Charge (M)	TierBlock-Mode (M)	Block Threshold Multiplier (M)	Block Threshold Divisor (M)
---------------------	--------------	--------------------------	---------------------	--------------------	--------------------------------	-----------------------------

14912 **10.2.2.4.5.2 Payload Details**

14913 **ProviderID (mandatory):** A unique identifier for the commodity supplier. The ProviderID in this command  
 14914 will always be the one stored as the attribute (see 10.10.2.2.1.1 or 10.10.2.2.1.9 depending on TariffType)  
 14915 except for the case where a change of supplier is pending and the new supplier wishes to publish its tariff  
 14916 information in advance.

14917 **Issuer Event ID (mandatory):** Unique identifier generated by the commodity provider. When new infor-  
 14918 mation is provided that replaces older information for the same time period, this field allows devices to de-  
 14919 termine which information is newer. The value contained in this field is a unique number managed by up-  
 14920 stream servers or a UTC based time stamp (UTC data type) identifying when the Publish command was  
 14921 issued. Thus, newer information will have a value in the Issuer Event ID field that is larger than older infor-  
 14922 mation.

14923 **Issuer Tariff ID (mandatory):** Unique identifier generated by the commodity supplier.

14924 **Start Time (mandatory):** A UTC Time field to denote the time at which the price signal becomes valid. A  
 14925 start date/time of 0x00000000 shall indicate that the command should be executed immediately.

14926 **Tariff Type/Charging Scheme (mandatory):** An 8-bit bitmap identifying the type of tariff published in this  
 14927 command. The least significant nibble represents an enumeration of the tariff type as detailed in Table 10-37  
 14928 (Generation Meters shall use the ‘Received’ Tariff), the most significant nibble represents an enumeration  
 14929 specifying the charging scheme as detailed in Table 10-38.

14930

**Table 10-37. Tariff Type Enumeration**

Value	Description
0x0	Delivered Tariff
0x1	Received Tariff
0x2	Delivered and Received Tariff

14931

14932

**Table 10-38. Tariff Charging Scheme Enumeration**

Value	Description
0x0	TOU Tariff
0x1	Block Tariff
0x2	Block/TOU Tariff with common thresholds
0x3	Block/TOU Tariff with individual thresholds per tier

14933

14934 **Tariff Label (mandatory):** The format and use of this field is the same as for the TariffLabel attribute or  
 14935 ReceivedTariffLabel attribute (depending on TariffType) as defined in 10.2.2.2.7.1 and 10.2.2.2.15.1 respec-  
 14936 tively.

14937 **Number of Price Tiers in Use (mandatory):** The format and use of this field is the same as for the Num-  
 14938 berofPriceTiersInUse attribute or ReceivedNumberofPriceTiersInUse attribute (depending on Tar-  
 14939 iffType/Charging Scheme) as defined in 10.2.2.2.7.2 and 10.2.2.2.15.2 respectively.

14940 **Number of Block Thresholds in Use (mandatory):** The format and use of this field is the same as for the  
14941 NumberofBlockThresholdsinUse attribute or ReceivedNumberofBlockThresholdsinUse attribute (depend-  
14942 ing on TariffType/Charging Scheme) as defined in 10.2.2.2.7.3 and 10.2.2.2.15.3 respectively.

14943 **Unit of Measure (mandatory):** The format and use of this field is the same as for the Unit of Measure  
14944 attribute as defined in 10.2.2.2.7.5.

14945 **Currency (mandatory):** The format and use of this field is the same as for the Currency attribute as defined  
14946 in 10.2.2.2.7.6.

14947 **Price Trailing Digit (mandatory):** The format and use of this field is the same as for the PriceTrailingDigit  
14948 attribute as defined in 10.2.2.2.7.7.

14949 **Standing Charge (mandatory):** The format and use of this field is the same as for the StandingCharge  
14950 attribute as defined in 10.2.2.2.4.2. A value of 0xFFFFFFFF indicates the field is not used. When publishing  
14951 Received tariffs (according to TariffType) this field should be set to 0xFFFFFFFF.

14952 **TierBlockMode (mandatory):** The format and use of this field is the same as for the TierBlockMode attri-  
14953 bute or ReceivedTierBlockMode attribute (depending on TariffType) as defined in 10.2.2.2.7.4 and  
14954 10.2.2.2.15.4 respectively. In case of TOU or Block Charging only, this field is not used and shall be set to  
14955 0xFF. For combined Block/TOU charging, this field is mandatory and must be set to a valid value.

14956 **BlockThresholdMultiplier (mandatory):** BlockThresholdMultiplier provides a value to be multiplied  
14957 against Threshold parameter(s). If present, this attribute must be applied to all Block Threshold values to  
14958 derive values that can be compared against the CurrentBlockPeriodConsumptionDelivered attribute within  
14959 the Metering cluster. This parameter must be used in conjunction with the BlockThresholdDivisor param-  
14960 eter(s). In case no multiplier is defined, this field shall be set to 1.

14961 **BlockThresholdDivisor (mandatory):** BlockThresholdDivisor provides a value to divide the result of ap-  
14962 plying the ThresholdMultiplier attribute to Block Threshold values to derive values that can be compared  
14963 against the CurrentBlockPeriodConsumptionDelivered attribute within the Metering cluster. This attribute  
14964 must be used in conjunction with the BlockThresholdMultiplier parameter(s). In case no divisor is defined,  
14965 this field shall be set to 1.

#### 14966 **10.2.2.4.5.3 Effect on Receipt**

14967 If the client is unable to store this PublishTariffInformation command, the device should respond using a  
14968 Default Response with a status of INSUFFICIENT\_SPACE.

14969

#### 14970 **10.2.2.4.6 PublishPriceMatrix Command**

14971 The PublishPriceMatrix command is used to publish the Block Price Information Set (up to 15 tiers x 15  
14972 blocks) and the Extended Price Information Set (up to 48 tiers). The PublishPriceMatrix command is sent in  
14973 response to a GetPriceMatrix command.

14974 Clients should be capable of storing at least **two** instances of the Price Matrix, the currently active and the  
14975 next one.

14976 There may be a separate Price Matrix for consumption delivered and received; in this case, each Price Matrix  
14977 will be identified by a different IssuerTariffId value.

14978 The Price server shall send only the number of tiers and blocks as defined in the corresponding Publish-  
14979 TariffInformation command (NumberofPriceTiersinUse, NumberofBlockThresholdsinUse+1).

14980 The maximum application payload may not be sufficient to transfer all Price Matrix elements in one com-  
14981 mand. Therefore the ESI may send as many PublishPriceMatrix commands as needed. In this case the first  
14982 command shall have CommandIndex set to 0, the second to 1 and so on; all associated commands shall use  
14983 the same value of Issuer Event ID. Note that, in this case, it is the client's responsibility to ensure that it  
14984 receives all associated PublishPriceMatrix commands before any of the payloads can be used.

14985 **10.2.2.4.6.1 Payload Format**

14986 The *PublishPriceMatrix* command shall be formatted as illustrated in Figure 10-25:  
 14987  
 14988

**Figure 10-25. Format of the *PublishPriceMatrix* Command Payload**

<b>Octets</b>	<b>4</b>	<b>4</b>	<b>4</b>	<b>4</b>	<b>1</b>	<b>1</b>	<b>1</b>	<b>Variable</b>
<b>Data Type</b>	uint32	uint32	UTC	uint32	uint8	uint8	map8	Variable
<b>Field Name</b>	Provider ID (M)	Issuer Event ID (M)	Start Time (M)	Issuer Tariff ID (M)	Command Index (M)	Total Number of Commands (M)	Sub-payload Control	Price Matrix Sub-payload

14989 **10.2.2.4.6.2 Payload Details**

14990 **Provider ID (mandatory):** An unsigned 32-bit field containing a unique identifier for the  
 14991 commodity provider. This field allows differentiation in deregulated markets where multiple commodity  
 14992 providers may be available.

14993 **Issuer Event ID (mandatory):** Unique identifier generated by the commodity provider. When new infor-  
 14994 mation is provided that replaces older information for the same time period, this field allows devices to de-  
 14995 termine which information is newer. The value contained in this field is a unique number managed by up-  
 14996 stream servers or a UTC based time stamp (UTC data type) identifying when the Publish command was  
 14997 issued. Thus, newer information will have a value in the Issuer Event ID field that is larger than older infor-  
 14998 mation.

14999 **Start Time (mandatory):** A UTC field to denote the time at which the price signal becomes valid. A start  
 15000 date/time of 0x00000000 shall indicate that the command should be executed immediately.

15001 **Issuer Tariff ID (mandatory):** Unique identifier generated by the commodity supplier. This must match the  
 15002 Issuer Tariff ID sent in the related PublishTariffInformation command.

15003 **Command Index (mandatory):** The Command Index is used to count the payload fragments in the case that  
 15004 an entire payload does not fit into one message. The Command Index starts at 0 and is incremented for each  
 15005 fragment belonging to the same command.

15006 **Total Number of Commands (mandatory):** In the case that an entire payload does not fit into one message,  
 15007 the Total Number of Commands field indicates the total number of sub-commands in the message.

15008 **Sub-Payload Control (mandatory):** An 8-bit bitmap, the least significant bit of which specifies the infor-  
 15009 mation type stored in the sub payload (see Table 10-39). The remaining bits are reserved.

**Table 10-39. PublishPriceMatrix Sub-Payload Control Bitmap**

Bit	Description
0	0 = The information stored in the sub payload is Block only or Block/TOU based 1 = The information stored in the sub payload is TOU based.

15011

15012 **10.2.2.4.6.2.1 PriceMatrix Sub-Payload**

15013 **Figure 10-26. Format of the *PriceMatrix* Command Sub-Payload**

<b>Octets</b>	<b>1</b>	<b>4</b>	<b>1</b>	<b>4</b>	<b>...</b>
<b>Data Type</b>	uint8	uint32	uint8	uint32	...

<b>Field Name</b>	Tier/Block ID (n)	Price(n)	Tier/Block ID (n+1)	Price(n+1)	...
-------------------	-------------------	----------	---------------------	------------	-----

15014

15015 **Tier/Block ID (Mandatory):** The Tier/Block ID specifies the TOU Tier or the TOU Tier and Block that the  
15016 subsequent Price field in the command applies to. If Bit 0 of the Sub-Payload Control field is set to Zero, then  
15017 the least significant nibble represents a value specifying the block number and the most significant nibble  
15018 represents the Tier that the subsequent Price field applies to. Valid values for the Block Number sub-field are  
15019 0 to 15 reflecting block 1 (0) to block 16(15). Valid values for the Tiers sub-field are from 0 to 15 reflecting  
15020 no tiers to tier fifteen.

15021 If Bit 0 of the Sub-Payload Control field is set to one, then the field is an 8-bit value specifying the TOU Tier  
15022 that the subsequent Price field applies to. Valid values are 1 to 48.

15023 **Price (Mandatory):** This field holds the price information for the Block/TOU or TOU identified by the  
15024 previous Tier/Block ID field. The price information is provided in a base unit of Currency with the decimal  
15025 point located as indicated by the Trailing Digits field of a PublishTariffInformation command or by the at-  
15026 tribute defined in the Tariff Information Attribute Set.

15027 **NOTE:** The number of blocks in use is one greater than the number of block thresholds in use. For TOU  
15028 charging only (number of block thresholds in use = 0, number of blocks in use = 1), the price information of  
15029 block 1, tier 1 to 15 shall be used.

15030

15031 **10.2.2.4.7 PublishBlockThresholds Command**

15032 The PublishBlockThresholds command is sent in response to a GetBlockThresholds command.

15033 Clients should be capable of storing at least **two** instances of the Block Thresholds, the currently active and  
15034 the next one.

15035 There may be a separate set of Block Thresholds for consumption delivered and received; in this case, each  
15036 set of Block Thresholds will be identified by a different IssuerTariffId value.

15037 The price server shall send only the number of block thresholds in use (NumberOfBlockThresholdsInUse) as  
15038 defined in the PublishTariffInformation command.

15039 The maximum application payload may not be sufficient to transfer all thresholds in one command. In this  
15040 case the Price server may send two consecutive PublishBlockThreshold commands (CommandIndex set to 0  
15041 and 1 respectively); both commands shall use the same value of Issuer Event ID. Note that, in this case, it is  
15042 the client’s responsibility to ensure that it receives all associated PublishBlockThreshold commands before  
15043 any of the payloads can be used.

15044 **10.2.2.4.7.1 Payload Format**

15045 The PublishBlockThresholds command shall be formatted as illustrated in Figure 10-27:

15046 **Figure 10-27. Format of the PublishBlockThresholds Command Payload**

<b>Octets</b>	<b>4</b>	<b>4</b>	<b>4</b>	<b>4</b>	<b>1</b>	<b>1</b>	<b>1</b>	<b>Variable</b>
<b>Data Type</b>	uint32	uint32	UTC	uint32	uint8	uint8	map8	Variable
<b>Field Name</b>	Provider ID (M)	Issuer Event ID (M)	Start Time (M)	Issuer Tariff ID (M)	Command Index (M)	Total Number of Commands (M)	Sub-payload Control (M)	Block Threshold Sub-payload

15047 **10.2.2.4.7.2 Payload Details**

15048 **Provider ID (mandatory):** An unsigned 32-bit field containing a unique identifier for  
 15049 the commodity provider. This field allows differentiation in deregulated markets where multiple commod-  
 15050 ity providers may be available.

15051 **Issuer Event ID (mandatory):** Unique identifier generated by the commodity provider. When new infor-  
 15052 mation is provided that replaces older information for the same time period, this field allows devices to de-  
 15053 termine which information is newer. The value contained in this field is a unique number managed by up-  
 15054 stream servers or a UTC based time stamp (UTC data type) identifying when the Publish command was  
 15055 issued. Thus, newer information will have a value in the Issuer Event ID field that is larger than older infor-  
 15056 mation.

15057 **Start Time (mandatory):** A UTC field to denote the time at which the price signal becomes valid. A start  
 15058 date/time of 0x00000000 shall indicate that the command should be executed immediately.

15059 **Issuer Tariff ID (mandatory):** Unique identifier generated by the commodity supplier. This must match the  
 15060 Issuer Tariff ID sent in the related PublishTariffInformation command.

15061 **Command Index (mandatory):** The Command Index is used to count the payload fragments in the case  
 15062 where the entire payload does not fit into one message. The Command Index starts at 0 and is incremented  
 15063 for each fragment belonging to the same command.

15064 **Total Number of Commands (mandatory):** In the case where the entire payload does not fit into one mes-  
 15065 sage, the Total Number of Commands field indicates the total number of sub-commands in the message.

15066 **Sub-Payload Control (Mandatory):** The Sub-Payload Control bitmap specifies the usage of the information  
 15067 contained within the Block Threshold Sub-Payload (see Table 10-40).

15068

**Table 10-40. PublishBlockThresholds Sub-Payload Control Bitmap**

Bit	Description
0	0 = Block Thresholds supplied apply to a specific TOU tier. 1 = Block Thresholds supplied apply to all TOU tiers or when Block Only charging is in operation

15069

15070 **10.2.2.4.7.2.1 BlockThreshold Sub-Payload**

15071 The BlockThreshold Sub-Payload consists of multiple sets of data which consist of a Tier ID, Block Thresh-  
 15072 old Count and the threshold values associated with the stated Tier. The number of thresholds contained in  
 15073 any one set is identified in the NumberOfBlockThresholds sub-field.

15074

**Figure 10-28. Format of the BlockThreshold Command Sub-Payload**

Octets	1	6	...	6	1	6	...	6	...
<b>Data Type</b>	map8	uint48	...	uint48	map8	uint48	...	uint48	...
<b>Field Name</b>	Tier / Number- OfBlock Thresh- olds (M)	Block Threshold 1 (M)	...	Block Threshold n (M)	Tier / Number- OfBlock Thresh- olds (M)	Block Thresh- old 1	...	Block Threshold n	...

15075

15076 **Tier/NumberOfBlockThresholds:** The Tier/NumberOfBlockThresholds field is an 8 bitmap. The format of  
 15077 the bitmap is decided by bit0 of the sub-payload control field.

15078 If Bit0 of the Sub-Payload Control field is 0, then the least significant nibble represents a value specifying  
 15079 the number of thresholds to follow in the command. The most significant nibble represents the Tier that the  
 15080 subsequent block threshold values apply to.

15081 If Bit0 of the Sub-Payload Control field is 1, then the most significant nibble is unused and should be set to  
15082 0.

15083 Valid values for the NumberOfBlockThresholds sub-field are 0 to 15 reflecting no block in use (0) to block  
15084 15(15). Valid values for the Tiers sub-field are from 0 to 15 reflecting no tier to tier fifteen.

15085 If the thresholds for a particular tier (Bit0 of the Sub-Payload Control field is 0) or the total number of thresh-  
15086 olds (Bit0 of the Sub-Payload Control field is 1) will not fit into a single PublishBlockThresholds command,  
15087 then the value of this NumberOfBlockThresholds sub-field shall indicate the number of thresholds of the  
15088 relevant type contained within this particular command only.

15089 **BlockThreshold:** The Block Thresholds represent the threshold values applicable to an individual block  
15090 period and, where applicable, to a particular tier.

15091 The thresholds are established such that crossing the threshold of energy consumption for the present block  
15092 activates the next higher block, which can affect the energy rate in a positive or negative manner. The values  
15093 are absolute and always increasing. The values represent the threshold at the end of a block. The Unit of  
15094 Measure will be based on the fields defined in the PublishTariffInformation command, the formatting being  
15095 defined by ThresholdDivisor and ThresholdMultiplier.

15096

#### 15097 **10.2.2.4.8 PublishCO<sub>2</sub>Value Command**

15098 The PublishCO<sub>2</sub>Value command is sent in response to a GetCO<sub>2</sub>Value command or if a new CO<sub>2</sub> conversion  
15099 factor is available.

15100 Clients should be capable of storing at least **two** instances of the CO<sub>2</sub> conversion factor, the currently active  
15101 and the next one.

##### 15102 **10.2.2.4.8.1 Payload Format**

15103 The PublishCO<sub>2</sub>Value command shall be formatted as illustrated in Figure 10-29:

15104 **Figure 10-29. Format of the PublishCO<sub>2</sub>Value Command Payload**

<b>Oc- tets</b>	<b>4</b>	<b>4</b>	<b>4</b>	<b>1</b>	<b>4</b>	<b>1</b>	<b>1</b>
<b>Data Type</b>	uint32	uint32	UTC	map8	uint32	enum8	map8
<b>Field Name</b>	Provider ID (M)	Issuer Event ID (M)	Start Time (M)	Tariff Type (M)	CO <sub>2</sub> Value (M)	CO <sub>2</sub> Value Unit (M)	CO <sub>2</sub> Value Trailing Digit (M)

##### 15105 **10.2.2.4.8.2 Payload Details**

15106 **Provider ID (mandatory):** An unsigned 32-bit field containing a unique identifier for  
15107 the commodity provider. This field allows differentiation in deregulated markets where multiple commod-  
15108 ity providers may be available.

15109 **Issuer Event ID (mandatory):** Unique identifier generated by the commodity provider. When new infor-  
15110 mation is provided that replaces older information for the same time period, this field allows devices to de-  
15111 termine which information is newer. The value contained in this field is a unique number managed by up-  
15112 stream servers or a UTC based time stamp (UTC data type) identifying when the Publish command was  
15113 issued. Thus, newer information will have a value in the Issuer Event ID field that is larger than older infor-  
15114 mation.

15115 **Start Time (mandatory):** A UTC field to denote the time at which the CO<sub>2</sub> value becomes valid. A start  
 15116 date/time of 0x00000000 shall indicate that the command should be executed immediately. A start date/time  
 15117 of 0xFFFFFFFF shall cause an existing PublishCO<sub>2</sub>Value command with the same Provider ID and Issuer  
 15118 Event ID to be cancelled (note that, in markets where permanently active price information is required for  
 15119 billing purposes, it is recommended that a replacement/superseding PublishCO<sub>2</sub>Value command is used in  
 15120 place of this cancellation mechanism).

15121 **Tariff Type (mandatory):** An 8-bit bitmap identifying the type of tariff published in this command. The  
 15122 least significant nibble represents an enumeration of the tariff type as detailed in Table 10-37 (Generation  
 15123 Meters shall use the ‘Received’ Tariff). The most significant nibble is reserved.

15124 **CO<sub>2</sub> Value (mandatory):** The format and use of this field is the same as for the CO<sub>2</sub> attribute or Re-  
 15125 ceivedCO<sub>2</sub> attribute (depending on TariffType) as defined in 10.2.2.2.7.9 and 10.2.2.2.15.6 respectively. A  
 15126 value of 0xFFFFFFFF indicates field not used.

15127 **CO<sub>2</sub> Unit (mandatory):** The format and use of this field is the same as for the CO<sub>2</sub>Unit attribute or Re-  
 15128 ceivedCO<sub>2</sub>Unit attribute (depending on TariffType) as defined in 10.2.2.2.7.10 and 10.2.2.2.15.7 respec-  
 15129 tively. A value of 0xFF indicates field not used.

15130 **CO<sub>2</sub> Trailing Digit (mandatory):** The format and use of this field is the same as for the CO<sub>2</sub>TrailingDigit  
 15131 attribute or ReceivedCO<sub>2</sub>TrailingDigit attribute (depending on TariffType) as defined in 10.2.2.2.7.11 and  
 15132 10.2.2.2.15.8 respectively. A value of 0xFF indicates field not used.

15133

15134 **10.2.2.4.9 PublishTierLabels Command**

15135 The PublishTierLabels command is generated in response to receiving a GetTierLabels command or when  
 15136 there is a tier label change.

15137 **10.2.2.4.9.1 Payload Format**

15138 **Figure 10-30. Format of the PublishTierLabels Command Payload**

<b>Octets</b>	<b>4</b>	<b>4</b>	<b>4</b>	<b>1</b>	<b>1</b>	<b>1</b>	<b>1</b>	<b>1-13</b>
<b>Data Type</b>	uint32	uint32	uint32	uint8	uint8	uint8	uint8	octstr
<b>Field Name</b>	Pro- vider ID (M)	Issuer Event ID (M)	Issuer Tariff ID (M)	Com- mand In- dex (M)	Total Number of Com- mands (M)	Number of Labels (M)	Tier ID	TierLabel

15139

<b>Octets</b>	...	<b>1</b>	<b>1-13</b>
<b>Data Type</b>	...	uint8	octstr
<b>Field Name</b>	...	Tier ID (number of labels - 1)	TierLabel (number of labels -1)

15140 **10.2.2.4.9.2 Payload Details**

15141 **Provider ID (mandatory):** An unsigned 32-bit field containing a unique identifier for  
 15142 the commodity provider. This field allows differentiation in deregulated markets where multiple commod-  
 15143 ity providers may be available.

15144 **Issuer Event ID (mandatory):** Unique identifier generated by the commodity provider. When new infor-  
 15145 mation is provided that replaces older information for the same time period, this field allows devices to de-  
 15146 termine which information is newer. It is expected that the value contained in this field is a unique number  
 15147 managed by upstream servers or a UTC based time stamp (UTC data type) identifying when the Publish  
 15148 command was issued. Thus, newer information will have a value in the Issuer Event ID field that is larger  
 15149 than older information.

15150 **Issuer Tariff ID (mandatory):** Unique identifier generated by the commodity supplier. This is used to iden-  
 15151 tify the tariff that the labels apply to.

15152 **Command Index (mandatory):** The Command Index is used to count the payload fragments in the case  
 15153 where the entire payload does not fit into one message. The Command Index starts at 0 and is incremented  
 15154 for each fragment belonging to the same command.

15155 **Total Number of Commands (mandatory):** In the case where the entire payload does not fit into one mes-  
 15156 sage, the Total Number of Commands field indicates the total number of sub-commands in the message.

15157 **Number of Labels (mandatory):** The number of Tier ID/Tier Label sets contained within the command.

15158 **Tier ID (mandatory):** The tier number that the associated Tier Label applies to.

15159 **Tier Label (mandatory):** Octet String field capable of storing a 12 character string (the first character indi-  
 15160 cates the string length, represented in hexadecimal format) encoded in the UTF-8 format.

15161

#### 15162 **10.2.2.4.10 PublishBillingPeriod Command**

15163 The PublishBillingPeriod command is generated in response to receiving a GetBillingPeriod(s) command or  
 15164 when an update to the Billing schedule is available from the commodity supplier.

15165 Nested and overlapping PublishBillingPeriod commands are not allowed. In the case of overlapping billing  
 15166 periods, the period with the newer IssuerEventID takes priority over all nested and overlapping periods. All  
 15167 existing periods that overlap, even partially, should be removed. Note however that there may be separate  
 15168 billing schedules for consumption delivered and received.

##### 15169 **10.2.2.4.10.1 Payload Format**

15170 **Figure 10-31. Format of the *PublishBillingPeriod* Command Payload**

Octets	4	4	4	3	1	1
Data Type	uint32	uint32	UTC	uint24	map8	map8
Field Name	Provider ID (M)	Issuer Event ID (M)	Billing Pe- riod Start Time (M)	Billing Pe- riod Dura- tion (M)	Billing Pe- riod Duration Type (M)	Tariff Type (M)

##### 15171 **10.2.2.4.10.2 Payload Details**

15172 **Provider ID (mandatory):** An unsigned 32-bit field containing a unique identifier for  
 15173 the commodity provider. This field allows differentiation in deregulated markets where multiple commod-  
 15174 ity providers may be available.

15175 **Issuer Event ID (mandatory):** Unique identifier generated by the commodity provider. When new infor-  
 15176 mation is provided that replaces older information for the same time period, this field allows devices to de-  
 15177 termine which information is newer. The value contained in this field is a unique number managed by up-  
 15178 stream servers or a UTC based time stamp (UTC data type) identifying when the Publish command was  
 15179 issued. Thus, newer information will have a value in the Issuer Event ID field that is larger than older infor-  
 15180 mation.



15181 **Billing Period Start Time (mandatory):** A UTC field to denote the time at which the billing period starts.  
 15182 A start time of 0x00000000 is a special time denoting “now”. A start date/time of 0xFFFFFFFF shall cause  
 15183 an existing PublishBillingPeriod command with the same Provider ID and Issuer Event ID to be cancelled  
 15184 (note that, in markets where permanently active price information is required for billing purposes, it is rec-  
 15185 ommended that a replacement/superseding PublishBillingPeriod command is used in place of this cancella-  
 15186 tion mechanism).

15187 **Billing Period Duration (mandatory):** An unsigned 24-bit field to denote the billing period duration. The  
 15188 duration units are defined by the Billing Period Duration Type field.

15189 Billing periods are always repeating, i.e. after BillingPeriodDuration has elapsed since a BillingPeriodStart-  
 15190 Time, a new billing period will start with the same duration.

15191 **Billing Period Duration Type (mandatory):** An 8-bit bitmap where the least significant nibble is an enu-  
 15192 merated sub-field indicating the time base used for the duration and the most significant nibble is an enumer-  
 15193 ated sub-field providing duration control. Enumerated values for the Duration Timebase are shown in Table  
 15194 10-34. Enumerated values for the Duration Control are shown in Table 10-35.

15195 **Tariff Type (mandatory):** An 8-bit bitmap identifying the type of tariff published in this command. The  
 15196 least significant nibble represents an enumeration of the tariff type as detailed in Table 10-37 (Generation  
 15197 Meters shall use the ‘Received’ Tariff). The most significant nibble is reserved.

15198

15199 **10.2.2.4.11 PublishConsolidatedBill Command**

15200 The PublishConsolidatedBill command is used to make consolidated billing information from previous bill-  
 15201 ing periods available to other end devices. This command is issued in response to a GetConsolidatedBill  
 15202 command or if new billing information is available.

15203 Nested and overlapping PublishConsolidatedBill commands are not allowed. In the case of overlapping con-  
 15204 solidated bills, the bill with the newer IssuerEventID takes priority over all nested and overlapping bills. All  
 15205 existing bills that overlap, even partially, should be removed. Note however that there may be separate con-  
 15206 solidated bills for consumption delivered and received.

15207 A server device shall be capable of storing **five** consolidated bill command events as a minimum.

15208 **10.2.2.4.11.1 Payload Format**

15209 **Figure 10-32. Format of the PublishConsolidatedBill Command Payload**

Octets	4	4	4	3	1	1	4	2	1
<b>Data Type</b>	uint32	uint32	UTC	uint24	map8	map8	uint32	uint16	map8
<b>Field Name</b>	Provider ID (M)	Issuer Event ID (M)	Billing Period Start Time (M)	Billing Period Duration (M)	Billing Period Duration Type (M)	Tariff Type (M)	Consolidated Bill (M)	Currency (M)	Bill Trailing Digit (M)

15210 **10.2.2.4.11.2 Payload Details**

15211 **Provider ID (mandatory):** An unsigned 32-bit field containing a unique identifier for  
 15212 the commodity provider. This field allows differentiation in deregulated markets where multiple commod-  
 15213 ity providers may be available.

15214 **Issuer Event ID (mandatory):** Unique identifier generated by the commodity provider. When new infor-  
15215 mation is provided that replaces older information for the same time period, this field allows devices to de-  
15216 termine which information is newer. The value contained in this field is a unique number managed by up-  
15217 stream servers or a UTC based time stamp (UTC data type) identifying when the Publish command was  
15218 issued. Thus, newer information will have a value in the Issuer Event ID field that is larger than older infor-  
15219 mation.

15220 **Billing Period Start Time (mandatory):** A UTC field containing the start time of the related billing period.  
15221 A start date/time of 0x00000000 shall indicate that the command should be executed immediately. A start  
15222 date/time of 0xFFFFFFFF shall cause an existing PublishConsolidatedBill command with the same Provider  
15223 ID and Issuer Event ID to be cancelled (note that, in markets where permanently active price information is  
15224 required for billing purposes, it is recommended that a replacement/superseding PublishConsolidatedBill  
15225 command is used in place of this cancellation mechanism).

15226 **Billing Period Duration (mandatory):** An unsigned 24-bit field denoting the duration of the related billing  
15227 period. The duration units are defined by the Billing Period Duration Type field.

15228 **Billing Period Duration Type (mandatory):** An 8-bit bitmap where the least significant nibble is an enu-  
15229 merated sub-field indicating the time base used for the duration and the most significant nibble is an enumer-  
15230 ated sub-field providing duration control. Enumerated values for the Duration Timebase are shown in Table  
15231 10-34. Enumerated values for the Duration Control are shown in Table 10-35.

15232 **Tariff Type (mandatory):** An 8-bit bitmap identifying the type of tariff published in this command. The  
15233 least significant nibble represents an enumeration of the tariff type as detailed in Table 10-37 (Generation  
15234 Meters shall use the ‘Received’ Tariff). The most significant nibble is reserved.

15235 **Consolidated Bill (mandatory):** An unsigned 32-bit field containing the consolidated bill value for the  
15236 stated billing period. The Consolidated Bill field should be provided in the same currency as used in the Price  
15237 cluster.

15238 **Currency (mandatory):** An unsigned 16-bit field containing identifying information concerning the local  
15239 unit of currency used in the Consolidated Bill field.

15240 The value of the currency field should match the values defined by ISO 4217.

15241 **BillTrailingDigit (mandatory):** An 8-bit field used to determine where the decimal point is located in the  
15242 Consolidated Bill field. The most significant nibble contains the Trailing Digit sub-field which indicates the  
15243 number of digits to the right of the decimal point.

15244

## 15245 10.2.2.4.12 PublishCPPEvent Command

15246 **Note:** The PublishCPPEvent command in this revision of this specification is provisional and not certifiable.  
15247 This feature may change before reaching certifiable status in a future revision of this specification.

15248 The PublishCPPEvent command is sent from an ESI to its Price clients to notify them of a Critical Peak  
15249 Pricing (CPP) event.

### 15250 10.2.2.4.12.1 Payload Format

15251 **Figure 10-33. Format of the PublishCPPEvent Command Payload**

<b>Octets</b>	<b>4</b>	<b>4</b>	<b>4</b>	<b>2</b>	<b>1</b>	<b>1</b>	<b>1</b>
<b>Data Type</b>	uint32	uint32	UTC	uint16	map8	enum8	enum8
<b>Field Name</b>	Provider ID (M)	Issuer Event ID (M)	Start Time (M)	Duration in Minutes (M)	Tariff Type (M)	CPP Price Tier (M)	CPP Auth (M)

### 15252 10.2.2.4.12.2 Payload Details

15253 **Provider ID (mandatory):** An unsigned 32-bit field containing a unique identifier for  
 15254 the commodity provider. This field allows differentiation in deregulated markets where multiple commod-  
 15255 ity providers may be available.

15256 **Issuer Event ID (mandatory):** Unique identifier generated by the commodity provider. When new infor-  
 15257 mation is provided that replaces older information for the same time period, this field allows devices to de-  
 15258 termine which information is newer. The value contained in this field is a unique number managed by up-  
 15259 stream servers or a UTC based time stamp (UTC data type) identifying when the Publish command was  
 15260 issued. Thus, newer information will have a value in the Issuer Event ID field that is larger than older infor-  
 15261 mation.

15262 **Start Time (mandatory):** A UTC field to denote the time at which the CPP event begins. A start date/time  
 15263 of 0x00000000 shall indicate that the command should be executed immediately. A start date/time of  
 15264 0xFFFFFFFF shall cause an existing PublishCPPEvent command with the same Provider ID and Issuer Event  
 15265 ID to be cancelled (note that, in markets where permanently active price information is required for billing  
 15266 purposes, it is recommended that a replacement/superseding PublishCPPEvent command is used in place of  
 15267 this cancellation mechanism).

15268 **Duration in Minutes:** Defines the duration of the CPP event.

15269 **Tariff Type (mandatory):** An 8-bit bitmap identifying the type of tariff published in this command. The  
 15270 least significant nibble represents an enumeration of the tariff type as detailed in Table 10-37 (Generation  
 15271 Meters shall use the ‘Received’ Tariff). The most significant nibble is reserved.

15272 **CPP Price Tier (mandatory):** An 8-bit enumeration identifying the price tier associated with this CPP event.  
 15273 The price(s) contained in the active price matrix for that price tier will override the normal pricing scheme.  
 15274 Prices ‘CPP1’ and ‘CPP2’ are reserved for this purposes (see 10.2.2.2.6 for further details).

15275

**Table 10-41. CPP Price Tier Enumeration**

Value	Description
0	‘CPP1’
1	‘CPP2’

15276

15277 **CPP Auth (mandatory):** An 8-bit enumeration identifying the status of the CPP event:

15278

**Table 10-42. CPP Auth Enumeration**

Value	Description
0	Pending
1	Accepted
2	Rejected
3	Forced

15279

15280 **10.2.2.4.12.3 When Generated**

15281 The PublishCPPEvent command is generated when the energy provider has requested the consumer to accept  
 15282 a CPP, when the consumer has accepted the CPP, or if the ESI has received a CPPEventResponse command.  
 15283 See Figure 10-34.

15284

**Figure 10-34. CPP Event Flow**

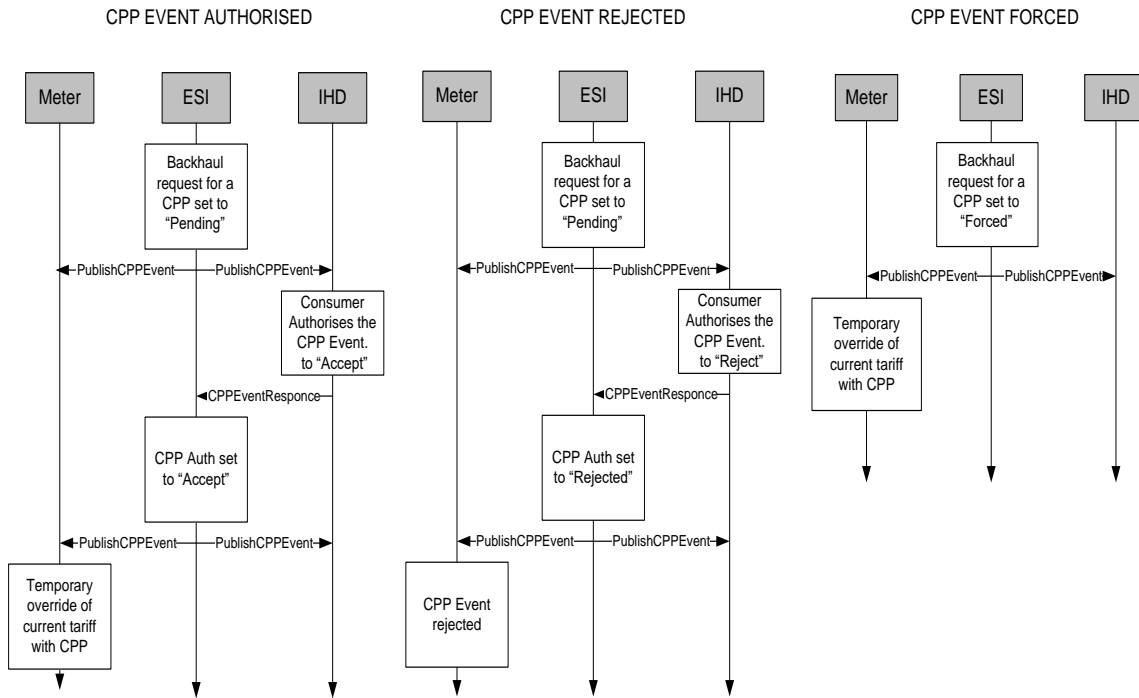

15285

**10.2.2.4.12.4 Effect on Receipt**

15286 When the PublishCPPEvent command is received, the IHD or Meter shall act in one of two ways:

15287 It shall notify the consumer that there is a CPP event that requires acknowledgment. The acknowledgement  
 15288 shall be either to accept the CPPEvent or reject the CPPEvent (in which case it shall send the CPPEventRe-  
 15289 sponse command, with the CPPAuth parameter set to Accepted or Rejected). It is recommended that the CPP  
 15290 event is ignored until a consumer either accepts or rejects the event.  
 15291

15292 The CPPAuth parameter is set to "Forced", in which case the CPPEvent has been accepted.

15293

**10.2.2.4.13 PublishCreditPayment Command**

15294 The PublishCreditPayment command is used to update the credit payment information when available.

15295 Nested and overlapping PublishCreditPayment commands are not allowed. In the case of overlapping credit  
 15296 payments, the payment with the newer Issuer Event ID takes priority over all nested and overlapping pay-  
 15297 ments. All existing payments that overlap, even partially, should be removed.  
 15298

15299 A server device shall be capable of storing **five** credit payments command events as a minimum.

**10.2.2.4.13.1 Payload Format**

**Figure 10-35. Format of the PublishCreditPayment Command Payload**

<b>Octets</b>	<b>4</b>	<b>4</b>	<b>4</b>	<b>4</b>	<b>1</b>	<b>4</b>	<b>4</b>	<b>1-21</b>
<b>Data Type</b>	uint32	uint32	UTC	uint32	enum8	uint32	UTC	octstr

Field Name	Provider ID (M)	Issuer Event ID (M)	Credit Payment Due Date (M)	Credit Payment Overdue Amount (M)	Credit Payment Status (M)	Credit Payment (M)	Credit Payment Date (M)	Credit Payment Ref (M)
------------	-----------------	---------------------	-----------------------------	-----------------------------------	---------------------------	--------------------	-------------------------	------------------------

15302 **10.2.2.4.13.2 Payload Details**

15303 **Provider ID (mandatory):** An unsigned 32-bit field containing a unique identifier for  
 15304 the commodity provider. This field allows differentiation in deregulated markets where multiple commod-  
 15305 ity providers may be available.

15306 **Issuer Event ID (mandatory):** Unique identifier generated by the commodity provider. When new infor-  
 15307 mation is provided that replaces older information for the same time period, this field allows devices to de-  
 15308 termine which information is newer. The value contained in this field is a unique number managed by up-  
 15309 stream servers or a UTC based time stamp (UTC data type) identifying when the Publish command was  
 15310 issued. Thus, newer information will have a value in the Issuer Event ID field that is larger than older infor-  
 15311 mation.

15312 **Credit Payment Due Date (mandatory):** A UTC field containing the time that the next credit payment is  
 15313 due. See also section 10.2.2.2.9.1.

15314 **Credit Payment Overdue Amount (mandatory):** An unsigned 32-bit field denoting the current amount  
 15315 this is overdue from the consumer. This field should be provided in the same currency as used in the Price  
 15316 cluster. See also section 10.2.2.2.9.3.

15317 **Credit Payment Status (mandatory):** An 8-bit enumeration identifying the current credit payment status.  
 15318 Refer to section 10.2.2.2.9.2 for the format of this enumeration.

15319 **Credit Payment (mandatory):** An unsigned 32-bit field denoting the last credit payment. This field should  
 15320 be provided in the same currency as used in the Price cluster. See also section 10.2.2.2.9.6.

15321 **Credit Payment Date (mandatory):** A UTC field containing the time at which the last credit payment was  
 15322 made. See also section 10.2.2.2.9.7.

15323 **Credit Payment Ref (mandatory):** A string of between 0-20 octets used to denote the last credit payment  
 15324 reference used by the energy supplier. See also section 10.2.2.2.9.8.

15325

15326 **10.2.2.4.14 PublishCurrencyConversion Command**

15327 The PublishCurrencyConversion command is sent in response to a GetCurrencyConversion command or  
 15328 when a new currency becomes available.

15329 **10.2.2.4.14.1 Payload Format**

15330 The PublishCurrencyConversion command shall be formatted as illustrated in the figure below:

15331

**Figure 10-36. Format of the PublishCurrencyConversion Command Payload**

Octets	4	4	4	2	2	4	1	4
Data Type	uint32	uint32	UTC	uint16	uint16	uint32	map8	map32
Field Name	Provider ID (M)	Issuer Event ID (M)	Start Time (M)	Old Currency (M)	New Currency (M)	Conversion Factor (M)	Conversion Factor Trailing Digit (M)	Currency Change Control Flags (M)

15332 **10.2.2.4.14.2 Payload Details**

15333 **Provider ID (mandatory):** An unsigned 32-bit field containing a unique identifier for  
15334 the commodity provider. This field allows differentiation in deregulated markets where multiple commod-  
15335 ity providers may be available.

15336 **Issuer Event ID (mandatory):** Unique identifier generated by the commodity provider. When new infor-  
15337 mation is provided that replaces older information for the same time period, this field allows devices to de-  
15338 termine which information is newer. The value contained in this field is a unique number managed by up-  
15339 stream servers or a UTC based time stamp (UTC data type) identifying when the Publish command was  
15340 issued. Thus, newer information will have a value in the Issuer Event ID field that is larger than older infor-  
15341 mation.

15342 **Start Time (mandatory):** A UTC field to denote the time at which the new currency becomes valid. A start  
15343 date/time of 0x00000000 shall indicate that the command should be executed immediately. A start date/time  
15344 of 0xFFFFFFFF shall cause an existing but pending PublishCurrencyConversion command with the same  
15345 Provider ID and Issuer Event ID to be cancelled.

15346 **Old Currency (mandatory):** An unsigned 16-bit field containing identifying information concerning the  
15347 old local unit of currency used in the Price cluster. The value of the Old Currency field should match the  
15348 values defined by ISO 4217.

15349 **New Currency (mandatory):** An unsigned 16-bit field containing identifying information concerning the  
15350 new local unit of currency used in the Price cluster. The value of the New Currency field should match the  
15351 values defined by ISO 4217.

15352 **Conversion Factor (mandatory):** The format and use of this field is the same as for the ConversionFactor  
15353 attribute as defined in 10.2.2.2.4.3.

15354 **Conversion Factor Trailing Digit (mandatory):** The format and use of this field is the same as for the  
15355 ConversionFactorTrailingDigit attribute as defined in 10.2.2.2.4.4.

15356 **Currency Change Control Flags (mandatory):** A 32-bit mask that denotes the functions that are required  
15357 to be carried out on processing of this command. See Table 10-43 below:

15358 **Table 10-43. Currency Change Control**

Bits	Description
0	1 = Clear Billing Information 0 = Do Not Clear Billing Information
1	1 = Convert Billing Information using the New Currency 0 = Do Not Convert Billing Information
2	1 = Clear Old Consumption Data 0 = Do Not Clear Old Consumption Data
3	1 = Convert Old Consumption Data using the New Cur- rency 0 = Do Not Convert Old Consumption Data

15359

15360 **10.2.2.4.15 CancelTariff Command**

15361 The CancelTariff command indicates that all data associated with a particular tariff instance should be dis-  
15362 carded.

15363 In markets where permanently active price information is required for billing purposes, it is recommended  
15364 that replacement/superseding PublishTariffInformation, PublishPriceMatrix, PublishBlockThresholds and  
15365 PublishTierLabels commands are used in place of a CancelTariff command.

15366 **10.2.2.4.15.1 Payload Format**

15367 The CancelTariff command shall be formatted as illustrated in Figure 10-37:

15368 **Figure 10-37. Format of the CancelTariff Command Payload**

<b>Octets</b>	<b>4</b>	<b>4</b>	<b>1</b>
<b>Data Type</b>	uint32	uint32	map8
<b>Field Name</b>	Provider ID (M)	Issuer Tariff ID (M)	Tariff Type (M)

15369 **10.2.2.4.15.2 Payload Details**

15370 **Provider ID (mandatory):** An unsigned 32-bit field containing a unique identifier for the commodity pro-  
 15371 vider. This field allows differentiation in deregulated markets where multiple commodity providers may be  
 15372 available.

15373 **Issuer Tariff ID (mandatory):** Unique identifier generated by the commodity Supplier. All parts of a tariff  
 15374 instance shall have the same Issuer Tariff ID.

15375 **Tariff Type (mandatory):** An 8-bit bitmap identifying the type of tariff to be cancelled by this command.  
 15376 The least significant nibble represents an enumeration of the tariff type as detailed in Table 10-37 (Generation  
 15377 Meters shall use the ‘Received’ Tariff). The most significant nibble is reserved.

15378 **10.2.2.4.15.3 Effect on Receipt**

15379 On receipt of this command, a client device shall discard all instances of PublishTariffInformation, Publish-  
 15380 PriceMatrix, PublishBlockThresholds and PublishTierLabels commands associated with the stated Provider  
 15381 ID, Tariff Type and Issuer Tariff ID.

15382

15383 **10.2.3 Client**

15384 **10.2.3.1 Dependencies**

15385 Events carried using this cluster include a timestamp with the assumption that target devices maintain a  
 15386 real time clock. Devices can acquire and synchronize their internal clocks via the Time cluster server.

15387 If a device does not support a real time clock it is assumed that the device will interpret and utilize the  
 15388 “Start Now” 0x00000000 value within the Time field.

15389 **Note:** The Price Client Cluster Attributes in this revision of this specification are provisional and not certi-  
 15390 fiable. These features may change before reaching certifiable status in a future revision of this specification.

15391 **10.2.3.2 Attributes**

15392

**Table 10-44. Price Client Cluster Attributes**

<b>Id</b>	<b>Name</b>	<b>Type</b>	<b>Range</b>	<b>Acc</b>	<b>Def</b>	<b>M</b>
0x0000	<i>PriceIncreaseRandomizeMinutes</i>	uint8	0x00 to 0x3C	RW	0x05	O
0x0001	<i>PriceDecreaseRandomizeMinutes</i>	uint8	0x00 to 0x3C	RW	0x0F	O
0x0002	<i>CommodityType</i>	enum8	0x00 to 0xFF	R	-	O

### 15393 **10.2.3.2.1 PriceIncreaseRandomizeMinutes Attribute**

15394 The PriceIncreaseRandomizeMinutes attribute represents the maximum amount of time to be used when  
15395 randomizing the response to a price increase. Note that although the granularity of the attribute is in  
15396 minutes, it is recommended the granularity of the randomization used within a responding device be in  
15397 seconds or smaller. If a device responds to a price increase it must choose a random amount of time, in  
15398 seconds or smaller, between 0 and PriceIncreaseRandomizeMinutes minutes. The device must implement  
15399 that random amount of time before or after the price change. How and if a device will respond to a price  
15400 increase is up to the manufacturer. Whether to respond before or after the price increase is also up to the  
15401 manufacturer.

15402 As an example, a water heater with a PriceIncreaseRandomizeMinutes set to 6 could choose to lower its  
15403 set point 315 seconds (but not more than 360 seconds) before the price increases.

15404 The valid range for this attribute is 0x00 to 0x3C.

15405 If PriceIncreaseRandomizeMinutes or PriceDecreaseRandomizeMinutes attributes are not supported by the  
15406 client, then it should use the default values for the attributes as specified in the Price Client Cluster Attribute  
15407 table.

### 15408 **10.2.3.2.2 PriceDecreaseRandomizeMinutes Attribute**

15409 The PriceDecreaseRandomizeMinutes attribute represents the maximum number of minutes to be used  
15410 when randomizing the response to a price decrease. Note that although the granularity of the attribute is in  
15411 minutes, it is recommended the granularity of the randomization used within a responding device be in sec-  
15412 onds or smaller. If a device responds to a price decrease it must choose a random amount of time, in seconds  
15413 or smaller, between 0 and PriceDecreaseRandomizeMinutes minutes and implement that random amount of  
15414 time before or after the price change. How and if a device will respond to a price decrease is up to the  
15415 manufacturer. Whether to respond before or after the price decrease is also up to the manufacturer.

15416 As an example, a dishwasher with a PriceDecreaseRandomizeMinutes set to 15 could choose to start its  
15417 wash cycle 723 seconds (but not more than 900 seconds) after the price decreases.

15418 The valid range for this attribute is 0x00 to 0x3C.

### 15419 **10.2.3.2.3 CommodityType Attribute**

15420 CommodityType provides a label for identifying the type of pricing client present. The attribute is an enu-  
15421 merated value representing the commodity. The defined values are represented by the non-mirrored values  
15422 (0-127) in the MeteringDeviceType attribute enumerations (refer to Table 10-73).

## 15423 **10.2.3.3 Commands Received**

15424 The client receives the cluster-specific response commands detailed in sub-clause 3.18.2.2.

## 15425 **10.2.3.4 Commands Generated**

15426 The client generates the cluster-specific commands detailed in sub-clause 10.2.2.3, as required by the appli-  
15427 cation.

## 15428 **10.2.4 Application Guidelines**

### 15429 **10.2.4.1 Registering for Commands**

15430 Devices should use bind request to register for unsolicited Publish Price, Display Message and Load  
15431 Control Event commands.



## 15432 **10.2.4.2 Attribute Reporting**

15433 Attribute reporting may be used for sending information in the Price Server Cluster Attributes table.  
15434 The Price Cluster attributes can be polled periodically for updates. Polling should not occur more frequently  
15435 than recommended in 10.4.4.2. Use of the Report Attribute command without report configuration may be  
15436 used for unsolicited notification of an attribute value change. Sleepy devices may have to poll.

## 15437 **10.2.4.3 Block Tariffs**

15438 Upon reaching the Start Time of a received Publish Price command, a device's behavior will depend on  
15439 the values of the Number of Block Thresholds and Number of Price Tiers fields. A client device needing  
15440 to determine if it should use Block Pricing shall send a Get Current Price command to the Price server and  
15441 check the Number of Block Thresholds in the Publish Price response. Any value between 1 and 15 indicates  
15442 that Block Pricing shall be used.

15443 The prices for a commodity being delivered to the premises shall be taken from the Block Pricing Information  
15444 Attribute Set whenever Block Pricing is active.

### 15445 **10.2.4.3.1 TOU Charging Only**

15446 Indicated by the Number of Block Thresholds field being set to zero. Charging shall be according to the  
15447 price fields within the Publish Price command itself.

### 15448 **10.2.4.3.2 Block Charging Only**

15449 Indicated by the Number of Price Tiers fields being set to zero while the Number of Block Thresholds is  
15450 between 0x01 and 0x0F.

15451 A server shall not update the Block Threshold and Block Price attribute sets of an active Block Period. Up-  
15452 dates to these attribute sets can only be done by creating a new Block Period. The server may create a new  
15453 active Block Period by updating either Block Period Start Time (attribute StartOfBlockPeriod) alone or Block  
15454 Period Duration in Minutes (attribute BlockPeriodDuration) followed by Block Period Start Time (attribute  
15455 StartOfBlockPeriod) along with updating other attributes as desired.

15456 When a server transmits a Publish Price command it shall additionally fill fields necessary to support back-  
15457 wards compatibility with clients that may not support Block Charging. The Price field shall be set according  
15458 to the Block Price Information Attribute Set. The Duration in Minutes field shall be set to 0xFFFF indicating  
15459 the price is valid “until changed”.

15460 A server shall additionally transmit a Publish Price command to clients under the following conditions:

- 15461 1. At the start of a Block Period
- 15462 2. When it is notified that a Block Threshold has been crossed
- 15463 3. When *Block Period Start Time* or *Block Period Duration in Minutes* have changed to indicate a  
15464 new active block period

15465 A client may cache attributes from the Block Threshold, Block Period, Block Price, and Billing Period at-  
15466 tribute sets. Cached attributes are valid only during the active Block Period when received. Upon reaching  
15467 Block Period Start Time or detecting a new active Block Period, the client should retrieve updated values for  
15468 cached attributes.

15469 A client shall check for a new active Block Period on receipt of an asynchronous Publish Price command  
15470 (i.e. not required on a Publish Price command in response to Get Current Price) by checking Block Period  
15471 Start Time and Block Period Duration in Minutes for update. Additionally, it shall infrequently (e.g. once an  
15472 hour) query the StartOfBlockPeriod and BlockPeriodDuration attributes to verify that the Block Period has  
15473 not ended early.

### 15474 **10.2.4.3.3 Block/TOU Combination Charging**

15475 The Number of Block Thresholds and Number of Price Tiers fields will both be set to non-zero values, indi-  
15476 cating the number of blocks and number of tiers respectively being used. The start of a Block period shall be  
15477 indicated by the value of the Block Period Start Time field within a Publish Block Period command. If the  
15478 currently active parameters are not already available on the client device then, upon reaching the Block Period Start  
15479 Time, the attributes for the required number of Block Thresholds, together with the Block Prices for all re-  
15480 quired blocks for the selected tier should be fetched from the server. The Block Period Duration in Minutes  
15481 field shall indicate the length of the block period.

15482 A Publish Price command will be received for the start of each new TOU period during a block period. At  
15483 this point the attributes for the Block Prices for all required blocks for the newly activated tier should be  
15484 fetched from the server.

15485 Devices shall cater for both ‘blocks in tiers’ and ‘tiers in blocks’ models. In either case, the relevant prices  
15486 will be defined in the Block Pricing Information Attribute Set. The ‘tiers in blocks’ model will always imple-  
15487 ment a single set of block thresholds, whereas the ‘blocks in tiers’ model may implement different thresholds  
15488 for each tier.

### 15489 **10.2.4.3.4 Application Guidelines for Block Pricing under Spe-** 15490 **cific Events**

15491 HAN device not communicating with meter for extended period of time:

15492 In this situation, when the HAN device reconnects with the meter, it will need to read the Block Information  
15493 Set to calculate the correct cost for the given period. This is done by applying the prices for each block/tier  
15494 combination to the consumption information for each block/tier combination. If a block period has passed  
15495 while the HAN device was not communicating with the meter, then the prior period consumption infor-  
15496 mation will not be known and the prior period cost cannot be calculated by the HAN device.

15497 Meter installation or swap-out:

15498 The new meter will need to be configured with the appropriate block thresholds, pricing, and block duration  
15499 by the utility. If this does not occur precisely at the start of that customer's billing period, the utility will  
15500 need to (a) pro-rate these amounts over the remaining billing period duration and (b) decide how to handle  
15501 the initial portion of the period. Any information from the initial part of the billing period will be lost when  
15502 the new meter is installed. As such, HAN devices may not display accurate information for this billing  
15503 period and utilities should advise customers of this situation. As a typical meter lifetime is expected to be  
15504 in the range of 10 to 20 years, this event is expected to be rare.

### 15505 **10.2.4.4 Handling of Enhanced Tariffs**

15506 In ‘Traditional’ Smart Energy networks, the back-haul connection and Price server are incorporated into the  
15507 meter. Fiscal accounting is out of scope of the Zigbee network. Indicative pricing information, determined  
15508 by the utility or by an ESI using information supplied by the utility, is communicated from the Price server  
15509 to other Smart Energy devices, using a Publish Price command, whenever the price changes.

15510 In Smart Energy networks where the meter is detached from the back-haul connection, the meter often being  
15511 battery-powered and therefore unable to communicate for the majority of the time, and specifically where a  
15512 Prepayment meter is required to perform independent accounting functionality, there is a need for the meter  
15513 to have local access to current price and price scheduling information at all times. The optional ‘Enhanced’  
15514 tariff mechanism described in this section provides functionality to satisfy this requirement.

15515 An enhanced tariff consists of a number of commands. Depending on the mode of operation, an associated  
15516 TOU calendar may also be required. PublishBlockThresholds and PublishPriceMatrix commands always in-  
15517 clude the number of block thresholds in use and number of blocks / tiers in use respectively. It is the respon-  
15518 sibility of a client to fetch all parts belonging to a tariff after it has received an unsolicited PublishTariffIn-  
15519 formation command. A client shall ensure that it successfully receives all commands associated with a tariff  
15520 before any of the data for that tariff can be used. It is recommended that a client checks that the data received  
15521 across all commands is valid.

15522 Whenever a new tariff is made available to a Price Server, it shall send an unsolicited PublishTariffInfor-  
15523 mation command to its bound clients (BOMDs shall be notified via notification flags). Other parts of the  
15524 tariff (PriceMatrix and BlockThresholds) are not sent unsolicited; the clients shall send corresponding  
15525 GetPriceMatrix and GetBlockThresholds commands, as applicable, to fetch the required information from  
15526 the server.

15527 The Price Cluster supports different charging modes:

15528 TOU charging

15529 Block charging

15530 TOU/Block combination charging

#### 15531 **10.2.4.4.1 Block Charging**

15532 In case of Block charging, the following information needs to be transferred from server to client:

15533 PublishTariffInformation

15534 PublishPriceMatrix (noTierBlock1 .. noTierBlockN)

15535 PublishBlockThresholds

15536 PublishBlockPeriod

15537 In addition, a Gas-ESI may send a PublishConversionFactor or PublishCalorificValue command along with  
15538 a tariff update, but does not necessarily need to.

#### 15539 **10.2.4.4.2 TOU Charging**

15540 In case of TOU charging, the following price information needs to be transferred from server to client:

15541 PublishTariffInformation

15542 PublishPriceMatrix (Tier1Block1 ... TierNBlock1)

15543 PublishCalendar (see 10.9 for further details)

15544 In addition, a Gas-ESI may send a PublishConversionFactor or PublishCalorificValue command along with  
15545 a tariff update, but does not necessarily need to.

15546 Note: the TOU Calendar and the Tariff are linked by the start time and not by any IDs.

#### 15547 **10.2.4.4.3 TOU/Block Charging**

15548 In case of TOU/Block charging, the following price information needs to be transferred from server to client:

15549 PublishTariffInformation

15550 PublishPriceMatrix (Tier1Block1 ... TierNBlockM)

15551 PublishBlockThresholds

15552 PublishBlockPeriod

15553 PublishCalendar (see 10.9 for further details)

15554 In addition, a Gas-ESI may send a PublishConversionFactor or PublishCalorificValue command along with  
15555 a tariff update, but does not necessarily need to.

#### 15556 **10.2.4.4.4 Critical Peak Pricing**

15557 **Note:** The following application guidelines that pertain to Critical Peak Pricing in this revision of this  
15558 specification are provisional and not certifiable. This text may change before reaching certifiable status in  
15559 a future revision of this specification.

15560 The following additional guidelines hold for the usage of CPP events:

15561 The price tiers used for CPP events (via the PublishCPPEvent command) are treated in the price matrix just  
15562 like the ones used in the TOU Calendar. In fact, nothing prevents a tariff scheme where the same price is  
15563 employed at regular times through the TOU calendar and ad-hoc via CPP events. Two prices are reserved in  
15564 the price matrix for CPP events, ‘CPP1’ and ‘CPP2’

15565 ESIs conforming to these specifications need to send out a Publish Price command along with the Pub-  
15566 lishCPPEvent command, for Smart Energy devices that do not support the latter.

#### 15567 **10.2.4.4.5 Generation Charging**

15568 All Generation meters shall use the ‘Received’ sections of the Price cluster to publish the tariff information,  
15569 and the Received section of the Metering Cluster.

15570

## 15571 **10.3 Demand Response and Load Control**

### 15572 **10.3.1 Overview**

15573 Please see Chapter 2 for a general cluster overview defining cluster architecture, revision, classification,  
15574 identification, etc.

15575 This cluster provides an interface to the functionality of Smart Energy Demand Response and Load Control.  
15576 Devices targeted by this cluster include thermostats and devices that support load control.

15577

**Figure 10-38. Demand Response/Load Control Cluster Client Server Example**

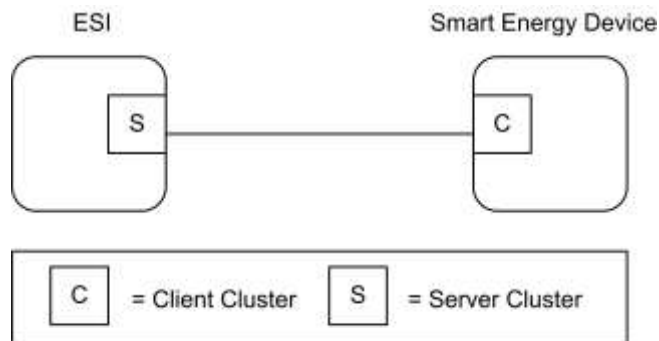

*Note: Device names are examples for illustration purposes only*

15578

15579

15580 Please note the ESI is defined as the Server due to its role in acting as the proxy for upstream demand re-  
15581 sponse/load control management systems and subsequent data stores.

15582 **10.3.1.1 Revision History**

15583 The global *ClusterRevision* attribute value SHALL be the highest revision number in the table below.

Rev	Description
1	mandatory global <i>ClusterRevision</i> attribute added
2	Updated from SE1.4 version; CCB 1291 1297 1447 1513 1880 2287 2964 2965

15584 **10.3.1.2 Classification**

Hierarchy	Role	PICS Code	Primary Transaction
Base	Application	DRLC	Type 1 (client to server)

15585 **10.3.1.3 Cluster Identifiers**

Identifier	Name
0x0701	Demand Response and Load Control

15586 **10.3.2 Server**

15587 By default the ESI will be labeled as the Server side in the cluster descriptions, being able to initiate load  
 15588 control commands to other devices in the network.

15589 **10.3.2.1 Dependencies**

15590 A server device shall be capable of storing at least two load control events.

15591 Events carried using this cluster include a timestamp with the assumption that target devices maintain a real-  
 15592 time clock. Devices can acquire and synchronize their internal clocks with the ESI as described in sub-clause  
 15593 3.12.

15594 If a device does not support a real-time clock, it is assumed the device will ignore all values within the Time  
 15595 field except the “Start Now” value.

15596 Additionally, for devices without a real-time clock, it is assumed those devices will utilize a method (i.e.  
 15597 ticks, countdowns, etc.) to approximate the correct duration period.

15598 **10.3.2.2 Attributes**

15599 There are no attributes for the Demand Response and Load Control Cluster server.

15600 **10.3.2.3 Commands Generated**

15601 The command IDs generated by the Demand Response and Load Control cluster server are listed in Table  
 15602 10-45.

15603

**Table 10-45. Command IDs for the Demand Response and Load Control Server**

Command Identifier	Description	M
0x00	Load Control Event	M
0x01	Cancel Load Control Event	M
0x02	Cancel All Load Control Events	M

15604 **10.3.2.3.1 Load Control Event Command**

15605 **10.3.2.3.1.1 Payload Format**

15606 The Load Control Event command payload shall be formatted as illustrated in Figure 10-39.

15607 **Figure 10-39. Format of the Load Control Event Command Payload**

Octets	4	2	1	4	2	1	1
Data Type	uint32	map16	uint8	UTC	uint16	uint8	uint8
Field Name	Issuer Event ID (M)	Device Class (M)	Utility Enrollment Group (M)	Start Time (M)	Duration in Minutes (M)	Criticality Level (M)	Cooling Temperature Offset (O)

15608

Octets	1	2	2	1	1	1
Data Type	uint8	int16	int16	int8	uint8	map8
Field Name	Heating Temperature Offset (O)	Cooling Temperature Set Point (O)	Heating Temperature Set Point (O)	Average Load Adjustment Percentage (O)	Duty Cycle (O)	Event Control (M)

15609 **Note:** M = Mandatory field, O = Optional field. An optional field SHALL define a value to indicate that it is  
15610 to be ignored.<sup>145</sup>

15611 **10.3.2.3.1.1.1 Payload Details**

15612 **Issuer Event ID (mandatory):** Unique identifier generated by the Energy provider. The value of this field  
15613 allows matching of Event reports with a specific Demand Response and Load Control event. The expected  
15614 value contained in this field shall be a unique number managed by upstream systems or a UTC based time  
15615 stamp (UTC data type) identifying when the Load Control Event was issued.

15616 In the case where two Load Control Events overlap, the newer event shall have a higher Issuer Event ID than  
15617 the old event, and an event with a higher Issuer Event ID shall supersede one with a lower ID if the Device  
15618 Class and/or Utility Enrollment Group overlap between the two events.<sup>146</sup>

<sup>145</sup> CCB 2287 2964 2965 (see 2.3.4 & 2.4 for more information)

<sup>146</sup> CCB 1291

15619 **Device Class (mandatory):** Bit encoded field representing the Device Class to apply the current Load Control Event. Each bit, if set individually or in combination, indicates the class device(s) needing to participate in the event. (Note that the participating device may be different than the controlling device. For instance, a thermostat may act on behalf of an HVAC compressor or furnace and/or Strip Heat/Baseboard Heater and should take action on their behalf, as the thermostat itself is not subject to load shed but controls devices that are subject to load shed.) The encoding of this field is in Table 10-46.

15625

**Table 10-46. Device Class Field BitMap/Encoding**

Bit	Description
0	HVAC Compressor or Furnace
1	Strip Heaters/Baseboard Heaters
2	Water Heater
3	Pool Pump/Spa/Jacuzzi
4	Smart Appliances
5	Irrigation Pump
6	Managed Commercial & Industrial (C&I) loads
7	Simple misc. (Residential On/Off) loads
8	Exterior Lighting
9	Interior Lighting
10	Electric Vehicle
11	Generation Systems

15626

15627 Device manufacturers shall recognize the Device Class or set of Devices Classes that corresponds to its functionality. For example, a thermostat (PCT) may react when Bit 0 is set since it controls the HVAC and/or furnace. Another example is a device that acts like an EMS where it controls exterior lights, interior lights, and simple misc. load control devices. In this case the EMS would react when Bits 7, 8, or 9 are set individually or in combination.

15632 If a 2<sup>nd</sup> DRLC event is received with a higher Event ID than the 1<sup>st</sup> and Device Classes overlap, the 2<sup>nd</sup> event shall supersede the first event.

15634 **Utility Enrollment Group (mandatory):** The Utility Enrollment Group field can be used in conjunction with the Device Class bits. It provides a mechanism to direct Load Control Events to groups of Devices. Example, by assigning two different groups relating to either Demand Response programs or geographic areas, Load Control Events can be further directed for a sub-set of Device Classes (i.e. Device Class Bit 0 and Utility Enrollment Group #1 vs. Device Class Bit 0 and Utility Enrollment Group #2). 0x00 addresses all groups, and values 0x01 to 0xFF address individual groups that match. Please refer to sub-clause 10.3.3.2.1 for further details.

15641 If the Device Class and/or Utility Enrollment Group fields do not apply to your End Device, the Load Control Event command shall be ignored by either dropping the message and not replying at all or by sending back a Default Response message with a SUCCESS status code.

15644 If a 2<sup>nd</sup> DRLC event is received with a higher Event ID than the 1<sup>st</sup> and Utility Enrollment Group fields overlap, the 2<sup>nd</sup> event shall supersede the first event.

15645

15646 **Start Time (mandatory):** UTC Timestamp representing when the event is scheduled to start. A start time of  
 15647 0x00000000 is a special time denoting “now.” Where the Start Time is “now”, any subsequent re-transmission  
 15648 of the event should continue to use a Start Time of “now”, however the Duration in Minutes field shall be  
 15649 adjusted to take into account any event time that has already elapsed (Internally, a DRLC server should note the actual Start Time  
 15650 <sup>used</sup> in order to maintain an ordered list of DRLC events in its buffer).

15651 **Duration In Minutes (mandatory):** Duration of this event in number of minutes. Maximum value is 1440  
 15652 (one day).

15653 When choosing a duration value, consideration should be given to the functionality and capabilities of the  
 15654 device(s) for which the event is destined (see description of Duty Cycle field for further details).

15655 **Criticality Level (mandatory):** This field defines the level of criticality of this event. The action taken  
 15656 by load control devices for an event can be solely based on this value, or combination with other Load  
 15657 Control Event fields supported by this device. For example, additional fields such as Average Load  
 15658 Adjustment Percentage, Duty Cycle, Cooling Temperature Offset, Heating Temperature Offset, Cooling  
 15659 Temperature Set Point or Heating Temperature Set Point can be used in combination with the Criticality  
 15660 level. Criticality levels are listed in Table 10-47.

**Table 10-47. Criticality Levels**

Criticality Level	Level Description	Participation
1	Green	Voluntary
2	1	Voluntary
3	2	Voluntary
4	3	Voluntary
5	4	Voluntary
6	5	Voluntary
7	Emergency	Mandatory
8	Planned Outage	Mandatory
9	Service Disconnect	Mandatory
0x0A to 0x0F	Utility Defined	Utility Defined

15662  
 15663 The criticality level 0x0 and 0x10 to 0xFF are reserved for future profile changes and not used.

15664 “Green” event, level 0x01, may be used to denote that the energy delivered uses an abnormal amount from  
 15665 non-“green” sources. Participation in this event is voluntary.

15666 The criticality levels 0x02 through 0x06 (Levels 1 through 5) indicate progressively increasing levels of load  
 15667 reduction are being requested by the utility. Participation in these events is voluntary.

15668 The criticality level 0x07 is used to indicate an “Emergency” event. Participation in this event is mandatory,  
 15669 as defined by the utility. The expected response to this event is termination of all non-essential energy use,  
 15670 as defined by the utility. Exceptions to participation in this event type must be managed by the utility.

15671 The criticality level 0x08 is used to indicate a “Planned Outage” event. Participation in this event is manda-  
 15672 tory, as defined by the utility. The expected response to this event is termination of delivery of all non-  
 15673 essential energy, as defined by the utility. Exceptions to participation in this event type must be managed by  
 15674 the utility.



- 15675 The criticality level 0x09 is used to indicate a “Service Disconnect” event. Participation in this event is mandatory, as defined by the utility. The expected response to this event is termination of delivery of all non-essential energy, as defined by the utility. Exceptions to participation in this event type must be managed by the utility.  
15676  
15677  
15678
- 15679 Levels 0x0A to 0x0F are available for Utility Defined criticality levels.
- 15680 **Cooling Temperature Offset (optional):** Requested offset to apply to the normal cooling setpoint at the time  
15681 of the start of the event in + 0.1 °C.
- 15682 **Heating Temperature Offset (optional):** Requested offset to apply to the normal heating setpoint at the time  
15683 of the start of the event in + 0.1 °C.
- 15684 The Cooling and Heating Temperature Offsets represent a temperature change (Delta Temperature) that will  
15685 be applied to both the associated heating and cooling set points. The temperature offsets (Delta Temperatures)  
15686 will be calculated per the Local Temperature in the Thermostat. The calculated temperature will be interpreted  
15687 as the number of degrees to be added to the cooling set point and subtracted from the heating set point.  
15688 Sequential demand response events are not cumulative. The Offset shall be applied to the normal setpoint.
- 15689 Each offset represents the temperature offset (Delta Temperature) in degrees Celsius, as follows: Delta Temperature  
15690 Offset / 10 = delta temperature in degrees Celsius. Where 0.00°C <= temperature <= 25.4 °C, corresponding  
15691 to a Temperature in the range 0x00 to 0x0FE. The maximum resolution this format allowed is  
15692 0.1 °C.
- 15693 A DeltaTemperature of 0xFF indicates that the temperature offset is not used.
- 15694 If a temperature offset is sent that causes the heating or cooling temperature set point to exceed the limit  
15695 boundaries that are programmed into the thermostat, the thermostat should respond by setting the temperature  
15696 at the limit.
- 15697 **Cooling Temperature Set Point (optional):** Requested cooling set point in 0.01 degrees Celsius.
- 15698 **Heating Temperature Set Point (optional):** Requested heating set point in 0.01 degrees Celsius.
- 15699 Cooling and heating temperature set points will be defined and calculated per the LocalTemperature attribute  
15700 in the Thermostat Cluster (see Chapter 6).
- 15701 These fields represent the temperature in degrees Celsius, as follows:
- 15702 Cooling Temperature Set Point / 100 = temperature in degrees Celsius
- 15703 where -273.15°C <= temperature <= 327.67°C, corresponding to a Cooling and/or Heating Temperature Set  
15704 Point in the range 0x954d to 0x7fff
- 15705 The maximum resolution this format allows is 0.01°C.
- 15706 A Cooling or Heating Temperature Set Point of 0x8000 indicates that the temperature set point is not used.
- 15707 If a temperature is sent that exceeds the temperature limit boundaries that are programmed into the thermostat,  
15708 the thermostat should respond by setting the temperature at the limit.
- 15709 The thermostat shall not use a Cooling or Heating Temperature Set Point that causes the device to use more  
15710 energy than the normal setting.
- 15711 When both a Temperature Offset and a Temperature Set Point are provided, the thermostat may use either as  
15712 defined by the device manufacturer. The thermostat should use the setting that provides the lowest energy  
15713 consumption.
- 15714 **Average Load Adjustment Percentage (optional):** Defines a maximum energy usage limit as a percentage  
15715 of the client implementations specific average energy usage. The load adjustment percentage is added to  
15716 100% creating a percentage limit applied to the client implementations specific average energy usage. A -  
15717 10% load adjustment percentage will establish an energy usage limit equal to 90% of the client implementations  
15718 specific average energy usage. Each load adjustment percentage is referenced to the client implementations  
15719 specific average energy usage. There are no cumulative effects.

15720 The range of this field is -100 to +100 with a resolution of 1 percent. A -100% value equals a total load shed.  
15721 A 0% value will limit the energy usage to the client implementation’s specific average energy usage. A  
15722 +100% value will limit the energy usage to double the client implementation’s specific average energy usage.

15723 A value of 0x80 indicates the field is not used. All other values are reserved for future use.

15724 **Duty Cycle (optional):** Defines the maximum On state duty cycle as a percentage of time. Example, if the  
15725 value is 80, the device would be in an “on state” for 80% of the time for the duration of the event. Range of  
15726 the value is 0 to 100. A value of 0xFF indicates the field is not used. All other values are reserved for future  
15727 use.

15728 Duty cycle control is a device specific issue and shall be managed by the device manufacturer. It is expected  
15729 that the duty cycle of the device under control will span the shortest practical time period in accordance with  
15730 the nature of the device under control and the intent of the request for demand reduction. For typical Device  
15731 Classes, three minutes for each 10% of duty cycle is recommended. It is expected that the load “off state”  
15732 will precede the “on state”.

15733 To avoid physical damage, some devices may limit how rapidly they can be cycled between on and off states  
15734 (“minimum on/off time”). If a Load Control Event duration is too short, or the combination of duration and  
15735 duty cycle would require switching states too quickly, these devices may be unable to react as expected to  
15736 the event. How a device reacts to an event that would violate the device's minimum on/off time is presently  
15737 a vendor-specific decision. Operators issuing Load Control Events should be aware of the typical capabilities  
15738 of classes of devices in their market, and specify their event duration and duty cycle parameters as appropri-  
15739 ate.

15740 **Event Control (mandatory):** Identifies additional control options for the event. The BitMap for this field is  
15741 described in Table 10-48.

**Table 10-48. Event Control Field BitMap**

Bit	Description
0	1= Randomize Start time, 0=Randomized Start not Applied
1	1= Randomize Duration time, 0=Randomized Duration not Applied <sup>147</sup>

15743

15744 Notes:

15745 The randomization attributes will be used in combination with these two bits to determine if the Event Start  
15746 (and hence Stop) and/or Event Duration are to be randomized. By default devices will randomize the start  
15747 but not duration of an event; the start and end of an event will be randomized by the same amount thus  
15748 ensuring that events are of equal length for all customers<sup>148</sup>. Refer to sub-clause 10.3.3.2.2 and sub-clause  
15749 10.3.3.2.3 for the settings of these values.

15750 When wanting to shed load quickly in an emergency, start randomization is typically not applied. Duration  
15751 randomization may be applied in order to slowly add load back onto the network at the end of the event. In  
15752 this emergency case, DR events will not be of equal length<sup>149</sup>.

**10.3.2.3.1.1.2 When Generated**

15754 This command is generated when the ESI wants to control one or more load control devices, usually as the  
15755 result of an energy curtailment command from the Smart Energy network.

**10.3.2.3.1.1.3 Responses to Load Control Event**

15757 The server receives the cluster-specific commands detailed in sub-clause 10.3.3.3.1.

<sup>147</sup> CCB 1513

<sup>148</sup> CCB 1513

<sup>149</sup> CCB 1513

15758 **10.3.2.3.2 Cancel Load Control Event Command**

15759 **10.3.2.3.2.1 Payload Format**

15760 The Cancel Load Control Event command payload shall be formatted as illustrated in Figure 10-40.

15761 **Figure 10-40. Format of the Cancel Load Control Event Payload**

<b>Octets</b>	4	2	1	1	4
<b>Data Type</b>	uint32	map16	uint8	map8	UTC
<b>Field Name</b>	Issuer Event ID	Device Class (M)	Utility Enrollment Group (M)	Cancel Control (M)	Effective Time (M)

15762 **10.3.2.3.2.1.1 Payload Details**

15763 **Issuer Event ID (mandatory):** Unique identifier generated by the Energy provider. The value of this field  
 15764 allows matching of Event reports with a specific Demand Response and Load Control event. It is expected  
 15765 the value contained in this field is a unique number managed by upstream systems or a UTC based time  
 15766 stamp (UTC data type) identifying when the Load Control Event was issued.

15767 **Device Class (mandatory):** Bit encoded field representing the Device Class to apply the current Load Control  
 15768 Event. Each bit, if set individually or in combination, indicates the class device(s) needing to participate  
 15769 in the event. (Note that the participating device may be different than the controlling device. For instance, a  
 15770 thermostat may act on behalf of an HVAC compressor or furnace and/or Strip Heat/Baseboard Heater and  
 15771 should take action on their behalf, as the thermostat itself is not subject to load shed but controls devices that  
 15772 are subject to load shed.) The encoding of the Device Class is listed in Table 10-46. It is recommended that  
 15773 the value of this field matches that originally specified in the event being cancelled.

15774 **Utility Enrollment Group (mandatory):** The Utility Enrollment Group field can be used in conjunction  
 15775 with the Device Class bits. It provides a mechanism to direct Load Control Events to groups of Devices.  
 15776 Example, by assigning two different groups relating to either Demand Response programs or geographic  
 15777 areas, Load Control Events can be further directed for a sub-set of Device Classes (i.e. Device Class Bit 0  
 15778 and Utility Enrollment Group #1 vs. Device Class Bit0 and Utility Enrollment Group #2). 0x00 addresses all  
 15779 groups, and values 0x01 to 0xFF address individual groups that match. Please refer to sub-clause 10.3.2.3.2.1  
 15780 for further details. It is recommended that the value of this field matches that originally specified in the event  
 15781 being cancelled.

15782 If the Device Class and/or Utility Enrollment Group fields don't apply to your End Device, the Cancel Load  
 15783 Control Event command is ignored.

15784 Device Class and/or Utility Group fields must be the same for a Cancel Load Control Event command as  
 15785 they were for the command to create the event. Should these fields be different there is no defined behavior  
 15786 for how DRLC servers should maintain their tables for replying to Get Scheduled Events commands.

15787 **Cancel Control (mandatory):** The encoding of the Cancel Control is listed in Table 10-49.

15788 **Table 10-49. Cancel Control**

<b>Bit</b>	<b>Description</b>
0	To be used when the Event is currently in process and acted upon as specified by the Effective Time field of the Cancel Load Control Event command.  A value of Zero (0) indicates that randomization is overridden and the event should be terminated immediately at the Effective Time.  A value of One (1) indicates the event should end using randomization settings in the original event.

15789

15790 Where the Cancel Control field indicates that randomization is to be used, the receiving device should first  
15791 check whether Duration Time was to be randomized and, if so, termination of the event should be adjusted  
15792 according to the value of the DurationRandomizationMinutes attribute.

15793 If Duration Time was not to be randomized, but the Event Control field in the original command indicated  
15794 that Start Randomization was to be used, termination of the event should be adjusted according to the value  
15795 of the StartRandomizationMinutes attribute.

15796 If the Event Control field in the original command specified that randomization was not to be used, an event  
15797 shall be terminated immediately.<sup>150</sup>

15798 **Effective Time (mandatory):** UTC Timestamp representing when the canceling of the event is scheduled to  
15799 start. An effective time of 0x00000000 is a special time denoting “now.” If the device would send an event  
15800 with an Effective Time of now, adjust the Duration In Minutes field to correspond to the remainder of the  
15801 event.

15802 **Note:** This field is deprecated; a Cancel Load Control command shall now take immediate effect. A value of  
15803 0x00000000 shall be used in all Cancel Load Control commands

15804 **10.3.2.3.2.1.2 When Generated**

15805 This command is generated when the ESI wants to cancel previously scheduled control of one or more load  
15806 control devices, usually as the result of an energy curtailment command from the Smart Energy network.

15807 **10.3.2.3.2.1.3 Responses to Cancel Load Control Event**

15808 The server receives the cluster-specific commands detailed in sub-clause 10.3.3.3.1.

15809 **Note:** If the Cancel Load Control Event command is received after the event has ended, the device shall reply  
15810 using the “Report Event Status Command” with an Event Status of “Rejected -Invalid Cancel Command  
15811 (Undefined Event)”.

15812 **10.3.2.3.3 Cancel All Load Control Events Command**

15813 **10.3.2.3.3.1 Payload Format**

15814 The Cancel All Load Control Events command payload shall be formatted as illustrated in Table 10-50.

15815 **Table 10-50. Format of the Cancel All Load Control Events Command Payload**

<b>Octets</b>	1
<b>Data Type</b>	map8
<b>Field Name</b>	Cancel Control

15816 **10.3.2.3.3.1.1 Payload Details**

15817 **Cancel Control:** The encoding of the Cancel Control is listed in Table 10-51.

<sup>150</sup> CCB 1513

15818

**Table 10-51. Cancel All Command Cancel Control Field**

Bit	Description
0	To be used when the Event is currently in process and a cancel command is received. A value of Zero (0) indicates that randomization is overridden and the event should be terminated immediately. A value of One (1) indicates the event should end using randomization settings in the original event.

15819 Where the *Cancel Control* field indicates that randomization is to be used, the receiving device should first  
 15820 check whether *Duration Time* was to be randomized and, if so, termination of the event should be adjusted  
 15821 according to the value of the *DurationRandomizationMinutes* attribute.

15822 If *Duration Time* was not to be randomized, but the *Event Control* field in the original command indicated  
 15823 that *Start Randomization* was to be used, termination of the event should be adjusted according to the value  
 15824 of the *StartRandomizationMinutes* attribute.

15825 If the *Event Control* field in the original command specified that randomization was not to be used, an  
 15826 event shall be terminated immediately.<sup>151</sup>

15827 **10.3.2.3.3.2 When Generated**

15828 This command is generated when the ESI wants to cancel all events for control device(s).

15829 **10.3.2.3.3.3 Responses to Cancel All Load Control Events**

15830 The server receives the cluster-specific commands detailed in sub-clause 10.3.3.1. The Cancel All Load  
 15831 Control Events command is processed by the device as if individual Cancel Load Control Event commands  
 15832 were received for all of the currently stored events in the device. The device will respond with a “Report  
 15833 Event Status Command” for each individual load control event canceled.

15834 **10.3.2.4 Commands Received**

15835 The server receives the cluster-specific commands detailed in sub-clause 10.3.3.

15836 **10.3.3 Client**

15837 This section identifies the attributes and commands provided by Client devices.

15838 **10.3.3.1 Dependencies**

15839 Devices receiving and acting upon Load Control Event commands must be capable of storing and supporting  
 15840 at least three unique instances of events. As a highly recommended recovery mechanism, when maximum  
 15841 storage of events has been reached and additional Load Control Events are received that are unique (not su-  
 15842 perseding currently stored events), devices should ignore additional Load Control Events and when storage  
 15843 becomes available, utilize the *GetScheduledEvents* command to retrieve any previously ignored events.

15844 Events carried using this cluster include a timestamp with the assumption that target devices maintain a  
 15845 real time clock. Devices can acquire and synchronize their internal clocks with the ESI as described in the  
 15846 Time cluster sub-clause 3.12.

15847 Devices MAY ‘drop’ events received before they have received and resolved time (‘dropping’ an event is  
 15848 defined as sending a default response with status code SUCCESS).

<sup>151</sup> CCB 1513

15849 If a device does not support a real time clock, it is assumed the device will ignore all values within the Time  
15850 field except the “Start Now” value.

15851 Additionally, for devices without a real time clock it is assumed those devices will utilize a method (i.e. ticks,  
15852 countdowns, etc.) to approximate the correct duration period.

### 15853 10.3.3.2 Client Cluster Attributes

15854 **Table 10-52. Demand Response Client Cluster Attributes**

<b>Id</b>	<b>Name</b>	<b>Type</b>	<b>Range</b>	<b>Acc</b>	<b>Default</b>	<b>M</b>
0x0000	<i>UtilityEnrollmentGroup</i>	uint8	0x00 to 0xFF	RW	0x00	M
0x0001	<i>StartRandomization Minutes<sup>152</sup></i>	uint8	0x00 to 0x3C	RW	0x1E	M
0x0002	<i>DurationRandomization Minutes<sup>153</sup></i>	uint8	0x00 to 0x3C	RW	0x00 <sup>154</sup>	M
0x0003	<i>DeviceClassValue</i>	uint16	0x0000 to 0xFFFF	RW	-	M

#### 15855 10.3.3.2.1 *UtilityEnrollmentGroup* Attribute

15856 The *UtilityEnrollmentGroup* provides a method for utilities to assign devices to groups. In other words,  
15857 Utility defined groups provide a mechanism to arbitrarily group together different sets of load control or  
15858 demand response devices for use as part of a larger utility program. The definition of the groups, implied  
15859 usage, and their assigned values are dictated by the Utilities and subsequently used at their discretion,  
15860 therefore outside the scope of this specification. The valid range for this attribute is 0x00 to 0xFF, where  
15861 0x00 (the default value) indicates the device is a member of all groups and values 0x01 to 0xFF indicates  
15862 that the device is member of that specified group.

#### 15863 10.3.3.2.2 *StartRandomizationMinutes* Attribute

15864 The *StartRandomizationMinutes*<sup>155</sup> represents the maximum number of minutes to be used when random-  
15865 izing the start of an event. As an example, if *StartRandomizationMinutes*<sup>156</sup> is set for 3 minutes, the device  
15866 could randomly select 2 minutes (but never greater than the 3 minutes) for this event, causing the start of  
15867 the event to be delayed by two minutes. The valid range for this attribute is 0x00 to 0x3C where 0x00  
15868 indicates start event randomization is not performed. When Duration Randomization is not applied (as de-  
15869 fined by the Event Control field), an event will be the same length for all customers; any randomization  
15870 applied to the start of an event will therefore be reflected on the end of the event<sup>157</sup>.

<sup>152</sup> CCB 1880

<sup>153</sup> CCB 1513 1880

<sup>154</sup> CCB 1513

<sup>155</sup> CCB 1880

<sup>156</sup> CCB 1880

<sup>157</sup> CCB 1513

15871 **10.3.3.2.3 Duration<sup>158</sup>RandomizationMinutes Attribute**

15872 The DurationRandomizationMinutes<sup>159</sup> attribute represents the maximum number of minutes to be used  
 15873 when randomizing the duration of an event. As an example, if DurationRandomizationMinutes<sup>160</sup> is set for  
 15874 3 minutes, the device could randomly select one minute (but never greater than 3 minutes) for this event,  
 15875 causing the duration of the event to be extended by one minute. The valid range for this attribute is 0x00  
 15876 to 0x3C where 0x00 (the default value) indicates event duration randomization is not performed. When Du-  
 15877 ration Randomization is enabled, DR events will NOT be of equal length for all customers<sup>161</sup>.

15878 When an event’s Event Control field indicates that both Start and Duration randomization are to be used, the  
 15879 start of the event will be delayed by the chosen Start Randomization period, then the duration of the event  
 15880 extended the chosen Duration Randomization period. The end of the event will be delayed by the sum of the  
 15881 2 chosen randomization periods. Note that this would not be standard practice.<sup>162</sup>

15882 **10.3.3.2.4 DeviceClassValue Attribute**

15883 The DeviceClassValue attribute identifies which bits the device will match in the Device Class fields. Please  
 15884 refer to Table 10-46 for further details. Although the attribute has a RW access property, the device is  
 15885 permitted to refuse to change the DeviceClass by setting the status field of the corresponding write attribute  
 15886 status record to NOT\_AUTHORIZED.

15887 Although, for backwards compatibility, the Type cannot be changed, this 16-bit integer should be treated as  
 15888 if it were a 16-bit bitmap.

15889 Device Class and/or Utility Enrollment Group fields are to be used as filters for deciding to accept or ignore  
 15890 a Load Control Event or a Cancel Load Control Event command. There is no requirement for a device to  
 15891 store or remember the Device Class and/or Utility Enrollment Group once the decision to accept the event  
 15892 has been made. A consequence of this is that devices that accept multiple device classes may have an event  
 15893 created for one device class superseded by an event created for another device class.

15894 In-Home Displays should report the device classes that they are interested in. An IHD that wishes to display  
 15895 all possible Load Control Events, even for classes not yet defined, should indicate a device class of 0xFFFF;  
 15896 this will allow DRLC servers to optimize the number of DRLC events they unicast, such that they are only  
 15897 sent to those devices that are interested in them.

15898 **10.3.3.3 Commands Generated**

15899 The command IDs generated by the Demand Response and Load Control client cluster are listed in Table  
 15900 10-53.

15901 **Table 10-53. Generated Command IDs for the Demand Response and Load Control Client**

Command Identifier Field Value	Description	M
0x00	Report Event Status	M
0x01	Get Scheduled Events	M

<sup>158</sup> CCB 1513

<sup>159</sup> CCB 1513

<sup>160</sup> CCB 1513 1880

<sup>161</sup> CCB 1513

<sup>162</sup> CCB 1513

15902 **10.3.3.3.1 Report Event Status Command**

15903 **10.3.3.3.1.1 Payload Format**

15904 The Report Event Status command payload shall be formatted as illustrated in Figure 10-41.

15905 **Figure 10-41. Format of the Report Event Status Command Payload**

<b>Octets</b>	4	1	4	1	2	2
<b>Data Type</b>	uint32	uint8	UTC	uint8	uint16	uint16
<b>Field Name</b>	Issuer Event ID (M)	Event Status (M)	Event Status Time (M)	Criticality Level Applied (M)	Cooling Temperature Set Point Applied (O)	Heating Temperature Set Point Applied (O)

15906

<b>Octets</b>	1	1	1	1	42
<b>Data Type</b>	int8	uint8	map8	uint8	opaque
<b>Field Name</b>	Average Load Adjustment Percentage Applied (O)	Duty Cycle Applied (O)	Event Control (M)	Signature Type (M)	Signature (O)

15907 **10.3.3.3.1.1.1 Payload Details**

15908 **Issuer Event ID (mandatory):** Unique identifier generated by the Energy provider. The value of this field  
 15909 allows matching of Event reports with a specific Demand Response and Load Control event. It is expected  
 15910 the value contained in this field is a unique number managed by upstream systems or a UTC based time  
 15911 stamp (UTC data type) identifying when the Load Control Event was issued.

15912 **Event Status (mandatory):** Table 10-54 lists the valid values returned in the Event Status field.



15913

**Table 10-54. Event Status Field Values**

Value	Description
0x01	Load Control Event command received
0x02	Event started
0x03	Event completed
0x04	User has chosen to “Opt-Out”, user will not participate in this event
0x05	User has chosen to “Opt-In”, user will participate in this event
0x06	The event has been cancelled
0x07	The event has been superseded
0x08	Event partially completed with User “Opt-Out”
0x09	Event partially completed due to User “Opt-In”
0x0A	Event completed, no User participation (Previous “Opt-Out”)
0xF8	Rejected -Invalid Cancel Command (Default)
0xF9	Rejected -Invalid Cancel Command (Invalid Effective Time)
0xFB	Rejected -Event was received after it had expired (Current Time > Start Time + Duration)
0xFD	Rejected -Invalid Cancel Command (Undefined Event)
0xFE	Load Control Event command Rejected

15914

15915 Should a device issue one or more “OptOut” or “OptIn” RES commands during an event that is eventually  
 15916 cancelled, the event shall be recorded as a cancelled event (Status = 0x06) at its effective time.

15917 Should a device issue one or more “OptOut” or “OptIn” RES commands during an event that is not  
 15918 cancelled, the event shall be recorded as partially completed based on the last RES command sent (Status =  
 15919 0x08 or 0x09).

15920 When a device returns a status of 0xFD (Rejected -Invalid Cancel Command (Undefined Event)), all  
 15921 optional fields should report their “Ignore” values.

15922 When a device receives a duplicate RES command, it should ignore the duplicate commands. Please note:  
 15923 As a recommended best practice, ESI applications should provide a mechanism to assist in filtering dupli-  
 15924 cate messages received on the WAN.

15925 **Event Status Time (mandatory):** UTC Timestamp representing when the event status occurred. This field  
 15926 shall not use the value of 0x00000000.

15927 **Criticality Level Applied (mandatory):** Criticality Level value applied by the device, see the correspond-  
 15928 ing field in the Load Control Event command for more information.

15929 **Cooling Temperature Set Point Applied (optional):** Cooling Temperature Set Point value applied by the  
 15930 device, see the corresponding field in the Load Control Event command for more information. The value  
 15931 0x8000 means that this field has not been used by the end device.

15932 **Heating Temperature Set Point Applied (optional):** Heating Temperature Set Point value applied by the  
 15933 device, see the corresponding field in the Load Control Event command for more information. The value  
 15934 0x8000 means that this field has not been used by the end device.

15935 **Average Load Adjustment Percentage Applied (optional):** Average Load Adjustment Percentage value  
 15936 applied by the device, see the corresponding field in the Load Control Event command for more information.  
 15937 The value 0x80 means that this field has not been used by the end device.

15938 **Duty Cycle Applied (optional):** Defines the maximum On state duty cycle applied by the device. The  
 15939 value 0xFF means that this field has not been used by the end device. Refer to sub-clause 10.3.2.3.1.1.1.

15940 **Event Control (mandatory):** Identifies additional control options for the event. Refer to sub-clause  
 15941 10.3.2.3.1.1.1.

15942 **Signature Type (mandatory):** An 8-bit Unsigned integer enumerating the type of algorithm used to  
 15943 create the Signature. The enumerated values are shown in Table 10-55:

**Table 10-55. Enumerated Values of Signature Types**

Enumerated Value	Signature Type
0x00	No Signature
0x01	ECDSA

15945  
 15946 If the signature field is not used, the signature type shall be set to 0x00, which will be used to indicate “no  
 15947 signature.” The signature field shall be filled with (48) 0xFF values.

15948 **Signature (optional):** A non-repudiation signature created by using the Matyas-Meyer-Oseas hash function  
 15949 (specified in Annex B.6 in [Z1]) used in conjunction with ECDSA. The signature creation process will  
 15950 occur in two steps:

15951 Pass the first ten fields, which includes all fields up to the Signature field, of the Report Event Status command  
 15952 (listed in Figure 10-41) through ECDSA using the device’s ECC Private Key, generating the signature (r,s).

15953 **Note:** ECDSA internally uses the MMO hash function in place of the internal SHA-1 hash function.

15954 Concatenate ECDSA signature components (r,s) and place into the Signature field within the Report Event  
 15955 Status command.

15956 **Note:** the lengths of r and s are implicit, based on the curve used. Verifying the signature will require breaking  
 15957 the signature field back into the discrete components r and s, based on the length.

15958 **10.3.3.3.1.2 When Generated**

15959 This command is generated when the client device detects a change of state for an active Load Control  
 15960 event. (The transmission of this command should be delayed after a random delay between 0 and 5 seconds,  
 15961 to avoid a potential storm of packets.)

15962 **10.3.3.3.2 Get Scheduled Events Command**

15963 This command is used to request that Load Control Events are re-issued to the requesting device. When re-  
 15964 ceived by the Server, matching Load Control Event commands (see sub-clause 10.3.2.3.1) shall be sent cov-  
 15965 ering active and scheduled Load Control Events. Events shall be sorted by Start Time and sent with earliest  
 15966 Start Time first. Events with the same Start Time shall be further sorted by Issuer Event ID and sent with  
 15967 least Issuer Event ID first<sup>163</sup>.

15968 **10.3.3.3.2.1 Payload Format**

15969 The Get Scheduled Events command payload shall be formatted as illustrated in Figure 10-42.

<sup>163</sup> CCB 1297

15970

**Figure 10-42. Format of the *Get Scheduled Events* Command Payload**

Octets	4	1	0/4 <sup>a</sup>
Data Type	UTC	uint8	uint32
Field Name	Start Time (M)	Number of Events (M)	Issuer Event ID (O)

15971

a. CCB 1297

15972

15973 **Start Time (mandatory):** UTC Timestamp representing the minimum Start Time of events that shall be  
 15974 matched and sent by the Server. A Start Time of 0x00000000 has no special meaning<sup>164</sup>.

15975 **Number of Events (mandatory):** Represents the maximum number of events to be sent. A value of 0  
 15976 indicates no maximum limit<sup>165</sup>. Example: Number of Events = 1 would return the first event with a Start  
 15977 Time greater than or equal to the value of Start Time field in the Get Scheduled Events command<sup>166</sup>.

15978 **Issuer Event ID (optional):** A value of 0xFFFFFFFF indicates this field will not be used. Represents the  
 15979 minimum Issuer Event ID of events to be matched and sent by the server with the same Start Time as the Get  
 15980 Scheduled Events command. Events starting after the specified Start Time are not filtered by this field and  
 15981 shall be matched and sent as normal.<sup>167</sup>

15982 **Note:** While the Issuer Event ID field is optional there are cases where support is required for correct opera-  
 15983 tion. For example, a client using a non-zero Number of Events shall use Issuer Event ID when there may be  
 15984 more events with the same Start Time than it can retrieve in a single request. Similarly a server storing  
 15985 multiple events with the same Start Time shall support Issuer Event ID to allow all clients reliable access.<sup>168</sup>

15986 **10.3.3.3.2 When Generated**

15987 This command is generated when the client device wishes to verify the available Load Control Events. It  
 15988 may also be generated after a loss of power, on reset, joining to a network, or any other case where the  
 15989 client device needs to recover currently active or scheduled Load Control Events<sup>169</sup>.

15990 A Default Response with status NOT\_FOUND shall be returned when there are no events available.

15991 **10.3.3.4 Commands Received**

15992 The client receives the cluster-specific commands detailed in sub-clause 10.3.2.

15993 **10.3.3.5 Attribute Reporting**

15994 Attribute reporting is not expected to be used for this cluster. The Client side attributes are not expected  
 15995 to be changed by the Client, only used during Client operations.

15996 **10.3.4 Application Guidelines**

15997 The criticality level is sent by the utility to the load control device to indicate how much load reduction is  
 15998 requested. The utility is not required to use all of the criticality levels that are described in this specifi-  
 15999 cation. A load control device is not required to provide a unique response to each criticality level that it  
 16000 may receive.

<sup>164</sup> CCB 1297

<sup>165</sup> CCB 1447

<sup>166</sup> CCB 1297

<sup>167</sup> CCB 1297

<sup>168</sup> CCB 1297

<sup>169</sup> CCB 1297

- 16001 The Average Load Adjustment Percentage, temperature offsets, and temperature set points are used by load  
16002 control devices and energy management systems on a “voluntary” or “optional” basis. These devices are  
16003 not required to use the values that are provided by the utility. They are provided as a recommendation by  
16004 the utility.
- 16005 The load control device shall, in a manner that is consistent with this specification, accurately report event  
16006 participation by way of the Report Event Status message.
- 16007 The Average Load Adjustment Percentage is sent by the utility to the load control device to indicate how  
16008 much load reduction is requested. The load control device may respond to this information in a unique  
16009 manner as defined by the device manufacturer.
- 16010 The Duty Cycle is sent by the utility to the load control device to indicate the maximum “On state” for  
16011 a device. The control device may respond to this information in a unique manner as defined by the device  
16012 manufacturer.
- 16013 The cooling temperature offset may be sent by the utility to the load shed control to indicate how much  
16014 indoor cooling temperature offset is requested. Response of a load control device to this information is not  
16015 mandatory. The control device may respond to this information in a unique manner as defined by the device  
16016 manufacturer.
- 16017 The heating temperature offset may be sent by the utility to the load control device to indicate how much  
16018 indoor heating temperature offset is requested. The control device may respond to this information in a  
16019 unique manner as defined by the device manufacturer.
- 16020 The cooling temperature may be sent by the utility to the load control device to indicate the indoor cooling  
16021 temperature setting that is requested. The control device may respond to this information in a unique  
16022 manner as defined by the device manufacturer.
- 16023 The heating temperature may be sent by the utility to the load control device to indicate the indoor heating  
16024 temperature setting that is requested. The control device may respond to this information in a unique  
16025 manner as defined by the device manufacturer.
- 16026 **Note:** The most recent Load Control Event supersedes any previous Load Control Event command for the set  
16027 of Device Classes and groups for a given time. Nested events and overlapping events are not allowed. The  
16028 current active event will be terminated if a new event is started with an overlapping Device Class and Utility  
16029 Enrollment Group.

### 16030 **10.3.4.1 Load Control Rules, Server**

#### 16031 **10.3.4.1.1 Load Control Server, Identifying Use of SetPoint** 16032 **and Offset Fields**

- 16033 The use of the fields, Heating and Cooling Temperature Set Points and Heating and Cooling Temperature  
16034 Offsets is optional. All fields in the payload must be populated. Non-use of these fields by the Server is  
16035 indicated by using the following values: 0x8000 for Set Points and 0xFF for Offsets. When any of these four  
16036 fields are indicated as optional, they shall be ignored by the client.

#### 16037 **10.3.4.1.2 Load Control Server, Editing of Scheduled Events**

- 16038 Editing of a scheduled demand response event is not allowed. Editing of an active demand response event is  
16039 not allowed. Nested events and overlapping events are not allowed. The current active event will be termi-  
16040 nated if a new event is started.

## 16041 **10.3.4.2 Load Control Rules, Client**

### 16042 **10.3.4.2.1 Start and Duration<sup>170</sup> Randomization**

16043 When shedding loads (turning a load control device off), the load control device will optionally apply start  
16044 time randomization based on the values specified in the Event Control Bits and the Client's Start Random-  
16045 ization Minutes attribute. By default, devices will apply a random delay as specified by the default value  
16046 for start randomization, but typically not apply duration<sup>171</sup> randomization, as defined in the Demand Re-  
16047 sponse Client Cluster Attributes table (Table 10-52); as a result, events will be equal length for all customers.

16048 Normally, any randomization applied to the start of a load control event will be carried forward when ending  
16049 the load control event. As an alternative, ending of a load control event may be varied independently of the  
16050 start by randomizing the duration of an event via use of the DurationRandomizationMinutes attribute<sup>172</sup>.

### 16051 **10.3.4.2.2 Editing of DR Control Parameters**

16052 In Load Control Device and energy management systems, editing of the demand response control parameters  
16053 while participating in an active demand response event is not allowed.

### 16054 **10.3.4.2.3 Response to Price Events + Load Control Events**

16055 The residential system's response to price driven events will be considered in addition to the residential  
16056 system's response to demand response events. Demand response events which require that the residential  
16057 system is turned off have priority over price driven events. Demand response events which require that the  
16058 residential system go to a fixed setting point have priority over price driven events. In this case, the thermostat  
16059 shall not use a Cooling or Heating Temperature Set Point that causes the device to use more energy than  
16060 the price driven event setting.

### 16061 **10.3.4.2.4 Opt-Out Messages**

16062 An event override message, "opt-out", will be sent by the load control device or energy management system  
16063 if the operator chooses not to participate in a demand response event by taking action to override the  
16064 programmed demand reduction response. The override message will be sent at the start of the event. In  
16065 the case where the event has been acknowledged and started, the override message will be sent when the  
16066 override occurs.

### 16067 **10.3.4.2.5 Thermostat/HVAC Controls**

16068 A residential HVAC system will be allowed to change mode, from off to Heat, off to Cool, Cool to Heat, or  
16069 Heat to Cool, during a voluntary event which is currently active. The HVAC control must acknowledge the  
16070 event, as if it was operating, in that mode, at the start of the event. The HVAC control must obey the event  
16071 rules that would have been enforced if the system had been operating in that mode at the start of the active  
16072 event.

16073 An event override message, "opt-out", will be sent by the load control device or energy management system  
16074 if the operator chooses not to participate in a demand response event by taking action to override the  
16075 programmed demand reduction response. The override message will be sent at the start of the event. In  
16076 the case where the event has been acknowledged and started, the override message will be sent when the  
16077 override occurs.

---

<sup>170</sup> CCB 1513

<sup>171</sup> CCB 1513

<sup>172</sup> CCB 1513

16078  
16079

### 10.3.4.2.6 Demand Response and Load Control Transaction Examples

16080 The example in Figure 10-43 depicts the transactions that would take place for two events, one that is success-  
16081 ful and another that is overridden by the user.

16082 **Figure 10-43. Example of Both a Successful and an Overridden Load Curtailment Event**

16083

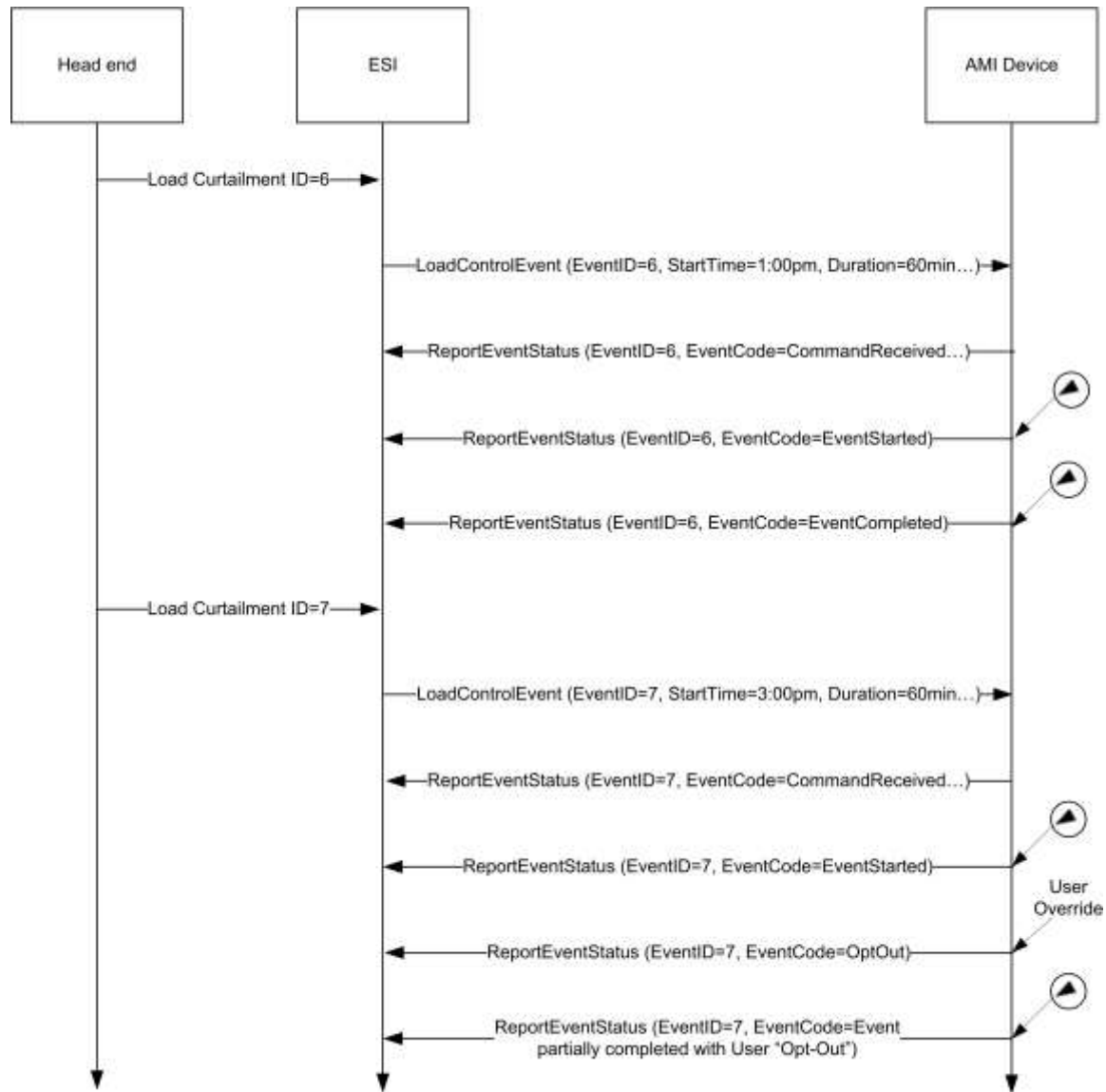

16084  
16085

16086 The example in Figure 10-44 depicts the transactions that would take place when an event is superseded by  
 16087 an event that is eventually cancelled.

16088 **Figure 10-44. Example of a Load Curtailment Superseded and Another Cancelled**

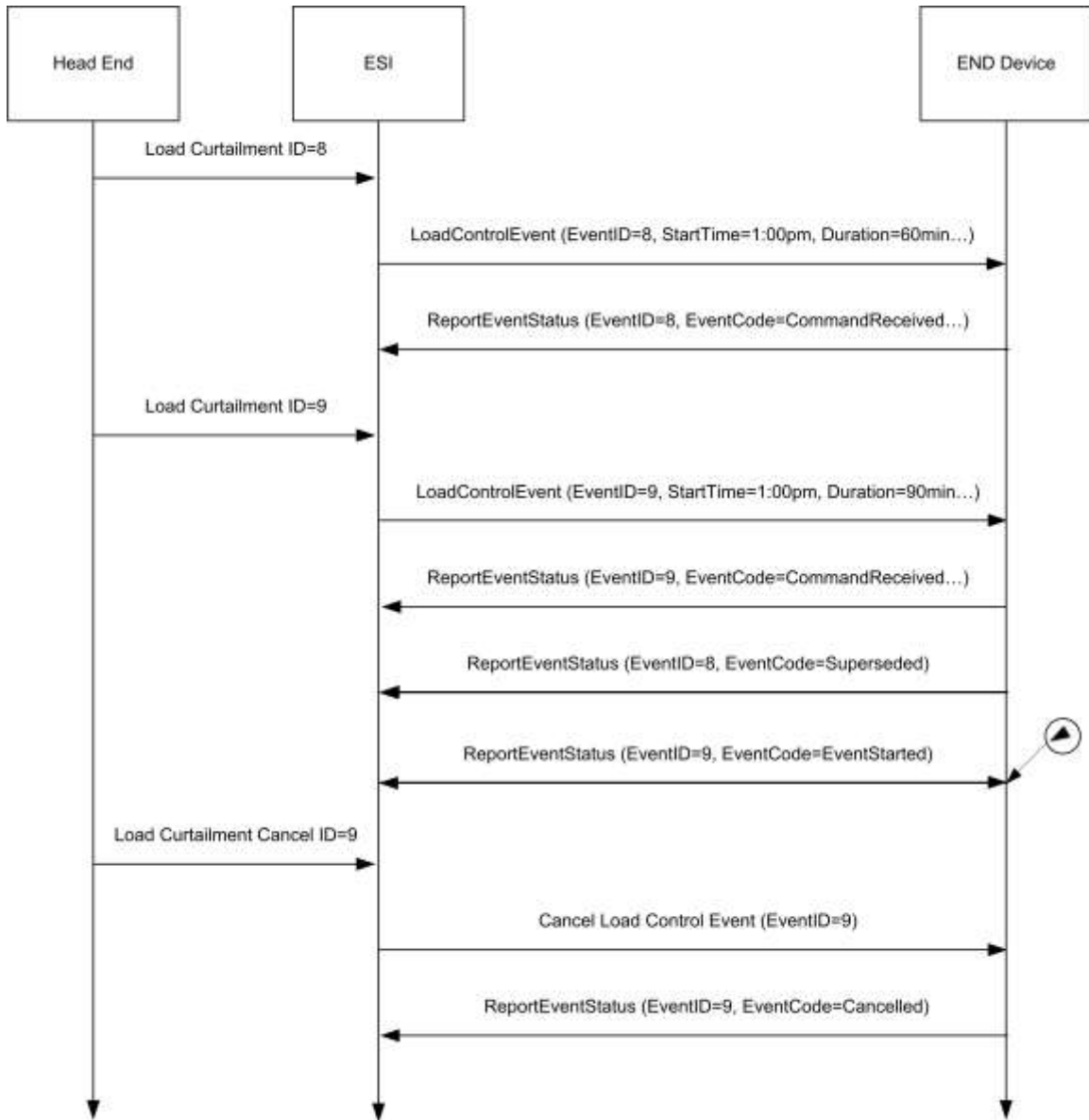

16089

16090

16091 Refer to section 10.3.5 for more information regarding the management and behavior of overlapping  
 16092 events.

### 16093 **10.3.5 Rules and Guidelines for Overlapping Events**

16094 This section describes multiple scenarios that Demand Response and Load Control devices may encounter  
 16095 over the Smart Energy network. The examples describe situations of overlapping events that are acceptable  
 16096 and where overlapping events that will be superseded due to conflicts.

### 16097 10.3.5.1 Definitions

16098 **Start Time** – “Start Time” field contained within the Load Control Event packet indicating when the event  
16099 should start. Please note, a “Start Time” value of 0x00000000 denotes “now” and the device should use its  
16100 current time as the “Start Time.”

16101 **Duration** – “Duration” field contained within the Load Control Event packet indicating how long the  
16102 event should occur.

16103 **End Time** – Time when Event completes as calculated by adding Duration to Start Time.

16104 **Scheduled Period** – Represents the time between the Start Time and the End Time of the event.

16105 **Effective Start Time** -Represents time at which a specific device starts a load control event based on the  
16106 Start Time plus any randomization offsets.

16107 **Effective End Time** – Represents time at which a specific device ends a load control event based on the  
16108 Start Time plus Duration, plus any randomization offsets (from Start and/or Duration Randomization)<sup>173</sup>.

16109 **Effective Scheduled Period** – Represents the time between the Effective Start Time and the Effective  
16110 End Time.

16111 **Overlapping Event** – Defined as an event where the Scheduled Period covers part or all of an existing, pre-  
16112 viously scheduled event.

16113 **Successive Events** – Defined as two events where the scheduled End Time of the first event is equal to the  
16114 Start Time of a subsequent scheduled event.

16115 **Nested Events** – Defined as two events where the scheduled Start Time and End Time of the second event  
16116 falls during the Scheduled Period of the first scheduled event and the second event is of shorter duration than  
16117 the first event.

### 16118 10.3.5.2 Rules and Guidelines

16119 The depicted behaviors and required application management decisions are driven from the following guid-  
16120 ance and rule set:

16121 1. Upstream Demand Response/Load Control systems and/or the ESI shall prevent mismanaged  
16122 scheduling of *Overlapping Events* or *Nested Events*. It is recognized Upstream Demand Re-  
16123 sponse/Load Control systems and/or the ESI will need to react to changing conditions on the grid  
16124 by sending *Overlapping Events* or *Nested Events* to supersede previous directives. But those sys-  
16125 tems must have the proper auditing and management rules to prevent a cascading set of error condi-  
16126 tions propagated by improperly scheduled events.

16127 2. When needed, Upstream Demand Response/Load Control systems and/or the ESI may resolve any  
16128 event scheduling conflicts by performing one of the following processes:

16129 1. Canceling individual events starting with the earliest scheduled event and re-issuing a new set  
16130 of events.

16131 2. Canceling all scheduled events and re-issuing a new set of events.

16132 3. Sending *Overlapping Events* or *Nested Events* to supersede previous directives.

16133 It is recommended that process 2.c is used for most situations since it can allow a smoother change  
16134 between two sets of directives, but no way does it negate the responsibilities identified in rule #1.

16135 3. When an End Device receives an event with the *End Time* in the past (*End Time* < *Current Time*),  
16136 this event is ignored and a *Report Event Status* command is returned with the Event Status set to  
16137 0xFB (Rejected -Event was received after it had expired).

---

<sup>173</sup> CCB 1513



- 16138 4. When an End Device receives an event with a *Start Time* in the past and an *End Time* in the future  
16139 ((*Start Time* < Current Time) AND (*End Time* > Current Time)), the event is processed immedi-  
16140 ately. The *Effective Start Time* is calculated using the Current Time as the *Start Time*. Original  
16141 *End Time* is preserved.
- 16142 5. Regardless of the state of an event (scheduled or executing), when an End Device detects an *Over-*  
16143 *lapping Event* condition the latest *Overlapping Event* will take precedence over the previous event.  
16144 Depending on the state of the event (scheduled or executing), one of the following steps shall take  
16145 place:
- 16146 1. If the previous event is scheduled and not executing, the End Device returns a *Report Event*  
16147 *Status* command (referencing the previous event) with the Event Status set to 0x07 (the event  
16148 has been superseded). After the *Report Event Status* command is successfully sent, the End  
16149 Device can remove the previous event schedule.
- 16150 2. If the previous event is executing, the End Device shall change directly from its current state to  
16151 the requested state at the *Effective Start Time* of the *Overlapping Event* (Note: Rule #4 effects  
16152 *Effective Start Time*). The End Device returns a *Report Event Status* command (referencing  
16153 the previous event) with the Event Status set to 0x07 (the event has been superseded).
- 16154 6. Randomization **shall not** cause event conflicts or unmanaged gaps. To clarify:
- 16155 1. When event start randomization is requested, time periods between the *Start Time* of an event  
16156 and the *Effective Start Time*, a device should either maintain its current state or apply changes  
16157 which contribute to energy saving. Preference would be to maintain current state.
- 16158 2. When event start and/or duration<sup>174</sup> randomization is used and the *Effective End Time* overlaps  
16159 the *Effective Start Time* of a *Successive Event*, the *Effective Start Time* takes precedence.  
16160 Events are not reported as superseded, End devices should report event status as it would a  
16161 normal set of *Successive Events*.
- 16162 3. It is recommended devices apply the same Start and Duration<sup>175</sup> Randomization values for con-  
16163 secutive events to help prevent unexpected gaps between events.
- 16164 4. Devices **shall not** artificially create a gap between *Successive Events*.
- 16165 7. It is permissible to have gaps when events are not *Successive Events* or *Overlapping Events*.
- 16166 8. If multiple device classes are identified for an event, future events for individual device classes (or  
16167 a subset of the original event) that cause an *Overlapping Event* will supersede the original event  
16168 strictly for that device class (or a subset of the original event). Note: Rule #5 applies to all *Over-*  
16169 *lapping Events*.

### 16170 10.3.5.3 Event Examples

16171 Smart Energy devices which act upon Demand Response and Load Control events shall use the following  
16172 examples for understanding and managing overlapping and superseded events. Within those examples,  
16173 references to multiple device classes will be used. Figure 10-45 depicts a representation of those devices  
16174 in a Smart Energy network.

---

<sup>174</sup> CCB 1513

<sup>175</sup> CCB 1513

16175

Figure 10-45. Smart Energy Device Class Reference Example

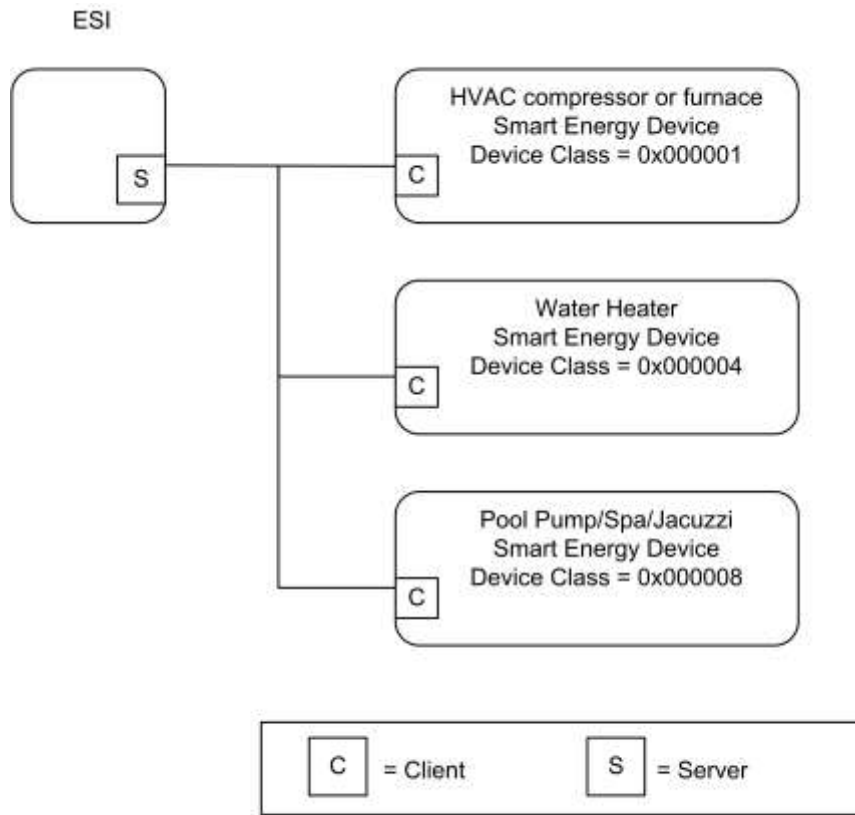

Note: Device names are examples for illustration purposes only

16176

16177 **10.3.5.3.1 Correct Overlapping Events for Different Device**  
16178 **Classes**

16179 Figure 10-46 depicts a correct series of DR/LC events for device class of 0x000001 (reference for the  
16180 BitMap definition) with an event scheduled for another device class during the same period.

16181

Figure 10-46. Correctly Overlapping Events

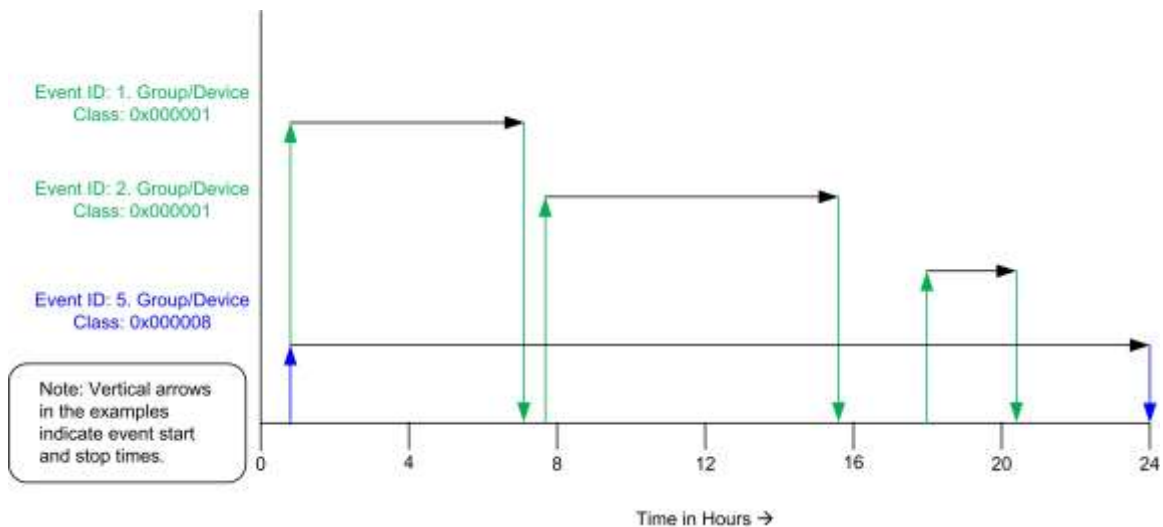

16182

16183

16184 In Figure 10-46, Device Class 0x000001 receives a sequence of 3 unique DR/LC events to be scheduled  
16185 and acted upon. During this same 24 hour period, Device Class 0x000008 receives one scheduled DR/LC  
16186 event that spans across the same time period as the events scheduled for Device Class 0x0000001. Because  
16187 both Device Classes are unique, there are no conflicts due to Overlapping Events.

### 16188 **10.3.5.3.2 Correct Superseded Event for a Device Class**

16189 Figure 10-47 depicts a correct series of DR/LC events for device class of 0x000001 (reference for the  
16190 BitMap definition) where an event is scheduled then later superseded.

16191

**Figure 10-47. Correct Superseding of Events**

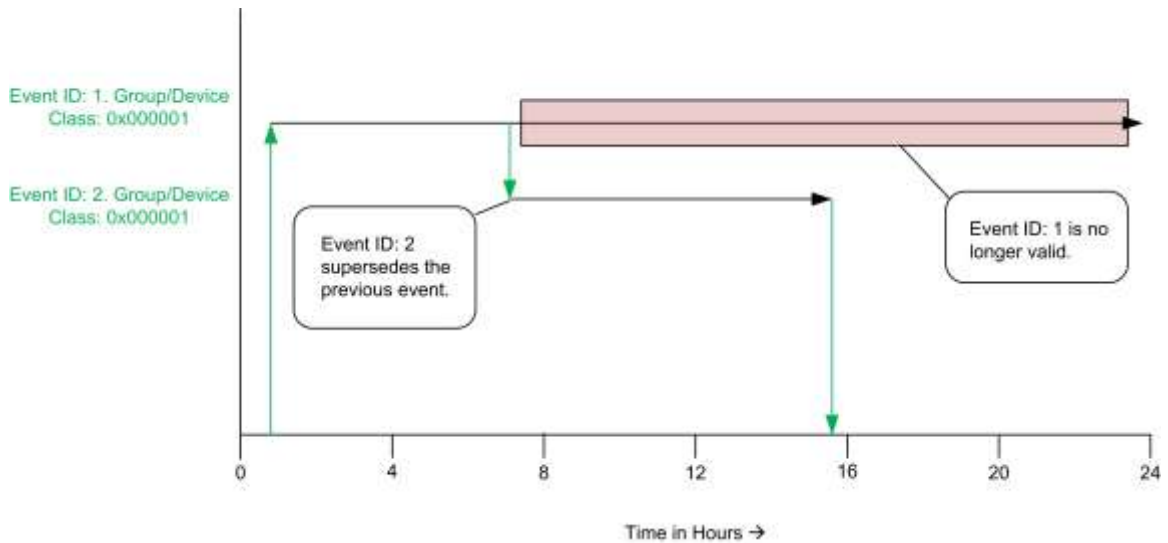

16192

16193

16194 In Figure 10-47, Device Class 0x000001 receives DR/LC Event ID#1 setup for a 24 hour Scheduled Period,  
16195 which later is superseded by DR/LC Event ID#2, invalidating the remainder of Event ID#1, which is cancelled.  
16196

### 16197 **10.3.5.3.3 Superseding Events for Subsets of Device Classes**

16198 Figure 10-48 depicts a correct series of DR/LC events for device class of 0x000001 (reference for the  
16199 BitMap definition) with an event scheduled for another device class during the same time period.

16200

**Figure 10-48. Superseded Event for a Subset of Device Classes**

16201

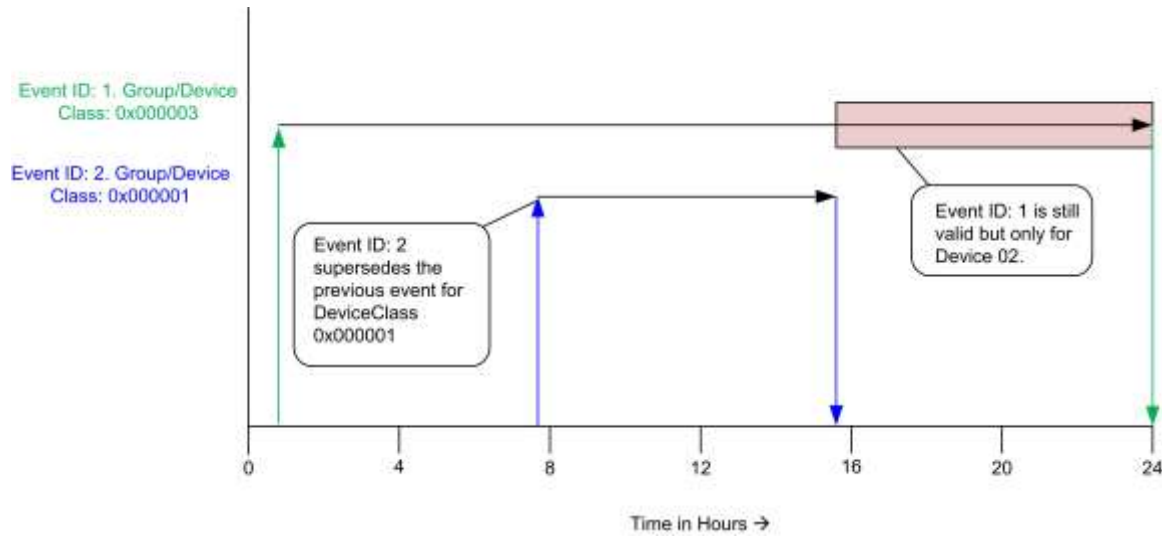

16202

16203 In Figure 10-48, Device Class 0x000003 receives DR/LC Event ID#1 setup for a 24 hour Scheduled Period,  
 16204 which is targeted for both Device Class 0x000002 and 0x000001 (OR'ed == 0x000003). In the example,  
 16205 Event ID#2 is issued only for Device Class 0x000001, invalidating the remainder of Event ID#1 for that  
 16206 device class. DR/LC Event ID#1 is still valid for Device Class 0x000002, which in the example should run  
 16207 to completion.

### 16208 10.3.5.3.4 Ending Randomization Between Events

16209 Figure 10-49 depicts two standard events with start and/or duration randomization where the Effective End  
 16210 Time of the first event is overlapped by a second scheduled DR/LC event for device class of 0x000001  
 16211 (reference for the BitMap definition)<sup>176</sup>.

16212

**Figure 10-49. Ending Randomization Between Events**

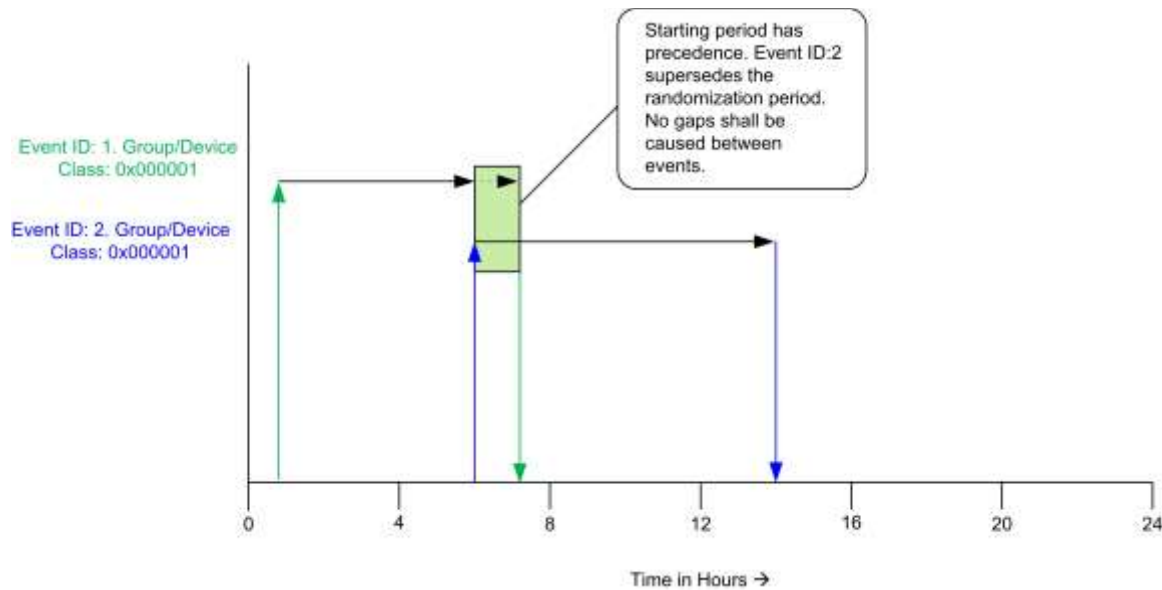

16213

<sup>176</sup> CCB 1513

16214 In Figure 10-49, Device Class 0x000001 receives a DR/LC Event ID#1 with a start and/or duration<sup>177</sup>  
16215 randomization setting (please refer to sub-clause 10.3.2.3.1.1.1 for more detail). A second DR/LC (Event  
16216 ID#2) is issued with a starting time which matches the ending time of DR/LC Event ID#1. In this situation,  
16217 the Start Time of Event ID#2 has precedence. Event ID#1 is not reported as superseded.

### 16218 10.3.5.3.5 Start Randomization Between Events

16219 Figure 10-50 depicts an Effective Start Time that overlaps a previously scheduled DR/LC event for device  
16220 class of 0x000001 (reference for the BitMap definition).

16221 **Figure 10-50. Start Randomization Between Events**

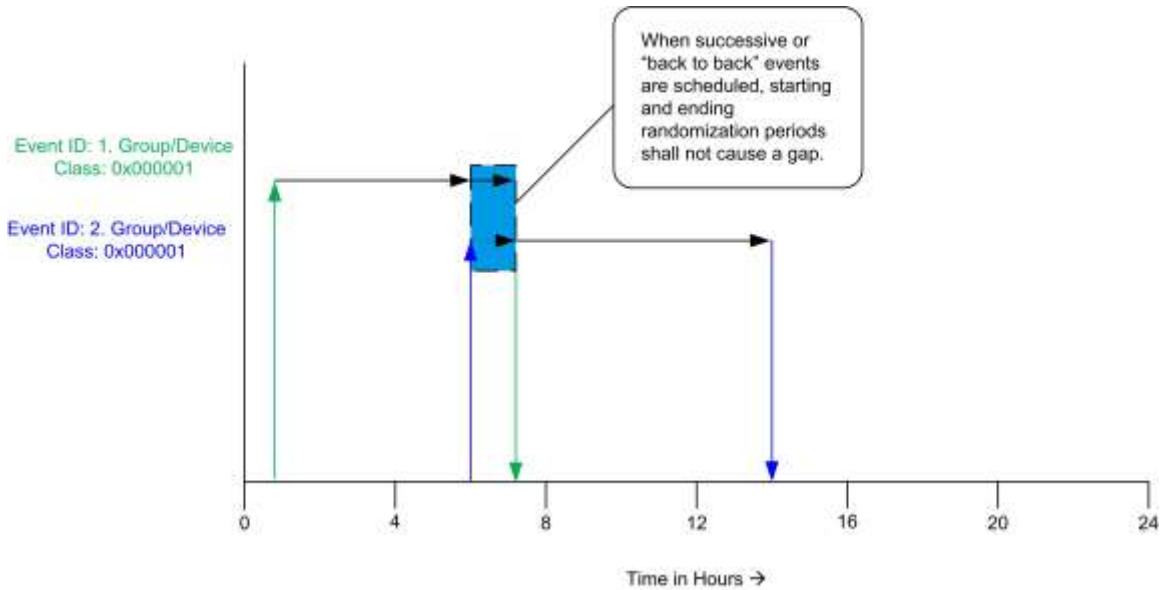

16222

16223

16224 In Figure 10-50, Device Class 0x000001 receives a DR/LC Event ID#1 with a duration<sup>178</sup> randomization  
16225 setting (please refer to sub-clause 10.3.2.3.1.1.1 for more detail). Effective End Time of Event ID#1 is not  
16226 known. A second DR/LC (Event ID#2) is issued with a starting randomization setting, which has an  
16227 Effective Start Time that could overlap or start after the Effective End Time of DR/LC Event ID#1. In  
16228 this situation, the Effective Start Time of Event ID#2 has precedence but the DR/LC device must also  
16229 prevent any artificial gaps caused by the Effective Start Time of Event ID#2 and Effective End Time of  
16230 Event ID#1.

### 16231 10.3.5.3.6 Acceptable Gaps Caused by Start and Stop Randomi- 16232 zation of Events

16233 Figure 10-51 depicts an acceptable gap between two scheduled DR/LC events for device class of 0x000001  
16234 (reference for the BitMap definition) using both starting and ending randomization with both events.

<sup>177</sup> CCB 1513

<sup>178</sup> CCB 1513

16235

**Figure 10-51. Acceptable Gaps with Start and Stop Randomization**

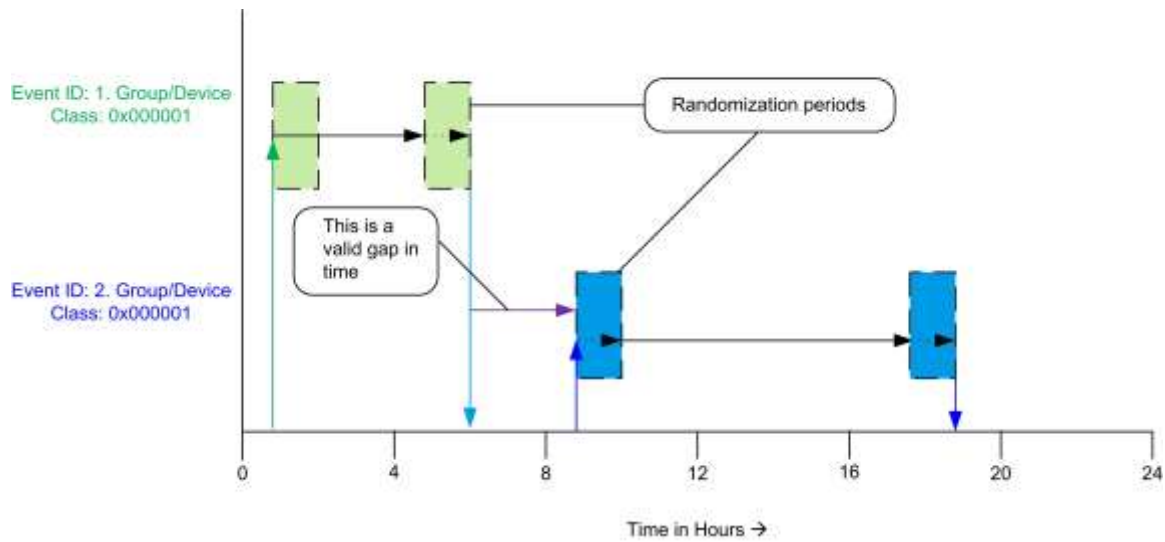

16236

16237

16238 In Figure 10-51, Device Class 0x000001 receives a DR/LC Event ID#1 with both a starting and ending  
 16239 randomization setting. (Please refer to sub-clause 10.3.2.3.1.1.1 for more detail). A second DR/LC Event  
 16240 ID#2 is also issued with both a starting and ending randomized setting. The primary configuration to note in  
 16241 this example is the Effective End Time of DR/LC Event ID#1 completes well in advance of the Effective  
 16242 Start Time of DR/LC Event ID#2. In this scenario, regardless of randomization, a gap is naturally created  
 16243 by the scheduling of the events and is acceptable.

## 16244 10.4 Metering

### 16245 10.4.1 Overview

16246 Please see Chapter 2 for a general cluster overview defining cluster architecture, revision, classification,  
 16247 identification, etc.

16248 The Metering Cluster provides a mechanism to retrieve usage information from Electric, Gas, Water, and  
 16249 potentially Thermal metering devices. These devices can operate on either battery or mains power, and can  
 16250 have a wide variety of sophistication. The Metering Cluster is designed to provide flexibility while limiting  
 16251 capabilities to a set number of metered information types. More advanced forms or data sets from metering  
 16252 devices will be supported in the Smart Energy Tunneling Cluster, which will be defined in sub-clause 10.6.

16253 The following figures identify three configurations as examples utilizing the Metering Cluster.

16254 In Figure 10-52, the metering device is the source of information provided via the Metering Cluster Server.

16255

**Figure 10-52. Standalone ESI Model with Mains Powered Metering Device**

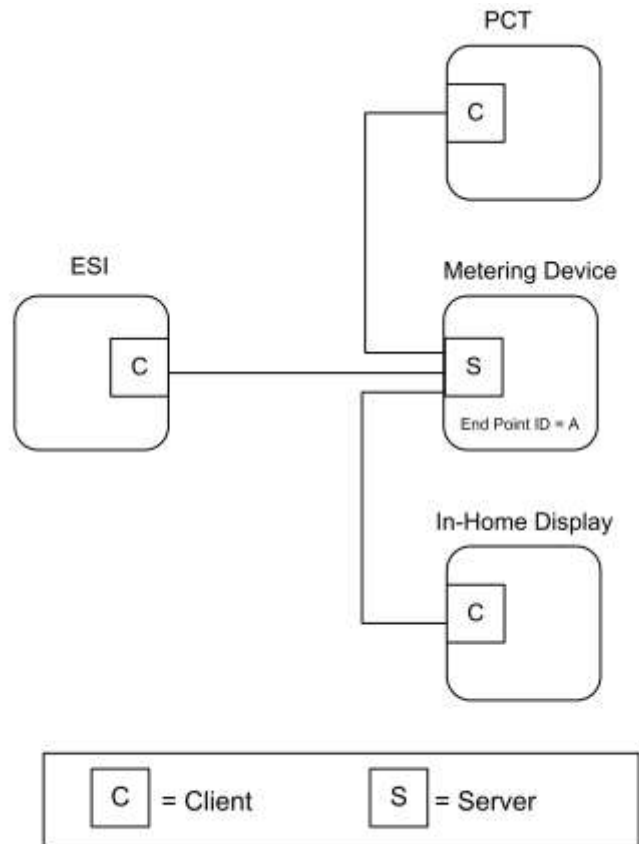

16256

*Note: Device names are examples for illustration purposes only*

16257

16258

16259

16260

In the example shown in Figure 10-53, the metering device is running on battery power and its duty cycle for providing information is unknown. It's expected the ESI will act like a mirrored image or a mailbox (Client) for the metering device data, allowing other Smart Energy devices to gain access to the metering device's data (provided via an image of its Metering Cluster).

16261

**Figure 10-53. Standalone ESI Model with Battery Powered Metering Device**

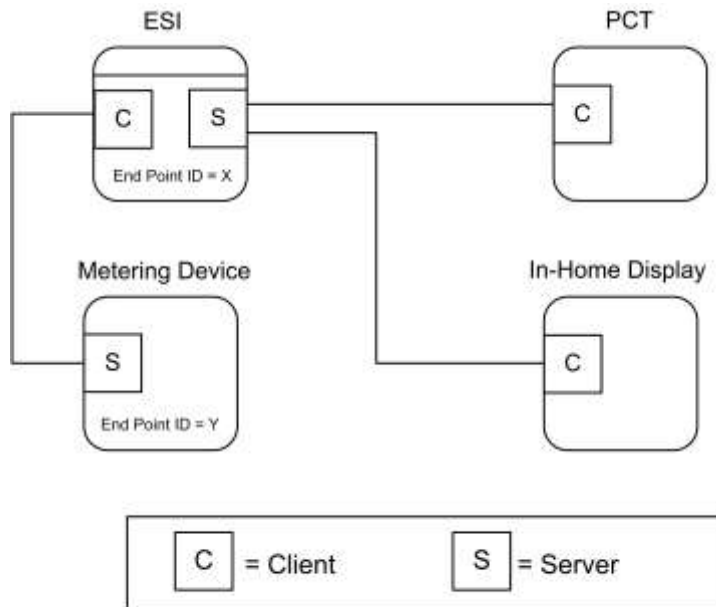

*Note: Device names are examples for illustration purposes only*

16262

16263 In the example shown in Figure 10-54, much like the previous example in Figure 10-53, the external metering  
 16264 device is running on battery power and its duty cycle for providing information is unknown. It's expected the  
 16265 ESI will act like a Client side mailbox for the external metering device data, allowing other Smart Energy  
 16266 devices to gain access to the metering device's data (provided via an image of its Metering Cluster).  
 16267 Since the ESI can also contain an integrated metering device where its information is also conveyed through  
 16268 the Metering Cluster, each device (external metering device mailbox and integrated meter) will be available  
 16269 via independent EndPoint IDs. Other Smart Energy devices that need to access the information must under-  
 16270 stand the ESI cluster support by performing service discoveries. It can also identify if an Endpoint ID is a  
 16271 mailbox/ mirror of a metering device by reading the MeteringDeviceType attribute (refer to sub-clause  
 16272 10.4.2.2.4.7).



16273

**Figure 10-54. ESI Model with Integrated Metering Device**

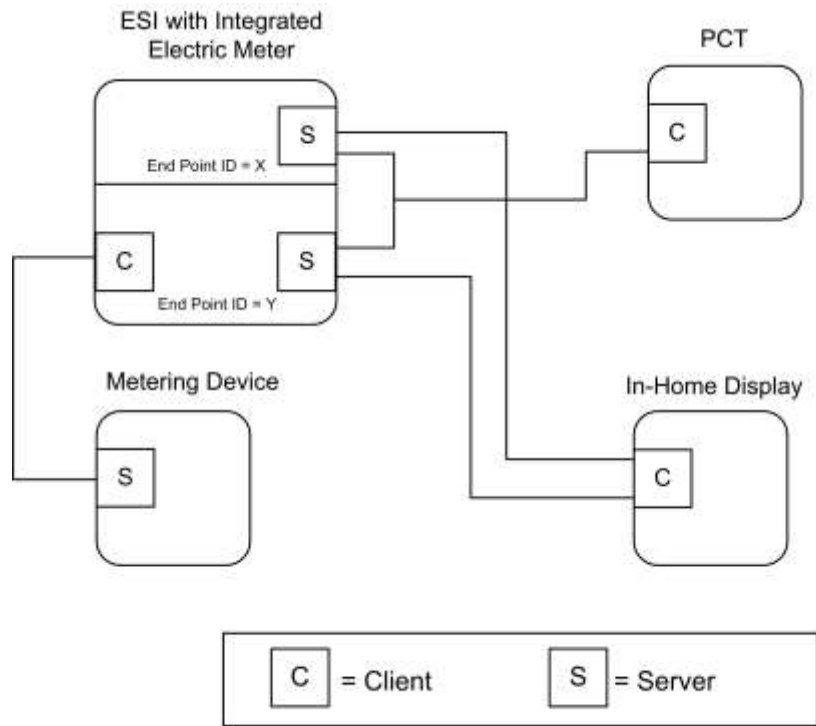

*Note: Device names are examples for illustration purposes only*

16274

16275 In the above examples (Figure 10-53 and Figure 10-54), it is expected the ESI would perform Attribute  
 16276 Reads (or configure Attribute Reporting) and use the GetProfile command to receive the latest information  
 16277 whenever the Metering Device (EndPoint Z) wakes up. When received, the ESI will update its mailbox  
 16278 (EndPoint ID Y in Figure 10-53 and Figure 10-54) to reflect the latest data available. A metering device  
 16279 using the mirror is also allowed (and recommended) to push metering data updates to the ESI via Report  
 16280 Attribute commands as described in sub-clause 10.4.4.4.

16281 Other Smart Energy devices can access EndPoint Y in the ESI to receive the latest information just as they  
 16282 would to access information in the ESI’s integrated Electric meter (as in Figure 10-54, EndPoint X) and  
 16283 other Metering devices (as in Figure 10-52, EndPoint A).

### 16284 10.4.1.1 Revision History

16285 The global *ClusterRevision* attribute value SHALL be the highest revision number in the table below.

Rev	Description
1	mandatory global <i>ClusterRevision</i> attribute added
2	Updated from SE1.4 version; CCB 1655 1679 1886 2010 2023 2183 2199 2286 2477

### 16286 10.4.1.2 Classification

Hierarchy	Role	PICS Code	Primary Transaction
Base	Application	SEMT	Type 1 (client to server)

16287 **10.4.1.3 Cluster Identifiers**

Identifier	Name
0x0702	Metering (Smart Energy)

16288 **10.4.2 Server**

16289 **10.4.2.1 Dependencies**

16290 Subscribed reporting of Metering attributes.

16291 **10.4.2.2 Attributes**

16292 For convenience, the attributes defined in this specification are arranged into sets of related attributes; each  
 16293 set can contain up to 256 attributes. Attribute identifiers are encoded such that the most significant octet  
 16294 specifies the attribute set and the least significant octet specifies the attribute within the set. The currently  
 16295 defined attribute sets are listed in Table 10-56.

16296 **Note:** Certain attributes within this cluster are provisionary and not certifiable. Refer to the individual  
 16297 attribute sets for details of the relevant attributes.

16298 **Table 10-56. Metering Cluster Server Attribute Sets**

Attribute Set Identifier	Description
0x00	Reading Information Set
0x01	TOU Information Set
0x02	Meter Status
0x03	Formatting
0x04	Historical Consumption
0x05	Load Profile Configuration
0x06	Supply Limit
0x07	Block Information (Delivered)
0x08	Alarms
0x09	Block Information (Received)
0x0A	Meter Billing Attribute Set
0x0B	Supply Control Attribute Set
0x0C	Alternative Historical Consumption

16299 **10.4.2.2.1 Reading Information Set**

16300 The set of attributes shown in Table 10-57 provides a remote access to the reading of the Electric, Gas,  
 16301 or Water metering device. A reading must support at least one register which is the actual total summation  
 16302 of the delivered quantity (kWh, m<sup>3</sup>, ft<sup>3</sup>, ccf, US gl).

16303 Please note: In the following attributes, the term “Delivered” refers to the quantity of Energy, Gas, or Water  
 16304 that was delivered to the customer from the utility. Likewise, the term “Received” refers to the quantity  
 16305 of Energy, Gas, or Water that was received by the utility from the customer.

16306 **Note:** Metering Cluster Reading Attribute 0x12 in this revision of this specification is provisional and  
 16307 not certifiable. This feature set may change before reaching certifiable status in a future revision of this  
 16308 specification.

16309

**Table 10-57. Reading Information Attribute Set**

Id	Name	Type	Range	Acc	Def	M
0x0000	<i>CurrentSummationDelivered</i>	uint48	0x000000000000 to 0xFFFFFFFFFFFFFFF	R	-	M
0x0001	<i>CurrentSummationReceived</i>	uint48	0x000000000000 to 0xFFFFFFFFFFFFFFF	R	-	O
0x0002	<i>CurrentMaxDemandDelivered</i>	uint48	0x000000000000 to 0xFFFFFFFFFFFFFFF	R	-	O
0x0003	<i>CurrentMaxDemandReceived</i>	uint48	0x000000000000 to 0xFFFFFFFFFFFFFFF	R	-	O
0x0004	<i>DFTSummation</i>	uint48	0x000000000000 to 0xFFFFFFFFFFFFFFF	R	-	O
0x0005	<i>DailyFreezeTime</i>	uint16	0x0000 to 0x173B	R	0x0000	O
0x0006	<i>PowerFactor</i>	int8	-100 to +100	R	0x00	O
0x0007	<i>ReadingSnapShotTime</i>	UTC		R	-	O
0x0008	<i>CurrentMaxDemandDeliveredTime</i>	UTC		R	-	O
0x0009	<i>CurrentMaxDemandReceivedTime</i>	UTC		R	-	O
0x000A	<i>DefaultUpdatePeriod</i>	uint8	0x00 to 0xFF	R	0x1E	O
0x000B	<i>FastPollUpdatePeriod</i>	uint8	0x00 to 0xFF	R	0x05	O
0x000C	<i>CurrentBlockPeriodConsumptionDelivered</i>	uint48	0x000000000000 to 0xFFFFFFFFFFFFFFF	R	-	O
0x000D	<i>DailyConsumptionTarget</i>	uint24	0x000000 to 0xFFFFFF	R	-	O
0x000E	<i>CurrentBlock</i>	enum8	0x00 to 0x10	R	-	O
0x000F	<i>ProfileIntervalPeriod</i>	enum8	0x00 to 0xFF	R	-	O

<b>Id</b>	<b>Name</b>	<b>Type</b>	<b>Range</b>	<b>Acc</b>	<b>Def</b>	<b>M</b>
0x0010	<i>Deprecated</i> <sup>179</sup>					
0x0011	<i>PresetReadingTime</i>	uint16	0x0000 to 0x173B	R	0x0000	O
0x0012	<i>SummationDeliveredPerReport</i> <sup>180</sup>	uint16	0x0000 to 0xFFFF	R	-	O
0x0013	<i>FlowRestriction</i>	uint8	0x00 to 0xFF	R	-	O
0x0014	<i>Supply Status</i>	enum8	0x00 to 0xFF	R	-	O
0x0015	<i>CurrentInletEnergyCarrierSummation</i>	uint48	0x000000000000 to 0xFFFFFFFFFFFFFF	R	-	O <sup>181</sup>
0x0016	<i>CurrentOutletEnergyCarrierSummation</i>	uint48	0x000000000000 to 0xFFFFFFFFFFFFFF	R	-	O
0x0017	<i>InletTemperature</i>	int24	-8,388,607 to 8,388,607	R	-	O <sup>182</sup>
0x0018	<i>OutletTemperature</i>	int24	-8,388,607 to 8,388,607	R	-	O <sup>183</sup>
0x0019	<i>ControlTemperature</i>	int24	-8,388,607 to 8,388,607	R	-	O
0x001A	<i>CurrentInletEnergyCarrierDemand</i>	int24	-8,388,607 to 8,388,607	R	-	O
0x001B	<i>CurrentOutletEnergyCarrierDemand</i>	int24	-8,388,607 to 8,388,607	R	-	O
0x001C	<i>PreviousBlockPeriodConsumptionDelivered</i>	uint48	0x000000000000 to 0xFFFFFFFFFFFFFF	R	-	O
0x001D	<i>CurrentBlockPeriod ConsumptionReceived</i>	uint48	0x000000000000 to 0xFFFFFFFFFFFFFF	R	-	O
0x001E	<i>CurrentBlockReceived</i>	enum8	0x00 – 0xFF	R	-	O
0x001F	<i>DFTSummation Received</i>	uint48	0x000000000000 to 0xFFFFFFFFFFFFFF	R	-	O
0x0020	<i>ActiveRegisterTier Delivered</i>	enum8	0 - 48	R	-	O

<sup>179</sup> CCB 1886

<sup>180</sup> CCB 1655

<sup>181</sup> CCB 1999

<sup>182</sup> CCB 1999

<sup>183</sup> CCB 1999

Id	Name	Type	Range	Acc	Def	M
0x0021	<i>ActiveRegisterTier Received</i>	enum8	0 - 48	R	-	O
0x0022	<i>LastBlockSwitchTime</i>	UTC		R	-	O

16310

16311 **10.4.2.2.1.1 *CurrentSummationDelivered Attribute***

16312 CurrentSummationDelivered represents the most recent summed value of Energy, Gas, or Water delivered  
 16313 and consumed in the premises. CurrentSummationDelivered is mandatory and must be provided as part of the  
 16314 minimum data set to be provided by the metering device. CurrentSummationDelivered is updated continu-  
 16315 ously as new measurements are made.

16316 **10.4.2.2.1.2 *CurrentSummationReceived Attribute***

16317 CurrentSummationReceived represents the most recent summed value of Energy, Gas, or Water generated  
 16318 and delivered from the premises. If optionally provided, CurrentSummationReceived is updated continuously  
 16319 as new measurements are made.

16320 **10.4.2.2.1.3 *CurrentMaxDemandDelivered Attribute***

16321 CurrentMaxDemandDelivered represents the maximum demand or rate of delivered value of Energy, Gas, or  
 16322 Water being utilized at the premises. If optionally provided, CurrentMaxDemandDelivered is updated  
 16323 continuously as new measurements are made.

16324 **10.4.2.2.1.4 *CurrentMaxDemandReceived Attribute***

16325 CurrentMaxDemandReceived represents the maximum demand or rate of received value of Energy, Gas, or  
 16326 Water being utilized by the utility. If optionally provided, CurrentMaxDemandReceived is updated continu-  
 16327 ously as new measurements are made.

16328 **10.4.2.2.1.5 *DFTSummation Attribute***

16329 DFTSummation represents a snapshot of attribute CurrentSummationDelivered captured at the time indi-  
 16330 cated by attribute DailyFreezeTime. If optionally provided, DFTSummation is updated once every 24 hours  
 16331 and captured at the time set in sub-clause 10.4.2.2.1.6.

16332 **10.4.2.2.1.6 *DailyFreezeTime Attribute***

16333 DailyFreezeTime represents the time of day when DFTSummation is captured. DailyFreezeTime is an un-  
 16334 signed 16-bit value representing the hour and minutes for DFT. The byte usages are:

16335 **Bits 0 to 7:** Range of 0 to 0x3B representing the number of minutes past the top of the hour.

16336 **Bits 8 to 15:** Range of 0 to 0x17 representing the hour of the day (in 24-hour format). Note that midnight  
 16337 shall be represented as 00:00 only.

16338 **10.4.2.2.1.7 *PowerFactor Attribute***

16339 PowerFactor contains the Average Power Factor ratio in 1/100ths. Valid values are 0 to 99.

16340 **10.4.2.2.1.8 *ReadingSnapShotTime Attribute***

16341 The ReadingSnapShotTime attribute represents the last time all of the CurrentSummationDelivered, Cur-  
 16342 rentSummationReceived, CurrentMaxDemandDelivered, and CurrentMaxDemandReceived attributes that  
 16343 are supported by the device were updated.

16344 **10.4.2.2.1.9** ***CurrentMaxDemandDeliveredTime Attribute***

16345 The CurrentMaxDemandDeliveredTime attribute represents the time when CurrentMaxDemandDelivered  
16346 reading was captured.

16347 **10.4.2.2.1.10** ***CurrentMaxDemandReceivedTime Attribute***

16348 The CurrentMaxDemandReceivedTime attribute represents the time when CurrentMaxDemandReceived  
16349 reading was captured.

16350 **10.4.2.2.1.11** ***DefaultUpdatePeriod Attribute***

16351 The DefaultUpdatePeriod attribute represents the interval (seconds) at which the InstantaneousDemand at-  
16352 tribute is updated when not in fast poll mode. InstantaneousDemand may be continuously updated as new  
16353 measurements are acquired, but at a minimum InstantaneousDemand must be updated at the DefaultUpdate-  
16354 Period. The DefaultUpdatePeriod may apply to other attributes as defined by the device manufacturer.

16355 **10.4.2.2.1.12** ***FastPollUpdatePeriod Attribute***

16356 The FastPollUpdatePeriod attribute represents the interval (seconds) at which the InstantaneousDemand at-  
16357 tribute is updated when in fast poll mode. InstantaneousDemand may be continuously updated as new  
16358 measurements are acquired, but at a minimum, InstantaneousDemand must be updated at the FastPol-  
16359 lUpdatePeriod. The FastPollUpdatePeriod may apply to other attributes as defined by the device manufac-  
16360 turer.

16361 **10.4.2.2.1.13** ***CurrentBlockPeriodConsumptionDelivered Attribute***

16362 The CurrentBlockPeriodConsumptionDelivered attribute represents the most recent summed value of En-  
16363 ergy, Gas or Water delivered and consumed in the premises during the Block Tariff Period.

16364 The CurrentBlockPeriodConsumptionDelivered is reset at the start of each Block Tariff Period.

16365 **10.4.2.2.1.14** ***DailyConsumptionTarget Attribute***

16366 The DailyConsumptionTarget attribute is a daily target consumption amount that can be displayed to the  
16367 consumer on a HAN device, with the intent that it can be used to compare to actual daily consumption (e.g.  
16368 compare to the CurrentDayConsumptionDelivered).

16369 This may be sent from the utility to the ESI, or it may be derived. Although intended to be based on  
16370 Block Thresholds, it can be used for other targets not related to blocks. The formatting will be based on  
16371 the HistoricalConsumptionFormatting attribute.

16372 Example: If based on a Block Threshold, the DailyConsumptionTarget could be calculated based on the  
16373 number of days specified in the Block Tariff Period and a given Block Threshold as follows: DailyConsump-  
16374 tionTarget = BlockNThreshold / ((BlockPeriodDuration / 60) / 24). Example: If the target is based on a  
16375 BlockIThreshold of 675kWh and where 43200 BlockThresholdPeriod is the number of minutes in the  
16376 billing period (30 days), the ConsumptionDailyTarget would be  $675 / ((43200 / 60) / 24) = 22.5$  kWh per  
16377 day.

16378 **10.4.2.2.1.15** ***CurrentBlock Attribute***

16379 When Block Tariffs are enabled, CurrentBlock is an 8-bit Enumeration which indicates the currently  
 16380 active block. If blocks are active then the current active block is based on the CurrentBlockPeriodConsump-  
 16381 tionDelivered and the block thresholds. Block 1 is active when the value of CurrentBlockPeriodConsump-  
 16382 tionDelivered is less than or equal to the<sup>184</sup> Block1Threshold value; Block 2 is active when CurrentBlock-  
 16383 PeriodConsumptionDelivered is greater than Block1Threshold value and less than or equal to  
 16384 the<sup>185</sup>Block2Threshold value, and so on. Block 16 is active when the value of CurrentBlockPeriodConsump-  
 16385 tionDelivered is greater than Block15Threshold value.

16386

**Table 10-58. Block Enumerations**

Enumerated Value	Register Block
0x00	No Blocks in use
0x01	Block1
0x02	Block2
0x03	Block3
0x04	Block4
0x05	Block5
0x06	Block6
0x07	Block7
0x08	Block8
0x09	Block9
0x0A	Block10
0x0B	Block11
0x0C	Block12
0x0D	Block13
0x0E	Block14
0x0F	Block15
0x10	Block16

16387 **10.4.2.2.1.16 ProfileIntervalPeriod Attribute**

16388 The ProfileIntervalPeriod attribute is currently included in the Get Profile Response command payload, but  
 16389 does not appear in an attribute set. This represents the duration of each interval. ProfileIntervalPeriod  
 16390 represents the interval or time frame used to capture metered Energy, Gas, and Water consumption for profiling  
 16391 purposes. The enumeration for this field shall match one of the ProfileIntervalPeriod values defined in sub-  
 16392 clause 10.4.2.3.1.1.1.<sup>186</sup>

16393 **10.4.2.2.1.17**

16394 **10.4.2.2.1.18 PresetReadingTime Attribute**

<sup>184</sup> CCB 1679

<sup>185</sup> CCB 1679

<sup>186</sup> CCB 1886

16395 The PresetReadingTime attribute represents the time of day (in quarter hour increments) at which the  
16396 meter will wake up and report a register reading even if there has been no consumption for the previous 24  
16397 hours. PresetReadingTime is an unsigned 16-bit value representing the hour and minutes. The byte usages  
16398 are:

16399 **Bits 0 to 7:** Range of 0 to 0x3B representing the number of minutes past the top of the hour.

16400 **Bits 8 to 15:** Range of 0 to 0x17 representing the hour of the day (in 24-hour format).

16401 E.g.: A setting of 0x172D would represent 23:45 hours or 11:45 pm; a setting of 0x071E would represent  
16402 07:30 hours or 7:30 am. A setting of 0xFFFF indicates this feature is disabled. The use of Attribute Reporting  
16403 Configuration is optional.

#### 16404 **10.4.2.2.1.19 SummationDeliveredPerReport<sup>187</sup> Attribute**

16405 The SummationDeliveredPerReport attribute represents the summation increment per report from the water  
16406 or gas meter. For example a gas meter might be set to report its register reading for every time 1 cubic meter  
16407 of gas is used. For a water meter it might report the register value every 10 liters of water usage. The value  
16408 of this attribute is defined by UnitofMeasure, the formatting by the SummationFormatting attribute. Note  
16409 that the value of this attribute will be the same as that used when configuring Attribute Reporting by value  
16410 change (as opposed to by time).<sup>188</sup>

#### 16411 **10.4.2.2.1.20 FlowRestriction Attribute**

16412 The FlowRestriction attribute represents the volume per minute limit set in the flow restrictor. This applies  
16413 to water but not for gas. A setting of 0xFF indicates this feature is disabled.

#### 16414 **10.4.2.2.1.21 SupplyStatus Attribute**

16415 The SupplyStatus attribute represents the state of the supply at the customer's premises. The enumerated  
16416 values for this field are outlined in Table 10-59.

---

<sup>187</sup> CCB 1655

<sup>188</sup> CCB 1655



16417

**Table 10-59. Supply Status Attribute Enumerations**

Enumerated Value	Status
0x00	Supply OFF
0x01	Supply OFF/ARMED
0x02	Supply ON

16418 **10.4.2.2.1.22 CurrentInletEnergyCarrierSummation Attribute**

16419 CurrentInletEnergyCarrierSummation is the current integrated volume of a given energy carrier measured on  
 16420 the inlet. The formatting and unit of measure for this value is specified in the EnergyCarrierUnitOfMeasure  
 16421 and EnergyCarrierSummationFormatting attributes (refer to Table 10-71).

16422 The Energy consumption registered in CurrentSummationDelivered is not necessarily a direct function of  
 16423 this value. The quality of the energy carrier may vary from day to day, e.g. Gas may have different quality.

16424 For heat and cooling meters the energy carrier is water at high or low temperature, the energy withdrawn from  
 16425 such a system is a function of the flow and the inlet and outlet temperature.

16426 **10.4.2.2.1.23 CurrentOutletEnergyCarrierSummation Attribute**

16427 CurrentOutletEnergyCarrierSummation is the current integrated volume of a given energy carrier measured  
 16428 on the outlet. The formatting and unit of measure for this value is specified in the EnergyCarrierUnitOf-  
 16429 Measure and EnergyCarrierSummationFormatting attributes (refer to Table 10-71).

16430 **10.4.2.2.1.24 InletTemperature Attribute**

16431 InletTemperature is the temperature measured on the energy carrier inlet.

16432 The formatting and unit of measure for this value is specified in the TemperatureUnitOfMeasure and Tem-  
 16433 peratureFormatting attributes (refer to Table 10-71).

16434 **10.4.2.2.1.25 OutletTemperature Attribute**

16435 OutletTemperature is the temperature measured on the energy carrier outlet.

16436 The formatting and unit of measure for this value is specified in the TemperatureUnitOfMeasure and Temper-  
 16437 atureFormatting attributes (refer to Table 10-71).

16438 **10.4.2.2.1.26 ControlTemperature Attribute**

16439 ControlTemperature is a reference temperature measured on the meter used to validate the Inlet/Outlet  
 16440 temperatures.

16441 The formatting and unit of measure for this value is specified in the TemperatureUnitOfMeasure and Temper-  
 16442 atureFormatting attributes (refer to Table 10-71).

16443 **10.4.2.2.1.27 CurrentInletEnergyCarrierDemand Attribute**

16444 CurrentInletEnergyCarrierDemand is the current absolute demand on the energy carrier inlet.

16445 The formatting and unit of measure for this value is specified in the EnergyCarrierUnitOfMeasure and En-  
 16446 ergyCarrierDemandFormatting attributes (refer to Table 10-71).

16447 For a heat or cooling meter this will be the current absolute flow rate measured on the inlet.

16448 **10.4.2.2.1.28 CurrentOutletEnergyCarrierDemand Attribute**

16449 CurrentOutletEnergyCarrierDemand is the current absolute demand on the energy carrier outlet.

16450 The formatting and unit of measure for this value is specified in the EnergyCarrierUnitOfMeasure and En-  
16451 ergyCarrierDemandFormatting attributes (refer to Table 10-71).

16452 For a heat or cooling meter this will be the current absolute flow rate measured on the outlet.

16453 **10.4.2.2.1.29 PreviousBlockPeriodConsumptionDelivered Attribute**

16454 The PreviousBlockPeriodConsumptionDelivered attribute represents the total value of Energy, Gas or Wa-  
16455 ter delivered and consumed in the premises at the end of the previous Block Tariff Period. If supported, the  
16456 PreviousBlockPeriodConsumptionDelivered attribute is updated at the end of each Block Tariff Period.

16457 **10.4.2.2.1.30 CurrentBlockPeriodConsumptionReceived Attribute**

16458 The *CurrentBlockPeriodConsumptionReceived* attribute represents the most recent summed value of En-  
16459 ergy, Gas or Water received by the energy supplier from the premises during the Block Tariff Period. The  
16460 *CurrentBlockPeriodConsumptionReceived* attribute is reset at the start of each Block Tariff Period.

16461 **10.4.2.2.1.31 CurrentBlockReceived Attribute**

16462 When Block Tariffs are enabled, *CurrentBlockReceived* is an 8-bit Enumeration which indicates the cur-  
16463 rently active block. If blocks are active then the current active block is based on the *CurrentBlockPeriod-*  
16464 *ConsumptionReceived* and the block thresholds. Block 1 is active when the value of *CurrentBlockPeriod-*  
16465 *ConsumptionReceived* is less than or equal to the Block1Threshold value; Block 2 is active when *Cur-*  
16466 *rentBlockPeriodConsumptionReceived* is greater than Block1Threshold value and less than or equal to the  
16467 Block2Threshold value, and so on. Block 16 is active when the value of *CurrentBlockPeriodConsumption-*  
16468 *Received* is greater than Block15Threshold value. Refer to Table 10-58 for block enumerations.

16469 **10.4.2.2.1.32 DFTSummationReceived Attribute**

16470 *DFTSummationReceived* represents a snapshot of attribute *CurrentSummationReceived* captured at the time  
16471 indicated by the *DailyFreezeTime* attribute (see 10.4.2.2.1.6).

16472 If optionally provided, *DFTSummationReceived* is updated once every 24 hours and captured at the time set  
16473 in the *DailyFreezeTime* attribute (see 10.4.2.2.1.6).

16474 **10.4.2.2.1.33 ActiveRegisterTierDelivered Attribute**

16475 The ActiveRegisterTierDelivered attribute indicates the current register tier that the energy consumed is  
16476 being accumulated against. Valid values for this attribute are defined in Table 10-27.

16477 **10.4.2.2.1.34 ActiveRegisterTierReceived Attribute**

16478 The ActiveRegisterTierReceived attribute indicates the current register tier that the energy generated is being  
16479 accumulated against. Valid values for this attribute are defined in Table 10-30

16480 **10.4.2.2.1.35 LastBlockSwitchTime Attribute**

16481 This attribute allows other devices to determine the time at which a meter switches from one block to an-  
16482 other.

16483 When Block Tariffs are enabled, the *LastBlockSwitchTime* attribute represents the timestamp of the last up-  
16484 date to the *CurrentBlock* attribute, as a result of the consumption exceeding a threshold, or the start of a  
16485 new block period and/or billing period.

16486 If, at the start of a new block period and/or billing period, the value of the *CurrentBlock* attribute is still set  
16487 to Block1 (0x01), the *CurrentBlock* attribute value will not change but the *LastBlockSwitchTime* attribute  
16488 shall be updated to indicate this change.

16489

16490 **10.4.2.2.2 Summation TOU Information Set**

16491 The set of attributes shown in Table 10-60 provides a remote access to the Electric, Gas, or Water  
 16492 metering device’s Time of Use (TOU) readings.

16493 Table 10-60. TOU Information Attribute Set

<b>Id</b>	<b>Name</b>	<b>Type</b>	<b>Range</b>	<b>Acc</b>	<b>Def</b>	<b>M</b>
0x0100	<i>CurrentTier1SummationDelivered</i>	uint48	0x000000000000 to 0xFFFFFFFFFFFFFFF	R	-	O
0x0101	<i>CurrentTier1SummationReceived</i>	uint48	0x000000000000 to 0xFFFFFFFFFFFFFFF	R	-	O
0x0102	<i>CurrentTier2SummationDelivered</i>	uint48	0x000000000000 to 0xFFFFFFFFFFFFFFF	R	-	O
0x0103	<i>CurrentTier2SummationReceived</i>	uint48	0x000000000000 to 0xFFFFFFFFFFFFFFF	R	-	O
0x0104	<i>CurrentTier3SummationDelivered</i>	uint48	0x000000000000 to 0xFFFFFFFFFFFFFFF	R	-	O
0x0105	<i>CurrentTier3SummationReceived</i>	uint48	0x000000000000 to 0xFFFFFFFFFFFFFFF	R	-	O
0x0106	<i>CurrentTier4SummationDelivered</i>	uint48	0x000000000000 to 0xFFFFFFFFFFFFFFF	R	-	O
0x0107	<i>CurrentTier4SummationReceived</i>	uint48	0x000000000000 to 0xFFFFFFFFFFFFFFF	R	-	O
0x0108	<i>CurrentTier5SummationDelivered</i>	uint48	0x000000000000 to 0xFFFFFFFFFFFFFFF	R	-	O
0x0109	<i>CurrentTier5SummationReceived</i>	uint48	0x000000000000 to 0xFFFFFFFFFFFFFFF	R	-	O
0x010A	<i>CurrentTier6SummationDelivered</i>	uint48	0x000000000000 to 0xFFFFFFFFFFFFFFF	R	-	O
0x010B	<i>CurrentTier6SummationReceived</i>	uint48	0x000000000000 to 0xFFFFFFFFFFFFFFF	R	-	O
0x010C	<i>CurrentTier7SummationDelivered</i>	uint48	0x000000000000 to 0xFFFFFFFFFFFFFFF	R	-	O
0x010D	<i>CurrentTier7SummationReceived</i>	uint48	0x000000000000 to 0xFFFFFFFFFFFFFFF	R	-	O
0x010E	<i>CurrentTier8SummationDelivered</i>	uint48	0x000000000000 to 0xFFFFFFFFFFFFFFF	R	-	O

<b>Id</b>	<b>Name</b>	<b>Type</b>	<b>Range</b>	<b>Acc</b>	<b>Def</b>	<b>M</b>
0x010F	<i>CurrentTier8SummationReceived</i>	uint48	0x000000000000 to 0xFFFFFFFFFFFFFFF	R	-	O
0x0110	<i>CurrentTier9SummationDelivered</i>	uint48	0x000000000000 to 0xFFFFFFFFFFFFFFF	R	-	O
0x0111	<i>CurrentTier9SummationReceived</i>	uint48	0x000000000000 to 0xFFFFFFFFFFFFFFF	R	-	O
0x0112	<i>CurrentTier10SummationDelivered</i>	uint48	0x000000000000 to 0xFFFFFFFFFFFFFFF	R	-	O
0x0113	<i>CurrentTier10SummationReceived</i>	uint48	0x000000000000 to 0xFFFFFFFFFFFFFFF	R	-	O
0x0114	<i>CurrentTier11SummationDelivered</i>	uint48	0x000000000000 to 0xFFFFFFFFFFFFFFF	R	-	O
0x0115	<i>CurrentTier11SummationReceived</i>	uint48	0x000000000000 to 0xFFFFFFFFFFFFFFF	R	-	O
0x0116	<i>CurrentTier12SummationDelivered</i>	uint48	0x000000000000 to 0xFFFFFFFFFFFFFFF	R	-	O
0x0117	<i>CurrentTier12SummationReceived</i>	uint48	0x000000000000 to 0xFFFFFFFFFFFFFFF	R	-	O
0x0118	<i>CurrentTier13SummationDelivered</i>	uint48	0x000000000000 to 0xFFFFFFFFFFFFFFF	R	-	O
0x0119	<i>CurrentTier13SummationReceived</i>	uint48	0x000000000000 to 0xFFFFFFFFFFFFFFF	R	-	O
0x011A	<i>CurrentTier14SummationDelivered</i>	uint48	0x000000000000 to 0xFFFFFFFFFFFFFFF	R	-	O
0x011B	<i>CurrentTier1SummationReceived</i>	uint48	0x000000000000 to 0xFFFFFFFFFFFFFFF	R	-	O
0x011C	<i>CurrentTier15SummationDelivered</i>	uint48	0x000000000000 to 0xFFFFFFFFFFFFFFF	R	-	O
0x011D	<i>CurrentTier15SummationReceived</i>	uint48	0x000000000000 to 0xFFFFFFFFFFFFFFF	R	-	O

<b>Id</b>	<b>Name</b>	<b>Type</b>	<b>Range</b>	<b>Acc</b>	<b>Def</b>	<b>M</b>
0x011E	<i>CurrentTier16SummationDelivered</i>	uint48	0x000000000000 to 0xFFFFFFFFFFFFFF	R	-	O
0x011F	<i>CurrentTier16SummationReceived</i>	uint48	0x000000000000 to 0xFFFFFFFFFFFFFF	R	-	O
0x0120	<i>CurrentTier17SummationDelivered</i>	uint48	0x000000000000 to 0xFFFFFFFFFFFFFF	R	-	O
0x0121	<i>CurrentTier17SummationReceived</i>	uint48	0x000000000000 to 0xFFFFFFFFFFFFFF	R	-	O
...	...	...	...	...	...	...
0x015E	<i>CurrentTier48SummationDelivered</i>	uint48	0x000000000000 to 0xFFFFFFFFFFFFFF	R	-	O
0x015F	<i>CurrentTier48SummationReceived</i>	uint48	0x000000000000 to 0xFFFFFFFFFFFFFF	R	-	O
0x01FC	<i>CPP1SummationDelivered</i>	uint48	0x000000000000 to 0xFFFFFFFFFFFFFF	R	-	O
0x01FE	<i>CPP2SummationDelivered</i>	uint48	0x000000000000 to 0xFFFFFFFFFFFFFF	R	-	O

16494 **10.4.2.2.2.1 *CurrentTierNSummationDelivered* Attributes**

16495 Attributes *CurrentTier1SummationDelivered* through *CurrentTierNSummationDelivered* represent the most  
 16496 recent summed value of Energy, Gas, or Water delivered to the premises (i.e. delivered to the customer  
 16497 from the utility) at a specific price tier as defined by a TOU schedule or a real time pricing period. If optionally  
 16498 provided, attributes *CurrentTier1SummationDelivered* through *CurrentTierNSummationDelivered* are up-  
 16499 dated continuously as new measurements are made.

16500 **10.4.2.2.2.2 *CurrentTierNSummationReceived* Attributes**

16501 Attributes *CurrentTier1SummationReceived* through *CurrentTierNSummationReceived* represent the most  
 16502 recent summed value of Energy, Gas, or Water provided by the premises (i.e. received by the utility from  
 16503 the customer) at a specific price tier as defined by a TOU schedule or a real time pricing period. If optionally  
 16504 provided, attributes *CurrentTier1SummationReceived* through *CurrentTierNSummationReceived* are up-  
 16505 dated continuously as new measurements are made.

16506 **10.4.2.2.2.3 *CPP1SummationDelivered* Attribute**

16507 *CPP1SummationDelivered* represents the most recent summed value of Energy, Gas, or Water delivered to  
 16508 the premises (i.e. delivered to the customer from the utility) while Critical Peak Price ‘CPP1’ was being  
 16509 applied. If optionally provided, attribute *CPP1SummationDelivered* is updated continuously as new meas-  
 16510 urements are made.

16511 **10.4.2.2.2.4 *CPP2SummationDelivered* Attribute**

16512 *CPP2SummationDelivered* represents the most recent summed value of Energy, Gas, or Water delivered to  
 16513 the premises (i.e. delivered to the customer from the utility) while Critical Peak Price ‘CPP2’ was being

16514 applied. If optionally provided, attribute *CPP2SummationDelivered* is updated continuously as new meas-  
16515 urements are made.

16516

16517 **10.4.2.2.3 Meter Status Attribute Set**

16518 The Meter Status Attribute Set is defined in Table 10-61.

16519

**Table 10-61. Meter Status Attribute Set**

<b>Id</b>	<b>Name</b>	<b>Type</b>	<b>Range</b>	<b>Acc</b>	<b>Def</b>	<b>M</b>
0x0200	<i>Status</i>	map8	0x00 to 0xFF	R	0x00	M
0x0201	<i>RemainingBatteryLife</i>	uint8	0x00 to 0xFF	R	-	O
0x0202	<i>HoursInOperation</i>	uint24	0x000000 to 0xFFFFFFFF	R	-	O <sup>189</sup>
0x0203	<i>HoursInFault</i>	uint24	0x000000 to 0xFFFFFFFF	R	-	O
0x0204	<i>Extended Status</i>	map64	0x0000000000000000 to 0xFFFFFFFFFFFFFFF F	R	-	O
0x0205	<i>Remaining BatteryLife in Days</i>	uint16	0x0000 to 0xFFFF	R	-	O
0x0206	<i>CurrentMeterID</i>	octstr		R	-	O
0x0207	<i>AmbientConsumption Indicator</i>	enum8	0x00 – 0x02	R	-	O

16520 **10.4.2.2.3.1 Status Attribute**

16521 The Status attribute provides indicators reflecting the current error conditions found by the metering  
16522 device. This attribute is an 8-bit field where when an individual bit is set, an error or warning condition  
16523 exists. The behavior causing the setting or resetting each bit is device specific. In other words, the appli-  
16524 cation within the metering device will determine and control when these settings are either set or cleared.  
16525 Depending on the commodity type, the bits of this attribute will take on different meaning. Table 10-62  
16526 through Table 10-65 show the bit mappings for the Status attribute for Electricity, Gas, Water and  
16527 Heating/Cooling, respectively. A battery-operated meter will report any change in state of the Status when  
16528 it wakes up via a Report Attributes command. The ESI is expected to make alarms available to upstream  
16529 systems together with consumption data collected from the battery operated meter.

16530

**Table 10-62. Mapping of the Status Attribute (Electricity)**

<b>Bit 7</b>	<b>Bit 6</b>	<b>Bit 5</b>	<b>Bit 4</b>	<b>Bit 3</b>	<b>Bit 2</b>	<b>Bit 1</b>	<b>Bit 0</b>
--------------	--------------	--------------	--------------	--------------	--------------	--------------	--------------

<sup>189</sup> CCB 1999

Reserved	Service Disconnect Open	Leak Detect	Power Quality	Power Failure	Tamper Detect	Low Battery	Check Meter
----------	-------------------------	-------------	---------------	---------------	---------------	-------------	-------------

16531

16532 The definitions of the Electricity Status bits are:

16533 **Service Disconnect Open:** Set to true when the service have been disconnected to this premises.

16534 **Leak Detect:** Set to true when a leak has been detected.

16535 **Power Quality:** Set to true if a power quality event has been detected such as a low voltage, high voltage.

16536 **Power Failure:** Set to true during a power outage.

16537 **Tamper Detect:** Set to true if a tamper event has been detected.

16538 **Low Battery:** Set to true when the battery needs maintenance.

16539 **Check Meter:** Set to true when a non fatal problem has been detected on the meter such as a measurement error, memory error, and self check error.

16541

**Table 10-63. Meter Status Attribute (Gas)**

Bit 7	Bit 6	Bit 5	Bit 4	Bit 3	Bit 2	Bit 1	Bit 0
Reverse Flow	Service Disconnect	Leak Detect	Low Pressure	Not Defined	Tamper Detect	Low Battery	Check Meter

16542

16543 The definitions of the Gas Status bits are:

16544 **Reverse Flow:** Set to true if flow detected in the opposite direction to normal (from consumer to supplier).

16545 **Service Disconnect:** Set to true when the service has been disconnected to this premises. Ex. The valve is in the closed position preventing delivery of gas.

16547 **Leak Detect:** Set to true when a leak has been detected.

16548 **Low Pressure:** Set to true when the pressure at the meter is below the meter's low pressure threshold value.

16549 **Tamper Detect:** Set to true if a tamper event has been detected.

16550 **Low Battery:** Set to true when the battery needs maintenance.

16551 **Check Meter:** Set to true when a non fatal problem has been detected on the meter such as a measurement error, memory error, or self check error.

16553

**Table 10-64. Meter Status Attribute (Water)**

Bit 7	Bit 6	Bit 5	Bit 4	Bit 3	Bit 2	Bit 1	Bit 0
Reverse Flow	Service Disconnect	Leak Detect	Low Pressure	Pipe Empty	Tamper Detect	Low Battery	Check Meter

16554

16555 The definitions of the Water Status bits are:

16556 **Reverse Flow:** Set to true if flow detected in the opposite direction to normal (from consumer to supplier).

16557 **Service Disconnect:** Set to true when the service has been disconnected to this premises. Ex. The valve is in the closed position preventing delivery of water.

16558

- 16559 **Leak Detect:** Set to true when a leak has been detected.
- 16560 **Low Pressure:** Set to true when the pressure at the meter is below the meter's low pressure threshold value.
- 16561 **Pipe Empty:** Set to true when the service pipe at the meter is empty and there is no flow in either direction.
- 16562 **Tamper Detect:** Set to true if a tamper event has been detected.
- 16563 **Low Battery:** Set to true when the battery needs maintenance.
- 16564 **Check Meter:** Set to true when a non fatal problem has been detected on the meter such as a measurement error, memory error, or self check error.

16566 **Table 10-65. Meter Status Attribute (Heat and Cooling)**

Bit 7	Bit 6	Bit 5	Bit 4	Bit 3	Bit 2	Bit 1	Bit 0
Flow Sensor	Service Disconnect	Leak Detect	Burst Detect	Temperature Sensor	Tamper Detect	Low Battery	Check Meter

- 16567
- 16568 The definitions of the Heat and Cooling Status bits are:
- 16569 **Flow Sensor:** Set to true when an error is detected on a flow sensor at this premises.
- 16570 **Service Disconnect:** Set to true when the service has been disconnected to this premises. Ex. The valve is in the closed position preventing delivery of heat or cooling.
- 16571
- 16572 **Leak Detect:** Set to true when a leak has been detected.
- 16573 **Burst Detect:** Set to true when a burst is detected on pipes at this premises.
- 16574 **Temperature Sensor:** Set to true when an error is detected on a temperature sensor at this premises.
- 16575 **Tamper Detect:** Set to true if a tamper event has been detected.
- 16576 **Low Battery:** Set to true when the battery needs maintenance.
- 16577 **Check Meter:** Set to true when a non fatal problem has been detected on the meter such as a measurement error, memory error, or self check error.
- 16578
- 16579 **Note:** It is not necessary to set aside Bit 7 as an “Extension Bit” for future expansion. If extra status bits are required an Extended Meter Status attribute may be added to support additional status values.
- 16580

16581 **10.4.2.2.3.2 RemainingBatteryLife Attribute**

16582 RemainingBatteryLife represents the estimated remaining life of the battery in % of capacity. A setting of  
16583 0xFF indicates this feature is disabled. The range 0 - 100 where 100 = 100%, 0xFF = Unknown.

16584 **10.4.2.2.3.3 HoursInOperation Attribute**

16585 HoursInOperation is a counter that increments once every hour during operation. This may be used as a  
16586 check for tampering.

16587 **Note:** For meters that are not electricity meters turning off the meter does not necessarily prevent delivery  
16588 of energy—but the meter might not be able to measure it.

16589 **10.4.2.2.3.4 HoursInFault Attribute**

16590 HoursInFault is a counter that increments once every hour when the device is in operation with a fault  
16591 detected. This may be used as a check for tampering.

16592 **Note:** For meters that are not electricity meters turning off the meter does not necessarily prevent delivery of  
16593 energy—but the meter might not be able to measure it.



16594 **10.4.2.2.3.5 ExtendedStatus Attribute**

16595 The *ExtendedStatus* attribute reflects the state of items in a meter that the standard *Status* attribute cannot  
 16596 show. The *Extended Status* BitMap is split into two groups of flags: general flags and metering type specific  
 16597 flags. Flags are currently defined for electricity and gas meters; flag definitions for other commodities will  
 16598 be added as and when their usage is agreed.

16599 These flags are set and reset by the meter autonomously; they cannot be reset by other devices. The mapping  
 16600 is as defined in the tables below. A meter which implements the attribute but does not implement a specific  
 16601 flag internally will simply have the corresponding bit always set to 0.

16602 **Table 10-66. General Flags of the Extended Status BitMap**

Bit	Flag name / Description
0	Meter Cover Removed
1	Strong Magnetic Field detected
2	Battery Failure
3	Program Memory Error
4	RAM Error
5	NV Memory Error
6	Measurement System Error
7	Watchdog Error
8	Supply Disconnect Failure
9	Supply Connect Failure
10	Measurement SW Changed/Tampered
11	Clock Invalid
12	Temperature Exceeded
13	Moisture Detected

16603  
 16604 The definitions of the General *Extended Status* bits are:

16605 **Meter Cover Removed:** Set to true when the device detects the meter cover being removed.

16606 **Strong Magnetic Field detected:** Set to true when the device detects presence of a strong magnetic field.

16607 **Battery Failure:** Set to true when the device detects that its battery has failed.

16608 **Program Memory Error:** Set to true when the device detects an error within its program (non-volatile)  
 16609 memory.

16610 **RAM Error:** Set to true when the device detects an instance of a Random Access Memory (RAM) error  
 16611 within the device memory.

16612 **NV Memory Error:** Set to true when the device detects an instance of a Non Volatile (NV) memory error  
 16613 within the device memory - this is a fatal meter error that will require the meter replacement.

16614 **Measurement System Error:** Set to true when the device detects an error within its measurement system.

16615 **Watchdog Error:** Set to true when the device has detected an instance of a watchdog reset event (following  
 16616 a catastrophic fault within the device).

16617 **Supply Disconnect Failure:** Set to true when the device has detected that the valve has not closed as ex-  
 16618 pected (for gas) or the contactor has not opened as expected (for electricity).

16619 **Supply Connect Failure:** Set to true when the device has detected that the valve has not opened as expected  
16620 (for gas) or the contactor has not closed as expected (for electricity).

16621 **Measurement SW Changed/Tampered:** Set to true when the device detects that its measurement software  
16622 has changed.

16623 **Clock Invalid:** Set to true when the device detects that its internal clock is invalid.

16624 **Temperature Exceeded:** Set to true when the metering device’s temperature exceeds a predefined limit.  
16625 There are various reasons for temperature rise in metering devices.

16626 **Moisture Detected:** Set to true when a sensor has detected the presence of moisture e.g. moisture in a gas  
16627 line which can cause a drop in gas pressure, or moisture detected in the sealed component area within a water  
16628 meter.

16629 **Table 10-67. Electricity -Meter specific Flags of the Extended Status BitMap**

Bit	Flag name / Description
24	Terminal Cover Removed
25	Incorrect Polarity
26	Current with No Voltage
27	Limit Threshold Exceeded
28	Under Voltage
29	Over Voltage

16630  
16631 The definitions of the Electricity-Meter-Specific *Extended Status* bits are:

16632 **Terminal Cover Removed:** Set to true when the device detects that its terminal cover has been removed.

16633 **Incorrect Polarity:** Set to true when the electricity meter detects incorrect polarity on the electricity supply.

16634 **Current with No Voltage:** Set to true when the meter has been tampered with, to disconnect the measure-  
16635 ment function from the supply. Electricity is still flowing but not being recorded.

16636 **Limit Threshold Exceeded:** Set to true when the electricity meter detects that the load has exceeded the  
16637 load limit threshold.

16638 **Under Voltage:** Set to true when the electricity meter indicates that the voltage measurement over the voltage  
16639 measurement period is lower than the voltage threshold.

16640 **Over Voltage:** Set to true when the electricity meter indicates that the voltage measurement over the voltage  
16641 measurement period is higher than the voltage threshold.

16642 **Table 10-68. Gas-Meter specific Flags of the Extended Status BitMap**

Bit	Flag name / Description
24	Battery Cover Removed
25	Tilt Tamper
26	Excess Flow

16643  
16644 The definitions of the Gas-Meter-Specific *Extended Status* bits are:

16645 **Battery Cover Removed:** Set to true when the gas meter detects that its battery cover has been removed.

16646 **Tilt Tamper:** Set to true when the meter detects a change in its physical properties (i.e. that it is being tilted;  
 16647 the tilt sensor has been activated or otherwise tampered with).

16648 **Excess Flow:** Set to true when the gas meter detects excess flow (e.g. when local supply restoration is at-  
 16649 tempted).

16650 **10.4.2.2.3.6 RemainingBatteryLifeInDays Attribute**

16651 *RemainingBatteryLifeInDays* attribute represents the estimated remaining life of the battery in days of ca-  
 16652 pacity. The range is 0 – 0xFFFE, where 0xFFFF represents 'Invalid', 'Unused' and 'Disabled'.

16653 **10.4.2.2.3.7 CurrentMeterID Attribute**

16654 *CurrentMeterID* attribute is the current id for the Meter. This could be the current firmware version supported  
 16655 on the meter.

16656 **10.4.2.2.3.8 AmbientConsumptionIndicator Attribute**

16657 The *AmbientConsumptionIndicator* attribute is an 8-bit enumeration which provides a simple (i.e. Low/Me-  
 16658 dium/High) indication of the amount of a commodity being consumed within the premises. The status is  
 16659 achieved by comparing the current value of the *InstantaneousDemand* attribute (see 10.4.2.2.5.1) with  
 16660 low/medium and medium/high thresholds. The status is defined in Table 10-69:

16661 **Table 10-69. LowMediumHighStatus Attribute**

Enumeration	Description
0x00	Low Energy usage
0x01	Medium Energy usage
0x02	High Energy usage

16662 The thresholds which are used to determine the value of this attribute are themselves defined as attributes  
 16663 within section 10.10.2.2.4.1 and section 10.10.2.2.4.2

16664

16665 **10.4.2.2.4 Formatting**

16666 The following set of attributes provides the ratios and formatting hints required to transform the received  
 16667 summations, consumptions, temperatures, or demands/ rates into displayable values. If the Multiplier and  
 16668 Divisor attribute values are non-zero, they are used in conjunction with the SummationFormatting, Con-  
 16669 sumptionFormatting, DemandFormatting, and TemperatureFormatting attributes.

16670 Equations required to accomplish this task are defined below:

16671 Summation = Summation received \* Multiplier / Divisor  
 16672 (formatted using SummationFormatting)

16673 Consumption = Consumption received \* Multiplier / Divisor  
 16674 (formatted using ConsumptionFormatting)

16675 Demand = Demand received \* Multiplier / Divisor  
 16676 (formatted using DemandFormatting)

16677 Temperature = Temperature received \* Multiplier / Divisor

16678 If the Multiplier and Divisor attribute values are zero, just the formatting hints defined in SummationFor-  
 16679 mation, ConsumptionFormatting, DemandFormatting and TemperatureFormatting attributes are used.

16680 The summation received, consumption received, demand received, and temperature received variables used  
 16681 above can be replaced by any of the attributes listed in sub-clauses 10.4.2.2.4.4, 10.4.2.2.4.5, 10.4.2.2.4.6,  
 16682 10.4.2.2.4.11, 10.4.2.2.4.12, and 10.4.2.2.4.14.

16683 Table 10-70 shows examples that demonstrate the relation between these attributes.

16684 **Table 10-70. Formatting Examples**

Attribute	Example 1	Example 2	Example 3
Value as transmitted and received	52003	617	23629
Unit of Measure	kWh	CCF	kWh
Multiplier	1	2	6
Divisor	1000	100	10000
Number of Digits to the left of the Decimal Point	5	4	5
Number of Digits to the right of the Decimal Point	0	2	3
Suppress leading zeros	False	False	True
Displayed value	00052	0012.34	14.177

16685  
 16686 The Consumption Formatting Attribute Set is defined in Table 10-71.

16687 Table 10-71. Formatting Attribute Set

Id	Name	Type	Range	Acc	Def	M
0x0300	<i>UnitofMeasure</i>	enum8	0x00 to 0xFF	R	0x00	M
0x0301	<i>Multiplier</i>	uint24	0x000000 to 0xFFFFFFFF	R	-	O
0x0302	<i>Divisor</i>	uint24	0x000000 to 0xFFFFFFFF	R	-	O
0x0303	<i>SummationFormatting</i>	map8	0x00 to 0xFF	R	-	M
0x0304	<i>DemandFormatting</i>	map8	0x00 to 0xFF	R	-	O
0x0305	<i>HistoricalConsumptionFormatting</i>	map8	0x00 to 0xFF	R	-	O
0x0306	<i>MeteringDeviceType</i>	map8	0x00 to 0xFF	R	-	M
0x0307	<i>SiteID</i>	octstr	1 to 33 octets	R	-	O
0x0308	<i>MeterSerialNumber</i>	octstr	1 to 25 octets	R	-	O

<b>Id</b>	<b>Name</b>	<b>Type</b>	<b>Range</b>	<b>Acc</b>	<b>Def</b>	<b>M</b>
0x0309	<i>EnergyCarrierUnitOfMeasure</i>	enum8	0x00 to 0xFF	R	-	O <sup>190</sup>
0x030A	<i>EnergyCarrierSummationFormatting</i>	map8	0x00 to 0xFF	R	-	O <sup>191</sup>
0x030B	<i>EnergyCarrierDemandFormatting</i>	map8	0x00 to 0xFF	R	-	O
0x030C	<i>TemperatureUnitOfMeasure</i>	enum8	0x00 to 0xFF	R	-	O <sup>192</sup>
0x030D	<i>TemperatureFormatting</i>	map8	0x00 to 0xFF	R	-	O <sup>193</sup>
0x030E	<i>ModuleSerialNumber</i>	octstr	1 to 25 octets	R	-	O
0x030F	<i>OperatingTariffLabel Delivered</i>	octstr	1 to 25 octets	R	-	O
0x0310	<i>OperatingTariffLabel Received</i>	octstr	1 to 25 octets	R	-	O
0x0311	<i>CustomerIDNumber</i>	octstr	1 to 25 octets	R	-	O
0x0312	<i>AlternativeUnitof Measure</i>	enum8	0x00 to 0xFF	R	0x00	O
0x0313	<i>AlternativeDemandFormatting</i>	map8	0x00 to 0xFF	R	-	O
0x0314	<i>AlternativeConsumptionFormatting</i>	map8	0x00 to 0xFF	R	-	O

16688

16689 **10.4.2.2.4.1 UnitofMeasure Attribute**

<sup>190</sup> CCB 1999

<sup>191</sup> CCB 1999

<sup>192</sup> CCB 1999

<sup>193</sup> CCB 1999

16690 UnitofMeasure provides a label for the Energy, Gas, or Water being measured by the metering device. The  
 16691 units of measure applies to all summations, consumptions/ profile interval and demand/rate supported by  
 16692 this cluster other than those specifically identified as being based upon the EnergyCarrierUnitOfMeasure or  
 16693 the AlternativeUnitofMeasure. Other measurements such as the power factor are self describing. This at-  
 16694 tribute is an 8-bit enumerated field. The bit descriptions for this Attribute are listed in Table 10-72.

16695

**Table 10-72. UnitofMeasure Attribute Enumerations**

Values	Description
0x00	kWh (Kilowatt Hours) & kW (Kilowatts) in pure binary format
0x01	m <sup>3</sup> (Cubic Meter) & m <sup>3</sup> /h (Cubic Meter per Hour) in pure binary format
0x02	ft <sup>3</sup> (Cubic Feet) & ft <sup>3</sup> /h (Cubic Feet per Hour) in pure binary format
0x03	ccf ((100 or Centum) Cubic Feet) & ccf/h ((100 or Centum) Cubic Feet per Hour) in pure binary format
0x04	US gl (US Gallons) & US gl/h (US Gallons per Hour) in pure binary format.
0x05	IMP gl (Imperial Gallons) & IMP gl/h (Imperial Gallons per Hour) in pure binary format
0x06	BTUs & BTU/h in pure binary format
0x07	Liters & l/h (Liters per Hour) in pure binary format
0x08	kPA (gauge) in pure binary format
0x09	kPA (absolute) in pure binary format
0x0A	mcf (1000 Cubic Feet) & mcf/h (1000 Cubic feet per hour) in pure binary format
0x0B	Unitless in pure binary format
0x0C	MJ (Mega Joule) and MJ/s (Mega Joule per second (MW)) in pure binary format
0x0D	kVar & kVarh in Binary Format
0x80	kWh (Kilowatt Hours) & kW (Kilowatts) in BCD format
0x81	m <sup>3</sup> (Cubic Meter) & m <sup>3</sup> /h (Cubic Meter per Hour) in BCD format
0x82	ft <sup>3</sup> (Cubic Feet) & ft <sup>3</sup> /h (Cubic Feet per Hour) in BCD format
0x83	ccf ((100 or Centum) Cubic Feet) & ccf/h ((100 or Centum) Cubic Feet per Hour) in BCD format
0x84	US gl (US Gallons) & US gl/h (US Gallons per Hour) in BCD format
0x85	IMP gl (Imperial Gallons) & IMP gl/h (Imperial Gallons per Hour) in BCD format
0x86	BTUs & BTU/h in BCD format
0x87	Liters & l/h (Liters per Hour) in BCD format
0x88	kPA (gauge) in BCD format
0x89	kPA (absolute) in BCD format
0x8A	mcf (1000 Cubic Feet) & mcf/h (1000 Cubic Feet per Hour) in BCD format
0x8B	unitless in BCD format
0x8C	MJ (Mega Joule) and MJ/s (Mega Joule per second (MW)) in BCD format

Values	Description
0x8D	kVar & kVarh in BCD Format

16696

16697 **Note:** When using BCD for meter reads, the values A to F are special values or indicators denoting  
 16698 “Opens”, “Shorts”, and etc. conditions when reading meter register hardware. Any SE device displaying  
 16699 the BCD based values to end users should use a non-decimal value to replace the A to F. In other words,  
 16700 a device could use an “\*” in place of the special values or indicators.

16701 **10.4.2.2.4.2 Multiplier Attribute**

16702 Multiplier provides a value to be multiplied against a raw or uncompensated sensor count of Energy, Gas, or  
 16703 Water being measured by the metering device. If present, this attribute must be applied against all sum-  
 16704 mation, consumption and demand values to derive the delivered and received values expressed in the unit  
 16705 of measure specified. This attribute must be used in conjunction with the Divisor attribute.

16706 **10.4.2.2.4.3 Divisor Attribute**

16707 Divisor provides a value to divide the results of applying the Multiplier Attribute against a raw or uncom-  
 16708 pensated sensor count of Energy, Gas, or Water being measured by the metering device. If present, this  
 16709 attribute must be applied against all summation, consumption and demand values to derive the delivered  
 16710 and received values expressed in the unit of measure specified. This attribute must be used in conjunction  
 16711 with the Multiplier attribute.

16712 **10.4.2.2.4.4 SummationFormatting Attribute**

16713 SummationFormatting provides a method to properly decipher the number of digits and the decimal  
 16714 location of the values found in the Summation Information Set of attributes. This attribute is to be decoded  
 16715 as follows:

16716 **Bits 0 to 2:** Number of Digits to the right of the Decimal Point.

16717 **Bits 3 to 6:** Number of Digits to the left of the Decimal Point.

16718 **Bit 7:** If set, suppress leading zeros.

16719 This attribute shall be used against the following attributes:

- 16720 • CurrentSummationDelivered
- 16721 • CurrentSummationReceived
- 16722 • *SummationDeliveredPerReport*<sup>194</sup>
- 16723 • TOU Information attributes
- 16724 • DFTSummation
- 16725 • Block Information attributes

16726 **10.4.2.2.4.5 DemandFormatting Attribute**

16727 DemandFormatting provides a method to properly decipher the number of digits and the decimal location  
 16728 of the values found in the Demand-related attributes. This attribute is to be decoded as follows:

16729 **Bits 0 to 2:** Number of Digits to the right of the Decimal Point.

16730 **Bits 3 to 6:** Number of Digits to the left of the Decimal Point.

16731 **Bit 7:** If set, suppress leading zeros.

---

<sup>194</sup> CCB 1655

16732 This attribute shall be used against the following attributes:

- 16733 • CurrentMaxDemandDelivered
- 16734 • CurrentMaxDemandReceived
- 16735 • InstantaneousDemand

#### 16736 **10.4.2.2.4.6 HistoricalConsumptionFormatting Attribute**

16737 HistoricalConsumptionFormatting provides a method to properly decipher the number of digits and the  
16738 decimal location of the values found in the Historical Consumption Set of attributes. This attribute is to be  
16739 decoded as follows:

16740 **Bits 0 to 2:** Number of Digits to the right of the Decimal Point.

16741 **Bits 3 to 6:** Number of Digits to the left of the Decimal Point.

16742 **Bit 7:** If set, suppress leading zeros.

16743 This attribute shall be used against the following attributes:

- 16744 • CurrentDayConsumptionDelivered
- 16745 • CurrentDayConsumptionReceived
- 16746 • PreviousDayConsumptionDelivered
- 16747 • PreviousDayConsumptionReceived
- 16748 • CurrentPartialProfileIntervalValue
- 16749 • Intervals
- 16750 • DailyConsumptionTarget
- 16751 • CurrentDayConsumptionDelivered
- 16752 • CurrentDayConsumptionReceived
- 16753 • PreviousDayNConsumptionDelivered
- 16754 • PreviousDayNConsumptionReceived
- 16755 • CurrentWeekConsumptionDelivered
- 16756 • CurrentWeekConsumptionReceived
- 16757 • PreviousWeekNConsumptionDelivered
- 16758 • PreviousWeekNConsumptionReceived
- 16759 • CurrentMonthConsumptionDelivered
- 16760 • CurrentMonthConsumptionReceived
- 16761 • PreviousMonthNConsumptionDelivered
- 16762 • PreviousMonthNConsumptionReceived

#### 16763 **10.4.2.2.4.7 MeteringDeviceType Attribute**

16764 MeteringDeviceType provides a label for identifying the type of metering device present. The attribute are  
16765 values representing Energy, Gas, Water, Thermal, Heat, Cooling, and mirrored metering devices. The de-  
16766 fined values are represented in Table 10-73. (Note that these values represent an Enumeration, and not  
16767 an 8-bit bitmap as indicated in the attribute description. For backwards compatibility reasons, the data  
16768 type has not been changed, though the data itself should be treated like an enum.)



16769 Where a mirror is provided for a battery-powered metering device, the mirror shall assume the relevant  
 16770 'Mirrored Metering' device type (127-142) whilst the meter itself shall utilize the 'Metering' device type  
 16771 (1 to 15). It shall be the responsibility of the device providing the mirror to modify the Device Type  
 16772 shown on the mirror to that of a 'Mirrored Metering' device.

16773

**Table 10-73. MeteringDeviceType Attribute**

Values	Description
0	Electric Metering
1	Gas Metering
2	Water Metering
3	Thermal Metering (deprecated)
4	Pressure Metering
5	Heat Metering
6	Cooling Metering
7	End Use Measurement Device (EUMD) for metering electric vehicle charging
8	PV Generation Metering
9	Wind Turbine Generation Metering
10	Water Turbine Generation Metering
11	Micro Generation Metering
12	Solar Hot Water Generation Metering
13	Electric Metering Element/Phase 1
14	Electric Metering Element/Phase 2
15	Electric Metering Element/Phase 3
127	Mirrored Electric Metering
128	Mirrored Gas Metering
129	Mirrored Water Metering
130	Mirrored Thermal Metering (deprecated)
131	Mirrored Pressure Metering
132	Mirrored Heat Metering
133	Mirrored Cooling Metering
134	Mirrored End Use Measurement Device (EUMD) for metering electric vehicle charging
135	Mirrored PV Generation Metering
136	Mirrored Wind Turbine Generation Metering
137	Mirrored Water Turbine Generation Metering
138	Mirrored Micro Generation Metering
139	Mirrored Solar Hot Water Generation Metering

Values	Description
140	Mirrored Electric Metering Element/Phase 1
141	Mirrored Electric Metering Element/Phase 2
142	Mirrored Electric Metering Element/Phase 3

16774

16775 **Note:** Heat and cooling meters are used for measurement and billing of heat (and cooling) delivered through  
16776 liquid (water) based central heating systems. The consumers are typically billed by the kWh, calculated  
16777 from the flow and the temperatures in and out.

16778 **10.4.2.2.4.8 SiteID Attribute**

16779 The SiteID is an Octet String field capable of storing a 32 character string (the first octet indicates length)  
16780 encoded in UTF-8 format. The SiteID is a text string, known in the UK as the MPAN number for electricity,  
16781 MPRN for gas and 'Stand Point' in South Africa. These numbers specify the meter point location in a  
16782 standardized way. The field is defined to accommodate the number of characters typically found in the UK  
16783 and Europe (16 digits). Generally speaking the field is numeric but is defined for the possibility of an alpha-  
16784 numeric format by specifying an octet string.

16785 **10.4.2.2.4.9 MeterSerialNumber Attribute**

16786 The MeterSerialNumber is an Octet String field capable of storing a 24 character string (the first octet  
16787 indicates length) encoded in UTF-8 format. It is used to provide a unique identification of the metering  
16788 device.

16789 **10.4.2.2.4.10 EnergyCarrierUnitOfMeasure Attribute**

16790 The EnergyCarrierUnitOfMeasure specifies the unit of measure that the EnergyCarrier is measured in. This  
16791 unit of measure is typically a unit of volume or flow and cannot be an amount of energy. The enumeration  
16792 of this attribute is otherwise identical to the UnitofMeasure attribute (Table 10-72).

16793 **10.4.2.2.4.11 EnergyCarrierSummationFormatting Attribute**

16794 EnergyCarrierSummationFormatting provides a method to properly decipher the number of digits and the  
16795 decimal location of the values found in the Summation- related attributes.

16796 This attribute is to be decoded as follows:

16797 **Bits 0 to 2:** Number of Digits to the right of the Decimal Point.

16798 **Bits 3 to 6:** Number of Digits to the left of the Decimal Point.

16799 **Bit 7:** If set, suppress leading zeros.

16800 This attribute shall be used in relation with the following attributes:

- 16801 • CurrentInletEnergyCarrierSummation
- 16802 • CurrentOutletEnergyCarrierSummation

16803 **10.4.2.2.4.12 EnergyCarrierDemandFormatting Attribute**

16804 EnergyCarrierDemandFormatting provides a method to properly decipher the number of digits and the  
16805 decimal location of the values found in the Demand-related attributes.

16806 This attribute is to be decoded as follows:

16807 **Bits 0 to 2:** Number of Digits to the right of the Decimal Point.

16808 **Bits 3 to 6:** Number of Digits to the left of the Decimal Point.

- 16809        **Bit 7:** If set, suppress leading zeros.
- 16810        This attribute shall be used in relation with the following attributes:
- 16811        • CurrentInletEnergyCarrierDemand
  - 16812        • CurrentOutletEnergyCarrierDemand
  - 16813        • CurrentDayMaxEnergyCarrierDemand
  - 16814        • PreviousDayMaxEnergyCarrierDemand
  - 16815        • CurrentMonthMaxEnergyCarrierDemand
  - 16816        • CurrentMonthMinEnergyCarrierDemand
  - 16817        • CurrentYearMinEnergyCarrierDemand
  - 16818        • CurrentYearMaxEnergyCarrierDemand

16819        **10.4.2.2.4.13    TemperatureUnitOfMeasure Attribute**

16820        The TemperatureUnitOfMeasure specifies the unit of measure that temperatures are measured in. The enumeration of this attribute is shown in Table 10-74.

16822        **Table 10-74. TemperatureUnitOfMeasure Enumeration**

Values	Description
0x00	K (Degrees Kelvin) in pure Binary format.
0x01	°C (Degrees Celsius) in pure Binary format.
0x02	°F (Degrees Fahrenheit) in pure Binary format.
0x80	K (Degrees Kelvin) in BCD format.
0x81	°C (Degrees Celsius) in BCD format.
0x82	°F (Degrees Fahrenheit) in BCD format.

16823        **10.4.2.2.4.14    TemperatureFormatting Attribute**

16824        TemperatureFormatting provides a method to properly decipher the number of digits and the decimal location of the values found in the Temperature-related attributes. This attribute is to be decoded as follows:

- 16826        **Bits 0 to 2:** Number of Digits to the right of the Decimal Point.
- 16827        **Bits 3 to 6:** Number of Digits to the left of the Decimal Point.
- 16828        **Bit 7:** If set, suppress leading zeros.

16829        This attribute shall be used in relation with the following attributes:

- 16830        • InletTemperature
- 16831        • OutletTemperature
- 16832        • ControlTemperature

16833        **10.4.2.2.4.15    ModuleSerialNumber Attribute**

16834        The ModuleSerialNumber attribute represents the serial number (unique identifier) of the meter module. It is an Octet String field capable of storing a 24 character string (the first Octet indicates length) encoded in UTF-8 format. It shall be used to uniquely identify the meter communications module.

16837        **10.4.2.2.4.16    OperatingTariffLabelDelivered Attribute**

16838 The `OperatingTariffLabelDelivered` attribute is the meter’s version of the `TariffLabel` attribute that is found  
16839 within the `Tariff Information` attribute set of the `Price Cluster`. It is used to identify the current consumption  
16840 tariff operating on the meter. See section 10.2.2.2.7.1. The attribute is an `Octet String` field capable of  
16841 storing a 24 character string (the first `Octet` indicates length) encoded in `UTF-8` format.

#### 16842 **10.4.2.2.4.17 OperatingTariffLabelReceived Attribute**

16843 The `OperatingTariffLabelReceived` attribute is the meter’s version of the `ReceivedTariffLabel` attribute that  
16844 is found within the `Tariff Information` attribute set of the `Price Cluster`. It is used to identify the current  
16845 generation tariff operating on the meter. See section 10.2.2.2.15.1. The attribute is an `Octet String` field  
16846 capable of storing a 24 character string (the first `Octet` indicates length) encoded in `UTF-8` format.

#### 16847 **10.4.2.2.4.18 CustomerIDNumber Attribute**

16848 The `CustomerIDNumber` attribute provides a customer identification which may be used to confirm the cus-  
16849 tomer at the premises. The attribute is an `Octet String` field capable of storing a 24 character string (not  
16850 including the first `Octet` which indicates length) encoded in `UTF-8` format.

#### 16851 **10.4.2.2.4.19 AlternativeUnitofMeasure Attribute**

16852 Unless stated otherwise, the *AlternativeUnitofMeasure* attribute provides a base for the attributes in the Al-  
16853 ternative Historical Consumption attribute set defined in Table 10-92.

16854 The *AlternativeUnitofMeasure* attribute shall be supported if any of the attributes within the Alternative His-  
16855 torical Consumption attribute set are to be used.

16856 The *AlternativeUnitofMeasure* attribute shall be set to a value that is different to the *UnitOfMeasure* attribute.

16857 The *AlternativeUnitofMeasure* attribute is an 8-bit enumerated field. The possible values for this attribute are  
16858 listed in Table 10-72.

#### 16859 **10.4.2.2.4.20 AlternativeDemandFormatting Attribute**

16860 *AlternativeDemandFormatting* provides a method to properly decipher the number of digits and the decimal  
16861 location of the values found in the Alternative Demand-related attributes. This attribute is to be decoded as  
16862 follows:

16863 **Bits 0 to 2:** Number of Digits to the right of the Decimal Point.

16864 **Bits 3 to 6:** Number of Digits to the left of the Decimal Point.

16865 **Bit 7:** If set, suppress leading zeros.

16866 This attribute shall be used against the following attribute:

- 16867 • `AlternativeInstantaneousDemand`
- 16868

#### 16869 **10.4.2.2.4.21 AlternativeConsumptionFormatting Attribute**

16870 *AlternativeConsumptionFormatting* provides a method to properly decipher the number of digits and the  
16871 decimal location of the consumption values found in the Alternative Historical Consumption Set of attrib-  
16872 utes. This attribute is to be decoded as follows:

16873 **Bits 0 to 2:** Number of Digits to the right of the Decimal Point.

16874 **Bits 3 to 6:** Number of Digits to the left of the Decimal Point.

16875 **Bit 7:** If set, suppress leading zeros.

16876 This attribute shall be used against the following attributes:

- 16877 • CurrentDayAlternativeConsumptionDelivered
- 16878 • CurrentDayAlternativeConsumptionReceived
- 16879 • PreviousDayAlternativeConsumptionDelivered
- 16880 • PreviousDayAlternativeConsumptionReceived
- 16881 • CurrentAlternativePartialProfileIntervalValue
- 16882 • PreviousDayNAlternativeConsumptionDelivered
- 16883 • PreviousDayNAlternativeConsumptionReceived
- 16884 • CurrentWeekAlternativeConsumptionDelivered
- 16885 • CurrentWeekAlternativeConsumptionReceived
- 16886 • PreviousWeekNAlternativeConsumptionDelivered
- 16887 • PreviousWeekNAlternativeConsumptionReceived
- 16888 • CurrentMonthAlternativeConsumptionDelivered
- 16889 • CurrentMonthAlternativeConsumptionReceived
- 16890 • PreviousMonthNAlternativeConsumptionDelivered
- 16891 • PreviousMonthNAlternativeConsumptionReceived
- 16892
- 16893

16894 **10.4.2.2.5 Historical Consumption Attribute**

16895 The Historical Consumption attribute set allows historical information to be presented in a base defined by  
 16896 the UnitofMeasure attribute (see 10.4.2.2.4.1). The Historical Attribute Set is defined in Table 10-75.

16897 **Table 10-75. Historical Consumption Attribute Set**

<b>Id</b>	<b>Name</b>	<b>Type</b>	<b>Range</b>	<b>Acc</b>	<b>Def</b>	<b>M</b>
0x0400	<i>InstantaneousDemand</i>	int24	-8,388,607 to 8,388,607	R	0	O
0x0401	<i>CurrentDayConsumptionDelivered</i>	uint24	0x000000 to 0xFFFFFFFF	R	-	O
0x0402	<i>CurrentDayConsumptionReceived</i>	uint24	0x000000 to 0xFFFFFFFF	R	-	O
0x0403	<i>PreviousDayConsumptionDelivered</i>	uint24	0x000000 to 0xFFFFFFFF	R	-	O
0x0404	<i>PreviousDayConsumptionReceived</i>	uint24	0x000000 to 0xFFFFFFFF	R	-	O
0x0405	<i>CurrentPartialProfileIntervalStartTimeDelivered</i>	UTC		R	-	O
0x0406	<i>CurrentPartialProfileIntervalStartTimeReceived</i>	UTC		R	-	O
0x0407	<i>CurrentPartialProfileIntervalValueDelivered</i>	uint24	0x000000 to 0xFFFFFFFF	R	-	O
0x0408	<i>CurrentPartialProfileIntervalValueReceived</i>	uint24	0x000000 to 0xFFFFFFFF	R	-	O
0x0409	<i>CurrentDayMaxPressure</i>	uint48	0x000000 000000 to 0xFFFFFFFF FFFFFFFF	R	-	O
0x040a	<i>CurrentDayMinPressure</i>	uint48	0x000000 000000 to 0xFFFFFFFF FFFFFFFF	R	-	O

<b>Id</b>	<b>Name</b>	<b>Type</b>	<b>Range</b>	<b>Acc</b>	<b>Def</b>	<b>M</b>
0x040b	<i>PreviousDayMaxPressure</i>	uint48	0x000000 000000 to 0xFFFFFFFF FFFFFFFF	R	-	O
0x040c	<i>PreviousDayMinPressure</i>	uint48	0x000000 000000 to 0xFFFFFFFF FFFFFFFF	R	-	O
0x040d	<i>CurrentDayMaxDemand</i>	int24	-8,388,607 to 8,388,607	R	-	O
0x040e	<i>PreviousDayMaxDemand</i>	int24	-8,388,607 to 8,388,607	R	-	O
0x040f	<i>CurrentMonthMaxDemand</i>	int24	-8,388,607 to 8,388,607	R	-	O
0x0410	<i>CurrentYearMaxDemand</i>	int24	-8,388,607 to 8,388,607	R	-	O
0x0411	<i>CurrentDayMaxEnergyCarrierDemand</i>	int24	-8,388,607 to 8,388,607	R	-	O
0x0412	<i>PreviousDayMaxEnergyCarrierDemand</i>	int24	-8,388,607 to 8,388,607	R	-	O
0x0413	<i>CurrentMonthMaxEnergyCarrierDemand</i>	int24	-8,388,607 to 8,388,607	R	-	O
0x0414	<i>CurrentMonthMinEnergyCarrierDemand</i>	int24	-8,388,607 to 8,388,607	R	-	O
0x0415	<i>CurrentYearMaxEnergyCarrierDemand</i>	int24	-8,388,607 to 8,388,607	R	-	O
0x0416	<i>CurrentYearMinEnergyCarrierDemand</i>	int24	-8,388,607 to 8,388,607	R	-	O
0x0420	<i>PreviousDay2ConsumptionDelivered</i>	uint24	0x000000 to 0xFFFFFFFF	R	-	O
0x0421	<i>PreviousDay2ConsumptionReceived</i>	uint24	0x000000 to 0xFFFFFFFF	R	-	O
0x0422	<i>PreviousDay3ConsumptionDelivered</i>	uint24	0x000000 to 0xFFFFFFFF	R	-	O
0x0423	<i>PreviousDay3ConsumptionReceived</i>	uint24	0x000000 to 0xFFFFFFFF	R	-	O
0x0424	<i>PreviousDay4ConsumptionDelivered</i>	uint24	0x000000 to 0xFFFFFFFF	R	-	O
0x0425	<i>PreviousDay4ConsumptionReceived</i>	uint24	0x000000 to 0xFFFFFFFF	R	-	O
0x0426	<i>PreviousDay5ConsumptionDelivered</i>	uint24	0x000000 to 0xFFFFFFFF	R	-	O
0x0427	<i>PreviousDay5ConsumptionReceived</i>	uint24	0x000000 to 0xFFFFFFFF	R	-	O
0x0428	<i>PreviousDay6ConsumptionDelivered</i>	uint24	0x000000 to 0xFFFFFFFF	R	-	O

<b>Id</b>	<b>Name</b>	<b>Type</b>	<b>Range</b>	<b>Acc</b>	<b>Def</b>	<b>M</b>
0x0429	<i>PreviousDay6ConsumptionReceived</i>	uint24	0x000000 to 0xFFFFFFFF	R	-	O
0x042a	<i>PreviousDay7ConsumptionDelivered</i>	uint24	0x000000 to 0xFFFFFFFF	R	-	O
0x042b	<i>PreviousDay7ConsumptionReceived</i>	uint24	0x000000 to 0xFFFFFFFF	R	-	O
0x042c	<i>PreviousDay8ConsumptionDelivered</i>	uint24	0x000000 to 0xFFFFFFFF	R	-	O
0x042d	<i>PreviousDay8ConsumptionReceived</i>	uint24	0x000000 to 0xFFFFFFFF	R	-	O
0x0430	<i>CurrentWeekConsumptionDelivered</i>	uint24	0x000000 to 0xFFFFFFFF	R	-	O
0x0431	<i>CurrentWeekConsumptionReceived</i>	uint24	0x000000 to 0xFFFFFFFF	R	-	O
0x0432	<i>PreviousWeekConsumptionDelivered</i>	uint24	0x000000 to 0xFFFFFFFF	R	-	O
0x0433	<i>PreviousWeekConsumptionReceived</i>	uint24	0x000000 to 0xFFFFFFFF	R	-	O
0x0434	<i>PreviousWeek2ConsumptionDelivered</i>	uint24	0x000000 to 0xFFFFFFFF	R	-	O
0x0435	<i>PreviousWeek2ConsumptionReceived</i>	uint24	0x000000 to 0xFFFFFFFF	R	-	O
0x0436	<i>PreviousWeek3ConsumptionDelivered</i>	uint24	0x000000 to 0xFFFFFFFF	R	-	O
0x0437	<i>PreviousWeek3ConsumptionReceived</i>	uint24	0x000000 to 0xFFFFFFFF	R	-	O
0x0438	<i>PreviousWeek4ConsumptionDelivered</i>	uint24	0x000000 to 0xFFFFFFFF	R	-	O
0x0439	<i>PreviousWeek4ConsumptionReceived</i>	uint24	0x000000 to 0xFFFFFFFF	R	-	O
0x043a	<i>PreviousWeek5ConsumptionDelivered</i>	uint24	0x000000 to 0xFFFFFFFF	R	-	O
0x043b	<i>PreviousWeek5ConsumptionReceived</i>	uint24	0x000000 to 0xFFFFFFFF	R	-	O
0x0440	<i>CurrentMonthConsumptionDelivered</i>	uint32	0x00000000 to 0xFFFFFFFF	R	-	O
0x0441	<i>CurrentMonthConsumptionReceived</i>	uint32	0x00000000 to 0xFFFFFFFF	R	-	O
0x0442	<i>PreviousMonthConsumptionDelivered</i>	uint32	0x00000000 to 0xFFFFFFFF	R	-	O
0x0443	<i>PreviousMonthConsumptionReceived</i>	uint32	0x00000000 to 0xFFFFFFFF	R	-	O

<b>Id</b>	<b>Name</b>	<b>Type</b>	<b>Range</b>	<b>Acc</b>	<b>Def</b>	<b>M</b>
0x0444	<i>PreviousMonth2ConsumptionDelivered</i>	uint32	0x00000000 to 0xFFFFFFFF	R	-	O
0x0445	<i>PreviousMonth2ConsumptionReceived</i>	uint32	0x00000000 to 0xFFFFFFFF	R	-	O
0x0446	<i>PreviousMonth3ConsumptionDelivered</i>	uint32	0x00000000 to 0xFFFFFFFF	R	-	O
0x0447	<i>PreviousMonth3ConsumptionReceived</i>	uint32	0x00000000 to 0xFFFFFFFF	R	-	O
0x0448	<i>PreviousMonth4ConsumptionDelivered</i>	uint32	0x00000000 to 0xFFFFFFFF	R	-	O
0x0449	<i>PreviousMonth4ConsumptionReceived</i>	uint32	0x00000000 to 0xFFFFFFFF	R	-	O
0x044a	<i>PreviousMonth5ConsumptionDelivered</i>	uint32	0x00000000 to 0xFFFFFFFF	R	-	O
0x044b	<i>PreviousMonth5ConsumptionReceived</i>	uint32	0x00000000 to 0xFFFFFFFF	R	-	O
0x044c	<i>PreviousMonth6ConsumptionDelivered</i>	uint32	0x00000000 to 0xFFFFFFFF	R	-	O
0x044d	<i>PreviousMonth6ConsumptionReceived</i>	uint32	0x00000000 to 0xFFFFFFFF	R	-	O
0x044e	<i>PreviousMonth7ConsumptionDelivered</i>	uint32	0x00000000 to 0xFFFFFFFF	R	-	O
0x044f	<i>PreviousMonth7ConsumptionReceived</i>	uint32	0x00000000 to 0xFFFFFFFF	R	-	O
0x0450	<i>PreviousMonth8ConsumptionDelivered</i>	uint32	0x00000000 to 0xFFFFFFFF	R	-	O
0x0451	<i>PreviousMonth8ConsumptionReceived</i>	uint32	0x00000000 to 0xFFFFFFFF	R	-	O
0x0452	<i>PreviousMonth9ConsumptionDelivered</i>	uint32	0x00000000 to 0xFFFFFFFF	R	-	O
0x0453	<i>PreviousMonth9ConsumptionReceived</i>	uint32	0x00000000 to 0xFFFFFFFF	R	-	O
0x0454	<i>PreviousMonth10ConsumptionDelivered</i>	uint32	0x00000000 to 0xFFFFFFFF	R	-	O
0x0455	<i>PreviousMonth10ConsumptionReceived</i>	uint32	0x00000000 to 0xFFFFFFFF	R	-	O
0x0456	<i>PreviousMonth11ConsumptionDelivered</i>	uint32	0x00000000 to 0xFFFFFFFF	R	-	O
0x0457	<i>PreviousMonth11ConsumptionReceived</i>	uint32	0x00000000 to 0xFFFFFFFF	R	-	O
0x0458	<i>PreviousMonth12ConsumptionDelivered</i>	uint32	0x00000000 to 0xFFFFFFFF	R	-	O



<b>Id</b>	<b>Name</b>	<b>Type</b>	<b>Range</b>	<b>Acc</b>	<b>Def</b>	<b>M</b>
0x0459	<i>PreviousMonth12ConsumptionReceived</i>	uint32	0x00000000 to 0xFFFFFFFF	R	-	O
0x045a	<i>PreviousMonth13ConsumptionDelivered</i>	uint32	0x00000000 to 0xFFFFFFFF	R	-	O
0x045b	<i>PreviousMonth13ConsumptionReceived</i>	uint32	0x00000000 to 0xFFFFFFFF	R	-	O
0x045c	<i>Historical Freeze Time</i>	uint16	0x0000 to 0x173B	R	0x0000	O

16898 **10.4.2.2.5.1 InstantaneousDemand Attribute**

16899 InstantaneousDemand represents the current Demand of Energy, Gas, or Water delivered or received at  
 16900 the premises. Positive values indicate demand delivered to the premises where negative values indicate  
 16901 demand received from the premises. InstantaneousDemand is updated continuously as new measurements  
 16902 are made. The frequency of updates to this field is specific to the metering device, but should be within the  
 16903 range of once every second to once every 5 seconds.

16904 **10.4.2.2.5.2 CurrentDayConsumptionDelivered Attribute**

16905 CurrentDayConsumptionDelivered represents the summed value of Energy, Gas, or Water delivered to the  
 16906 premises since the Historical Freeze Time (HFT). If optionally provided, CurrentDayConsumptionDelivered  
 16907 is updated continuously as new measurements are made. If the optional HFT attribute is not available, default  
 16908 to midnight local time.

16909 **10.4.2.2.5.3 CurrentDayConsumptionReceived Attribute**

16910 CurrentDayConsumptionReceived represents the summed value of Energy, Gas, or Water received from  
 16911 the premises since the Historical Freeze Time (HFT). If optionally provided, CurrentDayConsumptionRe-  
 16912 ceived is updated continuously as new measurements are made. If the optional HFT attribute is not available,  
 16913 default to midnight local time.

16914 **10.4.2.2.5.4 PreviousDayConsumptionDelivered Attribute**

16915 PreviousDayConsumptionDelivered represents the summed value of Energy, Gas, or Water delivered to the  
 16916 premises within the previous 24 hour period starting at the Historical Freeze Time (HFT). If optionally  
 16917 provided, PreviousDayConsumptionDelivered is updated every HFT. If the optional HFT attribute is not  
 16918 available, default to midnight local time.

16919 **10.4.2.2.5.5 PreviousDayConsumptionReceived Attribute**

16920 PreviousDayConsumptionReceived represents the summed value of Energy, Gas, or Water received from  
 16921 the premises within the previous 24 hour period starting at the Historical Freeze Time (HFT). If optionally  
 16922 provided, PreviousDayConsumptionReceived is updated every HFT. If the optional HFT attribute  
 16923 is not available, default to midnight local time.

16924 **10.4.2.2.5.6 CurrentPartialProfileIntervalStartTimeDelivered Attribute**

16925 CurrentPartialProfileIntervalStartTimeDelivered represents the start time of the current Load Profile interval  
 16926 being accumulated for commodity delivered.

16927 **10.4.2.2.5.7 CurrentPartialProfileIntervalStartTimeReceived Attribute**

16928 CurrentPartialProfileIntervalStartTimeReceived represents the start time of the current Load Profile interval  
 16929 being accumulated for commodity received.

16930 **10.4.2.2.5.8 CurrentPartialProfileIntervalValueDelivered Attribute**

16931 CurrentPartialProfileIntervalValueDelivered represents the value of the current Load Profile interval being  
16932 accumulated for commodity delivered.

16933 **10.4.2.2.5.9 CurrentPartialProfileIntervalValueReceived Attribute**

16934 CurrentPartialProfileIntervalValueReceived represents the value of the current Load Profile interval being  
16935 accumulated for commodity received.

16936 **10.4.2.2.5.10 CurrentDayMaxPressure Attribute**

16937 CurrentDayMaxPressure is the maximum pressure reported during a day from the water or gas meter.

16938 **10.4.2.2.5.11 PreviousDayMaxPressure Attribute**

16939 PreviousDayMaxPressure represents the maximum pressure reported during the previous day from the water  
16940 or gas meter.

16941 **10.4.2.2.5.12 CurrentDayMinPressure Attribute**

16942 CurrentDayMinPressure is the minimum pressure reported during a day from the water or gas meter.

16943 **10.4.2.2.5.13 PreviousDayMinPressure Attribute**

16944 PreviousDayMinPressure represents the minimum pressure reported during the previous day from the water  
16945 or gas meter.

16946 **10.4.2.2.5.14 CurrentDayMaxDemand Attribute**

16947 CurrentDayMaxDemand represents the maximum demand or rate of delivered value of Energy, Gas, or  
16948 Water being utilized at the premises.

16949 **10.4.2.2.5.15 PreviousDayMaxDemand Attribute**

16950 PreviousDayMaxDemand represents the maximum demand or rate of delivered value of Energy, Gas, or  
16951 Water being utilized at the premises.

16952 **Note:** At the end of a day the metering device will transfer the CurrentDayMaxPressure into PreviousDay-  
16953 MaxPressure, CurrentDayMinPressure into PreviousDayMinPressure and CurrentDayMaxDemand into Pre-  
16954 viousDayMaxDemand.

16955 **10.4.2.2.5.16 CurrentMonthMaxDemand Attribute**

16956 CurrentMonthMaxDemand is the maximum demand reported during a month from the meter.

16957 For electricity, heat and cooling meters this is the maximum power reported in a month.

16958 **10.4.2.2.5.17 CurrentYearMaxDemand Attribute**

16959 CurrentYearMaxDemand is the maximum demand reported during a year from the meter.

16960 For electricity, heat and cooling meters this is the maximum power reported in a year.

16961 **10.4.2.2.5.18 CurrentDayMaxEnergyCarrierDemand Attribute**

16962 CurrentDayMaxEnergyCarrierDemand is the maximum energy carrier demand reported during a day from  
16963 the meter.

16964 **Note:** At the end of a day the meter will transfer the CurrentDayMaxEnergyCarrierDemand into Previ-  
16965 ousDayMaxEnergyCarrierDemand.

16966 For heat and cooling meters this is the maximum flow rate on the inlet reported in a day.

16967 **10.4.2.2.5.19 PreviousDayMaxEnergyCarrierDemand Attribute**

16968 PreviousDayMaxEnergyCarrierDemand is the maximum energy carrier demand reported during the previous  
16969 day from the meter.

16970 **10.4.2.2.5.20 CurrentMonthMaxEnergyCarrierDemand Attribute**

16971 CurrentMonthMaxEnergyCarrierDemand is the maximum energy carrier demand reported during a month  
16972 from the meter.

16973 For heat and cooling meters this is the maximum flow rate on the inlet reported in a month.

16974 **10.4.2.2.5.21 CurrentMonthMinEnergyCarrierDemand Attribute**

16975 CurrentMonthMinEnergyCarrierDemand is the minimum energy carrier demand reported during a month  
16976 from the meter.

16977 For heat and cooling meters this is the minimum flow rate on the inlet reported in a month.

16978 **Note:** This attribute may be used to detect leaks if there has been no flow rate of zero in the last month.

16979 **10.4.2.2.5.22 CurrentYearMaxEnergyCarrierDemand Attribute**

16980 CurrentYearMaxEnergyCarrierDemand is the maximum energy carrier demand reported during a year from  
16981 the meter.

16982 For heat and cooling meters this is the maximum flow rate on the inlet reported in a year.

16983 **10.4.2.2.5.23 CurrentYearMinEnergyCarrierDemand Attribute**

16984 CurrentYearMinEnergyCarrierDemand is the minimum energy carrier demand reported during a year from  
16985 the heat meter.

16986 For heat and cooling meters this is the minimum flow rate on the inlet reported in a year.

16987 **Note:** This attribute may be used to detect leaks if there has been no flow rate of zero in the last year.

16988 **10.4.2.2.5.24 PreviousDayNConsumptionDelivered Attribute**

16989 PreviousDayNConsumptionDelivered represents the summed value of Energy, Gas, or Water delivered to  
16990 the premises within the previous 24 hour period starting at the Historical Freeze Time (HFT). If the optional  
16991 HFT attribute is not available, default to midnight local time.

16992 **10.4.2.2.5.25 PreviousDayNConsumptionReceived Attribute**

16993 PreviousDayNConsumptionReceived represents the summed value of Energy, Gas, or Water received from  
16994 the premises within the previous 24 hour period starting at the Historical Freeze Time (HFT). If the optional  
16995 HFT attribute is not available, default to midnight local time.

16996 **10.4.2.2.5.26 CurrentWeekConsumptionDelivered Attribute**

16997 CurrentWeekConsumptionDelivered represents the summed value of Energy, Gas, or Water delivered to the  
16998 premises since the Historical Freeze Time (HFT) on Monday to the last HFT read. If optionally provided,  
16999 CurrentWeekConsumptionDelivered is updated continuously as new measurements are made. If the optional  
17000 HFT attribute is not available, default to midnight local time.

17001 **10.4.2.2.5.27 CurrentWeekConsumptionReceived Attribute**

17002 CurrentWeekConsumptionReceived represents the summed value of Energy, Gas, or Water received from  
17003 the premises since the Historical Freeze Time (HFT) on Monday to the last HFT read. If optionally provided,  
17004 CurrentWeekConsumptionReceived is updated continuously as new measurements are made. If the optional  
17005 HFT attribute is not available, default to midnight local time.

17006 **10.4.2.2.5.28 PreviousWeekNConsumptionDelivered Attribute**

17007 PreviousWeekNConsumptionDelivered represents the summed value of Energy, Gas, or Water delivered to  
17008 the premises within the previous week period starting at the Historical Freeze Time (HFT) on the Monday to  
17009 the Sunday. If the optional HFT attribute is not available, default to midnight local time.

17010 **10.4.2.2.5.29 PreviousWeekNConsumptionReceived Attribute**

17011 PreviousWeekNConsumptionReceived represents the summed value of Energy, Gas, or Water received from  
17012 the premises within the previous week period starting at the Historical Freeze Time (HFT) on the Monday to  
17013 the Sunday. If the optional HFT attribute is not available, default to midnight local time.

17014 **10.4.2.2.5.30 CurrentMonthConsumptionDelivered Attribute**

17015 CurrentMonthConsumptionDelivered represents the summed value of Energy, Gas, or Water delivered to the  
17016 premises since the Historical Freeze Time (HFT) on the 1<sup>st</sup> of the month to the last HFT read. If optionally  
17017 provided, CurrentMonthConsumptionDelivered is updated continuously as new measurements are made. If  
17018 the optional HFT attribute is not available, default to midnight local time.

17019 **10.4.2.2.5.31 CurrentMonthConsumptionReceived Attribute**

17020 CurrentMonthConsumptionReceived represents the summed value of Energy, Gas, or Water received from  
17021 the premises since the Historical Freeze Time (HFT) on the 1<sup>st</sup> of the month to the last HFT read. If optionally  
17022 provided, CurrentMonthConsumptionReceived is updated continuously as new measurements are made. If  
17023 the optional HFT attribute is not available, default to midnight local time.

17024 **10.4.2.2.5.32 PreviousMonthNConsumptionDelivered Attribute**

17025 PreviousMonthNConsumptionDelivered represents the summed value of Energy, Gas, or Water delivered to  
17026 the premises within the previous Month period starting at the Historical Freeze Time (HFT) on the 1<sup>st</sup> of the  
17027 month to the last day of the month. If the optional HFT attribute is not available, default to midnight local  
17028 time.

17029 **10.4.2.2.5.33 PreviousMonthNConsumptionReceived Attribute**

17030 PreviousMonthNConsumptionReceived represents the summed value of Energy, Gas, or Water received  
17031 from the premises within the previous month period starting at the Historical Freeze Time (HFT) on the 1<sup>st</sup>  
17032 of the month to the last day of the month. If the optional HFT attribute is not available, default to midnight  
17033 local time.

17034 **10.4.2.2.5.34 HistoricalFreezeTime Attribute**

17035 *HistoricalFreezeTime* (HFT) represents the time of day, in Local Time, when Historical Consumption attrib-  
17036 utes and/or Alternative Historical Consumption attributes are captured. *HistoricalFreezeTime* is an unsigned  
17037 16-bit value representing the hour and minutes for HFT. The byte usages are:

17038 **Bits 0 to 7:** Range of 0 to 0x3B representing the number of minutes past the top of the hour.

17039  
17040 **Bits 8 to 15:** Range of 0 to 0x17 representing the hour of the day (in 24-hour format). *Note that midnight*  
17041 *shall be represented as 00:00 only.*

17042

17043 **10.4.2.2.6 Load Profile Configuration**

17044 The Load Profile Configuration Attribute Set is defined in Table 10-76.

17045

**Table 10-76. Load Profile Configuration Attribute Set**

Identifier	Name	Type	Range	Acc	Default	M
0x0500	<i>MaxNumberOfPeriodsDelivered</i>	uint8	0x00 to 0xFF	R	0x18	O

17046

**10.4.2.2.6.1 MaxNumberOfPeriodsDelivered Attribute**

17047  
 17048  
 17049  
 17050  
 17051

MaxNumberOfPeriodsDelivered represents the maximum number of intervals the device is capable of returning in one Get Profile Response command. It is required MaxNumberOfPeriodsDelivered fit within the default Fragmentation ASDU size of 128 bytes, or an optionally agreed upon larger Fragmentation ASDU size supported by both devices. Please refer to [Z1] for further details on Fragmentation settings.

17052

**10.4.2.2.7 Supply Limit Attributes**

17053  
 17054  
 17055  
 17056  
 17057  
 17058  
 17059

This set of attributes is used to implement a “Supply Capacity Limit” program where the demand at the premises is limited to a preset consumption level over a preset period of time. Should this preset limit be exceeded the meter could interrupt supply to the premises or to devices within the premises. The supply limit information in this attribute set can be used by In-Home Displays, PCTs, or other devices to display a warning when the supply limit is being approached. The Supply Limit Attribute Set is defined in Table 10-77.

**Table 10-77. Supply Limit Attribute Set**

Id	Name	Type	Range	Acc	Def	M
0x0600	<i>CurrentDemandDelivered</i>	uint24	0x000000 to 0xFFFFFFFF	R		O
0x0601	<i>DemandLimit</i>	uint24	0x000000 to 0xFFFFFFFF	R		O
0x0602	<i>DemandIntegrationPeriod</i>	uint8	0x01 to 0xFF	R	-	O
0x0603	<i>NumberOfDemandSubinter-</i>	uint8	0x01 to 0xFF	R	-	O
0x0604	<i>DemandLimitArmDuration</i>	uint16	0x0000 to	R	0x003C	O
0x0605	<i>LoadLimitSupplyState</i>	enum8	0x00 to 0xFF	R	0x00	O
0x0606	<i>LoadLimitCounter</i>	uint8	0x00 to 0xFF	R	0x01	O
0x0607	<i>SupplyTamperState</i>	enum8	0x00 to 0xFF	R	0x00	O
0x0608	<i>SupplyDepletionState</i>	enum8	0x00 to 0xFF	R	0x00	O
0x0609	<i>SupplyUncontrolled FlowState</i>	enum8	0x00 to 0xFF	R	0x00	O

17060

**10.4.2.2.7.1 CurrentDemandDelivered Attribute**

17061  
 17062  
 17063  
 17064

CurrentDemandDelivered represents the current Demand of Energy, Gas, or Water delivered at the premises. CurrentDemandDelivered may be continuously updated as new measurements are acquired, but at a minimum CurrentDemandDelivered must be updated at the end of each integration sub-period, which can be obtained by dividing the DemandIntegrationPeriod by the NumberOfDemandSubintervals.

17065 This attribute shall be adjusted using the Multiplier and Divisor attributes found in the Formatting Attribute  
17066 Set and can be formatted using the DemandFormatting attribute. The final result represents an engineering  
17067 value in the unit defined by the UnitofMeasure attribute.

#### 17068 **10.4.2.2.7.2 DemandLimit Attribute**

17069 DemandLimit reflects the current supply demand limit set in the meter. This value can be compared to the  
17070 CurrentDemandDelivered attribute to understand if limits are being approached or exceeded.

17071 Adjustment and formatting of this attribute follow the same rules as the CurrentDemandDelivered.

17072 A value of “0xFFFFF” indicates “demand limiting” is switched off.

#### 17073 **10.4.2.2.7.3 DemandIntegrationPeriod Attribute**

17074 DemandIntegrationPeriod is the number of minutes over which the CurrentDemandDelivered attribute is  
17075 calculated. Valid range is 0x01 to 0xFF. 0x00 is a reserved value.

#### 17076 **10.4.2.2.7.4 NumberOfDemandSubintervals Attribute**

17077 NumberOfDemandSubintervals represents the number of subintervals used within the DemandIntegration-  
17078 Period. The subinterval duration (in minutes) is obtained by dividing the DemandIntegrationPeriod by the  
17079 NumberOfDemandSubintervals. The CurrentDemandDelivered attribute is updated at each subinterval. Valid  
17080 range is 0x01 to 0xFF. 0x00 is a reserved value.

17081 As a Rolling Demand example, DemandIntegrationPeriod could be set at 30 (for 30 minute period) and  
17082 NumberOfDemandSubintervals could be set for 6. This would provide 5 minute ( $30/6 = 5$ ) subinterval  
17083 periods.

17084 As a Block Demand example, DemandIntegrationPeriod could be set at 30 (for 30 minute period) and  
17085 NumberOfDemandSubintervals could be set for 1. This would provide a single 30 minute subinterval  
17086 period.

#### 17087 **10.4.2.2.7.5 DemandLimitArmDuration Attribute**

17088 An unsigned 16-bit integer that defines the length of time, in seconds, that the supply shall be disconnected  
17089 if the DemandLimit attribute is enabled and the limit is exceeded. At the end of the time period the meter  
17090 shall move to the ARMED status. This will allow the user to reconnect the supply.

#### 17091 **10.4.2.2.7.6 LoadLimitSupplyState Attribute**

17092 The LoadLimitSupplyState attribute indicates the required status of the supply once device is in a load limit  
17093 state. The enumerated values for this field are outlined in Table 10-114.

#### 17094 **10.4.2.2.7.7 LoadLimitCounter Attribute**

17095 An unsigned 8-bit integer used for counting the number of times that the demand limit has exceeded the set  
17096 threshold.

17097 This attribute shall be reset to zero on receipt of a ResetLoadLimitCounter command (see 10.4.3.3.1.11 for  
17098 further details).

#### 17099 **10.4.2.2.7.8 SupplyTamperState Attribute**

17100 The SupplyTamperState indicates the required status of the supply following the detection of a tamper event  
17101 within the metering device. The enumerated values for this field are outlined in Table 10-114

#### 17102 **10.4.2.2.7.9 SupplyDepletionState Attribute**

17103 The SupplyDepletionState indicates the required status of the supply following detection of a depleted battery  
17104 within the metering device. The enumerated values for this field are outlined in Table 10-114.

17105 **10.4.2.2.7.10 SupplyUncontrolledFlowState Attribute**

17106 The SupplyUncontrolledFlowState indicates the required status of the supply following detection of an un-  
 17107 controlled flow event within the metering device. The enumerated values for this field are outlined in Table  
 17108 10-114.

17109

17110 **10.4.2.2.8 Block Information Set (Delivered)**

17111 The set of attributes shown in Table 10-78 provides a remote access to the Electric, Gas, or Water  
 17112 metering device's block readings. The Block Information attribute set supports Block pricing and combined  
 17113 Tier-Block pricing, the number of blocks is one greater than the number of block thresholds defined in the  
 17114 Pricing cluster.

17115 This attribute set is ONLY for Energy, Gas or Water delivered to and consumed within the premises.

17116 **Table 10-78. Block Information Attribute Set (Delivered)**

<b>Id</b>	<b>Name</b>	<b>Type</b>	<b>Range</b>	<b>Acc</b>	<b>Def</b>	<b>M</b>
0x0700	<i>CurrentNoTierBlock1SummationDelivered</i>	uint48	0x000000000000 to 0xFFFFFFFFFFFFFFF	R	-	O
0x0701	<i>CurrentNoTierBlock2SummationDelivered</i>	uint48	0x000000000000 to 0xFFFFFFFFFFFFFFF	R	-	O
0x0702	<i>CurrentNoTierBlock3SummationDelivered</i>	uint48	0x000000000000 to 0xFFFFFFFFFFFFFFF	R	-	O
0x070N	<i>CurrentNoTierBlockN+1SummationDelivered...</i>	uint48	0x000000000000 to 0xFFFFFFFFFFFFFFF	R	-	O
0x070f	<i>CurrentNoTierBlock16SummationDelivered</i>	uint48	0x000000000000 to 0xFFFFFFFFFFFFFFF	R	-	O
0x0710	<i>CurrentTier1Block1SummationDelivered</i>	uint48	0x000000000000 to 0xFFFFFFFFFFFFFFF	R	-	O
0x0711	<i>CurrentTier1Block2SummationDelivered</i>	uint48	0x000000000000 to 0xFFFFFFFFFFFFFFF	R	-	O
0x0712	<i>CurrentTier1Block3SummationDelivered</i>	uint48	0x000000000000 to 0xFFFFFFFFFFFFFFF	R	-	O
0x071N	<i>CurrentTier1BlockN+1SummationDelivered...</i>	uint48	0x000000000000 to 0xFFFFFFFFFFFFFFF	R	-	O
0x071f	<i>CurrentTier1Block16SummationDelivered</i>	uint48	0x000000000000 to 0xFFFFFFFFFFFFFFF	R	-	O
0x0720	<i>CurrentTier2Block1SummationDelivered</i>	uint48	0x000000000000 to 0xFFFFFFFFFFFFFFF	R	-	O
0x072N	<i>CurrentTier2BlockN+1SummationDelivered...</i>	uint48	0x000000000000 to 0xFFFFFFFFFFFFFFF	R	-	O
0x072f	<i>CurrentTier2Block16SummationDelivered</i>	uint48	0x000000000000 to 0xFFFFFFFFFFFFFFF	R	-	O
0x0730	<i>CurrentTier3Block1SummationDelivered</i>	uint48	0x000000000000 to 0xFFFFFFFFFFFFFFF	R	-	O

<b>Id</b>	<b>Name</b>	<b>Type</b>	<b>Range</b>	<b>Acc</b>	<b>Def</b>	<b>M</b>
0x073N	<i>CurrentTier3BlockN+1SummationDelivered...</i>	uint48	0x000000000000 to 0xFFFFFFFFFFFFFFF	R	-	O
0x073f	<i>CurrentTier3Block16SummationDelivered</i>	uint48	0x000000000000 to 0xFFFFFFFFFFFFFFF	R	-	O
0x0740	<i>CurrentTier4Block1SummationDelivered</i>	uint48	0x000000000000 to 0xFFFFFFFFFFFFFFF	R	-	O
0x074N	<i>CurrentTier4BlockN+1SummationDelivered...</i>	uint48	0x000000000000 to 0xFFFFFFFFFFFFFFF	R	-	O
0x074f	<i>CurrentTier4Block16SummationDelivered</i>	uint48	0x000000000000 to 0xFFFFFFFFFFFFFFF	R	-	O
0x0750	<i>CurrentTier5Block1SummationDelivered</i>	uint48	0x000000000000 to 0xFFFFFFFFFFFFFFF	R	-	O
0x075N	<i>CurrentTier5BlockN+1SummationDelivered...</i>	uint48	0x000000000000 to 0xFFFFFFFFFFFFFFF	R	-	O
0x075f	<i>CurrentTier5Block16SummationDelivered</i>	uint48	0x000000000000 to 0xFFFFFFFFFFFFFFF	R	-	O
0x0760	<i>CurrentTier6Block1SummationDelivered</i>	uint48	0x000000000000 to 0xFFFFFFFFFFFFFFF	R	-	O
0x076N	<i>CurrentTier6BlockN+1SummationDelivered...</i>	uint48	0x000000000000 to 0xFFFFFFFFFFFFFFF	R	-	O
0x076f	<i>CurrentTier6Block16SummationDelivered</i>	uint48	0x000000000000 to 0xFFFFFFFFFFFFFFF	R	-	O
0x0770	<i>CurrentTier7Block1SummationDelivered</i>	uint48	0x000000000000 to 0xFFFFFFFFFFFFFFF	R	-	O
0x077N	<i>CurrentTier7BlockN+1SummationDelivered...</i>	uint48	0x000000000000 to 0xFFFFFFFFFFFFFFF	R	-	O
0x077f	<i>CurrentTier7Block16SummationDelivered</i>	uint48	0x000000000000 to 0xFFFFFFFFFFFFFFF	R	-	O
0x0780	<i>CurrentTier8Block1SummationDelivered</i>	uint48	0x000000000000 to 0xFFFFFFFFFFFFFFF	R	-	O
0x078N	<i>CurrentTier8BlockN+1SummationDelivered...</i>	uint48	0x000000000000 to 0xFFFFFFFFFFFFFFF	R	-	O
0x078f	<i>CurrentTier8Block16SummationDelivered</i>	uint48	0x000000000000 to 0xFFFFFFFFFFFFFFF	R	-	O
0x0790	<i>CurrentTier9Block1SummationDelivered</i>	uint48	0x000000000000 to 0xFFFFFFFFFFFFFFF	R	-	O
0x079N	<i>CurrentTier9BlockN+1SummationDelivered...</i>	uint48	0x000000000000 to 0xFFFFFFFFFFFFFFF	R	-	O



<b>Id</b>	<b>Name</b>	<b>Type</b>	<b>Range</b>	<b>Acc</b>	<b>Def</b>	<b>M</b>
0x079f	<i>CurrentTier9Block16SummationDelivered</i>	uint48	0x000000000000 to 0xFFFFFFFFFFFFFFF	R	-	O
0x07a0	<i>CurrentTier10Block1SummationDelivered</i>	uint48	0x000000000000 to 0xFFFFFFFFFFFFFFF	R	-	O
0x07aN	<i>CurrentTier10BlockN+1SummationDelivered...</i>	uint48	0x000000000000 to 0xFFFFFFFFFFFFFFF	R	-	O
0x07af	<i>CurrentTier10Block16SummationDelivered</i>	uint48	0x000000000000 to 0xFFFFFFFFFFFFFFF	R	-	O
0x07b0	<i>CurrentTier11Block1SummationDelivered</i>	uint48	0x000000000000 to 0xFFFFFFFFFFFFFFF	R	-	O
0x07bN	<i>CurrentTier11BlockN+1SummationDelivered...</i>	uint48	0x000000000000 to 0xFFFFFFFFFFFFFFF	R	-	O
0x07bf	<i>CurrentTier11Block16SummationDelivered</i>	uint48	0x000000000000 to 0xFFFFFFFFFFFFFFF	R	-	O
0x07C0	<i>CurrentTier12Block1SummationDelivered</i>	uint48	0x000000000000 to 0xFFFFFFFFFFFFFFF	R	-	O
0x07cN	<i>CurrentTier12BlockN+1SummationDelivered...</i>	uint48	0x000000000000 to 0xFFFFFFFFFFFFFFF	R	-	O
0x07cf	<i>CurrentTier12Block16SummationDelivered</i>	uint48	0x000000000000 to 0xFFFFFFFFFFFFFFF	R	-	O
0x07d0	<i>CurrentTier13Block1SummationDelivered</i>	uint48	0x000000000000 to 0xFFFFFFFFFFFFFFF	R	-	O
0x07dN	<i>CurrentTier13BlockN+1SummationDelivered...</i>	uint48	0x000000000000 to 0xFFFFFFFFFFFFFFF	R	-	O
0x07df	<i>CurrentTier13Block16SummationDelivered</i>	uint48	0x000000000000 to 0xFFFFFFFFFFFFFFF	R	-	O
0x07e0	<i>CurrentTier14Block1SummationDelivered</i>	uint48	0x000000000000 to 0xFFFFFFFFFFFFFFF	R	-	O
0x07eN	<i>CurrentTier14BlockN+1SummationDelivered...</i>	uint48	0x000000000000 to 0xFFFFFFFFFFFFFFF	R	-	O
0x07ef	<i>CurrentTier14Block16SummationDelivered</i>	uint48	0x000000000000 to 0xFFFFFFFFFFFFFFF	R	-	O
0x07f0	<i>CurrentTier15Block1SummationDelivered</i>	uint48	0x000000000000 to 0xFFFFFFFFFFFFFFF	R	-	O

Id	Name	Type	Range	Acc	Def	M
0x07fN	<i>CurrentTier15BlockN+1SummationDelivered...</i>	uint48	0x000000000000 to 0xFFFFFFFFFFFFFFF	R	-	O
0x07ff	<i>CurrentTier15Block16SummationDelivered</i>	uint48	0x000000000000 to 0xFFFFFFFFFFFFFFF	R	-	O

17117 **10.4.2.2.8.1 CurrentTierNBlockNSummationDelivered Attributes**

17118 Attributes CurrentNoTierBlock1SummationDelivered through CurrentTier15Block16SummationDelivered  
17119 represent the most recent summed value of Energy, Gas, or Water delivered to the premises (i.e. delivered  
17120 to the customer from the utility) at a specific price tier as defined by a TOU schedule, Block Threshold or  
17121 a real time pricing period. If optionally provided, attributes CurrentNoTierBlock1SummationDelivered  
17122 through CurrentTier15Block16SummationDelivered are updated continuously as new measurements are  
17123 made.

17124 **Note:** SummationFormatting shall be used against the Block Information attribute set. The expected practical  
17125 limit for the number of Block attributes supported is 64. The CurrentTierNBlockNSummationDelivered  
17126 attributes are reset at the start of each Block Threshold Period.

17127

17128 **10.4.2.2.9 Alarms Set**

17129 The set of attributes shown in Table 10-79 provides a means to control which alarms may be generated from  
17130 the meter.

17131

**Table 10-79. Alarm Attribute Set**

Id	Name	Type	Range	Acc	Default	M
0x0800	<i>Generic Alarm Mask</i>	map16	0x0000 - 0xffff	RW	0xffff	O
0x0801	<i>Electricity Alarm Mask</i>	map32	0x00000000 - 0xffffffff	RW	0xffffffff	O
0x0802	<i>Generic Flow/Pressure Alarm Mask</i>	map16	0x0000 - 0xffff	RW	0xffff	O
0x0803	<i>Water Specific Alarm Mask</i>	map16	0x0000 - 0xffff	RW	0xffff	O
0x0804	<i>Heat and Cooling Specific Alarm Mask</i>	map16	0x0000 - 0xffff	RW	0xffff	O
0x0805	<i>Gas Specific AlarmMask</i>	map16	0x0000 - 0xffff	RW	0xffff	O
0x0806	ExtendedGenericAlarmMask	map48	0x000000000000 - 0xffffffffffff	RW	0xffffffffffff	O
0x0807	ManufacturerAlarmMask	map16	0x0000 - 0xffff	RW	0xffff	O

17132 **10.4.2.2.9.1 AlarmMask Attributes**

17133 The AlarmMask attributes of the Alarm Attribute Set specify whether each of the alarms listed in the corre-  
17134 sponding alarm group in Table 10-80 through Table 10-88 is enabled. When the bit number corresponding  
17135 to the alarm number (minus the group offset) is set to 1, the alarm is enabled, else it is disabled. Bits not  
17136 corresponding to a code in the respective table are reserved.

17137 **10.4.2.2.9.2 Alarm Codes**

17138 The alarm codes are organized in logical groups corresponding to the meter type as listed in Table 10-80.  
 17139 The three main alarm groups are: Generic, Electricity, and Flow/ Pressure. The Flow/Pressure Alarm Group  
 17140 is further divided into Generic Flow/Pressure, Water Specific, Heat and Cooling Specific, and Gas Specific.  
 17141 It is left for the manufacturer to select which (if any) alarm codes to support.

17142

**Table 10-80. Alarm Code Groups**

<b>Alarm Code</b>	<b>Alarm Condition</b>
<b>00-0F</b>	<b>Generic Alarm Group</b>
<b>10-2F</b>	<b>Electricity Alarm Group</b>
<b>30-6F</b>	<b>Flow/Pressure Alarm Group</b> which is sub-divided as: <b>30-3F</b> - Generic Flow/Pressure Alarm Group <b>40-4F</b> - Water Specific Alarm Group <b>50-5F</b> - Heat and Cooling Specific Alarm Group <b>60-6F</b> - Gas Specific Alarm Group
<b>70-AF</b>	<b>Extended Generic Alarm Group</b>
<b>B0-BF</b>	<b>Manufacturer Specific Alarm Group</b>

17143

17144 The generic Alarm Group maps the status from the MeterStatus attribute into a corresponding alarm. Hence,  
 17145 depending on the meter type, an alarm belonging to the Generic Alarm Group may have a different meaning.  
 17146 See sub-clause 10.4.2.2.3. In the case of overlap of alarm codes from the Generic Alarm Group with codes  
 17147 in other groups, e.g. Burst Detect, it is recommended to only use the code of the Generic Alarm Group, as  
 17148 shown in Table 10-81.

17149

**Table 10-81. Generic Alarm Group**

<b>Alarm Code</b>	<b>Alarm Condition</b>
00	Check Meter
01	Low Battery
02	Tamper Detect
03	Electricity: Power Failure Gas: Not Defined Water: Pipe Empty Heat/Cooling: Temperature Sensor
04	Electricity: Power Quality Gas: Low Pressure Water: Low Pressure Heat/Cooling: Burst Detect
05	Leak Detect
06	Service Disconnect
07	Electricity: Reserved Gas: Reverse Flow Water: Reverse Flow Heat/Cooling: Flow Sensor

Alarm Code	Alarm Condition
08	Meter Cover Removed
09	Meter Cover Closed
0A	Strong Magnetic Field
0B	No Strong Magnetic Field
0C	Battery Failure
0D	Program Memory Error
0E	RAM Error
0F	NV Memory Error

17150

17151 The Electricity Alarm Group defines alarms specific for electricity meters as defined in Table 10-82.

17152

**Table 10-82. Electricity Alarm Group**

Alarm Code	Alarm Condition
10	Low Voltage L1
11	High Voltage L1
12	Low Voltage L2
13	High Voltage L2
14	Low Voltage L3
15	High Voltage L3
16	Over Current L1
17	Over Current L2
18	Over Current L3
19	Frequency too Low L1
1A	Frequency too High L1
1B	Frequency too Low L2
1C	Frequency too High L2
1D	Frequency too Low L3
1E	Frequency too High L3
1F	Ground Fault
20	Electric Tamper Detect
21	Incorrect Polarity
22	Current No Voltage
23	Under Voltage

Alarm Code	Alarm Condition
24	Over Voltage
25	Normal Voltage
26	PF Below Threshold
27	PF Above Threshold
28	Terminal Cover Removed
29	Terminal Cover Closed
2A-2F	Reserved

17153

17154 The Generic Flow/Pressure Alarm Group defines alarms specific for Flow/Pressure based meters i.e. Water,  
 17155 Heat, Cooling, or Gas meters as defined in Table 10-83.

17156

**Table 10-83. Generic Flow/Pressure Alarm Group**

Alarm Code	Alarm Condition
30	Burst detect
31	Pressure too low
32	Pressure too high
33	Flow sensor communication error
34	Flow sensor measurement fault
35	Flow sensor reverse flow
36	Flow sensor air detect
37	Pipe empty
38-3F	Reserved

17157

17158 The Water Specific Alarm Group defines alarms specific for Water meters as defined in Table 10-84.

17159

**Table 10-84. Water Specific Alarm Group**

Alarm Code	Alarm Condition
40-4F	Reserved

17160

17161 The Heat and Cooling Specific Alarm Group defines alarms specific for Heat or Cooling meters as defined  
 17162 in Table 10-85.

17163

**Table 10-85. Heat and Cooling Specific Alarm Group**

Alarm Code	Alarm Condition
50	Inlet Temperature Sensor Fault
51	Outlet Temperature Sensor
52-5F	Reserved

17164

17165 The Gas Specific Alarm Group defines alarms specific for Gas meters as defined in Table 10-86.

17166

**Table 10-86. Gas Specific Alarm Group**

Alarm Code	Alarm Condition
60	Tilt Tamper
61	Battery Cover Removed
62	Battery Cover Closed
63	Excess Flow
64	Tilt Tamper Ended
65-6F	Reserved

17167

17168 The Extended Generic Alarm Group is an additional set of generic meter alarms, as defined in Table 10-87.

17169

**Table 10-87. Extended Generic Alarm Group**

Alarm Code	Alarm Condition
70	Measurement System Error
71	Watchdog Error
72	Supply Disconnect Failure
73	Supply Connect Failure
74	Measurement Software Changed
75	DST enabled
76	DST disabled
77	Clock Adj Backward (the internal clock has applied a negative adjustment)
78	Clock Adj Forward (the internal clock has applied a positive adjustment)
79	Clock Invalid
7A	Communication Error HAN
7B	Communication OK HAN
7C	Meter Fraud Attempt
7D	Power Loss

<b>Alarm Code</b>	<b>Alarm Condition</b>
7E	Unusual HAN Traffic
7F	Unexpected Clock Change
80	Comms Using Unauthenticated Component
81	Error Reg Clear
82	Alarm Reg Clear
83	Unexpected HW Reset
84	Unexpected Program Execution
85	EventLog Cleared
86	Limit Threshold Exceeded
87	Limit Threshold OK
88	Limit Threshold Changed
89	Maximum Demand Exceeded
8A	Profile Cleared
8B	Sampling Buffer cleared
8C	Battery Warning
8D	Wrong Signature
8E	No Signature
8F	Unauthorised Action from HAN
90	Fast Polling Start
91	Fast Polling End
92	Meter Reporting Interval Changed
93	Disconnect Due to Load Limit
94	Meter Supply Status Register Changed
95	Meter Alarm Status Register Changed
96	Extended Meter Alarm Status Register Changed.
97 - AF	Reserved

17170

17171 The Manufacturer Specific Alarm Group defines alarms specific for any meters as defined in Table 10-88.  
 17172 These are used for meter specific functionality that is not covered by the current Smart Energy specification.

17173

**Table 10-88. Manufacturer Specific Alarm Group**

<b>Alarm Code</b>	<b>Alarm Condition</b>
B0	Manufacturer Specific A
B1	Manufacturer Specific B
B2	Manufacturer Specific C

B3	Manufacturer Specific D
B4	Manufacturer Specific E
B5	Manufacturer Specific F
B6	Manufacturer Specific G
B7	Manufacturer Specific H
B8	Manufacturer Specific I
B9 - BF	Reserved
C0 – C4	Reserved (command based events)
C5 – FF	Reserved

17174

17175 **10.4.2.2.10 Block Information Attribute Set (Received)**

17176 The following set of attributes provides a remote access to the Electric, Gas, or Water metering devices block  
17177 readings. The Block Information attribute set supports Block pricing and combined Tier-Block pricing, the  
17178 number of blocks is one greater than the number of block thresholds defined in the Pricing cluster.

17179 This attribute set is ONLY for Energy generated from the premises and received by the utility.

17180

**Table 10-89. Block Information Attribute Set (Received)**

<b>Id</b>	<b>Name</b>	<b>Type</b>	<b>Range</b>	<b>Acc</b>	<b>Def</b>	<b>M</b>
0x0900	<i>CurrentNoTierBlock1SummationReceived</i>	uint48	0x000000000000 to 0xFFFFFFFFFFFFFFF	R	-	O
0x0901	<i>CurrentNoTierBlock2SummationReceived</i>	uint48	0x000000000000 to 0xFFFFFFFFFFFFFFF	R	-	O
0x0902	<i>CurrentNoTierBlock3SummationReceived</i>	uint48	0x000000000000 to 0xFFFFFFFFFFFFFFF	R	-	O
...	...	...	...	...	...	...
0x090f	<i>CurrentNoTierBlock16SummationReceived</i>	uint48	0x000000000000 to 0xFFFFFFFFFFFFFFF	R	-	O
0x0910	<i>CurrentTier1Block1SummationReceived</i>	uint48	0x000000000000 to 0xFFFFFFFFFFFFFFF	R	-	O
0x0911	<i>CurrentTier1Block2SummationReceived</i>	uint48	0x000000000000 to 0xFFFFFFFFFFFFFFF	R	-	O
0x0912	<i>CurrentTier1Block3SummationReceived</i>	uint48	0x000000000000 to 0xFFFFFFFFFFFFFFF	R	-	O
...	...	...	...	...	...	...
0x091f	<i>CurrentTier1Block16SummationReceived</i>	uint48	0x000000000000 to 0xFFFFFFFFFFFFFFF	R	-	O
0x0920	<i>CurrentTier2Block1SummationReceived</i>	uint48	0x000000000000 to 0xFFFFFFFFFFFFFFF	R	-	O



<b>Id</b>	<b>Name</b>	<b>Type</b>	<b>Range</b>	<b>Acc</b>	<b>Def</b>	<b>M</b>
...	...	...	...	...	...	...
0x092f	<i>CurrentTier2Block16SummationReceived</i>	uint48	0x000000000000 to 0xFFFFFFFFFFFFFFF	R	-	O
0x0930	<i>CurrentTier3Block1SummationReceived</i>	uint48	0x000000000000 to 0xFFFFFFFFFFFFFFF	R	-	O
...	...	...	...	...	...	...
0x093f	<i>CurrentTier3Block16SummationReceived</i>	uint48	0x000000000000 to 0xFFFFFFFFFFFFFFF	R	-	O
0x0940	<i>CurrentTier4Block1SummationReceived</i>	uint48	0x000000000000 to 0xFFFFFFFFFFFFFFF	R	-	O
...	...	...	...	...	...	...
0x094f	<i>CurrentTier4Block16SummationReceived</i>	uint48	0x000000000000 to 0xFFFFFFFFFFFFFFF	R	-	O
0x0950	<i>CurrentTier5Block1SummationReceived</i>	uint48	0x000000000000 to 0xFFFFFFFFFFFFFFF	R	-	O
...	...	...	...	...	...	...
0x095f	<i>CurrentTier5Block16SummationReceived</i>	uint48	0x000000000000 to 0xFFFFFFFFFFFFFFF	R	-	O
0x0960	<i>CurrentTier6Block1SummationReceived</i>	uint48	0x000000000000 to 0xFFFFFFFFFFFFFFF	R	-	O
...	...	...	...	...	...	...
0x096f	<i>CurrentTier6Block16SummationReceived</i>	uint48	0x000000000000 to 0xFFFFFFFFFFFFFFF	R	-	O
0x0970	<i>CurrentTier7Block1SummationReceived</i>	uint48	0x000000000000 to 0xFFFFFFFFFFFFFFF	R	-	O
...	...	...	...	...	...	...
0x097f	<i>CurrentTier7Block16SummationReceived</i>	uint48	0x000000000000 to 0xFFFFFFFFFFFFFFF	R	-	O
0x0980	<i>CurrentTier8Block1SummationReceived</i>	uint48	0x000000000000 to 0xFFFFFFFFFFFFFFF	R	-	O
...	...	...	...	...	...	...
0x098f	<i>CurrentTier8Block16SummationReceived</i>	uint48	0x000000000000 to 0xFFFFFFFFFFFFFFF	R	-	O
0x0990	<i>CurrentTier9Block1SummationReceived</i>	uint48	0x000000000000 to 0xFFFFFFFFFFFFFFF	R	-	O
...	...	...	...	...	...	...

<b>Id</b>	<b>Name</b>	<b>Type</b>	<b>Range</b>	<b>Acc</b>	<b>Def</b>	<b>M</b>
0x099f	<i>CurrentTier9Block16SummationReceived</i>	uint48	0x000000000000 to 0xFFFFFFFFFFFFFFF	R	-	O
0x09a0	<i>CurrentTier10Block1SummationReceived</i>	uint48	0x000000000000 to 0xFFFFFFFFFFFFFFF	R	-	O
...	...	...	...	...	...	...
0x09af	<i>CurrentTier10Block16SummationReceived</i>	uint48	0x000000000000 to 0xFFFFFFFFFFFFFFF	R	-	O
0x09b0	<i>CurrentTier11Block1SummationReceived</i>	uint48	0x000000000000 to 0xFFFFFFFFFFFFFFF	R	-	O
...	...	...	...	...	...	...
0x09bf	<i>CurrentTier11Block16SummationReceived</i>	uint48	0x000000000000 to 0xFFFFFFFFFFFFFFF	R	-	O
0x09c0	<i>CurrentTier12Block1SummationReceived</i>	uint48	0x000000000000 to 0xFFFFFFFFFFFFFFF	R	-	O
...	...	...	...	...	...	...
0x09cf	<i>CurrentTier12Block16SummationReceived</i>	uint48	0x000000000000 to 0xFFFFFFFFFFFFFFF	R	-	O
0x09d0	<i>CurrentTier13Block1SummationReceived</i>	uint48	0x000000000000 to 0xFFFFFFFFFFFFFFF	R	-	O
...	...	...	...	...	...	...
0x09df	<i>CurrentTier13Block16SummationReceived</i>	uint48	0x000000000000 to 0xFFFFFFFFFFFFFFF	R	-	O
0x09e0	<i>CurrentTier14Block1SummationReceived</i>	uint48	0x000000000000 to 0xFFFFFFFFFFFFFFF	R	-	O
...	...	...	...	...	...	...
0x09ef	<i>CurrentTier14Block16SummationReceived</i>	uint48	0x000000000000 to 0xFFFFFFFFFFFFFFF	R	-	O
0x09f0	<i>CurrentTier15Block1SummationReceived</i>	uint48	0x000000000000 to 0xFFFFFFFFFFFFFFF	R	-	O
...	...	...	...	...	...	...
0x09ff	<i>CurrentTier15Block16SummationReceived</i>	uint48	0x000000000000 to 0xFFFFFFFFFFFFFFF	R	-	O

17181 **10.4.2.2.10.1 CurrentTierNBlockNSummationReceived Attributes**

17182 Attributes *CurrentNoTierBlock1SummationReceived* through *CurrentTier15Block16SummationReceived*  
 17183 represent the most recent summed value of Energy, Gas, or Water received from the premises (i.e. to the  
 17184 utility from the customer) at a specific price tier as defined by a TOU schedule, Block Threshold or a real  
 17185 time pricing period. If optionally provided, attributes *CurrentNoTierBlock1SummationReceived* through  
 17186 *CurrentTier15Block16SummationReceived* are updated continuously as new measurements are made.

17187 **Note:** SummationFormatting shall be used against the Block Information attribute set. The practical limit for  
 17188 the number of Block attributes supported is 32. The CurrentTierNBlockNSummationReceived attributes are  
 17189 reset at the start of each Block Threshold Period.

17190

17191 **10.4.2.2.11 Meter Billing Attribute Set**

17192 The billing information within this attribute set is created on the metering device. The information in this  
 17193 attribute set is intended for use by simple IHDs.

17194

**Table 10-90. Meter Billing Attribute Set**

<b>Id</b>	<b>Name</b>	<b>Type</b>	<b>Range</b>	<b>Acc</b>	<b>Def</b>	<b>M</b>
0x0a00	<i>BillToDateDelivered</i>	uint32	0x00000000 to 0xFFFFFFFF	R	0x00000000	O
0x0a01	<i>BillToDateTimeStampDelivered</i>	UTC		R	0	O
0x0a02	<i>ProjectedBillDelivered</i>	uint32	0x00000000 to 0xFFFFFFFF	R	0x00000000	O
0x0a03	<i>ProjectedBillTimeStampDelivered</i>	UTC		R	0	O
0x0a04	<i>BillDeliveredTrailingDigit</i>	map8		R		O
0x0a10	<i>BillToDateReceived</i>	uint32	0x00000000 to 0xFFFFFFFF	R	0x00000000	O
0x0a11	<i>BillToDateTimeStampReceived</i>	UTC		R	0	O
0x0a12	<i>ProjectedBillReceived</i>	uint32	0x00000000 to 0xFFFFFFFF	R	0x00000000	O
0x0a13	<i>ProjectedBillTimeStampReceived</i>	UTC		R	0	O
0x0a14	<i>BillReceivedTrailingDigit</i>	map8		R		O

17195 **10.4.2.2.11.1 BillToDateDelivered Attribute**

17196 BillToDateDelivered provides a value for the costs in the current billing period. This attribute is measured in  
 17197 a base unit of Currency with the decimal point located as indicated by the BillDeliveredTrailingDigit attrib-  
 17198 ute.

17199 **10.4.2.2.11.2 BillToDateTimeStampDelivered Attribute**

17200 The UTC timestamp when the associated BillToDateDelivered attribute was last updated.

17201 **10.4.2.2.11.3 ProjectedBillDelivered Attribute**

17202 ProjectedBillDelivered provides a value indicating what the estimated state of the account will be at the end  
 17203 of the billing period based on past consumption. This attribute is measured in a base unit of Currency with  
 17204 the decimal point located as indicated by the BillDeliveredTrailingDigit attribute.

17205 **10.4.2.2.11.4 ProjectedBillTimeStampDelivered Attribute**

17206 The UTC timestamp when the associated ProjectedBillDelivered attribute was last updated.

17207 **10.4.2.2.11.5 BillDeliveredTrailingDigit Attribute**

17208 An 8-bit BitMap used to determine where the decimal point is located in the BillToDateDelivered and Pro-  
17209 jectedBillDelivered attributes. The most significant nibble indicates the number of digits to the right of the  
17210 decimal point. The least significant nibble is reserved and shall be 0. The BillDeliveredTrailingDigit attribute  
17211 represents the current active value.

17212 **10.4.2.2.11.6 BillToDateReceived Attribute**

17213 BillToDateReceived provides a value for the costs in the current billing period. This attribute is measured in  
17214 a base unit of Currency with the decimal point located as indicated by the BillReceivedTrailingDigit attribute.

17215 **10.4.2.2.11.7 BillToDateTimeStampReceived Attribute**

17216 The UTC timestamp when the associated BillToDateReceived attribute was last updated.

17217 **10.4.2.2.11.8 ProjectedBillReceived Attribute**

17218 ProjectedBillReceived provides a value indicating what the estimated state of the account will be at the end  
17219 of the billing period based on past generation. This attribute is measured in a base unit of Currency with the  
17220 decimal point located as indicated by the BillReceivedTrailingDigit attribute.

17221 **10.4.2.2.11.9 ProjectedBillTimeStampReceived Attribute**

17222 The UTC timestamp when the associated ProjectedBillReceived attribute was last updated.

17223 **10.4.2.2.11.10 BillReceivedTrailingDigit Attribute**

17224 An 8-bit BitMap used to determine where the decimal point is located in the BillToDateReceived and Pro-  
17225 jectedBillReceived attributes. The most significant nibble indicates the number of digits to the right of the  
17226 decimal point. The least significant nibble is reserved and shall be 0. The BillReceivedTrailingDigit attribute  
17227 represents the current active value.

17228

17229 **10.4.2.2.12 Supply Control Attribute Set**

17230 **Table 10-91. Supply Control Attribute Set**

<b>Id</b>	<b>Name</b>	<b>Type</b>	<b>Range</b>	<b>Acc</b>	<b>Def</b>	<b>M</b>
0x0b00	<i>ProposedChangeSupply ImplementationTime</i>	UTC		R	-	O
0x0b01	<i>ProposedChange SupplyStatus</i>	enum8	0x00 to 0xFF	R	-	O
0x0b10	<i>Uncontrolled Flow Threshold</i>	uint16		R	-	O
0x0b11	<i>Uncontrolled Flow Threshold Unit of Measure</i>	enum8		R	-	O
0x0b12	<i>Uncontrolled Flow Multiplier</i>	uint16		R	0x0001	O

<b>Id</b>	<b>Name</b>	<b>Type</b>	<b>Range</b>	<b>Acc</b>	<b>Def</b>	<b>M</b>
0x0b13	<i>Uncontrolled Flow Divisor</i>	uint16		R	0x0001	O
0x0b14	<i>Flow Stabilisation Period</i>	uint8		R	-	O
0x0b15	<i>Flow Measurement Period</i>	uint16		R	-	O

17231

17232 **10.4.2.2.12.1 ProposedChangeSupplyImplementationTime Attribute**

17233 The ProposedChangeImplementationTime attribute indicates the time at which a proposed change to the  
 17234 supply is to be implemented. If there is no change of supply pending, this attribute will be set to 0xFFFFFFFF.

17235 **10.4.2.2.12.2 ProposedChangeSupplyStatus Attribute**

17236 The ProposedChangeSupplyStatus indicates the proposed status of the supply once the change to the supply  
 17237 has been implemented. The enumerated values of this field are outlined in Table 10-102.

17238 **10.4.2.2.12.3 Uncontrolled Flow Threshold Attribute**

17239 The Uncontrolled Flow Threshold attribute indicates the threshold above which a flow meter (e.g. Gas or  
 17240 Water) shall detect an uncontrolled flow. A value of 0x0000 indicates the feature is unused.

17241 **10.4.2.2.12.4 Uncontrolled Flow Threshold Unit of Measure Attribute**

17242 The Uncontrolled Flow Threshold Unit of Measure attribute indicates the unit of measure used in conjunction  
 17243 with the Uncontrolled Flow Threshold attribute. The enumeration used for this field shall match one of the  
 17244 UnitOfMeasure values using a pure binary format as defined in this cluster (see sub-clause 10.4.2.2.4.1).

17245 **10.4.2.2.12.5 Uncontrolled Flow Multiplier Attribute**

17246 The Uncontrolled Flow Multiplier attribute indicates the multiplier, to be used in conjunction with the Un-  
 17247 controlled Flow Threshold and Uncontrolled Flow Divisor attributes, to determine the true flow threshold  
 17248 value. A value of 0x0000 is not allowed.

17249 **10.4.2.2.12.6 Uncontrolled Flow Divisor Attribute**

17250 The Uncontrolled Flow Divisor attribute indicates the divisor, to be used in conjunction with the Uncontrolled  
 17251 Flow Threshold and Uncontrolled Flow Multiplier attributes, to determine the true flow threshold value. A  
 17252 value of 0x0000 is not allowed.

17253 **10.4.2.2.12.7 Flow Stabilisation Period Attribute**

17254 The Flow Stabilisation Period attribute indicates the time given to allow the flow to stabilize. It is defined in  
 17255 units of tenths of a second.

17256 **10.4.2.2.12.8 Flow Measurement Period Attribute**

17257 The Flow Measurement Period attribute indicates the period over which the flow is measured and compared  
 17258 against the Uncontrolled Flow Threshold attribute. It is defined in units of 1 second.

17259

17260

### 10.4.2.2.13 Alternative Historical Consumption Attribute Set

17261  
17262  
17263  
17264  
17265

The Alternative Historical Attribute Set allows historical information to be presented in a base defined by the AlternativeUnitofMeasure (see 10.4.2.2.4.19) and in a format defined by the AlternativeDemandFormatting and AlternativeConsumptionFormatting attributes (see 10.4.2.2.4.20 and 10.4.2.2.4.21 respectively). The attributes within this set are defined in Table 10-92.

**Table 10-92. Alternative Historical Consumption Attribute Set**

<b>Id</b>	<b>Name</b>	<b>Type</b>	<b>Range</b>	<b>Acc</b>	<b>Def</b>	<b>M</b>
0x0c00	<i>AlternativeInstantaneousDemand</i>	int24	-8,388,607 to 8,388,607	R	0	O
0x0c01	<i>CurrentDayAlternativeConsumptionDelivered</i>	uint24	0x000000 to 0xFFFFFFFF	R	-	O
0x0c02	<i>CurrentDayAlternative ConsumptionReceived</i>	uint24	0x000000 to 0xFFFFFFFF	R	-	O
0x0c03	<i>PreviousDayAlternativeConsumptionDelivered</i>	uint24	0x000000 to 0xFFFFFFFF	R	-	O
0x0c04	<i>PreviousDayAlternativeConsumptionReceived</i>	uint24	0x000000 to 0xFFFFFFFF	R	-	O
0x0c05	<i>CurrentAlternativePartialProfileInterval StartTimeDelivered</i>	UTC		R	-	O
0x0c06	<i>CurrentAlternativePartialProfileInterval StartTimeReceived</i>	UTC		R	-	O
0x0c07	<i>CurrentAlternativePartialProfileInterval ValueDelivered</i>	uint24	0x000000 to 0xFFFFFFFF	R	-	O
0x0c08	<i>CurrentAlternativePartialProfileInterval ValueReceived</i>	uint24	0x000000 to 0xFFFFFFFF	R	-	O
0x0c09	<i>CurrentDayAlternativeMaxPressure</i>	uint48	0x000000 000000 to 0xFFFFFFFF FFFFFFFF	R	-	O
0x0c0a	<i>CurrentDayAlternativeMinPressure</i>	uint48	0x000000 000000 to 0xFFFFFFFF FFFFFFFF	R	-	O
0x0c0b	<i>PreviousDayAlternativeMaxPressure</i>	uint48	0x000000 000000 to 0xFFFFFFFF FFFFFFFF	R	-	O
0x0c0c	<i>PreviousDayAlternativeMinPressure</i>	uint48	0x000000 000000 to 0xFFFFFFFF FFFFFFFF	R	-	O
0x0c0d	<i>CurrentDayAlternativeMaxDemand</i>	int24	-8,388,607 to 8,388,607	R	-	O
0x0c0e	<i>PreviousDayAlternativeMaxDemand</i>	int24	-8,388,607 to 8,388,607	R	-	O
0x0c0f	<i>CurrentMonthAlternativeMaxDemand</i>	int24	-8,388,607 to 8,388,607	R	-	O
0x0c10	<i>CurrentYearAlternativeMaxDemand</i>	int24	-8,388,607 to 8,388,607	R	-	O

<b>Id</b>	<b>Name</b>	<b>Type</b>	<b>Range</b>	<b>Acc</b>	<b>Def</b>	<b>M</b>
0x0c20	<i>PreviousDay2AlternativeConsumption Delivered</i>	uint24	0x000000 to 0xFFFFFFFF	R	-	O
0x0c21	<i>PreviousDay2AlternativeConsumption Received</i>	uint24	0x000000 to 0xFFFFFFFF	R	-	O
0x0c22	<i>PreviousDay3AlternativeConsumption Delivered</i>	uint24	0x000000 to 0xFFFFFFFF	R	-	O
0x0c23	<i>PreviousDay3AlternativeConsumption Received</i>	uint24	0x000000 to 0xFFFFFFFF	R	-	O
0x0c24	<i>PreviousDay4AlternativeConsumption Delivered</i>	uint24	0x000000 to 0xFFFFFFFF	R	-	O
0x0c25	<i>PreviousDay4AlternativeConsumption Received</i>	uint24	0x000000 to 0xFFFFFFFF	R	-	O
0x0c26	<i>PreviousDay5AlternativeConsumption Delivered</i>	uint24	0x000000 to 0xFFFFFFFF	R	-	O
0x0c27	<i>PreviousDay5AlternativeConsumption Received</i>	uint24	0x000000 to 0xFFFFFFFF	R	-	O
0x0c28	<i>PreviousDay6AlternativeConsumption Delivered</i>	uint24	0x000000 to 0xFFFFFFFF	R	-	O
0x0c29	<i>PreviousDay6AlternativeConsumption Received</i>	uint24	0x000000 to 0xFFFFFFFF	R	-	O
0x0c2a	<i>PreviousDay7AlternativeConsumption Delivered</i>	uint24	0x000000 to 0xFFFFFFFF	R	-	O
0x0c2b	<i>PreviousDay7AlternativeConsumption Received</i>	uint24	0x000000 to 0xFFFFFFFF	R	-	O
0x0c2c	<i>PreviousDay8AlternativeConsumption Delivered</i>	uint24	0x000000 to 0xFFFFFFFF	R	-	O
0x0c2d	<i>PreviousDay8AlternativeConsumption Received</i>	uint24	0x000000 to 0xFFFFFFFF	R	-	O
0x0c30	<i>CurrentWeekAlternativeConsumption Delivered</i>	uint24	0x000000 to 0xFFFFFFFF	R	-	O
0x0c31	<i>CurrentWeekAlternativeConsumption Received</i>	uint24	0x000000 to 0xFFFFFFFF	R	-	O
0x0c32	<i>PreviousWeekAlternativeConsumption Delivered</i>	uint24	0x000000 to 0xFFFFFFFF	R	-	O
0x0c33	<i>PreviousWeekAlternativeConsumption Received</i>	uint24	0x000000 to 0xFFFFFFFF	R	-	O
0x0c34	<i>PreviousWeek2AlternativeConsumption Delivered</i>	uint24	0x000000 to 0xFFFFFFFF	R	-	O

<b>Id</b>	<b>Name</b>	<b>Type</b>	<b>Range</b>	<b>Acc</b>	<b>Def</b>	<b>M</b>
0x0c35	<i>PreviousWeek2AlternativeConsumption Received</i>	uint24	0x000000 to 0xFFFFFFFF	R	-	O
0x0c36	<i>PreviousWeek3AlternativeConsumption Delivered</i>	uint24	0x000000 to 0xFFFFFFFF	R	-	O
0x0c37	<i>PreviousWeek3AlternativeConsumption Received</i>	uint24	0x000000 to 0xFFFFFFFF	R	-	O
0x0c38	<i>PreviousWeek4AlternativeConsumption Delivered</i>	uint24	0x000000 to 0xFFFFFFFF	R	-	O
0x0c39	<i>PreviousWeek4AlternativeConsumption Received</i>	uint24	0x000000 to 0xFFFFFFFF	R	-	O
0x0c3a	<i>PreviousWeek5AlternativeConsumption Delivered</i>	uint24	0x000000 to 0xFFFFFFFF	R	-	O
0x0c3b	<i>PreviousWeek5AlternativeConsumption Received</i>	uint24	0x000000 to 0xFFFFFFFF	R	-	O
0x0c40	<i>CurrentMonthAlternativeConsumption Delivered</i>	uint32	0x00000000 to 0xFFFFFFFF	R	-	O
0x0c41	<i>CurrentMonthAlternativeConsumption Received</i>	uint32	0x00000000 to 0xFFFFFFFF	R	-	O
0x0c42	<i>PreviousMonthAlternativeConsumption Delivered</i>	uint32	0x00000000 to 0xFFFFFFFF	R	-	O
0x0c43	<i>PreviousMonthAlternativeConsumption Received</i>	uint32	0x00000000 to 0xFFFFFFFF	R	-	O
0x0c44	<i>PreviousMonth2AlternativeConsumption Delivered</i>	uint32	0x00000000 to 0xFFFFFFFF	R	-	O
0x0c45	<i>PreviousMonth2AlternativeConsumption Received</i>	uint32	0x00000000 to 0xFFFFFFFF	R	-	O
0x0c46	<i>PreviousMonth3AlternativeConsumption Delivered</i>	uint32	0x00000000 to 0xFFFFFFFF	R	-	O
0x0c47	<i>PreviousMonth3AlternativeConsumption Received</i>	uint32	0x00000000 to 0xFFFFFFFF	R	-	O
0x0c48	<i>PreviousMonth4AlternativeConsumption Delivered</i>	uint32	0x00000000 to 0xFFFFFFFF	R	-	O
0x0c49	<i>PreviousMonth4AlternativeConsumption Received</i>	uint32	0x00000000 to 0xFFFFFFFF	R	-	O
0x0c4a	<i>PreviousMonth5AlternativeConsumption Delivered</i>	uint32	0x00000000 to 0xFFFFFFFF	R	-	O
0x0c4b	<i>PreviousMonth5AlternativeConsumption Received</i>	uint32	0x00000000 to 0xFFFFFFFF	R	-	O



<b>Id</b>	<b>Name</b>	<b>Type</b>	<b>Range</b>	<b>Acc</b>	<b>Def</b>	<b>M</b>
0x0c4c	<i>PreviousMonth6AlternativeConsumption Delivered</i>	uint32	0x00000000 to 0xFFFFFFFF	R	-	O
0x0c4d	<i>PreviousMonth6AlternativeConsumption Received</i>	uint32	0x00000000 to 0xFFFFFFFF	R	-	O
0x0c4e	<i>PreviousMonth7AlternativeConsumption Delivered</i>	uint32	0x00000000 to 0xFFFFFFFF	R	-	O
0x0c4f	<i>PreviousMonth7AlternativeConsumption Received</i>	uint32	0x00000000 to 0xFFFFFFFF	R	-	O
0x0c50	<i>PreviousMonth8 AlternativeConsumption Delivered</i>	uint32	0x00000000 to 0xFFFFFFFF	R	-	O
0x0c51	<i>PreviousMonth8AlternativeConsumption Received</i>	uint32	0x00000000 to 0xFFFFFFFF	R	-	O
0x0c52	<i>PreviousMonth9AlternativeConsumption Delivered</i>	uint32	0x00000000 to 0xFFFFFFFF	R	-	O
0x0c53	<i>PreviousMonth9AlternativeConsumption Received</i>	uint32	0x00000000 to 0xFFFFFFFF	R	-	O
0x0c54	<i>PreviousMonth10AlternativeConsumption Delivered</i>	uint32	0x00000000 to 0xFFFFFFFF	R	-	O
0x0c55	<i>PreviousMonth10AlternativeConsumption Received</i>	uint32	0x00000000 to 0xFFFFFFFF	R	-	O
0x0c56	<i>PreviousMonth11AlternativeConsumption Delivered</i>	uint32	0x00000000 to 0xFFFFFFFF	R	-	O
0x0c57	<i>PreviousMonth11AlternativeConsumption Received</i>	uint32	0x00000000 to 0xFFFFFFFF	R	-	O
0x0c58	<i>PreviousMonth12AlternativeConsumption Delivered</i>	uint32	0x00000000 to 0xFFFFFFFF	R	-	O
0x0c59	<i>PreviousMonth12AlternativeConsumption Received</i>	uint32	0x00000000 to 0xFFFFFFFF	R	-	O
0x0c5a	<i>PreviousMonth13AlternativeConsumption Delivered</i>	uint32	0x00000000 to 0xFFFFFFFF	R	-	O
0x0c5b	<i>PreviousMonth13AlternativeConsumption Received</i>	uint32	0x00000000 to 0xFFFFFFFF	R	-	O

17266

17267

#### **10.4.2.2.13.1 AlternativeInstantaneousDemand Attribute**

17268

17269

17270

17271

17272

AlternativeInstantaneousDemand represents the current Demand delivered or received at the premises. Positive values indicate demand delivered to the premises where negative values indicate demand received from the premises. AlternativeInstantaneousDemand is updated continuously as new measurements are made. The frequency of updates to this field is specific to the metering device, but should be within the range of once every second to once every 5 seconds.

- 17273 **10.4.2.2.13.2 CurrentDayAlternativeConsumptionDelivered Attribute**
- 17274 CurrentDayAlternativeConsumptionDelivered represents the summed value delivered to the premises since  
17275 the Historical Freeze Time (HFT). If optionally provided, CurrentDayAlternativeConsumptionDelivered is  
17276 updated continuously as new measurements are made. If the optional HFT attribute is not available, default  
17277 to midnight local time.
- 17278 **10.4.2.2.13.3 CurrentDayAlternativeConsumptionReceived Attribute**
- 17279 CurrentDayAlternativeConsumptionReceived represents the summed value received from the premises  
17280 since the Historical Freeze Time (HFT). If optionally provided, CurrentDayAlternativeConsumptionRe-  
17281 ceived is updated continuously as new measurements are made. If the optional HFT attribute is not available,  
17282 default to midnight local time.
- 17283 **10.4.2.2.13.4 PreviousDayAlternativeConsumptionDelivered Attribute**
- 17284 PreviousDayAlternativeConsumptionDelivered represents the summed value delivered to the premises  
17285 within the previous 24 hour period starting at the lternative Historical Freeze Time (HFT). If optionally  
17286 provided, PreviousDayAlternativeConsumptionDelivered is updated every HFT. If the optional HFT attribute  
17287 is not available, default to midnight local time.
- 17288 **10.4.2.2.13.5 PreviousDayAlternativeConsumptionReceived Attribute**
- 17289 PreviousDayAlternativeConsumptionReceived represents the summed value received from the premises  
17290 within the previous 24 hour period starting at the Historical Freeze Time (HFT). If optionally provided,  
17291 PreviousDayAlternativeConsumptionReceived is updated every HFT. If the optional HFT attribute is not  
17292 available, default to midnight local time.
- 17293 **10.4.2.2.13.6 CurrentAlternativePartialProfileIntervalStartTimeDelivered Attribute**
- 17294
- 17295 CurrentAlternativePartialProfileIntervalStartTimeDelivered represents the start time of the current Load  
17296 Profile interval being accumulated for commodity delivered.
- 17297 **10.4.2.2.13.7 CurrentAlternativePartialProfileIntervalStartTimeReceived At-tribute**
- 17298
- 17299 CurrentAlternativePartialProfileIntervalStartTimeReceived represents the start time of the current Load  
17300 Profile interval being accumulated for commodity received.
- 17301 **10.4.2.2.13.8 CurrentAlternativePartialProfileIntervalValueDelivered At-tribute**
- 17302
- 17303 CurrentAlternativePartialProfileIntervalValueDelivered represents the value of the current Load Profile  
17304 interval being accumulated for commodity delivered.
- 17305 **10.4.2.2.13.9 CurrentAlternativePartialProfileIntervalValueReceived At-tribute**
- 17306
- 17307 CurrentAlternativePartialProfileIntervalValueReceived represents the value of the current Load Profile  
17308 interval being accumulated for commodity received.
- 17309 **10.4.2.2.13.10 CurrentDayAlternativeMaxPressure Attribute**
- 17310 CurrentDayAlternativeMaxPressure is the maximum pressure reported during a day from the water or gas  
17311 meter.
- 17312 **10.4.2.2.13.11 PreviousDayAlternativeMaxPressure Attribute**

17313 PreviousDayAlternativeMaxPressure represents the maximum pressure reported during previous day from  
17314 the water or gas meter.

17315 **10.4.2.2.13.12 CurrentDayAlternativeMinPressure Attribute**

17316 CurrentDayAlternativeMinPressure is the minimum pressure reported during a day from the water or gas  
17317 meter.

17318 **10.4.2.2.13.13 PreviousDayAlternativeMinPressure Attribute**

17319 PreviousDayAlternativeMinPressure represents the minimum pressure reported during previous day from the  
17320 water or gas meter.

17321 **10.4.2.2.13.14 CurrentDayAlternativeMaxDemand Attribute**

17322 CurrentDayAlternativeMaxDemand represents the maximum demand or rate of delivered value of Energy,  
17323 Gas, or Water being utilized at the premises.

17324 **10.4.2.2.13.15 PreviousDayAlternativeMaxDemand Attribute**

17325 *PreviousDayAlternativeMaxDemand* represents the maximum demand or rate of delivered value of En-  
17326 ergy, Gas, or Water being utilized at the premises.

17327 **Note:** At the end of a day the metering device will transfer the CurrentDayAlternativeMaxPressure into Pre-  
17328 viousDayAlternativeMaxPressure, CurrentDayAlternativeMinPressure into PreviousDayAlternativeMin-  
17329 Pressure and CurrentDayAlternativeMaxDemand into PreviousDayAlternativeMaxDemand.

17330 **10.4.2.2.13.16 CurrentMonthAlternativeMaxDemand Attribute**

17331 *CurrentMonthAlternativeMaxDemand* is the maximum demand reported during a month from the me-  
17332 ter.

17333 For electricity, heat and cooling meters this is the maximum power reported in a month.

17334 **10.4.2.2.13.17 CurrentYearAlternativeMaxDemand Attribute**

17335 *CurrentYearAlternativeMaxDemand* is the maximum demand reported during a year from the meter.

17336 For electricity, heat and cooling meters this is the maximum power reported in a year.

17337 **10.4.2.2.13.18 PreviousDayNAlternativeConsumptionDelivered Attribute**

17338 *PreviousDayNAlternativeConsumptionDelivered* represents the summed value delivered to the premises  
17339 within the previous 24 hour period starting at the *Historical Freeze Time* (HFT). If the optional HFT attrib-  
17340 ute is not available, default to midnight local time.

17341 **10.4.2.2.13.19 PreviousDayNAlternativeConsumptionReceived Attribute**

17342 *PreviousDayNAlternativeConsumptionReceived* represents the summed value received from the premises  
17343 within the previous 24 hour period starting at the *Historical Freeze Time* (HFT). If the optional HFT attrib-  
17344 ute is not available, default to midnight local time.

17345 **10.4.2.2.13.20 CurrentWeekAlternativeConsumptionDelivered Attribute**

17346 *CurrentWeekAlternativeConsumptionDelivered* represents the summed value delivered to the premises  
17347 since the *Historical Freeze Time* (HFT) on Monday to the last HFT read. If optionally provided, *Cur-*  
17348 *rentWeekAlternativeConsumptionDelivered* is updated continuously as new measurements are made. If the  
17349 optional HFT attribute is not available, default to midnight local time.

17350 **10.4.2.2.13.21 CurrentWeekAlternativeConsumptionReceived Attribute**

17351 *CurrentWeekAlternativeConsumptionReceived* represents the summed value received from the premises  
 17352 since the *Historical Freeze Time* (HFT) on Monday to the last HFT read. If optionally provided, *Cur-*  
 17353 *rentWeekAlternativeConsumptionReceived* is updated continuously as new measurements are made. If the  
 17354 optional HFT attribute is not available, default to midnight local time.

17355 **10.4.2.2.13.22 PreviousWeekNAAlternativeConsumptionDelivered Attribute**

17356 *PreviousWeekNAAlternativeConsumptionDelivered* represents the summed value delivered to the premises  
 17357 within the previous week period starting at the *Historical Freeze Time* (HFT) on the Monday to the Sun-  
 17358 day. If the optional HFT attribute is not available, default to midnight local time.

17359 **10.4.2.2.13.23 PreviousWeekNAAlternativeConsumptionReceived Attribute**

17360 *PreviousWeekNAAlternativeConsumptionReceived* represents the summed value received from the premises  
 17361 within the previous week period starting at the *Historical Freeze Time* (HFT) on the Monday to the Sun-  
 17362 day. If the optional HFT attribute is not available, default to midnight local time.

17363 **10.4.2.2.13.24 CurrentMonthAlternativeConsumptionDelivered Attribute**

17364 *CurrentMonthAlternativeConsumptionDelivered* represents the summed value delivered to the premises  
 17365 since the *Historical Freeze Time* (HFT) on the 1<sup>st</sup> of the month to the last HFT read. If optionally provided,  
 17366 *CurrentMonthAlternativeConsumptionDelivered* is updated continuously as new measurements are made.  
 17367 If the optional HFT attribute is not available, default to midnight local time.

17368 **10.4.2.2.13.25 CurrentMonthAlternativeConsumptionReceived Attribute**

17369 *CurrentMonthAlternativeConsumptionReceived* represents the summed value received from the premises  
 17370 since the *Historical Freeze Time* (HFT) on the 1<sup>st</sup> of the month to the last HFT read. If optionally provided,  
 17371 *CurrentMonthAlternativeConsumptionReceived* is updated continuously as new measurements are made. If  
 17372 the optional HFT attribute is not available, default to midnight local time.

17373 **10.4.2.2.13.26 PreviousMonthNAAlternativeConsumptionDelivered Attribute**

17374  
 17375 *PreviousMonthNAAlternativeConsumptionDelivered* represents the summed value delivered to the premises  
 17376 within the previous Month period starting at the *Historical Freeze Time* (HFT) on the 1<sup>st</sup> of the month to  
 17377 the last day of the month. If the optional HFT attribute is not available, default to midnight local time.

17378 **10.4.2.2.13.27 PreviousMonthNAAlternativeConsumptionReceived Attribute**

17379 *PreviousMonthNAAlternativeConsumptionReceived* represents the summed value received from the premises  
 17380 within the previous month period starting at the *Historical Freeze Time* (HFT) on the 1<sup>st</sup> of the month to the  
 17381 last day of the month. If the optional HFT attribute is not available, default to midnight local time.

17382

17383 **10.4.2.3 Server Commands**

17384 **10.4.2.3.1 Commands Generated**

17385 The command IDs generated by the Metering server cluster are listed in Table 10-93.

17386 **Table 10-93. Generated Command IDs for the Metering Server**

Id	Name	M
0x00	<i>Get Profile Response</i>	O
0x01	<i>Request Mirror</i>	O

<b>Id</b>	<b>Name</b>	<b>M</b>
0x02	<i>Remove Mirror</i>	O
0x03	<i>Request Fast Poll Mode Response</i>	O
0x04	<i>ScheduleSnapshot Response</i>	O
0x05	<i>TakeSnapshotResponse</i>	O
0x06	<i>Publish Snapshot</i>	O
0x07	<i>GetSampledData Response</i>	O
0x08	<i>ConfigureMirror</i>	O
0x09	<i>ConfigureNotification Scheme</i>	O
0x0A	<i>ConfigureNotification Flag</i>	O
0x0B	<i>GetNotifiedMessage</i>	O
0x0C	<i>Supply Status Response</i>	O
0x0D	<i>StartSamplingResponse</i>	O

17387 **10.4.2.3.1.1 Get Profile Response Command**

17388 **10.4.2.3.1.1.1 Payload Format**

17389 The Get Profile Response command payload shall be formatted as illustrated in Figure 10-55.

17390 **Figure 10-55. Format of the Get Profile Response Command Payload**

<b>Octets</b>	<b>4</b>	<b>1</b>	<b>1</b>	<b>1</b>	<b>Variable</b>
Data Type	UTC	enum8	enum8	uint8	Series of uint24s
Field Name	EndTime	Status	ProfileInter- valPeriod	NumberOfPeri- odsDelivered	Intervals

17391 **10.4.2.3.1.1.2 Payload Details**

17392 **EndTime:** 32-bit value (in UTC) representing the end time of the most chronologically recent interval being  
 17393 requested. Example: Data collected from 2:00 PM to 3:00 PM would be specified as a 3:00 PM interval  
 17394 (end time). It is important to note that the current interval accumulating is not included in most recent  
 17395 block but can be retrieved using the CurrentPartialProfileIntervalValue attribute.

17396 **Status:** Table 10-94 lists the valid values returned in the Status field.

17397 **Table 10-94. Status Field Values**

<b>Value</b>	<b>Description</b>
0x00	Success
0x01	Undefined Interval Channel requested

Value	Description
0x02	Interval Channel not supported
0x03	Invalid End Time
0x04	More periods requested than can be returned
0x05	No intervals available for the requested time

17398

17399 **ProfileIntervalPeriod:** Represents the interval or time frame used to capture metered Energy, Gas, and  
 17400 Water consumption for profiling purposes. ProfileIntervalPeriod is an enumerated field representing the  
 17401 timeframes listed in Table 10-95.

17402

**Table 10-95. ProfileIntervalPeriod Timeframes**

Enumerated Value	Timeframe
0	Daily
1	60 minutes
2	30 minutes
3	15 minutes
4	10 minutes
5	7.5 minutes
6	5 minutes
7	2.5 minutes
8	1 minute

17403

17404 **NumberOfPeriodsDelivered:** Represents the number of intervals the device is returning. Please note the  
 17405 number of periods returned in the Get Profile Response command can be calculated when the packets are  
 17406 received and can replace the usage of this field. The intent is to provide this information as a convenience.

17407 **Intervals:** Series of interval data captured using the period specified by the ProfileIntervalPeriod field. The  
 17408 content of the interval data depends of the type of information requested using the Channel field in the Get  
 17409 Profile Command, and will represent the change in that information since the previous interval. Data is orga-  
 17410 nized in a reverse chronological order, the most recent interval is transmitted first and the oldest interval is  
 17411 transmitted last. Invalid intervals should be marked as 0xFFFFFFFF.

17412 **10.4.2.3.1.1.3 When Generated**

17413 This command is generated when the Client command GetProfile is received. Please refer to sub-clause  
 17414 10.4.3.3.1.1.

17415 **10.4.2.3.1.2 Request Mirror Command**

17416 This command is used to request the ESI to mirror Metering Device data.

17417 **10.4.2.3.1.2.1 Payload Details**

17418 There are no fields for this command.

17419 **10.4.2.3.1.2.2 Effect on Receipt**

17420 On receipt of this command, the Client<sup>195</sup> shall send a RequestMirrorReponse command (see sub-clause  
 17421 10.4.3.3.1.2).

17422 **10.4.2.3.1.3 Remove Mirror Command**

17423 This command is used to request the ESI to remove its mirror of Metering Device data. The device  
 17424 sending the Remove Mirror command to the ESI shall send the command to the mirror endpoint to be  
 17425 removed. Only the device that created the mirror on the ESI or the ESI itself should be allowed to remove  
 17426 the mirror from the ESI.

17427 **10.4.2.3.1.3.1 Payload Details**

17428 There are no fields for this command.

17429 **10.4.2.3.1.3.2 Effect on Receipt**

17430 On receipt of this command, the Client<sup>196</sup> shall send a MirrorRemoved command (see sub-clause  
 17431 10.4.3.3.1.3).

17432 **10.4.2.3.1.4 Request Fast Poll Mode Response Command**

17433 **10.4.2.3.1.4.1 Payload Format**

17434 The Request Fast Poll Mode Response command payload shall be formatted as illustrated in Figure 10-56.

17435 **Figure 10-56. Format of the Request Fast Poll Mode Response Command Payload**

<b>Octets</b>	1	4
<b>Data Type</b>	uint8	UTC
<b>Field Name</b>	Applied Update Period (seconds) (M)	Fast Poll Mode End Time (M)

17436 **10.4.2.3.1.4.2 Payload Details**

17437 **Applied Update Period:** The period at which metering data shall be updated. This may be different than  
 17438 the requested fast poll. If the Request Fast Poll Rate is less than Fast Poll Update Period Attribute, it shall  
 17439 use the Fast Poll Update Period Attribute. Otherwise, the Applied Update Period shall be greater than or  
 17440 equal to the minimum Fast Poll Update Period Attribute and less than or equal to the Requested Fast Poll  
 17441 Rate.

17442 **Fast Poll Mode End Time:** UTC time that indicates when the metering server will terminate fast poll  
 17443 mode and resume updating at the rate specified by DefaultUpdatePeriod. For example, one or more metering  
 17444 clients may request fast poll mode while the metering server is already in fast poll mode. The intent is that the  
 17445 fast poll mode will not be extended since this scenario would make it possible to be in fast poll mode longer  
 17446 than 15 minutes.

17447 **10.4.2.3.1.4.3 When Generated**

17448 This command is generated when the client command Request Fast Poll Mode is received.

17449 **10.4.2.3.1.4.4 Effect on Receipt**

17450 On receipt of this command, the device may request or receive updates not to exceed the Applied Update  
 17451 Period until Fast Poll Mode End Time.

<sup>195</sup> CCB 2199

<sup>196</sup> CCB 2199

17452 **10.4.2.3.1.5 ScheduleSnapshotResponse Command**

17453 This command is generated in response to a ScheduleSnapshot command, and is sent to confirm whether the  
17454 requested snapshot schedule has been set up. See section 10.4.4.5 for further details.

17455 **10.4.2.3.1.5.1 Payload Format**

17456 **Figure 10-57. Format of the ScheduleSnapshotResponse Command Payload**

<b>Octets</b>	<b>4</b>	<b>Variable</b>
<b>Data Type</b>	uint32	
<b>Field Name</b>	Issuer Event ID (M)	Snapshot Response Payload (M)

17457 **10.4.2.3.1.5.2 Payload Details**

17458 **Issuer Event ID (mandatory):** Unique identifier generated by the commodity provider. The value contained  
17459 in this field indicates the value allocated to the ScheduleSnapshot command for which this response is gen-  
17460 erated.

17461 **10.4.2.3.1.5.3 Snapshot Response Payload**

17462 The ScheduleSnapshotResponse payload may contain several instances of the sub-payload defined in Figure  
17463 10-58. Each instance is an acknowledgment from the device for a scheduled snapshot and the ability for the  
17464 device to support that type of snapshot.

17465 **Figure 10-58. Format of the Snapshot Response Payload Sub-Payload**

<b>Octets</b>	<b>1</b>	<b>1</b>
<b>Data Type</b>	uint8	uint8
<b>Field Name</b>	Snapshot Schedule ID (M)	Snapshot Schedule Confirmation (M)

17466  
17467 **Snapshot Schedule ID (mandatory):** The unique ID of the Snapshot schedule; a range of 1-254 is supported  
17468 (see 10.4.3.3.1.5.2 for further details).

17469 **Snapshot Schedule Confirmation (mandatory):** This provides confirmation for the Snapshot schedule;  
17470 enumerations are defined in Table 10-96.

17471 **Table 10-96. Snapshot Schedule Confirmation**

<b>Enumeration</b>	<b>Description</b>
0x00	Accepted
0x01	Snapshot Type not supported
0x02	Snapshot Cause not supported
0x03	Snapshot Schedule Not Currently Available
0x04	Snapshot Schedules not supported by device
0x05	Insufficient space for snapshot schedule

17472  
17473 **10.4.2.3.1.6 TakeSnapshotResponse Command**

17474 This command is generated in response to a TakeSnapshot command, and is sent to confirm whether the  
17475 requested snapshot has been accepted and successfully taken. See section 10.4.4.5 for further details.



17476 **10.4.2.3.1.6.1**

**Payload Format**

17477

**Figure 10-59. Format of the *TakeSnapshotResponse* Command Payload**

<b>Octets</b>	<b>4</b>	<b>1</b>
<b>Data Type</b>	uint32	uint8
<b>Field Name</b>	Snapshot ID (M)	Snapshot Confirmation (M)

17478 **10.4.2.3.1.6.2**

**Payload Details**

17479 **Snapshot ID (mandatory):** Unique identifier allocated by the device creating the snapshot. The value con-  
 17480 tained in this field indicates the TakeSnapshot command for which this response is generated.

17481 **Snapshot Confirmation (mandatory):** This is the acknowledgment from the device that it can support this  
 17482 required type of snapshot. The enumerations are defined in Table 10-97.

17483

**Table 10-97. Snapshot Confirmation**

Enumeration	Description
0x00	Accepted
0x01	Snapshot Cause not supported

17484

17485 **10.4.2.3.1.7**

**Publish Snapshot Command**

17486 This command is generated in response to a GetSnapshot command or when a new snapshot is created. It is  
 17487 used to return a single snapshot to the client. See section 10.4.4.5 for further details.

17488 **10.4.2.3.1.7.1**

**Payload Format**

17489

**Figure 10-60. Format of the *Publish Snapshot* Command Payload**

<b>Oc-tets</b>	<b>4</b>	<b>4</b>	<b>1</b>	<b>1</b>	<b>1</b>	<b>4</b>	<b>1</b>	<b>Variable</b>
<b>Data Type</b>	uint32	UTC	uint8	uint8	uint8	map32	enum8	Snapshot type depend-ent
<b>Field Name</b>	Snap-shot ID (M)	Snap-shot Time (M)	Total Snap-shots Found (M)	Com-mand In-dex (M)	Total Number of Com-mands (M)	Snap-shot Cause (M)	Snap-shot Payload Type (M)	Snapshot Sub-Payload (M)

17490

17491 **10.4.2.3.1.7.2**

**Payload Details**

17492 **Snapshot ID (mandatory):** Unique identifier allocated by the device creating the snapshot.

17493 **Snapshot Time (mandatory):** This is a 32 bit value (in UTC Time) representing the time at which the data  
 17494 snapshot was taken.

17495 **Total Snapshots Found (mandatory):** An 8-bit Integer indicating the number of snapshots found, based on  
 17496 the search criteria defined in the associated GetSnapshot command. If the value is greater than 1, the client  
 17497 is able to request the next snapshot by incrementing the Snapshot Offset field in an otherwise repeated  
 17498 GetSnapshot command.

17499 **Command Index (mandatory):** The CommandIndex is used to count the payload fragments in the case  
 17500 where the entire payload (snapshot) does not fit into one message. The CommandIndex starts at 0 and is  
 17501 incremented for each fragment belonging to the same command.

17502 **Total Number of Commands (mandatory):** In the case where the entire payload (snapshot) does not fit  
 17503 into one message, the Total Number of Commands field indicates the total number of sub-commands that  
 17504 will be returned.

17505 **Snapshot Cause (mandatory):** A 32-bit BitMap indicating the cause of the snapshot. The snapshot cause  
 17506 values are listed in Table 10-98.

17507

**Table 10-98. Snapshot Cause BitMap**

Bit	Cause Description
0	General
1	End of Billing Period
2	End of Block Period
3	Change of Tariff Information
4	Change of Price Matrix
5	Change of Block Thresholds
6	Change of CV
7	Change of CF
8	Change of Calendar
9	Critical Peak Pricing
10	Manually Triggered from Client
11	End of Resolve Period
12	Change of Tenancy
13	Change of Supplier
14	Change of (Meter) Mode
15	Debt Payment
16	Scheduled Snapshot
17	OTA Firmware Download
18	Reserved for Prepayment cluster
19	Reserved for Prepayment cluster
20 – 31	Reserved

17508

17509 **SnapshotPayloadType (mandatory):** The SnapshotPayloadType is an 8-bit enumerator defining the format  
 17510 of the SnapshotSub-Payload in this message. The different snapshot types are listed in Table 10-99. The  
 17511 server selects the SnapshotPayloadType based on the charging scheme in use.

17512

**Table 10-99. Snapshot Payload Type**

Enumeration	Description	Charging Scheme
0	TOU Information Set DeliveredRegisters	TOU charging only
1	TOU Information Set Received Registers	TOU charging only
2	Block Tier Information Set Delivered	Block/TOU charging

3	Block Tier Information Set Received	Block/TOU charging
4	TOU Information Set Delivered (No Billing)	TOU charging only
5	TOU Information Set Received (No Billing)	TOU charging only
6	Block Tier Information Set Delivered (No Billing)	Block/TOU charging
7	Block Tier Information Set Received (No Billing)	Block/TOU charging
128	Data Unavailable	The data for this snapshot is currently unavailable; if used, there is currently no subsequent snapshot data.

17513

17514 If the snapshot is taken by the server due to a change of Tariff Information (cause = 3) which involves a  
 17515 change in charging scheme then two snapshots shall be taken, the first according to the charging scheme  
 17516 being dismissed, the second to the scheme being introduced.

17517 **SnapshotSub-Payload (mandatory):** the format of the SnapshotSub-Payload differs depending on the  
 17518 SnapshotPayloadType, as shown below. Note that, where the entire payload (snapshot) does not fit into one  
 17519 message, only the leading (non-Sub-Payload) fields of the Snapshot payload are repeated in each command;  
 17520 the SnapshotSub-Payload is divided over the required number of commands. Figure 10-61 explains this fur-  
 17521 ther.

17522

**Figure 10-61. Snapshot Utilizing Multiple Commands**

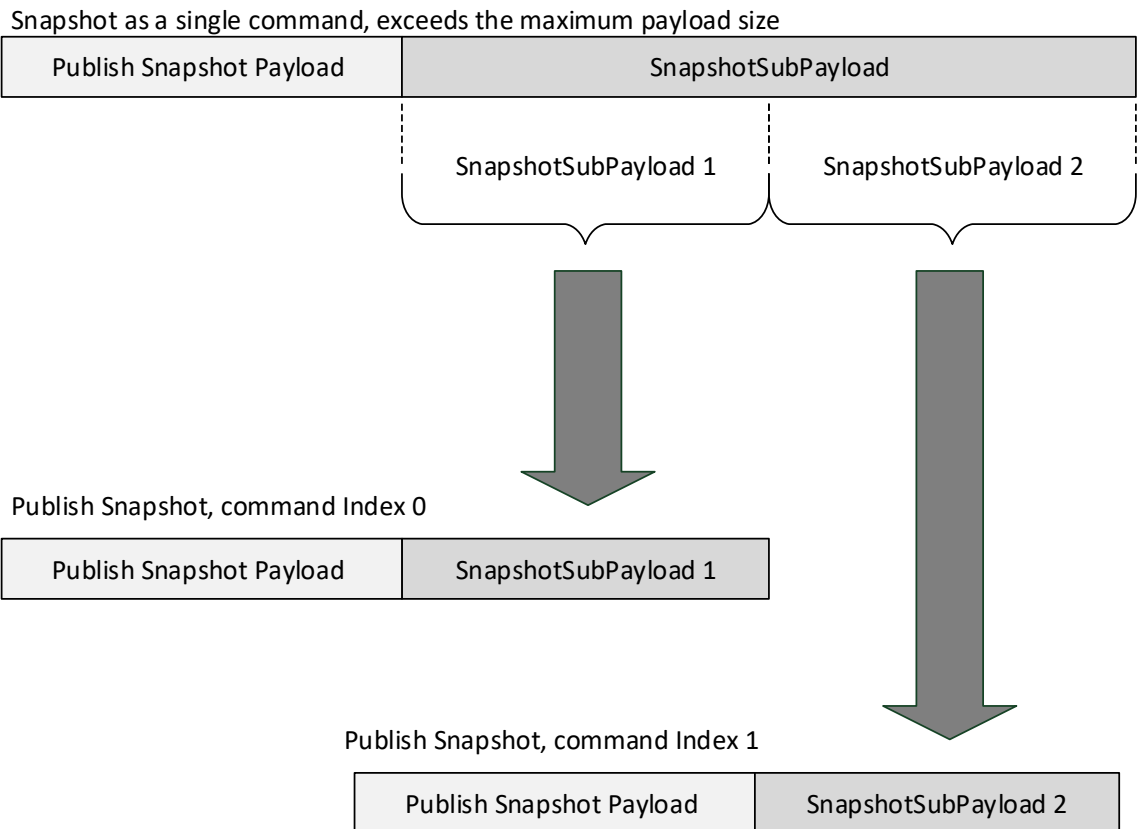

17523

17524 a SnapshotPayloadType 0 = TOU Information Delivered Set

17525

**Figure 10-62. TOU Information Delivered Snapshot Sub-Payload**

6	4	4	4	4	1	1	Variable
uint48	uint32	UTC	uint32	UTC	map8	uint8	Series of uint48
Current Summation Delivered (M)	BillToDate Delivered (M)	BillToDateTimeStamp Delivered (M)	Projected Bill Delivered (M)	Projected-Bill TimeStamp Delivered (M)	Bill Delivered Trailing Digit (M)	Number of Tiers in Use (M)	Tier Summation (M)

17526 **Current Summation Delivered (mandatory):** An unsigned 48-bit integer that returns the value of the CurrentSummationDelivered attribute at the stated snapshot timestamp.  
17527

17528 **BillToDateDelivered (mandatory):** An unsigned 32-bit integer that provides a value for the costs in the current billing period. This value is measured in a base unit of Currency with the decimal point located as indicated by the BillDeliveredTrailingDigit field.  
17529  
17530

17531 **BillToDateTimeStampDelivered (mandatory):** A UTC timestamp that indicates when the value of the associated BillToDateDelivered parameter was last updated.  
17532

17533 **ProjectedBillDelivered (mandatory):** An unsigned 32-bit integer that provides a value indicating what the estimated state of the account will be at the end of the billing period based on past consumption. This attribute is measured in a base unit of Currency with the decimal point located as indicated by the BillDeliveredTrailingDigit field.  
17534  
17535  
17536

17537 **ProjectedBillTimeStampDelivered (mandatory):** A UTC timestamp that indicates when the associated ProjectedBillDelivered parameter was last updated.  
17538

17539 **BillDeliveredTrailingDigit (mandatory):** An 8-bit BitMap used to determine where the decimal point is located in the BillToDateDelivered and ProjectedBillDelivered fields. The most significant nibble indicates the number of digits to the right of the decimal point. The least significant nibble is reserved and shall be 0.  
17540  
17541

17542 **Number of Tiers in Use (mandatory):** An 8-bit integer representing the number of tiers in use at the time the snapshot was taken.  
17543

17544 **TierSummation (mandatory):** The Publish Snapshot command contains N elements of CurrentTierNSummationDelivered attributes from the TOU Information Set. The Metering server shall send only the number of tiers in use, as stated in this command. The first element of the TOU Information Set (Delivered), is CurrentTier1Summation. For the following elements, the tier index is incremented until the number of tiers in use is reached.  
17545  
17546  
17547  
17548

17549 **b SnapshotPayloadType 1 = TOU Information Received Set**

17550

**Figure 10-63. TOU Information Received Snapshot Sub-Payload**

6	4	4	4	4	1	1	Variable
uint48	uint32	UTC	uint32	UTC	map8	uint8	Series of uint48
Current Summation Received (M)	BillToDate Received (M)	BillToDateTimeStamp Received (M)	Projected Bill Received (M)	Projected-Bill TimeStamp Received (M)	Bill Received Trailing Digit (M)	Number of Tiers in Use (M)	Tier Summation (M)

17551

17552 **Current Summation Received (mandatory):** An unsigned 48-bit integer that returns the value of the CurrentSummationReceived attribute at the stated snapshot timestamp. A value of 0xFFFFFFFFFFFF means not available.  
 17553  
 17554

17555 **BillToDateReceived (mandatory):** An unsigned 32-bit integer that provides a value for the costs in the current billing period. This value is measured in a base unit of Currency with the decimal point located as indicated by the BillReceivedTrailingDigit field.  
 17556  
 17557

17558 **BillToDateTimeStampReceived (mandatory):** A UTC timestamp that indicates when the value of the associated BillToDateReceived parameter was last updated.  
 17559

17560 **ProjectedBillReceived (mandatory):** An unsigned 32-bit integer that provides a value indicating what the estimated state of the account will be at the end of the billing period based on past generation. This attribute is measured in a base unit of Currency with the decimal point located as indicated by the BillReceivedTrailingDigit field.  
 17561  
 17562  
 17563

17564 **ProjectedBillTimeStampReceived (mandatory):** A UTC timestamp that indicates when the associated ProjectedBillReceived parameter was last updated.  
 17565

17566 **BillReceivedTrailingDigit (mandatory):** An 8-bit BitMap used to determine where the decimal point is located in the BillToDateReceived and ProjectedBillReceived fields. The most significant nibble indicates the number of digits to the right of the decimal point. The least significant nibble is reserved and shall be 0.  
 17567  
 17568

17569 **Number of Tiers in Use (mandatory):** An 8-bit integer representing the number of tiers in use at the time the snapshot was taken.  
 17570

17571 **TierSummation (mandatory):** The Publish Snapshot command contains N elements of CurrentTierNSummationReceived attributes from the TOU Information Set. The Metering server shall send only the number of tiers in use, as stated in this command. The first element of the TOU Information Set (Received), is CurrentTier1Summation. For the following elements, the tier index is incremented until the number of tiers in use is reached.  
 17572  
 17573  
 17574  
 17575

17576

17577 c SnapshotPayloadType 2 = Block Information Delivered Set

17578

**Figure 10-64. Block Information Delivered Snapshot Sub-Payload**

<b>6</b>	<b>4</b>	<b>4</b>	<b>4</b>	<b>4</b>	<b>1</b>
uint48	uint32	UTC	uint32	UTC	map8
Current Summation Delivered (M)	BillToDate Delivered (M)	BillToDate TimeStamp Delivered (M)	Projected Bill Delivered (M)	ProjectedBill TimeStamp Delivered (M)	Bill Delivered Trailing Digit (M)

17579

<b>1</b>	<b>Variable</b>	<b>1</b>	<b>Variable</b>
uint8	Series of uint48	map8	Series of uint48
Number of Tiers in Use (M)	Tier Summation (M)	Number of Tiers and Block Thresholds in Use (M)	Tier Block Summation (M)

17580

17581 **Current Summation Delivered (mandatory):** An unsigned 48-bit integer that returns the value of the CurrentSummationDelivered attribute at the stated snapshot timestamp.  
 17582

17583 **BillToDateDelivered (mandatory):** An unsigned 32-bit integer that provides a value for the costs in the  
 17584 current billing period. This value is measured in a base unit of Currency with the decimal point located as  
 17585 indicated by the BillDeliveredTrailingDigit field.

17586 **BillToDateTimeStampDelivered (mandatory):** A UTC timestamp that indicates when the value of the as-  
 17587 sociated BillToDateDelivered parameter was last updated.

17588 **ProjectedBillDelivered (mandatory):** An unsigned 32-bit integer that provides a value indicating what the  
 17589 estimated state of the account will be at the end of the billing period based on past consumption. This attribute  
 17590 is measured in a base unit of Currency with the decimal point located as indicated by the BillDeliveredTrail-  
 17591 ingDigit field.

17592 **ProjectedBillTimeStampDelivered (mandatory):** A UTC timestamp that indicates when the associated  
 17593 ProjectedBillDelivered parameter was last updated.

17594 **BillDeliveredTrailingDigit (mandatory):** An 8-bit BitMap used to determine where the decimal point is  
 17595 located in the BillToDateDelivered and ProjectedBillDelivered fields. The most significant nibble indicates  
 17596 the number of digits to the right of the decimal point. The least significant nibble is reserved and shall be 0.

17597 **Number of Tiers in Use (mandatory):** An 8-bit integer representing the number of tiers in use at the time  
 17598 the snapshot was taken.

17599 **TierSummation (mandatory):** The Publish Snapshot command contains N elements of CurrentTierNSum-  
 17600 mationDelivered attributes from the TOU Information Set. The Metering server shall send only the number  
 17601 of tiers in use, as stated in this command. The first element of the TOU Information Set (Delivered), is  
 17602 CurrentTier1Summation. For the following elements, the tier index is incremented until the number of tiers  
 17603 in use is reached.

17604 **Number of Tiers and Block Thresholds in Use (mandatory):** An 8-bit BitMap representing the number of  
 17605 tiers and block thresholds in use at the time the snapshot was taken. The most significant nibble defines the  
 17606 number of tiers in use, whereas the least significant nibble indicates the number of block thresholds in use.

17607 **TierBlockSummation (T,B):** The Publish Snapshot command contains N elements of the Block Information  
 17608 Attribute Set (Delivered). The metering server shall send only the number of Tiers and Blocks in use as stated  
 17609 in this command. The Block Information Attribute Set has two dimensions, the row – tier index (T) and the  
 17610 block – column index (B).

17611 The first element of the Tier Block Summation field is CurrentTier1Block1SummationDelivered attribute.  
 17612 For the following elements, the block index is incremented until the number of blocks in use is reached. Then  
 17613 the tier index is incremented and the block index starts at 1 again. This continues until the stated number of  
 17614 tiers in use is reached.

17615

17616 **d SnapshotPayloadType 3 = Block Information Received Set**

17617

**Figure 10-65. Block Information Received Snapshot Sub-Payload**

<b>6</b>	<b>4</b>	<b>4</b>	<b>4</b>	<b>4</b>	<b>1</b>
uint48	uint32	UTC	uint32	UTC	map8
Current Summation Received (M)	BillToDate Received (M)	BillToDate TimeStamp Received (M)	Projected Bill Received (M)	ProjectedBill TimeStamp Received (M)	Bill Re- ceived Trail- ing Digit (M)

17618

<b>1</b>	<b>Variable</b>	<b>1</b>	<b>Variable</b>
uint8	Series of uint48	map8	Series of uint48

Number of Tiers in Use (M)	Tier Summation (M)	Number of Tiers and Block Thresholds in Use (M)	Tier Block Summation (M)
----------------------------	--------------------	---	--------------------------

17619

17620 **Current Summation Received (mandatory):** An unsigned 48-bit integer that returns the value of the CurrentSummationReceived attribute at the stated snapshot timestamp. A value of 0xFFFFFFFFFFFF means not available.  
 17621  
 17622

17623 **BillToDateReceived (mandatory):** An unsigned 32-bit integer that provides a value for the costs in the current billing period. This value is measured in a base unit of Currency with the decimal point located as indicated by the BillReceivedTrailingDigit field.  
 17624  
 17625

17626 **BillToDateTimeStampReceived (mandatory):** A UTC timestamp that indicates when the value of the associated BillToDateReceived parameter was last updated.  
 17627

17628 **ProjectedBillReceived (mandatory):** An unsigned 32-bit integer that provides a value indicating what the estimated state of the account will be at the end of the billing period based on past generation. This attribute is measured in a base unit of Currency with the decimal point located as indicated by the BillReceivedTrailingDigit field.  
 17629  
 17630  
 17631

17632 **ProjectedBillTimeStampReceived (mandatory):** A UTC timestamp that indicates when the associated ProjectedBillReceived parameter was last updated.  
 17633

17634 **BillReceivedTrailingDigit (mandatory):** An 8-bit BitMap used to determine where the decimal point is located in the BillToDateReceived and ProjectedBillReceived fields. The most significant nibble indicates the number of digits to the right of the decimal point. The least significant nibble is reserved and shall be 0.  
 17635  
 17636

17637 **Number of Tiers in Use (mandatory):** An 8-bit integer representing the number of tiers in use at the time the snapshot was taken.  
 17638

17639 **TierSummation (mandatory):** The Publish Snapshot command contains N elements of CurrentTierNSummationReceived attributes from the TOU Information Set. The Metering server shall send only the number of tiers in use, as stated in this command. The first element of the TOU Information Set (Received) is CurrentTier1Summation. For the following elements, the tier index is incremented until the number of tiers in use is reached.  
 17640  
 17641  
 17642  
 17643

17644 **Number of Tiers and Block Thresholds in Use (mandatory):** An 8-bit BitMap representing the number of tiers and block thresholds in use at the time the snapshot was taken. The most significant nibble defines the number of tiers in use, whereas the least significant nibble indicates the number of block thresholds in use.  
 17645  
 17646

17647 **TierBlockSummation (T,B):** The Publish Snapshot command contains N elements of the Block Information Attribute Set (Received). The metering server shall send only the number of Tiers and Blocks in use as stated in this command. The Block Information Attribute Set has two dimensions, the row – tier index (T) and the block – column index (B).  
 17648  
 17649  
 17650

17651 The first element of the Tier Block Summation field is CurrentTier1Block1SummationReceived attribute.  
 17652 For the following elements, the block index is incremented until the number of blocks in use is reached. Then the tier index is incremented and the block index starts at 1 again. This continues until the stated number of tiers in use is reached.  
 17653  
 17654

17655

17656 e SnapshotPayloadType 4 = TOU Information Set Delivered (No Billing)

17657

**Figure 10-66. TOU Information Delivered (No Billing) Snapshot Sub-Payload**

6	1	Variable
uint48	uint8	Series of uint48

Current Summation Delivered (M)	Number of Tiers in Use (M)	Tier Summation (M)
---------------------------------	----------------------------	--------------------

17658

17659 **Current Summation Delivered (mandatory):** An unsigned 48-bit integer that returns the value of the CurrentSummationDelivered attribute at the stated snapshot timestamp.  
17660

17661 **Number of Tiers in Use (mandatory):** An 8-bit integer representing the number of tiers in use at the time  
17662 the snapshot was taken.

17663 **TierSummation (mandatory):** The Publish Snapshot command contains N elements of CurrentTierNSum-  
17664 mationDelivered attributes from the TOU Information Set. The Metering server shall send only the number  
17665 of tiers in use, as stated in this command. The first element of the TOU Information Set (Delivered) is Cur-  
17666 rentTier1Summation. For the following elements, the tier index is incremented until the number of tiers in  
17667 use is reached.

17668

17669 f SnapshotPayloadType 5 = TOU Information Set Received (No Billing)

17670 **Figure 10-67. TOU Information Received (No Billing) Snapshot Sub-Payload**

<b>6</b>	<b>1</b>	<b>Variable</b>
uint48	uint8	Series of uint48
Current Summation Received (M)	Number of Tiers in Use (M)	Tier Summation (M)

17671

17672 **Current Summation Received (mandatory):** An unsigned 48-bit integer that returns the value of the Cur-  
17673 rentSummationReceived attribute at the stated snapshot timestamp. A value of 0xFFFFFFFF means not  
17674 available.

17675 **Number of Tiers in Use (mandatory):** An 8-bit integer representing the number of tiers in use at the time  
17676 the snapshot was taken.

17677 **TierSummation (mandatory):** The Publish Snapshot command contains N elements of CurrentTierNSum-  
17678 mationReceived attributes from the TOU Information Set. The Metering server shall send only the number  
17679 of tiers in use, as stated in this command. The first element of the TOU Information Set (Received), is Cur-  
17680 rentTier1Summation. For the following elements, the tier index is incremented until the number of tiers in  
17681 use is reached.

17682

17683 g SnapshotPayloadType 6 = Block Tier Information Set Delivered (No Billing)

17684 **Figure 10-68. Block Information Delivered (No Billing) Snapshot Sub-Payload**

<b>6</b>	<b>1</b>	<b>Variable</b>	<b>1</b>	<b>Variable</b>
uint48	uint8	Series of uint48	map8	Series of uint48



Current Summation Delivered (M)	Number of Tiers in Use (M)	Tier Summation (M)	Number of Tiers and Block Thresholds in Use (M)	Tier Block Summation (M)
---------------------------------	----------------------------	--------------------	---	--------------------------

17685

17686 **Current Summation Delivered (mandatory):** An unsigned 48-bit integer that returns the value of the CurrentSummationDelivered attribute at the stated snapshot timestamp.  
 17687

17688 **Number of Tiers in Use (mandatory):** An 8-bit integer representing the number of tiers in use at the time the snapshot was taken.  
 17689

17690 **TierSummation (mandatory):** The Publish Snapshot command contains N elements of CurrentTierNSummationDelivered attributes from the TOU Information Set. The Metering server shall send only the number of tiers in use, as stated in this command. The first element of the TOU Information Set (Delivered), is CurrentTier1Summation. For the following elements, the tier index is incremented until the number of tiers in use is reached.  
 17691  
 17692  
 17693  
 17694

17695 **Number of Tiers and Block Thresholds in Use (mandatory):** An 8-bit BitMap representing the number of tiers and block thresholds in use at the time the snapshot was taken. The most significant nibble defines the number of tiers in use, whereas the least significant nibble indicates the number of block thresholds in use.  
 17696  
 17697

17698 **TierBlockSummation (T,B):** The Publish Snapshot command contains N elements of the Block Information Attribute Set (Delivered). The metering server shall send only the number of Tiers and Blocks in use as stated in this command. The Block Information Attribute Set has two dimensions, the row – tier index (T) and the block – column index (B).  
 17699  
 17700  
 17701

17702 The first element of the Tier Block Summation field is CurrentTier1Block1SummationDelivered attribute.  
 17703 For the following elements, the block index is incremented until the number of blocks in use is reached. Then the tier index is incremented and the block index starts at 1 again. This continues until the stated number of tiers in use is reached.  
 17704  
 17705

17706

17707 **h SnapshotPayloadType 7 = Block Tier Information Set Received (No Billing)**

17708

**Figure 10-69. Block Information Received (No Billing) Snapshot Sub-Payload**

6	1	Variable	1	Variable
uint48	uint8	Series of uint48	map8	Series of uint48
Current Summation Received (M)	Number of Tiers in Use (M)	Tier Summation (M)	Number of Tiers and Block Thresholds in Use (M)	Tier Block Summation (M)

17709

17710 **Current Summation Received (mandatory):** An unsigned 48-bit integer that returns the value of the CurrentSummationReceived attribute at the stated snapshot timestamp. A value of 0xFFFFFFFF means not available.  
 17711  
 17712

17713 **Number of Tiers in Use (mandatory):** An 8-bit integer representing the number of tiers in use at the time the snapshot was taken.  
 17714

17715 **TierSummation (mandatory):** The Publish Snapshot command contains N elements of CurrentTierNSummationReceived attributes from the TOU Information Set. The Metering server shall send only the number of tiers in use, as stated in this command. The first element of the TOU Information Set (Received), is CurrentTier1Summation. For the following elements, the tier index is incremented until the number of tiers in use is reached.  
 17716  
 17717  
 17718  
 17719

17720 **Number of Tiers and Block Thresholds in Use (mandatory):** An 8-bit BitMap representing the number of  
17721 tiers and block thresholds in use at the time the snapshot was taken. The most significant nibble defines the  
17722 number of tiers in use, whereas the least significant nibble indicates the number of block thresholds in use.

17723 **TierBlockSummation (T,B):** The Publish Snapshot command contains N elements of the Block Information  
17724 Attribute Set (Received). The metering server shall send only the number of Tiers and Blocks in use as stated  
17725 in this command. The Block Information Attribute Set has two dimensions, the row – tier index (T) and the  
17726 block – column index (B).

17727 The first element of the Tier Block Summation field is CurrentTier1Block1SummationReceived attribute.  
17728 For the following elements, the block index is incremented until the number of blocks in use is reached. Then  
17729 the tier index is incremented and the block index starts at 1 again. This continues until the stated number of  
17730 tiers in use is reached.

17731 **10.4.2.3.1.7.3 When Generated**

17732 A Publish Snapshot command is generated in response to GetSnapshot command or when a new snapshot is  
17733 created. The device shall send a single Publish Snapshot command according to the search criteria defined  
17734 in the associated GetSnapshot command. A Default Response with status NOT\_FOUND shall be returned if  
17735 there is no appropriate snapshot data available.

17736

17737 **10.4.2.3.1.8 GetSampledDataResponse Command**

17738 This command is used to send the requested sample data to the client. It is generated in response to a Get-  
17739 SampledData command (see 10.4.3.3.1.9).

17740 **10.4.2.3.1.8.1 Payload Format**

17741 **Figure 10-70. Format of the GetSampledDataResponse Command Payload**

Octets	2	4	1	2	2	Variable
<b>Data Type</b>	uint16	UTC	enum8	uint16	uint16	Series of uint24 <sup>197</sup>
<b>Field Name</b>	Sample ID (M)	SampleStart Time (M)	Sample-Type (M)	Sample-Request Interval (M)	NumberOfSamples (M)	Samples (M)

17742

17743 **10.4.2.3.1.8.2 Payload Details**

17744 **SampleID (mandatory):** Unique identifier allocated to this Sampling session. This field allows devices to  
17745 match response data with the appropriate request. See 10.4.2.3.1.14 for further details.

17746 **SampleStartTime (mandatory):** A UTC Time field to denote the time of the first sample returned in this  
17747 response.

17748 **SampleType (mandatory):** An 8 bit enumeration that identifies the type of data being sampled. Possible  
17749 values are defined in the following table:

17750

**Table 10-100. Sample Type Enumerations**

Enumeration	Description
0	Consumption Delivered
1	Consumption Received
2	Reactive Consumption

<sup>197</sup> SIGNED 24-bit values shall be used for samples of Instantaneous Demand.

	Delivered
3	Reactive Consumption Received
4	InstantaneousDemand

17751

17752 **SampleRequestInterval (mandatory):** An unsigned 16-bit field representing the interval or time in seconds  
 17753 between samples.

17754 **NumberOfSamples (mandatory):** Represents the number of samples being requested. This value cannot  
 17755 exceed the size stipulated in the MaxNumberofSamples field in the StartSampling command. If more samples  
 17756 are requested than can be delivered, the GetSampleDataResponse command will return the number of sam-  
 17757 ples equal to MaxNumberofSamples field. If fewer samples are available for the time period, only those  
 17758 available shall be returned.

17759 **Samples (mandatory):** Series of data samples captured using the interval specified by the Sample-  
 17760 RequestInterval field in the StartSampling command. Each sample contains the change in the relevant data  
 17761 since the previous sample, except for Instantaneous Demand where each (signed 24-bit) sample is a snapshot  
 17762 of the current value. Data is organised in a chronological order, the oldest sample is transmitted first and the  
 17763 most recent sample is transmitted last. Invalid samples should be marked as 0xFFFFFFFF.

17764 **10.4.2.3.1.8.3 When Generated**

17765 A GetSampledDataResponse command is generated in response to GetSampledData command. A Default  
 17766 Response with status NOT\_FOUND shall be returned if there is no appropriate Sample data available.

17767

17768 **10.4.2.3.1.9 ConfigureMirror Command**

17769 Where ‘Two Way Mirroring’ is being implemented, this command shall be sent to the mirror once the mirror  
 17770 has been created. The command allows a BOMD to provide the operational configuration of the associated  
 17771 Mirror. Note that this command is not required for a traditional ‘One way’ mirror (see 10.4.4.4.3 for further  
 17772 details).

17773 **10.4.2.3.1.9.1 Payload Format**

Figure 10-71. Format of the *ConfigureMirror* Command Payload

Octets	4	3	1	1
<b>Data Type</b>	uint32	uint24	Boolean	uint8
<b>Field Name</b>	Issuer Event ID (M)	Reporting In- terval (M)	Mirror Notification Reporting (M)	Notification Scheme (M)

17775 **10.4.2.3.1.9.2 Payload Details**

17776 **Issuer Event ID (mandatory):** Unique identifier generated by the device being mirrored. When new infor-  
 17777 mation is provided that replaces older information, this field allows devices to determine which information  
 17778 is newer. It is recommended that the value contained in this field is a UTC based time stamp (UTCTime data  
 17779 type) identifying when the command was issued. Thus, newer information will have a value in the Issuer  
 17780 Event ID field that is larger than older information.

17781 **Reporting Interval (mandatory):** An unsigned 24-bit integer to denote the interval, in seconds, at which a  
 17782 mirrored meter intends to use the ReportAttribute command.

17783 **Mirror Notification Reporting (mandatory):** A Boolean used to advise a BOMD how the Notification  
17784 flags should be acquired (see below).

17785 When Mirror Notification Reporting is set, the MirrorReportAttributeResponse command is enabled. In that  
17786 case, the Metering client on the mirror endpoint shall respond to the last or only ReportAttribute command  
17787 with the MirrorReportAttributeResponse. This is shown in Figure 10-72:

17788 **Figure 10-72. MirrorReportAttributeResponse Command Enabled**

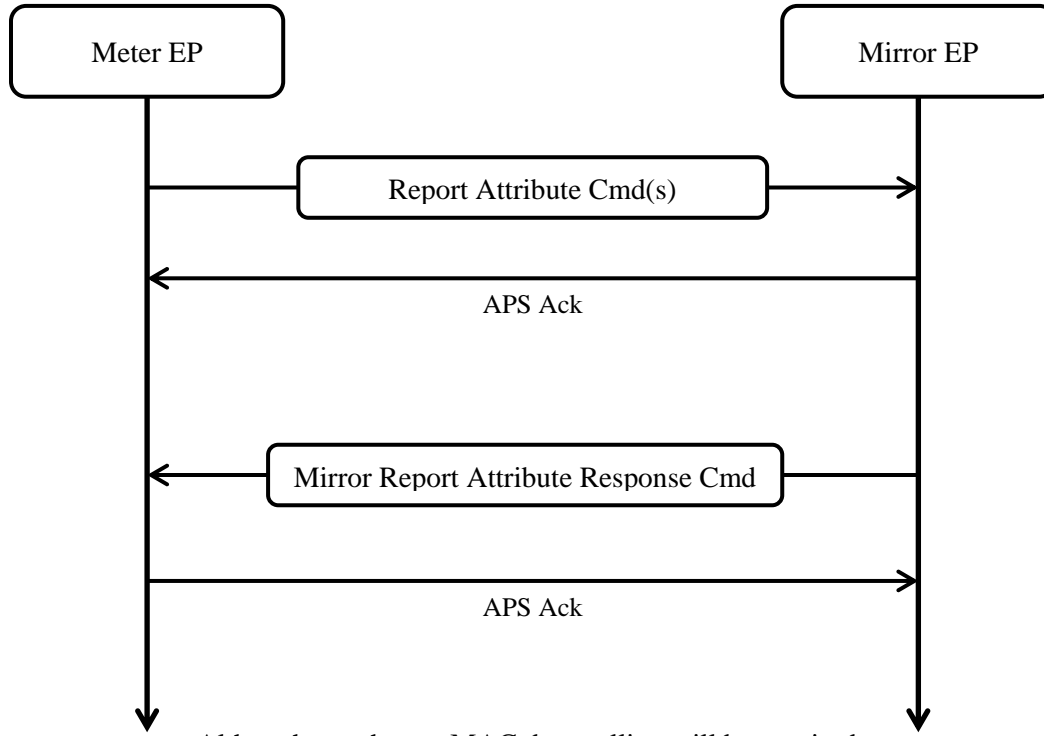

Although not shown, MAC data polling will be required

17789

17790 NOTES:

17791 On powering up, the BOMD will send one or more Report Attribute commands to the Metering client on the  
17792 mirror endpoint. The last attribute to be reported to the mirror shall be an Attribute Reporting Status attribute,  
17793 as defined in section Chapter 2.

17794 If MirrorReportAttributeResponse is enabled, the server does not need to request an APS ACK. If the server  
17795 requests an APS ACK, the Metering client on the mirror endpoint shall respond first with an APS ACK and  
17796 then send the MirrorReportAttributeResponse.

17797 If Mirror Notification Reporting is set to FALSE, the MirrorReportAttributeResponse command shall not be  
17798 enabled; the Metering server may poll the Notification flags by means of a normal ReadAttribute command,  
17799 as shown in Figure 10-73:

17800

**Figure 10-73. MirrorReportAttributeResponse Command Disabled**

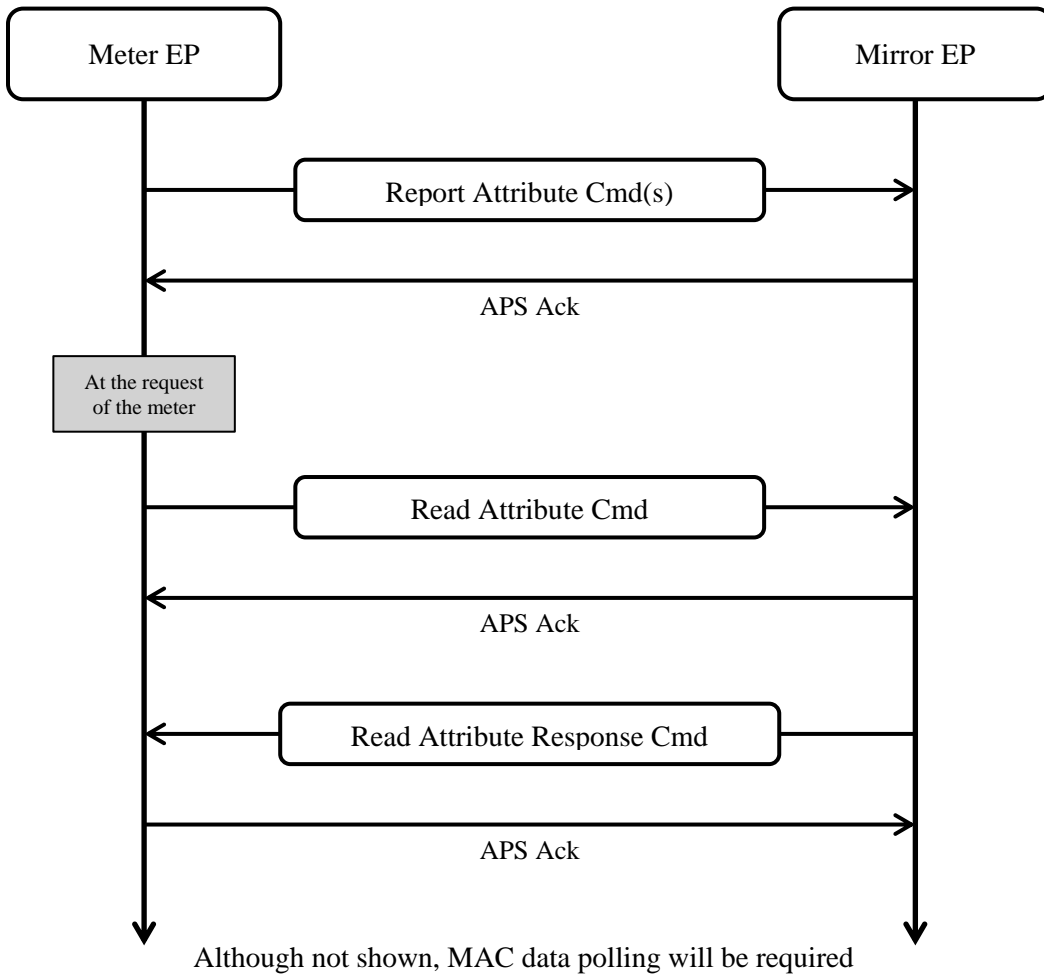

17801

17802

17803 **Notification Scheme (mandatory):** This unsigned 8-bit integer allows for the pre-loading of the Notification  
 17804 Flags bit mapping to commands. The following schemes are currently supported within the Smart Energy  
 17805 Standard:-

17806

**Figure 10-74. NotificationScheme Enumerations**

Value	Description
0x00	No Notification Scheme Defined
0x01	Predefined Notification Scheme A
0x02	Predefined Notification Scheme B
0x03 – 0x80	Reserved
0x81 – 0xFE	For MSP Requirements
0xFF	Reserved

17807

17808 **10.4.2.3.1.9.3 When Generated**

17809 The ConfigureMirror command is generated in response to the RequestMirrorResponse command when the  
 17810 Mirror has been created.

17811 **10.4.2.3.1.9.4 Effect on Receipt**

17812 On receipt of the ConfigureMirror command, the mirror will understand if the MirrorReportAttributeRe-  
17813 sponse command should be sent, and if there is a scheme for the Notifications flags. The Mirror will also  
17814 understand the interval at which the Meter shall report to the mirror.

17815 A Default Response with status INVALID\_FIELD shall be returned if the required Notification Scheme is  
17816 not supported by the Mirroring device.

17817

17818 **10.4.2.3.1.10 ConfigureNotificationScheme Command**

17819 **Note:** The ConfigureNotificationScheme command in this revision of this specification is provisional and  
17820 not certifiable. This feature may change before reaching certifiable status in a future revision of this specifi-  
17821 cation.

17822 Where ‘Two Way Mirroring’ is being implemented, and a non-default Notification Scheme is to be used, this  
17823 command shall be sent to the mirror once the mirror has been created. The command allows a BOMD to  
17824 provide details of the required Notification Scheme to the associated mirror, and should be used in conjunc-  
17825 tion with the associated ConfigureNotificationFlags command (see 10.4.2.3.1.11). No default schemes are  
17826 allowed to be overwritten (see 10.4.4.4.3.4 and 10.4.4.4.3.5 for further details); generic schemes should use  
17827 one of the reserved values 0x03 – 0x80, MSP schemes should use one of the values 0x081-0x0FE (see Figure  
17828 10-74). Section 10.4.4.4.3.3 provides further details.

17829 **10.4.2.3.1.10.1 Payload Format**

17830 **Figure 10-75. Format of the *ConfigureNotificationScheme* Command Payload**

Octets	4	1	4
Data Type	uint32	uint8	map32
Field Name	Issuer Event ID (M)	Notification Scheme (M)	Notification Flag Order (M)

17831 **10.4.2.3.1.10.2 Payload Details**

17832 **Issuer Event ID (mandatory):** Unique identifier generated by the device being mirrored. When new infor-  
17833 mation is provided that replaces older information, this field allows devices to determine which information  
17834 is newer. It is recommended that the value contained in this field is a UTC based time stamp (UTCTime data  
17835 type) identifying when the command was issued. Thus, newer information will have a value in the Issuer  
17836 Event ID field that is larger than older information.

17837 **Notification Scheme (mandatory):** An unsigned 8-bit integer that allows for the pre-loading of the Notifi-  
17838 cation Flags bit mapping to commands. Figure 10-74 details the schemes that are currently supported within  
17839 the Smart Energy Standard.

17840 **Notification Flag Order (mandatory):** A 32-bit bitmap, consisting of 8 nibbles which define the Notifica-  
17841 tion Flag attributes (and order) to be returned in a MirrorReportAttributeResponse command. The values to  
17842 be returned in each nibble are defined in Table 10-101.

17843

**Table 10-101. Notification Flags Order**

Value	Waiting Command
0	NotificationFlag1
1	NotificationFlag2

2	NotificationFlag3
3	NotificationFlag4
4	NotificationFlag5
5	NotificationFlag6
6	NotificationFlag7
7	NotificationFlag8
8 –E	Reserved
F	Blank / No Notification Flag

17844

17845 **10.4.2.3.1.10.3 When Generated**

17846 The ConfigureNotificationScheme command is generated when a new scheme is required.

17847 **10.4.2.3.1.10.4 Effect on Receipt**

17848 On receipt of the ConfigureNotificationScheme command, the mirror shall store the NotificationScheme in-  
 17849 formation, and wait for the associated ConfigureNotificationFlags command. Until all of the ConfigureNoti-  
 17850 ficationFlags commands have been received, the two-way mirror functionality should be disabled. The No-  
 17851 tification Flag Order parameter will allow the mirror to determine when all of the ConfigureNotificationFlags  
 17852 commands have been received.

17853

17854 **10.4.2.3.1.11 ConfigureNotificationFlags Command**

17855 **Note:** The ConfigureNotificationFlags command in this revision of this specification is provisional and not  
 17856 certifiable. This feature may change before reaching certifiable status in a future revision of this specification.

17857 Where ‘Two Way Mirroring’ is being implemented, and a non-default Notification Scheme is to be used, the  
 17858 ConfigureNotificationFlags command allows a BOMD to set the commands relating to the bit value for each  
 17859 NotificationFlags#N attribute that the scheme is proposing to use. This command should be used in conjunc-  
 17860 tion with the associated ConfigureNotificationScheme command (see 10.4.2.3.1.10). No predefined schemes  
 17861 are allowed to be overwritten (see 10.4.4.4.3.4 and 10.4.4.4.3.5 for further details). Section 10.4.4.4.3.3 pro-  
 17862 vides further details.

17863 **10.4.2.3.1.11.1 Payload Format**

17864

Figure 10-76. Format of the *ConfigureNotificationFlags* Command Payload

Octets	4	1	2	Variable
Data Type	uint32	uint8	uint16	-
Field Name	Issuer Event ID (M)	Notification Scheme (M)	Notification Flag Attribute ID (M)	Bit Field Allocation

17865 **10.4.2.3.1.11.2 Payload Details**

17866 **Issuer Event ID (mandatory):** Unique identifier generated by the device being mirrored. When new infor-  
 17867 mation is provided that replaces older information, this field allows devices to determine which information  
 17868 is newer. It is recommended that the value contained in this field is a UTC based time stamp (UTCTime data  
 17869 type) identifying when the command was issued. Thus, newer information will have a value in the Issuer  
 17870 Event ID field that is larger than older information.

17871 **Notification Scheme (mandatory):** An unsigned 8-bit integer that allows for the pre-loading of the Notifi-  
17872 cation Flags bit mapping to commands. Figure 10-74 details the schemes that are currently supported within  
17873 the Smart Energy Standard.

17874 **Notification Flag Attribute ID (mandatory):** An unsigned 16-bit integer that denotes the attribute id of the  
17875 Notification flag (2-8) that will be configured for this Notification scheme.

17876 **Bit Field Allocation (mandatory):** The bit field allocation sub payload is defined in Figure 10-77. The bit  
17877 order is defined by the position of sub-payload within the command.

17878 **Figure 10-77. Format of the Bit Field Allocation Command Sub Payload**

2	2	1	1 to 32		
uint16	uint16	uint8	uint8		uint8
Cluster ID	Manufacturer Code	No. of Commands	Command 1 Identifier	...	Command n Identifier

17879  
17880 **Cluster ID (mandatory):** An unsigned 16-bit integer that denotes the Cluster id of the Notification flag that  
17881 will be configured for this Notification scheme.

17882 **Manufacturer Code (mandatory):** An unsigned 16-bit integer that denotes the Manufacturer Code to be  
17883 used with these command IDs that are configured for this Notification flag within this Notification scheme.

17884 **No of Commands (mandatory):** An unsigned 8-bit integer that indicates the number of command identifiers  
17885 contained within this sub payload.

17886 **Command ID (mandatory):** An unsigned 8-bit integer that denotes the command that is to be used. The  
17887 command id should be used with the cluster id to reference the command(s).

17888 **10.4.2.3.1.11.3 When Generated**

17889 This command is sent once the mirror has been created, and the ConfigureNotificationScheme command has  
17890 been sent up the top level of the scheme. There is a ConfigureNotificationFlags command for each attribute  
17891 that the scheme is proposing to use. No default schemes are allowed to be overwritten.

17892 **10.4.2.3.1.11.4 Effect on Receipt**

17893 Once all ConfigureNotificationFlags commands have been received, a fully populated scheme will be avail-  
17894 able, and two way mirroring can then be enabled.

17895

17896 **10.4.2.3.1.12 GetNotifiedMessage Command**

17897 The GetNotifiedMessage command is used only when a BOMD is being mirrored. This command provides  
17898 a method for the BOMD to notify the Mirror message queue that it wants to receive commands that the Mirror  
17899 has queued. The Notification flags set within the command shall inform the mirror of the commands that the  
17900 BOMD is requesting.

17901 **10.4.2.3.1.12.1 Payload Format**

17902 **Figure 10-78. Format of the GetNotifiedMessage Command Payload**

Octets	1	2	4
Data Type	uint8	uint16	map32



Field Name	Notification Scheme (M)	Notification Flag Attribute ID (M)	Notification Flags #N (M)
------------	-------------------------	------------------------------------	---------------------------

17903 **10.4.2.3.1.12.2 Payload Details**

17904 **Notification Scheme (mandatory):** An unsigned 8-bit integer that allows for the pre-loading of the Notifi-  
 17905 cation Flags bit mapping to commands. Figure 10-74 details the schemes that are currently supported within  
 17906 the Smart Energy Standard.

17907 **Notification Flag Attribute ID (mandatory):** An unsigned 16-bit integer that denotes the attribute id of the  
 17908 notification flag (1-8) that is included in this command.

17909 **Notification Flags #N (mandatory):** The Notification Flags attribute/parameter indicating the command  
 17910 being requested. See 10.4.3.2.1.1 and 10.4.3.2.1.2 for further details.

17911 **10.4.2.3.1.12.3 When Generated**

17912 The GetNotifiedMessage command is generated in response to the flags that have been set within the Noti-  
 17913 ficationFlags#N attribute/parameter within the MirrorReportAttributeResponse command. The BOMD shall  
 17914 be in control of when it sends this command and what commands it shall request. This command should only  
 17915 be generated when there is no specific “GET” command to be used to fetch the information i.e. if the scheme  
 17916 supports GetProfile & GetProfileResponse, the attribute could be configured to inform the BOMD that the  
 17917 mirror requires some load profile information. Therefore, by setting the flag in this command, the BOMD is  
 17918 requesting that the GetProfile command is now sent to it.

17919 The BOMD may choose not to initiate the process if the battery level does not allow it, or if the request is  
 17920 sent too often.

17921 **10.4.2.3.1.12.4 Effect on Receipt**

17922 Dependent on the flags set within the command, the Mirror shall send down the appropriate command to the  
 17923 BOMD.

17924

17925 **10.4.2.3.1.13 Supply Status Response Command**

17926 This command is transmitted by a Metering Device in response to a Change Supply command.

17927 **10.4.2.3.1.13.1 Payload Format**

17928

Figure 10-79. Format of the *Supply Status Response Command Payload*

Octets	4	4	4	1
<b>Data Type</b>	uint32	uint32	UTC	enum8
<b>Field Name</b>	Provider ID (M)	Issuer Event ID (M)	Implementa- tion Date/Time (M)	Supply Status (af- ter implementa- tion) (M)

17929 **10.4.2.3.1.13.2 Payload Details**

17930 **Provider ID (mandatory):** An unsigned 32-bit field containing a unique identifier for the commodity pro-  
 17931 vider to whom this command relates.

17932 **Issuer Event ID (mandatory):** Unique identifier generated by the commodity provider. When new infor-  
 17933 mation is provided that replaces older information for the same time period, this field allows devices to de-  
 17934 termine which information is newer. The value contained in this field is a unique number managed by up-  
 17935 stream servers or a UTC based time stamp (UTCTime data type) identifying when the command was issued.  
 17936 Thus, newer information will have a value in the Issuer Event ID field that is larger than older information.

17937 **Implementation Date/Time (mandatory):** A UTC Time field to indicate the date at which the originating  
17938 command was to be applied.

17939 **Supply Status (mandatory):** An 8-bit enumeration field indicating the status of the energy supply controlled  
17940 by the Metering Device following implementation of the originating command. The enumerated values for  
17941 this field are outlined in Table 10-102.

17942 **Table 10-102. Supply Status Field Enumerations**

Enumerated Value	Status
0x00	Supply OFF
0x01	Supply OFF / ARMED
0x02	Supply ON

17943

17944 **10.4.2.3.1.13.3 When Generated**

17945 This command is transmitted by a Metering Device to indicate that a Change Supply command has been  
17946 successfully executed. It shall be sent if an acknowledgment is requested in the originating command (see  
17947 sub-clause 10.4.3.3.1.12).

17948

17949 **10.4.2.3.1.14 Start Sampling Response Command**

17950 This command is transmitted by a Metering Device in response to a StartSampling command.

17951 **10.4.2.3.1.14.1 Payload Format**

17952 The StartSamplingResponse command payload shall be formatted as illustrated in Figure 10-80.

17953 **Figure 10-80. Format of the StartSamplingResponse Command Payload**

<b>Octets</b>	<b>2</b>
<b>Data Type</b>	uint16
<b>Field Name</b>	Sample ID

17954 **10.4.2.3.1.14.2 Payload Details**

17955 **Sample ID:** 16 Bit Unsigned Integer indicating the ID allocated by the Metering Device for the requested  
17956 Sampling session. If the Metering Device is unable to support a further Sampling session, Sample ID shall  
17957 be returned as 0xFFFF. If valid, the Sample ID shall be used for all further communication regarding this  
17958 Sampling session.

17959 NOTE that the Metering Device may reserve a Sample ID of 0x0000 in order to provide an alternative  
17960 mechanism for retrieving Profile data. This mechanism will allow an increased number of samples to be  
17961 returned than is available via the existing (automatically started) Profile mechanism.

17962

17963 **10.4.3 Client**

17964 **10.4.3.1 Dependencies**

17965 No additional dependencies.

17966 **10.4.3.2 Attributes**

17967 For convenience, the attributes defined in this specification are arranged into sets of related attributes; each  
 17968 set can contain up to 256 attributes. Attribute identifiers are encoded such that the most significant Octet  
 17969 specifies the attribute set and the least significant Octet specifies the attribute within the set. The currently  
 17970 defined attribute sets are listed in Table 10-103.

17971 **Table 10-103. Metering Cluster Client Attribute Sets**

Attribute Set Identifier	Description
0x00	Notification Attribute Set

17972 **10.4.3.2.1 Notification Attribute Set**

17973 The Notification Attribute Set is used to notify battery operated mirrored devices (BOMDs) that the ESI or  
 17974 other HAN device has pending information which should be fetched.

17975 Only clients on a mirror endpoint shall support this attribute set.

17976 When commands / attributes are received into the ESI from the HES or other HAN devices, the ESI will store  
 17977 the corresponding information and set the appropriate bits in the Notification Flag attributes (BitMaps). The  
 17978 ESI shall reset the bit as soon as a ‘Get’ command with the corresponding message type is received and all  
 17979 commands of the appropriate type have been retrieved (this is to allow for multiple commands of the same  
 17980 type).

17981 **Table 10-104. Notification Attribute Set**

Identifi- fier	Name	Type	Range	Ac- cess	De- fault	Manda- tory / Op- tional
0x0000	FunctionalNotification- Flags	map32	0x00000000 - 0xFFFFFFFF	Read	0	O
0x0001	NotificationFlags2	map32	0x00000000 - 0xFFFFFFFF	Read	0	O
0x0002	NotificationFlags3	map32	0x00000000 - 0xFFFFFFFF	Read	0	O
0x0003	NotificationFlags4	map32	0x00000000 - 0xFFFFFFFF	Read	0	O
0x0004	NotificationFlags5	map32	0x00000000 - 0xFFFFFFFF	Read	0	O
0x0005	NotificationFlags6	map32	0x00000000 - 0xFFFFFFFF	Read	0	O
0x0006	NotificationFlags7	map32	0x00000000 - 0xFFFFFFFF	Read	0	O
0x0007	NotificationFlags8	map32	0x00000000 - 0xFFFFFFFF	Read	0	O

17982

17983 **10.4.3.2.1.1 FunctionalNotificationFlags Attribute**

17984 The FunctionalNotificationFlags attribute is implemented as a set of bit flags which are have a predefined  
17985 action associated with a bit that is not based on a specific command, but may require the Mirrored device to  
17986 trigger some additional functionality within the system. The Bit Flags are defined as shown below:

17987

**Table 10-105. Functional Notification Flags**

Bit Number	Waiting Command
0	New OTA Firmware
1	CBKE Update Request
2	Time Sync
3	Reserved
4	Stay Awake Request HAN
5	Stay Awake Request WAN
6-8	Push Historical Metering Data Attribute Set
9-11	Push Historical Prepayment Data Attribute Set
12	Push All Static Data - Basic Cluster
13	Push All Static Data - Metering Cluster
14	Push All Static Data - Prepayment Cluster
15	NetworkKeyActive
16	Display Message
17	Cancel All Messages
18	Change Supply
19	Local Change Supply
20	SetUncontrolledFlowThreshold
21	Tunnel Message Pending
22	Get Snapshot
23	Get Sampled Data
24	New Sub-GHz Channel Masks Available
25	Energy Scan Pending
26	Channel Change Pending
27-31	Reserved

17988

17989 **New OTA Firmware Flag:** will be set by the ESI, when the ESI has new OTA Firmware to send to the  
17990 BOMD. The BOMD can then make the decision on when it starts the OTA upgrade request.

17991 **CBKE Update Request Flag:** requests the BOMD to initiate the CBKE process with the Trust Center to  
17992 replace the link key currently in use.

17993 **Time Sync Request Flag:** requests the BOMD to initiate the time synchronization process with the Time  
17994 server.

17995 **The Stay Awake Request Flags:** will be set by the ESI when the ESI wants to send a command. There are  
17996 two types of the Stay Awake requests, one for HAN requests and one for WAN requests; an implementation  
17997 may react differently depending on the source of the request:

17998 **HAN requests:** The HAN Stay Awake flag should only be used for commands that originate from HAN and  
 17999 not from the ESI that is supporting the commodity of the Mirrored device.

18000 **WAN requests:** The WAN Stay Awake flag should only be used for commands that originate from the  
 18001 backhaul network.

18002

**Table 10-106. Example Usage of Stay Awake Request Flags**

Waiting Command
Schedule Snapshot
Take Snapshot
Start Logging
Get Logging
Get Profile
GetEventLog
ClearEventLog
Reset Demand limit Counter
Read Attribute
Write Attribute

18003

18004 Table 10-106 shows example usage of the Stay Awake Request flags. The most likely use is when profile  
 18005 data or snapshots are required. The commands shown require additional parameters to be sent by the request-  
 18006 ing device to solicit the correct response from the receiver.

18007 A battery operated meter should read the Notification Flags regularly or enable the MirrorReportAttributeRe-  
 18008 sponse command. If the StayAwakeRequest flag is set, the battery operated meter shall poll its parent node  
 18009 at least three times for pending messages. The polling interval shall be configurable and not less than 250  
 18010 ms.

18011 The ESI shall try to send commands after the BOMD has pushed meter readings or read the Notification  
 18012 Flags. After reception of a command, the BOMD shall read the NotificationFlags again. If the ESI has suc-  
 18013 cessfully transmitted all pending commands, it shall reset the StayAwakeRequest flag.

18014 Nevertheless, the BOMD can decide to go to sleep if the StayAwakeRequest flag is not reset after consecutive  
 18015 reads of the NotificationFlags attribute or if it is required by its power supply constraints.

18016 **Push Historical Metering Data Attribute Set:** This notification flag requests the BOMD to push a sub set  
 18017 of the historical consumption information found within the Metering cluster’s ‘Historical Consumption At-  
 18018 tribute Set’. The format of the bits is defined within Table 10-107.

18019

**Table 10-107. Push Historical Metering Data Definition**

Bit8	Bit7	Bit6	Description
0	0	1	The Meter shall push up the attributes that relate to the “Day” from the Metering cluster and that the device supports
0	1	0	The Meter shall push up the attributes that relate to the “Week” from the Metering cluster and that the device supports
1	1	0	The Meter shall push up the attributes that relate to the “Month” from the Metering cluster and that the device supports
1	1	1	The Meter shall push up the attributes that relate to the “Year” from the Metering cluster and that the device supports

18020

18021 **Push Historical Payment Data attribute Set:** This notification flag requests the BOMD to push a sub set  
 18022 of the historical consumption cost information found within the Prepayment cluster’s ‘Historical Cost Con-  
 18023 sumption Attribute Set’. The format of the bits is defined within Table 10-108.

18024 **Table 10-108. Push Historical Payment Data Attribute Definition**

Bit11	Bit10	Bit9	Description
0	0	1	The Meter shall push up the attributes that relate to the “Day” from the Prepayment cluster and that the device supports
0	1	0	The Meter shall push up the attributes that relate to the “Week” from the Prepayment cluster and that the device supports
1	1	0	The Meter shall push up the attributes that relate to the “Month” from the Prepayment cluster and that the device supports
1	1	1	The Meter shall push up the attributes that relate to the “Year” from the Prepayment cluster and that the device supports

18025  
 18026 **Push All Static Data - Basic Cluster:** This notification flag requests the BOMD to push all of the attributes  
 18027 within the Basic cluster that are supported by the mirrored meter.

18028 **Push all static Data - Metering Cluster:** This notification flag requests the BOMD to push all of the attrib-  
 18029 utes within the Metering cluster that are supported by the mirrored meter.

18030 **Push All Static Data - Prepayment Cluster:** This notification flag requests the BOMD to push all of the  
 18031 attributes within the Prepayment cluster that are supported by the mirrored meter.

18032 **Network Key Active:** When this notification flag has been set, the meter shall check with the TC to update  
 18033 the network key.

18034 **Display Message:** When this notification flag has been set, the meter shall send a Get Last Message com-  
 18035 mand to the associated Messaging cluster server (see 10.5.3.3.1 for further details).

18036 **Cancel All Messages:** When this notification flag has been set, the meter shall send a GetMessageCancell-  
 18037 ation command to the associated Messaging cluster server (see 10.5.3.3.3 for further details).

18038 **Change Supply Message:** When this notification flag has been set, the meter shall send a GetNotifiedMes-  
 18039 sage command to the mirror.

18040 **Local Change Supply Message:** When this notification flag has been set, the meter shall send a GetNoti-  
 18041 fiedMessage command to the mirror.

18042 **SetUncontrolledFlowThreshold Message:** When this notification flag has been set, the meter shall send a  
 18043 GetNotifiedMessage command to the mirror.

18044 **Tunnel Message Pending:** When set, this notification flag indicates to the BOMD that a message is pending  
 18045 retrieval via the tunnel. If any message(s) is/are pending, then the flag shall be cleared when the last pending  
 18046 message is retrieved.

18047 **Get Snapshot Message:** When this notification flag has been set, the meter shall send a GetNotifiedMessage  
 18048 command to the mirror.

18049 **Get Sampled Data Message:** When this notification flag has been set, the meter shall send a GetNotified-  
 18050 Message command to the mirror.

18051 **New Sub-GHz Channel Masks Available Flag:** will be set by the ESI when the ESI has new Sub-GHz  
 18052 channel masks available for the BOMD. The meter shall fetch the latest Sub-GHz channel mask attributes  
 18053 from the ESI.

18054 **Energy Scan Pending Flag:** will be set by the ESI when the ESI requires the BOMD to remain asleep and  
 18055 not reawaken for a period equal to the device’s Reporting Interval following the current activity i.e. unsolic-  
 18056 ited wake-ups shall be suppressed during this period. See [Z9] section 5.14.7 for further details.

18057 **Channel Change Pending Flag:** will be set by the ESI when the Coordinator’s Network Manager intends  
 18058 to change the operating sub-GHz channel. When this flag has been set, the BOMD shall read the Sub-GHz  
 18059 cluster Channel Change server attribute to determine the new sub-GHz page/channel. See [Z9] section 5.14.7  
 18060 for further details.

18061 **10.4.3.2.1.2 NotificationFlags Attribute**

18062 NotificationFlags2 to NotificationFlags8 are 32-bit bitmaps that each represent a series of flags. Each flag  
 18063 represents an outstanding command that the Mirror is holding on behalf of the BOMD. Each flag represents  
 18064 a different command. The format of these attributes is dictated by the scheme that is currently in operation.  
 18065

18066 **10.4.3.3 Client Commands**

18067 **10.4.3.3.1 Commands Generated**

18068 The command IDs generated by the Metering client cluster are listed in Table 10-109.

18069 **Table 10-109. Generated Command IDs for the Metering Client**

Command Identifier Field Value	Description	M
0x00	<i>Get Profile</i>	O
0x01	<i>Request Mirror Response</i>	O
0x02	<i>Mirror Removed</i>	O
0x03	<i>Request Fast Poll Mode</i>	O
0x04	<i>ScheduleSnapshot</i>	O
0x05	<i>TakeSnapshot</i>	O
0x06	<i>GetSnapshot</i>	O
0x07	<i>StartSampling</i>	O
0x08	<i>GetSampledData</i>	O
0x09	<i>MirrorReport AttributeResponse</i>	O
0x0A	<i>ResetLoadLimit Counter</i>	O
0x0B	<i>Change Supply</i>	O
0x0C	<i>Local Change Supply</i>	O
0x0D	<i>SetSupplyStatus</i>	O
0x0E	<i>SetUncontrolledFlowThreshold</i>	O

18070 **10.4.3.3.1.1 Get Profile Command**

18071 The Get Profile command payload shall be formatted as illustrated in Figure 10-81.

18072

**Figure 10-81. Format of the *Get Profile* Command Payload**

<b>Octets</b>	1	4	1
<b>Data Type</b>	enum8	UTC	uint8
<b>Field Name</b>	Interval Channel	End Time	NumberOfPeriods

18073 **10.4.3.3.1.1 Payload Details**

18074 **Interval Channel:** Enumerated value used to select the quantity of interest returned by the GetProfileResponse command. The Interval Channel values are listed in Table 10-110.

18075  
18076 **Table 10-110. Interval Channel Values**

Enumerated Value	Description
0	Consumption Delivered
1	Consumption Received
2	Reactive Consumption Delivered
3	Reactive Consumption Received
4	Reserved <sup>198</sup>

18077

18078 **EndTime:** 32-bit value (in UTC) used to select an Intervals block from all the Intervals blocks available. The  
18079 Intervals block returned is the most recent block with its EndTime equal or older to the one provided. The  
18080 most recent Intervals block is requested using an End Time set to 0x00000000, subsequent Intervals block  
18081 are requested using an End time set to the EndTime of the previous block - (number of intervals of the  
18082 previous block \* ProfileIntervalPeriod).

18083 **NumberOfPeriods:** Represents the number of intervals being requested. This value cannot exceed the  
18084 size stipulated in the MaxNumberOfPeriodsDelivered attribute. If more intervals are requested than can be  
18085 delivered, the GetProfileResponse will return the number of intervals equal to MaxNumberOfPeriodsDeliv-  
18086 ered. If fewer intervals are available for the time period, only those available are returned.

18087 **10.4.3.3.1.1.2 When Generated**

18088 The GetProfile command is generated when a client device wishes to retrieve a list of captured Energy, Gas  
18089 or water consumption for profiling purposes. Due to the potentially large amount of profile data available,  
18090 the client device should store previously gathered data and only request the most current data. When initially  
18091 gathering significant amounts of historical interval data, the GetProfile command should not be issued any  
18092 more frequently than 7.5 seconds to prevent overwhelming the ZigBee network.

18093 **10.4.3.3.1.1.3 Command Processing Response**

18094 If failure occurs in recognizing or processing the payload of the GetProfile command, the appropriate  
18095 enumerated status code(as defined in Chapter 2) will be returned. On success, a non-Default Response is  
18096 returned without a status code.

18097 **10.4.3.3.1.1.4 Effect on Receipt**

<sup>198</sup> This value is reserved so that the Interval Channel enumerations align with those for the Sample Type



18098 On receipt of this command, the device shall send a GetProfileReponse command (see sub-clause  
 18099 10.4.2.3.1.1).

18100 **10.4.3.3.1.2 Request Mirror Response Command**

18101 The Request Mirror Response Command allows the ESI to inform a sleepy Metering Device it has the  
 18102 ability to store and mirror its data.

18103 **10.4.3.3.1.2.1 Payload Format**

18104 The Request Mirror Response command payload shall be formatted as illustrated in Figure 10-82.

18105 **Figure 10-82. Format of the Request Mirror Response Command Payload**

<b>Octets</b>	2
<b>Data Type</b>	uint16
<b>Field Name</b>	EndPoint ID

18106 **10.4.3.3.1.2.2 Payload Details**

18107 **EndPoint ID:** 16 Bit Unsigned Integer indicating the End Point ID to contain the Metering Devices meter  
 18108 data. Valid End Point ID values are 0x0001 to 0x00F0. If the ESI is able to mirror the Metering Device data,  
 18109 the low byte of the unsigned 16 bit integer shall be used to contain the eight bit EndPoint ID. If the ESI is  
 18110 unable to mirror the Metering Device data, EndPoint ID shall be returned as 0xFFFF. All other EndPoint  
 18111 ID values are reserved. If valid, the Metering device shall use the EndPoint ID to forward its metered data.

18112

18113 **10.4.3.3.1.3 Mirror Removed Command**

18114 The Mirror Removed Command allows the ESI to inform a sleepy Metering Device mirroring support has  
 18115 been removed or halted.

18116 **10.4.3.3.1.3.1 Payload Format**

18117 The Mirror Removed command payload shall be formatted as illustrated in Figure 10-83.

18118 **Figure 10-83. Format of the Mirror Removed Command Payload**

<b>Octets</b>	2
<b>Data Type</b>	uint16
<b>Field Name</b>	Removed EndPoint ID

18119 **10.4.3.3.1.3.2 Payload Details**

18120 **Removed EndPoint ID:** 16 Bit Unsigned Integer indicating the End Point ID previously containing the  
 18121 Metering Device’s meter data.

18122

18123 **10.4.3.3.1.4 Request Fast Poll Mode Command**

18124 **10.4.3.3.1.4.1 Payload Format**

18125 The Request Fast Poll Mode shall be formatted as illustrated in Figure 10-84.

18126

**Figure 10-84. Format of the *Request Fast Poll Mode Command Payload***

<b>Octets</b>	1	1
<b>Data Type</b>	uint8	uint8
<b>Field Name</b>	Fast Poll Update Period (seconds)	Duration (minutes)

18127 **10.4.3.3.1.4.2 Payload Details**

18128 **Fast Poll Update Period:** Desired fast poll period not to be less than the FastPollUpdatePeriod attribute.

18129 **Duration:** Desired duration for the server to remain in fast poll mode not to exceed 15 minutes as  
18130 specified in sub-clause 10.4.4.2.

18131 **10.4.3.3.1.4.3 When Generated**

18132 The Request Fast Poll Mode command is generated when the metering client wishes to receive near real-  
18133 time updates of InstantaneousDemand. Fast poll mode shall only be requested as a result of user interaction  
18134 (for example, the pushing of a button or activation of fast poll mode by a menu choice).

18135 **10.4.3.3.1.4.4 Effect on Receipt**

18136 The metering device may continuously update InstantaneousDemand as measurements are acquired, but at a  
18137 minimum InstantaneousDemand must be updated at the end of each FastPollUpdatePeriod.

18138 **10.4.3.3.1.5 ScheduleSnapshot Command**

18139 This command is used to set up a schedule of when the device shall create snapshot data. See section 10.4.4.5  
18140 for further details. It is recommended that schedules are persisted across a reboot.

18141 **10.4.3.3.1.5.1 Payload Format**

**Figure 10-85. Format of the *ScheduleSnapshot Command Payload***

<b>Octets</b>	4	1	1	<b>Variable</b>
<b>Data Type</b>	uint32	uint8	uint8	
<b>Field Name</b>	Issuer Event ID (M)	Command Index (M)	Total Number of Commands (M)	Snapshot Schedule Payload (M)

18143 **10.4.3.3.1.5.2 Payload Details**

18144 **Issuer Event ID (mandatory):** Unique identifier generated by the commodity provider. When new infor-  
18145 mation is provided that replaces older information for the same time period, this field allows devices to de-  
18146 termine which information is newer. The value contained in this field is a unique number managed by up-  
18147 stream servers or a UTC based time stamp (UTCTime data type) identifying when the snapshot command  
18148 was issued. Thus, newer information will have a value in the Issuer Event ID field that is larger than older  
18149 information. This is required when the snapshot data needs to be transmitted over several messages, allowing  
18150 for the client to easily identify the set of messages that form a group.

18151 **Command Index (mandatory):** The CommandIndex is used to count the payload fragments for the case  
18152 where the entire payload does not fit into one message. The CommandIndex starts at 0 and is incremented  
18153 for each fragment belonging to the same command.

18154 **Total Number of Commands (mandatory):** In the case where the entire payload does not fit into one mes-  
18155 sage, the Total Number of Commands field indicates the total number of sub-commands in the message.

18156 **SnapshotSchedulePayload (mandatory):**

18157

**Figure 10-86. SnapshotSchedulePayload Format**

<b>1</b>	<b>4</b>	<b>3</b>	<b>1</b>	<b>4</b>
uint8	UTC	uint24	enum8	map32
Snapshot Schedule ID (M)	Snapshot Start Time (M)	Snapshot Schedule (M)	Snapshot Payload Type (M)	Snapshot Cause (M)

18158

18159 **Snapshot Schedule ID (mandatory):** The unique ID of the Snapshot schedule; a range of 1-254 is supported,  
 18160 denoting a maximum of 254 different schedules that could be set up within the device.

18161 **Snapshot Start Time (mandatory):** The Snapshot Start Time denotes the date/time when the Snapshot  
 18162 schedule is to start.

18163 **Snapshot Schedule (mandatory):** A 24-bit value indicating the schedule that should be used for the snap-  
 18164 shot. The snapshot schedule bit field is formatted as indicated in Table 10-111.

18165

**Table 10-111. Snapshot Schedule BitMap**

Bit	Description
0-19	The frequency that the snapshot should be taken in. The format of the duration is defined by bits 20-21
20-21	Frequency Type of the Snapshot 00 = Day 01 = Week 10 = Month 11 = Reserved
22-23	Wild-card Frequency of the Snapshot 00 = Start of 01 = End of 10 = Wild-card not used 11 = Reserved

18166

18167 **SnapshotPayloadType (mandatory):** The SnapshotPayloadType is an 8-bit enumerator defining the format  
 18168 of the SnapshotPayload required. The different snapshot types are listed in Table 10-99. The server selects  
 18169 the SnapshotPayloadType based on the charging scheme in use.

18170 **Snapshot Cause (mandatory):** A 32-bit BitMap indicating the cause of the snapshot. The snapshot cause  
 18171 values are listed in Table 10-98.

18172

18173 **10.4.3.3.1.6 TakeSnapshot Command**

18174 This command is used to instruct the cluster server to take a single snapshot. See section 10.4.4.5 for further  
 18175 details.

18176 **10.4.3.3.1.6.1 Payload Format**

18177

**Figure 10-87. Format of the TakeSnapshot Command Payload**

<b>Octets</b>	<b>4</b>
<b>Data Type</b>	map32

<b>Field Name</b>	Snapshot Cause (M)
-------------------	--------------------

18178 **10.4.3.3.1.6.2 Payload Details**

18179 **Snapshot Cause (mandatory):** A 32-bit BitMap indicating the cause of the snapshot. The snapshot cause  
18180 values are listed in Table 10-98. Note that the Manually Triggered from Client flag shall additionally be set  
18181 for all Snapshots triggered in this manner.

18182 **10.4.3.3.1.6.3 Effect on Receipt**

18183 On receipt of this command, the server shall take and store a snapshot with cause 10 (Manually Triggered  
18184 from Client) set in addition to the requested cause (see Table 10-98).

18185

18186 **10.4.3.3.1.7 GetSnapshot Command**

18187 This command is used to request snapshot data from the cluster server. See section 10.4.4.5 for further details.

18188 **10.4.3.3.1.7.1 Payload Format**

18189 **Figure 10-88. Format of the *GetSnapshot* Command Payload**

Octets	4	4	1	4
<b>Data Type</b>	UTC	UTC	uint8	map32
<b>Field Name</b>	Earliest Start Time (M)	Latest End Time (M)	Snapshot Offset (M)	Snapshot Cause (M)

18190 **10.4.3.3.1.7.2 Payload Details**

18191 **Earliest Start Time (mandatory):** A UTC Timestamp indicating the earliest time of a snapshot to be re-  
18192 turned by a corresponding Publish Snapshot command. Snapshots with a time stamp equal to or greater than  
18193 the specified Earliest Start Time shall be returned.

18194 **Latest End Time (mandatory):** A UTC Timestamp indicating the latest time of a snapshot to be returned  
18195 by a corresponding Publish Snapshot command. Snapshots with a time stamp less than the specified Latest  
18196 End Time shall be returned.

18197 **Snapshot Offset (mandatory):** Where multiple snapshots satisfy the selection criteria specified by the other  
18198 fields in this command, this field identifies the individual snapshot to be returned. An offset of zero (0x00)  
18199 indicates that the first snapshot satisfying the selection criteria should be returned, 0x01 the second, and so  
18200 on.

18201 **Snapshot Cause (mandatory):** This field is used to select only snapshots that were taken due to a specific  
18202 cause. The allowed values are listed in Table 10-98. Setting this field to 0xFFFFFFFF indicates that all snap-  
18203 shots should be selected, irrespective of the cause.

18204 **10.4.3.3.1.7.3 Effect on Receipt**

18205 On receipt of this command, the server shall respond with one or more Publish Snapshot commands repre-  
18206 senting the first (or next) snapshot meeting the selection criteria and Snapshot Offset value detailed in this  
18207 command. Details of the Publish Snapshot command are detailed in sub-clause 10.4.2.3.1.7.

18208 A Default Response with status NOT\_FOUND shall be returned if the server does not have a snapshot which  
18209 satisfies the received parameters (e.g. no snapshot with a timestamp between the Earliest Start Time and the  
18210 Latest End Time).

18211

18212 **10.4.3.3.1.8 StartSampling Command**

18213 The sampling mechanism allows a set of samples of the specified type of data to be taken, commencing at  
 18214 the stipulated start time. This mechanism may run concurrently with the capturing of profile data, and may  
 18215 refer to the same parameters, albeit possibly at a different sampling rate.

18216 **10.4.3.3.1.8.1 Payload Format**

18217 **Figure 10-89. Format of the StartSampling Command Payload**

Octets	4	4	1	2	2
Data Type	uint32	UTC	enum8	uint16	uint16
Field Name	Issuer Event ID (M)	StartSamplin g Time (M)	SampleType (M)	Sample-Request Inter- val (M)	MaxNumberof Samples (M)

18218 **10.4.3.3.1.8.2 Payload Details**

18219 **Issuer Event ID (mandatory):** Unique identifier generated by the commodity provider. When new infor-  
 18220 mation is provided that replaces older information for the same time period, this field allows devices to de-  
 18221 termine which information is newer. The value contained in this field is a unique number managed by up-  
 18222 stream servers or a UTC based time stamp (UTCTime data type) identifying when the command was issued.  
 18223 Thus, newer information will have a value in the Issuer Event ID field that is larger than older information.  
 18224 Commands should be ignored if the value of the Issuer Event ID is equal to or less than the previous value;  
 18225 a device MAY return a Default Response command in this case<sup>199</sup>.

18226 **StartSamplingTime (mandatory):** A UTC Time field to denote the time at which the sampling should start.  
 18227 A start Date/Time of 0x00000000 shall indicate that the command should be executed immediately. A start  
 18228 Date/Time of 0xFFFFFFFF shall cause an existing StartSampling command with the same Issuer Event ID  
 18229 to be cancelled.

18230 **SampleType (mandatory):** An 8 bit enumeration that identifies the type of data being sampled. Possible  
 18231 values are defined in Table 10-100.

18232 **SampleRequestInterval (mandatory):** An unsigned 16-bit field representing the interval or time in seconds  
 18233 between samples.

18234 **MaxNumberofSamples (mandatory):** A 16 bit unsigned integer that represents the number of samples to  
 18235 be taken.

18236 **10.4.3.3.1.8.3 Effect on Receipt**

18237 On receipt of the StartSampling command, in all cases except for the cancellation of a session,<sup>200</sup> the Meter-  
 18238 ing Device shall respond with a StartSamplingResponse command indicating the Sample ID allocated to this  
 18239 Sampling session. If the Metering Device is unable to support a further Sampling session, Sample ID shall  
 18240 be returned as 0xFFFF. See 10.4.2.3.1.14 for further details. When responding to the cancellation of a session  
 18241 (StartSamplingTime = 0xFFFFFFFF), the Metering Device shall send either a StartSamplingResponse com-  
 18242 mand as detailed above or alternatively a Default Response command<sup>201</sup>.

18243

18244 **10.4.3.3.1.9 GetSampledData Command**

18245 This command is used to request sampled data from the server. Note that it is the responsibility of the client  
 18246 to ensure that it does not request more samples than can be held in a single command payload.

<sup>199</sup> CCB 2010

<sup>200</sup> CCB 2286

<sup>201</sup> CCB 2286

18247 **10.4.3.3.1.9.1**

**Payload Format**

Figure 10-90. Format of the *GetSampledData* Command Payload

Octets	2	4	1	2
<b>Data Type</b>	uint16	UTC	enum8	uint16
<b>Field Name</b>	SampleID (M)	Earliest-SampleTime (M)	Sample-Type (M)	NumberOfSamples (M)

18249 **10.4.3.3.1.9.2**

**Payload Details**

18250 **SampleID (mandatory):** Unique identifier allocated to this Sampling session. This field allows devices to  
18251 match response data with the appropriate request. See 10.4.2.3.1.14 for further details.

18252 **EarliestSampleTime (mandatory):** A UTC Timestamp indicating the earliest time of a sample to be  
18253 returned. Samples with a timestamp equal to or greater than the specified EarliestSampleTime shall be returned.

18254 **SampleType (mandatory):** An 8 bit enumeration that identifies the required type of sampled data. Possible  
18255 values are defined in Table 10-100.

18256 **NumberOfSamples (mandatory):** Represents the number of samples being requested, This value cannot  
18257 exceed the size stipulated in the MaxNumberOfSamples field in the StartSampling command. If more samples  
18258 are requested than can be delivered, the GetSampledDataResponse command will return the number of sam-  
18259 ples equal to the MaxNumberOfSamples field. If fewer samples are available for the time period, only those  
18260 available are returned.

18261 **10.4.3.3.1.9.3**

**Effect on Receipt**

18262 On receipt of this command, the server shall respond with a GetSampledDataResponse command containing  
18263 the samples meeting the selection criteria detailed in this command. Details of the GetSampledDataResponse  
18264 command are detailed in sub-clause 10.4.2.3.1.8.

18265 A Default Response with status NOT\_FOUND shall be returned if the server does not have sample data  
18266 which satisfies the received parameters.

18267

18268 **10.4.3.3.1.10 MirrorReportAttributeResponse Command**

18269 This command is sent in response to the ReportAttribute command when the MirrorReporting attribute is set.

18270 **10.4.3.3.1.10.1**

**Payload Format**

Figure 10-91. Format of the *MirrorReportAttributeResponse* Command Payload

Octets	1	Variable
<b>Data Type</b>	uint8	map32
<b>Field Name</b>	Notification Scheme (M)	Notification Flags #N (M)

18272 **10.4.3.3.1.10.2**

**Payload Details**

18273 The payload of this command is defined within the ConfigureNotificationScheme command.

18274 **Notification Scheme (mandatory):** An unsigned 8-bit integer that allows for the pre-loading of the Notifi-  
18275 cation Flags bit mapping to commands. Figure 10-74 details the schemes that are currently supported within  
18276 the Smart Energy Standard.

18277 **Notification Flags #N (mandatory):** see sections 10.4.3.2.1.1 and 10.4.3.2.1.2.

18278 **10.4.3.3.1.10.3 When Generated**

18279 The MirrorReportAttributeResponse command is generated in response to the ReportAttribute command  
 18280 when the MirrorReporting attribute is set. The MirrorReportAttributeResponse command is sent from the  
 18281 Mirror to the meter.

18282 **10.4.3.3.1.10.4 Effect on Receipt**

18283 On receipt of the MirrorReportAttributeResponse, the meter shall check the flags contained within the pay-  
 18284 load. It is then up to the meter to request any information that is waiting on the ESI.

18285

18286 **10.4.3.3.1.11 ResetLoadLimitCounter Command**

18287 The ResetLoadLimitCounter command shall cause the LoadLimitCounter attribute to be reset (see  
 18288 10.4.2.2.7.7 for further details).

18289 **10.4.3.3.1.11.1 Payload Format**

18290 **Figure 10-92. Format of the *ResetLoadLimitCounter* Command Payload**

<b>Octets</b>	<b>4</b>	<b>4</b>
<b>Data Type</b>	uint32	uint32
<b>Field Name</b>	Provider ID (M)	Issuer Event ID (M)

18291 **10.4.3.3.1.11.2 Payload Details**

18292 **Provider ID (mandatory):** An unsigned 32-bit field containing a unique identifier for  
 18293 the commodity provider.

18294 **Issuer Event ID (mandatory):** Unique identifier generated by the commodity provider. This field allows  
 18295 devices to determine if a new command has been issued. The value contained in this field is a unique number  
 18296 managed by upstream servers or a UTC based time stamp (UTCTime data type) identifying when the com-  
 18297 mand was issued. Thus, a newer command will have a value in the Issuer Event ID field that is larger than  
 18298 previous versions of the command.

18299

18300 **10.4.3.3.1.12 Change Supply Command**

18301 This command is sent from the Head-end or ESI to the Metering Device to instruct it to change the status of  
 18302 the valve or load switch, i.e. the supply.

18303 **10.4.3.3.1.12.1 Payload Format**

18304 **Figure 10-93. Format of the *Change Supply* Command Payload**

<b>Octets</b>	<b>4</b>	<b>4</b>	<b>4</b>	<b>4</b>	<b>1</b>	<b>1</b>
<b>Data Type</b>	uint32	uint32	UTC	UTC	enum8	map8
<b>Field Name</b>	Provider ID (M)	Issuer Event ID (M)	Request Date/ Time (M)	Implementa- tion Date/Time (M)	Proposed Supply Status (after Implementa- tion)	Supply Control Bits

18305 **10.4.3.3.1.12.2 Payload Details**

18306 **Provider ID (mandatory):** An unsigned 32-bit field containing a unique identifier for the commodity pro-  
18307 vider to whom this command relates.

18308 **Issuer Event ID (mandatory):** Unique identifier generated by the commodity provider. When new infor-  
18309 mation is provided that replaces older information for the same time period, this field allows devices to de-  
18310 termine which information is newer. The value contained in this field is a unique number managed by up-  
18311 stream servers or a UTC based time stamp (UTCTime data type) identifying when the command was issued.  
18312 Thus, newer information will have a value in the Issuer Event ID field that is larger than older information.

18313 **Request Date/Time (mandatory):** A UTC Time field to indicate the date and time at which the supply  
18314 change was requested.

18315 **Implementation Date/Time (mandatory):** A UTC Time field to indicate the date at which the supply  
18316 change is to be applied. An Implementation Date/Time of 0x00000000 shall indicate that the command  
18317 should be executed immediately. An Implementation Date/Time of 0xFFFFFFFF shall cause an existing but  
18318 pending Change Supply command with the same Provider ID and Issuer Event ID to be cancelled (the status  
18319 of the supply will not change but the Proposed Change Supply Implementation Time attribute shall be reset  
18320 to zero).

18321 **Proposed Supply Status (after Implementation):** An 8-bit enumeration field indicating the status of the  
18322 energy supply controlled by the Metering Device following implementation of this command. The enumer-  
18323 ated values for this field are outlined in Table 10-102.

18324 **Supply Control Bits:** An 8-bit BitMap where the least significant nibble defines the Supply Control bits, the  
18325 encoding of which is outlined in Table 10-112:

18326

**Table 10-112. Supply Control Bits**

Bits	Description
0	Acknowledge Required
1	Reserved
2	Reserved
3	Reserved

18327

18328 **Acknowledge Required:** Indicates that a Supply Status Response command is to be sent in response to this  
18329 command. Note that the Supply Status Response command will only be returned to the originator when the  
18330 Change Supply command has been successfully executed.

18331 **10.4.3.3.1.12.3 When Generated**

18332 A Head-end or ESI may send an INTERRUPT, ARM or (if allowed) RESTORE command to a metering  
18333 device.

18334 The execution of an INTERRUPT or ARM command may be delayed, as indicated by the Implementation  
18335 Date/Time field; these commands shall only come from a Head-End via an ESI. A subsequent command with  
18336 a new Implementation Date/Time shall override an existing delayed command. A new command with an  
18337 Implementation Date/Time of 0x00000000 shall be executed immediately, but shall not cancel an existing  
18338 delayed command; to override an existing delayed command with a command to be executed immediately,  
18339 a command to cancel the existing command should first be sent followed by the new command to be executed  
18340 immediately (see notes on Implementation Date/ Time field in 10.4.3.3.1.12.2 for further details).

18341 The addition of credit or selection of Emergency credit shall not cause a delayed INTERRUPT command to  
18342 be cancelled (these will be cancelled by the Head-End and a new supply control command sent down).

18343 **10.4.3.3.1.12.4 Effect on Receipt**



18344 If required, a Supply Status Response command shall be returned to the originator when the Change Supply  
 18345 command has been successfully executed (see 10.4.2.3.1.13 for further details). Where the Supply Status  
 18346 Response command is NOT enabled, a Default Response message may be returned in response to the Change  
 18347 Supply command (subject to the setting of the associated Disable Default Response bit in the received com-  
 18348 mand)<sup>202</sup>.

18349 A Default Response, indicating ‘Unauthorized’ (NOT\_AUTHORIZED), shall be immediately returned to an  
 18350 originator requesting a supply change that is not allowed in the current application.

18351 A Default Response, indicating ‘Unavailable’ (UNSUP\_COMMAND<sup>203</sup>), shall be immediately returned to  
 18352 an originator requesting a supply change by a metering device that is incapable of carrying out the action  
 18353 (e.g. an INTERRUPT command to a metering device that has no contactor).

18354 A Default Response, indicating INVALID\_VALUE, shall be immediately returned to an originator request-  
 18355 ing a supply change containing a non-zero Implementation Date/Time that is less than or equal to the current  
 18356 date/time (i.e. is in the past).

18357 **10.4.3.3.1.13 Local Change Supply Command**

18358 This command is a simplified version of the Change Supply command, intended to be sent from an IHD to a  
 18359 meter as the consequence of a user action on the IHD. Its purpose is to provide a local disconnection/recon-  
 18360 nection button on the IHD in addition to the one on the meter.

18361 **10.4.3.3.1.13.1 Payload Format**

18362 **Figure 10-94. Format of the Local Change Supply Command Payload**

<b>Octets</b>	<b>1</b>
<b>Data Type</b>	enum8
<b>Field Name</b>	Proposed Supply Status

18363 **10.4.3.3.1.13.2 Payload Details**

18364 **Proposed Supply Status:** An 8-bit enumeration field indicating the status of the energy supply controlled  
 18365 by the Metering Device following implementation of this command. The enumerated values for this field are  
 18366 outlined in Table 10-113:

18367 **Table 10-113. Local Change Supply: Supply Status Field Enumerations**

<b>Enumerated Value</b>	<b>Description</b>
0x00	Reserved
0x01	Supply OFF / ARMED
0x02	Supply ON

18368

18369 **10.4.3.3.1.13.3 When Generated**

18370 An IHD may only request an OFF/ARMED or ON status for the supply. This corresponds to a local discon-  
 18371 nection or reconnection (from Armed state) of the supply, similar to what can be achieved with a button  
 18372 normally present on electricity meters equipped with a contactor.

18373 **10.4.3.3.1.13.4 Effect on Receipt**

18374 No Supply Status Response command shall be returned to the originator.

<sup>202</sup> CCB 2023

<sup>203</sup> CCB 2477 new name for status code cleanup

18375 A Default Response, indicating ‘Unauthorized’ (NOT\_AUTHORIZED), shall be immediately returned to an  
18376 originator requesting a supply change that is not allowed in the current application.

18377 A Default Response, indicating ‘Unavailable’ (UNSUP\_COMMAND<sup>204</sup>), shall be immediately returned to  
18378 an originator requesting a supply change by a metering device that is incapable of carrying out the action  
18379 (e.g. an INTERRUPT command to an electricity meter that has no contactor or to a gas meter for which this  
18380 command is not allowed).

18381

18382 **10.4.3.3.1.14 SetSupplyStatus Command**

18383 This command is used to specify the required status of the supply following the occurrence of certain events  
18384 on the meter. The meter shall check these requirements to understand whether the supply should be disabled  
18385 or enabled following one of these events.

18386 **10.4.3.3.1.14.1 Payload Format**

18387 **Figure 10-95. Format of the SetSupplyStatus Command Payload**

<b>Octets</b>	<b>4</b>	<b>1</b>	<b>1</b>	<b>1</b>	<b>1</b>
<b>Data Type</b>	uint32	enum8	enum8	enum8	enum8
<b>Field Name</b>	Issuer Event ID (M)	Supply Tamper State (M):	SupplyDepletion State (M):	Supply Uncontrolled FlowState (M):	LoadLimit Supply State (M):

18388 **10.4.3.3.1.14.2 Payload Details**

18389 **Issuer Event ID (mandatory):** Unique identifier generated by the commodity provider. When new infor-  
18390 mation is provided that replaces older information for the same time period, this field allows devices to de-  
18391 termine which information is newer. The value contained in this field is a unique number managed by up-  
18392 stream servers or a UTC based time stamp (UTCTime data type) identifying when the command was issued.  
18393 Thus, newer information will have a value in the Issuer Event ID field that is larger than older information.

18394 **SupplyTamperState (mandatory):** The SupplyTamperState indicates the required status of the supply fol-  
18395 lowing the detection of a tamper event within the metering device. The enumerated values for this field are  
18396 outlined in Table 10-114.

18397 **SupplyDepletionState (mandatory):** The SupplyDepletionState indicates the required status of the supply  
18398 following detection of a depleted battery within the metering device. The enumerated values for this field are  
18399 outlined in Table 10-114.

18400 **SupplyUncontrolledFlowState (mandatory):** The SupplyUncontrolledFlowState indicates the required sta-  
18401 tus of the supply following detection of an uncontrolled flow event within the metering device. The enumer-  
18402 ated values for this field are outlined in Table 10-114.

18403 **LoadLimitSupplyState (mandatory):** The LoadLimitSupplyState indicates the required status of the supply  
18404 once the device is in a load limit state. The enumerated values for this field are outlined in Table 10-114.

18405

**Table 10-114. SetSupplyStatus: Field Enumerations**

Enumerated Value	Description
0x00	Supply OFF
0x01	Supply OFF / ARMED
0x02	Supply ON
0x03	Supply UNCHANGED

<sup>204</sup> CCB 2477 new name for status code cleanup

18406

18407 **10.4.3.3.1.15 SetUncontrolledFlowThreshold Command**

18408 This command is used to update the ‘Uncontrolled Flow Rate’ configuration data used by flow meters.

18409 **10.4.3.3.1.15.1 Payload Format**

18410 **Figure 10-96. Format of the SetUncontrolledFlowThreshold Command Payload**

<b>Octets</b>	<b>4</b>	<b>4</b>	<b>2</b>	<b>1</b>	<b>2</b>	<b>2</b>
<b>Data Type</b>	uint32	uint32	uint16	enum8	uint16	uint16
<b>Field Name</b>	Provider ID (M)	Issuer Event ID (M)	Uncontrolled Flow Threshold (M)	Unit of Measure (M)	Multiplier (M)	Divisor (M)

18411

<b>Octets</b>	<b>1</b>	<b>2</b>
<b>Data Type</b>	uint8	uint16
<b>Field Name</b>	Stabilisation Period (M)	Measurement Period (M)

18412 **10.4.3.3.1.15.2 Payload Details**

18413 **Provider ID (mandatory):** An unsigned 32-bit field containing a unique identifier for the commodity provider to whom this command relates.

18415 **Issuer Event ID (mandatory):** Unique identifier generated by the commodity provider. When new information is provided that replaces older information for the same time period, this field allows devices to determine which information is newer. The value contained in this field is a unique number managed by upstream servers or a UTC based time stamp (UTCTime data type) identifying when the command was issued. Thus, newer information will have a value in the Issuer Event ID field that is larger than older information.

18420 **Uncontrolled Flow Threshold (mandatory):** The threshold above which a flow meter (e.g. Gas or Water) shall detect an uncontrolled flow. A value of 0x0000 indicates the feature is unused.

18422 **Unit of Measure (mandatory):** An enumeration indicating the unit of measure to be used in conjunction with the Uncontrolled Flow Threshold attribute. The enumeration used for this field shall match one of the UnitOfMeasure values using a pure binary format as defined in the Metering cluster (see sub-clause 10.4.2.2.4.1).

18426 **Multiplier (mandatory):** An unsigned 16-bit value indicating the multiplier, to be used in conjunction with the Uncontrolled Flow Threshold and Divisor fields, to determine the true flow threshold value. A value of 0x0000 is not allowed.

18429 **Divisor (mandatory):** An unsigned 16-bit value indicating the divisor, to be used in conjunction with the Uncontrolled Flow Threshold and Multiplier fields, to determine the true flow threshold value. A value of 0x0000 is not allowed.

18432 **Stabilisation Period (mandatory):** An unsigned 8-bit value indicating the time given to allow the flow to stabilize. It is defined in units of tenths of a second.

18434 **Measurement Period (mandatory):** An unsigned 16-bit value indicating the period over which the flow is  
18435 measured and compared against the Uncontrolled Flow Threshold value. It is defined in units of 1 second.

18436

18437

## 18438 **10.4.4 Metering Application Guidelines**

### 18439 **10.4.4.1 Attribute Reporting**

18440 Attribute reporting may be used for sending information in the Reading Information, TOU Information, Me-  
18441 ter Status, and Historical Consumption attribute sets. Use of the Report Attribute command without report  
18442 configuration may be used for unsolicited notification of an attribute value change. Sleepy devices may have  
18443 to poll.

### 18444 **10.4.4.2 Fast Polling or Reporting for Monitoring Energy Savings**

18446 Client devices, such as an energy gateway, smart thermostat, or in-home displays can monitor changes to  
18447 energy saving settings within the premises and give users near real time feedback and results. The Metering  
18448 cluster can support this by using Attribute Reporting and sending updates at a much faster rate for a short  
18449 period of time. Client devices can also perform a series of Attribute reads to accomplish the same task.  
18450 In either case, requests or updates shall be limited to a maximum rate of once every two seconds for a  
18451 maximum period of 15 minutes. These limitations are required to ensure Smart Energy profile based  
18452 devices do not waste available bandwidth or prevent other operations within the premises.

### 18453 **10.4.4.3 Metering Data Updates**

18454 The frequency and timeliness of updating metering data contained in the Metering Cluster attributes and  
18455 Profile Intervals is up to the individual Metering device manufacturer’s capabilities. As a best practice rec-  
18456 ommendation, updates of the metering data should not cause delivery of the information to end devices  
18457 more often than once every 30 seconds. End devices should also not request information more often  
18458 than once every 30 seconds. The Fast Polling attributes and commands shall be used by client devices  
18459 requesting information more often than once every 30 seconds.

#### 18460 **10.4.4.3.1 Fast Polling Periods**

18461 Since the DefaultUpdatePeriod specifies the normal update interval and FastPollUpdatePeriod specifies the  
18462 fastest possible update interval, it is recommended that metering clients read these attributes to determine the  
18463 optimal normal/fast polling interval and the optimal fast poll period to request. Client devices shall not re-  
18464 quest data more frequent than FastPollUpdatePeriod or the AppliedUpdatePeriod.

### 18465 **10.4.4.4 Mirroring**

18466 The SE Profile specifies Mirror support in the Metering cluster to store and provide access to data from  
18467 metering devices on battery power. Devices with resources to support mirroring advertize the capability  
18468 using the Basic Attribute Physical Environment.

#### 18469 **10.4.4.4.1 Discovery**

18470 The SE standard does not prescribe how Mirroring is implemented. Devices may query the Basic Cluster  
18471 attribute PhysicalEnvironment to determine Mirrored device capacity prior to CBKE (see sub-clause  
18472 10.4.4.4.2). This would allow a battery based end device to discover if an ESI has capacity to mirror data  
18473 prior to the process of joining the network in a secure manner, thereby reducing retry attempts. This would  
18474 also enhance the service discovery of the ZDO Match Descriptor that would be used to determine if an  
18475 endpoint can request the setup and removal of a mirrored Metering cluster. Once a device has joined the  
18476 network and performed CBKE, it can then request setup of a mirrored metering cluster. ZDO Discovery  
18477 should be supported to allow HAN devices to discover the mirror endpoints; only active mirror endpoints  
18478 shall be discoverable. This process may need to be repeated in the case of a Trust Center swap-out (refer  
18479 to [Z9] for further information).

#### 18480 **10.4.4.4.2 Mirror Attributes**

18481 The mandatory Basic, Metering, and (where applicable) Prepayment attributes shall be supported. The Basic  
18482 Cluster PhysicalEnvironment attribute shall be supported on ESIs supporting mirroring functionality; an  
18483 enumerated value of 0x01 shall indicate that the device currently has the capacity to provide a mirror to  
18484 an end device; if a device's capacity to provide a mirror has already been used and it cannot support further  
18485 mirrors, an enumerated value of 0x00 shall be used<sup>205</sup>. The Report Attribute command shall be used to push  
18486 data to the mirror. Only the metering device that has been granted a mirror on a certain endpoint is allowed  
18487 to push data to that endpoint. The NOT\_AUTHORIZED return status code shall be used to provide access con-  
18488 trol. The use of a Report Configuration shall not be required to generate Report Attribute Command.

18489 Manufacturers will design and manufacture devices to meet customer requirement specifications that will  
18490 state the functionality of the battery powered meter and therefore devices supporting mirroring in the field  
18491 will also have to support those requirements through an appropriate choice of optional attributes. Battery  
18492 powered devices will report attributes to the mirror as required by the customer specification. In the event  
18493 that the mirror is out of memory space or cannot support the attribute it shall respond ATTRIBUTE\_UN-  
18494 SUPPORTED back to the battery-powered meter. The same response (ATTRIBUTE\_UNsupported) will  
18495 be sent to a device querying the mirror for an attribute it doesn't support. A device querying the mirror for an  
18496 attribute that is supported but not yet available (the battery powered meter hasn't yet sent the attribute)  
18497 shall receive a response ATTRIBUTE\_UNAVAILABLE from the mirror.

#### 18498 **10.4.4.4.3 Two Way Mirror for BOMD**

18499 The primary purpose of a mirror is to present data from a sleepy battery operated mirrored device (BOMD),  
18500 to a HAN, when communication to the BOMD is not available. However, there is also a need to pass data to  
18501 the BOMD in these circumstances.

18502 In Zigbee terms, the device providing a mirror has to be a trusted device. There will be APS security between  
18503 originating device and mirror, and between mirror and BOMD. Messages that require end-to-end security  
18504 must be secured by other means.

18505 Any device on the HAN wishing to communicate with a BOMD must do so via the mirror. The mirror and  
18506 the BOMD must support the Notification Attribute Set of the Metering cluster, designed to allow the BOMD  
18507 to establish if there any messages waiting on the mirror for collection. There are 4 mechanisms provided to  
18508 allow information destined for a BOMD to be transferred to the BOMD:-

18509 For several required actions, the Notification Flag conveys all required information. Many of the bits within  
18510 the Functional Notification Flags attribute utilize this method; the Push All Static Data - Metering Cluster bit  
18511 is an example of this.

---

<sup>205</sup> CCB 2183

18512 For those clusters where the BOMD is a client (e.g. Price, Calendar, Device Management), the flags in the  
18513 Notification Attribute Set allow the BOMD to quickly determine if there is any new information of interest  
18514 to the BOMD. This information is normally sent from the backhaul (i.e. the Head End System). Upon waking,  
18515 and having acquired the status of the relevant Notification Flags, the BOMD will fetch those commands  
18516 matching the set flags by sending the appropriate ‘get’ command(s) **to the associated ESI endpoint**. (Note  
18517 that the associated data will usually be held on the device providing the ESI; therefore the associated get/pub-  
18518 lish commands could be utilized multiple times). It is recommended that a ‘binding-type’ mechanism is used  
18519 internally within the mirroring device to link the ESI and Mirror endpoints.

18520 Where a cluster server is located on the BOMD (e.g. Metering, Prepayment and Basic clusters), pre-specified  
18521 transient commands sent from cluster clients will have to be buffered on the Mirror until such time as the  
18522 BOMD awakes and can fetch them. Upon waking, and having acquired the status of the relevant Notification  
18523 Flags, the BOMD will fetch those commands matching the set flags by sending a GetNotifiedMessage com-  
18524 mand **to the Mirror endpoint**. In this case, the Mirror shall remember the address of the device initially  
18525 originating the command, so that any response can be returned, via the mirror, to that device. As an example,  
18526 the handling of a (Prepayment cluster) Consumer Top Up command utilizes this method.

18527 Non-specified transient commands, destined for cluster servers located on a BOMD, will also have to be  
18528 buffered on the Mirror until such time as the BOMD awakes. In this case, the appropriate ‘Stay Awake’  
18529 Notification flag will be set (to advise the BOMD to remain awake for a longer period) and, once the mirror-  
18530 ing device recognizes that the BOMD is awake, it shall attempt to push those buffered commands to the  
18531 BOMD as soon as possible. Attempts to transfer these commands shall be repeated until such time as the  
18532 command(s) is/are successfully moved to the BOMD (this may not be within the same BOMD wake period).  
18533 The Mirror shall again remember the address of the device initially originating the command, so that any  
18534 response can be returned, via the mirror, to that device. As an example, the handling of a (Metering cluster)  
18535 Get Profile command utilizes this method.

18536

Figure 10-97. Example of Data flow from IHD to Gas meter

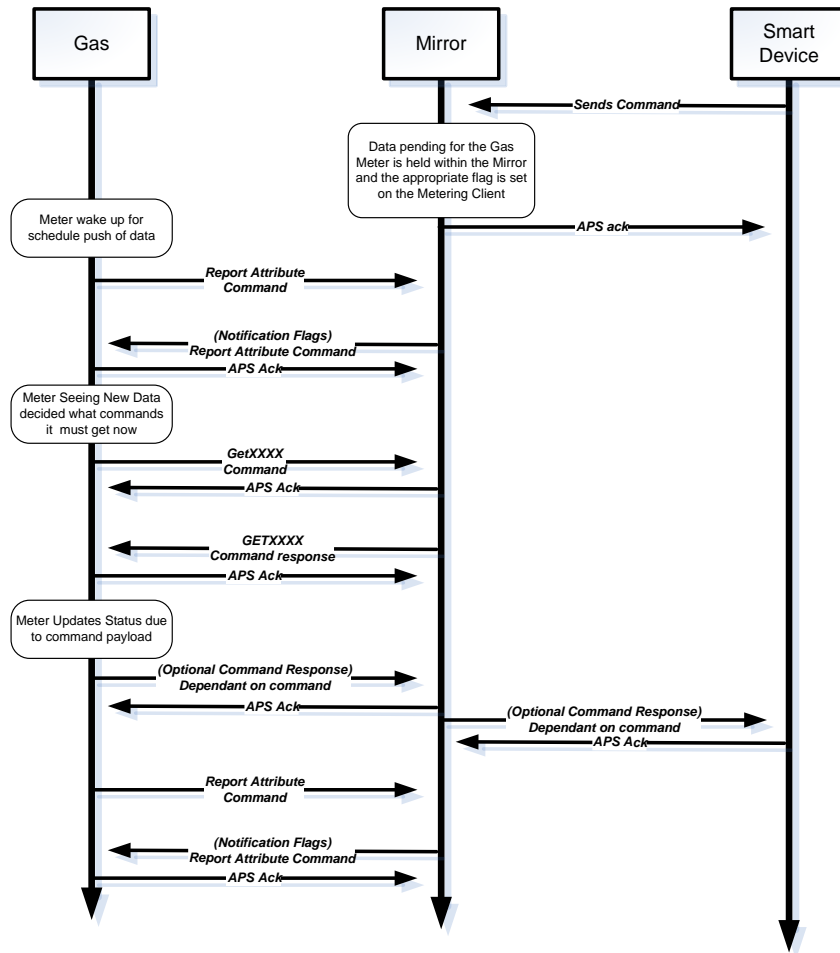

18537

18538 The example in Figure 10-97 shows how data is transferred from a HAN device (e.g. IHD) to a BOMD (e.g.  
 18539 gas meter) via the mirror. There are a number of commands that will be sent from the IHD to meter, for  
 18540 example:

18541 Credit Top Up

18542 Emergency Credit Select

18543 Local Change Supply

18544 The sequence of events is as follows:

18545 The IHD sends a command to the Mirror

18546 The mirror “caches” the command and sets the appropriate notification flag, to signal that data is waiting.  
 18547 The mirror also returns a Default Response to the initiating device with a status code of NOTIFICA-  
 18548 TION\_PENDING. If the command buffer on the mirror is already full, the mirror shall instead return a De-  
 18549 fault Response to the initiating device with a status code of INSUFFICIENT\_SPACE.

18550 The gas meter wakes up and polls for a notification

18551 The notification is returned

18552 This may be all that is required (e.g. a request to update static data on the mirror).

18553 The meter requests the data according to the Notification flag that was raised

18554 The mirror sends the command that was originally received from the IHD

18555 The meter may update data on the mirror in order to indicate to the device initiating the command that its  
18556 action has been carried out.

18557 A mirror that caches a command on behalf of a HAN device, prior to that command being sent to a BOMD,  
18558 may choose to time out that command after an appropriate period of time. The timeout period may be con-  
18559 figurable based on the operator of the network and is not defined by this specification. If the mirror chooses  
18560 to timeout a cached command, then it shall send a Default Response to the originator of the message with the  
18561 same Transaction Sequence Number as received in the cached command. The Default Response shall con-  
18562 tain the status code of TIMEOUT.

#### 18563 **10.4.4.4.3.1 Responses to an Initiating Device**

18564 Commands that have been buffered on a Mirror may trigger a Default Response or command-specific re-  
18565 sponses to be returned once the command has reached and been actioned by the BOMD. In turn, these re-  
18566 sponses should be communicated to the device originally initiating the buffered command.

18567 In order to ensure that these responses are correctly relayed back to the device initiating the original com-  
18568 mand, it is recommended that:-

18569 The mirroring device, if supporting Two-way Mirroring, be able to store information that can be used to track  
18570 the originator of a command stored in the buffer when the command is retrieved by the BOMD. This infor-  
18571 mation should include, as a minimum, the device address, endpoint and Transaction Sequence Number (TSN)  
18572 of the original command, for the purposes of relaying a response back to the originator. The TSN used when  
18573 the buffered command is forwarded to the BOMD should also be included in the stored information for the  
18574 purpose of matching the information to any associated response. The BOMD shall include the TSN of a  
18575 forwarded buffered command in any associated response. A TSN in the ZCL header is only 8 bits and this  
18576 may not provide enough information to produce a unique ID (or unique enough); if this is considered to be  
18577 insufficient information, the mirroring device could also store the cluster and command id.

18578 The mirroring device should relay the ZCL payload of the buffered command to the BOMD using a newly  
18579 generated ZCL command (i.e. using the address and security associated with the BOMD).

18580 The payload of a response from the BOMD to the retrieved buffered command, should be relayed to the  
18581 originating device in a newly generated response which utilizes the information stored by the mirroring de-  
18582 vice as detailed in point 1. This shall include the TSN of the command received from the originating HAN  
18583 device.

18584 All commands retrieved by the BOMD using the notification flag mechanism should support a ZCL default  
18585 response in cases where an explicit response is not defined (this is the normal mode of operation; however  
18586 the default response can be disabled).

#### 18587 **10.4.4.4.3.2 Unsolicited Commands from a BOMD**

18588 Where a command is sent unsolicited from a cluster server on a BOMD, the BOMD should publish that  
18589 command to the mirror and the mirror should then publish that command to all associated client devices that  
18590 have bound to the respective server on the mirror.

18591 Client devices wishing to receive unsolicited commands published from a BOMD shall bind to the respective  
18592 server(s) on the BOMD mirror.

#### 18593 **10.4.4.4.3.3 Configuring a Two Way Mirror**

18594 When utilizing a two-way mirror with a BOMD, certain configuration data must be passed from the BOMD  
18595 to the mirror once the mirror endpoint has been activated:-Under normal circumstances, a BOMD will utilize  
18596 one of the predefined Notification Schemes that will be pre-loaded onto the mirror. In this case, only a Con-  
18597 figureMirror command will be required; this command will advise the mirror of the reporting interval to be  
18598 used, the required mechanism to be used to acquire Notification Flag status, and the predefined Notification  
18599 Scheme to be used.



18600 Predefined Notification schemes cannot be modified. If a BOMD wishes to modify an existing predefined  
 18601 scheme, or utilize a new generic or MSP Notification Scheme, then the associated two-way mirror must be  
 18602 configured with information defining the new scheme before that scheme can be used. New generic schemes  
 18603 should use one of the reserved values 0x03–0x80, MSP schemes should use one of the values 0x081-0x0FE  
 18604 (see Figure 10-74).

18605 A BOMD can configure a new Notification Scheme on a mirror once that mirror has been created (endpoint  
 18606 known). The BOMD shall send a ConfigureNotificationScheme command to the mirror, together with asso-  
 18607 ciated ConfigureNotificationFlags command(s), before transmitting a ConfigureMirror command that uti-  
 18608 lizes the new Notification Scheme. On receipt of the ConfigureNotificationScheme command, the mirror  
 18609 shall store the NotificationScheme information, and wait for the associated ConfigureNotificationFlags com-  
 18610 mands. Until all of the ConfigureNotificationFlags commands have been received, the two-way mirror func-  
 18611 tionality should be disabled. The Notification Flag Order parameter in the ConfigureNotificationScheme  
 18612 command will allow the mirror to determine when all of the ConfigureNotificationFlags commands have  
 18613 been received.

18614 **10.4.4.4.3.4 Predefined Notification Scheme A**

18615 Notification Scheme A is a predefined scheme for the order of the bit strings within each of the Notification-  
 18616 Flag#N attributes. See sections 10.4.2.3.1.10 and 10.4.2.3.1.11 for configuration of other schemes. Refer to  
 18617 section 10.4.4.4.3 for details on the usage of these Notification Flags.

18618 **10.4.4.4.3.4.1 MirrorReportAttributeResponse Command Format**

18619 The format for Notification Scheme A is **0x0FFFFFFF** meaning that the first and only Notification flag to  
 18620 be transmitted within the MirrorReportAttributeResponse command will be the FunctionalNotificationFlags  
 18621 attribute.

18622 **FunctionalNotificationFlags Attribute:** Defined in section 10.4.3.2.1.1.  
 18623

18624 **10.4.4.4.3.5 Predefined Notification Scheme B**

18625 Notification Scheme B is a predefined scheme for the order of the bit strings within each of the Notification-  
 18626 Flag#N attributes. See sections 10.4.2.3.1.10 and 10.4.2.3.1.11 for configuration of other schemes. Refer to  
 18627 section 10.4.4.4.3 for details on the usage of these Notification Flags.

18628 **10.4.4.4.3.5.1 MirrorReportAttributeResponse Command Format**

18629 The format for Notification Scheme B is **0x01234FFF** meaning the first Notification flag to be transmitted  
 18630 within the MirrorReportAttributeResponse command will be the FunctionalNotificationFlags attribute fol-  
 18631 lowed by NotificationFlags2 to NotificationFlags5.

18632 **FunctionalNotificationFlags Attribute:** Defined in section 10.4.3.2.1.1.

18633 **NotificationFlags2 Attribute:** The NotificationFlags2 attribute shall be configured to support the Price clus-  
 18634 ter and is implemented as a set of bit flags which are defined as shown below:

18635

**Table 10-115. Notification Flags 2**

Bit Number	Waiting Command
0	PublishPrice <sup>a</sup>
1	PublishBlockPeriod
2	PublishTariffInformation
3	PublishConversionFactor
4	PublishCalorificValue
5	PublishCO2Value

Bit Number	Waiting Command
6	PublishBillingPeriod
7	PublishConsolidatedBill
8	PublishPriceMatrix
9	PublishBlockThresholds
10	PublishCurrencyConversion
11	Reserved
12	PublishCreditPaymentInfo
13	PublishCPPEvent
14	PublishTierLabels
15	CancelTariff
16-31	Reserved for future expansion

18636 <sup>a</sup> A Publish Price command may result from more than one ‘Get’ command; for clarity, a GetCurrentPrice  
18637 command should be sent when this flag is set, and a GetScheduledPrices command MAY also be sent.

18638 **NotificationFlags3 Attribute:** The NotificationFlags3 attribute shall be configured to support the Calendar  
18639 cluster and is implemented as a set of bit flags which are defined as shown below:

18640

**Table 10-116. Notification Flags 3**

Bit Number	Waiting Command
0	PublishCalendar
1	PublishSpecialDays
2	PublishSeasons
3	PublishWeek
4	PublishDay
5	CancelCalendar
6-31	Reserved for future expansion

18641

18642 **NotificationFlags4 Attribute:** The NotificationFlags4 attribute shall be configured to support the Prepay-  
18643 ment cluster and is implemented as a set of bit flags which are defined as shown below:

18644

**Table 10-117. Notification Flags 4**

Bit Number	Waiting Command
0	Select Available Emergency Credit
1	Change Debt
2	Emergency Credit Setup
3	Consumer Top Up
4	Credit Adjustment
5	Change Payment Mode
6	Get Prepay Snapshot
7	Get Top Up Log
8	Set Low Credit Warning Level
9	Get Debt Repayment Log
10	Set Maximum Credit Limit

11	Set Overall Debt Cap
12 – 31	Reserved for future expansion

18645

18646 **NotificationFlags5 Attribute:** The NotificationFlags5 attribute shall be configured to support the Device  
 18647 Management cluster and is implemented as a set of bit flags which are defined as shown below:

18648

**Table 10-118. Notification Flags 5**

Bit Number	Waiting Command
0	Publish Change of Tenancy
1	Publish Change of Supplier
2	Request New Password 1 Response
3	Request New Password 2 Response
4	Request New Password 3 Response
5	Request New Password 4 Response
6	UpdateSiteID
7	ResetBatteryCounter
8	UpdateCIN
9 - 31	Reserved for future expansion

18649

18650 **NotificationFlags6 Attribute:** This attribute is not supported, with any bits set.

18651 **NotificationFlags7 Attribute:** This attribute is not supported, with any bits set.

18652 **NotificationFlags8 Attribute:** This attribute is not supported, with any bits set.

### 18653 **10.4.4.5 An Introduction to Snapshots**

18654 Where a permanent back-haul connection is not guaranteed, there are occasions when the values of data items  
 18655 need to be frozen for purposes such as consumer billing. The Snapshot mechanism is provided to satisfy this  
 18656 requirement.

18657 Snapshots can be triggered in a number of ways:-

18658 Automatically as a result of certain activities (e.g. end of billing period, change of tariff, change of supplier)

18659 At pre-defined points using the ScheduleSnapshot command (and confirmed via a ScheduleSnapshotRe-  
 18660 sponse command)

18661 As a manual/one-off action using the TakeSnapshot command (and confirmed via a TakeSnapshotResponse  
 18662 command)

18663 A Publish Snapshot command should be generated whenever a new Snapshot is created. Details of stored  
 18664 Snapshots can be requested using the GetSnapshot command; the content(s) of the required Snapshot(s) will  
 18665 then be returned using one or more Publish Snapshot commands.

18666 It is recommended that Snapshot data is persisted across a reboot.

### 18667 **10.4.4.6 Supply Control**

18668 The Supply Control functionality allows a Head-end System to remotely control the status of the valve or  
 18669 contactor within a meter. The states of supply status are necessary due to the safety requirements in certain  
 18670 countries, these are:

- 18671 ON
- 18672 OFF
- 18673 ARMED
- 18674 The ARMED state is to allow for a remote restoration of the supply that requires action by the consumer
- 18675 (such as pressing a button on the meter or the IHD). This is to ensure the supply is not restored remotely
- 18676 whilst in an unsafe situation. The three corresponding commands derived from IEC 62055 are:
- 18677 RESTORE
- 18678 INTERRUPT
- 18679 ARM
- 18680
- 18681

18682 **10.5 Messaging**

18683 **10.5.1 Overview**

18684 This cluster provides an interface for passing text messages between ZigBee devices. Messages are  
 18685 expected to be delivered via the ESI and then unicast to all individually registered devices implementing  
 18686 the Messaging Cluster on the ZigBee network, or just made available to all devices for later pickup. Nested  
 18687 and overlapping messages are not allowed. The current active message will be replaced if a new message is  
 18688 received by the ESI.

18689 **Figure 10-98. Messaging Cluster Client/Server Example**

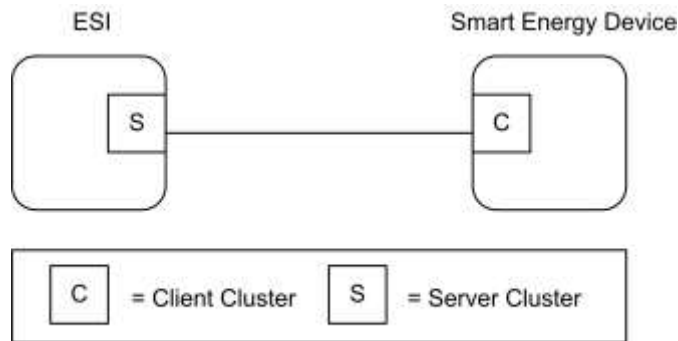

*Note: Device names are examples for illustration purposes only*

18690

18691 Please note the ESI is defined as the Server due to its role in acting as the proxy for upstream message man-  
 18692 agement systems and subsequent data stores.

18693 **10.5.1.1 Revision History**

18694 The global *ClusterRevision* attribute value SHALL be the highest revision number in the table below.

Rev	Description
1	mandatory global <i>ClusterRevision</i> attribute added
2	Updated from SE1.4 version; CCB 1819

18695 **10.5.1.2 Classification**

Hierarchy	Role	PICS Code	Primary Transaction
Base	Application	SEMS	Type 1 (client to server)

18696 **10.5.1.3 Cluster Identifiers**

Identifier	Name
0x0703	Messaging (Smart Energy)

18697 **10.5.2 Server**

18698 **10.5.2.1 Dependencies**

18699 None.

18700 **10.5.2.2 Attributes**

18701 None

18702 **10.5.2.3 Commands Generated**

18703 The command IDs generated by the Messaging server cluster are listed in Table 10-119.

18704 **Table 10-119. Generated Command IDs for the Messaging Server**

Command Identifier Field Value	Description	M
0x00	<i>Display Message</i>	M
0x01	<i>Cancel Message</i>	M
0x02	<i>Display Protected Message</i>	O
0x03	<i>Cancel All Messages</i>	O

18705 **10.5.2.3.1 Display Message Command**

18706 **10.5.2.3.1.1 Payload Format**

18707 The Display Message command payload shall be formatted as illustrated in Figure 10-99.

18708

**Figure 10-99. Format of the *Display Message Command Payload***

<b>Octets</b>	4	1	4	2	Variable	1
<b>Data Type</b>	uint32	map8	UTC	uint16	string	map8
<b>Field Name</b>	Message ID (M)	Message Control (M)	Start Time (M)	Duration In Minutes (M)	Message (M)	Extended Message Control (O)

18709

**10.5.2.3.1.1.1 Payload Details**

18710

**Message ID:** A unique unsigned 32-bit number identifier for this message. It's expected the value contained in this field is a unique number managed by upstream systems or a UTC based time stamp (UTC data type) identifying when the message was issued.

18711

18712

18713

**MessageControl:** An 8-bit bitmap field indicating control information related to the message. Bit encoding of this field is outlined in Table 10-120.

18714

18715

**Table 10-120. Message Control Field Bit Map**

Bits	Enumeration	Val	Description
0 to 1	Normal transmission only	0	Send message through normal command function to client.
	Normal and Inter- PAN transmission DEPRECATED	1	Send message through normal command function to client and pass message onto the Inter- PAN transmission mechanism. DEPRECATED
	Inter- PAN transmission only DEPRECATED	2	Send message through the Inter- PAN transmission mechanism. DEPRECATED
	<i>Reserved</i>	3	Reserved value for future use.
2 to 3	Low	0	Message to be transferred with a low level of importance.
	Medium	1	Message to be transferred with a medium level of importance.
	High	2	Message to be transferred with a high level of importance.
	Critical	3	Message to be transferred with a critical level of importance.
4	<i>Reserved</i>	<i>N/A</i>	This bit is reserved for future use.
5	Enhanced Confirmation Required	0	Message Confirmation not required.
		1	Message Confirmation required.
6	<i>Reserved</i>	<i>N/A</i>	This bit is reserved for future use.
7	Message Confirmation	0	Message Confirmation not required.

Bits	Enumeration	Val	Description
		1	Message Confirmation required.

18716

18717 Use of the Inter-PAN transmission mechanism within the Messaging cluster is now deprecated. A command  
 18718 where bits 0 to 1 indicate that it is for “Inter- PAN transmission only” shall be dropped; a Default Response  
 18719 command with a status of INVALID\_FIELD shall be returned.

18720 The Message Confirmation bit indicates the message originator requests a confirmation of receipt from a  
 18721 Utility Customer. If confirmation is required, the device should display the message or alert the user until it  
 18722 is either confirmed via a button, by selecting a confirmation option on the device, or the message expires.  
 18723 Confirmation is typically used when the Utility is sending down information such as a disconnection notice,  
 18724 or prepaid billing information.

18725 The Enhanced Confirmation Required bit indicates that information is to be included in the confirmation of  
 18726 receipt from a Utility Customer (‘YES’, ‘NO’ or a text string). Earlier devices may treat bit 5 as reserved. In this  
 18727 case, these devices will assume that this bit is set to 0 (only basic confirmation required). Note that the Mes-  
 18728 sage Confirmation bit shall always be set whenever the Enhanced Confirmation Required bit is set.

18729 **Note:** It is desired that the device provide a visual indicator (flashing display or indicate with its LEDs as  
 18730 examples) that a message requiring confirmation is being displayed, and requires confirmation.

18731 **Start Time (mandatory):** A UTC field to denote the time at which the message becomes valid. A Start  
 18732 Time of 0x00000000 is a special time denoting “now.” If the device would send an event with a Start Time  
 18733 of now, adjust the Duration In Minutes field to correspond to the remainder of the event.

18734 **Duration In Minutes (mandatory):** An unsigned 16-bit field is used to denote the amount of time in  
 18735 minutes after the Start Time during which the message is displayed. A Maximum value of 0xFFFF means  
 18736 “until changed”.

18737 **Message (mandatory):** A string containing the message to be delivered. The String shall be encoded in the  
 18738 UTF-8 format. Devices will have the ability to choose the methods for managing messages that are larger  
 18739 than can be displayed (truncation, scrolling, etc.).

18740 For supporting larger messages sent over the SE Profile network, both devices must agree upon a common  
 18741 Fragmentation ASDU Maximum Incoming Transfer Size. Please refer to [Z1] for further details on Frag-  
 18742 mentation settings.

18743 Any message that needs truncation shall truncate on a UTF-8 character boundary. The SE secure payload is  
 18744 59 bytes for the Message field in a non- fragmented, non-source routed Display Message packet (11 bytes  
 18745 for other Display Message fields). Devices using fragmentation can send a message larger than this. Reserv-  
 18746 ing bytes for source route will reduce this.

18747 **ExtendedMessageControl (optional):** An 8-bit BitMap field indicating additional control and status infor-  
 18748 mation for a given message. Bit encoding of this field is shown in Table 10-121:

18749

**Table 10-121. Extended Message Control Field Bit Map**

Bit	Enumeration	Value	Description
Bit 0	Message Confirmation Status	0	Message has not been confirmed
		1	Message has been confirmed
Bits 1 - 7	Reserved for future use		

18750

18751 The Message Confirmation Status bit allows the confirmation state of a message to be communicated in the  
 18752 event that there are multiple IHD’s (or other Messaging cluster client devices) on a network.

18753 The server shall initially transmit a message requiring a confirmation with the Message Confirmation Status  
18754 bit reset (0) to indicate the message had not yet been confirmed (the Message Confirmation bit of the Mes-  
18755 sageControl field will be set to indicate a confirmation is required).

18756 When the message is confirmed on one of the multiple IHDs in the premises, a Message Confirmation com-  
18757 mand will be returned to the server. At this point, the server shall re-transmit the original message, but with  
18758 the Message Confirmation Status bit now set (1) to indicate that the message has been confirmed. This will  
18759 indicate to other clients that the message no longer requires a confirmation.

### 18760 10.5.2.3.2 Cancel Message Command

18761 The Cancel Message command described in Figure 10-100 provides the ability to cancel the sending or  
18762 acceptance of previously sent messages. When this message is received the recipient device has the option of  
18763 clearing any display or user interfaces it supports, or has the option of logging the message for future reference.

18764 **Figure 10-100. Format of the *Cancel Message Command* Payload**

<b>Octets</b>	4	1
<b>Data Type</b>	uint32	map8
<b>Field Name</b>	Message ID (M)	Message Control (M)

#### 18765 10.5.2.3.2.1 Payload Details

18766 **Message ID (mandatory):** A unique unsigned 32-bit number identifier for the message being cancelled.  
18767 It's expected the value contained in this field is a unique number managed by upstream systems or a  
18768 UTC based time stamp (UTC data type) identifying when the message was originally issued.

18769 **MessageControl (mandatory):** This field is deprecated and should be set to 0x00.

### 18770 10.5.2.3.3 Display Protected Message Command

18771 The Display Protected Message command is for use with messages that are protected by a password or PIN.

#### 18772 10.5.2.3.3.1 Payload Format

18773 The payload for this command shall be the same as that for a conventional Display Message command. See  
18774 10.5.2.3.1.1.1 for payload details.

18775

### 18776 10.5.2.3.4 Cancel All Messages Command

18777 **Note:** The Cancel All Messages command in this revision of this specification is provisional and not certi-  
18778 fiable. This feature may change before reaching certifiable status in a future revision of this specification.

18779 The Cancel All Messages command indicates to a client device that it should cancel all display messages  
18780 currently held by it.

#### 18781 10.5.2.3.4.1 Payload Format

18782 **Figure 10-101. Format of the *Cancel All Messages Command* Payload**

<b>Oc- tets</b>	4
<b>Data Type</b>	UTC



Field Name	Implementation Date/Time (M)
------------	------------------------------

18783 **10.5.2.3.4.2 Payload Details**

18784 **Implementation Date/Time (mandatory):** A UTC Time field to indicate the date/time at which all existing  
 18785 display messages should be cleared.

18786 **10.5.3 Client**

18787 **10.5.3.1 Dependencies**

18788 None.

18789 **10.5.3.2 Attributes**

18790 None

18791 **10.5.3.3 Commands Generated**

18792 The command IDs generated by the Messaging cluster are listed in Table 10-122.

18793 **Table 10-122. Messaging Client Commands**

Id	Description	M
0x00	<i>Get Last Message</i>	M
0x01	<i>Message Confirmation</i>	M
0x02	<i>GetMessageCancellation</i>	

18794 **10.5.3.3.1 GetLastMessage Command**

18795 This command has no payload.

18796 **10.5.3.3.1.1 Effect on Receipt**

18797 On receipt of this command, the device shall send a Display Message or Display Protected Message com-  
 18798 mand as appropriate (refer to sub-clauses 10.5.2.3.1 and 10.5.2.3.3). A Default Response with status  
 18799 NOT\_FOUND shall be returned if no message is available.

18800 **10.5.3.3.2 MessageConfirmation Command**

18801 The Message Confirmation command described in Figure 10-102 provides an indication that a Utility Cus-  
 18802 tomer has acknowledged and/or accepted the contents of a message previously received from the Messaging  
 18803 cluster server<sup>206</sup>. Enhanced Message Confirmation commands shall contain an answer of ‘NO’, ‘YES’ and/or  
 18804 a message confirmation string.

18805 If the optional Message Confirmation Response is required, the Message Confirmation Control field shall  
 18806 also be present.

<sup>206</sup> CCB 1819

18807

**Figure 10-102. Format of the *Message Confirmation Command Payload***

<b>Octets</b>	4	4	1	1-21
<b>Data Type</b>	uint32	UTC	map8	octstr
<b>Field Name</b>	Message ID (M)	Confirmation Time (M)	Message Confirmation Control (O)	Message Confirmation Response (O)

18808 **10.5.3.3.2.1 Payload Details**

18809 **Message ID (mandatory):** A unique unsigned 32-bit number identifier for the message being confirmed.

18810 **Confirmation Time (mandatory):** UTC of user confirmation of message.

18811 **Message Confirmation Control (optional):** An 8-bit BitMap field indicating the simple confirmation that  
18812 is contained within the response. Bit encoding of this field is outlined in Table 10-123. Message Confirmation  
18813 Control; if this optional field is not available, a default value of 0x00 shall be used.

18814 **Table 10-123. Message Confirmation Control**

Bit	Enumeration	Value	Description
0	‘NO’ Returned		The answer is ‘NO’
1	‘YES’ Returned		The answer is ‘YES’
Bits 2 - 7	Reserved		

18815

18816 **Message Confirmation Response (optional):** An Octet String containing the message to be returned. The  
18817 first Octet indicates length. The string shall be encoded in the UTF-8 format. If this optional field is not  
18818 available, a default value of 0x00 shall be used.

18819 **10.5.3.3.3 GetMessageCancellation Command**

18820 **Note:** The GetMessageCancellation command in this revision of this specification is provisional and not  
18821 certifiable. This feature may change before reaching certifiable status in a future revision of this specification.

18822 This command initiates the return of the first (and maybe only) Cancel All Messages command held on the  
18823 associated server, and which has an implementation time equal to or later than the value indicated in the  
18824 payload.

18825 **10.5.3.3.3.1 Payload Format**

18826 **Figure 10-103. Format of the *GetMessageCancellation Command Payload***

<b>Octets</b>	4
<b>Data Type</b>	UTC
<b>Field Name</b>	Earliest Implementation Time (M)

18827 **10.5.3.3.3.2 Payload Details**

18828 **Earliest Implementation Time (mandatory):** UTC Timestamp indicating the earliest implementation time of  
18829 a Cancel All Messages command to be returned.

18830 **10.5.3.3.3.3 When Generated**

18831 This command is generated when the client device wishes to fetch any pending Cancel All Messages com-  
18832 mand from the server (see 10.5.2.3.4 for further details). In the case of a BOMD, this may be as a result of  
18833 the associated Notification flag.

18834 A Default response with status NOT\_FOUND shall be returned if there is no Cancel All Messages command  
18835 available that satisfies the requested criteria.

## 18836 **10.5.4 Application Guidelines**

18837 For Server and Client transactions, refer to Figure 10-104.

18838

Figure 10-104. Client/Server Message Command Exchanges

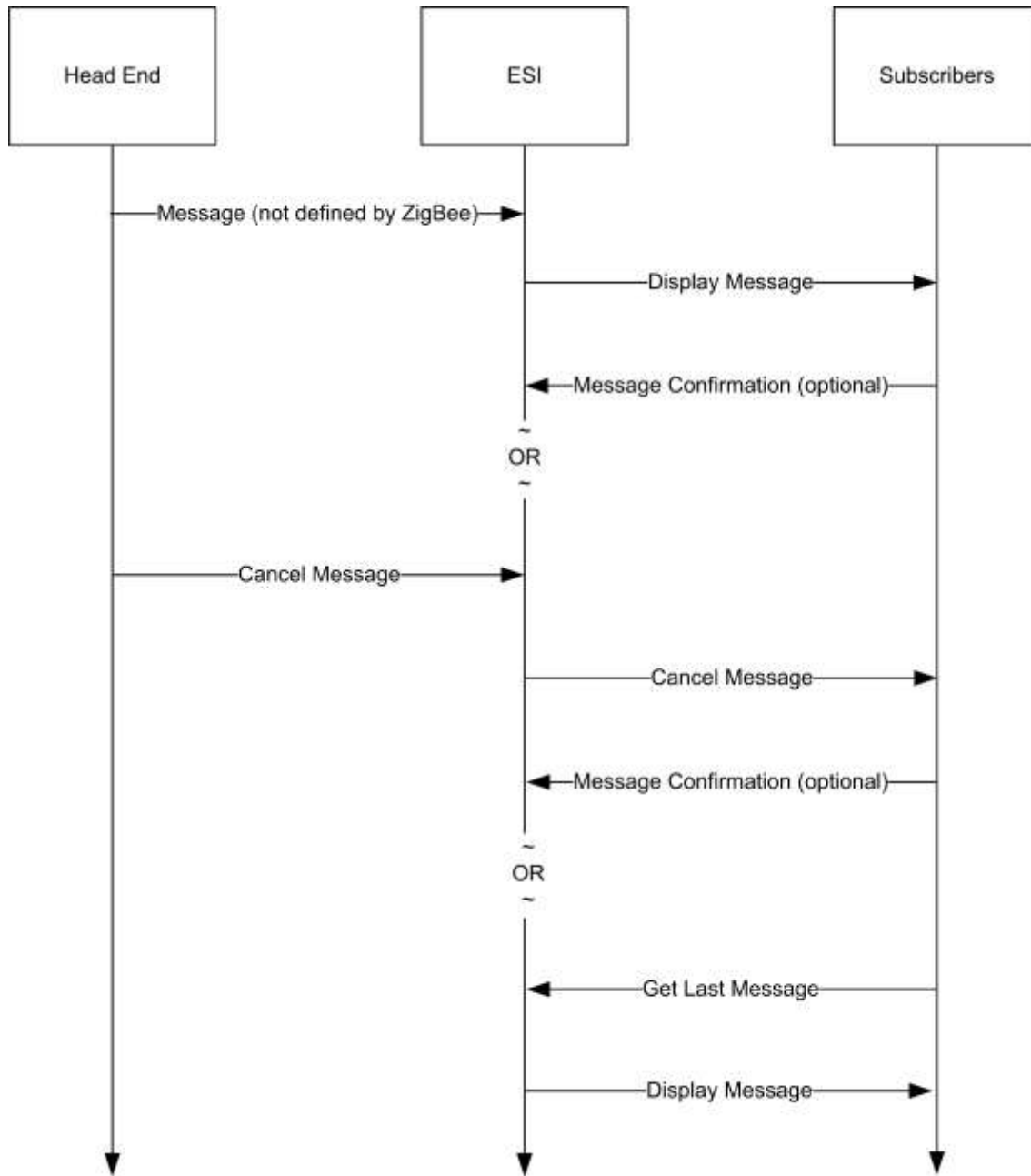

18839

## 18840 10.6 Tunneling

18841 **Note:** The optional support for flow control within the cluster in this revision of this specification is provisionary and not certifiable. This feature set may change before reaching certifiable status in a future revision  
 18842 of this specification.  
 18843

18844 **10.6.1 Overview**

18845 The tunneling cluster provides an interface for tunneling protocols. It is comprised of commands and attributes  
 18846 required to transport any existing metering communication protocol within the payload of standard ZigBee  
 18847 frames (including the handling of issues such as addressing, fragmentation and flow control). Examples for  
 18848 such protocols are DLMS/COSEM, IEC61107, ANSI C12, M-Bus, ClimateTalk, etc.

18849 The tunneling foresees the roles of a server and a client taking part in the data exchange. Their roles are  
 18850 defined as follows:

18851 **Client:** Requests a tunnel from the server and closes the tunnel if it is no longer needed.

18852 **Server:** Provides and manages tunnels to the clients.

18853 **Figure 10-105. A Client Requests a Tunnel from a Server to Exchange Complex Data in Both Directions**

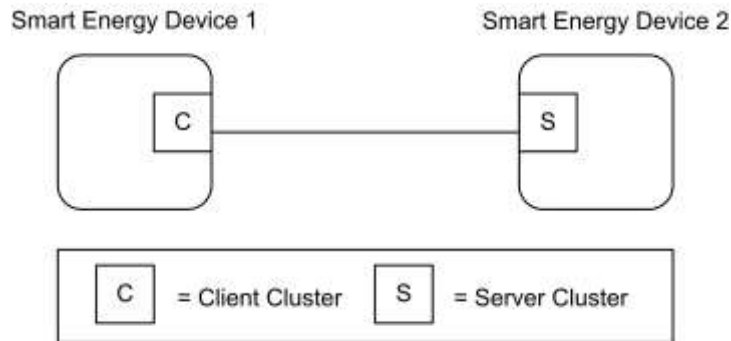

*Note: Device names are examples for illustration purposes only*

18854  
 18855

18856 The data exchange through the tunnel is symmetric. This means both client and server provide the com-  
 18857 mands to transfer data (TransferData). And both must make sure that only the partner to which the tunnel has  
 18858 been built up is granted RW access to it (e.g. tunnel identifier protection through checking the MAC address).

18859 Sleepy devices either close the tunnel immediately after they have pushed their data through it, or leave it  
 18860 open in which case an attribute in the server (CloseTunnelTimeout) decides whether the tunnel is closed  
 18861 from the server side during the sleeping phase or not. It is recommended that battery-powered (sleepy)  
 18862 devices fulfil the role of the Tunneling cluster client (and therefore have control over when they request a  
 18863 tunnel from the server).

18864 If data is transferred to a non-existent or wrong tunnel identifier, the receiver generates an error message  
 18865 (TransferDataError).

18866 The server may support more than one tunneling protocol. The type of tunnel to be opened is a mandatory  
 18867 parameter (ProtocolID) of the tunnel request (RequestTunnel) that the client needs to send to the server in  
 18868 order to set up a new tunnel. The response from the server (RequestTunnelResponse) will contain a param-  
 18869 eter with the status of the tunnel (TunnelStatus). If the tunnel request was successful, a unique identifier  
 18870 (TunnelID) is returned within the response. In an error case (e.g. the requested protocol is not supported) the  
 18871 status contains the type of error. The optional GetSupportedTunnelProtocols command provides a way to  
 18872 read out the supported protocols from the server. If the GetSupportedTunnelProtocols command is not sup-  
 18873 ported then either the client knows the supported protocols a priori or it has to try several times using different  
 18874 ProtocolIDs until the server responds with the tunnel status Success.

18875 The tunneling cluster adds optional support for flow control to handle streaming protocols such as  
 18876 IEC61107. If implemented, flow control messages are provided to control the data flow and send acknowl-  
 18877 edges to data messages on application level. However, flow control is an optional feature and disabled per  
 18878 default. In the default case, the acknowledge messages (AckTransferData) must not be sent in order to  
 18879 reduce complexity and prevent from unneeded overhead.

18880 The following sequence describes a typical usage:

- 18881 1. The client issues a service discovery to find devices which support the tunneling server cluster.  
18882 The discovery may either be directed to one device, if its address is known, or be a broadcast  
18883 (*MatchSimpleDescriptor*).
- 18884 2. The response to the discovery from the server contains an endpoint number (*SimpleDescriptor*). Us-  
18885 ing this endpoint, the client directs a tunnel request to a given server. Together with the request, the  
18886 client is required to provide an enumeration with the ID of the protocol that shall be tunneled. There  
18887 is the possibility to request tunnels for manufacturer specific protocols. In this case, the *ProtocolID*  
18888 has to be followed by a *ZigBee ManufacturerCode* to open the tunnel. An additional parameter for  
18889 *FlowControlSupport* accompanies the request, together with an indication of the client's incoming  
18890 buffer size (*RequestTunnel (ProtocolID, ManufacturerCode, FlowControlSupport, MaximumIn-*  
18891 *comingTransferSize)*).
- 18892 3. If the server supports the protocol, it allocates the required resources, assigns a tunnel identifier and  
18893 returns the ID number within the response including an additional tunnel status that the command  
18894 was successful and the server's incoming buffer size. If the command failed, the status contains the  
18895 reason in form of an error code (*RequestTunnelResponse (TunnelID, TunnelStatus, MaximumIn-*  
18896 *comingTransferSize)*). The tunnel identifier number would then be invalid in this case.
- 18897 4. Both server and client may exchange data (*TransferData(Data)*). In case the optional flow control  
18898 is utilized, each data transfer is acknowledged (*AckTransferData(NumberOfOctetsLeft)*). Addition-  
18899 ally, there is the possibility to stop (*AckTransferData(0)*) and resume (*ReadyData(Number-*  
18900 *OfOctetsLeft)*) the data transfer.
- 18901 5. After the transfer has been successfully completed, the client closes the tunnel again freeing the  
18902 tunnel identifier in the server (*CloseTunnel(TunnelID)*). If not, the server closes the tunnel by itself  
18903 after *CloseTunnelTimeout* seconds.

18904 The following sequence diagrams show the client/server model and the typical usage of the cluster without  
18905 flow control (Figure 10-106) and with flow control (Figure 10-107).

18906 **Figure 10-106. SE Device 1 (Client) Requests a Tunnel from SE Device 2 (Server) to Transfer Data Without Flow**  
18907 **Control (Default)**

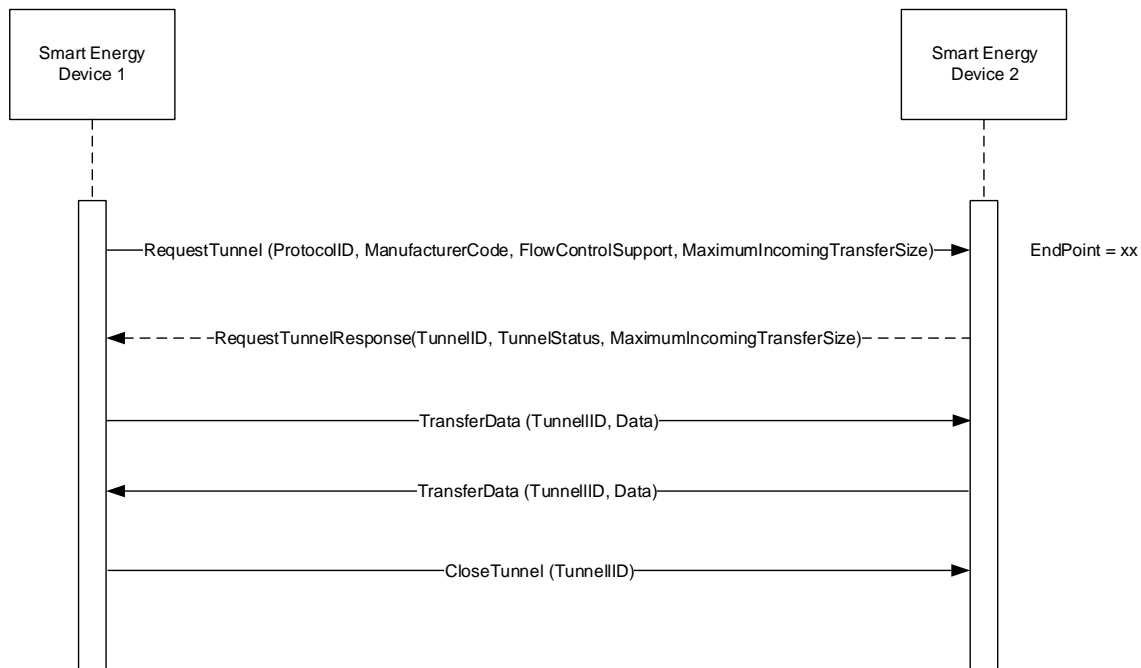

18908

18909  
 18910

**Figure 10-107. SE Device 1 (Client) Requests a Tunnel from SE Device 2 (Server) to Transfer Data with Flow Control**

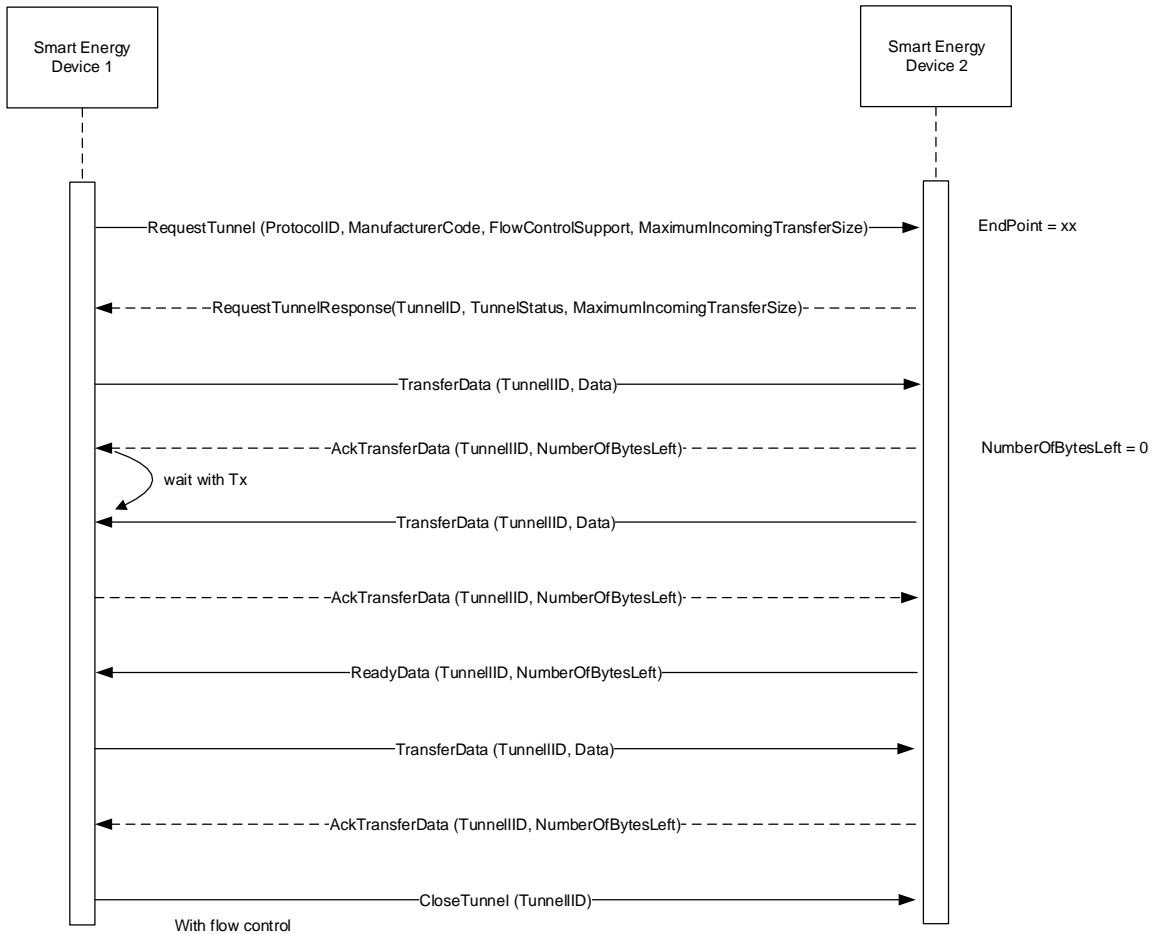

18911

18912

### 18913 10.6.1.1 Revision History

18914 The global *ClusterRevision* attribute value SHALL be the highest revision number in the table below.

Rev	Description
1	mandatory global <i>ClusterRevision</i> attribute added
2	Updated from SE1.4 version; CCB 1955

### 18915 10.6.1.2 Classification

Hierarchy	Role	PICS Code
Base	Application	SETUN

18916 **10.6.1.3 Cluster Identifiers**

Identifier	Name
0x0704	Tunneling (Smart Energy)

18917 **10.6.2 Server**

18918 **10.6.2.1 Dependencies**

18919 This cluster requires APS fragmentation [Z1] to be implemented, with maximum transfer sizes defined by  
18920 the device's negotiated input buffer sizes.

18921 **10.6.2.2 Attributes**

18922 **Table 10-124. Tunneling Cluster Attributes**

Identifier	Name	Type	Range	Access	Default	M
0x0000	<i>CloseTun-</i>	uint16	0x0001-	R	0xFFFF	M

18923 **10.6.2.2.1 CloseTunnelTimeout Attribute**

18924 CloseTunnelTimeout defines the minimum number of seconds that the server waits on an inactive tunnel  
18925 before closing it on its own and freeing its resources (without waiting for the CloseTunnel command from  
18926 the client). Inactive means here that the timer is re-started with each new reception of a command. 0x0000 is  
18927 an invalid value.

18928 **10.6.2.3 Parameters**

18929 Table 10-125 contains a summary of all parameters passed to or returned by the server commands. These  
18930 values are considered as parameters (and not attributes) in order to facilitate the handling of the tunneling  
18931 cluster for both the client and the server side. The parameters cannot be read or written via global commands.  
18932 The detailed description of these parameters can be found in the according command sections of the  
18933 document.

18934 **Table 10-125. Cluster Parameters Passed Through Commands**

Name	Type	Range	Default	M
ProtocolID	enum8	0x01 – 0xFF	0	M
ManufacturerCode	uint16	0x0000 – 0xFFFF	0	M
FlowControlSupport	bool	0 or 1	0	M
MaximumIncoming TransferSize	uint16	0x0000 – 0xFFFF	1500	M
TunnelID	uint16	0x0000 – 0xFFFF	(Return value)	M
Data	octstr	-	-	M
NumberOfOctetsLeft	uint16	0x0000 – 0xFFFF	-	M
TunnelStatus	uint8	0x00 – 0x04	-	M



Name	Type	Range	Default	M
TransferDataStatus	uint8	0x00 – 0x01	-	M

18935

## 18936 10.6.2.4 Commands Received

18937 Table 10-126 lists cluster-specific commands received by the server.

18938

**Table 10-126. Cluster-specific Commands Received by the Server**

Command Identifier Field Value	Description	M
0x00	<i>RequestTunnel</i>	M
0x01	<i>CloseTunnel</i>	M
0x02	<i>TransferData</i>	M
0x03	<i>TransferDataError</i>	M
0x04	<i>AckTransferData</i>	O
0x05	<i>ReadyData</i>	O
0x06	<i>GetSupportedTunnelProtocols</i>	O

### 18939 10.6.2.4.1 RequestTunnel Command

18940 RequestTunnel is the client command used to setup a tunnel association with the server. The request payload  
 18941 specifies the protocol identifier for the requested tunnel, a manufacturer code in case of proprietary protocols  
 18942 and the use of flow control for streaming protocols.

#### 18943 10.6.2.4.1.1 Payload Format

18944

**Figure 10-108. Format of the RequestTunnel Command Payload**

Octets	1	2	1	2
Data Type	enum8	uint16	bool	uint16
Field Name	ProtocolID (M)	Manufacturer Code (M)	FlowControl Support (M)	Maximum Incoming TransferSize

#### 18945 10.6.2.4.1.2 Payload Details

18946 **ProtocolID:** An enumeration representing the identifier of the metering communication protocol for which  
 18947 the tunnel is requested. Table 10-127 lists the possible values for the ProtocolID. The values above 199 may  
 18948 be used for manufacturer-specific protocols.

18949

**Table 10-127. ProtocolID Enumerations**

Values	Description
0	DLMS/COSEM (IEC 62056)
1	IEC 61107
2	ANSI C12

Values	Description
3	M-BUS
4	SML
5	ClimateTalk
6	GB-HRGP
7	IP v4 <sup>207</sup>
8	IP v6 <sup>208</sup>
200 to 254	Manufacturer-defined protocols

18950

18951 **Manufacturer Code:** A code that is allocated by the ZigBee Alliance, relating the manufacturer to a device  
 18952 and – for the tunneling - a manufacturer specific protocol. The parameter is ignored when the ProtocolID  
 18953 value is less than 200. This allows for 55 manufacturer-defined protocols for each manufacturer to be  
 18954 defined. A value of 0xFFFF indicates that the Manufacturer Code is not used.

18955 **FlowControlSupport:** A Boolean type parameter that indicates whether flow control support is requested  
 18956 from the tunnel (TRUE) or not (FALSE). The default value is FALSE (no flow control).

18957 **MaximumIncomingTransferSize:** A value that defines the size, in octets, of the maximum data packet that  
 18958 can be transferred to the client in the payload of a single TransferData command.

18959 **10.6.2.4.1.3 When Generated**

18960 Is never generated by the server.

18961 **10.6.2.4.1.4 Effect on Receipt**

18962 Triggers a process within the server to allocate resources and build up a new tunnel. A RequestTun-  
 18963 nelResponse is generated and sent back to the client containing the result of the RequestTunnel command.

18964 **10.6.2.4.2 CloseTunnel Command**

18965 Client command used to close the tunnel with the server. The parameter in the payload specifies the tunnel  
 18966 identifier of the tunnel that has to be closed. The server leaves the tunnel open and the assigned resources  
 18967 allocated until the client sends the CloseTunnel command or the CloseTunnelTimeout fires.

18968 **10.6.2.4.2.1 Payload Format**

18969 **Figure 10-109. Format of the CloseTunnel Command Payload**

<b>Octets</b>	2
<b>Data Type</b>	uint16
<b>Field Name</b>	TunnelID (M)

18970 **10.6.2.4.2.2 Payload Details**

<sup>207</sup> CCB 1955

<sup>208</sup> CCB 1955

18971 **TunnelID:** The identifier of the tunnel that shall be closed. It is the same number that has been previously  
 18972 returned in the response to a RequestTunnel command. Valid numbers range between 0..65535 and must  
 18973 correspond to a tunnel that is still active and maintained by the server.

18974 **10.6.2.4.2.3 When Generated**

18975 This command is never generated by the server.

18976 **10.6.2.4.2.4 Effect on Receipt**

18977 In case the given TunnelID is correct, the server closes the tunnel and frees the resources. The associated  
 18978 tunnel is no longer maintained. If the TunnelID value does not match an active tunnel on the server, the server  
 18979 shall return a Default Response with status NOT\_FOUND.

18980 **10.6.2.4.3 TransferData Command**

18981 Command that indicates (if received) that the client has sent data to the server. The data itself is contained  
 18982 within the payload.

18983 **10.6.2.4.3.1 Payload Format**

18984 **Figure 10-110. Format of the TransferData Command Payload**

<b>Octets</b>	2	Variable
<b>Data Type</b>	uint16	opaque
<b>Field Name</b>	TunnelID (M)	Data (M)

18985 **10.6.2.4.3.2 Payload Details**

18986 **TunnelID:** A number between 0..65535 that uniquely identifies the tunnel that has been allocated in the  
 18987 server triggered through the RequestTunnel command. This ID must be used to send data through the tunnel  
 18988 or passed with any commands concerning that specific tunnel.

18989 **Data:** Series of octets containing the data to be transferred through the tunnel in the format of the communi-  
 18990 cation protocol for which the tunnel has been requested and opened. The payload contains the assembled data  
 18991 exactly as it was sent by the client. Theoretically, its length is solely limited through the fragmentation algo-  
 18992 rithm and the RX/TX transfer buffer sizes within the communication partners. The content of the payload is  
 18993 up to the application sending the data. It is neither guaranteed, that it contains a complete PDU nor is any  
 18994 other assumption on its internal format made. This is left up to the implementer of the specific protocol tunnel  
 18995 behavior.

18996 **10.6.2.4.3.3 When Generated**

18997 Is generated whenever the server wants to tunnel protocol data to the client.

18998 **10.6.2.4.3.4 Effect on Receipt**

18999 Indicates that the server has received tunneled protocol data from the client.

19000 **10.6.2.4.4 TransferDataError Command**

19001 This command is generated by the receiver of a TransferData command if the tunnel status indicates that  
 19002 something is wrong. There are three cases in which TransferDataError is sent:

- 19003 • The *TransferData* received contains a *TunnelID* that does not match to any of the active tunnels of  
 19004 the receiving device. This could happen if a (sleeping) device sends a *TransferData* command to a  
 19005 tunnel that has been closed by the server after the *CloseTunnelTimeout*.

- 19006 • The *TransferData* received contains a proper *TunnelID* of an active tunnel, but the device sending  
19007 the data does not match to it.
- 19008 • The *TransferData* received contains more data than indicated by the *MaximumIncomingTransfer-*  
19009 *Size* of the receiving device.

**10.6.2.4.4.1 Payload Format**

Figure 10-111. Format of the *TransferDataError* Command Payload

<b>Octets</b>	2	1
<b>Data Type</b>	uint16	uint8
<b>Field Name</b>	TunnelID (M)	TransferDataStatus (M)

**10.6.2.4.4.2 Payload Details**

- 19013 **TunnelID:** A number between 0..65535 that uniquely identifies the tunnel that has been allocated in the  
19014 server triggered through the RequestTunnel command. This ID must be used for the data transfer through  
19015 the tunnel or passed with any commands concerning that specific tunnel.
- 19016 **TransferDataStatus:** The TransferDataStatus parameter indicates the error that occurred within the receiver  
19017 after the last TransferData command.
- 19018 The TransferDataStatus values are shown in Table 10-128.

19019

**Table 10-128. TransferDataStatus Values**

Value	Description	Remarks
0x00	No such tunnel	The <i>TransferData</i> command contains a <i>TunnelID</i> of a non-existent tunnel.
0x01	Wrong device	The <i>TransferData</i> command contains a <i>TunnelID</i> that does not match the device sending the data.
0x02	Data overflow	The <i>TransferData</i> command contains more data than indicated by the <i>MaximumIncomingTransferSize</i> of the receiving device

19020 **10.6.2.4.4.3 When Generated**

19021 Is generated if the server wants to tell the client that there was something wrong with the last *TransferData*  
 19022 command.

19023 **10.6.2.4.4.4 Effect on Receipt**

19024 Indicates that the client wants to tell the server that there was something wrong with the last *TransferData*  
 19025 command.

19026 **10.6.2.4.5 AckTransferData Command**

19027 Command sent in response to each *TransferData* command in case – and only in case – flow control has  
 19028 been requested by the client in the *TunnelRequest* command and is supported by both tunnel endpoints. The  
 19029 response payload indicates the number of octets that may still be received by the receiver.

19030 **10.6.2.4.5.1 Payload Format**

19031 **Figure 10-112. Format of the AckTransferData Command Payload**

<b>Octets</b>	2	2
<b>Data Type</b>	uint16	uint16
<b>Field Name</b>	TunnelID (M)	NumberOfBytesLeft (M)

19032 **10.6.2.4.5.2 Payload Details**

19033 **TunnelID:** A number between 0..65535 that uniquely identifies the tunnel that has been allocated in the  
 19034 server triggered through the *RequestTunnel* command. This ID must be used for the data transfer through  
 19035 the tunnel or passed with any commands concerning that specific tunnel.

19036 **NumberOfBytesLeft:** Indicates the number of bytes that may still be received by the initiator of this com-  
 19037 mand (receiver). It is most likely the remaining size of the buffer holding the data that is sent over *Transfer*-  
 19038 *Data*. As an example: A value of 150 indicates that the next *TransferData* command must not contain more  
 19039 than 150 bytes of payload or data will get lost. A value of 0 indicates that there is no more space left in  
 19040 the receiver and the sender should completely stop sending data. After the reception of a *ReadyData*  
 19041 command, the sender may continue its data transfer.

19042 **10.6.2.4.5.3 When Generated**

19043 If flow control is on, the command is issued by the server to inform the client that the last *TransferData*  
 19044 command has been successfully received and how much space is left to receive further data.

19045 **10.6.2.4.5.4 Effect on Receipt**

19046 If flow control is on, the reception of this command indicates that the client wants to inform the server that  
19047 the last TransferData command has been successfully received and how much space is left to receive further  
19048 data.

#### 19049 **10.6.2.4.6 ReadyData Command**

19050 The ReadyData command is generated – after a receiver had to stop the dataflow using the AckTransfer-  
19051 Data(0) command – to indicate that the device is now ready to continue receiving data. The parameter Num-  
19052 berOfOctetsLeft gives a hint on how much space is left for the next data transfer. The ReadyData command  
19053 is only issued if flow control is enabled.

##### 19054 **10.6.2.4.6.1 Payload Format**

19055 **Figure 10-113. Format of the ReadyData Command Payload**

<b>Octets</b>	2	2
<b>Data Type</b>	uint16	uint16
<b>Field Name</b>	TunnelID (M)	NumberOfOctetsLeft (M)

##### 19056 **10.6.2.4.6.2 Payload Details**

19057 **TunnelID:** A number between 0..65535 that uniquely identifies the tunnel that has been allocated in the  
19058 server triggered through the RequestTunnel command. This ID must be used for the data transfer through  
19059 the tunnel or passed with any commands concerning that specific tunnel.

19060 **NumberOfOctetsLeft:** Indicates the number of octets that may be received by the initiator of this com-  
19061 mand (receiver). It is most likely the remaining size of the buffer holding the data that is sent over Transfer-  
19062 Data. As an example: A value of 150 indicates that the next TransferData command must not contain more  
19063 than 150 bytes of payload or data will get lost. The value must be larger than 0. As for its exact value, it is  
19064 up to the implementer of the cluster to decide what flow control algorithm shall be applied.

##### 19065 **10.6.2.4.6.3 When Generated**

19066 If generated by the server, this command informs the client that it may now continue to send and how much  
19067 space is left within the server to receive further data.

##### 19068 **10.6.2.4.6.4 Effect on Receipt**

19069 If received by the server, this command informs the server that it may now continue to send and how much  
19070 space is left within the client to receive further data.

#### 19071 **10.6.2.4.7 Get Supported Tunnel Protocols Command**

19072 Get Supported Tunnel Protocols is the client command used to determine the tunnel protocols supported on  
19073 another device.

##### 19074 **10.6.2.4.7.1 Payload Format**

19075 **Figure 10-114. Format of the Get Supported Tunnel Protocols Command Payload**

<b>Octets</b>	1
<b>Data Type</b>	uint8
<b>Field Name</b>	Protocol Offset

##### 19076 **10.6.2.4.7.2 Payload Details**

19077 **Protocol Offset:** Where there are more protocols supported than can be returned in a single Supported Tunnel  
 19078 Protocols Response command, this field allows an offset to be specified on subsequent Get Supported Tunnel  
 19079 Protocols commands. An offset of zero (0x00) should be used for an initial (or only) Get Supported Tunnel  
 19080 Protocols command (indicating that the returned list of protocols should commence with first available pro-  
 19081 tocol). As a further example, if 10 protocols had previously been returned, the next Get Supported Tunnel  
 19082 Protocols command should use an offset of 10 (0x0A) to indicate the 11th available protocol should be  
 19083 the first returned in the next response.

19084 **10.6.2.4.7.3 Effect on Receipt**

19085 On receipt of this command, a device will respond with a Supported Tunnel Protocols Response com-  
 19086 mand, indicating the tunnel protocols it supports (see sub- clause 10.6.2.5.6 for further details).

19087

19088 **10.6.2.5 Commands Generated**

19089 Table 10-129 lists commands that are generated by the server.

19090

**Table 10-129. Cluster-Specific Commands Sent by the Server**

Command Identifier FieldValue	Description	M
0x00	<i>RequestTunnelResponse</i>	M
0x01	<i>TransferData</i>	M
0x02	<i>TransferDataError</i>	M
0x03	<i>AckTransferData</i>	O
0x04	<i>ReadyData</i>	O
0x05	<i>Supported Tunnel Protocols Response</i>	O
0x06	<i>TunnelClosureNotification</i>	O

19091 **10.6.2.5.1 RequestTunnelResponse Command**

19092 RequestTunnelResponse is sent by the server in response to a RequestTunnel command previously received  
 19093 from the client. The response contains the status of the RequestTunnel command and a tunnel identifier  
 19094 corresponding to the tunnel that has been set-up in the server in case of success.

19095 **10.6.2.5.1.1 Payload Format**

19096

**Figure 10-115. Format of the RequestTunnelResponse Command Payload**

<b>Octets</b>	2	1	2
<b>Data Type</b>	uint16	uint8	uint16
<b>Field Name</b>	TunnelID (M)	TunnelStatus (M)	Maximum Incoming TransferSize (M)

19097 **10.6.2.5.1.2 Payload Details**

19098 **TunnelID:** A number between 0..65535 that uniquely identifies the tunnel that has been allocated in the  
 19099 server triggered through the RequestTunnel command. This ID must now be used to send data through this  
 19100 tunnel (TunnelID, TransferData) and is also required to close the tunnel again (CloseTunnel). If the command  
 19101 has failed, the TunnelStatus contains the reason of the error and the TunnelID is set to 0xFFFF.

19102 **TunnelStatus:** The TunnelStatus parameter indicates the server’s internal status after the execution of a  
19103 RequestTunnel command.

19104 The TunnelStatus values are shown in Table 10-130.

19105 **Table 10-130. TunnelStatus Values**

Value	Description	Remarks
0x00	Success	The tunnel has been opened and may now be used to transfer data in both directions.
0x01	Busy	The server is busy and cannot create a new tunnel at the moment. The client may try again after a recommended timeout of 3 minutes.
0x02	No more tunnel IDs	The server has no more resources to setup requested tunnel. Clients should close any open tunnels before retrying.
0x03	Protocol not supported	The server does not support the protocol that has been requested in the ProtocolID parameter of the <i>RequestTunnel</i> command.
0x04	Flow control not supported	Flow control has been requested by the client in the <i>RequestTunnel</i> command but cannot be provided by the server (missing resources or no support).

19106

19107 **MaximumIncomingTransferSize:** A value that defines the size, in octets, of the maximum data packet that  
19108 can be transferred to the server in the payload of a single TransferData command.

19109 **10.6.2.5.1.3 When Generated**

19110 Is generated in reply to a RequestTunnel command to inform the client about the result of the request.

19111 **10.6.2.5.1.4 Effect on Receipt**

19112 Should never be received by the server.

19113 **10.6.2.5.2 TransferData Command**

19114 Command that transfers data from server to the client. The data itself has to be placed within the payload.

19115 **10.6.2.5.2.1 Payload Format**

19116 **Figure 10-116. Format of the TransferData Command Payload**

<b>Octets</b>	2	Variable
<b>Data Type</b>	uint16	opaque
<b>Field Name</b>	TunnelID (M)	Data (M)

19117 **10.6.2.5.2.2 Payload Details**

19118 **TunnelID:** A number between 0..65535 that uniquely identifies the tunnel that has been allocated in the  
19119 server triggered through the RequestTunnel command. This ID must be used for the data transfer through  
19120 the tunnel or passed with any commands concerning that specific tunnel.



19121 **Data:** Series of octets containing the data to be transferred through the tunnel in the format of the communi-  
 19122 cation protocol for which the tunnel has been requested and opened. The payload containing the  
 19123 assembled data exactly as it has been sent away by the client. Theoretically, its length is solely limited  
 19124 through the fragmentation algorithm and the RX/TX transfer buffer sizes within the communication partners.  
 19125 The content of the payload is up to the application sending the data. It is not guaranteed that it contains  
 19126 a complete PDU, nor is any assumption to be made on its internal format (which is left up to the implementer  
 19127 of the specific tunnel protocol).

19128 **10.6.2.5.2.3 When Generated**

19129 Is generated when the server wants to tunnel protocol data to the client.

19130 **10.6.2.5.2.4 Effect on Receipt**

19131 Indicates that the server has received tunneled protocol data from the client.

19132 **10.6.2.5.3 TransferDataError Command**

19133 See sub-clause 10.6.2.4.4.

19134 **10.6.2.5.4 AckTransferData Command**

19135 See sub-clause 10.6.2.4.5.

19136 **10.6.2.5.5 ReadyData Command**

19137 See sub-clause 10.6.2.4.6.

19138 **10.6.2.5.6 Supported Tunnel Protocols Response Command**

19139 Supported Tunnel Protocols Response is sent in response to a Get Supported Tunnel Protocols command  
 19140 previously received. The response contains a list of tunnel protocols supported by the device; the payload  
 19141 of the response should be capable of holding up to 16 protocols.

19142 **10.6.2.5.6.1 Payload Format**

19143 **Figure 10-117. Format of the Supported Tunnel Protocols Response Command Payload**

<b>Octets</b>	1	1	3	...	3
<b>Data Type</b>	bool	uint8			
<b>Field Name</b>	Protocol List Complete	Protocol Count	Protocol 1	...	Protocol n

19144

19145 where each protocol field shall be formatted as:

19146 **Figure 10-118. Format of the Supported Tunnel Protocols Response Command Protocol Fields**

<b>Octets</b>	2	1
<b>Data Type</b>	uint16	enum8
<b>Field Name</b>	Manufacturer Code	Protocol ID

19147 **10.6.2.5.6.2 Payload Details**

19148 **Protocol List Complete:** The Protocol List Complete field is a Boolean; a value of 0 indicates that there  
19149 are more supported protocols available (if more than 16 protocols are supported). A value of 1 indicates that  
19150 the list of supported protocols is complete.

19151 **Protocol Count:** The number of Protocol fields contained in the response.

19152 **Manufacturer Code:** A code that is allocated by the ZigBee Alliance, relating the manufacturer to a device  
19153 and - for tunneling - a manufacturer specific protocol. A value of 0xFFFF indicates a standard (i.e. non-  
19154 manufacturer specific) protocol

19155 **Protocol ID:** An enumeration representing the identifier of the metering communication protocol for the  
19156 supported tunnel. Table 10-127 lists the possible values for standard protocols

19157 **10.6.2.5.6.3 When Generated**

19158 Is generated in reply to a Get Supported Tunnel Protocols command, to indicate the tunnel protocols sup-  
19159 ported by the device

19160 **10.6.2.5.7 TunnelClosureNotification Command**

19161 TunnelClosureNotification is sent by the server to indicate that a tunnel has been closed due to expiration of  
19162 a CloseTunnelTimeout.

19163 **10.6.2.5.7.1 Payload Format**

19164 **Figure 10-119. Format of the TunnelClosureNotification Command Payload**

<b>Octets</b>	2
<b>Data Type</b>	uint16
<b>Field Name</b>	TunnelID (M)

19165 **10.6.2.5.7.2 Payload Details**

19166 **TunnelID:** The identifier of the tunnel that has been closed. It is the same number that has been previously  
19167 returned in the response to a RequestTunnel command. Valid numbers range between 0..65535 and must  
19168 correspond to a tunnel that was still active and maintained by the server.

19169 **10.6.2.5.7.3 When Generated**

19170 The command is sent by a server when a tunnel is closed due to expiration of CloseTunnelTimeout. It is  
19171 sent unicast to the client that had originally requested that tunnel.

19172 **10.6.3 Client**

19173 **10.6.3.1 Dependencies**

19174 This cluster requires APS fragmentation [Z1] to be implemented, with maximum transfer sizes defined by  
19175 the device's negotiated input buffer sizes.

19176 **10.6.3.2 Attributes**

19177 The client has no cluster specific attributes.

19178 **10.6.3.3 Commands Received**

19179 The client receives the cluster-specific response commands detailed in 10.6.2.5.

19180 **10.6.3.4 Commands Generated**

19181 The client generates the cluster-specific commands detailed in 0, as required by the application.

19182

19183 **10.7 Key Establishment**

---

19184 **10.7.1 Scope and Purpose**

19185 This section specifies a cluster that contains commands and attributes necessary for managing secure commu-  
19186 nication between ZigBee devices.

19187 This section should be used in conjunction with the ZigBee Cluster Library, Foundation Specification  
19188 (see Chapter 2), which gives an overview of the library and specifies the frame formats and general com-  
19189 mands used therein.

19190 This version is specifically for inclusion in the Smart Energy profile. The document which originates from  
19191 [Z10] will continue to be developed in a backward-compatible manner as a more general secure communi-  
19192 cation cluster for ZigBee applications as a whole.

19193 **10.7.2 General Description**

19194 **10.7.2.1 Introduction**

19195 As previously stated, this document describes a cluster for managing secure communication. The cluster  
19196 is for Key Establishment.

19197 **10.7.2.2 Security Credentials**

19198 Key Establishment requires that the device utilize pre-installed security credentials that are unique to the  
19199 device. Depending on the number of cryptographic suites that the device supports, there may be multiple  
19200 credentials installed. It is assumed that the device is capable of managing this and to provide the correspond-  
19201 ing credentials based on what suite is being actively used. The mechanism for negotiating the Key Establish-  
19202 ment suite is described in section 10.7.3.1.1.

19203 **10.7.2.3 Network Security**

19204 The Key Establishment Cluster has been designed to be used where the underlying network security cannot  
19205 be trusted. As such, no information that is confidential information will be transported.

## 19206 **10.7.2.4 Key Establishment**

19207 To allow integrity and confidentiality of data passed between devices, cryptographic schemes need to be  
19208 deployed. The cryptographic scheme deployed in the ZigBee Specification for frame integrity and confiden-  
19209 tiality is based upon a variant of the AES-CCM described in [N3] called AES-CCM\*. This relies on the  
19210 existence of secret keying material shared between the involved devices. There are methods to distribute this  
19211 secret keying material in a trusted manner. However, these methods are generally not scalable or communi-  
19212 cation may be required with a trusted key allocation party over an insecure medium. This leads to the re-  
19213 quirement for automated key establishment schemes to overcome these problems.

19214 Key establishment schemes can be affected using either a key agreement scheme or a key transport scheme.  
19215 The key establishment scheme described in this document uses a key agreement scheme, therefore key  
19216 transport schemes will not be considered further in this document.

19217 A key agreement scheme is where both parties contribute to the shared secret and therefore the secret keying  
19218 material to be established is not sent directly; rather, information is exchanged between both parties that  
19219 allows each party to derive the secret keying material. Key agreement schemes may use either symmetric key  
19220 or asymmetric key (public key) techniques. The party that begins a key agreement scheme is called the initi-  
19221 ator, and the other party is called the responder.

19222 Key establishment using key agreement involves an initiator and a responder and four steps:

- 19223 1. Establishment of a trust relationship
- 19224 2. Exchange of ephemeral data
- 19225 3. Use of this ephemeral data to derive secret keying material using key agreement
- 19226 4. Confirmation of the secret keying material.

19227 There are two basic types of key establishment that can be implemented:

- 19228 • Symmetric Key Key Establishment
- 19229 • Public Key Key Establishment

## 19230 **10.7.2.5 Symmetric Key Key Establishment**

19231 Symmetric Key Key Establishment (SKKE) is based upon establishing a link key based on a shared secret  
19232 (master key). If the knowledge of the shared secret is compromised, the established link key can also be  
19233 compromised. If the master key is publicly known or is set to a default value, it is known as Unprotected Key  
19234 Establishment (UKE). SKKE is the key establishment method used in the ZigBee specification therefore it  
19235 will not be considered any further.

## 19236 **10.7.2.6 Public Key Key Establishment**

19237 Public Key Key Establishment (PKKE) is based upon establishing a link key based on shared static and  
19238 ephemeral public keys. As the public keys do not require any secrecy, the established link key cannot be  
19239 compromised by knowledge of them.

19240 As a device's static public key is used as part of the link key creation, it can either be transported inde-  
19241 pendently to the device's identity where binding between the two is assumed, or it can be transported as part  
19242 of a implicit certificate signed by a Certificate Authority, which provides authentication of the binding  
19243 between the device's identity and its public key as part of the key establishment process. This is called  
19244 Certificate-Based Key Establishment (CBKE) and is discussed in more detail in sub-clause 10.7.6.2.

19245 CBKE provides the most comprehensive form of Key Establishment and therefore will be the method speci-  
19246 fied in this cluster.

19247 The purpose of the key agreement scheme as described in this document is to produce shared secret keying  
 19248 material which can be subsequently used by devices using AES-CCM\* the cryptographic scheme deployed  
 19249 in the ZigBee Specification or for any proprietary security mechanism implemented by the application.

19250 **10.7.2.7 General Exchange**

19251 Figure 10-120 shows an overview of the general exchange which takes place between initiator and responder  
 19252 to perform key establishment.

19253 **Figure 10-120. Overview of General Exchange**

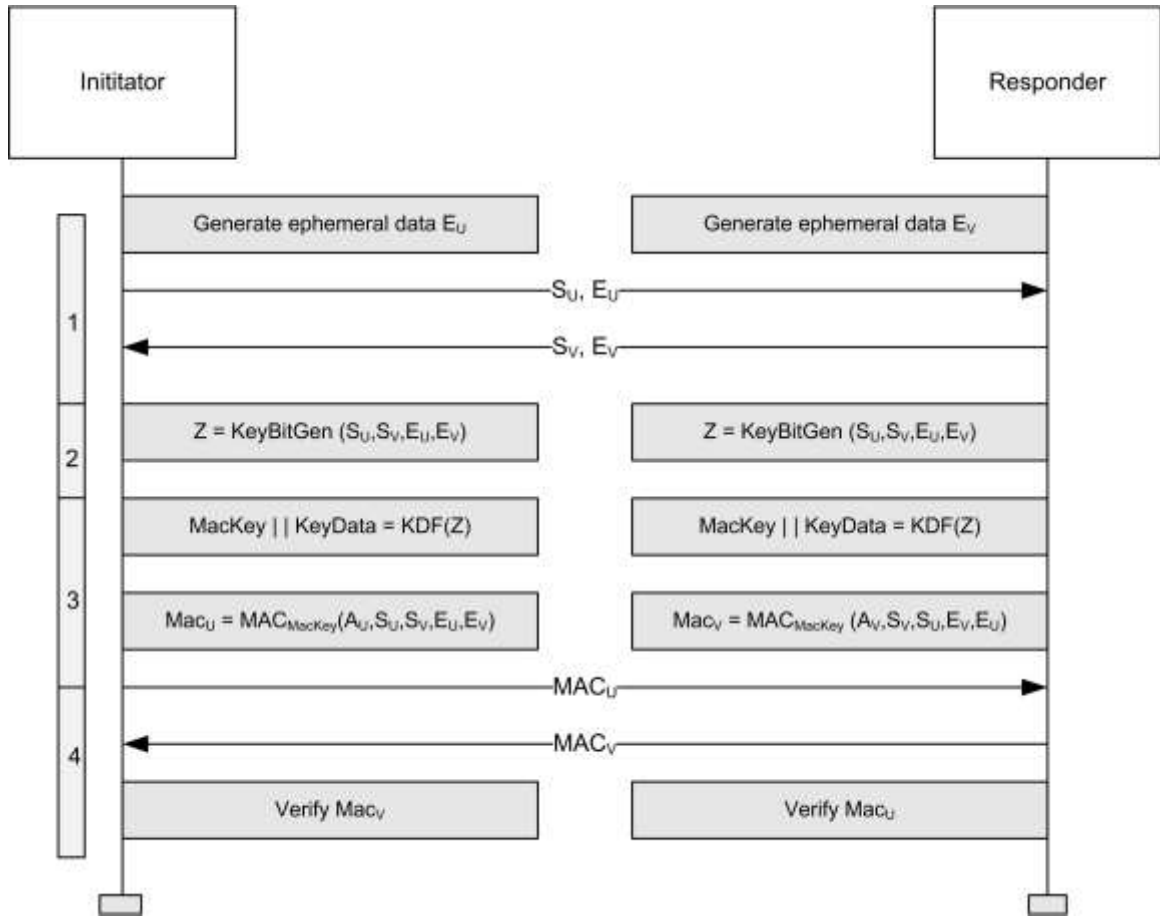

19254

19255

19256 The functions are:

- 19257 1. Exchange Static and Ephemeral Data
- 19258 2. Generate Key Bitstream
- 19259 3. Derive MAC key and Key Data
- 19260 4. Confirm Key using MAC

19261 The functions shown in Figure 10-120 depend on the Key Establishment mechanism.

### 19262 **10.7.2.7.1 Exchange Static and Ephemeral Data**

19263 Figure 10-120 shows static data  $S_U$  and  $S_V$ . For PKKE schemes, this represents a combination of the 64-bit  
19264 device address [Z11] and the device's static public key. The identities are needed by the MAC scheme and  
19265 the static public keys are needed by the key agreement scheme.

19266 Figure 10-120 also shows ephemeral data  $E_U$  and  $E_V$ . For PKKE schemes, this represents the public key of a  
19267 randomly generated key pair.

19268 The static and ephemeral data  $S_U$  and  $E_U$  are sent to V and the static and ephemeral data  $S_V$  and  $E_V$  are  
19269 sent to U.

### 19270 **10.7.2.7.2 Generate Key Bitstream**

19271 Figure 10-120 shows the KeyBitGen function for generating the key bitstream. The function's four param-  
19272 eters are the identifiers and the ephemeral data for both devices. This ensures the same key is generated  
19273 at both ends.

19274 For PKKE schemes, this is the ECMQV key agreement schemes specified in Section 6.2 of SEC1 [O1].  
19275 The static data  $S_U$  represents the static public key  $Q_{1,U}$  of party U, the static data  $S_V$  represents the static  
19276 public key  $Q_{1,V}$  of party V, the ephemeral data  $E_U$  represents the ephemeral public key  $Q_{2,U}$  of party U and  
19277 the ephemeral data  $E_V$  represents the ephemeral public key  $Q_{2,V}$  of party V.

### 19278 **10.7.2.7.3 Derive MAC Key and Key Data**

19279 Figure 10-120 shows the KDF (KeyDerivation Function) for generating the MAC Key and key data. The  
19280 MAC Key is used with a keyed hash message authentication function to generate a MAC and the key data  
19281 is the shared secret, e.g. the link key itself required for frame protection.

19282 For PKKE schemes, this is the key derivation function as specified in Section 3.6.1 of SEC1 [O1]. Note  
19283 there is no SharedInfo parameter of the referenced KDF, i.e. it is a null octet string of length 0.

19284 Figure 10-120 also shows generation of the MAC using the MAC Key derived using the KDF using a  
19285 message comprised of both static data  $S_U$  and  $S_V$  and ephemeral data  $E_U$  and  $E_V$  plus an additional component  
19286 A which is different for initiator and responder.

19287 For PKKE schemes, this is the MAC scheme specified in section 3.7 of SEC1 [O1]. The MAC in the  
19288 reference is the keyed hash function for message authentication specified in sub-clause 10.7.6.2.2.6 and the  
19289 message M is a concatenation of the identity (the 64-bit device address [E1]) of U, the identity of V and point-  
19290 compressed octet-string representations of the ephemeral public keys of parties U and V. The order of  
19291 concatenation depends on whether it is the initiator or responder. The additional component A is the single  
19292 octet  $02_{16}$  for the initiator and  $03_{16}$  for the responder.

### 19293 **10.7.2.7.4 Confirm Key Using MAC**

19294 Figure 10-120 shows MACs  $MAC_U$  and  $MAC_V$

19295 The MAC  $MAC_U$  is sent to V and the MAC  $MAC_V$  is sent to U. U and V both calculate the corresponding  
19296 MAC and compare it with the data received.

19297 **10.7.3 Overview**

19298 Please see Chapter 2 for a general cluster overview defining cluster architecture, revision, classification,  
19299 identification, etc.

19300 **Figure 10-121. Typical Usage of the Key Establishment Cluster**

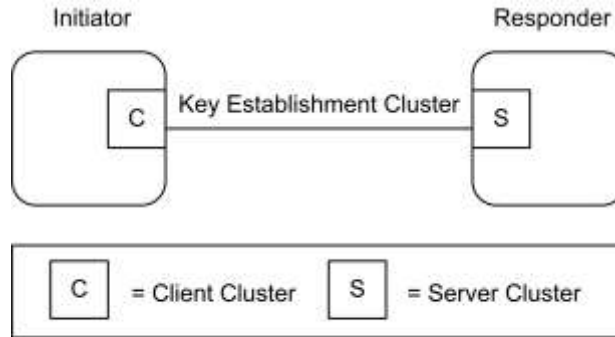

*Note: Device names are examples for illustration purposes only*

19301

19302

19303 This cluster provides attributes and commands to perform mutual authentication and establish keys between  
19304 two ZigBee devices. Figure 10-122 depicts a diagram of a successful key establishment negotiation.

19305

19306

**Figure 10-122. Key Establishment Command Exchange**

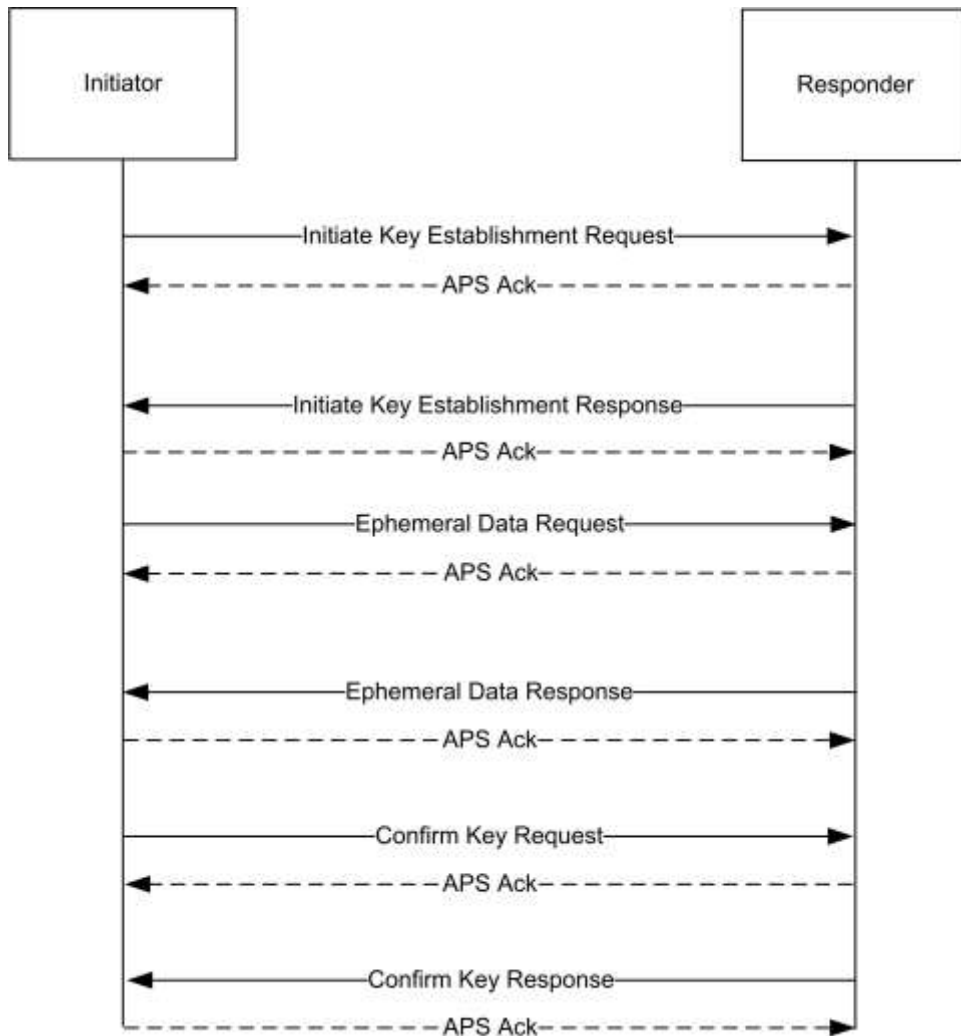

19307

19308

19309 As depicted above, all Key Establishment messages should be sent with APS retries enabled. A failure  
 19310 to receive an ACK in a timely manner can be seen as a failure of key establishment. No Terminate Key  
 19311 Establishment should be sent to the partner of device that has timed out the operation.

19312 The initiator can initiate the key establishment with any active endpoint on the responder device that  
 19313 supports the key establishment cluster. The endpoint can be either preconfigured or discovered, for example,  
 19314 by using ZDO Match-Desc-req. A link key successfully established using key establishment is valid for all  
 19315 endpoints on a particular device. The responder shall respond to the initiator using the source endpoint of the  
 19316 initiator's messages as the destination endpoint of the responder's messages.

19317 It is expected that the time it takes to perform the various cryptographic computations of the key establish-  
 19318 ment cluster may vary greatly based on the device. Therefore rather than set static timeouts, the Initiate  
 19319 Key Establishment Request and Response messages will contain approximate values for how long the device  
 19320 will take to generate the ephemeral data and how long the device will take to generate confirm key message.

19321 A device performing key establishment can use this information in order to choose a reasonable timeout  
 19322 for its partner during those operations. The timeout should also take into consideration the time it takes for  
 19323 a message to traverse the network including APS retries. A minimum transmission time of 2 seconds is  
 19324 recommended.



19325 For the Initiate Key Establishment Response message, it is recommended the initiator wait at least 2  
 19326 seconds before timing out the operation. It is not expected that generating an Initiate Key Establishment  
 19327 Response will take significant time compared to generating the Ephemeral Data and Confirm Key messages.

19328 **10.7.3.1.1 Negotiating the Key Establishment Suite**

19329 Devices may support multiple cryptographic key establishment suites and therefore the client and server must  
 19330 agree on the suite that is to be used. Devices shall only advertise the suites that they support and have security  
 19331 credentials for.

19332 The client device is expected to negotiate the key establishment suite with the server, which will be used for  
 19333 the rest of the key establishment exchange. The initiating device (client) may perform a Read Attribute re-  
 19334 quest on the KeyEstablishmentSuite attribute of the server. It will then compare its local value of the attribute  
 19335 to the server’s value to determine the common set of suites that are supported by both. The client shall choose  
 19336 the common suite with the highest bit value and then send the Initiate Key Establishment Request message  
 19337 using that suite. If no common suites are supported, the device shall leave the network.

19338 **10.7.3.2 Revision History**

19339 The global *ClusterRevision* attribute value SHALL be the highest revision number in the table below.

Rev	Description
1	mandatory global <i>ClusterRevision</i> attribute added
2	Updated from SE1.4 version

19340 **10.7.3.3 Classification**

Hierarchy	Role	PICS Code
Base	Application	SEKE

19341 **10.7.3.4 Cluster Identifiers**

Identifier	Name
0x0800	Key Establishment (Smart Energy)

19342 **10.7.4 Server**

19343 **10.7.4.1 Dependencies**

19344 None.

19345 **10.7.4.2 Attributes**

19346 For convenience, the attributes defined in this specification are arranged into sets of related attributes; each  
 19347 set can contain up to 16 attributes. Attribute identifiers are encoded such that the most significant three  
 19348 nibbles specify the attribute set and the least significant nibble specifies the attribute within the set. The  
 19349 currently defined attribute sets are listed in Table 10-131.

19350

**Table 10-131. Key Establishment Attribute Sets**

Attribute Set Identifier	Description
0x000	Information

19351 **10.7.4.2.1 Information**

19352 The *Information* attribute set contains the attributes summarized in Table 10-132.

19353

**Table 10-132. Information Attribute Sets**

Id	Name	Type	Range	Access	Default	M
0x0000	<i>KeyEstablishmentSuite</i>	enum16	0x0000 - 0xFFFF	R	0x0000	M

19354 **10.1.1.1.1.1.1.1.1 *KeyEstablishmentSuite* Attribute**

19355 The *KeyEstablishmentSuite* attribute is 16-bits in length and specifies all the cryptographic schemes for  
19356 key establishment on the device. A device shall set the corresponding bit to 1 for every cryptographic scheme  
19357 that it supports. All other cryptographic schemes and reserved bits shall be set to 0.

19358 Although, for backwards compatibility, the Type cannot be changed, this 16-bit Enumeration should be  
19359 treated as if it were a 16-bit BitMap.

19360

**Table 10-133. Values of the *KeyEstablishmentSuite* Attribute**

Bits	Description
0	Certificate-based Key Establishment Cryptographic Suite 1 (“Crypto Suite 1”)
1	Certificate-based Key Establishment Cryptographic Suite 2 (“Crypto Suite 2”)

19361 **10.7.4.2.1.1 Commands Received**

19362 The server side of the key establishment cluster is capable of receiving the commands listed in Table  
19363 10-134.

19364

**Table 10-134. Received Command IDs for the Key Establishment Cluster Server**

Command Identifier Field Value	Description	M
0x00	<i>Initiate Key EstablishmentRequest</i>	M
0x01	<i>Ephemeral Data Request</i>	M
0x02	<i>Confirm Key Data Request</i>	M
0x03	<i>Terminate Key Establishment</i>	M

19365 **10.7.4.2.1.1.1 Initiate Key Establishment Request Command**

19366 The Initiate Key Establishment Request command allows a device to initiate key establishment with another  
 19367 device. The sender shall indicate the identity information and key establishment protocol information that it  
 19368 wishes to use to the receiving device.

19369 **10.1.1.1.1.1.2 Payload Format**

19370 The Initiate Key Establishment Request command payload shall be formatted as illustrated in Figure 10-123.

19371 **Figure 10-123. Initiate Key Establishment Request Command Payload**

Octets	2	1	1	Variable
Data Type	map16	uint8	uint8	opaque
Field Name	Key Establish- ment suite	Ephemeral Data Generate Time	Confirm Key Generate Time	Identity (IDU)

19372

19373 **Key Establishment Suite:** This will be the type of KeyEstablishmentSuite that the initiator is requesting  
 19374 for the Key Establishment Cluster. For ‘Crypto Suite 1’ this will be 0x0001. For ‘Crypto Suite 2’ this will be  
 19375 0x0002. Only one suite shall be indicated in the command.

19376 **Ephemeral Data Generate Time:** This value indicates approximately how long the initiator device will  
 19377 take in seconds to generate the Ephemeral Data Request command. The valid range is 0x00 to 0xFE.

19378 **Confirm Key Generate Time:** This value indicates approximately how long the initiator device will take  
 19379 in seconds to generate the Confirm Key Request command. The valid range is 0x00 to 0xFE.

19380 **Identity field:** The identity field shall be the block of octets containing the implicit certificate CERTU. For  
 19381 KeyEstablishmentSuite = 0x0001 (‘Crypto Suite 1’), the certificate is specified in sub-clause 10.7.6.2.2. For  
 19382 KeyEstablishmentSuite = 0x0002 (‘Crypto Suite 2’) the certificate is specified in sub-clause 10.7.6.2.3.

19383 **10.1.1.1.1.1.3 Effect on Receipt**

19384 If the device does not currently have the resources to respond to a key establishment request it shall send a  
 19385 Terminate Key Establishment command with the result value set to NO\_RESOURCES and the Wait Time  
 19386 field shall be set to an approximation of the time that must pass before the device will have the resources to  
 19387 process a new Key Establishment Request.

19388 If the receiving device does not support the cryptographic suite specified in the message, it shall send a  
 19389 Terminate Key Establishment message with the status of UNSUPPORTED\_SUITE.

19390 If the KeyEstablishmentSuite field of the message has more than a single bit selected in the bitmap, the  
 19391 receiving device shall send a Terminate Key Establishment message with the status of BAD\_MESSAGE.

19392 The receiving device shall extract the Issuer field of the implicit certificate received in the message. It shall  
 19393 then examine all locally installed certificates using the same Cryptographic suite specified in the received  
 19394 message and compare the Issuer field contained within the certificate to the issuer within the received certifi-  
 19395 cate. If no locally installed certificates match the issuer in the received certificate, the device shall send a  
 19396 Terminate Key Establishment command with the result set to UNKNOWN\_ISSUER.

19397 If the implicit certificate received in the message is for the ‘Crypto Suite 2’ Cipher Suite, then the receiving  
 19398 device shall check the status of the *KeyUsage* field and, if the *Key Agreement* flag is NOT set, shall send  
 19399 a *Terminate Key Establishment* message with the status of INVALID\_CERTIFICATE. The receiving device  
 19400 shall also check the *Type*, *Curve* and *Hash* fields of such a certificate, and send a *Terminate Key Establishment*  
 19401 message with the status of INVALID\_CERTIFICATE if any of these fields contains an invalid value.

19402 If the device accepts the request it shall send an Initiate Key Establishment Response command  
 19403 containing its own identity information. It shall set the Key Establishment suite to the same value as in the  
 19404 received Initiate Key Establishment Request message. The identity information shall correspond to the same  
 19405 suite as specified in the Key Establishment suite. The device should verify the certificate belongs to the  
 19406 address that the device is communicating with. The binding between the identity of the communicating de-  
 19407 vice and its address is verifiable using an out-of-band method.

19408 For all future server messages within the current key establishment negotiation, the Key Establishment suite  
 19409 value received in this message shall be utilized. If the client receives a Terminate Key Establishment message,  
 19410 or times out the operation, the key establishment suite value must be renegotiated.

19411 **10.7.4.2.1.1.2 Ephemeral Data Request Command**

19412 The Ephemeral Data Request command allows a device to communicate its ephemeral data to another  
 19413 device and request that the device send back its own ephemeral data.

19414 *10.1.1.1.1.1.4 Payload Format*

19415 **Figure 10-124. Ephemeral Data Request Command Payload**

<b>Octets</b>	<b>Variable</b>
<b>Data Type</b>	opaque
<b>Field Name</b>	Ephemeral Data (QEU)

19416 *10.1.1.1.1.1.5 Effect on Receipt*

19417 If the device is not currently in the middle of negotiating Key Establishment with the sending device when  
 19418 it receives this message, it shall send back a Terminate Key Establishment message with a result of  
 19419 BAD\_MESSAGE. If the device is in the middle of Key Establishment with the sender but did not receive  
 19420 this message in response to an Initiate Key Establishment Response command, it shall send back a Ter-  
 19421 minate Key Establishment message with a result of BAD\_MESSAGE. If the device can process the request  
 19422 it shall respond by generating its own ephemeral data and sending an Ephemeral Data Response com-  
 19423 mand containing that value.

19424 The length of the frame shall correlate to the current key establishment suite that has been negotiated by the client and  
 19425 server (refer to Table 10-143 for relevant sizes). If the data is shorter than the expected length according to the cryp-  
 19426 tographic suite, the responder shall send back a Terminate Key Establishment message with a result of BAD\_MES-  
 19427 SAGE.

19428 **10.7.4.2.1.1.3 Confirm Key Request Command**

19429 The Confirm Key Request command allows the initiator sending device to confirm the key established with  
 19430 the responder receiving device based on performing a cryptographic hash using part of the generated  
 19431 keying material and the identities and ephemeral data of both parties.

19432 *10.1.1.1.1.1.6 Payload Format*

19433 The Confirm KeyRequest command payload shall be formatted as illustrated in Figure 10-125.

19434 **Figure 10-125. Confirm Key Request Command Payload**

<b>Octets</b>	16
<b>Data Type</b>	opaque
<b>Field Name</b>	Secure Message Authentication Code (MACU)

19435

19436 **Secure Message Authentication Code field:** The Secure Message Authentication Code field shall be the  
 19437 octet representation of MACU as specified in sub-clause 10.7.6.2.

19438 **10.1.1.1.1.1.7 Effect on Receipt**

19439 If the device is not currently in the middle of negotiating Key Establishment with the sending device when  
 19440 it receives this message, it shall send back a Terminate Key Establishment message with a result of  
 19441 BAD\_MESSAGE. If the device is in the middle of Key Establishment with the sender but did not receive  
 19442 this message in response to an Ephemeral Data Response command, it shall send back a Terminate Key  
 19443 Establishment message with a result of BAD\_MESSAGE.

19444 On receipt of the Confirm Key Request command the responder device shall compare the received  
 19445 MACU value with its own reconstructed version of MACU. If the two match the responder shall send back  
 19446 MACV by generating an appropriate Confirm Key Response command. If the two do not match, the  
 19447 responder shall send back a Terminate Key Establishment with a result of BAD\_KEY\_CONFIRM and  
 19448 terminate the key establishment.

19449 **10.7.4.2.1.1.4 Terminate Key Establishment Command**

19450 The Terminate Key Establishment command may be sent by either the initiator or responder to indicate a  
 19451 failure in the key establishment exchange.

19452 **10.1.1.1.1.1.8 Payload Format**

19453 The Terminate Key Establishment command payload shall be formatted as illustrated in Figure 10-126.

19454 **Figure 10-126. Terminate Key Establishment Command Payload**

Octets	1	1	2
Data Type	enum8	uint8	map16
Field Name	Status Code	Wait Time	KeyEstablishmentSuite

19455

19456 **Status Field:** The Status field shall be one of the error codes in Table 10-135.

19457 **Table 10-135. Terminate Key Establishment Command Status Field**

Enumeration	Value	Description
UNKNOWN_ISSUER	0x01	The Issuer field within the key establishment partner's certificate is unknown to the sending device, and it has terminated the key establishment.
BAD_KEY_CONFIRM	0x02	The device could not confirm that it shares the same key with the corresponding device and has terminated the key establishment.
BAD_MESSAGE	0x03	The device received a bad message from the corresponding device (e.g. message with bad data, an out of sequence number, or a message with a bad format) and has terminated the key establishment.
NO_RESOURCES	0x04	The device does not currently have the internal resources necessary to perform key establishment and has terminated the exchange.
UNSUPPORTED_SUITE	0x05	The device does not support the specified key establishment suite in the partner's Initiate Key Establishment message.
INVALID_CERTIFICATE	0x06	The received certificate specifies a type, curve, hash, or other parameter that is either unsupported by the device or invalid

19458

19459 **Wait Time:** This value indicates the minimum amount of time in seconds the initiator device should wait  
19460 before trying to initiate key establishment again. The valid range is 0x00 to 0xFE.

19461 **KeyEstablishmentSuite:** This value will be set the value of the KeyEstablishmentSuite attribute. It indicates  
19462 the list of key exchange methods that the device supports.

19463 **10.1.1.1.1.1.9 Effect on Receipt**

19464 On receipt of the Terminate Key Establishment command the device shall terminate key establishment with  
19465 the sender. If the device receives a status of BAD\_MESSAGE or NO\_RESOURCES it shall wait at least the  
19466 time specified in the Wait Time field before trying to re-initiate Key Establishment with the device.

19467 If the device receives a status of UNSUPPORTED\_SUITE it should examine the KeyEstablishmentSuite  
19468 field to determine if another suite can be used that is supported by the partner device. It may re-initiate key  
19469 establishment using that one of the supported suites after waiting the amount of time specified in the Wait  
19470 Time field. If the device does not support any of the types in the KeyEstablishmentSuite field, it should not  
19471 attempt key establishment again with that device.

19472 If the device receives a status of UNKNOWN\_ISSUER or BAD\_KEY\_CONFIRM the device should not  
19473 attempt key establishment again with the device, as it is unlikely that another attempt will be successful.

19474 **10.7.4.2.1.2 Commands Generated**

19475 The server generates the commands detailed in sub-clause 10.7.5.3, as well as those used for reading and  
19476 writing attributes.

19477 **10.7.5 Client**

19478 **10.7.5.1 Dependencies**

19479 The Key Establishment client cluster has no dependencies.

19480 **10.7.5.2 Attributes**

19481 For convenience, the attributes defined in this specification are arranged into sets of related attributes; each  
19482 set can contain up to 16 attributes. Attribute identifiers are encoded such that the most significant three  
19483 nibbles specify the attribute set and the least significant nibble specifies the attribute within the set. The  
19484 currently defined attribute sets are listed in Table 10-136.

19485 **Table 10-136. Key Establishment Attribute Sets**

Attribute Set Identifier	Description
0x000	Information

19486 **10.7.5.2.1 Information**

19487 The Information attribute set contains the attributes summarized in Table 10-137.

19488 **Table 10-137. Attributes of the Information Attribute Set**

Id	Name	Type	Range	Acc	Default	M
0x0000	KeyEstablishmentSuite	enum16	0x0000 – 0xFFFF	R	0x0000	M

19489 **10.7.5.2.1.1 KeyEstablishmentSuite Attribute**

19490 The KeyEstablishmentSuite attribute is 16-bits in length and specifies ALL the cryptographic schemes  
 19491 for key establishment on the device. A device shall set the corresponding bit to 1 for every cryptographic  
 19492 scheme that is supports. All other cryptographic schemes and reserved bits shall be set to 0. This attribute  
 19493 shall be set to one of the non-reserved values listed in Table 10-138.

19494 Although, for backwards compatibility, the Type cannot be changed, this 16-bit Enumeration should be  
 19495 treated as if it were a 16-bit BitMap.

19496

19497

**Table 10-138. Values of the KeyEstablishmentSuite Attribute**

KeyEstablishmentSuite	Description
0	Certificate-based Key Establishment Cryptographic Suite 1 (“Crypto Suite 1”)
1	Certificate-based Key Establishment Cryptographic Suite 2 (“Crypto Suite 2”)

### 19498 **10.7.5.3 Commands Received**

19499 The client side of the Key Establishment cluster is capable of receiving the commands listed in Table  
 19500 10-139.

19501

**Table 10-139. Received Command IDs for the Key Establishment Cluster Client**

Command Identifier Field Value	Description	M
0x00	<i>Initiate Key Establishment Response</i>	M
0x01	<i>Ephemeral Data Response</i>	M
0x02	<i>Confirm Key Data Response</i>	M
0x03	<i>Terminate Key Establishment</i>	M

#### 19502 **10.7.5.3.1 Initiate Key Establishment Response Command**

19503 The Initiate Key Establishment Response command allows a device to respond to a device requesting the  
 19504 initiation of key establishment with it. The sender will transmit its identity information and key establish-  
 19505 ment protocol information to the receiving device.

##### 19506 **10.7.5.3.1.1 Payload Format**

19507 The Initiate Key Establishment Response command payload shall be formatted as illustrated in Figure  
 19508 10-127.

19509

**Figure 10-127. Initiate Key Establishment Response Command Payload**

Octets	2	1	1	Variable
Data Type	map16	uint8	uint8	opaque
Field Name	Requested Key Establishment suite	Ephemeral Data Generate Time	Confirm Key Generate Time	Identity (IDU)

19510

19511 **Requested Key Establishment Suite:** This will be the type of KeyEstablishmentSuite that the initiator has  
19512 requested be used for the key establishment exchange. The responder device shall set a single bit in the bit-  
19513 mask indicating that it has accepted the requested suite; all other bits shall be set to zero.

19514 **Ephemeral Data Generate Time:** This value indicates approximately how long in seconds the responder  
19515 device takes to generate the Ephemeral Data Response message. The valid range is 0x00 to 0xFE.

19516 **Confirm Key Generate Time:** This value indicates approximately how long the responder device will take  
19517 in seconds to generate the Confirm Key Response message. The valid range is 0x00 to 0xFE.

19518 **Identity field:** The Identity field shall be the block of octets containing the implicit certificate CERTU. For  
19519 KeyEstablishmentSuite = 0x0001 ('Crypto Suite 1'), the certificate is specified in sub-clause 10.7.6.2.2. For  
19520 KeyEstablishmentSuite = 0x0002 ('Crypto Suite 2'), the certificate is specified in sub-clause 10.7.6.2.3.

### 19521 **10.7.5.3.1.2 Effect on Receipt**

19522 If the device is not currently in the middle of negotiating Key Establishment with the sending device when  
19523 it receives this message, it shall send back a Terminate Key Establishment message with a result of  
19524 BAD\_MESSAGE. If the device is in the middle of Key Establishment with the sender but did not receive  
19525 this message in response to an Initiate Key Establishment Request command, it shall send back a Terminate  
19526 Key Establishment message with a result of BAD\_MESSAGE.

19527 If the receiving device does not support the key establishment suite specified in the message, it shall send a  
19528 Terminate Key Establishment message with the status of UNSUPPORTED\_SUITE.

19529 If the Requested Key Establishment Suite field of the message has more than a single bit selected in the  
19530 bitmap, the receiving device shall send a Terminate Key Establishment message with the status of  
19531 BAD\_MESSAGE.

19532 On receipt of this command the device shall check the Issuer field of the device's implicit certificate. If the  
19533 Issuer field does not contain a value that corresponds to a known Certificate Authority, the device shall send  
19534 a Terminate Key Establishment command with the status value set to UNKNOWN\_ISSUER. If the device  
19535 does not currently have the resources to respond to a key establishment request it shall send a Terminate  
19536 Key Establishment command with the status value set to NO\_RESOURCES and the Wait Time field shall  
19537 be set to an approximation of the time that must pass before the device has the resources to process the  
19538 request.

19539 The receiver shall verify that the KeyEstablishmentSuite in the Initiate Key Establishment Response matches  
19540 the value that was sent in the Initiate Key Establishment Request. If the values do not match then the device  
19541 shall send a Terminate Key Establishment Request with UNSUPPORTED\_SUITE.

19542 If the implicit certificate received in the message is for the 'Crypto Suite 2' Cipher Suite, then the receiving  
19543 device shall check the status of the KeyUsage field and, if the Key Agreement flag is NOT set, shall send  
19544 a Terminate Key Establishment message with the status of INVALID\_CERTIFICATE. The receiving device  
19545 shall also check the Type, Curve and Hash fields of such a certificate, and send a Terminate Key Establishment  
19546 message with the status of INVALID\_CERTIFICATE if any of these fields contains an invalid value.

19547 If the device accepts the response it shall send an Ephemeral Data Request command. The device  
19548 should verify the certificate belongs to the address that the device is communicating with. The binding be-  
19549 tween the identity of the communicating device and its address is verifiable using out-of-band method.

19550 For all future client messages within the current key establishment negotiation, the Key Establishment suite  
19551 value received in this message shall be utilized. If the client receives a Terminate Key Establishment message,  
19552 or times out the operation, the key establishment suite value must be renegotiated.

### 19553 **10.7.5.3.2 Ephemeral Data Response Command**

19554 The Ephemeral Data Response command allows a device to communicate its ephemeral data to another  
19555 device that previously requested it.

### 19556 **10.7.5.3.2.1 Payload Format**



19557

**Figure 10-128. Ephemeral Data Response Command Payload**

<b>Octets</b>	<b>Variable</b>
<b>Data Type</b>	opaque
<b>Field Name</b>	Ephemeral Data (QEV)

19558 **10.7.5.3.2.2 Effect on Receipt**

19559 If the device is not currently in the middle of negotiating Key Establishment with the sending device when it  
 19560 receives this message, it shall send back a Terminate Key Establishment message with a result of  
 19561 BAD\_MESSAGE. If the device is in the middle of Key Establishment with the sender but did not receive this  
 19562 message in response to an Ephemeral Data Request command, it shall send back a Terminate Key Establishment  
 19563 message with a result of BAD\_MESSAGE.

19564 The length of the frame shall correlate to the current key establishment suite that has been negotiated by the  
 19565 client and server (refer to Table 10-143 for relevant sizes). If the length of the Ephemeral Data is shorter than  
 19566 the expected length according to the cryptographic suite, the responder shall send back a Terminate Key  
 19567 Establishment message with a result of BAD\_MESSAGE.

19568 On receipt of this command if the device can handle the request it shall perform key generation, key deriva-  
 19569 tion, and MAC generation. If successful it shall generate an appropriate Confirm Key Request command,  
 19570 otherwise it shall generate a Terminate Key Establishment with a result value of NO\_RESOURCES.

19571 **10.7.5.3.3 Confirm Key Response Command**

19572 The Confirm Key Response command allows the responder to verify the initiator has derived the same secret  
 19573 key. This is done by sending the initiator a cryptographic hash generated using the keying material and the  
 19574 identities and ephemeral data of both parties.

19575 **10.7.5.3.3.1 Payload Format**

19576 The Confirm Key Response command payload shall be formatted as illustrated in Figure 10-129.

19577

**Figure 10-129. Confirm Key Response Command Payload**

<b>Octets</b>	16
<b>Data Type</b>	opaque
<b>Field Name</b>	Secure Message Authentication Code (MACV)

19578

19579 **Secure Message Authentication Code field:** The Secure Message Authentication Code field shall be the  
 19580 octet representation of MACV as specified in sub-clause 10.7.6.2.

19581 **10.7.5.3.3.2 Effect on Receipt**

19582 If the device is not currently in the middle of negotiating Key Establishment with the sending device when  
 19583 it receives this message, it shall send back a Terminate Key Establishment message with a result of  
 19584 BAD\_MESSAGE. If the device is in the middle of Key Establishment with the sender but did not receive  
 19585 this message in response to a Confirm Key Request command, it shall send back a Terminate Key Estab-  
 19586 lishment message with a result of BAD\_MESSAGE.

19587 On receipt of the Confirm Key Response command the initiator device shall compare the received  
 19588 MACV value with its own reconstructed version of the MACV. If the two match then the initiator can  
 19589 consider the key establishment process to be successful. If the two do not match, the initiator should  
 19590 send a Terminate Key Establishment command with a result of BAD\_KEY\_CONFIRM.

19591 **10.7.5.3.4 Terminate Key Establishment Command**

19592 The Terminate Key Establishment command may be sent by either the initiator or responder to indicate a  
19593 failure in the key establishment exchange.

19594 **10.7.5.3.4.1 Payload Format**

19595 **Figure 10-130. Terminate Key Establishment Command Payload**

<b>Octets</b>	1	1	2
<b>Data Type</b>	enum8	uint8	map16
<b>Field Name</b>	Status Code	Wait Time	KeyEstablishmentSuite

19596

19597 **Status field:** The Status field shall be one of the error codes shown in Table 10-140.

19598 **Table 10-140. Terminate Key Establishment Command Status Field**

Enumeration	Value	Description
UNKNOWN_ISSUER	0x01	The Issuer field within the key establishment partner's certificate is unknown to the sending device, and it has terminated the key establishment.
BAD_KEY_CONFIRM	0x02	The device could not confirm that it shares the same key with the corresponding device and has terminated the key establishment.
BAD_MESSAGE	0x03	The device received a bad message from the corresponding device (e.g. message with bad data, an out of sequence number, or a message with a bad format) and has terminated the key establishment.
NO_RESOURCES	0x04	The device does not currently have the internal resources necessary to perform key establishment and has terminated the exchange.
UNSUPPORTED_SUITE	0x05	The device does not support the specified key establishment suite in the partner's Initiate Key Establishment message.
INVALID_CERTIFICATE	0x06	The received certificate specifies a type, curve, hash, or other parameter that is either unsupported by the device or invalid

19599

19600 **Wait Time:** This value indicates the minimum amount of time in seconds the initiator device should wait  
19601 before trying to initiate key establishment again. The valid range is 0x00 to 0xFE.

19602 **KeyEstablishmentSuite:** This value will be set to the value of the KeyEstablishmentSuite attribute. It indi-  
19603 cates the list of key exchange methods that the device supports.

19604 **10.7.5.3.4.2 Effect on Receipt**

19605 On receipt of the Terminate Key Establishment command the device shall terminate key establishment with  
19606 the sender. If the device receives a status of BAD\_MESSAGE or NO\_RESOURCES it shall wait at least the  
19607 time specified in the Wait Time field before trying to re-initiate Key Establishment with the device.

19608 If the device receives a status of UNKNOWN\_SUITE it should examine the KeyEstablishmentSuite field  
19609 to determine if another suite can be used that is supported by the partner device. It may re-initiate key  
19610 establishment using that one of the supported suites after waiting the amount of time specified in the Wait  
19611 Time field. If the device does not support any of the types in the KeyEstablishmentSuite field, it should not  
19612 attempt key establishment again with that device.

19613 If the device receives a status of UNKNOWN\_ISSUER or BAD\_KEY\_CONFIRM the device should not  
19614 attempt key establishment again with the device, as it is unlikely that another attempt will be successful.

#### 19615 **10.7.5.4 Commands Generated**

19616 The client generates the commands detailed in sub-clause 10.7.4.2.1.1, as well as those used for reading  
19617 and writing attributes.

### 19618 **10.7.6 Application Implementation**

#### 19619 **10.7.6.1 Network Security for Smart Energy Networks**

19620 The underlying network security for Smart Energy networks is assumed to be ZigBee Standard security  
19621 using pre-configured link keys.

19622 A temporary link key for a joining device is produced by performing the cryptographic hash function on a  
19623 random number assigned to the joining device (e.g. serial number) and the device identifier, which is the  
19624 device's 64-bit IEEE address [Z11].

19625 The joining device's assigned random number is then conveyed to the utility via an out-of-band mechanism  
19626 (e.g. telephone call, or web site registration). The utility then commissions the Trust Center at the  
19627 premises where the joining device is by installing the temporary link key on the Trust Center on the back  
19628 channel.

19629 When the joining device powers up, it will also create a temporary link key as above and therefore at the  
19630 time of joining both the joining device and the Trust Center have the same temporary link key, which can be  
19631 used to transport the network key securely to the joining device.

19632 At this point, the device will be considered joined and authenticated as far as network security is  
19633 concerned. The secure communication cluster can now be invoked to replace the temporary link key with  
19634 a more secure link key based on public key cryptography.

#### 19635 **10.7.6.2 Certificate-Based Key Establishment**

19636 The Certificate-Based Key-Establishment (CBKE) solution uses public-key technology with digital certifi-  
19637 cates and root keys. Each device has a private key and a digital certificate that is signed by a Certificate  
19638 Authority (CA).

19639 The digital certificate includes:

- 19640 • Reconstruction data for the device's public key
- 19641 • The device's extended 64-bit IEEE address
- 19642 • Profile specific information (e.g., the device class, network id, object type, validity date, etc.)

19643 Certificates provide a mechanism for cryptographically binding a public key to a device's identity and char-  
19644 acteristics.

19645 Trust for a CBKE solution is established by provisioning a CA root key and a digital certificate to each  
19646 device. A CA root key is the public key paired with the CA's private key. A CA uses its private key to sign  
19647 digital certificates and the CA root key is used to verify these signatures. The trustworthiness of a public  
19648 key is confirmed by verifying the CA's signature of the digital certificate. Certificates can be issued either  
19649 by the device manufacturer, the device distributor, or the end customer. For example, in practical situations,  
19650 the CA may be a computer (with appropriate key management software) that is kept physically secure at  
19651 the end customer's facility or by a third-party.

19652 At the end of successful completion of the CBKE protocol the following security services are offered:

- 19653 • Both devices share a secret link key.
- 19654 • Implicit Key Authentication: Both devices know with whom they share this link key.
- 19655 • Key Confirmation: Each device knows that the other device actually has computed the key cor-  
19656 rectly.
- 19657 • No Unilateral Key Control: No device has complete control over the shared link key that is estab-  
19658 lished.
- 19659 • Perfect Forward Secrecy: If the private key gets compromised none of future and past communica-  
19660 tions are exposed.
- 19661 • Known Key Security resilience: Each shared link key created per session is unique.

## 19662 **10.7.6.2.1 Notation and Representation**

### 19663 **10.7.6.2.1.1 Strings and String Operations**

19664 A string is a sequence of symbols over a specific set (e.g., the binary alphabet {0,1} or the set of all  
19665 octets). The length of a string is the number of symbols it contains (over the same alphabet). The right-  
19666 concatenation of two strings  $x$  and  $y$  of length  $m$  and  $n$  respectively (notation:  $x \parallel y$ ), is the string  $z$  of length  
19667  $m+n$  that coincides with  $x$  on its leftmost  $m$  symbols and with  $y$  on its rightmost  $n$  symbols. An octet is a bit  
19668 string of length 8.

### 19669 **10.7.6.2.1.2 Integers and Their Representation**

19670 Throughout this specification, the representation of integers as bit strings or octet strings shall be fixed. All  
19671 integers shall be represented as binary strings in most-significant-bit first order and as octet strings in most-  
19672 significant-octet first order. This representation conforms to the convention in Section 2.3 of SEC1 [O1].

### 19673 **10.7.6.2.1.3 Entities**

19674 Throughout this specification, each entity shall be a DEV and shall be uniquely identified by its 64-bit  
19675 IEEE device address [Z11]. The parameter entlen shall have the integer value 64.

## 19676 **10.7.6.2.2 Cryptographic Suite 1 Building Blocks**

19677 The following cryptographic primitives and data elements are defined for use with the CBKE 'Crypto Suite  
19678 1' Cipher suite protocol specified in this document.

### 19679 **10.7.6.2.2.1 Elliptic-Curve Domain Parameters**

19680 The elliptic curve domain parameters used by this Cryptographic suite shall be those for the curve "sect  
19681 163k1" as specified in section 3.4.1 of SEC2 [O2].

19682 All elliptic-curve points (and operations in this section) used by the 'Crypto Suite 1' Cipher Suite shall be  
19683 (performed) on this curve.

### 19684 **10.7.6.2.2.2 Elliptic-Curve Point Representation**

19685 All elliptic-curve points in the Cryptographic Suite 1 shall be represented as point compressed octet strings  
19686 as specified in sections 2.3.3 and 2.3.4 of SEC1 [O1]. Thus, each elliptic-curve point Cryptographic Suite  
19687 1 can be represented in 22 bytes.

#### 19688 **10.7.6.2.2.3 Elliptic-Curve Key Pair**

19689 An elliptic-curve-key pair consists of an integer  $d$  and a point  $Q$  on the curve determined by multiplying  
19690 the generating point  $G$  of the curve by this integer (i.e.,  $Q=dG$ ) as specified in section 3.2.1 of SEC1 [O1].  
19691 Here,  $Q$  is called the public key, whereas  $d$  is called the private key; the pair  $(d, Q)$  is called the key pair.  
19692 Each private key shall be represented as specified in section 2.3.7 of SEC1 [O1]. Each public key shall be  
19693 represented as defined in sub-clause 10.7.6.2.1.2 of this document.

#### 19694 **10.7.6.2.2.4 ECC Implicit Certificates**

19695 The exact format of the 48-byte implicit certificate  $IC_U$  used with CBKE scheme shall be specified as fol-  
19696 lows:

19697  $IC_U = PublicReconstrKey || Subject || Issuer || ProfileAttributeData$

19698 Where,

- 19699 1. *PublicReconstrKey*: the 22-byte representation of the public-key reconstruction data  $BEU$  as speci-  
19700 fied in the implicit certificate generation protocol, which is an elliptic-curve point as specified in  
19701 sub-clause 10.7.6.2.2.2 (see SEC4 [O1]);
- 19702 2. *Subject*: the 8-byte identifier of the entity  $U$  that is bound to the public-key reconstruction data  
19703  $BEU$  during execution of the implicit certificate generation protocol (i.e., the extended, 64-bit  
19704 IEEE 802.15.4 address [E1] of the device that purportedly owns the private key corresponding to  
19705 the public key that can be reconstructed with *PublicReconstrKey*);
- 19706 3. *Issuer*: the 8-byte identifier of the CA that creates the implicit certificate during the execution of the  
19707 implicit certificate generation protocol (the so-called Certificate Authority).
- 19708 4. *ProfileAttributeData*: the 10-byte sequence of octets that can be used by a ZigBee profile for any  
19709 purpose. The first two bytes of this sequence is reserved as a profile identifier, which must be de-  
19710 fined by another ZigBee standard.
- 19711 5. The string  $I_U$  as specified in Step 6 of the actions of the CA in the implicit certificate generation  
19712 protocol (see section SEC4 [O2]) shall be the concatenation of the *Subject*, *Issuer*, and *ProfileAt-*  
19713 *tributeData*:

19714 
$$I_U = Subject || Issuer || ProfileAttributeData$$

#### 19715 **10.7.6.2.2.5 Block-Cipher**

19716 The block-cipher used in this specification shall be the Advanced Encryption Standard AES-128, as  
19717 specified in FIPS Pub 197 [N4]. This block-cipher has a key size that is equal to the block size, in bits, i.e.,  
19718  $keylen = 128$ .

#### 19719 **10.7.6.2.2.6 Cryptographic Hash Function**

19720 The cryptographic hash function used in this specification shall be the blockcipher based cryptographic hash  
19721 function specified in Annex B.6 in [Z1], with the following instantiations:

- 19722 1. Each entity shall use the block-cipher  $E$  as specified in sub-clause B.1.1 in [Z1].
- 19723 2. All integers and octets shall be represented as specified in sub-clause 10.7.6.2.1.

19724 The Matyas-Meyer-Oseas hash function (specified in Annex B.6 in [Z1]) has a message digest size  $hashlen$   
19725 that is equal to the block size, in bits, of the established blockcipher.

#### 19726 **10.7.6.2.2.7 Keyed Hash Function for Message Authentication**

19727 The keyed hash message authentication code (HMAC) used in this specification shall be HMAC, as specified in the FIPS Pub 198 [N5] with the following instantiations:  
19728

- 19729 1. Each entity shall use the cryptographic hash  $H$  function as specified in sub-clause 10.7.6.2.2.6;
- 19730 2. The block size  $B$  shall have the integer value 16 (this block size specifies the length of the data integrity key, in bytes, that is used by the keyed hash function, i.e., it uses a 128-bit data integrity key). This is also *MacKeyLen*, the length of *MacKey*.  
19731  
19732
- 19733 3. The output size *HMAClen* of the HMAC function shall have the same integer value as the message digest parameter *hashlen* as specified in sub-clause 10.7.6.2.2.6.  
19734

#### 19735 **10.7.6.2.2.8 Derived Shared Secret**

19736 The derived shared secret *KeyData* is the output of the key establishment. *KeyData* shall have length *KeyDataLen* of 128 bits.  
19737

#### 19738 **10.7.6.2.3 Cryptographic Suite 2 Building Blocks**

19739 The elliptic curve domain parameters used by this Cipher suite shall be those for the curve “sect283k1” as specified in section 3.4.1 of SEC2 [O2].  
19740

19741 All elliptic-curve points (and operations in this section) used by the ‘Crypto Suite 2’ Cipher Suite shall be (performed) on this curve.  
19742

##### 19743 **10.7.6.2.3.1 Elliptic-Curve Point Representation**

19744 All elliptic-curve points in the ‘Crypto Suite 2’ Cipher Suite shall be represented as point compressed octet strings as specified in sections 2.3.3 and 2.3.4 of SEC1 [O1]. Thus, each elliptic-curve point can be represented in 37 bytes.  
19745  
19746

##### 19747 **10.7.6.2.3.2 Elliptic-Curve Key Pair**

19748 An elliptic-curve-key pair consists of an integer  $d$  and a point  $Q$  on the curve determined by multiplying the generating point  $G$  of the curve by this integer (i.e.,  $Q=dG$ ) as specified in section 3.2.1 of SEC1 [O1].  
19749 Here,  $Q$  is called the public key, whereas  $d$  is called the private key; the pair  $(d, Q)$  is called the key pair.  
19750 Each private key shall be represented as specified in section 2.3.7 of SEC1 [O1]. Each public key shall be  
19751 represented as defined in sub-clause 10.7.6.2.1.2 of this document.  
19752

##### 19753 **10.7.6.2.3.3 ECC Implicit Certificates**

19754 The exact format of the Cryptographic Suite 2 74-byte implicit certificate  $IC_U$  used with CBKE scheme follows the definitions given in SEC 4 [O3] for the minimal encoding scheme (MES) and shall be specified as follows:  
19755  
19756

19757  $IC_U = Type \parallel SerialNo \parallel Curve \parallel Hash \parallel Issuer \parallel ValidFrom \parallel ValidTo \parallel Subject \parallel KeyUsage \parallel PublicReconstrKey$

19758 where

19759 Type: is a 1-byte enumeration indicating whether the implicit certificate contains extensions. For the ‘Crypto Suite 2’ Cipher Suite this shall be 0x00 indicating no extensions are used;  
19760

19761 SerialNo: is an 8-byte representation of the certificate Serial Number;

19762 Curve: is a 1-byte elliptic curve identifier. For the ‘Crypto Suite 2’ Cipher Suite this shall be 0x0D indicating the sect283k1 curve is used;  
19763

19764 Hash: is a 1-byte hash identifier. For the ‘Crypto Suite 2’ Cipher Suite, this shall be 0x08 indicating that AES-MMO is used;  
19765

19766 Issuer: the 8-byte address of the CA that creates the implicit certificate during the execution of the implicit certificate generation protocol (the Certificate Authority);  
19767

19768 ValidFrom: the 5-byte Unix time from which the certificate is valid (this signed 40-bit integer matches that  
 19769 defined in SEC4 [O3]). For conversion between Unix and Zigbee time, the Zigbee Epoch (January 1, 2000)  
 19770 equates to 946,684,800 seconds in Unix time. NOTE that this field is currently reserved and should be set to  
 19771 a default value of 0;

19772 ValidTo: a 4-byte number giving the seconds from the ValidFrom time for which the certificate is considered  
 19773 valid. A number less than 0xFFFFFFFF gives the number in seconds while 0xFFFFFFFF indicates an infinite  
 19774 number of seconds;

19775 Subject: the 8-byte identifier of the entity U that is bound to the public-key reconstruction data BEU during  
 19776 execution of the implicit certificate generation protocol (i.e., the extended, 64-bit IEEE 802.15.4 address [E1]  
 19777 of the device that purportedly owns the private key corresponding to the public key that can be reconstructed  
 19778 with PublicReconstrKey);

19779 KeyUsage: 1-byte identifier indicating the key usage. The complete bit string is defined in SEC4 [O3], the  
 19780 bits relevant to the ‘Crypto Suite 2’ Cipher Suite are:-

19781

**Table 10-141. Values of the KeyUsage Field**

Bits	Description
0	Reserved
1	Reserved
2	Reserved
3	Key Agreement
4	Reserved
5	Reserved
6	Reserved
7	Digital Signature

19782

19783 For usage of the ‘Crypto Suite 2’ Cipher Suite for Key Establishment, bit 3 shall be set;

19784 PublicReconstrKey: the 37-byte representation of the public-key reconstruction data BEU as specified in the  
 19785 implicit certificate generation protocol, which is an elliptic-curve point as specified in sub-clause 10.7.6.2.2.2  
 19786 (see SEC4 [O3]).

19787

19788 The specification for ICu is further summarized in the following tabular form:

19789

**Table 10-142. ECC Implicit Certificate format**

Bytes	Name	Description
1	Type	Type of certificate = 0, implicit no extensions
8	SerialNo	Serial Number of the certificate
1	Curve	Curve identifier (sect283k1 is 13 or byte value 0x0D)
1	Hash	Hash identifier (AES-MMO is byte value 0x08)
8	Issuer	8 byte identifier, 64-bit IEEE 802.15.4 address
5	ValidFrom	40-bit Unix time from which the certificate is valid
4	ValidTo	32-bit # of seconds from the ValidFrom time for which the certificate is considered valid (0xFFFFFFFF = infinite)
8	SubjectID	8 byte identifier, 64-bit IEEE 802.15.4 address
1	KeyUsage	Bit flag indicating key usage (0x88 = digital signature or key agreement allowed)

37	PublicKey	37-byte compressed public key value from which the public key of the Subject is reconstructed.
----	-----------	--

19790 Note that the 74-byte certificate will necessitate the use of fragmentation with associated commands.

19791 **10.7.6.2.3.4 Block-Cipher**

19792 Refer to section 10.7.6.2.2.5 for definition.

19793 **10.7.6.2.3.5 Cryptographic Hash Function**

19794 Refer to section 10.7.6.2.2.6 for definition.

19795 **10.7.6.2.3.6 Keyed Hash Function for Message Authentication**

19796 Refer to section 10.7.6.2.2.7 for definition.

19797 **10.7.6.2.3.7 Derived Shared Secret**

19798 Refer to section 10.7.6.2.2.8 for definition.

19799

19800 **10.7.6.2.4 Certificate-Based Key-Establishment**

19801 The CBKE method is used when the authenticity of both parties involved has not been established and where  
19802 implicit authentication of both parties is required prior to key agreement.

19803 The CBKE protocol has an identical structure to the PKKE protocol, except that implicit certificates are  
19804 used rather than manual certificates. The implicit certificate protocol used with CBKE shall be the implicit  
19805 certificate scheme with associated implicit certificate generation scheme and implicit certificate processing  
19806 transformation as specified in SEC4 [O1], with the following instantiations:

- 19807 1. Each entity shall be a DEV;
- 19808 2. Each entity's identifier shall be its 64-bit device address [Z11]; the parameter *entlen* shall have the  
19809 integer value 64;
- 19810 3. Each entity shall use the cryptographic hash function as specified in sub-clause 10.7.6.2.2.6;

19811 The following additional information shall have been unambiguously established between devices operating  
19812 the implicit certificate scheme:

- 19813 1. Each entity shall have obtained information regarding the infrastructure that will be used for the  
19814 operation of the implicit certificate scheme - including a certificate format and certificate genera-  
19815 tion and processing rules (see SEC4 [O1]);
- 19816 2. Each entity shall have access to an authentic copy of the elliptic-curve public keys of one or more  
19817 certificate authorities that act as CA for the implicit certificate scheme (SEC4 [O1]).

19818 The methods by which this information is to be established are outside the scope of this standard.

19819 The methods used during the CBKE protocol are described below. The parameters used by these methods are  
19820 described in Table 10-143.



19821

**Table 10-143. Parameters Used by Methods of the CBKE Protocol**

Parameter	Size (Octets)		Description
	'Crypto Suite 1'	'Crypto Suite 2'	
CERTU	48	74	The initiator device's implicit certificate used to transfer the initiator device's public key (denoted $Q_{I,U}$ in the Elliptic Curve MQV scheme in SEC1 [O1]) and the initiator device's identity.
CERTV	48	74	The responder device's implicit certificate used to transfer the responder device's public key (denoted $Q_{I,V}$ in the Elliptic Curve MQV scheme in SEC1 [O1]) and the responder device's identity.
QEU	22	37	The ephemeral public key generated by the initiator device (denoted $Q_{2,U}$ in the Elliptic Curve MQV scheme in SEC1 [O1]).
QEV	22	37	The ephemeral public key generated by the responder device (denoted $Q_{2,V}$ in the Elliptic Curve MQV scheme in SEC1 [O1]).
MACU	16	16	The secure message authentication code generated by the initiator device (where the message M is $(02_{16} // ID_U // ID_V // QEU // QEV)$ and $ID_U$ and $ID_V$ are the initiator and responder device entities respectively as specified in sub-clause C.4.2.2.3 and $QEU$ and $QEV$ are the point-compressed elliptic curve points representing the ephemeral public keys of the initiator and responder respectively as specified in sub-clause 10.7.6.2.2.2. See also section 3.7 of SEC1 [O1]).
MACV	16	16	The secure message authentication code generated by the responder device (where the message M is $(03_{16} // ID_V // ID_U // QEV // QEU)$ and $ID_V$ and $ID_U$ are the responder and initiator device entities respectively as specified in sub-clause C.4.2.2.3 and $QEV$ and $QEU$ are the point-compressed elliptic curve points representing the ephemeral public keys of the responder and initiator respectively as specified in sub-clause 10.7.6.2.2.3. See also section 3.7 of SEC1 [O1]).

19822 **10.7.6.2.4.1 Exchange Ephemeral Data**

19823 **10.7.6.2.4.1.1 Initiator**

19824 The initiator device's implicit certificate CERTU and a newly generated ephemeral public key QEU are  
 19825 transferred to the responder device using the Initiate Key Establishment command via the Key Establish-  
 19826 ment Cluster Client.

19827 **10.7.6.2.4.1.2 Responder**

19828 The responder device's implicit certificate CERTV and a newly generated ephemeral public key QEV are  
19829 transferred to the initiator device using the Initiate Key Establishment response command via the Key Estab-  
19830 lishment Cluster Server.

19831 **10.7.6.2.4.2 Validate Implicit Certificates**19832 **10.7.6.2.4.2.1 Initiator**

19833 The initiator device's Key Establishment Cluster Client processes the Initiate Key Establishment response  
19834 command. The initiator device examines CERTV (formatted as  $IC_V$  as described in sub-clause 10.7.6.2.2.4),  
19835 confirms that the Subject identifier is the purported owner of the certificate, and runs the certificate pro-  
19836 cessing steps described in section SEC4 [O2].

19837 **10.7.6.2.4.2.2 Responder**

19838 The responder device's Key Establishment Cluster Server processes the Initiate Key Establishment com-  
19839 mand. The responder device examines CERTU (formatted as  $IC_U$  as described in sub-clause 10.7.6.2.2.4),  
19840 confirms that the Subject identifier is the purported owner of the certificate, and runs the certificate pro-  
19841 cessing steps described in section SEC 4 [O2].

19842 **10.7.6.2.4.3 Derive Keying Material**19843 **10.7.6.2.4.3.1 Initiator**

19844 The initiator performs the Elliptic Curve MQV scheme as specified in section 6.2 of SEC1 [O1] with the  
19845 following instantiations:

- 19846 1. The elliptic curve domain parameters shall be as specified in sub-clause 10.7.6.2.2.1;
- 19847 2. The KDF shall use the cryptographic hash function specified in sub-clause 10.7.6.2.2.2;
- 19848 3. The static public key  $Q_{1,U}$  shall be the static public key of the initiator;
- 19849 4. The ephemeral public key  $Q_{2,U}$  shall be an ephemeral public key of the initiator generated as part of  
19850 this transaction;
- 19851 5. The static public key  $Q_{1,V}$  shall be the static public key of the responder obtained from the re-  
19852 sponder's certificate communicated to the initiator by the responder;
- 19853 6. The ephemeral public key  $Q_{2,V}$  shall be based on the point-compressed octet string representation  
19854  $QEV$  of an ephemeral key of the responder communicated to the initiator by the responder;
- 19855 7. The KDF parameter *keydatalen* shall be  $MacKeyLen + KeyDataLen$ , where *MacKeyLen* is the  
19856 length of *MacKey* and *KeyDataLen* is the length of *KeyData*;
- 19857 8. The parameter *SharedInfo* shall be the empty string.

19858 The initiator device derives the keying material MacKey and KeyData from the output K as specified in  
19859 section 3.6.1 of SEC1 [O1] by using MacKey as the leftmost MacKeyLen octets of K and KeyData as the  
19860 rightmost KeyDataLen octets of K. KeyData is used subsequently as the shared secret and MacKey is used  
19861 for key confirmation.

19862 **10.7.6.2.4.3.2 Responder**

19863 The responder performs the Elliptic Curve MQV scheme as specified in section 6.2 of SEC1 [O1] with the  
19864 following instantiations:

- 19865 1. The elliptic curve domain parameters shall be as specified in sub-clause 10.7.6.2.2.1;
- 19866 2. The KDF shall use the cryptographic hash function specified in sub-clause 10.7.6.2.2.2;

- 19867 3. The static public key  $Q_{1,U}$  shall be the static public key of the initiator obtained from the initiator's  
19868 certificate communicated to the responder by the initiator;
- 19869 4. The ephemeral public key  $Q_{2,U}$  shall be based on the point-compressed octet string representation  
19870  $QEU$  of an ephemeral key of the initiator communicated to the responder by the initiator;
- 19871 5. The static public key  $Q_{1,V}$  shall be the static public key of the responder;
- 19872 6. The ephemeral public key  $Q_{2,V}$  shall be an ephemeral public key of the responder generated as part  
19873 of this transaction;
- 19874 7. The KDF parameter *keydatalen* shall be *MacKeyLen* + *KeyDataLen*, where *MacKeyLen* is the  
19875 length of *MacKey* and *KeyDataLen* is the length of *KeyData*;
- 19876 8. The parameter *SharedInfo* shall be the empty string.

19877 The responder device derives the keying material *MacKey* and *KeyData* from the output *K* as specified in  
19878 section 3.6.1 of SEC1 [O1] by using *MacKey* as the leftmost *MacKeyLen* octets of *K* and *KeyData* as the  
19879 rightmost *KeyDataLen* octets of *K*. *KeyData* is used subsequently as the shared secret and *MacKey* is used  
19880 for key confirmation.

#### 19881 **10.7.6.2.4.4 Confirm Keys**

##### 19882 **10.7.6.2.4.4.1 Initiator**

19883 The initiator device uses *MacKey* to compute its message authentication code *MACU* and sends it to the  
19884 responder device by using the Confirm Key command via the Key Establishment Cluster Client.

19885 The initiator device uses *MacKey* to confirm the authenticity of the responder by calculating *MACV* and  
19886 comparing it with that sent by the responder.

##### 19887 **10.7.6.2.4.4.2 Responder**

19888 The responder device uses *MacKey* to compute its message authentication code *MACV* and sends it to  
19889 the initiator device by using the Confirm Key response command via the Key Establishment Cluster Server.

19890 The responder device uses *MacKey* to confirm the authenticity of the initiator by calculating *MACU* and  
19891 comparing it with that sent by the initiator.

## 19892 **10.7.7 Key Establishment Test Vectors for Crypto-** 19893 **graphic Suite 1**

19894 The following details the key establishment exchange data transformation and validation of test vectors  
19895 for a pair of Smart Energy devices using Certificate based key exchange (CBKE) using Elliptical Curve  
19896 Cryptography (ECC).

### 19897 **10.7.7.1 Preconfigured Data**

19898 Each device is expected to have been preinstalled with security information prior to initiating key establish-  
19899 ment. The preinstalled data consists of the Certificate Authority's Public Key, a device specific certificate,  
19900 and a device specific private key.

#### 19901 **10.7.7.1.1 CA Public Key**

19902 The following is the Certificate Authority's Public Key.

19903 02 00 FD E8 A7 F3 D1 08  
19904 42 24 96 2A 4E 7C 54 E6  
19905 9A C3 F0 4D A6 B8

19906 **10.7.7.1.2 Responder Data**

19907 The following is the certificate for device 1. The device has an IEEE of (>) 0000000000000001, and will be  
19908 the responder.

19909 03 04 5F DF C8 D8 5F FB  
19910 8B 39 93 CB 72 DD CA A5  
19911 5F 00 B3 E8 7D 6D 00 00  
19912 00 00 00 00 00 01 54 45  
19913 53 54 53 45 43 41 01 09  
19914 00 06 00 00 00 00 00 00

19915

19916 The certificate has the following data embedded within it:

Public Key Reconstruction Data	03 04 5F DF C8 D8 5F FB 8B 39 93 CB 72 DD CA A5 5F 00 B3 E8 7D 6D
Subject (IEEE)	00 00 00 00 00 00 00 01
Issuer	54 45 53 54 53 45 43 41
Attributes	01 09 00 06 00 00 00 00 00 00

19917

19918 The private key for device 1 is as follows:

19919 00 b8 a9 00 fc ad eb ab  
19920 bf a3 83 b5 40 fc e9 ed  
19921 43 83 95 ea a7

19922

19923 The public key for device 1 is as follows:

19924 03 02 90 a1 f5 c0 8d ad  
19925 5f 29 45 e3 35 62 0c 7a  
19926 98 fa c4 66 66 a1

19927 **10.7.7.1.3 Initiator Data**

19928 The following is the certificate for device 2. The device has an IEEE of (>) 0000000000000002, and will be  
19929 the initiator.

19930 02 06 15 E0 7D 30 EC A2  
19931 DA D5 80 02 E6 67 D9 4B  
19932 C1 B4 22 39 83 07 00 00  
19933 00 00 00 00 00 02 54 45  
19934 53 54 53 45 43 41 01 09  
19935 00 06 00 00 00 00 00 00

19936

19937 The certificate has the following data embedded within it:

Public Key Reconstruction Data	02 06 15 E0 7D 30 EC A2 DA D5 80 02 E6 67 D9 4B C1 B4 22 39 83 07
Subject (IEEE)	00 00 00 00 00 00 00 02

Issuer	54 45 53 54 53 45 43 41
Attributes	01 09 00 06 00 00 00 00 00 00

19938

19939 The private key for device 2 is as follows:

19940 01 E9 DD B5 58 0C F7 2E

19941 CE 7F 21 5F 0A E5 94 E4

19942 8D F3 E7 FE E8

19943

19944 The public key for device 2 is:

19945 03 02 5B BA 38 D0 C7 B5

19946 43 6B 68 DF 72 8F 09 3E

19947 7A 1D 6C 43 7E 6D

### 19948 **10.7.7.2 Key Establishment Messages**

19949 Figure 10-131 shows the basic flow of messages back and forth between the initiator and the responder  
19950 performing key establishment using the Key Establishment Cluster.

19951

**Figure 10-131. Key Establishment Command Exchange**

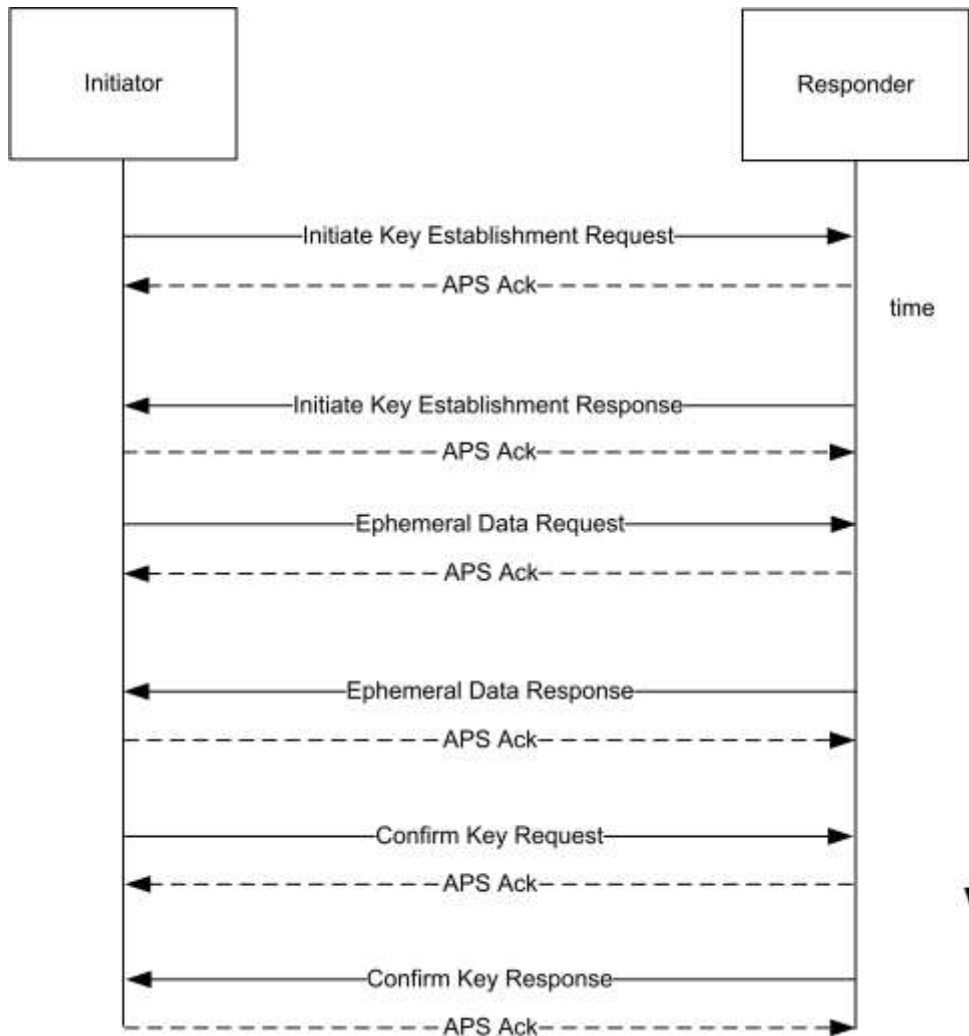

19952

19953 **10.7.7.2.1 Initiate Key Establishment Request**

19954 The following is the APS message sent by the initiator (device 2) to the responder (device 1) for the initiate  
19955 key establishment request.

19956 40 0A 00 08 09 01 0A 01  
19957 01 00 00 01 00 03 06 02  
19958 06 15 E0 7D 30 EC A2 DA  
19959 D5 80 02 E6 67 D9 4B C1  
19960 B4 22 39 83 07 00 00 00  
19961 00 00 00 00 02 54 45 53  
19962 54 53 45 43 41 01 09 00  
19963 06 00 00 00 00 00 00

19964

19965 **APS Header**

Frame Control	0x40
Destination Endpoint	0x0A

Cluster Identifier	0x0800
Profile ID	0x0109
Source Endpoint	0x0A
APS Counter	0x01

19966

19967 **ZCL Header**

Frame Control	0x01	Client to Server
Sequence Number	0x00	
Command Identifier	0x00	<i>Initiate Key Establishment Request</i>
Key Establishment Suite	0x0001	ECMQV
Ephemeral Data Generate Time	0x03	
Confirm Key Generate Time	0x06	
Identity (IDU)	*	Device 2's certificate

19968 **10.7.7.2.2 Initiate Key Establishment Response**

19969 The following is the APS message sent by the responder (device 1) to the initiator (device 2) for the initiate  
 19970 key establishment response.

19971 40 0A 00 08 09 01 0A 01  
 19972 09 00 00 01 00 03 06 03  
 19973 04 5F DF C8 D8 5F FB 8B  
 19974 39 93 CB 72 DD CA A5 5F  
 19975 00 B3 E8 7D 6D 00 00 00  
 19976 00 00 00 00 01 54 45 53  
 19977 54 53 45 43 41 01 09 00  
 19978 06 00 00 00 00 00 00

19979

19980 **APS Header**

Frame Control	0x40
Destination Endpoint	0x0A
Cluster Identifier	0x0800
Profile ID	0x0109
Source Endpoint	0x0A
APS Counter	0x01

19981

19982 **ZCL Header**

Frame Control	0x09	Server to Client
Sequence Number	0x00	

Command Identifier	0x00	<i>Initiate Key Establishment Response</i>
Key Establishment Suite	0x0001	ECMQV
Ephemeral Data Generate Time	0x03	
Confirm Key Generate Time	0x06	
Identity (IDV)	*	Device 1's certificate

19983 **10.7.7.2.3 Ephemeral Data Request**

19984 The following is the APS message sent by the initiator to the responder for the ephemeral data request.

19985 40 0A 00 08 09 01 0A 02  
 19986 01 01 01 03 00 E1 17 C8  
 19987 6D 0E 7C D1 28 B2 F3 4E  
 19988 90 76 CF F2 4A F4 6D 72  
 19989 88

19990

19991 **APS Header**

Frame Control	0x40
Destination Endpoint	0x0A
Cluster Identifier	0x0800
Profile ID	0x0109
Source Endpoint	0x0A
APS Counter	0x02

19992

19993 **ZCL Header**

Frame Control	0x01	Client to Server
Sequence Number	0x01	
Command Identifier	0x01	<i>Ephemeral Data Request</i>
Ephemeral Data (QEU)	03 00 E1 17 C8 6D 0E 7C D1 28 B2 F3 4E 90 76 CF F2 4A F4 6D 72 88	

19994 **10.7.7.2.4 Ephemeral Data Response**

19995 The following is the APS message sent by the responder to the initiator for the ephemeral data response.

19996 40 0A 00 08 09 01 0A 02  
 19997 09 01 01 03 06 AB 52 06  
 19998 22 01 D9 95 B8 B8 59 1F  
 19999 3F 08 6A 3A 2E 21 4D 84  
 20000 5E

20001

20002 **APS Header**



Frame Control	0x40
Destination Endpoint	0x0A
Cluster Identifier	0x0800
Profile ID	0x0109
Source Endpoint	0x0A
APS Counter	0x02

20003

20004 **ZCL Header**

Frame Control	0x09	Server to Client
Sequence Number	0x01	
Command Identifier	0x01	<i>Ephemeral Data Response</i>
Ephemeral Data (QEV)	03 06 AB 52 06 22 01 D9 95 B8 B8 59 1F 3F 08 6A 3A 2E 21 4D 84 5E	

20005 **10.7.7.2.5 Confirm Key Request**

20006 The following is the APS message sent by the initiator to the responder for the confirm key request.

20007 40 0A 00 08 09 01 0A 03  
 20008 01 02 02 B8 2F 1F 97 74  
 20009 74 0C 32 F8 0F CF C3 92  
 20010 1B 64 20

20011

20012 **APS Header**

Frame Control	0x40
Destination Endpoint	0x0A
Cluster Identifier	0x0800
Profile ID	0x0109
Source Endpoint	0x0A
APS Counter	0x02

20013

20014 **ZCL Header**

Frame Control	0x01	Client to Server
Sequence Number	0x02	
Command Identifier	0x02	<i>Confirm Key Request</i>
Secure Message Authentication Code (MACU)	B8 2F 1F 97 74 74 0C 32 F8 0F CF C3 92 1B 64 20	

20015 **10.7.7.2.6 Confirm Key Response**

20016 The following is the APS message sent by the responder to the initiator for the confirm key response.

20017 40 0A 00 08 09 01 0A 03  
 20018 09 02 02 79 D5 F2 AD 1C  
 20019 31 D4 D1 EE 7C B7 19 AC  
 20020 68 3C 3C

20021

20022 **APS Header**

Frame Control	0x40
Destination Endpoint	0x0A
Cluster Identifier	0x0800
Profile ID	0x0109
Source Endpoint	0x0A
APS Counter	0x02

20023

20024 **ZCL Header**

Frame Control	0x09	Server to Client
Sequence Number	0x02	
Command Identifier	0x02	<i>Confirm Key Response</i>
Secure Message Authentication Code (MACV)	79 D5 F2 AD 1C 31 D4 D1 EE 7C B7 19 AC 68 3C 3C	

20025 **10.7.7.3 Data Transformation**

20026 The following are the various values used by the subsequent transformation.

U	Initiator
V	Responder
M(U)	Initiator Message Text (0x02)
M(V)	Responder Message Text (0x03)
ID(U)	Initiator's Identifier (IEEE address)
ID(V)	Responder's Identifier (IEEE address)
E(U)	Initiator's Ephemeral Public Key
E(V)	Responder's Ephemeral Public Key
E-P(U)	Initiator's Ephemeral Private Key
E-P(V)	Responder's Ephemeral Private Key
CA	Certificate Authority's Public Key
Cert(U)	Initiator's Certificate

Cert(V)	Responder's Certificate
Private(U)	Initiator's Private Key
Private(V)	Responder's Private Key
Shared Data	A pre-shared secret. NULL in Key Establishment
Z	A shared secret

20027

20028 **Note:** '||' stands for bitwise concatenation

20029 **10.7.7.3.1 ECMQV Primitives**

20030 It is assumed that an ECC library is available for creating the shared secret given the local private key, local  
 20031 ephemeral public & private key, remote device's certificate, remote device's ephemeral public key, and  
 20032 the certificate authority's public key. Further it is assumed that this library has been separately validated  
 20033 with a set of ECC test vectors. Those test vectors are outside the scope of this document.

20034 **10.7.7.3.2 Key Derivation Function (KDF)**

20035 Once a shared secret (Z) is established, a transform is done to create a SMAC (Secure Message Authen-  
 20036 tication Code) and a shared ZigBee Key.

20037 **10.7.7.3.3 Initiator Transform**

20038 Upon receipt of the responder's ephemeral data response, the initiator has all the data necessary to calculate  
 20039 the shared secret and derive the data for the confirm key request (SMAC).

20040 **10.7.7.3.3.1 Ephemeral Data**

Public Key	03 00 E1 17 C8 6D 0E 7C D1 28 B2 F3 4E 90 76 CF F2 4A F4 6D 72 88
Private Key	00 13 D3 6D E4 B1 EA 8E 22 73 9C 38 13 70 82 3F 40 4B FF 88 62

20041 **10.7.7.3.3.2 Step Summary**

- 20042 1. Derive the Shared Secret using the ECMQV primitives
- 20043 1.  $Z = \text{ECC\_GenerateSharedSecret}(\text{Private}(U), E(U), E\text{-}P(U), \text{Cert}(V), E(V), CA)$
- 20044 2. Derive the Keying data
- 20045 1.  $\text{Hash-1} = Z \parallel 00\ 00\ 00\ 01 \parallel \text{SharedData}$
- 20046 2.  $\text{Hash-2} = Z \parallel 00\ 00\ 00\ 02 \parallel \text{SharedData}$
- 20047 3. Parse KeyingData as follows
- 20048 1.  $\text{MacKey} = \text{First 128 bits (Hash-1) of KeyingData}$
- 20049 2.  $\text{KeyData} = \text{Second 128 bits (Hash-2) of KeyingData}$
- 20050 4. Create MAC(U)
- 20051 1.  $\text{MAC}(U) = \text{MAC}(\text{MacKey}) \{ M(U) \parallel \text{ID}(U) \parallel \text{ID}(V) \parallel E(U) \parallel E(V) \}$

- 20052 5. Send MAC(U) to V.
- 20053 6. Receive MAC(V) from V.
- 20054 7. Calculate MAC(V)'
- 20055 1.  $MAC(V) = MAC(MacKey) \{ M(V) \parallel ID(V) \parallel ID(U) \parallel E(V) \parallel E(U) \}$
- 20056 8. Verify MAC(V)' is the same as MAC(V).

**10.7.7.3.3 Detailed Steps**

- 20058 1. Derive the Shared Secret using the ECMQV primitives
  - 20059 1.  $Z = ECC\_GenerateSharedSecret( Private(U), E(U), E-P(U), Cert(V), E(V), CA )$

20060 00 E0 D2 C3 CC D5 C1 06 A8 9C 4F 6C C2 6A 5F 7E  
20061 C9 DF 78 A7 BE

- 20062 2. Derive the Keying data
  - 20063 1. Hash-1 =  $Z \parallel 00\ 00\ 00\ 01 \parallel SharedData$

20064 **Concatenation**  
20065 00 E0 D2 C3 CC D5 C1 06 A8 9C 4F 6C C2 6A 5F 7E  
20066 C9 DF 78 A7 BE 00 00 00 01

20067 **Hash**  
20068 90 F9 67 B2 2C 83 57 C1 0C 1C 04 78 8D E9 E8 48

- 20069 2. Hash-2 =  $Z \parallel 00\ 00\ 00\ 02 \parallel SharedData$

20070 **Concatenation**  
20071 00 E0 D2 C3 CC D5 C1 06 A8 9C 4F 6C C2 6A 5F 7E  
20072 C9 DF 78 A7 BE 00 00 00 02

20073 **Hash**  
20074 86 D5 8A AA 99 8E 2F AE FA F9 FE F4 96 06 54 3A

- 20075 3. Parse KeyingData as follows
  - 20076 1. MacKey = First 128 bits (Hash-1) of KeyingData
  - 20077 2. KeyData = Second 128 bits (Hash-2) of KeyingData

- 20078 4. Create MAC(U)
  - 20079 1.  $MAC(U) = MAC(MacKey) \{ M(U) \parallel ID(U) \parallel ID(V) \parallel E(U) \parallel E(V) \}$

20080 **Concatenation**  
20081 02 00 00 00 00 00 00 00 02 00 00 00 00 00 00  
20082 01 03 00 E1 17 C8 6D 0E 7C D1 28 B2 F3 4E 90 76  
20083 CF F2 4A F4 6D 72 88 03 06 AB 52 06 22 01 D9 95  
20084 B8 B8 59 1F 3F 08 6A 3A 2E 21 4D 84 5E 88 00 10

20085 **Hash**  
20086 B8 2F 1F 97 74 74 0C 32 F8 0F CF C3 92 1B 64 20

- 20087 5. Send MAC(U) to V.
- 20088 6. Receive MAC(V) from V.

- 20089           7. Calculate MAC(V)'
- 20090           1.  $MAC(V) = MAC(MacKey) \{ M(V) \parallel ID(V) \parallel ID(U) \parallel E(V) \parallel E(U) \}$
- 20091           **Concatenation**
- 20092           03 00 00 00 00 00 00 01 00 00 00 00 00 00 00
- 20093           02 03 06 AB 52 06 22 01 D9 95 B8 B8 59 1F 3F 08
- 20094           6A 3A 2E 21 4D 84 5E 03 00 E1 17 C8 6D 0E 7C D1
- 20095           28 B2 F3 4E 90 76 CF F2 4A F4 6D 72 88 88 00 10
- 20096           **Hash**
- 20097           79 D5 F2 AD 1C 31 D4 D1 EE 7C B7 19 AC 68 3C 3C
- 20098           8. Verify MAC(V)' is the same as MAC(V).

20099           **10.7.7.3.4 Responder Transform**

20100           Upon receipt of the initiator's confirm key request, the responder has all the data necessary to calculate the shared secret, validate the initiator's confirm key message, and derive the data for the confirm key response (SMAC).

20101

20102

20103           **10.7.7.3.4.1 Ephemeral Data**

Public Key	03 06 AB 52 06 22 01 D9 95 B8 B8 59 1F 3F 08 6A 3A 2E 21 4D 84 5E
Private Key	03 D4 8C 72 10 DD BC C4 FB 2E 5E 7A 0A A1 6A 0D B8 95 40 82 0B

20104           **10.7.7.3.4.2 Step Summary**

- 20105           1. Derive the Shared Secret using the ECMQV primitives
- 20106           1.  $Z = ECC\_GenerateSharedSecret( Private(V), E(V), E-P(V), Cert(U), E(U), CA )$
- 20107           2. Derive the Keying data
- 20108           1.  $Hash-1 = Z \parallel 00\ 00\ 00\ 01 \parallel SharedData$
- 20109           2.  $Hash-2 = Z \parallel 00\ 00\ 00\ 02 \parallel SharedData$
- 20110           3. Parse KeyingData as follows
- 20111           1.  $MacKey = \text{First 128 bits (Hash-1) of KeyingData}$
- 20112           2.  $KeyData = \text{Second 128 bits (Hash-2) of KeyingData}$
- 20113           4. Create MAC(V)
- 20114           1.  $MAC(V) = MAC(MacKey) \{ M(V) \parallel ID(V) \parallel ID(U) \parallel E(V) \parallel E(U) \}$
- 20115           5. Calculate MAC(U)'
- 20116           1.  $MAC(U) = MAC(MacKey) \{ M(U) \parallel ID(U) \parallel ID(V) \parallel E(U) \parallel E(V) \}$
- 20117           6. Verify MAC(U) is the same as MAC(U).
- 20118           7. Send MAC(V) to U.

20119           **10.7.7.3.4.3 Detailed Steps**

- 20120           1. Derive the Shared Secret using the ECMQV primitives

20121 1.  $Z = \text{ECC\_GenerateSharedSecret}(\text{Private}(U), E(U), E\text{-}P(U), \text{Cert}(V), E(V), CA)$

20122 00 E0 D2 C3 CC D5 C1 06 A8 9C 4F 6C C2 6A 5F 7E

20123 C9 DF 78 A7 BE

20124 2. Derive the Keying data

20125 1. Hash-1 =  $Z \parallel 00\ 00\ 00\ 01 \parallel \text{SharedData}$

20126 **Concatenation**

20127 00 E0 D2 C3 CC D5 C1 06 A8 9C 4F 6C C2 6A 5F 7E

20128 C9 DF 78 A7 BE 00 00 00 01

20129 **Hash**

20130 90 F9 67 B2 2C 83 57 C1 0C 1C 04 78 8D E9 E8 48

20131 2. Hash-2 =  $Z \parallel 00\ 00\ 00\ 02 \parallel \text{SharedData}$

20132 **Concatenation**

20133 00 E0 D2 C3 CC D5 C1 06 A8 9C 4F 6C C2 6A 5F 7E

20134 C9 DF 78 A7 BE 00 00 00 02

20135 **Hash**

20136 86 D5 8A AA 99 8E 2F AE FA F9 FE F4 96 06 54 3A

20137 3. Parse KeyingData as follows

20138 1. MacKey = First 128 bits (Hash-1) of KeyingData

20139 2. KeyData = Second 128 bits (Hash-2) of KeyingData

20140 4. Create MAC(V)

20141 1.  $\text{MAC}(V) = \text{MAC}(\text{MacKey}) \{ M(V) \parallel \text{ID}(V) \parallel \text{ID}(U) \parallel E(V) \parallel E(U) \}$

20142 **Concatenation**

20143 03 00 00 00 00 00 00 00 01 00 00 00 00 00 00 00

20144 02 03 06 AB 52 06 22 01 D9 95 B8 B8 59 1F 3F 08

20145 6A 3A 2E 21 4D 84 5E 03 00 E1 17 C8 6D 0E 7C D1

20146 28 B2 F3 4E 90 76 CF F2 4A F4 6D 72 88 88 00 10

20147 **Hash**

20148 79 D5 F2 AD 1C 31 D4 D1 EE 7C B7 19 AC 68 3C 3C

20149 5. Calculate MAC(V)'

20150 1.  $\text{MAC}(U) = \text{MAC}(\text{MacKey}) \{ M(U) \parallel \text{ID}(U) \parallel \text{ID}(V) \parallel E(U) \parallel E(V) \}$

20151 **Concatenation**

20152 02 00 00 00 00 00 00 00 02 00 00 00 00 00 00 00

20153 01 03 00 E1 17 C8 6D 0E 7C D1 28 B2 F3 4E 90 76

20154 CF F2 4A F4 6D 72 88 03 06 AB 52 06 22 01 D9 95

20155 B8 B8 59 1F 3F 08 6A 3A 2E 21 4D 84 5E 88 00 10

20156 **Hash**

20157 B8 2F 1F 97 74 74 0C 32 F8 0F CF C3 92 1B 64 20

20158 6. Verify MAC(V) is the same as MAC(V).

20159 7. Send MAC(V) to U.

20160

20161 **10.7.8 Key Establishment Test Vectors for Crypto-**  
 20162 **graphic Suite 2**

20163 The following details the key establishment exchange data transformation and validation of test vectors  
 20164 for a pair of Smart Energy devices using Certificate based key exchange (CBKE) using Elliptical Curve  
 20165 Cryptography (ECC).

20166 **10.7.8.1 Preconfigured Data**

20167 Each device is expected to have been preinstalled with security information prior to initiating key estab-  
 20168 lishment. The preinstalled data consists of the Certificate Authority's Public Key, a device specific certifi-  
 20169 cate, and a device specific private key.

20170 **10.7.8.1.1 CA Public Key**

20171 The following is the Certificate Authority's Public Key:

20172 02 07 A4 45 02 2D 9F 39 f4 9B DC 38 38 00 26 A2  
 20173 7A 9E 0A 17 99 31 3A B2 8C 5C 1A 1C 6B 60 51 54  
 20174 DB 1D FF 67 52

20175 **10.7.8.1.2 Responder Data**

20176 The following is the certificate for device 1. The device has an EUI-64 address of 0A:0B:0C:0D:0E:0F:10:11,  
 20177 and will be the responder.  
 20178

20179 Certificate:

20180 00 26 22 A5 05 E8 93 8F 27 0D 08 11 12 13 14 15  
 20181 16 17 18 00 52 92 A3 5B FF FF FF FF 0A 0B 0C 0D  
 20182 0E 0F 10 11 88 03 03 B4 E9 DC 54 3A 64 33 3C 98  
 20183 23 08 02 2B 54 E6 7E 2F 15 F5 32 55 1B 0A 11 E2  
 20184 E2 C1 C1 D3 09 7A 43 24 E7 ED  
 20185

20186 The certificate has the following data embedded within it:

Certificate Type	00
Certificate Serial No:	26 22 A5 05 E8 93 8F 27
Curve:	0D (sect283k1)
Hash:	08 (zigbee-aes-mmo)
IssuerID:	11 12 13 14 15 16 17 18
ValidFrom:	00 52 92 A3 5B
ValidUntil:	FF FF FF FF
SubjectID:	0A 0B 0C 0D 0E 0F 10 11
KeyUsage	88
PublicKeyReconstructionPoint	03 03 B4 E9 DC 54 3A 64 33 3C 98 23 08 02 2B 54 E6 7E 2F 15 F5 32 55 1B 0A 11 E2 E2 C1 C1 D3 09 7A 43 24 E7 ED

20187

20188 The private key for device 1 is as follows:

20189 01 51 CD 0D BC B8 04 74 BF 7A C9 FE EB E3 9C 7A  
 20190 32 A6 35 18 93 8F CA 97 54 AA E1 32 BC 9C 73 BE

20191 94 A7 E1 BE

20192 The public key for device 1 is as follows:

20193 02 02 F4 FA 2A 30 40 43 3C 68 20 29 9D 18 2A 10  
20194 42 E4 14 04 E3 37 C5 7F 47 71 6B 42 DF AF 97 0F  
20195 15 80 A0 4C 9B

20196

### 20197 **10.7.8.1.3 Initiator Data**

20198 The following is the certificate for device 2. The device has an EUI-64 address of 0A:0B:0C:0D:0E:0F:10:12,  
20199 and will be the initiator.

20200

20201 Certificate:

20202 00 84 A9 33 B3 7F 01 8D EC 0D 08 11 12 13 14 15  
20203 16 17 18 00 52 92 A3 8A FF FF FF FF 0A 0B 0C 0D  
20204 0E 0F 10 12 88 03 07 62 77 E2 F7 E2 25 2B 16 A0  
20205 E9 2B 6E 87 71 BB 3F 20 79 46 CB D4 A4 5D 9A 9D  
20206 F6 ED AB 8C 79 6A 48 E8 9D EC

20207

20208 The certificate has the following data embedded within it:

Certificate Type	00
Certificate Serial No:	84 A9 33 B3 7F 01 8D EC
Curve:	0D (sect283k1)
Hash:	08 (zigbee-aes-mmo)
IssuerID:	11 12 13 14 15 16 17 18
ValidFrom:	00 52 92 A3 8A
ValidUntil:	FF FF FF FF
SubjectID:	0A 0B 0C 0D 0E 0F 10 12
KeyUsage	88
PublicKeyReconstructionPoint	03 07 62 77 E2 F7 E2 25 2B 16 A0 E9 2B 6E 87 71 BB 3F 20 79 46 CB D4 A4 5D 9A 9D F6 ED AB 8C 79 6A 48 E8 9D EC

20209

20210 The private key for device 2 is as follows:

20211 00 F2 56 1A DB 39 EF 49 C1 D6 2E F5 18 6C 6E 0C  
20212 15 8A 5A 45 BF CE 38 66 09 31 AC C3 69 45 92 D5  
20213 AC DE 90 06

20214 The public key for device 2 is as follows:

20215 03 03 0E 56 F7 AD E8 66 E7 63 72 76 4B A2 0A 9F  
20216 F1 FE 4C AE 52 2F 94 83 9E 70 F2 AD FC 1C A3 E9  
20217 7F 4D DC AF 2E

20218

### 20219 **10.7.8.2 Key Establishment Messages**

20220 The following is the basic flow of messages back and forth between the initiator and the responder per-  
20221 forming key establishment using the Key Establishment Cluster.



20222

**Figure 10-132. Key Establishment Command Exchange**

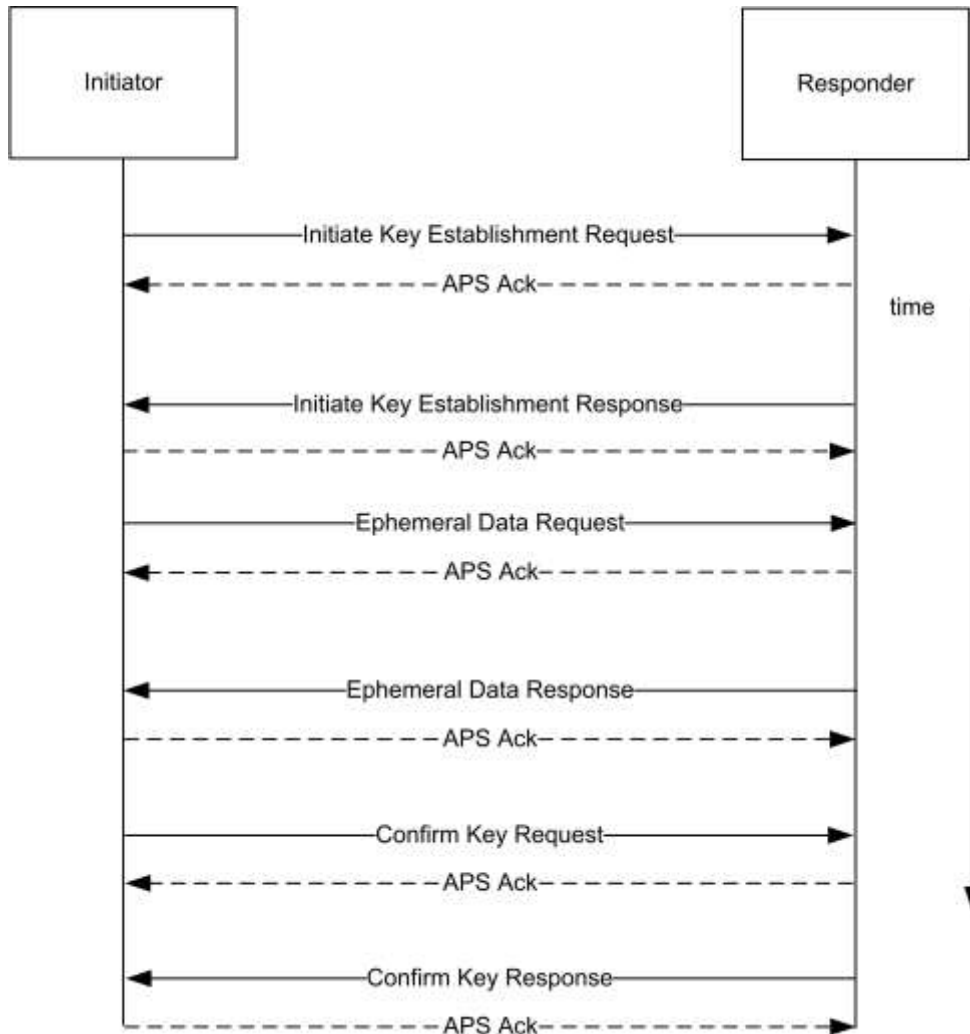

20223

20224 **10.7.8.2.1 Initiate Key Establishment Request**

20225 The following is the APS message sent by the initiator (device 2) to the responder (device 1) for the initiate  
 20226 key establishment request.

20227 40 0A 00 08 09 01 0A 01 01 00 00 02 00 03 06 00  
 20228 84 A9 33 B3 7F 01 8D EC 0D 08 11 12 13 14 15 16  
 20229 17 18 00 52 92 A3 8A FF FF FF FF 0A 0B 0C 0D 0E  
 20230 0F 10 12 88 03 07 62 77 E2 F7 E2 25 2B 16 A0 E9  
 20231 2B 6E 87 71 BB 3F 20 79 46 CB D4 A4 5D 9A 9D F6  
 20232 ED AB 8C 79 6A 48 E8 9D EC

20233 **APS Header**

Frame Control	0x40
Destination Endpoint	0x0A
Cluster Identifier	0x0800
Profile ID	0x0109

Source Endpoint	0x0A
APS Counter	0x01

20234  
20235

**ZCL Header**

Frame Control	0x01	Client to Server
Sequence Number	0x00	
Command Identifier	0x00	<i>Initiate Key Establishment Request</i>
Requested Security Suite	0x0002	CBKE-ECMQV-V2
Ephemeral Data Generate Time	0x03	
Confirm Key Generate Time	0x06	
Identity (IDU)	*	Device 2's certificate

20236

20237 **10.7.8.2.2 Initiate Key Establishment Response**

20238 The following is the APS message sent by the responder (device 1) to the initiator (device 2) for the initiate  
20239 key establishment response.

20240 40 0A 00 08 09 01 0A 01 09 00 00 02 00 03 06 00  
20241 26 22 A5 05 E8 93 8F 27 0D 08 11 12 13 14 15 16  
20242 17 18 00 52 92 A3 5B FF FF FF FF 0A 0B 0C 0D 0E  
20243 0F 10 11 88 03 03 B4 E9 DC 54 3A 64 33 3C 98 23  
20244 08 02 2B 54 E6 7E 2F 15 F5 32 55 1B 0A 11 E2 E2  
20245 C1 C1 D3 09 7A 43 24 E7 ED

20246 **APS Header**

Frame Control	0x40
Destination Endpoint	0x0A
Cluster Identifier	0x0800
Profile ID	0x0109
Source Endpoint	0x0A
APS Counter	0x01

20247  
20248

**ZCL Header**

Frame Control	0x09	Server to Client
Sequence Number	0x00	
Command Identifier	0x00	<i>Initiate Key Establishment Response</i>
Accepted Security Suite	0x0002	CBKE-ECMQV-V2
Ephemeral Data Generate Time	0x03	
Confirm Key Generate Time	0x06	
Identity (IDV)	*	Device 1's certificate

20249

20250 **10.7.8.2.3 Ephemeral Data Request**

20251 The following is the APS message sent by the initiator to the responder for the ephemeral data request.

20252 40 0A 00 08 09 01 0A 02 01 01 01 03 05 F3 39 4E  
 20253 15 68 06 60 EE CA A3 67 88 D9 B6 F3 12 B9 71 CE  
 20254 2C 96 17 57 0B F7 DF CD 21 C9 72 01 77 62 C3 32

20255 **APS Header**

Frame Control	0x40
Destination Endpoint	0x0A
Cluster Identifier	0x0800
Profile ID	0x0109
Source Endpoint	0x0A
APS Counter	0x02

20256

20257 **ZCL Header**

Frame Control	0x01	Client to Server
Sequence Number	0x01	
Command Identifier	0x01	<i>Ephemeral Data Request</i>
Ephemeral Data (QEU)	03 05 F3 39 4E 15 68 06 60 EE CA A3 67 88 D9 B6 F3 12 B9 71 CE 2C 96 17 57 0B F7 DF CD 21 C9 72 01 77 62 C3 32	

20258

20259 **10.7.8.2.4 Ephemeral Data Response**

20260 The following is the APS message sent by the responder to the initiator for the ephemeral data response.

20261 40 0A 00 08 09 01 0A 02 09 01 01 03 00 9A 51 31  
 20262 CF 5B 92 A0 16 37 8C 0F 7F 28 4E CD 47 F9 40 10  
 20263 F8 75 D4 3B F1 E9 A6 54 74 AD BF C6 36 96 A9 30

20264 **APS Header**

Frame Control	0x40
Destination Endpoint	0x0A
Cluster Identifier	0x0800
Profile ID	0x0109
Source Endpoint	0x0A
APS Counter	0x02

20265

20266 **ZCL Header**

Frame Control	0x09	Server to Client
Sequence Number	0x01	
Command Identifier	0x01	<i>Ephemeral Data Response</i>

Ephemeral Data (QEV)	03 00 9A 51 31 CF 5B 92
	A0 16 37 8C 0F 7F 28 4E
	CD 47 F9 40 10 F8 75 D4
	3B F1 E9 A6 54 74 AD BF
	C6 36 96 A9 30

20267

20268 **10.7.8.2.5 Confirm Key Request**

20269 The following is the APS message sent by the initiator to the responder for the confirm key request.

20270 40 0A 00 08 09 01 0A 03  
 20271 01 02 02 BF 7E 1A 26 D4  
 20272 EF 70 38 B5 68 13 E4 65  
 20273 A1 31 C9

20274 **APS Header**

Frame Control	0x40
Destination Endpoint	0x0A
Cluster Identifier	0x0800
Profile ID	0x0109
Source Endpoint	0x0A
APS Counter	0x03

20275

20276 **ZCL Header**

Frame Control	0x01	Client to Server
Sequence Number	0x02	
Command Identifier	0x02	<i>Confirm Key Request</i>
Secure Message Authentication Code (MACU)	BF 7E 1A 26 D4 EF 70 38 B5 68 13 E4 65 A1 31 C9	

20277

20278 **10.7.8.2.6 Confirm Key Response**

20279 The following is the APS message sent by the responder to the initiator for the confirm key response.

20280 40 0A 00 08 09 01 0A 03  
 20281 09 02 02 C5 B4 32 A9 99  
 20282 5A 09 2F 44 49 F8 36 13  
 20283 93 00 64

20284 **APS Header**

Frame Control	0x40
Destination Endpoint	0x0A
Cluster Identifier	0x0800
Profile ID	0x0109
Source Endpoint	0x0A

APS Counter	0x03
-------------	------

20285

20286 **ZCL Header**

Frame Control	0x09	Server to Client
Sequence Number	0x02	
Command Identifier	0x02	<i>Confirm Key Response</i>
Secure Message Authentication Code (MACV)	C5 B4 32 A9 99 5A 09 2F 44 49 F8 36 13 93 00 64	

20287

20288 **10.7.8.3 Data Transformation**

20289 The following are the various values used by the subsequent transformation.

U	Initiator
V	Responder
M(U)	Initiator Message Text (0x02)
M(V)	Responder Message Text (0x03)
ID(U)	Initiator's Identifier (IEEE address)
ID(V)	Responder's Identifier (IEEE address)
E(U)	Initiator's Ephemeral Public Key
E(V)	Responder's Ephemeral Public Key
E-P(U)	Initiator's Ephemeral Private Key
E-P(V)	Responder's Ephemeral Private Key
CA	Certificate Authority's Public Key
Cert(U)	Initiator's Certificate
Cert(V)	Responder's Certificate
Private(U)	Initiator's Private Key
Private(V)	Responder's Private Key
Shared Data	A pre-shared secret. NULL in Key Establishment.
Z	A shared secret

20290

20291 **Note:** '||' stands for bitwise concatenation

20292 **10.7.8.3.1 ECMQV Primitives**

20293 It is assumed that an ECC library is available for creating the shared secret given the local private key, local  
 20294 ephemeral public & private key, remote device's certificate, remote device's ephemeral public key, and  
 20295 the certificate authority's public key. Further it is assumed that this library has been separately validated  
 20296 with a set of ECC test vectors. Those test vectors are outside the scope of this document.

20297 **10.7.8.3.2 Key Derivation Function (KDF)**

20298 Once a shared secret (Z) is established, a transform is done to create a SMAC (Secure Message Authentication Code) and a shared Zigbee Key.  
20299

20300 **10.7.8.3.3 Initiator Transform**

20301 Upon receipt of the responder's ephemeral data response, the initiator has all the data necessary to calculate  
20302 the shared secret and derive the data for the confirm key request (SMAC).

20303 **10.7.8.3.3.1 Ephemeral Data**

Public Key	03 05 F3 39 4E 15 68 06 60 EE CA A3 67 88 D9 B6 F3 12 B9 71 CE 2C 96 17 57 0B F7 DF CD 21 C9 72 01 77 62 C3 32
Private Key	00 13 D3 6D E4 B1 EA 8E 22 73 9C 38 13 70 82 3F 40 4B FF 88 62 B5 21 FE CA 98 71 FB 36 91 84 6D 36 13 04 B4

20304

20305 **10.7.8.3.3.2 Step Summary**

- 20306 1. Derive the Shared Secret using the ECMQV primitives  
20307 1.  $Z = \text{ECC\_GenerateSharedSecret}(\text{Private}(U), E(U), E\text{-}P(U), \text{Cert}(V), E(V), CA)$   
20308 2. Derive the Keying data  
20309 1.  $\text{Hash-1} = Z \parallel 00\ 00\ 00\ 01 \parallel \text{SharedData}$   
20310 2.  $\text{Hash-2} = Z \parallel 00\ 00\ 00\ 02 \parallel \text{SharedData}$   
20311 3. Parse KeyingData as follows  
20312 1.  $\text{MacKey} = \text{First 128 bits (Hash-1) of KeyingData}$   
20313 2.  $\text{KeyData} = \text{Second 128 bits (Hash-2) of KeyingData}$   
20314 4. Create  $\text{MAC}(U)$   
20315 1.  $\text{MAC}(U) = \text{MAC}(\text{MacKey}) \{ M(U) \parallel \text{ID}(U) \parallel \text{ID}(V) \parallel E(U) \parallel E(V) \}$   
20316 5. Send  $\text{MAC}(U)$  to V.  
20317 6. Receive  $\text{MAC}(V)$  from V.  
20318 7. Calculate  $\text{MAC}(V)'$   
20319 1.  $\text{MAC}(V) = \text{MAC}(\text{MacKey}) \{ M(V) \parallel \text{ID}(V) \parallel \text{ID}(U) \parallel E(V) \parallel E(U) \}$   
20320 8. Verify  $\text{MAC}(V)'$  is the same as  $\text{MAC}(V)$ .  
20321

20322 **10.7.8.3.3.3 Detailed Steps**

- 20323 1. Derive the Shared Secret using the ECMQV primitives  
20324 1.  $Z = \text{ECC\_GenerateSharedSecret}(\text{Private}(U), E(U), E\text{-}P(U), \text{Cert}(V), E(V), CA)$   
20325 04 F7 72 4A 9A 77 B2 1D 27 47 CC EF 68 A4 57 E4  
20326 52 46 C4 BE 9F 66 FD 94 25 22 7B CB 2C C5 18 0E  
20327 A9 CC CB 9A

- 20328 2. Derive the Keying data
- 20329 1. Hash-1 = Z || 00 00 00 01 || SharedData
- 20330 **Concatenation**
- 20331 04 F7 72 4A 9A 77 B2 1D 27 47 CC EF 68 A4 57 E4
- 20332 52 46 C4 BE 9F 66 FD 94 25 22 7B CB 2C C5 18 0E
- 20333 A9 CC CB 9A 00 00 00 01
- 20334 **Hash**
- 20335 ED 38 0A 00 29 66 00 FB 6B 89 30 25 DE 5F D1 37
- 20336
- 20337 2. Hash-2 = Z || 00 00 00 02 || SharedData
- 20338 **Concatenation**
- 20339 04 F7 72 4A 9A 77 B2 1D 27 47 CC EF 68 A4 57 E4
- 20340 52 46 C4 BE 9F 66 FD 94 25 22 7B CB 2C C5 18 0E
- 20341 A9 CC CB 9A 00 00 00 02
- 20342 **Hash**
- 20343 AA 46 89 C7 0B E0 FA F0 C9 BE 53 4A BD 9F 4C DC
- 20344
- 20345 3. Parse KeyingData as follows
- 20346 1. MacKey = First 128 bits (Hash-1) of KeyingData
- 20347 2. KeyData = Second 128 bits (Hash-2) of KeyingData
- 20348 4. Create MAC(U)
- 20349 1. MAC(U) = MAC(MacKey) { M(U) || ID(U) || ID(V) || E(U) || E(V) }
- 20350 **Concatenation**
- 20351 02 0a 0b 0c 0d 0e 0f 10 12 0a 0b 0c 0d 0e 0f 10
- 20352 11 03 05 F3 39 4E 15 68 06 60 EE CA A3 67 88 D9
- 20353 B6 F3 12 B9 71 CE 2C 96 17 57 0B F7 DF CD 21 C9
- 20354 72 01 77 62 C3 32 03 00 9A 51 31 CF 5B 92 A0 16
- 20355 37 8C 0F 7F 28 4E CD 47 F9 40 10 F8 75 D4 3B F1
- 20356 E9 A6 54 74 AD BF C6 36 96 A9 30
- 20357 **Hash**
- 20358 BF 7E 1A 26 D4 EF 70 38 B5 68 13 E4 65 A1 31 C9
- 20359
- 20360 5. Send MAC(U) to V.
- 20361 6. Receive MAC(V) from V.
- 20362 7. Calculate MAC(V)'
- 20363 1. MAC(V) = MAC(MacKey) { M(V) || ID(V) || ID(U) || E(V) || E(U) }
- 20364 **Concatenation**
- 20365 03 0a 0b 0c 0d 0e 0f 10 11 0a 0b 0c 0d 0e 0f 10
- 20366 12 03 00 9A 51 31 CF 5B 92 A0 16 37 8C 0F 7F 28
- 20367 4E CD 47 F9 40 10 F8 75 D4 3B F1 E9 A6 54 74 AD
- 20368 BF C6 36 96 A9 30 03 05 F3 39 4E 15 68 06 60 EE
- 20369 CA A3 67 88 D9 B6 F3 12 B9 71 CE 2C 96 17 57 0B
- 20370 F7 DF CD 21 C9 72 01 77 62 C3 32
- 20371 **Hash**
- 20372 C5 B4 32 A9 99 5A 09 2F 44 49 F8 36 13 93 00 64
- 20373 8. Verify MAC(V)' is the same as MAC(V).

20374

20375 **10.7.8.3.4 Responder Transform**

20376 Upon receipt of the initiator's confirm key request, the responder has all the data necessary to calculate the  
20377 shared secret, validate the initiator's confirm key message, and derive the data for the confirm key response  
20378 (SMAC).

20379 **10.7.8.3.4.1 Ephemeral Data**

Public Key	03 00 9A 51 31 CF 5B 92 A0 16 37 8C 0F 7F 28 4E CD 47 F9 40 10 F8 75 D4 3B F1 E9 A6 54 74 AD BF C6 36 96 A9 30
Private Key	03 D4 8C 72 10 DD BC C4 FB 2E 5E 7A 0A A1 6A 0D B8 95 40 82 0B 8D C0 91 AB 52 1E A8 24 AF E1 17 CA DE 99 5B

20380

20381 **10.7.8.3.4.2 Step Summary**

- 20382 1. Derive the Shared Secret using the ECMQV primitives  
20383 1.  $Z = \text{ECC\_GenerateSharedSecret}(\text{Private}(V), E(V), E\text{-P}(V), \text{Cert}(U), E(U), CA)$
- 20384 2. Derive the Keying data  
20385 1.  $\text{Hash-1} = Z \parallel 00\ 00\ 00\ 01 \parallel \text{SharedData}$   
20386 2.  $\text{Hash-2} = Z \parallel 00\ 00\ 00\ 02 \parallel \text{SharedData}$
- 20387 3. Parse KeyingData as follows  
20388 1.  $\text{MacKey} = \text{First 128 bits (Hash-1) of KeyingData}$   
20389 2.  $\text{KeyData} = \text{Second 128 bits (Hash-2) of KeyingData}$
- 20390 4. Create  $\text{MAC}(V)$   
20391 1.  $\text{MAC}(V) = \text{MAC}(\text{MacKey}) \{ M(V) \parallel \text{ID}(V) \parallel \text{ID}(U) \parallel E(V) \parallel E(U) \}$
- 20392 5. Calculate  $\text{MAC}(U)'$   
20393 1.  $\text{MAC}(U) = \text{MAC}(\text{MacKey}) \{ M(U) \parallel \text{ID}(U) \parallel \text{ID}(V) \parallel E(U) \parallel E(V) \}$
- 20394 6. Verify  $\text{MAC}(U)'$  is the same as  $\text{MAC}(U)$ .
- 20395 7. Send  $\text{MAC}(V)$  to U  
20396

20397 **10.7.8.3.4.3 Detailed Steps**

- 20398 1. Derive the Shared Secret using the ECMQV primitives  
20399 1.  $Z = \text{ECC\_GenerateSharedSecret}(\text{Private}(V), E(V), E\text{-P}(V), \text{Cert}(U), E(U), CA)$   
20400 04 F7 72 4A 9A 77 B2 1D 27 47 CC EF 68 A4 57 E4  
20401 52 46 C4 BE 9F 66 FD 94 25 22 7B CB 2C C5 18 0E  
20402 A9 CC CB 9A
- 20403 2. Derive the Keying data  
20404 1.  $\text{Hash-1} = Z \parallel 00\ 00\ 00\ 01 \parallel \text{SharedData}$   
20405 **Concatenation**  
20406 04 F7 72 4A 9A 77 B2 1D 27 47 CC EF 68 A4 57 E4  
20407 52 46 C4 BE 9F 66 FD 94 25 22 7B CB 2C C5 18 0E  
20408 A9 CC CB 9A 00 00 00 01



20409                   **Hash**  
20410                   ED 38 0A 00 29 66 00 FB    6B 89 30 25 DE 5F D1 37  
20411  
20412                   2. Hash-2 = Z || 00 00 00 02 || SharedData  
20413                   **Concatenation**  
20414                    04 F7 72 4A 9A 77 B2 1D    27 47 CC EF 68 A4 57 E4  
20415                    52 46 C4 BE 9F 66 FD 94    25 22 7B CB 2C C5 18 0E  
20416                    A9 CC CB 9A 00 00 00 02

20417                   **Hash**  
20418                   AA 46 89 C7 0B E0 FA F0    C9 BE 53 4A BD 9F 4C DC  
20419

20420                   3. Parse KeyingData as follows  
20421                    1. MacKey = First 128 bits (Hash-1) of KeyingData  
20422                    2. KeyData = Second 128 bits (Hash-2) of KeyingData

20423                   4. Create MAC(V)  
20424                    1. MAC(V) = MAC(MacKey) { M(V) || ID(V) || ID(U) || E(V) || E(U) }  
20425                    **Concatenation**  
20426                    03 0a 0b 0c 0d 0e 0f 10    11 0a 0b 0c 0d 0e 0f 10  
20427                    12 03 00 9A 51 31 CF 5B    92 A0 16 37 8C 0F 7F 28  
20428                    4E CD 47 F9 40 10 F8 75    D4 3B F1 E9 A6 54 74 AD  
20429                    BF C6 36 96 A9 30 03 05    F3 39 4E 15 68 06 60 EE  
20430                    CA A3 67 88 D9 B6 F3 12    B9 71 CE 2C 96 17 57 0B  
20431                    F7 DF CD 21 C9 72 01 77    62 C3 32

20432                   **Hash**  
20433                   C5 B4 32 A9 99 5A 09 2F    44 49 F8 36 13 93 00 64

20434                   5. Calculate MAC(U)'  
20435                    1. MAC(U) = MAC(MacKey) { M(U) || ID(U) || ID(V) || E(U) || E(V) }  
20436                    **Concatenation**  
20437                    02 0a 0b 0c 0d 0e 0f 10    12 0a 0b 0c 0d 0e 0f 10  
20438                    11 03 05 F3 39 4E 15 68    06 60 EE CA A3 67 88 D9  
20439                    B6 F3 12 B9 71 CE 2C 96    17 57 0B F7 DF CD 21 C9  
20440                    72 01 77 62 C3 32 03 00    9A 51 31 CF 5B 92 A0 16  
20441                    37 8C 0F 7F 28 4E CD 47    F9 40 10 F8 75 D4 3B F1  
20442                    E9 A6 54 74 AD BF C6 36    96 A9 30

20443                   6. Verify MAC(U)' is the same as MAC(U).

20444                   7. Send MAC(V) to U  
20445  
20446

## 20447 **10.8 Prepayment**<sup>209</sup>

---

### 20448 **10.8.1 Overview**

20449 Please see Chapter 2 for a general cluster overview defining cluster architecture, revision, classification,  
20450 identification, etc.

20451 The Prepayment Cluster provides the facility to pass messages relating to the accounting  
20452 functionality of a meter between devices on the HAN. It allows for the implementation of a system con-  
20453 forming to the set of standards relating to Payment Electricity Meters (IEC 62055) and also for the case  
20454 where the accounting function is remote from the meter. Prepayment is used in situations where the supply  
20455 of a service may be interrupted or enabled under the control of the meter or system in relation to a  
20456 payment tariff. The accounting process may be within the meter or elsewhere in the system. The amount  
20457 of available credit is decremented as the service is consumed and is incremented through payments made  
20458 by the consumer. Such a system allows the consumer to better manage their energy consumption and  
20459 reduces the risk of bad debt owing to the supplier.

20460 In the case where the accounting process resides within the meter, credit updates are sent to the meter from  
20461 the ESI. Such messages are out of scope of this cluster. The cluster allows credit status to be made  
20462 available to other devices on the HAN for example to enable the consumers to view their status on an  
20463 IHD. It also allows them to select emergency credit if running low and also, where local markets allow,  
20464 restoring their supply remotely from within the HAN.

20465 In the case where the accounting process resides in the head end (Central Wallet scheme), the metering  
20466 system provides usage information to the head end for it to calculate the state of available credit in the con-  
20467 sumer's account. The head end will pass down to the metering system data that will be of use to the  
20468 consumer, for distribution on the HAN. The head end will also send commands to interrupt or restore the  
20469 supply depending on the state of the account.

20470 In either case, there will be the need to display credit status and this may be in monetary terms or in  
20471 energy terms. If running in monetary mode, the units of measure will be defined in the Price Cluster,  
20472 if in energy terms, the unit of measure will be defined in the Metering Cluster.

---

<sup>209</sup> NEW CERTIFIABLE CLUSTER IN THIS LIBRARY

20473

**Figure 10-133. Prepayment Cluster Client Server Example**

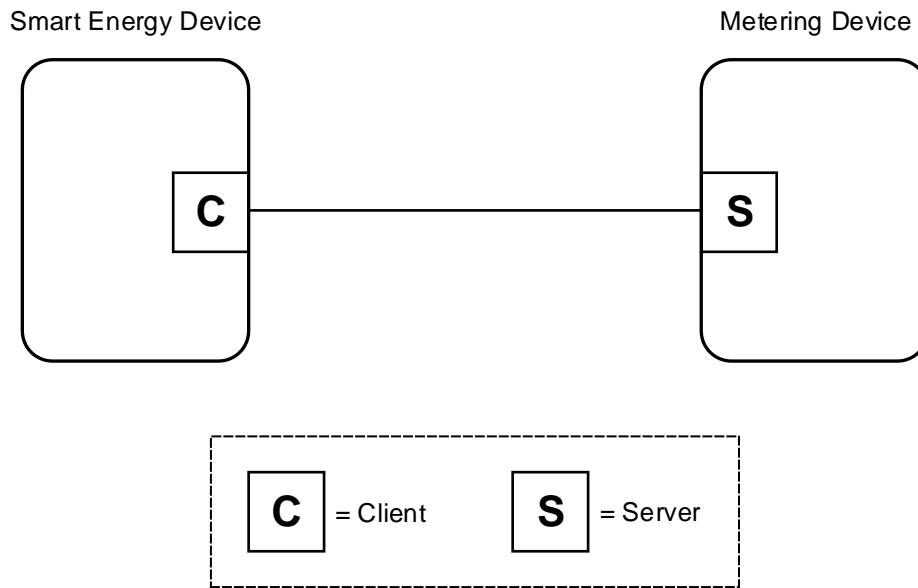

20474  
 20475  
 20476

*Note: Device names are examples for illustration purposes only*

20477 **10.8.1.1 Revision History**

20478 The global *ClusterRevision* attribute value SHALL be the highest revision number in the table below.

Rev	Description
1	mandatory global <i>ClusterRevision</i> attribute added; Added from SE1.4; CCB 2052

20479 **10.8.1.2 Classification**

Hierarchy	Role	PICS Code	Primary Transaction
Base	Application	SEPP	Type 1 (client to server)

20480 **10.8.1.3 Cluster Identifiers**

Identifier	Name
0x0705	Prepayment (Smart Energy)

20481 **10.8.2 Server**

20482 **10.8.2.1 Dependencies**

- 20483 • Events carried using this cluster include a timestamp with the assumption that target devices main-  
 20484 tain a real time clock. Devices can acquire and synchronize their internal clocks via the Time cluster  
 20485 server.
- 20486 • Use of the Price cluster is Mandatory when using the Prepayment cluster in Currency mode.

- 20487 • The Calendar cluster shall be used to set up the Friendly Credit period that the prepayment meter shall use (see 10.9 for further details).
- 20488
- 20489 • Use of the Metering cluster is Mandatory when using the Prepayment cluster in any mode.
- 20490 • Use of the Device Management cluster is mandatory when using the disconnection function within the Prepayment cluster.
- 20491

## 10.8.2.2 Attributes

20493 For convenience, the attributes defined in this specification are arranged into sets of related attributes; each set can contain up to 256 attributes. Attribute identifiers are encoded such that the most significant Octet specifies the attribute set and the least significant Octet specifies the attribute within the set. The currently defined attribute sets are listed in the following Table 10-144.

20497 **Table 10-144. Prepayment Cluster Server Attribute Sets**

Attribute Set Identifier	Description
0x00	Prepayment Information Set
0x01	Top-up Attribute Set
0x02	Debt Attribute Set
0x03	Reserved
0x04	Alarms Set
0x05	Historical Cost Consumption Information Set

### 10.8.2.2.1 Prepayment Information Attribute Set

20498 The following set of attributes provides access to the standard information relating to a Prepayment meter.

20500 **Table 10-145. Prepayment Information Attribute Set**

Id	Name	Type	Range	Acc	Def	M
0x0000	<i>Payment Control Configuration</i>	map16	0x0000 to 0xFFFF	R	0x0000	M
0x0001	<i>Credit Remaining</i>	int32	-2147483647 to 2147483647	R	-	O
0x0002	<i>Emergency Credit Remaining</i>	int32	-2147483647 to 2147483647	R	-	O
0x0003	<i>Credit Status</i>	map8	0x00 to 0x40	R	0x00	O
0x0004	CreditRemaining TimeStamp	UTC		R	-	O
0x0005	Accumulated Debt	int32	-2147483647 to 2147483647	R	-	O

<b>Id</b>	<b>Name</b>	<b>Type</b>	<b>Range</b>	<b>Acc</b>	<b>Def</b>	<b>M</b>
0x0006	OverallDebtCap	int32	-2147483647 to 2147483647	R	-	O
0x0010	EmergencyCredit Limit/Allowance	uint32	0x00000000 to 0xFFFFFFFF	R	-	O
0x0011	EmergencyCredit Threshold	uint32	0x00000000 to 0xFFFFFFFF	R	-	O
0x0020	TotalCreditAdded	uint48	0x000000000000 to 0xFFFFFFFFFFFFFFF	R	-	O
0x0021	MaxCreditLimit	uint32	0x00000000 to 0xFFFFFFFF	R	-	O
0x0022	MaxCreditPerTopUp	uint32	0x00000000 to 0xFFFFFFFF	R	-	O
0x0030	FriendlyCredit Warning	uint8	0x00 to 0xFF	R	0x0A	O
0x0031	LowCredit Warning	uint32	0x00000000 to 0xFFFFFFFF	R	-	O
0x0032	IHDLow CreditWarning	uint32	0x00000000 to 0xFFFFFFFF	RW	-	O
0x0033	InterruptSuspend Time	uint8	0x00 to 0xFF	R	60	O
0x0034	RemainingFriendlyCreditTime	uint16	0x0000 to 0xFFFF	R	-	O
0x0035	NextFriendly CreditPeriod	UTC		R	-	O
0x0040	CutOffValue	int32	-2147483647 to 2147483647	R	-	O
0x0080	TokenCarrierID	octstr	1 to 21 Octets	RW	-	O

20501 **10.8.2.2.1.1 PaymentControl Configuration Attribute**

20502 The *PaymentControlConfiguration* attribute represents the payment mechanisms currently enabled within  
 20503 the Metering Device. Bit encoding of this field is outlined in Table 10-146.

20504

**Table 10-146. Payment Control Configuration Attribute**

Bit	Description
0	Disconnection Enabled
1	Prepayment Enabled
2	Credit Management Enabled
3	
4	Credit Display Enabled
5	
6	Account Base
7	Contacto Fitted
8	Standing Charge Configuration
9	Emergency Standing Charge Configuration
10	Debt Configuration
11	Emergency Debt Configuration

20505

20506

Examples for the setting of this attribute:

Mode of Operation	Description	Bits										
		0	1	2	3	4	5	6	7	8	9	10
Credit Only	The meter is not fitted with a service interrupt device or the interrupt device is disabled. The meter does have an accounting function.	0	0	1	0	X	0	1	0	0	0	0
Credit with disconnect fitted	The meter is fitted with a service interrupt device which can be operated using the supply interrupt command.(for example, this mode allows the supply to the premises to be interrupted in the case of a change of tenancy).	1	0	1	0	X	0	1	1	0	0	0
Prepayment	The meter is fitted with a service interrupt device which can be operated using the supply interrupt command. The accounting function is enabled to allow the consumer's account balance to be shown in monetary values and when it reaches zero or a predefined limit, the supply will be interrupted by the meter. Additionally, the meter will respond to remote supply interruption commands	1	1	1	0	1	0	0	1	X	X	X

20507

- 20508 **Disconnection Enabled:** Indicates whether the metering device is to disconnect the energy supply on expiry  
20509 of available credit.
- 20510 **Prepayment Enabled:** Indicates if the meter is a ‘prepayment’ meter; if this value is 0, the meter is consid-  
20511 ered to be a ‘credit’ meter.
- 20512 **Credit Management Enabled:** Indicates whether the metering device should manage accounting func-  
20513 tionality according to available tariff information.
- 20514 **Credit Display Enabled:** Indicates whether the metering device should display the credit status.
- 20515 **Account Base:** Indicates whether the metering device is running in Monetary (0) or Unit based (1) units. If  
20516 Monetary based, the unit of measure is defined in the Price cluster, if Unit based, the unit of measure is  
20517 defined in the Metering cluster
- 20518 **Contactor Fitted:** Indicates whether the metering device is fitted with a Contactor i.e. is capable of discon-  
20519 necting the energy supply.
- 20520 **Standing Charge Configuration:** Indicates whether the standing charge collection is halted when the pre-  
20521 paid credit is exhausted.
- 20522 **Emergency Standing Charge Configuration:** Indicates whether the standing charge collection is halted  
20523 when the device is in Emergency Credit mode.
- 20524 **Debt Configuration:** Indicates whether the debt collection is halted when the prepaid credit is exhausted.
- 20525 **Emergency Debt Configuration:** Indicates whether the debt is collected when the device is in Emergency  
20526 Credit mode.
- 20527 **10.8.2.2.1.2 Credit Remaining Attribute**
- 20528 The *Credit Remaining* attribute represents the amount of credit remaining on the Metering Device. If Mon-  
20529 etary-based, this attribute is measured in a base unit of *Currency* with the decimal point located as indicated  
20530 by the *Trailing Digits* field, as defined in the Price cluster. If Unit-based, the unit of measure is as defined  
20531 in the Metering cluster (see sub-clause 10.4.2.2.4.1).
- 20532 **10.8.2.2.1.3 Emergency Credit Remaining Attribute**
- 20533 The *Emergency Credit Remaining* attribute represents the amount of Emergency Credit still available on  
20534 the Metering Device. If Monetary-based, this attribute is measured in a base unit of *Currency* with the decimal  
20535 point located as indicated by the *Trailing Digits* field, as defined in the Price cluster. If Unit-based, the unit  
20536 of measure is as defined in the Metering cluster (see sub-clause 10.4.2.2.4.1).
- 20537 **10.8.2.2.1.4 Credit Status Attribute**
- 20538 The *Credit Status* attribute represents the current status of credit within the Metering Device. Bit encoding  
20539 of this field is outlined in Table 10-147. Explanation of the use of this attribute can be found in section  
20540 10.8.4.1.

20541

**Table 10-147. Credit Status Attribute**

Bit	Description
0	Credit OK
1	Low Credit
2	Emergency Credit Enabled
3	Emergency Credit Available
4	Emergency Credit Selected
5	Emergency Credit In Use
6	Credit Exhausted

20542 **10.8.2.2.1.5 CreditRemainingTimeStamp Attribute**

20543 The UTC time at which the *Credit Remaining* attribute was last populated.

20544 **10.8.2.2.1.6 AccumulatedDebt Attribute**

20545 The *AccumulatedDebt* attribute represents the total amount of debt remaining on the Metering Device. This  
20546 attribute is always Monetary based and, as such, this attribute is measured in a base unit of *Currency* with  
20547 the decimal point located as indicated by the *Trailing Digits* field, as defined in the Price cluster.

20548 **10.8.2.2.1.7 OverallDebtCap Attribute**

20549 The *OverallDebtCap* attribute represents the total amount of debt that can be taken from top-ups (in the case  
20550 of multiple instantiated top-up based debts on the Metering Device). This attribute is configured to the re-  
20551 quired limit per unit time (fixed globally in the application at one week) that the consumer pays off against  
20552 their debts. This attribute is always a monetary value, and as such this attribute is measured in a base unit of  
20553 *Currency* with the decimal point located as indicated by the *Trailing Digits* field, as defined in the Price  
20554 cluster.

20555 As an example, a consumer has a single Percentage Based debt in operation, with a collection rate of 20%  
20556 and an *OverallDebtCap* of £5 per week. He buys £5 credit every day. Table 10-148 shows the resultant  
20557 allocation of the amounts purchased:

20558 **Table 10-148. OverallDebtCap Example**

	Amount Purchased	Amount to Debt	Amount to Credit
Monday	£5	20% = £1	£4
Tuesday	£5	20% = £1	£4
Wednesday	£5	20% = £1	£4
Thursday	£5	20% = £1	£4
Friday	£5	20% = £1	£4
Saturday	£5	Cap reached	£5
Sunday	£5	Cap reached	£5

20559  
20560 Once the cap value has been reached during a week then no further amounts are deducted from the purchases.

20561 As an extension of the example, if the customer purchased £50 credit on the Monday, the meter would take  
20562 £5 (not £10) and would also not take any further debt payments from any other purchases made in the same  
20563 week.

20564 **10.8.2.2.1.8 EmergencyCreditLimit/Allowance Attribute**



20565 The *EmergencyCreditLimit/Allowance* attribute may be updated by the utility company. This is the amount  
20566 of Emergency Credit available to loan to the consumer when the remaining balance goes below the low credit  
20567 threshold. If Monetary based, then this attribute is measured in base unit of *Currency* with the decimal point  
20568 located as indicated by the *Trailing Digits* field, as defined in the Price cluster. If Unit based, the unit of  
20569 measure is as defined in the Metering cluster (see sub-clause 10.4.2.2.4.1).

#### 20570 **10.8.2.2.1.9 EmergencyCreditThreshold Attribute**

20571 When credit (or emergency credit) falls below this threshold, an alarm is raised to warn the consumer of  
20572 imminent supply interruption and, if available, to offer Emergency Credit. If Monetary based, the unit of  
20573 measure is the same as that defined in the Price cluster. If Unit based, the unit of measure is as defined in the  
20574 Metering cluster (see sub-clause 10.4.2.2.4.1).

#### 20575 **10.8.2.2.1.10 TotalCreditAdded Attribute**

20576 An unsigned 48-bit integer value indicating running total of credit topped up to date. If Monetary based, this  
20577 attribute is measured in a base unit of *Currency* with the decimal point located as indicated by the *Trailing*  
20578 *Digits* field, as defined in the Price cluster. If Unit based, the unit of measure is as defined in the Metering  
20579 cluster (see sub-clause 10.4.2.2.4.1). At change of Tenant or Supplier, this attribute shall be reset to zero.

#### 20580 **10.8.2.2.1.11 MaxCreditLimit Attribute**

20581 An unsigned 32-bit integer value indicating the maximum credit balance allowed on a meter. Any further  
20582 top-up amount that will cause the meter to exceed this limit will be rejected. This value can be stated in  
20583 currency (as per the Price cluster) or in units (unit of measure will be defined in the Metering cluster) de-  
20584 pending on the Prepayment mode of operation defined in section 10.8.2.2.1.1 (*Payment Control Configura-*  
20585 *tion* attribute). A value of 0xFFFFFFFF shall indicate that this limit is disabled and that all further top-ups  
20586 should be permitted.

#### 20587 **10.8.2.2.1.12 MaxCreditPerTopUp Attribute**

20588 An unsigned 32-bit integer value indicating the maximum credit per top-up. Any single top-up greater than  
20589 this threshold will cause the meter to reject the top-up. This value can be stated in currency (as per the Price  
20590 cluster) or in units (unit of measure will be defined in the Metering cluster) depending on the Prepayment  
20591 mode of operation defined in section 10.8.2.2.1.1 (*Payment Control Configuration* attribute). A value of  
20592 0xFFFFFFFF shall indicate that this parameter is disabled and that there should be no limit on the amount of  
20593 allowed credit in a top-up.

#### 20594 **10.8.2.2.1.13 FriendlyCreditWarning Attribute**

20595 An unsigned 8-bit integer value indicating the amount of time, in minutes, before the *Friendly Credit Period*  
20596 *End Warning* alarm flag is triggered. The default value is 10 mins before the currently active Friendly Credit  
20597 period is due to end.

#### 20598 **10.8.2.2.1.14 LowCreditWarningLevel Attribute**

20599 An unsigned 32 bit integer that defines the **utility** low credit value below which the Low Credit warning  
20600 should sound. The Low Credit warning shall be triggered when the value between the remaining credit and  
20601 the disconnection point falls below this value. Falling below this value shall trigger the Low Credit warning  
20602 alert within this cluster. The value is in a base unit of *Currency* (as per the Price cluster) or in Units (as per  
20603 the Metering cluster). The attribute is set from the backhaul connection.

#### 20604 **10.8.2.2.1.15 IHDLowCreditWarningLevel Attribute**

20605 An unsigned 32 bit integer that is defined by the **consumer** for a low credit value below which a Low Credit  
20606 warning should sound. The Low Credit warning shall be triggered when the value between the remaining  
20607 credit and the disconnection point falls below this value. This shall not trigger the Low Credit warning alert  
20608 within this cluster. The value is in a base unit of *Currency* (as per the Price cluster) or in Units (as per the  
20609 Metering cluster).

#### 20610 **10.8.2.2.1.16 InterruptSuspendTime Attribute**

20611 When the end of a configured non-disconnect period is reached and the supply is to be interrupted due to  
 20612 insufficient credit being available, the meter will provide visual and audible alerts and the interruption will  
 20613 be suspended for a further period of minutes defined by this attribute. If no payments are applied to the meter  
 20614 during this period, or if insufficient credit is added, then, at the end of this period, an alert will be provided  
 20615 and the supply will then be interrupted.

20616 **10.8.2.2.1.17 RemainingFriendlyCreditTime Attribute**

20617 An unsigned 16-bit integer value indicating the amount of time remaining, in minutes, in a currently active  
 20618 Friendly Credit period. A value of zero shall indicate that no period is currently active (i.e. 0 = expired/no  
 20619 minutes left).

20620 **10.8.2.2.1.18 NextFriendlyCreditPeriod Attribute**

20621 The UTC time at which the next Friendly Credit period is due to commence.

20622 **10.8.2.2.1.19 CutOffValue Attribute**

20623 This attribute is a signed 32 bit integer that shall either be zero or a negative value (in all known cases). This  
 20624 allowance is measured in base unit of *Currency* with the decimal point located as indicated by the *Trailing*  
 20625 *Digits* field, as defined in the Price cluster. If Unit based, the unit of measure is as defined in the Metering  
 20626 cluster (see sub-clause 10.4.2.2.4.1).

20627 This attribute represents a threshold relating to the absolute value of the *CreditRemaining* attribute, that when  
 20628 reached (when credit is decrementing) causes the supply of service to be disconnected. There can be several  
 20629 types of credit within a payment metering system of which there are 2 specified in this specification (*Credit*  
 20630 and *EmergencyCredit*). The *CreditRemaining* attribute shall contain the net worth of a consumers account  
 20631 within the meter, consolidating all active credit types (both *Credit* and *EmergencyCredit* if in use). As *Emer-*  
 20632 *gencyCredit* is effectively a loan from the supplier it becomes a liability once it is used, and when it is ex-  
 20633 hausted will force the *RemainingCredit* to a negative value. There are a number of other factors that can  
 20634 affect the way a prepayment meter works and which values are displayed to the end consumer. However,  
 20635 when a meter’s *EmergencyCredit* has run out, the *CreditRemaining* value shall contain the total liability of  
 20636 the consumer (that he is required to pay before *EmergencyCredit* shall be available again) as a negative  
 20637 value.

20638 **10.8.2.2.1.20 TokenCarrierId Attribute**

20639 The *TokenCarrierId* attribute provides a method for utilities to publish the payment card number that is used  
 20640 with this meter set. The *TokenCarrierId* attribute is an Octet String capable of storing a 20 character string  
 20641 (the first Octet indicates length) encoded in the UTF-8 format. The *TokenCarrierId* attribute represents the  
 20642 current active value for the property.

20643 **10.8.2.2.2 Top-up Attribute Set**

20644 The following set of attributes provides access to previous successful credit *top-ups* on a prepayment  
 20645 meter. #1 is the most recent, based on time.

20646 **Table 10-149. Top-up Attribute Set**

Id	Name	Type	Range	Acc	Def	M
0x0100	<i>Top up Date/Time #1</i>	UTC		R	-	O
0x0101	<i>Top up Amount #1</i>	int32	-2147483647 to 2147483647	R	-	O
0x0102	<i>Originating Device #1</i>	enum8	0x00 to 0xFF	R	-	O

Id	Name	Type	Range	Acc	Def	M
0x0103	<i>Top up Code #1</i>	octstr	1 to 26 Octets	R	-	O
0x0110	<i>Top up Date/Time #2</i>	UTC		R	-	O
0x0111	<i>Top up Amount #2</i>	int32	-2147483647 to 2147483647	R	-	O
0x0112	<i>Originating Device #2</i>	enum8	0x00 to 0xFF	R	-	O
0x0113	<i>Top up Code #2</i>	octstr	1 to 26 Octets	R	-	O
0x0120	<i>Top up Date/Time #3</i>	UTC		R	-	O
0x0121	<i>Top up Amount #3</i>	int32	-2147483647 to 2147483647	R	-	O
0x0122	<i>Originating Device #3</i>	enum8	0x00 to 0xFF	R	-	O
0x0123	<i>Top up Code #3</i>	octstr	1 to 26 Octets	R	-	O
0x0130	<i>Top up Date/Time #4</i>	UTC		R	-	O
0x0131	<i>Top up Amount #4</i>	int32	-2147483647 to 2147483647	R	-	O
0x0132	<i>Originating Device #4</i>	enum8	0x00 to 0xFF	R	-	O
0x0133	<i>Top up Code #4</i>	octstr	1 to 26 Octets	R	-	O
0x0140	<i>Top up Date/Time #5</i>	UTC		R	-	O
0x0141	<i>Top up Amount #5</i>	int32	-2147483647 to 2147483647	R	-	O
0x0142	<i>Originating Device #5</i>	enum8	0x00 to 0xFF	R	-	O
0x0143	<i>Top up Code #5</i>	octstr	1 to 26 Octets	R	-	O

20647 **10.8.2.2.2.1 Top up Date/Time Attribute**

20648 The *Top up Date/Time* attribute represents the time that the credit was topped up on the Metering Device.  
 20649 There are five records containing this attribute, one for each of the last five top-ups.

20650 **10.8.2.2.2.2 Top up Amount Attribute**

20651 The *Top up Amount* attribute represents the amount of credit that was added to the Metering Device during  
 20652 the top up. If Monetary-based, this attribute is measured in a base unit of *Currency* with the decimal point  
 20653 located as indicated by the *Trailing Digits* field, as defined in the Price cluster. If Unit-based, the unit of  
 20654 measure is as defined in the Metering cluster (see sub-clause 10.4.2.2.4.1). There are five records contain-  
 20655 ing this attribute, one for each of the last five top-ups.

20656 **10.8.2.2.3 Originating Device Attribute**

20657 The *Originating Device* attribute represents the SE device that was the source of the top-up command. The  
20658 enumerated values of this field are outlined in Table 10-162. There are five records containing this attribute,  
20659 one for each of the last five top-ups.

20660 **10.8.2.2.4 Originating Device Attribute**

20661 The *Top up Code* attribute represents any encrypted number that was used to apply the credit to the meter;  
20662 the octet string shall be as it was received, i.e. not decoded. There are five records containing this attribute,  
20663 one for each of the last five top-ups.

20664 **10.8.2.2.3 Debt Attribute Set**

20665 The following set of attributes provides access to information on debt held on a Prepayment meter.

20666 **Table 10-150. Debt Attribute Set**

Id	Name	Type	Range	Acc	Def	M
0x0210	DebtLabel#1	octstr	1 to 13 Octets	R	-	O
0x0211	DebtAmount#1	uint32	0x00000000 to 0xFFFFFFFF	R	-	O
0x0212	DebtRecovery Method#1	enum8	0x00 to 0xFF	R	-	O
0x0213	DebtRecovery StartTime#1	UTC		R	-	O
0x0214	DebtRecovery CollectionTime#1	uint16	0x0000 – 0x05A0	R	0	O
0x0216	DebtRecovery Frequency#1	enum8	0x00 to 0xFF	R	-	O
0x0217	DebtRecovery Amount#1	uint32	0x00000000 to 0xFFFFFFFF	R	-	O
0x0219	DebtRecovery TopUpPercentage#1	uint16	0x0000 – 0x2710	R	0	O
0x0220	DebtLabel#2	octstr	1 to 13 Octets	R	-	O
0x0221	DebtAmount#2	uint32	0x00000000 to 0xFFFFFFFF	R	-	O
0x0222	DebtRecovery Method#2	enum8	0x00 to 0xFF	R	-	O
0x0223	DebtRecovery StartTime#2	UTC		R	-	O
0x0224	DebtRecovery CollectionTime#2	uint16	0x0000 – 0x05A0	R	0	O
0x0226	DebtRecovery Frequency#2	enum8	0x00 to 0xFF	R	-	O
0x0227	DebtRecovery Amount#2	uint32	0x00000000 to 0xFFFFFFFF	R	-	O

Id	Name	Type	Range	Acc	Def	M
0x0229	DebtRecovery TopUpPercentage#2	uint16	0x0000 – 0x2710	R	0	O
0x0230	DebtLabel#3	octstr	1 to 13 Octets	R	-	O
0x0231	DebtAmount#3	uint32	0x00000000 to 0xFFFFFFFF	R	-	O
0x0232	DebtRecovery Method#3	enum8	0x00 to 0xFF	R	-	O
0x0233	DebtRecovery StartTime#3	UTC		R	-	O
0x0234	DebtRecovery CollectionTime#3	uint16	0x0000 – 0x05A0	R	0	O
0x0236	DebtRecovery Frequency#3	enum8	0x00 to 0xFF	R	-	O
0x0237	DebtRecovery Amount#3	uint32	0x00000000 to 0xFFFFFFFF	R	-	O
0x0239	DebtRecovery TopUpPercentage#3	uint16	0x0000 – 0x2710	R	0	O

20667 **10.8.2.2.3.1 DebtLabel#N Attribute**

20668 The *DebtLabel#n* attribute provides a method for utilities to assign a name to a particular type of debt. The  
 20669 *DebtLabel#n* attribute is an Octet String field capable of storing a 12 character string (the first Octet indicates  
 20670 length) encoded in the UTF-8 format. This applies to all debt recovery methods.

20671 **10.8.2.2.3.2 DebtAmount#N Attribute**

20672 An unsigned 32-bit field to denote the amount of Debt remaining on the Metering Device. This parameter  
 20673 shall be measured in base unit of *Currency* with the decimal point located as indicated by the *Trailing Digits*  
 20674 field, as defined in the Price Cluster.

20675 **10.8.2.2.3.3 DebtRecoveryMethod#N Attribute**

20676 An enumerated attribute denoting the debt recovery method used for this debt type. The enumerated values  
 20677 for this field are outlined in Table 10-151 (Time based, Percentage based and Catch-Up based). This applies  
 20678 to all debt recovery methods.

20679 **Table 10-151. Debt Recovery Method Enumerations**

Enumerated Value	Recovery Method
0x00	Time Based
0x01	Percentage Based
0x02	Catch-Up Based (Fixed Period)

20680 **10.8.2.2.3.4 DebtRecoveryStartTime#N Attribute**

20681 A UTC Time field to denote the time at which the debt collection should start. This applies to all debt re-  
 20682 recovery methods.

20683 **10.8.2.2.3.5 DebtRecoveryCollectionTime#N Attribute**

20684 An unsigned 16-bit field denoting the time of day when the debt collection takes place. It is encoded as the  
20685 number of minutes after midnight and has a valid range 0 ... 1440 with a default value of 0. This applies to  
20686 all debt recovery methods.

20687 **10.8.2.2.3.6 DebtRecoveryFrequency#N Attribute**

20688 The *DebtRecoveryFrequency#N* attribute represents the period over which each *DebtRecoveryAmount#N*  
20689 is recovered. The enumerated values of this field are outlined in Table 10-152.

20690 **Table 10-152. Recovery Frequency Field Enumerations**

Enumerated Value	Recovery Period
0x00	Per Hour
0x01	Per Day
0x02	Per Week
0x03	Per Month
0x04	Per Quarter

20691 **10.8.2.2.3.7 DebtRecoveryAmount#N Attribute**

20692 The *DebtRecoveryAmount#N* attribute represents the amount of Debt recovered each period specified by  
20693 *DebtRecoveryFrequency#N*, measured in base unit of *Currency* with the decimal point located as indicated  
20694 by the *Trailing Digits* field, as defined in the Price Cluster. This attribute only applies to Time based and  
20695 Catch-Up based debt recovery. A value of 0 indicates not used.

20696 **10.8.2.2.3.8 DebtRecoveryTopUpPercentage#N Attribute**

20697 An unsigned 16-bit field used in Percentage based recovery to denote the percentage from a top- up amount  
20698 to be deducted from the debt. For example, if the *DebtRecoveryTopUpPercentage#N* is set to 10% and the  
20699 customer topped up the device with 10 units of *Currency*, then 1 unit is deducted from the amount being  
20700 topped up and paid towards the debt recovery, i.e the device is credited with only 9 units of currency. The  
20701 percentage is always in the following format xxx.xx. The default is 0.00% and maximum value is 100.00%.

20702 **10.8.2.2.4 Supply Control Set**

20703 The Supply Control functionality has been moved to the Metering cluster (see section 10.4 for further details).

20704 **10.8.2.2.5 Alarms Attribute Set**

20705 The following set of attributes provides a means to control which prepayment alarms may be generated from  
20706 the meter.

20707 **Table 10-153. Alarm Attribute Set**

Id	Name	Type	Range	Acc	Def	M
0x0400	PrepaymentAlarmStatus	map16	0x0000 - 0xffff	R	0x0000	O
0x0401	PrepayGenericAlarmMask	map16	0x0000 - 0xffff	RW	0xFFFF	O
0x0402	PrepaySwitchAlarmMask	map16	0x0000 - 0xffff	RW	0xFFFF	O

<b>Id</b>	<b>Name</b>	<b>Type</b>	<b>Range</b>	<b>Acc</b>	<b>Def</b>	<b>M</b>
0x0403	PrepayEventAlarmMask	map16	0x0000 - 0xffff	RW	0xFFFF	O

20708 **10.8.2.2.5.1 Prepayment Alarm Status Attribute**

20709 The *PrepaymentAlarmStatus* attribute provides indicators reflecting the current error conditions found by the  
 20710 prepayment metering device. This attribute is a 16-bit field where when an individual bit is set, an error or  
 20711 warning condition exists. The behaviour causing the setting or resetting of each bit is device specific. In other  
 20712 words, the application within the prepayment metering device will determine and control when these settings  
 20713 are either set or cleared. The ESI should make alarms available to upstream systems, together with consump-  
 20714 tion data collected from a battery operated meter.

20715 **Table 10-154. Prepayment Alarm Status Indicators**

<b>Bit field</b>	<b>Alarm Condition</b>	<b>Meaning / Description</b>
0	Low Credit Warning	An alarm triggered by a configured threshold.
1	Top Up Code Error	The Top up code has been sent but it is too long or short for the meter
2	Top Up Code Already Used	The Top up code has been sent but the credit value for this top up code has already been applied and this is a duplicate request.
3	Top Up Code Invalid	The Top up code is a correct length but is not a valid top up code.
4	Friendly Credit In Use	The meter is in a Friendly Credit period and Friendly Credit is being used due to no actual credit being available on the meter.
5	Friendly Credit Period End Warning	This is triggered when the time remaining in a Friendly Credit period falls below the value of the FriendlyCreditWarning attribute (default 1hr) and the above Friendly Credit In Use flag is set.
6	EC Available	An alarm triggered when Emergency credit is available to be selected
7	Unauthorised Energy Use	GAS: Valve Fault and unauthorised gas is being provided to the home ELECTRICITY: Disconnection Fault and unauthorised electricity is being provided to the house.
8	Disconnected Supply Due to Credit	Supply has been disconnected due to no credit on meter. Cleared by addition of credit or by selecting Emergency Credit
9	Disconnected Supply Due to Tamper	Supply has been disconnected due to a tamper detect on the meter. It can also be due to a fault on the meter that is not covered by another flag.
10	Disconnected Supply Due to HES	This is normally due to the HES cutting the supply
11	Physical Attack	Physical attack on the Prepayment Meter
12	Electronic Attack	Electronic attack on the Prepayment Meter
13	Manufacture Alarm Code A	Manufacture Alarm Code A
14	Manufacture Alarm Code B	Manufacture Alarm Code B

20716

20717 **10.8.2.2.5.2 Alarm Mask Attributes**

20718 The Alarm Mask attributes of the Alarms Attribute Set specify whether each of the alarms listed in the cor-  
20719 responding alarm group in Table 10-155 through Table 10-158 is enabled. When the bit number correspond-  
20720 ing to the alarm number (minus the group offset) is set to 1, the alarm is enabled, else it is disabled. Bits not  
20721 corresponding to a code in the respective table are reserved.

20722 **10.8.2.2.5.3 Alarm Codes**

20723 The alarm codes are organised in logical groups corresponding to the types of activity as listed below. The  
20724 three main alarm groups are: GenericAlarmMask, PrepaySwitchAlarmMask, and PrepayEventAlarmMask.

20725 **Table 10-155. Alarms Code Group**

Enumerated Alarm Codes	Alarm Condition
0x00 – 0x0F	PrePayGenericAlarmGroup
0x10 – 0x1F	PrepaySwitchAlarmGroup
0x20 – 0x4F	PrepayEventAlarmGroup

20726  
20727 The Alarms that can be enabled/disabled in the PrepayGenericAlarmGroup are as follows:

20728 **Table 10-156. PrepayGenericAlarmGroup**

Enumerated Alarm Code	Alarm Condition
0x00	Low Credit (for all types of credit)
0x01	No Credit (Zero Credit)
0x02	Credit Exhausted
0x03	Emergency Credit Enabled
0x04	Emergency Credit Exhausted
0x05	IHD Low Credit Warning
0x06	Event Log Cleared

20729  
20730 The Alarms that can be enabled/disabled in the *PrepaySwitchAlarmGroup* are as follows:

20731 **Table 10-157. PrepaySwitchAlarmGroup**

Enumerated Alarm Code	Alarm Condition
0x10	Supply ON
0x11	Supply ARM
0x12	Supply OFF
0x13	Disconnection Failure (Shut Off Mechanism Fail)
0x14	Disconnected due to Tamper Detected.
0x15	Disconnected due to Cut off Value.
0x16	Remote Disconnected.

20732  
20733 The Alarms that can be enabled/disabled in the *PrepayEventAlarmGroup* are as follows:



20734

**Table 10-158. PrepayEventAlarmGroup**

Enumerated Alarm Code	Alarm Condition
0x20	Physical Attack on the Prepay Meter
0x21	Electronic Attack on the Prepay Meter
0x22	Discount Applied
0x23	Credit Adjustment
0x24	Credit Adjustment Fail
0x25	Debt Adjustment
0x26	Debt Adjustment Fail
0x27	Mode Change
0x28	Topup Code Error
0x29	Topup Already Used
0x2A	Topup Code Invalid
0x2B	Friendly Credit In Use
0x2C	Friendly Credit Period End Warning
0x2D	Friendly Credit Period End
0x30	ErrorRegClear
0x31	AlarmRegClear
0x32	Prepay Cluster Not Found
0x41	ModeCredit2Prepay
0x42	ModePrepay2Credit
0x43	ModeDefault

20735

20736

### 10.8.2.2.6 Historical Cost Consumption Information Set

20737

**Table 10-159. Historical Cost Consumption Information Attribute Set**

Id	Name	Type	Range	Acc	Def	M
0x0500	HistoricalCostConsumption Formatting	map8	0x00 to 0xFF	R	-	O
0x0501	ConsumptionUnitofMeasurement	enum8	0x00 to 0xFF	R	0x00	O
0x0502	CurrencyScalingFactor	enum8	0x00 to 0xFF	R	-	O
0x0503	Currency	uint16	0x0000 to 0xFFFF	R	-	O
0x051C	CurrentDay CostConsumptionDelivered	uint48	0x000000000000 to 0xFFFFFFFFFFFFFF	R	-	O
0x051D	CurrentDay CostConsumptionReceived	uint48	0x000000000000 to 0xFFFFFFFFFFFFFF	R	-	O
0x051E	PreviousDay CostConsumptionDelivered	uint48	0x000000000000 to 0xFFFFFFFFFFFFFF	R	-	O

<b>Id</b>	<b>Name</b>	<b>Type</b>	<b>Range</b>	<b>Acc</b>	<b>Def</b>	<b>M</b>
0x051F	PreviousDay CostConsumptionReceived	uint48	0x000000000000 to 0xFFFFFFFFFFFFFFF	R	-	O
0x0520	PreviousDay2 CostConsumptionDelivered	uint48	0x000000000000 to 0xFFFFFFFFFFFFFFF	R	-	O
0x0521	PreviousDay2 CostConsumptionReceived	uint48	0x000000000000 to 0xFFFFFFFFFFFFFFF	R	-	O
0x0522	PreviousDay3 CostConsumptionDelivered	uint48	0x000000000000 to 0xFFFFFFFFFFFFFFF	R	-	O
0x0523	PreviousDay3 CostConsumptionReceived	uint48	0x000000000000 to 0xFFFFFFFFFFFFFFF	R	-	O
0x0524	PreviousDay4 CostConsumptionDelivered	uint48	0x000000000000 to 0xFFFFFFFFFFFFFFF	R	-	O
0x0525	PreviousDay4 CostConsumptionReceived	uint48	0x000000000000 to 0xFFFFFFFFFFFFFFF	R	-	O
0x0526	PreviousDay5 CostConsumptionDelivered	uint48	0x000000000000 to 0xFFFFFFFFFFFFFFF	R	-	O
0x0527	PreviousDay5 CostConsumptionReceived	uint48	0x000000000000 to 0xFFFFFFFFFFFFFFF	R	-	O
0x0528	PreviousDay6 CostConsumptionDelivered	uint48	0x000000000000 to 0xFFFFFFFFFFFFFFF	R	-	O
0x0529	PreviousDay6 CostConsumptionReceived	uint48	0x000000000000 to 0xFFFFFFFFFFFFFFF	R	-	O
0x052A	PreviousDay7 CostConsumptionDelivered	uint48	0x000000000000 to 0xFFFFFFFFFFFFFFF	R	-	O
0x052B	PreviousDay7 CostConsumptionReceived	uint48	0x000000000000 to 0xFFFFFFFFFFFFFFF	R	-	O
0x052C	PreviousDay8 CostConsumptionDelivered	uint48	0x000000000000 to 0xFFFFFFFFFFFFFFF	R	-	O
0x052D	PreviousDay8 CostConsumptionReceived	uint48	0x000000000000 to 0xFFFFFFFFFFFFFFF	R	-	O
0x0530	CurrentWeek CostConsumptionDelivered	uint48	0x000000000000 to 0xFFFFFFFFFFFFFFF	R	-	O
0x0531	CurrentWeek CostConsumptionReceived	uint48	0x000000000000 to 0xFFFFFFFFFFFFFFF	R	-	O
0x0532	PreviousWeek CostConsumptionDelivered	uint48	0x000000000000 to 0xFFFFFFFFFFFFFFF	R	-	O
0x0533	PreviousWeek CostConsumptionReceived	uint48	0x000000000000 to 0xFFFFFFFFFFFFFFF	R	-	O

<b>Id</b>	<b>Name</b>	<b>Type</b>	<b>Range</b>	<b>Acc</b>	<b>Def</b>	<b>M</b>
0x0534	PreviousWeek2 CostConsumptionDelivered	uint48	0x000000000000 to 0xFFFFFFFFFFFFFFF	R	-	O
0x0535	PreviousWeek2 CostConsumptionReceived	uint48	0x000000000000 to 0xFFFFFFFFFFFFFFF	R	-	O
0x0536	PreviousWeek3 CostConsumptionDelivered	uint48	0x000000000000 to 0xFFFFFFFFFFFFFFF	R	-	O
0x0537	PreviousWeek3 CostConsumptionReceived	uint48	0x000000000000 to 0xFFFFFFFFFFFFFFF	R	-	O
0x0538	PreviousWeek4 CostConsumptionDelivered	uint48	0x000000000000 to 0xFFFFFFFFFFFFFFF	R	-	O
0x0539	PreviousWeek4 CostConsumptionReceived	uint48	0x000000000000 to 0xFFFFFFFFFFFFFFF	R	-	O
0x053A	PreviousWeek5 CostConsumptionDelivered	uint48	0x000000000000 to 0xFFFFFFFFFFFFFFF	R	-	O
0x053B	PreviousWeek5 CostConsumptionReceived	uint48	0x000000000000 to 0xFFFFFFFFFFFFFFF	R	-	O
0x0540	CurrentMonth CostConsumptionDelivered	uint48	0x000000000000 to 0xFFFFFFFFFFFFFFF	R	-	O
0x0541	CurrentMonth CostConsumptionReceived	uint48	0x000000000000 to 0xFFFFFFFFFFFFFFF	R	-	O
0x0542	PreviousMonth CostConsumptionDelivered	uint48	0x000000000000 to 0xFFFFFFFFFFFFFFF	R	-	O
0x0543	PreviousMonth CostConsumptionReceived	uint48	0x000000000000 to 0xFFFFFFFFFFFFFFF	R	-	O
0x0544	PreviousMonth2 CostConsumptionDelivered	uint48	0x000000000000 to 0xFFFFFFFFFFFFFFF	R	-	O
0x0545	PreviousMonth2 CostConsumptionReceived	uint48	0x000000000000 to 0xFFFFFFFFFFFFFFF	R	-	O
0x0546	PreviousMonth3 CostConsumptionDelivered	uint48	0x000000000000 to 0xFFFFFFFFFFFFFFF	R	-	O
0x0547	PreviousMonth3 CostConsumptionReceived	uint48	0x000000000000 to 0xFFFFFFFFFFFFFFF	R	-	O
0x0548	PreviousMonth4 CostConsumptionDelivered	uint48	0x000000000000 to 0xFFFFFFFFFFFFFFF	R	-	O
0x0549	PreviousMonth4 CostConsumptionReceived	uint48	0x000000000000 to 0xFFFFFFFFFFFFFFF	R	-	O
0x054A	PreviousMonth5 CostConsumptionDelivered	uint48	0x000000000000 to 0xFFFFFFFFFFFFFFF	R	-	O

<b>Id</b>	<b>Name</b>	<b>Type</b>	<b>Range</b>	<b>Acc</b>	<b>Def</b>	<b>M</b>
0x054B	PreviousMonth5 CostConsumptionReceived	uint48	0x000000000000 to 0xFFFFFFFFFFFFFFF	R	-	O
0x054C	PreviousMonth6 CostConsumptionDelivered	uint48	0x000000000000 to 0xFFFFFFFFFFFFFFF	R	-	O
0x054D	PreviousMonth6 CostConsumptionReceived	uint48	0x000000000000 to 0xFFFFFFFFFFFFFFF	R	-	O
0x054E	PreviousMonth7 CostConsumptionDelivered	uint48	0x000000000000 to 0xFFFFFFFFFFFFFFF	R	-	O
0x054F	PreviousMonth7 CostConsumptionReceived	uint48	0x000000000000 to 0xFFFFFFFFFFFFFFF	R	-	O
0x0550	PreviousMonth8 CostConsumptionDelivered	uint48	0x000000000000 to 0xFFFFFFFFFFFFFFF	R	-	O
0x0551	PreviousMonth8 CostConsumptionReceived	uint48	0x000000000000 to 0xFFFFFFFFFFFFFFF	R	-	O
0x0552	PreviousMonth9 CostConsumptionDelivered	uint48	0x000000000000 to 0xFFFFFFFFFFFFFFF	R	-	O
0x0553	PreviousMonth9 CostConsumptionReceived	uint48	0x000000000000 to 0xFFFFFFFFFFFFFFF	R	-	O
0x0554	PreviousMonth10 CostConsumptionDelivered	uint48	0x000000000000 to 0xFFFFFFFFFFFFFFF	R	-	O
0x0555	PreviousMonth10 CostConsumptionReceived	uint48	0x000000000000 to 0xFFFFFFFFFFFFFFF	R	-	O
0x0556	PreviousMonth11 CostConsumptionDelivered	uint48	0x000000000000 to 0xFFFFFFFFFFFFFFF	R	-	O
0x0557	PreviousMonth11 CostConsumptionReceived	uint48	0x000000000000 to 0xFFFFFFFFFFFFFFF	R	-	O
0x0558	PreviousMonth12 CostConsumptionDelivered	uint48	0x000000000000 to 0xFFFFFFFFFFFFFFF	R	-	O
0x0559	PreviousMonth12 CostConsumptionReceived	uint48	0x000000000000 to 0xFFFFFFFFFFFFFFF	R	-	O
0x055A	PreviousMonth13 CostConsumptionDelivered	uint48	0x000000000000 to 0xFFFFFFFFFFFFFFF	R	-	O
0x055B	PreviousMonth13 CostConsumptionReceived	uint48	0x000000000000 to 0xFFFFFFFFFFFFFFF	R	-	O
0x055C	Historical Freeze Time	uint16	0x0000 to 0x173C	R	0x0000	O

20738

**10.8.2.2.6.1 HistoricalCostConsumptionFormatting Attribute**

20739 *HistoricalCostConsumptionFormatting* provides a method to properly decipher the decimal point location  
20740 for the values found in the Historical Cost Consumption Set of attributes. The most significant nibble indi-  
20741 cates the number of digits to the left of the decimal point, the least significant nibble the number of digits to  
20742 the right.

20743 This attribute shall be used against the following attributes:

- 20744 • *CurrentDayCostConsumptionDelivered*
- 20745 • *CurrentDayCostConsumptionReceived*
- 20746 • *PreviousDayNCostConsumptionDelivered*
- 20747 • *PreviousDayNCostConsumptionReceived*
- 20748 • *CurrentWeekCostConsumptionDelivered*
- 20749 • *CurrentWeekCostConsumptionReceived*
- 20750 • *PreviousWeekNCostConsumptionDelivered*
- 20751 • *PreviousWeekNCostConsumptionReceived*
- 20752 • *CurrentMonthCostConsumptionDelivered*
- 20753 • *CurrentMonthCostConsumptionReceived*
- 20754 • *PreviousMonthNCostConsumptionDelivered*
- 20755 • *PreviousMonthNCostConsumptionReceived*

#### 20756 **10.8.2.2.6.2 ConsumptionUnitofMeasurement Attribute**

20757 *ConsumptionUnitofMeasurement* provides a label for the Energy, Gas, or Water being measured by the me-  
20758 tering device. This attribute is an 8-bit enumerated field. The bit descriptions for this attribute are listed in  
20759 Table 10-72.

20760 This attribute shall be used against the following attributes:

- 20761 • *CurrentDayCostConsumptionDelivered*
- 20762 • *CurrentDayCostConsumptionReceived*
- 20763 • *PreviousDayNCostConsumptionDelivered*
- 20764 • *PreviousDayNCostConsumptionReceived*
- 20765 • *CurrentWeekCostConsumptionDelivered*
- 20766 • *CurrentWeekCostConsumptionReceived*
- 20767 • *PreviousWeekNCostConsumptionDelivered*
- 20768 • *PreviousWeekNCostConsumptionReceived*
- 20769 • *CurrentMonthCostConsumptionDelivered*
- 20770 • *CurrentMonthCostConsumptionReceived*
- 20771 • *PreviousMonthNCostConsumptionDelivered*
- 20772 • *PreviousMonthNCostConsumptionReceived*

#### 20773 **10.8.2.2.6.3 CurrencyScalingFactor Attribute**

20774 *CurrencyScalingFactor* provides a scaling factor for the *Currency* attribute for the Energy, Gas, or Water  
20775 being measured by the metering device. This attribute is an 8-bit enumeration, the enumerated values for  
20776 which are outlined in Table 10-160. Note that this attribute will allow for a different resolution for historical  
20777 values compared to values in the Price cluster.

20778 This attribute shall be used against the following attributes:

- 20779 • *CurrentDayCostConsumptionDelivered*
- 20780 • *CurrentDayCostConsumptionReceived*
- 20781 • *PreviousDayNCostConsumptionDelivered*
- 20782 • *PreviousDayNCostConsumptionReceived*
- 20783 • *CurrentWeekCostConsumptionDelivered*
- 20784 • *CurrentWeekCostConsumptionReceived*
- 20785 • *PreviousWeekNCostConsumptionDelivered*

- 20786 • *PreviousWeekNCostConsumptionReceived*
- 20787 • *CurrentMonthCostConsumptionDelivered*
- 20788 • *CurrentMonthCostConsumptionReceived*
- 20789 • *PreviousMonthNCostConsumptionDelivered*
- 20790 • *PreviousMonthNCostConsumptionReceived*

20791 **Table 10-160. CurrencyScalingFactor Enumerations**

Enumerated Value	Scaling Factor
0x00	x 10 <sup>-6</sup>
0x01	x 10 <sup>-5</sup>
0x02	x 10 <sup>-4</sup>
0x03	x 10 <sup>-3</sup>
0x04	x 10 <sup>-2</sup>
0x05	x 10 <sup>-1</sup>
0x06	x 1
0x07	x 10
0x08	x 100
0x09	x 10 <sup>3</sup>
0x0A	x 10 <sup>4</sup>
0x0B	x 10 <sup>5</sup>
0x0C	x 10 <sup>6</sup>

20792 **10.8.2.2.6.4 Currency Attribute**

20793 The *Currency* attribute provides the currency for the Energy, Gas, or Water being measured by the prepay-  
 20794 ment device. The value of the attribute should match one of the values defined by ISO 4217. This unsigned  
 20795 16-bit value indicates the currency in which the following attributes are represented:

- 20796 • *CurrentDayCostConsumptionDelivered*
- 20797 • *CurrentDayCostConsumptionReceived*
- 20798 • *PreviousDayNCostConsumptionDelivered*
- 20799 • *PreviousDayNCostConsumptionReceived*
- 20800 • *CurrentWeekCostConsumptionDelivered*
- 20801 • *CurrentWeekCostConsumptionReceived*
- 20802 • *PreviousWeekNCostConsumptionDelivered*
- 20803 • *PreviousWeekNCostConsumptionReceived*
- 20804 • *CurrentMonthCostConsumptionDelivered*
- 20805 • *CurrentMonthCostConsumptionReceived*
- 20806 • *PreviousMonthNCostConsumptionDelivered*
- 20807 • *PreviousMonthNCostConsumptionReceived*

20808 **10.8.2.2.6.5 CurrentDayCostConsumptionDelivered Attribute**

20809 *CurrentDayCostConsumptionDelivered* represents the summed value of Energy, Gas, or Water delivered to  
 20810 the premises since the HFT. If optionally provided, *CurrentDayCostConsumptionDelivered* is updated con-  
 20811 tinuously as new measurements are made. If the optional *Historical Freeze Time* attribute is not available,  
 20812 default to midnight local time.

20813 **10.8.2.2.6.6 CurrentDayCostConsumptionReceived Attribute**

20814 *CurrentDayCostConsumptionReceived* represents the summed value of Energy, Gas, or Water received from  
20815 the premises since the HFT. If optionally provided, *CurrentDayCostConsumptionReceived* is updated con-  
20816 tinuously as new measurements are made. If the optional *Historical Freeze Time* attribute is not available,  
20817 default to midnight local time.

#### 20818 **10.8.2.2.6.7 PreviousDayNCostConsumptionDelivered Attribute**

20819 *PreviousDayNCostConsumptionDelivered* represents the summed value of Energy, Gas, or Water delivered  
20820 to the premises within the previous 24 hour period starting at the HFT. If the optional *Historical Freeze Time*  
20821 attribute is not available, default to midnight local time.

#### 20822 **10.8.2.2.6.8 PreviousDayNCostConsumptionReceived Attribute**

20823 *PreviousDayNCostConsumptionReceived* represents the summed value of Energy, Gas, or Water received  
20824 from the premises within the previous 24 hour period starting at the HFT. If the optional *Historical Freeze*  
20825 *Time* attribute is not available, default to midnight local time.

#### 20826 **10.8.2.2.6.9 CurrentWeekCostConsumptionDelivered Attribute**

20827 *CurrentWeekCostConsumptionDelivered* represents the summed value of Energy, Gas, or Water delivered  
20828 to the premises since the HFT on Monday to the last HFT read. If optionally provided, *CurrentWeekCost-*  
20829 *ConsumptionDelivered* is updated continuously as new measurements are made. If the optional *Historical*  
20830 *Freeze Time* attribute is not available, default to midnight local time.

#### 20831 **10.8.2.2.6.10 CurrentWeekCostConsumptionReceived Attribute**

20832 *CurrentWeekCostConsumptionReceived* represents the summed value of Energy, Gas, or Water received  
20833 from the premises since the HFT on Monday to the last HFT read. If optionally provided, *CurrentWeekCost-*  
20834 *ConsumptionReceived* is updated continuously as new measurements are made. If the optional *Historical*  
20835 *Freeze Time* attribute is not available, default to midnight local time.

#### 20836 **10.8.2.2.6.11 PreviousWeekNCostConsumptionDelivered Attribute**

20837 *PreviousWeekNCostConsumptionDelivered* represents the summed value of Energy, Gas, or Water delivered  
20838 to the premises within the previous week period starting at the HFT on the Monday to the Sunday. If the  
20839 optional *Historical Freeze Time* attribute is not available, default to midnight local time.

#### 20840 **10.8.2.2.6.12 PreviousWeekNCostConsumptionReceived Attribute**

20841 *PreviousWeekNCostConsumptionReceived* represents the summed value of Energy, Gas, or Water received  
20842 from the premises within the previous week period starting at the HFT on the Monday to the Sunday. If the  
20843 optional *Historical Freeze Time* attribute is not available, default to midnight local time.

#### 20844 **10.8.2.2.6.13 CurrentMonthCostConsumptionDelivered Attribute**

20845 *CurrentMonthCostConsumptionDelivered* represents the summed value of Energy, Gas, or Water delivered  
20846 to the premises since the HFT on the 1<sup>st</sup> of the month to the last HFT read. If optionally provided, *Current-*  
20847 *MonthCostConsumptionDelivered* is updated continuously as new measurements are made. If the optional  
20848 *Historical Freeze Time* attribute is not available, default to midnight local time.

#### 20849 **10.8.2.2.6.14 CurrentMonthCostConsumptionReceived Attribute**

20850 *CurrentMonthCostConsumptionReceived* represents the summed value of Energy, Gas, or Water received  
20851 from the premises since the HFT on the 1<sup>st</sup> of the month to the last HFT read. If optionally provided, *Cur-*  
20852 *rentMonthCostConsumptionReceived* is updated continuously as new measurements are made. If the optional  
20853 *Historical Freeze Time* attribute is not available, default to midnight local time.

#### 20854 **10.8.2.2.6.15 PreviousMonthNCostConsumptionDelivered Attribute**

20855 *PreviousMonthNCostConsumptionDelivered* represents the summed value of Energy, Gas, or Water deliv-  
20856 ered to the premises within the previous Month period starting at the HFT on the 1<sup>st</sup> of the month to the last

20857 day of the month. If the optional *Historical Freeze Time* attribute is not available, default to midnight local  
20858 time.

20859 **10.8.2.2.6.16 PreviousMonthNCostConsumptionReceived Attribute**

20860 *PreviousMonthNCostConsumptionReceived* represents the summed value of Energy, Gas, or Water received  
20861 from the premises within the previous month period starting at the HFT on the 1<sup>st</sup> of the month to the last day  
20862 of the month. If the optional *Historical Freeze Time* attribute is not available, default to midnight local time.

20863 **10.8.2.2.6.17 HistoricalFreezeTime Attribute**

20864 *HistoricalFreezeTime* represents the time of day, in Local Time, when Historical Cost Consumption attrib-  
20865 utes are captured. *HistoricalFreezeTime* is an unsigned 16-bit value representing the hour and minutes for  
20866 HFT. The byte usages are:

20867 **Bits 0 to 7:** Range of 0 to 0x3B representing the number of minutes past the top of the hour.

20868 **Bits 8 to 15:** Range of 0 to 0x17 representing the hour of the day (in 24-hour format).

20869

20870 **10.8.2.3 Commands Received**

20871 Table 10-161 lists cluster-specific commands that are received by the server.

20872

**Table 10-161. Cluster -specific Commands Received by the Server**

Command Identifier Field Value	Description	M
0x00	<i>Select Available Emergency Credit</i>	O
0x02	<i>Change Debt</i>	O
0x03	<i>Emergency Credit Setup</i>	O
0x04	<i>Consumer Top Up</i>	O
0x05	<i>Credit Adjustment</i>	O
0x06	<i>Change Payment Mode</i>	O
0x07	<i>Get Prepay Snapshot</i>	O
0x08	<i>Get Top Up Log</i>	O
0x09	<i>Set Low Credit Warning Level</i>	O
0x0A	<i>Get Debt Repayment Log</i>	O
0x0B	<i>Set Maximum Credit Limit</i>	O
0x0C	<i>Set Overall Debt Cap</i>	O

20873

20874 **10.8.2.3.1 Select Available Emergency Credit Command**

20875 This command is sent to the Metering Device to activate the use of any Emergency  
20876 Credit available on the Metering Device.

20877 **10.8.2.3.1.1 Payload Format**



20878

**Figure 10-134. Format of the *Select Available Emergency Credit* Command Payload**

<b>Octets</b>	<b>4</b>	<b>1</b>
<b>Data Type</b>	UTC	enum8
<b>Field Name</b>	Command Issue Date/ Time (M)	Originating Device (M)

20879 **10.8.2.3.1.2 Payload Details**

20880 **Command Issue Date/Time (mandatory):** A UTC field to indicate the date and time at which the selection  
 20881 command was issued.

20882 **Originating Device (mandatory):** An 8-bit enumeration field identifying the SE device issuing the selec-  
 20883 tion command, using the lower byte of the Device ID defined in [Z9], and summarized in  
 20884 Table 10-162.

20885

**Table 10-162. Originating Device Field Enumerations**

Enumerated Value	Device
0x00	Energy Service Interface
0x01	Meter
0x02	In-Home Display Device

20886 **10.8.2.3.1.3 Effect on Receipt**

20887 A Mirroring device receiving this command shall return a Default Response with a status code of NOTIFI-  
 20888 CATION\_PENDING. If the command buffer on the mirror is already full, the mirror shall instead return a  
 20889 Default Response to the initiating device with a status code of INSUFFICIENT\_SPACE. The Mirroring de-  
 20890 vice may timeout the buffered message, in which case it shall return a Default Response with a status code  
 20891 of TIMEOUT (see 10.4.4.4.3 for further details).  
 20892

20893 **10.8.2.3.2 Change Supply Command**

20894 The *Change Supply* command has been moved to the Metering cluster (see 10.4 for further details).  
 20895

20896 **10.8.2.3.3 Change Debt Command**

20897 The *ChangeDebt* command is sent to the Metering Device to change the debt values.

20898 **10.8.2.3.3.1 Payload Format**

20899

**Figure 10-135. Format of the *Change Debt* Command Payload**

<b>Octets</b>	<b>4</b>	<b>1-13</b>	<b>4</b>	<b>1</b>	<b>1</b>	<b>4</b>	<b>2</b>
<b>Data Type</b>	uint32	octstr	int32	enum8	enum8	UTC	uint16
<b>Field Name</b>	Issuer Event ID (M)	Debt Label (M)	Debt Amount (M)	Debt Recovery Method (M)	Debt Amount Type (M)	Debt Recovery Start Time (M)	Debt Recovery Collection Time (M)

20900

<b>1</b>	<b>4</b>	<b>2</b>
----------	----------	----------

enum8	int32	uint16
Debt Recovery Frequency (M)	Debt Recovery Amount (M)	Debt Recovery Balance Percentage (M)

20901 **10.8.2.3.3.2 Payload Details**

20902 **Issuer Event Id (mandatory):** Unique identifier generated by the commodity provider. When new information is provided that replaces older information for the same time period, this field allows devices to determine which information is newer. The value contained in this field is a unique number managed by upstream servers or a UTC based time stamp (UTC data type) identifying when the command was issued.  
20905 Thus, newer information will have a value in the *Issuer Event ID* field that is larger than older information.  
20906

20907 **DebtLabel (mandatory):** The format and use of this field is the same as for the *DebtLabel#N* attribute as defined in 10.8.2.2.3.1. A value of 0xFF in the first Octet (length) shall indicate that the value of this parameter shall remain unchanged on the Metering device following receipt of this command.  
20908  
20909

20910 **DebtAmount (mandatory):** The format and use of this field is the same as for the *DebtAmount#N* attribute as defined in 10.8.2.2.3.2. A *DebtAmount* of 0xFFFFFFFF shall indicate that the value of this parameter shall remain unchanged on the Metering device following receipt of this command.  
20911  
20912

20913 **DebtRecoveryMethod (mandatory):** The format and use of this field is the same as for the *DebtRecoveryMethod#N* attribute as defined in 10.8.2.2.3.3. A *DebtRecoveryMethod* of 0xFF shall indicate that the value of this parameter shall remain unchanged on the Metering device following receipt of this command.  
20914  
20915

20916 **DebtAmountType (mandatory):** An 8-bit enumeration field identifying the type of debt information to be issued within this command. The Types are detailed in Table 10-163 below:  
20917

20918 **Table 10-163. Debt Amount Type Field Enumerations**

Enumerated Value	Debt Type
0x00	Type 1 Absolute
0x01	Type 1 Incremental
0x02	Type 2 Absolute
0x03	Type 2 Incremental
0x04	Type 3 Absolute
0x05	Type 3 Incremental

20919  
20920 **DebtRecoveryStartTime (mandatory):** The format and use of this field is the same as for the *DebtRecoveryStartTime#N* attribute as defined in 10.8.2.2.3.4. A *DebtRecoveryStartTime* of 0xFFFFFFFF shall indicate that the value of this parameter shall remain unchanged on the Metering device following receipt of this command.  
20921  
20922  
20923

20924 **DebtRecoveryCollectionTime (mandatory):** The format and use of this field is the same as for the *DebtRecoveryCollectionTime#N* attribute as defined in 10.8.2.2.3.5. A *DebtRecoveryCollectionTime* of 0xFFFF shall indicate that the value of this parameter shall remain unchanged on the Metering device following receipt of this command.  
20925  
20926  
20927

20928 **DebtRecoveryFrequency (mandatory):** The format and use of this field is the same as for the *DebtRecoveryFrequency#N* attribute as defined in 10.8.2.2.3.6. A *DebtRecoveryFrequency* of 0xFF shall indicate that the value of this parameter shall remain unchanged on the Metering device following receipt of this command. Note that the value of this field is unused when the *DebtRecoveryMethod* is set to *Percentage Based*.  
20929  
20930  
20931

20932 **DebtRecoveryAmount (mandatory):** The format and use of this field is the same as for the *DebtRecoveryAmount#N* attribute as defined in 10.8.2.2.3.7. A *DebtRecoveryAmount* of 0xFFFFFFFF shall indicate that the value of this parameter shall remain unchanged on the Metering device following receipt of this command.

20936 **DebtRecoveryBalancePercentage (mandatory):** The format and use of this field is the same as for the *DebtRecoveryTopUpPercentage#N* attribute as defined in 10.8.2.2.3.8. A *DebtRecoveryBalancePercentage* of 0xFFFF shall indicate that the value of this parameter shall remain unchanged on the Metering device following receipt of this command.

20940 **10.8.2.3.3.3 When Generated**

20941 This command is generated when there is a change to the debt, which the Head End System requires to be sent down to the meter.

20944 **10.8.2.3.4 Emergency Credit Setup Command**

20945 This command provides a method to set up the parameters for the Emergency Credit.

20946 **10.8.2.3.4.1 Payload Format**

20947 **Figure 10-136. Format of the *Emergency Credit Setup Command* Payload**

<b>Octets</b>	<b>4</b>	<b>4</b>	<b>4</b>	<b>4</b>
<b>Data Type</b>	uint32	UTC	uint32	uint32
<b>Field Name</b>	Issuer Event ID (M)	Start Time (M)	Emergency Credit Limit (M)	Emergency Credit Threshold (M)

20948 **10.8.2.3.4.2 Payload Details**

20949 **Issuer Event ID (mandatory):** Unique identifier generated by the commodity provider. When new information is provided that replaces older information for the same time period, this field allows devices to determine which information is newer. The value contained in this field is a unique number managed by upstream servers or a UTC based time stamp (UTC data type) identifying when the command was issued. Thus, newer information will have a value in the *Issuer Event ID* field that is larger than older information.

20954 **Start Time (mandatory):** A UTC field to denote the time at which the Emergency Credit settings become valid. A start date/time of 0x00000000 shall indicate that the command should be executed immediately. A start date/time of 0xFFFFFFFF shall cause an existing but pending *Emergency Credit Setup* command with the same *Issuer Event ID* to be cancelled.

20958 **Emergency Credit Limit (allowance) (mandatory):** An unsigned 32-bit field to denote the Emergency Credit limit on the Metering Device, measured in base unit of *Currency* (as per the Price cluster) or in Units (as per the Metering cluster) with the decimal point located as indicated by the *TrailingDigits* field, as defined in the Price cluster. When no Emergency Credit has been used, this is the value defined within the *EmergencyCreditRemaining* attribute (10.8.2.2.1.3).

20963 **Emergency Credit Threshold (mandatory):** An unsigned 32-bit field to denote the amount of credit remaining on the Metering Device below which the Emergency Credit facility can be selected. The value is measured in base unit of *Currency* (as per the Price cluster) or in Units (as per the Metering cluster) with the decimal point located as indicated by the *TrailingDigits* field, as defined in the Price cluster.

20967 **10.8.2.3.4.3 When Generated**

20968 The *Emergency Credit Setup* command is used when the Head End System has a requirement to change the Prepayment configuration on the meter.

20971 **10.8.2.3.5 Consumer Top Up Command**

20972 The *Consumer Top Up* command is used by the IHD and the ESI as a method to apply credit top up values  
20973 to a prepayment meter.

20974 **10.8.2.3.5.1 Payload Format**

20975 **Figure 10-137. Format of the *Consumer Top Up* Command Payload**

<b>Octets</b>	<b>1</b>	<b>1-26</b>
<b>Data Type</b>	enum8	octstr
<b>Field Name</b>	Originating Device (M)	TopUp Code (M)

20976 **10.8.2.3.5.2 Payload Details**

20977 **Originating Device (mandatory):** An 8 bit enumeration field identifying the Smart Energy device issuing  
20978 the selection command, as defined in Table 10-162.

20979 **Top Up Code (mandatory):** An octet string of between 1 and 26 characters (the first character indicates  
20980 the string length).

20981 **10.8.2.3.5.3 When Generated**

20982 The *Consumer Top Up* command shall be generated when a new Top-up amount of credit has been pur-  
20983 chased from the energy supplier and is required to be sent to the Meter. Alternatively, the command can be  
20984 used to transfer an instruction such as to connect or disconnect the supply, enable a particular display se-  
20985 quence, or other action via an appropriate *Top Up* (UTRN) *Code*.

20986 **10.8.2.3.5.4 Effect on Receipt**

20987 The meter shall update the *Top Up Date/Time#1*, *Top Up Amount#1* and the *Originating Device#1* attrib-  
20988 utes on the valid processing of this command. It shall then send the *ConsumerTopUpResponse* command to  
20989 all devices bound to the cluster.

20990 A Mirroring device receiving this command shall return a Default Response with a status code of NOTIFI-  
20991 CATION\_PENDING. If the command buffer on the mirror is already full, the mirror shall instead return a  
20992 Default Response to the initiating device with a status code of INSUFFICIENT\_SPACE. The Mirroring  
20993 device may timeout the buffered message, in which case it shall return a Default Response with a status  
20994 code of TIMEOUT (see 10.4.4.4.3 for further details).  
20995

20996 **10.8.2.3.6 Credit Adjustment Command**

20997 The *Credit Adjustment* command is sent to update the *Credit Remaining* attribute on a Prepayment meter. It  
20998 shall only be sent from an ESI to the Meter.

20999 **10.8.2.3.6.1 Payload Format**

21000 **Figure 10-138. Format of the *Credit Adjustment* Command Payload**

<b>Octets</b>	<b>4</b>	<b>4</b>	<b>1</b>	<b>4</b>
<b>Data Type</b>	uint32	UTC	enum8	int32
<b>Field Name</b>	Issuer Event ID (M)	Start Time (M)	Credit Adjustment Type (M)	Credit Adjustment Value (M)

21001 **10.8.2.3.6.2 Payload Details**

21002 **Issuer Event ID (mandatory):** Unique identifier generated by the commodity provider. When new information is provided that replaces older information for the same time period, this field allows devices to determine which information is newer. The value contained in this field is a unique number managed by upstream servers or a UTC based time stamp (UTC data type) identifying when the command was issued.  
 21003  
 21004  
 21005  
 21006 Thus, newer information will have a value in the *Issuer Event ID* field that is larger than older information.

21007 **Start Time (mandatory):** A UTC field to denote the time at which the credit adjustment settings become valid. A start date/time of 0x00000000 shall indicate that the command should be executed immediately. A start date/time of 0xFFFFFFFF shall cause an existing but pending *Credit Adjustment* command with the same *Issuer Event ID* to be cancelled.  
 21008  
 21009  
 21010

21011 **Credit Adjustment Type (mandatory):** An 8-bit enumeration field identifying the type of credit adjustment to be issued out within this command. The Types are detailed within Table 10-164 below.  
 21012

21013

**Table 10-164. Credit Type Field Enumerations**

Enumerated Value	Credit Type
0x00	Credit Incremental
0x01	Credit Absolute

21014 **Credit Adjustment Value (mandatory):** A signed 32-bit field to denote the value of the credit adjustment, measured in base unit of *Currency* (as per the Price cluster) or in *Units* (as per the Metering cluster) with the decimal point located as indicated by the *TrailingDigits* field, as defined in the Price cluster. This can be a positive or negative value.  
 21015  
 21016  
 21017

21018 **10.8.2.3.6.3 When Generated**

21019 The *Credit Adjustment* command shall be sent to the meter when the ESI has a new credit adjustment value for the meter.  
 21020

21021 **10.8.2.3.6.4 Effect on Receipt**

21022 The *Credit Adjustment Value* shall be used to update the *Credit Remaining* attribute to the correct value.  
 21023

21024 **10.8.2.3.7 Change Payment Mode Command**

21025 This command is sent to a Metering Device to instruct it to change its mode of operation, e.g. from Credit to Prepayment.  
 21026

21027 **10.8.2.3.7.1 Payload Format**

21028

**Figure 10-139. Format of the Change Payment Mode Command Payload**

Octets	4	4	4	2	4
<b>Data Type</b>	uint32	uint32	UTC	map16	int32
<b>Field Name</b>	Provider ID (M)	Issuer Event ID (M)	Implementation Date/Time (M)	Proposed Payment Control Configuration (M)	Cut Off Value (M)

21029 **10.8.2.3.7.2 Payload Details**

21030 **Provider ID (mandatory):** An unsigned 32 bit field containing a unique identifier for the commodity supplier to whom this command relates.  
 21031

21032 **Issuer Event ID (mandatory):** Unique identifier generated by the commodity provider. When new infor-  
21033 mation is provided that replaces older information for the same time period, this field allows devices to de-  
21034 termine which information is newer. The value contained in this field is a unique number managed by up-  
21035 stream servers or a UTC based time stamp (UTC data type) identifying when the command was issued.  
21036 Thus, newer information will have a value in the *Issuer Event ID* field that is larger than older information.

21037 **Implementation Date/Time (mandatory):** A UTC field to indicate the date from which the payment  
21038 mode change is to be applied. An *Implementation Date/Time* value of 0x00000000 shall indicate that the  
21039 command should be executed immediately. An *Implementation Date/Time* value of 0xFFFFFFFF shall  
21040 cause an existing but pending *Change Payment Mode* command with the same *Provider ID* and *Issuer*  
21041 *Event ID* to be cancelled.

21042 **Proposed Payment Control Configuration (mandatory):** An 16-bit BitMap indicating the actions re-  
21043 quired in relation to switching the payment mode. Bit encoding of this field is outlined in Table 10-146.

21044 **Cut off Value (mandatory):** The format and use of this field is the same as for the *CutOffValue* attribute  
21045 as defined in 10.8.2.2.1.19. A *CutOffValue* of 0xFFFFFFFF shall indicate that the value of this parameter  
21046 shall remain unchanged on the Metering device following receipt of this command.

#### 21047 **10.8.2.3.7.3 When Generated**

21048 The *Change Payment Mode* command shall be sent from the Energy Supplier, via the ESI, only when the  
21049 need to change the mode of the meter arises.

#### 21050 **10.8.2.3.7.4 Effect on Receipt**

21051 On receipt of the *ChangePaymentMode* command, the meter shall send the *ChangePaymentModeResponse*.  
21052 The meter should create all snapshots required before the mode is changed and transmit these to the ESI. It  
21053 should then also create all required snapshots and request valid Price, TOU and Prepayment information  
21054 (refer to sections 10.4.2.3.1.7 and 10.8.2.4.2 for further details).  
21055

### 21056 **10.8.2.3.8 Get Prepay Snapshot Command**

21057 This command is used to request the cluster server for snapshot data.

#### 21058 **10.8.2.3.8.1 Payload Format**

21059 **Figure 10-140. Format of the *Get Prepay Snapshot Command* Payload**

<b>Octets</b>	<b>4</b>	<b>4</b>	<b>1</b>	<b>4</b>
<b>Data Type</b>	UTC	UTC	uint8	map32
<b>Field Name</b>	Earliest Start Time (M)	Latest End Time (M)	Snapshot Offset (M)	Snapshot Cause (M)

#### 21060 **10.8.2.3.8.2 Payload Details**

21061 **Earliest Start Time (mandatory):** A UTC Timestamp indicating the earliest time of a snapshot to be re-  
21062 turned by a corresponding *Publish Prepay Snapshot* command. Snapshots with a time stamp equal to or  
21063 greater than the specified *Earliest Start Time* shall be returned.

21064 **Latest End Time (mandatory):** A UTC Timestamp indicating the latest time of a snapshot to be returned  
21065 by a corresponding *Publish Prepay Snapshot* command. Snapshots with a time stamp less than the speci-  
21066 fied *Latest End Time* shall be returned.

21067 **Snapshot Offset (mandatory):** Where multiple snapshots satisfy the selection criteria specified by the  
21068 other fields in this command, this field identifies the individual snapshot to be returned. An offset of zero

21069 (0x00) indicates that the first snapshot satisfying the selection criteria should be returned, 0x01 the second,  
 21070 and so on.

21071 **Snapshot Cause (mandatory):** This field is used to request only snapshots for a specific cause. The allow-  
 21072 able values are listed in Table 10-167. Setting the type to 0xFFFFFFFF indicates that all snapshots should  
 21073 be transmitted, irrespective of the cause.

21074 **10.8.2.3.8.3 Effect on Receipt**

21075 On receipt of this command, the server will respond with the appropriate data as detailed in sub-clause  
 21076 10.8.2.4.2.

21077 A Default Response with status NOT\_FOUND shall be returned if the server does not have a snapshot  
 21078 which satisfies the received parameters (e.g. no snapshot with a timestamp between the *Earliest Start Time*  
 21079 and the *Latest End Time*).  
 21080

21081 **10.8.2.3.9 Get Top Up Log**

21082 This command is sent to the Metering Device to retrieve the log of Top Up codes received by the meter.

21083 **10.8.2.3.9.1 Payload Format**

21084 **Figure 10-141. Format of the Get Top Up Log Command Payload**

<b>Octets</b>	<b>4</b>	<b>1</b>
<b>Data Type</b>	UTC	uint8
<b>Field Name</b>	Latest EndTime (M)	Number of Rec-ords(M)

21085 **10.8.2.3.9.2 Payload Details**

21086 **Latest End Time (mandatory):** UTC timestamp indicating the latest *TopUp Time* of Top Up rec-  
 21087 ords to be returned by the corresponding *Publish Top Up Log* commands. The first returned  
 21088 Top Up record shall be the most recent record with its *TopUp Time* equal to or older than the *Latest*  
 21089 *End Time* provided.

21090 **Number of Records (mandatory):** An 8-bit integer which represents the maximum number of records that  
 21091 the client is willing to receive in response to this command. A value of 0 would indicate all available rec-  
 21092 ords shall be returned. The first returned Top Up record shall be the most recent one in the log.

21093 **10.8.2.3.9.3 Effect on Receipt**

21094 On receipt of this command, the server will respond with *Publish Top Up Log* commands satisfying the  
 21095 specified criteria, as detailed in sub-clause 10.8.2.4.5.

21096 A Default Response with status NOT\_FOUND shall be returned if the server does not have any Top Up  
 21097 records which satisfy the received parameters (e.g. *TopUp Time* later than the *Latest End Time* pro-  
 21098 vided).  
 21099

21100 **10.8.2.3.10 Set Low Credit Warning Level**

21101 This command is sent from client to a Prepayment server to set the warning level for low credit.

21102 **10.8.2.3.10.1 Payload Format**

21103

**Figure 10-142. Format of the *Set Low Credit Warning Level Command Payload***

<b>Octets</b>	<b>4</b>
<b>Data Type</b>	uint32
<b>Field Name</b>	Low Credit Warning Level (M)

21104 **10.8.2.3.10.2 Payload Details**

21105 **Low Credit Warning Level (mandatory):** An unsigned 32 bit integer that defines the consumer Low  
 21106 Credit value, in base unit of *Currency* (as per the Price cluster) or in Units (as per the Metering cluster), be-  
 21107 low which Low Credit warning should sound. The Low Credit warning shall be triggered when the credit  
 21108 remaining on the meter falls below the value of the *Low Credit Warning Level* above the disconnection  
 21109 point; this shall trigger the Low Credit Warning alert within this cluster.  
 21110

21111 **10.8.2.3.11 Get Debt Repayment Log Command**

21112 This command is used to request the contents of the Repayment log.

21113 **10.8.2.3.11.1 Payload Format**

21114

**Figure 10-143. Format of the *GetDebtRepaymentLog Command Payload***

<b>Octets</b>	<b>4</b>	<b>1</b>	<b>1</b>
<b>Data Type</b>	UTC	uint8	enum8 <sup>210</sup>
<b>Field Name</b>	Latest EndTime (M)	Number of Debts (M)	Debt Type

21115 **10.8.2.3.11.2 Payload Details**

21116 **Latest End Time (mandatory):** UTC timestamp indicating the latest *Collection Time* of debt repayment  
 21117 records to be returned by the corresponding *Publish Debt Log* commands. The first returned debt repayment  
 21118 record shall be the most recent record with its *Collection Time* equal to or older than the *Latest End Time*  
 21119 provided.

21120 **Number of Debts (mandatory):** An 8-bit integer which represents the maximum number of debt repayment  
 21121 records that the client is willing to receive in response to this command. A value of 0 would indicate all  
 21122 available records shall be returned. The first returned debt repayment record shall be the most recent one in  
 21123 the log.

21124 **Debt Type (mandatory):** An 8-bit enumeration field identifying the type of debt record(s) to be returned:

21125

**Table 10-165. Debt Type Field Enumerations**

<b>Enumerated Value</b>	<b>Debt Type</b>
0x00	Debt 1
0x01	Debt 2
0x02	Debt 3
0xFF	All Debts

21126 **10.8.2.3.11.3 Effect on Receipt**

<sup>210</sup> CCB 2052



21127 On receipt of this command, the server will respond with *Publish Debt Log* commands satisfying the spec-  
 21128 ified criteria, as detailed in sub-clause 10.8.2.4.6.

21129 A Default Response with status NOT\_FOUND shall be returned if the server does not have any debt rec-  
 21130 ords which satisfy the received parameters (e.g. *Collection Time* later than the *Latest End Time* pro-  
 21131 vided).  
 21132

21133 **10.8.2.3.12 Set Maximum Credit Limit**

21134 This command is sent from a client to the Prepayment server to set the maximum credit level allowed in the  
 21135 meter.

21136 **10.8.2.3.12.1 Payload Format**

21137 **Figure 10-144. Format of the Set Maximum Credit Level Command Payload**

<b>Oc- tets</b>	<b>4</b>	<b>4</b>	<b>4</b>	<b>4</b>	<b>4</b>
<b>Data Type</b>	uint32	uint32	UTC	uint32	uint32
<b>Field Name</b>	Provider ID (M)	Issuer Event ID (M)	Implementa- tion Date/Time (M)	Maximum Credit Level (M)	Maximum Credit Per Top Up (M)

21138 **10.8.2.3.12.2 Payload Details**

21139 **Provider ID (mandatory):** An unsigned 32 bit field containing a unique identifier for the commodity sup-  
 21140 plier to whom this command relates.

21141 **Issuer Event ID (mandatory):** Unique identifier generated by the commodity provider. When new infor-  
 21142 mation is provided that replaces older information for the same time period, this field allows devices to de-  
 21143 termine which information is newer. The value contained in this field is a unique number managed by up-  
 21144 stream servers or a UTC based time stamp (UTC data type) identifying when the command was issued.  
 21145 Thus, newer information will have a value in the *Issuer Event ID* field that is larger than older information.

21146 **Implementation Date/Time (mandatory):** A UTC field to indicate the date from which the maximum  
 21147 credit level is to be applied. An *Implementation Date/Time* of 0x00000000 shall indicate that the command  
 21148 should be executed immediately. An *Implementation Date/Time* of 0xFFFFFFFF shall cause an existing but  
 21149 pending *Set Maximum Credit Limit* command with the same *Provider ID* and *Issuer Event ID* to be can-  
 21150 celled.

21151 **Maximum Credit Level (mandatory):** An unsigned 32 bit integer value indicating the maximum credit  
 21152 balance allowed on a meter. Any further top-up amount that will cause the meter to exceed this limit will be  
 21153 rejected. This value can be stated in currency (as per the Price cluster) or in units (unit of measure will be  
 21154 defined in the Metering cluster) depending on the Prepayment mode of operation defined in section  
 21155 10.8.2.2.1.1 (*Payment Control Configuration* attribute). A value of 0xFFFFFFFF will indicate that this  
 21156 limit is to be disabled and that all further top-ups should be permitted.

21157 **MaximumCreditPerTopUp (mandatory):** An unsigned 32-bit integer value indicating the maximum  
 21158 credit per top-up. Any single top-up greater than this threshold will cause the meter to reject the top-up.  
 21159 This value can be stated in currency (as per the Price cluster) or in units (unit of measure will be defined in  
 21160 the Metering cluster) depending on the Prepayment mode of operation defined in section 10.8.2.2.1.1 (*Pay-  
 21161 ment Control Configuration* attribute). A value of 0xFFFFFFFF will indicate that this parameter is to be  
 21162 disabled and that there should be no limit on the amount of credit allowed in a top-up.  
 21163

21164 **10.8.2.3.13 Set Overall Debt Cap**

21165 This command is sent from a client to the Prepayment server to set the overall debt cap allowed in the me-  
21166 ter.

21167 **10.8.2.3.13.1 Payload Format**

21168 **Figure 10-145. Format of the Set Overall Debt Cap Command Payload**

<b>Octets</b>	<b>4</b>	<b>4</b>	<b>4</b>	<b>4</b>
<b>Data Type</b>	uint32	uint32	UTC	int32
<b>Field Name</b>	Provider ID (M)	Issuer Event ID (M)	Implementation Date/Time (M)	Overall Debt Cap

21169 **10.8.2.3.13.2 Payload Details**

21170 **Provider ID (mandatory):** An unsigned 32 bit field containing a unique identifier for the commodity sup-  
21171 plier to whom this command relates.

21172 **Issuer Event ID (mandatory):** Unique identifier generated by the commodity provider. When new infor-  
21173 mation is provided that replaces older information for the same time period, this field allows devices to de-  
21174 termine which information is newer. The value contained in this field is a unique number managed by up-  
21175 stream servers or a UTC based time stamp (UTC data type) identifying when the command was issued.  
21176 Thus, newer information will have a value in the *Issuer Event ID* field that is larger than older information.

21177 **Implementation Date/Time (mandatory):** A UTC field to indicate the date from which the overall debt  
21178 cap is to be applied. An *Implementation Date/Time* of 0x00000000 shall indicate that the command should  
21179 be executed immediately. An *Implementation Date/Time* of 0xFFFFFFFF shall cause an existing but pend-  
21180 ing *Set Overall Debt Cap* command with the same *Provider ID* and *Issuer Event ID* to be cancelled.

21181 **Overall Debt Cap :** A signed 32 bit integer that defines the total amount of debt that can be taken from  
21182 top-ups (in the case of multiple instantiated top-up based debts on the Metering Device) (see 10.8.2.2.1.7).  
21183 This field is always a monetary value, and as such the field is measured in a base unit of *Currency* with the  
21184 decimal point located as indicated by the *Trailing Digits* field, as defined in the Price cluster.

21185

21186 **10.8.2.4 Commands Generated**

21187 Table 10-166 lists commands that are generated by the server.

21188 **Table 10-166. Cluster -specific Commands Sent by the Server**

<b>Command Identifier Field Value</b>	<b>Description</b>	<b>Mandatory/ Optional</b>
0x00	<i>Reserved</i>	O
0x01	<i>Publish Prepay Snapshot</i>	O
0x02	<i>Change Payment Mode Response</i>	O
0x03	<i>Consumer Top Up Response</i>	O
0x05	<i>Publish Top Up Log</i>	O
0x06	<i>Publish Debt Log</i>	O

21189

21190 **10.8.2.4.1 Supply Status Response Command**

21191 The *Supply Status Response* command has been moved to the Metering cluster (see 10.4 for further details).  
 21192

21193 **10.8.2.4.2 Publish Prepay Snapshot Command**

21194 This command is generated in response to a *GetPrepaySnapshot* command or when a new snapshot is cre-  
 21195 ated. It is used to return a single snapshot to the client.

21196 **10.8.2.4.2.1 Payload Format**

Figure 10-146. Format of the *Publish Prepay Snapshot Command* Payload

<b>Oc- tets</b>	<b>4</b>	<b>4</b>	<b>1</b>	<b>1</b>	<b>1</b>	<b>4</b>	<b>1</b>	<b>Varia- ble</b>
<b>Data Type</b>	uint32	UTC	uint8	uint8	uint8	map32	enum8	Variable
<b>Field Name</b>	Snap- shot ID (M)	Snap- shot Time (M)	Total Snap- shots Found (M)	Com- mand In- dex (M)	Total Number of Com- mands (M)	Snap- shot Cause (M)	Snap- shot Payload Type (M)	Snap- shot Payload (M)

21198 **10.8.2.4.2.2 Payload Details**

21199 **Snapshot ID (mandatory):** Unique identifier allocated by the device creating the snapshot.

21200 **Snapshot Time (mandatory):** This is a 32 bit value (in UTC) representing the time at which the data snap-  
 21201 shot was taken.

21202 **Total Snapshots Found (mandatory):** An 8-bit Integer indicating the number of snapshots found, based  
 21203 on the search criteria defined in the associated *GetPrepaySnapshot* command. If the value is greater than 1,  
 21204 the client is able to request the next snapshot by incrementing the *Snapshot Offset* field in an otherwise re-  
 21205 peated *GetPrepaySnapshot* command.

21206 **Command Index (mandatory):** The *Command Index* is uses to count the payload fragments in the case  
 21207 where the entire payload does not fit into one message. The *Command Index* starts at 0 and is incremented  
 21208 for each fragment belonging to the same command.

21209 **Total Number of Commands (mandatory):** In the case where the entire payload does not fit into one mes-  
 21210 sage, the *Total Number of Commands* field indicates the total number of sub-commands in the message.

21211 **Snapshot Cause (mandatory):** A 32-bit BitMap indicating the cause of the snapshot. The snapshot cause  
 21212 values are listed in Table 10-167.

21213

Table 10-167. Snapshot Payload Cause

Bit	Description
0	General
1	End of Billing Period
2	Reserved for Metering cluster
3	Change of Tariff Information
4	Change of Price Matrix
5	Reserved for Metering cluster

6	Reserved for Metering cluster
7	Reserved for Metering cluster
8	Reserved for Metering cluster
9	Reserved for Metering cluster
10	Manually Triggered from Client
11	Reserved for Metering cluster
12	Change of Tenancy
13	Change of Supplier
14	Change of Meter Mode
15	Reserved for Metering cluster
16	Reserved for Metering cluster
17	Reserved for Metering cluster
18	TopUp addition
19	Debt/Credit addition

21214 NOTE: Where applicable, these Prepayment snapshots shall be taken in conjunction with the associated  
21215 snapshots in the Metering cluster.

21216 **SnapshotPayloadType (mandatory):** The *SnapshotPayloadType* is an 8-bit enumerator defining the for-  
21217 mat of the *SnapshotPayload* in this message. The different snapshot types are listed in Table 10-168. The  
21218 server selects the *SnapshotPayloadType* based on the charging scheme in use.

21219 **Table 10-168. Snapshot Payload Type**

Enumeration	Description
0x00	Debt/Credit Status
0xFF	Not used

21220 **SnapshotPayload (mandatory):** the format of the *SnapshotPayload* differs depending on the *Snapshot-*  
21221 *PayloadType*.

21222 **10.8.2.4.2.2.1 SnapshotPayloadType = Debt/Credit Status**

21223 **Figure 10-147. Format of the Debt/Credit Status SnapshotPayloadType**

Octets	4	4	4	4	4	4
Data Type	int32	uint32	uint32	uint32	int32	int32
Field Name	Accumulated Debt (M)	Type 1 Debt Remaining (M)	Type 2 Debt Remaining (M)	Type 3 Debt Remaining (M)	Emergency Credit Remaining (M)	Credit Remaining (M)

21224 **Accumulated Debt (mandatory):** The *AccumulatedDebt* field represents the total amount of debt remain-  
21225 ing on the Metering Device, measured in a base unit of *Currency* with the decimal point located as indi-  
21226 cated by the *Trailing Digits* field, as defined in the Price cluster.

21227 **Type 1 Debt Remaining (mandatory):** The *Type1DebtRemaining* field represents the amount of Type 1  
21228 debt remaining on the Metering Device, measured in base unit of *Currency* with the decimal point located as  
21229 indicated by the *TrailingDigits* field, as defined in the Price cluster.

21230 **Type 2 Debt Remaining (mandatory):** The *Type2DebtRemaining* field represents the amount of Type 2  
 21231 debt remaining on the Metering Device, measured in base unit of *Currency* with the decimal point located as  
 21232 indicated by the *TrailingDigits* field, as defined in the Price cluster.

21233 **Type 3 Debt Remaining (mandatory):** The *Type3DebtRemaining* field represents the amount of Type 3  
 21234 debt remaining on the Metering Device, measured in base unit of *Currency* with the decimal point located as  
 21235 indicated by the *TrailingDigits* field, as defined in the Price cluster.

21236 **Emergency Credit Remaining (mandatory):** The *EmergencyCreditRemaining* field represents the amount  
 21237 of Emergency Credit still available on the Metering Device. If Monetary based, this field is measured in a  
 21238 base unit of *Currency* (as per the Price cluster) or in Units (as per the Metering cluster), with the decimal  
 21239 point located as indicated by the *TrailingDigits* field, as defined in the Price cluster. If Unit based, the unit  
 21240 of measure is as defined in the Metering cluster (see sub-clause 10.4.2.2.4.1).

21241 **Credit Remaining (mandatory):** The *CreditRemaining* field represents the amount of credit remaining on  
 21242 the Metering Device. If Monetary based, this field is measured in a base unit of *Currency* (as per the Price  
 21243 cluster) or in Units (as per the Metering cluster), with the decimal point located as indicated by the *Trailing-*  
 21244 *Digits* field, as defined in the Price cluster. If Unit based, the unit of measure is as defined in the Metering  
 21245 cluster (see sub-clause 10.4.2.2.4.1).  
 21246

### 21247 10.8.2.4.3 Change Payment Mode Response Command

21248 This command is sent in response to the *ChangePaymentMode* command. The *ChangePaymentModeRe-*  
 21249 *sponse* command shall only inform the ESI of the current default setting that would affect the meter when  
 21250 entering into Prepayment/PAYG or Credit mode. Should these values require changing then other commands  
 21251 within the Prepayment & Price cluster should be used.

#### 21252 10.8.2.4.3.1 Payload Format

21253 **Figure 10-148. Format of the Change Payment Mode Response Command Payload**

<b>Octets</b>	<b>1</b>	<b>4</b>	<b>4</b>	<b>4</b>
<b>Data Type</b>	map8	uint32	uint32	uint32
<b>Field Name</b>	Friendly Credit (M)	Friendly Credit Calendar ID (M)	Emergency Credit Limit (M)	Emergency Credit Threshold (M)

#### 21254 10.8.2.4.3.2 Payload Details

21255 **Friendly Credit (mandatory):** An 8-bit BitMap to show if the meter has a Friendly Credit calendar and  
 21256 that this calendar shall be enabled.

21257 **Table 10-169. Friendly Credit BitMap**

<b>Bit</b>	<b>Description</b>
0	Friendly credit enabled

21258 **Friendly Credit Calendar ID (mandatory):** An unsigned 32-bit field to denote the *IssuerCalendarID* that  
 21259 shall be used for the friendly credit periods. The *IssuerCalendarID* can be found within the TOU cluster  
 21260 (see 10.9).

21261 **Emergency Credit Limit/Allowance (mandatory):** An unsigned 32-bit field to denote the emergency  
 21262 credit limit on the Metering Device, measured in base unit of *Currency* with the decimal point located as  
 21263 indicated by the *TrailingDigits* field, as defined in the Price cluster. Should no emergency credit have been  
 21264 used, this is the value defined within the *EmergencyCreditRemaining* attribute (10.8.2.2.1.3).

21265 **Emergency Credit Threshold (mandatory):** An unsigned 32-bit field to denote the amount of credit re-  
 21266 maining on the Metering Device below which the *Emergency Credit* facility can be selected. The value is  
 21267 measured in base unit of *Currency* with the decimal point located as indicated by the *TrailingDigits* field,  
 21268 as defined in the Price cluster.

21269 **10.8.2.4.3.3 When Generated**

21270 The *ChangePaymentModeResponse* command is generated in response to a *ChangePaymentMode* command.  
 21271

21272 **10.8.2.4.4 Consumer Top Up Response Command**

21273 The Metering device responds either with the following values in the case of a credit token received:

- 21274 • Meter’s enumerated status, after receiving the top up, in the *Result Type* field
- 21275 • Received Top up token’s credit value in the *Top Up Value* field
- 21276 • The source of the top up, enumerated in the *Source of Top up* field
- 21277 • The credit remaining on the meter, after the addition of this Top Up, in the *Credit Remaining* field,

21278 OR, in the case of a connect/disconnect Top Up (UTRN) code, with the following:

- 21279 • Supply status, after processing of the token, enumerated in the *Result Type* field
- 21280 • Top up token’s credit value SET TO ZERO in the *Top Up Value* field
- 21281 • The source of the top up, enumerated in the *Source of Top up* field
- 21282 • The credit remaining on the meter, after the addition of this Top Up, in the *Credit Remaining* field

21283 **10.8.2.4.4.1 Payload Format**

21284 **Figure 10-149. Format of the Consumer Top Up Response Command Payload**

Octets	1	4	1	4
Data Type	enum8	int32	enum8	int32
Field Name	Result Type (M)	Top Up Value (M)	Source of Top up (M)	Credit Remaining (M)

21285 **10.8.2.4.4.2 Payload Details**

21286 **Result Type (mandatory):** An 8-bit enumerated value indicating whether the Metering Device accepted or  
 21287 rejected the top up. Enumerated values are described in Table 10-170

21288 **Table 10-170. Result Type Field Enumerations**

Enumerated Value	Result Type Description
0x00	Accepted
0x01	Rejected-Invalid Top Up
0x02	Rejected-Duplicate Top Up
0x03	Rejected-Error
0x04	Rejected-Max Credit Reached
0x05	Rejected-Keypad Lock
0x06	Rejected-Top Up Value Too Large

0x10	Accepted – Supply Enabled
0x11	Accepted – Supply Disabled
0x12	Accepted – Supply Armed

21289 **Top up Value (mandatory):** A signed 32-bit integer field representing the Top Up value available in the  
 21290 top up content. If it is Monetary based, this field is measured in a base unit of *Currency* with the decimal  
 21291 point located as indicated by the *Trailing Digits* field, as defined in the *Price* cluster. If Unit based, the unit  
 21292 of measure is as defined in the *Metering* cluster (see sub-clause 10.4.2.2.4.1). If *Result Type* is other than  
 21293 *Accepted*, this field has a maximum value (0xFFFFFFFF) which indicates an invalid Top Up value.

21294 **Source of Top Up (mandatory):** An 8-bit enumeration indicating the device that has issued the top up (see  
 21295 Table 10-162 for applicable enumerations).

21296 **Credit Remaining (mandatory):** The *Credit Remaining* field represents the amount of credit remaining on  
 21297 the *Metering Device* after addition of a top up. If Monetary based, this field is measured in a base unit of  
 21298 *Currency* with the decimal point located as indicated by the *Trailing Digits* field, as defined in the *Price*  
 21299 cluster. If Unit based, the unit of measure is as defined in the *Metering* cluster (see sub-clause 0). In case of  
 21300 *Result Type* other than *Accepted*, the *Credit Remaining* field has a maximum value (0xFFFFFFFF) repre-  
 21301 senting invalid credit remaining.

21302 **10.8.2.4.4.3 When Generated**

21303 The *ConsumerTopUpResponse* command is generated in response to a *ConsumerTopUp* command.  
 21304

21305 **10.8.2.4.5 Publish Top Up Log Command**

21306 This command is used to send the Top Up Code Log entries to the Prepayment client. The command shall  
 21307 be sent in response to a *Get Top Up Log* command and MAY be sent unsolicited whenever a new Top Up  
 21308 code is received and successfully processed<sup>211</sup>. When the command is being sent the result of a Top Up,  
 21309 the *Top Up Payload* shall contain details for that Top Up only. Where the *Top Up Payload* contains de-  
 21310 tails for more than one log entry, they are sent most recent entry first.

21311 **10.8.2.4.5.1 Payload Format**

21312 **Figure 10-150. Format of the *Publish Top Up Log* Command Payload**

Octets	1	1	Variable
Data Type	uint8	uint8	Variable
Field Name	Command Index (M)	Total Number of Commands (M)	Top Up Payload

21313 **10.8.2.4.5.2 Payload Details**

21314 **Command Index (mandatory):** The *Command Index* is used to count the payload fragments in the case  
 21315 where the entire payload does not fit into one message. The *Command Index* starts at 0 and is incremented  
 21316 for each fragment belonging to the same command<sup>212</sup>.

<sup>211</sup> CCB 2009

<sup>212</sup> CCB 2081

21317 **Total Number of Commands (mandatory):** In the case that an entire payload does not fit into one mes-  
21318 sage, the *Total Number of Commands* field indicates the total number of sub-commands in the message.

21319 **10.8.2.4.5.2.1 Top Up Payload Details**

21320 **Figure 10-151. Format of the Top Up Payload**

<b>Octets</b>	<b>1..26</b>	<b>4</b>	<b>4</b>	<b>1..26</b>	<b>4</b>	<b>4</b>	<b>1..26</b>	<b>4</b>	<b>4</b>
<b>Data Type</b>	octstr	int32	UTC	octstr	int32	UTC	octstr	int32	UTC
<b>Field Name</b>	TopUp Code (M)	TopUp Amount (M)	TopUp Time (M)	TopUp Code +1 (M)	TopUp Amount + 1 (M)	TopUp Time + 1 (M)	TopUp Code +n (M)	TopUp Amount + n (M)	TopUp Time + n (M)

21321 **TopUp Code (mandatory):** This is the value of the Top Up code stored in the log.

21322 **TopUp Amount (mandatory):** This is the amount of credit that was added to the Metering Device during  
21323 this Top Up.

21324 **TopUp Time (mandatory):** This is the UTC Timestamp when the Top Up was applied to the Metering  
21325 Device.  
21326

21327 **10.8.2.4.6 Publish Debt Log Command**

21328 This command is used to send the contents of the Repayment Log.

21329 **10.8.2.4.6.1 Payload Format**

21330 **Figure 10-152. Format of the Publish Debt Log Command Payload**

<b>Octets</b>	<b>1</b>	<b>1</b>	<b>Variable</b>
<b>Data Type</b>	uint8	uint8	Variable
<b>Field Name</b>	Command Index (M)	Total Number of Commands (M)	Debt Payload (M)

21331 **10.8.2.4.6.2 Payload Details**

21332 **Command Index (mandatory):** The *Command Index* is used to count the payload fragments in the case  
21333 where the entire payload does not fit into one message. The *Command Index* starts at 0 and is incremented  
21334 for each fragment belonging to the same command<sup>213</sup>.

21335 **Total Number of Commands (mandatory):** In the case that an entire payload does not fit into one message,  
21336 the *Total Number of Commands* field indicates the total number of sub-commands in the message.

21337 **Debt Payload (mandatory):** The *Debt Payload* shall contain one or more debt records, each of which shall  
21338 be of the following format:-

21339 **Figure 10-153. Format of a Debt Payload Record**

<b>Octets</b>	<b>4</b>	<b>4</b>	<b>1</b>	<b>4</b>
<b>Data Type</b>	UTC	uint32	enum8	uint32

<sup>213</sup> CCB 2081



Field Name	Collection Time (M)	Amount Collected (M)	Debt Type (M)	Outstanding Debt (M)
------------	---------------------	----------------------	---------------	----------------------

21340 **Collection Time (mandatory):** An UTC field identifying the time when the collection occurred.

21341 **Amount Collected (mandatory):** An unsigned 32-bit field to denote the amount of debt collected at this  
 21342 time. This parameter shall be measured in base unit of *Currency* with the decimal point located as indicated  
 21343 by the *Trailing Digits* field, as defined in the Price cluster.

21344 **Debt Type (mandatory):** An 8-bit enumeration field identifying the type of debt the record refers to. The  
 21345 enumerations are defined in Table 10-165.

21346 **Outstanding Debt (mandatory):** An unsigned 32-bit field to denote the amount of debt still outstanding  
 21347 after the debt was collected. This parameter shall be measured in base unit of *Currency* with the decimal  
 21348 point located as indicated by the *Trailing Digits* field, as defined in the Price cluster.

21349

## 21350 10.8.3 Client

### 21351 10.8.3.1 Dependencies

- 21352 • Events carried using this cluster include a timestamp with the assumption that target devices main-  
 21353 tain a real time clock. Devices can acquire and synchronize their internal clocks via the Time cluster  
 21354 server.

### 21355 10.8.3.2 Attributes

21356 The client has no attributes.

### 21357 10.8.3.3 Commands Received

21358 The client receives the cluster-specific response commands detailed in 10.8.2.4.

### 21359 10.8.3.4 Commands Generated

21360 The client generates the cluster-specific commands detailed in 10.8.2.3, as required by the application.

21361

## 21362 10.8.4 Application Guidelines

### 21363 10.8.4.1 Credit Status Attribute

21364 The purpose of the *Credit Status* attribute is to describe to any device on the HAN, what the status of a meter  
 21365 operating in Prepayment mode may be at any point in time. There are a number of important functionalities  
 21366 in Prepayment meters, and a variety of implementations depending on the manufacturer and their chosen  
 21367 system, however this attribute is designed to pick up the lowest common denominator of statuses that would  
 21368 be important to an end user looking to glean information about their meter in the HAN. For example, has  
 21369 their meter run out of credit, is Emergency Credit available or has Emergency Credit been selected?

21370 The diagram below describes the manner in which this attribute SHOULD be used when describing these  
 21371 statuses and others. This guidance note is not designed to prescribe how any Prepayment meter logic works,  
 21372 but merely to get a common understanding of the meter status to the end users' interface device. It is entirely  
 21373 up to device manufacturers to decide how to best use this information and display it.

21374 **Figure 10-154. Prepayment Credit Status Attribute Explained**

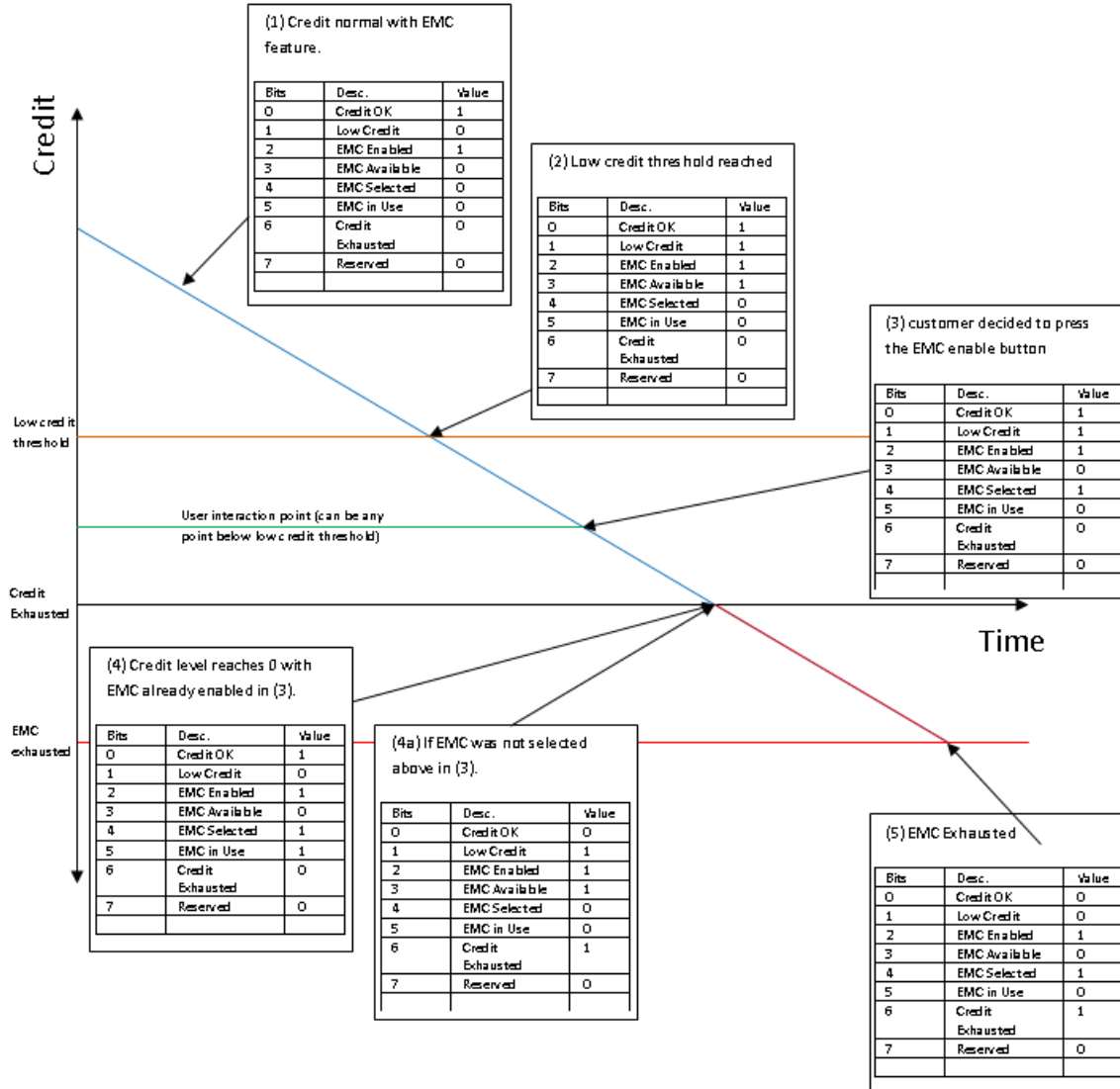

21375  
21376

21377 **10.8.4.1.1 Statuses Explained - an Example**

21378 Below is a brief explanation of each status noted on the diagram above in order to give a better indication of  
 21379 what the meter is doing at any given point. Imagine that the diagonal blue line represents the customer's  
 21380 credit, and when it turns into a plum colored diagonal line below the Time-Axis, the reader can assume that  
 21381 the meter is in negative credit, and Emergency Credit may or may not be invoked depending on the use case.

21382 The definitions of functionality below are modeled on the current understanding of Prepayment functionality.  
 21383 However there could well be a situation when meters are not disconnected when reaching the zero credit  
 21384 point, or indeed when Emergency Credit has been exhausted. This description is designed to aid understand-  
 21385 ing only and not specify meter functionality (see Figure 10-154):

- 21386  
21387  
21388
1. At this stage the meter has customer credit and has the Emergency Credit feature enabled. This means that when the meter reaches the Low Credit threshold, Emergency Credit will be available to be selected by the end user.
  
  2. At this point the meter still has customer credit available, but the meter has now reached the Low Credit threshold. This means that the end user may, should they choose to do so, select to engage the Emergency Credit. This will allow the meter to pass into a predefined amount of negative credit, without disconnection, when the meter credit reaches zero. The Emergency Credit can be selected at any point below the Low Credit threshold, but if this is not done before the customer’s credit reaches zero then the meter will disconnect the supply.  
21389  
21390  
21391  
21392  
21393  
21394
  
  3. Same as above except this is demonstrating the point at which the end user actually engages the Emergency Credit function, and in doing so making Emergency Credit no longer available for selection again.  
21395  
21396  
21397
  
  4. Meter reaches zero credit with Emergency Credit function engaged. This means that the option to engage Emergency Credit functionality is not available to the end user (as he has already done it), but the meter is still connected and ‘Credit OK’ remains set because Emergency Credit is available.  
21398  
21399  
21400
    - a. In this case the end user has decided not to engage Emergency Credit functionality before the credit level reaches zero, thereby removing the ‘Credit OK’ flag once the available credit has reached zero. The Emergency Credit function is still available, but requires end user interaction in order to engage it.  
21401  
21402  
21403  
21404
  
  5. At this point Emergency Credit is exhausted and the meter is assumed to have disconnected (this may not be the case depending on the supplier’s requirements). There is no available credit or Emergency Credit, and it is not possible for the end user to engage the Emergency Credit function.  
21405  
21406  
21407
- 21408  
21409  
21410  
21411  
21412  
21413  
21414
- At this point in time, when all credit is exhausted, the meter and IHD will need to display the “debt to clear”. This is the amount of credit that must be put onto the meter in order to exceed the Low Credit warning threshold and get the meter back on supply, with Emergency Credit available again (credit above zero will get the lights back on but Emergency Credit will not be available until credit is above the Low Credit Warning Threshold). The ‘debt to clear’ will be transmitted by way of the Credit Remaining register (as it will be a negative number at this time, made up of the debt that the meter has accrued while in Emergency Credit).
8. If Standing Charge, debt repayment charges and energy charges are normally being paid, these may not all be charged during an Emergency Credit period, but will still accrue in the background until Emergency Credit is exhausted (at point 5). Depending on energy supplier preference, it SHALL be configurable whether or not Emergency Credit is used to pay debt charges. The Emergency Credit value, along with debt charges accrued in the background while Emergency Credit was in operation, will be added to the ‘debt to clear’ register in the meter when Emergency Credit is exhausted, and displayed on the Credit Remaining register as a negative number.  
21415  
21416  
21417  
21418  
21419  
21420  
21421

## 21422 **10.9 Calendar<sup>214</sup>**

---

### 21423 **10.9.1 Overview**

21424 Please see Chapter 2 for a general cluster overview defining cluster architecture, revision, classification,  
21425 identification, etc.

---

<sup>214</sup> NEW CERTIFIABLE CLUSTER IN THIS LIBRARY

21426 The Calendar cluster implements commands to transfer calendar information within the premises. The cal-  
21427 endar information is distributed by an ESI.

21428 **Figure 10-155. Calendar Cluster Client Server Example**

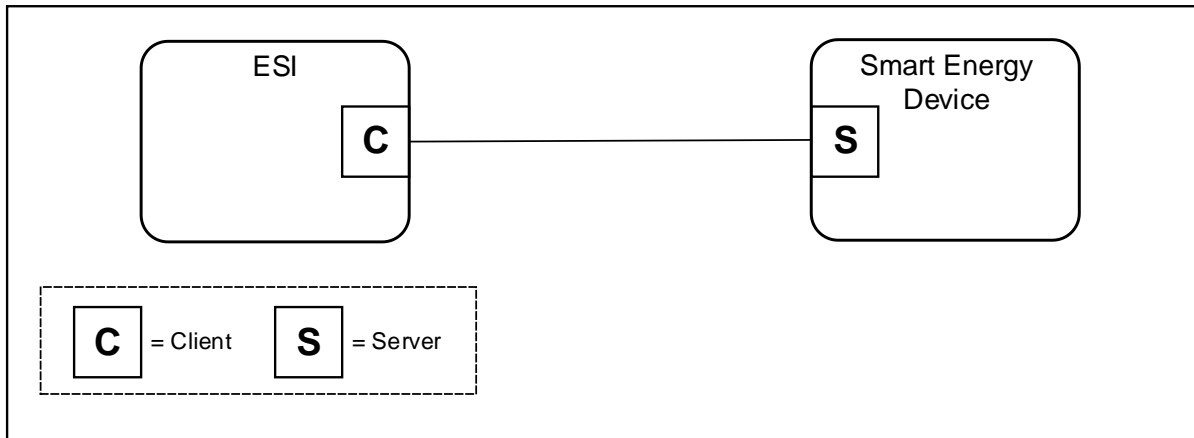

21429  
21430 *Note: Device names are examples for illustration purposes only*

21431 The server shall be able to store at least **two** instances of the calendar, typically the current and the next one.  
21432 It is recommended that a client is also capable of storing 2 instances. It is also recommended that a Calendar  
21433 server may additionally store at least **one** previous instance of the calendar.

21434  
21435 The Calendar server shall send unsolicited *PublishCalendar* and *PublishSpecialDays* commands to its clients  
21436 if they are bound to it. Other calendar items such as Day Profiles, Week Profiles and Season information  
21437 shall not be sent unsolicited. The clients shall send corresponding Get... commands to fetch the information  
21438 from the server as necessary. The Calendar server shall publish new calendars, to clients that have bound to  
21439 receive them, as soon as they become available. Devices with limited resources, and which cannot therefore  
21440 handle multiple calendars, should NOT ‘register’ (i.e. bind to the server) to receive unsolicited Calendar  
21441 cluster commands. If there is no next calendar available, a Default Response shall be returned with status  
21442 NOT\_FOUND; the ESI shall publish the information as soon as it gets it from the HES. Devices (particularly  
21443 battery-powered devices) should regularly check for updates to calendar items.

21444  
21445 The Calendar must be replaced as a whole; only the Special Day Table can be changed independently. To  
21446 uniquely identify the parts of a calendar, an Issuer Calendar ID is used. All parts belonging to the same  
21447 calendar must have the same Issuer Calendar ID. All parts of a particular calendar shall be successfully re-  
21448 trieved from the server before a client can use that calendar. It is anticipated that a change to any part of a  
21449 calendar, other than a Special Day Table, will result in a new calendar and a new Issuer Calendar ID.

21450 The Calendar cluster will support all of the following calendar types:

- 21451 • Delivered
- 21452 • Received
- 21453 • Delivered and Received
- 21454 • Friendly Credit
- 21455 • Auxiliary Load Switch

21456 Each calendar has three associated tables, a Season table, a Week Profile table and a Day Profile table. These  
21457 are described in Table 10-171. In addition, there is a Special Day Table which allows special days to be  
21458 defined (days where a special switching behavior overrides the normal operation). Each entry in the Special

21459 Day table contains a date together with the Day ID for a Day Profile (in the associated Calendar’s Day Profile  
 21460 table) to be used on that date.

21461

**Table 10-171. Calendar Data Structures**

<b>Table</b>	<b>Description</b>
Season Table	<p>Contains a list of Seasons defined by their starting date and a reference to the Week Profile to be executed. The list is arranged according to Season Start Date.</p> <p>The Week ID Ref defines the Week Profile active in this Season. If no season is defined, it is expected that the calendar will have one repeating Week Profile.</p> <p>NOTE: A 'Season', while normally considered to be a 3 or 6 month period, could be used for other arbitrary periods e.g. monthly or quarterly. The minimum resolution is 1 day, although a week would normally be the smallest interval.</p>
Week Profile Table	<p>Contains an array of Week Profiles to be used in the different Seasons. For each Week Profile, the Day Profile for every day of a week is identified.</p> <p>Monday to Sunday reference the Day ID of the Day Profile to be used for the corresponding day. The same Day Profile may be used for more than one day of the week. If no Week Profile is defined, it is expected that the calendar will have one repeating Day Profile.</p>
Day Profile Table	<p>Contains an array of Day Profiles, identified by their Day ID. Each Day Profile contains a list of scheduled actions and is defined by a script to be executed at the corresponding activation time (Start Time). The list is arranged according to Start Time.</p>
Special Day Table	<p>Defines special dates. On such dates, a special switching behavior overrides the normal one defined by the Season and Week Profile Tables.</p> <p>The Day Profile referenced through the Day ID in the Special Days Table activates the Day Schedule of the corresponding Day Profile.</p>

21462

21463 All dates and times shall be defined according to UTC, Standard or Local time. Alternatively, the Season  
 21464 Table may be used to accommodate requirements such as daylight saving.

21465

21466 Figure 10-156 shows a recommended Calendar command sequence (noting that this sequence is for a main-  
 21467 powered Smart Energy Device) :

21467

21468

**Figure 10-156. Recommended Calendar Command Sequence**

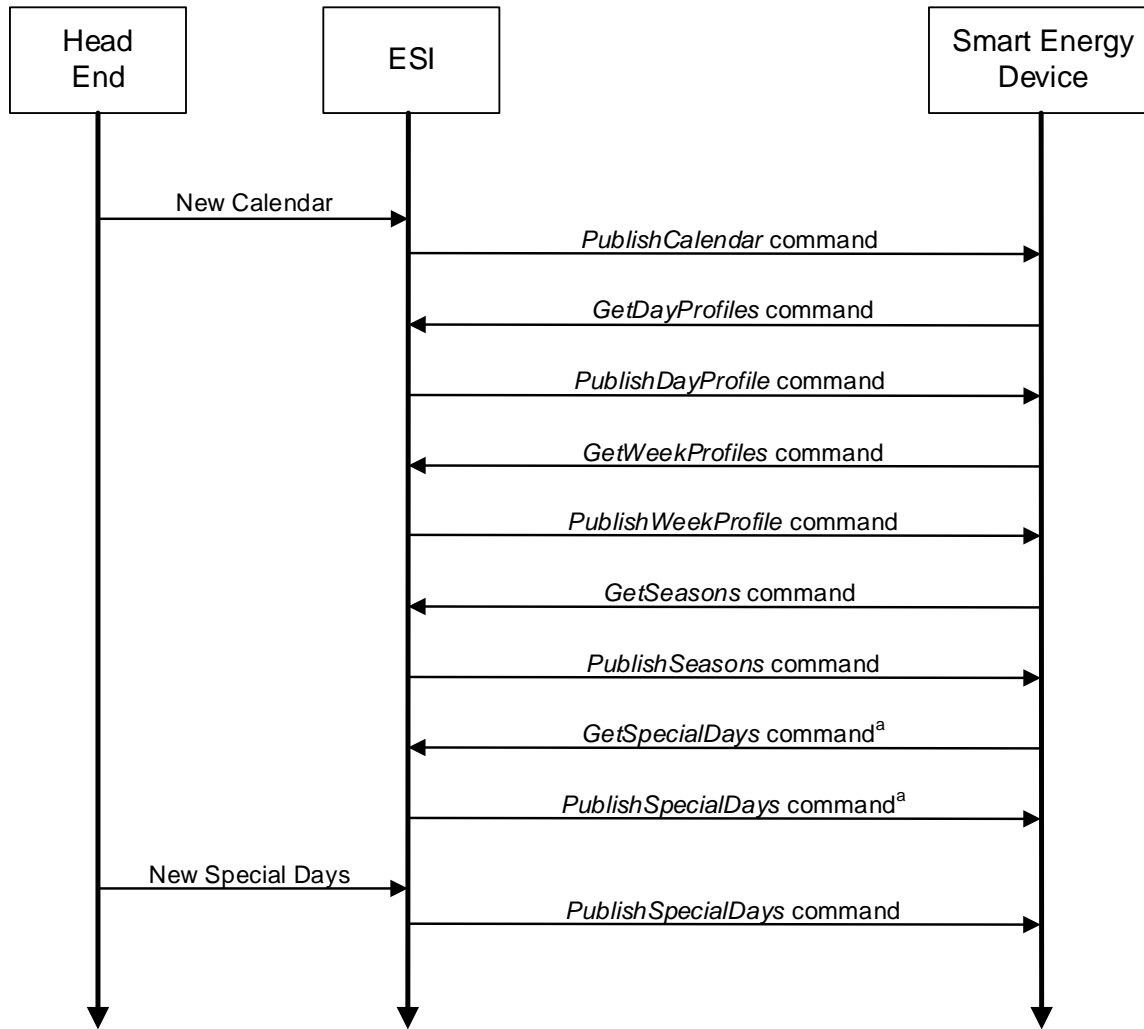

<sup>a</sup>Although not necessary, it is thought wise to check for updates when a new calendar is published

21469  
21470

### 21471 **10.9.1.1 Revision History**

21472 The global *ClusterRevision* attribute value SHALL be the highest revision number in the table below.

Rev	Description
1	mandatory global <i>ClusterRevision</i> attribute added; Added from SE1.4; CCB 2068

### 21473 **10.9.1.2 Classification**

Hierarchy	Role	PICS Code	Primary Transaction
Base	Application	SECA	Type 1 (client to server)

21474 **10.9.1.3 Cluster Identifiers**

Identifier	Name
0x0707	Calendar (Smart Energy)

21475

21476 **10.9.2 Server**

21477 **10.9.2.1 Dependencies**

21478 A device implementing the Calendar server shall also implement the Price server. A device implementing  
 21479 the Calendar client shall also implement the Price client. The commodity type of a Calendar server shall be  
 21480 inferred from that of the corresponding Price server (i.e. located on the same device/endpoint). It is expected  
 21481 that the TOU calendar and tariff information of the Price cluster is provided by the same utility supplier. The  
 21482 *ProviderID* for the TOU calendar shall be obtained from the *Tariff Information Set* of the Price Cluster.

21483 **10.9.2.2 Attributes**

21484 For convenience, the attributes defined in this cluster are arranged into sets of related attributes; each  
 21485 set can contain up to 256 attributes. Attribute identifiers are encoded such that the most significant Octet  
 21486 specifies the attribute set and the least significant Octet specifies the attribute within the set. The currently  
 21487 defined attribute sets are listed in the following Table 10-172.

21488

**Table 10-172. Calendar Cluster Server Attribute Sets**

Attribute Set Identifier	Description
0x00	Auxiliary Switch Label Attribute Set

21489 **10.9.2.2.1 Auxiliary Switch Label Attribute Set**

21490

**Table 10-173. Auxiliary Switch Label Attribute Set**

Id	Name	Type	Range	Acc	Def	M
0x0000	AuxSwitch1Label	octstr	1 to 23 Octets	RW	“Auxiliary 1”	O
0x0001	AuxSwitch2Label	octstr	1 to 23 Octets	RW	“Auxiliary 2”	O
0x0002	AuxSwitch3Label	octstr	1 to 23 Octets	RW	“Auxiliary 3”	O
0x0003	AuxSwitch4Label	octstr	1 to 23 Octets	RW	“Auxiliary 4”	O
0x0004	AuxSwitch5Label	octstr	1 to 23 Octets	RW	“Auxiliary 5”	O
0x0005	AuxSwitch6Label	octstr	1 to 23 Octets	RW	“Auxiliary 6”	O

<b>Id</b>	<b>Name</b>	<b>Type</b>	<b>Range</b>	<b>Acc</b>	<b>Def</b>	<b>M</b>
0x0006	AuxSwitch7Label	octstr	1 to 23 Octets	RW	“Auxiliary 7”	O
0x0007	AuxSwitch8Label	octstr	1 to 23 Octets	RW	“Auxiliary 8”	O

21491

21492 **10.9.2.2.1.1 AuxSwitchNLabel Attributes**

21493 The *AuxSwitchNLabel* attributes provide a method for assigning a label to an Auxiliary Switch. The  
21494 *AuxSwitchNLabel* attributes are Octet String fields capable of storing 22-character strings (the first Octet  
21495 indicates length) encoded in the UTF-8 format.

21496 **10.9.2.3 Commands Generated**

21497 Table 10-174 lists commands that are generated by the server.

21498 **Table 10-174. Cluster-specific Commands Sent by the Server**

<b>Command Identifier Field Value</b>	<b>Description</b>	<b>Mandatory / Optional</b>
0x00	PublishCalendar	M
0x01	PublishDayProfile	M
0x02	PublishWeekProfile	M
0x03	PublishSeasons	M
0x04	PublishSpecialDays	M
0x05	CancelCalendar	O

21499 **10.9.2.3.1 PublishCalendar Command**

21500 The *PublishCalendar* command is published in response to a *GetCalendar* command or if new calendar  
21501 information is available. The Calendar must be replaced as a whole; only the Special Day Table can be  
21502 changed independently. All parts of a calendar instance shall have the same Calendar ID.

21503 Nested and overlapping calendars are not allowed. In the case of overlapping calendars of the same type  
21504 (calendar type), the calendar with the newer *IssuerCalendarID* takes priority over all nested and overlapping  
21505 calendars. All existing calendar instances that overlap, even partially, should be removed. The only exception  
21506 to this is if a calendar instance with a newer *Issuer Event ID* overlaps with the end of the current active  
21507 calendar but is not yet active, then the active calendar is not deleted but modified so that the active calendar  
21508 ends when the new calendar begins.

21509 **10.9.2.3.1.1 Payload Format**

21510 **Figure 10-157. Format of the *PublishCalendar* Command Payload**

<b>Octets</b>	<b>4</b>	<b>4</b>	<b>4</b>	<b>4</b>	<b>1</b>	<b>1</b>	<b>1..13</b>
<b>Data Type</b>	uint32	uint32	uint32	UTC	enum8	uint8	octstr
<b>Field Name</b>	Provider Id (M)	Issuer Event ID (M)	Issuer Calendar ID (M)	Start Time (M)	Calendar Type (M)	Calendar Time Reference (M)	Calendar Name (M)



21511

<b>Octets</b>	<b>1</b>	<b>1</b>	<b>1</b>
Data Type	Unsigned 8-bit Integer	Unsigned 8-bit Integer	Unsigned 8-bit Integer
Field Name	Number of Seasons (M)	Number of Week Profiles (M)	Number of Day Profiles (M)

21512

21513 **10.9.2.3.1.2 Payload Details**

21514 **Provider Id (mandatory):** An unsigned 32-bit field containing a unique identifier for the commodity provider. This field allows differentiation in deregulated markets where multiple commodity providers may be available.  
 21515  
 21516

21517 **Issuer Event ID (mandatory):** Unique identifier generated by the commodity provider. When new information is provided that replaces older information for the same time period, this field allows devices to determine which information is newer. The value contained in this field is a unique number managed by upstream servers or a UTC based time stamp (UTC data type) identifying when the Publish command was issued. Thus, newer information will have a value in the *Issuer Event ID* field that is larger than older information.  
 21518  
 21519  
 21520  
 21521  
 21522

21523 **Issuer Calendar ID (mandatory):** Unique identifier generated by the commodity Supplier to identify a particular calendar.  
 21524

21525 **Start Time (mandatory):** A UTC field to denote the time at which the published calendar becomes valid. A start date/time of 0x00000000 shall indicate that the command should be executed immediately.  
 21526

21527 **Calendar Type (mandatory):** An 8-bit enumeration identifying the type of calendar published in this command. Table 10-175 details the enumeration of this field. Generation Meters shall use the ‘Received’ Calendar.  
 21528  
 21529

21530

**Table 10-175. Calendar Type Enumeration**

Value	Description
0x00	Delivered Calendar
0x01	Received Calendar
0x02	Delivered and Received Calendar
0x03	Friendly Credit Calendar
0x04	Auxillary Load Switch Calendar

21531

21532 **Calendar Time Reference (mandatory):** This field indicates how the Start Times contained in the calendar are to be interpreted. The following table shows possible values:  
 21533

21534

**Table 10-176. Calendar Time Reference Enumeration**

Value	Description
0x00	UTC time
0x01	Standard time
0x02	Local time

21535

21536 Standard time refers to UTC time adjusted according to the local time zone.

- 21537 Local time refers to Standard time adjusted according to local daylight savings regulations.
- 21538 Where the optional Standard and/or Local Time (as applicable) are not available on the Time cluster server  
21539 (and are not managed locally by the meter), the *Calendar Time Reference* shall default to UTC time.
- 21540 **Calendar Name (mandatory):** The *CalendarName* provides a method for utilities to assign a name to the  
21541 entire calendar. The *CalendarName* is an Octet String field capable of storing a 12 character string (the first  
21542 Octet indicates length) encoded in the UTF-8 format.
- 21543 **Number of Seasons (mandatory):** Number of entries in the Seasons Table. A value of 0x00 means no Sea-  
21544 son defined.
- 21545 **Number of Week Profiles (mandatory):** Number of week profiles in the Week Profile Table. A value of  
21546 0x00 means no Week Profile defined.
- 21547 **Number of Day Profiles (mandatory):** Number of day profiles in the Day Profile Table.
- 21548

### 21549 **10.9.2.3.2 PublishDayProfile Command**

- 21550 The *PublishDayProfile* command is published in response to a *GetDayProfile* command. If the *IssuerCalen-*  
21551 *darID* does not match with one of the stored calendar instances, the client shall ignore the command and  
21552 respond using Default Response with a status response of NOT\_FOUND.
- 21553 The Calendar server shall send only the number of Schedule Entries belonging to this calendar instance.  
21554 Server and clients shall be able to store at least 1 *DayProfile* for TOU and Auxiliary Load Switch calendars  
21555 and three *DayProfiles* for a Friendly Credit calendar, and at least one *ScheduleEntries* per day profile. If the  
21556 client is not able to store all *ScheduleEntries*, the device should respond using Default Response with a status  
21557 response of INSUFFICIENT\_SPACE.
- 21558 The ESI may send as many *PublishDayProfile* commands as needed, if the maximum application payload  
21559 is not sufficient to transfer all *ScheduleEntries* in one command. In this case:
- 21560 • The *ScheduleEntries* shall be arranged in a linear array ordered by the start time.
  - 21561 • The first command shall have *CommandIndex* set to 0, the second to 1 and so on.
  - 21562 • The *Total Number of Commands* sub-field shall be set in all commands to the total number of **com-**  
21563 **mands** being transferred.
  - 21564 • The *Total Number of Schedule Entries* field shall be set in all commands to the total number of  
21565 **entries** being transferred with the whole set of commands.
  - 21566 • All associated commands shall use the same value of *Issuer Event ID*.

#### 21567 **10.9.2.3.2.1 Payload Format**

21568 **Figure 10-158. Format of the *PublishDayProfile* Command Payload**

<b>Oc- tets</b>	<b>4</b>	<b>4</b>	<b>4</b>	<b>1</b>	<b>1</b>	<b>1</b>	<b>1</b>
<b>Data Type</b>	uint32	uint32	uint32	uint8	uint8	uint8	uint8

Field Name	Provider Id (M)	Issuer Event ID (M)	Issuer Calendar ID (M)	Day ID (M)	Total Number of Schedule Entries (M)	Command Index (M)	Total Number of Commands (M)
------------	-----------------	---------------------	------------------------	------------	--------------------------------------	-------------------	------------------------------

21569

Octets	1	Variable
Data Type	enum8	Series of Schedule Entries
Field Name	Calendar Type (M)	Day Schedule Entries

21570 **10.9.2.3.2.2 Payload Details**

21571 **Provider Id (mandatory):** An unsigned 32-bit field containing a unique identifier for the commodity provider. This field allows differentiation in deregulated markets where multiple commodity providers may be available.  
 21572  
 21573

21574 **Issuer Event ID (mandatory):** Unique identifier generated by the commodity provider. When new information is provided that replaces older information for the same time period, this field allows devices to determine which information is newer. The value contained in this field is a unique number managed by upstream servers or a UTC based time stamp (UTC data type) identifying when the Publish command was issued. Thus, newer information will have a value in the Issuer Event ID field that is larger than older information.  
 21575  
 21576  
 21577  
 21578  
 21579

21580 **Issuer Calendar ID (mandatory):** Unique identifier generated by the commodity supplier. All parts of a calendar instance shall have the same *Issuer Calendar ID*.  
 21581

21582 **Day ID (mandatory):** Unique identifier generated by the commodity supplier. The *Day ID* is used as reference to assign a Day Profile to a Special Day or days in a Week Profile. When generating calendars, *Day IDs* shall be allocated sequentially, starting from 1.  
 21583  
 21584

21585 **Total Number of Schedule Entries (mandatory):** An 8-bit integer representing the total number of *ScheduleEntries* in this Day Profile.  
 21586

21587 **Command Index (mandatory):** The *CommandIndex* is used to count the payload fragments in the case where the entire payload does not fit into one message. The *CommandIndex* starts at 0 and is incremented for each fragment belonging to the same command.  
 21588  
 21589

21590 **Total Number of Commands (mandatory):** In the case where the entire payload does not fit into one message, the *Total Number of Commands* field indicates the total number of sub-commands in the message.  
 21591

21592 **Calendar Type (mandatory):** An 8-bit enumeration identifying the type of calendar published in this command. Table 10-175 details the enumeration of this field. This field identifies the type of *Day Schedule Entry* included in this command.  
 21593  
 21594

21595 **10.9.2.3.2.3 Day Schedule Entries**

21596 The format of Day Schedule entries is dependent on the Calendar Type (see Table 10-175). If the Calendar  
 21597 Type is 0x00 – 0x02 then Rate Start Times shall be used. If the value is 0x03 then the Friendly Credit Start

21598 Times shall be used. If the value is 0x04 then the Auxilliary Load Start Times shall be used. A value other  
21599 than these would be invalid.

21600 **10.9.2.3.2.3.1 Schedule Entries for Rate Start Times**

21601 Schedule entries consist of a start time and the active price tier:

21602 **Figure 10-159. Schedule Entries for Rate Start Times Command Sub-Payload**

Octets	2	1
Data Type	uint16	enum8
Field Name	Start Time (M)	Price Tier (M)

21603 **Start Time (mandatory):** The *Start Time* is represented in minutes from midnight. *ScheduleEntries* must  
21604 be arranged in ascending order of *Start Times*. The first Schedule Entry must have 0x0000 (midnight) as  
21605 the *StartTime*.

21606 **Price Tier (mandatory):** This is the current price tier that is valid until the start time of the next Schedule  
21607 Entry.

21608 **10.9.2.3.2.3.2 Schedule Entries for Friendly Credit Start Times**

21609 A *Friendly Credit Start Time* entry consists of a start time and an indication if Friendly Credit is available.

21610 **Figure 10-160. Schedule Entries for Friendly Credit Start Times Command Sub-Payload**

Octets	2	1
Data Type	uint16	bool
Field Name	Start Time (M)	Friendly Credit Enable (M)

21611 **Start Time (mandatory):** The *Start Time* is represented in minutes from midnight. *ScheduleEntries* must  
21612 be arranged in ascending order of *Start Times*. The first Schedule Entry must have 0x0000 (midnight) as  
21613 the *StartTime*.

21614 **Friendly Credit Enable (mandatory):** The *Friendly Credit Enable* field is a Boolean denoting if the  
21615 Friendly Credit period is available for the consumer to use. A value of 1 means it is enabled and a 0 means  
21616 that the Friendly Credit period is not available for the consumer to use.

21617 **10.9.2.3.2.3.3 Schedule Entries for Auxilliary Load Start Times**

21618 An *Auxilliary Load Start Time* entry consists of a start time, the relevant Auxilliary Switch and the state of  
21619 the switch as a result of this action.

21620 **Figure 10-161. Schedule Entries for Auxilliary Load Start Times Command Sub-Payload**

Octets	2	1
Data Type	uint16	map8
Field Name	Start Time (M)	Auxiliary Load Switch State (M)

21621 **Start Time (mandatory):** The *Start Time* is represented in minutes from midnight. *ScheduleEntries* must be  
21622 arranged in ascending order of *Start Times*. The first Schedule Entry must have 0x0000 (midnight) as the  
21623 *StartTime*.

21624 **Auxiliary Load Switch State (mandatory):** The required status of the auxiliary switches is indicated by  
 21625 the state of the bits. Bit0 correspond to Auxiliary Switch 1 and bit7 corresponds to Auxiliary Switch 8. A  
 21626 bit set to “1” indicates an ON state and a bit set to “0” indicates an OFF state.  
 21627

21628 **10.9.2.3.3 PublishWeekProfile Command**

21629 The *PublishWeekProfile* command is published in response to a *GetWeekProfile* command. If the *IssuerCal-*  
 21630 *endarID* does not match with one of the stored calendar instances, the client shall ignore the command and  
 21631 respond using Default Response with a status response of NOT\_FOUND.

21632 The Calendar server shall send only the number of WeekProfiles belonging to this calendar instance. Server  
 21633 and clients shall be able to store at least 4 WeekProfiles for TOU calendars, and 1 WeekProfile for Friendly  
 21634 Credit and Auxiliary Load Switch calendars. If the client is not able to store all entries, the device should  
 21635 respond using Default Response with a status response of INSUFFICIENT\_SPACE.

21636 **10.9.2.3.3.1 Payload Format**

21637 **Figure 10-162. Format of the *PublishWeekProfile* Command Payload**

<b>Octets</b>	<b>4</b>	<b>4</b>	<b>4</b>	<b>1</b>
<b>Data Type</b>	uint32	uint32	uint32	uint8
<b>Field Name</b>	Provider Id (M)	Issuer Event ID (M)	Issuer Calendar ID (M)	Week ID (M)

21638

<b>1</b>	<b>1</b>	<b>1</b>	<b>1</b>	<b>1</b>	<b>1</b>	<b>1</b>
uint8	uint8	uint8	uint8	uint8	uint8	uint8
Day ID Ref Monday	Day ID Ref Tuesday	Day ID Ref Wednesday	Day ID Ref Thursday	Day ID Ref Friday	Day ID Ref Saturday	Day ID Ref Sunday

21639 **10.9.2.3.3.2 Payload Details**

21640 **Provider Id (mandatory):** An unsigned 32-bit field containing a unique identifier for the commodity pro-  
 21641 vider. This field allows differentiation in deregulated markets where multiple commodity providers may be  
 21642 available.

21643 **Issuer Event ID (mandatory):** Unique identifier generated by the commodity provider. When new infor-  
 21644 mation is provided that replaces older information for the same time period, this field allows devices to de-  
 21645 termine which information is newer. The value contained in this field is a unique number managed by up-  
 21646 stream servers or a UTC based time stamp (UTC data type) identifying when the Publish command was  
 21647 issued. Thus, newer information will have a value in the *Issuer Event ID* field that is larger than older infor-  
 21648 mation.

21649 **Issuer Calendar ID (mandatory):** Unique identifier generated by the commodity supplier. All parts of a  
 21650 calendar instance shall have the same *Issuer Calendar ID*.

21651 **Week ID (mandatory):** Unique identifier generated by the commodity supplier. The *Week ID* is used as  
 21652 reference to assign a Week Profile to a Season Entry. When generating calendars, *Week IDs* shall be allocated  
 21653 sequentially, starting from 1.

21654 **Day ID Ref Monday until Day ID Ref Sunday (mandatory):** Reference to the related Day Profile entry.

21655

21656 **10.9.2.3.4 PublishSeasons Command**

21657 The *PublishSeasons* command is published in response to a *GetSeason* command. If the *IssuerCalendarID*  
21658 does not match with one of the stored calendar instances, the client shall ignore the command and respond  
21659 using Default Response with a status response of NOT\_FOUND.

21660 The Calendar server shall send only the number of *SeasonEntries* belonging to this calendar instance. Server  
21661 and clients shall be able to store at least 4 *SeasonEntries* for TOU calendars, and 1 *SeasonEntry* for Friendly  
21662 Credit and Auxiliary Load Switch calendars. If the client is not able to store all *SeasonEntries*, the device  
21663 should respond using Default Response with a status response of INSUFFICIENT\_SPACE.

21664 The ESI may send as many *PublishSeasons* commands as needed, if the maximum application payload is  
21665 not sufficient to transfer all Season Entries in one command. In this case:

- 21666 • The *SeasonEntries* shall be arranged in a linear array ordered by the date.
- 21667 • The first command shall have *Command Index* set to 0, the second to 1 and so on.
- 21668 • The total number of seasons being transferred with the whole set of commands is known from the  
21669 previously received *PublishCalendar* command.
- 21670 • All associated commands shall use the same value of *Issuer Event ID*.

21671 **10.9.2.3.4.1 Payload Format**

21672 **Figure 10-163. Format of the *PublishSeasons* Command Payload**

Octets	4	4	4	1	1	Variable
Data Type	uint32	uint32	uint32	uint8	uint8	Series of Season Entries
Field Name	Provider Id (M)	Issuer Event ID (M)	Issuer Calendar ID (M)	Command Index (M)	Total Number of Commands (M)	Season Entry

21673 **10.9.2.3.4.2 Payload Details**

21674 **Provider Id (mandatory):** An unsigned 32-bit field containing a unique identifier for the commodity pro-  
21675 vider. This field allows differentiation in deregulated markets where multiple commodity providers may be  
21676 available.

21677 **Issuer Event ID (mandatory):** Unique identifier generated by the commodity provider. When new infor-  
21678 mation is provided that replaces older information for the same time period, this field allows devices to de-  
21679 termine which information is newer. The value contained in this field is a unique number managed by up-  
21680 stream servers or a UTC based time stamp (UTC data type) identifying when the Publish command was  
21681 issued. Thus, newer information will have a value in the *Issuer Event ID* field that is larger than older infor-  
21682 mation.

21683 **Issuer Calendar ID (mandatory):** Unique identifier generated by the commodity supplier. All parts of a  
21684 calendar instance shall have the same *Issuer Calendar ID*.

21685 **Command Index (mandatory):** The *Command Index* is used to count the payload fragments in the case  
21686 where the entire payload does not fit into one message. The *Command Index* starts at 0 and is incremented  
21687 for each fragment belonging to the same command.

21688 **Total Number of Commands (mandatory):** In the case where the entire payload does not fit into one mes-  
 21689 sage, the *Total Number of Commands* field indicates the total number of sub-commands in the message.

21690 **Season Entry:** A *Season Entry* consists of a *Season Start Date* and the reference (*Week ID Ref*) to the re-  
 21691 lated *Week Profile* entry. The *Start Date* of the *Season Entries* must be arranged in ascending order. The  
 21692 active season is valid until the *Season Start Date* of the next *Season Entry*.

21693 **Figure 10-164. Format of the Season Entry Sub-Payload**

<b>Octets</b>	<b>4</b>	<b>1</b>
<b>Data Type</b>	date	uint8
<b>Field Name</b>	Season Start Date (M)	Week ID Ref (M)

21694

21695 **10.9.2.3.5 PublishSpecialDays Command**

21696 The *PublishSpecialDays* command is published in response to a *GetSpecialDays* command or if a calendar  
 21697 update is available. If the *Calendar Type* does not match with one of the stored calendar instances, the client  
 21698 shall ignore the command and respond using Default Response with a status response of NOT\_FOUND.

21699 The Calendar server shall send only the number of *SpecialDayEntries* belonging to this calendar instance.  
 21700 Server and clients shall be able to store at least 25<sup>215</sup> *SpecialDayEntries*. If the client is not able to store all  
 21701 *SpecialDayEntries*, the device should respond using Default Response with a status response of INSUFFI-  
 21702 CIENT\_SPACE.

21703 If the maximum application payload is not sufficient to transfer all *SpecialDayEntries* in one command, the  
 21704 ESI may send as many *PublishSpecialDays* commands as needed. In this case:

- 21705 • The *SpecialDayEntries* shall be arranged in a linear array ordered by the date.
- 21706 • The first command shall have *Command Index* set to 0, the second to 1 and so on.
- 21707 • The *Total Number of SpecialDays* field shall be set in all commands to the total number of entries  
 21708 being transferred with the whole set of commands.
- 21709 • All associated commands shall use the same value of *Issuer Event ID*.

21710 Note that, in this case, it is the client’s responsibility to ensure that it receives all associated *PublishSpecial-*  
 21711 *Days* commands before any of the payloads can be used.

21712 **10.9.2.3.5.1 Payload Format**

21713 The *PublishSpecialDays* command shall be formatted as illustrated in Figure 10-165:

21714 **Figure 10-165. Format of the PublishSpecialDays Command Payload**

<b>Octets</b>	<b>4</b>	<b>4</b>	<b>4</b>	<b>4</b>	<b>1</b>	<b>1</b>
<b>Data Type</b>	uint32	uint32	uint32	UTC	enum8	uint8

<sup>215</sup> CCB 2068

Field Name	Provider Id (M)	Issuer Event ID (M)	Issuer Calendar Id (M)	Start Time (M)	Calendar Type (M)	Total Number of SpecialDays (M)
------------	-----------------	---------------------	------------------------	----------------	-------------------	---------------------------------

21715

<b>Octets</b>	<b>1</b>	<b>1</b>	<b>Variable</b>
<b>Data Type</b>	uint8	uint8	Series of Special Days
<b>Field Name</b>	Command Index (M)	Total Number of Commands (M)	Special Day Entry

21716 **10.9.2.3.5.2 Payload Details**

21717 **Provider Id (mandatory):** An unsigned 32-bit field containing a unique identifier for the commodity provider. This field allows differentiation in deregulated markets where multiple commodity providers may be available.  
21718  
21719

21720 **Issuer Event ID (mandatory):** Unique identifier generated by the commodity provider. When new information is provided that replaces older information for the same time period, this field allows devices to determine which information is newer. The value contained in this field is a unique number managed by upstream servers or a UTC based time stamp (UTC data type) identifying when the Publish command was issued. Thus, newer information will have a value in the Issuer Event ID field that is larger than older information. If multiple *PublishSpecialDays* commands are needed to transfer the whole Special Day Table, the commands belonging to the same Special Day Table shall use the same *IssuerEventID* and *StartTime*.  
21721  
21722  
21723  
21724  
21725  
21726

21727 **Issuer Calendar ID (mandatory):** Unique identifier generated by the commodity Supplier. All parts of a calendar instance shall have the same *Issuer Calendar ID*.  
21728

21729 **Start Time (mandatory):** A UTC field to denote the time at which the Special Day Table becomes valid. A start date/time of 0x00000000 shall indicate that the command should be executed immediately. A start date/time of 0xFFFFFFFF shall cause an existing *PublishSpecialDays* command with the same *Provider ID* and *Issuer Event ID* to be cancelled (note that, in markets where permanently active price information is required for billing purposes, it is recommended that a replacement/superseding *PublishSpecialDays* command is used in place of this cancellation mechanism).  
21730  
21731  
21732  
21733  
21734

21735 **Calendar Type (mandatory):** An 8-bit enumeration identifying the type of calendar this day profile belongs to. Generation Meters shall use the ‘Received’ Calendar. See Table 10-175.  
21736

21737 **Total Number of SpecialDays (mandatory):** An 8-bit integer representing the total number of Special Day entries in this Special Day Table.  
21738

21739 **Command Index (mandatory):** The *Command Index* is used to count the payload fragments in the case where the entire payload does not fit into one message. The *Command Index* starts at 0 and is incremented for each fragment belonging to the same command.  
21740  
21741

21742 **Total Number of Commands (mandatory):** In the case where the entire payload does not fit into one message, the *Total Number of Commands* field indicates the total number of sub-commands in the message.  
21743

21744 **SpecialDayEntry:** A *SpecialDayEntry* consists of the *Special Day Date* and a reference (*Day ID Ref*) to the related Day Profile entry. The dates of the Special Day Table must be arranged in ascending order.  
21745



21746

**Figure 10-166. Format of the *SpecialDayEntry* Sub-Payload**

<b>Octets</b>	<b>4</b>	<b>1</b>
<b>Data Type</b>	Date	uint8
<b>Field Name</b>	Special Day Date (M)	Day ID Ref (M)

21747

21748 **10.9.2.3.6 CancelCalendar Command**

21749 The *CancelCalendar* command indicates that all data associated with a particular calendar instance should  
 21750 be discarded.

21751 In markets where permanently active price (and hence calendar) information is required for billing pur-  
 21752 poses, it is recommended that replacement/superseding *PublishCalendar*, *PublishDayProfile*, *PublishWeek-*  
 21753 *Profile* and *PublishSeasons* commands are used in place of a *CancelCalendar* command. The exception is a  
 21754 ‘Friendly Credit’ calendar, where an instance is not always required.

21755 **10.9.2.3.6.1 Payload Format**

21756 The *CancelCalendar* command shall be formatted as illustrated in Figure 10-167:

21757

**Figure 10-167. Format of the *CancelCalendar* Command Payload**

<b>Octets</b>	<b>4</b>	<b>4</b>	<b>1</b>
<b>Data Type</b>	uint32	uint32	enum8
<b>Field Name</b>	Provider Id (M)	Issuer Calendar Id (M)	Calendar Type (M)

21758 **10.9.2.3.6.2 Payload Details**

21759 **Provider Id (mandatory):** An unsigned 32-bit field containing a unique identifier for the commodity pro-  
 21760 vider. This field allows differentiation in deregulated markets where multiple commodity providers may be  
 21761 available.

21762 **Issuer Calendar ID (mandatory):** Unique identifier generated by the commodity Supplier. All parts of a  
 21763 calendar instance shall have the same *Issuer Calendar ID*.

21764 **Calendar Type (mandatory):** An 8-bit enumeration identifying the type of calendar to be cancelled by this  
 21765 command. Table 10-175 details the enumeration of this field.

21766 **10.9.2.3.6.3 Effect on Receipt**

21767 On receipt of this command, a client device shall discard all instances of *PublishCalendar*, *PublishDayPro-*  
 21768 *file*, *PublishWeekProfile*, *PublishSeasons* and *PublishSpecialDays* commands associated with the stated  
 21769 *Provider ID*, *Calendar Type* and *Issuer Calendar ID*.  
 21770

21771 **10.9.2.4 Commands Received**

21772 Table 10-177 lists cluster-specific commands that are received by the server.

21773

**Table 10-177. Cluster -specific Commands Received by the Calendar Cluster Server**

Command Identifier FieldValue	Description	M
0x00	GetCalendar	O
0x01	GetDayProfiles	O
0x02	GetWeekProfiles	O
0x03	GetSeasons	O
0x04	GetSpecialDays	O
0x05	GetCalendarCancellation	O

21774

21775 **10.9.2.4.1 GetCalendar Command**

21776 This command initiates *PublishCalendar* command(s) for scheduled Calendar updates. To obtain the complete Calendar details, further *GetDayProfiles*, *GetWeekProfiles* and *GetSeasons* commands must be sent  
21777 using the *IssuerCalendarID* obtained from the appropriate *PublishCalendar* command.  
21778

21779 **10.9.2.4.1.1 Payload Format**

**Figure 10-168. Format of the GetCalendar Command Payload**

Octets	4	4	1	1	4
Data Type	UTC	uint32	uint8	enum8	uint32
Field Name	Earliest Start Time (M)	Min. Issuer Event ID (M)	Number of Calendars (M)	Calendar Type (M)	Provider Id (M)

21781 **10.9.2.4.1.2 Payload Details**

21782 **Earliest Start Time (mandatory):** UTC Timestamp indicating the earliest start time of calendars to be returned by the corresponding *PublishCalendar* command. The first returned *PublishCalendar* command shall  
21783 be the instance which is active or becomes active at or after the stated *Earliest Start Time*. If more than one  
21784 instance is requested, the active and scheduled instances shall be sent with ascending ordered *Start Time*.  
21785

21786 **Min. Issuer Event ID (mandatory):** A 32-bit integer representing the minimum *Issuer Event ID* of calendars  
21787 to be returned by the corresponding *PublishCalendar* command. A value of 0xFFFFFFFF means not specified;  
21788 the server shall return calendars irrespective of the value of the *Issuer Event ID*.

21789 **Number of Calendars (mandatory):** An 8-bit integer which represents the maximum number of *PublishCalendar*  
21790 commands that the client is willing to receive in response to this command. A value of 0 would  
21791 indicate all available *PublishCalendar* commands shall be returned.

21792 **Calendar Type (mandatory):** An 8-bit enumeration identifying the calendar type of the requested calendar.  
21793 Generation Meters shall use the ‘Received’ Calendar. See Table 10-175. A value of 0xFF means not specified.  
21794 If the *CalendarType* is not specified, the server shall return calendars regardless of its type.

21795 **Provider Id (mandatory):** An unsigned 32-bit field containing a unique identifier for the commodity provider.  
21796 This field allows differentiation in deregulated markets where multiple commodity providers may be

21797 available. A value of 0xFFFFFFFF means not specified; the server shall return calendars irrespective of the  
 21798 value of the *Provider Id*.  
 21799

21800 **10.9.2.4.2 GetDayProfiles Command**

21801 This command initiates one or more *PublishDayProfile* commands for the referenced Calendar.

21802 **10.9.2.4.2.1 Payload Format**

21803 **Figure 10-169. Format of the *GetDayProfiles* Command Payload**

<b>Octets</b>	<b>4</b>	<b>4</b>	<b>1</b>	<b>1</b>
<b>Data Type</b>	uint32	uint32	uint8	uint8
<b>Field Name</b>	Provider Id (M)	Issuer Calendar ID (M)	Start Day Id (M)	Number of Days (M)

21804 **10.9.2.4.2.2 Payload Details**

21805 **Provider Id (mandatory):** An unsigned 32-bit field containing a unique identifier for the commodity provider. This field allows differentiation in deregulated markets where multiple commodity providers may be  
 21806 available. A value of 0xFFFFFFFF means not specified; the server shall return day profiles irrespective of  
 21807 the value of the *Provider Id*.  
 21808

21809 **Issuer Calendar ID (mandatory):** *IssuerCalendarID* of the calendar to which the requested Day Profiles  
 21810 belong.

21811 **Start Day ID (mandatory):** Unique identifier for a Day Profile generated by the commodity supplier. The  
 21812 *Start Day ID* indicates the minimum ID of Day Profiles to be returned by the corresponding *PublishDayProfile*  
 21813 command. A value of 0x01 indicates that the (first) *PublishDayProfile* command should contain the  
 21814 profile with the lowest Day ID held by the server. A value of 0x00 is unused.

21815 **Number of Days (mandatory):** An 8-bit integer which represents the maximum number of Day Profiles that  
 21816 the client is willing to receive in response to this command. A value of 0x00 will cause the return of all day  
 21817 profiles with an ID equal to or greater than the *Start Day ID*.

21818 **Note:** A Day Profile table may need multiple *PublishDayProfile* commands to be transmitted to the client.  
 21819

21820 **10.9.2.4.3 GetWeekProfiles Command**

21821 This command initiates one or more *PublishWeekProfile* commands for the referenced Calendar.

21822 **10.9.2.4.3.1 Payload Format**

21823 **Figure 10-170. Format of the *GetWeekProfiles* Command Payload**

<b>Octets</b>	<b>4</b>	<b>4</b>	<b>1</b>	<b>1</b>
<b>Data Type</b>	uint32	uint32	uint8	uint8
<b>Field Name</b>	Provider Id (M)	Issuer Calendar ID (M)	Start Week Id (M)	Number of Weeks (M)

21831 **10.9.2.4.3.2 Payload Details**

21832 **Provider Id (mandatory):** An unsigned 32-bit field containing a unique identifier for the commodity pro-  
 21833 vider. This field allows differentiation in deregulated markets where multiple commodity providers may be  
 21834 available. A value of 0xFFFFFFFF means not specified; the server shall return week profiles irrespective of  
 21835 the value of the *Provider Id*.

21836 **Issuer Calendar ID (mandatory):** *IssuerCalendarID* of the calendar to which the requested Week Profiles  
 21837 belong.

21838 **Start Week ID (mandatory):** Unique identifier for a Week Profile generated by the commodity supplier.  
 21839 The *Start Week ID* indicates the minimum ID of Week Profiles to be returned by the corresponding *Publish-*  
 21840 *WeekProfile* command. A value of 0x01 indicates that the *PublishWeekProfile* command should contain the  
 21841 profile with the lowest Week ID held by the server. A value of 0x00 is unused.

21842 **Number of Weeks (mandatory):** An 8-bit integer which represents the maximum number of Week Pro-  
 21843 files that the client is willing to receive in response to this command. A value of 0x00 will cause the return  
 21844 of all week profiles with an ID equal to or greater than the *Start Week ID*.  
 21845

#### 21846 10.9.2.4.4 GetSeasons Command

21847 This command initiates one or more *PublishSeasons* commands for the referenced Calendar.

##### 21848 10.9.2.4.4.1 Payload Format

21849 **Figure 10-171. Format of the *GetSeasons* Command Payload**

<b>Octets</b>	<b>4</b>	<b>4</b>
<b>Data Type</b>	uint32	uint32
<b>Field Name</b>	Provider Id (M)	Issuer Calendar ID (M)

##### 21850 10.9.2.4.4.2 Payload Details

21851 **Provider Id (mandatory):** An unsigned 32-bit field containing a unique identifier for the commodity pro-  
 21852 vider. This field allows differentiation in deregulated markets where multiple commodity providers may be  
 21853 available. A value of 0xFFFFFFFF means not specified; the server shall return season tables irrespective of  
 21854 the value of the *Provider Id*.

21855 **Issuer Calendar ID (mandatory):** *IssuerCalendarID* of the calendar to which the requested Seasons belong.

21856 **Note:** A Season Table may need multiple *PublishSeasons* commands to be transmitted to the client.  
 21857

#### 21858 10.9.2.4.5 GetSpecialDays Command

21859 This command initiates one or more *PublishSpecialDays* commands for the scheduled Special Day Table  
 21860 updates.

##### 21861 10.9.2.4.5.1 Payload Format

21862 **Figure 10-172. Format of the *GetSpecialDays* Command Payload**

<b>Octets</b>	<b>4</b>	<b>1</b>	<b>1</b>	<b>4</b>	<b>4</b>
<b>Data Type</b>	UTC	uint8	enum8	uint32	uint32
<b>Field Name</b>	Start Time (M)	Number of Events (M)	Calendar Type (M)	Provider Id (M)	Issuer Calendar ID (M)

21863 **10.9.2.4.5.2 Payload Details**

21864 **Start Time (mandatory):** UTC Timestamp to select active and scheduled events to be returned by the cor-  
21865 responding *PublishSpecialDays* command. If the command has a *Start Time* of 0x00000000, replace that  
21866 *Start Time* with the current time stamp.

21867 **Number of Events (mandatory):** An 8-bit integer which represents the maximum number of Special Day  
21868 Table instances to be sent. A value of 0 would indicate all available Special Day tables shall be returned. The  
21869 first returned *PublishSpecialDays* command should be that which is active or becomes active at the stated  
21870 *Start Time*. The first returned Special Day table shall be the instance which is active or becomes active at the  
21871 stated *Start Time*. If more than one instance is requested, the active and scheduled instances shall be sent with  
21872 ascending ordered *Start Time*.

21873 Note: A Special Day table may need multiple *PublishSpecialDay* commands to be transmitted to the client.

21874 **Calendar Type (mandatory):** An 8-bit enumeration identifying the calendar type of the requested Special  
21875 Days. Generation Meters shall use the ‘Received’ Calendar. See Table 10-175. A value of 0xFF means not  
21876 specified. If the *CalendarType* is not specified, the server shall return Special Days regardless of their type.

21877 **Provider Id (mandatory):** An unsigned 32-bit field containing a unique identifier for the commodity pro-  
21878 vider. This field allows differentiation in deregulated markets where multiple commodity providers may be  
21879 available. A value of 0xFFFFFFFF means not specified; the server shall return Special Day tables irrespective  
21880 of the value of the *Provider Id*.

21881 **Issuer Calendar ID (mandatory):** Unique identifier generated by the commodity supplier. A value of  
21882 0x00000000 will cause the return of all Special Days profiles.  
21883

21884 **10.9.2.4.6 GetCalendarCancellation Command**

21885 This command initiates the return of the last *CancelCalendar* command held on the associated server.

21886 **10.9.2.4.6.1 Payload Details**

21887 This command has no payload.

21888 **10.9.2.4.6.2 When Generated**

21889 This command is generated when the client device wishes to fetch any pending *CancelCalendar* command  
21890 from the server (see 10.9.2.3.6 for further details). In the case of a BOMD, this may be as a result of the  
21891 associated Notification flag.

21892 A Default Response with status NOT\_FOUND shall be returned if there is no *CancelCalendar* command  
21893 available.  
21894

21895 **10.9.3 Client**

21896 **10.9.3.1 Dependencies**

21897 None.

21898 **10.9.3.2 Attributes**

21899 The client has no attributes.

### 21900 **10.9.3.3 Commands Received**

21901 The client receives the cluster-specific response commands detailed in 10.9.2.3.

### 21902 **10.9.3.4 Commands Generated**

21903 The client generates the cluster-specific commands detailed in 10.9.2.4, as required by the application.  
21904

## 21905 **10.9.4 Application Guidelines**

21906 The following notes should be read in conjunction with the overview in section 10.9.1.

21907 It is recommended that mains-powered client devices ‘register’ (bind) with an associated Calendar server in  
21908 order to receive new calendar information as soon as it becomes available. Calendar servers should publish  
21909 new calendar information to bound clients as soon as it is successfully received by the server.

21910 Battery-powered devices, or device with limited resources, should not bind to the Calendar cluster. These  
21911 devices are expected to poll the Calendar server regularly in order to check for updates to calendar items.

21912 It is recommended that calendar information is persisted on devices throughout a reboot or power-cycle.  
21913 However, ALL devices should request the latest calendar information following power up, after a reboot, or  
21914 following any period without HAN communication.

21915 Acquisition of a calendar starts when a client asks for or gets pushed a current or pending *PublishCalendar*  
21916 command. From the information contained in the *PublishCalendar* command, the client should request the  
21917 relevant day, week and/or season information, respectively utilizing *GetDayProfiles*, *GetWeekProfiles* and  
21918 *GetSeasons* commands.

21919 There may be specific days when special switching behavior overrides the normal one defined by the Season  
21920 or Week Profile tables. These special dates are contained within a Special Day Table associated with the  
21921 particular calendar instance. As Special Day Table information may change more frequently than the other  
21922 information contained within a calendar, any update to the Special Day Table will be sent unsolicited to  
21923 Calendar clients registered with the relevant Calendar server. Battery-powered devices are expected to poll  
21924 the Calendar server regularly for updates to the Special Day information in a similar way to that used for  
21925 other calendar information.

## 21926 **10.10 Device Management<sup>216</sup>**

---

### 21927 **10.10.1 Overview**

21928 Please see Chapter 2 for a general cluster overview defining cluster architecture, revision, classification,  
21929 identification, etc.

21930 The Device Management Cluster provides an interface to the functionality of devices within a Smart En-  
21931 ergy network. The cluster will support the following functions:

- 21932 • Supplier Control
- 21933 • Tenancy Control
- 21934 • Password Control

---

<sup>216</sup> NEW CERTIFIABLE CLUSTER IN THIS LIBRARY

- Event Configuration

21936 **Figure 10-173. Device Management Cluster Client/Server Example**

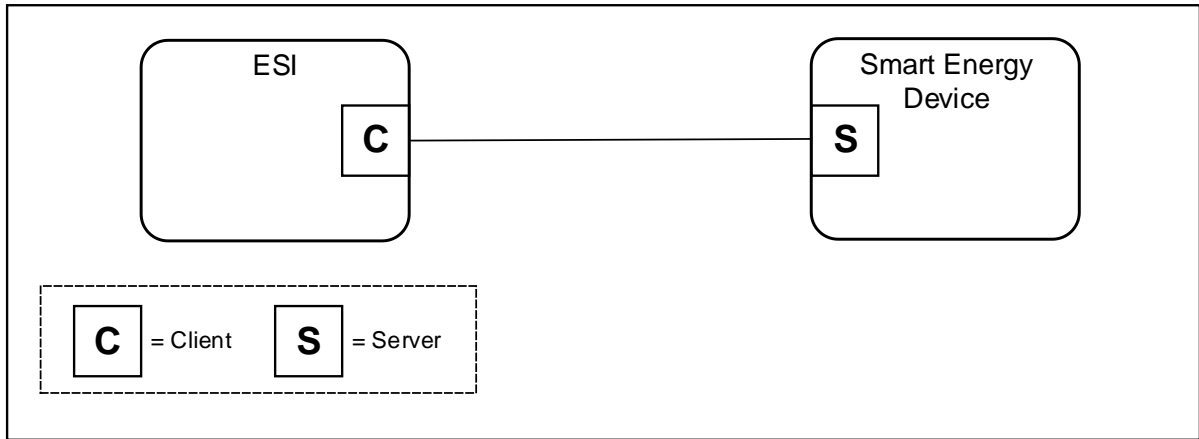

21937  
 21938

*Note: Device names are examples for illustration purposes only*

### 21939 **10.10.1.1 Supplier Control**

21940 This functionality provides a method to control the activities required to change the energy supplier to the  
 21941 premises (CoS).

### 21942 **10.10.1.2 Tenancy Control**

21943 This functionality provides a method to control the activities required when changing the tenant (consumer)  
 21944 of the property (CoT).

### 21945 **10.10.1.3 Password Control**

21946 Passwords or PINs are used to protect access to consumer data or to secure access to the energy supplier’s  
 21947 meter service menus.

21948 The Password commands provide a mechanism where a specific password located on a Smart Energy device  
 21949 may be changed to a new value or reset. The server shall maintain an access control list of the type of pass-  
 21950 word required vs. the device and, where applicable, store the last password for the device. Each device that  
 21951 supports this feature shall have a local default password.

21952 The server shall send unsolicited *RequestNewPasswordResponse* commands to its clients (except BOMDs  
 21953 unless unsolicited messages are enabled in its policy) when the backhaul connection requires the device to  
 21954 update the password.

### 21955 **10.10.1.4 Revision History**

21956 The global *ClusterRevision* attribute value SHALL be the highest revision number in the table below.

Rev	Description
1	mandatory global <i>ClusterRevision</i> attribute added; Added from SE1.4.

21957 **10.10.1.5 Classification**

Hierarchy	Role	PICS Code	Primary Transaction
Base	Application	SEDM	Type 1 (client to server)

21958 **10.10.1.6 Cluster Identifiers**

Identifier	Name
0x0708	Device Management (Smart Energy)

21959

21960 **10.10.2 Server**

21961 **10.10.2.1 Dependencies**

21962 Events carried using this cluster include a timestamp with the assumption that target devices maintain a real  
21963 time clock. Devices can acquire and synchronize their internal clocks via the Time cluster server.

21964 **10.10.2.2 Attributes**

21965 For convenience, the attributes defined in this specification are arranged into sets of related attributes; each  
21966 set can contain up to 256 attributes. Attribute identifiers are encoded such that the most significant Octet  
21967 specifies the attribute set and the least significant Octet specifies the attribute within the set. The currently  
21968 defined attribute sets are listed in the following Table 10-178.

21969 **Table 10-178. Device Management Cluster Server Attribute Sets**

Attribute Set Identifier	Description
0x00	Reserved
0x01	Supplier Control Attribute Set
0x02	Tenancy Control Attribute Set
0x03	Backhaul Control Attribute Set
0x04	HAN Control Attribute Set

21970

21971 **10.10.2.2.1 Supplier Control Attribute Set**

21972 **Table 10-179. Supplier Control Attribute Set**

Id	Name	Type	Range	Acc	Def	M
0x0100	ProviderID	uint32	0x00000000 to 0xFFFFFFFF	R	0x00000000	O
0x0101	ProviderName	octstr	1 to 17 Octets	R	-	O
0x0102	ProviderContactDetails	octstr	1 to 20 Octets	R	-	O



<b>Id</b>	<b>Name</b>	<b>Type</b>	<b>Range</b>	<b>Acc</b>	<b>Def</b>	<b>M</b>
0x0110	ProposedProviderID	uint32	0x00000000 to 0xFFFFFFFF	R	-	O
0x0111	ProposedProviderName	octstr	1 to 17 Octets	R	-	O
0x0112	ProposedProvider ChangeDate/Time	UTC	0x00000000 to 0xFFFFFFFF	R	-	O
0x0113	ProposedProvider ChangeControl	map32	0x00000000 - 0xffffffff	R	-	O
0x0114	ProposedProvider ContactDetails	octstr	1 to 20 Octets	R	-	O
0x0120	ReceivedProviderID	uint32	0x00000000 to 0xFFFFFFFF	R	-	O
0x0121	ReceivedProviderName	octstr	1 to 17 Octets	R	-	O
0x0122	ReceivedProvider ContactDetails	octstr	1 to 20 Octets	R	-	O
0x0130	ReceivedProposed ProviderID	uint32	0x00000000 to 0xFFFFFFFF	R	-	O
0x0131	ReceivedProposed Provider Name	octstr	1 to 17 Octets	R	-	O
0x0132	ReceivedProposed Provider ChangeDate/Time	UTC	0x00000000 to 0xFFFFFFFF	R	-	O
0x0133	ReceivedProposed Provider ChangeControl	map32	0x00000000 - 0xffffffff	R	-	O
0x0134	ReceivedProposed Provider ContactDetails	octstr	1 to 20 Octets	R	-	O

21973

21974 **10.10.2.2.1.1 Provider ID Attribute**

21975 An unsigned 32-bit field containing a unique identifier for the current commodity supplier. The default value  
 21976 of 0x00000000 shall be used for installation.

21977 **10.10.2.2.1.2 Provider Name Attribute**

21978 An octet string containing the name of the current supplier of the commodity to the device. The attribute is  
 21979 capable of storing a 16 character string (the first octet indicates length) encoded in the UTF-8 format.

21980 **10.10.2.2.1.3 Provider Contact Details Attribute**

21981 An octet string containing the contact details of the current Provider delivering a commodity to the premises.  
 21982 The attribute is capable of storing a 19 character string (the first octet indicates length) encoded in UTF-8  
 21983 format.

21984 **10.10.2.2.1.4 Proposed Provider ID Attribute**

21985 An unsigned 32-bit field containing a unique identifier for the commodity supplier associated with the pro-  
 21986 posed change to the supply of the commodity.

21987 **10.10.2.2.1.5 Proposed Provider Name Attribute**

21988 The *Proposed Provider Name* indicates the name for the commodity supplier associated with the proposed  
 21989 change to the supply of energy. This attribute is an octet string field capable of storing a 16 character string  
 21990 (the first octet indicates length) encoded in the UTF-8 format.

21991 **10.10.2.2.1.6 Proposed Provider Change Date/Time Attribute**

21992 A UTC time that defines the time and date when the new supplier will take over the supply of the commodity  
 21993 to the Meter/HAN.

21994 **10.10.2.2.1.7 Proposed Provider Change Control Attribute**

21995 This is a 32-bit mask that denotes the functions that are required to be carried out on processing of the change  
 21996 of supplier. The format of this Bitmap is shown within Table 10-180.

21997 **Table 10-180. Proposed Change Control BitMap**

Bit	Value	Description
0	Pre Snapshots (see Metering & Prepayment clusters for additional information)	A snapshot shall be triggered
1	Post Snapshots (see Metering & Prepayment clusters for additional information)	A snapshot shall be triggered
2	Reset Credit Register	All Credit Registers shall be reset to their default value
3	Reset Debit Register	All Debt Registers shall be reset to their default value
4	Reset Billing Period	All Billing periods shall be reset to their default value
5	Clear Tariff Plan	The tariff shall be reset to its default value
6	Clear Standing Charge	The Standing Charge shall be reset to its default value
7	Block Historical Load Profile Information	Historical LP information shall no longer be available to be published to the HAN. With regards to a meter that is mirrored, this information may be available to the HES but not to the HAN. Any historical LP shall be cleared from the IHD.
8	Clear Historical Load Profile Information	Historical LP information shall be cleared from all devices
9	Clear IHD Data - Consumer	All consumer data shall be removed
10	Clear IHD Data - Supplier	All supplier data shall be removed
11 & 12	Meter Contactor State "On / Off / Armed"	The required status of the meter contactor post action. Available bit combinations are shown in Table 10-181. NOTE: In certain markets, this value cannot trigger automatic reconnection of the supply, only maintain the current status of, disconnect or ARM the supply.
13	Clear Transaction Log	All transaction logs shall be cleared from all devices
14	Clear Prepayment Data	All Prepayment Registers shall be reset to their default state

21998

21999 **Table 10-181. Meter Contactor State Bit Combinations**

Bit Combination	Status
0b00	Supply OFF
0b01	Supply OFF / ARMED

0b10	Supply ON (see note)
0b11	Supply UNCHANGED

22000

22001 **10.10.2.2.1.8 Proposed Provider Contact Details Attribute**

22002 An octet string containing the contact details of the Provider associated with the proposed change of supply  
 22003 of the commodity delivered to the premises. The attribute is capable of storing a 19 character string (the first  
 22004 octet indicates length) encoded in UTF-8 format.

22005 **10.10.2.2.1.9 ReceivedProviderID Attribute**

22006 An unsigned 32-bit field containing a unique identifier for the commodity supplier receiving the Received  
 22007 energy.

22008 **10.10.2.2.1.10 ReceivedProviderName Attribute**

22009 The name of the current supplier of Received energy services to the device. This attribute is an octet string  
 22010 field capable of storing a 16 character string (the first octet indicates length) encoded in the UTF-8 format.

22011 **10.10.2.2.1.11 ReceivedProviderContactDetails Attribute**

22012 An octet string containing the contact details of the current Provider receiving a commodity from the prem-  
 22013 ises. The attribute is capable of storing a 19 character string (the first octet indicates length) encoded in UTF-  
 22014 8 format.

22015 **10.10.2.2.1.12 ReceivedProposedProviderID Attribute**

22016 An unsigned 32-bit field containing a unique identifier for the commodity supplier associated with the prop-  
 22017 posed change to the Receiving of energy.

22018 **10.10.2.2.1.13 ReceivedProposedProviderName Attribute**

22019 The *Received Proposed Provider Name* indicates the name for the commodity supplier associated with the  
 22020 proposed change to the Receiving of energy. This attribute is an octet string field capable of storing a 16  
 22021 character string (the first octet indicates length) encoded in the UTF-8 format.

22022 **10.10.2.2.1.14 ReceivedProposedProviderChangeDate/Time Attribute**

22023 A UTC time that defines the time and date that the new supplier will take over the Received of energy from  
 22024 the Meter/HAN.

22025 **10.10.2.2.1.15 ReceivedProposedProviderChangeControl Attribute**

22026 This is a 32-bit mask that denotes the functions that are required to be carried out on processing of the change  
 22027 of supplier. The format of this Bitmap is shown within Table 10-180.

22028 **10.10.2.2.1.16 Received Proposed Provider Contact Details Attribute**

22029 An octet string containing the contact details of the Provider associated with the proposed change of receipt  
 22030 of the commodity from the premises. The attribute is capable of storing a 19 character string (the first octet  
 22031 indicates length) encoded in UTF-8 format.

22032 **10.10.2.2.2 Tenancy Control Attribute Set**

22033 **Table 10-182. Tenancy Control Attribute Set**

Id	Name	Type	Range	Acc	Def	M
0x0200	ChangeofTenancy UpdateDate/Time	UTC		R	-	O
0x0201	Proposed Tenancy Change Control	map32	0x00000000 - 0xffffffff	R	-	O

22034

22035 **10.10.2.2.2.1 ChangeofTenancyUpdateDate/Time Attribute**

22036 The *ChangeofTenancyUpdateDate/Time* attribute indicates the time at which a proposed change to the tenancy is to be implemented. Until an initial change of tenancy becomes available, this attribute shall be set to 0xFFFFFFFF (i.e. invalid).

22039 **10.10.2.2.2.2 ProposedTenancyChangeControl Attribute**

22040 This is a 32-bit mask that denotes the functions that are required to be carried out on processing of the change of tenancy. The format of this Bitmap is shown within Table 10-180. Until an initial change of tenancy becomes available, this attribute shall be set to 0x00000000.

22043

22044 **10.10.2.2.3 Backhaul Control Attribute Set**

22045 **Table 10-183. Backhaul Control Attribute Set**

Id	Name	Type	Range	Acc	Def	M
0x0300	WAN Status	enum8	0x00 to 0xFF	R	-	O

22046

22047 **10.10.2.2.3.1 WAN Status Attribute**

22048 The *WAN Status* attribute is an 8-bit enumeration defining the state of the WAN (Wide Area Network) connection as listed in the table below:

22050 **Table 10-184. State of the WAN Connection**

Enumeration	Description
0x00	Connection to WAN is not available
0x01	Connection to WAN is available

22051 **10.10.2.2.4 HAN Control Attribute Set**

22052 **Table 10-185. HAN Control Attribute Set**

Id	Name	Type	Range	Acc	Def	M
0x0400	LowMediumThreshold	uint32	0x00000000 to 0xFFFFFFFF	R	-	O

<b>Id</b>	<b>Name</b>	<b>Type</b>	<b>Range</b>	<b>Acc</b>	<b>Def</b>	<b>M</b>
0x0401	MediumHighThreshold	uint32	0x00000000 to 0xFFFFFFFF	R	-	O

22053

22054 **10.10.2.2.4.1 Low Medium Threshold Attribute**

22055 The *Low Medium Threshold* attribute is an unsigned 32-bit integer indicating the threshold at which the value  
 22056 of *Instantaneous Demand* is deemed to have moved from low energy usage to medium usage. The unit of  
 22057 measure for this value is as specified by the *UnitOfMeasure* attribute within the Metering cluster (see Table  
 22058 10-72 for definition).

22059 **10.10.2.2.4.2 Medium High Threshold Attribute**

22060 The *Medium High Threshold* attribute is an unsigned 32-bit integer indicating the threshold at which the  
 22061 value of *Instantaneous Demand* is deemed to have moved from medium energy usage to high usage. The unit  
 22062 of measure for this value is as specified by the *UnitOfMeasure* attribute within the Metering cluster (see  
 22063 Table 10-72 for definition).

22064

22065 **10.10.2.3 Commands Received**

22066 Table 10-186 lists cluster-specific commands that are received by the server.

22067 **Table 10-186. Cluster -specific Commands Received by the Device Management Cluster Server**

<b>Command Identifier FieldValue</b>	<b>Description</b>	<b>M</b>
0x00	Get Change of Tenancy	O
0x01	Get Change of Supplier	O
0x02	Request New Password	O
0x03	GetSiteID	O
0x04	Report Event Configuration	O
0x05	GetCIN	O

22068

22069 **10.10.2.3.1 Get Change of Tenancy Command**

22070 This command is used to request the ESI to respond with information regarding any available change of  
 22071 tenancy.

22072 **10.10.2.3.1.1 Payload Details**

22073 There are no fields for this command.

22074 **10.10.2.3.1.2 Effect on Receipt**

22075 The ESI shall send a *PublishChangeofTenancy* command. A Default Response with status NOT\_FOUND  
 22076 shall be returned if there is no change of tenancy information available.

22077

22078 **10.10.2.3.2 Get Change of Supplier Command**

22079 This command is used to request the ESI to respond with information regarding any available change of  
22080 supplier.

22081 **10.10.2.3.2.1 Payload Details**

22082 There are no fields for this command.

22083 **10.10.2.3.2.2 Effect on Receipt**

22084 The ESI shall send a *PublishChangeofSupplier* command. A Default Response with status NOT\_FOUND  
22085 shall be returned if there is no change of supplier information available.  
22086

22087 **10.10.2.3.3 RequestNewPassword Command**

22088 This command is used to request the current Password from the server.

22089 **10.10.2.3.3.1 Payload Format**

22090 **Figure 10-174. Format of the *RequestNewPassword* Command Payload**

<b>Octets</b>	<b>1</b>
<b>Data Type</b>	enum8
<b>Field Name</b>	Password Type (M)

22091 **10.10.2.3.3.2 Payload Details**

22092 **PasswordType (mandatory):** Indicates which password is requested. The possible password types are de-  
22093 fined in Table 10-188.

22094 **10.10.2.3.3.3 Effect on Receipt**

22095 The ESI shall send a *RequestNewPasswordResponse* command. A Default Response with status  
22096 NOT\_FOUND shall be returned if there is no password available.  
22097

22098 **10.10.2.3.4 GetSiteID Command**

22099 This command is used to request the ESI to respond with information regarding any pending change of Site  
22100 ID.

22101 **10.10.2.3.4.1 Payload Details**

22102 There are no fields for this command.

22103 **10.10.2.3.4.2 Effect on Receipt**

22104 The ESI shall send an *UpdateSiteID* command. A Default Response with status NOT\_FOUND shall be re-  
22105 turned if there is no change of Site ID pending.  
22106

22107 **10.10.2.3.5 Report Event Configuration Command**

22108 This command is sent in response to a *GetEventConfiguration* command.

22109 **10.10.2.3.5.1 Payload Format**

22110

**Figure 10-175. Format of the Report Event Configuration Command Payload**

<b>Octets</b>	<b>1</b>	<b>1</b>	<b>variable</b>
<b>Data Type</b>	uint8	uint8	variable
<b>Field Name</b>	Command Index (M)	Total Commands (M)	Event Configuration Payload (M)

22111 **10.10.2.3.5.2 Payload Details**

22112 **Command Index (mandatory):** The *Command Index* is used to count the payload fragments in the case  
 22113 where the entire payload does not fit into one message. The *Command Index* starts at 0 and is incremented  
 22114 for each fragment belonging to the same command.

22115 **Total Commands (mandatory):** This parameter holds the total number of responses.

22116 **Event Configuration Payload (mandatory):** The log payload is a series of events, in time sequential order.  
 22117 The event payload consists of the logged events and detailed within the event configuration attribute list:

22118

**Figure 10-176. Format of the Event Configuration Sub-Payload**

<b>Octets</b>	<b>2</b>	<b>1</b>	<b>...</b>	<b>2</b>	<b>1</b>
<b>Data Type</b>	uint16	map8	...	uint16	map8
<b>Field Name</b>	Event ID (M)	Event Configuration (M)	...	Event ID n (M)	Event Configuration n (M)

22119 **Event ID (mandatory):** The *Event ID* is the attribute ID of the Event Configuration attribute. Zigbee Event  
 22120 IDs are detailed in Table 10-192 to Table 10-200.

22121 **Event Configuration (mandatory):** The configuration bitmap applicable to the event, as defined in Table  
 22122 10-193.  
 22123

22124 **10.10.2.3.6 GetCIN Command**

22125 This command is used to request the ESI to respond with information regarding any pending change of Cus-  
 22126 tomer ID Number.

22127 **10.10.2.3.6.1 Payload Details**

22128 There are no fields for this command.

22129 **10.10.2.3.6.2 Effect on Receipt**

22130 The ESI shall send an *UpdateCIN* command. A Default Response with status NOT\_FOUND shall be returned  
 22131 if there is no change of Customer ID Number pending.  
 22132

22133 **10.10.2.4 Commands Generated**

22134 Table 10-187 lists commands that are generated by the server.

22135

**Table 10-187. Cluster-specific Commands Sent by the Server**

Command Identifier Field Value	Description	Mandatory / Optional
--------------------------------	-------------	----------------------

0x00	Publish Change of Tenancy	O
0x01	Publish Change of Supplier	O
0x02	Request New password Response	O
0x03	UpdateSiteID	O
0x04	SetEventConfiguration	O
0x05	GetEventConfiguration	O
0x06	UpdateCIN	O

22136

### 22137 10.10.2.4.1 Publish Change of Tenancy Command

22138 This command is used to change the tenancy of a meter.

#### 22139 10.10.2.4.1.1 Payload Format

22140 **Figure 10-177. Format of the *Publish Change of Tenancy Command* Payload**

<b>Octets</b>	<b>4</b>	<b>4</b>	<b>1</b>	<b>4</b>	<b>4</b>
<b>Data Type</b>	uint32	uint32	map8	UTC	map32
<b>Field Name</b>	Provider ID (M)	Issuer Event ID (M)	Tariff Type (M)	Implementation Date/Time(M)	Proposed Tenancy Change Control (M)

#### 22141 10.10.2.4.1.2 Payload Details

22142 **Provider ID (mandatory):** An unsigned 32 bit field containing a unique identifier for the commodity provider to whom this command relates.

22144 **Issuer Event ID (mandatory):** Unique identifier generated by the commodity provider. When new information is provided that replaces older information for the same time period, this field allows devices to determine which information is newer. The value contained in this field is a unique number managed by upstream servers or a UTC based time stamp (UTC data type) identifying when the Publish command was issued. Thus, newer information will have a value in the *Issuer Event ID* field that is greater than older information.

22150 **Tariff Type (Mandatory):** An 8-bit bitmap identifying the type of tariff published in this command. The least significant nibble represents an enumeration of the tariff type as detailed in Table 10-37 (Generation Meters shall use the ‘Received’ Tariff). The most significant nibble is reserved.

22153 **Implementation Date/Time (mandatory):** A UTC field to indicate the date from which the change of tenancy is to be applied. This value shall always be in advance of the *CommandDate/Time* and/or the *LocalTime* by at least 24hrs. An *Implementation Date/Time* of 0xFFFFFFFF shall cause an existing but pending *Publish Change of Tenancy* command with the same *Provider ID* and *Issuer Event ID* to be cancelled.

22157 **Proposed Tenancy Change Control (mandatory):** A 32-bit mask that denotes the functions that are required to be carried out on processing of this command. See Table 10-180 for further details.

#### 22159 10.10.2.4.1.3 When Generated

22160 The *PublishChangeofTenancy* command shall be generated from the ESI, and sent to the meter, when a change of tenancy is required. This command can be sent prior to the change of tenancy. The meter should use the standard Default Response.

#### 22163 10.10.2.4.1.4 Effect on Receipt



22164 On receipt of the *PublishChangeofTenancy* command, the device shall update the *ChangeofTenancyUpdateDate/Time* and *ProposedTenancyChangeControl* attributes, but only action the command at the *ImplementationDate/Time*. At the *ImplementationDate/Time*, the device shall check the *ProposedTenancyChangeControl* attribute to understand what additional action(s) it must carry out pre and post the change.  
 22165  
 22166  
 22167  
 22168

### 22169 10.10.2.4.2 Publish Change of Supplier Command

22170 This command is used to change the Supplier (commodity provider) that is supplying the property. This  
 22171 command shall only be used if there is a requirement for the *ProviderID* to be a static value within the Pre-  
 22172 payment and Price clusters. Should there be a requirement for the *ProviderID* to be dynamic, this command  
 22173 and the associated attributes should not be used. It is recommended that this command is sent at least one  
 22174 week before the proposed date of change.

#### 22175 10.10.2.4.2.1 Payload Format

22176

Figure 10-178. Format of the *Publish Change of Supplier Command Payload*

Oc-tets	4	4	1	4	4	4	1 - 16	1 - 20
Data Type	uint32	uint32	map8	uint32	UTC	map32	octstr	octstr
Field Name	Current Provider ID (M)	Issuer Event ID (M)	Tar-iff Type (M)	Pro-posed Provider ID (M)	Provider Change Implementation Time (M)	Pro-vider Change Control (M)	Pro-posed Provider Name (M)	Pro-posed Provider Contact Details (M)

#### 22177 10.10.2.4.2.2 Payload Details

22178 **Current Provider ID (mandatory):** An unsigned 32 bit field containing a unique identifier for the current  
 22179 commodity provider to whom this command relates.

22180 **Issuer Event ID (mandatory):** Unique identifier generated by the commodity provider. When new infor-  
 22181 mation is provided that replaces older information for the same time period, this field allows devices to de-  
 22182 termine which information is newer. The value contained in this field is a unique number managed by up-  
 22183 stream servers or a UTC based time stamp (UTC data type) identifying when the Publish command was  
 22184 issued. Thus, newer information will have a value in the *Issuer Event ID* field that is larger than older infor-  
 22185 mation.

22186 **Tariff Type (Mandatory):** An 8-bit bitmap identifying the type of tariff published in this command. The  
 22187 least significant nibble represents an enumeration of the tariff type as detailed in Table 10-37 (Generation  
 22188 Meters shall use the ‘Received’ Tariff). The most significant nibble is reserved.

22189 **Proposed Provider ID (mandatory):** An unsigned 32 bit field containing a unique identifier for the com-  
 22190 modity provider associated with the proposed change to the supply. Depending on the *Tariff Type*, this value  
 22191 will be taken from either attribute 10.10.2.2.1.4 or 10.10.2.2.1.12.

22192 **Provider Change Implementation Time (mandatory):** A UTC field to indicate the date/time at which a  
 22193 proposed change to the provider is to be implemented. Depending on the *Tariff Type*, this value will be taken  
 22194 from either attribute 10.10.2.2.1.6 or 10.10.2.2.1.14. A *Provider Change Implementation Time* of  
 22195 0xFFFFFFFF shall cause an existing but pending *Publish Change of Supplier* command with the same Cur-  
 22196 rent *Provider ID* and *Issuer Event ID* to be cancelled.

22197 **Proposed Provider Name (mandatory):** An octet string that denotes the name of the new commodity pro-  
22198 vider. This is dependent on the *Tariff Type* value; for Received, the parameter should match the attribute in  
22199 section 10.10.2.2.1.13, for all other values it should match the attribute in section 10.10.2.2.1.5.

22200 **Proposed Provider Contact Details (mandatory):** An octet string that denotes the contact details of the  
22201 new commodity provider. The field shall be capable of storing a 19 character string (the first octet indicates  
22202 length) encoded in UTF-8 format.

22203 **Provider Change Control (mandatory):** A 32-bit mask that denotes the functions that are required to be  
22204 carried out on processing of this command. See section 10.10.2.2.1.7 or 10.10.2.2.1.15, depending on the  
22205 *Tariff Type*.

22206 **10.10.2.4.2.3 When Generated**

22207 The *PublishChangeofSupplier* command shall be generated from the ESI, and sent to the meter, when a  
22208 change of commodity provider is required. It shall also be generated in response to a *Get Change of Supplier*  
22209 command. The *PublishChangeofSupplier* command contains a start date/time which allows the command to  
22210 be sent in advance of the changeover date.

22211 **10.10.2.4.2.4 Effect on Receipt**

22212 Following receipt of a *PublishChangeofSupplier* command, the meter shall only action the command at the  
22213 *ProviderChangeImplementationTime*. At this point in time, the meter shall check the *Provider Change Con-*  
22214 *trol* field to understand what action(s) it must carry out pre and post the change.  
22215

22216 **10.10.2.4.3 Request New Password Response Command**

22217 This command is used to send the current password to the client. A *RequestNewPasswordResponse* command  
22218 is sent either as a response to a *RequestNewPassword* command or unsolicited when the HES has changed  
22219 the password.

22220 **10.10.2.4.3.1 Payload Format**

22221 **Figure 10-179. Format of the *RequestNewPasswordResponse* Command Payload**

Octets	4	4	2	1	1 - 11
Data Type	uint32	UTC	uint16	enum8	octstr
Field Name	Issuer Event ID (M)	Implementation Date/Time (M)	Duration in minutes (M)	Password Type (M)	Password (M)

22222 **10.10.2.4.3.2 Payload Details**

22223 **Issuer Event ID (mandatory):** Unique identifier generated by the commodity provider. When new infor-  
22224 mation is provided that replaces older information for the same time period, this field allows devices to de-  
22225 termine which information is newer. The value contained in this field is a unique number managed by up-  
22226 stream servers or a UTC based time stamp (UTC data type) identifying when the Publish command was  
22227 issued. Thus, newer information will have a value in the *Issuer Event ID* field that is larger than older infor-  
22228 mation.

22229 **Implementation Date/Time (mandatory):** A UTC field to indicate the date at which the originating com-  
22230 mand was to be applied.

22231 **Duration in minutes (mandatory):** An unsigned 16-bit integer that denotes the duration in minutes that the  
22232 password is valid for. A value of Zero means the password is valid until changed.

22233 **PasswordType (mandatory):** Indicates which password should be changed. The possible password types  
 22234 are defined in Table 10-188. The password types can be used flexibly by various end devices. The scope of  
 22235 authority assigned to a password type should be defined by the corresponding end device.

22236 **Table 10-188. Password Type Enumeration**

Enumerated Value	Description	Usage
0x00	Reserved	Not Used
0x01	Password 1	Used for access to the Service menu
0x02	Password 2	Used for access to the Consumer menu
0x03	Password 3	TBD
0x04	Password 4	TBD

22237  
 22238 **Password (mandatory):** An octet string of length 11 that contains the password (the first octet is the length,  
 22239 allowing 10 octets for the password).

22240 **10.10.2.4.3.3 Effect on Receipt**

22241 On receipt of this command, the client shall update the specified password.  
 22242

22243 **10.10.2.4.4 Update SiteID Command**

22244 This command is used to set the *SiteID* attribute on a meter (see 10.4.2.2.4.8).

22245 **10.10.2.4.4.1 Payload Format**

22246 **Figure 10-180. Format of the Update SiteID Command Payload**

<b>Octets</b>	<b>4</b>	<b>4</b>	<b>4</b>	<b>1-33</b>
<b>Data Type</b>	uint32	UTC	uint32	octstr
<b>Field Name</b>	Issuer Event ID (M)	SiteID Time (M)	Provider ID (M)	SiteID (M)

22247 **10.10.2.4.4.2 Payload Details**

22248 **Issuer Event ID (mandatory):** Unique identifier generated by the commodity provider. When new infor-  
 22249 mation is provided that replaces older information for the same time period, this field allows devices to de-  
 22250 termine which information is newer. The value contained in this field is a unique number managed by up-  
 22251 stream servers or a UTC based time stamp (UTC data type) identifying when the Publish command was  
 22252 issued. Thus, newer information will have a value in the *Issuer Event ID* field that is larger than older infor-  
 22253 mation.

22254 **SiteID Time (mandatory):** A UTC field to denote the time at which the update of *SiteID* will take place. A  
 22255 date/time of 0x00000000 shall indicate that the command should be executed immediately (comparison  
 22256 against a time source should NOT be made in this case). A date/time of 0xFFFFFFFF shall cause an existing  
 22257 but pending *Update SiteID* command with the same *Provider ID* and *Issuer Event ID* to be cancelled.

22258 **Provider ID:** An unsigned 32-bit field containing a unique identifier for the commodity provider to whom  
 22259 this command relates.

22260 **SiteID (mandatory):** An octet string that denotes the Site ID.  
 22261

22262 **10.10.2.4.5 SetEventConfiguration Command**

22263 This command provides a method to set the event configuration attributes, held in a client device.

22264 **10.10.2.4.5.1 Payload Format**

22265 **Figure 10-181. Format of the Set Event Configuration Command Payload**

<b>Octets</b>	<b>4</b>	<b>4</b>	<b>1</b>	<b>1</b>	<b>Variable</b>
<b>Data Type</b>	uint32	UTC	map8	enum8	variable
<b>Field Name</b>	Issuer Event ID (M)	Start Date/Time (M)	Event Configuration (M)	Configuration Control (M)	Event Configuration Payload (M)

22266 **10.10.2.4.5.2 Payload Details**

22267 **Issuer Event ID (mandatory):** Unique identifier generated by the commodity provider. When new information is provided that replaces older information for the same time period, this field allows devices to determine which information is newer. The value contained in this field is a unique number managed by upstream servers or a UTC based time stamp (UTC data type) identifying when the command was issued. Thus, 22268 22269 22270 22271 newer information will have a value in the *Issuer Event ID* field that is larger than older information.

22272 **Start Date/Time (mandatory):** A UTC field to indicate the date and time at which the new configuration is 22273 to be applied.

22274 **Event Configuration (mandatory):** This field holds the new event configuration to be applied, as defined 22275 in Table 10-193.

22276 **Configuration Control (mandatory):** The *Configuration Control* enumeration allows the new configura- 22277 22278 tion value to be applied to several events via a single command. The value of this field defines the format of the event configuration payload:

22279 **Table 10-189. Configuration Control Enumeration**

<b>Value</b>	<b>Description</b>
0x00	Apply by List
0x01	Apply by Event Group
0x02	Apply by Log Type
0x03	Apply by Configuration Match

22280 **10.10.2.4.5.2.1 Apply by List**

22281 The ‘Apply by List’ option allows individual or lists of events to be configured by a single command:

22282 **Figure 10-182. Format of the ‘Apply by List’ Sub-Payload**

<b>Octets</b>	<b>1</b>	<b>2</b>	<b>...</b>	<b>2</b>
<b>Data Type</b>	uint8	uint16	...	uint16
<b>Field Name</b>	Number of Events (M)	Event ID 1 (M)	...	Event ID n (M)

22283 **Number of Events (mandatory):** This field holds the number of events contained within the command. 22284

22285 **Event ID (mandatory):** The *Event ID* is the attribute ID of the event configuration attribute. Zigbee Event 22286 IDs are detailed in Table 10-192 to Table 10-200.

22287 **10.10.2.4.5.2.2 Apply by Event Group**

22288 The ‘Apply by Event Group’ option allows all events belonging to a stated event group (attribute set) to be  
 22289 configured by a single command:

22290 **Figure 10-183. Format of the ‘Apply by Event Group’ Sub-Payload**

<b>Octets</b>	<b>2</b>
<b>Data Type</b>	uint16
<b>Field Name</b>	Event Group ID (M)

22291  
 22292 **Event Group ID (mandatory):** The *Event Group ID* field indicates which attribute set the event belongs to  
 22293 (see Table 10-190). The *Event Group ID* is in the form ‘0xnnFF’, where *nn* is the Attribute Set Identifier (the  
 22294 final attribute in the sets defined in Table 10-192 to Table 10-200 is reserved as a ‘wildcard’ attribute to allow  
 22295 definition of the *Event Group IDs*).

22296 **10.10.2.4.5.2.3 Apply by Log Type**

22297 The ‘Apply by Log Type’ option allows all configurations recorded in a given log to be configured:

22298 **Figure 10-184. Format of the ‘Apply by Log Type’ Sub-Payload**

<b>Octets</b>	<b>1</b>
<b>Data Type</b>	uint8
<b>Field Name</b>	Log ID

22299  
 22300 **Log ID:** The *Log ID* specifies the log ID of events to be updated with the new *Configuration Value* field  
 22301 passed in the command. The applicable values for this field are defined by bits 0-2 of the Table 10-193.

22302 **10.10.2.4.5.2.4 Apply by Configuration Match**

22303 The ‘Apply by Configuration Match’ option allows all events matching a given configuration value to be  
 22304 changed to the new configuration value:

22305 **Figure 10-185. Format of the ‘Apply by Configuration Match’ Sub-Payload**

<b>Octets</b>	<b>1</b>
<b>Data Type</b>	map8
<b>Field Name</b>	Configuration Value Match (M)

22306  
 22307 **Configuration Value Match (mandatory):** This field indicates that any configuration attribute which  
 22308 matches this value shall be assigned the new configuration value passed in the *Event Configuration* field of  
 22309 the main command payload (see 10.10.2.4.5.1).  
 22310

22311 **10.10.2.4.6 GetEventConfiguration Command**

22312 This command allows the server to request details of event configurations.

22313 **10.10.2.4.6.1 Payload Format**

22314 **Figure 10-186. Format of the *Get Event Configuration* Command Payload**

<b>Octets</b>	<b>2</b>
<b>Data Type</b>	uint16
<b>Field Name</b>	Event ID (M)

22315 **10.10.2.4.6.2 Payload Details**

22316 **Event ID (mandatory):** The *Event ID* specifies a particular event to be queried. A value of 0xFFFF is reserved to indicate all event IDs. A value equal to the *Event Group ID* (the final attribute in the sets defined in Table 10-192 to Table 10-200 is reserved for this purpose) shall indicate all event IDs within the indicated attribute set. The Zigbee Event IDs are detailed in Table 10-192 to Table 10-200.  
22318  
22319  
22320

22321 **10.10.2.4.7 Update CIN Command**

22322 This command is used to set the *CustomerIDNumber* attribute held in the Metering cluster (see 10.4.2.2.4.18).

22323 **10.10.2.4.7.1 Payload Format**

22324 **Figure 10-187. Format of the Update CIN Command Payload**

Octets	4	4	4	1-25
<b>Data Type</b>	uint32	UTC	uint32	octstr
<b>Field Name</b>	Issuer Event ID (M)	CIN Implementation Time (M)	Provider ID (M)	CustomerID Number (M)

22325 **10.10.2.4.7.2 Payload Details**

22326 **Issuer Event ID (mandatory):** Unique identifier generated by the commodity provider. When new information is provided that replaces older information for the same time period, this field allows devices to determine which information is newer. The value contained in this field is a unique number managed by upstream servers or a UTC based time stamp (UTC data type) identifying when the Publish command was issued. Thus, newer information will have a value in the *Issuer Event ID* field that is larger than older information.  
22327  
22328  
22329  
22330  
22331

22332 **CIN Implementation Time (mandatory):** A UTC field to denote the date/time at which the updated *CustomerIDNumber* will become active. A value of 0x00000000 shall indicate that the command should be executed immediately (comparison against a time source should NOT be made in this case). A value of 0xFFFFFFFF shall cause an existing but pending *UpdateCIN* command with the same *Provider ID* and *Issuer Event ID* to be cancelled.  
22333  
22334  
22335  
22336

22337 **Provider ID (mandatory):** An unsigned 32-bit field containing a unique identifier for the commodity provider to whom this command relates.  
22338

22339 **CustomerIDNumber (mandatory):** An octet string that denotes the Customer ID Number.

22340 **10.10.2.4.7.3 Effect on Receipt**

22341 Upon successful receipt of this command, the meter shall update the *CustomerIDNumber* attribute and return a Default Response indicating SUCCESS.  
22342

22343 A Default Response indicating NOT\_AUTHORIZED shall be returned if the Provider ID contained within the command does not match the current Provider ID. For all other failures, a Default Response indicating FAILURE shall be returned.  
22344  
22345

22346

22347 **10.10.3 Client**

22348 **10.10.3.1 Dependencies**

- 22349 • Events carried using this cluster include a timestamp with the assumption that target devices main-  
 22350 tain a real time clock. Devices can acquire and synchronize their internal clocks via the Time cluster  
 22351 server.

22352 **10.10.3.2 Attributes**

22353 **Table 10-190. Device Management Cluster Client Attribute Sets**

Attribute Set Identifier	Description
0x00	Supplier Attribute Set
0x01	Price Event Configuration Attribute Set
0x02	Metering Event Configuration Attribute Set
0x03	Messaging Event Configuration Attribute Set
0x04	Prepay Event Configuration Attribute Set
0x05	Calendar Event Configuration Attribute Set
0x06	Device Management Event Configuration Attribute Set
0x07	Tunnel Event Configuration Attribute Set
0x08	OTA Event Configuration Attribute Set
0x80 – 0xFF	Reserved for non-Zigbee Event Configuration

22354

22355 **10.10.3.2.1 Supplier Attribute Set**

22356 **Table 10-191. Supplier Attribute Set**

Id	Name	Type	Range	Acc	Def	M
0x0000	ProviderID	uint32	0x00000000 to 0xFFFFFFFF	R	-	O
0x0010	ReceivedProvider ID	uint32	0x00000000 to 0xFFFFFFFF	R	-	O

22357

22358 **10.10.3.2.1.1 ProviderID Attribute**

22359 An unsigned 32 bit field containing a unique identifier for the commodity provider to whom this attribute  
 22360 relates.

22361 **10.10.3.2.1.2 ReceivedProviderID Attribute**

22362 An unsigned 32 bit field containing a unique identifier for the commodity provider to whom this attribute  
 22363 relates. This attribute is only for the Received supply.  
 22364

22365 **10.10.3.2.2 Price Event Configuration Attribute Set**

22366 The following attributes allow events related to pricing to be configured.

22367 It should be noted that triggers for events are an implementation issue, however it is suggested that the ‘Tariff  
22368 Activated’ events should only be logged (if configured to do so) when moving from one tariff type to another,  
22369 not when a tariff is modified.

22370 **Table 10-192. Price Event Configuration Attribute Set**

<b>Id</b>	<b>Name</b>	<b>Type</b>	<b>Range</b>	<b>Acc</b>	<b>Def</b>	<b>M</b>
0x0100	TOUTariffActivation	map8	0x00 to 0xFF	R	-	O
0x0101	BlockTariffActivated	map8	0x00 to 0xFF	R	-	O
0x0102	BlockTOUTariffActivated	map8	0x00 to 0xFF	R	-	O
0x0103	SingleTariffRateActivated	map8	0x00 to 0xFF	R	-	O
0x0104	AsynchronousBillingOccurred	map8	0x00 to 0xFF	R	-	O
0x0105	SynchronousBillingOccurred	map8	0x00 to 0xFF	R	-	O
0x0106	Tariff NotSupported	map8	0x00 to 0xFF	R	-	O
0x0107	PriceClusterNotFound	map8	0x00 to 0xFF	R	-	O
0x0108	CurrencyChangePassiveActivated	map8	0x00 to 0xFF	R	-	O
0x0109	CurrencyChangePassiveUpdated	map8	0x00 to 0xFF	R	-	O
0x010A	PriceMatrixPassiveActivated	map8	0x00 to 0xFF	R	-	O
0x010B	PriceMatrixPassiveUpdated	map8	0x00 to 0xFF	R	-	O
0x010C	TariffChangePassiveActivated	map8	0x00 to 0xFF	R	-	O
0x010D	TariffChangedPassiveUpdated	map8	0x00 to 0xFF	R	-	O
0x01B0	PublishPriceReceived	map8	0x00 to 0xFF	R	-	O
0x01B1	PublishPriceActioned	map8	0x00 to 0xFF	R	-	O
0x01B2	PublishPriceCancelled	map8	0x00 to 0xFF	R	-	O
0x01B3	PublishPriceRejected	map8	0x00 to 0xFF	R	-	O
0x01B4	PublishTariffInformation Received	map8	0x00 to 0xFF	R	-	O
0x01B5	PublishTariffInformation Actioned	map8	0x00 to 0xFF	R	-	O
0x01B6	PublishTariffInformation Cancelled	map8	0x00 to 0xFF	R	-	O



<b>Id</b>	<b>Name</b>	<b>Type</b>	<b>Range</b>	<b>Acc</b>	<b>Def</b>	<b>M</b>
0x01B7	PublishTariffInformation Rejected	map8	0x00 to 0xFF	R	-	O
0x01B8	PublishPriceMatrixReceived	map8	0x00 to 0xFF	R	-	O
0x01B9	PublishPriceMatrixActioned	map8	0x00 to 0xFF	R	-	O
0x01BA	PublishPriceMatrixCancelled	map8	0x00 to 0xFF	R	-	O
0x01BB	PublishPriceMatrixRejected	map8	0x00 to 0xFF	R	-	O
0x01BC	PublishBlockThresholdsReceived	map8	0x00 to 0xFF	R	-	O
0x01BD	PublishBlockThresholdsActioned	map8	0x00 to 0xFF	R	-	O
0x01BE	PublishBlockThresholdsCancelled	map8	0x00 to 0xFF	R	-	O
0x01BF	PublishBlockThresholdsRejected	map8	0x00 to 0xFF	R	-	O
0x01C0	PublishCalorificValueReceived	map8	0x00 to 0xFF	R	-	O
0x01C1	PublishCalorificValueActioned	map8	0x00 to 0xFF	R	-	O
0x01C2	PublishCalorificValueCancelled	map8	0x00 to 0xFF	R	-	O
0x01C3	PublishCalorificValueRejected	map8	0x00 to 0xFF	R	-	O
0x01C4	PublishConversionFactorReceived	map8	0x00 to 0xFF	R	-	O
0x01C5	PublishConversionFactorActioned	map8	0x00 to 0xFF	R	-	O
0x01C6	PublishConversionFactorCancelled	map8	0x00 to 0xFF	R	-	O
0x01C7	PublishConversionFactorRejected	map8	0x00 to 0xFF	R	-	O
0x01C8	PublishCO <sub>2</sub> ValueReceived	map8	0x00 to 0xFF	R	-	O
0x01C9	PublishCO <sub>2</sub> ValueActioned	map8	0x00 to 0xFF	R	-	O
0x01CA	PublishCO <sub>2</sub> ValueCancelled	map8	0x00 to 0xFF	R	-	O
0x01CB	PublishCO <sub>2</sub> ValueRejected	map8	0x00 to 0xFF	R	-	O
0x01CC	PublishCPPEventReceived	map8	0x00 to 0xFF	R	-	O
0x01CD	PublishCPPEventActioned	map8	0x00 to 0xFF	R	-	O
0x01CE	PublishCPPEventCancelled	map8	0x00 to 0xFF	R	-	O
0x01CF	PublishCPPEventRejected	map8	0x00 to 0xFF	R	-	O
0x01D0	PublishTierLabelsReceived	map8	0x00 to 0xFF	R	-	O

<b>Id</b>	<b>Name</b>	<b>Type</b>	<b>Range</b>	<b>Acc</b>	<b>Def</b>	<b>M</b>
0x01D1	PublishTierLabelsActioned	map8	0x00 to 0xFF	R	-	O
0x01D2	PublishTierLabelsCancelled	map8	0x00 to 0xFF	R	-	O
0x01D3	PublishTierLabelsRejected	map8	0x00 to 0xFF	R	-	O
0x01D4	PublishBillingPeriodReceived	map8	0x00 to 0xFF	R	-	O
0x01D5	PublishBillingPeriodActioned	map8	0x00 to 0xFF	R	-	O
0x01D6	PublishBillingPeriodCancelled	map8	0x00 to 0xFF	R	-	O
0x01D7	PublishBillingPeriodRejected	map8	0x00 to 0xFF	R	-	O
0x01D8	PublishConsolidatedBillReceived	map8	0x00 to 0xFF	R	-	O
0x01D9	PublishConsolidatedBillActioned	map8	0x00 to 0xFF	R	-	O
0x01DA	PublishConsolidatedBillCancelled	map8	0x00 to 0xFF	R	-	O
0x01DB	PublishConsolidatedBillRejected	map8	0x00 to 0xFF	R	-	O
0x01DC	PublishBlockPeriodReceived	map8	0x00 to 0xFF	R	-	O
0x01DD	PublishBlockPeriodActioned	map8	0x00 to 0xFF	R	-	O
0x01DE	PublishBlockPeriodCancelled	map8	0x00 to 0xFF	R	-	O
0x01DF	PublishBlockPeriodRejected	map8	0x00 to 0xFF	R	-	O
0x01E0	PublishCreditPaymentInfoReceived	map8	0x00 to 0xFF	R	-	O
0x01E1	PublishCreditPaymentInfoActioned	map8	0x00 to 0xFF	R	-	O
0x01E2	PublishCreditPaymentInfoCancelled	map8	0x00 to 0xFF	R	-	O
0x01E3	PublishCreditPaymentInfoRejected	map8	0x00 to 0xFF	R	-	O
0x01E4	PublishCurrencyConversionReceived	map8	0x00 to 0xFF	R	-	O
0x01E5	PublishCurrencyConversionActioned	map8	0x00 to 0xFF	R	-	O
0x01E6	PublishCurrencyConversionCancelled	map8	0x00 to 0xFF	R	-	O
0x01E7	PublishCurrencyConversionRejected	map8	0x00 to 0xFF	R	-	O
0x01FF	Reserved for Price cluster Group ID	--	--	R	-	O

22371

22372 **10.10.3.2.2.1 Event Configuration Attributes**

22373 The least-significant 3 bits of the Event Configuration bitmaps indicate how the event should be logged; the  
 22374 remaining bits provide options for treatment rules to be applied.

22375

**Table 10-193. Event Configuration Bitmaps**

Bit	Description	
Bits 0-2	Enumerated Value	Description
	0	Do not Log
	1	Log as Tamper
	2	Log as Fault
	3	Log as General Event
	4	Log as Security Event
	5	Log as Network Event
	6-7	Reserved
Bit 3	Push Event to WAN	
Bit 4	Push Event to HAN	
Bit 5	Raise Alarm (Zigbee)	
Bit 6	Raise Alarm (Physical i.e. audible/visible)	

22376

22377 **10.10.3.2.3 Metering Event Configuration Attribute Set**

22378 The following attributes allow events related to the meter to be configured.

22379

**Table 10-194. Metering Event Configuration Attribute Set**

Id	Name	Type	Range	Acc	Def	M
0x0200	Check Meter	map8	0x00 to 0xFF	R	-	O
0x0201	Low Battery	map8	0x00 to 0xFF	R	-	O
0x0202	Tamper Detect	map8	0x00 to 0xFF	R	-	O
0x0203	<b>Supply Status</b> - Electricity: Power Failure - Gas: Not Defined - Water: Pipe Empty - Heat/Cooling: Temperature Sensor	map8	0x00 to 0xFF	R	-	O
0x0204	<b>Supply Quality</b> - Electricity: Power Quality - Gas: Low Pressure - Water: Low Pressure - Heat/Cooling: Burst Detect	map8	0x00 to 0xFF	R	-	O
0x0205	Leak Detect	map8	0x00 to 0xFF	R	-	O
0x0206	Service Disconnect	map8	0x00 to 0xFF	R	-	O

<b>Id</b>	<b>Name</b>	<b>Type</b>	<b>Range</b>	<b>Acc</b>	<b>Def</b>	<b>M</b>
0x0207	<b>Reverse Flow</b> - <i>Electricity: Reserved</i> - <i>Gas: Reverse Flow</i> - <i>Water: Reverse Flow</i> - <i>Heat/Cooling: Flow Sensor</i>	map8	0x00 to 0xFF	R	-	O
0x0208	MeterCoverRemoved	map8	0x00 to 0xFF	R	-	O
0x0209	MeterCoverClosed	map8	0x00 to 0xFF	R	-	O
0x020A	Strong MagneticField	map8	0x00 to 0xFF	R	-	O
0x020B	NoStrongMagneticField	map8	0x00 to 0xFF	R	-	O
0x020C	BatteryFailure	map8	0x00 to 0xFF	R	-	O
0x020D	ProgramMemoryError	map8	0x00 to 0xFF	R	-	O
0x020E	RAMError	map8	0x00 to 0xFF	R	-	O
0x020F	NVMemoryError	map8	0x00 to 0xFF	R	-	O
0x0210	LowVoltageL1	map8	0x00 to 0xFF	R	-	O
0x0211	HighVoltageL1	map8	0x00 to 0xFF	R	-	O
0x0212	LowVoltageL2	map8	0x00 to 0xFF	R	-	O
0x0213	HighVoltageL2	map8	0x00 to 0xFF	R	-	O
0x0214	LowVoltageL3	map8	0x00 to 0xFF	R	-	O
0x0215	HighVoltageL3	map8	0x00 to 0xFF	R	-	O
0x0216	OverCurrentL1	map8	0x00 to 0xFF	R	-	O
0x0217	OverCurrentL2	map8	0x00 to 0xFF	R	-	O
0x0218	OverCurrentL3	map8	0x00 to 0xFF	R	-	O
0x0219	FrequencyTooLowL1	map8	0x00 to 0xFF	R	-	O
0x021A	FrequencyTooHighL1	map8	0x00 to 0xFF	R	-	O
0x021B	FrequencyTooLowL2	map8	0x00 to 0xFF	R	-	O
0x021C	FrequencyTooHighL2	map8	0x00 to 0xFF	R	-	O
0x021D	FrequencyTooLowL3	map8	0x00 to 0xFF	R	-	O
0x021E	FrequencyTooHighL3	map8	0x00 to 0xFF	R	-	O

<b>Id</b>	<b>Name</b>	<b>Type</b>	<b>Range</b>	<b>Acc</b>	<b>Def</b>	<b>M</b>
0x021F	GroundFault	map8	0x00 to 0xFF	R	-	O
0x0220	ElectricTamperDetect	map8	0x00 to 0xFF	R	-	O
0x0221	IncorrectPolarity	map8	0x00 to 0xFF	R	-	O
0x0222	CurrentNoVoltage	map8	0x00 to 0xFF	R	-	O
0x0223	UnderVoltage	map8	0x00 to 0xFF	R	-	O
0x0224	OverVoltage	map8	0x00 to 0xFF	R	-	O
0x0225	NormalVoltage	map8	0x00 to 0xFF	R	-	O
0x0226	PFBelowThreshold	map8	0x00 to 0xFF	R	-	O
0x0227	PFAboveThreshold	map8	0x00 to 0xFF	R	-	O
0x0228	TerminalCoverRemoved	map8	0x00 to 0xFF	R	-	O
0x0229	TerminalCoverClosed	map8	0x00 to 0xFF	R	-	O
0x0230	BurstDetect	map8	0x00 to 0xFF	R	-	O
0x0231	PressureTooLow	map8	0x00 to 0xFF	R	-	O
0x0232	PressureTooHigh	map8	0x00 to 0xFF	R	-	O
0x0233	FlowSensorCommunicationError	map8	0x00 to 0xFF	R	-	O
0x0234	FlowSensorMeasurementFault	map8	0x00 to 0xFF	R	-	O
0x0235	FlowSensorReverseFlow	map8	0x00 to 0xFF	R	-	O
0x0236	Flow sensor air detect	map8	0x00 to 0xFF	R	-	O
0x0237	PipeEmpty	map8	0x00 to 0xFF	R	-	O
0x0240 to 0x024F	RESERVED (Water Specific Alarm Group)					
0x0250	InletTemperatureSensorFault	map8	0x00 to 0xFF	R	-	O
0x0251	OutletTemperatureSensorFault	map8	0x00 to 0xFF	R	-	O
0x0260	ReverseFlow	map8	0x00 to 0xFF	R	-	O
0x0261	TiltTamper	map8	0x00 to 0xFF	R	-	O
0x0262	BatteryCoverRemoved	map8	0x00 to 0xFF	R	-	O

<b>Id</b>	<b>Name</b>	<b>Type</b>	<b>Range</b>	<b>Acc</b>	<b>Def</b>	<b>M</b>
0x0263	BatteryCoverClosed	map8	0x00 to 0xFF	R	-	O
0x0264	ExcessFlow	map8	0x00 to 0xFF	R	-	O
0x0265	Tilt Tamper Ended	map8	0x00 to 0xFF	R	-	O
0x0270	MeasurementSystemError	map8	0x00 to 0xFF	R	-	O
0x0271	WatchdogError	map8	0x00 to 0xFF	R	-	O
0x0272	SupplyDisconnectFailure	map8	0x00 to 0xFF	R	-	O
0x0273	SupplyConnectFailure	map8	0x00 to 0xFF	R	-	O
0x0274	MeasurementSoftwareChanged	map8	0x00 to 0xFF	R	-	O
0x0275	DSTenabled	map8	0x00 to 0xFF	R	-	O
0x0276	DSTdisabled	map8	0x00 to 0xFF	R	-	O
0x0277	ClockAdjBackward	map8	0x00 to 0xFF	R	-	O
0x0278	ClockAdjForward	map8	0x00 to 0xFF	R	-	O
0x0279	ClockInvalid	map8	0x00 to 0xFF	R	-	O
0x027A	CommunicationErrorHAN	map8	0x00 to 0xFF	R	-	O
0x027B	CommunicationOKHAN	map8	0x00 to 0xFF	R	-	O
0x027C	MeterFraudAttempt	map8	0x00 to 0xFF	R	-	O
0x027D	PowerLoss	map8	0x00 to 0xFF	R	-	O
0x027E	UnusualHANTraffic	map8	0x00 to 0xFF	R	-	O
0x027F	UnexpectedClockChange	map8	0x00 to 0xFF	R	-	O
0x0280	CommsUsingUnauthenticated Component	map8	0x00 to 0xFF	R	-	O
0x0281	ErrorRegClear	map8	0x00 to 0xFF	R	-	O
0x0282	AlarmRegClear	map8	0x00 to 0xFF	R	-	O
0x0283	UnexpectedHWReset	map8	0x00 to 0xFF	R	-	O
0x0284	UnexpectedProgramExecution	map8	0x00 to 0xFF	R	-	O
0x0285	LimitThresholdExceeded	map8	0x00 to 0xFF	R	-	O

<b>Id</b>	<b>Name</b>	<b>Type</b>	<b>Range</b>	<b>Acc</b>	<b>Def</b>	<b>M</b>
0x0286	LimitThresholdOK	map8	0x00 to 0xFF	R	-	O
0x0287	LimitThresholdChanged	map8	0x00 to 0xFF	R	-	O
0x0288	MaximumDemandExceeded	map8	0x00 to 0xFF	R	-	O
0x0289	ProfileCleared	map8	0x00 to 0xFF	R	-	O
0x028A	LoadProfileCleared	map8	0x00 to 0xFF	R	-	O
0x028B	BatteryWarning	map8	0x00 to 0xFF	R	-	O
0x028C	WrongSignature	map8	0x00 to 0xFF	R	-	O
0x028D	NoSignature	map8	0x00 to 0xFF	R	-	O
0x028E	SignatureNotValid	map8	0x00 to 0xFF	R	-	O
0x028F	UnauthorisedActionfromHAN	map8	0x00 to 0xFF	R	-	O
0x0290	FastPollingStart	map8	0x00 to 0xFF	R	-	O
0x0291	FastPollingEnd	map8	0x00 to 0xFF	R	-	O
0x0292	MeterReportingInterval Changed	map8	0x00 to 0xFF	R	-	O
0x0293	DisconnecttoLoadLimit	map8	0x00 to 0xFF	R	-	O
0x0294	MeterSupplyStatusRegister Changed	map8	0x00 to 0xFF	R	-	O
0x0295	MeterAlarmStatusRegister Changed	map8	0x00 to 0xFF	R	-	O
0x0296	ExtendedMeterAlarmStatus Register Changed.	map8	0x00 to 0xFF	R	-	O
0x0297	DataAccessViaLocalPort	map8	0x00 to 0xFF	R	-	O
0x0298	Configure Mirror Success	map8	0x00 to 0xFF	R	-	O
0x0299	Configure Mirror Failure	map8	0x00 to 0xFF	R	-	O
0x029A	Configure Notification Flag Scheme Success	map8	0x00 to 0xFF	R	-	O
0x029B	Configure Notification Flag Scheme Failure	map8	0x00 to 0xFF	R	-	O
0x029C	Configure Notification Flags Success	map8	0x00 to 0xFF	R	-	O
0x029D	Configure Notification Flags Failure	map8	0x00 to 0xFF	R	-	O
0x029E	Stay Awake Request HAN	map8	0x00 to 0xFF	R	-	O

<b>Id</b>	<b>Name</b>	<b>Type</b>	<b>Range</b>	<b>Acc</b>	<b>Def</b>	<b>M</b>
0x029F	Stay Awake Request WAN	map8	0x00 to 0xFF	R	-	O
0x02B0	ManufacturerSpecificA	map8	0x00 to 0xFF	R	-	O
0x02B1	ManufacturerSpecificB	map8	0x00 to 0xFF	R	-	O
0x02B2	ManufacturerSpecificC	map8	0x00 to 0xFF	R	-	O
0x02B3	ManufacturerSpecificD	map8	0x00 to 0xFF	R	-	O
0x02B4	ManufacturerSpecificE	map8	0x00 to 0xFF	R	-	O
0x02B5	ManufacturerSpecificF	map8	0x00 to 0xFF	R	-	O
0x02B6	ManufacturerSpecificG	map8	0x00 to 0xFF	R	-	O
0x02B7	ManufacturerSpecificH	map8	0x00 to 0xFF	R	-	O
0x02B8	ManufacturerSpecificI	map8	0x00 to 0xFF	R	-	O
0x02C0	Get Profile Command Received	map8	0x00 to 0xFF	R	-	O
0x02C1	Get Profile Command Actioned	map8	0x00 to 0xFF	R	-	O
0x02C2	Get Profile Command Cancelled	map8	0x00 to 0xFF	R	-	O
0x02C3	Get Profile Command Rejected	map8	0x00 to 0xFF	R	-	O
0x02C4	RequestMirrorResponse Command Received	map8	0x00 to 0xFF	R	-	O
0x02C5	RequestMirrorResponse Command Actioned	map8	0x00 to 0xFF	R	-	O
0x02C6	RequestMirrorResponse Command Cancelled	map8	0x00 to 0xFF	R	-	O
0x02C7	RequestMirrorResponse Command Rejected	map8	0x00 to 0xFF	R	-	O
0x02C8	MirrorRemoved Command Received	map8	0x00 to 0xFF	R	-	O
0x02C9	MirrorRemoved Command Actioned	map8	0x00 to 0xFF	R	-	O
0x02CA	MirrorRemoved Command Cancelled	map8	0x00 to 0xFF	R	-	O
0x02CB	MirrorRemoved Command Rejected	map8	0x00 to 0xFF	R	-	O
0x02CC	GetSnapshot Command Received	map8	0x00 to 0xFF	R	-	O



<b>Id</b>	<b>Name</b>	<b>Type</b>	<b>Range</b>	<b>Acc</b>	<b>Def</b>	<b>M</b>
0x02CD	GetSnapshot Command Actioned	map8	0x00 to 0xFF	R	-	O
0x02CE	GetSnapshot Command Cancelled	map8	0x00 to 0xFF	R	-	O
0x02CF	GetSnapshot Command Rejected	map8	0x00 to 0xFF	R	-	O
0x02D0	TakeSnapshot Command Received	map8	0x00 to 0xFF	R	-	O
0x02D1	TakeSnapshot Command Actioned	map8	0x00 to 0xFF	R	-	O
0x02D2	TakeSnapshot Command Cancelled	map8	0x00 to 0xFF	R	-	O
0x02D3	TakeSnapshot Command Rejected	map8	0x00 to 0xFF	R	-	O
0x02D4	MirrorReportAttributeResponse Command Received	map8	0x00 to 0xFF	R	-	O
0x02D5	MirrorReportAttributeResponse Command Actioned	map8	0x00 to 0xFF	R	-	O
0x02D6	MirrorReportAttributeResponse Command Cancelled	map8	0x00 to 0xFF	R	-	O
0x02D7	MirrorReportAttributeResponse Command Rejected	map8	0x00 to 0xFF	R	-	O
0x02D8	ScheduleSnapshot Command Received	map8	0x00 to 0xFF	R	-	O
0x02D9	ScheduleSnapshot Command Actioned	map8	0x00 to 0xFF	R	-	O
0x02DA	ScheduleSnapshot Command Cancelled	map8	0x00 to 0xFF	R	-	O
0x02DB	ScheduleSnapshot Command Rejected	map8	0x00 to 0xFF	R	-	O
0x02DC	StartSampling Command Received	map8	0x00 to 0xFF	R	-	O
0x02DD	StartSampling Command Actioned	map8	0x00 to 0xFF	R	-	O
0x02DE	StartSampling Command Cancelled	map8	0x00 to 0xFF	R	-	O
0x02DF	StartSampling Command Rejected	map8	0x00 to 0xFF	R	-	O
0x02E0	GetSampledData Command Received	map8	0x00 to 0xFF	R	-	O

<b>Id</b>	<b>Name</b>	<b>Type</b>	<b>Range</b>	<b>Acc</b>	<b>Def</b>	<b>M</b>
0x02E1	GetSampledData Command Actioned	map8	0x00 to 0xFF	R	-	O
0x02E2	GetSampledData Command Cancelled	map8	0x00 to 0xFF	R	-	O
0x02E3	GetSampledData Command Rejected	map8	0x00 to 0xFF	R	-	O
0x02E4	Supply ON	map8	0x00 to 0xFF	R	-	O
0x02E5	Supply ARMED	map8	0x00 to 0xFF	R	-	O
0x02E6	Supply OFF	map8	0x00 to 0xFF	R	-	O
0x02E7	Disconnected due to Tamper Detected.	map8	0x00 to 0xFF	R	-	O
0x02E8	ManualDisconnect	map8	0x00 to 0xFF	R	-	O
0x02E9	ManualConnect	map8	0x00 to 0xFF	R	-	O
0x02EA	RemoteDisconnection	map8	0x00 to 0xFF	R	-	O
0x02EB	RemoteConnect	map8	0x00 to 0xFF	R	-	O
0x02EC	LocalDisconnection	map8	0x00 to 0xFF	R	-	O
0x02ED	LocalConnect	map8	0x00 to 0xFF	R	-	O
0x02EE	Change Supply Received	map8	0x00 to 0xFF	R	-	O
0x02EF	Change Supply Actioned	map8	0x00 to 0xFF	R	-	O
0x02F0	Change Supply Cancelled	map8	0x00 to 0xFF	R	-	O
0x02F1	Change Supply Rejected	map8	0x00 to 0xFF	R	-	O
0x02F2	Local Change Supply Received	map8	0x00 to 0xFF	R	-	O
0x02F3	Local Change Supply Actioned	map8	0x00 to 0xFF	R	-	O
0x02F4	Local Change Supply Cancelled	map8	0x00 to 0xFF	R	-	O
0x02F5	Local Change Supply Rejected	map8	0x00 to 0xFF	R	-	O
0x02F6	PublishUncontrolledFlow Threshold Received	map8	0x00 to 0xFF	R	-	O
0x02F7	PublishUncontrolledFlow Threshold Actioned	map8	0x00 to 0xFF	R	-	O
0x02F8	PublishUncontrolledFlow Threshold Cancelled	map8	0x00 to 0xFF	R	-	O

<b>Id</b>	<b>Name</b>	<b>Type</b>	<b>Range</b>	<b>Acc</b>	<b>Def</b>	<b>M</b>
0x02F9	PublishUncontrolledFlow Threshold Rejected	map8	0x00 to 0xFF	R	-	O
0x02FF	Reserved for Metering cluster Group ID	--	--	R	-	O

22380

22381 **10.10.3.2.3.1 Event Configuration Attributes**

22382 The attributes in this set allow a server device to configure how an event is handled when triggered. All  
 22383 attributes in this set are bitmaps as defined in Table 10-193.

22384

22385 **10.10.3.2.4 Messaging Event Configuration Attribute Set**

22386 The following attributes allow events related to messaging to be configured.

22387

**Table 10-195. Messaging Event Configuration Attribute Set**

<b>Id</b>	<b>Name</b>	<b>Type</b>	<b>Range</b>	<b>Acc</b>	<b>Def</b>	<b>M</b>
0x0300	Message Confirmation Sent	map8	0x00 to 0xFF	R	-	O
0x03C0	DisplayMessageReceived	map8	0x00 to 0xFF	R	-	O
0x03C1	DisplayMessageActioned	map8	0x00 to 0xFF	R	-	O
0x03C2	DisplayMessageCancelled	map8	0x00 to 0xFF	R	-	O
0x03C3	DisplayMessageRejected	map8	0x00 to 0xFF	R	-	O
0x03C4	CancelMessageReceived	map8	0x00 to 0xFF	R	-	O
0x03C5	CancelMessageActioned	map8	0x00 to 0xFF	R	-	O
0x03C6	CancelMessageCancelled	map8	0x00 to 0xFF	R	-	O
0x03C7	CancelMessageRejected	map8	0x00 to 0xFF	R	-	O
0x03FF	Reserved for Messaging cluster Group ID	--	--	R	-	O

22388

22389 **10.10.3.2.4.1 Event Configuration Attributes**

22390 The attributes in this set allow a server device to configure how an event is handled when triggered. All  
 22391 attributes in this set are bitmaps as defined in Table 10-193.

22392

22393 **10.10.3.2.5 Prepayment Event Configuration Attribute Set**

22394 The following attributes allow events related to prepayment to be configured.

22395

**Table 10-196. Prepayment Event Configuration Attribute Set**

<b>Id</b>	<b>Name</b>	<b>Type</b>	<b>Range</b>	<b>Acc</b>	<b>Def</b>	<b>M</b>
0x0400	Low Credit	map8	0x00 to 0xFF	R	-	O
0x0401	No Credit (Zero Credit)	map8	0x00 to 0xFF	R	-	O
0x0402	Credit Exhausted	map8	0x00 to 0xFF	R	-	O
0x0403	Emergency Credit Enabled	map8	0x00 to 0xFF	R	-	O
0x0404	Emergency Credit Exhausted	map8	0x00 to 0xFF	R	-	O
0x0405	IHD Low Credit Warning	map8	0x00 to 0xFF	R	-	O
0x0420	Physical Attack on the Prepay Meter	map8	0x00 to 0xFF	R	-	O
0x0421	Electronic Attack on the Prepay Meter	map8	0x00 to 0xFF	R	-	O
0x0422	Discount Applied	map8	0x00 to 0xFF	R	-	O
0x0423	Credit Adjustment	map8	0x00 to 0xFF	R	-	O
0x0424	Credit Adjust Fail	map8	0x00 to 0xFF	R	-	O
0x0425	Debt Adjustment	map8	0x00 to 0xFF	R	-	O
0x0426	Debt Adjust Fail	map8	0x00 to 0xFF	R	-	O
0x0427	Mode Change	map8	0x00 to 0xFF	R	-	O
0x0428	Topup Code Error	map8	0x00 to 0xFF	R	-	O
0x0429	Topup Already Used	map8	0x00 to 0xFF	R	-	O
0x042A	Topup Code Invalid	map8	0x00 to 0xFF	R	-	O
0x042B	Topup Accepted via Remote	map8	0x00 to 0xFF	R	-	O
0x042C	Topup Accepted via Manual Entry	map8	0x00 to 0xFF	R	-	O
0x042D	Friendly Credit In Use	map8	0x00 to 0xFF	R	-	O
0x042E	Friendly Credit Period End Warning	map8	0x00 to 0xFF	R	-	O
0x042F	Friendly Credit Period End	map8	0x00 to 0xFF	R	-	O
0x0430	ErrorRegClear	map8	0x00 to 0xFF	R	-	O
0x0431	AlarmRegClear	map8	0x00 to 0xFF	R	-	O
0x0432	Prepay Cluster Not Found	map8	0x00 to 0xFF	R	-	O

<b>Id</b>	<b>Name</b>	<b>Type</b>	<b>Range</b>	<b>Acc</b>	<b>Def</b>	<b>M</b>
0x0433	Topup Value Too Large	map8	0x00 to 0xFF	R	-	O
0x0441	ModeCredit2Prepay	map8	0x00 to 0xFF	R	-	O
0x0442	ModePrepay2Credit	map8	0x00 to 0xFF	R	-	O
0x0443	ModeDefault	map8	0x00 to 0xFF	R	-	O
0x04C0	SelectAvailableEmergencyCredit Received	map8	0x00 to 0xFF	R	-	O
0x04C1	SelectAvailableEmergencyCredit Actioned	map8	0x00 to 0xFF	R	-	O
0x04C2	SelectAvailableEmergencyCredit Cancelled	map8	0x00 to 0xFF	R	-	O
0x04C3	SelectAvailableEmergencyCredit Rejected	map8	0x00 to 0xFF	R	-	O
0x04C4	Change Debt Received	map8	0x00 to 0xFF	R	-	O
0x04C5	Change Debt Actioned	map8	0x00 to 0xFF	R	-	O
0x04C6	Change Debt Cancelled	map8	0x00 to 0xFF	R	-	O
0x04C7	Change Debt Rejected	map8	0x00 to 0xFF	R	-	O
0x04C8	Emergency Credit Setup Received	map8	0x00 to 0xFF	R	-	O
0x04C9	Emergency Credit Setup Actioned	map8	0x00 to 0xFF	R	-	O
0x04CA	Emergency Credit Setup Cancelled	map8	0x00 to 0xFF	R	-	O
0x04CB	Emergency Credit Setup Rejected	map8	0x00 to 0xFF	R	-	O
0x04CC	Consumer Topup Received	map8	0x00 to 0xFF	R	-	O
0x04CD	Consumer Topup Actioned	map8	0x00 to 0xFF	R	-	O
0x04CE	Consumer Topup Cancelled	map8	0x00 to 0xFF	R	-	O
0x04CF	Consumer Topup Rejected	map8	0x00 to 0xFF	R	-	O
0x04D0	Credit Adjustment Received	map8	0x00 to 0xFF	R	-	O
0x04D1	Credit Adjustment Actioned	map8	0x00 to 0xFF	R	-	O
0x04D2	Credit Adjustment Cancelled	map8	0x00 to 0xFF	R	-	O
0x04D3	Credit Adjustment Rejected	map8	0x00 to 0xFF	R	-	O

<b>Id</b>	<b>Name</b>	<b>Type</b>	<b>Range</b>	<b>Acc</b>	<b>Def</b>	<b>M</b>
0x04D4	Change Payment Mode Received	map8	0x00 to 0xFF	R	-	O
0x04D5	Change Payment Mode Actioned	map8	0x00 to 0xFF	R	-	O
0x04D6	Change Payment Mode Cancelled	map8	0x00 to 0xFF	R	-	O
0x04D7	Change Payment Mode Rejected	map8	0x00 to 0xFF	R	-	O
0x04D8	GetPrepaySnapshotReceived	map8	0x00 to 0xFF	R	-	O
0x04D9	GetPrepaySnapshotActioned	map8	0x00 to 0xFF	R	-	O
0x04DA	GetPrepaySnapshotCancelled	map8	0x00 to 0xFF	R	-	O
0x04DB	GetPrepaySnapshotRejected	map8	0x00 to 0xFF	R	-	O
0x04DC	GetTopupLogReceived	map8	0x00 to 0xFF	R	-	O
0x04DD	GetTopupLogActioned	map8	0x00 to 0xFF	R	-	O
0x04DE	GetTopupLogCancelled	map8	0x00 to 0xFF	R	-	O
0x04DF	GetTopupLogRejected	map8	0x00 to 0xFF	R	-	O
0x04E0	Set Low Credit Warning Level Received	map8	0x00 to 0xFF	R	-	O
0x04E1	Set Low Credit Warning Level Actioned	map8	0x00 to 0xFF	R	-	O
0x04E2	Set Low Credit Warning Level Cancelled	map8	0x00 to 0xFF	R	-	O
0x04E3	Set Low Credit Warning Level Rejected	map8	0x00 to 0xFF	R	-	O
0x04E4	GetDebtRepayLog Received	map8	0x00 to 0xFF	R	-	O
0x04E5	GetDebtRepayLog Actioned	map8	0x00 to 0xFF	R	-	O
0x04E6	GetDebtRepayLog Cancelled	map8	0x00 to 0xFF	R	-	O
0x04E7	GetDebtRepayLog Rejected	map8	0x00 to 0xFF	R	-	O
0x04E8	SetMaximumCreditLimit Received	map8	0x00 to 0xFF	R	-	O
0x04E9	SetMaximumCreditLimit Actioned	map8	0x00 to 0xFF	R	-	O
0x04EA	SetMaximumCreditLimit Cancelled	map8	0x00 to 0xFF	R	-	O
0x04EB	SetMaximumCreditLimit Rejected	map8	0x00 to 0xFF	R	-	O

<b>Id</b>	<b>Name</b>	<b>Type</b>	<b>Range</b>	<b>Acc</b>	<b>Def</b>	<b>M</b>
0x04EC	SetOverallDebtCap Received	map8	0x00 to 0xFF	R	-	O
0x04ED	SetOverallDebtCap Actioned	map8	0x00 to 0xFF	R	-	O
0x04EE	SetOverallDebtCap Cancelled	map8	0x00 to 0xFF	R	-	O
0x04EF	SetOverallDebtCap Rejected	map8	0x00 to 0xFF	R	-	O
0x04FF	Reserved for Prepayment cluster Group ID	--	--	R	-	O

22396

22397 **10.10.3.2.5.1 Event Configuration Attributes**

22398 The attributes in this set allow a server device to configure how an event is handled when triggered. All  
 22399 attributes in this set are bitmaps as defined in Table 10-193.  
 22400

22401 **10.10.3.2.6 Calendar Event Configuration Attribute Set**

22402 The following attributes allow events related to calendars to be configured.

22403 **Table 10-197. Calendar Event Configuration Attribute Set**

<b>Id</b>	<b>Name</b>	<b>Type</b>	<b>Range</b>	<b>Acc</b>	<b>Def</b>	<b>M</b>
0x0500	Calendar Cluster Not Found	map8	0x00 to 0xFF	R	-	O
0x0501	Calendar Change Passive Activated	map8	0x00 to 0xFF	R	-	O
0x0502	Calendar Change Passive Updated	map8	0x00 to 0xFF	R	-	O
0x05C0	PublishCalendar Received	map8	0x00 to 0xFF	R	-	O
0x05C1	PublishCalendar Actioned	map8	0x00 to 0xFF	R	-	O
0x05C2	PublishCalendar Cancelled	map8	0x00 to 0xFF	R	-	O
0x05C3	PublishCalendar Rejected	map8	0x00 to 0xFF	R	-	O
0x05C4	Publish Day Profile Received	map8	0x00 to 0xFF	R	-	O
0x05C5	Publish Day Profile Actioned	map8	0x00 to 0xFF	R	-	O
0x05C6	Publish Day Profile Cancelled	map8	0x00 to 0xFF	R	-	O
0x05C7	Publish Day Profile Rejected	map8	0x00 to 0xFF	R	-	O
0x05C8	Publish Week Profile Received	map8	0x00 to 0xFF	R	-	O
0x05C9	Publish Week Profile Actioned	map8	0x00 to 0xFF	R	-	O

<b>Id</b>	<b>Name</b>	<b>Type</b>	<b>Range</b>	<b>Acc</b>	<b>Def</b>	<b>M</b>
0x05CA	Publish Week Profile Cancelled	map8	0x00 to 0xFF	R	-	O
0x05CB	Publish Week Profile Rejected	map8	0x00 to 0xFF	R	-	O
0x05CC	Publish Seasons Received	map8	0x00 to 0xFF	R	-	O
0x05CD	Publish Seasons Actioned	map8	0x00 to 0xFF	R	-	O
0x05CE	Publish Seasons Cancelled	map8	0x00 to 0xFF	R	-	O
0x05CF	Publish Seasons Rejected	map8	0x00 to 0xFF	R	-	O
0x05D0	Publish Special Days Received	map8	0x00 to 0xFF	R	-	O
0x05D1	Publish Special Days Actioned	map8	0x00 to 0xFF	R	-	O
0x05D2	Publish Special Days Cancelled	map8	0x00 to 0xFF	R	-	O
0x05D3	Publish Special Days Rejected	map8	0x00 to 0xFF	R	-	O
0x05FF	Reserved for Calendar cluster Group ID	--	--	R	-	O

22404

22405 **10.10.3.2.6.1 Event Configuration Attributes**

22406 The attributes in this set allow a server device to configure how an event is handled when triggered. All  
22407 attributes in this set are bitmaps as defined in Table 10-193.  
22408

22409 **10.10.3.2.7 Device Management Event Configuration Attribute**  
22410 **Set**

22411 The following attributes allow events related to device management to be configured.

22412 **Table 10-198. Device Management Event Configuration Attribute Set**

<b>Id</b>	<b>Name</b>	<b>Type</b>	<b>Range</b>	<b>Acc</b>	<b>Def</b>	<b>M</b>
0x0600	Password1Change	map8	0x00 to 0xFF	R	-	O
0x0601	Password2Change	map8	0x00 to 0xFF	R	-	O
0x0602	Password3Change	map8	0x00 to 0xFF	R	-	O
0x0603	Password4Change	map8	0x00 to 0xFF	R	-	O
0x0604	EventLogCleared	map8	0x00 to 0xFF	R	-	O
0x0610	Zigbee APS Timeout	map8	0x00 to 0xFF	R	-	O



<b>Id</b>	<b>Name</b>	<b>Type</b>	<b>Range</b>	<b>Acc</b>	<b>Def</b>	<b>M</b>
0x0611	Zigbee IEEE Transmission Failure Over Threshold	map8	0x00 to 0xFF	R	-	O
0x0612	Zigbee IEEE Frame Check Sequence Threshold	map8	0x00 to 0xFF	R	-	O
0x0613	Error Certificate	map8	0x00 to 0xFF	R	-	O
0x0614	Error Signature	map8	0x00 to 0xFF	R	-	O
0x0615	Error Program Storage	map8	0x00 to 0xFF	R	-	O
0x06C0	Publish CoT Received	map8	0x00 to 0xFF	R	-	O
0x06C1	Publish CoT Actioned	map8	0x00 to 0xFF	R	-	O
0x06C2	Publish CoT Cancelled	map8	0x00 to 0xFF	R	-	O
0x06C3	Publish CoT Rejected	map8	0x00 to 0xFF	R	-	O
0x06C4	Publish CoS Received	map8	0x00 to 0xFF	R	-	O
0x06C5	Publish CoS Actioned	map8	0x00 to 0xFF	R	-	O
0x06C6	Publish CoS Cancelled	map8	0x00 to 0xFF	R	-	O
0x06C7	Publish CoS Rejected	map8	0x00 to 0xFF	R	-	O
0x06C8	Change Password Received	map8	0x00 to 0xFF	R	-	O
0x06C9	Change password Actioned	map8	0x00 to 0xFF	R	-	O
0x06CA	Change Password Cancelled	map8	0x00 to 0xFF	R	-	O
0x06CB	Change Password Rejected	map8	0x00 to 0xFF	R	-	O
0x06CC	SetEventConfiguration Received	map8	0x00 to 0xFF	R	-	O
0x06CD	SetEventConfiguration Actioned	map8	0x00 to 0xFF	R	-	O
0x06CE	SetEventConfiguration Cancelled	map8	0x00 to 0xFF	R	-	O
0x06CF	SetEventConfiguration Rejected	map8	0x00 to 0xFF	R	-	O
0x06D0	UpdateSiteID Received	map8	0x00 to 0xFF	R	-	O
0x06D1	UpdateSiteID Actioned	map8	0x00 to 0xFF	R	-	O
0x06D2	UpdateSiteID Cancelled	map8	0x00 to 0xFF	R	-	O
0x06D3	UpdateSiteID Rejected	map8	0x00 to 0xFF	R	-	O

<b>Id</b>	<b>Name</b>	<b>Type</b>	<b>Range</b>	<b>Acc</b>	<b>Def</b>	<b>M</b>
0x06D4	UpdateCIN Received	map8	0x00 to 0xFF	R	-	O
0x06D5	UpdateCIN Actioned	map8	0x00 to 0xFF	R	-	O
0x06D6	UpdateCIN Cancelled	map8	0x00 to 0xFF	R	-	O
0x06D7	UpdateCIN Rejected	map8	0x00 to 0xFF	R	-	O
0x06FF	Reserved for Device Management cluster Group ID	--	--	R	-	O

22413

22414 **10.10.3.2.7.1 Event Configuration Attributes**

22415 The attributes in this set allow a server device to configure how an event is handled when triggered. All  
22416 attributes in this set are bitmaps as defined in Table 10-193.  
22417

22418 **10.10.3.2.8 Tunnel Event Configuration Attribute Set**

22419 The following attributes allow events related to tunneling to be configured.

22420 **Table 10-199. Tunneling Event Configuration Attribute Set**

<b>Id</b>	<b>Name</b>	<b>Type</b>	<b>Range</b>	<b>Acc</b>	<b>Def</b>	<b>M</b>
0x0700	Tunneling Cluster Not Found	map8	0x00 to 0xFF	R	-	O
0x0701	Unsupported Protocol	map8	0x00 to 0xFF	R	-	O
0x0702	IncorrectProtocol	map8	0x00 to 0xFF	R	-	O
0x07C0	RequestTunnel Command Received	map8	0x00 to 0xFF	R	-	O
0x07C1	RequestTunnel Command Rejected	map8	0x00 to 0xFF	R	-	O
0x07C2	RequestTunnel Command Generated	map8	0x00 to 0xFF	R	-	O
0x07C3	CloseTunnel Command Received	map8	0x00 to 0xFF	R	-	O
0x07C4	CloseTunnel Command Rejected	map8	0x00 to 0xFF	R	-	O
0x07C5	CloseTunnel Command Generated	map8	0x00 to 0xFF	R	-	O
0x07C6	TransferData Command Received	map8	0x00 to 0xFF	R	-	O
0x07C7	TransferData Command Rejected	map8	0x00 to 0xFF	R	-	O

<b>Id</b>	<b>Name</b>	<b>Type</b>	<b>Range</b>	<b>Acc</b>	<b>Def</b>	<b>M</b>
0x07C8	TransferData Command Generated	map8	0x00 to 0xFF	R	-	O
0x07C9	TransferDataError Command Received	map8	0x00 to 0xFF	R	-	O
0x07CA	TransferDataError Command Rejected	map8	0x00 to 0xFF	R	-	O
0x07CB	TransferDataError Command Generated	map8	0x00 to 0xFF	R	-	O
0x07CC	AckTransferData Command Received	map8	0x00 to 0xFF	R	-	O
0x07CD	AckTransferData Command Rejected	map8	0x00 to 0xFF	R	-	O
0x07CE	AckTransferData Command Generated	map8	0x00 to 0xFF	R	-	O
0x07CF	ReadyData Command Received	map8	0x00 to 0xFF	R	-	O
0x07D0	ReadyData Command Rejected	map8	0x00 to 0xFF	R	-	O
0x07D1	ReadyData Command Generated	map8	0x00 to 0xFF	R	-	O
0x07D2	GetSupportedTunnelProtocols Command Received	map8	0x00 to 0xFF	R	-	O
0x07D3	GetSupportedTunnelProtocols Command Rejected	map8	0x00 to 0xFF	R	-	O
0x07D4	GetSupportedTunnelProtocols Command Generated	map8	0x00 to 0xFF	R	-	O
0x07FF	Reserved for Tunnel cluster Group ID	--	--	R	-	O

22421

22422 **10.10.3.2.8.1 Event Configuration Attributes**

22423 The attributes in this set allow a server device to configure how an event is handled when triggered. All  
 22424 attributes in this set are bitmaps as defined in Table 10-193.

22425

22426 **10.10.3.2.9 OTA Event Configuration Attribute Set**

22427 The following attributes allow events related to OTA to be configured.

22428

**Table 10-200. OTA Event Configuration Attribute Set**

<b>Id</b>	<b>Name</b>	<b>Type</b>	<b>Range</b>	<b>Acc</b>	<b>Def</b>	<b>M</b>
0x0800	FirmwareReadyForActivation	map8	0x00 to 0xFF	R	-	O
0x0801	FirmwareActivated	map8	0x00 to 0xFF	R	-	O
0x0802	Firmware Activation Failure	map8	0x00 to 0xFF	R	-	O
0x0803	Patch Ready For Activation	map8	0x00 to 0xFF	R	-	O
0x0804	Patch Activated	map8	0x00 to 0xFF	R	-	O
0x0805	Patch Failure	map8	0x00 to 0xFF	R	-	O
0x08C0	Image Notify Command Received	map8	0x00 to 0xFF	R	-	O
0x08C1	Image Notify Command Rejected	map8	0x00 to 0xFF	R	-	O
0x08C2	Query Next Image Request Generated	map8	0x00 to 0xFF	R	-	O
0x08C3	Query Next Image Response Received	map8	0x00 to 0xFF	R	-	O
0x08C4	Query Next Image Response Rejected	map8	0x00 to 0xFF	R	-	O
0x08C5	Image Block Request Generated	map8	0x00 to 0xFF	R	-	O
0x08C6	Image Page Request Generated	map8	0x00 to 0xFF	R	-	O
0x08C7	Image Block Response Received	map8	0x00 to 0xFF	R	-	O
0x08C8	Image Block Response Rejected	map8	0x00 to 0xFF	R	-	O
0x08C9	Upgrade End Request Generated	map8	0x00 to 0xFF	R	-	O
0x08CA	Upgrade End Response Received	map8	0x00 to 0xFF	R	-	O
0x08CB	Upgrade End Response Rejected	map8	0x00 to 0xFF	R	-	O
0x08CC	Query Specific File Request Generated	map8	0x00 to 0xFF	R	-	O
0x08CD	Query Specific File Response Received	map8	0x00 to 0xFF	R	-	O
0x08CE	Query Specific File Response Rejected	map8	0x00 to 0xFF	R	-	O
0x08FF	Reserved for OTA cluster Group ID	--	--	R	-	O

22429

22430 **10.10.3.2.9.1 Event Configuration Attributes**

22431 The attributes in this set allow a server device to configure how an event is handled when triggered. All  
22432 attributes in this set are bitmaps as defined in Table 10-193.  
22433

### 22434 **10.10.3.3 Commands Received**

22435 The client receives the cluster-specific response commands detailed in sub-clause 10.10.2.4.

### 22436 **10.10.3.4 Commands Generated**

22437 The client generates the cluster-specific commands detailed in sub-clause 10.10.2.3, as required by the appli-  
22438 cation.

22439

## 22440 **10.10.4 Application Guidelines**

### 22441 **10.10.4.1 Passwords**

22442 The use of Password within this cluster could also be viewed as PIN codes. The current use case for Pass-  
22443 words is to cover either the consumer PIN code, or to secure the engineer maintenance screens found on a  
22444 metering device.

### 22445 **10.10.4.2 Consumer Password Use Case**

22446 The Password or (normally) PIN code is part of the application and, as such, not a data item that would need  
22447 to be supplied by the HES or held by the server. There is normally a screen on a device to be able to set or  
22448 enter a new password. The main use case for the consumer is therefore to instruct the device to reset the PIN  
22449 so that the consumer can again gain access to the IHD screens. The server is therefore only required to hold  
22450 an access list that contains the device EUI64 address.

### 22451 **10.10.4.3 Engineer Password Use Case**

22452 The Engineer password is normally used to access maintenance screens on meters, so that key functions can  
22453 be secured and only accessed by an authorised personal, or for data that is sensitive to the operation of the  
22454 device such as Joining or Leaving the HAN.

### 22455 **10.10.4.4 Password Security Recommendations**

22456 If additional security is required by the application, it is recommended that the password octet-string is sent  
22457 as a hashed value, using MMO hashing to create a 48-bit hashed value. The Device Management Cluster is  
22458 APS Secured and the password is always unicast to the individual device. An Access Control List within the  
22459 server is recommended, to allow for the management of the passwords against the EUI-64 address of the  
22460 device. However, the actual format of the password octet-string is down to the implementation requirements  
22461 of the system.

22462 If a device is unable to use a password then NO data should be shown that has been deemed to be password  
22463 protected.

22464

22465 **10.11 Events<sup>217</sup>**

22466 **10.11.1 Overview**

22467 Please see Chapter 2 for a general cluster overview defining cluster architecture, revision, classification,  
22468 identification, etc.

22469 The Events cluster provides an interface for passing event information between Zigbee devices. Events are  
22470 generated and logged by a server device and read by a client device.

22471 **Figure 10-188. Event Cluster Client/Server Example**

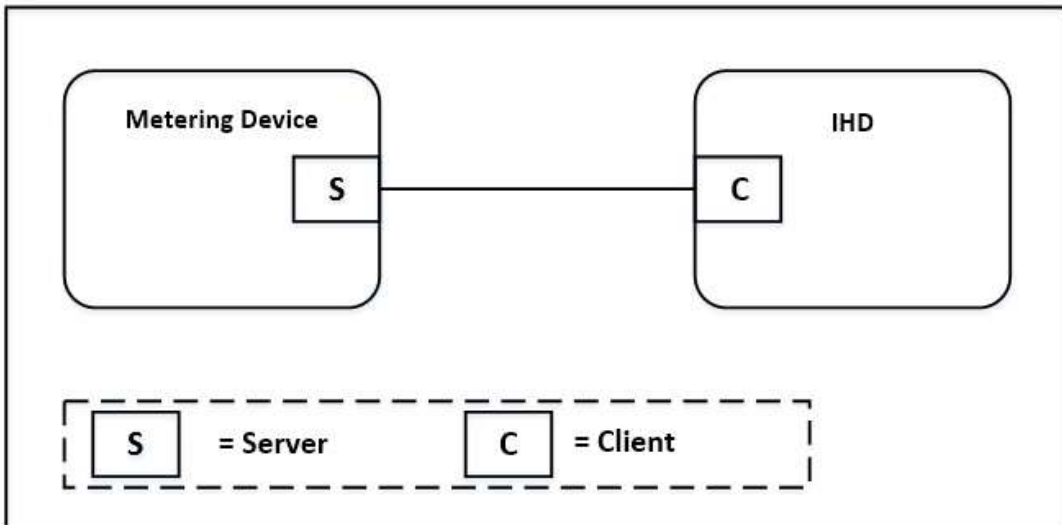

22472  
22473 *Note: Device names are examples for illustration purposes only*

22474

<sup>217</sup> NEW CERTIFIABLE CLUSTER IN THIS LIBRARY

22475

**Figure 10-189. Mirrored BOMD Event Cluster Client/Server Example**

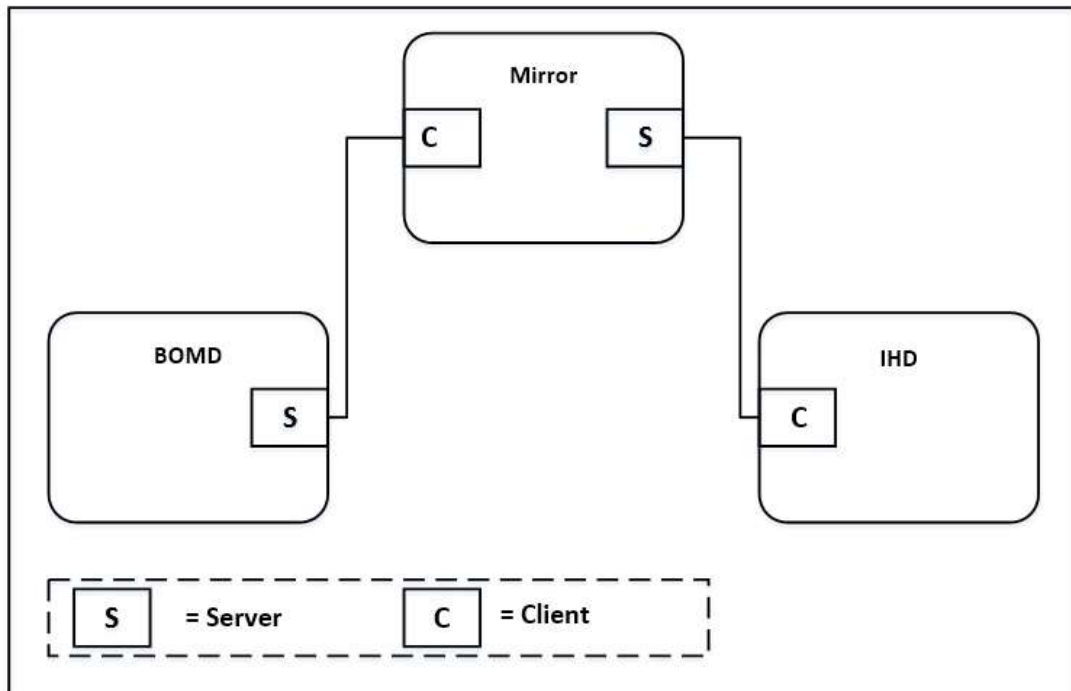

22476  
 22477

*Note: Device names are examples for illustration purposes only*

22478 **10.11.1.1 Revision History**

22479 The global *ClusterRevision* attribute value SHALL be the highest revision number in the table below.

Rev	Description
1	mandatory global <i>ClusterRevision</i> attribute added; Added from SE1.4.

22480 **10.11.1.2 Classification**

Hierarchy	Role	PICS Code	Primary Transaction
Base	Application	SEEV	Type 1 (client to server)

22481 **10.11.1.3 Cluster Identifiers**

Identifier	Name
0x0709	Events (Smart Energy)

22482 **10.11.2 Server**

22483 **10.11.2.1 Dependencies**

- 22484 • Events carried using this cluster include a timestamp with the assumption that target devices maintain a real time clock. Devices can acquire and synchronize their internal clocks via the Time cluster server.  
22485  
22486
- 22487 • A server device supporting this cluster should also support the Device Management cluster in order to allow events to be configured over the air.  
22488
- 22489 • In order that Events Cluster client devices are able to receive events published from an Events Cluster server on a BOMD, the BOMD mirror should support both an Events cluster client and server. The BOMD should publish events to the mirror and the mirror should, if required (based on the control flags in the *PublishEvent* command), publish events to all bound Events Cluster client devices.  
22490  
22491  
22492  
22493
- 22494 • Events Cluster client devices wishing to receive events published from a BOMD shall bind to the Events Cluster server on the BOMD mirror.  
22495
- 22496 • A Mirror may store the events pushed from a BOMD, effectively mirroring the BOMD event logs. The Mirror may also support the reading and clearing of event logs by Events Cluster client devices.  
22497
- 22498 • How events are internally stored within an Events Cluster server device is out of scope of this specification.  
22499  
22500

22501 **10.11.2.2 Attributes**

22502 None.

22503 **10.11.2.3 Commands Received**

22504 Table 10-201 lists cluster-specific commands that are received by the server.

22505 **Table 10-201. Cluster -specific Commands Received by the Events Cluster Server**

Command Identifier FieldValue	Description	M
0x00	GetEventLog	O
0x01	Clear Event Log Request	O

22506

22507 **10.11.2.3.1 Get Event Log Command**

22508 The *GetEventLog* command allows a client to request events from a server's event logs. One or more *PublishEventLog* commands are returned on receipt of this command.  
22509

22510 The *LogID* sub-field, in conjunction with the *Event ID* field, shall provide the filtering to enable the desired event(s) to be identified. The following examples show the usage of these 2 fields:-  
22511



- 22512 1. Get all events from the Security Event Log (Log ID = Security (4), Event ID = 0x0000)
- 22513 2. Get all events from all logs (Log ID = 0, Event ID = 0x0000)
- 22514 3. Get all occurrences of a specific event 0x1111 from all logs (Log ID = 0, Event ID = 0x1111)
- 22515 4. Get all occurrences of a specific event 0x1111 from the Security Event log (Log ID = Security (4),
- 22516 Event ID = 0x1111).

22517 **10.11.2.3.1.1 Payload Format**

22518 **Figure 10-190. Format of the Get Event Log Command Payload**

<b>Octets</b>	<b>1</b>	<b>2</b>	<b>4</b>	<b>4</b>	<b>1</b>	<b>2</b>
<b>Data Type</b>	map8	uint16	UTC	UTC	uint8	uint16
<b>Field Name</b>	Event Control/ Log ID (M)	Event ID (M)	Start Time (M)	End Time (M)	Number of Events (M)	Event Offset (M)

22519 **10.11.2.3.1.2 Payload Details**

22520 **Event Control/Log ID (mandatory):** The least significant nibble is an enumeration indicating the Log ID  
 22521 (see Table 10-202). The most significant nibble is a bitmap indicating control options (see Table 10-203):

22522 **Table 10-202. Log ID Enumeration**

Bit	Enumerated Value	Description
0-3	0x0	All logs
	0x1	Tamper Log
	0x2	Fault Log
	0x3	General Event Log
	0x4	Security Event Log
	0x5	Network Event Log

22523

22524 **Table 10-203. Event Control Bitmap**

Bit	Description
4	0- retrieve the minimal information per event (Event ID and Time) 1-retrieve the full information per event (Event ID, Time and Octet string, if available)

22525

22526 **Event ID (mandatory):** The *Event ID* specifies a particular event to be queried; a value of 0x0000 is reserved  
 22527 to indicate all Event IDs. The Event IDs for the Smart Energy profile are detailed in tables Table 10-192 to  
 22528 Table 10-200.

22529 *Note: If event configuration is supported via the device management cluster the Zigbee Event IDs are defined*  
 22530 *in tables Table 10-192 to Table 10-200.*

22531 **Start Time (mandatory):** This field specifies the start time (earliest time) of the range of events to be re-  
 22532 turned. Events that match the search criteria and have a timestamp **greater than or equal to** the start time  
 22533 shall be returned.

22534 **End Time (mandatory):** specifies the end time (latest time) of the range of events to be reported in the  
 22535 response. Events that match the search criteria and have a timestamp **less than** the specified end time shall  
 22536 be returned. Events with a timestamp **equal to** that of the *End Time* shall not be returned; this ensures that,  
 22537 in the case where the *End Time* is set to the current time, events generated whilst reading the event log are  
 22538 not included in the response.

22539 **Number of Events (mandatory):** This parameter indicates the maximum number of events requested i.e.  
 22540 the maximum number of events that the client is willing to receive; the value 0x00 indicates all events that  
 22541 fall into the defined criteria.

22542 **Event Offset (mandatory):** The *Event Offset* field provides a mechanism to allow client devices to page  
 22543 through multiple events which match a given search criteria. As an example, a client device requests two  
 22544 events from a given search criteria with an *Event Offset* of 0. The server returns the two most recent events  
 22545 (events 1 and 2) in a *PublishEvent* command and indicates that 4 events match the given criteria. The client  
 22546 re-sending the original *Get Event Log* command, but with the *Event Offset* field now set to 2, shall result in  
 22547 the server returning events 3 and 4.

22548 **10.11.2.3.1.3 Effect on Receipt**

22549 On receipt of this command, the device shall respond with a *PublishEventLog* command A Default Response  
 22550 with status NOT\_FOUND shall be returned if no events match the given search criteria.  
 22551

22552 **10.11.2.3.2 Clear Event Log Request Command**

22553 This command requests that an Events server device clear the specified event log(s). The Events server device  
 22554 SHOULD clear the requested events logs, however it is understood that market specific restrictions may be  
 22555 applied to prevent this.

22556 **10.11.2.3.2.1 Payload Format**

22557 **Figure 10-191. Format of the Clear Event Log Request Command Payload**

<b>Octets</b>	<b>1</b>
<b>Data Type</b>	map8
<b>Field Name</b>	Log ID (M)

22558 **10.11.2.3.2.2 Payload Details**

22559 **Log ID (mandatory):** The least significant nibble specifies the Log to be cleared (see Table 10-202). The  
 22560 most significant nibble is reserved.

22561 **10.11.2.3.2.3 Effect on Receipt**

22562 On receipt of this command, a device supporting the Events cluster as a server should clear the specified  
 22563 event logs. A *Clear Event Log Response* command shall be generated, indicating which event logs have  
 22564 been successfully cleared.  
 22565

22566 **10.11.2.4 Commands Generated**

22567 Table 10-204 lists cluster-specific commands that are generated by the server.

22568

**Table 10-204. Cluster -specific Commands Generated by the Events Cluster Server**

Command Identifier Field Value	Description	M
0x00	Publish Event	O
0x01	Publish EventLog	O
0x02	Clear Event Log Response	O

22569

22570

### 10.11.2.4.1 Publish Event Command

22571  
 22572  
 22573

This command is generated upon an event trigger from within the reporting device and if enabled by the associated Event Configuration (bitmap) attribute in the Device Management cluster (see Table 10-193 for further information).

22574

#### 10.11.2.4.1.1 Payload Format

22575

**Figure 10-192. Format of the Publish Event Command Payload**

Octets	1	2	4	1	1..255
Data Type	map8	uint16	UTC	map8	octstr
Field Name	Log ID (M)	Event ID (M)	Event Time (M)	Event Control (M)	Event Data (M)

22576

#### 10.11.2.4.1.2 Payload Details

22577  
 22578

**Log ID (mandatory):** The least significant nibble is an enumeration indicating the Log ID (see Table 10-202). The most significant nibble is reserved.

22579  
 22580

**Event ID (mandatory):** The *Event ID* specifies a particular event. If event configuration is supported (via the Device Management cluster), the Zigbee Event IDs are as defined in Table 10-192 to Table 10-200.

22581

**Event Time (mandatory):** The timestamp of the event occurrence in UTC format.

22582

**Event Control (mandatory):** An 8-bit bitmap specifying actions to be taken regarding this event:

22583

**Table 10-205. Event Action Control Bitmap**

Bit	Description (if set)
0	Report Event to HAN devices – this flag indicates that the event is intended for the HAN; the event should be published to all bound Events cluster client devices. If the event is generated by a BOMD and received by a mirror, the mirror should publish this event to all bound Events cluster clients.
1	Report Event to the WAN – this flag indicates that the event is intended for the WAN; if the receiving device is capable, it should report this event to the WAN.

22584  
 22585  
 22586  
 22587  
 22588

**Event Data (mandatory):** A variable length octet string array used to hold additional information captured when the event occurred. The first element (element 0) of the array indicates the length of the string, NOT including the first element.

22589 **10.11.2.4.2 Publish Event Log Command**

22590 This command is generated on receipt of a *Get Event Log* command. The command shall return the most  
22591 recent event first, up to the number of events requested.

22592 **10.11.2.4.2.1 Payload Format**

22593 **Figure 10-193. Format of the *Publish Event Log* Command Payload**

<b>Octets</b>	<b>2</b>	<b>1</b>	<b>1</b>	<b>1..xx</b>
<b>Data Type</b>	uint16	uint8	uint8	opaque
<b>Field Name</b>	Total Number of Matching Events (M)	Command Index (M)	Total Commands (M)	Log Payload (M)

22594 **10.11.2.4.2.2 Payload Details**

22595 **Total Number of Matching Events (mandatory):** This field indicates the total number of events found  
22596 which match the search criteria received in the associated *Get Event Log* command. The value of this field  
22597 may be greater than the total number of events requested; if this is the case then further events may be re-  
22598 trieved using the *Event Offset* field of the *Get Event Log* command (see 10.11.2.3.1).

22599 **Command Index (mandatory):** In the case where the entire number of events being returned does not fit  
22600 into a single message, the *Command Index* is used to count the required number of *Publish Event Log* com-  
22601 mands. The *Command Index* starts at 0 and is incremented for each command returned due to the same *Get*  
22602 *Event Log* command.

22603 **Total Commands (mandatory):** This parameter indicates the total number of *Publish Event Log* commands  
22604 that are required to return the requested event logs.

22605 **10.11.2.4.2.2.1 Log Payload**

22606 The *Log Payload* is a series of events and associated data. The event payload consists of the logged events  
22607 as detailed in Figure 10-194:

22608 **Figure 10-194. Format of the *Publish Event Log* Command Log Sub-Payload**

<b>Octets</b>	<b>1</b>	<b>1</b>	<b>2</b>	<b>4</b>	<b>1..255</b>	<b>...</b>	<b>1</b>	<b>2</b>	<b>4</b>	<b>1..255</b>
<b>Data Type</b>	map8	map8	uint16	UTC	octstr	...	map8	uint16	UTC	octstr
<b>Field Name</b>	Number of Events / Log Payload Control (M)	Log ID (M)	Event ID (M)	Event Time (M)	Event Data (M)	...	Log ID (O)	Event ID (O)	Event Time (O)	Event Data (O)

22609 **Number of Events /Log Payload Control (mandatory):** This field is split into two parts; the least signifi-  
22610 cant nibble represents the *Log Payload Control* as defined in Table 10-206, whilst the most significant nibble  
22611 indicates the number of events contained within the log payload of this command. Note that an event which  
22612 crosses a payload boundary is considered to be 1 event in the log payload. Wherever possible events  
22613 SHOULD NOT be sent across payload boundaries.  
22614

22615

**Table 10-206. Log Payload Control Bitmap**

Bit	Description
0	0 - Events do not cross frame boundary 1 – An event in this log payload does cross a payload frame boundary

22616

22617 **Log ID (mandatory):** The least significant nibble is an enumeration indicating the Log ID (see Table  
 22618 10-202). The most significant nibble is reserved.

22619 **Event ID:** The *Event ID* specifies a particular event. If event configuration is supported (via the Device  
 22620 Management cluster), Zigbee-specified Event IDs are as defined in Table 10-192 to Table 10-200.

22621 **Event Time:** The timestamp of the event occurrence in UTC format.

22622 **Event Data:** A variable length octet string array used to hold additional information captured when the event  
 22623 occurred. The first element (element 0) of the array indicates the length of the string, NOT including the first  
 22624 element. This field should contain a single octet of 0x00 when ‘minimal information’ is requested in the  
 22625 associated *Get Event Log* command (see 10.11.2.3.1.2 for further details).  
 22626

22627 **10.11.2.4.3 Clear Event Log Response Command**

22628 This command is generated on receipt of a *Clear Event Log Request* command.

22629 **10.11.2.4.3.1 Payload Format**

22630

**Figure 10-195. Format of the *Clear Event Log Response* Command Payload**

<b>Octets</b>	1
<b>Data Type</b>	map8
<b>Field Name</b>	ClearedEventsLogs (M)

22631 **10.11.2.4.3.2 Payload Details**

22632 **ClearedEventsLogs (mandatory):** This 8-bit BitMap indicates which logs have been cleared, as detailed  
 22633 in Table 10-207.

22634 *Note: It is understood that certain markets may require that event logs cannot be cleared; this BitMask*  
 22635 *provides a method for the server device to indicate which logs have been successfully cleared.*

22636

**Table 10-207. ClearedEventsLogs Bitmap**

Bit	Description
0	0 – All Logs NOT Cleared 1 - All Logs Cleared
1	0 - Tamper Log NOT Cleared 1 - Tamper Log Cleared
2	0 - Fault Log NOT Cleared 1 - Fault Log Cleared
3	0 - General Event Log NOT Cleared 1 - General Event log Cleared

4	0 - Security Event Log NOT Cleared 1 - Security Log Cleared
5	0 - Network Event Log NOT cleared 1 - Network Event Log cleared

22637

22638

## 22639 **10.11.3 Client**

### 22640 **10.11.3.1 Dependencies**

22641 Events carried using this cluster include a timestamp with the assumption that target devices maintain a real  
22642 time clock. Devices can acquire and synchronize their internal clocks via the Time cluster server.

### 22643 **10.11.3.2 Attributes**

22644 None

### 22645 **10.11.3.3 Commands Received**

22646 See section 10.11.2.4.

### 22647 **10.11.3.4 Commands Generated**

22648 See section 10.11.2.3.

22649

## 22650 **10.12 Sub-GHz<sup>218</sup>**

---

### 22651 **10.12.1 Overview**

22652 Please see Chapter 2 for a general cluster overview defining cluster architecture, revision, classification,  
22653 identification, etc.

22654 The Sub-GHz cluster provides attributes and commands specific to the use of Sub-GHz frequencies for a  
22655 Smart Energy network.

---

<sup>218</sup> NEW CERTIFIABLE CLUSTER IN THIS LIBRARY

22656

**Figure 10-196. Sub-GHz Cluster Client/Server Example**

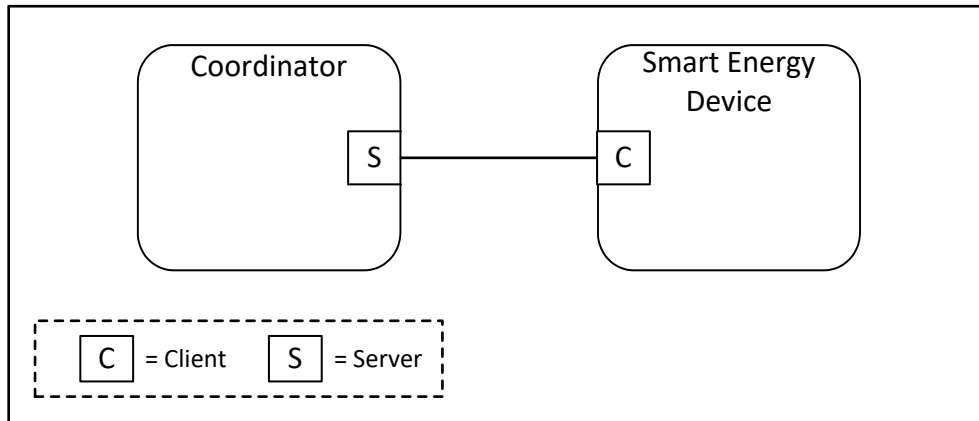

22657

22658

*Note: Device names are examples for illustration purposes only*

### 22659 **10.12.1.1 Revision History**

22660 The global *ClusterRevision* attribute value SHALL be the highest revision number in the table below.

Rev	Description
1	mandatory global <i>ClusterRevision</i> attribute added; Added from SE1.4.

### 22661 **10.12.1.2 Classification**

Hierarchy	Role	PICS Code	Primary Transaction
Base	Application	SESG	Type 1 (client to server)

### 22662 **10.12.1.3 Cluster Identifiers**

Identifier	Name
0x070B	Sub-GHz (Smart Energy)

22663

## 22664 **10.12.2 Server**

### 22665 **10.12.2.1 Dependencies**

22666 None.

22667 **10.12.2.2 Attributes**

22668 **Table 10-208. Sub-GHz Cluster Server Attributes**

<b>Id</b>	<b>Name</b>	<b>Type</b>	<b>Range</b>	<b>Acc</b>	<b>Def</b>	<b>M</b>
0x0000	Channel Change	map32	0x00000000 to 0xFFFFFFFF	R	-	M
0x0001	Page 28 Channel Mask	map32	0xE0000000 to 0xE7FFFFFF	R	0xE7FFFFFF	O
0x0002	Page 29 Channel Mask	map32	0xE8000000 to 0xE80001FF	R	0xE80001FF	O
0x0003	Page 30 Channel Mask	map32	0xF0000000 to 0xF7FFFFFF	R	0xF7FFFFFF	O
0x0004	Page 31 Channel Mask	map32	0xF8000000 to 0xFFFFFFFF	R	0xFFFFFFFF	O

22669

22670 **10.12.2.2.1 Channel Change Attribute**

22671 This is a 32-bit channel mask that defines the sub-GHz channel that the Coordinator’s Network Manager  
22672 intends to move to. Bits 0 – 26 indicate the channel that is to be used, bits 27-31 indicate the binary-encoded  
22673 channel page (see below for further details).

22674 **10.12.2.2.2 Page 28 Channel Mask Attribute**

22675 This is a 32-bit channel mask that defines the channels that are to be scanned when forming, joining or re-  
22676 joining a network. Page 28 defines the first 27 channels within the 863-876MHz frequency band. The format  
22677 of this Bitmap is shown within Table 10-209.

22678 **Table 10-209. Page 28 Channel Mask**

<b>Bit</b>	<b>Description</b>
0	863 Channel 0
1	863 Channel 1
2	863 Channel 2
3	863 Channel 3
4	863 Channel 4
5	863 Channel 5
6	863 Channel 6
7	863 Channel 7
8	863 Channel 8
9	863 Channel 9
10	863 Channel 10
11	863 Channel 11
12	863 Channel 12
13	863 Channel 13
14	863 Channel 14
15	863 Channel 15



Bit	Description
16	863 Channel 16
17	863 Channel 17
18	863 Channel 18
19	863 Channel 19
20	863 Channel 20
21	863 Channel 21
22	863 Channel 22
23	863 Channel 23
24	863 Channel 24
25	863 Channel 25
26	863 Channel 26
27 – 31	Page Number (11100b = 28d)

22679

22680 **10.12.2.2.3 Page 29 Channel Mask Attribute**

22681 This is a 32-bit channel mask that defines the channels that are to be scanned when forming, joining or re-  
 22682 joining a network. Page 29 defines channels 27 to 34 and channel 62 of the 863-876MHz frequency band.  
 22683 The format of this Bitmap is shown within Table 10-210.

22684

**Table 10-210. Page 29 Channel Mask**

Bit	Description
0	863 Channel 27
1	863 Channel 28
2	863 Channel 29
3	863 Channel 30
4	863 Channel 31
5	863 Channel 32
6	863 Channel 33
7	863 Channel 34
8	863 Channel 62
9 – 26	Unused (set to 0)
27 – 31	Page Number (11101b = 29d)

22685

22686 **10.12.2.2.4 Page 30 Channel Mask Attribute**

22687 This is a 32-bit channel mask that defines the channels that are to be scanned when forming, joining or re-  
 22688 joining a network. Page 30 defines channels 35 to 61 of the 863-876MHz frequency band. The format of this  
 22689 Bitmap is shown within Table 10-211.

22690

**Table 10-211. Page 30 Channel Mask**

Bit	Description
0	863 Channel 35
1	863 Channel 36

Bit	Description
2	863 Channel 37
3	863 Channel 38
4	863 Channel 39
5	863 Channel 40
6	863 Channel 41
7	863 Channel 42
8	863 Channel 43
9	863 Channel 44
10	863 Channel 45
11	863 Channel 46
12	863 Channel 47
13	863 Channel 48
14	863 Channel 49
15	863 Channel 50
16	863 Channel 51
17	863 Channel 52
18	863 Channel 53
19	863 Channel 54
20	863 Channel 55
21	863 Channel 56
22	863 Channel 57
23	863 Channel 58
24	863 Channel 59
25	863 Channel 60
26	863 Channel 61
27 – 31	Page Number (11110b = 30d)

22691

22692 **10.12.2.2.5 Page 31 Channel Mask Attribute**

22693 This is a 32-bit channel mask that defines the channels that are to be scanned when forming, joining or re-  
 22694 joining a network. Page 31 defines the 27 channels within the 915-921MHz frequency band. The format of  
 22695 this Bitmap is shown within Table 10-212.

22696

**Table 10-212. Page 31 Channel Mask**

Bit	Description
0	915 Channel 0
1	915 Channel 1
2	915 Channel 2
3	915 Channel 3
4	915 Channel 4
5	915 Channel 5
6	915 Channel 6
7	915 Channel 7

Bit	Description
8	915 Channel 8
9	915 Channel 9
10	915 Channel 10
11	915 Channel 11
12	915 Channel 12
13	915 Channel 13
14	915 Channel 14
15	915 Channel 15
16	915 Channel 16
17	915 Channel 17
18	915 Channel 18
19	915 Channel 19
20	915 Channel 20
21	915 Channel 21
22	915 Channel 22
23	915 Channel 23
24	915 Channel 24
25	915 Channel 25
26	915 Channel 26
27 – 31	Page Number (11111b = 31d)

22697  
 22698

22699 **10.12.2.3 Commands Generated**

22700 Table 10-213 lists cluster-specific commands that are generated by the server.

22701 **Table 10-213. Cluster-specific Commands Generated by the Sub-GHz Cluster Server**

Command Identifier FieldValue	Description	M
0x00	Suspend Cluster Messages	M

22702

22703 **10.12.2.3.1 Suspend Cluster Messages Command**

22704 The *Suspend Cluster Messages* command is sent to client device(s) by the server device when the server  
 22705 device has determined that the client device(s) shall suspend their cluster communications to the server device  
 22706 for the period stated in the command. The command is also sent in response to a *Get Suspend Cluster Mes-*  
 22707 *sages Status* command.

22708 **10.12.2.3.1.1 Payload Format**

22709 **Figure 10-197. Format of the *Suspend Cluster Messages* Command Payload**

Octets	1
--------	---

<b>Data Type</b>	uint8
<b>Field Name</b>	Suspension Period (M)

22710 **10.12.2.3.1.2 Payload Details**

22711 **Suspension Period (mandatory):** An unsigned 8-bit integer indicating the period, in minutes, during which  
22712 cluster communications from the device shall be suspended. A value of zero shall indicate that cluster com-  
22713 munications are not currently suspended.

22714 **10.12.2.3.1.3 When Generated**

22715 This command is generated when the server device determines that cluster communications from the receiv-  
22716 ing client device shall be suspended in order to reduce the Duty Cycle of the server device. The command is  
22717 also sent in response to a *Get Suspend Cluster Messages Status* command.

22718 **10.12.2.3.1.4 Effect on Receipt**

22719 On receipt of this command with a non-zero payload, the device shall suspend its cluster communications to  
22720 the server device for the period indicated by the payload, at which time normal operation may resume.

22721 **10.12.3 Client**

22722 **10.12.3.1 Dependencies**

22723 None.

22724 **10.12.3.2 Attributes**

22725 There are no attributes for the Sub-GHz cluster client.

22726 **10.12.3.3 Commands Generated**

22727 Table 10-214 lists cluster-specific commands that are generated by the server.

22728 **Table 10-214. Cluster-specific Commands Generated by the Sub-GHz Cluster Client**

Command Identifier Field Value	Description	M
0x00	Get Suspend Cluster Messages Status	M / O*

\*Mandatory for BOMDs, Optional for all other devices

22729  
22730

22731 **10.12.3.3.1 Get Suspend Cluster Messages Status Command**

22732 The *Get Suspend Cluster Messages Status* command allows a client device to request the current status of its  
22733 cluster communications with the server. This command is Mandatory for BOMDs.

22734 **10.12.3.3.1.1 Payload Details**

22735 There are no fields for this command.

22736 **10.12.3.3.1.2 When Generated**

22737 This command is sent unsolicited whenever a client device wishes to determine the current status of its cluster  
 22738 communications from the server.

22739 **10.12.3.3.1.3 Effect on Receipt**

22740 The server shall return a *Suspend Cluster Messages* command (see 10.12.2.3.1 for further details).

22741 **10.13 Meter Identification**

22742 **10.13.1 Overview**

22743 Please see Chapter 2 for a general cluster overview defining cluster architecture, revision, classification,  
 22744 identification, etc.

22745 This cluster provides attributes and commands for determining advanced information about utility metering  
 22746 device, as shown in Figure 10-198.

22747 **Note:** *Where a physical node supports multiple endpoints it will often be the case that many of these settings*  
 22748 *will apply to the whole node, that is they are the same for every endpoint on the device. In such cases they*  
 22749 *can be implemented once for the node, and mapped to each endpoint.*

22750 **Figure 10-198. Typical Usage of the Meter Identification Cluster**

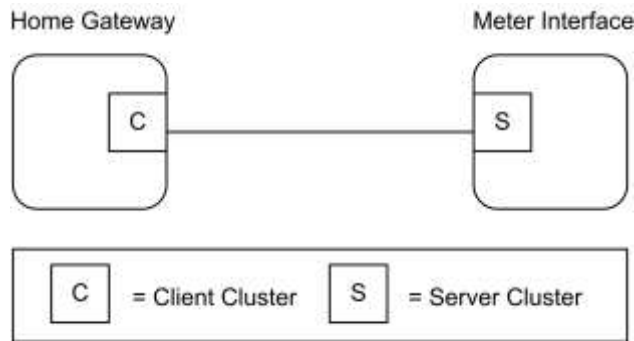

22751 *Note: Device names are examples for illustration purposes only*

22752 **10.13.1.1 Revision History**

22753 The global *ClusterRevision* attribute value SHALL be the highest revision number in the table below.

Rev	Description
1	global mandatory <i>ClusterRevision</i> attribute added
2	Moved to this Energy chapter; CCB 2817 2860

22754 **10.13.1.2 Classification**

Hierarchy	Role	PICS Code	Primary Transaction
Base	Application	MTRID	Type 2 (server to client)

22755 **10.13.1.3 Cluster Identifiers**

Identifier	Name
0x0b01	Meter Identification

22756 **10.13.2 Server**

22757 **10.13.2.1 Meter Identification Attribute Set**

22758 The Meter Identification server cluster contains the attributes summarized in Table 10-215.

22759 **Table 10-215. Attributes of the Meter Identification Server Cluster**

Identifier	Name	Type	Range	Access	Def	M/O
0x0000	<i>CompanyName</i>	string	0 to 16 Octets	R	MS	M
0x0001	<i>MeterTypeID</i>	uint16	0x0000 to 0xffff	R	MS	M
0x0004	<i>DataQualityID</i>	uint16	0x0000 to 0xffff	R	MS	M
0x0005	<i>CustomerName</i>	string	0 to 16 Octets	RW	MS	O
0x0006	<i>Model</i>	octstr	0 to 16 Octets	R	MS	O
0x0007	<i>PartNumber</i>	octstr	0 to 16 Octets	R	MS	O
0x0008	<i>ProductRevision</i>	octstr	0 to 6 Octets	R	MS	O
0x000A	<i>SoftwareRevision</i>	octstr	0 to 6 Octets	R	MS	O
0x000B	<i>UtilityName</i>	string	0 to 16 Octets	R	MS	O
0x000C	<i>POD</i>	string	0 to 16 Octets	R	MS	M
0x000D	<i>AvailablePower</i>	int24	0x000000 to 0xfffffff	R	MS	M
0x000E	<i>PowerThreshold</i>	int24	0x000000 to 0xfffffff	R	MS	M

22760 **10.13.2.1.1 CompanyName Attribute**

22761 *CompanyName* is an Octet String field capable of storing up to 16 character string (the first Octet indicates  
22762 length) encoded in the UTF-8 format. Company Name defines the meter manufacturer name, decided by  
22763 manufacturer.

22764 **10.13.2.1.2 MeterTypeID Attribute**

22765 *MeterTypeID* defines the Meter installation features, decided by manufacturer. Though this attribute is de-  
22766 fined as an unsigned, it is an enumeration.<sup>219</sup> Table 10-216 provides Meter Type IDs field content.

<sup>219</sup> CCB 2817 2860

22767

**Table 10-216. Meter Type IDs**

Device	Meter Type ID
Utility Primary Meter	0x0000
Utility Production Meter	0x0001
Utility Secondary Meter	0x0002
Private Primary Meter	0x0100
Private Production Meter	0x0101
Private Secondary Meters	0x0102
Generic Meter	0x0110

22768

22769 **10.13.2.1.3 DataQualityID Attribute**

22770 *DataQualityID* defines the Meter Simple Metering information certification type, decided by manufacturer.  
 22771 Though this attribute is defined as an unsigned, it is an enumeration.<sup>220</sup>

22772 Table 10-217 provides Data Quality IDs field content.

22773

**Table 10-217. Data Quality IDs**

Device	Meter Type ID
All Data Certified	0x0000
Only Instantaneous Power not Certified	0x0001
Only Cumulated Consumption not Certified	0x0002
Not Certified data	0x0003

22774

22775 **10.13.2.1.4 CustomerName Attribute**

22776 *CustomerName* is a Character String field capable of storing up to 16 character string (the first Octet indicates  
 22777 length) encoded in the ASCII format.

<sup>220</sup> CCB 2817 2860

22778 **10.13.2.1.5 Model Attribute**

22779 *Model* is an Octet String field capable of storing up to 16 character string (the first Octet indicates length)  
22780 encoded in the UTF-8 format. *Model* defines the meter model name, decided by manufacturer.

22781 **10.13.2.1.6 PartNumber Attribute**

22782 *PartNumber* is an Octet String field capable of storing up to 16 character string (the first Octet indicates  
22783 length) encoded in the UTF-8 format. *PartNumber* defines the meter part number, decided by manufacturer.

22784 **10.13.2.1.7 ProductRevision Attribute**

22785 *ProductRevision* is an Octet String field capable of storing up to 6 character string (the first Octet indicates  
22786 length) encoded in the UTF-8 format. *ProductRevision* defines the meter revision code, decided by manufac-  
22787 turer.

22788 **10.13.2.1.8 SoftwareRevision Attribute**

22789 *SoftwareRevision* is an Octet String field capable of storing up to 6 character string (the first Octet indicates  
22790 length) encoded in the UTF-8 format. *SoftwareRevision* defines the meter software revision code, decided by  
22791 manufacturer.

22792 **10.13.2.1.9 UtilityName Attribute**

22793 *UtilityName* is a Character String field capable of storing up to 16 character string (the first Octet indicates  
22794 length) encoded in the ASCII format.

22795 **10.13.2.1.10 POD Attribute**

22796 *POD (Point of Delivery)* is a Character String field capable of storing up to 16 character string (the first  
22797 Octet indicates length) encoded in the ASCII format. *POD* is the unique identification ID of the premise  
22798 connection point. It is also a contractual information known by the clients and indicated in the bill.

22799 **10.13.2.1.11 AvailablePower Attribute**

22800 *AvailablePower* represents the *InstantaneousDemand* that can be distributed to the customer (e.g., 3.3KW  
22801 power) without any risk of overload. The *Available Power* SHALL use the same formatting conventions as  
22802 the one used in the simple metering cluster formatting attribute set for the *InstantaneousDemand* attribute,  
22803 i.e., the *UnitOfMeasure* and *DemandFormatting*.

22804 **10.13.2.1.12 PowerThreshold Attribute**

22805 *PowerThreshold* represents a threshold of *InstantaneousDemand* distributed to the customer (e.g., 4.191KW)  
22806 that will lead to an imminent risk of overload. The *PowerThreshold* SHALL use the same formatting con-  
22807 ventions as the one used in the *AvailablePower* attributes and therefore in the simple metering cluster for-  
22808 matted attribute set for the *InstantaneousDemand* attribute, i.e., the *UnitOfMeasure* and *DemandFormatting*.

22809 **10.13.2.1.13 Commands Received**

22810 No cluster-specific commands are received or generated by the server.



22811 **10.13.3 Client**

22812 The client has no dependencies and no cluster specific attributes. The client does not receive or generate any  
22813 cluster specific commands.



22814

## CHAPTER 11 OVER-THE-AIR UPGRADE

22815

22816

22817

22818

The Cluster Library is made of individual chapters such as this one. See Document Control in the Cluster Library for a list of all chapters and documents. References between chapters are made using a *X.Y* notation where *X* is the chapter and *Y* is the sub-section within that chapter. References to external documents are contained in Chapter 1 and are made using [*Rn*] notation.

22819

### 11.1 Introduction

22820

#### 11.1.1 Purpose

22821

22822

22823

The objective of this chapter is to provide detailed technical requirements for Over-The-Air image upgrade. This chapter presents a clear methodology for implementation of the OTA Upgrade cluster using the existing ZigBee stack(s), ZigBee Cluster Library and this OTA cluster.

22824

22825

22826

22827

The main goal of Over-The-Air Upgrade cluster is to provide an interoperable means for devices from different manufacturers to upgrade each other's image. Additionally, the OTA Upgrade cluster defines a mechanism by which security credentials, logs and configuration file types are accessible by offering a solution that utilizes a set of optional and mandatory commands.

22828

#### 11.1.2 Scope

22829

22830

22831

This chapter will only describe features that require implementation in order to be ZigBee OTA upgrade (cluster) certified. Other optional features including using multicast for sending upgrade messages and (upgrade) cloning will not be discussed in this document.

22832

22833

Currently, only Application Bootloader support is required in order to support ZigBee OTA Upgrade cluster. MAC Bootloader upgrading is not supported at the moment.

22834

#### 11.1.3 Terminology

22835

22836

**Application Standard or Standard** – This is a noun that refers to any application standard specification that includes this specification. Examples: ZigBee Home Automation, ZigBee Smart Energy, etc.

22837

### 11.2 General Description

22838

#### 11.2.1 Introduction

22839

22840

22841

The existing OTA upgrade methods available are platform specific, not OTA interoperable and do not provide a common framework for upgrading networks that support a mix of devices from multiple platforms and ZigBee Stack vendors.

22842

22843

22844

22845

The intent of this chapter is to provide an interoperable OTA upgrade of new image for devices deployed in the field. As long as the device supports the OTA Upgrade cluster and it is certified by an approved test house, its image SHALL be upgradeable by another device from the same or different manufacturer that also implemented and certified the OTA Upgrade cluster.

22846

22847

22848

22849

22850

22851

OTA Upgrade cluster will also require that in order to support OTA upgrade, the device will need to have an application bootloader installed as well as sufficient memory (external or internal) to store the newly loaded image. An application bootloader uses the running ZigBee stack and application to retrieve and store a new image. Depending upon the manufacturer, the image MAY consist of a bootloader image, a ZigBee stack image or only a patch to the application image. Whatever comprises the OTA upgrade image being sent to the node does not concern the ZigBee OTA cluster and it is outside the scope.

22852 To use an application bootloader, the device is required to have sufficient memory (internal or external) to  
 22853 store the newly downloaded OTA upgrade image. By doing so, the current running image is not overwritten  
 22854 until the new image has been successfully downloaded. It also allows the possibility of a node saving an  
 22855 image in its memory and forwarding that image to another node. Application bootloading provides flexibility  
 22856 of when the device decides to download new OTA upgrade image as well as when the device decides to  
 22857 switch to running the new image.

22858 Since the bootloading is done at the application level, it automatically makes use of various features already  
 22859 offered by the ZigBee Network Layer and Application Sub Layer (APS) including the ability to bootload a  
 22860 device that is multiple hops away, message retries to increase reliability, and security. It also allows the  
 22861 network to continue to operate normally while the bootload is in progress. In addition, it supports bootloading  
 22862 of sleeping (RxOnWhenIdle=FALSE) devices.

22863 The application bootload messages are built upon typical ZigBee messages, with additional ZigBee Cluster  
 22864 Library (ZCL) header and payload and ZigBee OTA cluster specific payload.

22865 An application standard that includes this specification MAY, of course, add requirements and dependen-  
 22866 cies not defined here. Such a standard SHALL not relax requirements by changing a feature here from  
 22867 mandatory to optional, but it MAY specify features it deems mandatory, that are optional in this specifica-  
 22868 tion.

22870 For example: The ZigBee Smart Energy standard has particular OTA cluster security feature requirements  
 22871 that are defined as mandatory in the ZSE specification, but are optional here.

## 11.2.2 Cluster List

22872  
 22873 The clusters defined in this document are listed in Table 11-1.

22874 **Table 11-1. Clusters Specified in This Document**

Cluster ID	Cluster Name	Description
0x0019	OTA Upgrade	Parameters and commands for upgrading image on devices Over-The-Air.

22875  
 22876

**Figure 11-1. Typical Usage of OTA Upgrade Cluster**

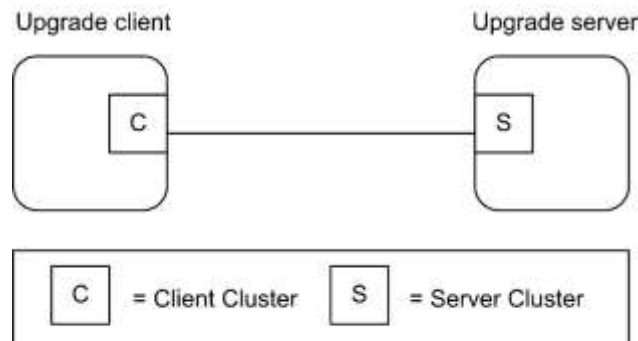

*Note: Device names are examples for illustration purposes only*

22877  
 22878

22879 Upgrade Client is a device to be upgraded with new image. Upgrade server is a device that has the new image  
 22880 to send to the client. This document SHALL specify how the client discovers the server, the over the air  
 22881 message format between the client and server, and the means for the server to signal the client to switch to  
 22882 running the new image.

22883 It is possible that the upgrade server MAY have several OTA upgrade images from different manufacturers.  
22884 How the upgrade server receives these OTA upgrade images and how it stores and manages them are outside  
22885 the scope of this document.

22886 In addition to the typical use case of transferring new firmware images to client devices, OTA Upgrade cluster  
22887 MAY also be used to transfer device specific file types such as log, configuration or security credentials  
22888 (needed for upgrading from SE 1.0 or SE 1.1 to SE 2.0). The cluster provides flexibility in OTA header and  
22889 a set of optional commands that make transferring of such file types possible.

## 22890 **11.3 OTA Upgrade**

---

### 22891 **11.3.1 Overview**

22892 Please see section 2.2 for a general cluster overview defining cluster architecture, revision, classification,  
22893 identification, etc.

22894 The cluster provides a standard way to upgrade devices in the network via OTA messages. Thus the upgrade  
22895 process MAY be performed between two devices from different manufacturers. Devices are required to have  
22896 application bootloader and additional memory space in order to successfully implement the cluster.

22897 It is the responsibility of the server to indicate to the clients when update images are available. The client  
22898 MAY be upgraded or downgraded. The upgrade server knows which client devices to upgrade and to what  
22899 file version. The upgrade server MAY be notified of such information via the backend system. For ZR clients,  
22900 the server MAY send a message to notify the device when an updated image is available. It is assumed that  
22901 ZED clients will not be awake to receive an unsolicited notification of an available image. All clients (ZR  
22902 and ZED) SHALL query (poll) the server periodically to determine whether the server has an image update  
22903 for them. Image Notify is optional.

22904 The cluster is implemented in such a way that the client service works on both ZED and ZR devices. Being  
22905 able to handle polling is mandatory for all server devices while being able to send a notify is optional. Hence,  
22906 all client devices must be able to use a ‘poll’ mechanism to send query message to the server in order to see  
22907 if the server has any new file for it. The polling mechanism also puts fewer resources on the upgrade server.  
22908 It is ideal to have the server maintain as little state as possible since this will scale when there are hundreds  
22909 of clients in the network. The upgrade server is not required to keep track of what pieces of an image that a  
22910 particular client has received; instead the client SHALL do that. Lastly poll makes more sense for devices  
22911 that MAY need to perform special setup to get ready to receive an image, such as unlocking flash or allocating  
22912 space for the new image.

22913 **11.3.1.1 Revision History**

22914 The global mandatory *ClusterRevision* attribute SHALL reflect the revision of the implemented cluster spec-  
22915 ification as identified by one or more cluster identifiers listed below in this specification (see 2.3.5.1).

22916 The global *ClusterRevision* attribute value SHALL be the highest revision number in the table below.

Rev	Description
1	mandatory global <i>ClusterRevision</i> attribute added; CCBs 1374 1470 1477 1540 1594 2046 2056
2	alternative Image Activation Policies; 128-bit Crypto suite, Smart Energy Profile 1.2a & 1.2b
3	CCB 2219 2220 2221 2222 2223 2224 2225 2226 2227 2228 2296 2307 2315 2342 2398 2464
4	CCB 2477 2519 2873

22917 **11.3.1.2 Classification**

Hierarchy	Role	PICS Code
Base	Utility	OTA

22918 **11.3.1.3 Cluster Identifiers**

Identifier	PICS Code	Name
0x0019	OTA	OTA Upgrade

22919 **11.3.2 Security**

22920 Security for the OTA Upgrade cluster encompasses these areas: image verification, image transport, and  
22921 image encryption. Security mechanisms in the application standard dictate the security level of over-the-air  
22922 image upgrading. For example, an application standard with strict security policies (such as Smart Energy)  
22923 MAY support image signature as well as encryption in both network and APS layers; while other application  
22924 standards MAY only support network encryption. Each application standard must decide the list of required  
22925 security policies for their use of the OTA Upgrade cluster.

22926 **11.3.2.1 Terminology**

22927 There are many aspects to security. These can be broken down into the following areas: confidentiality,  
22928 integrity, authentication, availability, and non-repudiation. Authorization and auditing can also be considered  
22929 as part of security.

22930 **Confidentiality** – This is the requirement that no third party can read data that is not intended for that party.  
22931 This is discussed below in Image Encryption.

22932 **Integrity** – This is the property of security where the recipient can verify that data was not modified between  
22933 the time it was initially distributed by the sender and when it was received by the intended recipient. Modi-  
22934 fications to the data by third parties can be detected. This is discussed in Image Verification below.

22935 **Authentication** – This is the property where the identity of the sender of data can be verified by the intended  
22936 recipient. This is discussed in Image Verification below.

22937 **Availability** – This refers to the property that resources are available when they are required and cannot be  
22938 unfairly consumed by an attacker. The OTA Upgrade cluster does not address this; as such it will not be  
22939 discussed any further.

22940 **Non-repudiation** – This refers to the property where a sender/receiver cannot deny that a security exchange  
22941 took place. The OTA Upgrade cluster does not address this; as such it will not be discussed any further.

## 22942 **11.3.3 Image Verification**

### 22943 **11.3.3.1 Asymmetric Verification of Authenticity and In-** 22944 **tegrity**

22945 It is strongly encouraged that there is a means to verify the authenticity and integrity of the bootload image.  
22946 This is most often accomplished through asymmetric encryption technologies (i.e. public/private keys) where  
22947 only one device is able to create a digital signature but many devices are able to verify it. Bootload images  
22948 MAY be signed by the private key of the manufacturer with that signature appended to the image that is  
22949 transported to the device. Once the complete image has been received the signature is verified using the  
22950 public key of the signer.

22951 Devices MAY be pre-installed with the certificate (public key) of the device that created the signature, or  
22952 they MAY receive the certificate over-the-air. How the signer's security data is obtained is considered outside  
22953 the scope of the OTA Upgrade cluster and is manufacturer specific. When signer certificates are sent over-  
22954 the-air and not pre-installed, it is recommended that the transportation of the certificate be done using en-  
22955 cryption from a trusted source to reduce the chance an attacker MAY inject their own signer certificate into  
22956 the device.

22957 Images with verification mechanisms built in MAY be transported over insecure communication mechanisms  
22958 while still maintaining their authenticity and integrity. In fact, it is likely that the originator of the upgrade  
22959 image (the manufacturer) will not be directly connected to any ZigBee networks and therefore distribute the  
22960 upgrade image across other mediums (such as the internet) before arriving on the ZigBee network. In that  
22961 case it is crucial that the Image Verification be independent of the communication medium. Any attempts to  
22962 tamper with the signature or the data itself must be detected and will cause the upgrade image to be rejected  
22963 by the target device. An attacker that crafts its own signed image and tries to have it accepted will be rejected  
22964 since that image will not be signed by the manufacturer's signing authority.

22965 It is up to each application standard to determine the minimum requirements for image verification. For  
22966 example: for the ZigBee Smart Energy standard there is already a minimum set of security requirements  
22967 included in NEMA SG-AMI 1-2009. The OTA Upgrade cluster will communicate the methods in use for  
22968 basic image verification. Individual manufacturers are free to augment this and provide their own extensions.  
22969 Those extensions are outside the scope of the OTA Upgrade cluster.

22970 Without asymmetric encryption technology, a device is limited in its ability to authenticate images. Images  
22971 MAY be encrypted with symmetric keys such that only those devices that need to decrypt the image have  
22972 access to the key. However, the security of this system is dependent on the security of all devices that have  
22973 access to the symmetric key.

### 22974 **11.3.3.2 Verification of Integrity by Hash Value**

22975 For application standards that do not require the asymmetric verification method, the authenticity of the OTA  
22976 image cannot be verified. However, it is possible to verify the integrity of the OTA image by using the hash  
22977 value method in section 11.7.2. There will be no signer certificate nor any signature involved.

## 22978 11.3.4 Image Transport

22979 When there is a means to verify the authenticity of the bootload images, transport of the images in a secure  
22980 fashion provides little additional security to the integrity and authenticity. What secure transportation pro-  
22981 vides is a means to communicate the policies about *when* a device SHOULD perform upgrade or *what version*  
22982 it SHOULD upgrade to.

22983 A secured ZigBee network uses network security for all messages, but that does not provide point-to-point  
22984 security. APS security SHOULD be used to assure that messages are sent from only the trusted source (the  
22985 upgrade server). This will be utilized to provide implicit and explicit authorization by the upgrade server  
22986 about when devices will *initiate* bootload events.

22987 Distribution of upgrade image via broadcast or multicast messages is not recommended because its lack of  
22988 point-to-point security. Reception of upgrade images via broadcast or multicast SHOULD not be inferred as  
22989 authorization by the upgrade server to initiate the upgrade. In this case, the act of receiving the image and  
22990 upgrading it SHOULD be split up into separate events. The latter communications SHOULD be done via  
22991 unicast to verify that the upgrade server has authorized a device to upgrade to a previously received image.  
22992 Applications must determine what level of authorization is required by the upgrade server.

## 22993 11.3.5 Image Signature

22994 An application standard MAY require that the OTA Upgrade cluster provides mechanisms to sign the OTA  
22995 file to protect the authenticity and integrity of the image.

## 22996 11.3.6 Image Integrity Code

22997 An application standard MAY require that the OTA Upgrade cluster provides hash mechanisms to provide  
22998 protection against unintended data corruption.

# 22999 11.4 OTA File Format

---

## 23000 11.4.1 General Structure

23001 The OTA file format is composed of a header followed by a number of sub-elements. The header describes  
23002 general information about the file such as version, the manufacturer that created it, and the device it is in-  
23003 tended for. Sub-elements in the file MAY contain upgrade data for the embedded device, certificates, con-  
23004 figuration data, log messages, or other manufacturer specific pieces. Below is an example file.

23005 **Figure 11-2. Sample OTA File**

Octets	Variable	Variable	Variable	Variable
Data	OTA Header	Upgrade Image	Signer Certificate	Signature

23006  
23007 The OTA header will not describe details of the particular sub-elements. Each sub-element is self-describing.  
23008 With exception of a few sub-elements, the interpretation of the data contained is up to the manufacturer of  
23009 the device.



23010 **11.4.2 OTA Header Format**

23011 **Table 11-2. OTA Header Fields**

Octets	Data Types	Field Names	M/O
4	uint32	OTA upgrade file identifier	M
2	uint16	OTA Header version	M
2	uint16	OTA Header length	M
2	map16	OTA Header Field control	M
2	uint16	Manufacturer code	M
2	uint16	Image type	M
4	uint32	File version	M
2	uint16	ZigBee Stack version	M
32	ASCII <sup>221</sup>	OTA Header string	M
4	uint32	Total Image size (including header)	M
0/1	uint8	Security credential version	O
0/8	EUI64	Upgrade file destination	O
0/2	uint16	Minimum hardware version	O
0/2	uint16	Maximum hardware version	O

23012 The first entry of the table above (OTA upgrade file identifier) represents the first field in the OTA header,  
 23013 and the last entry represents the last field. The endianness used in each data field SHALL be little endian in  
 23014 order to be compliant with general ZigBee messages.

23015 Please refer to Chapter 2, Foundation Specification, for more description on data types.

23016 **11.4.2.1 OTA Upgrade File Identifier**

23017 The value is a unique 4-byte value that is included at the beginning of all ZigBee OTA upgrade image files  
 23018 in order to quickly identify and distinguish the file as being a ZigBee OTA cluster upgrade file, without  
 23019 having to examine the whole file content. This helps distinguishing the file from other file types on disk. The  
 23020 value is defined to be “0x0BEEF11E”.

23021 **11.4.2.2 OTA Header Version**

23022 The value enumerates the version of the header and provides compatibility information. The value is com-  
 23023 posed of a major and minor version number (one byte each). The high byte (or the most significant byte)  
 23024 represents the major version and the low byte (or the least significant byte) represents the minor version  
 23025 number. A change to the minor version means the OTA upgrade file format is still backward compatible,  
 23026 while a change to the major version suggests incompatibility.

23027 The current OTA header version SHALL be 0x0100 with major version of “01” and minor version of “00”.

<sup>221</sup> this does not have a length byte, so it is not a character string data type

23028 **11.4.2.3 OTA Header Length**

23029 This value indicates full length of the OTA header in bytes, including the OTA upgrade file identifier, OTA  
 23030 header length itself to any optional fields. The value insulates existing software against new fields that MAY  
 23031 be added to the header. If new header fields added are not compatible with current running software, the  
 23032 implementations SHOULD process all fields they understand and then skip over any remaining bytes in the  
 23033 header to process the image or signing certificate. The value of the header length depends on the value of the  
 23034 OTA header field control, which dictates which optional OTA header fields are included.

23035 **11.4.2.4 OTA Header Field Control**

23036 The bit mask indicates whether additional information such as Image Signature or Signing Certificate are  
 23037 included as part of the OTA Upgrade Image.

23038 **Table 11-3. OTA Header Field Control Bitmask**

Bits	Name
0	Security Credential Version Present
1	Device Specific File
2	Hardware Versions Present

23039 Security credential version present bit indicates whether security credential version field is present or not in  
 23040 the OTA header.

23041 Device specific file bit in the field control indicates that this particular OTA upgrade file is specific to a single  
 23042 device.

23043 Hardware version present bit indicates whether minimum and maximum hardware version fields are present  
 23044 in the OTA header or not.

23045 **11.4.2.5 Manufacturer Code**

23046 This is the ZigBee assigned identifier for each member company. When used during the OTA upgrade pro-  
 23047 cess, manufacturer code value of 0xffff has a special meaning of a wild card. The value has a ‘match all’  
 23048 effect. OTA server MAY send a command with wild card value for manufacturer code to match all client  
 23049 devices from all manufacturers.

23050 **11.4.2.6 Image Type**

23051 The manufacturer SHOULD assign an appropriate and unique image type value to each of its devices in order  
 23052 to distinguish the products. This is a manufacturer specific value. However, the OTA Upgrade cluster has  
 23053 reserved the last 64 values of image type value to indicate specific file types such as security credential, log,  
 23054 and configuration. When a client wants to request one of these specific file types, it SHALL use one of the  
 23055 reserved image type values instead of its own (manufacturer specific) value when requesting the image via  
 23056 Query Next Image Request command.

23057 **Table 11-4. Image Type Values**

File Type Values	File Type Description
0x0000 – 0xffbf	Manufacturer Specific
0xffc0	Client Security credentials

File Type Values	File Type Description
0xffc1	Client Configuration
0xffc2	Server Log
0xffc3	Picture
0xffff	wild card

23058

23059 Image type value of 0xffff has a special meaning of a wild card. The value has a ‘match all’ effect. For  
 23060 example, the OTA server MAY send Image Notify command with image type value of 0xffff to indicate to  
 23061 a group of client devices that it has all types of images for the clients. Additionally, the OTA server MAY  
 23062 send Upgrade End Response command with image type value of 0xffff to indicate a group of clients, with  
 23063 disregard to their image types, to upgrade.

23064 **11.4.2.7 File Version**

23065 For firmware image, the file version represents the release and build number of the image’s application and  
 23066 stack. The application release and build numbers are manufacturer specific, however, each manufacturer  
 23067 SHOULD obtain stack release and build numbers from their stack vendor. OTA Upgrade cluster makes the  
 23068 recommendation below regarding how the file version SHOULD be defined, in an attempt to make it easy  
 23069 for humans and upgrade servers to determine which versions are newer than others. The upgrade server  
 23070 SHOULD use this version value to compare with the one received from the client.

23071 The server MAY implement more sophisticated policies to determine whether to upgrade the client based on  
 23072 the file version. A higher file version number indicates a newer file.

23073

**Table 11-5. Recommended File Version Definition**

Application Release	Application Build	Stack Release	Stack Build
1 byte	1 byte	1 byte	1 byte
8-bit integer	8-bit integer	8-bit integer	8-bit integer

23074

For example,

23075

File version A: 0x10053519 represents application release 1.0 build 05 with stack release 3.5 b19.

23076

File version B: 0x10103519 represents application release 1.0 build 10 with stack release 3.5 b19.

23077

File version C: 0x10103701 represents application release 1.0 build 10 with stack release 3.7 b01.

23078

File version B is newer than File version A because its application version is higher, while File version C is  
 23079 newer than File version B because its stack version is higher.

23080

The file version value MAY be defined differently for different image types. For example, version scheme  
 23081 for security credential data MAY be different than that of log or configuration file or a normal firmware  
 23082 upgrade image version. The specific implementation of a versioning scheme is manufacturer specific.

23083

Note that a binary-coded decimal convention (BCD) concept is used here for version number. This is to allow  
 23084 easy conversion to decimal digits for printing or display, and allows faster decimal calculations.

23085 **11.4.2.8 ZigBee Stack Version**

23086 This information indicates the ZigBee stack version that is used by the application. This provides the upgrade  
23087 server an ability to coordinate the distribution of images to devices when the upgrades will cause a major  
23088 jump that usually breaks the over-the-air compatibility, for example, from ZigBee Pro to upcoming ZigBee  
23089 IP. The values below represent currently available ZigBee stack versions.

23090 **Table 11-6. ZigBee Stack Version Values**

ZigBee Stack Version Values	Stack Name
0x0000	ZigBee 2006
0x0001	ZigBee 2007
0x0002	ZigBee Pro
0x0003	ZigBee IP

23091 **11.4.2.9 OTA Header String**

23092 This is a manufacturer specific string that MAY be used to store other necessary information as seen fit by  
23093 each manufacturer. The string SHALL be a null terminated string using ASCII encoding. Any bytes after the  
23094 terminating character MAY be used by manufacturers for additional data transport and SHALL not be inter-  
23095 preted as human readable data. The idea is to have a human readable string that can prove helpful during  
23096 development cycle. The string is defined to occupy 32 bytes of space in the OTA header.

23097 **11.4.2.10 Total Image Size**

23098 The value represents the total image size in bytes. This is the total of data in bytes that SHALL be transferred  
23099 over-the-air from the server to the client. In most cases, the total image size of an OTA upgrade image file is  
23100 the sum of the OTA header and the actual file data (along with its tag) lengths. If the image is a signed image  
23101 and contains a certificate of the signer, then the Total image size SHALL also include the signer certificate  
23102 and the signature (along with their tags) in bytes.

23103 This value is crucial in the OTA upgrade process. It allows the client to determine how many image request  
23104 commands to send to the server to complete the upgrade process.

23105 **11.4.2.11 Security Credential Version**

23106 This information indicates security credential version type, such as SE1.0 or SE2.0 that the client is required  
23107 to have, before it SHALL install the image. One use case for this is so that after the client has downloaded a  
23108 new image from the server, it SHOULD check if the value of security credential version allows for running  
23109 the image. If the client’s existing security credential version does not match or is outdated from what specified  
23110 in the OTA header, it SHOULD obtain new security credentials before upgrading to running the new image.

23111 **Table 11-7. Security Credential Version**

Security Credential Version Values	Security Credential Version Types
0x00	SE 1.0
0x01	SE 1.1

Security Credential Version Values	Security Credential Version Types
0x02	SE 2.0
0x03	SE 1.2

23112 **11.4.2.12 Upgrade File Destination**

23113 If Device Specific File bit is set, it indicates that this OTA file contains security credential/certificate data or  
 23114 other type of information that is specific to a particular device. Hence, the upgrade file destination field (in  
 23115 OTA header) SHOULD also be set to indicate the IEEE address of the client device that this file is meant  
 23116 for.

23117 **11.4.2.13 Minimum Hardware Version**

23118 The value represents the earliest hardware platform version this image SHOULD be used on. This field is  
 23119 defined as follows:

23120 **Table 11-8. Hardware Version Format**

Version	Revision
1 byte	1 byte
8-bit integer	8-bit integer

23121  
 23122 The high byte represents the version and the low byte represents the revision.

23123 **11.4.2.14 Maximum Hardware Version**

23124 The value represents the latest hardware platform this image SHOULD be used on. The field is defined the  
 23125 same as the Minimum Hardware Version (above).

23126 The hardware version of the device SHOULD not be earlier than the minimum (hardware) version and  
 23127 SHOULD not be later than the maximum (hardware) version in order to run the OTA upgrade file.

23128 **11.4.3 Sub-element Format**

23129 Sub-elements in the file are composed of an identifier followed by a length field, followed by the data. The  
 23130 identifier provides for forward and backward compatibility as new sub-elements are introduced. Existing  
 23131 devices that do not understand newer sub-elements MAY ignore the data.

23132 **Figure 11-3. Sub-element Format**

Octets	2-bytes	4-bytes	Variable
Data	Tag ID	Length Field	Data

23133

23134 Sub-elements provide a mechanism to denote separate sections of data utilized by the device for the upgrade.  
 23135 For example, a device that has multiple processors each with their own firmware image could use a separate  
 23136 sub-element for each one. The details of how this is handled would be up to the manufacturer of the device.  
 23137 A few sub-elements are not manufacturer-specific and defined by the OTA cluster itself. See section 11.4.4  
 23138 below.

### 23139 **11.4.3.1 Tag ID**

23140 The tag identifier denotes the type and format of the data contained within the sub-element. The identifier is  
 23141 one of the values from Table 11-9 below.

### 23142 **11.4.3.2 Length Field**

23143 This value dictates the length of the rest of the data within the sub-element in bytes. It does not include the  
 23144 size of the Tag ID or the Length Fields.

### 23145 **11.4.3.3 Data**

23146 The length of the data in the sub-element must be equal to the value of the Length Field in bytes. The type  
 23147 and format of the data contained in the sub-element is specific to the Tag.

## 23148 **11.4.4 Tag Identifiers**

23149 Sub-elements are generally specific to the manufacturer and the implementation. However, this specification  
 23150 has defined a number of common identifiers that MAY be used across multiple manufacturers.

23151 **Table 11-9. Tag Identifiers**

Tag Identifiers	Description
0x0000	Upgrade Image
0x0001	ECDSA Signature (Crypto Suite 1)
0x0002	ECDSA Signing Certificate (Crypto Suite 1)
0x0003	Image Integrity Code
0x0004	Picture Data
0x0005	ECDSA Signature (Crypto Suite 2)
0x0006	ECDSA Signing Certificate (Crypto Suite 2)
0xf000 – 0xffff	Manufacturer Specific Use

23152  
 23153 Manufacturers MAY define tag identifiers for their own use and dictate the format and behavior of devices  
 23154 that receive images with that data.

## 23155 **11.4.5 Crypto Suites**

23156 The specification allows use of one of two crypto suites. Crypto Suite 1 corresponds to the version offering  
 23157 ‘80-bit’ symmetric equivalent security, Crypto Suite 2 allows ‘128-bit’ symmetric equivalent security. Each  
 23158 utilizes different key lengths and signature sizes and thus requires unique tags with different sizes.

23159 **11.4.6 ECDSA Signature Sub-element (Crypto Suite 1)**

23160 The ECDSA Signature sub-element contains a signature for the entire file as means of insuring that the data  
 23161 was not modified at any point during its transmission from the signing device.

23162 If an image contains an ECDSA Signature Sub-element it SHALL be the last sub-element in the file.

23163 **Figure 11-4. ECDSA Signature**

Octets	2-bytes	4-bytes	8-bytes	42-bytes
<b>Data</b>	Tag ID: 0x0001	Length Field: 0x00000032	Signer IEEE Address	Signature Data

23164 **11.4.6.1 Signer IEEE Address**

23165 This field SHALL contain the IEEE address of the device that created the signature, in little endian format.

23166 **11.4.6.2 Signature Data**

23167 This field SHALL contain the ECDSA signature data, and is generated as described in the section 11.7.

23168 **11.4.7 ECDSA Signing Certificate Sub-element**

23169 This sub-element is used to include information about the authority that generated the signature for the OTA  
 23170 file.

23171 **Figure 11-5. ECDSA Signing Certificate Sub-element**

Octets	2-bytes	4-bytes	48-bytes
<b>Data</b>	Tag ID: 0x0002	Length Field: 0x00000030	ECDSA Certificate

23172 **11.4.7.1 ECDSA Certificate (Crypto Suite 1)**

23173 This SHALL contain the data for the ECDSA certificate of the device. The certificate SHALL be formatted  
 23174 as described in [Z9] in section C.4.2.2.4.

23175 **11.4.8 Image Integrity Code Sub-element**

23176 This sub-element includes a hash value used to verify the integrity of the OTA file.

23177 **Figure 11-6. Hash Value Sub-element**

Octets	2-bytes	4-bytes	16-bytes
<b>Data</b>	Tag ID: 0x0003	Length Field: 0x00000010	Hash Value

23178 **11.4.8.1 Hash Value**

23179 This hash value used to verify the integrity of the OTA file and the detail to generate the hash is listed in  
23180 section 11.7.2.

23181 **11.4.9 ECDSA Signature Sub-element (Crypto Suite 2)**

23182 The ECDSA Signature sub-element contains a signature for the entire file as means of insuring that the data  
23183 was not modified at any point during its transmission from the signing device.

23184 If an image contains an ECDSA Signature Sub-element it SHALL be the last sub-element in the file.

23185 **Figure 11-7. ECDSA Signature**

Octets	2-bytes	4-bytes	8-bytes	72-bytes
<b>Data</b>	Tag ID: 0x0005	Length Field: 0x00000050	Signer IEEE Address	Signature Data

23186 **11.4.9.1 Signer IEEE Address**

23187 This field SHALL contain the IEEE address of the device that created the signature, in little endian format.

23188 **11.4.9.2 Signature Data**

23189 This field SHALL contain the ECDSA signature data, and is generated as described in the section 11.7.

23190 **11.4.10 ECDSA Signing Certificate Sub-element**  
23191 **(Crypto Suite 2)**

23192 This sub-element is used to include information about the authority that generated the signature for the OTA  
23193 file.

23194 **Figure 11-8. ECDSA Signing Certificate Sub-element**

Octets	2-bytes	4-bytes	74-bytes
<b>Data</b>	Tag ID: 0x0006	Length Field: 0x0000004A	ECDSA Certificate

23195 **11.4.10.1 ECDSA Certificate (Crypto Suite 2)**

23196 This SHALL contain the data for the ECDSA certificate of the device. The certificate SHALL be formatted  
23197 as described in [Z9] in section C.4.2.3.3.

23198 **11.5 OTA File Naming**

23199 OTA Upgrade cluster provides recommendation below regarding OTA Upgrade image file naming conven-  
23200 tion and extension. This is an effort to assist the upgrade server in sorting different image files received from  
23201 different manufacturers.



- 23202 The OTA Upgrade image file name SHOULD contain the following information at the beginning of the name  
23203 with each field separated by a dash (“-“): manufacturer code, image type and file version. The value of each  
23204 field stated SHOULD be in hexadecimal number and in capital letter. Each manufacturer MAY append more  
23205 information to the name as seen fit to make the name more specific. The OTA Upgrade file extension  
23206 SHOULD be “.zigbee”.
- 23207 An example of OTA Upgrade image file name and extension is “1001-00AB-10053519-upgradeMe.zigbee”.

## 23208 11.6 Signatures

---

- 23209 It is up to the application standard to determine whether or not a signature is necessary for over the air upgrade  
23210 files. If a standard has mandated the use of signatures then a device adhering to that standard SHALL only  
23211 accept images that have a signature sub-element. If such a device receives an OTA file that does not contain  
23212 a signature sub-element, then the device will discard the image and proceed with any further processing  
23213 required by the specific application standard. The device must verify the signature as described in the fol-  
23214 lowing sections prior to acting on any data inside the file.
- 23215 If a standard does not require the use of signatures then devices MAY still choose to use images with signa-  
23216 tures. However, it is highly recommended that such a device only accept images either with signatures or  
23217 without, but not accept both. A device greatly reduces its security if it will accept signed or unsigned upgrade  
23218 files.

## 23219 11.7 ECDSA Signature Calculation

---

- 23220 It is EXPECTED that in most all cases the signer device is not a real ZigBee device and is not part of any  
23221 ZigBee network. Therefore, the signer’s IEEE is not a real ZigBee device address, but the address of a virtual  
23222 device that exists only to sign upgrade images for a manufacturer and or a set of products. Its address  
23223 SHOULD be separate from the block of device addresses produced by a manufacturer as certified ZigBee  
23224 devices.
- 23225 The signature calculation SHALL be performed as follows:
- 23226 1. A valid OTA image SHALL have previously been created including all the necessary header fields,  
23227 tags, and their data, in the image.
  - 23228 2. The signer shall select a crypto suite to use based on its own security policies.
  - 23229 3. An ECDSA signer certificate tag sub-element SHALL be constructed, based on the selected crypto  
23230 suite, and SHALL contain the certificate of the signing device, appended to the image.
  - 23231 4. An ECDSA signature tag sub-element SHALL be constructed, based on the previously selected  
23232 crypto suite, including only the tag ID, the length of the tag, and the signer’s IEEE address (see  
23233 11.4.6 and 11.4.9). No actual signature data SHALL be included yet. The tag SHALL be appended  
23234 to the image.
  - 23235 5. The OTA image header SHALL be updated with a new total image size, including the signature  
23236 certificate tag sub-element that was added, and the full size of the ECDSA signature tag sub-element  
23237 (see 11.4.6 and 11.4.9).
  - 23238 6. A message digest SHALL be calculated over the entire image.
    - 23239 a. The message digest SHALL be computed by using the Matyas-Meyer-Oseas cryptographic  
23240 hash specified in the ZigBee core specification 05-3474-20 Section B.6. This uses the ex-  
23241 tended AES-MMO hash proposed as a change to an earlier version of the ZigBee core  
23242 specification 05-3474-20 Section B.6.
  - 23243 2. The ECDSA algorithm SHALL be used to calculate the signature using the message digest and the  
23244 signer device’s private key.

- 23245 3. The r and s components of the signature SHALL both be appended to the image. The r component  
23246 SHALL be appended first, and then the s component.

## 23247 11.7.1 ECDSA Signature Verification

23248 The signature of a completely downloaded OTA file SHALL be verified as follows.

- 23249 18. The ZigBee device SHALL first determine if the signer of the image is an authorized signer.
- 23250 2. It does this by extracting the signer IEEE from ECDSA signature tag sub-element.
- 23251 1. If an ECDSA signature tag sub-element is not found in the image, then the image SHALL be  
23252 discarded as invalid and no further processing SHALL be done.
- 23253 3. The device SHALL compare the extracted signer IEEE with the list of local, known, authorized  
23254 signers and determine if there is a match.
- 23255 4. If no match is found, then the image SHALL be discarded as invalid and no further processing  
23256 SHALL be done.
- 23257 19. The device SHALL then check the ECDSA Crypto Suite of the image.
- 23258 a. The device SHALL check which crypto suite is used for both the ECDSA Signature tag and EC-  
23259 DSA Signing Certificate tag. If both elements do not use the same crypto suite, then the device  
23260 SHALL discard the image as invalid and no further processing SHALL be done.
- 23261 b. The device SHALL check which crypto suites are locally allowed and supported. If the device  
23262 does not locally support the crypto suite used by the ECDSA Signing certificate tag or a security  
23263 policy does not allow its use for verifying locally, then it SHALL discard the image as invalid and  
23264 no further processing SHALL be done.
- 23265 20. The device SHALL then obtain the certificate associated with the signer IEEE.
- 23266 5. The device SHALL extract the signer certificate data from the ECDSA signing certificate sub-ele-  
23267 ment.
- 23268 1. If there is no ECDSA signing certificate tag sub-element, then it SHALL discard the image as  
23269 invalid and no further processing SHALL be done.
- 23270 6. The device SHALL verify that the signer IEEE address within the ECDSA signature tag sub-ele-  
23271 ment matches the subject field of the ECDSA signing certificate sub-element.
- 23272 2. **Note:** The subject field IEEE is in big-endian format and the signer IEEE is in little endian  
23273 format.
- 23274 7. If the addresses do not match, then the image SHALL be discarded as invalid and no further pro-  
23275 cessing SHALL be done.
- 23276 21. The device SHALL then obtain the CA public key associated with the signer.
- 23277 8. The device SHALL obtain the IEEE of the CA public key from the issuer field within the ECDSA  
23278 certificate data of the ECDSA signing certificate sub-element.
- 23279 9. If the IEEE of the CA does not match its list of known CAs, or the public key for that CA could  
23280 not be locally obtained, then the image SHALL be discarded as invalid and no further processing  
23281 SHALL be done.
- 23282 22. The device SHALL then calculate the message digest of the image.
- 23283 10. The digest SHALL be calculated using the Matyas-Meyer-Oseas cryptographic hash function over  
23284 the entire image except for the signature data of the ECDSA signature sub-element.
- 23285 3. **Note:** The calculation SHALL include the signature tag ID of the ECDSA signature sub-ele-  
23286 ment, the length field of the ECDSA signature sub-element, and the signer IEEE field of the  
23287 ECDSA signature sub-element.

- 23288 23. The signer’s public key SHALL be obtained by extracting it from the signer certificate.
- 23289 24. The device SHALL then pass the calculated digest value, signer certificate, and CA public key to the  
23290 ECDSA verification algorithm.
- 23291 25. If the ECDSA algorithm returns success, then the image SHALL be considered valid.
- 23292 26. If the ECDSA algorithm returns any other result, then the image SHALL be discarded as invalid and  
23293 no further processing SHALL be done.

## 23294 11.7.2 Image Integrity Code

23295 It is up to the application standard to determine whether or not an image integrity code is necessary for over  
23296 the air upgrade files. Standards that require the use of digital signatures SHALL NOT use this Image Integrity  
23297 Hash Code sub-element in conjunction to the ECDSA signature. If a standard has mandated the use of hash  
23298 values then a device adhering to that standard SHALL only accept images that have a valid hash sub-element.  
23299 If such a device receives an OTA file that does not contain a hash sub-element, then the device will discard  
23300 the image and proceed with any further processing required by the specific application standard. The device  
23301 must verify the hash as described in the following sections prior to acting on any data inside the file.

23302 The hash value provides protection against unintended data corruption. An OTA image which is hosted at a  
23303 back-end image repository might be stored and forwarded at several intermediate locations before it reaches  
23304 the OTA server, where it is typically stored on a local file system. There is a potential for this file being  
23305 corrupted either during transfer or as a result of file system errors. The hash value provides an interoperable  
23306 way for OTA servers to detect corrupt images before advertising such files to OTA clients. Otherwise corrupt  
23307 images might only be detected by OTA clients after complete download over-the-air. Since this condition  
23308 cannot be detected by the OTA server, it would offer the same (corrupt) file over and over again.

23309 If the application standard does not mandate the use of this hash value, it is strongly recommended that image  
23310 integrity is ascertained using another approach, for example a hash value (SHA-256 or comparable) that is  
23311 maintained out-of-band and provided by the device vendor together with the OTA image.

### 23312 11.7.2.1 Hash Value Calculation

23313 The hash value calculation SHALL be performed as follows:

- 23314 27. A valid OTA image SHALL have previously been created including all the necessary header fields,  
23315 tags, and their data, in the image.
- 23316 28. An AES-MMO hash value tag sub-element header SHALL be constructed including only the tag ID  
23317 and the length of the sub-element data (16 bytes). No actual data SHALL be included yet. The tag  
23318 header SHALL be appended to the image.
- 23319 29. The OTA image header SHALL be updated with a new total image size, including the hash tag sub-  
23320 element header that was added, and the full size of the hash tag sub-element ( $6 + 16 = 22$  bytes).
- 23321 30. The hash value SHALL be calculated using the Matyas-Meyer-Oseas cryptographic hash specified in  
23322 section B.6 of [R5]. The hash is calculated starting with the OTA image header and spanning just be-  
23323 fore the hash sub-element header, i.e. the calculation takes in to account the first byte of the image  
23324 header up to the last byte of the sub-element preceding the hash sub-element.
- 23325 31. The computed hash value SHALL be appended to the image.

### 23326 11.7.2.2 Hash Value Verification

23327 The hash value of a complete OTA file SHALL be verified as follows.

- 23328 32. The device SHALL calculate the hash value of the image using the Matyas-Meyer-Oseas crypto-  
23329 graphic hash function. The hash is calculated starting with the OTA image header and spanning just

- 23330 before the hash sub-element header, i.e. the calculation takes in to account the first byte of the image  
23331 header up to the last byte of the sub-element preceding the hash sub-element.
- 23332 33. The device SHALL then compare the calculated hash value with the data stored in the hash sub-  
23333 element data. If both octet strings are equal, the image SHALL be considered intact, otherwise the im-  
23334 age SHALL be considered corrupt.
- 23335 34. If the image is regarded corrupt, it SHALL be discarded as invalid and no further processing SHALL  
23336 be done.

## 23337 **11.8 Discovery of the Upgrade Server**

23338 Before becoming part of the network, a device MAY be preprogrammed with the IEEE address of the au-  
23339 thorized upgrade server. In this case, once the device is part of the network, it SHALL discover the network  
23340 address of the upgrade server via ZDO network address discovery command.

23341 If the device is not preprogrammed with the upgrade server's IEEE address, the device SHALL discover the  
23342 upgrade server before it participates in any upgrade process. The device SHALL send Match Descriptor  
23343 Request (ZDO command) to discover an upgrade server by specifying a single OTA cluster ID in the input  
23344 Cluster attribute. If the receiving node is an upgrade server, it SHALL reply with Match Descriptor Response,  
23345 with the (active) endpoint that the OTA cluster is implemented on, hence, identifying itself as acting as server  
23346 in OTA Upgrade cluster. Since Match descriptor request MAY be sent as unicast or broadcast, the client  
23347 MAY get multiple responses if there are more than one server in the network. The client SHALL use the first  
23348 response received. Each application standard SHOULD specify the frequency of OTA server discovery done  
23349 by the client. After discovering the OTA server's short ID via the ZDO Match descriptor request the client  
23350 SHALL discover the IEEE address of the upgrade server via ZDO IEEE address discovery command and  
23351 store the value in UpgradeServerID attribute.

23352 A node SHALL have an application link key with the Upgrade server; it SHALL request one prior to any  
23353 OTA operations.

23354 If the upgrade server is the trust center, it SHOULD use its trust center link key.

23355 In the case of the ZigBee Smart Energy standard, where the upgrade server is not the trust center, the device  
23356 SHALL perform partner link key request.

### 23357 **11.8.1 Server and Client**

23358 The server must be able to store one or more OTA upgrade image(s). The server MAY notify devices in the  
23359 network when it receives new OTA upgrade image by sending an Image Notify Command. The Image Notify  
23360 Command will be received reliably only on ZR devices since ZED devices MAY have their radio off at the  
23361 time. The Image Notify Command MAY be sent as unicast or broadcast. If sent as broadcast, the message  
23362 also has a jitter mechanism built in to avoid the server being overwhelmed by the requests from the clients.  
23363 If sent as unicast, the client SHALL ignore the jitter value.

23364 The client device will send Query Next Image Request Command if the information in the Image Notify  
23365 Command is of interest and after applying the jitter value. All devices SHALL send in a Query Next Image  
23366 Request Command periodically regardless of whether an Image Notify was sent by the OTA server.

23367 When the device has received a response to its query indicating a new OTA upgrade image is available, the  
23368 client device SHALL request blocks of the OTA upgrade image. The process continues until the client re-  
23369 ceives all image data. At that point, the client SHALL verify the integrity of the whole image received and  
23370 send Upgrade End Request Command along with the upgrade status. The server SHALL notify the client of  
23371 when to upgrade to new image in the Upgrade End Response.

23372 It is the responsibility of the server to ensure that all clients in the network are upgraded. The server MAY  
23373 be told which client to upgrade or it MAY keep a database of all clients in the network and track which client  
23374 has not yet been upgraded.

## 23375 11.8.2 Sleepy Devices

23376 The upgrade server has no reliable way to immediately notify the sleepy devices of the availability of new  
23377 OTA Upgrade image, hence, the devices SHALL query the server periodically to learn if there are new im-  
23378 ages available. The query for new upgrade image MAY be done as a separate event or it MAY be done in  
23379 addition to normal scheduled communication between the device and the server. The frequency as to how  
23380 often the sleepy devices query the server SHALL be specified by each application standard. Moreover, it is  
23381 important to realize that the frequency that the sleepy device checks for new image (sending Query Next  
23382 Image command) determines how often the particular node could be upgraded. This rate will also drive how  
23383 fast code updates MAY be pushed out to each network. For the SE 1.x to SE 2.0 transition, if sleepy devices  
23384 only check in once a month for the new image then it will likely to take over a month to complete the transi-  
23385 tion. If the application standard fails to set any requirement on the sleepy device checking for new images,  
23386 then it is unlikely that the OTA upgrade feature will work reliably for those devices.

23387 It is a recommendation that sleepy devices SHALL make their best effort to poll more rapidly during the  
23388 OTA Upgrade Image download process in order to ensure that the download completes in a timely manner.  
23389 However, it is acknowledged that some sleepy devices MAY not be able to do so due to limitation on their  
23390 batteries or due to other reasons such as battery-less/Green Power devices. Hence, such devices MAY take  
23391 much longer to complete the download process.

## 23392 11.9 Dependencies

---

23393 Each device that wishes to implement the OTA Upgrade cluster SHALL have the following:

- 23394 • ZigBee Device Object (ZDO) match descriptor request and response commands. The command is used  
23395 to discover upgrade server.
- 23396 • ZigBee Cluster Library (ZCL) global commands and basic cluster attributes.
- 23397 • Application Bootloader: To actually upgrade existing image with newly installed one on the additional  
23398 memory space. The implementation of the Bootloader along with its specification, for example, where  
23399 it lives and its size are outside the scope of this document.
- 23400 • Additional Memory Space SHALL be large enough to hold the whole OTA Upgrade Image: It is im-  
23401 portant to be able to store the new image until the device receives a signal from the server to switch to  
23402 running the image. This is because it MAY be necessary for all devices in the network to switch their  
23403 images at once if the new image is not OTA compatible with the old one.
- 23404 • In addition, if the client device is composed of multiple processors; each requires separate image, then  
23405 the additional memory space SHALL be large enough to hold all the images for all the processors that  
23406 make up the device. In case of server devices, its additional memory space will depend on how many  
23407 images the devices are planning to hold.
- 23408 • The specification of the additional memory space and its connection to the processor is outside the  
23409 scope of this document.

## 23410 11.10 OTA Cluster Attributes

---

23411 Below are attributes defined for OTA Upgrade cluster. Currently, **all attributes are client side attributes**  
23412 (only stored on the client). There is no server side attribute at the moment. All attributes with the exception  
23413 of UpgradeServerID SHOULD be initialized to their default values before being used.

23414

**Table 11-10. Attributes of OTA Upgrade Cluster**

<b>Id</b>	<b>Name</b>	<b>Type</b>	<b>Range</b>	<b>Acc</b>	<b>Default</b>	<b>M/O</b>
0x0000	<i>UpgradeServerID</i>	EUI64	-	R	0xffffffffffffffff	M
0x0001	<i>FileOffset</i>	uint32	<i>all</i>	R	0xffffffff	O
0x0002	<i>CurrentFileVersion</i>	uint32	<i>all</i>	R	0xffffffff	O
0x0003	<i>CurrentZigBeeStackVersion</i>	uint16	<i>all</i>	R	0xffff	O
0x0004	<i>DownloadedFileVersion</i>	uint32	<i>all</i>	R	0xffffffff	O
0x0005	<i>DownloadedZigBeeStackVersion</i>	uint16	<i>all</i>	R	0xffff	O
0x0006	<i>ImageUpgradeStatus</i>	enum8	<i>all</i>	R	0x00	M
0x0007	<i>Manufacturer ID</i>	uint16	<i>all</i>	R	-	O
0x0008	<i>Image Type ID</i>	uint16	<i>all</i>	R	-	O
0x0009	<i>MinimumBlockPeriod</i>	uint16	0x0000-0xfffe	R	0	O
0x000a	<i>Image Stamp</i>	uint32	<i>all</i>	R		O
0x000b	<i>UpgradeActivationPolicy</i>	enum8	0x00-0x01	R	0x00	O
0x000c	<i>UpgradeTimeout Policy</i>	enum8	0x00-0x01	R	0x00	O

23415

### 11.10.1 UpgradeServerID Attribute

23416  
23417  
23418  
23419

The attribute is used to store the IEEE address of the upgrade server resulted from the discovery of the upgrade server's identity. If the value is set to a non-zero value and corresponds to an IEEE address of a device that is no longer accessible, a device MAY choose to discover a new Upgrade Server depending on its own security policies.

23420  
23421  
23422  
23423  
23424  
23425

The attribute is mandatory because it serves as a placeholder in a case where the client is programmed, during manufacturing time, its upgrade server ID. In addition, the attribute is used to identify the current upgrade server the client is using in a case where there are multiple upgrade servers in the network. The attribute is also helpful in a case when a client has temporarily lost connection to the network (for example, via a reset or a rejoin), it SHALL try to rediscover the upgrade server via network address discovery using the IEEE address stored in the attribute.

23426  
23427

By default, the value is 0xffffffffffffffff, which is an invalid IEEE address. The attribute is a client-side attribute and stored on the client. Please refer to section 11.8 for a description of OTA server discovery.

23428

### 11.10.2 FileOffset Attribute

23429  
23430  
23431  
23432

The parameter indicates the current location in the OTA upgrade image. It is essentially the (start of the) address of the image data that is being transferred from the OTA server to the client. The attribute is optional on the client and is made available in a case where the server wants to track the upgrade process of a particular client.

23433 **11.10.3 CurrentFileVersion Attribute**

23434 The file version of the running firmware image on the device. The information is available for the server to  
 23435 query via ZCL read attribute command. The attribute is optional on the client.

23436 **11.10.4 CurrentZigBeeStackVersion Attribute**

23437 The ZigBee stack version of the running image on the device. The information is available for the server to  
 23438 query via ZCL read attribute command. The attribute is optional on the client. See 11.4.2.8 for values.

23439 **11.10.5 DownloadedFileVersion Attribute**

23440 The file version of the downloaded image on additional memory space on the device. The information is  
 23441 available for the server to query via ZCL read attribute command. The information is useful for the OTA  
 23442 upgrade management, so the server MAY ensure that each client has downloaded the correct file version  
 23443 before initiate the upgrade. The attribute is optional on the client.

23444 **11.10.6 DownloadedZigBeeStackVersion Attribute**

23445 The ZigBee stack version of the downloaded image on additional memory space on the device. The infor-  
 23446 mation is available for the server to query via ZCL read attribute command. The information is useful for the  
 23447 OTA upgrade management, so the server SHALL ensure that each client has downloaded the correct ZigBee  
 23448 stack version before initiate the upgrade. The attribute is optional on the client.

23449 **11.10.7 ImageUpgradeStatus Attribute**

23450 The upgrade status of the client device. The status indicates where the client device is at in terms of the  
 23451 download and upgrade process. The status helps to indicate whether the client has completed the download  
 23452 process and whether it is ready to upgrade to the new image. The status MAY be queried by the server via  
 23453 ZCL read attribute command. Hence, the server MAY not be able to reliably query the status of ZED client  
 23454 since the device MAY have its radio off.

23455 **Table 11-11. Image Upgrade Status Attribute Values**

Image Upgrade Status Values	Description
0x00	Normal
0x01	Download in progress
0x02	Download complete
0x03	Waiting to upgrade
0x04	Count down
0x05	Wait for more
0x06	Waiting to Upgrade via External Event

23456

23457 Normal status typically means the device has not participated in any download process. Additionally, the  
 23458 client SHALL set its upgrade status back to Normal if the previous upgrade process was not successful.

23459 Download in progress status is used from when the client device receives SUCCESS status in the Query Next  
 23460 Image Response command from the server prior to when the device receives all the image data it needs.

23461 Download complete status indicates the client has received all data blocks required and it has already verified  
23462 the OTA Upgrade Image signature (if applied) and has already written the image onto its additional memory  
23463 space. The status will be modified as soon as the client receives Upgrade End Response command from the  
23464 server.

23465 Wait to upgrade status indicates that the client is told by the server to wait until another (upgrade) command  
23466 is sent from the server to indicate the client to upgrade its image.

23467 Count down status indicates that the server has notified the client to count down to when it SHALL upgrade  
23468 its image.

23469 Wait for more (upgrade) image indicates that the client is still waiting to receive more OTA upgrade image  
23470 files from the server. This is true for a client device that is composed of multiple processors and each proces-  
23471 sor requires different image. The client SHALL be in this state until it has received all necessary OTA up-  
23472 grade images, then it SHALL transition to Download complete state.

### 23473 **11.10.8 Manufacturer ID Attribute**

23474 This attribute SHALL reflect the ZigBee assigned value for the manufacturer of the device. See also section  
23475 11.4.2.5.

### 23476 **11.10.9 Image Type ID Attribute**

23477 This attribute SHALL indicate the image type identifier of the file that the client is currently downloading,  
23478 or a file that has been completely downloaded but not upgraded to yet. The value of this attribute SHALL be  
23479 0xFFFF when the client is not downloading a file or is not waiting to apply an upgrade.

### 23480 **11.10.10 *MinimumBlockPeriod* Attribute**

23481 This attribute acts as a rate limiting feature for the server to slow down the client download and prevent  
23482 saturating the network with block requests. The attribute lives on the client but can be changed during a  
23483 download if rate limiting is supported by both devices.

23484 This attribute SHALL reflect the minimum delay between Image Block Request commands generated by the  
23485 client in milliseconds. The value of this attribute SHALL be updated when the rate is changed by the server,  
23486 but SHOULD reflect the client default when an upgrade is not in progress or a server does not support this  
23487 feature.

### 23488 **11.10.11 Image Stamp Attribute**

23489 This attribute acts as a second verification to identify the image in the case that sometimes developers of the  
23490 application have forgotten to increase the firmware version attribute. It is a 32 bit value and has a valid range  
23491 from 0x00000000 to 0xFFFFFFFF. This attribute value must be consistent during the lifetime of the same  
23492 image and also must be unique for each different build of the image. This attribute value SHOULD not be  
23493 hardcoded or generated by any manual process. This attribute value SHOULD be generated by performing a  
23494 hash or checksum on the entire image. There are two possible methods to generate this checksum. It can be  
23495 generated dynamically during runtime of the application or it can be generated during compile time of the  
23496 application.

### 23497 **11.10.12 UpgradeActivationPolicy Attribute**

23498 This attribute indicates what behavior the client device supports for activating a fully downloaded but not  
23499 installed upgrade image. Table 11-12 below lists the enumerated values and the descriptions.



23500

**Table 11-12. UpgradeActivationPolicy Enumerations**

Policy Enumeration Value	Short Name	Description
0x00	OTA Server Activation Allowed	This value indicates that the OTA server’s command, to tell the device when to upgrade, will be applied by the client.
0x01	Out-of-band Activation Only	This value indicates that the activation of the image is done via out-of-band mechanisms. Attempts by the OTA server to tell the client to install the image will be rejected. Examples of an out-of-band mechanism to apply the image are: user prompt, or non-ZigBee protocol message.

23501

23502 Client devices with an *UpgradeActivationPolicy* value of 0x01 SHALL still send an *UpgradeEndRequest*  
 23503 command to the OTA Server at the completion of their download. In this case, clients SHALL NOT process  
 23504 an *UpgradeEndResponse* with a status of SUCCESS unless it has an UpgradeTime of 0xFFFFFFFF; upon  
 23505 receipt of an *UpgradeEndResponse* with a status of SUCCESS, but having an UpgradeTime field other than  
 23506 0xFFFFFFFF, the client SHALL send back a Default Response with a status of NOT\_AUTHORIZED.

23507 In the absence of this optional attribute, the default value of 0x00 shall be assumed.

23508

### 11.10.13 UpgradeTimeoutPolicy Attribute

23509 This attribute indicates what behavior the client device supports for activating a fully downloaded image  
 23510 when the OTA server cannot be reached.

23511 There may be circumstances when the OTA client is waiting on an explicit activation command and yet the  
 23512 activation command cannot be retrieved. This may be due to the fact that the OTA server is down, or, if  
 23513 *UpgradeActivationPolicy* is 0x01, the out-of-band communications mechanism is inaccessible.

23514 In these circumstances the behavior of the device is dictated by the UpgradeTimeoutPolicy. After enough  
 23515 failed attempts to retrieve the activation command without any response, the OTA client’s behavior SHALL  
 23516 be dictated by Table 11-13.

23517 When the *UpgradeTimeoutPolicy* attribute is set to 0x00 and the *UpgradeActivationPolicy* is 0x00, section  
 23518 11.16 defines the requirements on how often retries are performed and at what required intervals. If the  
 23519 *UpgradeTimeoutPolicy* attribute is set to 0x00 and the *UpgradeActivationPolicy* is 0x01, any retry mecha-  
 23520 nism and timeouts are manufacturer specific. Whilst there may be situations where the mechanisms defined  
 23521 in section 11.16 could be disabled when the *UpgradeActivationPolicy* is 0x00, the setting of the *Up-  
 23522 gradeTimeoutPolicy* attribute to 0x01 in this case is currently reserved.

23523 In the absence of this optional attribute, the default value of 0x00 shall be assumed.

23524

**Table 11-13. UpgradeTimeoutPolicy Enumerations**

Policy Enumeration Value	Short Name	Description
0x00	Apply Upgrade After Timeout	After the specified time has elapsed and the number of required retry attempts has been made, the device SHALL apply a downloaded but not installed image.
0x01	Do not Apply Upgrade After Timeout	No amount of time or failed attempts to retrieve the activation command SHALL trigger the device to apply a downloaded but not installed image.

23525

23526

## 11.11 OTA Cluster Parameters

23527 Below are defined parameters for OTA Upgrade cluster server. These values are considered as parameters  
23528 and not attributes because their values tend to change often and are not static. Moreover, some of the param-  
23529 eters MAY have multiple values on the upgrade server at one instance. For example, for DataSize parameter,  
23530 the value MAY be different for each OTA upgrade process. These parameters are included in commands sent  
23531 from server to client. The parameters cannot be read or written via ZCL global commands.

23532

**Table 11-14. Parameters of OTA Upgrade Cluster**

Name	Type	Range	Default	M/O
<i>QueryJitter</i>	uint8	0x01 – 0x64	0x32	M
<i>DataSize</i>	uint8	0x00 – 0xff	0xff	M
<i>OTAImageData</i>	Opaque	Varied	all 0xff's	M
<i>CurrentTime</i>	UTC	<i>all</i>	0xffffffff	M
<i>UpgradeTime</i> or <i>RequestTime</i>	UTC	<i>all</i>	0xffffffff	M

23533

### 11.11.1 QueryJitter Parameter

23534 The parameter is part of Image Notify Command sent by the upgrade server. The parameter indicates whether  
23535 the client receiving Image Notify Command SHOULD send in Query Next Image Request command or not.

23536 The server chooses the parameter value between 1 and 100 (inclusively) and includes it in the Image Notify  
23537 Command. On receipt of the command, the client will examine other information (the manufacturer code and  
23538 image type) to determine if they match its own values. If they do not, it SHALL discard the command and  
23539 no further processing SHALL continue. If they do match, then it will determine whether or not it SHOULD  
23540 query the upgrade server. It does this by randomly choosing a number between 1 and 100 and comparing it  
23541 to the value of the QueryJitter parameter received. If it is less than or equal to the QueryJitter value from the  
23542 server, it SHALL continue with the query process. If not, then it SHALL discard the command and no further  
23543 processing SHALL continue.

23544 By using the QueryJitter parameter, it prevents a single notification of a new OTA upgrade image from  
23545 flooding the upgrade server with requests from clients.

23546

### 11.11.2 DataSize Parameter

23547 A value that indicates the length of the OTA image data included in the (Image Block Response) command  
23548 payload sent from the server to client.

23549

### 11.11.3 OTAImageData Parameter

23550 This is a part of OTA upgrade image being sent over the air. The length of the data is dictated by the data  
23551 size parameter. The server does not need to understand the meaning of the data, only the client does. The  
23552 data MAY also be compressed or encrypted to increase efficiency or security.

23553 The parameter is a series of octets and is used with the file offset value (defined in section 11.10.2) to indicate  
23554 the location of the data and the data size value to indicate the length of the data.

23555

## 11.11.4 CurrentTime and UpgradeTime/RequestTime Parameters

23556

23557 If CurrentTime and UpgradeTime are used in the command (ex. Upgrade End Response), the server uses the  
 23558 parameters to notify the client when to upgrade to the new image. If CurrentTime and RequestTime are used  
 23559 in the command (ex. Image Block Response), the server is notifying the client when to request for more  
 23560 upgrade data. The CurrentTime indicates the current time of the OTA server. The UpgradeTime indicates the  
 23561 time that the client SHALL upgrade to running new image. The RequestTime indicates when the client  
 23562 SHALL request for more data.

23563 The value of the parameters and their interpretation MAY be different depending on whether the devices  
 23564 support ZCL Time cluster or not. If ZCL Time cluster is supported, the values of both parameters MAY  
 23565 indicate the UTC Time values that represent the Universal Time Coordinated (UTC) time. If the device does  
 23566 not support ZCL Time cluster, then it SHALL compute the offset time value from the difference between the  
 23567 two time parameters. The resulted offset time is in seconds. A device that does support the time cluster MAY  
 23568 use offset time instead of UTC Time when it sends messages that reference the time according to Table 11-15.

23569 The table below shows how to interpret the time parameter values depending on whether Time cluster is  
 23570 supported on the device. The intention here is to be able to support a mixed network of nodes that MAY not  
 23571 all support Time cluster.

23572

**Table 11-15. Meaning of CurrentTime and UpgradeTime Parameters**

CurrentTime Value	UpgradeTime or RequestTime Value	Description
0x00000000	Any	Device SHALL use UpgradeTime or RequestTime as an offset time from now.
0x00000001 – 0xfffffffffe	Any	Server supports Time cluster; client SHALL use UpgradeTime/RequestTime value as UTCTime if it also supports Time cluster or it SHALL compute the offset time if it does not.
Any	0xffffffff	The client SHOULD wait for a (upgrade) command from the server. Note that value of 0xffffffff SHOULD not be used for RequestTime.

23573

23574 For client devices with an *UpgradeActivationPolicy* value of 0x00, using a value of all 0xFF's for Up-  
 23575 gradeTime to indicate a wait (for an Upgrade End Response command from the server) on ZED client devices  
 23576 is not recommended since an upgrade server SHOULD not be assumed to know the wake up cycle of the end  
 23577 device; hence it is not guaranteed that the end device will receive the upgrade command. If the wait value  
 23578 (0xffffffff) is used on a ZED client, the client SHOULD keep querying the server at a reasonable rate (not  
 23579 faster than once every 60 minutes) to see if it is time to upgrade. Client devices with an *UpgradeActivation-*  
 23580 *Policy* value of 0x01 will expect an UpgradeTime of all 0xFF's, but SHALL NOT keep querying the server.

23581 Using value of all 0xFF's for RequestTime to indicate an indefinite wait time is not recommended. If the  
 23582 server does not know when it will have the image data ready, it SHALL use a reasonable wait time and when  
 23583 the client resends the image request, the server SHALL keep telling it to wait. There is no limit to how many  
 23584 times the server SHOULD the client to wait for the upgrade image. Using value of 0xffffffff SHALL cause  
 23585 the client to wait indefinitely and server MAY not have a way to tell the client to stop waiting especially for  
 23586 ZED client.

23587  
23588

## 11.12 OTA Upgrade Diagram

Figure 11-9. OTA Upgrade Message Diagram

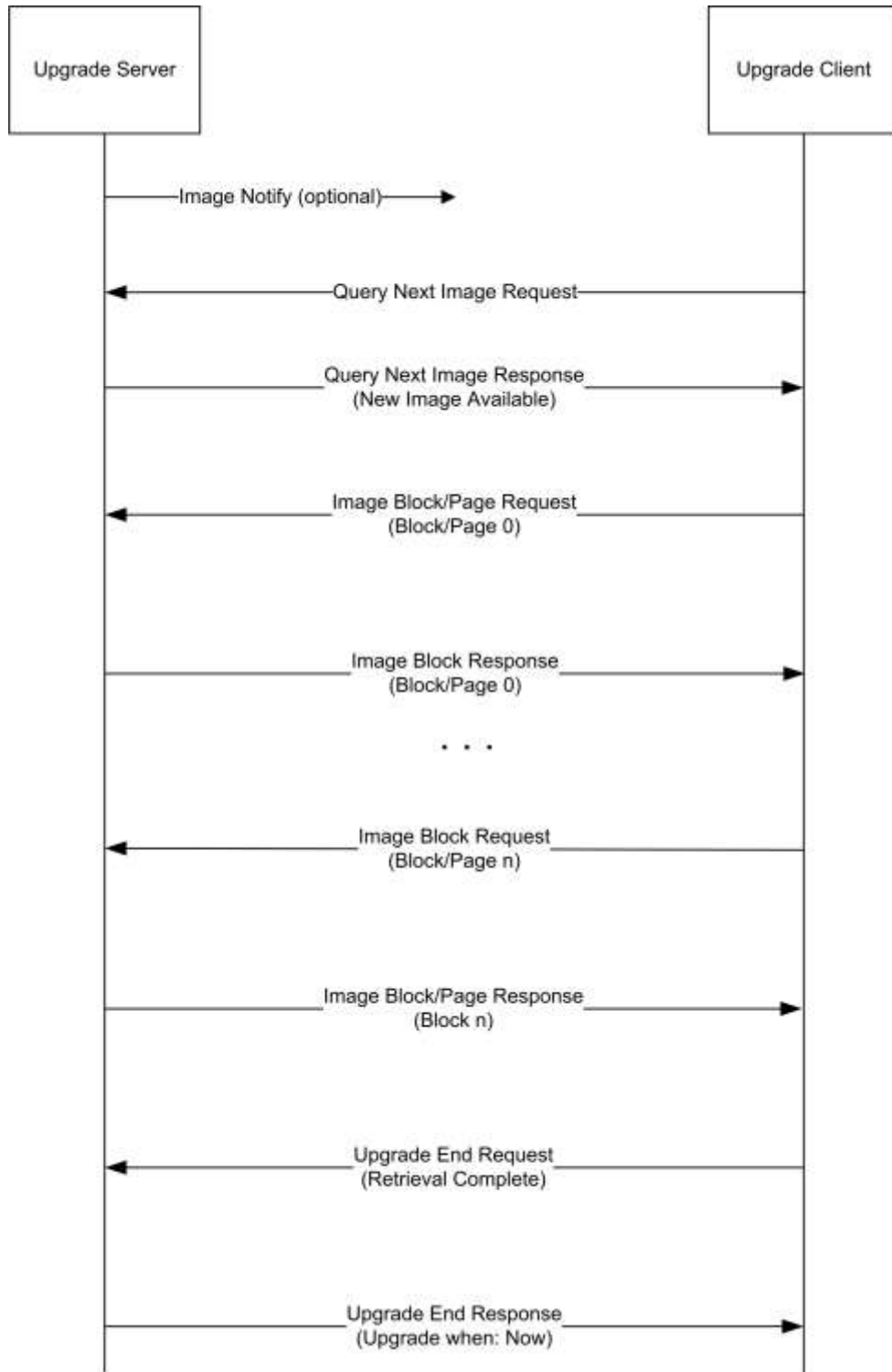

23589  
23590

23591 Please refer to section 11.13 for the command description used in Figure 11-9.

## 23592 11.13 Command Frames

23593 OTA upgrade messages do not differ from typical ZigBee APS messages so the upgrade process SHOULD  
 23594 not interrupt the general network operation. All OTA Upgrade cluster commands SHALL be sent with APS  
 23595 retry option, hence, require APS acknowledgement; unless stated otherwise.

23596 OTA Upgrade cluster commands, the frame control value SHALL follow the description below:

- 23597 • Frame type is 0x01: commands are cluster specific (not a global command).
- 23598 • Manufacturer specific is 0x00: commands are not manufacturer specific.
- 23599 • Direction: SHALL be either 0x00 (client->server) or 0x01 (server->client) depending on the com-  
 23600 mands.
- 23601 • Disable default response is 0x00 for all OTA request commands sent from client to server: default re-  
 23602 sponse command SHALL be sent when the server receives OTA Upgrade cluster request commands  
 23603 that it does not support or in case an error case happens. A detailed explanation of each error case  
 23604 along with its recommended action is described for each OTA cluster command.
- 23605 • Disable default response is 0x01 for all OTA response commands (sent from server to client) and for  
 23606 broadcast/multicast Image Notify command: default response command is not sent when the client re-  
 23607 ceives a valid OTA Upgrade cluster response commands or when it receives broadcast or multicast Im-  
 23608 age Notify command. However, if a client receives invalid OTA Upgrade cluster response command, a  
 23609 default response SHALL be sent. A detailed explanation of each error case along with its recom-  
 23610 mended action is described for each OTA cluster command.

### 23611 11.13.1 OTA Cluster Command Identifiers

23612 Command identifier values are listed in Table 11-16 below.

23613 **Table 11-16. OTA Upgrade Cluster Command Frames**

<b>Id</b>	<b>Name</b>	<b>Direction</b>	<b>Disable Default Re- sponse</b>	<b>M/O</b>
0x00	<i>Image Notify</i>	Server -> Client(s) (0x01)	Set if sent as broadcast or multicast; Not Set if sent as unicast	O
0x01	<i>Query Next Image Request</i>	Client -> Server (0x00)	Not Set	M
0x02	<i>Query Next Image Response</i>	Server -> Client (0x01)	Set	M
0x03	<i>Image Block Request</i>	Client -> Server (0x00)	Not Set	M
0x04	<i>Image Page Request</i>	Client -> Server (0x00)	Not Set	O
0x05	<i>Image Block Response</i>	Server -> Client (0x01)	Set	M
0x06	<i>Upgrade End Request</i>	Client -> Server (0x00)	Not Set	M
0x07	<i>Upgrade End Response</i>	Server -> Client (0x01)	Set	M

<b>Id</b>	<b>Name</b>	<b>Direction</b>	<b>Disable Default Response</b>	<b>M/O</b>
0x08	<i>Query Device Specific File Request</i>	Client -> Server (0x00)	Not Set	O
0x09	<i>Query Device Specific File Response</i>	Server -> Client (0x01)	Set	O

23614 **11.13.2 OTA Cluster Status Codes**

23615 OTA Upgrade cluster uses ZCL defined status codes during the upgrade process. These status codes are  
 23616 included as values in status field in payload of OTA Upgrade cluster’s response commands and in default  
 23617 response command. Some of the status codes are new and are still in the CCB process in order to be included  
 23618 in the ZCL specification.

23619 **Table 11-17. Status Code Defined and Used by OTA Upgrade Cluster**

<b>ZCL Status Code</b>	<b>Value</b>	<b>Description</b>
SUCCESS	0x00	Success Operation
ABORT	0x95	Failed case when a client or a server decides to abort the upgrade process.
NOT_AUTHORIZED	0x7E	Server is not authorized to upgrade the client
INVALID_IMAGE	0x96	Invalid OTA upgrade image (ex. failed signature validation or signer information check or CRC check)
WAIT_FOR_DATA	0x97	Server does not have data block available yet
NO_IMAGE_AVAILABLE	0x98	No OTA upgrade image available for a particular client
MALFORMED_COMMAND	0x80	The command received is badly formatted. It usually means the command is missing certain fields or values included in the fields are invalid ex. invalid jitter value, invalid payload type value, invalid time value, invalid data size value, invalid image type value, invalid manufacturer code value and invalid file offset value
UNSUP_COMMAND <sup>222</sup>	0x81	Such command is not supported on the device
REQUIRE_MORE_IMAGE	0x99	The client still requires more OTA upgrade image files in order to successfully upgrade

23620 **11.13.3 Image Notify Command**

23621 The purpose of sending Image Notify command is so the server has a way to notify client devices of when  
 23622 the OTA upgrade images are available for them. It eliminates the need for ZR client devices having to check  
 23623 with the server periodically of when the new images are available. However, all client devices still need to  
 23624 send in Query Next Image Request command in order to officially start the OTA upgrade process.

<sup>222</sup> CCB 2477 status code renamed

23625 **11.13.3.1 Payload Format**

23626 **Figure 11-10. Format of Image Notify Command Payload**

Octets	1	1	0/2	0/2	0/4
Data Type	enum8	uint8	uint16	uint16	uint32
Field Name	Payload type	Query jitter	Manufacturer code	Image type	(new) File version

23627 **11.13.3.2 Payload Field Definitions**

23628 **11.13.3.2.1 Image Notify Command Payload Type**

23629 **Table 11-18. Image Notify Command Payload Type**

Payload Type Values	Description
0x00	Query jitter
0x01	Query jitter and manufacturer code
0x02	Query jitter, manufacturer code, and image type
0x03	Query jitter, manufacturer code, image type, and new file version

23630 **11.13.3.2.2 Query Jitter**

23631 See section 11.11.1 for detailed description.

23632 **11.13.3.2.3 Manufacturer Code**

23633 Manufacturer code when included in the command SHOULD contain the specific value that indicates certain  
 23634 manufacturer. If the server intends for the command to be applied to all manufacturers, then the value  
 23635 SHOULD be omitted. See section 2 for detailed description.

23636 **11.13.3.2.4 Image Type**

23637 Image type when included in the command SHOULD contain the specific value that indicates certain file  
 23638 type. If the server intends for the command to be applied to all image type values then the wild card value  
 23639 (0xffff) SHOULD be used. See section 11.4.2.6 for detailed description.

23640 **11.13.3.2.5 (new) File Version**

23641 The value SHALL be the OTA upgrade file version that the server tries to upgrade client devices in the  
 23642 network to. If the server intends for the command to be applied to all file version values then the wild card  
 23643 value (0xffffffff) SHOULD be used. See section 11.10.3 for detailed description.

### 23644 11.13.3.3 When Generated

23645 For ZR client devices, the upgrade server MAY send out a unicast, broadcast, or multicast indicating it has  
23646 the next upgrade image, via an Image Notify command. Since the command MAY not have APS security (if  
23647 it is broadcast or multicast), it is considered purely informational and *not authoritative*. Even in the case of a  
23648 unicast, ZR SHALL continue to perform the query process described in later section.

23649 When the command is sent with payload type value of zero, it generally means the server wishes to notify all  
23650 clients disregard of their manufacturers, image types or file versions. Query jitter is needed to protect the  
23651 server from being flooded with clients' queries for next image.

23652 The server MAY choose to send the Image Notify command to a more specific group of client devices by  
23653 choosing higher payload type value. Only devices with matching information as the ones included in the  
23654 Image Notify command will send back queries for next image.

23655 However, payload type value of 0x03 has a slightly different effect. If the client device has all the information  
23656 matching those included in the command including the new file version, the device SHALL then ignore the  
23657 command. This indicates that the device has already gone through the upgrade process. This is to prevent the  
23658 device from downloading the same image version multiple times. This is only true if the command is sent as  
23659 broadcast/multicast.

23660 Query jitter value indicates how the server wants to space out the responses from the client; generally as a  
23661 result of sending the command as broadcast or multicast. The client will only respond back if it randomly  
23662 picks a value that is equal or smaller than the query jitter value. When sending Image Notify command as  
23663 broadcast or multicast, the Disable Default Response bit in ZCL header must be set (to 0x01) to avoid the  
23664 client from sending any default response back to the upgrade server. This agrees with section 2.4.12.

23665 If the command is sent as unicast, a payload type value of zero and Query jitter set to the maximum value of  
23666 100 is recommended in order to signal the client to send in a Query Next Image Request. If the command is  
23667 unicast and the payload type is non-zero, all other fields SHALL be ignored.<sup>223</sup>

23668 The upgrade server MAY choose to send Image Notify command to avoid having ZR clients sending in  
23669 Query Next Image Request to it periodically.

### 23670 11.13.3.4 Effect on Receipt

23671 On receipt of a unicast Image Notify command, the device SHALL always send a Query Next Image request  
23672 back to the upgrade server.

23673 On receipt of a broadcast or multicast Image Notify command, the device SHALL keep examining each field  
23674 included in the payload with its own value. For each field, if the value matches its own, it SHALL proceed  
23675 to examine the next field. If values in all three fields (naming manufacturer code, image type and new file  
23676 version) match its own values, then it SHALL discard the command. The new file version in the payload  
23677 SHALL be a match, it either matches the device's current running file version or matches the downloaded  
23678 file version (on the additional memory space).

23679 If manufacturer code or the image type values in the payload does not match the device's own value, it  
23680 SHALL discard the command. For payload type value of 0x01, if manufacturer code matches the device's  
23681 own value, the device SHALL proceed. For payload type value of 0x02, if both manufacturer code and image  
23682 type match the device's own values, the device SHALL proceed. For payload type value of 0x03, if both  
23683 manufacturer code and image type match the device's own values but the new file version is not a match, the  
23684 device SHALL proceed. In this case, the (new) file version MAY be lower or higher than the device's file  
23685 version to indicate a downgrade or an upgrade of the firmware respectively.

---

<sup>223</sup> CCB 2519



23686 To proceed, the device SHALL randomly choose a number between 1 and 100 and compare it to the value  
 23687 of the QueryJitter value in the received message. If the generated value is less than or equal to the received  
 23688 value for QueryJitter, it SHALL query the upgrade server. If not, then it SHALL discard the message and no  
 23689 further processing SHALL continue.

23690 By using the QueryJitter field, a server MAY limit the number of devices that will query it for a new OTA  
 23691 upgrade image, preventing a single notification of a new software image from flooding the upgrade server  
 23692 with requests.

23693 In application standards that mandate APS encryption for OTA upgrade cluster messages, OTA messages  
 23694 sent as broadcast or multicast SHOULD be dropped by the receivers.

### 23695 11.13.3.5 Handling Error Cases

23696 The section describes all possible error cases that the client MAY detect upon reception invalid Image Notify  
 23697 command from the server, along with the action that SHALL be taken.

#### 23698 11.13.3.5.1 Malformed Command

23699 For invalid broadcast or multicast Image Notify command, for example, out-of-range query jitter value is  
 23700 used, or the reserved payload type value is used, or the command is badly formatted, the client SHALL ignore  
 23701 such command and no processing SHALL be done.<sup>224</sup>

## 23702 11.13.4 Query Next Image Request Command

### 23703 11.13.4.1 Payload Format

23704 **Figure 11-11. Format of Query Next Image Request Command Payload**

Octets	1	2	2	4	0/2
Data Type	map8	uint16	uint16	uint32	uint16
Field Name	Field control	Manufacturer code	Image type	(Current) File version	Hardware version

### 23705 11.13.4.2 Payload Field Definitions

#### 23706 11.13.4.2.1 Query Next Image Request Command Field Control

23707 The field control indicates whether additional information such as device’s current running hardware version  
 23708 is included as part of the Query Next Image Request command.

23709 **Table 11-19. Query Next Image Request Field Control Bitmask**

Bits	Name
0	Hardware Version Present

<sup>224</sup> CCB 2519

#### 23710 **11.13.4.2.2 Manufacturer Code**

23711 The value SHALL be the device's assigned manufacturer code. Wild card value SHALL not be used in this  
23712 case. See Chapter 2 for detailed description.

#### 23713 **11.13.4.2.3 Image Type**

23714 The value SHALL be between 0x0000 - 0xffbf (manufacturer specific value range). See section 11.4.2.6 for  
23715 detailed description. For other image type values, Query Device Specific File Request command SHOULD  
23716 be used.

#### 23717 **11.13.4.2.4 File Version (current)**

23718 The file version included in the payload represents the device's current running image version. Wild card  
23719 value SHALL not be used in this case. See section 11.10.3 for more detailed description.

#### 23720 **11.13.4.2.5 Hardware Version (optional)**

23721 The hardware version if included in the payload represents the device's current running hardware version.  
23722 Wild card value SHALL not be used in this case. See section 11.4.2.13 for hardware version format descrip-  
23723 tion.

#### 23724 **11.13.4.3 When Generated**

23725 Client devices SHALL send a Query Next Image Request command to the server to see if there is new OTA  
23726 upgrade image available. ZR devices MAY send the command after receiving Image Notify command. ZED  
23727 device SHALL periodically wake up and send the command to the upgrade server. Client devices query what  
23728 the *next* image is, based on their own information.

#### 23729 **11.13.4.4 Effect on Receipt**

23730 The server takes the client's information in the command and determines whether it has a suitable image for  
23731 the particular client. The decision SHOULD be based on specific policy that is specific to the upgrade server  
23732 and outside the scope of this document... However, a recommended default policy is for the server to send  
23733 back a response that indicates the availability of an image that matches the manufacturer code, image type,  
23734 and the highest available file version of that image on the server. However, the server MAY choose to up-  
23735 grade or downgrade a clients' image, as its policy dictates. If client's hardware version is included in the  
23736 command, the server SHALL examine the value against the minimum and maximum hardware versions in-  
23737 cluded in the OTA file header.

23738 How the server retrieves and stores the clients' file is also outside the scope of this document. The server  
23739 MAY have a backend communication to retrieve the images or it MAY have database software to manage  
23740 file storage.

#### 23741 **11.13.4.5 Handling Error Cases**

23742 All error cases resulting from receiving Query Next Image Request command are handled by the correspond-  
23743 ing Query Next Image Response command with the exception of the malformed request command described  
23744 below that is handled by default response command. Please refer to section 11.13.5.3 for more information  
23745 regarding how the Query Next Image response command is generated.

23746 **11.13.4.5.1 Malformed Command**

23747 Upon reception a badly formatted Query Next Image Request command, for example, the command is miss-  
 23748 ing one of the payload fields; the server SHALL send default response command with MAL-  
 23749 FORMED\_COMMAND status to the client and it SHALL not process the command further.

23750 **11.13.5 Query Next Image Response Command**

23751 **11.13.5.1 Payload Format**

23752 **Figure 11-12. Format of Query Next Image Response Command Payload**

Octets	1	0/2	0/2	0/4	0/4
Data Type	enum8	uint16	uint16	uint32	uint32
Field Name	Status	Manufacturer code	Image type	File version	Image size

23753 **11.13.5.2 Payload Field Definitions**

23754 **11.13.5.2.1 Query Next Image Response Status**

23755 Only if the status is SUCCESS that other fields are included. For other (error) status values, only status field  
 23756 SHALL be present. See section 11.13.2 for a complete list and description of OTA Cluster status codes.

23757 **11.13.5.2.2 Manufacturer Code**

23758 The value SHALL be the one received by the server in the Query Next Image Request command. See Chapter  
 23759 2 for detailed description.

23760 **11.13.5.2.3 Image Type**

23761 The value SHALL be the one received by the server in the Query Next Image Request command. See section  
 23762 11.4.2.6 for detailed description.

23763 **11.13.5.2.4 File Version**

23764 The file version indicates the image version that the client is required to install. The version value MAY be  
 23765 lower than the current image version on the client if the server decides to perform a downgrade. The version  
 23766 value MAY not be the same as the client’s current version. Reinstallation of the same software version is not  
 23767 supported. In general, the version value SHOULD be higher than the current image version on the client to  
 23768 indicate an upgrade. See section 11.4.2.7 for more description.

23769 **11.13.5.2.5 Image Size**

23770 The value represents the total size of the image (in bytes) including header and all sub-elements. See section  
 23771 11.4.2.10 for more description.

### 23772 **11.13.5.3 When Generated**

23773 The upgrade server sends a Query Next Image Response with one of the following status: SUCCESS,  
23774 NO\_IMAGE\_AVAILABLE or NOT\_AUTHORIZED. When a SUCCESS status is sent, it is considered to  
23775 be the explicit authorization to a device by the upgrade server that the device MAY upgrade to a specific  
23776 software image.

23777 A status of NO\_IMAGE\_AVAILABLE indicates that the server is authorized to upgrade the client but it  
23778 currently does not have the (new) OTA upgrade image available for the client. For all clients (both ZR and  
23779 ZED), they SHALL continue sending Query Next Image Requests to the server periodically until an image  
23780 becomes available.

23781 A status of NOT\_AUTHORIZED indicates the server is not authorized to upgrade the client. In this case, the  
23782 client MAY perform discovery again to find another upgrade server. The client MAY implement an intelli-  
23783 gence to avoid querying the same unauthorized server.

### 23784 **11.13.5.4 Effect on Receipt**

23785 A status of SUCCESS in the Query Next Image response indicates to the client that the server has a new  
23786 OTA upgrade image. If the file version contained in the Query Next Image Response is the same as the  
23787 CurrentFileVersion attribute (the current running version of software) or the *DownloadedFileVersion at-*  
23788 *tribute for the specified Image Type*, then the message SHOULD be discarded and no further processing  
23789 SHOULD be done. Reinstallation of the same software version is not supported. Otherwise the client MAY  
23790 begin requesting blocks of the image using the Image Block Request command. A ZED client MAY choose  
23791 to change its wake cycle to retrieve the image more quickly.

### 23792 **11.13.5.5 Handling Error Cases**

23793 The Query Next Image Response command SHALL have the disable default response bit set. Hence, if the  
23794 command is received successfully, no default response command SHALL be generated. However, the default  
23795 response SHALL be generated to indicate the error cases below.

#### 23796 **11.13.5.5.1 Malformed Command**

23797 Upon reception a badly formatted Query Next Image Response command, for example, the command is  
23798 missing one of the payload field, other payload fields are included when the status field is not SUCCESS,  
23799 the image type value included in the command does not match that of the device or the manufacturer code  
23800 included in the command does not match that of the device; the client SHOULD ignore the message and  
23801 SHALL send default response command with MALFORMED\_COMMAND status to the server.

23802 **11.13.6 Image Block Request Command**

23803 **11.13.6.1 Payload Format**

23804 **Figure 11-13. Format of Image Block Request Command Payload**

Octets	1	2	2	4	4	1	0/8	0/2
Data Type	map8	uint16	uint16	uint32	uint32	uint8	EUI64	uint16
Field Name	Field control	Manufacturer code	Image type	File version	File offset	Maximum data size	Request node address	MinimumBlock-Period

23805 **11.13.6.2 Payload Field Definitions**

23806 **11.13.6.2.1 Image Block Request Command Field Control**

23807 Field control value is used to indicate additional optional fields that MAY be included in the payload of  
 23808 Image Block Request command. Currently, the device is only required to support field control value of 0x00;  
 23809 support for other field control value is optional. A device SHALL process commands issued with unimple-  
 23810 mented/unrecognized field control bits set. Devices SHALL correctly process messages containing fields  
 23811 indicated by unrecognized/unimplemented field control bits.

23812 Field control value 0x00 (bit 0 not set) indicates that the client is requesting a generic OTA upgrade file;  
 23813 hence, there is no need to include additional fields. The value of Image Type included in this case SHALL  
 23814 be manufacturer specific.

23815 Field control value of 0x01 (bit 0 set) means that the client’s IEEE address is included in the payload. This  
 23816 indicates that the client is requesting a device specific file such as security credential, log or configuration;  
 23817 hence, the need to include the device’s IEEE address in the image request command. The value of Image  
 23818 type included in this case SHALL be one of the reserved values that are assigned to each specific file type.

23819 **Table 11-20. Image Block Request Field Control Bitmask**

Bits	Name
0	Request node’s IEEE address Present
1	MinimumBlockPeriod present

23820 **11.13.6.2.2 Manufacturer Code**

23821 The value SHALL be that of the client device assigned to each manufacturer by ZigBee. See Chapter 2 for  
 23822 detailed description.

### 23823 **11.13.6.2.3 Image Type**

23824 The value SHALL be between 0x0000 - 0xffbf (manufacturer specific value range). See section 11.4.2.6 for  
23825 detailed description.

### 23826 **11.13.6.2.4 File Version**

23827 The file version included in the payload represents the OTA upgrade image file version that is being re-  
23828 quested. See section 11.4.2.7 for more detailed description.

### 23829 **11.13.6.2.5 File Offset**

23830 The value indicates number of bytes of data offset from the beginning of the file. It essentially points to the  
23831 location in the OTA upgrade image file that the client is requesting the data from. The value reflects the  
23832 amount of (OTA upgrade image file) data (in bytes) that the client has received so far.

23833 See section 11.10.2 for more description.

### 23834 **11.13.6.2.6 Maximum Data Size**

23835 The value indicates the largest possible length of data (in bytes) that the client can receive at once. The server  
23836 SHALL respect the value and not send the data that is larger than the maximum data size. The server MAY  
23837 send the data that is smaller than the maximum data size value, for example, to account for source routing  
23838 payload overhead if the client is multiple hops away. By having the client send both file offset and maximum  
23839 data size in every command, it eliminates the burden on the server for having to remember the information  
23840 for each client.

### 23841 **11.13.6.2.7 Request Node Address (optional)**

23842 This is the IEEE address of the client device sending the Image Block Request command.

### 23843 **11.13.6.2.8 MinimumBlockPeriod (optional)**

23844 This is the current value of the *MinimumBlockPeriod* attribute of the device that is making the request as set  
23845 by the server. If the device supports the attribute, then it SHALL include this field in the request. The value  
23846 is in milliseconds.

23847 This attribute does not necessarily reflect the actual delay applied by the client between Image Block Re-  
23848 quests, only the value set by the server on the client.

## 23849 **11.13.6.3 When Generated**

23850 The client device requests the image data at its leisure by sending Image Block Request command to the  
23851 upgrade server. The client knows the total number of request commands it needs to send from the image size  
23852 value received in Query Next Image Response command.

23853 The client repeats Image Block Requests until it has successfully obtained all data. Manufacturer code, image  
23854 type and file version are included in all further queries regarding that image. The information eliminates the  
23855 need for the server to remember which OTA Upgrade Image is being used for each download process.

23856 If the client supports the *MinimumBlockPeriod* attribute it SHALL include the value of the attribute as the  
23857 MinimumBlockPeriod field of the Image Block Request message. The client SHALL ensure that it delays at  
23858 least MinimumBlockPeriod after the previous Image Block Request was sent before sending the next Image  
23859 Block Request message. A client MAY delay its next Image Block Requests longer than its MinimumBlock-  
23860 Period attribute.

23861 **11.13.6.4 Effect on Receipt**

23862 The server uses the manufacturer code, image type, and file version to uniquely identify the OTA upgrade  
 23863 image request by the client. It uses the file offset to determine the location of the requested data within the  
 23864 OTA upgrade image. If the server supports rate-limited transfers it SHALL check the MinimumBlockPeriod  
 23865 field and compare it to the desired rate for the client. If the server receives an Image Block Request with a  
 23866 field control mask of 0x02, (i.e., MinimumBlockPeriod present) and the server does not support rate-limited  
 23867 transfers the server SHALL ignore the MinimumBlockPeriod value and process the command.

23868 **11.13.6.5 Handling Error Cases**

23869 In most cases, the server sends Image Block Response command in response to the client’s Image Block  
 23870 Request command. However, with the exception of a few error cases described below that the server SHALL  
 23871 send default response command as a response.

23872 **11.13.6.5.1 Malformed Command**

23873 Upon reception a badly formatted Image Block Request command, for example, the command is missing one  
 23874 of the payload field or the file offset value requested by the client is invalid, for example, the value is larger  
 23875 than the total image size; the server SHOULD ignore the message and it SHALL send default response com-  
 23876 mand with MALFORMED\_COMMAND status to the client.

23877 **11.13.6.5.2 No Image Available**

23878 If either manufacturer code or image type or file version information in the request command is invalid or  
 23879 the OTA upgrade file for the client for some reason has disappeared which result in the server no longer able  
 23880 to retrieve the file, it SHALL send default response command with NO\_IMAGE\_AVAILABLE status to the  
 23881 client. After three attempts, if the client keeps getting the default response with the same status, it SHOULD  
 23882 go back to sending Query Next Image Request periodically or waiting for next Image Notify command.

23883 **11.13.6.5.3 Command Not Supported**

23884 If the client sends image request command with field control value of 0x01 that indicates device specific file  
 23885 request and if the server does not support such request, it SHALL send default response with UNSUP\_COM-  
 23886 MAND<sup>225</sup> status. Upon reception of such response, the client SHOULD terminate the attempt to request the  
 23887 device specific file and it MAY try to query different server.

23888 **11.13.7 Image Page Request Command**

23889 **11.13.7.1 Payload Format**

23890 **Figure 11-14. Image Page Request Command Payload**

Octets	1	2	2	4	4	1	2	2	0/8
Data Type	map8	uint16	uint16	uint32	uint32	uint8	uint16	uint16	EUI64

<sup>225</sup> CCB 2477 status code renamed

Octets	1	2	2	4	4	1	2	2	0/8
Field Name	Field control	Manufacturer code	Image type	File version	File offset	Maximum data size	Page size	Response Spacing	Request node address

23891 **11.13.7.2 Payload Field Definitions**

23892 **11.13.7.2.1 Image Page Request Command Field Control**

23893 Field control value is used to indicate additional optional fields that MAY be included in the payload of  
23894 Image Page Request command. Currently, the device is only required to support field control value of 0x00;  
23895 support for other field control value is optional.

23896 Field control value 0x00 indicates that the client is requesting a generic OTA upgrade file; hence, there is no  
23897 need to include additional fields. The value of Image Type included in this case SHALL be manufacturer  
23898 specific.

23899 Field control value of 0x01 means that the client’s IEEE address is included in the payload. This indicates  
23900 that the client is requesting a device specific file such as security credential, log or configuration; hence, the  
23901 need to include the device’s IEEE address in the image request command. The value of Image type included  
23902 in this case SHALL be one of the reserved values that are assigned to each specific file type.

23903 **Table 11-21. Image Page Request Field Control Bitmask**

Bits	Name
0	Request node’s IEEE address Present

23904 **11.13.7.2.2 Manufacturer Code**

23905 The value SHALL be that of the client device assigned to each manufacturer by ZigBee. See Chapter 2 for  
23906 detailed description.

23907 **11.13.7.2.3 Image Type**

23908 The value SHALL be between 0x0000 - 0xffbf (manufacturer specific value range). See section 11.4.2.6 for  
23909 detailed description.

23910 **11.13.7.2.4 File Version**

23911 The file version included in the payload represents the OTA upgrade image file version that is being re-  
23912 quested. See section 11.4.2.7 for more detailed description.

23913 **11.13.7.2.5 File Offset**

23914 The value indicates number of bytes of data offset from the beginning of the file. It essentially points to the  
23915 location in the OTA upgrade image file that the client is requesting the data from. The value reflects the  
23916 amount of (OTA upgrade image file) data (in bytes) that the client has received so far.

23917 See section 11.10.2 for more description.



23918 **11.13.7.2.6 Maximum Data Size**

23919 The value indicates the largest possible length of data (in bytes) that the client can receive at once. The server  
23920 SHALL respect the value and not send the data that is larger than the maximum data size. The server MAY  
23921 send the data that is smaller than the maximum data size value, for example, to account for source routing  
23922 payload overhead if the client is multiple hops away. By having the client send both file offset and maximum  
23923 data size in every command, it eliminates the burden on the server for having to remember the information  
23924 for each client.

23925 **11.13.7.2.7 Page Size**

23926 The value indicates the number of bytes to be sent by the server before the client sends another Image Page  
23927 Request command. In general, page size value SHALL be larger than the maximum data size value.

23928 **11.13.7.2.8 Response Spacing**

23929 The value indicates how fast the server SHALL send the data (via Image Block Response command) to the  
23930 client. The value is determined by the client. The server SHALL wait at the minimum the (response) spacing  
23931 value before sending more data to the client. The value is in milliseconds.

23932 **11.13.7.2.9 Request Node Address (optional)**

23933 This is the IEEE address of the client device sending the Image Block Request command.

23934 **11.13.7.3 When Generated**

23935 The support for the command is optional. The client device MAY choose to request OTA upgrade data in  
23936 one page size at a time from upgrade server. Using Image Page Request reduces the numbers of requests sent  
23937 from the client to the upgrade server, compared to using Image Block Request command. In order to conserve  
23938 battery life a device MAY use the Image Page Request command. Using the Image Page Request command  
23939 eliminates the need for the client device to send Image Block Request command for every data block it needs;  
23940 possibly saving the transmission of hundreds or thousands of messages depending on the image size.

23941 The client keeps track of how much data it has received by keeping a cumulative count of each data size it  
23942 has received in each Image Block Response. Once the count has reach the value of the page size requested,  
23943 it SHALL repeat Image Page Requests until it has successfully obtained all pages. Note that the client MAY  
23944 choose to switch between using Image Block Request and Image Page Request during the upgrade process.  
23945 For example, if the client does not receive all data requested in one Image Page Request, the client MAY  
23946 choose to request the missing block of data using Image Block Request command, instead of requesting the  
23947 whole page again.

23948 Since a single Image Page Request MAY result in multiple Image Block Response commands sent from the  
23949 server, the client, especially ZED client, SHOULD make its best effort to ensure that all responses are re-  
23950 ceived. A ZED client MAY select a small value for the response spacing and stay awake to receive all data  
23951 blocks. Or it MAY choose a larger value and sleeps between receiving each data block.

23952 Manufacturer code, image type and file version are included in all further queries regarding that image. The  
23953 information eliminates the need for the server to remember which OTA Upgrade Image is being used for  
23954 each download process.

#### 23955 **11.13.7.4 Effect on Receipt**

23956 The server uses the file offset value to determine the location of the requested data within the OTA upgrade  
23957 image. The server MAY respond to a single Image Page Request command with possibly multiple Image  
23958 Block Response commands; depending on the value of page size. Each Image Block Response command  
23959 sent as a result of Image Page Request command SHALL have increasing ZCL sequence number. Note that  
23960 the sequence number MAY not be sequential (for example, if the server is also upgrading another client  
23961 simultaneously); additionally ZCL sequence numbers are only 8-bit and MAY wrap.

23962 In response to the Image Page Request, the server SHALL send Image Block Response commands with no  
23963 APS retry to disable APS acknowledgement. The intention is to minimize the number of packets sent by the  
23964 client in order to optimize the energy saving. APS acknowledgement is still used for Image Block Response  
23965 sent in response to Image Block Request command.

23966 Image Block Response message (in response to Image Page Request) only relies on network level retry. This  
23967 MAY not be as reliable over multiple hops communication, however, the benefit of using Image Page Re-  
23968 quest is to save energy on the ZED client and using APS ack with the packet undermines that effort. ZED  
23969 client needs to make the decision which request it uses. Image Page Request MAY speed up the upgrade  
23970 process; the client transmits fewer packets, hence, less energy use but it MAY be less reliable. On the other  
23971 hand, Image block request MAY slow down the upgrade process; the client is required to transmit more  
23972 packets but it is also more predictable and reliable; it also allows the upgrade process to proceed at the client's  
23973 pace.

#### 23974 **11.13.7.5 Handling Error Cases**

23975 In most cases, the server sends Image Block Response command in response to the client's Image Page  
23976 Request command. However, with the exception of a few error cases described below that the server SHALL  
23977 send default response command as a response.

##### 23978 **11.13.7.5.1 Malformed Command**

23979 Upon reception a badly formatted Image Page Request command, for example, the command is missing one  
23980 of the payload fields or the file offset value requested by the client is invalid. The server SHOULD ignore  
23981 the message and it SHALL send default response command with MALFORMED\_COMMAND status to the  
23982 client.

##### 23983 **11.13.7.5.2 No Image Available**

23984 If either manufacturer code or image type or file version information in the request command is invalid or  
23985 the OTA upgrade file for the client for some reason has disappeared which result in the server no longer able  
23986 to retrieve the file, it SHALL send default response command with NO\_IMAGE\_AVAILABLE status to the  
23987 client. After three attempts, if the client keeps getting the default response with the same status, it SHOULD  
23988 go back to sending Query Next Image Request periodically or waiting for next Image Notify command.

##### 23989 **11.13.7.5.3 Command Not Supported**

23990 If the client sends Image Page Request command with field control value of 0x00 to request OTA upgrade  
23991 image and the server does not support Image Page Request command, it SHALL send default response with  
23992 UNSUP\_COMMAND<sup>226</sup> status. Upon reception of such response, the client SHALL switch to using Image  
23993 Block Request command instead to request OTA image data.

---

<sup>226</sup> CCB 2477 status code renamed

23994 If the client sends image request command with field control value of 0x01 that indicates device specific file  
 23995 request and if the server does not support such request, it SHALL send default response with UNSUP\_COM-  
 23996 MAND<sup>227</sup> status. Upon reception of such response, the client SHOULD terminate the attempt to request the  
 23997 device specific file and it MAY try to query different server.

## 23998 11.13.8 Image Block Response Command

### 23999 11.13.8.1 Payload Format

24000 **Figure 11-15. Image Block Response Command Payload with SUCCESS status**

Octets	1	2	2	4	4	1	Variable
Data Type	enum8	uint16	uint16	uint32	uint32	uint8	Opaque
Field Name	Success status	Manufacturer code	Image type	File version	File offset	Data size	Image data

24001

24002

24003

24004 **Figure 11-16. Image Block Response Command Payload with WAIT\_FOR\_DATA status**

Octets	1	4	4	2
Data Type	enum8	uint32	uint32	uint16
Field Name	Wait for data Status	Current time	Request time	MinimumBlock-Period

24005

<sup>227</sup> CCB 2477 status code renamed

24006

**Figure 11-17. Image Block Response Command Payload with ABORT status**

<b>Octets</b>	<b>1</b>
<b>Data Type</b>	enum8
<b>Field Name</b>	Abort Status

24007 **11.13.8.2 Payload Field Definitions**

24008 **11.13.8.2.1 Image Block Response Status**

24009 The status in the Image Block Response command MAY be SUCCESS, ABORT or WAIT\_FOR\_DATA. If  
24010 the status is ABORT then only the status field SHALL be included in the message, all other fields SHALL  
24011 be omitted.

24012 See section 11.13.2 for a complete list and description of OTA Cluster status codes.

24013 **11.13.8.2.2 Manufacturer Code**

24014 The value SHALL be the same as the one included in Image Block/Page Request command. See Chapter 2  
24015 for detailed description.

24016 **11.13.8.2.3 Image Type**

24017 The value SHALL be the same as the one included in Image Block/Page Request command. See section  
24018 11.4.2.6 for detailed description.

24019 **11.13.8.2.4 File Version**

24020 The file version indicates the image version that the client is required to install. The version value MAY be  
24021 lower than the current image version on the client if the server decides to perform a downgrade. The version  
24022 value MAY not be the same as the client’s current version. Reinstallation of the same software version is not  
24023 supported. However, in general, the version value SHOULD be higher than the current image version on the  
24024 client to indicate an upgrade. See section 11.4.2.7 for more description.

24025 **11.13.8.2.5 File Offset**

24026 The value represents the location of the data requested by the client. For most cases, the file offset value  
24027 included in the (Image Block) response SHOULD be the same as the value requested by the client. For  
24028 (unsolicited) Image Block responses generated as a result of Image Page Request, the file offset value SHALL  
24029 be incremented to indicate the next data location.

24030 **11.13.8.2.6 Data Size**

24031 The value indicates the length of the image data (in bytes) that is being included in the command. The value  
24032 MAY be equal or smaller than the maximum data size value requested by the client. See section 11.11.2 for  
24033 more description.

### 24034 **11.13.8.2.7 Image Data**

24035 The actual OTA upgrade image data with the length equals to data size value. See section 11.11.3 for more  
24036 description.

### 24037 **11.13.8.2.8 Current Time and Request Time**

24038 If status is WAIT\_FOR\_DATA, the payload then includes the server's current time and the request time that  
24039 the client SHALL retry the request command. The client SHALL wait at least the request time value before  
24040 trying again. In case of sleepy device, it MAY choose to wait longer than the specified time in order to not  
24041 disrupt its sleeping cycle. If the current time value is zero that means the server does not support UTC time  
24042 and the client SHALL treat the request time value as offset time. If neither time value is zero, and the client  
24043 supports UTC time, it SHALL treat the request time value as UTC time. If the client does not support UTC  
24044 time, it SHALL calculate the offset time from the difference between the two time values. The offset indicates  
24045 the minimum amount of time to wait in seconds. The UTC time indicates the actual time moment that needs  
24046 to pass before the client SHOULD try again. See section 11.15.4 for more description.

### 24047 **11.13.8.2.9 MinimumBlockPeriod**

24048 This value is only included if the status is WAIT\_FOR\_DATA and the server supports rate limiting. This is  
24049 the minimum delay that the server wants the client to wait between subsequent block requests. The client  
24050 SHALL update its *MinimumBlockPeriod* attribute to this value. The MinimumBlockPeriod field value  
24051 SHALL be observed in all future Image Block Request messages for the duration of the firmware image  
24052 download, or until updated by the server.

24053 If the server does not support rate limiting or does not wish to slow the client's download, the field SHALL  
24054 be set to 0.

24055 The client SHALL check the existence of this field by looking at the length of the message. If the field does  
24056 not exist, then the field SHALL have the value of zero.

24057 See 11.10.10 for more description of the valid ranges and use of this attribute.

24058 See section 11.15.3 for more description on how the rate limiting feature works.

### 24059 **11.13.8.3 When Generated**

24060 Upon receipt of an Image Block Request command the server SHALL generate an Image Block Response.  
24061 If the server is able to retrieve the data for the client and does not wish to change the image download rate, it  
24062 will respond with a status of SUCCESS and it will include all the fields in the payload. The use of file offset  
24063 allows the server to send packets with variable data size during the upgrade process. This allows the server  
24064 to support a case when the network topology of a client MAY change during the upgrade process, for exam-  
24065 ple, mobile client MAY move around during the upgrade process. If the client has moved a few hops away,  
24066 the data size SHALL be smaller. Moreover, using file offset eliminates the need for data padding since each  
24067 Image Block Response command MAY contain different data size. A simple server implementation MAY  
24068 choose to only support largest possible data size for the worst-case scenario in order to avoid supporting  
24069 sending packets with variable data size.

24070 The server SHALL respect the maximum data size value requested by the client and SHALL not send the  
24071 data with length greater than that value. The server MAY send the data with length smaller than the value  
24072 depending on the network topology of the client. For example, the client MAY be able to receive 100 bytes  
24073 of data at once so it sends the request with 100 as maximum data size. But after considering all the security  
24074 headers (perhaps from both APS and network levels) and source routing overhead (for example, the client is  
24075 five hops away), the largest possible data size that the server can send to the client SHALL be smaller than  
24076 100 bytes.

24077 If the server simply wants to cancel the download process, it SHALL respond with ABORT status. An ex-  
24078 ample is while upgrading the client the server MAY receive newer image for that client. It MAY then choose  
24079 to abort the current process so that the client MAY reinitiate a new upgrade process for the newer image.

24080 If the server does not have the image block available for the client yet or it wants to slow down (pause or  
24081 rate-limit) the download process, it SHALL send the response back with status WAIT\_FOR\_DATA and with  
24082 RequestTime value that the client SHALL wait before resending the request. This is a one-time (temporary)  
24083 delay of the download for the client.

24084 If the Image Block Request message contains the MinimumBlockPeriod field and the server wishes to slow  
24085 the client's rate of sending Image Block requests, then the server SHALL send an Image Block Response  
24086 with status WAIT\_FOR\_DATA. In this case the RequestTime and CurrentTime in the message SHALL be  
24087 set so that their delta is zero, and the MinimumBlockPeriod field SHALL be set to the minimum delay that  
24088 server wants the client to add between all subsequent Image Block Requests.

#### 24089 **11.13.8.4 Effect on Receipt**

24090 When the client receives the Image Block Response it SHALL examine the status field. If the value is SUC-  
24091 CESS, it SHALL write the image data to its additional memory space. The client then SHALL continue to  
24092 send Image Block Request commands with incrementing block numbers to request the remaining blocks of  
24093 the OTA upgrade image. If the client has received the final block of the image, it SHALL generate an Upgrade  
24094 End request command. In case of the client using Image Page Request, after receiving an Image Block Re-  
24095 sponse, the client SHALL wait for response spacing time before expecting another Image Block Response  
24096 from the server. A ZED client MAY go to sleep in between receiving Image Block Responses in order to  
24097 save the energy.

24098 If the client receives a response with ABORT status, it SHALL abort the upgrade process. It MAY retry the  
24099 entire upgrade operation at a later point in time.

24100 Upon receipt of WAIT\_FOR\_DATA status, the client SHALL wait at a minimum for the specified Re-  
24101 questTime and try to retrieve the image data again by resending Image Block Request or Image Page Request  
24102 command with the same file offset value. If the CurrentTime and RequestTime are the same value and the  
24103 client supports the *MinimumBlockPeriod* attribute, then it SHALL examine if the message contains the Min-  
24104 imumBlockPeriod field in the Image Block Response. If the field is present and has a value is different than  
24105 its current attribute value, it SHALL update its local attribute. Prior to sending its next Image Block Request  
24106 message it SHALL add a minimum delay equal to the new value of its *MinimumBlockPeriod* attribute.

24107 If the delta between the CurrentTime and RequestTime is zero and the MinimumBlockPeriod field is not  
24108 present or is zero, the client MAY immediately send an Image Block Request command.

#### 24109 **11.13.8.5 Handling Error Cases**

24110 If Image Block Response command is received successfully by the client, no default response will be gener-  
24111 ated if the disable default response bit is set in the ZCL header. However, a few error cases described below  
24112 MAY cause the client to send default response to the server with an error code.

##### 24113 **11.13.8.5.1 Malformed Command**

24114 Upon reception a badly formatted Image Block Response command, for example, the command is missing  
24115 one of the payload field, the payload fields do not correspond to the status field, the request time value re-  
24116 turned by the server is invalid, for example, the value is less than the client's current time or the value is less  
24117 than the server's own current time, the data size value returned by the server is invalid, for example, the value  
24118 is greater than the maximum data size specified by the client, or the value does not match the number of bytes  
24119 of data actually included in the payload, or the value, when combined with file offset, is greater than the total  
24120 image size or the file offset value returned by the server is invalid. The client SHOULD ignore the command  
24121 and SHALL send default response command with MALFORMED\_COMMAND status to the server.

24122 **11.13.9 Upgrade End Request Command**

24123 **11.13.9.1 Payload Format**

24124 **Figure 11-18. Format of Upgrade End Request Command Payload**

Octets	1	2	2	4
Data Type	enum8	uint16	uint16	uint32
Field Name	Status	Manufacturer code	Image type	File version

24125 **11.13.9.2 Payload Field Definitions**

24126 **11.13.9.2.1 Upgrade End Request Command Status**

24127 The status value of the Upgrade End Request command SHALL be SUCCESS, INVALID\_IMAGE, RE-  
 24128 QUIRE\_MORE\_IMAGE, or ABORT. See section 11.13.2 for more description.

24129 **11.13.9.2.2 Manufacturer Code**

24130 The value SHALL be that of the client device assigned to each manufacturer by ZigBee. See Chapter 2 for  
 24131 detailed description.

24132 **11.13.9.2.3 Image Type**

24133 The value SHALL be between 0x0000 - 0xffbf (manufacturer specific value range). See section 11.4.2.6 for  
 24134 detailed description.

24135 **11.13.9.2.4 File Version**

24136 The file version included in the payload represents the newly downloaded OTA upgrade image file version.  
 24137 See section 11.4.2.7 for more detailed description.

24138 **11.13.9.3 When Generated**

24139 Upon reception all the image data, the client SHOULD verify the image to ensure its integrity and validity.  
 24140 If the device requires signed images it SHALL examine the image and verify the signature as described in  
 24141 section 11.7.1. Clients MAY perform additional manufacturer specific integrity checks to validate the image,  
 24142 for example, CRC check on the actual file data.

24143 If the image fails any integrity checks, the client SHALL send an Upgrade End Request command to the  
 24144 upgrade server with a status of INVALID\_IMAGE. In this case, the client MAY reinitiate the upgrade pro-  
 24145 cess in order to obtain a valid OTA upgrade image. The client SHALL not upgrade to the bad image and  
 24146 SHALL discard the downloaded image data.

24147 If the image passes all integrity checks and the client does not require additional OTA upgrade image file, it  
24148 SHALL send back an Upgrade End Request with a status of SUCCESS. However, if the client requires  
24149 multiple OTA upgrade image files before performing an upgrade, it SHALL send an Upgrade End Request  
24150 command with status REQUIRE\_MORE\_IMAGE. This SHALL indicate to the server that it cannot yet up-  
24151 grade the image it received.

24152 If the client decides to cancel the download process for any other reasons, it has the option of sending Upgrade  
24153 End Request with status of ABORT at any time during the download process. The client SHALL then try to  
24154 reinitiate the download process again at a later time.

24155 When a client finishes downloading a device specific file, it SHALL send Upgrade End Request command  
24156 with status of SUCCESS to the server to indicate the end of the upgrade process.

#### 24157 **11.13.9.4 Effect on Receipt**

24158 For manufacturer specific image type file download, upon receipt of a SUCCESS Upgrade End Request  
24159 command the upgrade server SHALL reply with the Upgrade End Response indicating when the client  
24160 SHALL upgrade to the newly retrieved image. For other status value received such as INVALID\_IMAGE,  
24161 REQUIRE\_MORE\_IMAGE, or ABORT, the upgrade server SHALL not send Upgrade End Response com-  
24162 mand but it SHALL send default response command with status of success and it SHALL wait for the client  
24163 to reinitiate the upgrade process.

24164 The server MAY utilize the Upgrade End Request command as a means to know when devices are done  
24165 downloading a particular image. This helps the server manage the images and remove those that are no longer  
24166 needed. However, the upgrade server SHOULD not rely on receiving the command and MAY impose upper  
24167 limits on how long it will store a particular OTA upgrade image. The specific implementation of this is  
24168 outside the scope of this document.

#### 24169 **11.13.9.5 Handling Error Cases**

24170 Upgrade End Request command does not have disable default response bit set. Hence, in a case where the  
24171 Upgrade End Request command has been received and the server does not send Upgrade End Response  
24172 command in response, a default response command SHALL be sent with SUCCESS status. If the Upgrade  
24173 End Request command has not been received, default response command with error status SHALL be sent  
24174 as described below.

##### 24175 **11.13.9.5.1 Malformed Command**

24176 Upon reception a badly formatted Upgrade End Request command, for example, the command is missing  
24177 one of the payload fields. The server SHALL send default response command with MALFORMED\_COM-  
24178 MAND status to the client.



24179 **11.13.9.6 Upgrade End Response Command**

24180 **11.13.9.6.1 Payload Format**

24181 **Figure 11-19. Format of Upgrade End Response Command Payload**

<b>Octets</b>	<b>2</b>	<b>2</b>	<b>4</b>	<b>4</b>	<b>4</b>
<b>Data Type</b>	uint16	uint16	uint32	UTC	UTC
<b>Field Name</b>	Manufacturer code	Image type	File version	Current time	Upgrade time

24182 **11.13.9.6.2 Payload Field Definitions**

24183 The ability to send the command with wild card values for manufacturer code, image type and file version is  
 24184 useful in this case because it eliminates the need for the server having to send the command multiple times  
 24185 for each manufacturer as well as having to keep track of all devices’ manufacturers in the network.

24186 **11.13.9.6.3 Manufacturer Code**

24187 Manufacturer code MAY be sent using wildcard value of 0xffff in order to apply the command to all devices  
 24188 disregard of their manufacturers. See Chapter 2 for detailed description.

24189 **11.13.9.6.4 Image Type**

24190 Image type MAY be sent using wildcard value of 0xffff in order to apply the command to all devices disre-  
 24191 gard of their manufacturers. See section 11.4.2.6 for detailed description.

24192 **11.13.9.6.5 File Version**

24193 The file version included in the payload represents the newly downloaded OTA upgrade image file version.  
 24194 The value SHALL match that included in the request. Alternatively, file version MAY be sent using wildcard  
 24195 value of 0xffffffff in order to apply the command to all devices disregard of their manufacturers. See section  
 24196 11.4.2.7 for more detailed description.

24197 Current Time and Upgrade Time

24198 Current time and Upgrade time values are used by the client device to determine when to upgrade its running  
 24199 firmware image(s) with the newly downloaded one(s). See section 11.15.4 for more description.

24200 **11.13.9.7 When Generated**

24201 When an upgrade server receives an Upgrade End Request command with a status of INVALID\_IMAGE,  
 24202 REQUIRE\_MORE\_IMAGE, or ABORT, no additional processing SHALL be done in its part. If the upgrade  
 24203 server receives an Upgrade End Request command with a status of SUCCESS, it SHALL generate an Up-  
 24204 grade End Response with the manufacturer code and image type received in the Upgrade End Request along  
 24205 with the times indicating when the device SHOULD upgrade to the new image.

24206 The server MAY send an unsolicited Upgrade End Response command to the client. This MAY be used for  
24207 example if the server wants to synchronize the upgrade on multiple clients simultaneously. For client devices,  
24208 the upgrade server MAY unicast or broadcast Upgrade End Response command indicating a single client  
24209 device or multiple client devices SHALL switch to using their new images. The command MAY not be  
24210 reliably received by sleepy devices if it is sent unsolicited.

24211 For device specific file download, the client SHOULD not always expect the server to respond back with  
24212 Upgrade End Response command. For example, in a case of a client has just finished retrieving a log file  
24213 from the server, the server MAY not need to send Upgrade End Response command. However, if the client  
24214 has just retrieved a security credential or a configuration file, the server MAY send Upgrade End Response  
24215 command to notify the client of when to apply the file. The decision of whether Upgrade End Response  
24216 command SHOULD be sent for device specific file download is manufacturer specific.

#### 24217 **11.13.9.8 Effect on Receipt**

24218 The client SHALL examine the manufacturer code, image type and file version to verify that they match its  
24219 own. If the received values do not match its own values or they are not wild card values, then it SHALL  
24220 discard the command and no further processing SHALL continue. If all values match, the client SHALL  
24221 examine the time values to determine the upgrade time. For more information on determining the time, please  
24222 refer to section 11.15.4.

#### 24223 **11.13.9.9 Handling Error Cases**

24224 If Upgrade End Response command is received successfully by the client or if it is sent as broadcast or  
24225 multicast, no default response will be generated. However, a few error cases described below MAY cause  
24226 the client to send default response to the server.

##### 24227 **11.13.9.9.1 Malformed Command**

24228 Upon reception a badly formatted Upgrade End Response command, for example, the command is missing  
24229 one of the payload field or the request time value returned by the server is invalid, for example, the value is  
24230 less than the client's current time or the value is less than the server's own current time. The client SHOULD  
24231 ignore the command and SHALL send default response command with MALFORMED\_COMMAND status  
24232 to the server.

24233 **11.13.10 Query Device Specific File Request Command**

24234 **11.13.10.1 Payload Format**

24235 **Figure 11-20. Format of Query Device Specific File Request Command Payload**

<b>Octets</b>	<b>8</b>	<b>2</b>	<b>2</b>	<b>4</b>	<b>2</b>
<b>Data Type</b>	EUI64	uint16	uint16	uint32	uint16
<b>Field Name</b>	Request node address	Manufacturer code	Image type	File version	(Current) ZigBee stack version

24236 **11.13.10.2 Payload Field Definitions**

24237 **11.13.10.2.1 Request Node Address**

24238 This is the IEEE address of the client device sending the request command. This indicates that the client is  
 24239 requesting a device specific file such as security credential, log or configuration; hence, the need to include  
 24240 the device’s IEEE address in the image request command.

24241 **11.13.10.2.2 Manufacturer Code**

24242 The value SHALL be that of the client device assigned to each manufacturer by ZigBee. See Chapter 2 for  
 24243 detailed description.

24244 **11.13.10.2.3 Image Type**

24245 The value of image type included in this case SHALL be one of the reserved values that are assigned to each  
 24246 specific file type. The value SHOULD be between 0xffc0 – 0xfffe<sup>228</sup>. See section 11.4.2.6 for detailed de-  
 24247 scription.

24248 **11.13.10.2.4 File Version**

24249 The value indicates the version of the device specific file being requested. See section 11.4.2.7 for more  
 24250 detailed description.

24251 **11.13.10.2.5 (current) ZigBee Stack Version**

24252 The value MAY represent the current running ZigBee stack version on the device or the ZigBee stack version  
 24253 of the OTA upgrade image being stored in additional memory space. The decision of which value to include  
 24254 depends on which device specific file being requested. For example, if the client is requesting a new security  
 24255 credential file in order to be able to run the newly downloaded image (ex. SE 2.0), then it SHOULD include  
 24256 the ZigBee stack version value of the new image.

<sup>228</sup> CCB 2873 removed text that was in error. Refer to detailed description.

24257 **11.13.10.3 When Generated**

24258 Client devices SHALL send a Query Device Specific File Request command to the server to request for a  
24259 file that is specific and unique to it. Such file could contain non-firmware data such as security credential  
24260 (needed for upgrading from Smart Energy 1.1 to Smart Energy 2.0), configuration or log. When the device  
24261 decides to send the Query Device Specific File Request command is manufacturer specific. However, one  
24262 example is during upgrading from SE 1.1 to 2.0 where the client MAY have already obtained new SE 2.0  
24263 image and now needs new SE 2.0 security credential data.

24264 The fields included in the payload helps the upgrade server in obtaining or creating the right file for the client.

24265 **11.13.10.4 Effect on Receipt**

24266 The server takes the client’s information in the command and either obtain the file via the backend system or  
24267 create the file itself. Details of how the file is being obtained or created is manufacturer specific and outside  
24268 the scope of this document. The device specific file SHALL follow OTA upgrade file format (section 11.3)  
24269 and SHALL have Device Specific File bit set in OTA header field control. Moreover, the value of the Up-  
24270 grade File Destination field in the OTA header SHALL match the Request node address value in the com-  
24271 mand’s field.

24272 **11.13.10.5 Handling Error Cases**

24273 In most cases all error cases resulted from receiving Query Device Specific File Request command are han-  
24274 dled by the corresponding Query Device Specific File Response command with the exception of a few error  
24275 cases described below that are handled by default response command.

24276 **11.13.10.5.1 Malformed Command**

24277 Upon reception a badly formatted Query Device Specific File Request command, for example, the command  
24278 is missing one of the payload fields; the server SHALL send default response command with MAL-  
24279 FORMED\_COMMAND status to the client and it SHALL not process the command further.

24280 **11.13.10.5.2 Command Not Supported**

24281 Certain server MAY not support transferring of device specific file and the implement of Query Device  
24282 Specific File Request command; in this case the server SHALL send default response with UNSUP\_COM-  
24283 MAND<sup>229</sup> status.

24284 **11.13.11 Query Device Specific File Response Com-**  
24285 **mand**

24286 **11.13.11.1 Payload Format**

24287 **Figure 11-21. Format of Query Device Specific File Response Command Payload**

Octets	1	0/2	0/2	0/4	0/4
Data Type	enum8	uint16	uint16	uint32	uint32
Field Name	Status	Manufacturer code	Image type	File version	Image size

<sup>229</sup> CCB 2477 status code renamed

## 24288 **11.13.11.2 Payload Field Definitions**

### 24289 **11.13.11.2.1 Query Device Specific File Response Status**

24290 Only if the status is SUCCESS that other fields are included. For other (error) status values, only status field  
24291 SHALL be present.

### 24292 **11.13.11.2.2 Manufacturer Code**

24293 The value SHALL be the one received by the server in the Query Device Specific File Request command.  
24294 See Chapter 2 for detailed description.

### 24295 **11.13.11.2.3 Image Type**

24296 The value SHALL be the one received by the server in the Query Device Specific File Request command.  
24297 See section 11.4.2.6 for detailed description.

### 24298 **11.13.11.2.4 File Version**

24299 The file version indicates the image version that the client is required to download. The value SHALL be the  
24300 same as the one included in the request. See section 11.4.2.7 for more description.

### 24301 **11.13.11.2.5 Image Size**

24302 The value represents the total size of the image (in bytes) including all sub-elements. See section 11.4.2.10  
24303 for more description.

## 24304 **11.13.11.3 When Generated**

24305 The server sends Query Device Specific File Response after receiving Query Device Specific File Request  
24306 from a client. The server SHALL determine whether it first supports the Query Device Specific File Request  
24307 command. Then it SHALL determine whether it has the specific file being requested by the client using all  
24308 the information included in the request. The upgrade server sends a Query Device Specific File Response  
24309 with one of the following status: SUCCESS, NO\_IMAGE\_AVAILABLE or NOT\_AUTHORIZED.

24310 A status of NO\_IMAGE\_AVAILABLE indicates that the server currently does not have the device specific  
24311 file available for the client. A status of NOT\_AUTHORIZED indicates the server is not authorized to send  
24312 the file to the client.

## 24313 **11.13.11.4 Effect on Receipt**

24314 A status of SUCCESS in the Query Device Specific File response indicates to the client that the server has a  
24315 specific file for it. The client SHALL begin requesting file data using the Image Block Request or Image  
24316 Page Request command with a field control value set to 0x01 and include its IEEE address. A ZED client  
24317 MAY choose to change its wake cycle to retrieve the file more quickly.

24318 If the client receives the response with status of NOT\_AUTHORIZED, it MAY perform discovery again to  
24319 find another upgrade server. The client MAY implement an intelligence to avoid querying the same unau-  
24320 thorized server.

### 24321 **11.13.11.5 Handling Error Cases**

24322 Query Device Specific File Response command SHALL have disable default response bit set. Hence, if the  
24323 command is received successfully, no default response command SHALL be generated. However, the default  
24324 response SHALL be generated to indicate the error cases below.

#### 24325 **11.13.11.5.1 Malformed Command**

24326 Upon reception a badly formatted Query Device Specific File Response command, for example, the com-  
24327 mand is missing one of the payload field, other payload fields are included when the status field is not SUC-  
24328 CESS, the manufacturer code included in the command does not match that of the device or the image type  
24329 value included in the command does not match that of the device; the client SHOULD ignore the message  
24330 and SHALL send default response command with MALFORMED\_COMMAND status to the server.

## 24331 **11.14 Multiple Files Required for a Bootload**

24332 ZigBee devices MAY require multiple bootload files in order to be upgraded correctly. These files often  
24333 correspond to multiple embedded chips contained within the physical device that have separate firmware  
24334 images to run them.

24335 A device has a number of options for managing these files depending on its own internal configuration or  
24336 dependencies. This section describes the three main options:

### 24337 **11.14.1 Single OTA File with multiple sub-elements**

24338 One of the simplest mechanisms to support multiple firmware images is to bundle all the images into a single  
24339 OTA file. Within the OTA file each firmware image could be noted with a different sub-element tag indicat-  
24340 ing the module it is designated for. The advantage of this system is that it allows for a single OTA client to  
24341 request a single OTA file from the server that contains all the upgrade data it needs. Management of the  
24342 multiple firmware images is handled internally by the device.

24343 Typically, a manufacturer would put all of the firmware images used by the device into the image and upgrade  
24344 all modules at the same time. In that case the device manufacturer would need a download storage space (e.g.  
24345 an external EEPROM) big enough to hold an OTA image that contained all the firmware images for all the  
24346 modules.

24347 The OTA client reports only the overall upgrade status regardless of how many internal modules are being  
24348 manipulated. The OTA client's attributes reflect only the single OTA *Image Type ID*, *CurrentFileVersion*,  
24349 *DownloadedVersion*, and *ImageUpgradeStatus* attributes.

### 24350 **11.14.2 Separate OTA Files Upgraded Independently**

24351 Another method that can be used is to have each upgradeable module within the physical device request  
24352 bootload images from the OTA server separately. In this case a module would report the same manufacturer  
24353 ID but a different image type ID. The modules would operate on separate endpoints to properly report the  
24354 attributes about the current state of that module's upgrade cycle (*ImageUpgradeStatus*) as well as the version  
24355 number it is running (*CurrentFileVersion*) and downloading (*DownloadedFileVersion*). As each module  
24356 completed a download they would separately request permission to finish the upgrade via the *Upgrade End*  
24357 *Request* command.

24358 During the manufacturer specific part of the upgrade, it is possible that the OTA client endpoint undergoing  
24359 the upgrade, or even the entire ZigBee NWK layer, MAY not be accessible over-the-air. Once the upgrade  
24360 is complete the endpoint's client attributes reflecting the new version would be updated.

24361 Manufacturers are free to choose different versioning schemes for each image type used by the physical  
24362 device and decide when to release updates for each module. However, in general it is assumed that each  
24363 module can be upgraded independently of the others. Each OTA file would need to be given to the OTA  
24364 server and managed separately.

24365 Though each module operates independently it is certainly possible that specific, shared resources MAY  
24366 preclude multiple simultaneous downloads or upgrades. For example, if the device has a single EEPROM  
24367 that can store only one download image at a time, then only one OTA client MAY be downloading or updat-  
24368 ing. Other OTA clients on other endpoints corresponding to other modules would have to wait until the  
24369 required resources are free for it to use.

### 24370 **11.14.3 Multiple OTA Files Dependent on Each Other**

24371 The last method a device might use to handle upgrading separate modules in the physical device is to use  
24372 multiple OTA files that have a dependency on each other. In this case the OTA client would sequentially  
24373 download and apply each OTA file before going to the next one.

24374 This method might be used in the case where a single OTA file containing all the OTA images is not possible  
24375 because the device does not contain a storage space big enough to hold all the module firmware images.  
24376 Additionally, each module cannot operate independently due to an internal device restriction.

24377 The details of the dependencies within the OTA files are specific to the manufacturer of the device. For  
24378 example, if the device required the OTA file for Image Type 7 before it received the OTA file for Image  
24379 Type 3, the device must manage this.

24380 After each OTA file has been downloaded and processed the OTA client SHALL send an Upgrade End  
24381 Request command with a status of REQUIRE\_MORE\_IMAGE. It SHALL then download and process the  
24382 next file. In this case the act of “processing” is manufacturer specific; it MAY or MAY NOT involve upgrad-  
24383 ing the internal component. During each OTA file download the OTA client SHALL update its attributes to  
24384 reflect the module that is being upgraded. For example, the Image Type ID, CurrentFileVersion, Downloa-  
24385 dedFileVersion SHALL be set to the values of the internal module that the OTA client is processing an up-  
24386 grade image for.

24387 Upon completion of the download for all modules the OTA client SHALL send an Upgrade End Request  
24388 command with a status of SUCCESS. The OTA server has the ability to delay or abort the final upgrade via  
24389 the normal mechanisms.

## 24390 **11.15 OTA Upgrade Cluster Management**

24391 This section provides ways for the upgrade server to monitor and manage the network-wide OTA upgrade  
24392 process. It is important to realize that the server cannot reliably query the upgrade status of the sleepy devices.

### 24393 **11.15.1 Query Upgrade Status**

24394 Server MAY send ZCL read attribute command for Image Upgrade Status attribute on the client devices. The  
24395 attribute indicates the progress of the client’s file download as well as its upgrade progress. The server MAY  
24396 want to make sure that all clients have completely downloaded their new images prior to issuing the Upgrade  
24397 End Response command.

24398 A client SHALL only download a single file at a time. It SHALL not download a second file while the first  
24399 file download is incomplete. This insures that the values in the client’s attributes can be correlated to a single  
24400 download instance.

24401  
24402

## 11.15.2 Query Downloaded ZigBee Stack and File Versions

24403 The server MAY send ZCL read attribute command to a client to determine its downloaded ZigBee stack  
24404 version and file version. The server SHOULD make sure that the client has downloaded the correct image  
24405 prior to issuing the Upgrade End Response command.

24406

## 11.15.3 Rate Limiting

24407 The OTA Upgrade Cluster server can rate limit how quickly clients download files by setting the *Mini-*  
24408 *imumBlockPeriod* attribute. This feature is only available if the client supports the attribute, and the server  
24409 supports this optional feature. Client support can be determined by requesting the *MinimumBlockPeriod* at-  
24410 tribute from the client, or if the Image Block Request message contains the *MinimumBlockPeriod* field.

24411 The server has the ability to set the attribute while the client is downloading by responding to any Image  
24412 Block Request with an Image Block Response with a status of WAIT\_FOR\_DATA. The Image Block Re-  
24413 sponse SHALL include the Block Request field with the new delay desired by the server for all the client's  
24414 subsequent requests. Upon receipt of the Image Block Response the client will record the new value in its  
24415 local *MinimumBlockPeriod* attribute and use it for the rest of the download.

24416 The server can change the download delay of the client multiple times over the course of the download based  
24417 on whatever criteria it deems appropriate. For example, if the server detects only 1 client is downloading, it  
24418 could allow that client to download at full speed (*MinimumBlockPeriod* = 0), but if other clients simultane-  
24419 ously start downloads it could limit all clients to 1 Image Block Request every 500 milliseconds. Alterna-  
24420 tively, it could give higher priority to certain clients to download their upgrade image and let them download  
24421 at full speed, while slowing down other clients.

24422 The *MinimumBlockPeriod* attribute is a minimum delay. The client MAY request data slower than what the  
24423 server specifies (i.e. with a longer delay). Sleeping end devices MAY do this normally to conserve battery  
24424 power.

24425 Below is a diagram showing how the rate limiting process generally works.

24426



24427

**Figure 11-22. Rate Limiting Exchange**

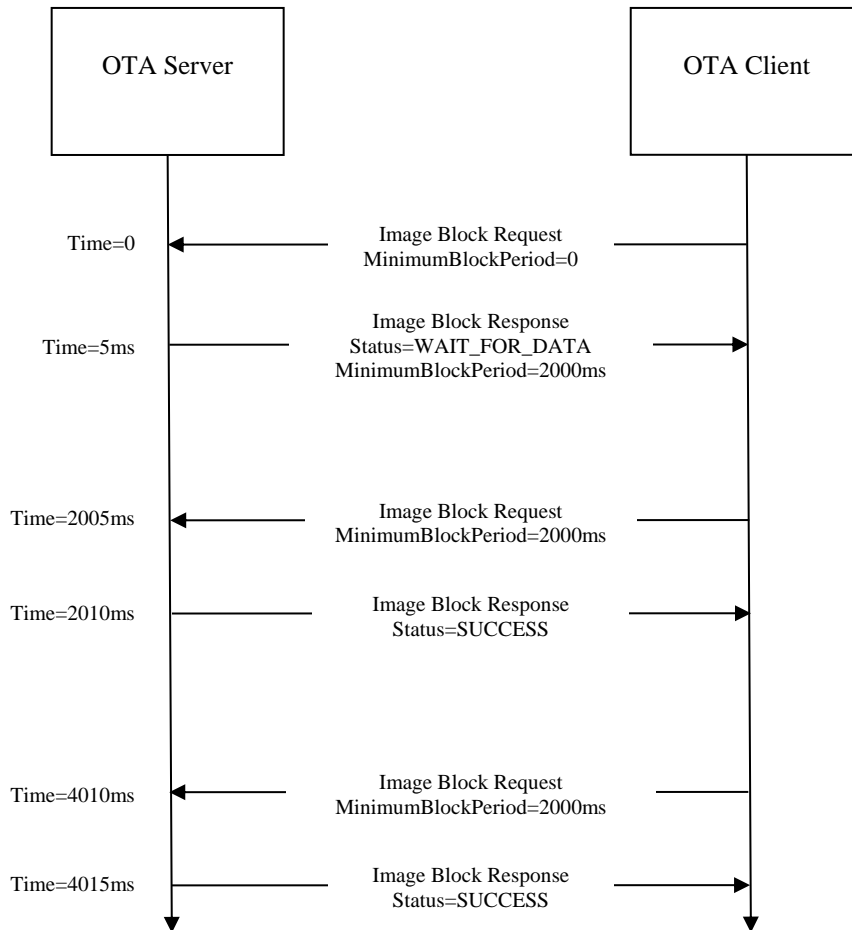

24428

24429

### 11.15.4 Current Time, Request Time, and MinimumBlockPeriod

24430

24431 When a server sends an Image Block Response with a status of WAIT\_FOR\_DATA, it can delay the client's  
 24432 next Image Block Request. This can be done persistently for all subsequent requests, or temporarily as a  
 24433 onetime delay.

24434 The onetime delay can be created by setting the Current Time and Request Time fields as described in section  
 24435 11.13.8.2.8. This might occur if the server does not immediately have access to the block of the upgrade  
 24436 image requested by the client, and the server must fetch the block from another location.

24437 The persistent delay can be enabled by setting the MinimumBlockPeriod as described in section 11.13.6.2.8  
 24438 however this only works if the client and server support this functionality.

24439

## 24440 **11.16 OTA Upgrade Process**

24441 Once a device has completely downloaded the image and returned a status of SUCCESS in the Upgrade End  
24442 Request, it SHALL obey the server's directive based on when it SHOULD upgrade. However, there are many  
24443 failure scenarios where this MAY not be possible. In such failure case, the device SHOULD attempt to con-  
24444 tact the server and determine what SHOULD be done, but if that has failed as well, then it MAY apply its  
24445 update without an explicit command by the server.

24446 After receiving an Upgrade End Response from the server the client will apply the upgrade according to time  
24447 values specified in the message. If the response directs the device to wait forever, it SHALL periodically  
24448 query the server about when it SHOULD apply the new upgrade. This SHALL happen at a period no more  
24449 often than once every 60 minutes. If the server is unreachable after 3 retries, the device MAY apply the  
24450 upgrade (see section 11.11.4 for further details).

24451 The client does not need to persistently store the time indicating when to apply the upgrade. If the client feels  
24452 that it has lost connection to the upgrade server, it SHALL first try to rediscover the upgrade server perhaps  
24453 by rejoining to the network and performing network address discovery using the stored UpgradeServerID  
24454 attribute. Once the server is found, the client SHALL resend an Upgrade End Request command with a status  
24455 of SUCCESS to the server, including the relevant upgrade file information. The server SHALL send it a  
24456 response again indicating when it SHOULD upgrade. If the device is unable to communicate to the upgrade  
24457 server or it cannot synchronize the time, it MAY apply the upgrade anyway.

24458 When the time comes for the client to upgrade, the device SHOULD begin the manufacturer specific method  
24459 to upgrade its image. The upgrade MAY involve one or more hardware resets. Once the device has completed  
24460 the upgrade it SHOULD be able to reinitialize itself and start communicating on the network again. Previous  
24461 network information such as channel, power, short pan id, extended pan id SHOULD be preserved across the  
24462 upgrade.

## 24463 **11.17 Application Standard Specific Decisions**

24464 Below are the decisions that each application standard needs to make in order to ensure successful OTA  
24465 upgrade of devices in the network.

- 24466 • The following are security considerations that SHOULD be taken into account when using this cluster.
  - 24467 • Whether image signatures will be used to sign the OTA upgrade file. If a signature is used, what  
24468 type of image signature will it be (example: ECDSA).
  - 24469 • What encryption will be used during the transport of OTA data
- 24470 • Whether to use offset or UTC time in Image Block Response and Upgrade End Response commands.  
24471 Refer to sections 11.11.4 and 11.13.9 for more details. If the application standard does not specify  
24472 which type of (OTA upgrade) time to support, it is default to using the offset time since it does not re-  
24473 quire an implementation of ZCL time cluster. Once the application standard has decided which type of  
24474 time to support, only that type of time SHALL be used consistently across the OTA upgrading. The  
24475 standard SHALL avoid using both types of time simultaneously to avoid any confusion and incon-  
24476 consistency between the two time values.

24477 Other application standard wide decisions that SHOULD be answered are:

- 24478 • How often the OTA client SHALL discover the OTA server until it finds one that is authorized to do  
24479 the upgrade.
- 24480 • How often the ZED client SHALL query the OTA server for new OTA upgrade image.
- 24481 • How often the ZED devices SHALL query for image data.

### 24482 **11.17.1 SE Profile Standard: OTA Upgrade from SE 1.x** 24483 **to SE 2.0**

24484 The definition of SE Profile 2.0 is currently still being worked on by the ZigBee SE group. However, it is  
24485 suggested that in order to successfully upgrade a device from SE 1.x to SE 2.0, such process MAY involve  
24486 transferring new security data over-the-air from the server to the client device. OTA Upgrade cluster has  
24487 provided a set of commands that MAY be used to obtain such security data. The security data will be re-  
24488 quested separately by the client using Query Device Specific File Request command. The data is sent from  
24489 the server to the client as an OTA upgrade file via similar set of commands used to request firmware image.  
24490 This OTA security file will be specific to a particular client device.

24491 A client SHOULD request new security data necessary for SE Profile 2.0 via Query Device Specific File  
24492 Request command. After obtaining the security data file, the server will include the file information in the  
24493 Query Device Specific File Response command in response to the client's request. Upon reception the re-  
24494 sponse, the client then SHALL obtain the file via Image Block or Page Request command. Query Device  
24495 Specific File Request and Response commands are described in sections 11.13.10 and 11.13.11 respectively.

## 24496 **11.18 OTA Upgrade Recovery**

24497 Each manufacturer is encouraged to implement a recovery method that SHOULD be used to recover the node  
24498 in a case when the OTA upgrade fails. The recovery method is particularly important in a case where the  
24499 device MAY not be able to communicate to the server over-the-air. The actual recovery implementation is  
24500 manufacturer specific; however, some of the options are discussed in this section.

24501 One option for recovery method is the ability for the application bootloader to swap the images between its  
24502 external flash and its internal flash, rather than just overwriting the internal with the external. A sample use  
24503 case is where the upgraded device is functional enough to receive a message, but broken enough to not be  
24504 able to initiate OTA upgrade process again. A manufacturer specific command MAY be sent from the server  
24505 to notify the device to revert back to its previous image.

24506 In a case where the device is no longer able to communicate to the server over-the-air; the application boot-  
24507 loader could revert to the previous image via a button press on power up.



24508

## CHAPTER 12 TELECOMMUNICATION

24509

The Cluster Library is made of individual chapters such as this one. See Document Control in the Cluster

24510

Library for a list of all chapters and documents. References between chapters are made using a *X.Y* notation

24511

where *X* is the chapter and *Y* is the sub-section within that chapter. References to external documents are

24512

contained in Chapter 1 and are made using [*Rn*] notation.

24513

### 12.1 General Description

24514

#### 12.1.1 Introduction

24515

The clusters specified in this chapter are for use typically in telecommunication applications but may be used

24516

in any application domain.

24517

#### 12.1.2 Cluster List

24518

This section lists the clusters specified in this chapter and gives examples of typical usage for the purpose of

24519

clarification. The clusters specified in this chapter are listed in Table 12-1.

24520

Table 12-1. Telecom Cluster List

ID	Cluster Name	Description
0x0900	Information	Commands and attributes for information delivery
0x0905	Chatting	Commands and attributes for sending chat messages
0x0904	Voice Over ZigBee	Commands and attributes for voice receiving and transmitting

24521

### 12.2 Information

24522

#### 12.2.1 Scope and Purpose

24523

This section specifies the Information cluster, which provides commands and attributes for information deli-

24524

very service on ZigBee networks and also specifies three types of special nodes on which this cluster works.

24525

The Information Node (IN) provides information contents in both pull-based and push-based information

24526

delivery to a mobile terminal. The contents may have links to other contents and thus they may be organized

24527

in a structure. The Mobile Terminal (MT) is used by an end-user to retrieve information from the IN. The

24528

Access Point (AP) node updates contents stored in an IN and has a role of gateway connected to the operator

24529

network. The AP is also assumed to be a ZigBee coordinator which forms a network with INs and MTs. APs

24530

may function as an IN.

24531

Information Delivery Service in this document is considered ‘Pull-based delivery’ and ‘Push-based delivery’.

24532

Both methods are provided by a single cluster, the information cluster.

24533

Figure 12-2 shows typical usage of the cluster. This cluster may use Partition cluster.

24534

#### 12.2.1.1 Data Structure of Contents Data

24535

Typical data structure of contents data is as illustrated in Figure 12-1. Each content data has its Content ID,

24536

which is used when the client cluster requests content to the server cluster.

24537 A content data includes ‘the title strings’, ‘actual content’, ‘number of child contents’ and ‘children’s content  
24538 IDs’.

24539 To let each content data have its children content data makes it enables to organize list-structure or tree-  
24540 structure and obtain a hierarchical content data structure, and a user who uses information delivery can re-  
24541 quest information along to child information links.

24542 To obtain the first contents ID, there are methods, reading server attribute ‘Root ID’, using ID sent by out-  
24543 of-band like via GPRS network and using ID provided by another telecom application clusters (ex. Payment  
24544 or gaming).

24545 **Figure 12-1. Typical Content Data Structure**

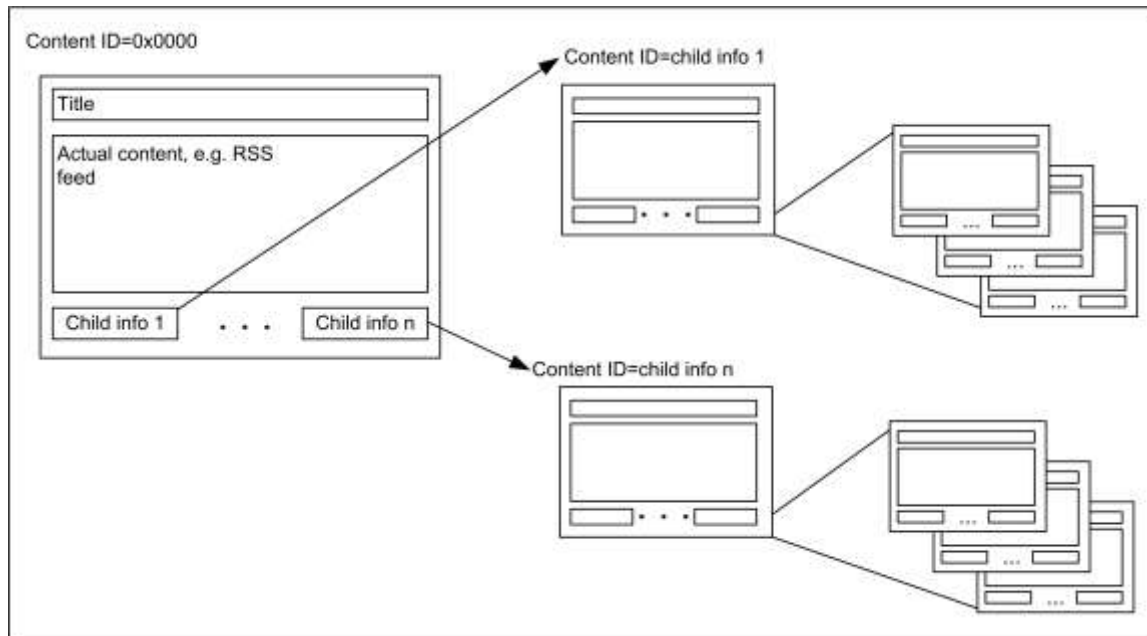

24546

24547 **12.2.2 Cluster List**

24548 A cluster specified in this document is listed in Table 12-2.

24549 Server cluster is expected to be implemented in the Information Node. Client cluster (including functions  
24550 related to contents provisioning) is expected to be implemented in the Mobile Terminal. The update command  
24551 and configuration commands are expected to be implemented in the Access Point. The Access Point may  
24552 have functionality of the Information node and it has server cluster in that case. Some user specific content  
24553 is provided with processing user-side information, defined as a preference. If a preference needs to be pro-  
24554 cesses not in the Information Node but in an Access Point or in a server beyond the Access Point as a gate-  
24555 way, information indicates the Access Point’s ID so that the Mobile Terminal can switch to access it (as  
24556 illustrated in Figure 12-3) or the Information Node acts as proxy and access the Access Point with client  
24557 function to forward preference, commands to the Access Point and contents to the Mobile Terminal (as illus-  
24558 trated below).

24559 **Table 12-2. Clusters Specified for the Information Delivery**

Cluster Name	Description
Information cluster	Attributes and commands for providing Information service to a ZigBee device.

24560

24561

**Figure 12-2. Typical Usage of the Information Cluster**

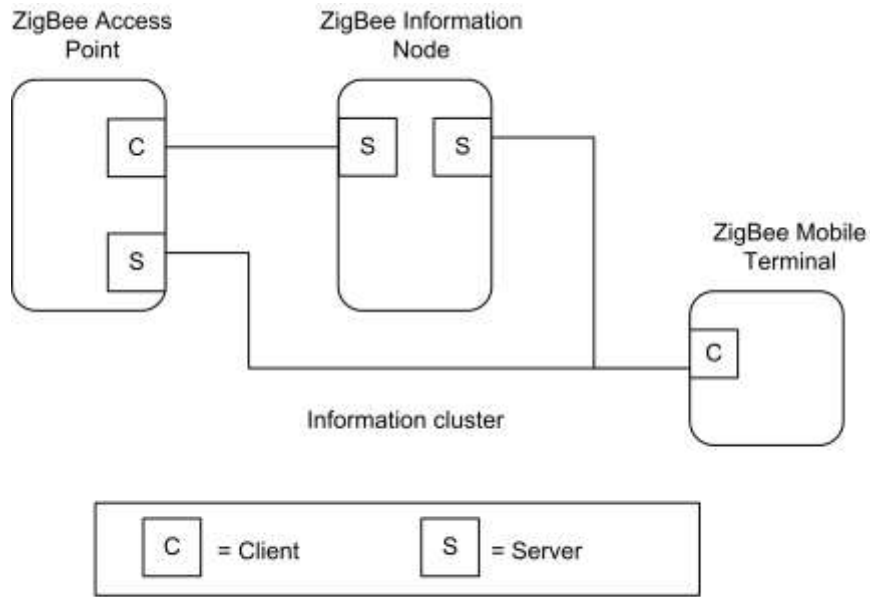

*Note: Device names are examples for illustration purposes only*

24562

24563

24564

**Figure 12-3. Typical Usage of the Information Cluster – with Proxy Function**

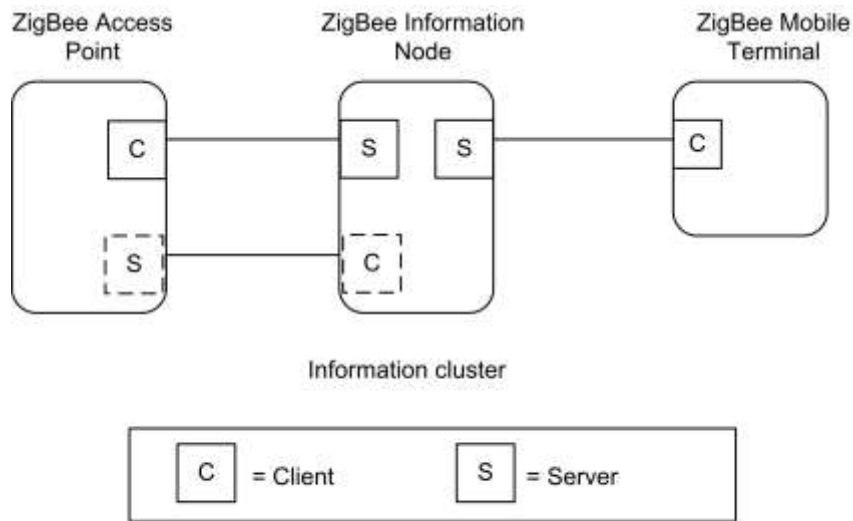

*Note: Device names are examples for illustration purposes only*

*Note2: Dashed boxes are for the case IN works as proxy for MT*

24565

### 24566 **12.2.3 Overview**

24567 Please see Chapter 2 for a general cluster overview defining cluster architecture, revision, classification,  
 24568 identification, etc.

24569 This cluster provides attributes and commands for Information Delivery Service.

24570 **12.2.3.1 Revision History**24571 The global *ClusterRevision* attribute value SHALL be the highest revision number in the table below.

Rev	Description
1	mandatory global <i>ClusterRevision</i> attribute added;CCB 1811 1812 1821

24572 **12.2.3.2 Classification**

Hierarchy	Role	PICS Code	Primary Transaction
Base	Application	TELIN	Type 2 (server to client)

24573 **12.2.3.3 Cluster Identifiers**

Identifier	Name
0x0900	Information (Telecom)

24574 **12.2.4 Server**

24575 The Information Node (IN) has a server cluster which provides information delivery service. A client cluster  
 24576 in Mobile Terminal (MT) requests information and the IN responds with requested contents on pull-based  
 24577 delivery. The IN server cluster can provide push-based delivery the client cluster in the MT (if properly  
 24578 configured).

24579 Content may have links to the other contents. A link is called as child information in this document and it is  
 24580 represented as a ContentID. Contents can be organized in tree-structure.

24581 Content may be one of three explicitly specified types: octet strings, character strings or RSS feed, so that  
 24582 the browser in the MT can understand easily what content it should access.

24583 Cluster also provides such function that the client cluster in the AP can update contents and delete them in  
 24584 the IN.

24585 Preference is used for carrying user-side information to let the IN provide user specific contents based on the  
 24586 user-side information. Contents may be modified along with that information on the IN. An example scenario  
 24587 of Information cluster is illustrated in Figure 12-4.

24588 A preference may be processed not in an IN but in an AP or in a server beyond the AP as a gateway. In that  
 24589 case, the IN needs to have client function to forward preference, commands and contents as proxy for MT  
 24590 (Forwarding scenario) or the IN needs to inform the MT to switch its access from the IN to the AP (Redirec-  
 24591 tion scenario). The Cluster supports both scenarios. If the preference, commands and contents are forwarded  
 24592 by the IN between the MT and the AP, they may be just relayed transparently through the IN, or they may  
 24593 be processed by the IN. The IN may process the preference before forwarding it, and may process the stored  
 24594 preference together with the contents to create the customized contents after receiving the response from the  
 24595 AP, then sending the contents to the MT.



24596

Figure 12-4. An Example Sequence

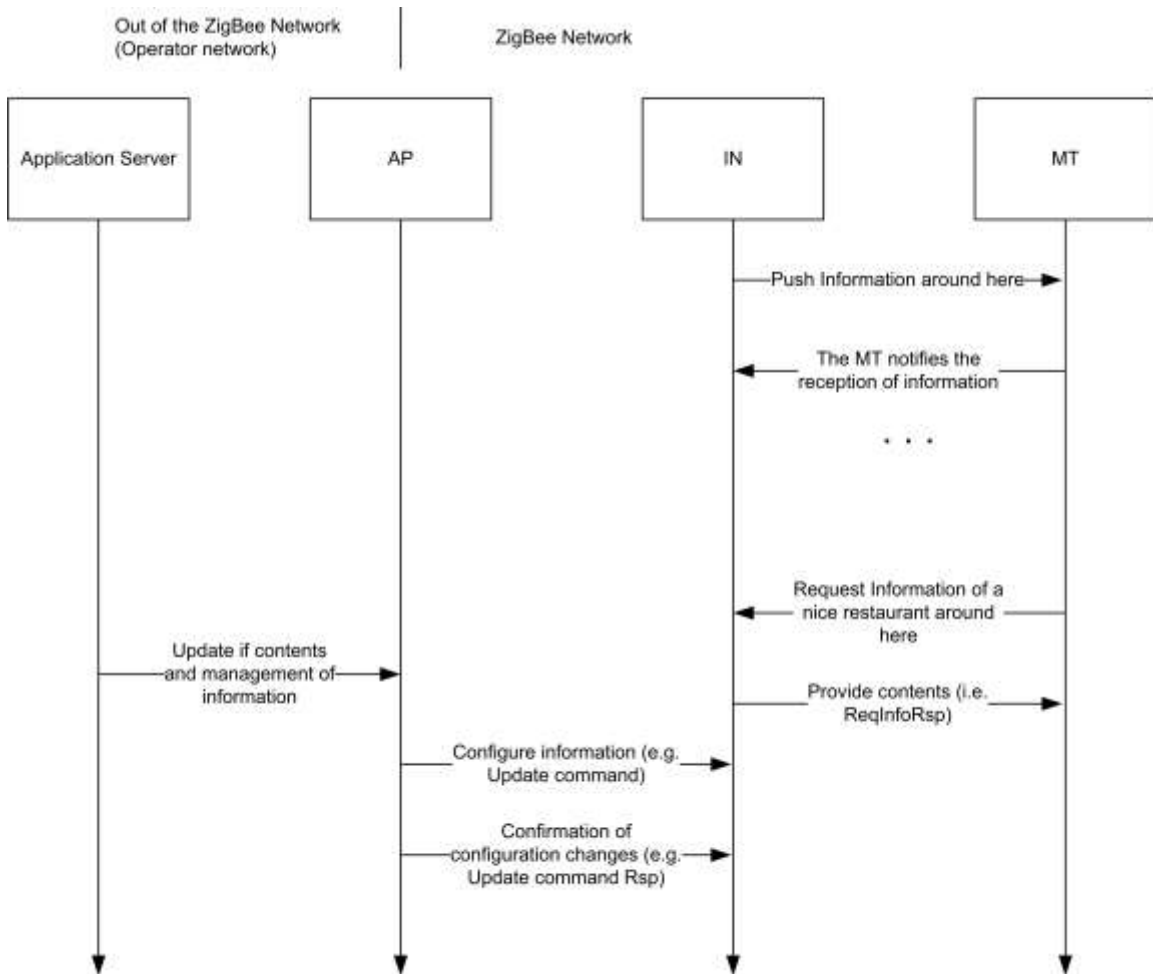

24597

24598

**Pull-based service is expected to work as follows:**

24599

11. It provides decentralized contents distributed by Update command from the central node (the AP). (e.g., tree-structure contents distribution, specific permission to peep the contents to the authorized user)

24600

24601

24602

12. Advanced application program provides service in conjunction with the other functions like a Location cluster, or the preference data from the MT. (e.g., direction service based on the location information of user, push service matching individual attribute – invitation of a test drive of new car to men in thirties which hobby is driving or etc.)

24603

24604

24605

24606

13. Hybrid service of the item a. and b.

24607

24608

24609

24610

24611

24612

24613

24614

24615

24616

24617

The preference format is application dependent and is used by the service like the item b. Of course the application uses the preference shall have the ability to parse it. If the application doesn't have the ability, it shall report it that. The cluster provides a status code to inform it. For example, let's assume the IN provides service like item a. and the AP connected a network out of the ZigBee and an application server is deployed there. First the MT access to the IN to get general contents for the all of users. The IN can provide simple contents to the MT. Second, the MT request a content – good restaurant to the IN, which content is indicated to redirect to the AP. The MT switch its access to the AP. The AP requests preference to the MT to get user-side information, favorite food in the example. The AP sends the preference to the application server and it replies with the food restaurant which the user likes. Thus the AP can provide the content modified along with user-side information – the restaurant which provides he likes – to the MT. The example illustrated in Figure 12-5.

24618

**Figure 12-5. Preference Scenarios (Triggered by the Client or by the Server)**

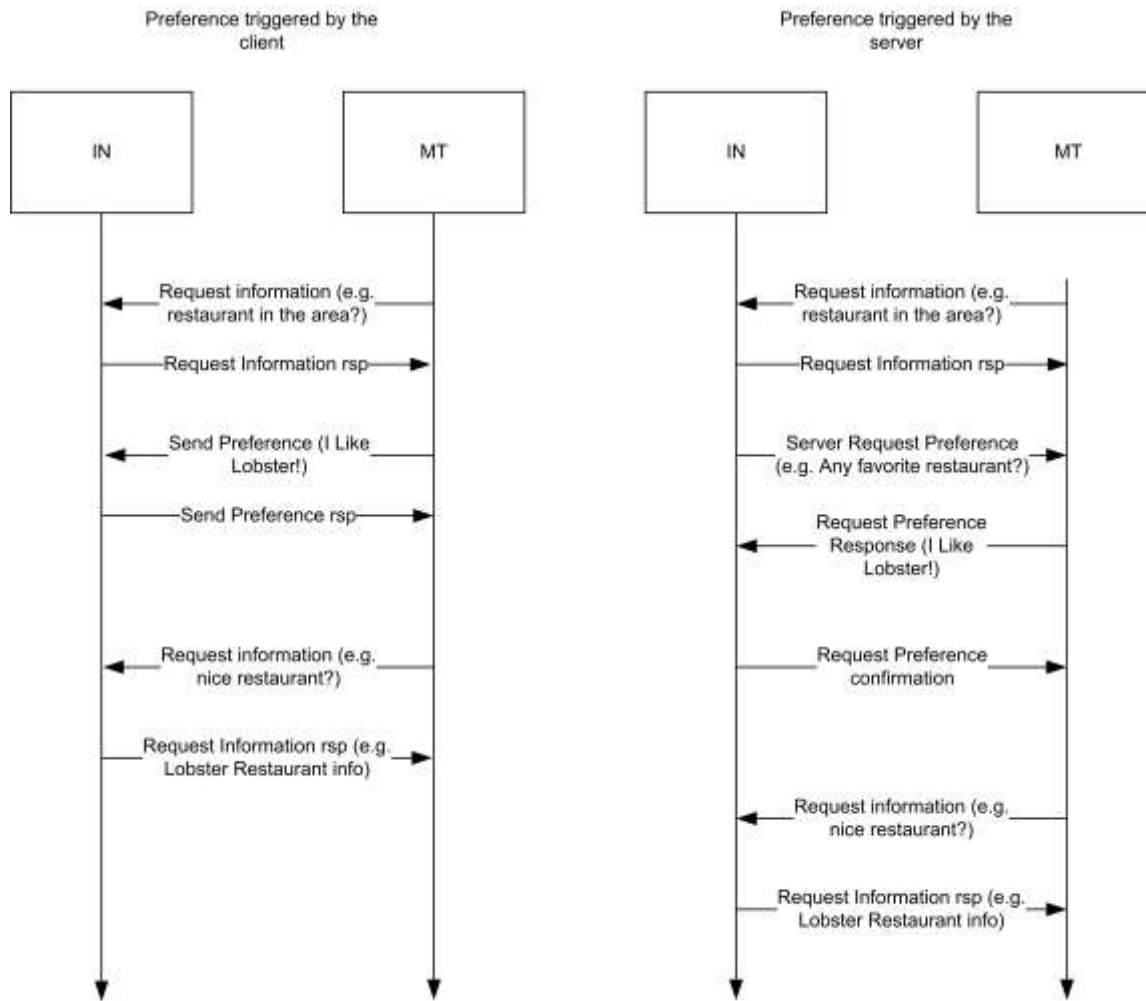

24619

24620 **12.2.4.1 Dependencies**

24621 None

24622 **12.2.4.2 Attributes**

24623 For convenience, the attributes defined in this specification are arranged into sets of related attributes; each  
 24624 set can contain up to 16 attributes. Attribute identifiers are encoded such that the most significant three nib-  
 24625 bles specify the attribute set and the least significant nibble specifies the attribute within the set. The currently  
 24626 defined attribute sets are listed in Table 12-3.

24627

**Table 12-3. Information Cluster Attribute Sets**

Attribute Set Identifier	Description
0x000	Node Information
0x001	Contents Information
0x002 – 0xffff	Reserved

24628 **12.2.4.2.1 Node Information Attribute Set**

24629 The Node Information attribute set contains the attributes summarized in Table 12-4.

24630 **Table 12-4. Node Information Attribute Set**

<b>Id</b>	<b>Name</b>	<b>Type</b>	<b>Range</b>	<b>Access</b>	<b>M/O</b>
0x0000	<i>NodeDescription</i>	string		R	M
0x0001	<i>DeliveryEnable</i>	bool	0x00 – 0x01	R	M
0x0002	<i>PushInformationTimer</i>	uint32		R	O
0x0003	<i>EnableSecureConfiguration</i>	bool	0x00 – 0x01	R	M

24631 **12.2.4.2.1.1 NodeDescription Attribute**

24632 This *NodeDescription* Attribute holds strings which indicate what Information Delivery service is available  
 24633 so that an end-user can select and distinguish this service.

24634 **12.2.4.2.1.2 DeliveryEnable Attribute**

24635 The *Delivery Enable* attribute is Boolean and indicates whether the cluster is able to communicate with the  
 24636 other nodes. It is a read only attribute but it can be changed by using the Configure Delivery Enable command.  
 24637 If it is set to TRUE (0x01), the Information cluster is able to manage the following commands: Request  
 24638 Information, Push Information Response, Send Preference and Request Preference Response.

24639 **12.2.4.2.1.3 PushInformationTimer Attribute**

24640 The *Push Information Timer* is an Unsigned 32-bit integer and indicates whether the cluster is able to send  
 24641 Push Information command and the time between those commands. It is a read only attribute but it can be  
 24642 changed by using the Configure Push Information timer command. If this attribute is set to 0, then the auto-  
 24643 matic Push Information is disabled, otherwise the value is considered as an interval (in milliseconds) that  
 24644 elapses between Push Information commands. If this attribute is set to 0, it's still possible for the device to  
 24645 push information triggered by an event such as button being pushed.

24646 **12.2.4.2.1.4 EnableSecureConfiguration Attribute**

24647 The Enable Secure Configuration attribute is a Boolean and indicates whether an application layer security  
 24648 is required in order to process the configuration commands: Update, Delete, Configure Delivery Enable,  
 24649 Configure Set Root ID, Configure Node Description, Configure Push Information timer. If this attribute is  
 24650 set to TRUE, then server side of the cluster need to use application link keys for processing those commands.  
 24651 If FALSE, then all the commands can be processed without using link keys.

24652 **12.2.4.2.2 Contents Information Attribute Set**

24653 The Node Information attribute set contains the attributes summarized in Table 12-5.

24654 **Table 12-5. Contents Information Attribute Set**

<b>Identifier</b>	<b>Name</b>	<b>Type</b>	<b>Range</b>	<b>Access</b>	<b>M/O</b>
0x0010	<i>NumberOfContents</i>	uint16	0x0000 - 0xFFFF	R	O
0x0011	<i>ContentRootID</i>	uint16	0x0000 - 0xFFFF	R	O

24655 **12.2.4.2.2.1 NumberOfContents Attribute**

24656 This attribute holds the total number of contents which this server node has. It should reflect the result of  
 24657 updating command by AP. This attribute holds the total number of contents which this server node has. If  
 24658 the number is more than 0xffff, this attribute shall be set to 0xffff.

#### 24659 **12.2.4.2.2.2 ContentRootID Attribute**

24660 This attribute holds root Content ID of octet strings, character string and RSSFeed Contents. *ContentRootID*  
 24661 is a start pointer so that user can access variety contents. If this attribute doesn't exist, there are no contents.  
 24662 0xffff for this attribute means it is not specified yet.

### 24663 **12.2.4.3 Commands Received**

24664 The received command IDs for the information cluster are listed in Table 12-6. Please notice that at least one  
 24665 of the commands shall be implemented though they are defined as optional.

24666 **Table 12-6. Received Command IDs for the Information Cluster**

<b>Id</b>	<b>Description</b>	<b>M/O</b>	<b>Command Type</b>
0x00	Request Information	M	<i>Operation</i>
0x01	Push Information Response	M	<i>Operation</i>
0x02	Send Preference	O	<i>Operation</i>
0x03	Request Preference Response	O	<i>Operation</i>
0x04	Update	O	<i>Configuration</i>
0x05	Delete	O	<i>Configuration</i>
0x06	Configure Node Description	O	<i>Configuration</i>
0x07	Configure Delivery Enable	O	<i>Configuration</i>
0x08	Configure Push Information Timer	O	<i>Configuration</i>
0x09	Configure Set Root ID	O	<i>Configuration</i>

#### 24667 **12.2.4.3.1 Request Information Command**

24668 This is a command requesting information as a list, as a content of text strings and as an RSS feed from  
 24669 mobile terminal to the Information Node or to the Access Point. An Information Node (or an Access Point)  
 24670 that receives this command shall reply by Request Information Response Command with requested infor-  
 24671 mation to the sender of this command. It specifies how to indicate content By the 'Inquiry Type' and also  
 24672 specifies what data type of content is requested by the 'Data Type ID'. For example, in pull scenario, MT  
 24673 gets contents list, sending this command (e.g., Inquiry ID = 'Request by depth') and receiving Request In-  
 24674 formation Response Command with the list of titles. By another Request Information Command indicating  
 24675 contents ID, MT can get an individual content.

##### 24676 **12.2.4.3.1.1.1 Frame Format**

24677 The Request Information command shall be formatted as illustrated in Figure 12-6.

24678

**Figure 12-6. Payload Format of Request Information Command**

<b>Octets</b>	1	1	Variable
<b>Data Type</b>	enum8	map8	See 12.2.4.3.1.2
<b>Field Name</b>	Inquiry ID	Data Type ID	Request Information Payload

24679

24680 Inquiry ID shall be set as one of IDs listed in Table 12-7.

24681 Data Type ID indicates what type of contents the response command requires. It shall be formatted by combination of bitmasks described in Table 12-8. A bit for ‘Title’ indicates the request requires ‘Title strings’ and it can be combined other type of contents. Flagging ‘Title’ bit means a request title be attached and the other bits used for filter. If ‘Title’ bit, ‘Octet’ bit and ‘RSS’ bit are flagged, that means request is “Octet content attached title and RSS content attached title are required.” In the case that the only ‘Title’ bit is flagged, the request means “Just titles are required.” Please notice that all the contents shall maintain a title in the local database.

24688

**Table 12-7. Inquiry ID**

<b>Inquiry ID</b>	<b>Description</b>	<b>M/O</b>
0x00	Request a content by a content ID	M
0x01	Request contents by multiple IDs	O
0x02	Request all	O
0x03	Request by depth	O

24689

24690

**Table 12-8. Data Type IDs**

<b>Data Type ID</b>	<b>Bit Mask</b>	<b>Description</b>
0x01	0000 0001	Title
0x02	0000 0010	Octet String
0x04	0000 0100	Character String
0x08	0000 1000	RSS Feed
0x1X – 0xfX	-	Reserved

24691

**12.2.4.3.1.2 Request Information Payload**

24692

Request Information Payload changes along with Inquiry ID listed in Table 12-7. Payload formats for each Inquiry ID are described following sections.

24693

24694

**12.2.4.3.1.3 Inquiry ID**

24695

**12.2.4.3.1.3.1 Format for Request a Content by a Content ID**

24696

The command with this ID requests a single content by a Content ID. Format is illustrated in Figure 12-7.

24697 A server shall respond Request Information Response command with a content indicated by the content ID.

24698 **Figure 12-7. Payload Format for Request a Content by a Content ID**

<b>Octets</b>	2
<b>Data Type</b>	uint16
<b>Field Name</b>	Content ID

24699 **12.2.4.3.1.3.2 Format for Request Contents by Multiple IDs**

24700 The command with this ID requests several contents by indicating several content IDs. It shall be formatted  
24701 as illustrated in Figure 12-8.

24702 A server shall respond Request Information Response command with contents indicated by content IDs.

24703 **Figure 12-8. Request Information Payload for Request Contents by Multiple IDs**

<b>Octets</b>	2	2	...	2
<b>Data Type</b>	uint16	uint16		uint16
<b>Field Name</b>	Content ID 1	Content ID 2	...	Content ID <i>n</i>

24704 **12.2.4.3.1.3.3 Format for Request All**

24705 The command with this ID requests all contents. No payload format is specified and it should be empty.

24706 A server shall respond Request Information Response command with all contents.

24707 **12.2.4.3.1.3.4 Format for Request by Depth**

24708 Upon receipt of the command with this ID, server shall reply Request Information Response command with  
24709 concatenated contents indicated by Start ID and Depth. Request Information Payload format for this ID is  
24710 specified in Figure 12-9.

24711 Start ID field holds content ID for starting point to retrieve structured contents.

24712 Depth field holds how many levels to request from Start ID tracing child information. If a depth equals to  
24713 0x00, the requested content should be single content of Start ID itself.

24714 Server shall provide concatenated contents, which needs a prevention of duplication induced by the loop of  
24715 links. (For example, if the content has a child content which child ID refers its parent (A→B, B→A), there  
24716 is a loop. If the requester indicates 2 for the depth and requests content "A", searching child information  
24717 would be like as A→B→A. However only content A and B should be carried in this case).

24718

**Figure 12-9. Request Information Payload for Request by Depth**

<b>Octets</b>	2	1
<b>Data Type</b>	uint16	uint8
<b>Field Name</b>	Start ID	Depth

24719

### 12.2.4.3.2 Push Information Response Command

24720 This command is used by the client to notify the reception of the data carried by Push Information Command,  
 24721 and it is used by the server to confirm if it is correctly stored or not into MT. This command shall not be used  
 24722 if the Push Information Command is sent by broadcast. It is to prevent explosion of response.

24723 Payload format shall be as illustrated in Figure 12-10.

24724

**Figure 12-10. Payload Format of Push Information Response Command**

<b>Octets:</b>	2	1	...	2	1
<b>Field:</b>	Notification 1		...	Notification <i>n</i>	
	Content ID 1	Status Feedback 1	...	Content ID <i>n</i>	Status Feedback <i>n</i>

24725

24726 Notification field has two sub-fields, content ID and Status Feedback. Content ID indicates what content the  
 24727 notification has the status for. Status Feedback indicates the status of the reception of the content.

24728 Possible message for Status Feedback are SUCCESS, FAILURE, MALFORMED\_COMMAND, UN-  
 24729 SUP\_COMMAND, INVALID\_FIELD, INSUFFICIENT\_SPACE and FAILURE<sup>230</sup>.

24730

### 12.2.4.3.3 Send Preference Command

24731 This command carries a preference that is specific information of interest for the user, from the client to the  
 24732 server. Upon receipt of this command on the server, the server application may modify or change user specific  
 24733 contents along with preference information. The type of data put into the preference is based on the Prefer-  
 24734 ence Type field. Payload format for this command shall be as illustrated in Figure 12-11.

24735

**Figure 12-11. Payload Format for Send Preference Command**

<b>Octet:</b>	2	Variable
<b>Field</b>	Preference Type	Preference Payload, see Table 12-9

24736 The Preference Type determines the format of the preference Payload. All devices must support Preference  
 24737 Type of 0x0000.

24738

**Table 12-9. Preference Type**

Preference Type	Description
-----------------	-------------

<sup>230</sup> CCB 2477 status code cleanup

0x0000	Preference is Multiple Content ID
0x0001	Preference is Multiple Octet Strings
0x0002 – 0x7fff	Reserved
0x8000 – 0xffff	Used for Vendor Specific Format
0xfffc – 0xffff	Reserved

24739

24740

**Figure 12-12. Payload Format for Preference Is Multiple Content ID (0x0000)**

<b>Octets</b>	1	2	...	2
<b>Data Type</b>	uint8	uint16	...	uint16
<b>Field Name</b>	Count	Content ID 1		Content ID N (based on Count)

24741

24742

**Figure 12-13. Payload Format for Preference Is Multiple Octet Strings (0x0001)**

<b>Octets</b>	1	Variable (1-256)	...	Variable (1-256)
<b>Data Type</b>	uint8	octstr	...	octstr
<b>Field Name</b>	Count	Preference Data 1		Preference Data N (based on Count)

24743 As described in Figure 12-5 there are two scenarios for the preference:

24744 35. Preference triggered by server side (Information Node or Access Point):

- 24745 • IN ← (Request Information) ← MT
- 24746 • IN → (Request Information Response) → MT
- 24747 • IN → (Server Request Preference) → MT
- 24748 • IN ← (Request Preference Response) ← MT
- 24749 • IN → (Request Preference Confirmation) → MT
- 24750 • IN ← (Request Information) ← MT
- 24751 • IN → (Request Information Response) → MT

24752 36. Preference triggered by client side (e.g., Mobile terminal):

- 24753 • IN ← (Request Information) ← MT
- 24754 • IN → (Request Information Response) → MT
- 24755 • IN ← (Send Preference) ← MT
- 24756 • IN → (Send Preference Response) → MT
- 24757 • IN ← (Request Information) ← MT
- 24758 • IN → (Request Information Response) → MT



24759 **12.2.4.3.4 Request Preference Response Command**

24760 This command carries a preference as a response of ‘Server Request Preference’ command on pull-basis.  
 24761 Format shall be as illustrated in Figure 12-14.

24762 **Figure 12-14. Payload Format of Request Preference Response Command**

Octets:	1	2	Variable
Field:	Status Feedback	Preference Type	Preference Payload, see Table 12-9

24763

24764 Status Feedback carries a message as a response to previous ‘Server Request Preference’ command. Possible  
 24765 messages are SUCCESS, FAILURE, NOT\_FOUND, MALFORMED\_COMMAND, UNSUP\_  
 24766 COMMAND, INVALID\_FIELD and FAILURE<sup>231</sup>. Besides, REQUEST\_DENIED is included to these mes-  
 24767 sages for this cluster specification.

24768 **12.2.4.3.5 Update Command**

24769 Server cluster in the IN which receives this command from the AP shall updates contents by the one which  
 24770 the command carried except that there is an error in the IN. Update command also indicates various control  
 24771 to the contents by the control fields. Control fields affect to all of contents carried by the Update command,  
 24772 so contents required to be indicated different control should be carried by another Update command.

24773 Payload format is as illustrated in Figure 12-15.

24774 **Figure 12-15. Payload Format for Update Command**

Octet	1	1	Variable
Data Type	enum8	map8	Payload Format for Multiple Content
Field Name	Access Control Field	Option Field	Contents Data

24775 **12.2.4.3.5.1 Access Control Field**

24776 Access Control Field is 8-bit enumeration and is used to indicate security level for the validation to access  
 24777 the contents which are carried by the Update command. All of contents carried by the Update command shall  
 24778 be affected by this control field. The enumeration values are listed up in Table 12-10.

24779 **Table 12-10. Value of the Access Control Field**

Access Control Mode Value	Description
0x00	Free to access
0x01	Link key establishment based
0x02	Billing based
0x03 – 0xfe	Reserved

<sup>231</sup> CCB 2477 status code cleanup

Access Control Mode Value	Description
0xff	Vendor Specific

24780 **Free to access:** All of the clients is permitted to access the contents without special validation.

24781 **Link key establishment based:** The client to access to the IN shall be required to establish link key establishment to achieve the contents. Contents shall be encrypted by the link key.  
24782

24783 **Billing based:** The client to access the contents is required to finish the Billing cluster procedure.

24784 **Vendor specific:** No special method is defined in this document. The application defines it. (Out-of-box, out-of-band, etc.)  
24785

24786 **12.2.4.3.5.2 Option Field**

24787 Option Field is used for advanced indication while updating contents. Forwarding flag, Redirection flag,  
24788 Overwrite update flag are defined in the current version. The ‘Forwarding’ flag or the ‘Redirection’ flag are  
24789 used to indicate ‘content’ so that the commands of request and response related to the indicated ‘content’  
24790 shall be forwarded or redirected to the AP. If both ‘Forward’ flag and ‘Redirection’ flag are 1, the server  
24791 cluster shall reply the INVALID\_FIELD by the Update Response command.

24792 The format is as illustrated in Figure 12-16.

24793 **Figure 12-16. Format for Redirection Control Field**

<b>Bits: 1</b>	<b>1</b>	<b>1</b>	<b>5</b>
Forward	Redirection	Overwrite update	Reserved

24794 **Forward flag:** The Information Node is required to forward messages from the MT to the AP and message  
24795 from the AP to the MT with acting as proxy. All the requests from the MT for the contents updated with this  
24796 flag are forwarded to the AP. A Preference from the MT is also sent to AP if the IN has it. The AP answers  
24797 the response command to the IN with requested contents and they are forwarded to the MT similarly. Figure  
24798 12-17 shows an example usage of forwarding.

24799

Figure 12-17. An Example Sequence of Forwarding Case

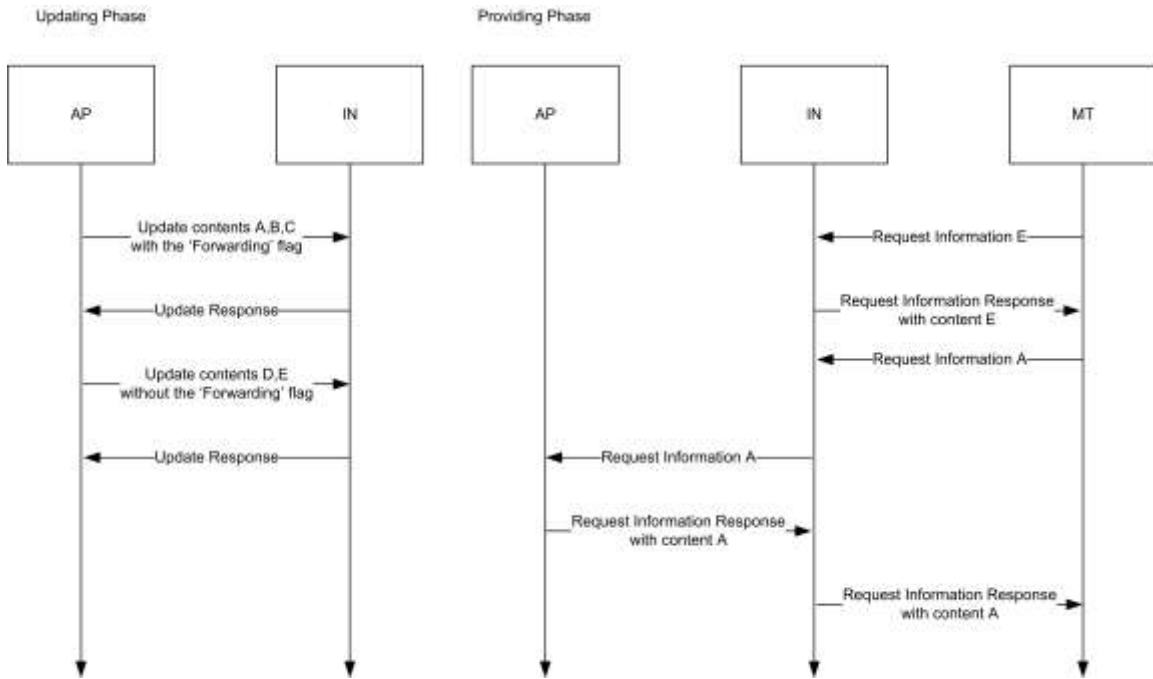

24800

24801

24802 **Redirection flag:** A client requested the contents indicated by this flag shall receive Request Information  
 24803 Response command with Status feedback 'INDICATION\_REDIRECTION\_TO\_AP'. The client is required  
 24804 to switch to access from the Information Node to the Access Point. This flag makes MT enable to switch  
 24805 access to AP automatically without user's operation (Like that user access the child content). For example,  
 24806 let IN have general site-dependent information and content depends on user-side information generated by a  
 24807 server beyond the operator network which AP is connected. Figure 12-18 shows an example usage of redi-  
 24808 recting.

24809

**Figure 12-18. An Example Sequence of Redirecting Case**

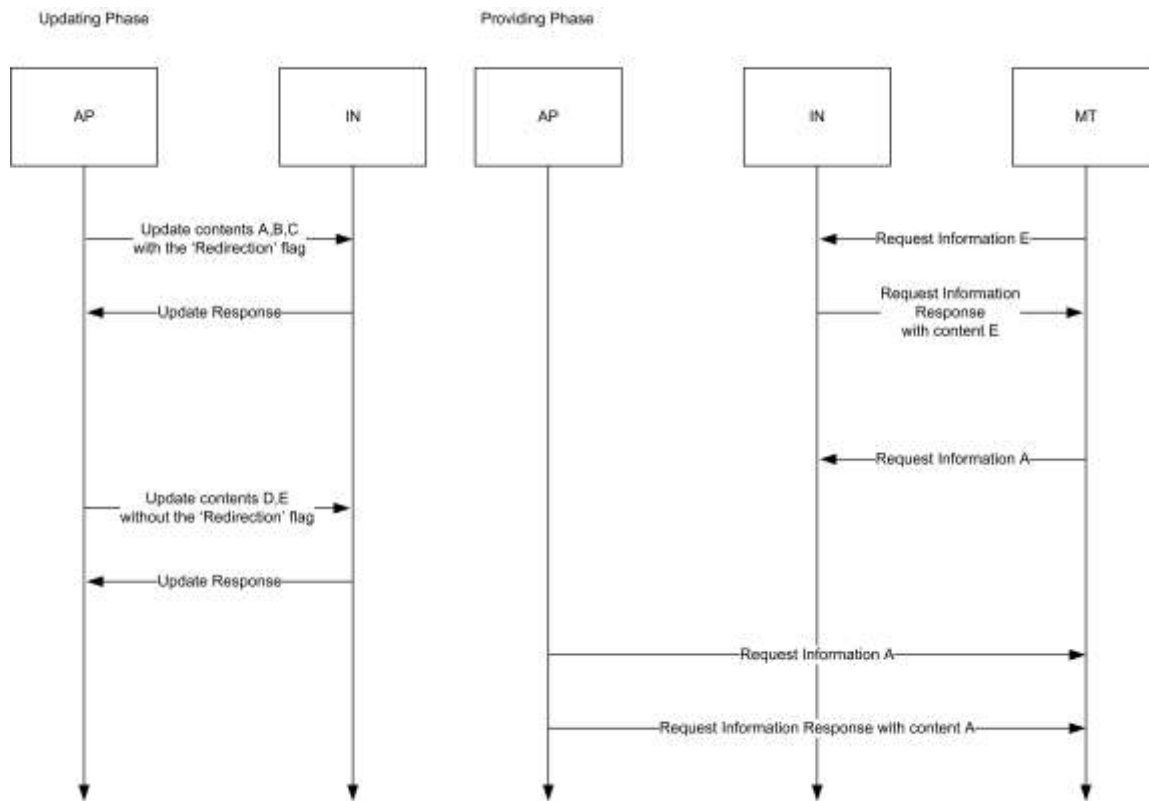

24810

24811

24812 **Overwrite:** For the case that the IN has already contents corresponding to the one required to Update, the  
 24813 command indicates if it can be overwritten or not. If it is 0b1, the contents carried by the Update command  
 24814 overwrites the contents which the IN has. If it is 0b0, overwriting is not permitted. In that case, the error  
 24815 'FAILURE' on Update Response command is issued by the IN and the command is ignored if the IN has  
 24816 corresponding contents.

24817 **12.2.4.3.6 Delete Command**

24818 Server cluster in the IN which receives this command from the AP shall delete contents by the one which the  
 24819 command carried except that there is an error in the IN. Delete command also indicates various control to the  
 24820 contents by the control fields. Control fields affect to all of contents carried by the Delete command, so  
 24821 contents required to be indicated different control should be carried by another Delete command.

24822 Payload format is as illustrated in Figure 12-19.

24823 **Figure 12-19. Payload Format for Delete Command**

<b>Octet</b>	1	2	...	2
<b>Data Type</b>	map8	uint16	...	uint16
<b>Field Name</b>	Deletion Option	ContentID 1	...	ContentID <i>n</i>

24824 **12.2.4.3.6.1 Deletion Option Field**

24825 Deletion Option field enables various deletion functions. The format is as illustrated in Figure 12-20.

24826 **Figure 12-20. Format for Deletion Option Field**

<b>Bits: 1</b>	<b>2-8</b>
Recursive	Reserved

24827

24828 **Recursive:** If it is 0b1, all the sub tree starting for the content carried by the Delete command are deleted. If  
 24829 it is 0b0, only the content carried by the Delete command is deleted. How the children are linked to the rest  
 24830 of the tree is out of scope of this document, it is application dependent.

24831 **12.2.4.3.7 Configure Node Description**

24832 Payload format for the Configure Node Description command shall be as illustrated in Figure 12-21.

24833 Upon recipient of this command, the server cluster shall change its Node Description attribute to the value  
 24834 of the “Description” field in this command. The use of this specific command guarantees that Node Descrip-  
 24835 tion attribute can be reconfigured only when Delivery Enable attribute is set to TRUE. Upon reception of this  
 24836 command the recipient will reply with Default Response with status field equal to SUCCESS (if the requester  
 24837 set the Disable Default response bit of ZCL header to 0). The Configure Node Description command will be  
 24838 acknowledged with Default Response with status field equal to NOT\_AUTHORIZED in case the recipient  
 24839 entity requires a secure link for configuration (i.e., Enable Secure Configuration attribute set to TRUE) while  
 24840 the sender didn’t use the proper link key for sending the configuration commands.

24841 **Figure 12-21. Payload Format for Configure Node Description Command**

<b>Octets</b>	<b>Variable</b>
<b>Data Type</b>	string
<b>Field Name</b>	Description

24842 **12.2.4.3.8 Configure Delivery Enable**

24843 Payload format for the Configure Delivery Enable command shall be as illustrated in Figure 12-22.

24844 Upon recipient of this command, the server side of the Information cluster should set the value present in the  
 24845 ‘Enable flag’ field into the Delivery Enable attribute. Note that, if Enable Secure Configuration attribute is  
 24846 set to TRUE (0x01) this command should be handled only whether the entity sending this message will have  
 24847 previously set up its link key with the recipient entity.

24848 If the ‘Enable flag’ is set to FALSE (0x00), the server cluster shall stop the information delivery service.  
 24849 However the device supporting this server cluster (i.e., Information node) shall still accept those commands  
 24850 needed to configure the node: Update, Delete, Configure Node Description, Configure Delivery Enable, Con-  
 24851 figure Push Information timer and Configure Set Root ID.

24852 All cluster specific commands except from “configuration” commands will be replied by their respective  
 24853 responses with status code REQUEST\_DENIED if the Delivery Enable attribute is disabled.

24854 The Configure Delivery Enable command will be acknowledged with Default Response with status field  
 24855 equal to NOT\_AUTHORIZED in case the recipient entity requires a secure link for configuration (i.e., Enable  
 24856 Secure Configuration attribute set to TRUE) while the sender didn’t use the proper link key for sending the  
 24857 configuration commands.

24858

**Figure 12-22. Payload Format for Configure Delivery Enable Command**

<b>Octets:</b>	<b>1</b>
<b>Field:</b>	Enable flag

24859 **12.2.4.3.9 Configure Push Information Timer**

24860 Payload format for the Configure Push Information Timer command shall be as illustrated in Figure 12-23.

24861 Upon recipient of this command, the server side of the Information cluster shall change its Push Information  
24862 timer attribute to the value of the ‘Timer’ field carried in this command.

24863 The Configure Push Information Timer command will be acknowledged with Default Response with status  
24864 field equal to NOT\_AUTHORIZED in case the recipient entity requires a secure link for configuration (i.e.,  
24865 Enable Secure Configuration attribute set to TRUE) while the sender didn’t use the proper link key for send-  
24866 ing the configuration commands.

24867 **Figure 12-23. Payload Format for Configure Push Information Timer Command**

<b>Octets:</b>	<b>4</b>
<b>Field:</b>	Timer

24868 **12.2.4.3.10 Configure Set Root ID**

24869 Payload format for the Configuration Set Root ID command shall be as illustrated in Figure 12-24.

24870 Upon recipient of this command, the server side of Information cluster shall change its Root ID attribute to  
24871 the value of the ‘Root ID’ field in this command.

24872 The Configure Set Root ID command will be acknowledged with Default Response with status field equal to  
24873 NOT\_AUTHORIZED in case the recipient entity requires a secure link for configuration (i.e., Enable Secure  
24874 Configuration attribute set to TRUE) while the sender didn’t use the proper link key for sending the config-  
24875 uration commands.

24876 **Figure 12-24. Payload Format for Configure Set Root ID Command**

<b>Octets:</b>	<b>2</b>
<b>Field:</b>	Root ID

24877 **12.2.4.4 Commands Generated**

24878 The generated command IDs for the Information cluster are listed in Table 12-11. Please notice that at least  
24879 one of the following commands shall be implemented.

24880 **Table 12-11. Generated Command IDs for the Information Cluster**

Command Identifier Field Value	Description	M/O	Command Type
0x00	Request Information Response	M	<i>Operation</i>
0x01	Push Information	M	<i>Operation</i>

Command Identifier Field Value	Description	M/O	Command Type
0x02	Send Preference Response	O	Operation
0x03	Server Request Preference	O	Operation
0x04	Request Preference Confirmation	O	Operation
0x05	Update Response	O	Configuration
0x06	Delete Response	O	Configuration

24881 **12.2.4.4.1 Request Information Response Command**

24882 This command is a response command according to a Request Information command which a client requests  
 24883 and carries requested information or carries status feedback if error occurs. Payload format for this command  
 24884 shall be as illustrated in Figure 12-25.

24885 **Figure 12-25. Payload Format of Request Information Response Command**

Octet:	1	1	Variable	...	1	Variable
Field:	Number	Status Feed-back 1	Single Content or ContentID	...	Status Feedback <i>n</i>	Single Content or ContentID

24886  
 24887 Number indicates how many single contents are carried by this command. Pairs of ‘Status Feedback’ and  
 24888 ‘Single Content’ appear corresponding to this number.  
 24889 Single content is the actual content which format is specified in 12.2.6.1.  
 24890 Status Feedback carries a message as a response to the previous ‘Request Information’ command sent by the  
 24891 client. Possible messages are SUCCESS, FAILURE, NOT\_FOUND, MALFORMED\_COMMAND, UN-  
 24892 SUP\_COMMAND, INVALID\_FIELD and FAILURE<sup>232</sup>. Besides, INDICATION\_REDIREC-  
 24893 TION\_TO\_AP, REQUEST\_DENIED, PREFERENCE\_IGNORED and MULTIPLE\_RE-  
 24894 QUEST\_NOT\_ALLOWED are included to these messages for this cluster specification.  
 24895 If a content is not available due to some reason (an error in many cases), the ‘Single Content’ field should be  
 24896 replaced by the “Content ID” in order to report which content requested has an error. (i.e., all the status codes  
 24897 except SUCCESS and PREFERENCE\_IGNORED).

24898 **12.2.4.4.2 Push Information Command**

24899 This is a command putting information especially from an information node (or an access point) to a mobile  
 24900 terminal on push basis. A content sent to mobile terminal (e.g., a list of contents, a content described in octets  
 24901 strings, character strings, a title of content or RSS feed) is carried by this command.

24902 **Figure 12-26. Payload Format of Push Information Command**

Octet:	Variable
Field:	Contents Data

<sup>232</sup> CCB 2477 status code cleanup

24903

24904 Format for Contents Data shall be as illustrated in 12.2.6.

24905 **12.2.4.4.3 Send Preference Response Command**

24906 This command is used by the server to notify whether the data carried by Send Preference Command gener-  
24907 ated by the client is accepted correctly or not.

24908 Payload format shall be as illustrated in Figure 12-27.

24909 Status Feedback carries a message as a response to the previous command ‘Send Preference’ command from  
24910 the client. Possible values are: SUCCESS, ZCL\_PREFERENCE\_DENIED, ZCL\_PREFERENCE\_IG-  
24911 NORED. If all the Preference Data are correctly processed, it is enough to respond with a unique Status  
24912 Feedback equals to SUCCESS.

24913 Also, if the server device does not support the Preference Type carried by the command, a unique Status  
24914 Feedback value will be set to ZCL\_PREFERENCE\_IGNORED (0x74).

24915 **Figure 12-27. Payload Format for Send Preference Response Command and Request Preference Confirmation**  
24916 **Command**

<b>Octet:</b>	<b>1</b>	<b>...</b>	<b>1</b>
<b>Field:</b>	Status Feedback 1	...	Status Feedback <i>n</i>

24917 **12.2.4.4.4 Server Request Preference Command**

24918 This command requests a Preference as user-side information in the MT on pull-basis.

24919 Upon receipt of this command at client cluster in the MT, the client is required to respond by Request Pref-  
24920 erence Response command.

24921 This command has no payload.

24922 **12.2.4.4.5 Request Preference Confirmation Command**

24923 This command is used by the server to notify whether the data carried by Request Preference Response  
24924 command generated by the client is accepted correctly or not.

24925 Payload format shall be as illustrated in Figure 12-27 above.

24926 Status Feedback carries a message as a response to the previous command ‘Request Preference Response’  
24927 command from the client. Possible values are: SUCCESS, ZCL\_PREFERENCE\_DENIED, ZCL\_PREFER-  
24928 ENCE\_IGNORED. If all the Preference Data are correctly processed, it is enough to respond with a unique  
24929 Status Feedback equals to SUCCESS.

24930 Also, if the server device does not support the Preference Type carried by the command, a unique Status  
24931 Feedback value will be set to ZCL\_PREFERENCE\_IGNORED (0x74).

24932 **12.2.4.4.6 Update Response Command**

24933 This command is used to notify any result of Update Command received by IN.

24934 Payload format for this command shall be as illustrated in Figure 12-28.

24935 Notification field has two sub-fields, content ID and Status Feedback. Content ID indicates what content the  
24936 notification has the status for. Status Feedback indicates the status of the reception of the content.



24937

**Figure 12-28. Payload Format of Update Response and Delete Response command**

<b>Octet:</b>	<b>2</b>	<b>1</b>	<b>...</b>	<b>2</b>	<b>1</b>
<b>Field:</b>	Notification 1		...	Notification <i>n</i>	
	Content ID 1	Status Feedback 1		Content ID <i>n</i>	Status Feed-back <i>n</i>

24938

24939 Status Feedback carries a message as a response to the previous command ‘Update’ command from the client.  
 24940 Possible messages are SUCCESS, FAILURE, MALFORMED\_COMMAND, UNSUP\_  
 24941 COMMAND, INVALID\_FIELD, INSUFFICIENT\_SPACE and FAILURE<sup>233</sup>. Besides, REQUEST\_DE-  
 24942 NIED is included into these messages for this cluster specification

24943 **12.2.4.4.7 Delete Response Command**

24944 This command is used to notify any result of Delete Command received by IN.

24945 Payload format for this command shall be as illustrated in Figure 12-28.

24946 Notification field has two sub-fields, content ID and Status Feedback. Content ID indicates what content the  
 24947 notification has the status for. Status Feedback indicates the status of the reception of the content.

24948 **12.2.5 Client**

24949 **12.2.5.1 Command Received**

24950 The client receives the cluster specific commands detailed in 12.2.4.4.

24951 **12.2.5.2 Command Generated**

24952 The client generates the cluster specific commands detailed in 12.2.4.3, as required by application.

24953 **12.2.6 Payload Formats for Contents Data**

24954 This section describes about payload format for contents data as used in the commands defied for the Infor-  
 24955 mation cluster.

24956 **12.2.6.1 Payload Format for Multiple Contents**

24957 Payload format for the contents shall be as illustrated in Figure 12-29.

<sup>233</sup> CCB 2477 status code cleanup

24958

**Figure 12-29. Payload Format for Multiple Contents**

<b>Octet</b>	1	Variable	...	Variable
<b>Data Type</b>	uint8	Format for Single Content (defined in this section)		Format for Single Content (defined in this section)
<b>Field Name</b>	Number	Single Content 1	...	Single Content <i>n</i>

24959

24960 Number field holds a number of single contents. The payload format for the single content is specified in  
24961 Figure 12-30.

24962

**Figure 12-30. Format for Single Content**

<b>Octet</b>	2	1	Variable	Variable	1	2/0	...	2/0
<b>Data Type</b>	uint16	map8	Long Character String (defined in this cluster section)	Payload Format for 'Content' (defined in this cluster section)	uint8	uint16	....	uint16
<b>Field Name</b>	Content ID	Data Type ID	Title String	Content String	Number of children	Content ID 1	...	Content ID <i>n</i>

24963

24964 Content ID corresponds to the content. There is no rule provided by this document. It is expected to be defined  
24965 by the service provider.

24966 Data Type indicates the supported data types of content (it could be title and/or long octet, long character  
24967 string or RSS). If a combination of type is supported by a Single Content, the order of data types shall be the  
24968 one described in Figure 12-30. If a bit field of 'Title' in Data Type ID is 0b1, 'Title String' field will be  
24969 inserted in the Single Content frame. If another bit than the 'Title' field is 0b1, 'content strings' field and  
24970 following fields appear.

24971 Title String appears in the Single Content frame only if a 'Title' bit in Data Type ID field is flagged. It  
24972 represents title string in 'character string' data type; 'long character string' data type already includes 2 bytes  
24973 count field.

24974 Content String holds actual content data described in data type. It is inserted in the frame only if another bit  
24975 than the 'Title' field is 0b1 in the Data Type ID field.

24976 Number of Children indicates how many links to child-contents this content has. If there is no child for this  
24977 content this field shall be set to 0.

24978 Content ID *n* holds List of child-contents ID.

24979 **12.2.6.2 Contents Data Types**

24980 **12.2.6.2.1 Title String**

24981

Figure 12-31. Format for Title String

<b>Octet: 2</b>	<b>Variable</b>
Count	Title

24982 **12.2.6.2.2 Long Octet String**

24983 Extended count field to two bytes. Count represents how many octets the Octet Data's length is.

24984

Figure 12-32. Format for Long Octet String

<b>Octet: 2</b>	<b>Variable</b>
Count	Octet Data

24985 **12.2.6.2.3 Long Character String**

24986 Extended count field to two bytes. Count represents how many characters the Character Data's length is. It  
24987 should not be in Bytes if the character set is not 8-bit code (e.g., 2-bytes code).

24988

Figure 12-33. Format for Long Character String

<b>Octet: 2</b>	<b>Variable</b>
Count	Character Data

24989 **12.2.6.2.4 RSS Feed**

24990 Length field represents length in bytes not in character count. What character set is used should be defined  
24991 in RSS feed data. In many cases, it would be ASCII compatible coding – like a UTF-8.

24992

Figure 12-34. Format for RSS Feed

<b>Octet: 2</b>	<b>Variable</b>
Length	RSS Feed Data

24993

## 12.2.6.3

24994

### 12.2.6.3 Chatting

24995

## 12.2.7 Introduction

24996

Please see Chapter 2 for a general cluster overview defining cluster architecture, revision, classification, identification, etc.

24997

24998

### 12.2.7.1 Scope and Purpose

24999

This section specifies the Chatting cluster, which provides commands and attributes for sending chat messages among ZigBee devices. This cluster is to provide a standardized interface for people using ZigBee devices to chat with each other like they using instant messaging applications through Internet. The transaction sequence numbers used in the ZCL command frames for the Chatting cluster should be the same for the requests and responses; the default responses should use also the same transaction sequence numbers of the related commands in order to match the correspondent packets.

25000

25001

25002

25003

25004

25005

There are two kinds of chatting scenarios:

25006

#### 37. Centralized Server

25007

In this kind of scenario a centralized server is used for managing and controlling the messaging between the different ZigBee nodes. Different chat sessions can be made available by the server. The node entering the ZigBee network may search for the available chat sessions and join one of them after choosing one out of different available sessions. Different nodes can join one chat session and can interact with each other.

25008

25009

25010

25011

25012

#### 38. Ad Hoc Chat Sessions

25013

In this kind of scenario no infrastructure is needed. Any ZigBee node can start and manage a chat session. A ZigBee node in a particular ZigBee network can start a chat session. A node should only be a chairman of one chat session, i.e., it should only start one chat session. It is recommended to do so, since in the ad hoc scenario, the chairman can be any devices which may have low computing power and capability, and maintaining more than one session may be difficult for the devices. To start a chat session it has to decide a unique identifier for the chat session. This identifier shall be unique among all the chat sessions in the networks. For this requirement the implementer shall make it mandatory for a node to select a chat identifier which will be unique in the whole ZigBee network. The identifier may be set the same as the address of the device that starts the session, so as to guarantee its uniqueness.

25014

25015

25016

25017

25018

25019

25020

25021

25022

This document should be used in conjunction with Chapter 2, Foundation, which gives an overview of the library and specifies the frame formats and general commands used therein.

25023

25024

This cluster provides attributes and commands for devices to send chatting messages to each other.

25025

**Figure 12-35. Typical Usage of the Chatting Cluster**

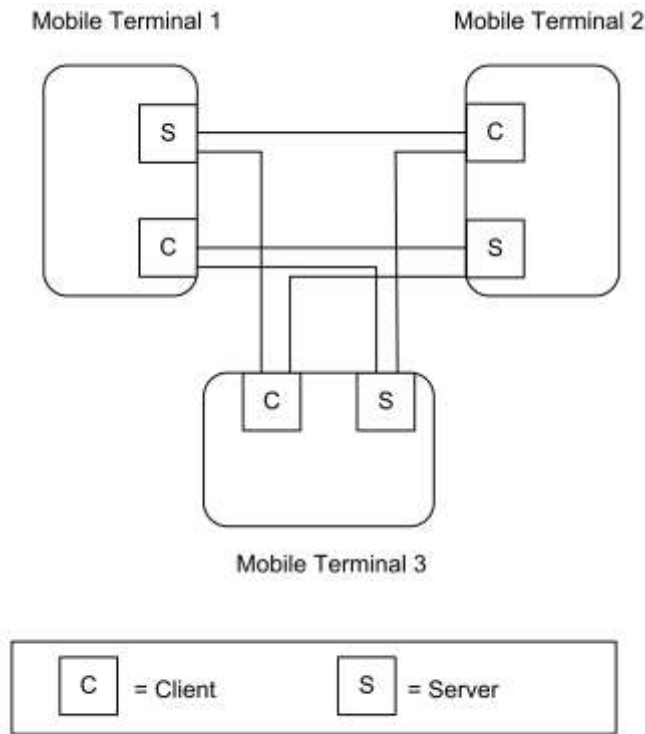

25026

*Note: Device names are examples for illustration purposes only*

25027 **12.2.7.2 Revision History**

25028 The global *ClusterRevision* attribute value SHALL be the highest revision number in the table below.

Rev	Description
1	mandatory global <i>ClusterRevision</i> attribute added

25029 **12.2.7.3 Classification**

Hierarchy	Role	PICS Code	Primary Transaction
Base	Application	CHAT	Type 1 (client to server)

25030 **12.2.7.4 Cluster Identifiers**

Identifier	Name
0x0905	Chatting

25031 **12.2.8 Server**

25032 The server manages the list of participants, the chat session ID, etc. It can respond to the devices which are  
 25033 going to join chat sessions, or it can ask someone to leave the chat session. The server has the functions which  
 25034 are more related to managing the session than sending chatting messages.

25035 The messages in the chat sessions are usually sent by the multicast method. So the server should also manage  
 25036 the chat group. There is an example which can be a guideline for implementing. Once the server forms a new  
 25037 chat session, it should form a new group. The group ID may be the same as the chat session ID. If a new user  
 25038 joins the chat session, it should also join the chat group. To fulfill this, the server should use the Add Group  
 25039 command specified in groups cluster to add the newcomer to the chat group. And if a user leaves the chat  
 25040 session, it should also leave the chat group. To fulfill this, the server should use the Remove Group command  
 25041 specified in groups cluster to remove the user from the chat group.

### 25042 12.2.8.1 Dependencies

25043 This cluster does not depend on any other existing clusters. However, in order to successfully fulfill the  
 25044 chatting, Information cluster, Groups cluster and Billing cluster may also need to be implemented in the same  
 25045 device where the chatting cluster is implemented.

### 25046 12.2.8.2 Attributes

25047 For convenience, the attributes defined in this specification are arranged into sets of related attributes; each  
 25048 set can contain up to 16 attributes. Attribute identifiers are encoded such that the most significant three nib-  
 25049 bles specify the attribute set and the least significant nibble specifies the attribute within the set. The currently  
 25050 defined attribute sets are listed in Table 12-12.

25051 **Table 12-12. Chatting Attributes Sets**

Attribute Set Identifier	Description
0x000	User Related
0x001	Chat Session Related

#### 25052 12.2.8.2.1 User Related Attribute Set

25053 The User Related Attribute Set contains the attributes summarized in Table 12-13.

25054 **Table 12-13. Attributes of the User Related Attribute Set**

Identifier	Name	Type	Range	Access	M/O
0x0000	<i>U_ID</i>	uint16	0x0000-0xffff	R	M
0x0001	<i>Nickname</i>	string		R	M

##### 25055 12.2.8.2.1.1 U\_ID Attribute

25056 The *U\_ID* attribute is the unique identification of the user in the chat room. It may be same as the address  
 25057 given to the device while joining in the ZigBee network, or may be same as the 2 least significant bytes of  
 25058 UserID of Billing cluster. The value 0xffff means this attribute is not set.

##### 25059 12.2.8.2.1.2 Nickname Attribute

25060 The *Nickname* attribute is a unique display name of the user identified by the *U\_ID* while talking in the public  
 25061 chat room. User sets the *Nickname* while joining the chat room.

#### 25062 12.2.8.2.2 Chat Session Related Attribute Set

25063 The Chat Session Related set contains the attributes summarized in Table 12-14.

25064

**Table 12-14. Attributes of Chat Session Related Attribute Set**

Identifier	Name	Type	Range	Access	M/O
0x0010	<i>C_ID</i>	uint16	0x0000-0xffff	R	M
0x0011	<i>Name</i>	string		R	M
0x0012	<i>EnableAddChat</i>	bool	TRUE/FALSE	R	O

25065 **12.2.8.2.2.1 C\_ID Attribute**

25066 The *C\_ID* attribute is the unique identification of a chat room. It is assigned by the chat server while creating  
 25067 a new chat room following the user command or chosen by the chairman. It may be same as the chat group  
 25068 ID. If the server maintains several chat rooms, this attribute should be set as the ID of the latest formed chat  
 25069 room. The value 0xffff means this attribute is not set.

25070 **12.2.8.2.2.2 Name Attribute**

25071 The *Name* attribute is the name or topic of the chat room which is identified by the *C\_ID* attribute.

25072 **12.2.8.2.2.3 EnableAddChat Attribute**

25073 The *EnableAddChat* attribute indicates whether the server permits other users to add new chat rooms in it.  
 25074 TRUE (0x01) indicates the server permit other users to add new chat rooms, while FALSE (0x00) indicates  
 25075 not permit to do so.

25076 **12.2.8.3 Commands Received**

25077 The received commands IDs for the chatting cluster are listed in Table 12-15.

25078 **Table 12-15. Command IDs for the Chatting Cluster**

Command Identifier Field Value	Description	M/O
0x00	Join Chat Request	M
0x01	Leave Chat Request	M
0x02	Search Chat Request	M
0x03	Switch Chairman Response	O
0x04	Start Chat Request	O
0x05	ChatMessage	M
0x06	Get Node Information Request	O

25079 **12.2.8.3.1 Join Chat Request Command**

25080 The Join Chat Request command is used for a node to request to join one chatting session.

25081 The Join Chat request command shall be formatted as illustrated in Figure 12-36.

25082

**Figure 12-36. Format of the Join Chat Request Command**

<b>Octets</b>	2	Variable	2
<b>Data Type</b>	uint16	string	uint16
<b>Field Name</b>	U_ID	Nickname	C_ID

25083 The U\_ID field indicates unique identification of the user in the chat room.

25084 The Nickname field is type of character string which is a unique display name of the user while talking in  
25085 the public chat room.

25086 The C\_ID field is unique identification of a chat room. It indicates the ID of the chat room which the client  
25087 wants to join.

25088 This command should be unicast to the server which manages the chat room indicated by the C\_ID.

### 25089 **12.2.8.3.2 Leave Chat Request Command**

25090 The Leave Chat Request command is used for a node to request to leave one chatting session. The client may  
25091 require the Default Response command to be sent from the server so that to confirm the leave command has  
25092 been successfully received.

25093 The Leave Chat request command shall be formatted as illustrated in Figure 12-37.

25094 **Figure 12-37. Format of the Leave Chat Request Command**

<b>Octets</b>	2	2
<b>Data Type</b>	uint16	uint16
<b>Field Name</b>	C_ID	U_ID

25095

25096 The C\_ID field indicates the ID of the chat room which the node wants to leave. The U\_ID field indicates  
25097 unique identification of the user in the chat room.

25098 This command should be unicast to the server which manages the chat room the user to leave.

### 25099 **12.2.8.3.3 Search Chat Request Command**

25100 The Search Chat Request command is used for a node to request to search for the available chat session on  
25101 the server.

25102 The Search Chat Request command shall contain no payload and shall be originated by the devices which  
25103 want to have a chat with others and sent to the server. It may be broadcast in the network.

### 25104 **12.2.8.3.4 Switch Chairman Response Command**

25105 The Switch Chairman Response command is used for nodes to response to the Switch Chairman Request  
25106 command.

25107 The Switch Chairman Response command shall be formatted as illustrated in Figure 12-38.



25108

**Figure 12-38. Format of the Switch Chairman Response Command**

<b>Octets</b>	2	2
<b>Data Type</b>	uint16	uint16
<b>Field Name</b>	C_ID	U_ID

25109

25110 The C\_ID field in the command indicates the ID of the chat room of which the receiving node is the old  
 25111 chairman. The U\_ID field in the command is the unique ID of node which wants to be the chairman of the  
 25112 chat room.

25113 This command shall be unicast to the chairman, announcing that the node indicated by the U\_ID volunteers  
 25114 to be the new chairman.

25115 **12.2.8.3.5 Start Chat Request Command**

25116 The Start Chat Request command is used for a device to request to create one chat session. The new chat  
 25117 session to be created shall be managed by the responder. That is, once the chat session is created, the re-  
 25118 sponder but not the requester will be the chairman of the chat room.

25119 The Start Chat request command shall be formatted as illustrated in Figure 12-39.

25120

**Figure 12-39. Format of the Start Chat Request Command**

<b>Octets</b>	Variable	2	Variable
<b>Data Type</b>	string	uint16	string
<b>Field Name</b>	Name	U_ID	Nickname

25121 The Name field indicates the topic of the chat room. The U\_ID field indicates unique identification of the  
 25122 user in the chat room. The Nickname field indicates the Nickname set by the requester.

25123 The command is originated by the devices which want to create one chat room and attract others who have  
 25124 the same interest in the topic. It should be unicast to the server which manages the chat rooms.

25125 **12.2.8.3.6 ChatMessage Command**

25126 The *ChatMessage* command is used for chatting, i.e., one node to send a message to other nodes. In the case  
 25127 of peer chatting, such as to exchange some private messages, it may be unicast to the chairman first, the  
 25128 chairman may forward this command with unicast method to the destination user. The *ChatMessage* com-  
 25129 mand may be sent directly to the destination node in peer chatting case if the destination network address and  
 25130 endpoint are known by the sender. *Get Node Information Request* and *Response* commands shall be used to  
 25131 acquire the necessary network address and endpoint information. In the case of normal chatting (a message  
 25132 to be sent to the whole room), all nodes in the same chat room are expected to receive the message. The  
 25133 *ChatMessage* command should be multicast to other nodes in the chat room.

25134 In peer chatting case, if the command contains illegal parameter such as non-existing U\_ID field, the chair-  
 25135 man should return a Default Response command with INVALID\_FIELD status.

25136 The *ChatMessage* command shall be formatted as illustrated in Figure 12-40.

25137

**Figure 12-40. Format of the ChatMessage Command**

<b>Octets</b>	2	2	2	Variable	Variable
<b>Data Type</b>	uint16	uint16	uint16	string	string
<b>Field Name</b>	Destination U_ID	Source U_ID	C_ID	Nickname	Message

25138

25139 The Destination U\_ID field indicates the destination node’s U\_ID. The Source U\_ID field indicates the  
25140 source node’s U\_ID. The C\_ID indicates the ID of the chat room which the sender belongs to. The Nickname  
25141 field indicates the sender’s Nickname, which shall be in Character string data type.

25142 In the case of peer chatting, the Destination U\_ID field and the Source U\_ID field shall be set to the specific  
25143 nodes’ U\_ID. In the case of normal chatting (sending a message to all the users in the chat room), Destination  
25144 U\_ID shall be set to 0xffff while Source U\_ID shall be set to the specific source node’s U\_ID.

### 25145 **12.2.8.3.7 Get Node Information Request Command**

25146 The Get Node Information Request command is used for peer chatting to get the network address and end-  
25147 point number of the peer node, so as to use ChatMessage command to send private message to the node.  
25148 When one wants to send private message to another node in the same chatting session, it shall check whether  
25149 it has that node’s network address and endpoint number. If not, it shall send this command to the server.

25150 The Get Node Information Request command shall be formatted as illustrated inFigure 12-41.

25151 **Figure 12-41. Format of the Get Node Information Request Command**

<b>Octets</b>	2	2
<b>Data Type</b>	uint16	uint16
<b>Field Name</b>	C_ID	U_ID

25152

25153 The C\_ID field indicates the ID of the chat room which the investigated node belongs to. The U\_ID field  
25154 indicates the U\_ID of the node to be investigated.

25155 This command should be unicast to the chairman node. A chatting table should be maintained by the chair-  
25156 man. It may be also maintained by other nodes. When a chairman has assigned a U\_ID to a node it shall add  
25157 related information into the chatting table, and when a node leaves the chatting session it shall remove the  
25158 record of the leaving device from the table. A node may get the address of another node from the chairman  
25159 by using the Get Node Information Request command. Once it gets the information, the node may store it  
25160 for future usage. The detail format of the chatting table is implementer dependent. An example of each item  
25161 of the table may be illustrated as Figure 12-42. The node number field indicates the number of NodeInfor-  
25162 mation field. The NodeInformation field is as specified in Figure 12-50.

25163 **Figure 12-42. Format of an Item of the Chatting Table**

C_ID	Node number	NodeInformation 1	...	NodeInformation <i>n</i>
------	-------------	-------------------	-----	--------------------------

25164 **12.2.8.4 Commands Generated**

25165 The generated commands IDs for the Chatting cluster are listed in Table 12-16.

25166 **Table 12-16. Generated Command IDs for the Chatting Cluster**

Command Identifier Field Value	Description	M/O
0x00	Start Chat Response	O
0x01	Join Chat Response	M
0x02	User Left	M
0x03	User Joined	M
0x04	Search Chat Response	M
0x05	Switch Chairman Request	O
0x06	Switch Chairman Confirm	O
0x07	Switch Chairman Notification	O
0x08	Get Node Information Response	O

25167 **12.2.8.4.1 Start Chat Response Command**

25168 The Start Chat Response command is used for server to response to the Start Chat request command. If  
 25169 successful, the server shall then form a new chat room and make itself the chairman.

25170 The Start Chat Response command shall be formatted as illustrated in Figure 12-43.

25171 **Figure 12-43. Format of the Start Chat Response Command**

<b>Octets</b>	1	0/2
<b>Data Type</b>	enum8	uint16
<b>Field Name</b>	Status	C_ID

25172

25173 The Status field indicates the status of the previous request. . If it is SUCCESS, the C\_ID field shall exist, or  
 25174 else the C\_ID field shall not exist. The C\_ID field indicates the unique identification of the chat room and it  
 25175 is assigned by the server. If the server doesn't permit to add a new chat room, i.e., the attribute EnableAdd-  
 25176 Chat being set to FALSE, the server shall return this command with FAILURE Status.

25177 This command shall be unicast to the requester.

25178 **12.2.8.4.2 Join Chat Response Command**

25179 The Join Chat Response is used for server to response the Join Chat Request command.

25180 The Join Chat Response shall be formatted as illustrated in Figure 12-44.

25181

**Figure 12-44. Format of the Join Chat Response Command**

<b>Octets</b>	1	2	0/2	Variable	Variable	0/2	Variable
<b>Data Type</b>	enum8	uint16	uint16	string	-	uint16	string
<b>Field Name</b>	Status	C_ID	U_ID 1	Nickname 1	...	U_ID <i>n</i>	Nickname <i>n</i>

25182

25183 The Status field indicates the status of the previous request.. If it is SUCCESS, the list of the U\_ID and  
 25184 Nickname fields shall exist, or else the list shall not exist. The C\_ID field indicates the ID of the chat room  
 25185 which the server manages. It shall be the same as the C\_ID field in the corresponding Join Chat Request  
 25186 command. The list of the U\_ID and Nickname fields indicate other participants in the chat room. Each U\_ID  
 25187 field and the Nickname field respectively indicate the unique ID and the nickname of each user in the chat  
 25188 room.

25189 This command shall be unicast to the requester. After receiving this command, the node should check whether  
 25190 it has received the Add Group command from the chairman. If not, it should wait for that command so as to  
 25191 know which group it belongs to. How long it should wait for the command is specific to the implementation.

### 25192 **12.2.8.4.3 User Left Command**

25193 The User Left command is used for server to inform other participants that someone has left the chat room.

25194 The User Left shall be formatted as illustrated in Figure 12-45.

25195

**Figure 12-45. Format of the User Left Command**

<b>Octets</b>	2	2	Variable
<b>Data Type</b>	uint16	uint16	string
<b>Field Name</b>	C_ID	U_ID	Nickname

25196

25197 The C\_ID indicates the ID of the chat room which the user left. The U\_ID field indicates the left participant's  
 25198 unique ID in the chat room. The Nickname field is the nickname of the left participant.

25199 The command shall be multicast to all users in the same chat room.

### 25200 **12.2.8.4.4 User Joined Command**

25201 The User Joined command is used for server to inform other participants that someone has just joined the  
 25202 chat room.

25203 The User Joined command shall be formatted as illustrated in Figure 12-46.

25204

**Figure 12-46. Format of the User Joined Command**

<b>Octets</b>	2	2	Variable
<b>Data Type</b>	uint16	uint16	string
<b>Field Name</b>	C_ID	U_ID	Nickname

25205

25206 The C\_ID indicates the ID of the chat room which the newcomer joined. The U\_ID field indicates the new-  
 25207 comer’s unique ID in the chat room. The Nickname field is the nickname of the newcomer.

25208 This command should be multicast to all users in the same chat room. When the newcomer receives the  
 25209 command, it shall compare the U\_ID field in the command with U\_ID of itself, if same, it shall ignore the  
 25210 command.

25211 **12.2.8.4.5 Search Chat Response Command**

25212 The Search Chat Response command is used for server to respond to the Search Chat Request command.

25213 The Search Chat Response command shall be formatted as illustrated in Figure 12-47.

25214

**Figure 12-47. Format of the Search Chat Response command**

<b>Octets</b>	1	0/2	Variable	Variable	0/2	Variable
<b>Data Type</b>	map8	uint16	string	...	uint16	string
<b>Field Name</b>	Options	C_ID 1	Name 1	...	C_ID <i>n</i>	Name <i>n</i>

25215

25216 The Options field indicates the options of this command. Bit 0 of the Options field indicates whether the  
 25217 server permits other users to add new chat rooms in it. The value 0b0 means permit while 0b1 means not  
 25218 permit. Other bits of this field are reserved. The list of the C\_ID and Name fields indicates the information  
 25219 of the available chat rooms. Each C\_ID field and Name field indicate respectively the chat room identification  
 25220 and topic of each available chat room. It’s recommended at least one chat room should be maintained by the  
 25221 server. If no chat room is maintained, the list of C\_ID and Name fields shall not exist.

25222 This command should be unicast to the requester. Only the chairman can send out this command, and the list  
 25223 of chat room information shall only contain the information of the chat rooms which it manages. The server  
 25224 may also broadcast this command to notify other users which chat rooms it manages. After receiving this  
 25225 command, the network address and endpoint number should be extracted from the network layer header and  
 25226 APS header, so as to acquiring the chairman’s network address and endpoint number.

25227 **12.2.8.4.6 Switch Chairman Request Command**

25228 In the case of Ad-Hoc chat, when a chairman wants to leave the chat session, he can use this command to  
 25229 appoint a new chairman out of the participating Devices which can continue to manage the chat room.

25230 The Switch Chairman Request command shall be multicast to every device which is in the same chat room.  
 25231 It shall be formatted as illustrated in Figure 12-48.

25232 **Figure 12-48. Format of the Switch Chairman Request Command**

<b>Octets</b>	2
<b>Data Type</b>	uint16
<b>Field Name</b>	C_ID

25233 The C\_ID field indicates the ID of the chat room where the chairman is requested to be changed.

25234 **12.2.8.4.7 Switch Chairman Confirm Command**

25235 The Switch Chairman Confirm command is used by the old chairman to inform the node which the chairman  
25236 has selected to be the new chairman.

25237 The Switch Chairman Confirm command shall be formatted as illustrated in Figure 12-49.

25238 **Figure 12-49. Format of the Switch Chairman Confirm Command**

<b>Octets</b>	2	Variable	Variable	Variable
<b>Data Type</b>	uint16	-	...	-
<b>Field Name</b>	C_ID	NodeInformation 1	...	NodeInformation <i>n</i>

25239  
25240 The C\_ID field indicates the ID of the chat room which the chairman manages. The NodeInformation field  
25241 is formatted as illustrated in Figure 12-50. Each *NodeInformation* field contains information about a node  
25242 participating in the chat session. This field shall contain the following sub-fields, the U\_ID sub-field, *Address*  
25243 sub-field, *Endpoint* sub-field and the *Nickname* sub-field. The U\_ID sub-field, *Address* sub-field, *Endpoint*  
25244 sub-field and *Nickname* sub-field indicate the node’s unique ID, network address, endpoint number and nick-  
25245 name respectively. This command shall be unicast to the new chairman.

25246 **Figure 12-50. Format of the NodeInformation Field**

<b>Octets</b>	2	2	1	Variable
<b>Data Type</b>	uint16	data16	uint8	string
<b>Sub-field Name</b>	U_ID	Address	Endpoint	Nickname

25247 **12.2.8.4.8 Switch Chairman Notification Command**

25248 The Switch Chairman Notification command is used by the old chairman to inform other participants in the  
25249 chat room about the change in the chairman. The Switch Chairman Confirm command shall be formatted as  
25250 illustrated in Figure 12-51.

25251

**Figure 12-51. Format of the Switch Chairman Notification Command**

<b>Octets</b>	2	2	2	1
<b>Data Type</b>	uint16	uint16	data16	uint8
<b>Field Name</b>	C_ID	U_ID	Address	Endpoint

25252

25253 The C\_ID field is the ID of the chat room which the chairman manages. The U\_ID field is the unique ID of  
 25254 the node which is the new chairman of the chat room. The *Address* field and the *Endpoint* field are the  
 25255 network address and the endpoint number of the new chairman respectively. The command should be mul-  
 25256 ticast to other nodes in the same chat room.

25257

### 12.2.8.4.9 Get Node Information Response Command

25258 The Get Node Information Response command is used by the server to give a response to the Get Node  
 25259 Information Request command, so that the requesting node can obtain the desired information including  
 25260 network address and endpoint number of a specific node. If successful, the server shall provide the node  
 25261 information in the response command.

25262 The Get Node Information Response command shall be formatted as illustrated in Figure 12-52.

25263

**Figure 12-52. Format of the Get Node Information Response Command**

<b>Octets</b>	1	2	2	0/2	0/1	Variable
<b>Data Type</b>	enum8	uint16	uint16	data16	uint8	string
<b>Field Name</b>	Status	C_ID	U_ID	Address	Endpoint	Nickname

25264

25265 The *Status* indicates the status of the previous request. If it is SUCCESS, the *Address* field, the *Endpoint* field  
 25266 and the *Nickname* field shall exist, or else those fields shall not exist. The C\_ID field and the U\_ID field shall  
 25267 be the same as the corresponding *Get Node Information Request* command. The C\_ID field is the ID of the  
 25268 chat room which the investigated node belongs to. The U\_ID field is the unique ID of the investigated node.  
 25269 The *Address* field, the *Endpoint* field and the *Nickname* field indicate the network address, the endpoint  
 25270 number and the nickname of the investigated node respectively. The command shall be unicast to requester.  
 25271 After receiving this command, the node may store the information of the investigated node for future usage.

25272

## 12.2.9 Client

25273

### 12.2.9.1 Commands Received

25274 The client receives the cluster specific commands detailed in 12.2.8.4 as required by application profiles.

25275

### 12.2.9.2 Commands Generated

25276 The client generates the cluster specific commands detailed in 12.2.8.3 as required by application profiles.

25277 **12.3 Voice Over ZigBee**

25278 **12.3.1 Scope and Purpose**

25279 This section specifies a single cluster, the VoZ cluster, which provides commands and attributes for voice  
25280 receiving and transmitting among ZigBee devices. This cluster is to provide a standardized interface for the  
25281 devices to receive/transmit voice data packets.

25282 This section should be used in conjunction with Chapter 2, Foundation, which gives an overview of the  
25283 library and specifies the frame formats and general commands used therein.

25284 The cluster specified in this document is typically used for telecom applications but may be used in any  
25285 other application domains. This cluster may use Partition cluster.

25286 **Figure 12-53. Typical Usage of the VoZ Cluster**

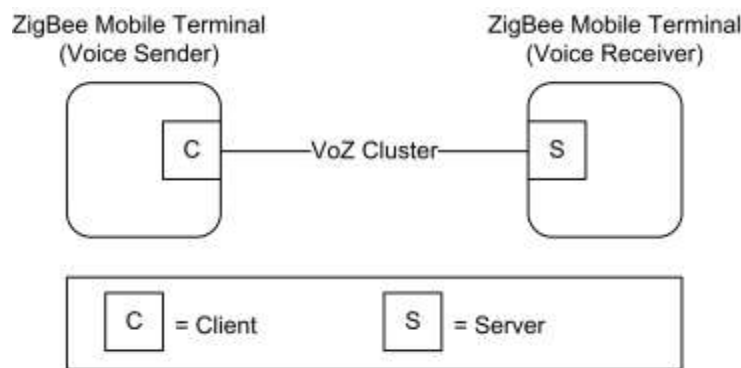

*Note: Device names are examples for illustration purposes only*

25287

25288 **12.3.2 Overview**

25289 Please see Chapter 2 for a general cluster overview defining cluster architecture, revision, classification,  
25290 identification, etc.

25291 This cluster provides attributes and commands for devices to receive/transmit their voice data. One of the  
25292 devices plays a role of a receiver and the other does that of a sender. For example, a receiver receives voice  
25293 data from the other MT (voice sender).

25294 An important thing to notice for this VoZ cluster is that there are two different types of service for this cluster.  
25295 One of them is voice transmission between humans (human-to-human). The other type of the service is voice  
25296 transmission from human to device (human-to-device voice data transmission, i.e., voice command) in order  
25297 to send a voice ‘command’ to a device. Therefore, the meaning of ‘voice’ delivery includes not only human  
25298 voice delivery (human-to-human), but also voice delivery for device control (human-to-device, i.e., voice  
25299 command). These two types of service will be referenced whenever necessary.

25300 **12.3.2.1 Revision History**

25301 The global *ClusterRevision* attribute value SHALL be the highest revision number in the table below.

Rev	Description
1	mandatory global <i>ClusterRevision</i> attribute added



25302 **12.3.2.2 Classification**

Hierarchy	Role	PICS Code	Primary Transaction
Base	Application	VOZ	Type 1 (client to server)

25303 **12.3.2.3 Cluster Identifiers**

Identifier	Name
0x0904	Voice Over ZigBee

25304 **12.3.3 Server**

25305 The server stores the data to be shared. It may response to the request from other devices and transmit the  
 25306 data to them, or it may actively request other devices to transmit the data to them.

25307 **12.3.3.1 Dependencies**

25308 None

25309 **12.3.3.2 Attributes**

25310 For convenience, the attributes defined in this specification are arranged into sets of related attributes; each  
 25311 set can contain up to 16 attributes. Attribute identifiers are encoded such that the most significant three nib-  
 25312 bles specify the attribute set and the least significant nibble specifies the attribute within the set. The currently  
 25313 defined attribute sets are listed in Table 12-17.

25314

**Table 12-17. VoZ Attribute Sets**

Attribute Set Identifier	Description
0x000	Voice Information
0x001 – 0xffff	Reserved

25315 **12.3.3.2.1 Establishment Information Attribute Set**

25316 The Establishment Information attribute set contains the attributes summarized in Table 12-18.

25317

**Table 12-18. Attributes of the Voice Information Attribute Set**

Id	Name	Type	Range	Access	M/O
0x0000	<i>CodecType</i>	enum8	G.711(PCM) =0x01 G.726(ADPCM)=0x02 CELP =0x03 AMR =0x04	RW	M
0x0001	<i>SamplingFre- quency</i>	enum8	SF_8K =0x01 SF_7K =0x02 SF_3_5K =0x03	RW	M

Id	Name	Type	Range	Access	M/O
0x0002	<i>Codecrate</i>	enum8	CR_64K =0x01 CR_40K =0x02 CR_32K =0x03 CR_24K =0x04 CR_16K =0x05 CR_8K =0x06 CR_6_3K =0x07 CR_5_3K =0x08 CR_AMR-NB =0x09 CR_AMR-WB=0x0a	RW	M
0x0003	<i>Establishment Timeout</i>	uint8	0x01-0xff	-	M
0x0004	<i>CodecTypeSub1</i>	enum8	-	RW	O
0x0005	<i>CodecTypeSub2</i>	enum8	-	RW	O
0x0006	<i>CodecTypeSub3</i>	enum8	-	RW	O
0x0007	<i>CompressionType</i>	enum8	ALaw =0x01 uLaw =0x02	-	O
0x0008	<i>CompressionRate</i>	enum8	-	-	O
0x0009	<i>OptionFlags</i>	map8	0x00-0xff	RW	O
0x000a	<i>Threshold</i>	uint8	0x00-0xff	RW	O

25318 **12.3.3.2.1.1 CodecType Attribute**

25319 The *CodecType* attribute specifies the enumeration of the codec type. G.711 Codec is PCM (pulse code modulation) method by the ITU-T. G.726 Codec is ADPCM (adaptive differential PCM) method which has involved G.721 and G.723 ITU-T codec. CELP (code excited linear prediction) is voice codec of CDMA-based digital mobile communication system. AMR (adaptive multirate codec) is used to 3GP European mobile equipment.

25324 **12.3.3.2.1.2 SamplingFrequency Attribute**

25325 The *SamplingFrequency* attribute specifies the enumeration of the sampling frequency (Hz).  
25326 PCM, ADPCM, CELP: 8KHz, AMR: 3.5KHz, 7KHz

25327 **12.3.3.2.1.3 CodecRate Attribute**

25328 The *CodecRate* attribute specifies the enumeration of the codec rate (Kbps).  
25329 Various codec rates available.  
25330 PCM: 64Kbps, ADPCM: 40/32/24/16Kbps, CELP: 5.3/8Kbps, AMR: 5 ~ 12Kbps

25331 **12.3.3.2.1.4 EstablishmentTimeout Attribute**

25332 The *EstablishmentTimeout* attribute sets timeout value to 1/10 sec in order to disconnect an establishment between devices when there is no response after the establishment.

25334 **12.3.3.2.1.5 CodecTypeSub1, CodecTypeSub2, CodecTypeSub3 Attribute**  
25335

25336 *CodecTypeSub1*, *CodecTypeSub2*, and *CodecTypeSub3* attributes are used for additionally supportable Co-  
 25337 decs other than the system default one. It has the same range value as that of *CodecType* attribute.

25338 **12.3.3.2.1.6 CompressionType Attribute**

25339 The *CompressionType* attribute specifies the enumeration of the compression type

25340 ALaw: the compression technology for transmission data to minimize the quantification error in PCM, (Eu-  
 25341 rope)

25342 uLaw: the compression technology for transmission data to minimize the quantification error in PCM, (US,  
 25343 Japan)

25344 **12.3.3.2.1.7 CompressionRate Attribute**

25345 The *CodecRate* attribute specifies the enumeration of compression rate.

25346 Compression rate is defined based on compression type.

25347 **12.3.3.2.1.8 OptionFlags Attribute**

25348 The *OptionFlags* attribute indicates the optional function. It shall be formatted as illustrated in Figure 12-54.

25349 **Figure 12-54. Format of the OptionFlags Attribute**

<b>Bits: b0</b>	<b>b1</b>	<b>b2</b>	<b>b3-b7</b>
Occupancy	PLC	VAD	Reserved

25350 The Occupancy field specifies whether the occupancy sensor is active or not. If the Occupancy field is set to  
 25351 one, it indicates the occupancy sensor is active. If the Occupancy field is set to zero, it indicates the occupancy  
 25352 sensor is inactive.

25353 PLC (Packet Loss Concealment): enabled in logic level high in order to correct voice data when there is loss  
 25354 for the data

25355 VAD (Voice Activity Detection): enabled in logic level high in order to distinguish mute voice data from  
 25356 non-mute voice data

25357 **12.3.3.2.1.9 Threshold Attribute**

25358 The *Threshold* attribute specifies the value for voice loudness in voice transmission.

25359 **12.3.3.3 Commands Received**

25360 The received command IDs for the VoZ cluster are listed in Table 12-19.

25361 Before proceeding, please refer to the section 12.3.2 of overview, and especially, to the service type that there  
 25362 are two types of service in this cluster. The commands in this section are developed and used not only for  
 25363 human-to-human voice delivery, but also for human-to-device voice delivery in order to send a voice com-  
 25364 mand to control the device.

25365 **Table 12-19. Command IDs for the VoZ Cluster**

<b>Command Identifier Field Value</b>	<b>Description</b>	<b>M/O</b>
0x00	Establishment Request	M
0x01	Voice Transmission	M

Command Identifier Field Value	Description	M/O
0x02	Voice Transmission Completion	O
0x03	Control Response	O

25366 **12.3.3.3.1 Establishment Request Command**

25367 The Establishment Request command is used for a device to request for a connection of the voice information  
25368 from another device. It shall be originated by the voice transmission source device and sent to the transmis-  
25369 sion destination device.

25370 The establishment request command shall be formatted as illustrated in Figure 12-55.

25371 For Codec Type, Sampling Frequency, Codec Rate and etc., please refer to Table 12-18. For Service Type,  
25372 please refer to section 12.3.2; the Service Type equal to 0x00 indicates human-human service and 0x01 in-  
25373 dicates human-device service. Most commands in this section are developed and used for human-to-device  
25374 communication.

25375 **Figure 12-55. Format of the Establishment Request Command**

Octets	Data Type	Field Name
1	map8	Flag
1	enum8	Codec Type
1	enum8	Samp. Freq.
1	enum8	Codec Rate
1	enum8	Service Type
1/0	enum8	Codec TypeS1
1/0	enum8	Codec TypeS2
1/0	enum8	Codec TypeS3
1/0	enum8	Comp. Type
1/0	enum8	Comp. Rate

25376  
25377 The Flag field value of Figure 12-55 is set according to the bit values of Figure 12-56 when a VoZ device  
25378 has an optional attribute value such as CodecTypeSub1.

25379 **Figure 12-56. Format of the Flag**

Bits: b0	b1	b2	b3	b4-b7
CodecTypeSub1	CodecTypeSub2	CodecTypeSub3	Compression	Reserved

25380 **12.3.3.3.2 Voice Transmission Command**

25381 The Voice Transmission command is used for a device to transmit the voice data to other devices. It shall be  
25382 originated by the voice transmission source device and sent to the voice transmission destination device. If  
25383 required, Partition Cluster should be used for this command.

25384 In case of transmitting multiple voice data, the Sequence Number in the ZCL Header should be sequentially  
25385 increased in order to detect the loss of data and reassemble them.

25386

**Figure 12-57. Format of the Voice Transmission Command**

<b>Octets</b>	Variable
<b>Data Type</b>	-
<b>Field Name</b>	Voice Data

25387

### 12.3.3.3.3 Voice Transmission Completion

25388

The Voice Transmission Completion command is sent to the destination device when needed, after the source device transmits all voice data which should be transmitted.

25389

25390

The voice transmission command completion shall be formatted as illustrated in Figure 12-58.

25391

**Figure 12-58. Format of the Voice Transmission Completion Command**

<b>Octets</b>	Variable
<b>Data Type</b>	-
<b>Field Name</b>	ZCL Header

25392

### 12.3.3.3.4 Control Response Command

25393

The Control Response command is used to respond with the success or failure of the control, when a device receives the Control command.

25394

25395

The voice control response command shall be formatted as illustrated in Figure 12-59.

25396

**Figure 12-59. Format of the Control Response Command**

<b>Octets</b>	1
<b>Data Type</b>	enum8
<b>Field Name</b>	ACK=0x01 NAK=0x00

25397

### 12.3.3.4 Commands Generated

25398

The generated command IDs for the VoZ cluster are listed in Table 12-20.

25399

Before proceeding, please refer to the section 12.3.2 of overview, and especially, to the service type that there are two types of service in this cluster. The commands in this section are developed and used not only for human-to-human voice delivery, but also for human-to-device voice delivery in order to send a voice command to control the device.

25400

25401

25402

25403

**Table 12-20. Generated Command IDs for the VoZ Cluster**

Command Identifier Field Value	Description	M/O
0x00	Establishment Response	M
0x01	Voice Transmission Response	M
0x02	Control	O

25404 **12.3.3.4.1 Voice Transmission Response Command**

25405 The Voice Transmission Response command is to notify the sender of NACK. It shall be originated by the  
25406 voice transmission destination device and sent to the voice transmission source device.

25407 The voice transmission response command shall be formatted as illustrated in Figure 12-60.

25408 **Figure 12-60. Format of the Voice Transmission Response Command**

<b>Octets</b>	1	1
<b>Data Type</b>	uint8	enum8
<b>Field Name</b>	Sequence Number of ZCL Header	Error Flag

25409

25410 If there is an error in processing the received voice data, the receiving device should respond with the Voice  
25411 Transmission Response command with the sequence number of ZCL Header and the Error Flag set to an  
25412 error reason according to Table 12-21.

25413

**Table 12-21. The Error Flag of Voice Transmission Response**

Error Flag Identifier Field Value	Description
0x00	Failure to decode voice data
0x01	Wrong order of voice data

25414 **12.3.3.4.2 Establishment Response Command**

25415 The Establishment Response command is to notify the device which previously requests for connecting the  
 25416 voice information. It shall be originated by the voice transmission destination device and sent to the voice  
 25417 transmission source device.

25418 The Establishment Response command shall be formatted as illustrated in Figure 12-61.

25419 **Figure 12-61. Format of the Establishment Response Command**

<b>Octets</b>	1	1/0
<b>Data Type</b>	enum8	enum8
<b>Field Name</b>	ACK=0x01 NAK=0x00	CodecType

25420

25421 When a receiving device receives the Establishment Request command with *CodecType* which is not sup-  
 25422 ported, it responds with the Establishment Response command with NAK and *CodecType* supported by the  
 25423 device.

25424 If the requested *CodecType* exists among *CodecTypeSub1*, *CodecTypeSub2*, and *CodecTypeSub3*, the *Co-*  
 25425 *decType* field is set to the value.

25426 If the device receives the Establishment Response command with NAK and *CodecType*, it first checks  
 25427 whether it supports the *CodecType* in the received command. If it supports, the device transmits the Estab-  
 25428 lishment Request command with its *CodecType* again.

25429 **12.3.3.4.3 Control Command**

25430 The Control command is to control the voice transmission source device. It shall be originated by the voice  
 25431 transmission destination device and sent to the voice transmission source device.

25432 For example, this command is used for such as walkie-talkie communication or radio listening.

25433 The voice control command shall be formatted as illustrated in Figure 12-62.

25434

**Figure 12-62. Format of the Control Command**

<b>Octets</b>	1
<b>Data Type</b>	enum8
<b>Field Name</b>	Control Type

25435

25436 The Control Type field indicates the control options, including the play operation (0x01), the stop operation  
25437 (0x02), and the disconnection operation (0x03). The play operation is to request for starting voice data trans-  
25438 mission. The stop operation is to request for stopping voice data transmission. The disconnection operation  
25439 is to terminate the connection between the voice transmission source/destination devices.

## 25440 **12.3.4 Client**

### 25441 **12.3.4.1 Command Received**

25442 The client receives the cluster specific commands detailed in 12.3.3.4 as required by application profiles

### 25443 **12.3.4.2 Command Generated**

25444 The client generates the cluster specific commands detailed in 12.3.3.3 as required by application profiles.



25445

## CHAPTER 13 COMMISSIONING

25446  
25447  
25448  
25449

The Cluster Library is made of individual chapters such as this one. See Document Control in the Cluster Library for a list of all chapters and documents. References between chapters are made using a *X.Y* notation where *X* is the chapter and *Y* is the sub-section within that chapter. References to external documents are contained in Chapter 1 and are made using [*Rn*] notation.

25450

### 13.1 General Description

25451

#### 13.1.1 13.1.1 Introduction

25452

This chapter contains commissioning methods for devices that can be used in any application domain.

25453

#### 13.1.2 13.1.2 Cluster List

25454  
25455

This section lists the clusters specified in this document. The clusters defined in this document are listed in Table 13-1.

25456

Table 13-1. Clusters for Commissioning

ID	Cluster Name	Description
0x0015	Commissioning	The commands and attributes for commissioning a device onto the network
0x1000	Touchlink	The commands and attributes for Touchlink commissioning a device

25457

### 13.2 Commissioning

25458

#### 13.2.1 Overview

25459  
25460

Please see Chapter 2 for a general cluster overview defining cluster architecture, revision, classification, identification, etc.

25461  
25462

This cluster provides attributes and commands pertaining to the commissioning and management of devices operating in a network.

25463  
25464  
25465

This cluster will typically be supported using a “Commissioning Tool.” But, depending on the application and installation scenario, this tool may take many forms. For purposes of this document, any device that implements the client side of this cluster may be considered a commissioning tool.

25466  
25467

As with all clusters defined in the Cluster Library, an application may have as many instances of this cluster as needed and may place them on any addressable endpoint.

25468  
25469

This cluster is exclusively used for commissioning the ZigBee stack and defining device behavior with respect to the ZigBee network. It does not apply to applications operating on those devices.

25470 **13.2.1.1 Security and Authorization**

25471 The attributes and commands covered in this cluster specification are critical to the operation of a ZigBee  
25472 device. An application entity that receives a request to access the attributes of this cluster or to execute one  
25473 of the commands described in sub-clause 13.2.2.3 shall determine whether the originator is authorized to  
25474 make that request and whether the security processing applied to the received frame was appropriate. The  
25475 method or methods whereby this is accomplished are out of the scope of this document but it is strongly  
25476 recommended that Entity Authentication, as described in [B1], be used. This, and any other methods used to  
25477 authorize commissioning tools and other devices acting as a client for this cluster, shall be detailed in any  
25478 Application Profile documents that use it.

25479 Similarly, it is strongly recommended that the cluster specified here be deployed only on a single device  
25480 endpoint or that, at very least, all deployments of this cluster be managed by a single application object with  
25481 a unitary set of security requirements etc.

25482 **13.2.1.2 Revision History**

25483 The global *ClusterRevision* attribute value SHALL be the highest revision number in the table below.

Rev	Description
1	mandatory global <i>ClusterRevision</i> attribute added
2	CCB 2477 2862 2870

25484 **13.2.1.3 Classification**

Hierarchy	Role	PICS Code
Base	Utility	CS

25485 **13.2.1.4 Cluster Identifiers**

Identifier	Name
0x0015	Commissioning

25486 **13.2.2 Server**

25487 The attributes accessible on the server side of this cluster are typically attributes of the ZigBee stack, which  
25488 are either described in the layer Information Base for some stack layer, or are ZDO configuration attributes.  
25489 The function of the server is to provide read/write access to these attributes and to manage changes of certain  
25490 critical attributes in a way that prevents the device from getting into an inconsistent and unrecoverable state.

25491 Thus, for example, the application entity that receives and processes commands to set attributes in the Startup  
25492 Parameters attribute set shall check whether the *StartupControl* attribute has been set to a value that is incon-  
25493 sistent with the value of the *ExtendedPanID* attribute (see Table 13-2). If such a condition arises, e.g., a  
25494 request is made to set the *StartupControl* attribute to 0x02, indicating network rejoin, and simultaneously to  
25495 clear the *ExtendedPanID* attribute indicating an unspecified network, then a status code of FAILURE<sup>235</sup> shall  
25496 be reported.

<sup>235</sup> CCB 2477 status code cleanup

25497 **13.2.2.1 Dependencies**

25498 None

25499 **13.2.2.2 Attributes**

25500 For convenience, the attributes defined in this specification are arranged into sets of related attributes; each  
 25501 set can contain up to 16 attributes. Attribute identifiers are encoded such that the most significant three nib-  
 25502 bles specify the attribute set and the least significant nibble specifies the attribute within the set. The currently  
 25503 defined attribute sets are listed in Table 13-1.

25504 **Table 13-1. Commissioning Attribute Sets**

Attribute Set Identifier	Description
0x000, 0x001	Startup Parameters
0x002	Join Parameters
0x003	End Device Parameters
0x004	Concentrator Parameters

25505

25506 For each of these sets, each attribute is mandatory unless specifically specified as optional in the relevant  
 25507 sub-clause defining it. Similarly, any default values are specified in these sub-clauses.

25508 **13.2.2.2.1 Startup Parameters Attribute Set**

25509 The Startup Parameters attribute set contains the attributes summarized in Table 13-2.

25510 These are application attributes and, as such, are sent, received and managed by application entities. How-  
 25511 ever, except where otherwise noted, each of them corresponds to, and is intended to provide a value for a  
 25512 particular stack attribute that controls the startup behavior of the stack. The ZigBee specification describes a  
 25513 schematic startup procedure (see [B1]), which governs the order and manner in which these stack attributes  
 25514 must be used in order to gain access to a network or form a new network. This procedure should run when a  
 25515 device starts up, but may also run without an actual restart as part of the ongoing operation of the device.

25516 The Restart Device command (see 13.2.2.3.1) provides a means whereby a set of Startup Parameters - the  
 25517 “current” Startup Parameters attribute set - stored at the application layer, can be installed in the stack and  
 25518 put into force by executing the startup procedure described above and in the specification. A change to one  
 25519 of the attributes contained in this set, e.g., the *ShortAddress* attribute, does not immediately result in a change  
 25520 to the underlying stack attribute. The attribute set will be installed on receipt of a Restart Device command.

25521 Note that the attributes in this set are mutually interdependent and must be taken as a whole. One consequence  
 25522 of this is that, while there are no explicit requirements with regard to storage class for these attributes, imple-  
 25523 menters must carefully consider whether to make a particular attribute non-volatile or static in order to pre-  
 25524 vent inconsistencies in the attribute set after an unintentional processor restart. Another consequence is that,  
 25525 wherever possible, startup attributes should be written atomically using a single write attributes command  
 25526 frame.

25527

**Table 13-2. Attributes of the Startup Parameters Attribute Set**

<b>Id</b>	<b>Name</b>	<b>Type</b>	<b>Range</b>	<b>Def</b>	<b>Acc</b>	<b>MO</b>
0x0000	ShortAddress	uint16	0x0000 – 0xffff7	-	RW	M
0x0001	ExtendedPANId	EUI64	0x0000000000000000 - 0xffffffffffffe	0xffffffffffff	RW	M
0x0002	PANId	uint16	0x0000 - 0xffff	-	RW	M
0x0003	Channelmask	map32	Any valid IEEE 802.15.4 channel mask (see [E1]).	-	RW	M
0x0004	ProtocolVersion	uint8	0x02	-	RW	M
0x0005	StackProfile	uint8	0x01 - 0x02	-	RW	M
0x0006	StartupControl	enum8	0x00 - 0x03	-	RW	M
0x0010	TrustCenterAddress	EUI64	Any valid IEEE Address	<i>all zeros</i>	RW	M
0x0011	TrustCenterMasterKey	key128	Any 128-bit value	<i>all zeros</i>	RW	O
0x0012	NetworkKey	key128	Any 128-bit value	<i>all zeros</i>	RW	M
0x0013	UseInsecureJoin	bool	FALSE/TRUE	TRUE	RW	M
0x0014	PreconfiguredLinkKey	key128	Any 128-bit value	<i>all zeros</i>	RW	M
0x0015	NetworkKeySeqNum	uint8	0x00 - 0xff	0x00	RW	M
0x0016	NetworkKeyType	enum8	Any valid key type value	-	RW	M
0x0017	NetworkManagerAddress	uint16	Any valid network address	0x000	RW	M

25528

25529 Except where specifically noted, an implementer of this cluster shall provide read access to all attributes of  
 25530 the Startup Parameters attribute set. However, if an attempt is made to read an attribute that may not be read,  
 25531 a NOT\_AUTHORIZED<sup>236</sup> status value shall be returned.

25532 Even in cases where the commissioning cluster is a mandatory part of a given application profile, an imple-  
 25533 menter is not required to provide write access for all attributes. If write access is not provided, it is assumed  
 25534 that the implementer has some other preferred, generally out-of-band, method for setting the value of the  
 25535 underlying stack attribute, and that the value returned on read reflects the actual value in use. If an attempt is  
 25536 made to write to such an attribute, a READ\_ONLY<sup>237</sup> status value shall be returned

### 25537 **13.2.2.2.1.1 ShortAddress Attribute**

25538 The *ShortAddress* attribute contains the intended 16-bit network address of the device. This attribute corre-  
 25539 sponds to the *nwkShortAddress* attribute of the NIB (see [B1]).

25540 The default value is the value stored in the *nwkShortAddress* attribute of the NIB. When this attribute is not  
 25541 set as part of the Restart Device Request command, this default value ensures that the previous short address  
 25542 is preserved. This makes it possible for a device to preserve its short address after being commissioned.

<sup>236</sup> CCB 2477 status code cleanup

<sup>237</sup> CCB 2477 status code cleanup

25543 Stack profile compatibility for this attribute is described in Table 13-3.

25544 **Table 13-3. Stack Profile Compatibility for the *ShortAddress* Attribute**

StackProfile Value	Supported	Comment
0x01	No	Under the ZigBee stack profile a ZigBee router or device shall obtain a network address from its parent at network formation time.
0x02	Yes	Under the ZigBee PRO stack profile and stochastic addressing a device may, under certain circumstances, generate its own network address and keep it through the joining process (see [B1]). In this case, it may make sense for that address to be provided by a tool if, for example, this will reduce the likelihood of address conflicts.

25545 **13.2.2.2.1.2 ExtendedPANId Attribute**

25546 The *ExtendedPANId* attribute holds the extended PAN Id of the network of which the device should be a  
 25547 member. See 13.2.2.2.1.7 for usage details.

25548 The default value of 0xffffffffffff indicates an unspecified value. In the case where a device is required to  
 25549 join a commissioning network on startup, this attribute may be set, under application control, to the global  
 25550 commissioning EPID (see 13.2.4.1).

25551 Depending in the value of the *StartupControl* attribute, this attribute may correspond to the *nwkEx-*  
 25552 *tendedPANID* attribute of the NIB (see [B1]) or the *apsUseExtendedPANID* attribute of the AIB (see [B1]).

25553 **13.2.2.2.1.3 PANId Attribute**

25554 The *PANId* attribute holds the PAN Id of the network of which the device should be a member. This attribute  
 25555 corresponds to the *macPANId* attribute of the MAC PIB (see [E1]).

25556 The default value is macPANID.

25557 Stack profile compatibility for this attribute is described in Table 13-4.

25558 **Table 13-4. Stack Profile Compatibility for the *PANId* Attribute**

StackProfile Value	Comment
0x01	Under the ZigBee stack profile, The ZigBee coordinator shall select an appropriate PANId at network formation time. In this case the value of the PANId attribute may be used. A ZigBee router or ZigBee end device shall obtain a PANId from its parent at network join time. In this case, the value of the PANId attribute shall be ignored.
0x02	Under the ZigBee PRO stack profile a ZigBee router or end device that has the StartupControl attribute equal to 0x00, must have the PANId attribute set to the correct value since it has no other way of obtaining it.

25559 **13.2.2.2.1.4 ChannelMask Attribute**

25560 The *ChannelMask* attribute is an IEEE802.15.4 channel mask, see [E1], containing the set of channels the  
25561 device should scan as part of the network join or formation procedures. This attribute corresponds to the  
25562 *apsChannelMask* attribute of the AIB (see [B1]).

25563 The default value is the value of *apsChannelMask*.

#### 25564 **13.2.2.2.1.5 ProtocolVersion Attribute**

25565 The *ProtocolVersion* attribute is used to select the current protocol version for a device that supports multiple  
25566 versions of the ZigBee specification.

25567 <sup>238</sup>A device may support a single protocol version or multiple protocol versions at the option of the imple-  
25568 menter.

25569 Currently only one value, 0x02 denoting ZigBee 2006 and later, is supported. The default value shall be the  
25570 protocol version supported by the application if only one protocol version is supported. Should more than  
25571 one protocol version be supported, the default value may be any of the protocol versions supported.

25572 The *ProtocolVersion* attribute corresponds to a NWK layer constant, *nwkcProtocolVersion*, which is defined  
25573 as a constant because most implementations will support only a single ZigBee protocol version. In this case,  
25574 the attribute will be read-only. However, there is nothing to prevent a device with sufficient resources from  
25575 supporting more than one ZigBee protocol version under control of the commissioning cluster.

#### 25576 **13.2.2.2.1.6 StackProfile Attribute**

25577 The *StackProfile* attribute is used to select the stack profile for the device.

25578 <sup>239</sup>A device may only support one stack profile.

25579 Supported values include:

25580       0x01: ZigBee Stack profile

25581       0x02: ZigBee PRO Stack Profile

25582 This attribute corresponds to the *nwkcStackProfile* attribute of the NIB (see [B1]). The default value shall be  
25583 the stack profile supported by the application if only one stack profile is supported. Should more than one  
25584 stack profile be supported, the default value may be any of the stack profiles supported.

#### 25585 **13.2.2.2.1.7 StartupControl Attribute**

25586 The *StartupControl* attribute is an enumerated type that determines how certain other parameters are to be  
25587 used. Values for this attribute and interaction with other attributes are shown in Table 13-5. If an attribute  
25588 appears in the “required attributes” column this indicates that this attribute must be set to a value that is valid  
25589 for the intended operational network in order for this *StartupControl* attribute value to be used. Note that in  
25590 some cases the default value may be sufficient.

25591 If an attribute appears in the “optional attributes” column it means that the attribute value will affect startup  
25592 or operation under the given attribute set but that any value, including the default, is a valid value. If an  
25593 attribute appears in the “ignored attributes” column it means that the value of this attribute has no effect on  
25594 device startup when the *StartupControl* attribute value in the “value” column is in force.

---

<sup>238</sup> CCB 2862

<sup>239</sup> CCB 2862

25595

**Table 13-5. StartupControl Attribute Usage**

Value	Description	Required Attributes	Optional Attributes	Ignored Attributes
0x00	Indicates that the device should consider itself part of the network indicated by the <i>ExtendedPANId</i> attribute. In this case it will not perform any explicit join or rejoin operation.	ShortAddress, ExtendedPANId, PANId, TrustCenterAddress, NetworkKey, NetworkKeySeqNum, NetworkKeyType	ChannelMask, UseInsecureJoin, NetworkManagerAddress, TrustCenterMasterKey (required for Stack Profile 2, optional for Stack Profile 1), PreconfiguredLinkKey	-
0x01	Indicates that the device should form a network with extended PAN ID given by the <i>ExtendedPANId</i> attribute.  The AIB attribute <i>apsDesignatedCoordinator</i> (see [B1]) shall be set to TRUE in this case.	ExtendedPANId	PANId, ChannelMask, NetworkManagerAddress, NetworkKey, NetworkKeyType, TrustCenterAddress	ShortAddress, UseInsecureJoin, NetworkKeySeqNum, TrustCenterMasterKey, PreconfiguredLinkKey
0x02	Indicates that the device should rejoin the network with extended PAN ID given by the <i>ExtendedPANId</i> attribute.  The AIB attribute <i>apsDesignatedCoordinator</i> (see [B1]) shall be set to FALSE in this case.	ExtendedPANId	ShortAddress, ChannelMask, UseInsecureJoin, NetworkKey, NetworkKeySeqNum, NetworkKeyType, TrustCenterAddress, TrustCenterMasterKey, NetworkManagerAddress, PreconfiguredLinkKey	PANId
0x03	Indicates that the device should start “from scratch” and join the network using (unsecured) MAC association.  The AIB attribute <i>apsDesignatedCoordinator</i> (see [B1]) shall be set to FALSE in this case.	-	ExtendedPANId, ChannelMask, PreconfiguredLinkKey	ShortAddress, UseInsecureJoin, PANId, TrustCenterAddress, NetworkKey, NetworkKeySeqNum, NetworkKeyType, NetworkManagerAddress, TrustCenterMasterKey

25596

25597 Note that these values control the execution of the device startup procedure as specified in [B1], sub-clause  
 25598 2.5.5.5.6.2. See this sub-clause for a detailed description of the operation of this procedure.

25599 The default value of the StartupControl attribute for an un-commissioned device is 0x03.

25600 Stack profile compatibility for this attribute is shown in Table 13-6.

25601 **Table 13-6. Stack Profile Compatibility for the *StartupControl* Attribute**

StackProfile Value	StartupControl Value		Comment
	Mandatory	Optional	
0x01	0x01 0x03	0x02	ZigBee networks use tree-structured address assignment and must form, at startup, from the ZigBee coordinator. The “mode” implied by <i>StartupControl</i> = 0 in which a device is essentially preconfigured to run on a network without having to explicitly join in order to get an address or PAN Id is not supported.
0x02	0x01 0x03	0x00 0x02	StartupControl = 0 is supported under the ZigBee Pro stack profile.

25602

25603 **Note:** An implementation shall return an error code of `INVALID_VALUE` when a client attempts to write  
25604 an unsupported *StartupControl* value.

#### 25605 **13.2.2.2.1.8 TrustCenterAddress Attribute**

25606 The trust center address to use when performing security operations on the network whose extended PAN ID  
25607 is given by the *ExtendedPANId* attribute is, in turn, given by the *TrustCenterAddress* attribute.

25608 This attribute corresponds to the *apsTrustCenterAddress* attribute of the AIB (see [B1]).

25609 The default value of 0x0000000000000000 indicates unspecified.

#### 25610 **13.2.2.2.1.9 TrustCenterMasterKey Attribute**

25611 This attribute holds the trust center master key to use during key establishment with the TC of the network  
25612 with the extended PAN ID given by the *ExtendedPANId* attribute.

25613 The default value, i.e., a 128-bit value containing all zeros, indicates that the key is unspecified.

25614 This attribute corresponds to the *MasterKey* element of the key-pair set from the *apsDeviceKeyPairSet* at-  
25615 tribute of the AIB for which the *DeviceAddress* element corresponds to the value of the *TrustCenterAddress*  
25616 attribute. (see [B1]).

#### 25617 **13.2.2.2.1.10 NetworkKey Attribute**

25618 This attribute supplies the NWK key to use when communicating with the network specified by the *Extend-  
25619 edPANId* attribute. The default value, i.e., a 128-bit value containing all zeros, indicates that the key is un-  
25620 specified.

25621 This attribute corresponds to the active key from the *nwkSecurityMaterialSet* attribute of the NIB (see [B1]).

#### 25622 **13.2.2.2.1.11 UseInsecureJoin Attribute**

25623 This attribute is a Boolean flag that enables the use of unsecured join as a fallback case at startup time. It  
25624 corresponds to the Boolean AIB attribute *apsUseInsecureJoin* (see [B1]). The default value is TRUE.

#### 25625 **13.2.2.2.1.12 PreconfiguredLinkKey Attribute**



25626 The preconfigured link key is the key between the device and the trust center. The default value, i.e., a 128-  
 25627 bit value containing all zeros, indicates that the key is unspecified.

25628 This attribute corresponds to the LinkKey element of the Key-Pair descriptor contained in the *apsDeviceKey-*  
 25629 *PairSet* attribute of the AIB (see [B1]).

25630 **13.2.2.2.1.13 NetworkKeySeqNum Attribute**

25631 This attribute sets the network key's sequence number. The default value is 0x00.

25632 This attribute corresponds to the value of the *nwkActiveKeySeqNumber* attribute of the NIB (see [B1]).

25633 **13.2.2.2.1.14 NetworkKeyType Attribute**

25634 This attribute sets the network key's type. It corresponds to the value of the KeyType element of the current  
 25635 security material descriptor corresponding to the Trust Center found in the *nwkSecurityMaterialSet* attribute  
 25636 of the NIB (see [B1]).

25637 The default value is 0x01 when the StackProfile is 0x01 and 0x05 when the StackProfile is 0x02.

25638 **13.2.2.2.1.15 NetworkManagerAddress Attribute**

25639 This attribute sets the address of the Network Manager. It corresponds to the value of the *nwkManagerAddr*  
 25640 attribute of the NIB (see [B1]).

25641 The default value is 0x0000 indicating that, by default, the Network Manager is on the ZigBee coordinator.

25642 **13.2.2.2.2 Join Parameters Attribute Set**

25643 The Join Parameters attribute set contains the attributes summarized in Table 13-7.

25644 These attributes control the details of the network joining process. Each of them, as described below, corre-  
 25645 sponds to a ZDO configuration attribute, the function and use of which is described in the ZigBee specifica-  
 25646 tion (see [B1]).

25647 **Table 13-7. Attributes of the Join Parameters Attribute Set**

Id	Name	Type	Range	Def	Acc	M/O
0x0020	ScanAttempts	uint8	0x001 – 0xff	0x05	RW	O
0x0021	TimeBetweenScans	uint16	0x0001 - 0xffff	0x64	RW	O
0x0022	RejoinInterval	uint16	0x0001 - <i>MaxRejoinInterval</i>	0x3c	RW	O
0x0023	MaxRejoinInterval	uint16	0x0001 - 0xffff	0x0e10	RW	O

25648

25649 As with the attributes in Table 13-2, an implementer of this cluster shall provide read access to all attributes.  
 25650 The implementer may provide write access. If write access is not provided, it is assumed that the implementer  
 25651 has some other preferred method for setting the value of the underlying stack attribute, and that the value  
 25652 returned on read reflects the actual value in use.

25653 **13.2.2.2.2.1 ScanAttempts Attribute**

25654 The *ScanAttempts* attribute determines how many scan attempts to make before selecting the ZigBee Coord-  
 25655 inator or Router to join.

25656 This attribute corresponds to the *:Config\_NWK\_Scan\_Attempts* configuration attribute of the ZDO (see  
 25657 [B1]).

25658 The default value for this attribute is 0x05.

25659 **13.2.2.2.2 TimeBetweenScans Attribute**

25660 The *TimeBetweenScans* attribute determines the time between each scan attempt.

25661 This attribute corresponds to the *:Config\_NWK\_Time\_btwn\_Scans* configuration attribute of the ZDO (see [B1]).

25663 The units of this attribute are milliseconds and the default value is 0x64.

25664 **13.2.2.2.3 RejoinInterval Attribute**

25665 The *RejoinInterval* determines the interval between attempts to rejoin the network if an end device finds itself disconnected.

25667 This attribute corresponds to the *:Config\_Rejoin\_Interval* configuration attribute of the ZDO (see [B1]).

25668 The units of this attribute are seconds and the default value is 0x3c.

25669 **13.2.2.2.4 MaxRejoinInterval Attribute**

25670 The *MaxRejoinInterval* attribute imposes an upper bound on the *RejoinInterval* parameter.

25671 This attribute corresponds to the *:Config\_Max\_Rejoin\_Interval* configuration attribute of the ZDO (see [B1]).

25672 The units of this attribute are seconds and the default value is 0x0e10.

25673 **13.2.2.2.3 End Device Parameters Attribute Set**

25674 The End Device Parameters attribute set contains the attributes summarized in Table 13-8.

25675 **Table 13-8. Attributes of the End Device Parameters Attribute Set**

Id	Name	Type	Range	Def	Acc	M/O
0x0030	IndirectPollRate	uint16	0x0000 – 0xffff	-	RW	O
0x0031	ParentRetryThreshold	uint8	0x00 - 0xff	-	R	O

25676

25677 As with the attributes in Table 13-2 and Table 13-7, an implementer of this cluster shall provide read access  
25678 to all attributes. The implementer may provide write access. If write access is not provided, it is assumed that  
25679 the implementer has some other preferred method for setting the value of the underlying stack attribute, and  
25680 that the value returned on read reflects the actual value in use.

25681 **13.2.2.2.3.1 IndirectPollRate Attribute**

25682 The *IndirectPollRate* attribute determines the rate at which a device, usually an end device, where the *macRx-  
25683 OnWhenIdle* attribute of the PIB has a value of FALSE, will poll for messages from its parent.

25684 This attribute corresponds to the *:Config\_NWK\_IndirectPollRate* configuration attribute of the ZDO (see [B1]).

25686 The units for this attribute are milliseconds and the default value, broad limits for which are given in [Z2]  
25687 and [Z3], shall be determined by the relevant application. Values assigned using this cluster should be within  
25688 the given limits in order to promote correct network operation.

25689 **13.2.2.2.3.2 ParentRetryThreshold Attribute**

25690 The *ParentRetryThreshold* attribute determines how many times a ZigBee end device should attempt to con-  
 25691 tact its parent before initiating the rejoin process. ZigBee routers and ZigBee coordinators should return a  
 25692 value of 0xff for this attribute on read, and should return an error on any attempt to write it.

25693 This attribute corresponds to the *:Config\_Parent\_Link\_Retry\_Threshold* configuration attribute of the ZDO  
 25694 (see [B1]).

#### 25695 **13.2.2.2.4 Concentrator Parameters Attribute Set**

25696 The Concentrator Parameters attribute set contains the attributes summarized in Table 13-9.

25697 **Table 13-9. Attributes of the Concentrator Parameters Attribute Set**

Id	Name	Type	Range	Def	Acc	M/O
0x0040	ConcentratorFlag	bool	FALSE/TRUE	FALSE	RW	O
0x0041	ConcentratorRadius	uint8	0x00 - 0xff	0x0f	RW	O
0x0042	ConcentratorDiscoveryTime	uint8	0x00 - 0xff	0 <sup>240</sup>	RW	O

25698

25699 As with the other attribute sets in this cluster, an implementer shall provide read access to all attributes. The  
 25700 implementer may provide write access. If write access is not provided, it is assumed that the implementer has  
 25701 some other preferred method for setting the value of the underlying stack attribute, and that the value returned  
 25702 on read reflects the actual value in use.

##### 25703 **13.2.2.2.4.1 ConcentratorFlag Attribute**

25704 The *ConcentratorFlag* attribute will configure the device to be a concentrator for the purpose of many-to-  
 25705 one routing. This attribute corresponds to the *nwkIsConcentrator* attribute of the NIB (see [B1]).

25706 The default value for this attribute is FALSE.

##### 25707 **13.2.2.2.4.2 ConcentratorRadius Attribute**

25708 The *ConcentratorRadius* attribute determines the hop count radius for concentrator route discoveries. This  
 25709 attribute corresponds to the *nwkConcentratorRadius* attribute of the NIB (see [B1]).

25710 The default value for this attribute is 0x0f.

##### 25711 **13.2.2.2.4.3 ConcentratorDiscoveryTime Attribute**

25712 Routes to the concentrator are known as inbound routes. These routes are created after the receipt of a com-  
 25713 mand from the concentrator. The *ConcentratorDiscoveryTime* attribute determines the period for triggering  
 25714 such route creation.

25715 This attribute corresponds to the *nwkConcentratorDiscoveryTime* attribute of the NIB (see [B1]).

25716 The units of this attribute are seconds and the default value is 0, which indicates that the discovery time is  
 25717 unknown and must be performed by the application.

<sup>240</sup> CCB 2870

25718 **13.2.2.3 Commands Received**

25719 The received command IDs for the commissioning cluster server are listed in Table 13-10. These commands  
25720 may, in principle, be received as unicasts or as broadcasts, but application developers should be aware that,  
25721 since these commands require a response, broadcasting them to a large number of devices may not be advis-  
25722 able.

25723 **Table 13-10. Commands Received by the Commissioning Cluster Server**

Command Identifier	Description	M/O
0x00	Restart Device	M
0x01	Save Startup Parameters	O
0x02	Restore Startup Parameters	O
0x03	Reset Startup Parameters	M

25724  
25725 In Table 13-10, if the actions associated with an optional command are not implemented, at least the relevant  
25726 response command (see Table 13-12) must be returned with status UNSUP\_COMMAND<sup>241</sup>.

25727 **13.2.2.3.1 Restart Device Command**

25728 The Restart Device command is used to optionally install a set of startup parameters in a device and run the  
25729 startup procedure so as to put the new values into effect. The new values may take effect immediately or after  
25730 an optional delay with optional jitter. The server will send a Restart Device Response command back to the  
25731 client device before executing the procedure or starting the countdown timer required to time the delay.

25732 **13.2.2.3.1.1 Payload Format**

25733 The Restart Device command is formatted as shown in Figure 13-1.

25734 **Figure 13-1. Format of the Restart Device Command Payload**

<b>Octets</b>	1	1	1
<b>Data Type</b>	8-bit bitmap	Unsigned 8-bit integer	Unsigned 8-bit integer
<b>Field Name</b>	Options	Delay	Jitter

25735  
25736 **Figure 13-2. Format of the Options Field**

<b>Bits: 0...2</b>	<b>3</b>	<b>4...7</b>
Startup Mode	Immediate	Reserved

<sup>241</sup> CCB 2477 status code cleanup

25737

25738 The Startup Mode sub-field of the options field is 3 bits in length and shall take one of the nonreserved values  
 25739 from Table 13-11.

25740

**Table 13-11. Startup Mode Sub-field Values**

Field value	Description
0b000	Restart the device using, i.e., installing, the current set of startup parameters.
0b001	Restart the device using, and not replacing, the current state of the device, i.e., the current set of stack attributes.

25741

25742 The Immediate sub-field of the options field is 1 bit in length. If this sub-field has a value of 1 then the device  
 25743 is to execute the restart either immediately on receipt of the Restart Device Request frame, if the value of the  
 25744 delay field is 0, or immediately after the prescribed delay and jitter has transpired if not. If the immediate  
 25745 sub-field has a value of 0, then the device may wait to restart until after the prescribed delay and jitter, if any,  
 25746 have transpired but may also wait for a “convenient” moment, e.g., until pending frames have been transmit-  
 25747 ted, to actually perform the restart.

25748 The delay field is one octet in length and gives a delay in seconds, in the range [0...255], after which the  
 25749 startup procedure is to be invoked.

25750 The jitter field is one octet in length and specifies a random jitter range. While possible field values fall in  
 25751 the interval [0...255], the actual jitter, in milliseconds, that should be added to the delay, given in seconds,  
 25752 in the delay field should be:

25753  $RAND(<jitter\ field\ contents> * 80)$  ms.

25754 Where  $RAND(X)$  returns a random number in the interval [0...X].

25755 **13.2.2.3.1.2 Effect on Receipt**

25756 On receipt of the Restart Device command, the application checks the current startup attribute set for con-  
 25757 sistency. If the attribute set is incorrect or inconsistent, processing of the command is terminated and a Restart  
 25758 Device Response command is returned to the sender of the request with a status value of FAILURE<sup>242</sup>. Oth-  
 25759 erwise, the application sends a Restart Device Response command to the sender of the request with a status  
 25760 value of SUCCESS, then leaves the current network, installs the current startup attribute set, if the startup  
 25761 mode sub-field of the options field has a value of 0b00, and runs the restart procedure after the given delay  
 25762 and jitter have transpired.

25763 **13.2.2.3.2 Save Startup Parameters Command**

25764 In addition to the current set of startup parameters, which every device implementing the commissioning  
 25765 cluster must maintain, a device may store and maintain up to 256 sets of startup attributes. The Save Startup  
 25766 Parameters Request command allows for the current attribute set to be stored under a given index. Note that  
 25767 while the startup attribute set index is 8 bits, allowing for as many as 256 attribute sets, the actual number of  
 25768 attribute sets will typically be much smaller.

25769 While storage of additional startup attribute sets is optional, a device that chooses to store additional startup  
 25770 attribute sets must store them in such a way that they are non-volatile.

<sup>242</sup> CCB 2477 status code cleanup

25771 **13.2.2.3.2.1 Payload Format**

25772 The Save Startup Parameters command is formatted as shown in Figure 13-3.

25773 **Figure 13-3. Format of Save Startup Parameters Command Payload**

<b>Octets</b>	1	1
<b>Data Type</b>	8-bit bitmap	Unsigned 8-bit integer
<b>Field Name</b>	Options (Reserved)	Index

25774

25775 The Options field is one octet in length and is reserved.

25776 The Index field is one octet in length and gives an index under which the current startup parameter attribute set is to be saved.

25778 **13.2.2.3.2.2 Effect on Receipt**25779 On receipt of the Save Startup Parameters command, the application shall check the value of the index field  
25780 of the command payload. If the index field has a value that is equal to an index under which a set of startup  
25781 parameters has already been saved then the current startup parameters attribute set is simply saved in place  
25782 of the previously saved set and a Save Startup Parameters Response command is sent back to the sender of  
25783 the request with a status value of SUCCESS.25784 If the value of the index field is such that no startup parameters attribute set has been saved under that index  
25785 then the application shall check that there is storage capacity to save another attribute set. If there is capacity  
25786 then the current startup parameters attribute set shall be stored under the index given in the index field such  
25787 that it may be restored at a future time in response to the receipt of a Restore Startup Parameters Request  
25788 command carrying the same index. A Save Startup Parameters Response command with status value of SUC-  
25789 CESS is then sent as described above.25790 If there is not storage capacity, then a save Startup Parameters Response command is sent back to the sender  
25791 of the request with a status INSUFFICIENT\_SPACE.25792 **13.2.2.3.3 Restore Startup Parameters Command**25793 A device that implements the optional Save Startup Parameters command shall also implement the Restore  
25794 Startup Parameters Request command (and vice-versa). This command allows a saved startup parameters  
25795 attribute set to be restored to current status overwriting whatever was there previously.25796 **13.2.2.3.3.1 Payload Format**

25797 The Restore Startup Parameters command is formatted as shown in Figure 13-4.

25798 **Figure 13-4. Restore Startup Parameters Command Payload**

<b>Octets</b>	1	1
<b>Data Type</b>	8-bit bitmap	Unsigned 8-bit integer
<b>Field Name</b>	Options (Reserved)	Index

25799

25800 The options field is one octet in length and is reserved.

25801 The index field is one octet in length and gives the index of the saved startup parameter attribute set to be  
 25802 restored to current status.

25803 **13.2.2.3.3.2 Effect on Receipt**

25804 On receipt of the Restore Startup Parameters command, the application shall check the value of the index  
 25805 field of the command payload. If the index field has a value that is equal to an index under which a startup  
 25806 parameters attribute set has been saved then that attribute set is copied into the current startup parameters  
 25807 attribute set overwriting whatever was there and a Restore Startup Parameters Response command is sent  
 25808 back to the sender of the request with a status value of SUCCESS. If the value of the index field is such that  
 25809 no startup parameters attribute set has been saved under that index then a Restore Startup Parameters Re-  
 25810 sponse command is sent back to the sender of the request with a status value of INVALID\_FIELD.

25811 **13.2.2.3.4 Reset Startup Parameters Command**

25812 This command allows current startup parameters attribute set and one or all of the saved attribute sets to be  
 25813 set to default values. There is also an option for erasing the index under which an attribute set is saved thereby  
 25814 freeing up storage capacity.

25815 **13.2.2.3.4.1 Payload Format**

25816 The Reset Startup Parameters command is formatted as shown in Figure 13-5.

25817 **Figure 13-5. Format of Reset Startup Parameters Command Payload**

<b>Octets</b>	1	1
<b>Data Type</b>	8-bit bitmap	Unsigned 8-bit integer
<b>Field Name</b>	Options	Index

25818  
 25819 The Options field is formatted as shown in Figure 13-6.

25820 **Figure 13-6. Format of the Options Field**

<b>Bits: 0</b>	<b>1</b>	<b>2</b>	<b>3...7</b>
Reset Current	Reset All	Erase Index	Reserved

25821  
 25822 The Reset Current sub-field of the options field is 1 bit in length. If it has a value of 1 then all attributes in  
 25823 the current startup parameters attribute set shall be reset to their default values. Otherwise the current startup  
 25824 parameters attribute set shall remain unchanged.

25825 The Reset All sub-field of the options field is 1 bit in length. If it has a value of 1 then all attributes of all  
 25826 saved startup parameter attribute sets shall be reset to their default values. Otherwise, all attributes of the  
 25827 saved attribute set with an index given by the value of the index field shall be set to their default values

25828 The Erase Index sub-field of the options field is 1 bit in length. If it has a value of 1 then the index under  
 25829 which a saved attribute set has been saved shall be cleared as well, essentially freeing the storage associated  
 25830 with that index.

25831 The Index field is one octet in length and gives the index of a saved startup parameter attribute set. The value  
25832 of this field is ignored if either the reset all sub-field or the reset current sub-field of the options field have a  
25833 value of 1.

#### 25834 **13.2.2.3.4.2 Effect on Receipt**

25835 On receipt of the Reset Startup Parameters Request command the application interprets the options field and  
25836 index field as described in sub-clause 13.2.2.3.4.1 and acts accordingly. The Reset Startup Parameters Re-  
25837 sponse command sent back to the sender of the request shall always have a status value of SUCCESS.

### 25838 **13.2.2.4 Commands Generated**

25839 The command IDs for the commands generated by the commissioning cluster server are listed in Table 13-12.

25840 **Table 13-12. Commands Generated by the Commissioning Cluster Server**

Command Identifier	Description	M/O
0x00	Restart Device Response	M
0x01	Save Startup Parameters Response	M
0x02	Restore Startup Parameters Response	M
0x03	Reset Startup Parameters Response	M

25841  
25842 These commands should always be issued as unicasts.

#### 25843 **13.2.2.4.1 Payload Format**

25844 All response commands emitted by the server have the same payload format as shown in Figure 13-7.

25845 **Figure 13-7. Format of Reset Startup Parameters Command Payload**

<b>Octets</b>	1
<b>Data Type</b>	8-bit enumeration
<b>Field Name</b>	Status

25846  
25847 Status values are chosen from the set of non-reserved values shown in Chapter 2

#### 25848 **13.2.2.4.2 Effect on Receipt**

25849 On receipt of one of the response commands shown in Table 13-12, the client is made aware that the server  
25850 has received the corresponding request and is informed of the status of the request.

## 25851 **13.2.3 Client**

25852 The commissioning cluster client (e.g., implemented on a commissioning tool) manages the attributes de-  
25853 scribed above on a remote device and sends the Restart Device command as necessary.



### 25854 **13.2.3.1 Dependencies**

25855 None

### 25856 **13.2.3.2 Attributes**

25857 The client cluster has no attributes.

### 25858 **13.2.3.3 Commands Received**

25859 The client receives the cluster specific commands generated by the server (see 13.2.2.4).

### 25860 **13.2.3.4 Commands Generated**

25861 The client generates the cluster specific commands received by the server, as required by the application. See  
25862 13.2.2.3.

## 25863 **13.2.4 Commissioning EUI-64s**

25864 To assist in ensuring that commissioning can be achieved in an interoperable environment while minimizing  
25865 the possibility of interference from existing or future ZigBee and 802.15.4 networks and devices a range of  
25866 IEEE-defined 64-bit extended unique identifiers (EUI-64s), as been reserved for use as Extended PAN IDs.  
25867 The reserved range is as follows:

- 25868 • 00-50-C2-77-10-00-00-00 is the global commissioning EPID
- 25869 • 00-50-C2-77-10-00-00-01 to 00-50-C2-77-10-00-FF-FF are EUI-64s reserved for other commissioning  
25870 use

### 25871 **13.2.4.1 Global Commissioning EPID**

25872 The global commissioning EPID is intended to serve as a single EUI-64 to be used by any ZigBee application  
25873 for the purpose of commissioning. It is recommended that profile and application developers that require  
25874 interoperability between products offered by different OEMs incorporate this global commissioning EPID  
25875 within their respective application profiles as the EPID that devices attempt to join when they are first turned  
25876 on straight “out-of-the-box.”

25877 This global commissioning EPID provides a guarantee that devices will join a specific network for commis-  
25878 sioning purposes. As part of commissioning, devices are then provided with a startup attribute set (SAS) that  
25879 ensures that they join a network other than this global commissioning network. These SASs may be provided  
25880 over-the-air using the commissioning cluster or some other out-of-band method.

25881 It is also recommended that this global commissioning EPID be used only for commissioning, and especially  
25882 not for ongoing operational use. Commissioning networks formed using the global commissioning EPID  
25883 should be temporary and such networks should be stopped upon completion of commissioning to minimize  
25884 the possibility of such networks interfering with other attempts at forming commissioning networks.

### 25885 **13.2.4.2 EUI-64s Reserved for Other Uses**

25886 Additional EUI-64s have been reserved for other use by the Alliance. At this point, their intended usage has  
25887 not been specified. These identifiers should not be used without prior agreement with the ZigBee Alliance.  
25888 It is recommended that if a profile or application developer requires the use of these additional EUI-64s, they  
25889 should contact the Core Stack Group (CSG) within the ZigBee Alliance.

25890 

## 13.3 Touchlink Commissioning

25891 The *Touchlink Commissioning* cluster provides commands to support touchlink commissioning. This cluster  
25892 should not be considered part of a sub-device but rather part of the entire device. The touchlink commissioning  
25893 cluster is comprised of two sets of commands – one providing touchlink commissioning functionality  
25894 and one providing commissioning utility functionality.

25895 The touchlink commissioning command set has command identifiers in the range 0x00 – 0x3f and shall be  
25896 transmitted using the inter-PAN transmission service.

25897 The commissioning utility command set has command identifiers in the range 0x40 – 0xff and shall be trans-  
25898 mitted using the standard unicast transmission service, similar to that used for other ZCL cluster commands.  
25899 These commands enable the exchange of control information between controllers (i.e., devices with a device  
25900 identifier in the range 0x0800 – 0x0850).

25901 A controller application endpoint may send an *endpoint information* command frame to another controller  
25902 application endpoint to announce itself. It is then up to the recipient controller application endpoint to decide  
25903 to take further action to get information about the lights that are controlled by the originator. If it decides to  
25904 do so, it can use the *get group identifiers request* command frame to get knowledge about the group of lights  
25905 controlled by the originator. The originator responds with a *get group identifiers response* command frame  
25906 containing the requested information (which may have a start index field and a count field equal to 0, indi-  
25907 cating no groups are used). Similarly, the recipient device can use the *get endpoint list request* command  
25908 frame to get knowledge about the list of individual lights controlled by the originator. The originator responds  
25909 with a *get endpoint list response* command frame containing the requested information (which may have a  
25910 start index field and a count field equal to 0, indicating no lights are controlled).

25911 **Note:** A typical controller application will likely reside inside battery powered remote controllers on top of  
25912 a ZigBee sleeping end-device. As such, care should be taken as to when to send these commands to ensure  
25913 the recipient is awake. It is recommended that such commands are sent just after touchlink commissioning  
25914 between two controllers when the devices are not yet asleep and still polling for data from their parent.

25915 

### 13.3.1 Overview

25916 Please see Chapter 2 for a general cluster overview defining cluster architecture, revision, classification,  
25917 identification, etc.

25918 The *touchlink commissioning* cluster shall have a cluster identifier of 0x1000. Those commands in the touch-  
25919 link commissioning command set shall be sent using the profile identifier, 0xc05e whereas those commands  
25920 in the commissioning utility command set shall sent using the profile identifier, 0x0104.

25921 

#### 13.3.1.1 Revision History

25922 The global *ClusterRevision* attribute value SHALL be the highest revision number in the table below.

Rev	Description
1	mandatory global <i>ClusterRevision</i> attribute added
2	added Profile Interop bit in Scan Request frame, CCB 2115 2105
3	CCB 2648

25923 

#### 13.3.1.2 Classification

Hierarchy	Role	PICS Code
Base	Utility	TL

25924 **13.3.1.3 Cluster Identifiers**

Identifier	Name
0x1000	Touchlink Commissioning

25925 **13.3.2 Server**

25926 **13.3.2.1 Attributes**

25927 The server has no attributes.

25928 **13.3.2.2 Commands Received**

25929 When a device implements the *touchlink commissioning* cluster at the ZCL server side, it shall be able to  
25930 receive the commands listed in Table 13-13.

25931

**Table 13-13. Commands Received by the Server Side of the Touchlink Commissioning Cluster**

	Command Identifier Field Value	Description	M/O	Reference
Touchlink	0x00	Scan request	M	13.3.2.2.1
	0x02	Device information request	M	13.3.2.2.2
	0x06	Identify request	M	13.3.2.2.3
	0x07	Reset to factory new request	M	13.3.2.2.4
	0x10	Network start request	M	13.3.2.2.5
	0x12	Network join router request	M	13.3.2.2.6
	0x14	Network join end device request	M	13.3.2.2.7
	0x16	Network update request	M	13.3.2.2.8
	All other values in the range 0x00 – 0x3f	<i>Reserved</i>	-	-
Utility	0x41	Get group identifiers request	O*	13.3.2.2.9
	0x42	Get endpoint list request	O*	13.3.2.2.10
	All other values in the range 0x40 – 0xff	<i>Reserved</i>	-	-

25932 \* These are mandatory for a controller device as defined in the device specification.

25933 **13.3.2.2.1 Scan Request Command Frame**

25934 The *scan request* command frame is used to initiate a scan for other devices in the vicinity of the originator.  
25935 The information contained in this command frame relates to the scan request initiator.

25936 This inter-PAN command shall be formatted according to the general inter-PAN frame format with the fol-  
25937 lowing clarifications. In the MAC header, the ACK request and destination addressing mode sub-fields of  
25938 the frame control field shall be set to 0 (no ACK requested) and 0b10 (short network address), respectively,  
25939 the destination address field shall be set to 0xffff (broadcast network address) and the source PAN ID field  
25940 shall be set to any value in the range 0x0001 – 0xffff, if the device is factory new, or the PAN identifier of  
25941 the device, otherwise. In the APS header, the delivery mode sub-field of the frame control field shall be set  
25942 to 0b10 (broadcast). In the ZCL header, the direction sub-field of the frame control field shall be set to 0  
25943 (client to server) and the command identifier shall be set to 0x00 (scan request).

25944 The ZCL payload field shall contain the *scan request* command frame itself, formatted as illustrated in Figure  
25945 13-8.

25946

**Figure 13-8. Format of the Scan Request Command Frame**

<b>Octets</b>	4	1	1
<b>Data Type</b>	Unsigned 32-bit integer	8-bit bitmap	8-bit bitmap
<b>Field Name</b>	Inter-PAN transaction identifier	ZigBee information	Touchlink information

25947

**13.3.2.2.1.1 Inter-PAN Transaction Identifier Field**

25948  
 25949  
 25950

The *inter-PAN transaction identifier* field is 32-bits in length and specifies an identifier for the inter-PAN transaction. This field shall contain a 32-bit non-zero random number and is used to identify the current transaction.

25951

**13.3.2.2.1.2 ZigBee Information Field**

25952  
 25953

The *ZigBee information* field is 8-bits in length and specifies information related to ZigBee. This field shall be formatted as illustrated in Figure 13-9.

25954

**Figure 13-9. Format of the ZigBee Information Field**

<b>Bits: 0-1</b>	2	3-7
Logical type	Rx on when idle	Reserved

25955  
 25956

The *logical type* subfield is 2-bits in length and specifies the logical type of the device. The value of this subfield shall be set to 0b00 for a coordinator, 0b01 for a router or 0b10 for an end device.

25957  
 25958

The Rx on when idle subfield is 1 bit in length and specifies the *RxOnWhenIdle* state of the device. The value of this subfield shall be set to 1 to indicate that the receiver is left on when the device is idle or 0 otherwise.

25959

**13.3.2.2.1.3 Touchlink information field**

25960  
 25961

The *Touchlink information* field is 8-bits in length and specifies touchlink-specific information. This field shall be formatted as illustrated in Figure 13-10.

25962

**Figure 13-10. Format of the Scan Request Touchlink Information Field**

<b>Bits: 0</b>	1	2-3	4	5	6	7
Factory new	Address assignment	Reserved	Link initiator	Undefined (can be 0 or 1)	Reserved	Profile Interop

25963  
 25964

The *factory new* subfield is 1 bit in length and specifies whether the device is factory new. The value of this subfield shall be set to 1 to indicate the device is factory new or 0 otherwise.

25965  
 25966  
 25967

The address assignment subfield is 1 bit in length and specifies whether the device is capable of assigning addresses. The value of this subfield shall be set to 1 to indicate the device is capable of assigning addresses or 0 otherwise.

25968  
 25969  
 25970  
 25971

The link initiator subfield is 1 bit in length and specifies whether the device is capable of initiating a link operation. The value of this subfield shall be set to 1 to indicate the device is capable of initiating a link (i.e., it supports the touchlink commissioning cluster at the client side) or 0 otherwise (i.e., it does not support the touchlink commissioning cluster at the client side).

25972 The Profile Interop subfield is 1 bit in length and specifies which profile the device implements. If the ZLL  
25973 profile is implemented, this bit shall be set to 0. In all other case (Profile Interop / ZigBee 3.0), this bit shall  
25974 be set to 1.

25975

### 25976 **13.3.2.2.2 Device Information Request Command Frame**

25977 The *device information request* command frame is used to request information regarding the sub-devices of  
25978 a remote device.

25979 This inter-PAN command shall be formatted according to the general inter-PAN frame format with the fol-  
25980 lowing clarifications. In the MAC header, the ACK request and destination addressing mode sub-fields of  
25981 the frame control field shall be set to 1 (ACK requested) and 0b11 (extended IEEE address), respectively,  
25982 the destination address field shall contain the IEEE address of the destination and the source PAN ID field  
25983 shall be set to the same value used in the preceding *scan request* inter-PAN command frame, if the device is  
25984 factory new, or the PAN identifier of the device, otherwise. In the APS header, the delivery mode sub-field  
25985 of the frame control field shall be set to 0b00 (normal unicast). In the ZCL header, the direction sub-field of  
25986 the frame control field shall be set to 0 (client to server) and the command identifier shall be set to 0x02  
25987 (device information request).

25988 The ZCL payload field shall contain the *device information request* command frame itself, formatted as il-  
25989 lustrated in Figure 13-11.

25990

**Figure 13-11. Format of the Device Information Request Command Frame**

<b>Octets</b>	4	1
<b>Data Type</b>	Unsigned 32-bit integer	Unsigned 8-bit integer
<b>Field Name</b>	Inter-PAN transaction identifier	Start index

#### 25991 **13.3.2.2.2.1 Inter-PAN Transaction Identifier Field**

25992 The *inter-PAN transaction identifier* field is 32-bits in length and specifies an identifier for the inter-PAN  
25993 transaction. This value shall be identical to the *inter-PAN transaction identifier* field of the original *scan*  
25994 *request* inter-PAN command frame sent by the initiator.

#### 25995 **13.3.2.2.2.2 Start Index Field**

25996 The *start index* field is 8-bits in length and specifies the starting index (starting from 0) into the device table  
25997 from which to get device information.

### 25998 **13.3.2.2.3 Identify Request Command Frame**

25999 The *identify request* command frame is used to request that the recipient identifies itself in some application  
26000 specific way to aid with touchlinking.

26001 This inter-PAN command shall be formatted according to the general inter-PAN frame format with the fol-  
 26002 lowing clarifications. In the MAC header, the ACK request and destination addressing mode sub-fields of  
 26003 the frame control field shall be set to 1 (ACK requested) and 0b11 (extended IEEE address), respectively,  
 26004 the destination address field shall contain the IEEE address of the destination and the source PAN ID field  
 26005 shall be set to the same value used in the preceding *scan request* inter-PAN command frame, if the device is  
 26006 factory new, or the PAN identifier of the device, otherwise. In the APS header, the delivery mode sub-field  
 26007 of the frame control field shall be set to 0b00 (normal unicast). In the ZCL header, the direction sub-field of  
 26008 the frame control field shall be set to 0 (client to server) and the command identifier shall be set to 0x06  
 26009 (identify request).

26010 The ZCL payload field shall contain the *identify request* command frame itself, formatted as illustrated in  
 26011 Figure 13-12.

26012

**Figure 13-12. Format of the Identify Request Command Frame**

<b>Octets</b>	4	2
<b>Data Type</b>	Unsigned 32-bit integer	Unsigned 16-bit integer
<b>Field Name</b>	Inter-PAN transaction identifier	Identify duration

26013 **13.3.2.2.3.1 Inter-PAN Transaction Identifier Field**

26014 The *inter-PAN transaction identifier* field is 32-bits in length and specifies an identifier for the inter-PAN  
 26015 transaction. This value shall be identical to the *inter-PAN transaction identifier* field of the original *scan*  
 26016 *request* inter-PAN command frame sent by the initiator.

26017 **13.3.2.2.3.2 Identify Duration Field**

26018 The *identify duration* field is 16-bits in length and shall specify the length of time the recipient is to remain  
 26019 in identify mode. The value of this field shall be set to one of the values listed in Table 13-14.

26020

**Table 13-14. Values of the Identify Duration Field**

<b>Identify duration Field Value</b>	<b>Description</b>
0x0000	Exit identify mode
0x0001 – 0xffff	Number of seconds to remain in identify mode
0xffff	Remain in identify mode for a default time known by the receiver

26021 Note that if a device is not capable of identifying for the exact time specified in the identify duration field, it  
 26022 shall identify itself for a duration as close as possible to the requested value.

26023 **13.3.2.2.4 Reset to Factory New Request Command Frame**

26024 The *reset to factory new request* command frame is used to request that the recipient resets itself back to its  
 26025 factory new state.

26026 This inter-PAN command shall be formatted according to the general inter-PAN frame format with the fol-  
 26027 lowing clarifications. In the MAC header, the ACK request and destination addressing mode sub-fields of  
 26028 the frame control field shall be set to 1 (ACK requested) and 0b11 (extended IEEE address), respectively,  
 26029 the destination address field shall contain the IEEE address of the destination and the source PAN ID field  
 26030 shall be set to the same value used in the preceding scan request inter-PAN command frame, if the device is  
 26031 factory new, or the PAN identifier of the device, otherwise. In the APS header, the delivery mode sub-field  
 26032 of the frame control field shall be set to 0b00 (normal unicast). In the ZCL header, the direction sub-field of  
 26033 the frame control field shall be set to 0 (client to server) and the command identifier shall be set to 0x07 (reset  
 26034 to factory new request).

26035 The ZCL payload field shall contain the reset to factory new request command frame itself and this shall be  
 26036 formatted as illustrated in Figure 13-13.

26037 **Figure 13-13. Format of the Reset to Factory New Request Command Frame**

<b>Octets</b>	4
<b>Data Type</b>	Unsigned 32-bit integer
<b>Field Name</b>	Inter-PAN transaction identifier

#### 26038 **13.3.2.2.4.1 Inter-PAN Transaction Identifier Field**

26039 The *inter-PAN transaction identifier* field is 32-bits in length and specifies an identifier for the inter-PAN  
 26040 transaction. This field shall contain a non-zero 32-bit random number and is used to identify the current reset  
 26041 to factory new request.

#### 26042 **13.3.2.2.5 Network Start Request Command Frame**

26043 The *network start request* command frame is used by a factory new initiator to form a new network with a  
 26044 router.

26045 This inter-PAN command shall be formatted according to the general inter-PAN frame format with the fol-  
 26046 lowing clarifications. In the MAC header, the ACK request and destination addressing mode sub-fields of  
 26047 the frame control field shall be set to 1 (ACK requested) and 0b11 (extended IEEE address), respectively,  
 26048 the destination address field shall contain the IEEE address of the destination and the source PAN ID field  
 26049 shall be set to the same value used in the preceding *scan request* inter-PAN command frame, if the device is  
 26050 factory new, or the PAN identifier of the device, otherwise. In the APS header, the delivery mode sub-field  
 26051 of the frame control field shall be set to 0b00 (normal unicast). In the ZCL header, the direction sub-field of  
 26052 the frame control field shall be set to 0 (client to server) and the command identifier shall be set to 0x10  
 26053 (network start request).

26054 The ZCL payload field shall contain the *network start request* command frame itself, formatted as illustrated  
 26055 in Figure 13-14.

26056 **Figure 13-14. Format of the Network Start Request Command Frame**

<b>Octets</b>	<b>Data Type</b>	<b>Field Name</b>
4	Unsigned 32-bit integer	Inter-PAN transaction identifier
8	IEEE address	Extended PAN identifier
1	Unsigned 8-bit integer	Key index
16	128-bit security key	Encrypted network key
1	Unsigned 8-bit integer	Logical channel



Octets	Data Type	Field Name
2	Unsigned 16-bit integer	PAN identifier
2	Unsigned 16-bit integer	Network address
2	Unsigned 16-bit integer	Group identifiers begin
2	Unsigned 16-bit integer	Group identifiers end
2	Unsigned 16-bit integer	Free network address range begin
2	Unsigned 16-bit integer	Free network address range end
2	Unsigned 16-bit integer	Free group identifier range begin
2	Unsigned 16-bit integer	Free group identifier range end
8	IEEE address	Initiator IEEE address
2	Unsigned 16-bit integer	Initiator network address

26057 **13.3.2.2.5.1 Inter-PAN Transaction Identifier Field**

26058 The *inter-PAN transaction identifier* field is 32-bits in length and specifies an identifier for the inter-PAN  
 26059 transaction. This value shall be identical to the *inter-PAN transaction identifier* field of the original *scan*  
 26060 *request* inter-PAN command frame sent by the initiator.

26061 **13.3.2.2.5.2 Extended PAN Identifier Field**

26062 The *extended PAN identifier* field is 64-bits in length and shall contain the extended PAN identifier of the  
 26063 new network. If this value is equal to zero, the target shall determine the extended PAN identifier for the new  
 26064 network.

26065 **13.3.2.2.5.3 Key Index Field**

26066 The *key index* field is 8-bits in length and shall specify the index (in the range 0x00 – 0x0f) of the key (and  
 26067 hence the protection method) to be used in the *encrypted network key* field.

26068 **13.3.2.2.5.4 Encrypted Network Key Field**

26069 The *encrypted network key* field is 128-bits in length and shall specify the network key to use for the network,  
 26070 encrypted according to the algorithm indicated by the *key index* field.

26071 **13.3.2.2.5.5 Logical Channel Field**

26072 The *logical channel* field is 8-bits in length and shall contain the touchlink channel to be used for the new  
 26073 network. If this value is equal to zero, the target shall determine the logical channel for the new network.

26074 **13.3.2.2.5.6 PAN Identifier Field**

26075 The *PAN identifier* field is 16-bits in length and shall contain the identifier of the new PAN. If this value is  
 26076 equal to zero, the target shall determine the PAN identifier for the new network.

26077 **13.3.2.2.5.7 Network Address Field**

26078 The *network address* field is 16-bits in length and contains the short network address (in the range 0x0001 –  
 26079 0xffff) assigned to the recipient.

26080 **13.3.2.2.5.8 Group Identifiers Begin Field**

26081 The *group identifiers begin* field is 16-bits in length and specifies the start of the range of group identifiers  
 26082 that the recipient can use for its endpoints. If this value is equal to zero, a range of group identifiers has not  
 26083 been allocated.

26084 **13.3.2.2.5.9 Group Identifiers End Field**

26085 The *group identifiers end* field is 16-bits in length and specifies the end of the range of group identifiers that  
26086 the recipient can use for its endpoints. If the value of the *group identifiers begin* field is equal to zero, a range  
26087 of group identifiers has not been allocated and this field shall be ignored.

#### 26088 **13.3.2.2.5.10 Free Network Address Range Begin Field**

26089 The *free network address range begin* field is 16-bits in length and shall contain the value of the  
26090 *aplFreeNwkAddrRangeBegin* attribute, specifying the start of the range of network addresses that the recip-  
26091 ient can assign. If this value is equal to zero, a range of network addresses has not been allocated by the  
26092 initiator for subsequent allocation by the target.

#### 26093 **13.3.2.2.5.11 Free Network Address Range End Field**

26094 The *free network address range end* field is 16-bits in length and shall contain the value of the  
26095 *aplFreeNwkAddrRangeEnd* attribute, specifying the end of the range of network addresses that the recipient  
26096 can assign. If the value of the *free network address range begin* field is equal to zero, a range of network  
26097 addresses has not been allocated by the initiator for subsequent allocation by the target and this field shall be  
26098 ignored.

#### 26099 **13.3.2.2.5.12 Free Group Identifier Range Begin Field**

26100 The *free group identifiers begin* field is 16-bits in length and shall contain the value of the *aplFreeGroupID-*  
26101 *RangeBegin* attribute, specifying the start of the range of group identifiers that the recipient can assign. If  
26102 this value is equal to zero, a range of group identifiers has not been allocated by the initiator for subsequent  
26103 allocation by the target.

#### 26104 **13.3.2.2.5.13 Free Group Identifier Range End Field**

26105 The *free group identifiers end* field is 16-bits in length and shall contain the value of the *aplFreeGroupID-*  
26106 *RangeEnd* attribute, specifying the end of the range of group identifiers that the recipient can assign. If the  
26107 value of the *free group identifier range begin* field is equal to zero, a range of group identifiers has not been  
26108 allocated by the initiator for subsequent allocation by the target and this field shall be ignored.

#### 26109 **13.3.2.2.5.14 Initiator IEEE Address**

26110 The *initiator IEEE address* is 64-bits in length and shall contain the IEEE address of the initiator of the new  
26111 network.

#### 26112 **13.3.2.2.5.15 Initiator Network Address Field**

26113 The *initiator network address* is 16-bits in length and shall contain the short network address of the initiator  
26114 of the new network.

### 26115 **13.3.2.2.6 Network Join Router Request Command Frame**

26116 The *network join router request* command frame is used by a non-factory-new initiator to join a router to its  
26117 network.

26118 This inter-PAN command shall be formatted according to the general inter-PAN frame format with the fol-  
26119 lowing clarifications. In the MAC header, the ACK request and destination addressing mode sub-fields of  
26120 the frame control field shall be set to 1 (ACK requested) and 0b11 (extended IEEE address), respectively,  
26121 the destination address field shall contain the IEEE address of the destination and the source PAN ID field  
26122 shall be set to the same value used in the preceding scan request inter-PAN command frame, if the device is  
26123 factory new, or the PAN identifier of the device, otherwise. In the APS header, the delivery mode sub-field  
26124 of the frame control field shall be set to 0b00 (normal unicast). In the ZCL header, the direction sub-field of  
26125 the frame control field shall be set to 0 (client to server) and the command identifier shall be set to 0x12  
26126 (network join router request).

26127 The ZCL payload field shall contain the network join router request command frame itself, formatted as  
 26128 illustrated in Figure 13-15.

26129 **Figure 13-15. Format of the Network Join Router Request Command Frame**

Octets	Data Type	Field Name
4	Unsigned 32-bit integer	Inter-PAN transaction identifier
8	IEEE address	Extended PAN identifier
1	Unsigned 8-bit integer	Key index
16	128-bit security key	Encrypted network key
1	Unsigned 8-bit integer	Network update identifier
1	Unsigned 8-bit integer	Logical channel
2	Unsigned 16-bit integer	PAN identifier
2	Unsigned 16-bit integer	Network address
2	Unsigned 16-bit integer	Group identifiers begin
2	Unsigned 16-bit integer	Group identifiers end
2	Unsigned 16-bit integer	Free network address range begin
2	Unsigned 16-bit integer	Free network address range end
2	Unsigned 16-bit integer	Free group identifier range begin
2	Unsigned 16-bit integer	Free group identifier range end

26130 **13.3.2.2.6.1 Inter-PAN Transaction Identifier Field**

26131 The *inter-PAN transaction identifier* field is 32-bits in length and specifies an identifier for the inter-PAN  
 26132 transaction. This value shall be identical to the inter-PAN transaction identifier field of the original scan  
 26133 request inter-PAN command frame sent by the initiator.

26134 **13.3.2.2.6.2 Extended PAN Identifier Field**

26135 The *extended PAN identifier* field is 64-bits in length and shall contain the extended PAN identifier of the  
 26136 network.

26137 **13.3.2.2.6.3 Key Index Field**

26138 The *key index* field is 8-bits in length and shall specify the index (in the range 0x00 – 0x0f) of the key (and  
 26139 hence the protection method) to be used in the *encrypted network key* field.

26140 **13.3.2.2.6.4 Encrypted Network Key Field**

26141 The *encrypted network key* field is 128-bits in length and shall specify the network key to use for the network,  
 26142 encrypted according to the algorithm indicated by the *key index* field.

26143 **13.3.2.2.6.5 Network Update Identifier Field**

26144 The *network update identifier* field is 8-bits in length and shall specify the value of the *nwkUpdateId* attribute  
 26145 of the initiator.

26146 **13.3.2.2.6.6 Logical Channel Field**

26147 The *logical channel* field is 8-bits in length and shall contain the ZLL channel to be used for the network.

26148 **13.3.2.2.6.7 PAN Identifier Field**

26149 The *PAN identifier* field is 16-bits in length and shall contain the PAN identifier of the network.

**26150 13.3.2.2.6.8 Network Address Field**

26151 The *network address* field is 16-bits in length and contains the short network address assigned to the target.

**26152 13.3.2.2.6.9 Group Identifiers Begin Field**

26153 The *group identifiers begin* field is 16-bits in length and specifies the start of the range of group identifiers  
26154 that the router can use for its endpoints. If this value is equal to zero, a range of group identifiers has not been  
26155 allocated.

**26156 13.3.2.2.6.10 Group Identifiers End Field**

26157 The *group identifiers end* field is 16-bits in length and specifies the end of the range of group identifiers that  
26158 the router can use for its endpoints. If the value of the *group identifiers begin* field is equal to zero, a range  
26159 of group identifiers has not been allocated and this field shall be ignored.

**26160 13.3.2.2.6.11 Free Network Address Range Begin Field**

26161 The *free network address range begin* field is 16-bits in length and shall contain the value of the  
26162 *aplFreeNwkAddrRangeBegin* attribute, specifying the start of the range of network addresses that the router  
26163 can assign. If this value is equal to zero, a range of network addresses has not been allocated by the initiator  
26164 for subsequent allocation by the target.

**26165 13.3.2.2.6.12 Free Network Address Range End Field**

26166 The *free network address range end* field is 16-bits in length and shall contain the value of the  
26167 *aplFreeNwkAddrRangeEnd* attribute, specifying the end of the range of network addresses that the router can  
26168 assign. If the value of the *free network address range begin* field is equal to zero, a range of network addresses  
26169 has not been allocated by the initiator for subsequent allocation by the target and this field shall be ignored.

**26170 13.3.2.2.6.13 Free Group Identifier Range Begin Field**

26171 The *free group identifiers begin* field is 16-bits in length and shall contain the value of the *aplFreeGroupID-*  
26172 *RangeBegin* attribute, specifying the start of the range of group identifiers that the router can assign. If this  
26173 value is equal to zero, a range of group identifiers has not been allocated by the initiator for subsequent  
26174 allocation by the target.

**26175 13.3.2.2.6.14 Free Group Identifier Range End Field**

26176 The *free group identifiers end* field is 16-bits in length and shall contain the value of the *aplFreeGroupID-*  
26177 *RangeEnd* attribute, specifying the end of the range of group identifiers that the router can assign. If the value  
26178 of the *free group identifier range begin* field is equal to zero, a range of group identifiers has not been allo-  
26179 cated by the initiator for subsequent allocation by the target and this field shall be ignored.

**26180 13.3.2.2.7 Network Join End Device Request Command Frame**

26181 The *network join end device request* command frame is used by a non-factory-new initiator to join a factory  
26182 new end device to its network.

26183 This inter-PAN command shall be formatted according to the general inter-PAN frame format with the fol-  
26184 lowing clarifications. In the MAC header, the ACK request and destination addressing mode sub-fields of  
26185 the frame control field shall be set to 1 (ACK requested) and 0b11 (extended IEEE address), respectively,  
26186 the destination address field shall contain the IEEE address of the destination and the source PAN ID field  
26187 shall be set to the same value used in the preceding *scan request* inter-PAN command frame, if the device is  
26188 factory new, or the PAN identifier of the device, otherwise. In the APS header, the delivery mode sub-field  
26189 of the frame control field shall be set to 0b00 (normal unicast). In the ZCL header, the direction sub-field of  
26190 the frame control field shall be set to 0 (client to server) and the command identifier shall be set to 0x14  
26191 (network join end device request).

26192 The ZCL payload field shall contain the *network join end device request* command frame itself, formatted as  
 26193 illustrated in Figure 13-16.

26194 **Figure 13-16. Format of the Network Join End Device Request Command Frame**

Octets	Data Type	Field Name
4	Unsigned 32-bit integer	Inter-PAN transaction identifier
8	IEEE address	Extended PAN identifier
1	Unsigned 8-bit integer	Key index
16	128-bit security key	Encrypted network key
1	Unsigned 8-bit integer	Network update identifier
1	Unsigned 8-bit integer	Logical channel
2	Unsigned 16-bit integer	PAN identifier
2	Unsigned 16-bit integer	Network address
2	Unsigned 16-bit integer	Group identifiers begin
2	Unsigned 16-bit integer	Group identifiers end
2	Unsigned 16-bit integer	Free network address range begin
2	Unsigned 16-bit integer	Free network address range end
2	Unsigned 16-bit integer	Free group identifier range begin
2	Unsigned 16-bit integer	Free group identifier range end

26195 **13.3.2.2.7.1 Inter-PAN Transaction Identifier Field**

26196 The *inter-PAN transaction identifier* field is 32-bits in length and specifies an identifier for the inter-PAN  
 26197 transaction. This value shall be identical to the *inter-PAN transaction identifier* field of the original *scan*  
 26198 *request* inter-PAN command frame sent by the initiator.

26199 **13.3.2.2.7.2 Extended PAN Identifier Field**

26200 The *extended PAN identifier* field is 64-bits in length and shall contain the extended PAN identifier of the  
 26201 network.

26202 **13.3.2.2.7.3 Key Index Field**

26203 The *key index* field is 8-bits in length and shall specify the index (in the range 0x00 – 0x0f) of the key (and  
 26204 hence the protection method) to be used in the *encrypted network key* field.

26205 **13.3.2.2.7.4 Encrypted Network Key Field**

26206 The *encrypted network key* field is 128-bits in length and shall specify the network key to use for the network,  
 26207 encrypted according to the algorithm indicated by the *key index* field.

26208 **13.3.2.2.7.5 Network Update Identifier Field**

26209 The *network update identifier* field is 8-bits in length and shall specify the current value of the *nwkUpdateId*  
 26210 attribute of the originator.

26211 **13.3.2.2.7.6 Logical Channel Field**

26212 The *logical channel* field is 8-bits in length and shall contain the ZLL channel to be used for the network.

26213 **13.3.2.2.7.7 PAN Identifier Field**

26214 The *PAN identifier* field is 16-bits in length and shall contain the PAN identifier of the network.

**26215 13.3.2.2.7.8 Network Address Field**

26216 The *network address* field is 16-bits in length and contains the short network address assigned to the target.

**26217 13.3.2.2.7.9 Group Identifiers Begin Field**

26218 The *group identifiers begin* field is 16-bits in length and specifies the start of the range of group identifiers  
26219 that the end device can use for its endpoints. If this value is equal to zero, a range of group identifiers has not  
26220 been allocated.

**26221 13.3.2.2.7.10 Group Identifiers End Field**

26222 The *group identifiers end* field is 16-bits in length and specifies the end of the range of group identifiers that  
26223 the end device can use for its endpoints. If the value of the *group identifiers begin* field is equal to zero, a  
26224 range of group identifiers has not been allocated and this field shall be ignored.

**26225 13.3.2.2.7.11 Free Network Address Range Begin Field**

26226 The *free network address range begin* field is 16-bits in length and shall contain the value of the  
26227 *aplFreeNwkAddrRangeBegin* attribute, specifying the start of the range of network addresses that the end  
26228 device can assign. If this value is equal to zero, a range of network addresses has not been allocated by the  
26229 initiator for subsequent allocation by the target.

**26230 13.3.2.2.7.12 Free Network Address Range End Field**

26231 The *free network address range end* field is 16-bits in length and shall contain the value of the  
26232 *aplFreeNwkAddrRangeEnd* attribute, specifying the end of the range of network addresses that the end device  
26233 can assign. If the value of the *free network address range begin* field is equal to zero, a range of network  
26234 addresses has not been allocated by the initiator for subsequent allocation by the target and this field shall be  
26235 ignored.

**26236 13.3.2.2.7.13 Free Group Identifier Range Begin Field**

26237 The *free group identifiers begin* field is 16-bits in length and shall contain the value of the *aplFreeGroupID-*  
26238 *RangeBegin* attribute, specifying the start of the range of group identifiers that the end device can assign. If  
26239 this value is equal to zero, a range of group identifiers has not been allocated by the initiator for subsequent  
26240 allocation by the target.

**26241 13.3.2.2.7.14 Free Group Identifier Range End Field**

26242 The *free group identifiers end* field is 16-bits in length and shall contain the value of the *aplFreeGroupID-*  
26243 *RangeEnd* attribute, specifying the end of the range of group identifiers that the end device can assign. If the  
26244 value of the *free group identifier range begin* field is equal to zero, a range of group identifiers has not been  
26245 allocated by the initiator for subsequent allocation by the target and this field shall be ignored.

**26246 13.3.2.2.8 Network Update Request Command Frame**

26247 The *network update request* command frame is used to attempt to bring a router that may have missed a  
26248 network update back onto the network.

26249 This inter-PAN command shall be formatted according to the general inter-PAN frame format with the fol-  
26250 lowing clarifications. In the MAC header, the ACK request and destination addressing mode sub-fields of  
26251 the frame control field shall be set to 1 (ACK requested) and 0b11 (extended IEEE address), respectively,  
26252 the destination address field shall contain the IEEE address of the destination and the source PAN ID field  
26253 shall be set to the PAN identifier of the initiating device. In the APS header, the delivery mode sub-field of  
26254 the frame control field shall be set to 0b00 (normal unicast). In the ZCL header, the direction sub-field of the  
26255 frame control field shall be set to 0 (client to server) and the command identifier shall be set to 0x16 (network  
26256 update request).

26257 The ZCL payload field shall contain the *network update request* command frame itself, formatted as in Figure  
 26258 13-17.

26259 **Figure 13-17. Format of the Network Update Request Command Frame**

<b>Octets</b>	4	8	1	1	2	2
<b>Data Type</b>	uint32	IEEE address	uint8	uint8	uint16	uint16
<b>Field Name</b>	Inter-PAN transaction identifier	Extended PAN identifier	Network update identifier	Logical channel	PAN identifier	Network address

26260 **13.3.2.2.8.1 Inter-PAN Transaction Identifier Field**

26261 The *inter-PAN transaction identifier* field is 32-bits in length and specifies an identifier for the inter-PAN  
 26262 transaction. This field shall contain a non-zero 32-bit random number and is used to identify the current  
 26263 network update request.

26264 **13.3.2.2.8.2 Extended PAN Identifier Field**

26265 The *extended PAN identifier* field is 64-bits in length and shall contain the extended PAN identifier of the  
 26266 network.

26267 **13.3.2.2.8.3 Network Update Identifier Field**

26268 The *network update identifier* field is 8-bits in length and shall specify the current value of the *nwkUpdateId*  
 26269 attribute of the originator.

26270 **13.3.2.2.8.4 Logical Channel Field**

26271 The *logical channel* field is 8-bits in length and shall contain the ZLL channel to be used for the network.

26272 **13.3.2.2.8.5 PAN Identifier Field**

26273 The *PAN identifier* field is 16-bits in length and shall contain the PAN identifier of the network.

26274 **13.3.2.2.8.6 Network Address Field**

26275 The *network address* field is 16-bits in length and contains the short network address assigned to the target.

26276 **13.3.2.2.9 Get Group Identifiers Request Command**

26277 The *get group identifiers request* command is used to retrieve the actual group identifiers that the endpoint  
 26278 is using in its multicast communication in controlling different (remote) devices.

26279 This command shall be formatted as illustrated in Figure 13-18.

26280

**Figure 13-18. Format of the Get Group Identifiers Request Command**

<b>Octets</b>	1
<b>Data Type</b>	Unsigned 8-bit integer
<b>Field Name</b>	Start index

26281 **13.3.2.2.9.1 Start Index Field**

26282 The *start index* field is 8-bits in length and shall contain the index (starting from 0) at which to start returning  
26283 group identifiers.

26284 **13.3.2.2.10 Get Endpoint List Request Command**

26285 The *get endpoint list request* command is used to retrieve addressing information for each endpoint the device  
26286 is using in its unicast communication in controlling different (remote) devices.

26287 This command shall be formatted as illustrated in Figure 13-19.

26288 **Figure 13-19. Format of the Get Endpoint List Request Command**

<b>Octets</b>	1
<b>Data Type</b>	Unsigned 8-bit integer
<b>Field Name</b>	Start index

26289 **13.3.2.2.10.1 Start Index Field**

26290 The *start index* field is 8-bits in length and shall contain the index (starting from 0) at which to start returning  
26291 endpoint identifiers.

26292 **13.3.2.3 Commands Generated**

26293 When a device implements the *touchlink commissioning* cluster at the ZCL server side, it shall be able to  
26294 generate the commands listed in Table 13-15.

26295 **Table 13-15. Commands Generated by the Server Side of the Touchlink Commissioning Cluster**

	<b>Command Identifier Field Value</b>	<b>Description</b>	<b>Mandatory/Optional</b>	<b>Reference</b>
<b>Touchlink</b>	0x01	Scan response	Mandatory	13.3.2.3.1
	0x03	Device information response	Mandatory	13.3.2.3.2
	0x11	Network start response	Mandatory	13.3.2.3.3
	0x13	Network join router response	Mandatory	13.3.2.3.4
	0x15	Network join end device response	Mandatory	13.3.2.3.5



	All other values in the range 0x00 – 0x3f	Reserved	-	-
Utility	0x40	Endpoint information	Mandatory	13.3.2.3.6
	0x41	Get group identifiers response	Mandatory	13.3.2.3.7
	0x42	Get endpoint list response	Mandatory	13.3.2.3.8
	All other values in the range 0x40 – 0xff	Reserved	-	-

26296 **13.3.2.3.1 Scan Response Command Frame**

26297 The *scan response* command frame is used to respond to the originator of a *scan request* command frame  
 26298 with device details. The information contained in this command frame relates to the target that is responding  
 26299 to the scan request command frame.

26300 Note: If the Profile Interop bit of the Touchlink Information field of the received Scan Request command is  
 26301 set to zero, the device may choose to represent its device information in the form of ZLL device infor-  
 26302 mation to support legacy devices. If this bit is set to one, the device shall use the device information as  
 26303 given in its simple descriptors.

26304 This inter-PAN command shall be formatted according to the general inter-PAN frame format with the fol-  
 26305 lowing clarifications. In the MAC header, the ACK request and destination addressing mode sub-fields of  
 26306 the frame control field shall be set to 1 (ACK requested) and 0b11 (extended IEEE address), respectively,  
 26307 the destination address field shall contain the IEEE address of the destination and the source PAN ID field  
 26308 shall be set to any value in the range 0x0001 – 0xffff, if the device is factory new, or the PAN identifier of  
 26309 the device, otherwise. In the APS header, the delivery mode sub-field of the frame control field shall be set  
 26310 to 0b00 (normal unicast). In the ZCL header, the direction sub-field of the frame control field shall be set to  
 26311 1 (server to client) and the command identifier shall be set to 0x01 (scan response).

26312 The ZCL payload field shall contain the scan response command frame itself, formatted as illustrated in  
 26313 Figure 13-20.

26314 **Figure 13-20. Format of the Scan Response Command Frame**

Octets	Data Type	Field Name
4	Unsigned 32-bit integer	Inter-PAN transaction identifier
1	Unsigned 8-bit integer	RSSI correction
1	8-bit bitmap	ZigBee information
1	8-bit bitmap	Touchlink information
2	16-bit bitmap	Key bitmask
4	Unsigned 32-bit integer	Response identifier
8	IEEE address	Extended PAN identifier
1	Unsigned 8-bit integer	Network update identifier
1	Unsigned 8-bit integer	Logical channel
2	Unsigned 16-bit integer	PAN identifier
2	Unsigned 16-bit integer	Network address
1	Unsigned 8-bit integer	Number of sub-devices
1	Unsigned 8-bit integer	Total group identifiers
0/1	Unsigned 8-bit integer	Endpoint identifier
0/2	Unsigned 16-bit integer	Profile identifier
0/2	Unsigned 16-bit integer	Device identifier

Octets	Data Type	Field Name
0/1	Unsigned 8-bit integer	Version
0/1	Unsigned 8-bit integer	Group identifier count

26315 **13.3.2.3.1.1 Inter-PAN Transaction Identifier Field**

26316 The *inter-PAN transaction identifier* field is 32-bits in length and specifies an identifier for the inter-PAN  
26317 transaction. This value shall be identical to the *inter-PAN transaction identifier* field of the original *scan*  
26318 *request* inter-PAN command frame received from the initiator.

26319 **13.3.2.3.1.2 RSSI Correction Field**

26320 The *RSSI correction* field is 8-bits in length and specifies a pre-programmed RSSI correction offset, specific  
26321 to this device in the range 0x00 – 0x20.

26322 **13.3.2.3.1.3 ZigBee Information Field**

26323 The *ZigBee information* field is 8-bits in length and specifies information related to ZigBee. This field shall  
26324 be formatted as illustrated in Figure 13-21.

26325 **Figure 13-21. Format of the ZigBee Information Field**

Bits: 0-1	2	3-7
Logical type	Rx on when idle	Reserved

26326 The *logical type* subfield is 2-bits in length and specifies the logical type of the device. The value of this  
26327 subfield shall be set to 0b00 for a coordinator, 0b01 for a router or 0b10 for an end device.

26328 The Rx on when idle subfield is 1 bit in length and specifies the *RxOnWhenIdle* state of the device. The value  
26329 of this subfield shall be set to 1 to indicate that the receiver is left on when the device is idle or 0 otherwise.

26330 **13.3.2.3.1.4 Touchlink Information Field**

26331 The *Touchlink information* field is 8-bits in length and shall be formatted as illustrated in Figure 13-22.

26332 **Figure 13-22. Format of the Scan Response Touchlink Information Field**

Bits: 0	1	2-3	4	5	6	7
Fac- tory new	Address assign- ment	Re- served	Touchlink ini- tiator	Touchlink priority request	Reserved	Profile Interop

26333  
26334 The *factory new* subfield is 1 bit in length and specifies whether the device is factory new. The value of this  
26335 subfield shall be set to 1 to indicate the device is factory new or 0 otherwise.

26336 The address assignment subfield is 1 bit in length and specifies whether the device is capable of assigning  
26337 addresses. The value of this subfield shall be set to 1 to indicate the device is capable of assigning addresses  
26338 or 0 otherwise.

26339 The touchlink initiator subfield is 1 bit in length and specifies whether the device is initiating a touchlink  
26340 operation. The value of this subfield shall be set to 1 to indicate the device is initiating a touchlink or 0  
26341 otherwise.

26342 The *touchlink priority request* subfield is 1 bit in length and specifies that the target has requested some  
26343 priority, possibly after a button push by the user. The value of this subfield shall be set to 1 to indicate that  
26344 the device has requested priority or 0 otherwise.

26345 The Profile Interop subfield is 1 bit in length and specifies which profile the device implements. If the ZLL  
26346 profile is implemented, this bit shall be set to 0. In all other case (Profile Interop / ZigBee 3.0), this bit shall  
26347 be set to 1.

#### 26348 **13.3.2.3.1.5 Key Bitmask Field**

26349 The *key bitmask* field is 16-bits in length and specifies which keys (and hence which encryption algorithms)  
26350 are supported by the device. The appropriate key shall be present on the device only if its corresponding bit  
26351 is set to 1 otherwise the key is not supported. Bit  $i$  of the *key bitmask field* shall correspond to key index  $i$ ,  
26352 where  $0 \leq i \leq 15$ .

#### 26353 **13.3.2.3.1.6 Response Identifier Field**

26354 The *response identifier* field is 32-bits in length and specifies a random identifier for the response, used  
26355 during the network key transfer mechanism.

#### 26356 **13.3.2.3.1.7 Extended PAN Identifier Field**

26357 The *extended PAN identifier* field is 64-bits in length and specifies the extended PAN identifier of the device  
26358 responding to the scan request.

26359 If the *factory new* subfield of the *touchlink information* field indicates that the device is factory new and the  
26360 value of this field is equal to zero, the target is not able to propose any network parameters. If the *factory  
26361 new* subfield of the *touchlink information* field indicates that the device is factory new and the value of this  
26362 field is not equal to zero, it can be used as the extended PAN identifier of a potential new network. Alternati-  
26363 vely, if the *factory new* subfield of the *touchlink information* field indicates that the device is not factory  
26364 new, this field indicates the current extended PAN identifier of the network on which the device operates.

#### 26365 **13.3.2.3.1.8 Network Update Identifier Field**

26366 The network update identifier field is 8-bits in length and specifies the current value of the *nwkUpdateId*  
26367 attribute of the originator. If the factory new subfield of the touchlink information indicates the device to be  
26368 in factory new mode, this field shall contain the value 0x00.

#### 26369 **13.3.2.3.1.9 Logical Channel Field**

26370 The logical channel field is 8-bits in length and specifies the touchlink channel on which the device is oper-  
26371 ating.

26372 If the *factory new* subfield of the *touchlink information* field indicates that the device is factory new and the  
26373 value of the extended PAN identifier field is equal to zero, the target is not able to propose a logical channel  
26374 for the network. If the *factory new* subfield of the *touchlink information* field indicates that the device is  
26375 factory new and the value of the extended PAN identifier field is not equal to zero, this value can be used as  
26376 the logical channel of a potential new network. Alternatively, if the *factory new* subfield of the *touchlink  
26377 information* field indicates that the device is not factory new, this field indicates the current logical channel  
26378 of the network on which the device operates.

#### 26379 **13.3.2.3.1.10 PAN Identifier Field**

26380 The PAN identifier field is 16-bits in length and specifies the identifier of the PAN on which the device  
26381 operates.

26382 If the *factory new* subfield of the *touchlink information* field indicates that the device is factory new and the  
26383 value of the extended PAN identifier field is equal to zero, the target is not able to propose a PAN identifier  
26384 for the network. If the *factory new* subfield of the *touchlink information* field indicates that the device is  
26385 factory new and the value of the extended PAN identifier field is not equal to zero, this value can be used as  
26386 the PAN identifier of a potential new network. Alternatively, if the *factory new* subfield of the *touchlink*  
26387 *information* field indicates that the device is not factory new, this field indicates the current PAN identifier  
26388 of the network on which the device operates.

#### 26389 **13.3.2.3.1.11 Network Address Field**

26390 The network address field is 16-bits in length and specifies the current network address of the device. If the  
26391 factory new subfield of the touchlink information indicates the device to be in factory new mode, this value  
26392 shall be set to 0xffff.

#### 26393 **13.3.2.3.1.12 Number of Sub-devices Field**

26394 The number of sub-devices field is 8-bits in length and specifies the number of sub-devices (endpoints) sup-  
26395 ported by the device.

#### 26396 **13.3.2.3.1.13 Total Group Identifiers Field**

26397 The total group identifiers field is 8-bits in length and specifies the number of unique group identifiers that  
26398 this device requires.

#### 26399 **13.3.2.3.1.14 Endpoint Identifier Field**

26400 The endpoint identifier field is 8-bits in length and specifies the endpoint identifier of the sub-device. This  
26401 field shall only be present when the number of sub-devices field is equal to 1.

#### 26402 **13.3.2.3.1.15 Profile Identifier Field**

26403 The profile identifier field is 16-bits in length and specifies the profile identifier supported by the sub-device.  
26404 This field shall only be present when the number of sub-devices field is equal to 1.

#### 26405 **13.3.2.3.1.16 Device Identifier Field**

26406 The device identifier field is 16-bits in length and specifies the device identifier supported by the sub-device.  
26407 This field shall only be present when the number of sub-devices field is equal to 1.

#### 26408 **13.3.2.3.1.17 Version Field**

26409 The version field is 8-bits in length and specifies the version of the device description supported by the sub-  
26410 device on the endpoint specified by the *endpoint identifier* field. The least significant 4 bits of this value shall  
26411 correspond to the *application device version* field of the appropriate simple descriptor; the most significant  
26412 4 bits shall be set to 0x0.

26413 This field shall only be present when the number of sub-devices field is equal to 1.

#### 26414 **13.3.2.3.1.18 Group Identifier Count Field**

26415 The group identifier count field is 8-bits in length and specifies the number of group identifiers required by  
26416 the sub-device. This field shall only be present when the number of sub-devices field is equal to 1.

### 26417 **13.3.2.3.2 Device Information Response Command Frame**

26418 The *device information response* command frame is used to return information about the sub-devices sup-  
26419 ported by a node.

26420 Note: If the Profile Interop bit of the Touchlink Information field of the Scan Request command received at  
 26421 the beginning of the current touchlink exchange is set to zero, the device may choose to represent its device  
 26422 information in the form of ZLL device information to support legacy devices. If this bit is set to one, the  
 26423 device shall use the device information as given in its simple descriptors.

26424 This inter-PAN command shall be formatted according to the general inter-PAN frame format with the fol-  
 26425 lowing clarifications. In the MAC header, the ACK request and destination addressing mode sub-fields of  
 26426 the frame control field shall be set to 1 (ACK requested) and 0b11 (extended IEEE address), respectively,  
 26427 the destination address field shall contain the IEEE address of the destination and the source PAN ID field  
 26428 shall be set to the same value used in the preceding scan response inter-PAN command frame, if the device  
 26429 is factory new, or the PAN identifier of the device, otherwise. In the APS header, the delivery mode sub-field  
 26430 of the frame control field shall be set to 0b00 (normal unicast). In the ZCL header, the direction sub-field of  
 26431 the frame control field shall be set to 1 (server to client) and the command identifier shall be set to 0x03  
 26432 (device information response).

26433 The ZCL payload field shall contain the *device information response* command frame itself, formatted as  
 26434 illustrated in Figure 13-23.

26435 **Figure 13-23. Format of the Device Information Response Command Frame**

<b>Octets</b>	4	1	1	1	(n*16)
<b>Data Type</b>	uint32	uint8	uint8	uint8	Variable
<b>Field Name</b>	Inter-PAN transaction identifier	Number of sub devices	Start index	Device information record count	Device information record (see Figure 13-24)

26436

26437 **Figure 13-24. Format of the Device Information Record Field**

<b>Octets</b>	8	1	2	2	1	1	1
<b>Data Type</b>	IEEE address	uint8	uint16	uint16	uint8	uint8	uint8
<b>Field Name</b>	IEEE address	Endpoint identifier	Profile identifier	Device identifier	Version	Group identifier count	Sort

26438 **13.3.2.3.2.1 Inter-PAN Transaction Identifier Field**

26439 The *inter-PAN transaction identifier* field is 32-bits in length and specifies an identifier for the inter-PAN  
 26440 transaction. This value shall be identical to the *inter-PAN transaction identifier* field of the original *scan*  
 26441 *request* inter-PAN command frame received from the initiator.

26442 **13.3.2.3.2.2 Number of Sub-devices Field**

26443 The *number of sub devices* field is 8-bits in length and specifies the number of sub devices contained in the  
 26444 device, as reported in the *scan response* inter-PAN command frame.

26445 **13.3.2.3.2.3 Start Index Field**

26446 The *start index* field is 8-bits in length and specifies the starting index into the device table from which to  
26447 get device information. This value of this field shall be equal to the value of the start index field of the *device*  
26448 *information request* command frame.

#### 26449 **13.3.2.3.2.4 Device Information Record Count Field**

26450 The *device information record count* field is 8-bits in length and specifies the number *n* of device information  
26451 records that follow. This value shall be in the range 0x00 – 0x05.

#### 26452 **13.3.2.3.2.5 IEEE Address Field**

26453 The *IEEE address* field is 64-bits in length and shall contain the IEEE address of the device referred to by  
26454 the device information record.

#### 26455 **13.3.2.3.2.6 Endpoint Identifier Field**

26456 The *endpoint identifier* field is 8-bits in length and shall contain the endpoint identifier of the sub-device  
26457 referred to by the device information record.

#### 26458 **13.3.2.3.2.7 Profile Identifier**

26459 The *profile identifier* field is 16-bits in length and shall contain the identifier of the profile supported by the  
26460 sub-device referred to by the device information record.

#### 26461 **13.3.2.3.2.8 Device Identifier Field**

26462 The *device identifier* field is 16-bits in length and shall contain the device identifier of the sub-device referred  
26463 to by the device information record.

#### 26464 **13.3.2.3.2.9 Version Field**

26465 The *version* field is 8-bits in length and shall contain the version of the device description supported by the  
26466 sub-device on the endpoint specified by the *endpoint identifier* field. The least significant 4 bits of this value  
26467 shall correspond to the *application device version* field of the appropriate simple descriptor; the most signif-  
26468 icant 4 bits shall be set to 0x0.

#### 26469 **13.3.2.3.2.10 Group Identifier Count Field**

26470 The *group identifier count* field is 8-bits in length and shall contain the number of unique group identifiers  
26471 required by the sub-device referred to by the device information record.

#### 26472 **13.3.2.3.2.11 Sort Field**

26473 The *sort* field is 8-bits in length and shall contain the sorting order of the sub-device referred to by the device  
26474 information record. This field is used to identify if a sorting of sub-devices is needed and what the order is,  
26475 e.g., to sort the different lights in a luminaire in a selection list on the remote control. A value of zero shall  
26476 indicate 'not sorted'. Non-zero values shall indicate the order in the list, with the value 0x01 indicating the  
26477 top of the list.

### 26478 **13.3.2.3.3 Network Start Response Command Frame**

26479 The *network start response* command frame is used by a router to respond to a *network start request* com-  
26480 mand frame received from an end device.

26481 This inter-PAN command shall be formatted according to the general inter-PAN frame format with the fol-  
 26482 lowing clarifications. In the MAC header, the ACK request and destination addressing mode sub-fields of  
 26483 the frame control field shall be set to 1 (ACK requested) and 0b11 (extended IEEE address), respectively,  
 26484 the destination address field shall contain the IEEE address of the destination and the source PAN ID field  
 26485 shall be set to the same value used in the preceding *scan response* inter-PAN command frame, if the device  
 26486 is factory new, or the PAN identifier of the device, otherwise. In the APS header, the delivery mode sub-field  
 26487 of the frame control field shall be set to 0b00 (normal unicast). In the ZCL header, the direction sub-field of  
 26488 the frame control field shall be set to 1 (server to client) and the command identifier shall be set to 0x11  
 26489 (network start response).

26490 The ZCL payload field shall contain the *network start response* command frame itself, formatted as illustrated  
 26491 in Figure 13-25.

26492 **Figure 13-25. Format of the Network Start Response Command Frame**

<b>Octets</b>	4	1	8	1	1	2
<b>Data Type</b>	uint32	uint8	IEEE address	uint8	uint8	uint16
<b>Field Name</b>	Inter-PAN transaction identifier	Status	Extended PAN identifier	Network update identifier	Logical channel	PAN identifier

26493 **13.3.2.3.3.1 Inter-PAN Transaction Identifier Field**

26494 The *inter-PAN transaction identifier* field is 32-bits in length and specifies an identifier for the inter-PAN  
 26495 transaction. This value shall be identical to the *inter-PAN transaction identifier* field of the original *scan*  
 26496 *request* inter-PAN command frame received from the initiator.

26497 **13.3.2.3.3.2 Status Field**

26498 The status field is 8-bits in length and shall contain the status code corresponding to the result of the network  
 26499 start request. This field shall be set to one of the values listed in Table 13-16.

26500 **Table 13-16. Values of the Status Field of the Network Start Response Command Frame**

Status Field Value	Description
0x00	Success
0x01	Failure
0x02 – 0xff	Reserved

26501 **13.3.2.3.3.3 Extended PAN Identifier Field**

26502 The *extended PAN identifier* field is 64-bits in length and shall contain the extended identifier of the new  
 26503 PAN.

26504 **13.3.2.3.3.4 Network Update Identifier Field**

26505 The *network update identifier* field is 8-bits in length and shall be set to 0x00 in this version of the specifica-  
 26506 tion.

26507 **13.3.2.3.3.5 Logical Channel Field**

26508 The *logical channel* field is 8-bits in length and shall contain the ZLL channel used by the new network.

26509 **13.3.2.3.3.6 PAN Identifier Field**26510 The *PAN identifier* field is 16-bits in length and shall contain the identifier of the new PAN.26511 **13.3.2.3.4 Network Join Router Response Command Frame**26512 The *network join router response* command frame is used by a router to respond to a *network join router request* command frame received from a non-factory-new end device.

26514 This inter-PAN command shall be formatted according to the general inter-PAN frame format with the following clarifications. In the MAC header, the ACK request and destination addressing mode sub-fields of the frame control field shall be set to 1 (ACK requested) and 0b11 (extended IEEE address), respectively, 26515 the destination address field shall contain the IEEE address of the destination and the source PAN ID field 26516 shall be set to the same value used in the preceding *scan response* inter-PAN command frame, if the device 26517 is factory new, or the PAN identifier of the device, otherwise. In the APS header, the delivery mode sub-field 26518 of the frame control field shall be set to 0b00 (normal unicast). In the ZCL header, the direction sub-field 26519 of the frame control field shall be set to 1 (server to client) and the command identifier shall be set to 0x13 26520 (network join router response). 26521 26522

26523 The ZCL payload field shall contain the *network join router response* command frame itself, formatted as 26524 illustrated in Figure 13-26.26525 **Figure 13-26. Format of the Network Join Router Response Command Frame**

<b>Octets</b>	4	1
<b>Data Type</b>	Unsigned 32-bit integer	Unsigned 8-bit integer
<b>Field Name</b>	Inter-PAN transaction identifier	Status

26526 **13.3.2.3.4.1 Inter-PAN Transaction Identifier Field**26527 The *inter-PAN transaction identifier* field is 32-bits in length and specifies an identifier for the inter-PAN 26528 transaction. This value shall be identical to the *inter-PAN transaction identifier* field of the original *scan request* 26529 inter-PAN command frame received from the initiator.26530 **13.3.2.3.4.2 Status Field**26531 The *status* field is 8-bits in length and shall contain the status code corresponding to the result of the network 26532 join router request. This field shall be set to one of the values listed in Table 13-17.26533 **Table 13-17. Values of the Status Field of the Network Join Router Response Command Frame**

Status Field Value	Description
0x00	Success
0x01	Failure
0x02 – 0xff	Reserved



26534 **13.3.2.3.5 Network Join End Device Response Command**  
 26535 **Frame**

26536 The *network join end device response* command frame is used by a factory new end device to respond to a  
 26537 *network join end device request* command frame received from a non-factory new end device.

26538 This inter-PAN command shall be formatted according to the general inter-PAN frame format with the fol-  
 26539 lowing clarifications. In the MAC header, the ACK request and destination addressing mode sub-fields of  
 26540 the frame control field shall be set to 1 (ACK requested) and 0b11 (extended IEEE address), respectively,  
 26541 the destination address field shall contain the IEEE address of the destination and the source PAN ID field  
 26542 shall be set to the same value used in the preceding *scan response* inter-PAN command frame, if the device  
 26543 is factory new, or the PAN identifier of the device, otherwise. In the APS header, the delivery mode sub-field  
 26544 of the frame control field shall be set to 0b00 (normal unicast). In the ZCL header, the direction sub-field of  
 26545 the frame control field shall be set to 1 (server to client) and the command identifier shall be set to 0x15  
 26546 (network join end device response).

26547 The ZCL payload field shall contain the *network join end device response* command frame itself, formatted  
 26548 as illustrated in Figure 13-27.

26549 **Figure 13-27. Format of the Network Join End Device Response Command Frame**

<b>Octets</b>	4	1
<b>Data Type</b>	Unsigned 32-bit integer	Unsigned 8-bit integer
<b>Field Name</b>	Inter-PAN transaction identifier	Status

26550 **13.3.2.3.5.1 Transaction Identifier Field**

26551 The *inter-PAN transaction identifier* field is 32-bits in length and specifies an identifier for the inter-PAN  
 26552 transaction. This value shall be identical to the *inter-PAN transaction identifier* field of the original *scan*  
 26553 *request* inter-PAN command frame received from the initiator.

26554 **13.3.2.3.5.2 Status Field**

26555 The *status* field is 8-bits in length and shall contain the status code corresponding to the result of the network  
 26556 join end device request. This field shall be set to one of the values listed in Table 13-18.

26557 **Table 13-18. Values of the Status Field of the Network Join End Device Response Command Frame**

Status Field Value	Description
0x00	Success
0x01	Failure
0x02 – 0xff	Reserved

26558 **13.3.2.3.6 Endpoint Information Command**

26559 The *endpoint information* command is used to inform the remote endpoint about the general information of  
26560 the local endpoint. This command may be a trigger for the remote endpoint to get more information from the  
26561 local device using the other commands described in this cluster.

26562 **Note:** if the related endpoint(s) reside on sleeping end devices, the polling time and polling frequency must  
26563 be chosen such that the exchange of information is done efficiently and in a timely manner.

26564 The endpoint information command shall be sent using unicast transmission. On receipt of this command,  
26565 the device shall respond using a ZCL default response command.

26566 This command shall be formatted as illustrated in Figure 13-28.

26567 **Figure 13-28. Format of the Endpoint Information Command**

Octets	8	2	1	2	2	1
Data Type	IEEE address	uint16	uint8	uint16	uint16	uint8
Field Name	IEEE address	Network address	Endpoint identifier	Profile identifier	Device identifier	Version

26568 **13.3.2.3.6.1 IEEE Address Field**

26569 The *IEEE address* field is 64-bits in length and specifies the IEEE address of the local device.

26570 **13.3.2.3.6.2 Network Address Field**

26571 The *network address* field is 16-bits in length and specifies the short network address of the local device.

26572 **13.3.2.3.6.3 Endpoint Identifier Field**

26573 The *endpoint identifier* field is 8-bits in length and specifies the identifier of the local endpoint.

26574 **13.3.2.3.6.4 Profile Identifier Field**

26575 The *profile identifier* field is 16-bits in length and specifies the identifier of the profile supported on the  
26576 endpoint specified in the *endpoint identifier* field.

26577 **13.3.2.3.6.5 Device Identifier Field**

26578 The *device identifier* field is 16-bits in length and specifies the identifier of the device description supported  
26579 on the endpoint specified in the *endpoint identifier* field.

26580 **13.3.2.3.6.6 Version Field**

26581 The *version* field is 8-bits in length and specifies the version of the device description supported by the sub-  
 26582 device on the endpoint specified by the *endpoint identifier* field. The least significant 4 bits of this value shall  
 26583 correspond to the *application device version* field of the appropriate simple descriptor; the most significant  
 26584 4 bits shall be set to 0x0.

26585 **13.3.2.3.7 Get Group Identifiers Response Command**

26586 The *get group identifiers response* command allows a remote device to respond to the get group identifiers  
 26587 request command.

26588 This command shall be formatted as illustrated in Figure 13-29.

26589 **Figure 13-29. Format of the Get Group Identifiers Response Command**

<b>Octets</b>	1	1	1	(n*3)
<b>Data Type</b>	uint8	uint8	uint8	Variable
<b>Field Name</b>	Total	Start index	Count	Group information record list

26590 **13.3.2.3.7.1 Total Field**

26591 The *total* field is 8-bits in length and specifies the total number of group identifiers supported by the device.

26592 **13.3.2.3.7.2 Start Index Field**

26593 The *start index* field is 8-bits in length and specifies the internal starting index from which the following  
 26594 group identifiers are taken and corresponds to the *start index* field of the *get group identifiers request* com-  
 26595 mand.

26596 **13.3.2.3.7.3 Count Field**

26597 The *count* field is 8-bits in length and specifies the number of entries in the *group information record list*  
 26598 field. If no entries are returned, this field shall be set to 0.

26599 **13.3.2.3.7.4 Group Information Record List Field**

26600 The *group information record* field is (n \* 24)-bits in length, where n is equal to the value of the *count* field,  
 26601 and specifies the requested group information. Each entry in this field shall be formatted as illustrated in  
 26602 Figure 13-30.

26603 **Figure 13-30. Format of a Group Information Record Entry**

<b>Octets</b>	2	1
<b>Data Type</b>	uint16	uint8
<b>Field Name</b>	Group identifier	Group type

26604

26605 The *group identifier* sub-field is 16-bits in length and specifies the identifier of the group described by this  
 26606 record.

26607 The *group type* sub-field is 8-bits in length and has been introduced for future extensions. The group type  
26608 shall indicate the meaning of a group in the user interface. In the current version of this specification, this  
26609 value shall be set to 0x00.

### 26610 13.3.2.3.8 Get Endpoint List Response Command

26611 The *get endpoint list response* command allows a remote device to respond to the get endpoint list request  
26612 command.

26613 This command shall be formatted as illustrated in Figure 13-31.

26614 **Figure 13-31. Format of the Get Endpoint List Response Command**

<b>Octets</b>	1	1	1	( <i>n</i> *8)
<b>Data Type</b>	uint8	uint8	uint8	Variable
<b>Field Name</b>	Total	Start index	Count	Endpoint information record list (see Figure 13-32)

26615

26616 **Figure 13-32. Format of an Endpoint Information Record Entry**

<b>Octets</b>	2	1	2	2	1
<b>Data Type</b>	uint16	uint8	uint16	uint16	uint8
<b>Field Name</b>	Network address	Endpoint identifier	Profile identifier	Device identifier	Version

#### 26617 13.3.2.3.8.1 Total Field

26618 The *total* field is 8-bits in length and specifies the total number of endpoints supported by the device.

#### 26619 13.3.2.3.8.2 Start Index Field

26620 The *start index* field is 8-bits in length and specifies the internal starting index from which the following list  
26621 of endpoints are taken and corresponds to the *start index* field of the *get endpoint list request* command.

#### 26622 13.3.2.3.8.3 Count Field

26623 The *count* field is 8-bits in length and specifies the number of entries in the *endpoint information record list*  
26624 field. If no entries are returned, this field shall be set to 0.

#### 26625 13.3.2.3.8.4 Network Address Field

26626 The *network address* field is 16-bits in length and specifies the short network address of the device specified  
26627 by the current endpoint information record.

#### 26628 13.3.2.3.8.5 Endpoint Identifier Field

26629 The *endpoint identifier* field is 8-bits in length and specifies the identifier of the endpoint on the device  
26630 specified by the *network address* field.

26631 **13.3.2.3.8.6 Profile Identifier Field**

26632 The *profile identifier* field is 16-bits in length and specifies the identifier of the profile supported on the  
 26633 endpoint, specified in the *endpoint identifier* field, on the device specified by the *network address* field.

26634 **13.3.2.3.8.7 Device Identifier Field**

26635 The *device identifier* field is 16-bits in length and specifies the identifier of the device description supported  
 26636 on the endpoint, specified in the *endpoint identifier* field, on the device specified by the *network address*  
 26637 field.

26638 **13.3.2.3.8.8 Version Field**

26639 The *version* field is 8-bits in length and specifies the version of the device description supported by the sub-  
 26640 device on the endpoint, specified by the *endpoint identifier* field, on the device specified by the *network*  
 26641 *address* field. The least significant 4 bits of this value shall correspond to the *application device version* field  
 26642 of the appropriate simple descriptor; the most significant 4 bits shall be set to 0x0.

26643 **13.3.3 Client**

26644 **13.3.3.1 Attributes**

26645 The client has no attributes.

26646 **13.3.3.2 Commands Received**

26647 The client receives the cluster specific response commands listed in Table 13-19. These commands are de-  
 26648 tailed in 13.3.2.2.

26649 **Table 13-19. Commands Received by the Client Side of the ZLL Commissioning Cluster**

	Identifier	Description	Usage
Touchlink	0x01	Scan response	Mandatory
	0x03	Device information response	Mandatory
	0x11	Network start response	Mandatory
	0x13	Network join router response	Mandatory
	0x15	Network join end device response	Mandatory
Utility	0x40	Endpoint information	Optional
	0x41	Get group identifiers response	Mandatory if <i>get group identifiers request</i> command is generated; otherwise Optional
	0x42	Get endpoint list response	Mandatory if <i>get endpoint list request</i> command is generated; otherwise Optional

26650 **13.3.3.3 Commands Generated**

26651 The client generates the cluster specific commands listed in Table 13-20. These commands are detailed in  
 26652 13.3.2.3.

26653

**Table 13-20. Commands Generated by the Client Side of the ZLL Commissioning Cluster**

	Identifier	Description	Usage
Touchlink	0x00	Scan request	Mandatory
	0x02	Device information request	Mandatory
	0x06	Identify request	Mandatory
	0x07	Reset to factory new request	Mandatory
	0x10	Network start request	Mandatory
	0x12	Network join router request	Mandatory
	0x14	Network join end device request	Mandatory
Utility	0x16	Network update request	Mandatory
	0x41	Get group identifiers request	Optional
	0x42	Get endpoint list request	Optional

26654

## 13.3.4 Functional Description

26655

### 13.3.4.1 Profile Identifier

26656 Those commands in the touchlink commissioning command set shall be sent using the profile identifier,  
26657 0xc05e whereas those commands in the commissioning utility command set shall sent using the ZHA profile  
26658 identifier, 0x0104.

26659

### 13.3.4.2 Constants

26660 The constants that define the characteristics of touchlink commissioning are listed in Table 13-21.

26661

**Table 13-21. Touchlink Commissioning Constants**

Constant	Description	Value
<i>aplcInterPANTransIdLifetime</i>	The maximum length of time an inter-PAN transaction identifier remains valid.	8s
<i>aplcMinStartupDelayTime</i>	The length of time an initiator waits to ensure that the recipient has completed its startup procedure.	2s
<i>aplcRxWindowDuration</i>	The maximum duration that a device leaves its receiver enabled during the joining procedure for subsequent configuration information.	5s
<i>aplcScanTimeBaseDuration</i>	The base duration for a scan operation during which the receiver is enabled for scan responses.	0.25s

26662

### 13.3.4.3 Attributes

26663 Touchlink commissioning defines internal attributes required to allow a device to manage the way it operates.  
26664 These attributes are summarized in Table 13-22.

26665

**Table 13-22. Touchlink Commissioning Attributes**

Attribute	Type	Ref	Default
<i>aplFreeNwkAddrRangeBegin</i>	Unsigned 16-bit integer	10.1.1.3.1	0x0001
<i>aplFreeNwkAddrRangeEnd</i>	Unsigned 16-bit integer	10.1.1.3.2	0xffff7
<i>aplFreeGroupIDRangeBegin</i>	Unsigned 16-bit integer	10.1.1.3.3	0x0001
<i>aplFreeGroupIDRangeEnd</i>	Unsigned 16-bit integer	10.1.1.3.4	0xfeff

26666

### 13.3.4.3.1 *aplFreeNwkAddrRangeBegin* Attribute

26667  
 26668  
 26669  
 26670  
 26671

The *aplFreeNwkAddrRangeBegin* attribute is an unsigned 16-bit integer in the range 0x0000 – 0xffff7 and contains the starting value of the free network address range for address assignment capable devices. Address assignment capable devices should use and maintain this value when assigning addresses via touchlink commissioning. If the device is not address assignment capable or it has joined a network through classical ZigBee joining mechanisms, this attribute should be set to 0x0000.

26672

### 13.3.4.3.2 *aplFreeNwkAddrRangeEnd* Attribute

26673  
 26674  
 26675  
 26676  
 26677

The *aplFreeNwkAddrRangeEnd* attribute is an unsigned 16-bit integer in the range 0x0000 – 0xffff7 and contains the end value of the free network address range for address assignment capable devices. Address assignment capable devices should use and maintain this value when assigning addresses via touchlink commissioning. If the device is not address assignment capable or it has joined a network through classical ZigBee joining mechanisms, this attribute should be set to 0x0000.

26678

### 13.3.4.3.3 *aplFreeGroupIDRangeBegin* Attribute

26679  
 26680  
 26681  
 26682  
 26683

The *aplFreeGroupIDRangeBegin* attribute is an unsigned 16-bit integer in the range 0x0000 – 0xfeff and contains the starting value of the free group identifier range for address assignment capable devices. Address assignment capable devices should use and maintain this value when assigning group identifiers via touchlink commissioning. If the device is not address assignment capable or it has joined a network through classical ZigBee joining mechanisms, this attribute should be set to 0x0000.

26684

### 13.3.4.3.4 *aplFreeGroupIDRangeEnd* Attribute

26685  
 26686  
 26687  
 26688  
 26689

The *aplFreeGroupIDRangeEnd* attribute is an unsigned 16-bit integer in the range 0x0000 – 0xfeff and contains the end value of the free group identifier range for address assignment capable devices. Address assignment capable devices should use and maintain this value when assigning group identifiers via touchlink commissioning. If the device is not address assignment capable or it has joined a network through classical ZigBee joining mechanisms, this attribute should be set to 0x0000.

26690

## 13.3.4.4 Device Information Table

26691  
 26692  
 26693  
 26694  
 26695

Each device supporting touchlink commissioning shall contain a *device information table* that holds the necessary (static) application information that is exchanged during touchlink device discovery. Each entry gives information about a so called sub-device which is a self-contained device such as a dimmable light. In ZigBee terms, a sub-device resides as a device application on an endpoint. Each entry shall be formatted as illustrated in Figure 13-33.

26696

Figure 13-33. Format of the device information table

Field name	Data type	Bits
IEEE address	IEEE address	64
Endpoint identifier	Unsigned 8-bit integer	8
Profile identifier	Unsigned 16-bit integer	16
Device identifier	Unsigned 16-bit integer	16
Device version	Unsigned 4-bit integer	4
Reserved	-	4
Number of groups identifiers	Unsigned 8-bit integer	8
Sort tag	Unsigned 8-bit integer	8

#### 26697 **13.3.4.4.1 IEEE Address Field**

26698 The *IEEE address* field is 64-bits in length and specifies the unique IEEE identifier for each single node.

#### 26699 **13.3.4.4.2 Endpoint Identifier Field**

26700 The *endpoint identifier* field is 8-bits in length and specifies the identifier of the endpoint on which the sub-  
26701 device is implemented. This value is determined by the application and can be freely chosen by the applica-  
26702 tion in the range 0x01 – 0xf0.

#### 26703 **13.3.4.4.3 Profile Identifier Field**

26704 The *profile identifier* field is 16-bits in length and specifies the identifier of the profile supported by the sub-  
26705 device. This value shall correspond to the *application profile identifier* field of the simple descriptor.

#### 26706 **13.3.4.4.4 Device Identifier Field**

26707 The *device identifier* field is 16-bits in length and specifies the identifier of the device description supported  
26708 by the sub-device. This value shall correspond to the *application device identifier* field of the simple de-  
26709 scriptor.

#### 26710 **13.3.4.4.5 Device Version Field**

26711 The *device version* field is 4-bits in length and specifies the version of the device description supported by  
26712 the sub-device. This value shall correspond to the *application device version* field of the simple descriptor.

#### 26713 **13.3.4.4.6 Number of Group Identifiers Field**

26714 The *number of group identifiers* field is 8-bits in length and specifies the number of unique group identifiers  
26715 required by the application on that specific endpoint.

#### 26716 **13.3.4.4.7 Sort Tag Field**

26717 The *sort tag* field is 8-bits in length and specifies a sorting of the sub-devices, if required. A value of 0x00  
26718 indicates that the field is not sorted. Other values indicate the order in the list.



26719 **13.3.4.5 Inter-PAN frame format**

26720 When using the inter-PAN frame format for touchlink commissioning, frames shall be either broadcast or  
26721 unicast directly to the recipient, depending on the frame (i.e. indirect transmissions are not permitted). The  
26722 general format of an inter-PAN frame is illustrated below.  
26723

Group	Field name	Octets	Description
MAC header	Frame control	2	Frame Type = 0b001 Security Enabled = 0 Frame Pending = 0 ACK Request = 0 (no ACK requested) or 1 (ACK requested) Intra-PAN = 0 Dest. Addressing Mode = 0b10 (short address) or 0b11 (extended address) Frame Version = As appropriate Source Addressing Mode = 0b11
	Sequence number	1	As appropriate
	Destination PAN ID	2	0xffff
	Destination address	2/8	0xffff if broadcast IEEE address of destination otherwise
	Source PAN ID	2	As appropriate
	Source address	8	IEEE address of source
NWK header	Frame control	2	Frame type = 0b11 Protocol version = as appropriate Remaining sub-fields = 0
APS header	Frame control	1	Frame type = 0b11 Delivery mode = 0b00 (unicast) or 0b10 (broadcast) ACK format = 0 Security = 0 ACK request = 0 Extended header present = 0
	Group address	0	Not included
	Cluster identifier	2	0x1000
	Profile identifier	2	0xc05e
ZCL header	Frame control	1	Frame type = 0b01 Manufacturer specific = As appropriate <sup>243</sup> Direction = 0 (client to server) or 1 (server to client) Disable default response = 1
	Manufacturer code	0/2	Included only if the manufacturer specific sub-field is set to 1.
	Transaction sequence number	1	Incremented for every transmission of a command
	Command identifier	1	See clause 13.3
ZCL payload	Command payload	Variable	See clause 13.3
MAC footer	Frame check sequence	2	As appropriate for the frame

Figure 13-34. General format of an inter-PAN frame

26724

26725

26726 **13.3.4.6 Inter-PAN Transaction Identifier**

26727 All *touchlink commissioning* cluster inter-PAN command frames shall carry a 32-bit transaction identifier.

26728 The transaction identifier shall be created by the initiator of a *scan request* inter-PAN command frame and  
 26729 shall be random, non-zero and non-sequential. Related inter-PAN command frames which follow the *scan*  
 26730 *request*, i.e., *scan response*, *device information request/response*, *identify request*, *reset to factory new re-*  
 26731 *quest*, *network start request/response*, *network join router request/response* and *network join end device re-*  
 26732 *quest/response* define the scope of a transaction (illustrated in Figure 13-35) and shall carry the same trans-  
 26733 action identifier as was defined in the *scan request*. While within the scope of a transaction (and for at most  
 26734 *aplInterPANTransIdLifetime*), the transaction identifier is said to be valid.

26735 **Figure 13-35. Scope of a touchlink commissioning inter-PAN transaction**

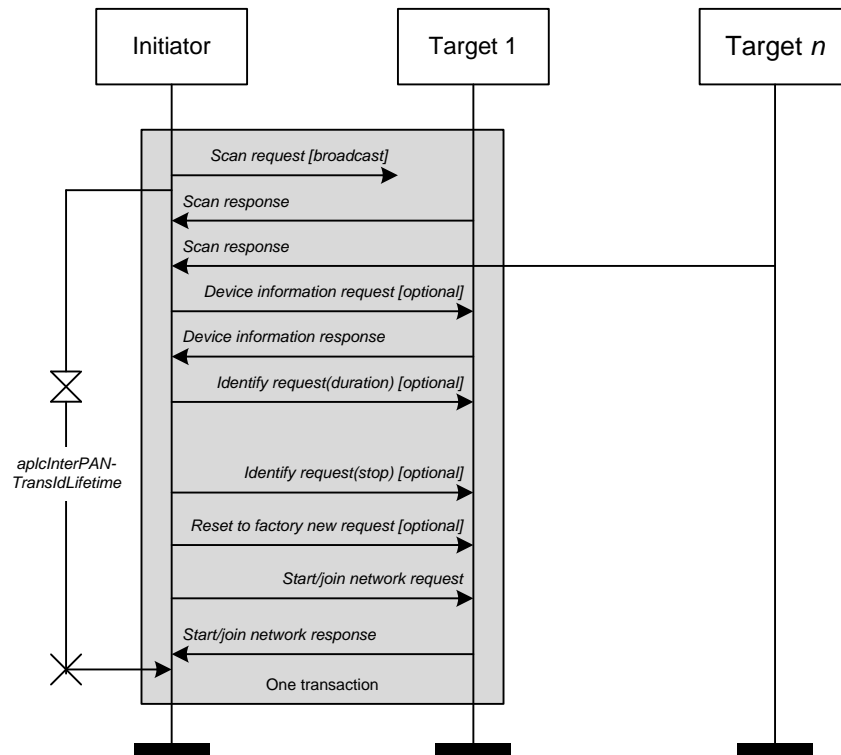

26736

26737 If a target, receiving a *scan request* inter-PAN command frame, is a sleeping end device, it shall enable its  
 26738 receiver while the transaction identifier is valid or for at most *aplInterPANTransIdLifetime* seconds after  
 26739 reception of the original *scan request* inter-PAN command frame. A device may disable its receiver before  
 26740 *aplInterPANTransIdLifetime* seconds have elapsed if the transaction has successfully completed and the  
 26741 device has started or joined the network.

26742 During a transaction, a device shall only accept inter-PAN command frames that contain a valid transaction  
 26743 identifier, i.e., inter-PAN command frames from within a transaction that have the same transaction identifier  
 26744 as was received in the *scan request* inter-PAN command frame, unless a device wants to start a new transac-  
 26745 tion after receiving a new *scan request* inter-PAN command frame from the same or another initiator carrying  
 26746 a new transaction identifier.

### 26747 **13.3.4.7 Commissioning Scenarios**

26748 Touchlink commissioning between devices is performed from an *initiator* to a *target*, both of which can be  
26749 implemented from either an end device or a router. The commissioning mechanisms depend on whether the  
26750 initiator is factory new or non-factory new. If the initiator is factory new, it requests a new network to be  
26751 started and if the initiator is non-factory new it requests the target to join its network. If the target is non-  
26752 factory new and already part of a network, it can be *stolen* onto the network of the initiator. However, the  
26753 target can decide whether to accept a request to start a new network or join an existing network when re-  
26754 quested to do so by the initiator. If the initiator is a factory new end device, it must be commissioned with a  
26755 router target so that a new network can be formed.

26756 For detailed information on touchlink commissioning, see the Base Device Behavior Specification.

### 26757 **13.3.4.8 Address Assignment**

26758 Network addresses and group identifiers are assigned by address assignment capable devices and all network  
26759 addresses and group identifiers must be unique.

#### 26760 **13.3.4.8.1 Network Address Assignment**

26761 Network addresses are assigned by devices that are address assignment capable. All network addresses must  
26762 be unique. The method used to ensure this is to assign subdivisions of the available address space to devices  
26763 that join the network and that are address assignment capable.

26764 Since ZigBee reserves the network address 0x0000 for the coordinator and the address range (0xffff8 ...  
26765 0xfffff) for broadcast, the total touchlink network address space is defined in the range (0x0001 ... 0xffff7).  
26766 Devices that are address assignment capable shall keep track of their current free network address range,  
26767 ( $N_{min}$  ...  $N_{max}$ ). When such a device is factory-new,  $N_{min} = 0x0001$  and  $N_{max} = 0xffff7$ .

26768 When a factory-new initiator device, which is address assignment capable, has just formed a new network, it  
26769 shall assign itself the network address  $N_{min}$  (i.e., 0x0001) and then increment  $N_{min}$ , i.e., the range changes  
26770 to (0x0002 ... 0xffff7).

26771 When a device is joined to an existing network, it shall be assigned the first (i.e.,  $N_{min}$ ) network address  
26772 from the free network address range of the initiator through which it is joining. The initiator that started the  
26773 network shall then increment  $N_{min}$ .

26774 If a device cannot be assigned a network address, it shall not be permitted to operate on the network.

26775 If a device that is address assignment capable joins the network, it shall also receive its own free network  
26776 address range ( $N'_{min}$  ...  $N'_{max}$ ). The initiator shall split its own free network address range at an implementa-  
26777 tion specified point and the upper range (i.e., highest in value) shall be assigned to the new address assignment  
26778 capable device.

26779 If after splitting the free network address range, the resulting two address ranges are smaller than an imple-  
26780 mentation specific threshold, the new device shall not be joined to the network.

#### 26781 **13.3.4.8.2 Group Identifier Assignment**

26782 Group identifiers are used when addressing a subset of devices using broadcast mechanisms and they are  
26783 typically used by a controller application residing at a certain endpoint. The group identifiers need to be  
26784 unique in the network and their range is (0x0001 ... 0xfeff). Group identifier 0x0000 is used for the default  
26785 group in the ZCL *scene* cluster. Group identifiers (0xff00 ... 0xffff) shall be reserved.

26786 The number of group identifiers needed by an application residing on an endpoint is given in the device  
26787 information table. Since group identifier assignment is linked to network address assignment, the total num-  
26788 ber of group identifiers needed by all endpoints on a node is reported in the *scan response* command frame.  
26789 A device that is network address assignment capable shall also be group identifier assignment capable and  
26790 each shall keep track of their current free group identifier range, ( $G_{min} \cdots G_{max}$ ). When such a device is  
26791 factory-new,  $G_{min} = 0x0001$  and  $G_{max} = 0xfeff$ .

26792 When a factory-new initiator device which is assignment capable has just formed a new network, it shall take  
26793 the group identifiers, starting from  $G_{min}$  (i.e., 0x0001) for its own endpoints and shall then increment  
26794  $G_{min}$  with the number of endpoints supported on the device.

26795 When a device is joined to the network, it shall receive a range of group identifiers for its endpoints and the  
26796 initiator shall then increment  $G_{min}$  with the number of endpoints supported on the new device.

26797 If a device that is about to be joined is also address assignment capable, it shall also receive a free group  
26798 identifier range ( $G'_{min} \cdots G'_{max}$ ), if possible. The initiator shall split its own free group identifier range at an  
26799 implementation specified point and the upper range (i.e., highest in value) shall be assigned to the new ad-  
26800 dress assignment capable device.

26801 If, after division of a free group identifier range, the resulting two group identifier ranges are smaller than an  
26802 implementation specific threshold, the new device shall not be joined to the network.

### 26803 **13.3.4.9 Network Update**

#### 26804 **13.3.4.9.1 Initiator Procedure**

26805 If an initiator finds a device during device discovery that is part of the same network as the initiator but that  
26806 reports a network update identifier in its *scan response* inter-PAN command frame that is lower than that of  
26807 the initiator, it may generate and transmit a *network update request* inter-PAN command frame to the target  
26808 using the unicast data service.

26809 The *network update request* inter-PAN command frame shall contain the current network parameters of the  
26810 initiator in the extended PAN identifier, network update identifier, logical channel and PAN identifier fields.  
26811 In addition, the *network update request* inter-PAN command frame shall also contain the network address of  
26812 the target.

26813 Conversely, if an initiator finds a device during device discovery that is part of the same network as the  
26814 initiator but that reports a network update identifier in its *scan response* inter-PAN command frame that is  
26815 higher than that of the initiator, it shall update its stored network update identifier and logical channel with  
26816 the values received in the *scan response* inter-PAN command frame and change to the new channel accord-  
26817 ingly.

26818 If the initiator is an end device, it shall then perform a network rejoin request by issuing the NLME-JOIN.re-  
26819 quest primitive to the NWK layer, ensuring the *RejoinNetwork* parameter is set to indicate that the device is  
26820 joining the network using the NWK rejoining procedure. If the network rejoin was successful (indicated by  
26821 the reception of the NLME-JOIN.confirm), the initiator can use the network to communicate.

### 26822 13.3.4.9.2 Target Procedure

26823 On receipt of the *network update request* inter-PAN command frame with a valid transaction identifier (i.e.,  
26824 immediately following a device discovery) by a target, it shall first compare the values of the extended PAN  
26825 identifier and PAN identifier fields with its corresponding stored value. If the two values are not identical,  
26826 the target shall discard the frame and perform no further processing. If the two values are identical, the target  
26827 shall then compare the value of the network update identifier field with its corresponding stored value. If the  
26828 value in the frame is higher than its stored value, the target shall update its stored network update identifier  
26829 and logical channel with the values received in the *network update request* inter-PAN command frame, ac-  
26830 cording to the policy described in 13.3.4.10<sup>244</sup>. Otherwise, the target shall discard the frame and perform no  
26831 further processing.

26832 The target shall not send a response to a *network update request* inter-PAN command frame.

### 26833 13.3.4.10 Frequency Agility

26834 Touchlink supports a channel change mechanism in an application-defined way. When the channel change  
26835 mechanism is instigated, the device shall broadcast a *Mgmt\_NWK\_Update\_req* command frame with the  
26836 *scan channels* field set to indicate the channel on which to begin operating, the *scan duration* field set to 0xfe  
26837 (channel change request) and the *nwkUpdateId* field set to the value of the *nwkUpdateId* attribute of the  
26838 transmitting device, incremented by one. This command frame shall be broadcast to all devices for which  
26839 *macRxOnWhenIdle* is equal to True (i.e., a network address of 0xfffd).

26840 Routers receiving this *Mgmt\_NWK\_Update\_req* command frame shall update their NIB and execute their  
26841 channel change procedure. End devices shall rejoin using the NWK rejoining procedure.

26842 Routers that have missed the *Mgmt\_NWK\_Update\_req* command frame can be brought back into the net-  
26843 work through a touch-link procedure. For this reason, a device shall indicate the value of its *nwkUpdateId*  
26844 attribute when it responds to a scan request via a *scan response* command frame.

26845 If a touch-link initiator wants to bring a router back into the network (i.e., if the value of the *nwkUpdateId*  
26846 indicated in the scan response command frame is older than the value of the *nwkUpdateId* attribute of the  
26847 scan initiator), it shall send a unicast inter-PAN *network update request* command frame.

26848 If a touch-link initiator detects a router reporting a *nwkUpdateId* attribute that is newer than its own  
26849 *nwkUpdateId* attribute, it shall update its network settings (i.e., logical channel, PAN identifier and  
26850 *nwkUpdateId*) accordingly based on the values found in the *scan response* command frame sent by that  
26851 router. If the touch-link initiator is an end device, it shall execute a re-join procedure.

26852 Note: the *nwkUpdateId* attribute can take the value 0x00 – 0xff and may wrap around so care must be taken  
26853 when comparing for newness. For consistency, each device shall determine the *nwkUpdateId* to use (ID)  
26854 using the following algorithm:

```
ID1 ← First nwkUpdateId;  
ID2 ← Second nwkUpdateId;  
if ( ABS( ID1 - ID2 ) > 200 ) then  
    ID ← MIN( ID1, ID2 );  
else  
    ID ← MAX( ID1, ID2 );  
endif
```

26855

<sup>244</sup> CCB 2648

26856 **13.3.4.11 Security**

26857 Devices in a ZigBee PRO network shall use ZigBee network layer security. Each network shall have its own  
 26858 network key. In touchlink, the network key shall be generated randomly by the initiator that starts the new  
 26859 network.

26860 In this clause concatenation of strings is represented by the “||” symbol.

26861 **13.3.4.11.1 Transferring the Network Key during Touchlink Commissioning**  
 26862

26863 The touchlink security architecture is based on using a fixed secret key, known as the touchlink key, which  
 26864 shall be stored in each device. During touchlink commissioning, all devices use the touchlink key to en-  
 26865 crypt/decrypt the exchanged network key.

26866 The architecture that is used to allow for a transfer the encrypted network key is depicted in Figure 13-36.  
 26867

**Figure 13-36. Overview of Touchlink Security**

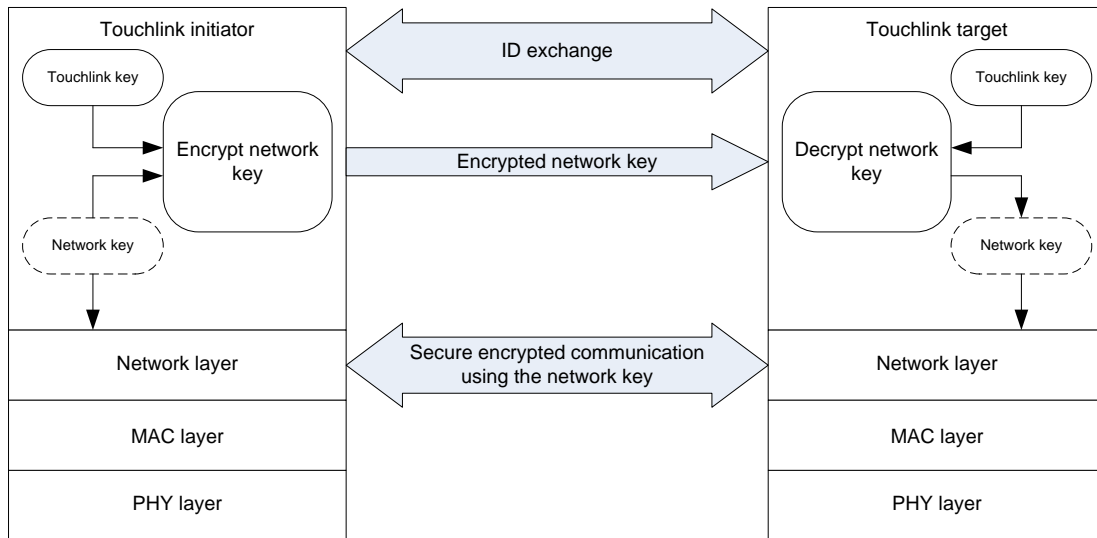

26868

26869 In order to transfer the network key between the initiator and a possible target in a secure way, 16 possible  
 26870 algorithms can be used to encrypt the network key.

26871 The possible target shall indicate in the key bitmask field of its *scan response* inter-PAN command frame,  
 26872 transmitted during device discovery, which key encryption algorithms are supported.

26873 On receipt of each *scan response* inter-PAN command frame, the initiator shall compare the value in the  
 26874 received key bitmask field with its own stored key bitmask to find out if the two devices contain a common  
 26875 key. If no common key is found (i.e., the bitwise AND of the two is equal to zero), the initiator shall not  
 26876 select this target for further commissioning.

26877 If a common key is found (i.e., the bitwise AND of the two is not equal to zero), the initiator shall set the key  
 26878 index to the bit position corresponding to the matching key with the highest index, encrypts the network key  
 26879 using the appropriate algorithm, listed in Table 13-23, and includes both the index and the encrypted key it  
 26880 in the key index and encrypted network key fields, respectively, of the *network start request*, *network join*  
 26881 *router* or *network join end device* inter-PAN command frames.

26882

**Table 13-23. Key Encryption Algorithms**

Key index	Key description	Algorithm
-----------	-----------------	-----------

0	Development key	See 13.3.4.11.4
1-3	Reserved	-
4	Master key	See 13.3.4.11.5
5-14	Reserved for future use	-
15	Certification key	See 13.3.4.11.5

26883 **13.3.4.11.2 Transferring the Network Key during Classical**  
26884 **ZigBee Commissioning**

26885 During classical ZigBee commissioning where a device is being joined to a network without a trust center, a  
26886 pre-installed link key is used to secure the transfer of the network key when authenticating. The pre-installed  
26887 link key is a secret shared by all certified devices. It will be distributed only to certified manufacturers and is  
26888 bound with a safekeeping contract.

26889 Prior to the successful completion of the certification, a certification pre-installed link key is used to allow  
26890 testing. The certification pre-installed link key shall have the value of:

```
Certification pre-installed    0xd0 0xd1 0xd2 0xd3 0xd4 0xd5 0xd6 0xd7
link key (0:15) =             0xd8 0xd9 0xda 0xdb 0xdc 0xdd 0xde 0xdf
```

26891 Additionally, if the decryption of the APS message fails with the key described above, devices shall try to  
26892 decode the APS message using the known default trust center link key.

26893 **13.3.4.11.3 ZigBee Settings**

26894 The following ZigBee security related NIB attributes shall be set (See [ZigBee], Section 4.3.3):

- 26895 • nwkSecurityLevel: 0x05 (use data encryption and frame integrity),
- 26896 • nwkAllFresh: False (do not check frame counter),
- 26897 • nwkSecureAllFrames: True (only accept secured frames).

26898 **13.3.4.11.4 Key Index 0**

26899 The network key encryption algorithm with a key index equal to 0 is known as the development key. This  
26900 algorithm encrypts the network key with AES in ECB mode in one single step where the AES key is equal  
26901 to:

```
"PhLi" || TrID || "CLSN" || RsID
```

26903 Where TrID is the transaction identifier field of the original *scan request* command frame passed between  
26904 the initiator and target and RsID is the response identifier of the *scan response* command frame passed  
26905 between the target and the initiator (both values are random 32-bit integers). The ASCII characters in quotes  
26906 ("") should be converted to their equivalent hexadecimal byte values, with the leftmost character being the  
26907 leftmost byte.

26908 For example:

<b>Encrypted Network Key (0:15)</b>	0x48 0x3c 0x2b 0x19 0x7c 0x27 0xc3 0xcc 0x76 0xa3 0xd6 0x3b 0x2e 0xa8 0xdb 0x0b
<b>Transaction identifier</b>	0xea9cd138
<b>Response identifier</b>	0x8f8dbab4



<b>Resulting AES Key (0:15)</b>	0x50 0x68 0x4c 0x69 0xea 0x9c 0xd1 0x38 0x43 0x4c 0x53 0x4e 0x8f 0x8d 0xba 0xb4
<b>Decrypted Network Key (0:15)</b>	0xac 0xbe 0xf1 0x44 0x70 0x27 0xd8 0xd9 0x5a 0xfa 0x42 0xb0 0x77 0xe4 0x88 0xa5

26909 Note: The development key (key index 0) shall only be used during the development phase of Light Link  
 26910 products. Commercial Light Link products shall not use nor indicate having support for the development key.

### 26911 13.3.4.11.5 Key Index 4 and 15

#### 26912 13.3.4.11.5.1 Key Usage

26913 The touchlink security details described in this section apply to key index 4 and 15 of Table 13-23. The secure  
 26914 NWK key transport methods indicted by key index 4 and 15 use the same algorithm, as described in section  
 26915 13.3.4.11.5.2. However, they differ in the type of key they use for NWK key protection.

##### 26916 13.3.4.11.5.1.1 Master Key (key index 4)

26917 The touchlink master key is a secret shared by all certified devices. It will be distributed only to certified  
 26918 manufacturers and is bound with a safekeeping contract.

26919 The device using the touchlink master key in combination with the algorithm described in this document  
 26920 shall always set bit 4 in the key bitmask field of the *scan response* command frame to 0b1 (see 13.3.2.3.1).

##### 26921 13.3.4.11.5.1.2 Certification Key (key index 15)

26922 Prior to the successful completion of the certification, a certification key is used to allow testing of the secu-  
 26923 rity mechanisms as specified in this document. The certification key shall have the value of:

Certification key (0:15) = 0xc0 0xc1 0xc2 0xc3 0xc4 0xc5 0xc6 0xc7  
 0xc8 0xc9 0xca 0xcb 0xcc 0xcd 0xce 0xcf

26924 The device using the certification key in combination with the algorithm described in this document shall  
 26925 always set bit 15 in the key bitmask field of the *scan response* command frame to 0b1 (see 13.3.2.3.1).

26926 The certification key may also be used during the development phase of products. However, commercial  
 26927 products shall not use nor indicate having support for the certification key.

#### 26928 13.3.4.11.5.2 Algorithm

##### 26929 13.3.4.11.5.2.1 Encrypting Network Keys for Touchlink Initiator

26930 The touchlink initiator shall perform the following steps to encrypt the network key and transport it to the  
 26931 touchlink target:

- 26932 • Exchange of transaction identifier and response identifier as part of the touchlink procedure.
- 26933 • Derive the ephemeral transport key (see Figure 13-37) from the transaction identifier, response identi-  
 26934 fier and touchlink master or certification key, as described in 13.3.4.11.5.2.3.
- 26935 • Encrypt the network key using the calculated transport key and the AES ECB mode, as described in  
 26936 13.3.4.11.5.2.3.
- 26937 • Transmit the encrypted network key to the touchlink target as part of the touchlink procedure.

##### 26938 13.3.4.11.5.2.2 Decrypting network keys for touchlink target

26939 The touchlink target shall perform the following steps to decrypt the network key received from the touchlink  
 26940 initiator:

- 26941 • Exchange of transaction identifier and response identifier as part of the touchlink procedure.

- 26942       • Receive the encrypted network key as part of the touchlink procedure.
- 26943       • Derive the transport key (see Figure 13-37) from the transaction identifier, response identifier and touchlink master or certification key, as described in 13.3.4.11.5.2.3.
- 26944
- 26945       • Decrypt the received encrypted network key by using the calculated transport key and the AES
- 26946       ECB mode, as described in 13.3.4.11.5.2.3.
- 26947       • Store the received network key in the NIB parameter of the touchlink target.

26948       **13.3.4.11.5.2.3           Calculations Required for the Encryption/Decryption of the Network**  
26949       **Key**

26950       The encryption/decryption key calculation to encrypt/decrypt the network key is illustrated in Figure 13-37.

26951

**Figure 13-37. Steps Required to Encrypt/Decrypt the Network Key**

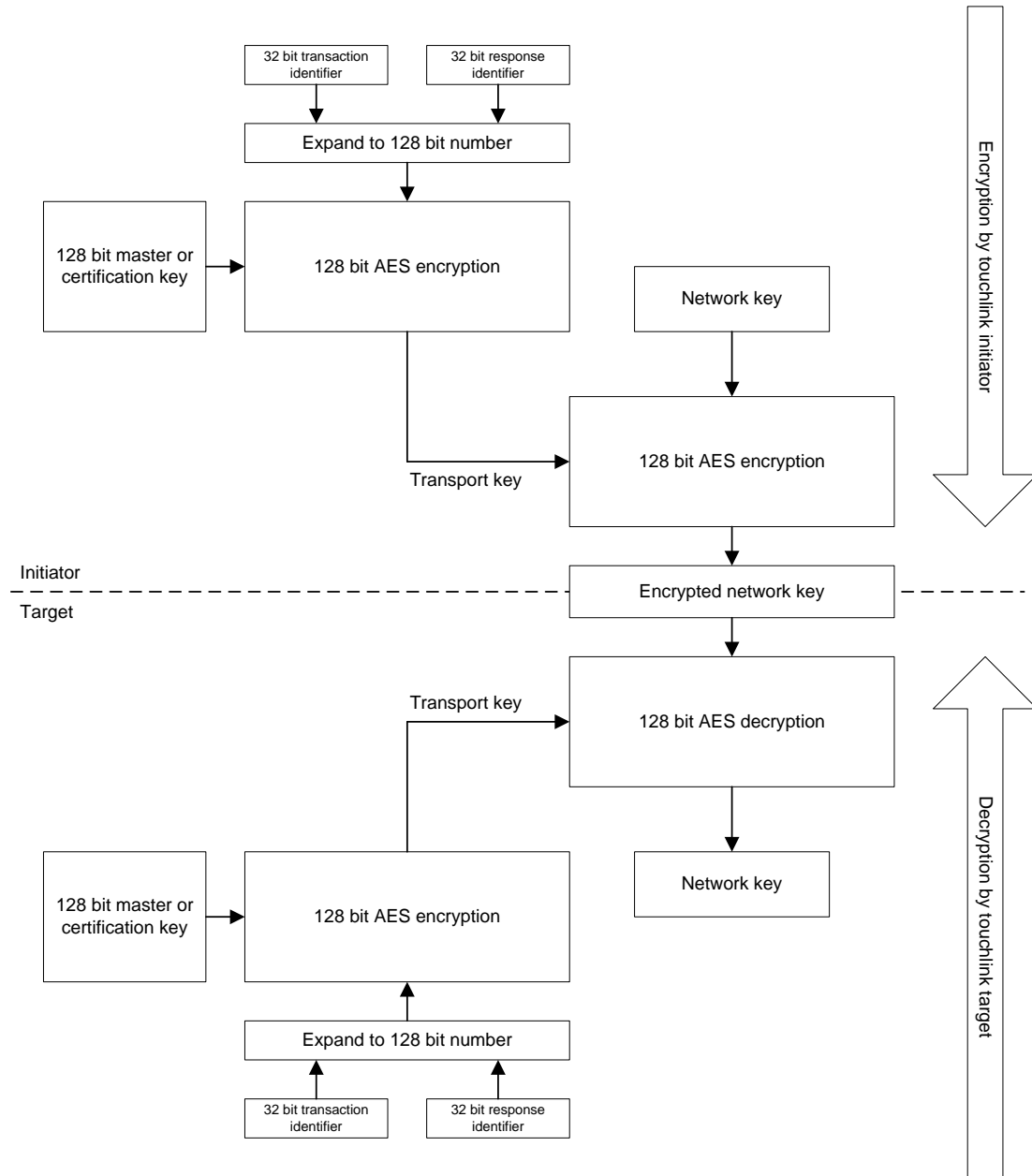

26952

26953 Unless explicitly specified otherwise, all numbers in this chapter are formatted little Endian, i.e., with their  
 26954 least significant octet first.

26955 The basic ingredients to perform the encryption/decryption of the network key are:

- 26956 • The 32 bit transaction identifier
- 26957 • The 32 bit response identifier
- 26958 • The touchlink master or certification key

26959 The encryption of the network key is performed by the following processing steps:

- 26960 39. Merge and expand the transaction identifier and response identifier into a 128 bit number by concate-  
 26961 nating them (in Little Endian representation) as follows:

- 26962 Transaction identifier || transaction identifier || response identifier || response identifier.
- 26963 40. Calculate the transport key by executing the 128 bit AES encryption with the expanded 128 bit number  
26964 obtained from step 1 as *plaintext*, and touchlink master or certification key as *key*.
- 26965 41. Encrypt the network key by executing the 128 bit AES encryption using the network key as *plaintext*  
26966 and the transport key obtained from step 2 as *key*.
- 26967 The decryption of the network key is performed by the following processing steps:
- 26968 42. Merge and expand the transaction identifier and response identifier into a 128 bit number, as described  
26969 in step 1.
- 26970 43. Calculate the transport key by executing the 128 bit AES encryption with the expanded 128 bit number  
26971 obtained from step 4 used as *plaintext*, and touchlink master or certification key as *key*.
- 26972 44. Decrypt the network key by executing the 128 bit AES decryption with the transport key obtained from  
26973 step 5 as *key* and the encrypted network key as *ciphertext*.
- 26974 All AES functions used in steps 2, 3, and 5 above shall use AES encryption in ECB mode and the AES  
26975 function in step 6 shall use AES decryption in ECB mode.

### 26976 13.3.4.11.6 Touchlink Security Test Vectors

26977 This annex provides sample test vectors for the touchlink security specification (as defined in sub-clause  
26978 13.3.4.11), in order to assist in building interoperable security implementations.

#### 26979 13.3.4.11.6.1 Touchlink initiator operation

<b>Touchlink Certification Key (0:15)</b>	0xc0 0xc1 0xc2 0xc3 0xc4 0xc5 0xc6 0xc7 0xc8 0xc9 0xca 0xcb 0xcc 0xcd 0xce 0xcf
<b>Transaction ID</b>	0x3eaa2009
<b>Response ID</b>	0x88762fb1
<b>Expanded input (0:15)</b>	0x3e 0xaa 0x20 0x09 0x3e 0xaa 0x20 0x09 0x88 0x76 0x2f 0xb1 0x88 0x76 0x2f 0xb1

26980 After AES ECB encryption:  
26981

<b>Transport Key (0:15)</b>	0x66 0x9e 0x08 0xe4 0x02 0x77 0xed 0x9a 0xb3 0x6b 0x25 0x80 0x45 0x6b 0x41 0x76
<b>NWK key (0:15)</b>	0x11 0x22 0x33 0x44 0x55 0x66 0x77 0x88 0x99 0xaa 0xbb 0xcc 0xdd 0xee 0xff 0x00

26982 After AES ECB encryption:  
26983

<b>Encrypted Network Key (0:15)</b>	0x83 0x22 0x63 0x68 0x73 0xa7 0xbb 0x2a 0x18 0x9a 0x53 0x70 0x8c 0x60 0x7b 0xd0
-------------------------------------	--

#### 26984 13.3.4.11.6.2 Touchlink target operation

<b>Touchlink Certification Key (0:15)</b>	0xc0 0xc1 0xc2 0xc3 0xc4 0xc5 0xc6 0xc7 0xc8 0xc9 0xca 0xcb 0xcc 0xcd 0xce 0xcf
<b>Transaction ID</b>	0x3eaa2009

<b>Response ID</b>	0x88762fb1
<b>Expanded input (0:15)</b>	0x3e 0xaa 0x20 0x09 0x3e 0xaa 0x20 0x09 0x88 0x76 0x2f 0xb1 0x88 0x76 0x2f 0xb1

26985

26986

After AES ECB encryption:

<b>Transport Key (0:15)</b>	0x66 0x9e 0x08 0xe4 0x02 0x77 0xed 0x9a 0xb3 0x6b 0x25 0x80 0x45 0x6b 0x41 0x76
<b>Received encrypted NWK key (0:15)</b>	0x83 0x22 0x63 0x68 0x73 0xa7 0xbb 0x2a 0x18 0x9a 0x53 0x70 0x8c 0x60 0x7b 0xd0

26987

26988

After AES ECB decryption:

<b>NWK key (0:15)</b>	0x11 0x22 0x33 0x44 0x55 0x66 0x77 0x88 0x99 0xaa 0xbb 0xcc 0xdd 0xee 0xff 0x00
-----------------------	--

26989

26990

26991

Note: the first (i.e., leftmost on the page) byte of the encrypted network key is sent first in the associated encrypted network key fields of the network start request, network join router request and network join end device request inter-PAN command frames.



26992

## CHAPTER 14 RETAIL

26993  
 26994  
 26995  
 26996

The Cluster Library is made of individual chapters such as this one. See Document Control in the Cluster Library for a list of all chapters and documents. References between chapters are made using a *X.Y* notation where *X* is the chapter and *Y* is the sub-section within that chapter. References to external documents are contained in Chapter 1 and are made using [*Rn*] notation.

26997

## 14.1 General Description

26998

### 14.1.1 Introduction

26999  
 27000

The clusters specified in this chapter are for use typically in retail applications, but may be used in any application domain.

27001

### 14.1.2 Cluster List

27002  
 27003

This section lists the clusters specified in this chapter and gives examples of typical usage for the purpose of clarification.

27004

The clusters specified in this chapter are listed in Table 14-1.

27005

**Table 14-1. Clusters Specified in this Chapter**

ID	Cluster Name	Description
0x0617	Retail Tunnel Cluster	Interface for manufacturer specific information to be exchanged
0x0022	Mobile Device Configuration Cluster	Interface to manage mobile devices in a network
0x0023	Neighbor Cleaning Cluster	Interface to manage mobile devices in a network
0x0024	Nearest Gateway Cluster	Interface to enable communication of nearest gateway to devices

27006

## 14.2 Retail Tunnel (MSP Tunnel)

27007

### 14.2.1 Overview

27008  
 27009

Please see Chapter 2 for a general cluster overview defining cluster architecture, revision, classification, identification, etc.

27010  
 27011  
 27012  
 27013

This cluster provides an interface for transferring information encoded through a specific Manufacturer specific Profile from a device (e.g., a backend application using a gateway) to a handheld device (e.g., the Retail HHD). The messages that are transferred use a transfer APDU command as for other tunneling clusters defined (e.g., 11073 Protocol tunnel, or ISO 7818 tunnel).

27014

**Figure 14-1. Typical Usage of the Retail Tunnel Cluster**

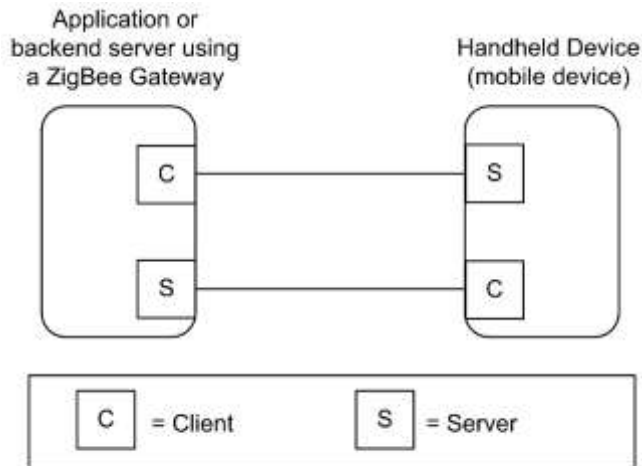

27015

*Note: Device names are examples for illustration purposes only*

### 27016 14.2.1.1 Revision History

27017 The global *ClusterRevision* attribute value SHALL be the highest revision number in the table below.

Rev	Description
1	mandatory global <i>ClusterRevision</i> attribute added

### 27018 14.2.1.2 Classification

Hierarchy	Role	PICS Code	Primary Transaction
Base	Application	RTUN	Type 1 (client to server)

### 27019 14.2.1.3 Cluster Identifiers

Identifier	Name
0x0617	Retail Tunnel

## 27020 14.2.2 Server

### 27021 14.2.2.1 Dependencies

27022 This cluster may leverage on the Partition cluster in order to carry payloads not fitting into a single ZCL  
27023 payload.

### 27024 14.2.2.2 Attributes

27025 The currently defined attributes for this cluster are listed in Table 14-2.



27026

**Table 14-2. Attributes of the Retail Tunnel cluster**

Id	Name	Type	Range	Acc	Def	M/O
0x0000	<i>ManufacturerCode</i>	uint16	0x1000 – 0x10ff	R	-	M
0x0001	<i>MSPProfile</i>	uint16	0xC000 – 0xFFFF	R	-	M

27027 **14.2.2.2.1 ManufacturerCode Attribute**

27028 The *ManufacturerCode* attribute specifies the manufacturer code relating the manufacturer of the device.  
 27029 This attribute can be used to match the proper protocol associated to the manufacturer of the device and  
 27030 tunneled through this cluster. See [Z12] Manufacturer Code Database.

27031 **14.2.2.2.2 MSPProfile Attribute**

27032 The *MSPProfile* attribute specifies the manufacturer specific profile used in the tunneled messages carried by  
 27033 the Transfer APDU commands. The *MSPProfile* attribute can be used to have the information of the proper  
 27034 protocol used by the communication entities supporting the MSP Tunnel cluster in order to properly decode  
 27035 the messages tunneled in this cluster.

27036 **14.2.2.3 Commands Received**

27037 Table 14-3 lists the cluster-specific commands that are received by the server.

27038 **Table 14-3. Cluster-specific Commands Received by the Server**

Command identifier field value	Description	Mandatory / Optional
0x00	Transfer APDU	M

27039 **14.2.2.3.1 Transfer APDU Command**

27040 **14.2.2.3.1.1 Payload Format**

27041 The Transfer APDU command shall be formatted as illustrated in Figure 14-2.

27042 **Figure 14-2. Format of the Transfer APDU Command**

Bits	Variable
Data Type	Octet String
Field Name	APDU

27043 **14.2.2.3.1.2 APDU Field**

27044 The APDU field is of variable length and is an APDU as defined in the *MSPProfile* attribute of the Manufac-  
 27045 turer indicated by the *ManufacturerCode* attribute.

27046 **14.2.2.3.1.3 When Generated**

27047 This command is generated when a message has to be transferred across a MSP tunnel. The message can be  
27048 only decoded by the recipient entity if it is provided by the proper decodes of the Manufacturer specific  
27049 profile as defined in [Z7].

#### 27050 **14.2.2.3.1.4 Effect on Receipt**

27051 On receipt of this command, a device shall process the APDU according to the specific MSP transported.

### 27052 **14.2.2.4 Commands Generated**

27053 No cluster-specific commands are generated by the server cluster.

## 27054 **14.2.3 Client**

27055 The client has no dependencies, no cluster specific attributes. The client does not receive any cluster-specific  
27056 commands. The client generates the cluster-specific commands detailed in 14.2.2.3.

# 27057 **14.3 Mobile Device Configuration**

---

## 27058 **14.3.1 Overview**

27059 Please see Chapter 2 for a general cluster overview defining cluster architecture, revision, classification,  
27060 identification, etc.

27061 This cluster provides an interface to enable the management of mobile devices in a network.

27062 If a stack supports neighbor entry aging, the mobile device will be able to use this cluster to refresh the  
27063 information in the parent/neighbor. An application will be also able to configure aging timeout (using the  
27064 Neighbor cleaning cluster) greater than *KeepAliveTime*, managing in this way the timeout used for cleaning  
27065 neighbor table setting appropriate value. Besides, *Rejoin timeout* can be used to allow the device force a  
27066 rejoin and then allow the mobile device solution to work with stacks not supporting the cleaning of the neigh-  
27067 bor tables.

27068

**Figure 14-3. Typical Usage of the Mobile Device Configuration Cluster**

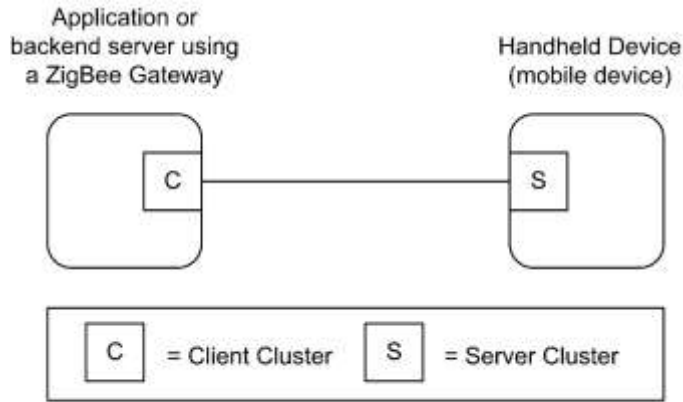

*Note: Device names are examples for illustration purposes only*

27069

27070 **14.3.1.1 Revision History**

27071 The global *ClusterRevision* attribute value SHALL be the highest revision number in the table below.

Rev	Description
1	mandatory global <i>ClusterRevision</i> attribute added

27072 **14.3.1.2 Classification**

Hierarchy	Role	PICS Code
Base	Utility	MOBCFG

27073 **14.3.1.3 Cluster Identifiers**

Identifier	Name
0x0022	Mobile Device Configuration

27074 **14.3.2 Server**

27075 **14.3.2.1 Dependencies**

27076 This cluster should be supported by devices that are mobile in the network. The devices building the network  
 27077 infrastructure should use the Neighbor Cleaning Cluster to manage the loss of the mobile devices from the  
 27078 radio range.

27079 **14.3.2.2 Attributes**

27080 The currently defined attributes for this cluster are listed in Table 14-4.

27081

**Table 14-4. Attributes of the Mobile Device Cleaning Cluster**

Identifier	Name	Type	Range	Acc	Unit	Default	M/O
0x0000	<i>KeepAliveTime</i>	uint16	0x0001- 0xFFFF	RW	Seconds	15 seconds (0x000F)	M
0x0001	<i>RejoinTimeout</i>	uint16	0x0000- 0xFFFF	RW	Seconds	0xFFFF (Never)	M

27082 **14.3.2.2.1 KeepAliveTime Attribute**

27083 The *KeepAliveTime* attribute specifies the time period to elapse before a mobile device send a Keep Alive  
 27084 Notification message to the manager of the network (e.g. application backend servers using a gateway).  
 27085 Please note that a value of this attribute equal to 0xFFFF means that the mobile device shall not send  
 27086 *KeepAliveNotification* messages. This attribute is used to “refresh” neighbor table information on its parent  
 27087 devices, avoiding expiration or aging of the correspondent entry.

27088 **14.3.2.2.2 RejoinTimeout Attribute**

27089 The *RejoinTimeout* attribute specifies the time after which the device shall perform a secure network rejoin  
 27090 to clean the entries in the neighbor table for parent devices not cleaning them with the Neighbor Cleaning  
 27091 Cluster. Please note that a value of this attribute equal to 0xFFFF means that the mobile device is not re-  
 27092 quested to perform the network Rejoin to clean the mesh. (Note: The mobile device may choose to transmit  
 27093 a Network Leave frame to the short address being cleaned.)

27094 **14.3.2.3 Commands Received**

27095 No cluster-specific commands are received by the server side of this cluster.

27096 **14.3.2.4 Commands Generated**

27097 Table 14-5 lists cluster-specific commands that are generated by the server.

27098 **Table 14-5. Cluster-specific Commands Generated by the Server**

Command Id	Description	M/O
0x00	<i>Keep Alive Notification</i>	M

27099 **14.3.2.4.1 Keep Alive Notification Command**

27100 **14.3.2.4.1.1 Payload Format**

27101 The Keep Alive Notification command shall be formatted as illustrated in Figure 14-4.

27102 **Figure 14-4. Format of the Keep Alive Notification Command**

Bits	Variable	Variable
Data Type	uint16	uint16
Field Name	<i>KeepAliveTime</i>	<i>RejoinTimeout</i>

27103 **14.3.2.4.1.1 KeepAliveTime Field**

27104 This field corresponds to the *KeepAliveTime* attribute.

27105 **14.3.2.4.1.2 RejoinTimeout Field**

27106 This field corresponds to the *RejoinTimeout* attribute.

27107 **14.3.2.4.1.2 When Generated**

27108 This command is generated when a time greater than *KeepAliveTime* attribute elapses.

27109 **14.3.2.4.1.3 Effect on Receipt**

27110 On receipt of this command, a parent or neighbor device shall refresh neighbor table information on the  
27111 mobile node sending the Keep Alive Notification by resetting the timers managing the expiration of the  
27112 entries in the neighbors table.

27113 **14.3.3 Client**

27114 The client has no dependencies, no cluster specific attributes. The client receives the commands specified in  
27115 section 14.2.2.4. The client does not generate any cluster-specific commands.

27116 **14.4 Neighbor Cleaning**

---

27117 **14.4.1 Overview**

27118 Please see Chapter 2 for a general cluster overview defining cluster architecture, revision, classification,  
27119 identification, etc.

27120 This cluster provides an interface to enable the management of mobile devices in a network.

27121 If a stack supports neighbor entry aging, the mobile device will be able to use this cluster to clean the infor-  
27122 mation in the parent/neighbor. An application will be able to configure the aging timeout greater than a  
27123 *KeepAliveTime* (attribute supported by a mobile device), managing in this way the timeout used for cleaning  
27124 neighbor table setting appropriate value.

27125

**Figure 14-5. Typical Usage of the Neighbor Cleaning Cluster**

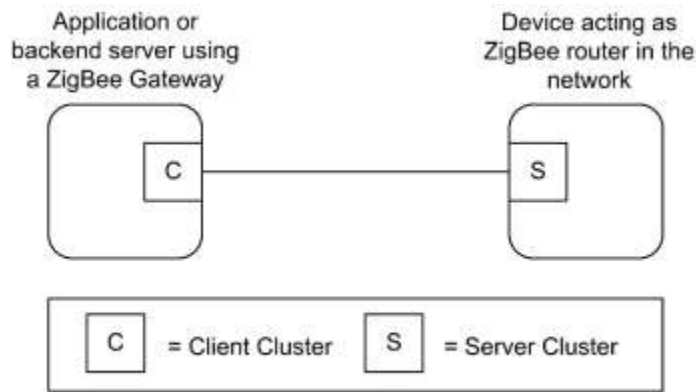

*Note: Device names are examples for illustration purposes only*

27126

### 27127 14.4.1.1 Revision History

27128 The global *ClusterRevision* attribute value SHALL be the highest revision number in the table below.

Rev	Description
1	mandatory global <i>ClusterRevision</i> attribute added

### 27129 14.4.1.2 Classification

Hierarchy	Role	PICS Code
Base	Utility	NBCLEAN

### 27130 14.4.1.3 Cluster Identifiers

Identifier	Name
0x0023	Neighbor Cleaning

## 27131 14.4.2 Server

### 27132 14.4.2.1 Dependencies

27133 This cluster should be supported by devices that are acting as routers for Mobile devices in the network;  
27134 besides, the mobile devices within the network infrastructure (e.g., Hand Held devices or Mobile phones)  
27135 should use the Mobile Device Configuration Cluster to take advantage of the mobility feature.

### 27136 14.4.2.2 Attributes

27137 The currently defined attributes for this cluster are listed in the following table.

27138

**Table 14-6. Attributes of the Neighbor Cleaning Cluster**

Id	Name	Type	Range	Acc	Unit	Default	M/O
0x0000	<i>NeighborCleaningTimeout</i>	uint16	0x0001 - 0xFFFF	RW	Seconds	30 seconds (0x001E)	M

27139

### 14.4.2.2.1 NeighborCleaningTimeout Attribute

27140  
 27141  
 27142  
 27143

The *NeighborCleaningTimeout* attribute specifies the time period to elapse without receiving any messages from a neighbor device (router or end device) which is a mobile device, before cleaning its neighbor table entry. (Note: The cleaning device may choose to transmit a Network Leave frame to the short address being cleaned.)

27144

## 14.4.2.3 Commands Received

27145

Table 14-7 lists cluster-specific commands which are received by the server side of this cluster.

27146

**Table 14-7. Cluster-specific Commands Generated by the Server**

Command Id	Description	M/O
0x00	<i>PurgeEntries</i>	M

27147

### 14.4.2.3.1 PurgeEntries Command

27148

#### 14.4.2.3.1.1 Payload Format

27149

The *PurgeEntries* command has no payload.

27150

#### 14.4.2.3.1.2 When Generated

27151  
 27152

This command is generated by the manager of the network supporting the mobile devices in order to force the cleaning of the neighbor table entries.

27153

#### 14.4.2.3.1.3 Effect on Receipt

27154  
 27155

On receipt of this command, a parent or neighbor device should clean the neighbor tables to delete aged entries; please notice that this feature can be executed only if enabled by the stack.

27156

## 14.4.2.4 Commands Generated

27157

No cluster-specific commands are generated by the server.

27158

## 14.4.3 Client

27159  
 27160

The client has no dependencies and no cluster specific attributes. The client does not receive any cluster-specific commands. The client does generate the cluster-specific commands specified in 14.4.2.3.

## 27161 14.5 Nearest Gateway

### 27162 14.5.1 Overview

27163 Please see Chapter 2 for a general cluster overview defining cluster architecture, revision, classification,  
27164 identification, etc.

27165 This cluster provides an interface to enable the dissemination of “nearest gateway” information.

27166 Based on MTORR information initiated by gateway devices (concentrator), the remaining routers in the net-  
27167 work can determine which gateway is closest based on path cost, i.e., the “nearest gateway.” The cluster  
27168 allows that information to be communicated to devices in the network that need that information.

27169 **Figure 14-6. Typical Usage of the Nearest Gateway Cluster**

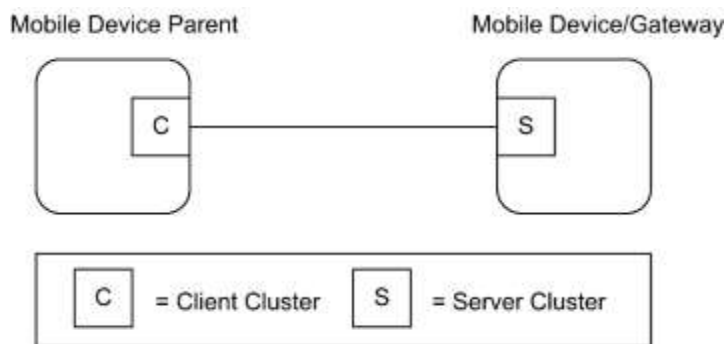

*Note: Device names are examples for illustration purposes only*

27170

#### 27171 14.5.1.1 Revision History

27172 The global *ClusterRevision* attribute value SHALL be the highest revision number in the table below.

Rev	Description
1	mandatory global <i>ClusterRevision</i> attribute added

#### 27173 14.5.1.2 Classification

Hierarchy	Role	PICS Code
Base	Utility	NEARGW

#### 27174 14.5.1.3 Cluster Identifiers

Identifier	Name
0x0024	Nearest Gateway



27175 **14.5.2 Server**

27176 **14.5.2.1 Dependencies**

27177 This cluster should be supported by devices that are mobile in the network and, optionally, gateway devices.

27178 **14.5.2.2 Attributes**

27179 The currently defined attributes for this cluster are listed in the following table.

27180 **Table 14-8. Attributes of the Nearest Gateway Cluster**

Id	Name	Type	Range	Acc	Default	M/O
0x0000	<i>Nearest Gateway</i>	16-bit NWK address	0x0000- 0xFFFF8	RW	0x0000	M
0x0001	<i>New Mobile Node</i>	16-bit NWK address	0x0000- 0xFFFF8	W	0x0000	M

27181 **14.5.2.2.1 Nearest Gateway Attribute**

27182 The *Nearest Gateway* attribute specifies the gateway that is nearest in terms of path cost.

27183 **14.5.2.2.2 New Mobile Node Attribute**

27184 The *New Mobile Node* attribute specifies the new mobile node that joined the server.

27185 **14.5.2.3 Commands Received**

27186 No cluster-specific commands are received by the server side of this cluster.

27187 **14.5.2.4 Commands Generated**

27188 No cluster-specific commands are generated by the server side of this cluster.

27189 **14.5.3 Client**

27190 The client has no dependencies and no cluster specific attributes. The client does not receive nor generate  
 27191 any cluster-specific commands.

27192 **14.5.4 Examples of Use**

27193 Figure 14-7 describes an example of the possible use of the nearest gateway cluster.

27194

Figure 14-7. Sequence Diagram

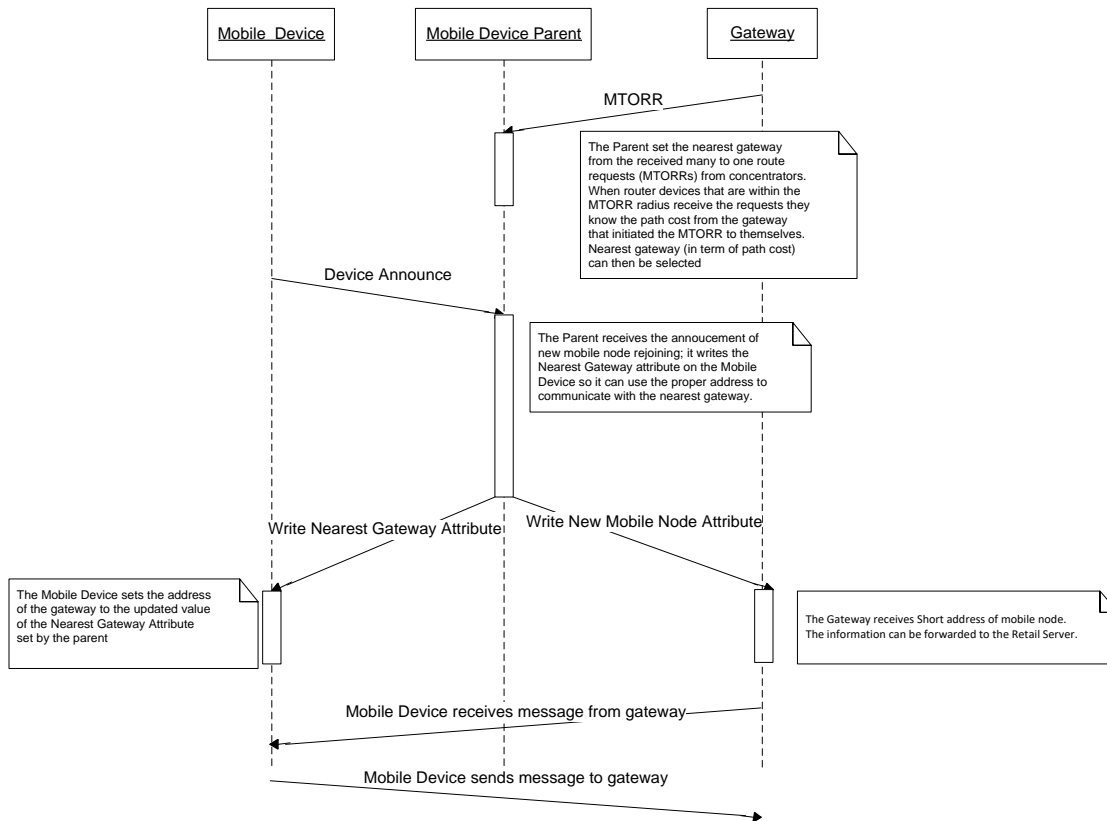

27195

27196

## CHAPTER 15 APPLIANCE

27197  
27198  
27199  
27200

The Cluster Library is made of individual chapters such as this one. See Document Control in the Cluster Library for a list of all chapters and documents. References between chapters are made using a *X.Y* notation where *X* is the chapter and *Y* is the sub-section within that chapter. References to external documents are contained in Chapter 1 and are made using [*Rn*] notation.

27201

### 15.1 General Description

27202

#### 15.1.1 Introduction

27203  
27204

The clusters specified in this chapter are for use typically in appliance management, but MAY be used in any application domain.

27205

#### 15.1.2 Cluster List

27206  
27207

This section lists the clusters specified in this chapter and gives examples of typical usage for the purpose of clarification.

27208

The clusters specified in this chapter are listed in Table 10-1.

27209

Table 15-1. Appliance Management Clusters

Id	Cluster Name	Description
0x001b	EN50523 Appliance Control	Commands and attributes for controlling household appliances
0x0b00	EN50523 Appliance Identification	Commands and attributes for appliance information and device settings
0x0b02	EN50523 Appliance Events and Alerts	Commands and attributes for appliance events and alerts
0x0b03	EN50523 Appliance Statistics	Commands and attributes for appliance statistics

27210

### 15.2 EN50523 Appliance Control

27211

This section describes the EN50523 Appliance Control cluster.

27212

#### 15.2.1 Overview

27213  
27214

Please see section 2.2 for a general cluster overview defining cluster architecture, revision, classification, identification, etc

27215  
27216

This cluster provides an interface to remotely control and to program household appliances. Example of control is Start, Stop and Pause commands.

27217  
27218  
27219

The status “read” and “set” is compliant to the EN50523 “Signal State” and “Execute Command” functional blocks. Appliances parameters (e.g., Duration and Remaining Time) have been added, since they were missing from the original specs.

27220

**Figure 15-1. Typical Usage of the Appliance Control Cluster**

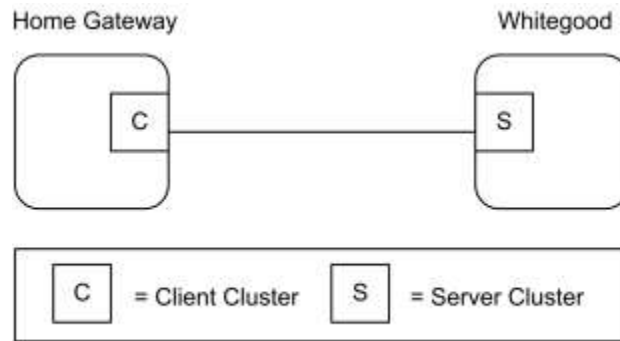

27221

*Note: Device names are examples for illustration purposes only*

27222  
27223  
27224

**Note:** Where a physical node supports multiple endpoints it will often be the case that many of these settings will apply to the whole node, that is, they are the same for every endpoint on the device. In such cases they can be implemented once for the node and mapped to each endpoint.

27225

### 15.2.1.1 Revision History

27226

The global *ClusterRevision* attribute value SHALL be the highest revision number in the table below.

Rev	Description
1	mandatory global <i>ClusterRevision</i> attribute added

27227

### 15.2.1.2 Classification

Hierarchy	Role	PICS Code	Primary Transaction
Base	Application	APLNC	Type 2 (server to client)

27228

### 15.2.1.3 Cluster Identifiers

Identifier	Name
0x001b	EN50523 Appliance Control

27229

## 15.2.2 General Description

27230

### 15.2.2.1 Dependencies

27231

None

27232

## 15.2.3 Server Attributes

27233  
27234  
27235  
27236

For convenience, the attributes defined in this specification are arranged into sets of related attributes; each set can contain up to 256 attributes. Attribute identifiers are encoded such that the most significant byte specifies the attribute set and the least significant byte specifies the attribute within the set. The currently defined attribute sets are listed in Table 15-2.

27237

**Table 15-2. Appliance Control Attribute Set**

Attribute Set Identifier	Description
0x00	Appliance Functions

27238

### 15.2.3.1 Appliance Functions Attribute Set

27239

The Appliance Functions attribute set contains the attributes summarized in Table 15-3.

27240

These attributes control the Appliance cycle parameters. Each of them, as described below, corresponds to an Appliance internal status configuration.

27241

27242

**Table 15-3. Attributes of the Appliance Functions Attribute Set**

Id	Name	Type	Range	Access	Default	M/O
0x0000	<i>StartTime</i>	uint16	0x0000 – 0xffff	RP	0x0000	M
0x0001	<i>FinishTime</i>	uint16	0x0000 – 0xffff	RP	0x0000	M
0x0002	<i>RemainingTime</i>	uint16	0x0000 – 0xffff	RP	0x0000	O

27243

### 15.2.3.2 StartTime Attribute

27244

*StartTime* attribute determines the time (either relative or absolute) of the start of the machine activity. Default format for Oven devices is absolute time. The default format for other appliances is relative time. *StartTime* SHOULD be set less than *FinishTime*.

27245

27246

27247

Table 15-4 provides details about time encoding which is used for *StartTime* attribute organization.

27248

**Table 15-4. Time Encoding**

Bit Range	Function	
0..5	Minutes ranging from 0 to 59	
6..7	Time encoding	
	Value	Enumeration
	0x0 0x1 0x2..0x3	RELATIVE ABSOLUTE Reserved
8..15	Hours ranging from 0 to 255 if RELATIVE encoding is selected 0 to 23 if ABSOLUTE encoding is selected	

27249

### 15.2.3.3 FinishTime Attribute

27250

*FinishTime* attribute determines the time (either relative or absolute) of the expected end of the machine activity. Default format for Oven is absolute time. The default format for other appliances is relative time. *FinishTime* SHOULD be set greater than *StartTime*.

27251

27252

27253 *FinishTime* attribute exploits time encoding reported in Table 15-4.

### 27254 **15.2.3.4 RemainingTime Attribute**

27255 *RemainingTime* attribute determines the time, in relative format, of the remaining time of the machine cycle.  
27256 It represents the time remaining to complete the machine cycle and it is updated only during the RUNNING  
27257 state of the Appliance. During the other states of the Appliance *RemainingTime* attribute is indicated as the  
27258 not valid value “0”.

27259 *RemainingTime* attribute exploits time encoding reported in Table 15-4.

## 27260 **15.2.4 Server Commands Received**

27261 The command IDs for the Appliance Control cluster are listed in Table 15-5.

27262 **Table 15-5. Cluster-specific Commands Received by the Server**

Command Identifier Field Value	Description	M/O
0x00	Execution of a Command	O
0x01	Signal State	M
0x02	Write Functions	O
0x03	Overload Pause Resume	O
0x04	Overload Pause	O
0x05	Overload Warning	O

### 27263 **15.2.4.1 Execution of a Command**

27264 This basic message is used to remotely control and to program household appliances. Examples of control  
27265 are START, STOP and PAUSE.

#### 27266 **15.2.4.1.1 Payload Format**

27267 The Execution of a Command payload SHALL be formatted as illustrated in Figure 15-2.

27268 **Figure 15-2. Format of the Execution of a Command Payload**

Octets	1
Data Type	enum8
Field Name	Command Identification

##### 27269 **15.2.4.1.1.1 Payload Details**

27270 The *Command Identification* field: the command identification is an 8-bits in length field identifying the  
27271 command to be executed. The enumeration used for this field SHALL match Table 15-6.

27272

**Table 15-6. Command Identification Values**

Enumeration	Value	Description
START	0x01	Start appliance cycle
STOP	0x02	Stop appliance cycle
PAUSE	0x03	Pause appliance cycle
START SUPERFREEZING	0x04	Start superfreezing cycle
STOP SUPERFREEZING	0x05	Stop superfreezing cycle
START SUPERCOOLING	0x06	Start supercooling cycle
STOP SUPERCOOLING	0x07	Stop supercooling cycle
DISABLE GAS	0x08	Disable gas
ENABLE GAS	0x09	Enable gas
<i>Manufacturer Specific</i>	0x80..0xff	Manufacturer Specific

27273 **15.2.4.1.2 Effects on Receipt**

27274 On receipt of this command, the appliance SHALL execute the command given in the Command Identifica-  
 27275 tion field. The device application SHALL be informed of the imposed command (and potential personalized  
 27276 tasks could start, e.g., by means of a message to appliance Main Board controller).

27277 After the command execution, the appliance SHALL generate a Signal State Notification with the new ap-  
 27278pliance state.

27279 **15.2.4.2 Signal State Command**

27280 This basic message is used to retrieve Household Appliances status. This command does not have a payload.

27281 **15.2.4.2.1 Effects on Receipt**

27282 On receipt of this command, the device SHALL generate a Signal State Response command.

27283 **15.2.4.3 Write Functions Command**

27284 This basic message is used to set appliance functions, i.e., information regarding the execution of an appliance  
 27285 cycle. Condition parameters such as start time or finish time information could be provided through this  
 27286 command. A function is mirrored by the cluster attribute that represents its current state. See Effect on Receipt  
 27287 below to understand the difference between writing a function and writing an attribute value.

27288 **15.2.4.3.1 Payload Format**

27289 The Write Functions command frame SHALL be formatted as illustrated in Format of the Write Functions  
 27290 Command Frame.

27291

**Figure 15-3. Format of the Write Functions Command Frame**

<b>Octets</b>	Variable
<b>Field Name</b>	Write Functions record

27292

27293 Write Functions record SHALL be formatted as illustrated in Figure 15-4.

27294

**Figure 15-4. Format of the Write Functions Record Field**

<b>Octets</b>	2	1	Variable
<b>Data Type</b>	uint16	enum8	Variable
<b>Field Name</b>	Function identifier (i.e., attribute identifier)	Function data type	Function data

27295 **15.2.4.3.2 Payload Details**

27296 The **Function identifier** field: the Function Identifier is 16-bits in length and SHALL contain the identifier  
27297 of the function that is to be written.

27298 The **Function data type** field: the function data type field SHALL contain the data type identifier of the  
27299 attribute that is to be written.

27300 The **Function data** field: the function data field is variable in length and SHALL contain the actual value of  
27301 the function that is to be written.

27302 **15.2.4.3.3 Effects on Receipt**

27303 On receipt of this command, the appliance SHALL set the function given in the Function identifier field. The  
27304 Function attribute is actually changed only when the appliance internal functions have been changed.

27305 If attribute reporting is configured on some function attributes, an attribute reporting command is generated  
27306 when the attribute, and therefore internal appliance function is actually modified. In case attribute reporting  
27307 is not used, the correct execution of the Write Function command SHOULD be verified by using Read At-  
27308 tribute command to poll the written attribute.

27309 **15.2.4.4 Overload Pause Resume Command**

27310 This command SHALL be used to resume the normal behavior of a household appliance being in pause mode  
27311 after receiving a Overload Pause command.

27312 **15.2.4.4.1 Payload Format**

27313 The Overload Pause Resume Command SHALL have no payload.

27314 **15.2.4.4.2 Effects on Receipt**

27315 On receipt of this command, the appliance SHALL resume its operations.



27316 **15.2.4.5 Overload Pause Command**

27317 This command SHALL be used to pause the household appliance as a consequence of an imminent overload  
 27318 event.

27319 **15.2.4.5.1 Payload Format**

27320 The Overload Pause Command SHALL have no payload.

27321 **15.2.4.5.2 Effects on Receipt**

27322 On receipt of this command, the appliance SHALL pause its operations. In order to resume the normal oper-  
 27323 ation an Overload Pause Resume command SHOULD be issued by the device supporting the client side of  
 27324 the Appliance control cluster.

27325 **15.2.4.6 Overload Warning Command**

27326 This basic message is used to send warnings the household appliance as a consequence of a possible overload  
 27327 event, or the notification of the end of the warning state.

27328 **15.2.4.6.1 Payload Format**

27329 The Overload Warning Command payload SHALL be formatted as illustrated in Figure 15-5.  
 27330

**Figure 15-5. Format of the Overload Warning Payload**

<b>Octets</b>	2
<b>Data Type</b>	enum8
<b>Field Name</b>	Warning Event

27331 **15.2.4.6.2 Payload Details**

27332 The Warning Event field represents the identifier of the events that needs to be communicated to the devices  
 27333 to alert about possible overload, as shown in Table 15-7.  
 27334

**Table 15-7. Format of the Event ID Enumerator**

<b>Event ID</b>	<b>Description</b>
0x00	Warning 1: overall power above “available power” level
0x01	Warning 2: overall power above “power threshold” level
0x02	Warning 3: overall power back below the “available power” level
0x03	Warning 4: overall power back below the “power threshold” level
0x04	Warning 5: overall power will be potentially above “available power” level if the appliance starts

27335 **15.2.4.6.3 Effects on Receipt**

27336 On receipt of this command, the appliance SHALL show the possible warning state on a display (e.g., show-  
27337 ing an icon with possible overload condition when activating the appliance in case of Warnings 1-2) or re-  
27338 sume the normal state in case of events showing the return on normal state (e.g., Warning 3-4).

27339 **15.2.5 Server Commands Generated**

27340 Table 15-8 lists commands that are generated by the server.

27341 **Table 15-8. Cluster-specific Commands Sent by the Server**

Command Identifier Field Value	Description	M/O
0x00	Signal State Response	M
0x01	Signal State Notification	M

27342 **15.2.5.1 Signal State Response Command**

27343 This command SHALL be used to return household appliance status, according to Appliance Status Values  
27344 and Remote Enable Flags Values.

27345 **15.2.5.1.1 Payload Format**

27346 The Signal State Response Command payload SHALL be formatted as illustrated in Figure 15-6.

27347 The Appliance Status field: the data field is an 8 bits in length enumerator identifying the appliance status.  
27348 The enumeration used for this field SHALL match the specifications in Table 15-9.

27349 The Remote Enable Flags and Device Status 2 field: the data field is an 8 bits in length unsigned integer  
27350 defining remote enable flags and potential appliance status 2 format. The unsigned integer used for this field  
27351 SHALL match the specifications in Table 15-10.

27352 The Appliance Status 2 field: the command identification is a 24 bits in length unsigned integer representing  
27353 potential non-standardized or proprietary data.

27354 **Figure 15-6. Format of the Signal State Response Command Payload**

<b>Octets</b>	1	1	0/3
<b>Data Type</b>	enum8	uint8	uint24
<b>Field Name</b>	Appliance Status	Remote Enable Flags and Device Status 2	Appliance Status 2

27355 **15.2.5.1.1.1 Payload Details**

27356 **ApplianceStatus**

27357 *ApplianceStatus* represents the current status of household appliance. *ApplianceStatus* must be included as  
27358 part of the minimum data set to be provided by the household appliance device. *ApplianceStatus* is updated  
27359 continuously as appliance state changes.

27360 Table 15-9 provides states defined.

27361

**Table 15-9. Appliance Status Values**

Enumeration	Value	Description
OFF	0x01	Appliance in off state
STAND-BY	0x02	Appliance in stand-by
PROGRAMMED	0x03	Appliance already programmed
PROGRAMMED WAITING TO START	0x04	Appliance already programmed and ready to start (e.g., has not reached <i>StartTime</i> )
RUNNING	0x05	Appliance is running
PAUSE	0x06	Appliance is in pause
END PROGRAMMED	0x07	Appliance end programmed tasks
FAILURE	0x08	Appliance is in a failure state
PROGRAMME INTERRUPTED	0x09	The appliance programmed tasks have been interrupted
IDLE	0x0a	Appliance in idle state
RINSE HOLD	0x0b	Appliance rinse hold
SERVICE	0x0c	Appliance in service state
SUPERFREEZING	0x0d	Appliance in superfreezing state
SUPERCOOLING	0x0e	Appliance in supercooling state
SUPERHEATING	0x0f	Appliance in superheating state
<i>Manufacturer Specific</i>	0x80..0xff	Manufacturer specific value range

27362

27363 **RemoteEnableFlags Field**

27364 *RemoteEnableFlags* represents the current status of household appliance correlated with remote control.

27365 *RemoteEnableFlags* is mandatory and must be included as part of the minimum data set to be provided by  
 27366 the household appliance device.

27367 *RemoteEnableFlags* is updated continuously when appliance state remote-controllability changes.

27368 Table 15-10 provides details about flags organization.

27369

**Table 15-10. Remote Enable Flags Values**

Bit Range	Function
0..3	Remote Enable Flags

Bit Range	Function	
	Value	Enumeration
	0x0	DISABLED
	0x7	TEMPORARILY LOCKED/DISABLED
	0xf	ENABLED REMOTE CONTROL
	0x1.	ENABLED REMOTE AND ENERGY CONTROL
	0x2..0x06, 0x8..0xe	Reserved
4..7	Device Status 2 Structure	
	Value	Enumeration
	0x0	PROPRIETARY
	0x1	PROPRIETARY
	0x2	IRIS SYMPTOM CODE
	0x3..0xf	Reserved

27370

27371 **ApplianceStatus2 Field**

27372 ApplianceStatus2 represents a detailed definition of Appliance state. If optionally provided, ApplianceSta-  
27373 tus2 is updated continuously as appliance state change.

27374 This field contains non-standardized or proprietary data. In the case of IRIS Symptom Code, 3 bytes repre-  
27375 senting the 3 digit encoding is provided (possibly complemented with proprietary bytes).

27376 **15.2.5.1.2 Effect on Receipt**

27377 On receipt of this command, the device is informed of a Household Appliance status.

27378 **15.2.5.2 Signal State Notification Command**

27379 This command SHALL be used to return household appliance status, automatically when appliance status  
27380 changes.

27381 **15.2.5.2.1 Payload Format**

27382 The Signal State Notification Command payload SHALL be formatted as illustrated for the Signal State  
27383 Response Command Payload.

27384 **15.2.5.2.2 Effects on Receipt**

27385 On receipt of this command, the device is informed of a Household Appliance status.

27386 **15.2.6 Client**

27387 The client cluster has no dependencies or specific cluster attributes. The client side of this cluster receives  
27388 the cluster specific commands generated by the server. The client side of this cluster generates the cluster  
27389 specific commands received by the server as required by the application.

27390 **15.3 EN50523 Appliance Identification**

27391 **15.3.1 Overview**

27392 Please see section 2.2 for a general cluster overview defining cluster architecture, revision, classification,  
 27393 identification, etc.

27394 Attributes and commands for determining basic information about a device and setting user device infor-  
 27395 mation.

27396 The Appliance Identification Cluster is a transposition of EN50523 “Identify Product” functional block.

27397 **Note:** *Where a physical node supports multiple endpoints it will often be the case that many of these settings*  
 27398 *will apply to the whole node, that is they are the same for every endpoint on the device. In such cases they*  
 27399 *can be implemented once for the node, and mapped to each endpoint.*

27400 **15.3.1.1 Revision History**

27401 The global *ClusterRevision* attribute value SHALL be the highest revision number in the table below.

Rev	Description
1	mandatory global <i>ClusterRevision</i> attribute added; CCB 1893

27402 **15.3.1.2 Classification**

Hierarchy	Role	PICS Code	Primary Transaction
Base	Application	APLNCID	Type 2 (server to client)

27403 **15.3.1.3 Cluster Identifiers**

Identifier	Name
0x0b00	EN50523 Appliance Identification

27404 **15.3.2 Server**

27405 **15.3.2.1 Attributes**

27406 For convenience, the attributes defined in this specification are arranged into sets of related attributes; each  
 27407 set can contain up to 16 attributes. Attribute identifiers are encoded such that the most significant three nib-  
 27408 bles specify the attribute set and the least significant nibble specifies the attribute within the set. The currently  
 27409 defined attribute sets are listed in Table 15-11.

27410 **Table 15-11. Appliance Identification Attribute Sets**

Attribute Set Identifier	Description
0x000	Basic Appliance Identification
0x001	Extended Appliance Identification

27411

27412 **15.3.2.2 Basic Appliance Identification Attribute Set**

27413 The Basic Appliance Identification attribute set contains the attributes summarized in Table 15-12.

27414 **Table 15-12. Attributes of the Appliance Identification Attribute Set**

Identifier	Name	Type	Range	Access	Def	M/O
0x0000	<i>BasicIdentification</i>	uint56	-	R	-	M

27415

27416 **15.3.2.3 BasicIdentification Attribute**

27417 *BasicIdentification* is 56-bit bitmap (7 octets) and contains the basic appliance identification.

27418 *BasicIdentification* is mandatory and must be included as part of the minimum data set to be provided by the  
27419 household appliance device.

27420 Table 15-13 provides attribute content specification.

27421 **Table 15-13. Basic Appliance Identification Content Specification**

Attribute Name	Field	Bits
<i>BasicIdentification</i>	Company ID	0x00-0x0f
	Brand ID	0x10-0x1f
	Product Type ID	0x20-0x2f
	Spec. Ver.	0x37-0x30

27422

27423 Table 15-13 provides Company ID and Brand ID fields content, according to [N2], Table 5.

27424 Table 15-14 provides Product Type IDs field content, again according to [N2] (see Table 6).

27425

**Table 15-14. Product Type IDs**

Device (Appliance)	Product Type ID
White Goods	0x0000
Dishwasher	0x5601

Device (Appliance)	Product Type ID
Tumble Dryer	0x5602
Washer Dryer	0x5603
Washing Machine	0x5604
Hobs	0x5E03
Induction Hobs	0x5E09
Oven	0x5E01
Electrical Oven	0x5E06
Refrigerator Freezer	0x6601

27426 **15.3.2.4 Extended Appliance Identification Attribute Set**

27427 The Extended Appliance Identification attribute set contains the attributes summarized in Table 15-15.

27428 **Table 15-15. Attributes of the Extended Appliance Identification Attribute Set**

Identifier	Name	Type	Range	Acc	Def	M/O
0x0010	<i>CompanyName</i>	string	0 to 16 Octets	R	-	O
0x0011	<i>CompanyId</i>	uint16	<i>all</i>	R	-	O
0x0012	<i>BrandName</i>	string	0 to 16 Octets	R	-	O
0x0013	<i>BrandId</i>	uint16	<i>all</i>	R	-	O
0x0014	<i>Model</i>	octstr	0 to 16 Octets	R	-	O
0x0015	<i>PartNumber</i>	octstr	0 to 16 Octets	R	-	O
0x0016	<i>ProductRevision</i>	octstr	0 to 6 Octets	R	-	O
0x0017	<i>SoftwareRevision</i>	octstr	0 to 6 Octets	R	-	O
0x0018	<i>ProductTypeName</i>	octstr	2 Octets	R	-	O
0x0019	<i>ProductTypeId</i>	uint16	<i>all</i>	R	-	O
0x001A	<i>CECEDSpecificationVersion</i>	uint8	<i>all</i>	R	-	O

27429

### 27430 **15.3.2.5 *CompanyName* Attribute**

27431 *CompanyName* is a ZCL Character String field capable of storing up to 16 character string (the first Octet  
27432 indicates length) encoded in the UTF-8 format. Example Company Name labels are “Electrolux”, “Indesit  
27433 Company”, “Candy”. The complete list of valid labels is defined in [E2], Table 7.

### 27434 **15.3.2.6 *CompanyID* Attribute**

27435 *CompanyID* is 16-bit in length unsigned integer which defines the appliance company identifier. The com-  
27436 plete list of valid company identifiers is defined in [E2], Table 7.

### 27437 **15.3.2.7 *BrandName* Attribute**

27438 *BrandName* is a ZCL Character String field capable of storing up to 16 character string (the first Octet indi-  
27439 cates length) encoded in the UTF-8 format. Example Brand Name labels are “Rex”, “Ariston”, “Hoover”.  
27440 The complete list of valid labels is defined in [E2], Table 7.

### 27441 **15.3.2.8 *BrandID* Attribute**

27442 *BrandID* is 16-bit in length unsigned integer which defines the appliance brand identifier. The complete list  
27443 of valid brand identifiers is defined in [E2], Table 7.

27444 Note that Brand Ids and Company Ids are independently defined. The advantage is that one brand of one  
27445 producer MAY have the same ID as a brand name of another producer.

### 27446 **15.3.2.9 *Model* Attribute**

27447 *Model* is a ZCL Octet String field capable of storing up to 16 character string (the first Octet indicates length)  
27448 encoded in the UTF-8 format. *Model* defines the appliance model name, decided by manufacturer.

### 27449 **15.3.2.10 *PartNumber* Attribute**

27450 *PartNumber* is a ZCL Octet String field capable of storing up to 16 character string (the first Octet indicates  
27451 length) encoded in the UTF-8 format. *PartNumber* defines the appliance part number, decided by manufac-  
27452 turer.

### 27453 **15.3.2.11 *ProductRevision* Attribute**

27454 *ProductRevision* is a ZCL Octet String field capable of storing up to 6 character string (the first Octet indi-  
27455 cates length) encoded in the UTF-8 format. *ProductRevision* defines the appliance revision code, decided by  
27456 manufacturer.

### 27457 **15.3.2.12 *SoftwareRevision* Attribute**

27458 *SoftwareRevision* is a ZCL Octet String field capable of storing up to 6 character string (the first Octet indi-  
27459 cates length) encoded in the UTF-8 format. *SoftwareRevision* defines the appliance software revision code,  
27460 decided by manufacturer.

### 27461 **15.3.2.13 *ProductTypeName* Attribute**

27462 *ProductTypeName* is a 2 Octet in length String field which defines the appliance type label. Example  
27463 *ProductTypeName* labels are “WM”, “RE”, “GO”, respectively for Washing Machine, Refrigerator and Gas  
27464 Oven. The complete list of valid labels is defined in [E2], Table 8.



27465 **15.3.2.14 ProductTypeID Attribute**

27466 *ProductTypeID* is a 16-bit in length unsigned integer which defines the appliance type identifier. The struc-  
27467 ture and complete list of valid *ProductTypeIDs* is defined in [E2], Table 7.

27468 **15.3.2.15 CECEDSpecificationVersion Attribute**

27469 *CECEDSpecificationVersion* is an 8-bit in length unsigned integer which defines the CECED reference doc-  
27470 umentation. Compliance and certification of appliance communication capabilities can be defined according  
27471 to Table 15-16 (see [E2], Table 10).

27472

**Table 15-16. CECED Specification Version**

Specification Version	Value
Compliant with v1.0, not certified	0x10
Compliant with v1.0, certified	0x1A
Compliant with vX.0, not certified	0xX0
Compliant with vX.0, certified	0xXA

27473 **15.3.2.16 Commands Received**

27474 No cluster-specific commands are received by the server.

27475 **15.3.2.17 Commands Generated**

27476 No cluster-specific commands are generated by the server.

27477 **15.3.3 Client**

27478 The client cluster has no dependencies or cluster specific attributes. The client cluster has no cluster specific  
27479 commands generated or received.

27480 **15.4 EN50523 Appliance Events and Alerts**

---

27481 **15.4.1 Overview**

27482 Please see Chapter 2 for a general cluster overview defining cluster architecture, revision, classification,  
27483 identification, etc.

27484 Attributes and commands for transmitting or notifying the occurrence of an event, such as “temperature  
27485 reached” and of an alert such as alarm, fault or warning.

27486 It is based on the “Signal event” syntax of EN50523 and completed where necessary.

27487

**Figure 15-7. Typical Usage of the Appliance Events and Alerts Cluster**

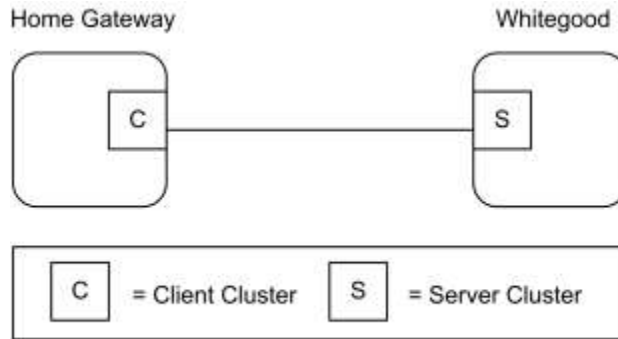

*Note: Device names are examples for illustration purposes only*

27488

27489 There are two different types of occurrences: events and alerts.

27490 Each event is described through two fields:

- 27491 • An event header
- 27492 • An event identification value;

27493 The server notifies the client about the event occurred. There is no possibility for the client to get the event  
27494 from the server and to have a response.

27495 Each alert is described through three fields:

- 27496 • An alert identification value;
- 27497 • A category: either WARNING, DANGER, or FAILURE.
- 27498 • A presence/recovery flag, either the alert has been detected or the alert has been recovered.

27499 The server notifies the client regarding the alerts occurred. The client can also request the alerts from the  
27500 server and receive the related response.

### 27501 **15.4.1.1 Revision History**

27502 The global *ClusterRevision* attribute value SHALL be the highest revision number in the table below.

Rev	Description
1	mandatory global <i>ClusterRevision</i> attribute added

### 27503 **15.4.1.2 Classification**

Hierarchy	Role	PICS Code	Primary Transaction
Base	Application	APPLEV	Type 2 (server to client)

### 27504 **15.4.1.3 Cluster Identifiers**

Identifier	Name
0x0b002	EN50523 Appliance Events and Alerts

27505 **15.4.2 Server**

27506 **15.4.2.1 Dependencies**

27507 None

27508 **15.4.2.2 Attributes**

27509 None

27510 **15.4.2.3 Commands Received**

27511 The received command IDs for the Appliance Events and Alerts Cluster are listed in Table 15-17.

27512 **Table 15-17. Received Commands IDs for the Events and Alerts Cluster**

Command Identifier Field Value	Description	M/O
0x00	Get Alerts	M

27513

27514 **15.4.2.3.1 Get Alerts Command**

27515 This basic message is used to retrieve Household Appliance current alerts.

27516 **15.4.2.3.1.1 Payload Format**

27517 This command does not have a payload.

27518 **15.4.2.3.1.2 Effects on Receipt**

27519 On receipt of this command, the device SHALL generate a Get Alerts Response command.

27520 **15.4.2.4 Commands Generated**

27521 The generated command IDs for the Appliance Events and Alerts Cluster are listed in Table 15-18.

27522 **Table 15-18. Generated Commands IDs for the Appliance Events and Alerts Cluster**

Command Identifier Field Value	Description	M/O
0x00	Get Alerts Response	M
0x01	Alerts Notification	M
0x02	Event Notification	M

27523 **15.4.2.4.1 Get Alerts Response Command**

27524 This message is used to return household appliance current alerts.

27525 **15.4.2.4.1.1 Payload Format**

27526 The payload SHALL be formatted as illustrated in Figure 15-8.

27527 **Figure 15-8. Format of the Get Alerts Response Command Payload**

<b>Octets</b>	1	3	...	3
<b>Data Type</b>	uint8	uint24	...	uint24
<b>Field Name</b>	Alerts Count <sup>245</sup>	Alert structure 1	...	Alert structure <i>n</i>

27528 **15.4.2.4.1.1.1 Payload Details**

27529 The **Alerts Count** field: the data field is an 8 bits in length unsigned integer, containing the following alerts  
27530 structures count and alert structure type.

27531 Table 15-19 provides details about Alerts Count and Structure field organization.

27532 **Table 15-19. Alert Count Organization**

<b>Bit range</b>	<b>Function</b>	
0..3	Number of Alerts <i>n</i>	
4..7	Type of alert	
	<b>Value</b>	<b>Enumeration</b>
	0x0 0x1..0xf	UNSTRUCTURED Reserved

27533

<sup>245</sup> Even if the ApplianceAlertList array number of element field is 16-bit in length, the actual content is limited to 0x000*n*, where, in actual implementations, *n* is lower than 255 (except for the invalid condition, 0xffff). Then, the notification of the Alert count is mapped to a single byte (following appliance interworking specifications).

27534 Each *Alerts Structure* field SHALL be formatted as illustrated in Table 15-20.

27535

**Table 15-20. Alerts Structure Organization**

Bit range	Function	
0..7	Alert id	
8..11	Category	
	Value	Enumeration
	0x0 0x1 0x2 0x3 0x4 – 0xf	Reserved WARNING DANGER FAILURE Reserved
12..13	Presence recovery	
	Value	Enumeration
	0x0 0x1 0x2 – 0x3	RECOVERY PRESENCE Reserved
16..23	Manufacturer specific bits	

27536

27537 The *Alert ID* field can have the following values:

- 27538
- Value 0 is reserved.
- 27539
- Values ranging from 1 to 63 are standardized.
- 27540
- Values ranging from 64 to 127 are reserved.
- 27541
- Values ranging from 128 to 255 are manufacturer specific.

27542 **15.4.2.4.1.2 Effects on Receipt**

27543 On receipt of this command, the device is informed of a Household Appliance warning and fault occurrence.

27544 **15.4.2.4.2 Alerts Notification Command**

27545 This message is used to notify the current modification of warning and/or fault conditions.

27546 **15.4.2.4.2.1 Payload Format**

27547 The payload SHALL be formatted as illustrated in Figure 15-9.

27548

**Figure 15-9. Format of the Alerts Notification Command Payload**

<b>Octets</b>	1	3	...	3
<b>Data Type</b>	uint8	uint24	...	uint24
<b>Field Name</b>	Alerts Count	Alert structure 1	...	Alert structure <i>n</i>

27549 **15.4.2.4.2.1 Payload Details**

27550 See Get Alert Response command.

27551 **15.4.2.4.2.2 Effects on Receipt**

27552 On receipt of this command, the device is informed of a Household Appliance warning and fault occurrence.

27553 **15.4.2.4.3 Event Notification Command**

27554 This message is used to notify an event occurred during the normal working of the appliance.

27555 **15.4.2.4.3.1 Payload Format**

27556 The payload SHALL be formatted as illustrated in Figure 15-10.

27557 **Figure 15-10. Format of the Event Notification Command Payload**

<b>Octets</b>	1	1
<b>Data Type</b>	uint8	uint8
<b>Field Name</b>	Event Header	Event Identification

27558 **15.4.2.4.3.1.1 Payload Details**

27559 The *Event Header* is a reserved field set to 0.

27560 The *Event Identification* field: the *Event Identification* is an 8-bits in length field identifying the event to be notified. The codes used for this field SHALL match those shown in Table 15-21:

27562

**Table 15-21. Event Identification**

<b>Event Identification</b>	<b>Value</b>	<b>Description</b>
END_OF_CYCLE	0x01	End of the working cycle reached
TEMPERATURE_REACHED	0x04	Set Temperature Reached
END_OF_COOKING	0x05	End of cooking process
SWITCHING OFF	0x06	
<i>Manufacturer Specific</i>	0x40-0xf6	Manufacturer specific Id range
WRONG_DATA	0xf7	
<i>Manufacturer Specific</i>	0xf8-0xff	Manufacturer specific Id range

27563 **15.4.2.4.3.2 Effects on Receipt**

27564 On receipt of this command, the device is informed of a Household Appliance working event occurrence.

27565 **15.4.3 Client**

27566 The client cluster has no dependencies or specific cluster attributes. The client side of this cluster receives  
 27567 the cluster specific commands generated by the server. The client side of this cluster generates the cluster  
 27568 specific commands received by the server as required by the application.

27569 **15.5 Appliance Statistics**

27570 **15.5.1 Overview**

27571 This cluster provides a mechanism for the transmitting appliance statistics to a collection unit (gateway). The  
 27572 statistics can be in format of data logs. In case of statistic information that will not fit the single payload, the  
 27573 Partition cluster SHOULD be used.

27574 Each appliance uses persistent memory to temporarily store collected statistic logs (entries). The maximum  
 27575 number of stored statistic logs is appliance dependent. If some log notification packets are lost due to tem-  
 27576 porary unreliable RF communication, sequential Log IDs allow the collection of the missing logs. The fol-  
 27577 lowing is a simple example of an application-level policy used for log collection. When receiving logs with  
 27578 non-consecutive Log IDs, the client can ask server side for the available log queue to verify the actual  
 27579 availability of the missing log. If present, the log can be explicitly retrieved using the LogRequest com-  
 27580 mand.  
 27581

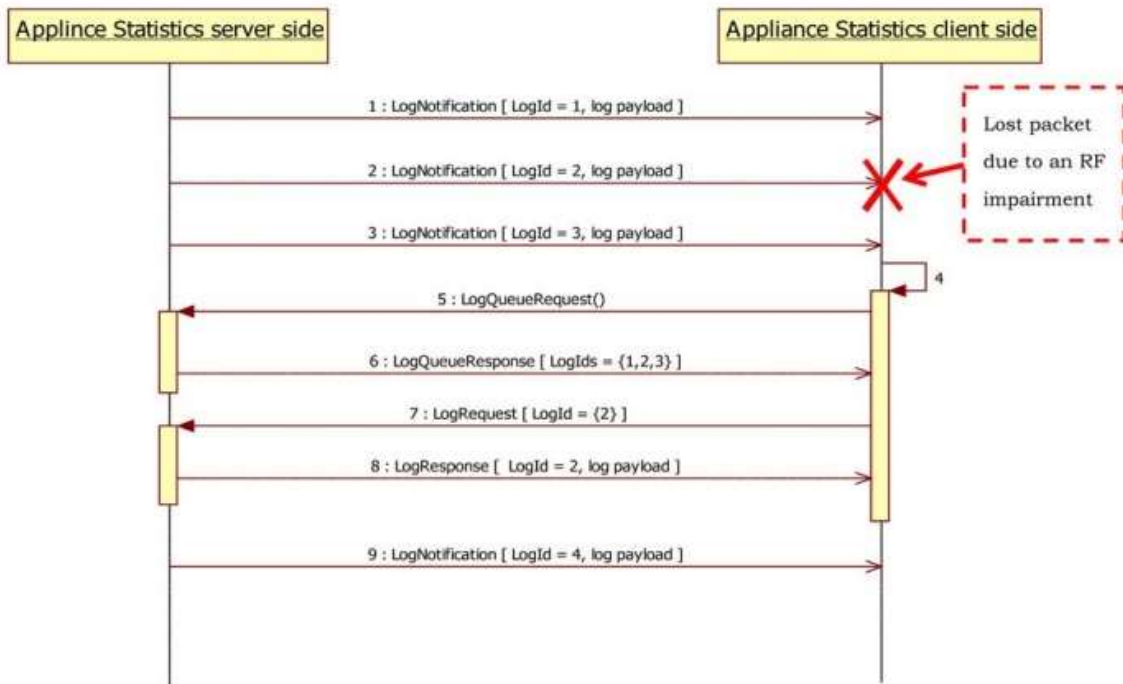

27582

27583 **15.5.1.1 Revision History**

27584 The global *ClusterRevision* attribute value SHALL be the highest revision number in the table below.

Rev	Description
1	mandatory global <i>ClusterRevision</i> attribute added;CCB 1893

27585 **15.5.1.2 Classification**

Hierarchy	Role	PICS Code	Primary Transaction
Base	Application	APPLST	Type 2 (server to client)

27586 **15.5.1.3 Cluster Identifiers**

Identifier	Name
0x0b003	EN50523 Appliance Statistics

27587 **15.5.2 Server**

27588 **15.5.2.1 Attributes**

27589 The server side of this cluster contains the attributes the statistics and log information shown in Table 15-22.

27590 **Table 15-22. Server Attributes**

Identifier	Description	Type	Access	Default	M/O
0x0000	<i>LogMaxSize</i>	uint32	R	0x0000003C	M
0x0001	<i>LogQueueMaxSize</i>	uint8	R	0x01	M

27591 **15.5.2.1.1 LogMaxSize Attribute**

27592 The *LogMaxSize* attribute describes the maximum size of a log payload that can be transferred using the Log  
27593 Notification and Log Response commands. In case the *LogMaxSize* attribute is greater than 70 bytes (0x46)  
27594 the Appliance Statistics commands SHOULD be transferred using the partition cluster. This is the case of a  
27595 “bulk log” transferred from a server side (e.g., White Goods) to a client side (e.g., home gateway) of the  
27596 Appliance Statistics Cluster.

27597 **15.5.2.1.2 LogQueueMaxSize Attribute**

27598 The *LogQueueMaxSize* attribute describes the maximum number of logs that are available in the server side  
27599 of the Appliance Statistics cluster. The logs MAY be retrieved by the client using the Log Request command.

27600 **15.5.2.2 Commands**

27601 The generated command IDs for the Appliance Statistics Server are listed in Table 15-23.



27602

**Table 15-23. Commands Generated by the Appliance Statistics Server**

Command ID	Description	M/O
0x00	Log Notification	M
0x01	Log Response	M
0x02	Log Queue Response	M
0x03	Statistics Available	M

27603 **15.5.2.2.1 Log Notification**

27604 The Appliance Statistics Cluster server occasionally sends out a Log Notification command to the devices to  
 27605 which it needs to log information related to statistics (e.g., home gateways) which implement the client side  
 27606 of Appliance Statistics Cluster.

27607 **15.5.2.2.1.1 Payload Format**

27608

**Figure 15-11. Format of the Log Notification Payload**

<b>Octets</b>	4	4	4	1	...	1
<b>Data Type</b>	UTC	uint32	uint32	data8	data8	data8
<b>Field Name</b>	Time Stamp	Log ID	Log Length	Log Payload		

27609 **15.5.2.2.1.2 When Generated**

27610 The Log Notification command is generated when the appliance needs to send log information related to its  
 27611 statistics to a remote device (e.g., home gateway) without being solicited by the client side. The log infor-  
 27612 mation sent with the Log Notification command from the server side is not solicited by specific command  
 27613 generated by the client side of the Appliance Statistics cluster. The Log ID field identifies uniquely the log  
 27614 information contained in the log payload. Log IDs SHALL be consecutive. Log Length field indicated the  
 27615 length in bytes of the log payload and SHALL be less than *LogMaxSize* attribute.

27616 If the device generating the Log Notification command is not able to generate the time stamp information it  
 27617 SHALL insert an invalid UTC Time (0xffffffff). In this case the server side of the Appliance statistics cluster  
 27618 (e.g., a home gateway) SHOULD insert a timestamp of the received log notification if available before storing  
 27619 or transmitting the log information to backend systems.

27620 **15.5.2.2.1.3 Effect Upon Receipt**

27621 Upon receipt of the Log Notification command, the Appliance statistics client will respond with a Default  
 27622 Response command if requested or if an error occurs. In case of error the server side of Appliance statistics  
 27623 cluster MAY store the information in the queue and notify the client that there are statistics available by using  
 27624 the Statistic Available command.

27625 **15.5.2.2.2 Log Response**

27626 The Appliance Statistics Cluster server sends out a Log Response command to respond to a Log Request  
 27627 command generated by the client side of the Appliance Statistics cluster.

27628 **15.5.2.2.2.1 Payload Format**

27629 The payload of the Log Response command is the same as the Log Notification command.

27630 **15.5.2.2.2.2 When Generated**

27631 The Log Response command is generated to respond to Log Request sent from a device supporting the client  
27632 side of the Appliance Statistics cluster (e.g., home gateway).

27633 **15.5.2.2.2.3 Effect Upon Receipt**

27634 Upon receipt of the Log Response command, the Appliance statistics client will respond with a Default Re-  
27635 sponse command if requested or if an error occurs.

27636 **15.5.2.2.3 Log Queue Response**

27637 The Log Queue Response command is generated as a response to a Log Queue Request command in order  
27638 to notify the client side of the Appliance statistics cluster about the logs stored in the server side (queue) that  
27639 can be retrieved by the client side of this cluster through a Log Request command. Please note that the  
27640 LogQueueSize field SHALL be less than the *LogQueueMaxSize* attribute.

27641 **15.5.2.2.3.1 Payload Format**

27642 **Figure 15-12. Format of the Log Queue Response Payload**

<b>Octets</b>	1	4	4	4
<b>Data Type</b>	uint8	uint32	...	uint32
<b>Field Name</b>	Log Queue Size	Log ID	...	Log ID

27643 **15.5.2.2.3.2 When Generated**

27644 The Log Queue Response command is generated in response to a Log Queue Request sent from a device  
27645 supporting the client side of the Appliance Statistics cluster (e.g., home gateway) Please note that if Log  
27646 Queue Size is equal to zero (not logs in the queue), the packet SHALL not carry Log IDs.

27647 **15.5.2.2.3.3 Effect Upon Receipt**

27648 Upon receipt of the Log Queue Response command, the Appliance statistics client will respond with a De-  
27649 fault Response command if requested or if an error occurs. The client side of the appliance statistics willing  
27650 to get the logs in the queue SHALL then use only the Log IDs that have been indicated in the Log Queue  
27651 Response.

27652 **15.5.2.2.4 Statistics Available**

27653 The Appliance Statistics Cluster server sends out a Statistic Available command to notify the client side of  
27654 the Appliance Statistics cluster that there are statistics that can be retrieved by using the Log Request com-  
27655 mand.

27656 **15.5.2.2.4.1 Payload Format**

27657 The Statistic Available command is the same as the Log Queue Response command. The Log IDs that can  
27658 be retrieved by the client are indicated in the payload.

27659 **15.5.2.2.4.2 When Generated**

27660 The Statistic Available command is generated to notify a device supporting the client side of the Appliance  
 27661 Statistics cluster (e.g., home gateway) to get the statistics information from the log queue as soon as available  
 27662 to perform this operation.

27663 **15.5.2.2.4.3 Effect Upon Receipt**

27664 Upon receipt of the Statistic Available command, the client side of the Appliance Statistics cluster is notified  
 27665 on the availability of statistics in the server side that can be retrieved by using Log Request commands.

27666 The Appliance statistics client will respond with a Default Response command if requested or if an error  
 27667 occurs.

27668 **15.5.3 Client**

27669 **15.5.3.1 Attributes**

27670 There are no attributes on the client side of the Appliance Statistics Cluster.

27671 **15.5.3.2 Commands**

27672 The generated command IDs for the Appliance Statistics Client are listed in Table 15-24.

27673 **Table 15-24. Commands Generated by the Appliance Statistics Client**

Command ID	Description	M/O
0x00	Log Request	M
0x01	Log Queue Request	M

27674

27675 **15.5.3.2.1 Log Request**

27676 The Log Request command is send from a device supporting the client side of the Appliance Statistics cluster  
 27677 (e.g., Home Gateway) to retrieve the log from the device supporting the server side (e.g., appliance).

27678 **15.5.3.2.1.1 Payload Format**

27679 **Figure 15-13. Format of the Log Request Payload**

<b>Octets</b>	4
<b>Data Type</b>	uint32
<b>Field Name</b>	Log ID

27680 **15.5.3.2.1.2 When Generated**

27681 The Log Request command is generated to retrieve a log information from a device supporting the server  
 27682 side of the Appliance Statistics cluster (e.g., appliance). The log information is addressed by referencing it  
 27683 with the Log ID field. In order to get the Log ID that can be retrieved with the Log Request command, the  
 27684 Log Queue Request command MAY be used.

27685 **15.5.3.2.1.3 Effect Upon Receipt**

27686 Upon receipt of the Log Request command, the Appliance statistics server will respond with a Log Response  
27687 command if the log is available or with a Default Response if an error occurs. In case the Log ID is not  
27688 available in the server side of the cluster the status code carried by the Default Response SHALL be  
27689 “NOT\_FOUND.”

### 27690 **15.5.3.2.2 Log Queue Request**

27691 The Log Queue Request command is sent from a device supporting the client side of the Appliance Statistics  
27692 cluster (e.g., Home Gateway) to retrieve the information about the logs inserted in the queue, from the device  
27693 supporting the server side (e.g., appliance).

#### 27694 **15.5.3.2.2.1 Payload Format**

27695 The Log Queue Request command has no payload.

## 27696 **15.5.4 Appliance Statistics Cluster Sequence Diagram**

27697 Figure 15-14 shows a typical sequence interaction between the client and server sides of the Appliance Sta-  
27698 tistics Cluster.

27699

Figure 15-14. Appliance Statistics Cluster Sequence Diagram

27700

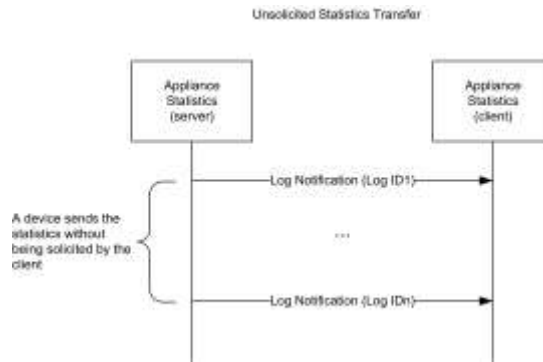

27701

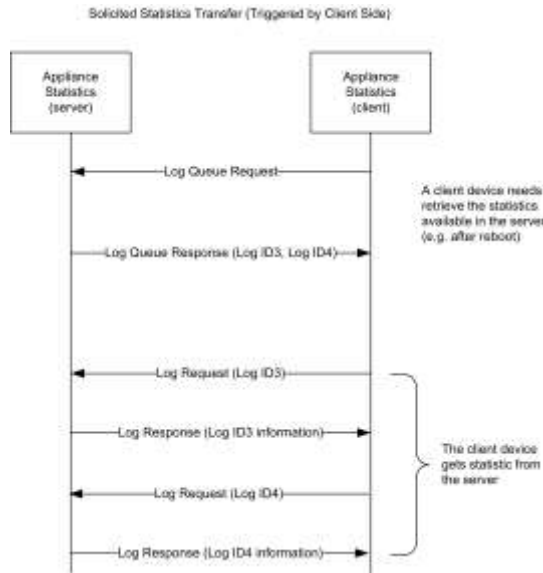

27702

27703

