

The Wireless World

4^D

THE PRACTICAL RADIO JOURNAL

with

Complete Foreign Programmes

Friday, October 5th, 19

free!

Blueprints of splendid sets



Colvern have specially designed two brilliant "no to the minute" sets and blueprints of them are being given away free (except for small postage charge). Using the new

COLPAK

(Made under licence from patents, Hans Vogt)

these sets offer the very latest in efficiency, precision and design. Send for blueprints to-day!

To COLVERN LTD., Romford, Essex. Please send me full details and blueprint of the

COLPAK CLASS B
A.C. MAINS SET

Stamps value 3d. to cover postage are enclosed.

* Strike out name of blueprint not required.

Name

Address

If you would like a copy of our Ferrocart booklet, please put a X here.....

HAVE YOU HEARD THE DIFFERENCE A STENTORIAN MAKES TO YOUR SET?



TELSEN

D.R. TRANSFORMER

—the L.F. Transformer with a STRAIGHT LINE

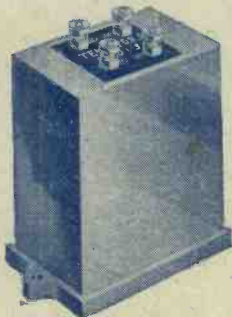

CHARACTERISTIC which gives UNIFORM AMPLIFICATION over the entire range of audio-frequencies. The spaced layer windings are impregnated with a non-hygroscopic material of very low specific inductive capacity which absolutely eliminates all possibility of shorted turns or breakdowns due to large magnetic surges

D.R.3 (ratio 3-1)
D.R.5 (ratio 5-1) **8'6**

Announcement of the Telsen Electric Co., Ltd., Aston, Birmingham.

TELSEN FOR EVERYTHING IN RADIO

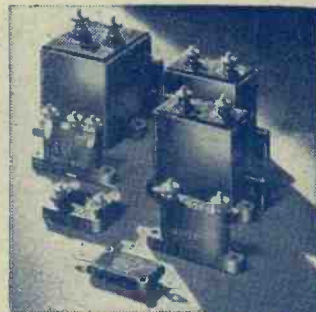

from a thoroughbred line

T.C.C.

ALL-BRITISH

CONDENSERS

To buy T.C.C. is to buy a pedigree condenser—one with a record of achievement behind it.... 27 years' research exclusively on condensers. That's why leading Set designers invariably say "T.C.C., of course."

The TELEGRAPH CONDENSER CO., LTD., Welles Farm Road, N. Acton, London, W.3.

5653

Input, Line & Mains Transformers

for RELAY WORK

For relay systems and other public services where continuity of operation is of paramount importance, the component apparatus must be reliable to an exceptional degree.

Engineers in some of the most important undertakings throughout the Country automatically think of Savage when additional apparatus is under consideration because they know that Savage never lets them down.

Apart from their reliability, Savage input and line transformers pass on sound energy with a high degree of fidelity—yet another reason why they merit your consideration when planning new gear.



Savage

SOUND SYSTEMS

56-58, CLERKENWELL ROAD, E.C.1.

Telephone: Clerkenwell 3068.

Mention of "The Wireless World," when writing to advertisers, will ensure prompt attention.

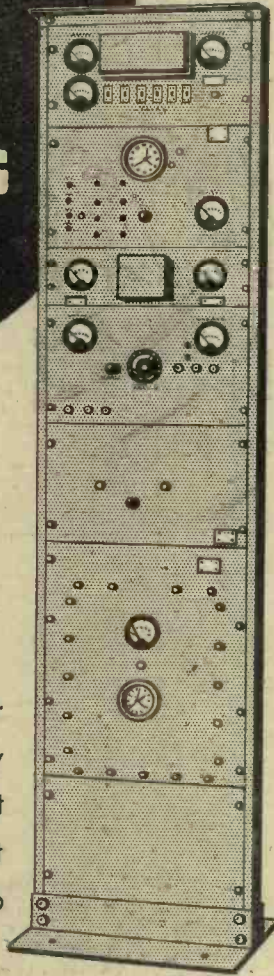

ONLY "ATLAS" HAS THESE 6 OUTPUTS

... This wonderful new "ATLAS T. 10/30" is quite unique. It has no less than 6 TAPPED OUTPUTS. This ensures correct H.T. supply to any and every battery set—straight, superhet, Class "B" and "Q.P.P." Not only is it the ideal mains unit for your present set, but it is also the ideal unit for every set you may buy or construct in the future. In addition to H.T. supply, it embodies a trickle-charger to keep your accumulator always fully charged.

FOR A.C. MAINS.
H.T. Tappings 60/80 v. (min. and max.) 50/90 v. (min., med. and max.), 120 v. and 150 v. Tapped Outputs 10, 20 or 30 mA at 120 or 150 v. Trickle Charger 2 v. at 0.5 amps. Westinghouse Rectifiers. Guaranteed 12 months.
H.P. Terms: 10/- deposit and 8 monthly payments of 8/6 each.
Ask your dealer to-day for a demonstration.

ATLAS

MAINS UNITS CLARKE'S ATLAS

H. Clarke & Co. (M/cr.) Ltd., Patricroft, Manchester.
London: Bush House, W.C.2. Glasgow: G.E.S. Co. Ltd., 38 Oswald St.
I.F.S.: R. Marks Ltd., 27 Upper Liffey St., Dublin.

The Autocar Buyers' Guide of 1935 Cars

dated Oct. 5th
Now on Sale

This special number contains a carefully prepared alphabetical table of all cars on the British market for 1935, giving the principal mechanical features, leading dimensions, annual tax, and chassis and complete car prices.

An important novel feature—introduced for the first time last year and with great success—is the supplementary Guide to Cars with special coachwork.

From all Newsagents and Bookstalls.
PRICE 6d.

LIFFE & SONS LTD., LONDON, S.E.1

The Wireless World

THE
PRACTICAL RADIO
JOURNAL
24th Year of Publication

No. 788.

FRIDAY, OCTOBER 5TH, 1934.

VOL. XXXV. No. 14.

Proprietors: ILIFFE & SONS LTD.

Editor:

HUGH S. POCOCK.

Editorial,

Advertising and Publishing Offices:
DORSET HOUSE, STAMFORD STREET,
LONDON, S.E. 1.

Telephone: Hop 3333 (50 lines).
Telegrams: "Ethaworld, Watloo, London."

COVENTRY: Hertford Street.

Telegrams: "Autocar, Coventry" Telephone: 5210 Coventry.

BIRMINGHAM:

Guildhall Buildings, Navigation Street, 2.
Telegrams: "Autopress, Birmingham." Telephone: 2971 Midland (4 lines).

MANCHESTER: 260, Deansgate, 3.

Telegrams: "Iliffe, Manchester." Telephone: Blackfriars 4412 (4 lines).

GLASGOW: 26B, Renfield Street, C.2.

Telegrams: "Iliffe, Glasgow." Telephone: Central 4857.

PUBLISHED WEEKLY. ENTERED AS SECOND
CLASS MATTER AT NEW YORK, N.Y.

Subscription Rates:

Home, £1 1s. 8d.; Canada, £1 1s. 8d.; other
countries, £1 3s. 10d. per annum.

*As many of the circuits and apparatus described in these
pages are covered by patents, readers are advised, before
making use of them, to satisfy themselves that they would
not be infringing patents.*

CONTENTS

	Page
Editorial	277
What Causes Sidebands	278
Short Waves and the Amateur	281
New Frequency-Changer	283
Hints and Tips	285
News of the Week	286
FOREIGN PROGRAMME	
SUPPLEMENT, pp. I—XXIV	
Broadcast Brevities	287
Unbiased	288
Portadyne Set Review	289
Letters to the Editor	290
New Apparatus	292

EDITORIAL COMMENT

Tuning Scales

Still the Weakest Point

A YEAR ago we drew attention to the fact that whilst in the gradual evolution of the broadcast receiver of to-day very great ingenuity had been shown in the development of electrical circuits and the refinements of all kinds which have gone to improving the performance of receivers, yet the tuning scale has not received a fair share of attention.

The earliest types of tuning arrangement took the form of a pointer moving over the scale of a variable condenser, and in the years which have passed since first receivers were developed it must be agreed, we think, that little progress has been made in the way of adding to the convenience of the user who wishes to tune in to the stations required. It is true that in the past year, in particular, several new forms of tuning scales have appeared, and some of these are commendable improvements, but the average remains about the same because a good many sets have tuning scales even less convenient to read than those earliest forms which provided for the calibration of the variable condenser.

Many years ago it required an Act of Parliament to ensure that clocks installed in public places should have dials large enough and sufficiently clear to be really serviceable, and the "Parliament clock," as the product of the official specification was called, was the origin of the bold white dial which has still maintained its position as the commonest form of public clock. In the year 1934 it ought not to require an Act of Parliament to produce more serviceable types of tuning dials for wireless sets. Public demand should be sufficient to bring about the necessary change, but yet it is difficult for the

public to indicate its preference when there is so little to choose from which can be regarded as really a satisfactory solution of this difficulty. Manufacturers, we suppose, hesitate to produce sets with prominent scales, lest this should detract from the general appearance of the receiver, but we believe that it requires only a little courage to market an arrangement which would be both attractive in appearance and really serviceable in use.

The Exhibitions

Changes Demanded

OUR Correspondence columns contain a number of letters which are representative of a very large total which we have received during the Exhibitions period, all of them expressing disappointment at certain aspects of the shows. We hope that those responsible for organising these annual events will take notice of these objections and not be blind to the fact that the success of an exhibition cannot always be gauged from the total of the box office receipts.

Although the organisers' funds may be greatly augmented by the box office receipts, a broader view than this should be taken and the Exhibitions planned primarily as wireless shows. If the organisers were unconnected with the radio industry, greed for box office takings might be excused, but not where the shows are run by the representatives of the industry itself. It should be someone's duty to review the whole position and decide whether we are to have real *radio* exhibitions in the future, or arrange instead to augment the income of the Radio Manufacturers' Association by means of stage showmanship and irrelevant entertainments.



The G.P.O. single side-band transmitter at Rugby for communication with Canada.

What Causes Side-bands

A Synthetic Demonstration

IN view of the future possibility of single side-band broadcasting, it seems desirable to review the general subject of modulation and side-bands. The present introductory article will be followed by another dealing with practical aspects of single side-band working

A RECENT issue of *The Wireless World*, in discussing future possibilities, referred to the production of side-bands in the process of modulation and showed how the emission and reception of *both* side-bands were not essential for reproduction. The same article envisaged the advantages that might accrue from single side-band operation, although it was compelled to admit—as at present any such article must—that the immediate and even more remotely future possibilities could not be very exactly prophesied.

Explanations of the setting-up of side-bands are by no means new and have appeared in these columns on previous occasions. The present explanation is intended rather for new readers and is an attempt to give a simple but clear picture of the physical processes.

Are Side-bands Real?

A few years ago there was an active but short-lived controversy as to whether or not there were really any side-bands. Judging as impartially as one can do, one was left with the impression that the discussion ended in much the same way as those assertions made from time to time that the world is really flat. The controversy arose primarily in the case of what can best be described generically as “high selectivity tone-corrected receivers,” and it is interesting to note that theoretical investigation made by the Radio Research Board led to the conclusion “that the be-

haviour of receiving circuits of very high selectivity combined with tone-correction has been found to be quite in accordance with that predicted from an application of the usual side-wave analysis.”

To return, then, to our muttons, let us first consider the process of modulation. This is illustrated in detail in Fig. 1, where (a) shows a carrier wave of 20,000 cycles. This low value has been chosen chiefly for convenience of drawing and illustration in this and succeeding diagrams, and the reader will have no difficulty in visualising the process when the carrier is of the order

of the 1,000 kilocycles of a 300-metre wave. Further, *frequency* is used in this article instead of wavelength (as was done in *The Wireless World* of June 15th), since it is more amenable to the synthetic demonstration that follows. Fig. 1 (a) thus shows quite a number of cycles of our 20 kc. carrier drawn to a suitable time-scale, while Fig. 1 (b) shows an audio frequency of 1,000 cycles drawn to the same time scale. Fig. 1 (c) then illustrates how the 1,000-cycle component is applied to vary the amplitude of the 20 kilocycle carrier. The height A above and below the zero line is the amplitude of the carrier in Fig. 1 (a). The 1,000-cycle wave is then applied so that A is periodically varied between the values $A+B$ and $A-B$. The case shown represents full modulation of 100 per cent., that is, $B=A$, so that A varies between $2A$ and zero. This need not necessarily, and will not generally, be the case, e.g., for lower values of modulation, where, however, the general relation of variation between the limits $A+B$ and $A-B$ still holds good. (This is illustrated later in Fig. 4, which shows a similar compounding for 50 per cent. modulation.) The result of the combination on the actual appearance of the carrier is then shown in Fig. 1 (d).

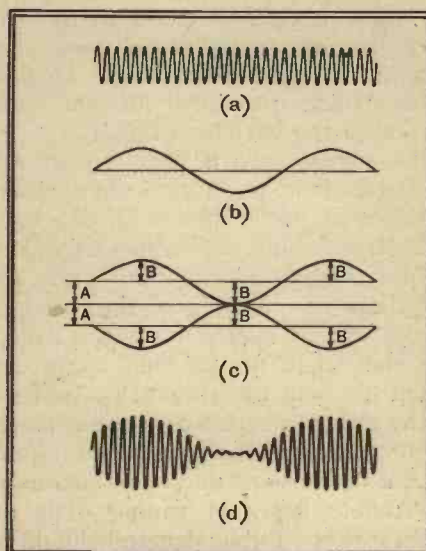

Fig. 1.—Illustrating the process of modulation: 100 per cent. modulated wave.

Action of Modulation

This, then, is the process of amplitude modulation. The result as regards the setting-up of side-bands is best considered, first by a simple statement and then by a

What Causes Side-bands—

“spectrum diagram.” The statement is this, that if a radio frequency F is modulated by a lower frequency N , the frequency F continues to exist completely undisturbed, but there are set up along with it two new radio frequencies of the values $F+N$ and $F-N$ respectively. This is illustrated in the spectrum diagram of Fig. 2, where we have a frequency drawn to a linear scale from 0 up to over 20,000 cycles. The position of our modulating

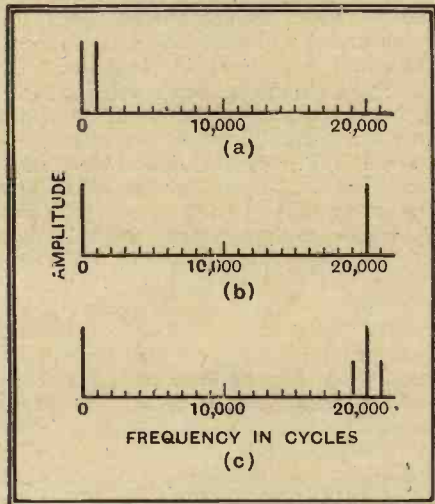

Fig. 2.—The production of side-bands. (a) Spectrum position of modulating frequency. (b) Spectrum position of carrier frequency. (c) Spectrum position of carrier and side-bands.

frequency of 1,000 cycles is shown in Fig. 2 (a), and the corresponding scale-position of our 20 kc/s carrier in Fig. 2 (b). The result of modulation is shown in Fig. 2 (c); the 20 kc/s frequency continues undisturbed, but the result of modulation is to produce two new frequencies of 21 kc/s and 19 kc/s respectively, that is, 1 kc/s displaced on each side of the carrier.

Unfortunately, this is not easily demonstrated by simple physical argument. The most direct proof is an algebraic or trigonometric one, which is what we want to avoid.

The Mixing Process

A sufficiently convincing proof, however, is to take a graphical representation of frequencies of 20, 19, and 21 kilocycles and combine them in a drawing and add them together. This is done in Fig. 3, where (a) is a continuous wave of 20 kc/s and of amplitude A , (b) is another continuous wave of amplitude $\frac{1}{2}B$ and of frequency 21 kc/s, while (c) is a third wave of amplitude $\frac{1}{2}B$ but of frequency 19 kc/s. The addition of the three waves is shown in Fig. 3 (d), which we see to be exactly the same as the 100 per cent. modulated wave of Fig. 1 (d).

As a matter of fact, if we took the three frequencies and put them all together into one circuit the actual result would be exactly the same. Thus, as a physical fact we can get the current wave shape of Fig. 1 (d) by two methods: (i) by modulating

a 20 kc/s carrier by 1,000 cycles, (ii) by combining currents of 20, 21, and 19 kc/s.

Several interesting facts should be noted in connection with Fig. 3 as a whole. By tracing down vertically we can see how the phases of the side-band frequencies vary with respect to each other and with respect to the carrier. At some instants their peaks are exactly opposite each other, at others they are exactly together. At some instants their added peaks are further added to the carrier, at other instants the added peaks of the side-band frequencies oppose the carrier. A very important relation can be observed—that at the end of each half-cycle of the carrier the side-band frequencies are always of equal value but of opposite electrical sense, so that their total instantaneous effect is zero. The actual time-duration of each half-cycle of the modulated carrier is thus not altered from the unmodulated condition of Fig. 3 (a). This can be verified by following down the vertical lines.

Another interesting fact, obvious from both Fig. 2 and Fig. 3, is that for a carrier

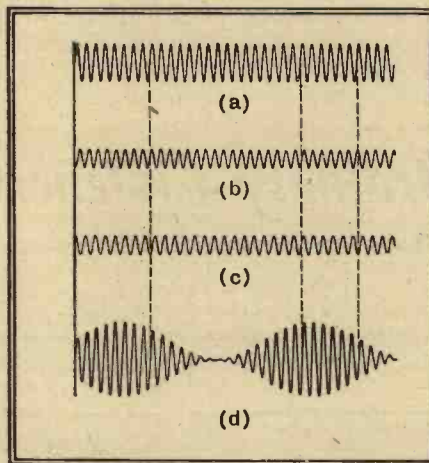

Fig. 3.—The synthesis of a modulated wave. (a) Carrier of 20 kc. (b) Upper (frequency) side-band of 21 kc. (c) Lower (frequency) side-band of 19 kc. (d) Carrier modulated 100 per cent. at 1,000 cycles.

fully modulated by a single frequency the amplitude of each of the side-band frequencies is half that of the carrier.

The case of 50 per cent. modulation is shown in Fig. 4, which should be compared with Fig. 1. If this case were synthesised in the same manner as Fig. 3, we should require the side-band frequencies (19 and 21 kc/s) to be each one-quarter the amplitude of the carrier, so that their additive total effect is equal to half that of the carrier.

Consideration of what happens at the receiver is best effected by means of the spectrum diagram of Fig. 2. The receiver should be such as to respond equally strongly to the whole band of frequencies contained in Fig. 2 (c)—that is, from 19 to 21 kc/s. The relations of the side-bands to the carrier can then be considered in the light of ordinary heterodyne reception. The 19 kc/s component will beat with the carrier of 20 kc/s to produce a heterodyne note of 1 kc, our original

modulating frequency. The 21 kc/s component will also beat with the 20 kc/s carrier, to give us the same beat note, and these two beat notes will be added to each other, as can be shown by consideration of their phases, implicit from the phase-relations already considered in the case of the side-band frequencies of Fig. 3. (Incidentally, there are other effects due to the 19 and 21 kc/s components beating with each other, but these need not be considered here.) The important point is that in order to get back our 1,000-cycle beat note we must have a carrier frequency for one or other, or both, of the side-bands to beat with. In the case shown this is supplied by the carrier transmitted and received. But suppose by any means—magic if you like—the receiver fails to receive the 19 and 20 kc/s components of Fig. 2 (c), we could still get our 1,000-cycle beat note by introducing locally a 20 kc/s component to beat with the 21 kc/s side-band which it has received. This is a most important point to recall in relation to practical single side-band working.

Broadcast Modulation

Finally, let us apply the conditions considered above to values of frequency more typical of those which we encounter in broadcasting practice.

In the first place, in broadcast telephony we are not concerned, except during the brief periods of tuning note, with modulation by a single frequency, as we have so far considered. True, at times a single instrument playing alone may approximate to it, but in general we are concerned with modulation by any frequency, or simultaneously by many of the whole

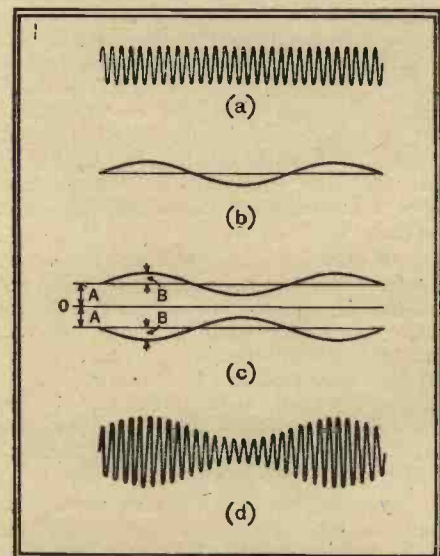

Fig. 4.—50 per cent. modulated wave.

range of frequencies contained in our audio spectrum (see *The Wireless World*, June 29th, 1934). If we accept 10 kc/s as the desirable upper limit, this means that at any instant our modulation may consist of a large number of frequencies lying anywhere between the limits of 30 cycles and 10 kilocycles. This is indicated in Fig. 5 (a) in its appropriate position in a spectrum of frequencies which we can only

What Causes Side-bands—

show quasi-continuously because of obvious space limitations. The shaded shape of Fig. 5 (a) is thus taken as representing any or all of the frequencies up to 10 kc/s; the shape of the envelope taken is arbitrary and insignificant.

Secondly, in broadcast practice we are concerned with carriers of much higher frequency than the 20 kc/s considered in Figs. 1-4. Suppose we take a carrier of 1,000 kc/s (300 metres). This carrier then occupies the position in our (quasi) continuous spectrum shown in Fig. 5 (b). The result of modulation is shown in Fig. 5 (c), and is seen to consist of two bands of frequencies corresponding to our modulating band and spaced on each side of the carrier by the width of our modulating band of frequencies extending from zero to 10 kc/s.

The physical processes of reception, however, should offer no real difficulty in the light of the simpler case considered.

The essential point is that any component in the received side-bands *beats* with the carrier, producing a beat-note which is exactly the same as the original note pitched above zero frequency. Thus, the

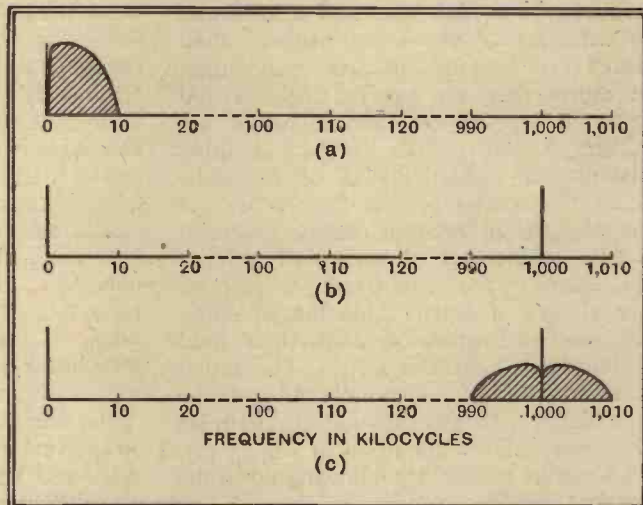

Fig. 5.—Illustrating the process of modulation where in (c) bands of frequencies on either side of the carrier are shown.

output due to that particular component is restored to the spectrum position which it occupied in Fig. 5 (a), and the corresponding note is reproduced.

The Diary of an Ordinary Listener

IT rarely happens that we can combine duty and inclination in one act, but this was my case on Thursday, September 20th. Inclination prompted me to listen to the Promenade Concert of Liszt's music from the Queen's Hall, while the stern voice of Duty reminded me that foreign programmes should engage my attention. I therefore rejoiced to observe that Thursday's "Prom" was being relayed by Radio Paris and Strasbourg, so I was able to listen with a clear conscience. Of the programme itself it would be superfluous to write, as many of my readers must have heard it, so I will only say that it came through from Radio Paris almost as clearly as from Daventry.

On Friday the concert by the Poste Parisien Station Orchestra, conducted by T. Mathieu, proved most suited to my taste, as it included a suite of six short numbers by Bach, a Viola Concerto in B Minor by Handel, and Gabriel Fauré's "Elegie" played as a cello solo. The Eiffel Tower, also, was broadcasting Haydn's pianoforte concerto in D major and another by Chopin in F minor.

Sunday evening's entertainment was mainly of an operatic nature, beginning with a concert by the A.V.R.O. Orchestra from Hilversum, in which I heard the Spinning-wheel and Jewel songs from "Faust" charmingly rendered by Elisabeth Rothberg. I then went over to Radio Toulouse for a concert version of "The Mastersingers," of which I thought too many good parts had been cut out. "The Mastersingers" is the only one of Wagner's (as far as I know) in which the action proceeds at a reasonable pace without long halts for biographical narrative, moralising or argument—with the exception, perhaps, of Hans Sachs' fine monologue—and one does not feel per-

"Prize-song" and the fine quintet at the end of the first scene of Act. III. I also missed Beckmesser's ludicrous attempt to make a prize-song from the rough notes stolen from Sachs and, above all, the thrilling *ensemble* after Walther's singing of his true version.

Hilversum as of Yore

On Monday, after hearing an excellent Caruso record from Milan, I came in for an orchestral concert at Munich which included Weber's "Euryanthe" overture and Debussy's delightful "L'Après-midi d'un Faune." From Munich I went over to Hilversum and heard the A.V.R.O. Orchestra in Mozart's Symphony in G Minor. The station was coming through well that evening, free from heterodyne trouble and altogether up to its old satisfactory form.

Paris P.T.T., Strasbourg and most of the French State stations broadcast, on Tuesday, an excellent performance of "Cavalleria Rusticana" from the Opéra-Comique. Reception from Strasbourg was fairly good, but suffered occasionally from fading, at which times echoes of the Queen's Hall "Prom" would creep in. I tried Ecole Supérieure, but it was not strong enough to be really satisfactory; however, I quite enjoyed the opera, which is one of the few in which I do not long to see the action. Perhaps this is because it has never been my fate to see a Turidda whose personal charms seemed calculated to decoy two maidens from the strict path of virtue, unless, indeed, the Sicilian girls gauge a man's attraction in pounds avoirdupois. Incidentally, it seems a pity that so many operatic tenors and sopranos should be such corporeal misfits for the parts they have to enact. The last Marguerite I saw combined the voice of an angel with the figure of a haystack, and Faust, after two ineffectual attempts to encircle her waist, was forced to give up the task as hopeless.

CALIBAN.



RADIO AT CIVIL AERODROMES. An increasing number of civil air ports are now equipped with radio ground stations. The photograph shows one of the motor "trailers," fitted with Marconi transmitting and receiving apparatus, as installed at the Hull, Belfast and Portsmouth air ports.



Short-Waves and the Amateur

Practical Information for the Enthusiast

By G2TD and G5KU

THERE are signs that the popularity of short-wave reception is rapidly increasing and there is, in consequence, a demand for practical information and some guidance as to what is happening on the short waves in different parts of the world. This article is the first of a series designed to supply this information.

SOONER or later the short-wave broadcast listener will commence to explore the narrow but well-defined wavebands allotted to the transmitting amateurs scattered in all countries of the world. Although much of this work is carried out by morse code there are quite a few stations working telephony, and at suitable times a large number of American amateurs may be heard working 'phone to other countries, particularly Great Britain and Belgium.

The great fascination of short-wave reception is the amount of uncertainty which attends it. A listener may find near-by signals fading out completely, while stations using less power than the average electric house lamp, and located six thousand miles distant, will commence to "pour" in.

This phenomenon would be impossible if short-wave transmission relied upon the transmitted energy passing over the earth's surface. The average amateur with his 10-watt transmitter finds that this ground ray is soon absorbed, and may not be heard possibly more than fifty miles from his station.

How, then, are these vast distances covered, and why is it that the conditions vary so rapidly from hour to hour?

The answer may be found by studying Fig. 1.

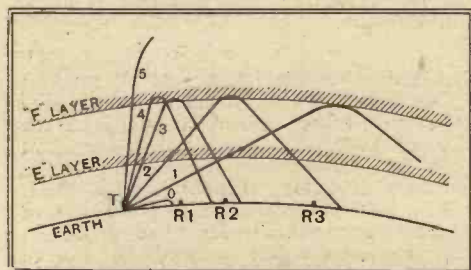

Fig. 1.—A diagram illustrating the effects of skip distance in relation to receivers at varying distances from a short-wave transmitter

Here we depict the earth's surface, a transmitting station T, and three listening stations, R1, R2, and R3. When the transmitter is in operation, the radiation

may be regarded as spraying out in all directions, although for convenience we have left out the other rays on the left-hand side of T. Above the earth's surface there exist two distinct electrified layers, the E and F respectively. The height of these layers has been fairly accurately determined, and as an average we estimate the E layer to be at a height of eighty miles from the earth's surface, while the F layer is another two hundred miles higher. We see that the energy in ray O, which passes close to the earth's surface, soon dies away, and neither R1, R2, nor R3 will obtain a signal. On the other hand, the high elevation angle of ray 5 finds the electrified layer unable to reflect it back to ground, and thus it passes out into space and is lost. Rays 1, 2, 3, and 4 do return to ground and permit reception at R2 and R3. It will be seen that R1 hears nothing, and is said to be within the skip distance of the transmission from T.

Now, the properties of these electrified layers vary very considerably, since their electrification is due to solar influence, and consequently the possibilities of transmission over exceptional distances vary enormously, particularly during a day. Sun-spots may produce practically a complete wipe-out of conditions for several days. The rays, in passing through the E layer before being reflected back to earth, also suffer attenuation, and the degree of attenuation varies considerably.

Some idea of the changes in effective distance of transmission at various times of the day may be obtained by examining Fig. 2, which shows an envelope of reception distance in miles plotted against B.S.T. hours. This curve has been compiled for the 20-metre band from observations extending from August 1st, 1934, to September 23rd, and, while slight departures are bound to occur, the general shape is sufficiently accurate to form a reliable guide to the possible hourly variations which are now occurring.

All distances below the contour of the envelope are the effective skip distances in force, and it will be seen that the best times for serious DX listening are at 16.00,

20.00-22.00, and 06.00-08.00 B.S.T. respectively. For European listening, 12.00-20.00 and 08.00-12.00 B.S.T. will find these stations generally within the skip distance.

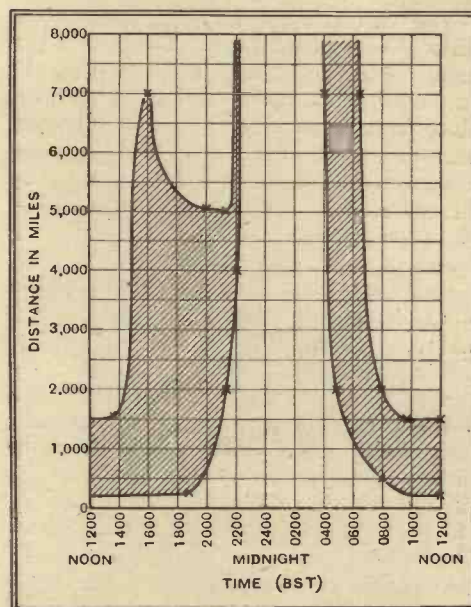

Fig. 2.—Curves drawn from observations on reception conditions on the 10-metre band from August 1st to September 23rd, 1934.

From 23.00-04.00 there is generally a complete fade-out, since only the low-angle rays appear to be reflected, and the skip distance becomes enormous, the reflected rays possibly missing the earth altogether.

Recent DX

DX conditions on the 20-metre band appear to have been at a peak during the first two weeks in August, when VK2CM and VS6AG were heard on morse.

Plenty of W6's, notably W6QC and W6HML, have been heard in the late afternoon, and outstanding phone reception of K4SA (Porto Rico), W2DC and W9USA (Hall of Science) has been obtained around 22.00 B.S.T. During the last few days FM4AA (Morocco) has been consistently heard on telephony at about 19.00 B.S.T. with excellent quality of transmission. Italian I1XX has also been worked on phone. The Russian amateurs have recently appeared very active and can usually be heard calling "Test U" during the late afternoon and early evening. There appear to be certain periods when these stations will only communicate between themselves as they only call

Short-Waves and the Amateur—

CQ at other periods. Amongst Russian and Siberian amateurs recently worked we mention UIBC, UIBL, UIAN, U6ON and many others have been heard. A few of these stations appear to be using badly filtered rectified A.C. supply voltage, but some are notable for their very pure CW, particularly UIBC. It will be seen that these notes are mainly directed to the 20-metre band, and it is the writer's belief that it is one of the most active and interesting DX bands in present use. Most of our notes will concern the conditions and activities of this band until such time as calls for a review of the other bands rises.

10-metre Contest

The 10-metre band is very empty and little DX is heard here. Interest in this band, however, should be revised by the International 10-metre contest which takes place from October 1st, 1934, to September 30th, 1935, and is open to all licensed transmitters. It is subject to awards by the R.S.G.B. of an "International 28 megacycle Contest Trophy" and certificates of merit to members.

Full particulars may be obtained from R.S.G.B. Headquarters, 53, Victoria St., S.W.1.

Without being unduly pessimistic the writers are of the opinion that the 10-metre conditions are not likely to yield very good DX. Two years hence a different story might be told, as the return to peak conditions will be noticeable. It will be interesting to see if these predictions subsequently prove correct.

Attention is also drawn to the Melbourne Centenary International DX Contest covering all licensed wave-bands and open to licensed amateur transmitters and receivers in all parts of the world. This contest is to be held from 00.01 G.M.T. Saturday, October 6th, until Sunday, October 7th, 1934, at 23.59 G.M.T., and will be continued over the four week-ends in October at the times stated above on each occasion. Full details may be found in the September, 1934, *T. and R. Bulletin*. An interesting 20-metre telephony contest has been initiated by a provincial member of the R.S.G.B. This contest is from October 1st, 1934 to March 31st, 1935, and is open to licensed amateur transmitters who are members of the R.S.G.B. Apparatus to the value of £7 will be awarded to the successful contestant scoring the highest number of points. This contest should provide interest for the receiving amateur who is unable to copy morse. With regard to morse students a schedule of slow morse code transmission takes place as follows:

Date.	G.M.T.	W/L (Metres).	Station.
Oct. 7th	00.30	165	G2OI
"	10.00	165.3	G2DQ
"	11.00	176.5	G2UV
Oct. 14th	00.30	165	G2OI
"	10.00	82.6	G2DQ
"	11.00	176.5	G2UV

This should prove helpful to learners.

Radio, Records and Talkies

The Home Radio-Cinegram

THE complete home entertainer incorporating a "talkie" outfit as well as a radio-gramophone is a thing which has often been suggested and it is extremely interesting to find a piece of apparatus in which the idea is carried out in practical form. Such an instrument is the "Vivagram," which has recently made its appearance.

As will be seen from the photograph the instrument follows conventional practice for a radiogram and the only unusual feature to be seen is the folding translucent screen, on to which the picture is projected from a built-in 9.5 m.m. projector of special design. It is the fact of having the screen as an integral part of the machine, which renders the latter altogether unusual there being no necessity for the erection of a screen at the other side of the room. This in itself renders the apparatus specially attractive to the domestic user.

The screen, when not in use folds back into the cabinet in a perfectly straightforward manner. At the same time a distant screen can be used in the customary manner if desired, and an external loud speaker placed behind it for the showing of "talkies," the sound-on-disc system being used in conjunction with the 9.5 m.m. films. The projector and radio-gramophone portion of the instrument can, of course, be used separately, when desired, in conjunction with silent films and ordinary gramophone records.

The size of the projected picture, 15in. by 10in., is ample for home needs and owing to its relatively small size it is of exceptional brilliance in spite of the inevitable optical losses associated with the reflecting system;

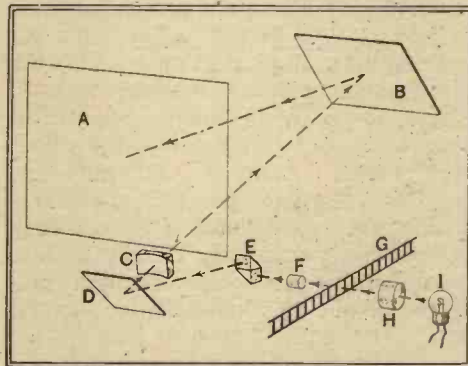

The principle of projection shown in schematic form. A—translucent screen, B—mirror, C—diverging lens, D—mirror, E—crossed prisms, F—projection lens, G—cinema film, H—condenser, I—lamp.

the latter are, of course, unavoidable owing to the projector and screen being so close together. The brilliance of reproduction, which is very largely due to the special translucent screen, enables the projected picture to be viewed in comfort even with the ordinary room lights on.

The actual projector apparatus is mounted on the motorboard in order to render it very easily accessible for film-changing. For the same reason the film is run horizontally as will be noticed in the sketch. The optical arrangement which permits the screen and projector to be mounted in the same cabinet can be readily



The "Vivagram" Radio-Cinegram.

understood by a study of the sketch, which is self-explanatory.

The designer of this comprehensive home entertainer is Mr. George W. Ford, who has been connected with the cinematograph industry for some thirty years. Further details may be obtained on application to him at 49, Craignair Gardens, Patcham, Brighton.

THE RADIO INDUSTRY

USING an R.I. Antinodal Short-wave Converter (AC model) in conjunction with a Murphy A8 receiver, Mr. R. Everard, a member of the International Short Wave Club, has received 246 stations (all verified) from 32 different countries. In addition he has logged about 100 American, and hundreds of European, amateurs.

Benjamin Electric, Ltd., of Brantwood Works, Tariff Road, London, N17, have decided to produce a special model of the Magnavox Double-Six speaker, at the price of £5 17s. 6d., for use with *Wireless World* sets requiring a field coil resistance of 1,250 ohms. As it is anticipated that most purchasers of this instrument will already have an output transformer, this is not included, but can be obtained at an additional cost of 12s. 6d.

The factory premises of Haynes Radio at Queensway, Enfield, Middlesex, have been extended by the addition of 3,000 square feet of floor space, and in consequence it has become possible to transfer the firm's offices from Hatton Garden to the works, where all communications should in future be addressed. Telephone: Enfield 2726.

New Frequency-Changer

THE TRIODE - HEXODE

Avoiding Oscillator - Modulator Interaction

AS a frequency-changer the popularity of the heptode is well deserved, but it is shown in this article not to be entirely free from defects which are of particular importance on short wavelengths. The author describes a new valve—the triode-hexode—which is especially designed to overcome these faults.

THE function of the frequency-changer of a superheterodyne is well known, and it will be remembered that until recently two valves were employed. One valve operated as an oscillator, and its output was applied with the incoming signal to the other valve, which functioned as a detector—the desired intermediate frequency being obtained in the output of the detector and being equal to the difference between the signal and oscillator frequencies. At a somewhat later date the triode was superseded by the screen-grid valve for the first detector, with a considerable improvement in efficiency.

Although such an arrangement is capable of giving a good performance, it suffers from two major disadvantages—interaction occurs between the signal and oscillator frequency circuits, and radiation from the aerial is likely to occur unless a signal-frequency H.F. stage is used. These disadvantages can be minimised by careful design, but they cannot be completely avoided. They occur to an even greater degree with later frequency-changers in which a single screen-grid or H.F. pentode valve is used in an endeavour to reduce the cost of a receiver. Such frequency-changers have the additional drawback that they cannot be biased for volume-control purposes.

It was in an endeavour to overcome these defects that the now popular heptode and octode were developed, and they very largely overcome the defects of the earlier types. They suffer from a disadvantage of their own, however, which has for some time been rather obscure.

Interaction in the Heptode

The operation of the heptode has been previously dealt with,¹ and it will be remembered that the seven electrodes all lie in a single electron stream, so forming a true single-valve frequency-changer. Despite statements to the contrary, a change in the voltage applied to either the control grid or the oscillator anode affects the currents flowing in the circuits attached to the positive electrodes. Some

of these effects are necessary, of course, for the proper operation of the valve, but others are distinctly undesirable.

As an illustration, we may consider the action of the oscillator electrodes. The oscillator grid controls the electron stream in order to provide the proper "coupling" to the detector section of the valve. The potential of the oscillator anode, however, is always in opposite phase to that of the oscillator grid, so that it partially neutralises the effect of the latter. This effect is by no means serious, but it occurs to a greater degree in many British heptodes than in the original American pentagrids, for in some of the later valves the oscillator anode bars have been placed more directly in the electron stream in order to

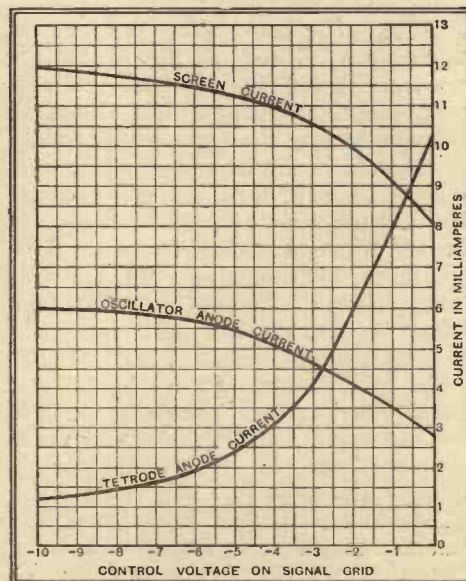

Fig. 1.—The variation of current to the different electrodes of a heptode when the grid bias is altered is shown by these curves.

obtain a higher oscillator mutual conductance.

Another effect of similar nature, however, is responsible for much more serious consequences. When the negative potential applied to the control grid is increased, the detector anode current falls, while the screen and oscillator-anode currents both rise, as shown in Fig. 1, for a representative heptode. It will be seen that there is consequently a negative mutual conductance between the control grid and the



By
E. E. SHELTON
B.Sc.
(Lissen Valve
Laboratory)

oscillator anode, and because of this a signal applied to the control grid can cause the oscillator anode voltage to vary in sympathy.

The practical result of this appears as interaction between the signal-frequency and oscillator circuits. The effect may not be very evident on the medium and long wavebands, but it may assume great importance in short-wave reception where the ratio of oscillator to signal frequencies is very small. The effect has been dealt with in a paper by Klipsch, to which reference should be made for a full discussion of the phenomenon.²

The Triode-hexode

The amplified signal-frequency voltage which occurs on the oscillator anode in the manner just described can be transferred back to the control grid by the interelectrode capacity between the oscillator anode and control grid, for the screening between these electrodes is necessarily imperfect. The effect of this feedback depends upon the phase of the voltages concerned, and this in turn depends upon whether the oscillator circuit is tuned to a higher or lower frequency than the signal-frequency circuits. In the ordinary superheterodyne the oscillator circuit is tuned to a higher frequency than the signal-frequency circuits, and the feedback is consequently anti-phase and reduces the efficiency. It can be shown experimentally that if the oscillator be tuned to the other beat the feedback is in phase with the signal, and increases the efficiency to such a degree that in some cases instability may result.

In order to overcome these disadvantages of the heptode, a new valve of the electron-coupled type has been designed and is known as the triode-hexode. It consists of two separate valves built into a single envelope—one a triode and the

¹ The Pentagrid Converter, by Claude L. Lyons, B.Sc., *The Wireless World*, May 12th, 1933.

² Suppression of Interlocking in First Detector Circuits, by Paul W. Klipsch, *The Proceedings of the Institute of Radio Engineers*, June 1934.

New Frequency-Changer—

other a hexode. The arrangement will be clear from Fig. 2, and it can be seen that the triode acts as the oscillator with any conventional circuit.

The hexode has six electrodes, a cathode, two screen grids, a coupling grid, and an anode. The control grid (1) immediately surrounds the cathode and is itself surrounded by the first screen grid (2). The coupling grid (3) comes next, and is separated from the anode by the second screen grid (4); in practice, the two screen grids are connected together internally and are brought out to a single pin in the base. The coupling grid (3) is also connected internally to the triode grid, so that the valve has only a seven-pin base, the connections to which are arranged in the same way as in the heptode, and a top connection for the control grid.

Variations in the oscillator anode potential have no effect upon the screen and anode currents of the hexode, and changes in the hexode screen, anode, or control grid voltages do not alter the oscillator anode current. An increase in the control grid bias causes both screen and anode currents to fall, as shown by the curves of Fig. 3, thus leading to economy of current in a battery receiver and an increased grid base in a mains set.

In operation, the hexode anode voltage should be as high as possible consistent with the maker's rating, and the mini-

mum control grid bias should be zero for the battery valve and -1.5 volts for the mains type. The oscillator grid is best self-biased by a grid leak and condenser,

is non-radiating and can be controlled from the AVC system, it gives complete freedom from interaction between the signal and oscillator frequency circuits and also a lower level of background hiss. These points are important in normal broadcast reception, but they are doubly so on the short wavelengths.

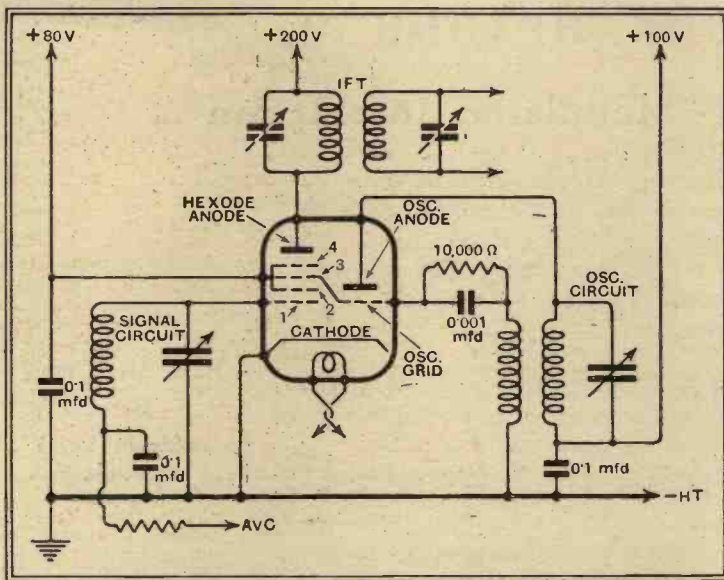

Fig. 2.—The connections of the triode-hexode in a typical frequency-changer circuit show that they are little different from those adopted for a heptode.

as shown in Fig. 2, and under these conditions there are definite optimum voltages for the screen grids and the oscillator anode. When correctly operated the hexode anode A.C. resistance is high, and the total current consumption quite moderate, being only 8 mA. for the Lissen AC FC and 4 mA. for the battery model, the FC2. The conversion conductances are 0.65 mA/V. and 0.4 mA/V. respectively, and it will be seen that the ratio of conversion conductance to total current at minimum bias is greater in the triode-hexode than in the heptode, and at least as good as that with the conventional two-valve frequency-changer or its equivalent, the triode-pentode. This ratio is of importance in comparing different frequency-changers, because it governs the amount of background hiss found in the reception of a weak signal. Background hiss is due to ionisation of the minute trace of gas remaining in the receiving valves, and for a given valve is proportional to the total current passing. The noise from the valve in the first stage of a receiver is the most important, because it is amplified by the succeeding stages. For both these reasons, maximum background hiss occurs at minimum bias when using variable- μ H.F. valves.

If one assumes that the valve manufacturers offer valves of equal "hardness," the valve selected for the first stage should be the one having the highest ratio of mutual conductance to total current at minimum bias, or for a frequency-changer valve the highest ratio of conversion conductance to total current at minimum bias, for this will be the valve giving the highest ratio of signal to noise.

It will thus be seen that the triode-hexode offers important advantages over other frequency-changers in that, while it

Safety First

The New I.E.E. Regulations

UNTIL recently the user of an A.C.-D.C. set was in a somewhat anomalous position; his apparatus may or may not have complied with the I.E.E. regulations when connected to D.C. supply, but it certainly infringed the rules when fed from A.C. mains. In a recent Editorial it was urged that it was high time that the universal type of set, now becoming so popular, should be taken into account when the regulations were reconsidered.

This has now been done, and it is good news to the A.C.-D.C. set user to know that his position is regularised, and that his receiver, if suitably designed, is capable of satisfying official requirements, whether used on A.C. or D.C. In the 10th edition of the Regulations,* just issued, it is laid down that a receiver may be isolated from A.C. mains by a double-wound transformer, but, when fitted throughout with indirectly heated valves capable of withstanding the full mains voltage between heater and cathode, direct connection is permitted. Where isolation is not provided by a transformer the receiver is to be designed as if for D.C. supplies, which means that all external connections, such as aerial, earth, pick-up, loud speaker, etc., are to be isolated from metallic connection with the mains, and all live parts are to be adequately guarded.

With regard to A.C. sets in general, it is stipulated that the earth terminal shall be metallically connected to that part of the inner structure which is designed to operate at earth potential. The aerial terminal must similarly be in metallic connection with the earth terminal, or, if isolated from it (e.g., by a series condenser), must also be isolated from the inner structure. "Live" external terminals for loud speakers, pick-ups, etc., are forbidden. The only method of headphone connection permitted is through a double-wound transformer of high insulation.

With regard to D.C. sets, all external connections, such as aerial, earth or loud speaker, are to be isolated from metallic contact with the inner structure, which in practice means that either double-wound transformers or condensers must be used.

Isolating condensers for D.C. mains sets must be tested to withstand at least twice the supply voltage, and for A.C. "three times the R.M.S. value of the A.C. voltage applied to the terminals of the condenser." Loud speaker isolating condensers shall be tested at three times the D.C. anode voltage of the output valve.

* "Regulations for the Electrical Equipment of Buildings," tenth edition, September, 1934. Issued by the Institution of Electrical Engineers, and published by E. and F. N. Spon, Ltd., 57, Haymarket, London, S.W.1. Price 1s., or 1s. 2d. post free.

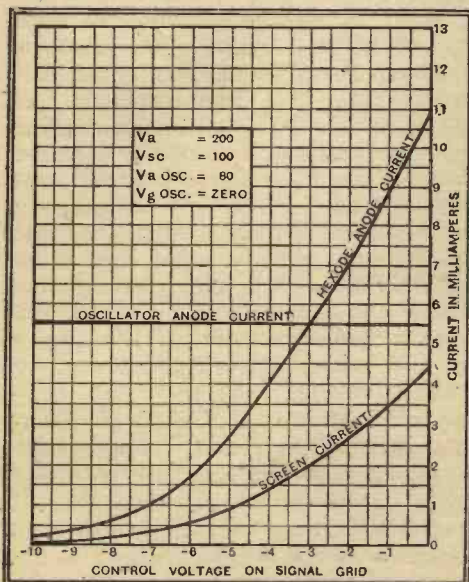

Fig. 3.—The current variations with grid bias for the triode-hexode show that the oscillator anode current is constant.

Hints and Tips

Aids to Better Reception

USERS of D.C. mains receivers who are troubled by hum or a noisy background may be reminded that it is worth while to try the effect of operating the set without an external earth connection. As a result of doing so, noises may be appreciably reduced, and, at the same time, there may be no appreciable falling-off in signal strength or general performance. This is because the set is more or less effectively earthed through the mains, which are always connected to earth.

Without an Earth

The omission of a direct earth connection is particularly likely to be beneficial in cases where the positive pole of the supply is earthed, and should always be tried in such circumstances.

IT is fortunate that intermittent short-circuits between rotor and stator vanes of variable condensers are now of comparatively rare occurrence. In the design of no other components have greater improvements been made; the modern

Scraping Condenser Vanes

ganged condenser is truly an instrument of precision and likely to remain so if properly treated. But, in spite of these improvements, there seems to have been of late a mild epidemic of "shorting" condensers, and a few suggestions on localising faults of this nature may be of some interest.

As a rule, a defect of the kind under consideration will manifest itself by loud cracklings in the loud speaker at one or

A READER'S BAFFLE. Back and front views of an unconventional baffle made by Mr. T. B. Nuttall. It is of wood, with a thick non-resonant lining of plaster of paris.

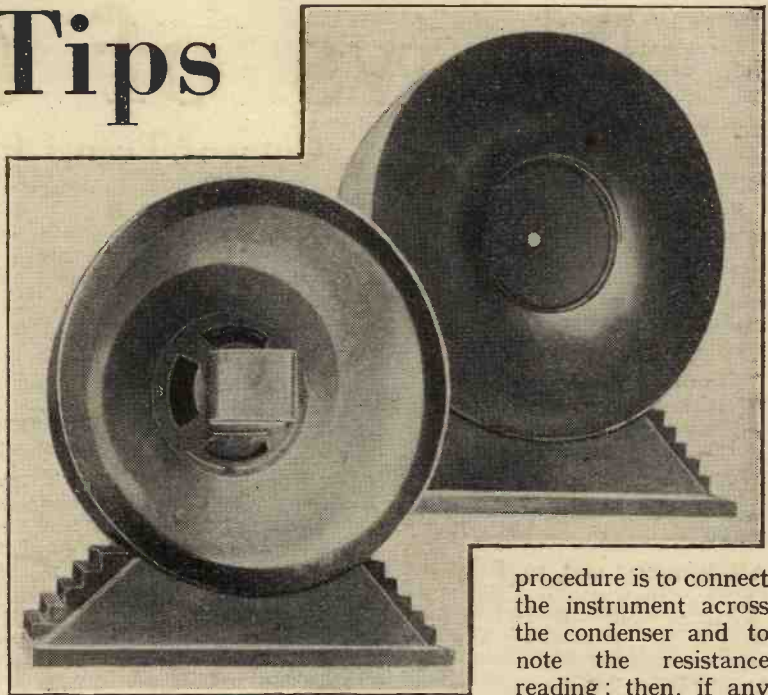

procedure is to connect the instrument across the condenser and to note the resistance reading; then, if any considerable reduction

in resistance is observed as the spindle is rotated, it can only be due to a complete or partial short-circuit. Of course, the test is best made with the coil switch in the long-wave position.

In many modern sets (e.g., those with A.V.C.) the metallic grid circuit is completed through a decoupling or other resistance of high value, as shown in Fig. 1(b). Due to the presence of this high resistance, tests are more easily made, and all that is necessary is to connect a comparatively insensitive continuity indicator across the condenser. Normally it will show either a lack of continuity or a high resistance, and an intermittent condenser short-circuit will be easy to detect.

Referring to the typical circuit arrangement of Fig. 1(a), it will be appreciated that the condenser is shunted by the tuning coil, and so a testing instrument G connected across its terminals will always indicate continuity, irrespective of the condition of the condenser. But the long-wave winding is certain to have a resistance of quite a fair number of ohms, and so, with the help of a moderately sensitive ohm-meter (such as that included in several popular multi-range testing instruments), an easy test becomes possible. The

more fairly definite condenser settings. Sometimes the trouble may be either accentuated or temporarily cured by applying sideways pressure to the spindle, directly or through the reduction gearing.

When operating a gang-tuned receiver, it will sometimes be found that the application of reaction has not the desired effect of increasing signal strength; indeed, even a decrease in intensity may actually be observed, in spite of the fact that it is possible to increase reaction up to the point of self-oscillation.

When Reaction Fails
In such circumstances we have a fairly definite indication that the tuned circuits of the receiver are out of alignment and that reganging is necessary. It is probable that the error in alignment will be principally, if not entirely, in that particular circuit to which reaction is applied.

In the unlikely event of reaction failing to work normally after realignment, it is reasonable to suspect the presence of a peculiar and fortunately rare form of parasitic oscillation; self-oscillation at some frequency differing widely from that to which the circuits are tuned may be taking place, and the usual whistle will not be evident. The usual cure for this is to insert a 1,000-ohm resistance at some convenient point in series with the reaction circuit.

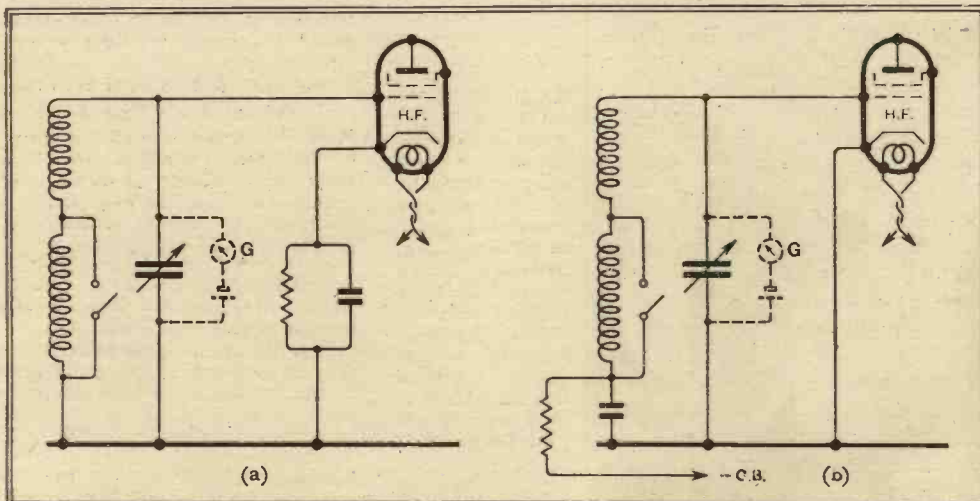

Fig. 1.—Testing for condenser short-circuits; the tests may be affected by the parallel tuning coil.

News of the Week

Current Events in Brief Review

Sweden's "Droitwich"

THE new 150-kW. station at Motala is expected to begin test transmissions before Christmas so that programmes can go out on high power for the first time on January 1st next.

Those Spare 'Phones

THE Lord Mayor of Manchester has appealed for headphones in connection with the fund supplying wireless to the bedridden poor. Loud speakers are not wanted, but 'phones, old or new, should be sent to the Town Hall.

All Roads Lead to Belfast

THE Belfast Radio Exhibition opens to-day (Friday) in the King's Hall, Balmoral. During next week variety programmes will be broadcast nightly in a specially constructed theatre which will be open to the public. Broadcast stars, including the Houston Sisters, Norman Long, Anona Winn, Leonard Henry, Stanelli, Harry Hemsley, and Nomo King, are taking part, supported by the Eight Step Sisters.

"Ultra-shorts" for Newspapermen

NOT all running commentaries in America are confined to broadcasting. A familiar sight is the newspaper reporter with an ultra-short-wave transmitting set strapped to his back. During the recent U.S. National Amateur Golf Championships reporters equipped in this fashion described the play from the greens and bunkers, the signals being picked up at the club house and wired to the news rooms.

Penang's Radio Show

PROMINENT British radio firms will be represented at a wireless exhibition to be held at Penang on December 6th, 7th, and 8th next. Penang is the port for Northern Malaya with a population of 150,000.

Mr. Hasl Has It

THE smallest wireless set in the world" is always sure of a welcome, whether invented by a famous scientist in Buenos Aires or a humble peasant in Latvia. This week, according to a Sunday newspaper, the invention hails from Ljubljana, the lucky inventor being a Mr. Hasl, a footballer. The set is no bigger than a watch.

Prizes for D.F.

A FIFTY-WATT mobile station operating on 230 metres was the quarry in a recent D.F. competition held in the suburbs of Budapest. Much of the enthusiasm of the hunters was due to the fact that substantial prizes were offered by Budapest Radio. The actual discoverer of the roving transmitter received approximately £7, and the runner-up an ultra-modern receiving set. Twelve other prizes were awarded.

As Others See Us

A FRENCHMAN'S opinion of Radiolympia is entertainingly set forth by M. Buisson in our contemporary, *Le Petit Radio*. M. Buisson, who paid a personal visit to South Kensington, writes: "Absolutely nothing outstanding in the evolution of British radio, except the almost total abandonment of H.F. assemblages in favour of superbeterodynes, to the exclusion of the important types of sets which at average prices rule the market in France."

"I admired the perfect discipline of the British Salon. All sets worked sympathetically at the same time."

Tenth Anniversary

THIS is a festival week in Austrian broadcasting, marking the tenth anniversary of the first transmissions. Special programmes from Bisamberg are being relayed to a number of European stations.

It Makes a Difference

THE fact that the Frenchman now has to pay for his radio entertainment seems to have stimulated his interest in the subject. At all events, attendance at the recent Paris Radio Salon broke all records; 90,000 visitors passed through the turnstiles as compared with 74,000 in 1933.

Australian Record-breaker

AN Australian amateur has established two-way telephony communication with amateur stations in each of the six continents of the world, using a power of less than 10 watts, according to reports received by the American Radio Relay League.

The record-breaking operator is G. Pollock, owner of the amateur station VK2XU, at 9, Acacia Street, Belmore, New South Wales, Australia.

Universal Valves

MAZDA Universal AC/DC valves and the AC/TP have, we understand, met with a big demand, and supplies have not been sufficient to enable retail stocks to be held. Readers who have any difficulty in obtaining these valves for use in *Wireless World* receivers for which they have been specified are recommended to communicate with the Cosmos Lamp Works, Ltd., Brimsdown, Enfield, Middlesex.

Radio Sets by Air

TRIBUTE to the excellence of British radio receivers has come from France in the shape of large orders following the Olympia Radio Show. The first consignment of a large order by the General Electric Company was carried over to France from Croydon by Imperial Airways on September 21st.

When air transport is used the sets can be conveyed from the G.E.C. factory at Coventry to their French destination in less than six hours.

Radio Show at Edinburgh

WEDNESDAY, October 10th, sees the opening of the Scottish National Radio Exhibition at the Waverley Market, Edinburgh. The show, which will remain open until October 20th, will embody some of the best features of Radiolympia, and, in addition, will provide television displays and a B.B.C. model studio from which a number of first-class programmes will be broadcast.

The G.P.O. anti-interference display and film will be on view, as well as the model railway transferred from Olympia.

Single-sideband Broadcasting

UNTIL 1937, listeners can rest assured that there will be no change-over to single-sideband transmission by the broadcasting stations of Europe. The British delegation at the recent Lisbon radio conference merely took the opportunity, we understand, of discussing the single-sideband system as a means of "clearing the ether." The International Telecommunication Convention, the only body vested with enough power to bring about such a change, does not meet for another three years.

The use of single-sideband transmission would double the space available for stations in a given waveband.

A Programme Problem

AMERICAN broadcasting appears to have "de-slumped" in the last few months, for, according to a Washington correspondent, the radio impresarios are racking their minds to find "holes" in their schedules for additional programme features. Evening entertainment, for those who do not object to advertising "blurbs," is now at its best, and the station authorities are trying to improve the day sessions, which formerly have not attracted the sponsor owing to their comparatively small audience.

Most daylight hours are filled with "sustaining" programmes, which are devised to fill time which no advertiser will pay for, and to prevent the listener from switching over to a rival network.

Friend or Foe?

NEVER was the Press more interested in the possibilities of news by wireless than at the present time. At an international conference to be held in Brussels, beginning October 20th next, the International Federation of Journalists will discuss the subject from all angles—professional, technical, and legal.

Apropos of this conference, it is noteworthy that American broadcasting organisations have received some pungent advice on the subject from Senator C. C. Dill, of Washington, who exhorted the National Association of Broadcasters at its last meeting to "tear itself free from Press domination by setting up a news organisation of its own."



RADIO SETS BY AIR. A busy scene at Croydon last week when a large consignment of G.E.C. sets was despatched by air to France. Air transport offers the best facilities in speed, simplification of packing and in overall costs. British sets are finding a good market on the Continent.

BROADCAST BREVITIES

By Our Special Correspondent

Wave Squatting

THE "little" Nationals, as the B.B.C. now call the London, West and North Nationals, are to hold the fort, whether Droitwich makes them superfluous or not, until the North Scottish and North-Eastern transmitters are ready to take over.

This wave-squatting, as they call it in America, is to prevent their wavelengths from being grabbed by wave-snatchers abroad, following some notable precedents set at the time of the Lucerne change-over.

Nine Years Ago

In two days' time Droitwich officially takes over from Daventry 5XX, and the old station will be dismantled without delay.

How soon wireless events become history! It seems a very short time since Capt. P. P. Eckersley, in July, 1925, announced the opening of the "biggest radio station in the world" (*sic*)—I have just consulted the B.B.C. archives—and all the important people made a special journey to Daventry to witness the inaugural ceremony on July 27th.

No Flag-waving at Droitwich

Droitwich, which opens without any speech-making or waving of flags, has six times the power, and, to take the licence figures, three times the audience of 5XX on the inaugural day.

A Droitwich Film

Look out for the Droitwich film, which will be touring the cinemas within a few weeks. Produced by John Grierson, of the Post Office Film Unit, this new film includes some brilliant photography, and gives an excellent impression of the magnitude of the undertaking. It lasts fifteen minutes.

Pathetic Cases

A number of complaints have already reached the B.B.C. that Droitwich is overloading receivers in the district. The most comical grouse comes from two listeners, who state that Droitwich is scarcely more powerful than Daventry. Their sets are fitted with A.V.C.

Old Masts: New Tests

Externally, the old 5XX will remain the same for a long time to come. The 500ft. masts, upon which Peers and Cabinet Ministers gazed so exultantly nine years ago, are to be saved for a time for omnidirectional short-wave tests.

Not Enough Kick

ONE instinctively feels sorry for those singers who, according to the B.B.C., declare that they seldom "get a kick out of their performances; everything goes according to plan, and naught emerges save the critics' comments in the next day's papers."

Judging from some of these comments, plenty of kicks do emerge, but the singers are not easily satisfied.

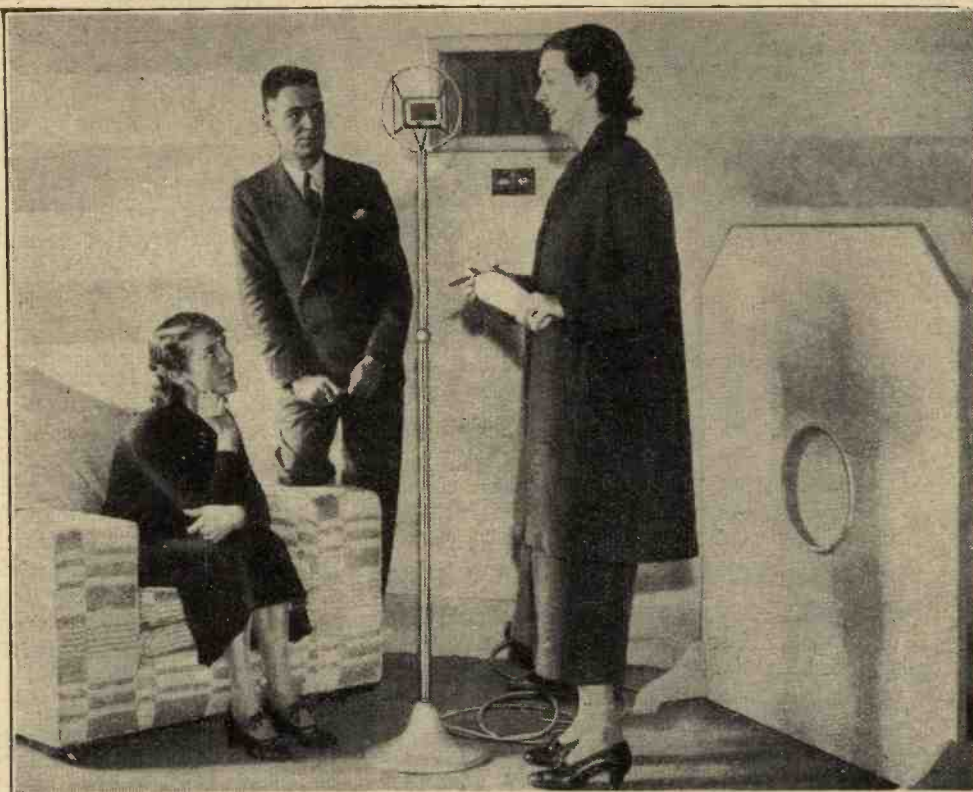

THE COMPLETE BROADCASTER. The whole art of addressing the microphone is now taught at a miniature "Broadcasting House" installed by the London School of Broadcasting in Bond Street. In a voice test such as that shown in progress, the student's speech is recorded and afterwards played over to assist correction of faults. Behind the microphone is Mr. Bertram Fryer, the director, for many years in the Variety Branch of the B.B.C.

B.B.C.'s Biggest Studio

THE new broadcasting studio at Maida Vale is by far the largest in the B.B.C.'s considerable collection, measuring 110ft. x 72ft., and having a cubic capacity of 220,000ft.

Its main uses will be for large orchestral concerts and chorus work. A very impressive control room has been fitted which will handle transmissions from four microphone points.

Four Smaller Studios

When the main studio has been put through its paces in a few days' time, and the engineers have tested it for "sound leakage," work will begin on four smaller studios.

New Recording Department

Maida Vale will fulfil another useful function as the new home of B.B.C. recording. (Thus Broadcasting House, so painfully lacking in space, gets rid of another burden.) Recording will be carried out on a far larger scale than hitherto in a department which combines the Blattnerphone and disc-recording methods.

Her Majesty's Microphone

A LOT of fuss has been made about the microphone used by the Queen for the launching of the "Queen Mary."

I understand that the particular instrument used for public-address purposes had singular beauty of appearance, construction, and performance. The B.B.C. does not disclaim these virtues for its own instrument, but emphasises that the specimen used for the broadcast—a Reisz-Round—was "taken from stock," and was the same as would have been supplied for a broadcast by any member of the public, whether a Member of Parliament or one of the unemployed.

At Sandringham

Incidentally, the B.B.C. microphone on these occasions is always made as inconspicuous as possible. On the King's study desk at Sandringham the microphone is actually concealed.

Prince George at the Microphone

MANY listeners will seize the opportunity of hearing Prince George at the microphone when he opens the new Civic Centre at Swansea on October 18th. The proceedings are to be broadcast in the West Region beginning at 12.10 p.m., and while Prince George is inspecting the new Guildhall and Law Courts a few words of introduction will be given by the commentator. Later in the proceedings the Prince will declare the new Guildhall, Law Courts and Brangwyn Hall open for public use.

Speeches will be given by Lord Sankey, the Earl of Plymouth, and Lord Iveagh.

A Council of Twenty-Three

MR. BERNARD SHAW remains chairman of the Advisory Committee on Spoken English, which now has twenty-three members. The original Committee consisted of only seven members.

Breakdown and Recovery

WHILE I was spending a fragrant half-hour at Broadcasting House last week news was rushed through that West Regional had closed down at 12.1 p.m.

Later came the report that working had been resumed at 12.29 p.m. Cause of mishap: Burst water hose in No. 2, C Unit. Life is never dull at "B.H."

They Know

THE Czecho-Slovakian broadcasting authorities have declined on principle to inaugurate a "Women's Hour."

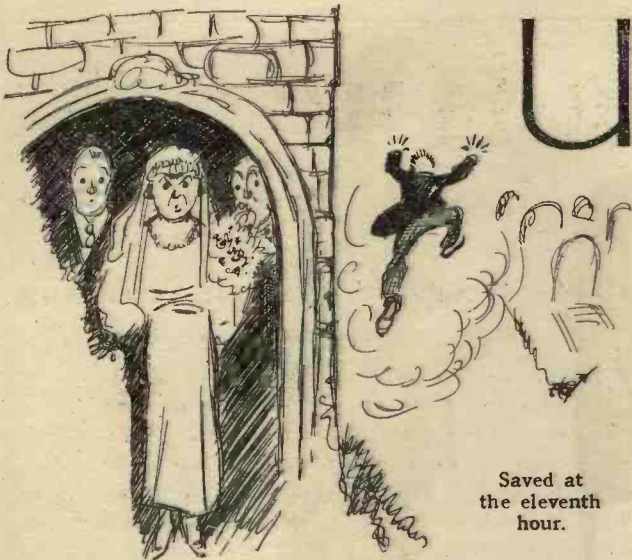

Saved at
the eleventh
hour.

A Mike at the Altar

APPARENTLY England is not the only country where the old Spanish custom prevails of a bride pretending to be demure and shy, for, according to a Continental newspaper, a special amplifier has been installed in a church in far-away Albania in order to put a bit of pep into the bride's softly spoken "I will."

It appears that, just as in this country, she is scarcely audible, and the amplifier has been installed in order to assist the officiating clergy. While glad to see that radio, or, at any rate, one of its by-products, has once more been called to the aid of suffering humanity, I must confess that I think that the apparatus is a bit of a back number.

Surely it is high time that all this business of bridal reluctance to say a couple of words which she is bursting to get off her chest was thoroughly debunked. I think that a good opportunity of putting the principles of radio to real use in this matter has been missed. It is surely the one immediate application to which the newly-invented "Humanoscope" can be put. This device, according to information given by the daily Press, "is able to reveal mental activities," which is, I suppose, a roundabout way of saying that it is a radio thought-reader.

With such an apparatus in use, the necessity of asking the bride a perfectly idiotic and superfluous question would be obviated, while at the same time many an unfortunate man could be saved at the eleventh hour from the consequences of his own timidity, since this truth-revealing radio instrument would naturally prevent him from plunging into the orgy of perjury which is all too common nowadays.

Surprising Discovery

I HAVE nothing but sympathy for people whose enjoyment of broadcasting is marred by interference from an electric face-lifter or some other engine of female beauty, but I think it about time that a word was put in on behalf of the ordinary citizen whose enjoyment of life is spoilt by the unending bellow from the loud speakers of selfish set owners who

UNBIASED

not only operate them at an unnecessarily large volume but tune in to some Continental station at a perfectly ghastly hour of the morning and keep at it all day and until long past midnight.

The recently issued edict against the tooting of motor horns during the night hours is all very well in its way, but it seems foolish to

fulminate and legislate against this comparatively harmless harassing of the nocturnal nerves when the far greater menace of the nerve-shattering loud speaker is left unmolested.

As a direct consequence, a very undesirable state of affairs is arising, as was revealed to me by a well-known manufacturer of electrical apparatus whom I met the other evening in a pub.

He had for some time past, he told me, been puzzled to account for a steady rise in the sales-curve of violet-ray machines. Since these things are supposed to cure everything, ranging from angina pectoris to spots before the eyes, he had at first supposed that some of his advertising staff had been busy writing to the daily papers explaining how they had been cured of long-standing pimples on the epiglottis by the use of one of these contraptions. His enquiries drew a complete blank, however, and, in spite of a diligent search, he was



At a perfectly ghastly hour.

unable to find anything of a laudatory nature that had recently been published.

It was purely by chance that he eventually found out the real reason for the steadily increasing sales. It appears that among the many thousands who strayed into the G.P.O. anti-interference demonstration at Radiolympia there were hosts of sufferers of the type I have mentioned whose nerves had been so completely shattered that they were robbed of the last vestiges of the moral integrity which they had once possessed. The result of this

was that they had wilfully put to a wrong use the technical information bestowed so freely and gladly on them.

After learning that interference from electro-medical apparatus was the most pernicious of all, and could only be cured by using the gadgets in a room lined with screening material, such as wire netting, they had deliberately gone their way and prostituted the information so bountifully given them by purchasing violet-ray machines and effectively silencing the offensive noises of their neighbours' loud

By

FREE GRID

speakers by putting into practice the old maxim that the best form of defence is attack.

It must be remembered that no illegal act is being committed, since it is perfectly lawful for a man to impart electrical massage to his epidermis *ad lib.*, and none can say him nay.

An Unfortunate Firm

CONTRARY to the generally experienced rush of prosperity which most radio firms seem to be experiencing at this time of year, there is one unfortunate firm which the very glut of orders is forcing into the bankruptcy court.

According to an interview which has been granted to the representative of a well-known northern newspaper, this firm are in the unfortunate position of making a loss of a few shillings on every set they sell, owing (so they say) to its absurdly low price. As they are at present simply inundated with orders the future looks exceedingly black. The obvious thing which ignorant laymen like yourselves or me would suggest would be either to increase the price or cut the costs.

Unfortunately, however, things are not so simple as that, since it is revealed that if the former were done the public would cancel their orders, since it is the cheap price which attracts them. With regard to costs, they are already cut to the bone, and so nothing can be done in that quarter. Again, foolish people like yourselves and me would suggest that even then all is not lost, as much money could be saved by discontinuing the making of the sets, and, in addition, customers would be saved money, time and temper. It is quite evident, however, that if we suggest such a course we merely reveal our hardness of heart, as, according to the newspaper report, the firm "does not like to disappoint the public."

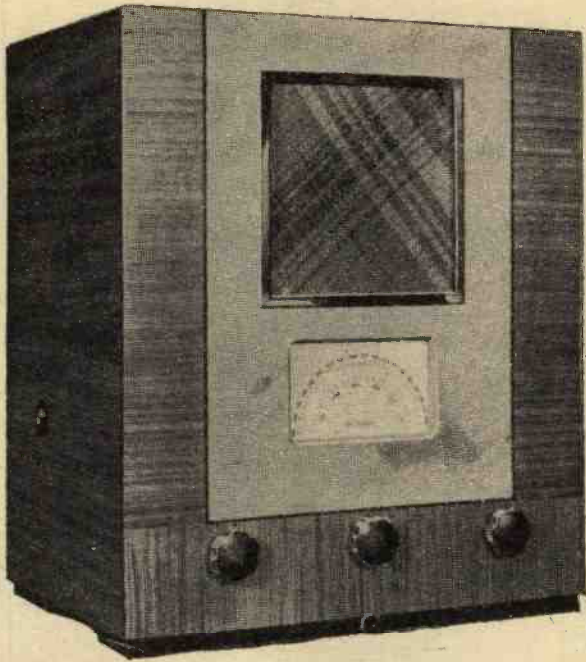

Portadyne

MODEL A37

A Superheterodyne Receiver of High Selectivity

FEATURES.—*Type.*—Table-model superheterodyne for AC mains. *Circuit.*—Octode frequency-changer—variable- μ pentode IF amplifier—double-diode-triode second detector—power pentode output valve. Full-wave valve rectifier. *Controls.*—(1) Tuning. (2) Volume and on-off switch. (3) Wave-range switch. (4) Tone control switch. (5) Noise suppression switch. *Price.*—12½ guineas. *Makers.*—Portadyne Radio, Gorst Road, North Acton, London, N.W.10.

DUE largely to the improvement in the characteristics of valves, the performance of the moderately priced superheterodyne is this year better than ever, and the receiver under review is typical of the excellent value now obtainable. Range and selectivity reach a standard which was obtainable only with six- or seven-valve receivers a year or two ago, yet the present circuit, if we exclude the rectifier valve, comprises only four valves.

The first valve is one of the new octode frequency-changers, and is preceded by a band-pass input filter. Chokes are included in the aerial lead both on long and medium waves to reduce interference from second-channel whistles. The intermediate-frequency amplifying valve is a variable- μ pentode and is associated with four tuned circuits. Rectification is by means of a double-diode-triode, one anode of which is used for detection and the other for supplying the AVC bias. The IF input for the latter diode is derived from the primary of the second IF transformer, which, on

account of its comparatively broad tuning, reduces sideband "screech" when tuning through a station. The bias for the triode amplifying portion of the second detector valve also supplies the delay voltage for AVC. Both the IF amplifier and the frequency changer are controlled, and it is rarely necessary to resort to the manual volume control.

Noise Suppression

Resistance coupling is employed between the second detector and the power pentode output valve. The field of the moving-coil loud speaker is used for smoothing, and an external loud speaker may be connected in parallel with the primary of the output transformer.

The output pentode is corrected for accentuation of the high audio frequencies, but a further fixed reduction may be made by a switch at the base of the front panel which shunts a small condenser across the grid circuit of the output valve. The degree of control thus afforded is not sufficient seriously to affect quality of reproduction, but may make all the difference to the enjoyment of the programme from a distant station. In addition, there is a noise sup-

pression switch at the side of the cabinet which completely cuts out background noise when moving from one station to the next and also exercises some discrimination between strong and weak signals. Its action is to apply a small initial bias to the detector diode, with the result that, while strong and medium stations are unaffected, the weak transmissions, together with the general level of background noise, fail to reach the point at which the rectifier comes into action.

The overall sensitivity is sufficiently high to give reliable reception of six or seven foreign stations on medium waves in daylight, and after dark no programme which is higher in strength than the prevailing noise level will be missed.

A high sensitivity calls for a correspondingly high degree of selectivity, and this quality is one of the outstanding features of the set. In Central London, the Brookmans Park National transmitter occupied a band of only 12 kc/s and the Regional transmitter 45 kc/s. In other words, adjacent channel reception is just possible near the National transmitter, and approximately two channels are lost on each side of the Regional. The long-wave selectivity would be sufficient to give clear reception of the Deutschlandsender, but for

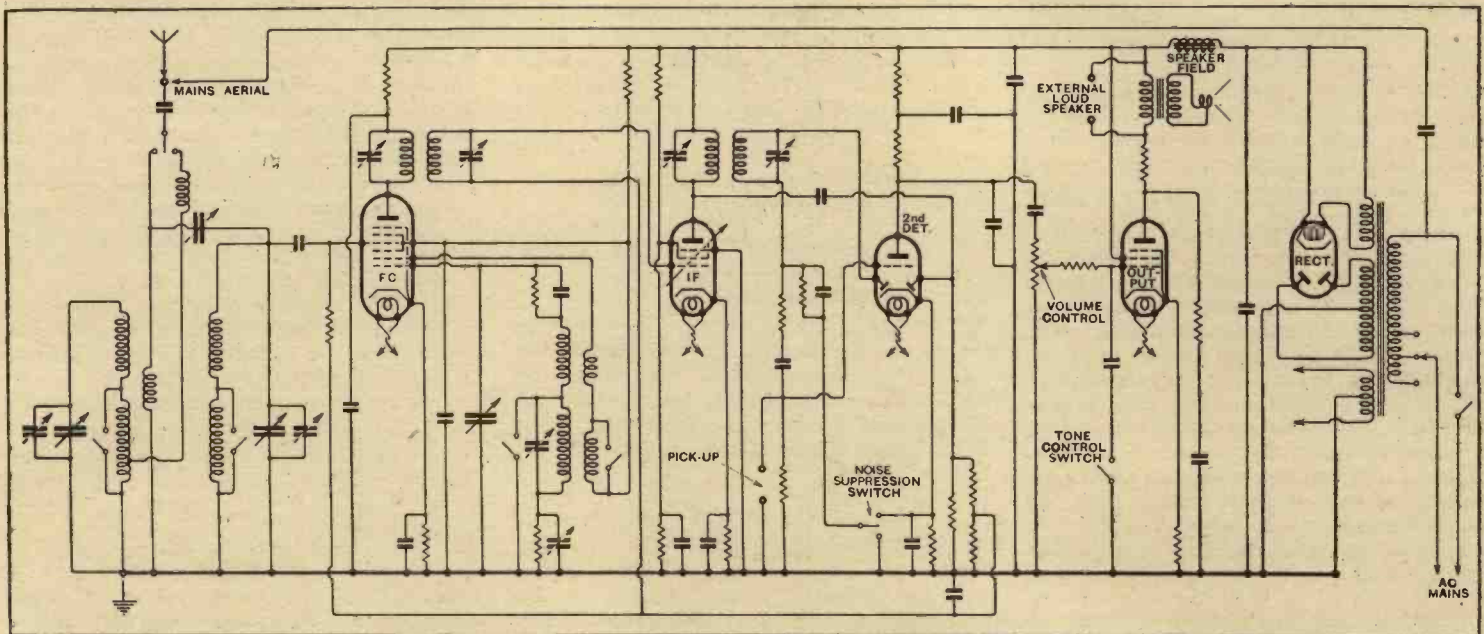

Complete circuit diagram. Inter-station noise suppression is obtained by applying a fixed bias to the diode detector.

Portadyne Model A37—the usual slight side-band interference from Daventry and Radio Paris. The only second-channel whistle noted was at 460 metres on the medium waveband.

The reproduction is free from noticeable cabinet resonance and the bass and treble are well balanced. The good quality is maintained up to the full volume available from the local station, which was estimated to be of the order of 2 watts.

The cabinet is of tasteful design, and the centre panel of bird's-eye maple blends well with the white tuning dial and the green material covering the loud-speaker aperture. The dial is clearly calibrated in wavelengths, and the pointer is provided by the image of an arrow, which is thrown alternately on the long- and medium-wave scales by separate pilot lamps travelling with the main condenser spindle.

Provision is made for the reproduction of

gramophone records, and a mains earth connection is included for those who are unable to erect an outdoor aerial. With the mains

aerial, however, only the medium-wave locals gave reliable results, and for other stations a short indoor aerial is desirable.

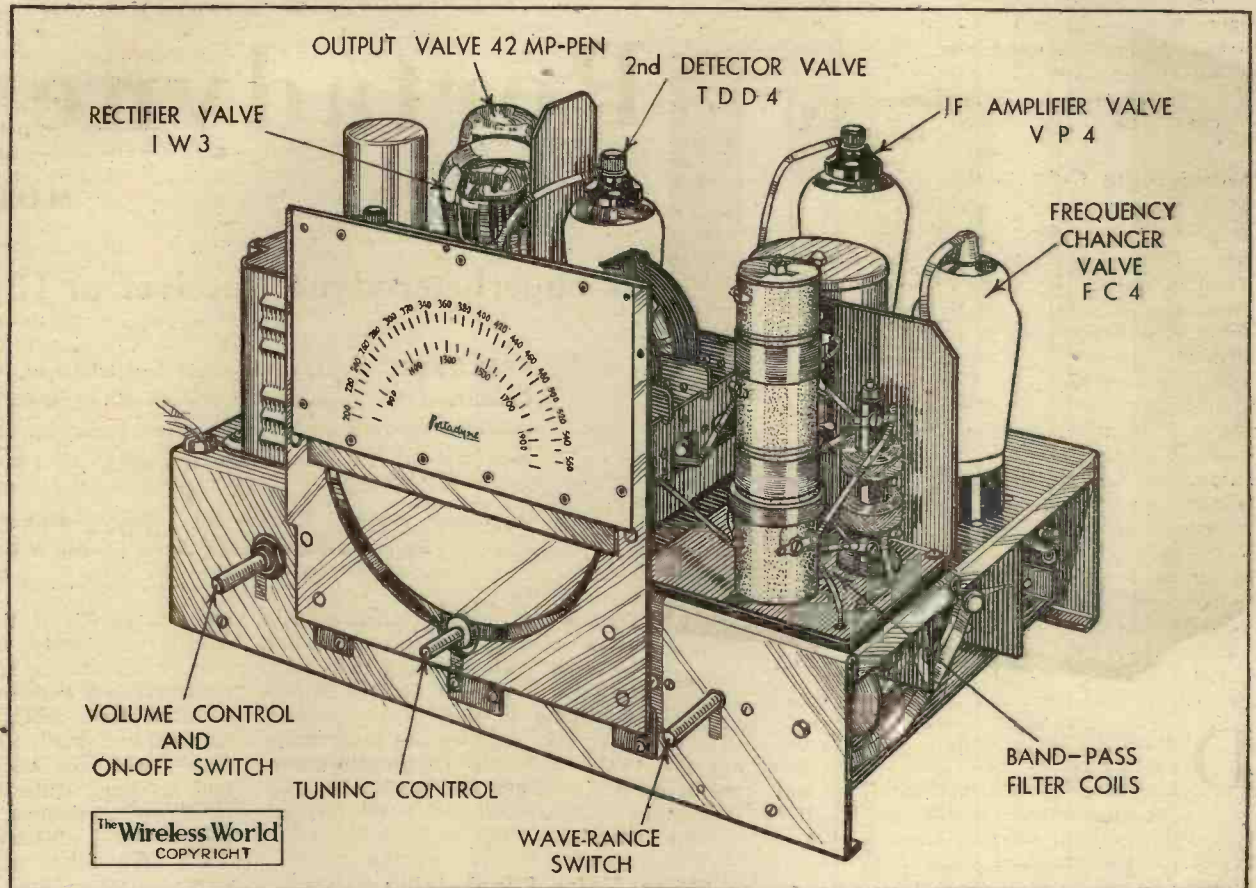

General view of the chassis. The band-pass filter coils are unscreened.

Letters to the Editor

The Editor does not hold himself responsible for the opinions of his correspondents

Cinema Reproduction

I VENTURE to add this letter to the many you have already received on the question of cinema quality in the hope that your readers may be interested in the experience of an amateur whose pleasurable duty it is to provide "Talkie" entertainment in one of H.M. ships.

I fully endorse the opinions expressed by your correspondents who state that the quality of most cinemas is very far from good. With the equipment I have installed here I believe I have achieved the best quality obtainable as a result of a compromise with cost and portability, and subject to the limitations imposed by the input from the often poorly recorded sound tracks on many films. This quality I estimate at about 50 per cent. better than that given by the average provincial cinema, and the same amount lower than "medium high fidelity" radio reception. In this connection I wish you speedy success in your search for some form of measurement of fidelity.

Lastly, is it too much to hope that some explanation may be forthcoming from the film technicians as to why: (a) Variable area recording, with its intrinsic weakness in the reproducer in that harmonic distortion is bound to occur if the light slit be shortened by dirt in the gate, or incorrect tracking, is allowed to exist at the same

time as variable density recording, which is much less prone to these effects; (b) Electromagnetic recorders are, I believe, almost exclusively used nowadays in place of the "light" system, in which the audio-frequency output from the microphone amplifiers modulates the recording light beam direct. I should have thought that the latter would be far better for recording transients, having no inertia, as well as more free from frequency and harmonic distortion.

I fear that the answer may lie in the economic, or money-making, sphere!

G. W. HARPER,
Lieutenant-Commander, R.N.

The Manchester Show

YOU have printed interesting notes in recent numbers of *The Wireless World* relating to the Olympic Show as viewed by a Student of Quality, etc. For we Northerners the Manchester Show is "Our Show," and it occurs that a few notes on this may be of interest.

As the writer is also a quality fanatic he shares much of the views of your previous contributor on the London Show. The Manchester Show was bright and colourful with good display, but little to interest the keen amateur; and, alas, many of the leaders of the industry usually at Manchester were

missing this year. There was less display of technical matter and detail design than in the past, so I suppose the majority rely for sales on the cunning design of their cabinet work. Strangely enough, the biggest crowds appeared to be interested in the stand of a well-known "gadget" manufacturer where there was not even a complete set or cabinet, which, in my view, goes to prove that the public are more interested in technical matters than manufacturers give them credit for. I must take several of the leading valve makers to task for being unable to supply real technical literature, and the makers of automatic record changers which were not "automatically record changing."

The loud speaker makers alone appeared to be the one bright spot in the show for the amateur, there being at least two firms showing high-note tweeters which could be cut out by pressing a bell-push switch.

I happened to be travelling home with a non-technical listener who had visited the show for the sole purpose of ordering a receiver. He had come away without ordering anything for the reason, as he put it, that he "appeared to have stumbled on a Furniture Exhibition!" I believe there were supposed to be some demonstration rooms, but the only ones I managed to find tucked away in the gallery

of the Annexe appeared to be hallowed places for trade men who must not be disturbed in their discussions of big business, or was it the latest club story?

H. BRYAN DAVIES.

Colwyn Bay.

Radiolympia Criticisms

YOUR editorial of September 7th, together with Mr. R. B. Ransome's letter on the "Common Supply" at Olympia and "Disappointed Visitor's" comments, all point to a need not yet met in any way known to me. I offer a very optimistic suggestion, but one not impossible of execution if one of the large general emporiums will take it up. It is that an impartial body shall provide a series of demonstration rooms, similar to gramophone record audition chambers, but large enough to represent fairly the normal conditions in private sitting rooms. The smaller rooms (say, 14ft. by 14ft.) should contain a selection of battery sets, and a similar room should be reserved for small mains-operated sets. Rather larger rooms would be used for demonstrating the intermediate types of receivers and the lesser-powered radiograms, while still larger rooms would exhibit the super-quality sets and *de luxe* radiograms. Independent loud speakers would also be shown in all rooms, and it should be possible within limits to move a receiver or reproducer to a given position in the room at the listener's request. Obviously the demonstrators would have to be as impartial as the traditional civil servant, and the rooms would be supplied by all manufacturers with courage enough to let their producers stand up to a competitive test under conditions approaching to normal. Probably only the large stores could afford the necessary space—the ordinary retailer cannot do it.

At present, the effect of the large Radio Exhibitions must be well-nigh bewildering, and it is impossible for an intending purchaser to make an unbiased choice from the dozens—almost scores—of competing makes, *on performance alone, unadvised and unprompted*, (if he so wishes) under conditions approximating to the daily use of the article required. Many people rely upon the guidance of a discriminating friend, but such a friend is often prejudiced in favour of some particular type, and it would do him no harm to accompany the purchaser to an audition such as I suggest.

Concluding, may I alter a well-known saying?—"Blessed is he who expecteth much, for some day he may not be disappointed."

Beckenham. W. C. BURBRIDGE.

I NOTICE that you have unfavourably commented upon the fact that, at both "Radiolympia" and at the Kelvin Hall, the only telephony available was from one common B.B.C. amplifier. This, of course, does not give the set manufacturers an opportunity to demonstrate more than the loud speakers in their products, and gives little or no indication of the powers of their products as actual radio receivers.

Surely it would not be difficult to arrange a very small transmitter in the Hall itself, working, perhaps, on a regulation "artificial aerial" with a power of only a watt or two, but capable of dealing with an unimpeachably wide band of audio-frequencies. By this means visitors could get some information, perhaps not very much, about the radio-frequency side of the

sets on view, and certainly more about the audio-frequency performance.

Carlisle.

Ex-6GY.

The Exhibitions

AS a regular reader of *The Wireless World* and a visitor to the Radio Exhibitions for the past six years, I thought what a big disappointment this year's show was. Do not misunderstand me. From a showman's point of view it was the best ever, but not for the real "fan," who was anxious to hear receivers and speakers under working conditions.

Some years ago a start was made in this direction by a system of demonstration rooms, but this has now been abandoned. Surely it would have been wiser to have improved on this idea so that the public could have judged for themselves the advance in design and reproduction instead of having to be content with viewing "dead" receivers and trusting to luck. Hoping something will be done before next year's show and wishing your paper continued success.

W. S. WILSON.

Lincoln.

MAY I be permitted to endeavour to enlighten one or two of your readers who seem in doubt as to the actual purpose of Radiolympia? Primarily, this exhibition is intended for the trade, the main object of the exhibitors being to obtain trade orders. As, however, the general public has displayed such interest, increasing with each successive exhibition, if Press reports are to be believed, it would appear that the general scope of the exhibition has been widened to appear attractive to both the

will be in use, particularly as the general lay-out of Olympia positively lends itself to such a scheme. As "Free Grid" remarks, the presence of innumerable "experts," mouthing unintelligible pseudo-scientific multi-adjectived expressions serves only to further bewilder the earnest seeker of knowledge. If the exhibitors have faith in their own wares let them afford visitors to the exhibition, in whatever guise they come, an opportunity of adjudging their true performance.

In conclusion, I would add that my opinions are shared with almost every person I have approached on the matter, they all agreeing that their main impression after seeing all the stands is that of still further puzzlement as to which receiver is most suited to their individual tastes.

Twickenham.

L. J. LOWEN.

"Signatures"

I SUGGEST that the real reason why pianos and organs carry the maker's name in a conspicuous position is that they are there to be played by anyone who has the will and skill to do so. If the player is asked to perform on an instrument he has never seen before, the maker's name will give him some very valuable information before he strikes the first note. I know that the effects I can produce on a Blüthner or Steinway are entirely different, and therefore modify my interpretation accordingly. Playing the same piece on a Norman and Beard or a Harrison and Harrison organ may call for quite different registration. Although many people have helped to make them, all the instruments of any one of the makers I have named have

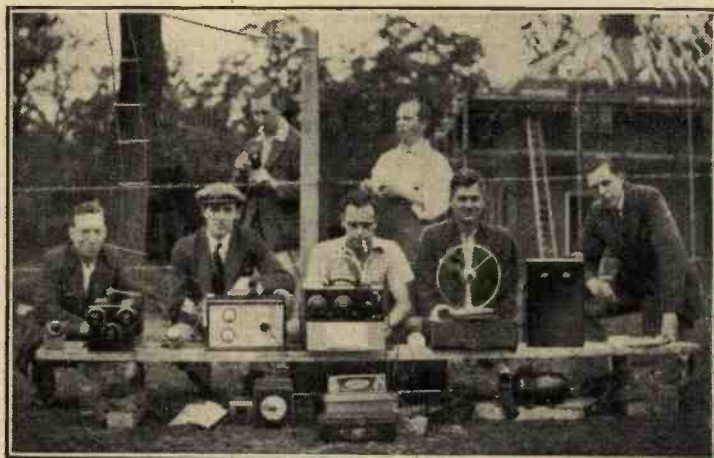

A fixed station, G6TV and a mobile transmitter, G5SG, took part in a five-metre field day recently held by the Kentish Town and District Radio Society. The photograph shows the members with their apparatus at the end of their busy day.

trade buyer and the prospective private purchaser.

But I would endorse the remarks of your other correspondents and contributors in their complaints as to the methods used to display the receivers. It is absolutely impossible for the technician and ignoramus alike to obtain any actual idea as to the performance of any one receiver under actual reception conditions, and I would consequently suggest that Radiolympia is abortive in its most essential function; namely, to afford an opportunity of viewing new products and comparing them.

Until recent years many exhibitors rented private demonstration rooms. These, admittedly, were not as good as they might have been, but it is surely within the bounds of possibility to further the idea, and create numbers of sound-proof audition rooms (or even near sound-proof) to enable all and sundry to hear the article in question as it

a strong family likeness in spite of the fact that every instrument has its own individuality. Other solo instruments are marked inconspicuously, if at all, because they are carried about as personal property by the performer.

A motor car is clearly marked for much the same reason as a piano or organ, so that a driver experienced in the type can get in and handle that particular model at once with ease and skill. Perhaps the same argument could be used to justify the conspicuous marking of tennis rackets, cricket bats, typewriters and sewing machines, but I do not think that a case can be made out for so marking the radio set. The modern set ought not to call for any virtuosity on the part of the operator; moreover, an apparatus whose sole function is the faithful reproduction of sound has no right to any individuality or idiosyncrasy.

Cambridge.

PATRICK KING.

New Apparatus Reviewed

Recent Products of the Manufacturers



Terminals are provided for connections to this Scientific Supply Stores coil for the Standard Two.

STANDARD TWO COIL

A COIL assembly for the *Wireless World* Standard Two has been received for test from Scientific Supply Stores (Wireless), Ltd., of 126, Newington Causeway, Elephant and Castle, London, S.E.1. This assembly conforms in every way to the published specification, and the two coils L1 and L2 are wired together internally, thus reducing the number of connections which must be made by the constructor. Terminals are provided for all external connections, and the coils can be relied upon to give a satisfactory performance. The unit is priced at 5s. 6d.

ECLIPSE MAGAZINE HACK SAW

A HACK saw is one of the most useful of workshop tools, for quite apart from its obvious use in wireless constructional work there are many occasions where small jobs of a domestic nature call for a saw capable of cutting all kinds of metal, bakelite and the like. The same blade rarely suffices for all purposes, but spare blades often get mislaid unless a special receptacle is kept for them.

The new Eclipse Magazine Hack Saw Frame No. 30M ensures that one can always place a hand on the spares since they are accommodated in the hollow back of the frame. This holds five blades, so with the one in the saw there are six available for use.

Three different styles are supplied, two of each of 18, 22 and 32 teeth per inch, and these suffice for all ordinary needs covering the requirements for mild steel, hard steel, brass, for tubes and thin sheet metal, also for ebonite and similar materials. The frame is strongly made and well finished, and complete with six blades costs 5s.

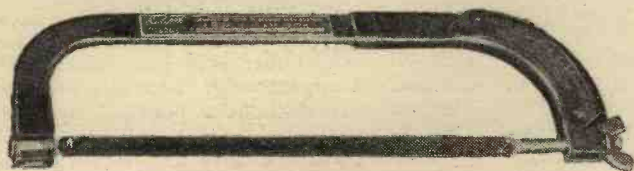

The makers are James Neill and Co. (Sheffield), Ltd., Composite Steel Works, Napier Street, Sheffield 11.

AN ALL-WAVE TUNING COIL

THE Lissen Four-range coil is believed to be the only one of its kind that covers the short, the medium and the long wavebands, so providing in a very compact form the means for constructing an all-wave receiver using but a single coil and tuning condenser. It has a four-position switch built into the base, and the whole is completely screened. The windings are

so arranged that the efficiency on all wavebands is as good as can be obtained with a coil of such wide waveband coverage, yet keeping the dimensions within practical limits.

When tuned by a 0.0005 mfd. condenser and with one of 0.0003 mfd. for reaction control, the four wavebands provided are from 12.5 metres to 41 metres, 28 to 86 metres, 206 to 553 metres, and 974 to 2,128 metres respectively. To tune down to 12.5



Lissen Four-range coil for use in all-wave receivers.

metres requires a condenser of very low minimum capacity, yet quite practical, and a small condenser (about 50 micro-mfds.) in series with the aerial, the other wavebands being obtained with a 0.0001 mfd. condenser in the aerial lead.

Reaction is smooth and satisfactory throughout, and the best position for the condenser is between the anode of the valve and the reaction coil, and not in the "earthy" side as is more usual. The test circuit was a straightforward det.-LF arrangement using the Lissen HL2 valve as detector. The HF choke must have a very low self-capacity to ensure a satisfactory short-wave performance, but if needs be it is quite practical to include a special short-wave HF choke between the anode of the valve and the standard broadcast HF choke,

Spare blades with teeth of different pitch are accommodated in the frame of the Eclipse Magazine Hack Saw No. 30M.

though we did not find this expedient necessary.

Selectivity on the medium and the long wavebands was good for a single circuit, though an HF stage could be employed, using another coil of the same pattern for the HF coupling. Both short-wavebands produced a satisfactory crop of signals showing the efficiency is not affected by the other windings, though a slow motion drive of not less than 150 to 1 is essential for ease of operation.

The makers are Lissen, Ltd., Lissenium Works, Worple Road, Isleworth, Middle-

sex, and the price is 15s., which includes an extension rod, knob, coupler for ganging two coils and fixing screws.

UTILITY CONDENSERS AND DIALS

THE new season's Utility steel-frame gang condensers are similar in design to last year's models, but several minor improvements have been made, and in workmanship and in price they compare favourably with any on the market.

The rotors are fitted with aluminium vanes embedded in a solid boss securely fixed to a steel spindle supported at the front in ball-bearings and at the back by a plain thrust bearing, the whole assembly being very rigid and free from end-play. These vanes are semi-circular, and the correct capacity law required for present-day circuits is obtained by fitting suitably shaped plates in each stator section.

Tests were made with the new model W.349/3, a superhet three-gang condenser designed for use with 110 kc/s IF amplifiers. Using the customary standard values of inductance, i.e., 157 micro-H. for pre-selector coils and 126.5 micro-H. for the oscillator coil on the medium waveband, the tracking did not vary by more than 3 kc/s at any part of the waveband. For the long wave coils of 1900 micro-H. and 925 micro-H. respectively are needed with a variable padding condenser of 0.002 mfd. With the sections of equal capacity the average discrepancy was just over 0.6 per cent. The minimum capacity with the trimmers fully out was 27 micro-mfds., and

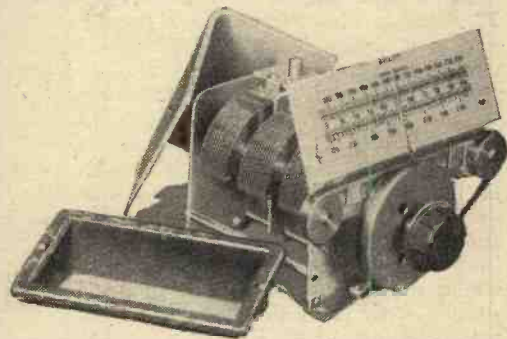

Utility Model W.349/3 superhet three-gang condenser and new straight-line dial.

they gave a variation of 30 micro-mfds. approximately. The maximum change in capacity of each pre-selector section was 481 micro-mfds. These values are quite satisfactory for modern circuit requirements. The price of this model is 17s., and the two-gang type costs 11s.

The new slow motion dials are made in two styles, one with a ratio of 12 to 1 and the other with two ratios, viz., 12 to 1, and 150 to 1. The design is the same in both models, full vision scales illuminated by twin lamps being fitted, and the pointer is driven by a narrow steel band maintained taut by spring tension.

The 12 to 1 ratio model is wavelength calibrated, but the dual-ratio type has a 0-100 division scale. The single-ratio type costs 6s. 6d., and the micro dial 15s.

The makers are Wilkins and Wright, Ltd., Utility Works, Holyhead Road, Birmingham, 21.

Straight H.F. v. The Superheterodyne

The Reasons for a Welcome Change in Set Design

By F. H. HAYNES.

SUPERHETERODYNES have the following advantages: (1) Stable H.F. amplification, and (2) uniform selectivity across the tuning range. Their failings are: (1) Liability to heterodyne whistle by (a) second channel, and (b) excitation of the tuned input circuits from the oscillator; (2) tracking, although generally satisfactory, is not precise on both wave ranges; (3) distortion, or, alternatively, lack of selectivity in the intermediate amplifier; (4) non-uniform sensitivity across the tuning scale unless an intricate circuit system is used by which both the output and coupling of the oscillator are modified with change of tuning; and (5) poor sensitiveness to an exceedingly weak input, unless a pre-first detector H.F. stage is fitted.

In superheterodynes to-day we find, strangely enough, intermediate amplifiers of both higher and lower frequencies than the incoming signal. If of higher frequency, selectivity and amplification will suffer, and if lower the problem of obtaining high selectivity without distortion arises, together with liability to second channel heterodyne.

Why not, therefore, keep the signal frequency unchanged? Because at the commencement of the vogue of the single-dial superheterodyne the defects of straight H.F. amplifiers of high gain were: (1) Instability owing to the excessive value of grid to plate capacity of the older type of screen-grid valve; (2) distortion by increase of modu-

lation of the carrier—the variable-mu valve was only just making its appearance; (3) poor selectivity as a result of cross-modulation; and (4) the goodness of the tuned circuits declined as the capacity of the tuning condenser increased, so that sensitiveness as well as selectivity were by no means uniform across the tuning range.

To-day the position of the straight H.F. amplifier is quite different. The Ferrocart tuning coils, even in a circuit arranged for high selectivity, produce very considerable stage gain, and this can be used to full advantage owing to the remarkably low grid-to-anode capacity of the type of H.F. valve now available. The H.F. pentode, as compared with the screen-grid valve, does not introduce effects of cross-modulation. The variable-mu type handles a considerable signal input without distortion by change of modulation, and with the aid of amplified A.V.C. can be arranged automatically to adjust the signal-handling properties so as to be always in a condition of accepting without distortion a signal input in excess of that by which it is actuated. The characteristic of a tuned circuit having Ferrocart coils is such that sensitivity is almost uniform across the tuning range. High selectivity is obtained without side-band cutting, due mainly to filter design and partly to the important fact that amplified A.V.C. renders the receiver insensitive to a slightly off-tune interfering signal. The Haynes two-H.F.

tuner, Model R, typifies all these features, and is a forerunner of a new vogue in receiver design.

At the 1932 Radio Exhibition the Haynes Single Dial Superheterodyne, then nearly a year old, stood alone. To-day it is typical, but is already superseded by the two H.F. straight set having Ferrocart filters, low-capacity H.F. pentodes, amplified A.V.C., and diode detection, a perfectly stable arrangement which sets an entirely new standard for range, selectivity, and quality, with neither background noise nor self-heterodyne whistle.

That *Wireless World* readers agree with these views is revealed by the remarkable demand for this new product. Haynes tuners, amplifiers, chassis, and radiogramophones embody exclusive features, and have achieved an unrivalled reputation for outstanding performance. Demonstrations are given every Friday evening from 7.30 to 9.30 p.m. at the factory and at other times if advice is received by telephone. A 32-page booklet is available on request which describes the new two H.F. tuner unit and the exclusive Haynes system of Duophase L.F. amplification, as well as Haynes loud speakers.

A new factory extension of 3,000 square feet now includes accommodation for the London office, and the address is: Haynes Radio, Queensway, Enfield, Middlesex; telephone: Enfield 2726.

Announcement of Haynes Radio, Queensway, Enfield, Middlesex.

"Wireless World"

says:

"The mechanical design of the GRILLE Model has received more than usually careful attention. The bass response is exceptionally good... the balance of tone would do justice to units of much larger size and price. In the upper register the response is good to 8,000 cycles, after which it falls gradually. The reproduction is generally clean and crisp, with a broad bass foundation which is not usually found in permanent magnet units of its size."

THE 7-FOLD VIGILANCE TEST WINS PRAISE
FOR ALL TYPES OF GOODMAN SPEAKERS

From the lowest priced speaker up to the big, public address instrument, the 1935 range of GOODMAN'S Speakers are winning universal praise from technicians and laymen. Now... from the "Wireless World" comes the news that a GOODMAN'S Speaker is specified in the "Wireless World" "Standard Two"... conclusive evidence of the efficiency and fidelity of our products.

TEST No. 1.

The first test in the series concerns the power and performance of our permanent magnets. To commence with, all magnets must be above a certain minimum flux density, otherwise they are not passed into production, and, in addition, several magnets from every batch are subjected to a vibration and heat test in order that consistency of results given by the remainder is beyond question. Finally the flux density is again checked with the magnet in position on the chassis. Thus do GOODMAN'S engineers ensure that every speaker which goes into use... the speaker that you will ultimately use... is the finest obtainable.

Illustrated booklet free on request.

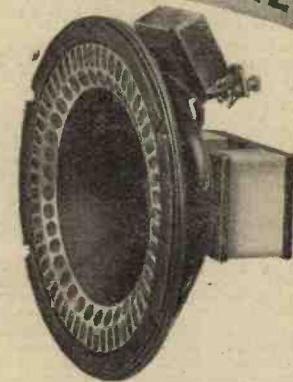

"Grille" type permanent Magnet Moving Coil Speaker with 8" Cone and Multi-load transformer. 45/- or with special extension transformer. 52/6

GOODMANS

(CLERKENWELL) LTD

BROAD YARD WORKS, TURNMILL ST, CLERKENWELL, E.C.1. Tel: Clerkenwell 3838/39

Mention of "The Wireless World," when writing to advertisers, will ensure prompt attention.

MISCELLANEOUS ADVERTISEMENTS

NOTICES.

THE CHARGE FOR ADVERTISEMENTS in these columns is 12 words or less, 3/- and 3d. for every additional word.

Each paragraph is charged separately and name and address must be counted.

ADVERTISEMENTS for these columns are accepted up to **FIRST POST ON MONDAY MORNING** (previous to date of issue) at the Head Offices of "The Wireless World," Dorset House, Stamford Street, London, S.E.1, or on **SATURDAY MORNING** at the Branch Offices, 19, Hertford Street, Coventry; Guildhall Buildings, Navigation Street, Birmingham, 2; 260, Deansgate, Manchester, 3; 26b, Renfield Street, Glasgow, C.2.

The proprietors retain the right to refuse or withdraw advertisements at their discretion.

Postal Orders and Cheques sent in payment for advertisements should be made payable to **ILIFFE & SONS Ltd.**, and crossed & Co. Notes being untraceable if lost in transit should not be sent as remittances.

The proprietors are not responsible for clerical or printers' errors, although every care is taken to avoid mistakes.

For particulars of Box Number Advertisements and Deposit System see previous issues.

Set Manufacturers' Surplus, Clearance and Bankrupt Stocks offered in any of these columns may not be Manufacturers' current lines. Radio components advertised at below the list price do not carry any manufacturer's guarantee.

RECEIVERS AND AMPLIFIERS, ETC.

H.M.V. Radiogram 501, A.C. volts 100-260; £8, near offer.—4, Barons Court, W.14. Fulham 4854. [6604]

G.E.C. 1933-34 Overseas A.C. superhet, short-medium waves, as new.—Box 1753, c/o *The Wireless World*. [6600]

G.E.C. Superhet A.V.C.5 for A.C. Mains, cost £14/14 last week; accept £10/10.—1, Oakhill Rd., East Putney, S.W. [6582]

CROSLEY and Emmerson's Midgets and Car Radio; send for wholesale catalogue, importer.—Royal, 5, Buckingham Rd., London, E.18. [6447]

7-VALVE Century Car Radio, complete, as new; £7/7; K.B. 4-valve A.C. superhet., Model 444, as new, £6/10.—58, Flat, Mantell St., N.1. [6633]

COLUMBIA Model 309 D.C. 2-valve Mains Receiver; list 9 guineas, offered complete 2 guineas each, carriage paid.—Rogers, Radio, Lowestoft. [6577]

OUR Kit of Parts for "Wireless World" Quality Amplifier, complete in every detail, including valves; amplifier only. £8/10; feeder unit, 36/-. [6577]

OUR Kit of Parts for "Wireless World" Olympic S.S. Six, complete in every detail, including valves and loud-speaker; £14/10. [6577]

SEND for Detailed List of Components for Either of the Above Kits; carriage paid, cash with order. [6402]

WARD, 45, Farringdon St., London, E.C.4. Phone: Holborn 9703. [6402]

SCOTT'S Guaranteed "Wireless World" Kits, complete in every detail; Quality amplifier, £8/10; Olympic S.S. Six, £14/10; all including valves.—67, Harlesden Gardens, N.W.10. [6625a]

1935 Models, 4 valve superhet A.C. or D.C., m.c. speakers, £3/19/6; 5 valve, £5/5; car radio, £8/10, including valves; approx. *Wireless World* deposit.—Lovell Bros., 11, Avon Rd., London, E.17. [6503]

£5/5—Band pass 4-valve chassis by Plessey, Magnavox m.c., complete with valves, in high class walnut or oak cabinet, either A.C. or D.C.; ditto radiogram, £7/10; c.o.d., carriage forward.—Kay, 167, City Rd., London, E.C.1. [6619]

SIX Valve Radiogram, all electric A.C. model, together with amplifier, D.C. converter, extra gramophone motor and pick-up in cabinet, also extra speaker, would suit restaurant, club, etc., cost £170, what offers?—Can be inspected any time at 842, Romford Road, Manor Park, E.12. [6594]

PUBLIC Address Amplifiers.—A.C. mains, three stage, 21 watts, undistorted A.C. output, complete with valves, £15; universal A.C./D.C. three stage, 7 watts output, complete, £13; guaranteed 12 months; trade supplied; deferred terms.—D. E. Clarkson, B.Sc. (Eng.), Bridge Works, Bridge Rd., Wallington, Surrey. Phone: Wallington 3955. [6280]

ARMSTRONG—Latest 5v. bandpass superheterodyne chassis, with fully delayed A.V.C., 7 highly efficient tuned circuits, bandpass input, Marconi Heptode frequency changer, combined 1st detector and oscillator, bandpass I.F., coupled to Marconi H.F.; pentode, bandpass coupled to Cossor Double Diode, giving distortionless detection and A.V.C., resistance coupled to Mazda high slope pentode, Marconi bi-phase rectifier, full vision illuminated tuning, calibrated in wavelengths, combined radio and gramophone volume control, corrected pentode output, giving exceptionally good reproduction; £6/18/6, with valves, royalties paid.

ARMSTRONG—Universal triple bandpass superheterodyne chassis, with fully delayed A.V.C., 7 stages, incorporating latest Octode frequency changer and first detector, screened pentode intermediate stage, latest Mazda double diode high slope pentode, full vision illuminated dial calibrated wavelengths, combined radio and gramophone switching, this chassis is really universal, giving equally good results on A.C. and D.C. mains, free from hum; £6/18/6, including Mullard F.C.13, Mullard V.P.15a, Mullard U.R.2, Mazda P.P.4020, Philips R.C.1 valves.

ALL Armstrong Chassis are Constructed of the Highest Grade Components Throughout, carry 12 months' service free guarantee, and are sent on 7 days' approval, carriage paid.

ARMSTRONG MANUFACTURING Co., 100, King's Rd., N.W.1. Phone: Gulliver 3105. [6542]



With this new Clix "A.E." Master Plug—the only really universal plug—you can carry the heavy lead-in wires straight to your set, without breaks or joins. This Clix plug takes any wire up to three-sixteenths inch overall, and the Clix method of wiring ensures perfect contact. Price 3d. each.

IT IS WORTH YOUR WHILE TO SEND A POST-CARD FOR A COPY OF OUR NEW TWO-COLOUR ILLUSTRATED FOLDER "W."

LECTRO LINX LTD.

79a Rochester Row, London, S.W.1

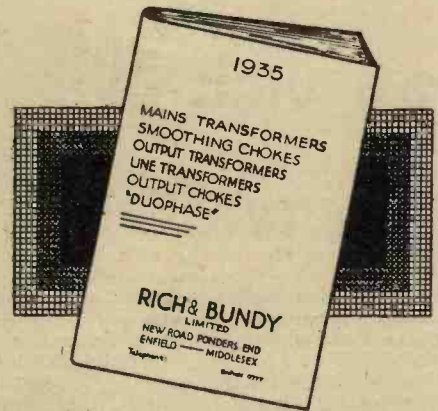

OUR NEW CATALOGUE contains 32 pages of up-to-date technical information on mains equipment and gives characteristic curves and circuits for DUOPHASE TRANSFORMERS.

SEND FOR A COPY NOW. Enclose 1d. stamp for postage.

RICH & BUNDY LTD.
New Road, Ponders End, Middlesex.
Telephone: Enfield 0777.

STILL IN PRODUCTION
SCREENED H.F. CHOKES; HETERODYNE WHISTLE FILTERS; AIR-CORE SLAB CHOKES

and now the **DROITWICH SUPER WAVETRAP**

Please mention the line which interests you, enclosing stamp.

POSTLETHWAITE BROS.
KINVER, NR. STOURBRIDGE.

Every Thursday 3d.

MOTOR CYCLE

w.w.15

Receivers and Amplifiers, Etc.—Contd.

MIDGET Receivers.—Every one brand new, complete with valves and speaker; all carriage paid, cash with order or c.o.d.; working off A.C. and D.C. mains, any voltage, with universal adaptor included; Emerson 5-valve L and M wave bands, A.V.C., pick-up terminals, in handsome figured walnut cabinet (10 1/2 x 7 1/2 x 5 1/2) at £4/6/3; the same, less cabinet, for experimenters wishing to make own cabinet at £3/13/6; Victor Midgets (8 only) in massively constructed walnut cabinet (14 x 10 1/2 x 8), 5-valve superhet., A.V.C., tone control, illuminated dials, undistorted output 3 watts, in fact every refinement found in an expensive receiver, gets 70 stations, list £15/15, at £6/10; also (3 only) Spartan 6-valve superhets., answering to the Victor specification, getting nearly all stations, at £7/7/6.—Degallier's, 4-21, Upper Marylebone St., London, W.1. (S.A.E. with all enquiries.) [6615]

ACCUMULATORS—BATTERIES.

MILNES H.T. Units, all units and speakers in stock; spares, service; demonstration free.—Pearce, 30, King's Cross Rd., W.C.1. [6632]

BATTERY Drudgery Abolished, astounding results, particulars and battery log book free.—Instantbrite, Peebles Works, London, N.W.6. [6587]

MAINS EQUIPMENT.

VORTEXION Specified Olympic S.S. 6 Transformer, S.S.352, 5 years' guarantee, 25/-; less terminals and guarantee, 21/-; power chassis, £3/17/6; choke, 12/6; Single Span model, 25/-; power chassis, £3/10.

VORTEXION—Quality Amplifier or Super Monodial, 425-0-425, 120 m.a., 4v. 6-8a. C.T., 4v. 3a. C.T., 4v. 1a., 4v. 1a., super shrouded, core size 2 1/4 in. x 1 1/4 in., 2 1/2 regulation primary engraved insulated terminals, weight 14lb., 26/-, carriage 2/-; normal shrouded, 22/-; open type, 20/-, post 1/3; speaker field replacement choke, 16/-; special output transformer to "W.W." specification, 12/6, post 9d.; state valve and speaker; "W.W." universal output transformer, £1; normal 40h. 50 m.a. primary output transformers, 10/6, post 9d.

VORTEXION 7.30h. 120 m.a. Choke, 215 ohms, in die cast shrouding to match; 12/6.

LIMITED, but unequalled. Good enough for a "Wireless World" specification is good enough for you.

VORTEXION Cost Little More than the Cheapest, but unequalled by the dearest.

VORTEXION Standards Despatched by Return.

VORTEXION A.C./34, used by author in construction of A.V.C. Three, as illustrated; 19/-.

GUARANTEED 12 Months, and within 5% normal and 2 1/2% super models, neat shrouding, with detachable feet, as used by Government Departments, etc., etc., any model guaranteed 5 years at extra cost of 2/-.

ALL Secondaries Centre Tapped.

VORTEXION—250-0-250 60 m.a., 4v. 1 to 2a., 4v. 2 to 4a., open type, 10/-; shrouded, 12/6; post 9d.

VORTEXION—Ferrocart III 350-0-350, 60 m.a., 4v. 2.5 C.T., 4v. 3.5 C.T.; open type 13/6, shrouded 16/-; post 9d.

VORTEXION—Super model for H.T.8 or 9 or 10, 4v. 1 to 2, 4v. 2 to 4, open type 14/6, shrouded 16/6; post 1/-.

VORTEXION—350-0-350, 120 m.a., 4v. 2 to 5a., 4v. 2 to 4a., 4v. 2.5a.; open type 14/6, shrouded 16/6; super shrouded model, weight 11lb., 4 filaments to specification, 21/-; post 1/3.

VORTEXION—400 or 450 or 500v. 120 m.a., 4v. 2 to 5, 4v. 2 to 5, 4v. 2.5a.; open type 19/-, shrouded 23/-.

VORTEXION—400 or 450 or 500, 150 m.a., 4v. 4a., 4v. 2.5, 4v. 2, 4v. 2, 4v. 2, core size 2 1/4 x 1 1/4 in., a super job, 2% regulation, 35/-; shrouded, with terminals; less terminals, 30/-; open type, 26/-; post 1/3.

VORTEXION Auto Transformers to B.E.S.A. Specification, 100, 110, or 120v. to 200, 220, or 240 volts, 60 watts, 9/-; post 9d.; 120 watts, shrouded 12/6, post 1/-; 200 watts, shrouded 16/6, post 1/-; 2,000 watts, £4/10.

VORTEXION 1,000-watt Transformers; £4/10, carriage free.

VORTEXION 30h. at 60 m.a. Chokes, 5/6; 40h. at 60 m.a., 8/6; 30h. at 150 m.a., 200 ohms, 10/6 open type, 12/6 shrouded.

VORTEXION Transformers Made to Your Specification; price according to wattage, 5v. filaments same price unless wattage grossly exceeded; special quotations by return.

VORTEXION (S. A. BROWN), 182, The Broadway, Wimbledon, S.W.19. Tel.: Liberty 2814. [6561]

P. PARTRIDGE, B.Sc., A.M.I.E.E., A.I.Rad.E.

PARTRIDGE Mains Transformers.—"Certainly above the average... very soundly constructed."—*Wireless Trader*.

PARTRIDGE Output Transformers.—Officially recommended by Messrs. Tungram for their 21w. output valves.

PARTRIDGE—See last week's detailed advertisement; delivery from stock; trade enquiries invited.

PARTRIDGE, N., King's Buildings, Dean Stanley Street, London, S.W.1. Tel.: Vic. 5035. [6598]

TANTALUM for A.C. Chargers. H.T. and L.T.—Blackwell's Metallurgical Works, Ltd., Garston, Liverpool. [6470]

BATTERY Chargers.—The N.P. for the lowest priced efficient instruments; trade lists.

BATTERY Chargers.—Special discount to users; prices from 52/- to £15.—N.P. Electrical, 514, Alum Rock, Birmingham. [6629]

Mains Equipment.—Contd.

HOYNE'S Transformers are Manufactured by Engineers with 14 Years' Experience in Radio Transformer Design.

HOYNE'S Transformers, fitted with tapped and screened primaries, filaments, all centre tapped, stout cast aluminium clamps and clearly marked terminal strips are fitted to all models, write for list.

HOYNE'S Components are Guaranteed for One Year; one type only manufactured, the best, as used by many well-known set manufacturers after testing all others.

HOYNE'S.—"W.W." transformers wound strictly to specification of author: "W.W." test reports, June 22nd: "The insulation is particularly good throughout... the transformer is satisfactory in all respects."

HOYNE'S.—Push-pull quality amplifier transformer, 25/-, post 1/3; 7/30 henrys choke, 9/6, post 9d; 20 henrys, 7/6, post 9d.

HOYNE'S.—Single span, 15/-, post 1/-; choke, 10 henrys, 7/6, post 9d.

HOYNE'S.—Everyman A.C. super transformer, 12/6, post 1/-; choke, 10 henrys, 7/6, post 9d.

HOYNE'S.—A.V.C. Straight Four transformer, 18/-, post 1/3; choke, 26 henrys, 12 m.a., 140 ohms, 9/6, post 9d.

HOYNE'S.—Push-pull quality amplifier, complete to "W.W." specifications, wired and fully tested, less valves, £5/12/6; complete kit of components including metal chassis, £5/2/6; field replacement choke, 1,250 ohms, 13/6, post 1/-; output transformer, 12/6, post 1/-.

HOYNE'S.—250-0-250v. 60 m.a., 4v. 1 to 2a., 4v. 2 to 4a., 10/-, post 9d.; with extra 4v. 1 to 2a. winding, 12/6, post 1/-.

HOYNE'S.—Ferrocort III, 350-0-350v., 60-70 m.a., 4v. 2 to 3a., 4v. 2 to 4a., 12/6, post 1/-; with extra 4v. 1 to 2a. winding, 13/6, post 1/-.

HOYNE'S.—350-0-350v., 120 m.a., 4v. 2 to 3a., 4v. 4 to 6a., 4v. 1a., 4v. 1a., 18/-, post 1/3.

HOYNE'S.—400 or 450 or 500v., 120 m.a., 4v. 2 to 3a., 4v. 2 to 5a., 4v. 1 to 2a., 18/-, post 1/3.

HOYNE'S.—500-450-0-450-500v. 140 m.a., 4v. 2 to 4a., 4v. 4 to 6a., 4v. 2a., 4v. 2a., 27/6, post 1/3; weight 11lb.

HOYNE'S Transformers, built to specifications, keenest prices, best materials and workmanship; quotation by return.

M. J. HOYNE, ALL-POWER TRANSFORMER, Ltd., Offices and Works, 8a, Gladstone Rd., Wimbledon, S.W.19. Tel.: Liberty 3303. [6488

PARAMOUNT Mains Transformers, equal to any, and better than most; try them once and you will always use them!

PARAMOUNT Auto Transformers, 100-120v. up to 200 250 volts, or vice versa, 60 watt, 8/6; 120 watt, 10/-; shrouded 2/- extra, post 9d.

PARAMOUNT.—250-0-250v. 60 m.a., 4v. 1 to 2 amp., 4v. 2 to 4a., open type, 9/6; shrouded, 11/6; post 9d.

PARAMOUNT.—350-0-350v. 60 m.a., 4v. 2-5a., 4v. 3 to 5a., 13/-; shrouded, 15/-; post 9d.; 120 m.a., 4v. 5 amp., 4v. 4 amp., 4v. 2-5a., with screened primary, shrouded, 16/-; post 1/-.

PARAMOUNT.—Single span model, with 1 1/2 in. x 1 1/2 in. core size, 350-0-350v. 100 m.a., 4v. 5a., 4v. 1a., 4v. 2-5a., shrouded, with screened primary, 2 1/2% regulation, 20/-.

PARAMOUNT.—500v. or 450v. or 400v. 120 m.a., 4v. 4v. 4a., 4v. 2-5a., screened primary, 18/-; shrouded, 21/-, post 1/3; 150 m.a., 4v. 2-5a., 4v. 4a., three 4v. 2a., with 2 1/2 in. x 1 1/2 in. core size, shrouded, 28/-, post 1/3.

PARAMOUNT.—Westinghouse transformers, H.T.8, 9 or 10, with 4v. 2a., 4v. 4a., shrouded, 16/-, post 1/-.

PARAMOUNT.—Chokes, 30h. 60 m.a., 5/6; 20h. 120 m.a., 8/6, post 9d.

PARAMOUNT Mains Transformers are Guaranteed for 12 Months.

PARAMOUNT Products are Fitted with Neat Aluminium Frames or Shrouds, all filaments C.T., insulating paper 2 1/2 mils. thick between each layer, and tested thoroughly before leaving our works.

PARAMOUNT Transformers Made to Your Own Specifications; price according to wattage; quotations by return.

PARAMOUNT Guaranteed Electrolytic Condensers, 4+4 mid., 500v. peak, 3/6, post 3d.

PARAMOUNT Mains Transformers, manufactured by R. H. Salter, 66, Hartfield Rd., Wimbledon, S.W.19 (one minute from Wimbledon Station). Tel.: Liberty 3226. [6315

ELIMINATORS, with charger, portable set type, A.C. 200-250 volts 50-100 cycles, brand new, unused, guaranteed, 25/- each; Midget receivers at bargain prices; call and inspect.—General Radio Service, Condon House, St. Paul's Churchyard, E.C.4. City 3176. [6631

CABINETS.

MANUFACTURERS' Clearance.

ULTRA "Panther," a modern cabinet, with contrasting figured walnut veneer panels, 20x17x11, 13/6; pedestal type, 35x22x12, 30/-, undrilled; photo sent on request.

SET and Speaker Cabinets; 5/- upwards.

RADIOGRAM Cabinet; 37/6 upwards.

SPEAKER Cabinets; 4/6 upwards.

SEND Particulars of Your Requirements (giving size of set, etc.), or call and make your choice from our stocks of over 100 different types; from 3/6 to £4/10.

REFER to Previous Advt. for Detailed List of Bargains.

H. L. SMITH and Co., Ltd., 287-9, Edgware Rd., London, W.2. Tel.: Padd. 5891. [6052

DYNAMOS, ETC.

CRYPTO Motor Generator, new, 250 A.C. to 15v. 13a. D.C., list £18/10; sell £10.—43, Zetland Rd., Redcar, Yorks. [6583

M. L. Converter D.C. 220v., A.C. 110v. 80w., practically unused; £4.—B., 17, Beddington Road, Seven Kings. [6584

THE Best Dynamo Value Obtainable Anywhere, 12-volt 10-amp. C.A.V., ball-bearing generators, 4-pole, 4-brush, shunt wound, totally enclosed, suitable for charging or lighting, complete with driving pulley, revs. 750, clockwise, every one guaranteed; 14/6, sent carriage forward, cash with order.—Wickham, 6, Gerridge St., S.E.1. [6580

The greatest Value in TRANSFORMERS ever offered!

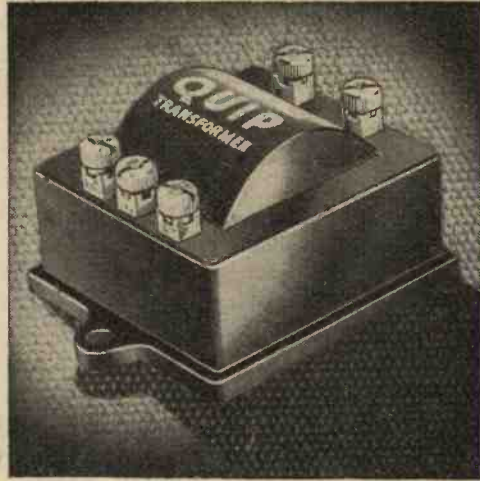

as specified for the new "Standard 2"

"QUIP" TRANSFORMER Designed for the new Q.P.P. Double Pentode valves, or any push-pull circuit requiring a high step-up ratio, parallel fed. High primary inductance 60/70 henrys and straight line amplification over 50 to 9,000 cycles, full step-up ratio of 1-8. Extremely low capacity windings and minimum flux leakage. PRICE 10'6

"MAX" TRANSFORMER MAX Parallel Feed Transformer. One of the most outstanding Graham Farish contributions to better and lower-priced 1935 Radio. Alternative ratios of 1-1, 1-2, 1-3, 1-4, 1-5 and 1-6 are obtainable with the same transformer. Black bakelite case fitted with the new type of terminal developed by Graham Farish for the home constructor. Without doubt the greatest value in radio today. PRICE 4'6



GRAHAM FARISH LTD. MASON'S HILL, BROMLEY, KENT.



GRAMOPHONES, PICK-UPS, RECORDERS.

B.T.H. Needle Armature Pick-up and Volume Control, used few times only, 28/-; H.T.I. with Eye transformer, 11/6.—18, Oak Bank, Harpurhey, Manchester 9. [6605

LOUD-SPEAKERS.

27/6!!!—Brand new B.T.H.-R.K. speakers, 6v. field, suitable for P.A. work, etc.

27/6!!!—B.T.H. speakers, as above, for 100-250v. A.C., complete with field rectifier.

MAGNAVOX D.C.152 (9in. cone), 22/6; Magnavox 154 (6 1/4 in. cone), 18/3; all with hum-bucking coils, power or pentode transformers, and 2,500- or 6,500-ohm fields; Magnavox P.M.254, 18/-; Magnavox P.M.252, 22/6.

ATTENTION to All Orders Within 24 Hours; carriage paid; cash with order or c.o.d.

WARD, 2nd Floor, 45, Farringdon St., London, E.C.4. Telephone: Holborn 9703. [6404

VITAVOX Public Address Loudspeakers, types and sizes to suit all requirements, any type repaired or re-conditioned.—Vitavox Acoustics; Ashford Road, Cricklewood, N.W.2. [6592

17/6.—Celestion P.P.M.W. (listed 45/6); 19/6. Goodman's Dreadnaught P.M. (6 only), 8in. cone, listed 39/6; 18/6 T. type P.M. 1934-35 model, 8in. cone; 15/6, super 6in. 1934 model, listed 27/6; new, sealed and boxed; match any output, including Class "B"; 7 days' approval against cash.—Mountgrove Supplies, 76, Mountgrove Rd., N.5. [6627

VAUXHALL.—Magnavox permanent magnets, universal, suitable for Class "B" power or pentode, 6in. cone 15/6, 7in. cone 17/6, 10in. cone 23/-; mains energised, 2,500 or 6,500, 10in. cone, 23/-; 7in. cone 15/3; brand new, with humbucking coils; state power or pentode transformer; unused manufacturers' stock; immediate delivery, carriage paid, cash with order or c.o.d.—Vauxhall Utilities, 163a, Strand, W.C.2. Temple Bar 9338. [6458

MOVING Coil Speakers for Experimenters Wanting Something Different, hear the drums and oboe without resonance, every one guaranteed brand new; carriage paid, cash with order or c.o.d.; American Rolas, 7 1/2 in. diameter, 100-150v. D.C. (2,000 ohms), 110-175v. D.C. (2,500 ohms), 200-250v. D.C. (6,500 ohms), worth £2, at 16/6 each; Senior models, 9in. diameter (same voltages as above), worth 52/-, at 24/- each; permanent magnets, 3 1/2 cobalt magnets, 7,400 lines per sq. cm., 7 1/2 in. diameter, worth 52/-, at 28/-; 9in. Senior model, worth 63/-, at 33/-; all in sealed cartons, with multi-ratio transformer, energised incorporate humbuckers.—Degallier's, 4-21, Upper Marylebone St., London, W.1. [6616

TRANSMITTING APPARATUS.

PREMIER SUPPLY STORES Offers the Following Brand New Gear: Standard cables, transmitting valves (out of limits), 4211E and 4211D, 15/- each; 4212D, £3; American 866, 20/-; T.C.C. 2 ml., 1,500v. working, 6/-; Standard cables transformers, 1,000-0-1,000v. 250 m.a., 4v. 3a. C.T., 4v. 3a. C.T., 49/6; 2,000-0-2,000v. 150 m.a., 4v. 6a., Premier Supply Stores, 20, High St., Clapham, S.W.4. 'Phone: Macaulay 2188. [6623

VALVES.

4/9.—Gecovalve U.X.245 American output valves, unopened cartons, list 15/-, cash with order, postage paid.—Kay, 167, City Road, London, E.C.1. [6491

METROPOLITAN RADIO SERVICE Co. for American Valves with a Guarantee; any type at keenest prices; trade supplied.—1021, Finchley Rd., Golders Green, N.W.11. Speedwell 3000. [6436

SURPLUS VALVES.—All brand new; battery types, 2-volt, H.F.2, L.F.2, L.P.2, 1/9; super power, P.P.2, 2/6; screens and pentodes, 3/9; A.C. mains, 4-volt 1 amp., general purpose, 3/3; power, 4/-; screens and pentodes, 4/6; full wave rectifiers, 3/6; postage paid cash with order, or c.o.d. over 10/.—Clarion Radio Valve Co., 885, Tyburn Rd., Edlington, Birmingham. [6339

PREMIER SUPPLY STORES Announce the Purchase of the Complete Stock of a World Famous Continental valve manufacturer, all the following standard main types fully guaranteed, 4/6 each: H., H.L., L. power, medium, high, low mag. and variable mu screen grids, one, three and four Watt A.C. output, directly heated pentodes, 250v. 60 m.a. full wave rectifiers, D.C. types, 20v. 18 amp., filament screen grid H. 9 H.L. power.

THE Following Types, 5/6 each: 350v. 120 m.a., full wave rectifier, 500v. 120 m.a. full wave rectifier, 2 1/2 watt indirectly heated pentode.

THE Following American Types, 4/6; 250, 112, 171, 210, 245, 226, 47, 46, 24, 35, 51, 57, 58, 55, 37, 80.

THE Following Sizes, 6/6 each: 42, 77, 78, 2525, 36, 38, 83, 39, 44, 53, 6A7, 6B7, 2A5, 2A6, 2A7, 2B7, 5Z3, 6C6, 6A4, 6J6, 6F7; the following valve: 866, 25/-.

PREMIER SUPPLY STORES, 20 and 22, High St., Clapham, S.W.4. [6622

ALL Types of Brand New American Valves in Stock, only first-class makes such as Arcturus and R.C.A. stocked, guaranteed for 6 months, 247, 235, 551, 89, 18, 19, 46, 59, 6A7, 15, 42, 41, 38, 39, 78, 75, 57, 58, 224, 44, 36, 235, 83, 43, 5Z3, 12/-; 25Z5, 12Z3, 14/6; UX171, UX199, UX280, UX245, UX226, UX227, 7/6; UX250, UX210, UX281, 17/6; UX867 photocells, 25/-; all other types of American valves in stock; we also stock transmitting valves, post paid, cash with order or c.o.d.

WARD, 45, Farringdon St., London, E.C.4: Telephone: Holborn 9703. [6517

COMPONENTS, ETC., FOR SALE.

R. RYALL'S RADIO, 44, Lamb's Conduit St., London, W.C.1. Nearest tube Holborn; trams 33, 35 pass by. Off Theobalds Rd., quickest approach from Holborn, through Red Lion St. Holborn 3529. Open Saturday afternoon till 5 o'clock, Thursdays 1 o'clock. Hours 11 to 7 p.m.

R.I. 14-28H. Chokes, second-hand, 10/6; B.T.H. R.K. Junior, corrugated cone, heavy type, 20/-; ex-G.P.O. galvo, 20 m.a., 5/-; Polar twin tub, with drive, 5/-.

HEAYBERD W.31, with H.T.8, new, 30/-; H.T.7, new, with second-hand E.L. transformer with 4v. 6 amps., 22/6; Ultra Panther console, £12/12.

VARLEY Square Peak B.P. Coils, 2/6; fine set cabinets, V room for speaker, to clear, 5/-; large Ormond magnet, only 10/-; set Ferrocort coils, G.1/2/8, new, 20/-.

(This advertisement continued on next page.)

Components, Etc., for Sale.—Contd.

(This advertisement continued from previous page.)

POLAR Minor 3-gang Condensers, with "Arcuate," or "Semi Circular" drive, new, list 24/6, 14/6; set three Radiophone coils on base with switch, B.P. Superhet 8/9, post 9d.; Radiophone Radiopacks, 2H.F., with volume control, 32/6, post 1/5.

YAGERPHONE 3v. and Rectifier Chassis Complete, in good order, with valves, 65/-; pairs Polar thumb drive, 0005 condensers with double escutcheon plate, 12/6; Ready Radio 0005 extenser condensers, new, 2/6, can be paralleled for S.W. work.

RYALL'S RADIO Offer Reliable Resistances, suitable for all sets where a 1-watt resistance is specified, in values 100, 150, 250, 400, 500, 600, 1,000, 2,000, 5,000, 10,000, 15,000, 20,000, 25,000, 30,000, 40,000, 50,000, 75,000, 100,000, 150,000, 250,000, 1/2 meg., 1 meg., 2 meg., all values stated in ohms, 4d. each; also 2-3-watt type, 400, 700, 800, 1,000, 4,000, 5,000, 6,000, 10,000, 20,000, 9d. each, wire ends.

FERRANTI Transformers, A.F.5, 18/6; A.F.7, 18/6; O.P.M.1, 10/-; O.P.M.1c, 15/6; O.P.M.16c, 15/6; O.P.M.11c, 16/6.

BRITISH Radiophone Volume Controls, with mains on/off switch, new, 5,000, 10,000, 15,000, 20,000, 35,000, 100,000, 2/6 each.

BRITISH Radiophone Radiopaks: B.P. superhet. 110 kc/s. 30/-, postage 1/3; sets Radiophone 5-coil units on base, with terminals, B.P. superhet. 110kc/s, 8/9, postage 9d.; Ferrocart coils, G1-2-8, 25/-; all with mains switch.

SPECIAL Offer of New Garrard Double Spring Motors, No. 11B, 12in. turntable, fully automatic unit plate, etc.; 20/-.

T.C.C. 0-1 Non-inductive Tubular Condensers, 10d. each, 350v.; T.C.C. electrolytic 15 mfd., 50v., 1/4, new; T.C.C. 0.01 mica, type M, 1/-; T.C.C. 0.0001, type M, 5d.; H.M.V. condenser blocks, 250v. working, 4x4x1x1x1/2 mfd., 4/-; T.C.C. 0.1x0.1, 450v. working, 1/6; T.C.C. 8 mfd., electrolytic, 500v. working, 4/-; Dubilier 2 mfd., 250v. working, 1/6.

UNIKNOBS, Polar 2-gang, new, brown, 8/-, with cover, 9/6; R. and A. type output transformers, 18-23-32-1, new, 5/-; Paxolin formers, with guides, lin., 8d.; R.I. Hypermite transformers, 6/-, second-hand; R.I. Parafed transformers, 5/-, second-hand.

RADIOPHONE Disc Drives, less escutcheon, fit 1/2in. spindle, read 0-100 from left to right; 1/6 post free.

NEW Lotus D.C. 2v. Sets, D.C. 2/H.L., with D.C. 2/Pen., sensitive and selective, original make; £4/10.

R. 24. [6596]

MILDMAY RADIO EXCHANGE.

SPECIAL Removal Notice.—As and from October the 5th all correspondence, letters and orders must be addressed to our new premises at 6, Pentonville Road, Angel, Islington, London. 2 mins. from Euston and King's Cross.

EPOCH 99K P.M. moving coil speaker, listed at £6/2/6, 50/-; Bakers 1931-2 super power P.M. moving coil speaker, 30/-; Epoch A.2. P.M. moving coil speaker; 25/-.

EPOCH 994F for D.C. Mains, 37/6; Magnavox type 152, 2,500 ohms, 27/6; ditto, ditto, 200 ohms, 17/6; R.A. 100 P.M. moving coil speaker, 18/-; B.T.H. R.K. Junior P.M. moving coil speakers; 22/6.

KOLSTER BRANDES "Pup" 2-valve A.C. Mains Receivers, complete with valves and speaker, in self-contained cabinet for mains of 200-250 volts, A.C. 37/6 each.

THE "20 Century" Radio Testers, a complete valve and set tester that will give emission reading of all types of valves, battery, A.C. or D.C., without any extra batteries being required, listed at £2/5, offered at the low price of £1 each.

FERRANTI Type E.I. A.C. Mains Supply Unit, complete with rectifying valve, listed at £10; input 200-250 volts A.C., output 200 volts 115 m/amps; £4.

FERRANTI S.V.10 Mains Transformer, input 200-250 volts A.C., 27/6; Ferranti type S.V.8-6 mains transformer, 12/6; Ferranti P.11 auto transformer, 10/-; Ferranti B.3 chokes, 4/- each, 50 m/amps.

RADIOPHONE—3 gang condensers, with screen, 0005, 9/6 each; 4 gang ditto, 10/-; Ferranti 3 gang condensers, 0.0005, 10/6; T.C.C. 4 mfd. condensers, working voltage 1,500 volts; 13/- each.

FERRANTI Transformers.—A.F.4, 7/6; A.F.3, 10/6; A.F.5, 18/-; A.F.6, 18/-; A.F.7, 18/6; A.F.7c, 20/-; A.F.5c, 20/-; O.P.1. 1-1 ratio, 7/-; O.P.2. 25-1 ratio, 7/6; O.P.3c P.P. ratio 1-1, 8/6; O.P.M.1. 10/-; O.P.M.2, 10/-; O.P.M.4, 12/-; O.P.M.12c, 7/-; O.P.M.17c, 8/6; B. chokes, 4/-.

FERRACART G.1, G.2, G.3, 20/-; Lissen superhet coils, 3 gang, 10/-; Wearite and Lewcos superhet coils, 4/- each; set Wearite Everman Four coils, 15/-; set Varley B.P. 19 coils; Colvern K.61. 62, 63 coils, 17/6.

SPECIAL Offer of Brand New Regentone A.C. Mains Units in Sealed Boxes, type W.5.A. having an output of 150 volts 20 m/a., with 4 tappings, 2 variable, also trickle charger for 2, 4, or 6 volt accumulators, listed at £4/15; our net price 38/6 each.

THE Above Post or Carriage Paid.

PHONE: Clissold 5001.

NOTE Our New Address as and from Oct. 6th, top of advert.

24, Mildmay Grove, London, N.1. [6599]

PREMIER SUPPLY STORES

ANNOUNCE a City Branch at 165 and 165a, Fleet St., E.C. (next door to Anderton's Hotel), for the convenience of callers; post orders and callers to High St., Clapham.

OFFER the Following Manufacturers' Surplus New Goods at a Fraction of the Original Cost; all goods guaranteed perfect; carriage paid over 5/-, under 5/- postage 6d. extra, I.F.S. and abroad, carriage extra. Order under 5/- cannot be sent c.o.d. Please send for illustrated catalogue post free.

STUPENDOUS Purchase of Set Manufacturers' Stock.—All electric 3-valve (S.G. det. pen.) set, in walnut cabinet, with moving coil speaker, 200-250 volt 40-60 cycles, chassis built. 200-2,000 metres, with 4 valves; £4/19/6.

A.L.ELECTRIC 3-stage Amplifiers, 200-250v., 40-60 cycles, 10 watts undistorted output, complete with 5 valves, £7/7; suitable speakers, pick-ups and microphone can be supplied.

(This advertisement continued in third column.)

Components, Etc., for Sale.—Contd.

(This advertisement continued from first column.)

TYPE 4480, 9in. diameter, permanent magnet, handles 4 watts, 7 ohms speech coil, 13/6; multi ratio transformer, 4/6 extra.

ELIMINATOR Kits, including transformer, choke, Westinghouse metal rectifier, condensers, resistances and diagram, 120v. 20 m.a., 20/-; trickle charger, 8/- extra; 150v. 30 milliamps, with 4v. 2-4 amps. C.T., L.T., 25/-; trickle charger, 6/6 extra; 250v. 60 milliamps, with 4v. 3-5 amps. C.T., L.T., 30/-; 300v. 60 m.a., with 4 volts 3-5 amps, 37/6; 200v. 50 m.a., with 4v. 3-5 amps. L.T., 27/6.

PREMIER Chokes, 40 milliamps, 25 hys., 4/-; 65 milliamps, 30 hys., 5/6; 150 milliamps, 30 hys., 10/6; 60 milliamps, 80 hys., 2.500 ohms, 5/6; 25 milliamps, 20 hys., 2/9.

ALL Premier Guaranteed Mains Transformers Have Engraved Terminal Strips, with terminal connections, input 200-250v. 40-100 cycles, all windings paper interleaved.

PREMIER H.T.7 Transformer, output 135v. 80 m.a., for voltage doubling, 8/6; 4v. 3-4a., C.T. L.T., 2/- extra; with Westinghouse rectifier, giving 200v. 30 m.a., 17/6.

PREMIER H.T.8 and 9 Transformers, 250v. 60 m.a. and 300v. 60 m.a. rectified, with 4v. 3-5a. and 4v. 1-2a., C.T. L.T. and screened primary, 10/-; with Westinghouse rectifier, 18/6.

PREMIER H.T.10 Transformer, 200v. 100 m.a., rectified with 4v. 3-5a., and 4v. 1-2a., C.T. L.T., and screened primary, 10/-; with Westinghouse rectifier, 19/6.

PREMIER Mains Transformer, output 250-0-250v. 60 m.a., 4v. 3-5a., 4v. 2-3a., 4v. 1-2a. (all C.T.), with screened primary; 10/-.

PREMIER Mains Transformers, output 350-0-350v. 90 m.a., 4v. 3-5a., 4v. 2-3a., 4v. 1-2a. (all C.T.), with screened primary; 10/-.

PREMIER Auto Transformers, 100-110/200-250v. or vice versa, 100-watt; 10/-.

WESTERN ELECTRIC Mains Transformers, 300-0-300v. 65 m.a., 4v. 1-2a., 4v. 2-3a., 6/6; 500-0-500v. 150 m.a., 4v. 3-5a., 4v. 2-3a., 4v. 1-2a., 4v. 1a. C.T., 4v. 1a. C.T., 19/6.

SPECIAL Offer of Mains Transformers, manufactured by Philips, input 100-200v or 200-250v., output 180-0-180 volts 40 m.a., 4v. 1 amp., 4v. 3 amps., 4/6; 200-0-200v., 4v. 1a., 4v. 3a., 4/6.

PREMIER L.T. Charger Kits, consisting of Premier transformer and Westinghouse rectifier, input 200-250v., A.C., output 8v. 1/2 amp., 14/6; 8v. 1 amp., 17/6; 6v. 2 amp., 27/6; 30v. 1 amp., 30/6; 2v. 1/2 amp., 11/-.

B.T.H. Truspeed Induction Type (A.C. only) Electric Gramophone Motors, 100-250v.; 30/- complete.

SPECIAL Offer B.T.H. Gramophone Motors, A.C. and D.C. 100-250v.; 30/-; listed £3/3.

COLLARO Gramo Unit, consisting of A.C. motor, 200-250v. high quality pick-up and volume control, 49/- without volume control, 46/-.

EDISON BELL Double Spring Gramophone Motors, E complete with turntable and all fittings, a really sound job; 15/-.

SPECIAL Offer of Wire Wound Resistances, 4 watts, any value up to 50,000 ohms, 1/-; 8 watts, any value up to 15,000 ohms, 1/6; 15 watts, any value up to 50,000 ohms, 2/-; 25 watts, any value up to 50,000 ohms, 2/6.

CENTRALAB Potentiometers, 400 ohms. 1/-; 50,000, 100,000, 1/2 meg., any value, 2/-; 200 ohms, wire wound, 1/-.

POLAR Star, manufacturers' model, 3-gang condensers, fully screened; 7/6, with trimmers; unscreened, 5/-.

AMERICAN Triple Gang 0.0005 Condensers, with trimmers, 4/11; Utility bakelite 2-gang 0.0005, screened, with uniknob trimmer, 3/6; Polar bakelite condensers, 0.00035, 0.0003, 0.0005, 1/-.

ORMOND Condensers, 0.0005 2-gang semi-shielded, 2/6; brass vanes with trimmers, 3/6; British Radiophone 110 kc/s intermediate, 3/-.

MAGNAVOX D.C. 152, 2,500 ohms, 17/6; D.C. 154, 2,500 ohms, 12/6; D.C. 152 magna, 2,500 ohms, 37/6, all complete with humbucking coils; please state whether power or pentode required; A.C. conversion kit for above types, 10/-; Magnavox P.M., 7in. cone, 18/6.

RELIABLE Canned Coils with Circuit, accurately matched dual range, iron cored; 3/6.

RELIABLE Intervalve Transformers, 2/-; multi-ratio output transformers, 4/6.

T.C.C. Electrolytic Condensers, 550v. working, 650v. peak, 8 mfd., 4/-; 4mf., or 8 mfd., 440v. working, 3/-; 15mf. 50v. working, 1/-; 25v. working, 25mf., 1/3; 6 mfd. 50v. and 2 mfd. 100v. working, 6d.; 8+4 mfd., 450v. working, 4/-; 50 mfd. 50v. working, 2/9; 2,000 mfd., 12v., 7/6.

T.C.C. Condensers, 250v. working, 1 mf. 1/3, 2 mf. 1/9, 4 mf. 3/-; 4 mf., 450 v. working 4/-; 4 mf., 750v. working, 6/-.

H.M.V. Condensers, 400v. working, 4+4+1+1+1+1+1+0.1+0.1+0.1, 4/9; 4+2+1+1+1+1+0.5, 3/9.

DUBILIER Condensers, 8 or 4 mfd., dry electrolytic, 450v. working; 3/-.

VARLEY Constant Square Peak Coils, band-pass type B.P.7, brand new, in maker's cartons, with instructions and diagrams; 2/4.

VARLEY H.F. Intervalve Coils, B.P.8, band-pass, complete with instructions, in original cartons; 2/6.

SCREENED H.F. Chokes, by one of the largest manufacturers in the country; 1/6.

PREMIER British-made Meters, moving iron, flush mounting, accurate, 0-10, 0-15 50 m.a., 0-100, 0-250 m.a., 0-1, 0-5 amps; all at 6/-.

WESTERN Electric Condensers, 250v. working 1 mf., 6d.; 2 mf., 1/-; 4mf., 2/-; 460v. working, 1 mf., 1/-; 2 mf., 1/6.

WIRE-WOUND Potentiometers, 1,000, 2,500, 15,000, 20,000, 50,000, 90,000, 120,000, 200,000, 500,000, 2/- each; 1,000 ohm. semi-variable, carry 150 m.a., 2/-.

COSMOCORD Pick-ups, complete with arm and volume control, a really good job; 12/-.

A LARGE Selection of Pedestal, table and radiogram, cabinets, by best manufacturers at a fraction of original cost, for callers.

THE Following Lines 6d. each, or 5/- per dozen.—Chassis valve holders, 5-, 6- or 7-pin, screened screen-grid leads, any value 1-watt wire end resistances, wire-end condensers, 0.0001 to 0.1. Bulgin 3-amp. main switches; Cydon capacitors, double trimmers.

PREMIER SUPPLY STORES.

20-22, High St., Clapham, S.W.4. 'Phone: Macaulay 2188. Nearest station: Clapham North, Underground. [6621]

COMPARISONS.

Although "our output for the next ten years was booked up" at Olympia (vide daily press) we took more orders at Manchester than at the London Show.

Perhaps the North is more critical than the South; but at both Shows we were told that the Hartley-Turner Speaker was "by far the best." One gentleman at Manchester went so far as to say that our Loud Speaker was "gradely." That, we understand, is the highest possible praise.

We can supply you with apparatus gradely throughout. Apparatus designed only for High Fidelity Reproduction.

Illustrated Literature free on request.

Hartley Turner Radio Ltd.

THORNBURY ROAD, ISLEWORTH, MIDDLESEX. Telephone: HOUnslow 1854.

HARTLEY-TURNER SPEAKERS AND AMPLIFIERS

SUPPLIED ON EASY TERMS.

We specialise in the supply of this superb equipment on convenient terms. Please write for full particulars and quotation.

All radio Apparatus supplied promptly and on the lowest terms. PRICE LIST FREE.

The LONDON RADIO SUPPLY COMPANY 11, OAT LANE, NOBLE STREET, LONDON, E.C.2. Phone: National 1977. (Est. 1925).

THE WORLD'S HANDIEST AERIAL



PIX Self Adhesive Strip Aerial gives a wonderful pick-up, clear of interference. Fixed in a jiffy without tools. Press it anywhere you want to run it—it sticks. Just the thing for a modern home.

PIX, London, S.E.1.

PIX INVISIBLE AERIAL

2/- Double length 3/6

SPEEDY SERVICE—NO SUBSTITUTES

EVERY RADIO REQUIREMENT VALVES—SPEAKERS—SETS—COMPONENTS, etc.

Order your needs to-day from the postal service specialists: all goods are brand new and guaranteed and are delivered immediately carriage paid at list prices for cash with order or C.O.D. (Pay the postman)

INTERNATIONAL RADIO BUREAU 199, DEANS GATE MANCHESTER.





FIFTH EDITION
—Revised and Enlarged

**HANDBOOK of
 TECHNICAL INSTRUCTION
 for
 WIRELESS TELEGRAPHISTS**

By H. M. Dowsett, M.I.E.E., F.Inst.P., M.Inst.R.E.
 Author of "Wireless Telegraphy and Telephony"
 "Wireless Telegraphy and Broadcasting"

THIS standard handbook provides a complete theoretical course for students wishing to qualify for the Postmaster-General's Certificate of proficiency. Additional chapters included in this new edition are those on Echo Sounding Apparatus, Short-wave Marine Transmission and Reception, Marine Telephony, and Band Repeaters — all recent developments which concern the sea-going operator. All sets in general use (Marconi, Siemens, Radio Communication) are also described. A chapter on Direction-finding includes information on laying-off bearings, specially drawn direction-finding charts and methods of calculating great-circle distances.

Demy 8vo 570 pages
 525 diagrams and illustrations

PRICE 15/- net
 By Post 15/9

Leaflet containing full particulars will be forwarded on request

Obtainable from all leading booksellers or direct from the publishers

ILIFFE & SONS LTD.
 DORSET HOUSE, STAMFORD STREET, LONDON, S.E.1

W.W.96

Mention of "The Wireless World," when writing to advertisers, will ensure prompt attention.



**THIS
 MODERN TREATISE**

ON THE USE OF WESTINGHOUSE METAL RECTIFIERS AND WESTECTORS IS A VERITABLE REFERENCE BOOK ON THE A.C. MAINS OPERATION OF RADIO RECEIVERS.

**IT'S YOURS ON
 RECEIPT OF THE
 ATTACHED COUPON
 AND 3d. IN STAMPS**

THE WESTINGHOUSE BRAKE & SAXBY SIGNAL CO. LTD.
 82, YORK ROAD, KING'S CROSS, LONDON, N.1.

Please send me, by return of post, a copy of the new 1935 edition of "THE ALL-METAL WAY," I enclose 3d. in stamps.

NAME

ADDRESS

PLEASE WRITE IN BLOCK CAPITALS.

W.W.62034.

Revitalise your set

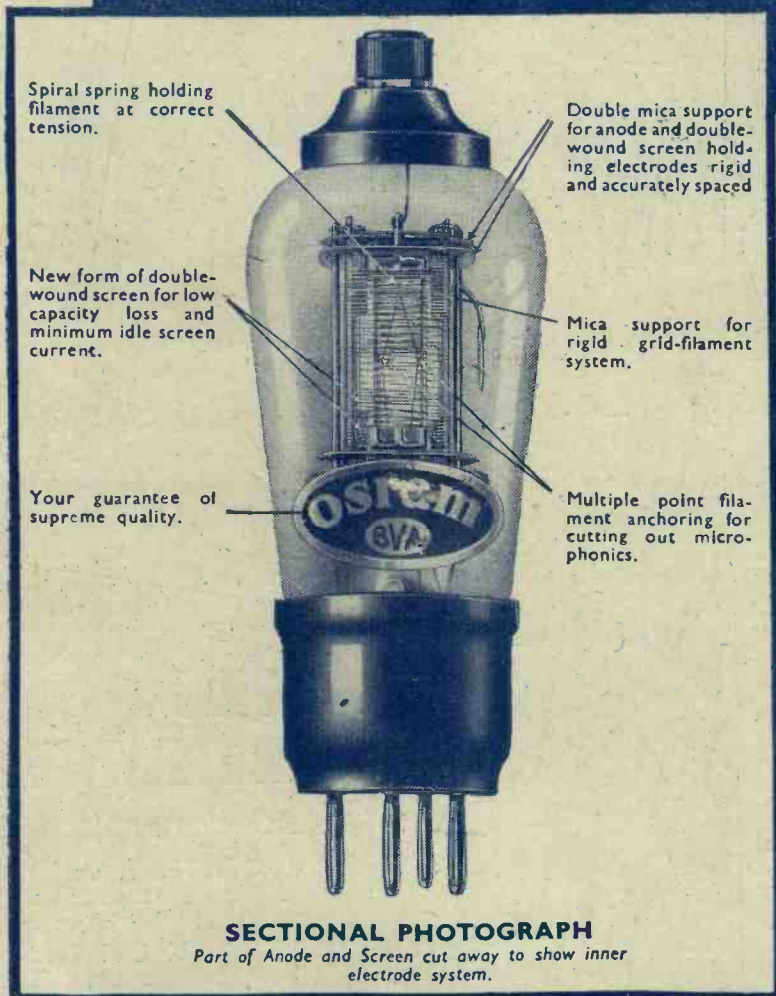

3 2-VOLT SCREEN-GRID VALVES

mean —

- 1** GREATER SENSITIVITY WITH COMPLETE STABILITY—owing to low capacity and higher impedance.
- 2** ENTIRE ABSENCE OF MICROPHONICS — due to latest multiple anchored filament.
- 3** H.T. CURRENT CONSUMPTION FROM 1.5 M.A. ONLY.

S23 A low H.T. non-microphonic screen-grid valve for kit sets and portables employing one or more screen-grid valves. Mutual conductance 1.1 ma/volt ... **Price 12/6**

S24 A high slope, non-microphonic screen-grid for all single stage H.F. sets using screened coils. Mutual conductance 1.4 ma/volt **Price 12/6**

VS24 A "variable- μ " screen-grid to give full and distortionless control of volume with only a 9 volt bias battery. Mutual conductance 1.5 to 0.01 ma/volt ... **Price 12/6**

These Valves can be supplied metallised or plain.

Osram

2 VOLT BATTERY

Valves

MADE IN ENGLAND

SOLD BY ALL RADIO DEALERS

WRITE for the OSRAM VALVE GUIDE (1934 Edition) sent post free.

The Wireless World

4^D

THE PRACTICAL RADIO JOURNAL

with

Complete Foreign Programmes

Friday, October 12th, 1934.

TELSEN D.R. TRANSFORMER

—the L.F. Transformer with a STRAIGHT LINE

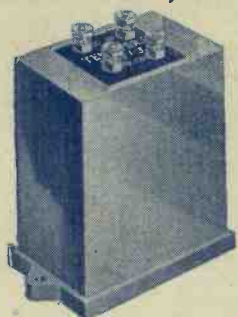

CHARACTERISTIC

which gives UNIFORM AMPLIFICATION over the entire range of audio-frequencies. The spaced layer windings are impregnated with a non-hygroscopic material of very low specific inductive capacity which absolutely eliminates all possibility of shorted turns or breakdowns due to large magnetic surges

D.R.3 (ratio 3-1) **8'6**
D.R.5 (ratio 5-1)

Announcement of the Telsen Electric Co., Ltd., Aston, Birmingham.

TELSEN FOR EVERYTHING IN RADIO

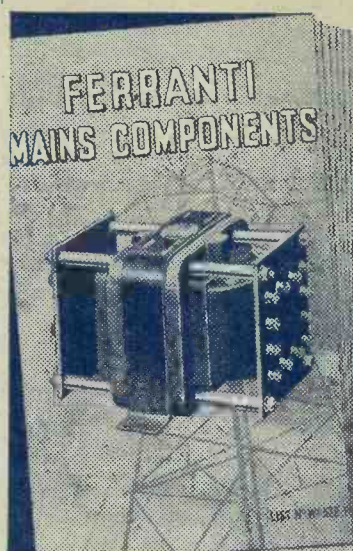

SEND FOR THE NEW FERRANTI MAINS COMPONENTS BOOKLET

Resistances, Condensers, Chokes, Mains Transformers.

1½d. post free from:

FERRANTI LTD., HOLLINWOOD LANCs.



Utmost DEPENDABILITY

There are Dubilier Condensers designed to operate in all types of radio circuits under the most severe operating conditions with the utmost reliability.

Write for a free copy of the new illustrated booklet.

DUBILIER CONDENSERS

DUBILIER CONDENSER Co. (1925) Ltd., Ducon Works, Victoria Road, N. Acton, W.3

POWER

H.T. FROM L.T.

D.C. TO A.C. —

MACHINES TO MEET EVERY NEED



WRITE FOR FREE BOOKLET to ROTAX LTD. RADIO DEPT. 1 WILLESDEN LONDON N.W.10



KB

5-valve SUPERHET

with automatic volume control

Yet it only costs 10 GUINEAS

THE KB '381' would have been a "luxury-price" receiver two years ago—if it could have been built. There's never been a specification like it for 10 guineas. Read this. Latest multiple-function valves that do the work of 8 ordinary valves—and do it better. Delayed automatic volume control to prevent fading. Band-pass tuning for perfect selectivity (see diagram). Powerful pentode and moving-coil speaker to give generous volume and full, rich tone. Operation on either A.C. or D.C. mains of 200-250 volts—no need to fear change of mains or residence. Designed for KB "Rejectostat" System to prevent electrical interference. The KB '381' will give you clean, clear reception *and go on giving it to you.* It is above all a reliable receiver. For instance, ordinary valves were not robust enough for KB, so special valves were made. Every component is anchored down. The KB 381 has roughed it all round England and has come back smiling. It is a set you can depend on. See it and hear it at the nearest KB authorised dealer.

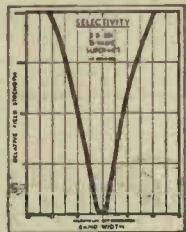

This diagram shows the high selectivity of the new KB 381 Superhet.

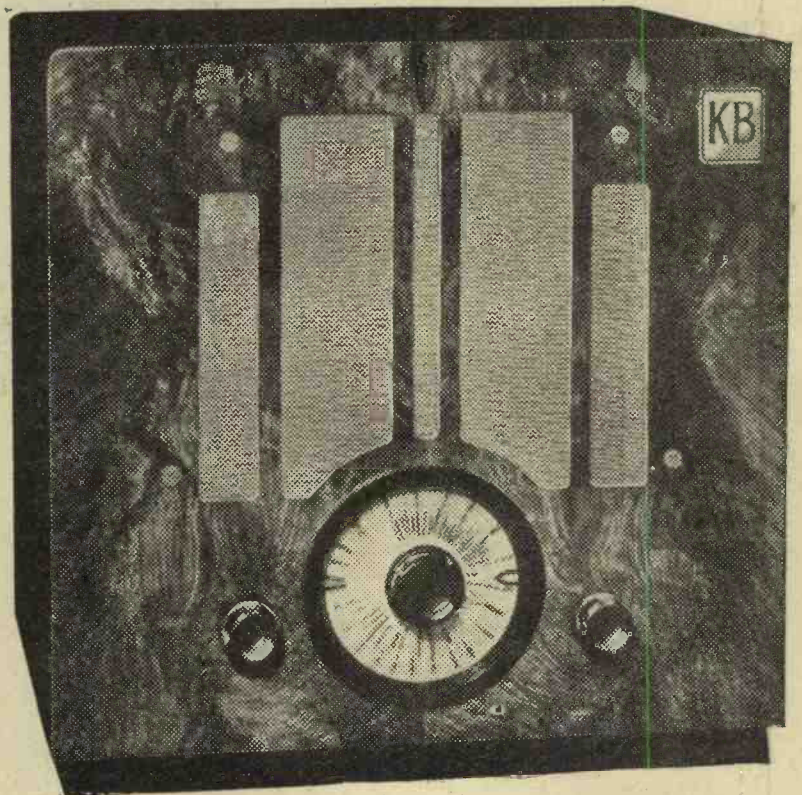

KB '381' SUPERHET for A.C. or D.C. mains

£10 10s. or 18/- a month

First payment of 28/- (including 3/- insurance) and 12 monthly payments of 18/-.

KB

'NEW PUP'

A 3-valve receiver of amazing value.

BATTERY MODEL £5 15s. or 10/- a month.

A.C. MODEL £6 17s. 6d. or 12/- a month.

KB RADIO

from £5 - 15 to 65 guineas

Send for new KB CATALOGUE

Post in unsealed envelope using ½d. stamp to—

KOLSTER-BRANDES LTD., CRAY WORKS, SIDCUP, KENT.

Please send me full particulars of the new KB receivers.

W.W.

12.10.34

Name.....Address.....

The Wireless World

THE
PRACTICAL RADIO
JOURNAL
24th Year of Publication

No. 789.

FRIDAY, OCTOBER 12TH, 1934.

VOL. XXXV. No. 15.

Proprietors: ILIFFE & SONS LTD.

Editor:
HUGH S. POCOCK.

Editorial,
Advertising and Publishing Offices:
DORSET HOUSE, STAMFORD STREET,
LONDON, S.E.1.

Telephone: Hop 3333 (50 lines).
Telegrams: "Ethaworld, Watloo, London."

COVENTRY: Hertford Street.

Telegrams: "Autocar, Coventry" Telephone:
5210 Coventry.

BIRMINGHAM:

Guildhall Buildings, Navigation Street, 2.
Telegrams: "Autopress, Birmingham." Telephone:
2971 Midland (4 lines).

MANCHESTER: 260, Deansgate, 3.

Telegrams: "Iliffe, Manchester." Telephone:
Blackfriars 4412 (4 lines).

GLASGOW: 26B, Renfield Street, C.2.

Telegrams: "Iliffe, Glasgow." Telephone: Central 4857.

PUBLISHED WEEKLY. ENTERED AS SECOND
CLASS MATTER AT NEW YORK, N.Y.

Subscription Rates:

Home, £1 1s. 8d.; Canada, £1 1s. 8d.; other
countries, £1 3s. 10d. per annum.

*As many of the circuits and apparatus described in these
pages are covered by patents, readers are advised, before
making use of them, to satisfy themselves that they would
not be infringing patents.*

CONTENTS

	Page
Editorial Comment	293
Receiver Performance Data	294
Alternatives to Home Television..	297
Triode to Double-Diode Pentode—III	299
Practical Hints and Tips	302
Broadcast Brevities	303
News of the Week	304

FOREIGN PROGRAMME

SUPPLEMENT, pp. I—XXII

H.M.V. Autoradiogram	305
Letters to the Editor	306
New Apparatus Reviewed	308

EDITORIAL COMMENT

B.B.C. Performances Importance of Microphone Technique

THE repetition by the B.B.C. this year of the idea of a public theatre performance in association with the Radio Show opens up again the question of whether such performances are really in keeping with the idea of broadcasting and a suitable policy for the B.B.C. to pursue.

We have often expressed our own views on this question. We believe that, in general, the whole technique of broadcasting should be developed on the lines that the microphone is the medium of approach to the public, and that any attempt to combine a visual performance restricted to a small number of people, as for example in a theatre, with microphone performances where the peculiar technique of broadcasting is called upon, can only result in failure both of the visual and the microphone effects.

To take a very simple example, we can agree that in an orchestral performance there is a correct positioning of the performers for ideal microphone pick-up and, if this arrangement is properly carried out, then an audience in the studio or concert-hall where the performance takes place will not be listening under suitable conditions.

Again, in staging a play, for example, the producer of a performance before the microphone has all sorts of stunts and effects at his disposal which cannot be put over to equal effect on a stage, and the producer would, in fact, often find himself hopelessly handicapped if he were expected to cater for both requirements.

It has often been stated that some artistes find themselves incapable of a good performance if they are not con-

fronted with a sympathetic audience. Our only comment in such cases would be that these artistes have so far failed to develop a proper attitude towards the microphone, and, in all probability, they fail to broadcast as well as they might, because they endeavour to entertain the visible instead of the invisible audience.

Although we find ourselves out of sympathy with a good deal which appears in Mr. Lance Sieveking's recent book, *The Stuff of Radio*, yet we do certainly concede that he is approaching his task at the B.B.C. on the right lines when he emphasises the totally different conceptions which it is necessary to have of stage or microphone production.

A Suggestion

The medium of broadcasting is quite definitely the microphone, and it is this monopoly which has been granted to the B.B.C. to exploit. If their energies are to be dissipated in other directions by attempting to give public performances at the same time, we contend that their real job is bound to suffer.

Finally, there is a means of more direct approach to the public which would be in keeping and, we believe, very beneficial at the same time. We refer to the installation of loud speakers to provide the public performances, such speakers operating from the broadcast transmissions.

We see no reason why, in the interests of educating the public to a proper appreciation of the capabilities of broadcasting, public loud-speaker performances should not be given both at the B.B.C. and in local halls and theatres. This would set up a standard of reception for the public which is to-day so badly needed. It is a scheme in which the B.B.C. and the radio industry might well agree to co-operate.

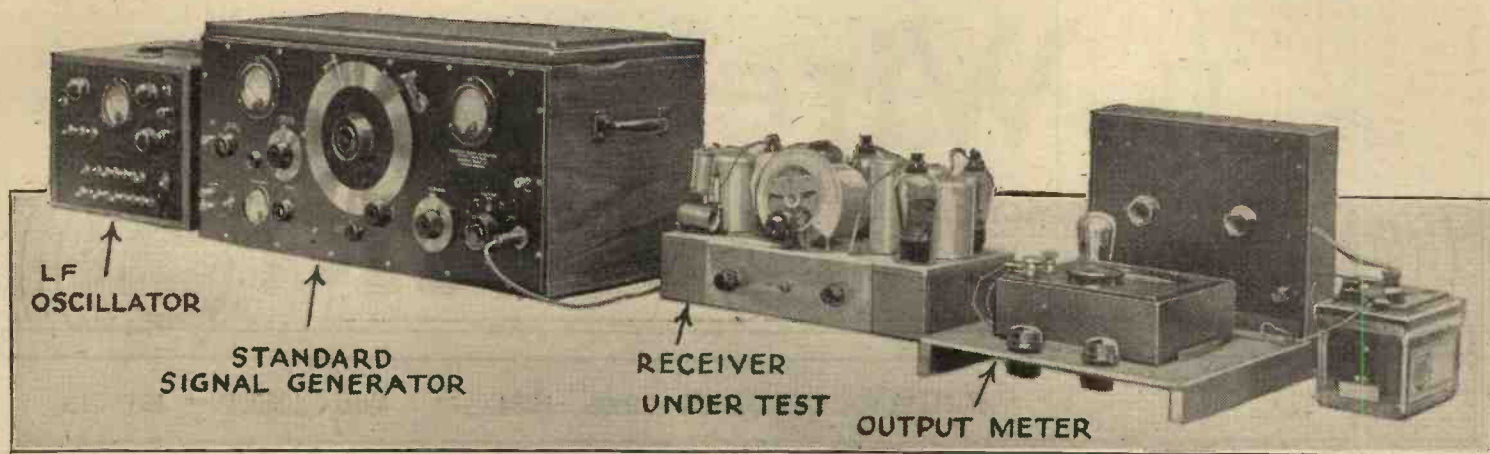

Receiver Performance Data

1. Measurement and Expression of Sensitivity

By W. T. COCKING

MANY characteristics of a receiver are now capable of being accurately measured and the performance can be expressed in figures or curves. Although the tests which can be applied are as yet hardly as extensive as in the case of certain components, they do enable an accurate comparison of different receivers to be made. In this series of articles, the methods of testing sets are described and some notes are given on the interpretation to be given to the results

THE performance of a receiver has for too long been expressed in vague terms which, if not altogether meaningless, can give no accurate information as to the relative capabilities of different sets. This state of affairs has been brought about by the difficulty of measuring the performance and the high cost of the necessary apparatus. In spite of this, the day is fast coming when it will seem as absurd to select a receiver on a vague statement as to its capabilities as it would now be to buy a valve without knowing its characteristics.

Just as when selecting a valve or component we must know certain definite attributes which can be accurately described by figures, so in the case of a receiver a choice can be made on a similar basis. It is necessary to consider, therefore, just what we wish to know about a receiver intended for the reception of broadcasting.

Set Testing

In deciding whether a particular receiver will fulfil our needs, we want to know if it will give full volume reproduction from certain stations at our point of reception and with the aerial which we have available. We want to know also if it will receive these stations without interference from their neighbours and how loud the reproduction will be.

Moreover, it is necessary to know how much distortion the apparatus introduces, and if we are interested in distant reception we require some guide as to the efficiency of AVC in overcoming fading. There are many other factors also upon which definite information may be desirable, but these are the chief ones and

suffice to give a general idea of the performance.

Now, whenever we consider the question of receiver measurements we come up against the problem of the loud speaker. It is obvious that a complete expression of the performance should include the characteristics of the loud speaker, for it has an effect not only upon the quality of reproduction but also upon the effective sensitivity. It is, however, extraordinarily difficult to devise satisfactory methods of measuring the characteristics of a loud speaker, partly because it is affected greatly by the acoustics of the room in which it is used and its position in that room, partly because the results obtained depend upon the position of the measuring apparatus relative to the speaker, and partly because a typical loud speaker possesses many resonances. For ease in measurement, and because of these factors, therefore, it is the usual practice where measurements are made at all to ignore the speaker, and to specify the characteristics of the receiver alone. At the present time there appears to be no option but to follow this course, but in the future it may happen that some reasonably simple and satisfactory way of including the loud speaker may be developed. It is the general practice, therefore, to replace the loud speaker by a resistance of

suitable value and to specify the output of a receiver by the power developed in this resistance under the conditions of test.

The Input to the Receiver

The question of the input must now be considered. Measurements cannot be carried out on the signal from a broadcasting station, for the exact value of the input cannot be relied upon to remain steady and the modulation depth is constantly varying. The test signal, therefore, is locally produced by equipment known as a Standard Signal Generator. The essential part of the generator is a radio-frequency oscillator which can readily be adjusted to any desired frequency, and which can be modulated to any desired degree at any audio frequency. The output of the oscillator is fed to a calibrated attenuator so arranged that the output of the generator can be varied at will from 1 volt RMS to 1 microvolt (0.00001 volt). As may readily be imagined, the apparatus must be very thoroughly screened if the output from the attenuator is to be the only voltage reaching the receiver under test, and, if it is not, any measurements are worthless.

The output voltage of the generator is developed across a resistance of about 10 ohms, except in the case of large outputs, and the next point to consider is how this may be introduced into the receiver so that its effect is exactly comparable with that of a true signal. An aerial can be fairly accurately represented by an inductance, a capacity, and a resistance all connected in series, so that an artificial aerial of this nature is used in set testing. The connec-

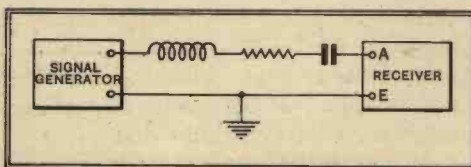

Fig. 1.—The constants of a standard artificial aerial are chosen to represent the electrical characteristics of an average aerial.

Receiver Performance Data—

tions are shown in Fig. 1 and the values assigned to the components are those which enable it most accurately to represent the average aerial. The inductance is given a value of $20 \mu\text{H.}$, the resistance is 25 ohms, and the capacity 0.0002 mfd.; actually the resistance is usually 15 ohms only, for the 10 ohms output resistance of the signal generator must be allowed for. The effective height of the average aerial represented by this network is taken as 4 metres (13ft.), so that if such an aerial be used it is possible to link figures for sensitivity with the field strength of a transmitter. If the field strength of a station be $10 \mu\text{V./metre}$, it will produce $40 \mu\text{V.}$ in an aerial with an effective height of 4 metres, so that standard output will be obtained with a receiver having a sensitivity of $40 \mu\text{V.}$

Before we can measure the sensitivity of a receiver, there are two further points to be settled—one is the volume at which measurements are to be taken, and the other is the modulation depth which is to be used in the signal. Modern broadcasting transmitters of good design rarely employ modulation depths greater than 80 per cent., and it seems obvious that for high quality reproduction the output stage of the receiver should be just fully loaded when the carrier is modulated 80 per cent. One might thus rate the sensitivity of a receiver as the input required fully to load the output stage on 80 per cent. modulation. Although the writer believes that such a rating gives a true picture of the performance of a set, it is not the standard practice. The sensitivity figure normally given represents the aerial input required to give an output of 50 milliwatts with 30 per cent. modulation, the modulation frequency being 400 cycles.

The low modulation depth is employed partly to avoid difficulties due to detector distortion in some receivers, and partly because it is more convenient in the signal generator. This need not cause us any concern, for the measurements can be made at any convenient modulation depth if the output figure be changed appropriately. Thus an output of 50 milliwatts for 30 per cent. modulation will require the same aerial input to produce it as an output of 356 milliwatts with 80 per cent. modulation.

Sensitivity

The writer believes that the most satisfactory method at the present time is to measure sensitivity in accordance with the standard practice, but to quote in addition a figure which enables the input for maximum output to be readily calculated. *The sensitivity of a receiver can thus be defined as the RMS value of carrier voltage modulated 30 per cent. at 400 cycles required in a standard artificial aerial having an inductance of $20 \mu\text{H.}$, a resistance of 25 ohms and a capacity of 200 mmfds. to produce an output of 50 milliwatts in the load impedance of the output stage when the load impedance is a resist-*

ance of the valve required for maximum undistorted output.

If the sensitivity of a set be given on this standard basis, the input necessary for full output on an 80 per cent. modulated

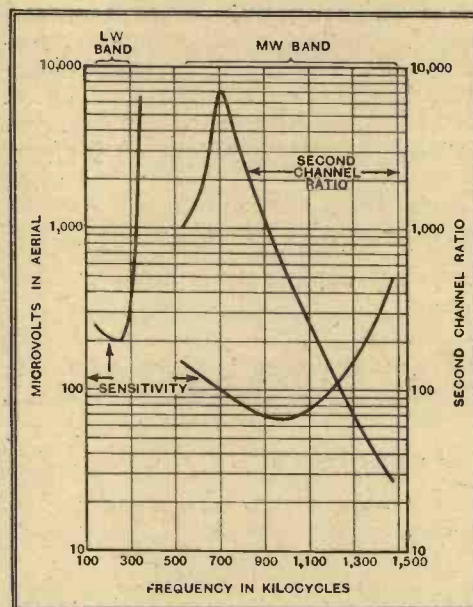

Fig. 2.—The sensitivity and second channel ratio curves of a typical small superheterodyne show wide variations over the tuning range.

carrier can readily be calculated provided that the maximum output of the set is known, the set is linear, and AVC does not operate too early. Increasing the modulation depth to 80 per cent. alone increases the output from 50 milliwatts to $(80/30)^2 \times 50 = 356$ milliwatts, so that we have only to divide the maximum power output figure by 356 and take the square root of the result in order to obtain a figure which represents the ratio of aerial inputs for standard and maximum outputs. Thus if a set has a sensitivity of $10 \mu\text{V.}$ and a maximum output of 4 watts it means that an output of 50 milliwatts will be obtained

an audible signal will be obtained from stations producing only $10 \mu\text{V.}$

It may be remarked that it is not sufficient to take a single measurement of sensitivity when testing a receiver, for the sensitivity usually varies widely through the tuning range. It is necessary, therefore, to take readings at a number of different carrier frequencies and to express the results in graphical form. A typical sensitivity curve for a modern superheterodyne of the three-valve type is shown in Fig. 2. This curve is for standard output, and it should be noted that the highest sensitivity corresponds to the lowest part of the curve. This may at first seem misleading, and it is important to remember that the higher the sensitivity of a receiver the lower is the figure for aerial input. The exact tuning range may also be derived from the curve in the obvious manner.

Second Channel Ratio

Since it may conveniently be plotted on the same sheet, this is a suitable point at which to introduce another attribute of a receiver which is susceptible to accurate measurement—second channel interference. The testing procedure is to set the signal generator to the frequency at which a measurement is required and tune the receiver to it. The input is then adjusted to produce standard output and a note is made of the figure. The generator is then tuned to a frequency higher by twice the intermediate frequency and the input increased until standard output is obtained again. The ratio of the two inputs is called the second channel ratio, and the higher the figure obtained the less likely is the set to suffer from second channel interference. The results obtained at a number of different points for a typical receiver are plotted in Fig. 2 against the right-hand scale.

At this point the question may well be raised as to the interpretation to be placed

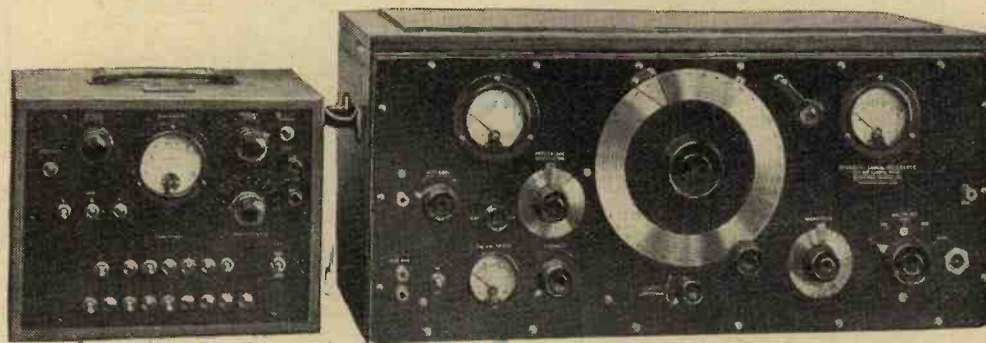

The Standard Signal Generator (right) is provided with internal modulation at 400 cycles only, so that when measurements must be made with other modulation frequencies an LF oscillator (left) is needed.

with an aerial input of $10 \mu\text{V.}$ modulated 30 per cent. In order to obtain the full 4 watts output from an 80 per cent. modulated signal, the input must be increased to $10 \times \sqrt{4000/356} = 10 \times 3.35 = 33.5 \mu\text{V.}$ Full volume reproduction can thus only be obtained with this set from stations producing $33.5 \mu\text{V.}$ or more in the aerial, but

on the curves. It is obviously easy to compare two receivers when curves for both are available, but without considerable experience it is admittedly somewhat difficult to decide from the curves whether a set will give the desired performance. It may be remarked, therefore, that in Central London the London Regional trans-

Receiver Performance Data—

mitter sets up about 0.2 volt (200,000 μ V.) in a typical outdoor aerial. Under the same conditions the voltage produced by many of the stronger distant stations in daylight is about 250 μ V. When used on this aerial, therefore, any receiver having a full output sensitivity of 250 μ V. will enable full volume to be obtained from these stations. If a better aerial be used, of course, a less sensitive set is needed, while a poorer aerial would demand more sensitive equipment.

The second channel interference ratio required depends upon how close to a local station the receiver is to be used. If second channel interference is to be completely avoided in the service area of a broadcasting station the ratio should be at least 10,000-1. In general, however, a figure varying from 1,000-1 to 5,000-1 may be considered fairly satisfactory, although several distant stations will suffer serious interference.

Now it will be observed that the sensitivity curve of Fig. 2 is by no means flat,

and that the receiver is much more sensitive at some parts of the tuning range than at others. At 1,000 kc/s, for instance, an input of only 66 μ V. is needed for standard output, whereas at 520 kc/s and 1,480 kc/s, the limits of the tuning range, the input must be 150 μ V. and 510 μ V. respectively. On the long waveband, the sensitivity of this particular receiver is somewhat less and does not exceed 200 μ V. at any point, while there is a great falling off at 350 kc/s, for at this frequency the input must be 6,500 μ V. This is a fairly general characteristic, but receivers differ widely in the manner of the variation in sensitivity. The second channel interference ratio also varies considerably and, in general, it falls off at the higher frequencies (lower wavelengths). The particular curve of Fig. 2, however, shows a very high ratio for frequencies around 700 kc/s, and this is due to the fact that the receiver employed a special second channel interference suppression circuit which was only fully effective over a limited range of frequencies.

In Next Week's Issue:—**The Standard AC Three**

A Straight Mains Set Using Iron-cored Coils

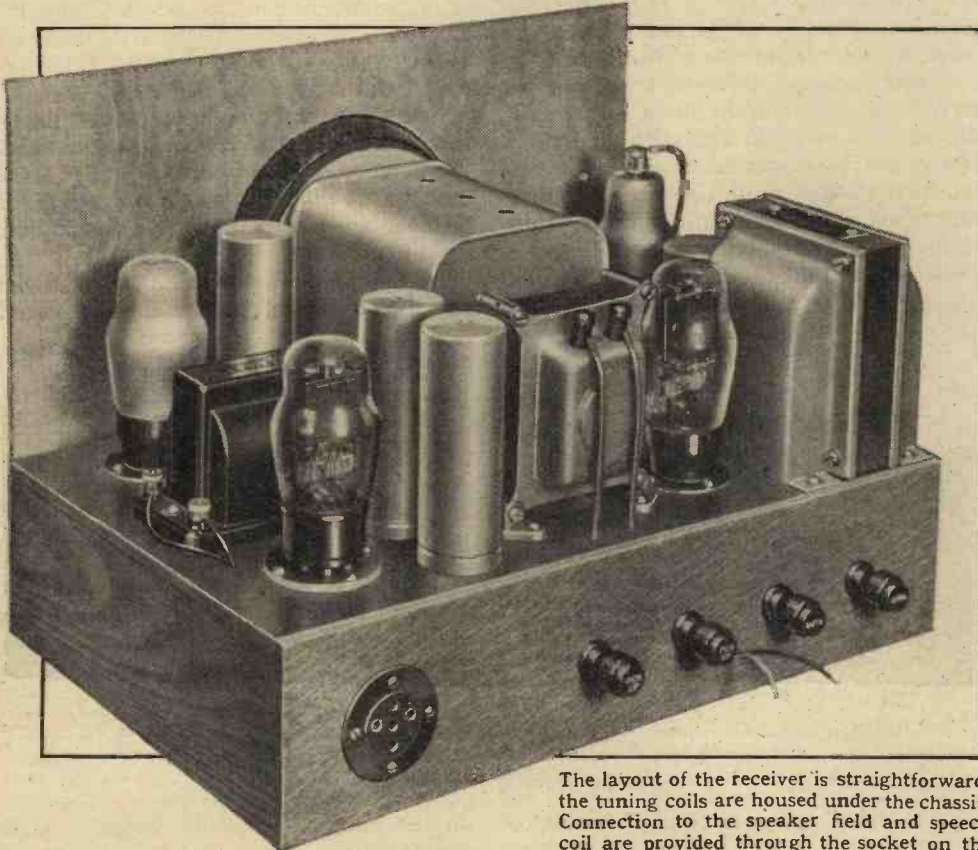

The layout of the receiver is straightforward, the tuning coils are housed under the chassis. Connection to the speaker field and speech coil are provided through the socket on the rear of the set.

THE three-valve straight set embodying an HF stage is still deservedly popular, for the use of iron-cored coils enables surprisingly high selectivity to be obtained with only three tuned cir-

cuits. Ganged tuning is used in the Standard AC Three, and reaction is applied to the inter-valve coupling in order to obtain maximum sensitivity and selectivity. The grid detector is coupled to the

output pentode by a resistance-capacity-fed LF transformer, and the field winding of the moving-coil loud speaker is energised from the mains equipment. A high degree of smoothing is incorporated in order to ensure hum-free reception.

The quality of reproduction reaches a very satisfying standard, and both sensitivity and selectivity are adequate for general Continental reception. Provision is made for the use of a gramophone pick-up.

LIST OF PARTS

- 1 Three-gang condenser Polar "Minor"
(British Radiophone, J.B., Utility.)
- 1 Slow-motion dial Polar Semi-circular Drive
- 2 Bulbs Bulgin 610
- 1 Mains transformer, primary, 200 to 250 volts, 50 cycles; secondaries, 350-0-350 volts, 60 mA.; 4 volts, 2.5 amps., centre-tapped; 4 volts, 4 amps., centre-tapped Bryce
(Davenset, Partridge, Rich and Bundy, Sound Sales, Vortexion, Wearite)
- 1 LF choke Wearite H.T.12
(Bulgin, Davenset, Partridge, Rich and Bundy, Sound Sales, Vortexion)
- 1 LF transformer, ratio 1:3½ Feranti A.F.8
(Graham Farish, Varley)
- 1 Reaction condenser, 0.0003 mfd. Ormond R.508
- 1 Knob for above Ormond R.355
- 1 Wire-wound potentiometer, 10,000 ohms. Watmel T.6
(Bulgin, Haynes Radio, Wearite)
- 1 Set of Ferrocart coils with mains switch Colvern Types 1, 2, and 3
- 2 HF chokes Bulgin H.F.9
(Kinva, Wearite)
- 4 Valve-holders, 5-pin Clix Chassis Mounting Standard Type
- 1 Valve-holder, 7-pin Clix Chassis Mounting Type
(Goltone)
- 1 Fixed condenser, 0.0001 mfd. Dubilier 665
- 1 Fixed condenser, 0.0002 mfd. Dubilier 665
- 1 Fixed condenser, 0.0005 mfd. Dubilier 665
- 1 Fixed condenser, 0.001 mfd. Dubilier 670
- 1 Fixed condenser, 0.006 mfd. Dubilier 670
- 3 Tubular condensers, 0.1 mfd. Dubilier 4503
- 1 Non-inductive condenser, 1 mfd. Dubilier 9200
- 2 Electrolytic condensers, 50 mfd. 12 volts Dubilier 3001
- 1 Electrolytic condenser, 4 mfd. Polar-N.S.F.
- 3 Electrolytic condensers, 8 mfd. Polar-N.S.F.
(Graham Farish, T.C.C., T.M.C.-Hydra, Telsen)
- 1 5-pin plug Goltone R.19-146
(British Radio Gramophone Co., Bulgin)
- 4 Ebonite shrouded terminals, A.E., pick-up (2) Belling-Lee "B"
- 1 Resistance, 300 ohms, 1 watt Graham Farish "Ohmite"
- 1 Resistance, 600 ohms, 1 watt Graham Farish "Ohmite"
- 1 Resistance, 1,000 ohms, 1 watt Graham Farish "Ohmite"
- 2 Resistances, 5,000 ohms, 1 watt Graham Farish "Ohmite"
- 2 Resistances, 10,000 ohms, 1 watt Graham Farish "Ohmite"
- 1 Resistance, 20,000 ohms, 1 watt Graham Farish "Ohmite"
- 1 Resistance, 25,000 ohms, 1 watt Graham Farish "Ohmite"
- 1 Resistance, 1 megohm, 1 watt Graham Farish "Ohmite"
(Bryce, Dubilier, Erie, Ferranti, Claude Lyons, Polar-N.S.F., Watmel)
- 1 Length screened sleeving Harbros
- 2 ozs. No. 22 tinned copper wire, 6 lengths Systoflex, wood, etc.
- Wood panel, 14in. by 10in. Peto-Scott
- Plymax baseboard, 14in. by 9in. by ½in. Peto-Scott
- Screen Peto-Scott
- Screws: 20 ½in. No. 4 R/hd.; 3 ½in. No. 4 R/hd.; 8 ½in. No. 6 R/hd.; 5 ½in. No. 4BA with nuts and washers; 7 ½in. No. 6BA with nuts and washers.
- Valves: 1 Hivac ACVS; 1 Hivac ACHL; 1 Hivac ACY; 1 Hivac UU120/350.
- Loud speaker, with pentode transformer, 2,500-ohms field, and hum-bucking coil Magnavox Magna 152

BLUE PRINTS

For the convenience of constructors full sized blue prints are available of the following popular *Wireless World* sets that have been fully described for home construction, price 1s. 6d., post free.

The Standard Battery Two. (Sept. 28th, 1934.)

1935 AC Short-wave Receiver. (Aug. 31st and Sept. 7th, 1934.)

Olympic 8-S Six. An AC Superhet. (Aug. 10th, 17th and 24th, 1934.)

Universal Single-Span Superhet. For AC or DC mains. (July 6th and 13th, 1934.)

These can be obtained from the Publishers, Hiffe & Sons Ltd. Dorset House, Stamford Street, London, S.E.1.

Alternatives to Home Television

The Programme Value of Still Pictures

BBROADCAST transmission of still pictures is not new. The B.B.C. some years ago conducted transmissions of this nature for a while, but, as the author of this article points out, the arrangements then, both as regards the receiving apparatus and the nature of the broadcasts, were unsatisfactory. The subject is one which merits reconsideration.

AT the time of writing there is no definite indication as to when the Postmaster-General's Television Committee is likely to report. Even less is there any indication as to the probable nature of its report. Generally speaking, it is known that the Committee has reviewed and inspected various systems and has been more or less in suspense during the holiday season. Presumably, resumption of its deliberations in the early autumn may mean a report in the later autumn or early winter.

A recent article¹ in *The Wireless World* discussed the economics of television, and, fortunately or unfortunately, there is no doubt that the Committee's report must necessarily be coloured by considerations both of economics and of organisation. Obviously, the Committee cannot make a purely technical discussion and report without some suggestions, or, at least, implications as to how the technical recommendations can be carried out. Still less can it make technical recommendations which simply cannot be carried out.

Pending the appearance of the report (and, possibly, also, a good deal of earnest consideration of it) it is rather difficult to predict the extent to which it will bring broadcast domestic television within closely measurable distance.

Meantime, therefore, there is no harm in considering some of the palliatives which have appeared offering partial solutions of the difficulties of television.

Retarded Television

One, hailing apparently from France, is for "retarded television." The exponent of this system points out that the great difficulty is that of the frequency band necessary for instantaneous reproduction, and that this frequency band is narrowed down in proportion to the rate at which we slow down the transmission. All perfectly true! Thus, he proposes that the scene should be cinema-photographed, and that this film should be transmitted at a *much slower rate*, so that the frequency band necessary should fall within the limits of available practical channels and conveniently operated apparatus. This is then to be "stored" again in celluloid by means of more or less "frame-by-frame" photography, and

reproduced on the screen at the normal projection rate.

The arrangement is particularly envisaged in connection with the (relatively) rapid transmission of events for theatre reproduction. For example, a 4/3 ratio picture scanned in 120 lines and presented at 25 frames per second would necessitate sidebands of nearly a quarter of a megacycle. Electrical transmission at the rate of one frame per second—that is, slowing down by 25 times—would demand sidebands of about 10 kilocycles, and each frame would be of the picture-quality of 120-line television. Further slowing down would give correspondingly better picture-quality within the same frequency limits, or, alternatively, would give the same picture-quality with a correspondingly narrower frequency band.

The arrangement has obviously no domestic implications or applications. On purely technical grounds it appears a possible method of transmitting and disseminating pictures of news events. But

television or animated-picture transmission and reproduction is one revived recently from America. This is the use of facsimile transmission for the reproduction of "still" pictures, combined—it must be implied—with a more inspired use of the system as regards programme subjects than was displayed, for example, in the B.B.C.'s efforts of a few years ago, using the "Fultograph" apparatus. The prime argument is that this, too, is in the nature of a slowed-down television system, with, indeed, a very great reduction of speed. Apart from speed, the essential principles of scanning and transmission are not so dissimilar.

The suggestion gains considerable point from a new facsimile system which has recently been demonstrated in America, designed for home use and working on a continuous paper strip three inches wide, *with ink*, thus avoiding the objection to the earlier arrangement utilised by the B.B.C., where a chemical process was employed.

Requirements for Facsimile

The idea of broadcast facsimile reproduction is really less retrogressive than at first appears. The designer of the new American set draws up several requirements for a home facsimile reproducer:—



Radio News photo.

A new American receiver for home reproduction of pictures. It prints directly in ink on a continuous paper strip three inches wide and can be operated from the output of an ordinary broadcast receiver.

whether cinema patrons have such a burning desire for "hot" news of a pictorial quality definitely lower than that to which they are accustomed is a matter (fortunately) for others than ourselves to decide or even to consider.

An interesting alternative suggestion to

(1) Sufficiently simple to be not too expensive in production.

(2) Capable of inexpert operation for considerable periods of time without much attention.

(3) The record should be on plain paper so as to avoid the delay, trouble and ex-

¹ *Financial Aspects of Television*, Aug. 3rd, 1934.

Alternatives to Home Television—

pense of chemical or photographic processing.

(4) Operation should be continuously and fully visible.

(5) The recorder should use continuous paper-feed so that it does not need to be reloaded at each picture.

(6) The record should be in ink giving permanent copy, quick-drying and non-smudging.

(7) The speed of operation should be relatively high so that each picture is reproduced fairly quickly.

Shortcomings of Previous Transmissions

The idea of facsimile transmission not being really retrogressive will perhaps appeal to those who recall the B.B.C. transmissions of a few years ago. Without desiring to raise any discussion as to the convenience or simplicity of the home-receiving system then available, it is not unreasonable to express the opinion that the transmissions provided by the B.B.C. were singularly uninspired and not calculated to instil much enthusiasm in the heart of the recipient. The material transmitted was practically entirely in the nature of "newspaper illustrations," or of things which one had already got in the morning paper. If not, it was *never* in the nature of anything that one pined to get before the evening paper. It had no connection whatever with the programme, and had no unique "broadcast" value in that it never represented anything that could not be got (most probably better) by other means. In this last connection it is interesting to speculate what might have been the history of broadcast facsimile if a Tom Webster had given exclusive sports pictures, or if a Strube or Hazeltine had been hired to give exclusive and topical cartoons, or, indeed, anything that was really *exclusive to wireless* and not otherwise available.

In considering the above postulates for a home-picture reproducer, also, several of the points enumerated are of the greatest importance in the possibility of bringing a still-picture reproduction to the level of real "home use." Most important, perhaps, is the possibility of direct ink writing with no chemical preparation or processing. This is one of the points that might reasonably change the system from the level of a toy in the spare attic to that of a definite accessory to broadcast reception in the drawing-room. Whether this is to be regarded as progressive or retrogressive, it is certain that it is just the sort of thing that decides whether or not there is to be a sufficient market for it. After all, the whole of the modern radio industry only followed on the initiation of broadcasting, and on the realisation—slow but now nearly complete—that a radio receiver *could* be made an elegant and comely thing that need not be out of keeping with the furnishing of a room. Another point of considerable importance is that of constant paper-feed, so that, besides lack of pre-

paration and attention, the system need not be restricted to the transmission of a single picture x by y inches, but be capable of a continuous reel or strip operation.

The new American system is stated to incorporate the various points enumerated, although it is understood that the system



A direct reproduction from an untouched picture received in this country from the Berlin long-wave station during a picture broadcast in March, 1929.

is not yet perfected to such a degree as to be ready to place on the market. The transmitter can be used for the scanning of a still picture or a continuous strip or for a transparency such as a photographic film.

The American inventors appear to envisage the system as being—in American broadcast practice—particularly useful for the transmission of "comic strips" (so dear to the American newspaper reader), news flashes, and possibly also for publicity matter. The last is mercifully excluded from British practice, and whether the other two are likely to be popular features or not is also very questionable. The comic-strip usage could only hope to be acceptable if it presented "something different."

Illustrate the Sound Programmes

But another application which appears never to have been considered really seriously is that of correlation with the actual sound programme. Whatever the immediate future of television, it seems beyond doubt that it will remain for some time both technically and economically impossible to "fill a room" with television as we can now do so easily with sound. Until this is more nearly attainable on a domestic scale—for that is what counts—it is not beyond possibility that still-pictures, illustrative of the programme, might have considerable value. This is already conceded by the mere fact that *The Radio Times* is illustrated by photographs of the artists, and, frequently, scenes from plays, and so on. The value of illustration in books must be conceded by the mere fact of their existence. Works of fiction gain in value to many readers by the presence of illustrations, even although these are the mere crystallising of another's imagination. The imperturbability of the immortal

Jeaves has been admirably conveyed by pictures, which just correctly supplement Mr. Wodehouse's graphic verbal description.

Admittedly the pictorial illustration of broadcast programmes by means of still pictures would call for some new programme technique. But so, too, will television, while we are all aware that the mere broadcast of sound has itself called for a new programme technique differing from that of the stage or platform, although learning from it.

At the moment it would be unwise and premature to go farther, but the existence of *simple* home reproduction of pictures presents possibilities which are too great to be dismissed as ridiculous.

CLUB NEWS**A Tenth Birthday**

The celebration of its tenth birthday has given the Croydon Radio Society a good send-off for the coming season. On Tuesday Captain P. P. Eckersley, M.I.E.E., gave a lecture with the title "From Writtle to 1934."

The Society's programme is highly attractive and it should induce many enthusiasts in the district to join. There will be loud speaker and gramophone pick-up nights, lectures by experts, and several musical evenings with records, under the direction of Mr. H. G. Salter, the Society's "Christopher Stone." Full particulars of membership can be obtained from the Hon. Secretary, Mr. E. L. Cumbers, 14, Campden Road, South Croydon.

A New Theory

"The Refraction of Wireless Signals by the Detector"—a new theory, with demonstration—is the subject of a lecture to be given by Mr. D'Arcy Ford at a meeting on Monday next of the Exeter and District Wireless Society. The syllabus for the coming session contains numerous attractive fixtures which include a demonstration of quality reception by the Marconiphone Co., a lecture on Television by the Edison Swan Electric Co., Ltd., and an account of recent short-wave experiments by Mr. H. A. Bartlett (G5QA).

The Society has opened a small library of technical books and magazines for the benefit of members. Full particulars of membership can be obtained from the Hon. Sec., Mr. W. J. Ching, 9, Sivell Place, Heavitree, Exeter.

The Witching Hour

A midnight D.F. test was held by Slade Radio (Birmingham) on Saturday, September 29th, when a dozen competitors, including parties from Rugby and district, set out at 12.5 a.m. in pursuit of a hidden transmitter. This was operated by Mr. C. H. Young (G2AK), who was hidden in a lane near Hopwas. The five successful competitors were Messrs. G. T. Peck, E. A. Kingscote, J. McLay, W. E. Chilvers, and J. J. Grant. The Harcourt Challenge Cup and a Novice Trophy Cup were presented to the winners when the party met for breakfast at a nearby hostelry.

On Thursday next, October 18th, the General Electric Co., Ltd., will demonstrate commercial applications of the photo-electric cell. The address of the Hon. Sec. is 110, Hillaries Road, Gravelly Hill, Birmingham.

From TRIODE to DOUBLE-DIODE-PENTODE

Part III. Pentodes, Screened and Unscreened

By A. L. M. SOWERBY, M.Sc.

THE third of a series of articles in which the purpose of each electrode in the modern valve is discussed. This instalment gives just that essential information about the pentode which enables that somewhat tricky but highly popular valve to be used to best advantage.

(Continued from page 269, September 28th issue)

AT the end of the preceding article of this series it was pointed out that the screened pentode, as used for high-frequency and intermediate-frequency amplification, may be regarded as a simple screened tetrode from which the evil effects of secondary emission have been removed by the introduction of the suppressor grid between screen and anode. As a consequence, the irregularities of the anode-volts/anode-current curves that are typical of the tetrode do not occur in the pentode curves reproduced in Fig. 13.

From these curves, which were taken with the screen held at 100 volts positive, it will be seen that there is no sharp change in the behaviour of the valve when the voltage on the anode drops to that on the screen. On the contrary, the nearly horizontal part of the characteristic, which in the closely corresponding tetrode is the only portion useful for ordinary purposes, extends to the left

do all that the screen-grid valve will do, and, in addition, will cope without difficulty with tasks that are beyond the capacity of the ordinary tetrode. But substitution of a screened pentode for a screen-grid valve, in a set where the latter is working well within its capacity, will make no appreciable difference to results.

If it is permissible for the anode voltage to fall to that of the screen, it should be equally permissible for the screen-voltage to be raised to equal that of the anode. Although screened pentodes, being intended as replacements for screen-grid valves, are designed for a fairly low screen voltage, a second class of pentodes, the output pentodes, are not.

These valves are intended to handle without distortion the power needed for operating a loud speaker. The limitation of anode-voltage swing typical of the tetrode clearly rules out this type of valve, but the pentode can fulfil the task admirably.

ticular valve must not be allowed to exceed 8 watts, the pairs of values of anode voltage and current giving this dissipation have been plotted, as a guide to safe operation, on the diagram. The bias-point must, therefore, always be chosen so as to keep the working conditions on the left of the curve marked "Max. Anode Dissipation."

From these curves the performance of the valve as an output valve can be determined. The first point to consider is the load into which the valve is to work; that is, the value of the impedance to be connected in its anode circuit.

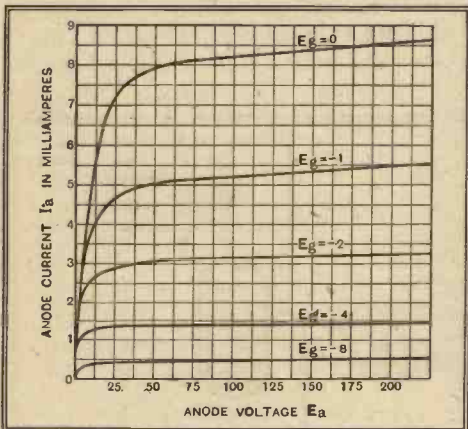

Fig. 13.—Characteristics of a variable-mu screened pentode.

cover the anode voltages as low as 50 volts or below. Thus the alternating voltage on the anode due to the signal may swing the anode momentarily to potentials below that at which the screen is held without causing overload or distortion.

In brief, one may sum up the screened pentode as simply an improved version of the ordinary screen-grid valve; it will

The Output Pentode

An output pentode differs from a screened pentode in two major respects. To provide adequate power for the speaker it is necessary that the valve should take a fairly large standing current; this is looked after by designing the valve to operate with its screen at the same voltage as its anode. The other difference is bound up with the fact that electrostatic screening between anode and grid is not nearly so necessary in low-frequency amplifiers as in those designed for operation at high-frequency. In an output pentode, in consequence, all connections to the various electrodes are taken out through the base of the valve, and the terminal on the top of the bulb, necessary in the screened valve to ensure isolation between anode and grid circuits, is discarded.

Fig. 14 gives the anode-volts/anode-current characteristics of an output pentode. These curves were taken with the screen held at 200 volts, and show the characteristic shape of all pentode curves. Since, for reasons of valve-life, the mean power dissipated at the anode of this par-

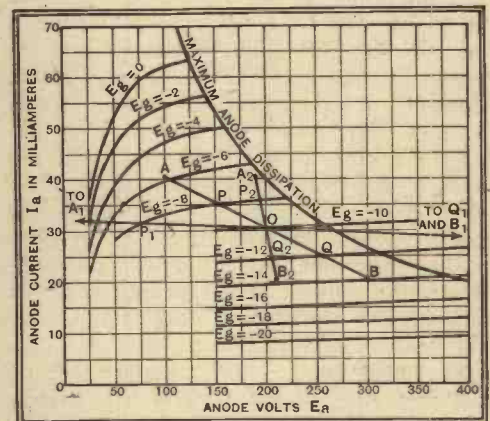

Fig. 14.—Curves of a typical output pentode (Cossor 41MP/Pen). Screen voltage is maintained constant at 200 volts.

Suppose it is intended to work the valve at $E_a = 200$, $E_s = 200$, $E_g = -10$, corresponding to the point O on Fig. 14. The load will be a loud speaker which has a low resistance (for simplicity, we will assume zero resistance) to the steady direct current, but a high impedance to alternating (signal) currents. This high impedance can be considered, for theoretical purposes at any rate, as a pure resistance if we make the assumption that the signal voltage developed across it drives through it a signal current which is entirely consumed either in driving air backwards and forwards by moving the cone or in frictional and other losses resulting, eventually, as heat. This assumption, though perhaps not completely justifiable, is made in nearly all cases in examining

From Triode to Double-Diode-Pentode
the behaviour of an output valve.

Since the load is assumed to have no D.C. resistance, the voltage actually on the anode of the valve will be that of the anode-current supply source—namely, 200 volts. If a signal sufficiently strong to swing the anode current by 10 milliamps. is applied to the grid, the anode voltage will swing to an extent depending on the signal-frequency impedance of the load. If this is 10,000 ohms the

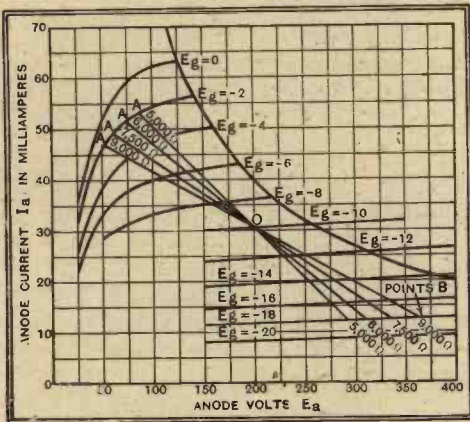

Fig. 15.—Load lines of output pentode; the 7,500-ohm line corresponds to zero second-harmonic distortion, and is therefore at least approximately the best to use.

anode voltage will swing by 100 volts, which means that in response to the signal the anode voltage and anode current will swing over the range of values given by the line AB. These two points are fixed by the fact that at A the anode current is 10 mA. greater, and the anode voltage 100 volts less, than at O, while at B the current is 10 mA. less, and the voltage 100 volts higher than at O. The line AOB, in fact, is the load-line, corresponding to that discussed in Part I, in connection with a triode. The sole difference between that load-line and this lies in the assumption now made that the load has a resistance towards A.C. and none towards D.C., whereas in considering the resistance-coupled triode stage the load was a true resistance, equally effective towards both steady currents and those due to the signal.

As before, the amplification obtained from the stage may be seen by noticing the points where the load-line cuts the successive curves corresponding to various values of bias. A signal swinging the grid from -8v. to -12v. will cause the anode to swing between points P and Q, representing a voltage change at the anode of 255-155=100 volts. The amplification of the stage will thus be 100/4=25 times. Just as with the resistance-coupled triode or tetrode, the amplification will depend on the value of the load, rising as this is made higher. Comparison of the load-line discussed with those for 1,000 and 100,000 ohms. (A2B2 and A1B1 in Fig. 14) shows this quite clearly. For the low load the gain is only 2.75 times, while for the higher it rises (with much distortion) to some unspecified value in excess of 60 times.

In this case, however, it is not enough only to develop a high voltage across the speaker, for this requires power to operate it. This power depends on the product of alternating voltage across the speaker with the alternating current driven through it by this voltage, and it will be seen at once by comparison of the three load-lines that although a higher load develops a higher voltage, the current through the speaker is less. With a very high load (line approaching the horizontal) the current through the load would be trifling even though the anode voltage were to swing right down to zero; the power, therefore, could only be small. Similarly if the load were very low (line approaching the vertical) the voltage developed across the load could never be large, even though the current were to swing right down to zero; once again, the power could only be small. It will be evident, therefore, that it is necessary to choose the correct load for the pentode with some care, making the best possible compromise between the conflicting requirements of high current and high voltage in such a way that their product, representing the power, is at its maximum.

How this is done is shown in Fig. 15 where, for the same steady-current conditions as those taken in discussing Fig. 14, four load-lines are drawn. These represent, in order from steep to flat, loads of 5,000, 6,000, 7,500, and 9,000 ohms. In considering the available output from the valve, it will not be safe to assume that the grid can be swung to zero, because the valve considered belongs to the class of indirectly heated pentodes, in all of which grid-current, with its attendant damping of the input coupling (resistance or transformer), begins to flow while the grid is still negative. With this in mind, we will limit the grid-swing, in the positive direction, to -2 volts; this value is chosen for our discussion chiefly because there is a curve for it. With an initial bias of -10 volts, a swing to -2 volts on the one side will carry the grid to -18 volts on the other. It remains to see what load gives the maximum output together with unnoticeably low distortion when the grid is given this peak signal of 8 volts.

Harmonic Distortion

In pentodes, it is found that a type of distortion equivalent to the introduction of the third harmonic of the signal sets the limit to the available power. Further, it usually so happens that for a signal and a load with which the amount of second harmonic distortion introduced is exactly zero, the third harmonic has just about reached its maximum permissible limit. The condition for zero second harmonic is that the distance between the working point O and the point where the load-line cuts the curve representing the maximum positive grid-voltage reached (A) should be exactly equal to the distance between O and that where the line cuts the curve represent-

ing the maximum excursion of the grid in a negative direction (B). For the lines on Fig. 15 representing loads of 5,000 and 6,000 ohms OA is longer than OB, while for the 9,000-ohm line OA is shorter than OB. The two halves of the 7,500-ohm line are, however, almost identical in length. From this we conclude that it is only with this exact load that the full grid-swing from -2v. to -18v. can be applied to the valve without causing audible distortion.

Taking this load, 7,500 ohms, as correct, we see that the grid-swing of +8v. swings the current between the limits 49 and 12 milliamps., while the voltage across the load swings from 340 to 60 volts. The peak signal current is thus 37/2 or 18½ milliamps., and the peak signal voltage 280/2 or 140 volts. Corresponding R.M.S. values are found by dividing each of these by $\sqrt{2}$, and the product of the resulting figures, $(140 \times 18\frac{1}{2})/2 = 1,300$, is the power in milliwatts that can be delivered by the valve under these conditions.

Maximum Power Output

To find the absolute best conditions of operation, including load, bias, and standing current, to ensure that the last possible milliwatt of power is extracted from the valve, it would be necessary to repeat the analysis already made for other bias values at the anode voltage intended to be used, and to make a more detailed examination of the curves with a view to determining the exact percentage of the third harmonic introduced. The exact optimum load and bias could then be definitely settled by comparison of the various figures for available output at the permitted maximum of total distortion. Such an analysis is extremely long and tedious; the results of it are given away with every valve on the instruction leaflet. We will therefore assume that the analysis

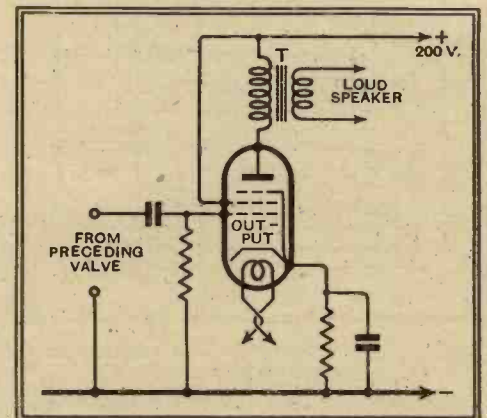

Fig. 16.—A modern pentode output stage, in which the valve load is adjusted to the required value by correct choice of the ratio of the output transformer T.

has been performed, and that the result of it is the 7,500-ohm load-line shown on Fig. 15.

Two useful figures, by which the performance of this valve can rapidly be compared with that of others, can be

From Triode to Double-Diode-Pentode

extracted from the details of this figure. Of these the first is the *sensitivity*, expressed in milliwatts per volt squared of signal applied to the grid, which shows the output that is yielded in return for a signal input of 1 volt. Since the input voltage for 1,300 mW. is $8/\sqrt{2v}$. R.M.S., we find that the sensitivity of this valve, operated under the conditions and with the limitations described, is $1,300/5.3^2$ or 40.6 mW./v².

The efficiency of the valve as a converter of D.C. to A.C. power can also be found. The anode circuit consumes 30.5 mA. at 200 volts, drawing, therefore, 6,100 mW. of D.C. power. The efficiency is, therefore, $1,300/6,100=21.3$ per cent. If the power available had been reckoned in the usual manner, allowing the grid to swing to zero bias, the power would have been 2,000 mW. and the efficiency 33 per cent.; by a slightly more careful choice of operating conditions this might have been pushed up to 40 per cent. or so.

Such figures as these cannot even be approached by the triode valve, which yields efficiencies of the order of 15 per cent.; this is one of the reasons why the pentode is generally chosen as the output valve for a modern set. The other main reason for this preference for the pentode lies in its sensitivity; it requires

(To be concluded.)

a much smaller signal-voltage to drive it than does the triode. In the early days of the pentode it was sometimes claimed that its substitution for a triode was equivalent to adding another stage of amplification to the set; though its superiority is not, and never could be, as great as this extravagant claim implies, yet the increased sensitivity it confers upon a receiver is very evident indeed.

To set against these advantages we have to remember that the pentode requires a rather exact adjustment of load impedance to enable it to give its full output without distortion. The triode, on the other hand, is very much more tolerant in this respect, as can be proved by drawing the appropriate load-lines across the curves of an output triode and analysing the resulting figure as we have done in the case of the pentode. In the days when the moving-iron speaker was still widely used, this point told heavily in favour of the triode on account of the variation of speaker-impedance with frequency, which meant that correct loading could never be attained over the whole frequency-range. Now, that the moving-coil instrument, with its much more constant impedance, is almost universally used, this advantage of the triode is much less weighty, and the extra sensitivity and efficiency of the pentode have resulted in its almost universal adoption.

DISTANT RECEPTION NOTES

IT is announced that the main Rome station which works on 420.8 metres with a power of 50 kilowatts is shortly to go up to 120 kilowatts. The work is actually in hand and should be completed within the next three months or so. In order that an alternative programme may be transmitted a second 120-kilowatt station is contemplated for Rome.

It is rather difficult to see how this is to be fitted in if the provisions of the Lucerne Plan are to be complied with. Under the Lucerne Agreement Rome No. 2 is a mere partner on the wavelength of 238.5 metres. There is a proviso that its power is not to exceed 1 kilowatt and another that, should it cause interference, it must use an aerial directed towards the East. In any case it is an integral part of the Lucerne Plan that no station with a wavelength below 240 metres shall have a power rating in excess of 30 kilowatts. A possible way out of the difficulty is for Rome No. 2 and another Italian station with an individual channel to conduct synchronised transmissions on the same wavelength, after the manner of our own London and West Nationals.

Now that Droitwich's transmissions are in full swing some readers may find it difficult if not impossible to receive the Deutschlandsender clear of interference, since the separation between the two is but nine kilocycles. A good modern super-heterodyne should in most cases be able to do what is necessary, but in cases where Droitwich does occupy too much of the long waveband a simple wavetrap of the series-rejector type may be found useful.

Though many readers may consider wavetraps museum specimens nowadays, they still have their uses. There are, for in-

stance, few better ways of suppressing second-channel whistles from the local twin transmitters in a superhet prone to such than by the use of a special dual wavetrap.

Were it not for atmospheric interference long-distance listening would be superlatively good at the present time. The last sunspot cycle came to an end many months before it was expected to do so. By all the calculations we should still be approaching the minimum, though actually the number of spots on the sun's surface and their position show that the minimum is past and that we are well on our way towards another maximum.

Atmospherics: The Best Policy

Atmospherics are not constant; nor are they as a rule particularly violent. Still, they are present on an average two or three evenings a week just now, and the best policy when they are about is to confine oneself to the more powerful stations whose strength is such that unwanted noises are not too much in evidence.

Of the long-wave stations Huizen, Radio-Paris, Luxembourg and Kalundborg are the most reliable. Motala, Warsaw and the Eiffel Tower generally succeed in heterodyning one another, which is not surprising considering that 10 kilocycles cover all three. Zeesen has considerable variations in strength and Oslo, though nearly always receivable on the loudspeaker, is not at the moment up to its best form.

Beromünster has now restarted with an output power of 100 kilowatts—and sounds like it. Budapest, Stuttgart, Vienna, Florence, Brussels No. 1 and Prague are always to be received with full volume.

Söttens has had a sudden access of strength, and other medium-wave stations which belong to the first-rate class are Rome, Munich, Leipzig, Milan, Berlin, Hamburg, Brussels No. 2, Breslau, the Poste Parisien, Hilversum, Bordeaux PTT, Frankfurt, Königsberg, Trieste and Nürnberg. D. EXER.

The Radio Industry

THE new season's Ekco sets have attracted attention not only on technical grounds, but on the score of their outward form. "Suitability for purpose" is clearly the keynote, and those who follow modern design will be interested to hear that colour is now to be introduced. In addition to the existing black and walnut cabinets we are to have green, grey, and ivory models, all of which are designed by Mr. Wells Coates, who expresses the opinion that a radio set has its own important function in the home, and should no more be designed to look like anything else than should a motor car.

In addition to giving full technical data concerning such components as chokes, condensers, power transformers, resistances, etc., the latest list, entitled "Ferranti Mains Components," issued by Ferranti, Ltd., Hollinwood, Lancs., contains useful technical information on the elimination of back-coupling, and a handy abac for estimating the value of feed resistances.

R. A. Rothermel, Ltd., of Canterbury Road, London, N.W.6, who are agents in this country for the piezo-electric speakers made by the

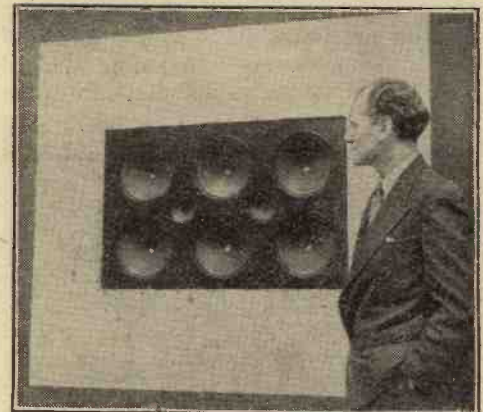

A battery of Piezo-electric loud speakers designed to cover an exceptionally wide frequency band.

Brush Company of America, send us the accompanying photograph of a battery of these speakers. The larger instruments have slightly varying frequency characteristics; the two smaller ones are purely high-note reproducers.

The L. Eastwood Sound System announce a change of address to 63, Doddington Grove, London, S.W.11.

The telegraphic address of the Marylebone branch of Brown Brothers, Ltd., will be Submotoris, Wesdo, London.

We have received from the Tobe Deutschmann Corporation, of Canton, Mass., U.S.A., a set of booklets and technical bulletins dealing with the suppression of mains interference.

A revised price list of Amplion products, which shows reduced prices for the Radiolux and Radiolux Radiogram models, has been received from Amplion, Ltd., 82-84, Rosoman Street, Rosebery Avenue, London, E.C.1.

The Piggott Electrical Co., Ltd., of Salisbury Square House, London, E.C.4, have taken over the business of A. S. Markes and Co., 17, Percy Street, London, W.1.

Practical HINTS AND TIPS

IT should be remembered that the semi-aperiodic input circuit of the Single-Span series of receivers was necessarily designed on the assumption that the sets would be used with aerials of more or less normal dimensions. It therefore follows

Single-Span Aerials

that the falling-off in range brought about by using an exceptionally small aerial will be rather more noticeable with a set employing the Single-Span principle than with one of more conventional design.

WE have become so accustomed to consider everything associated with the grid circuit of an amplifying valve as being at a negative potential with respect to earth that it may come almost as a shock to find that the indirectly heated

Positive and Negative

cathode of such a valve is actually positive to the "base line." It would seem that when tests of a receiver are being made with a voltmeter the conclusion is sometimes reached that this is an indication that something is wrong.

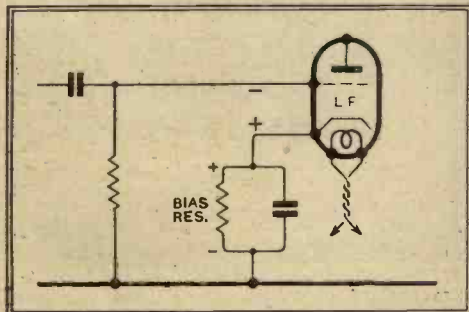

Fig. 1.—Conditions for negative bias; the cathode is positive with respect to the earth line, but the grid is negative to the cathode.

But a brief consideration of the matter will show that the cathode of a mains valve, when grid bias is obtained in the conventional way, must be positive with respect to the earth line—from which it follows that the earth line will be negative to the cathode. As the grid is in direct metallic connection with earth, it must have the same potential, and thus the desired state of affairs—grid negative with respect to cathode—is brought about. This is shown diagrammatically in Fig. 1.

It therefore follows that, when using a multi-range voltmeter for checking anode and grid voltages in a typical A.C. receiver, the negative terminal of the instrument may be joined to the chassis all the time. Measurements of grid bias will then be made on one of the low-voltage ranges of the meter between earth and cathode of the valve concerned. Even if

Aids to Better Reception

the instrument is of high resistance, the reading will not be entirely accurate, but if continuity in the grid circuit can be assumed it may be concluded that at least some negative voltage is reaching the grid if a meter deflection is obtained in the manner described.

ALTHOUGH the use of headphones is now restricted mainly to short-wave listeners and the deaf, the subject is of sufficient general interest to warrant treatment, especially if we also take into account those who find a pair of phones to be a useful aid in testing a receiver.

Protecting Headphone Users

Everyone knows that it is inadvisable to connect headphones directly to a mains-operated set. But it should be put on record that the official attitude as to what constitutes adequate protection has recently undergone a change; certain methods which have been in fairly general use for some time are no longer in conformity with the revised I.E.E. regulations.

A simple choke-condenser filter, such as that shown in Fig. 2 (a) was generally thought to provide adequate protection in the case of a conventional AC set. But its effectiveness is obviously dependent on the single condenser used; this condenser has to withstand the full HT voltage, and if it should break down, the phones would no longer be isolated from the HT supply. Further, an arrangement of this kind would obviously be inadequate when used with positively earthed DC mains.

From most points of view the use of a pair of isolating condensers, one on each side of the phones as shown in diagram (b), was thought to be preferable, if only because the condensers are not normally called upon to withstand full HT voltage. Only the

Fig. 2.—Methods of isolating headphones from mains-operated receivers.

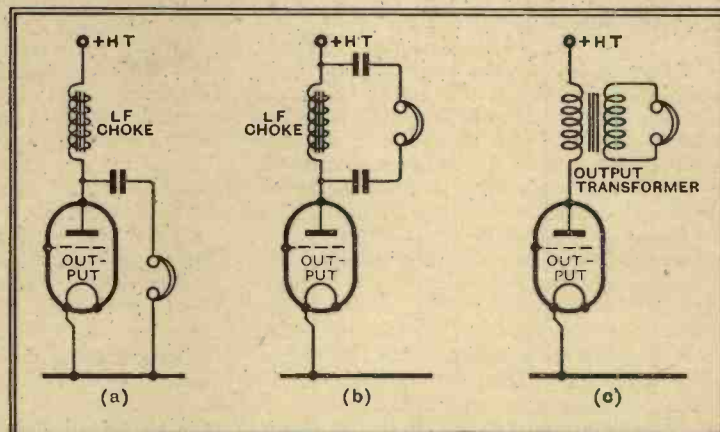

DC voltage-drop across the choke is normally applied to them, and this is almost negligibly small.

But it has now apparently been decided that neither of these arrangements afford

sufficient protection, and the only method of connecting phones to a mains set that has the approval of the I.E.E. is that illustrated in diagram (c), where a double-wound transformer (which must be of high insulation) is employed. Suitable telephone output transformers do not seem to be very readily obtainable nowadays, but no doubt the new regulations will turn the attention of more manufacturers to the matter.

WHEN an extra tuned aerial circuit is added to a receiver with the object of improving selectivity it is generally anticipated that the alteration will be responsible for a certain loss in signal strength. But in practice it is by

Losing Signal Strength

no means unusual to find that the addition in question has the opposite effect, and in addition to an enormous gain in selectivity, the general sensitivity of the receiver is improved to an appreciable extent.

It might seem that in such cases theory does not agree with practice, but actually there is usually quite a simple explanation of the apparent discrepancy. With the ordinary single-tuned aerial circuit it is usually impracticable to work with anything approaching optimum aerial coupling; as a rule it is necessary, in order to attain a fair degree of selectivity, to couple the aerial so loosely to the tuned circuit that signal strength is much less than it might be. On adding the extra circuit, however, the gain in true selectivity is so considerable that aerial coupling may be set at a value giving maximum transference of energy, and this may more than make good the loss of sensitivity due to the addition of another tuned circuit.

When installing a two-circuit aerial tuner, it is therefore always worth while trying experimental alterations to the coupling between the aerial and the primary circuit.

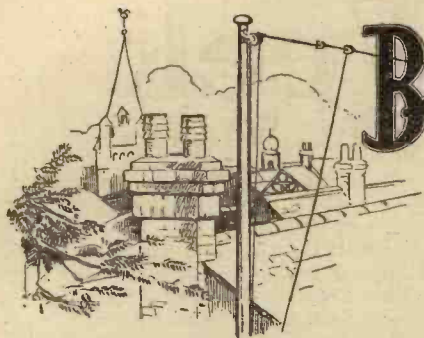

Broadcast Brevities

By Our Special
Correspondent



Activity at Daventry

THERE is no time to shed a tributary tear on the bier of 5XX, for already the engineers are hastening to dismantle the old transmitter in preparation for Empire short-wave tests on a scale far grander than any that have gone before.

That there is unwonted activity at Daventry no one with a short-wave set can doubt, for the strength of the ground ray, particularly in the case of GSD, has been extraordinary in the past week or two.

Single-Sideband Tests

MARCONI engineers are now digesting the results of recent tests in single-sideband transmission from the company's experimental station G2BS at Chelmsford.

The tests were carried out on 1,400 metres between 9 and 10 a.m., and readers who have been hearing strange squawky sounds, suggesting overloading of the output valve, can set their imaginations at rest.

I understand that no further tests are likely for some time to come.

Is School Wireless Perfect?

MOST schools indulging in broadcast lessons are now equipped with reasonably good apparatus. The days of the gargling trumpet on the schoolmaster's desk have gone, and many a child whose pants in the early days would have ached after treatment for "inattention," now hears every word of the wireless discourse with pleasure and profit.

Plain Van on the Road

Even so, the B.B.C. engineers are not satisfied. They feel that no set is really foolproof, and this is the reason why a plain van will leave Broadcasting House within the next few days, fitted with a magnificent receiver and numerous loud-speaker points. It will undertake a 1,000-mile tour, embracing a very large number of schools, the object being to instruct teachers in the art of getting the very best out of available instruments.

The Competitive Spirit

When the "beak" hears the perfect reproduction of the B.B.C. instruments, properly tuned-in to the required station, he will be smitten with the competitive spirit until he achieves such realism as will make Miss Winifred Cullis and Co. seem to step out of the loud speaker into the classroom.

A Television "Battle"

THE result of a battle will become known on Wednesday next, October 17th, when Eustace Robb puts over his first "three-quarter-hour" evening television show.

As everybody knows, B.B.C. programmes concluding at 11 p.m. have a habit of over-reaching themselves. This fact is a direct

threat to the television period, supposedly starting at 11 and terminating at 11.45. The "battle" is with the authorities for the right to televise for a full forty-five minutes, regardless of the time of starting.

There are indications that television will win.

The Joke Factory

AS Herbert Spencer would banteringly announce in his lighter moments: "There is a soul of truth in things erroneous," and this applies with great force to recent tales of the B.B.C. Joke Factory. It is untrue to suggest that the B.B.C. runs a humour works staffed by professional funny men. What is true is that the Corporation has its own gagster, Max Kester, whose job it is to run through artists' material and in many cases pep it up, make it snappier, and in other ways improve it.

B.B.C. Jokes are Copyright

One very important factor dominates Max Kester's efforts, and that is the question of copyright. If a famous comedian offers a well-worn music-hall sketch and Max inserts a good gag, that gag remains the copyright of the B.B.C.; the comedian must delete it from his "copy" before using the same material again in "the Halls."

The B.B.C. has quite a bright collection of copyright jokes which are resurrected from time to time.

"Wonder Bar"

THE broadcasting version of "Wonder Bar," which C. Denis Freeman will produce on October 15th (National) and October 17th (Regional), incorporates the chief features of both stage and screen versions. I hear that the additional musical numbers by Harry Warren which were used in the film will be included.

"Wonder Bar" was originally written in German and produced on the Continent in

The Dancing Daughters

THE B.B.C.'s new troupe of dancers, replacing the eight step-sisters, will make their debut in "Music Hall" on October 20th (National). They have been selected from the dancers who appeared in Radiolympia in the summer, and, as I have mentioned before, are trained by Rosalind Wade.

Their broadcasting designation is to be "The Dancing Daughters."

Doubling Parts

IN last week's broadcast of "Monsieur Beaucaire," Mr. Gordon McConnell, the producer, resorted to the useful dodge of doubling the chief part.

Doubling is not often necessary at the broadcast microphone. It was done in the case of Richard Tauber broadcasting in "Lilac Time," the spoken parts being taken by another actor, and also in "Love in Greenwich Village," although it is said



A DARING "O.B." On September 28th a parachutist described his sensations while jumping from a plane near Berlin, and the record was broadcast from the German stations on Saturday last, October 6th. The upper picture shows the parachutist with his weighted aerial. (Left) A close-up showing the belt-transmitter with cover removed.

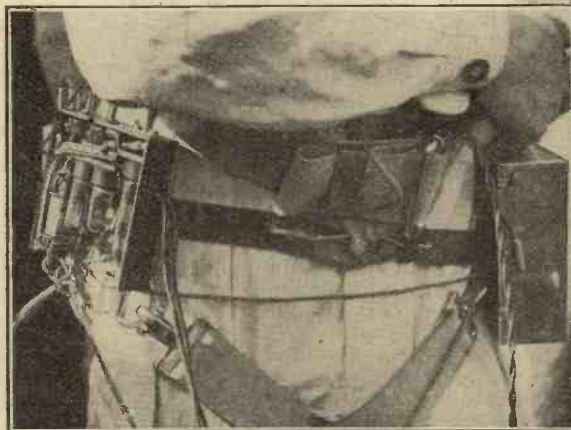

1930. It has proved one of the few really big world-wide successes in musical plays since the War. In New York the part of Sam Wonder, proprietor of the "Wonder Bar," was played by Al Jolson. In the broadcast version Ben Welden, who plays the part of Sam Wonder, is, perhaps, the best-known American actor in this country.

that nobody knew it at the time. In this play Harman Grisewood spoke a part that was sung by Leonard Gowings.

A. J. Alan

WATCH these columns for an interesting announcement regarding the B.B.C.'s champion story-teller.

News of the Week

Current Events in Brief Review

Calling the Universe

USING the ambitious title "Difusora Universal," a new short-wave station has come on the air at Lima, Peru, using the call-sign OA4AC. Said to be the most powerful station in South America, it employs an output of 20 kilowatts on a wavelength of 38.36 metres.

Bristol's Triumph

THE Bristol Radio Exhibition, which closed last week after breaking all attendance records, not only gave a tremendous fillip to the wireless trade, but, according to the *Bristol Evening World*, has made the B.B.C. West-Country-conscious. The actual attendance during the week of the show was in the region of 25,000.

Mike Crashing in Ireland

IRISH broadcasting has had its first taste of microphone-crashing. During a recent broadcast from a well-known Dublin restaurant four young men seized the microphone and delivered a protest against the holding of a political congress. After registering the protest, only part of which was broadcast, the men left the restaurant.

A Glorious Failure

CURIOUS motorists upset an enterprising "O.B." attempted by the Paris P.T.T. station a few days ago, when it



ULTRA SHORTS IN U.S. ARMY. This soldier, with his six-metre transmitter and receiver on his back, attracted a lot of attention at the Madison Square Garden Radio Show in New York. The equipment weighs about 25 lb.

had been arranged to broadcast the belling of the stags in Compiègne Forest. More than half a mile of wiring was taken into the forest, microphones being slung from tree to tree, but when the stags saw the crowds of curious spectators and sniffed the petrol-tainted glade they retreated.

Captain Eckersley on the Future

"POSSIBLE Future Developments in Broadcasting" is the title of a lecture to be given by Captain P. P. Eckersley, M.I.E.E., before the British Radio Institution at King's College, Strand, W.C.2, on Tuesday next, October 16th, at 7 p.m. Readers of *The Wireless World* are cordially invited to attend.

Better Irish Broadcasting?

A NEW director is to be appointed to the Dublin broadcasting station to replace Mr. S. Clandillon. According to a Dublin correspondent, surprise was caused six months ago when it was announced that Mr. Clandillon had been removed from the office which he had held since the opening of the station. In the last six months there have been general complaints regarding the standard of broadcasting from Athlone.

The Quality Mark

PRICE lowering, it appears, brought about a definite downward tendency in the quality of reproduction among many receivers at the Paris Radio Show. In consequence the Société pour la Diffusion des Sciences and Arts is discussing a scheme, which may operate next year, whereby receivers attaining a certain standard of quality will be granted a "quality mark" by the Union of Electrical Syndicates.

America Discovers Man-made Static

TO combat radio interference, the United States Radio Manufacturers' Association is calling an interference conference at Rochester, N.Y., in November. The conference will consider interference problems created by power lines, street car trolleys, lifts, and other familiar offenders.

In the radio interference field America seems to be lagging behind Europe. It may be foolhardy to suggest as a reason the average American's comparative insensitiveness to noise, but, reading between the lines, it would appear that steps are being taken at this late hour only because of the examples set by the enlightened broadcasting authorities in the Old World.

"Non-Profit" Programmes

EDUCATIONAL, religious, and other "non-profit" organisations are claiming 25 per cent. of the American broadcasting wavelengths, according to a Washington correspondent. They laid their schemes before the new Federal Communications Commission on October 1st in preparation for the Annual Assembly of the National Advisory Council on Radio in Education, held in Chicago on October 8th and 9th. Although a very large proportion of the American programmes are of the trade-sponsored variety, there is a growing demand for non-commercial transmissions.

France and Television

THE French Postmaster-General has authorised the formation of a Television Commission to keep watch on the progress of television and facilitate tests at the State stations. The well-known research worker, M. Belin, will be a member of the Commission.

Anti-speaker Static

THE Paris *Figaro* is conducting a vigorous campaign against noisy loud speakers at open



A SPECIAL STAMP now in use in Italy to commemorate the holding of the recent Radio-Biological Congress at Venice, which was presided over by Marchese Marconi.

windows, and in a series of vivid articles has described the sufferings of mothers at the bedsides of sick children, overwhelmed night and day by the radio of neighbours, of people dying to the strains of strident jazz, and authors driven crazy.

As a result (reports the *Figaro*) many listeners are manufacturing static with Ruhmkorf coils, which make reception impossible within an area of three or four hundred yards. This practice, which is illegal in France, is extremely difficult to discover and is therefore warmly recommended by many correspondents of the *Figaro*.

Weather Forecasts for Motorists

THAT every petrol filling station should be a weather bureau is the suggestion of the United States Bureau of Air Commerce. The regular weather reports would be picked up with special receivers having a range of from 200 to 400 kc/s.

In a country like America these bulletins would be of the utmost value in the mountainous and rugged districts where fogs, heavy rain, and snow often necessitate a diversion of route.

The Irish Show

MUCH more money is being spent on wireless in Ireland this year as compared with 1933, and the impression gathered from a visit to the Annual Radio Show at the Mansion House, Dublin, was that the Irish public are definitely more "radio-conscious." Many British firms were represented, and the attendance was such that the organisers may have to seek bigger premises next year.

The Dublin broadcasting station put on a special programme for the week, which was relayed to the Mansion House and distributed throughout the Show. The all-mains set was in the ascendancy, and there seems to be no return in Ireland to the battery receiver, doubtless because of the widespread use of the Shannon power scheme all over the country.

International DX'ers Alliance

THE International DX'ers Alliance now has five representatives in the British Isles. They are Mr. R. L. Rawles, Publicity Department, Blackwater, Isle of Wight; Mr. F. R. Crowder, 12, Belle Vue Place, Belle Vue Road, Leeds, 3; Mr. W. W. Warner, 56, East Grove Road, St. Leonards, Exeter, Devon; Mr. R. Ellis, Arbiston Estate, Bellshill, Lanarkshire, Scotland; and Mr. R. Mumford, 47, Sydney Parade, Co. Dublin, Irish Free State.

"Crisis in Spain"

THE events of last week-end vividly recalled the B.B.C.'s feature programme "Crisis in Spain" (writes Cecil W. Lusty, who recently visited the Spanish stations on behalf of *The Wireless World*). Spain is one of the few European countries where the broadcasting buildings are unprotected. The Barcelona studios, where the rebel president, Don Lluís Companys and his insurgents were shelled, is situated in the Calle de Caspe, near the Plaza de Cataluna, famous for the beauty of its fountains. At the time of my visit my bona fides were not even inspected, and I was surprised at the utter disregard of safety in the event of revolutionary disorders. The transmitter is on the historic Mount Tibidabo, on the outskirts of Barcelona. Here again I found no protection for the apparatus, the site offering a splendid target for surprise attacks.

The value of a broadcasting station in times of emergency was amply demonstrated during the recent disturbance. The turning point in the battle occurred when Senor Companys' session at the microphone was suddenly ended by the station's capture. While at the microphone the insurgent leader poured out a flood of exhortations which were picked up by the peasants of Cataluna.

H.M.V.

Autoradiogram

MODEL 570

FEATURES.—*Type.*—Superheterodyne radio-gramophone for AC mains, including automatic record changer. **Circuit.**—Heptode frequency changer—var.-mu screened-grid IF amplifier—double-diode-triode second detector—power triode output valve. Full-wave valve rectifier. **Controls.**—(Radio). (1) Tuning. (2) Manual volume control and noise suppression switch. (3) Tone control. (4) Waverange and on-off switch. (5) Noise suppression adjustment. (Record Changer). (1) Starting button. (2) Reject button. (3) Record jaw adjustment (4) Repeat switch. (5) Speed Regulator. **Price.**—33 guineas. **Makers.**—The Gramophone Co. Ltd., 98/108, Clerkenwell Road, London, E.C.1



Superheterodyne Radio Circuit with AVC and Automatic Record Changer

THE Gramophone Company has always enjoyed a reputation for sound design and reliability in its radio receivers and for cabinet work of outstanding design and finish. These qualities are again in evidence in the Model 570 radio-gramophone, but the most outstanding feature is the exceptionally wide specification having regard to the price. It would seem that good value for money is a feature which will become inseparable from the name of H.M.V.

The radio circuit is basically the same as that of the Model 442 described in our issue of May 4th. A band-pass input filter precedes the heptode frequency changer, and special circuits are included to suppress second channel interference. The single IF stage is followed by a double-diode-triode detector from which AVC bias is derived. The final valve is a large triode which is coupled to the amplifying portion of the detector by a transformer.

The modifications which have been made in adapting this chassis to the Model 570 radio-gramophone include the provision of separate volume controls for radio and gramophone operation, and the addition of a special "bass-boosting" circuit in parallel with the pick-up. The reason for the duplication of the volume control is that it has always been a point of H.M.V. policy to fit the gramophone volume control outside the cabinet so that the lid may remain closed

throughout the playing of a record. The "Reject" button for the record changer is also incorporated in the spindle of the volume control so that once the record-changer magazine has been loaded it is unnecessary to make any adjustments inside the cabinet.

In addition to the usual tuning, waverange and manual volume controls there is a tone control which is effective both on radio and gramophone, and a noise suppression control which is brought into operation by lifting the manual control knob. This has the effect of bringing into circuit a pre-set sensitivity control mounted near the aerial and earth terminals at the back of the set. The tuning indicator is of the so-called "Fluid Light" type, exact tuning being indicated by the maximum length of the images of two arrows thrown on a translucent screen immediately above the tuning scale. Accurate tuning is necessary in this receiver as the higher frequencies are over-accentuated as the tuning control is moved away from the position of maximum volume.

indicative of the high overall amplification of the set.

The automatic volume control has a wide range, and in Central London little difference is noticeable in the volume from London Regional and Midland Regional. The London Regional and National transmitters occupied a band width of approximately 43 and 35 kc/s. respectively. Second channel whistles were completely absent on the medium waveband, but one or two faint whistles, due to oscillator harmonics, were detected on the long waveband.

Both on radio and gramophone the bass reproduction has the characteristic fullness of most H.M.V. designs, and the reproduction of organ music is exceptionally good. The new type of loud speaker also reproduces the higher audio frequencies extremely well, and on gramophone records the quality was improved by reducing the high-note response slightly by means of the tone control.

High Sensitivity

There is an ample reserve of range and sensitivity for all normal requirements, and with the noise suppression control out of action the high level of background noise is

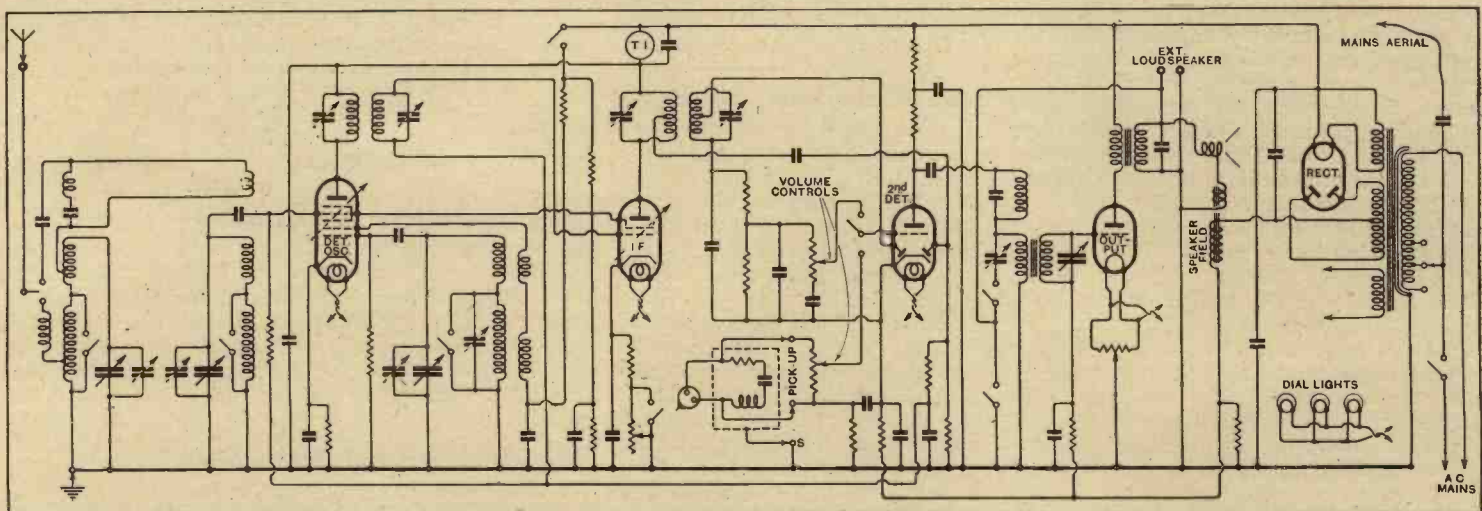

Simplified circuit diagram. Separate volume controls are used for radio and gramophone, and a "bass-boosting" circuit is associated with the pick-up.

H.M.V. Autoradio-gram, Model 570—

The cabinet is solidly constructed with the view to minimising resonance, and the base-board supporting the record-changer unit is mounted on a three-point coil-spring suspension. The receiver chassis is screwed to the right-hand side of the cabinet with the valves mounted horizontally, while the loud speaker is tilted slightly upwards. The tone-correction circuit for the pick-up is constructed as a separate screened unit, and is mounted well away from all other components in the bottom left-hand corner of the cabinet.

A mains aerial connection is provided, and the output circuit is designed to accommodate two external loud speakers, one high and one of low impedance.

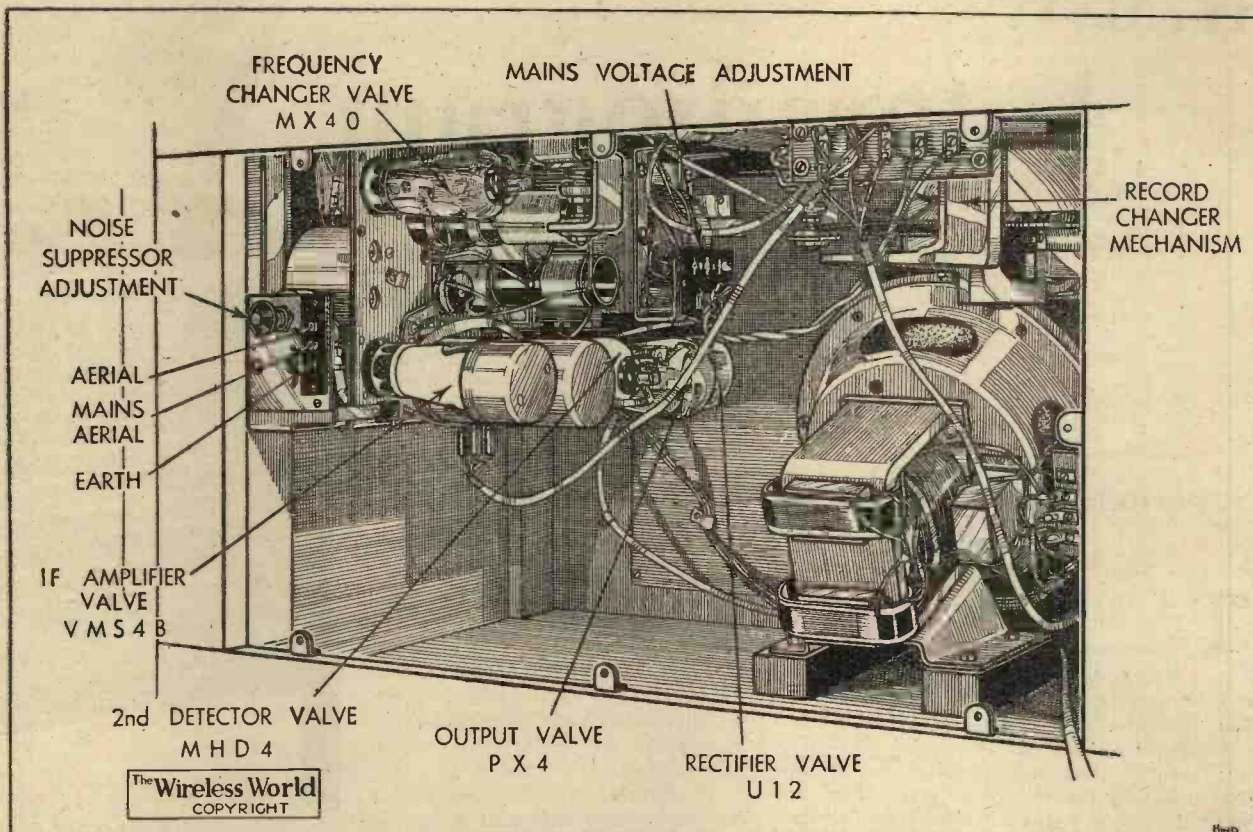
THE LAYOUT OF THE PRINCIPAL COMPONENTS

Interior of the cabinet. The receiver chassis is mounted on the left and the record-changer mechanism, which is seen immediately above the loud speaker, is mounted on a three-point spring suspension.

Letters to the Editor

The Editor does not hold himself responsible for the opinions of his correspondents

The Common Supply at Olympia

IT was with great pleasure that I read "Exhibitor's" article on "Common Supply" at Olympia. I am entirely in agreement with his views on this matter. What useful purpose this noise serves, other than as a background to the chatter of the Exhibition, I fail to see. I went to Olympia for two reasons; first, to try to find a better loud speaker than my present one, and, secondly, to see the broadcast artistes. Leaving out the second reason, as being outside the purpose of a radio exhibition, I walked around in search of my main goal; at first I was agreeably impressed with the quite good tone of the 35s. class of speaker (my own is a £7 model), but during my travels I found that all speakers sounded much alike, from the cheapest to the best, and disappointment began to steal over me. Had I come fifty miles to find the cheapest speakers as good as mine? No, there was not one speaker I could find in my limited time anything like as good! Then I made what I thought to be two discoveries. First, when listening to the small cheap speakers which might have a lack of bass or top. I found this was immediately supplied by the surrounding air containing the missing notes sent over from the Stand next door or the one behind. Secondly, all the time I was in the Exhibition the music was supplied by records with an entire absence of scratch. As "Exhibitor" says, first-class reproduction is inseparable from scratch, and I knew then that my search for a loud

speaker with a good "top" register was doomed, for music containing the higher frequencies was not being transmitted.

After spending time, money and energy on getting to what should be a radio exhibition which should make one feel dissatisfied with one's own outfit and from which a choice could be made, I arrived home to switch on my own set and feel very satisfied for yet another year. Surely not the purpose for which an exhibition is staged!

Thanking you for the stand you take for "quality first" reproduction, and the space you allow for its discussion.

Dunmow.

S. W. WEBB.

The Luxembourg Effect

I WAS extremely interested in your article on the "Luxembourg Effect," as I have noted this phenomenon for some two or three weeks past in this and neighbouring districts, though, I must admit, without recording any exact data.

I am writing, however, in the hope that my observations may contribute a small amount of information to the sum required. In the main, it would appear that Luxembourg itself seems to be the greatest sufferer, with Radio-Paris being the offending station. I have also noted another station also interfering with Luxembourg in the same manner, but have as yet been unable to identify it with certainty. One or two listeners have also informed me that some similar effect appears to occur in the

reception of London Regional, generally between 6.0 and 7.0 p.m., but I personally have not observed any such interference, which may well be due to other and more common causes. I have also noted the effect on the following stations: Poste-Parisien, Breslau, Brussels 2, Langenberg, Milan, Leipzig, Rome, Trieste, Warsaw and Fécamp, the last being a somewhat doubtful case.

The general time of reception was between 9.0 and 10.0 p.m., the areas covered being Twickenham, Richmond, Feltham and Heston, and the receivers used were a Philips 274a, Ekco AD65 and AC85, G.E.C. AVC5, Ultra 22, H.M.V.442, and a Ferranti Lancastria. A Philips 274a was also used at a time when the effect was known to be taking place, but no effects could be noted when it was used.

Twickenham.

L. J. LOWEN,

Empire Broadcasting

THE remarks of your correspondent "Heptode" on Empire Broadcasting Receivers in your issue for August 31st are also applicable to Bombay. You would be surprised to learn how very few of the exhibitors at Radiolympia have ever been heard of in India. The ordinary man here might easily come to the conclusion that most radio equipment was made in the United States, next Holland and Germany, with Great Britain a very bad last. The reason is, perhaps, because a number of American firms produce excellent all-wave

sets; judging by the number sold, they must be what most buyers want. I would, however, say that the type of set best suited for this market is a set designed for short- and medium-wave reception. The medium wave is wanted for local station work, and (if you live in a good locality and take the trouble to put up a really good aerial) for reception of European broadcasting after dark during the cold weather.

The Viceroy has, as you are aware, forecast a considerable development of broadcasting in India in his recent address to the Legislatures, but I am unable to give you any idea of the number of listeners in India at present. The Government of India keep no record of the number of wireless licences taken out, and it is probable that there are many pirates. There must, however, be a considerable number of listeners in Bombay, judging by the aerials one sees and by the number of radio dealers.

There is little in the way of service after sales to be obtained here, and what there is is thoroughly inefficient. A manufacturer who backs up good sets with good service should meet with the success he would deserve, and it should not be impossible for such a manufacturer to be British.

BOMBAYITE.

MY experience has been that people are inclined to pay slightly more for a British-built receiver, but they will certainly not pay 100 per cent. more than they would have to pay for the American equivalent.

To me it seems that if a British manufacturer turns out a decent SW/MW receiver he labours under the impression that he has created something entirely out of the ordinary (and charges accordingly), while his American counterpart has already been on the job, at a normal figure, probably twelve months ahead of him.

The British Empire transmissions are receivable here practically any time that they are on the air, and I have had Europeans and Egyptians in my showrooms expressing surprise that, while a British firm can put up a transmitter giving such results, it is impossible to obtain a British-built set on which to hear these transmissions.

Last year the import figures for radio receivers imported into Egypt were:—American, 60 per cent.; Dutch, 25 per cent.; British, 5 per cent.; German, 5 per cent.; and various, 5 per cent., and one can safely say that 50 per cent. of the American quota were SW/MW receivers.

Taking this as an index, what would world figures have amounted to during the past twelve months, which is approximately the time the latest type have been on this market?

It might also be interesting to manufacturers to note the tendency mentioned in your report of the German Radio Show, wherein it is stated that nearly all machines include short-wave tuning.

As I have mentioned "specification, performance and price," I suppose I should add that the average American A.C. driven receiver sold here has eight valves, includes A.V.C. and Class B output, and sells at approximately £21 10s. The six-valve set sells at £15 10s.

Cairo.

F. A. SHEPHERD.

Cinema Quality

AS an ex-operator I can speak with some knowledge on the cinema-quality controversy, and my views may be of interest to your readers.

The most frequent cause of bad quality

can be traced to the photo-electric cell and its associated equipment. P.E. cells are comparatively costly affairs, and are usually run until they give up the ghost altogether. They are polarised by means of an H.T. battery, which, of course, has an irritating habit of running down in time and also costs money to replace, which is why they are run to the last few volts.

The bulb which supplies the illuminant has also a limited life and turns yellow with age. To keep in the manager's good book the operator—who to-day is usually just a "yes-man"—turns a blind eye to it until his fear for the show outweighs his fear for the manager, and he asks for new bulbs.

Now, the focusing of this light on to the sound track requires exceedingly good sight and a delicate touch. The former physical quality is not common among cine operators for obvious reasons, while the slightest suggestion of a turn of the adjusting screw will banish the sibilants altogether. The optical system is supposed to be hermetically sealed, but it is strange how surplus oil from the projector can find its way inside the cylinder, choking the slit and filming over the lenses. Needless to say, where the interior of this delicate affair is not strictly taboo to the operator he usually fights shy of having anything to do with it.

The more accurately this optical system is adjusted the less amplification is needed;

so that if it is not adjusted "just so" the fader—which controls the input to the first stage of the amplifier—has to be turned a step or two higher in order to retain the normal volume level. Thus, what you hear in the auditorium is really the cumulative effect of two sources of distortion—the insensitivity of the optical system and the overloading of the valves.

As regards service, The Western Electric Co. is the only firm, to my knowledge, who have insisted on compulsory servicing right from the early days. With most other systems service is optional, and, since it costs money, is only called in when a complete breakdown occurs which is beyond the operator.

The B.T.P. system had two tone controls, and, believe me, some realistic results could be achieved by their intelligent use. However, I was informed the other day by one of their engineers that where they have not scrapped them altogether they have combined them into one knob, since their misuse by the so-called "talkie operators" who are in the business to-day was bringing discredit on their apparatus! As everyone knows, what is good for clarity of speech is not so for depth in music, and this backward step is to be deprecated.

I appreciate that the majority of cinemas cannot afford to retain technically qualified operators, but unless they do, or, failing

MULTILINE RECEIVER AND RECORDING TABLE

TWO examples of special wireless and recording equipment supplied by Radio-Furniture and Fittings, Ltd., 106, Victoria Street, London, S.W.1, are shown in the illustrations. The radio-gramophone is a Multiline receiver feeding twelve remote loud speakers, and giving three changes of programme at each. Two of the receiving circuits are fixed for the local programmes, while the third can be tuned to any of the principal European or home stations. Alternatively, this feed circuit may be used for gramophone reproduction, and an automatic record changer is provided for the purpose.

The other illustration shows a recording table fitted with two turntables, and a continuous record extending over any number of discs can be made.

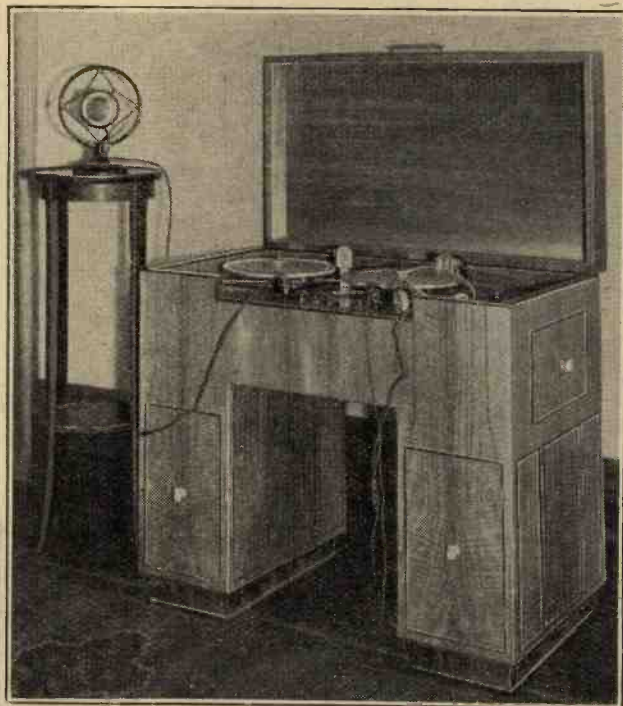

that, have their equipment inspected at regular and frequent intervals, we must not expect much in the way of improved quality.

In conclusion, I would say that the majority of installations were put down when the novelty and not the quality of talking pictures was what mattered. There are seventeen cinemas in Burnley, and I am speaking from personal knowledge when I say that 75 per cent. of the installations in them are from three to four years old. Do not blame the exhibitors for this. They only rent the apparatus from the manufacturers, who, having already expended a substantial amount in laying down the equipment in the first place, are by no means in a hurry to replace it until the accumulated rents show a profit.

Burnley, Lancs. GEORGE DIXON.

New Apparatus Reviewed

Recent Products of the Manufacturers

VARLEY DUO NICORE COILS

THE Duo Nicore series of iron-cored coils is a new range introduced by Varley to meet the needs of those desirous of utilising existing wave-change switches. The omission of this fitting has enabled the coil to be made very much smaller, the overall size being 2½ in. in diameter at the base and 3½ in. high. They are screened, and the series includes pre-selector circuit coils, superheterodyne oscillator coils for heptodes and similar type valves, for separate oscillator valves, and for triode-pentode frequency changers.

There are two types of IF transformers, one for 110 kc/s, and the other for 465 kc/s amplifiers; in the case of the latter a series of oscillator coils are available for the different types of frequency changers mentioned.

All coils are similar in shape and in appearance, but the LF transformers have a narrow slot in the can with a screw head protruding for controlling the band width, and a large nut on the top with a slotted screw in its centre for adjusting the trimmers, the nut



Varley Duo Nicore 110 kc/s IF transformer, showing band-width control screw and trimmer adjusters on top.

being for the primary, and the screw for the secondary trimmer.

The band width control enables the coils to be adjusted to give either a single-peak resonance curve or a band-pass response of about 9 kc/s peak separation with the 110 kc/s type on which our tests were made. It was observed also that, having carefully trimmed the circuits with single-peak resonance setting when the coils were adjusted for maximum band width, a perfectly symmetrical response curve was obtained with the peaks equally spaced on each side of the resonance frequency.

Measurements with two pre-selector coils, the BP80 type, showed that their inductances are very closely matched, there being less than one-half micro-henry difference between them on both wavebands. The inductances were 156.7 and 156.5 m-mH. respectively for the medium-wave windings, and 2,260 m-mH. for the long-wave sections, no measurable difference being determinable with the two coils on this waveband.

The coils are quite efficient, and reaction is smooth and satisfactory throughout with those coils incorporating a winding for this purpose.

This series have list numbers of from

BP80 to BP88, there being nine coils in all, and the price is 6s. in each case.

The makers are Varley (Oliver Pell Control, Ltd.), Bloomfield Road, London, S.E. 18.

CLIX TWO-WAY MAINS ADAPTOR

WHEN a mains receiver is used as a transportable set it may happen that in some places a lamp-holder adaptor is needed, whereas in others a two-pin plug for a wall socket must be used. In order to

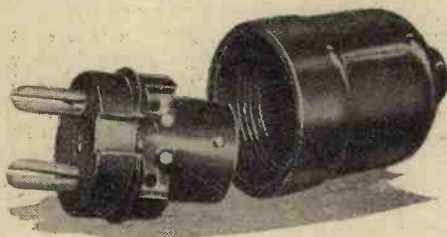

Clix Universal two-way mains adaptor.

meet all contingencies with a single fitment on the mains lead, Lectro-Linx, Ltd., 79a, Rochester Row, London, S.W. 1, has designed an adaptor which can be quickly changed from a lamp-holder fitting into a two-pin plug without disconnecting the lead.

It consists of a Bakelite shell into which screws another moulding, and to this is joined the lead from the set. The screw-in portion is fitted with a two-pin plug at one end and a lamp adaptor at the other, so whichever is required it is only necessary to remove the centre part and screw it in the holder with the appropriate fitting exposed.

The prongs of the plug part are of the same pattern as fitted to Clix Master Wander Plugs, being "D" shaped and not split, so that they retain their form and do not become compressed. The price of this very useful fitting is 1s. 3d.

ANACOS EARTH ROD

THIS earthing device is made by Frederick Smith and Co., Anaconda Works, Salford 3, Lancs, which firm is associated with the London Electric Wire Co. and Smith's, Ltd., and it consists of a cruciform-section

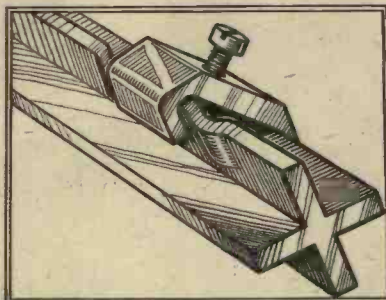

Novel wire-grip on the Anacos copper earth rod which is of cruciform section.

rod of the finest hard-drawn copper. Being free of impurities it should be immune to corrosive effects in any soil. It measures ½ in. only across the diagonals, but the area of copper in contact with the ground is equal to that of a tube just over ½ in. in diameter for rods of the same length.

The rod is sufficiently robust to stand being driven into quite hard ground without

buckling, as the girder-like construction gives it great strength; also, it offers the minimum of resistance, since the edges virtually cut their way into the soil.

A novel type of wire grip is fitted which makes a good electrical contact with leads up to ½ in. dia., and the price is 1s. 8d. for an 18 in. rod, and 2s. for one 24 in. long.

NEW CLARKE'S ATLAS MAINS UNIT

THE latest Atlas battery eliminator made by H. Clarke and Co. (M/c), Ltd., Atlas Works, Patricroft, Manchester, is the Model T.10/30 for AC mains, which incorporates several novel features and refinements that their wide experience of this class of unit has shown to be desirable. Its output is extremely flexible, and the controls provided enable the voltages to be adjusted to suit the requirements of most battery sets consuming not more than 30 mA. of current. For example, there are three separate voltage supplies, and each tapping provides a high or a low value, the detector tapping, however, gives the choice of three alternatives. For the screen supply to HF amplifying valves the two alternative voltages were found to be 58 and 83 volts, while from the detector tappings we obtained 40, 55, and 85 volts when taking about 3, 5, and 7 mA. respectively from these three sockets. The power valve can be given either 120 or 150 volts, and this output remains reasonably constant at current loads of 10, 20, and 30 mA., for there is a socket



Clarke's Atlas latest HT supply unit Model T.10/30 incorporating a LT trickle charger.

board with a screw-in plug to adjust the voltage according to the total current taken from the supply unit.

Our measurements gave 125 and 149 volts respectively at a 20 mA. lead, and 117 volts and 149 volts with 30 mA. of current flowing. The voltage at the intermediate tappings did not change appreciably, provided the load-adjusting plug was inserted into the appropriate socket.

A practical test, using a sensitive three-valve set, showed that the smoothing is quite adequate for all purposes, while the voltages could be adjusted sufficiently close to the battery voltages used hitherto, so that the performance of the set remained unaltered. Where a 120-volt battery was used originally, the higher voltage available from the eliminator, and the fact that 30 mA. are available, enables a larger power valve to be fitted if desired.

The workmanship is of that high standard always associated with Atlas products, and it is finished in olive green. It incorporates a 0.5 amp. trickle charger for the LT battery, and Westinghouse rectifiers are employed for both purposes. The price is 69s. 6d.

Tradition



The Technical press agrees with us in our statement that the Amplion 1935 "Lion" Speakers faithfully uphold our reputation for producing speakers that give life-like reproduction, fine tonal balance, sensitivity and the ability to handle heavy input without the slightest signs of distortion.

"Popular Wireless" says:—

"To-day, Amplion moving coil loudspeakers are continuing to enjoy tremendous popularity, proof—if proof is wanted—that the old-time traditions associated with this famous name have been well maintained... The Amplion 'Lion' speaker, a high class permanent magnet moving coil instrument, is an outstanding example."

Because "Lion" Permanent Magnet moving coil loudspeakers can be correctly matched to every class of output, they are suitable for use with any receiver.

UNIVERSAL TRANSFORMER 1 to 20 AND 2,000 to 40,000 OHMS.

PROVISION FOR VOLUME OR TONE CONTROL AND USE OF ADDITIONAL SPEAKER.

"Lion" 7" cone 47/6
 "Lion Super" 10" cone 55/-

AMPLION SPEAKER, RECEIVER AND COMPONENT LISTS FREE.

47/6
 (7" CONE)

AMPLION

LION LOUDSPEAKERS

AMPLION (1932) LTD.,
 82-84, Rosoman St., London, E.C.1.

**TAKE
 NO
 RISKS...**



— BUY A —

FULL O' POWER BATTERY

The Incomparable Radio Battery with exclusive features, which can be depended upon to provide the maximum of enjoyment from your wireless set, and the best possible service at the lowest cost consistent with dependability.

Buy one to-day, it proves its value by performance.

STUDY ECONOMY

In these times a Power Battery is a real economy. Three times the service at less than double the cost of a popular type. Ask your dealer about them.

FULL O' POWER
 made by



Battery
 Specialists
 for over
 60 years

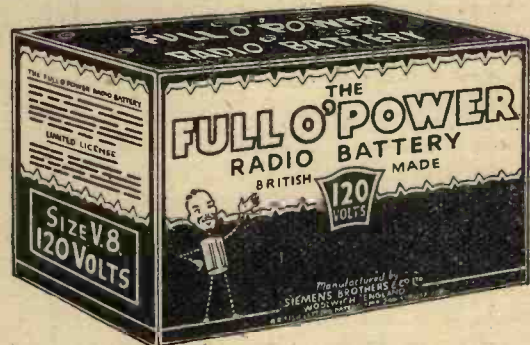

★ BE SURE AND ASK YOUR DEALER FOR A SIEMENS FULL-O-POWER BATTERY

Advt. of Siemens Electric Lamps & Supplies Ltd, 38-39, Upper Thames Street, London, E.C.4

MISCELLANEOUS ADVERTISEMENTS

NOTICES.

THE CHARGE FOR ADVERTISEMENTS in these columns is

12 words or less, 3/- and 3d. for every additional word.

Each paragraph is charged separately and name and address must be counted.

SERIES DISCOUNTS are allowed to Trade Advertisers as follows on orders for consecutive insertions, provided a contract is placed in advance, and in the absence of fresh instructions the entire "copy" is repeated from the previous issue: 13 consecutive insertions 5%; 26 consecutive, 10%; 52 consecutive, 15%.

ADVERTISEMENTS for these columns are accepted up to **FIRST POST ON MONDAY MORNING** (previous to date of issue) at the Head Offices of "The Wireless World," Dorset House, Stamford Street, London, S.E.1, or on **SATURDAY MORNING** at the Branch Offices, 19, Herford Street, Coventry; Guildhall Buildings, Navigation Street, Birmingham, 2; 260, Deansgate, Manchester, 3; 26a, Renfield Street, Glasgow, C.2.

Advertisements that arrive too late for a particular issue will automatically be inserted in the following issue unless accompanied by instructions to the contrary. All advertisements in this section must be strictly prepaid.

The proprietors retain the right to refuse or withdraw advertisements at their discretion.

Postal Orders and Cheques sent in payment for advertisements should be made payable to **LIFFE & SONS Ltd., and crossed & Co.** Notes being untraceable if lost in transit should not be sent as remittances.

All letters relating to advertisements should quote the number which is printed at the end of each advertisement and the date of the issue in which it appeared.

The proprietors are not responsible for clerical or printers' errors, although every care is taken to avoid mistakes.

See *Manufacturers' Surplus, Clearance and Bankrupt Stocks offered in any of these columns may not be Manufacturers' current lines. Radio components advertised at below the list price do not carry any manufacturer's guarantee.*

RECEIVERS AND AMPLIFIERS, ETC.

1935 W.W. A.C. S/W. Receiver, complete Author kit including valves, unopened, write best offer.—Box 1814, c/o *The Wireless World*. [6647]

OUR Kit of Parts for "Wireless World" Quality Amplifier, complete in every detail, including valves; amplifier only, £8/10; feeder unit, 36/-. [6639]

OUR Kit of Parts for "Wireless World" Olympic S.S. Six, complete in every detail, including valves and loud-speaker; £14/10. [6639]

SEND for Detailed List of Components for Either of the Above Kits; carriage paid, cash with order. **WARD, 45, Farringdon St., London, E.C.4.** Phone: Holborn 9703. [6402]

OLYMPIC S.S. Six, first specified parts, wired, tested specified valves, week old; receiver, £9/10; or power, £5/10.—Stockdale, 7, Leamington Avenue, Burnley. [6665]

BURNE-JONES Stenode, with separate Baker loud-speaker; or would separate; demonstration by appointment; £12/10.—Box 1789, c/o *The Wireless World*. [6639]

EMERSON and CROSLLEY 1935 Midgets, car radio, and all American valves, send for wholesale catalogue, importer.—Royal, 5, Buckingham Road, London, E.18. [6654]

1935 Models 4 Valve Superhet Midgets, A.C. or D.C., M.C. speaker, £3/19/6; 5 valves, £4/19/6; car radio, £7/15 including valves.—Lovell Bros., 11, Avon Road, London, E.17. [6655]

FERRACART III Chassis Complete with Valves, P.x4 output, Ferranti transformer, latest Colvern coils, beautiful quality; £6.—Legge, Lyndhurst, Newbridge Avenue, Wolverhampton. [6667]

WEBSTER Portable, A.C. amplifier, complete with microphone, Gram. motor, turntable, pick-up, loud-speaker, valves, etc., in leatherette carrying case, ideal outfit for dance band; £17/10. [6667]

H.M.V. Playing Desk, fitted with D.C. amplifier, metal case, less valves; £5. [6667]

MARCONI 60 watt A.C. Amplifier, type P.13, 110-250 volts, suitable for microphone, gramophone or radio, in polished oak case complete with valves; £10. [6667]

DISMANTLING Several Large Cinema Amplifiers, containing Ferranti meters, ditto chokes and transformers, Farneko transformers, heavy duty condensers, etc. [6667]

I HAVE a Large Stock of Talkie Apparatus, complete outfits, portable and otherwise, soundheads, driven and pull-through; further particulars of same send stamp; callers invited.—H. Franks, 23, Percy St., Tottenham Court Rd., W.1. Museum 8585. [6678]

MAINS RADIO DEVELOPMENT Company Offer Brand New Alba Three Valve A.C. 200-250v. Receivers, band pass tuning, complete with ring valves, moving coil speaker in handsome walnut cabinet, perfect; £5/15, post free. [6648]

MAINS RADIO DEVELOPMENT Company, 4-6, Muswell Hill Road, London, N.6. Phone: Tudor 4046. [6648]



ULTRA SHORT WAVES

FAITHFULLY RECEIVED ON
S. G. BROWN

Only the most sensitive 'phones will reproduce those faint signals. S. G. Brown A Reed Type are well known to thousands of early listeners and ultra short wave enthusiasts. Many may imagine that Headphones are obsolete, but over 500 pairs of S.G. Brown 'Phones of various types are made each week by the same men and tools and of the same quality material as at Brown's at Acton in past years. NOW manufactured solely under licence by

H
E
A
D
P
H
O
N
E
S

NATIONAL RADIO SERVICE Co.

Chairman: Capt. P. P. Eckersley, M.I.E.E.
15-16, ALFRED PLACE, W.C.1.

Telephone: Museum 7561.

N.R.S. is Britain's Foremost Radio Repair and Service Company



Take the Lift

THE MODERN WAY TO SUCCESS.

Instead of remaining in the crowd, struggling with others along the old zig-zag paths, decide now to take the more modern, more certain, and much quicker way to the top.

If you are ambitious for something more than a "bread and butter" job send for a copy of our unique 256-page Guide, entitled "ENGINEERING OPPORTUNITIES." In this handbook Professor A. M. Low (the eminent Engineer and Consultant), shows clearly and definitely the most certain way to a well-paid post.

The book gives particulars of all leading Examinations including A.M.I.Mech.E., A.M.I.C.E., A.M.I.E.E., A.M.I.A.E., A.M.I.W.T., City and Guilds, G.P.O., etc., and also outlines over a hundred Home-Study Courses in all branches of Civil, Mech., Elec., Motor, Radio and Aero Engineering.

Write, call or phone for your **FREE COPY** of this important Handbook to-day. We promise that it will be a moment of your time well spent. There is no cost or obligation.

BRITISH INSTITUTE OF ENGINEERING TECHNOLOGY
387, Shakespeare House, 29/31, Oxford Street, London.

BOOKS on WIRELESS

Write for complete list to
LIFFE & SONS LTD.
Dorset House, Stamford St., London, S.E.1. w.w.1

NUMBERED ADDRESSES.

For the convenience of private advertisers, letters may be addressed to numbers at "The Wireless World" Office. When this is desired, the sum of 6d. to defray the cost of registration and to cover postage on replies must be added to the advertisement charge, which must include the words Box 000, c/o "The Wireless World." All replies should be addressed to the Box number shown in the advertisement, c/o "The Wireless World," Dorset House, Stamford Street, London, S.E.1. Readers who reply to Box No. advertisements are warned against sending remittance through the post except in registered envelopes; in all such cases the use of the Deposit System is recommended, and the envelope should be clearly marked "Deposit Department."

DEPOSIT SYSTEM.

Readers who hesitate to send money to advertisers in these columns may deal in perfect safety by availing themselves of our Deposit System. If the money be deposited with "The Wireless World," both parties are advised of its receipt.

The time allowed for decision is three days, counting from receipt of goods, after which period, if buyer decides not to retain goods, they must be returned to sender. If a sale is effected, buyer instructs us to remit amount to seller, but if not, seller instructs us to return amount to depositor. Carriage is paid by the buyer, but in the event of no sale, and subject to there being no different arrangement between buyer and seller, each pays carriage one way. The seller takes the risk of loss or damage in transit, for which we take no responsibility. For all transactions up to £10, a deposit fee of 1/- is charged; on transactions over £10 and under £50, the fee is 2/6; over £50, 5/-. All deposit matters are dealt with at Dorset House, Stamford Street, London, S.E.1, and cheques and money orders should be made payable to Liffe & Sons Limited.

SPECIAL NOTE.—Readers who reply to advertisements and receive no answer to their enquiries are requested to regard the silence as an indication that the goods advertised have already been disposed of. Advertisers often receive so many enquiries that it is quite impossible to reply to each one by post. When sending remittances direct to an advertiser, stamp for return should also be included for use in the event of the application proving unsuccessful.

Receivers and Amplifiers, Etc.—Contd.

BARGAIN.—Manufacturers' stock 1935 model 4-valve A.C. Band Pass sets, Mazda valves, handsome walnut cabinets, Rola speakers, complete, delivered free; £5/15; sent on seven days' approval.—Stott, Clare Hill, Huddersfield. [6670]

6-VALVE Superheterodynes, brand new, 1935 models, 14-2,000 metres range, D.C. or A.C. 6in. M.C. speakers, latest improvements, A.V.C., etc., 14in.x9 1/4in. x8in. list £25; a few left at 12 guineas.—No. 2, Twickenham House, Abingdon. [6669]

NEW Monoidal A.C. Super Chassis, with original monoidal power pack, trade assembled, Ferranti M.1 speaker, complete and working in console cabinet, also primistatic electrostatic speaker, best offer.—20, Woodland Avenue, Boscombe, Hants. [6664]

PUBLIC Address Amplifiers and High-quality Receivers.—Amplifiers, A.C. mains, and A.C./D.C. from £13; receivers (6-valve), 5 watts output, from £12; trade supplied; deferred terms.—D. E. Clarkson, B.Sc (Eng.), 10, Park Rd., Wallington, Surrey. Phone: Wallington 3953. [6668]

ARMSTRONG.—Latest 5v. bandpass superheterodyne chassis, with fully delayed A.V.C., 7 highly efficient tuned circuits, bandpass input, Marconi Heptode frequency changer, combined 1st detector and oscillator, bandpass I.F. coupled to Marconi H.F. pentode, bandpass coupled to Cossor Double Diode, giving distortionless detection and A.V.C., resistance coupled to Mazda high slope pentode, Marconi bi-phase rectifier, full vision illuminated tuning, calibrated in wavelengths, combined radio and gramophone volume control, corrected pentode output, giving exceptionally good reproduction; £6/18/6, with valves, royalties paid. [6668]

ARMSTRONG Universal Superheterodyne, chassis works on A.C. or D.C. mains, specification as superheterodyne model above; £5/18/6, complete with valves, royalties paid. [6668]

ARMSTRONG Senior Universal A.C./D.C. Chassis, 3 tuned circuits, full bandpass tuning, 3 1/2 watts double pentode output, massive construction, with valves; £5/18/6. [6668]

ARMSTRONG A.C.4 Chassis, incorporating 3 pentodes, 3 tuned circuits, full band-pass, 3 watts output; £5/18/6, with valves. [6668]

ARMSTRONG Latest 4v. Battery Chassis, 2 screened stages, 3 tuned circuits, single knob tuning, full vision dial calibrated wavelengths, good selectivity with exceptional pulling power; £4/10, with valves. [6668]

ALL Armstrong Chassis are Constructed of the Highest Grade Components Throughout, carry 12 months' service free guarantee, and are sent on 7 days' approval, carriage paid. [6668]

ARMSTRONG MANUFACTURING Co. 100, King's Rd., N.W.1. Phone: Gulliver 3105. [6668]

DEGALLIER'S Offer Brand New Midget Receivers, every one guaranteed, carriage paid; cash with order or c.o.d.; s.a. envelope with all enquiries; every one complete with valves and speaker, working off A.C. and D.C., 100-130 or 200-250 volts, with adaptor supplied; Emerson 5-valve L and M wave, pick-up terminals, in handsome walnut cabinet (10 1/2 x 7 1/2 x 5 1/2), at £4/6/3; the same, suitable for experimenters, less cabinet, at £3/13/6; Victor Midgets (last nine), in massively constructed walnut cabinet (14 x 10 1/2 x 8), 5-valve superhet, A.V.C., illuminated dial, in fact every refinement found in an expensive receiver, gets over 70 stations, list £15/15, at £6/10; Spartan 6-valve superhet, gets over 80 stations, all refinements as in Victor, at £7/10.—Degallier's, No. 6, Coryton House, 21, Upper Marylebone St., London, W.1. Museum 7795. [6672]

Receivers and Amplifiers, Etc.—Contd.
£5/5—Band pass 4-valve chassis by Plessey, Magnavox m.c., complete with valves, in high class walnut or oak cabinet, either A.C. or D.C.; ditto radiogram, £7/10; c.o.d., carriage forward.—Kay, 167, City Rd., London, E.C.1. [6619]

ACCUMULATORS—BATTERIES.
MILNES H.T. Units, all units and speakers in stock; spares, service; demonstration free.—Pearce, 30, King's Cross Rd., W.C.1. [6685]

BATTERY Drudgery Abolished, astounding results, particulars and battery log book free.—Instantbrite, Peebles Works, London, N.W.6. [6587]

MAINS EQUIPMENT.

V. VORTEXION Specified Olympic S.S. 6 Transformer, S.S.352, 5 years' guarantee, 25/-; less terminals and guarantee, 21/-; power chassis, £3/17/6; choke, 12/6; Single Span model, 25/-; power chassis, £3/10.

VORTEXION—Quality Amplifier or Super Monodial, 425-0-425, 120 m.a., 4v. 6-8a. C.T., 4v. 3a. C.T., 4v. 1a., 4v. 1s., super shrouded, core size 2 1/4 in. x 1 1/4 in., 2 1/2% regulation primary engraved insulated terminals; weight 14lb., 26/-, carriage 2/-; normal shrouded, 22/-; open type, 20/-, post 1/3; speaker field replacement choke, 16/-; special output transformer to "W.W." specification, 12/6, post 9d.; state valve and speaker; "W.W." universal output transformer, £1; normal 40h. 50 m.a. primary output transformers, 10/6, post 9d.

VORTEXION 7.30h. 120 m.a. Choke, 215 ohms, in die cast shrouding to match; 12/6.

IMITATED, but unequalled. Good enough for a "Wireless World" specification is good enough for you.

VORTEXION Cost Little More than the Cheapest, but unequalled by the dearest.

VORTEXION Standards Despatched by Return.

VORTEXION A.C./34, used by author in construction of A.V.C. Three, as illustrated; 18/-.

GUARANTEED 12 Months, and within 5% normal and 2 1/2% super models, neat shrouding, with detachable feet, as used by Government Departments, etc., etc., any model guaranteed 5 years at extra cost of 2/-.

ALL Secondaries Centre Tapped.

VORTEXION—250-0-250 60 m.a., 4v. 1 to 2a., 4v. 2 to 4a., open type, 10/-; shrouded, 12/6; post 9d.

VORTEXION—Ferrocart III 350-0-350, 60 m.a., 4v. 2.5 C.T., 4v. 3.5 C.T.; open type 13/6, shrouded 16/-; post 9d.

VORTEXION—Super model for H.T.8 or 9 or 10, 4v. 1 to 2, 4v. 2 to 4, open type 14/6, shrouded 16/6; post 1/-.

VORTEXION—350-0-350, 120 m.a., 4v. 2 to 5a., 4v. 2 to 4a., 4v. 2.5a.; open type 14/6, shrouded 16/6; super shrouded model, weight 11lb., 4 filaments to specification, 21/-; post 1/3.

VORTEXION—400 or 450 or 500v. 120 m.a., 4v. 2 to 5, 4v. 2 to 5, 4v. 2.5a.; open type 19/-, shrouded 23/-.

VORTEXION—400 or 450 or 500, 150 m.a., 4v. 4a., 4v. 2.5, 4v. 2, 4v. 2, 4v. 2, core size 2 1/4 x 1 1/4 in., a super job, 2% regulation, 35/-; shrouded, with terminals; less terminals, 30/-; open type, 26/-; post 1/3.

VORTEXION Auto Transformers to B.E.S.A. Specification, 100, 110, or 120v. to 200, 220, or 240 volts, 60 watts, 9/-; post 9d.; 120 watts, shrouded 12/6, open type 10/6, post 1/-; 200 watts, shrouded 16/6, post 1/-; 2,000 watts, £4/10.

VORTEXION 1,000-watt Transformers; £4/10, carriage free.

VORTEXION 30h. at 60 m.a. Chokes, 5/6; 40h. at 60 m.a., 8/6; 30h. at 150 m.a., 200 ohms, 10/6 open type, 12/6 shrouded.

VORTEXION Transformers Made to Your Specification; price according to wattage, 6v. filaments same price unless wattage grossly exceeded; special quotations by return.

VORTEXION (S. A. BROWN), 182, The Broadway, Wimbledon, S.W.19. Tel.: Liberty 2814. [6561]

HOYNE'S Transformers are Manufactured by Engineers with 14 Years' Experience in Radio Transformer Design.

HOYNE'S Transformers, fitted with tapped and screened primaries, filaments, all centre tapped, stout cast aluminium clamps and clearly marked terminal strips are fitted to all models, write for list.

HOYNE'S Components are Guaranteed for One Year; one type only manufactured, the best, as used by many well-known set manufacturers after testing all others.

HOYNE'S—"W.W." transformers would strictly to specification of author; "W.W." test reports, June 22nd: "The insulation is particularly good throughout the transformer is satisfactory in all respects."

HOYNE'S—Push-pull quality amplifier transformer, 25/-, post 1/3; 7/30 henrys choke, 9/6, post 9d.; 20 henrys, 7/6, post 9d.

HOYNE'S—Single span, 15/-, post 1/-; choke, 10 henrys, 7/6, post 9d.

HOYNE'S—Everyman A.C. super transformer, 12/6, post 1/-; choke, 10 henrys, 7/6, post 9d.

HOYNE'S—A.V.C. Straight Four transformer, 18/-, post 1/3; choke, 26 henrys, 12 m.a., 140 ohms, 9/6, post 9d.

HOYNE'S—Push-pull quality amplifier, complete to "W.W." specifications, wired and fully tested, less valves, £5/12/6; complete kit of components including metal chassis, £5/2/6; field replacement choke, 1,250 ohms, 13/6, post 1/-; output transformer, 12/6, post 1/-.

HOYNE'S—250-0-250v. 60 m.a., 4v. 1 to 2a., 4v. 2 to 4a., 10/-, post 9d.; with extra 4v. 1 to 2a. winding, 12/6, post 1/-.

HOYNE'S—Ferrocart III, 350-0-350v., 60-70 m.a., 4v. 2 to 3a., 4v. 2 to 4a., 12/6, post 1/-; with extra 4v. 1 to 2a. winding, 13/6, post 1/-.

HOYNE'S—350-0-350v., 120 m.a., 4v. 2 to 3a., 4v. 4 to 6a., 4v. 1a., 4v. 1a., 18/-, post 1/3.

HOYNE'S—400 or 450 or 500v., 120 m.a., 4v. 2 to 3a., 4v. 2 to 5a., 4v. 1 to 2a., 18/-, post 1/3.

HOYNE'S—500-450-0-450-500v. 140 m.a., 4v. 2 to 4a., 4v. 4 to 6a., 4v. 2a., 4v. 2a., 27/6, post 1/3; weight 11lb.

HOYNE'S Transformers, built to specifications, keenest prices, best materials and workmanship; quotation by return.

M. J. HOYNE, ALL-POWER TRANSFORMER, Ltd., Offices and Works, 8a, Gladstone Rd., Wimbledon, S.W.19. Tel.: Liberty 3303. [6488]



● Sturdy bon filaments for strength

● Cross-braced mesh anodes for cool working

● General factor of safety for consistent reliability

MARCONI rec

valves are designed with the widest ances and most robust electrode compatible with highest efficiency rectification, and can be relied upon consistency of characteristics throughout their long working life. There are directly and indirectly heated types every purpose.

POPULAR MARCONI RECTIFIERS

U10	Output 250V.	60 m.A.	P.
U12	"	325V.	120 m.A.
*MUI2	"	350V.	120 m.A.
U14	"	500V.	120 m.A.
*MUI4	"	550V.	120 m.A.

*With I.H. Cathode

★ A card to The Marconiphone Co. Ltd., Tottenham Court Road, W.1, will bring the comprehensive new catalogue of Marconi



THE CHOICE OF THE EXPERTS

THE NEW INTEREST IN RADIO.

If we were not whom we are, you might hear that HARTLEY-TURNER IS SWEEPING THE COUNTRY.

Being just ourselves, we express our gratification that the public is responding most admirably to our appeal to an "canned" reproduction and get down to the real thing.

HARTLEY-TURNER REPRODUCTION is different; it is so realistic.

SPEAKERS, KIT SETS, RADIOGRAMS and the BOFFLE are described in free illustrated literature.

"New Notes in Radio" Vol. 1, "The Speaker"; 3d. post free. (Vol. 2, dealing with the set, ready in about a fortnight.)

Hartley Turner Radio Ltd.

CHENBURY ROAD, ISLEWORTH, MIDDLESEX.
Telephone: HOUnslow 1854.

HARTLEY-TURNER SPEAKERS AND AMPLIFIERS

APPLIED ON EASY TERMS.

We specialise in the supply of this superb equipment on convenient terms. Please write for full particulars and quotation.

radio Apparatus supplied promptly on the lowest terms.
PRICE LIST FREE.

ON RADIO SUPPLY COMPANY
LANE, NOBLE STREET, LONDON, E.C.2.
National 1977. (Est. 1925).

MOBILITY

Essentially portable, the new M.25 mobile equipment has been designed to work direct from a car battery.

M.25 can be used anywhere—indoors or out, being quite independent of mains current.

At efficiency and low cost make M.25 of interest to all who appreciate quality sound amplification. Write or phone:

"The Sound People"

TANNOY

PRODUCTS
(GUY R. FOUNTAIN LTD.),
CANTERBURY GROVE,
WEST NORWOOD, LONDON, S.E.27.
Telephone: Streatham 4122 (6 lines), and Branches,
MANCHESTER: 2, Whitworth Street West,
Deansgate.

Valves.—Contd.

PREMIER SUPPLY STORES announce the Purchase of the Complete Stock of a World Famous Continental valve manufacturer, all the following standard main types fully guaranteed, 4/6 each; H., H.L., L. power, medium, high, low mag. and variable mu screen grids, one, three and four watt A.C. output, directly heated pentodes, 250v. 60 m.a. full wave rectifiers, D.C. types, 20v. 18 amp. filaments, screen grid H., H.L. power.

THE Following Types, 5/6 each: 350v. 120 m.a., full wave rectifier, 500v. 120 m.a., full wave rectifier, 2½ watt indirectly heated pentode.

THE Following American Types, 4/6: 250, 112, 171, 210, 245, 226, 47, 46, 24, 35, 51, 57, 58, 55, 37, 80.

THE Following Sizes, 6/6 each: 42, 77, 78, 25Z5, 36, 38, 83, 39, 44, 53, 6A7, 6B7, 2A5, 2A6, 2A7, 2B7, 5Z3, 6C6, 6A4, 6D6, 6F7; the following valve: 866, 25/-.

PREMIER SUPPLY STORES, 20 and 22, High St., Clapham, S.W.4. [6622

ALL Types of Brand New American Valves in Stock, only first-class makes such as Arcturus and R.C.A. stocked, guaranteed for 6 months, 247, 235, 551, 89, 18, 19, 46, 59, 6A7, 15, 42, 41, 38, 39, 78, 75, 57, 58, 224, 44, 36, 235, 83, 43, 5Z3, 12/-; 25Z5, 12Z3, 14/6; UX171, UX199, UX280, UX245, UX226, UX227, 7/6; UX250, UX210, UX281, 17/6; UX867 photocells, 25/-; all other types of American valves in stock; we also stock transmitting valves, post paid, cash with order or c.o.d.

WARD, 45, Farringdon St., London, E.C.4. Telephone: Holborn 9703. [6517

COMPONENTS, ETC., FOR SALE.

M.R.E.

MILDMAY RADIO EXCHANGE offers the following, sound and perfect; cash with order or c.o.d.

SPECIAL Offer of G.E.C. "M.C.S." 3-valve Battery Operated Receivers, complete with valves and fitted with moving coil speaker in self-contained cabinets; limited number only; 57/6 each.

SPECIAL Offer Cossor 3-valve Screen Grid Receivers, complete with valves and moving coil speakers, in oblong type cabinets, type 342, pentode output: £3/15 each.

SPECIAL Offer Regentone A.C. Mains Units, type W5a, brand new and in sealed boxes, output 150 volts 20 m. amps., having 4 tappings, 2 variable, also trickle charger for 2-, 4-, or 6-volt accumulators, listed at £4/14; our price 39/-.

RADIOLAB Universal Set and Valve Tester, full voltage range from 10-1,000 volts, A.C. or D.C. mains, complete with all valve adaptors, for 4-, 5-, and 7-pin valves, listed at £12/12; our price £7/17/6.

FERRANTI Service Tester, £6/6 model, £3/7/6; Ferranti 0-250 volts A.C. meter, 27/6; Ferranti triple range A.C. meter, 0-2.5 volt, 0-25 volt, 0-250 volt, 37/6.

FERRANTI A.F.4, 7/6; A.F.3 10/6; A.F.5, 18/-; A.F.6, 18/-; A.F.7, 18/6; A.F.7c, 20/-; A.F.5c, 20/-; O.P.1, 1-1 ratio, 7/6; O.P.2, 25-1, 7/-; A.P.3c, P.P., ratio 1-1, 8/6; O.P.M.1, 10/-; O.P.M.2, 10/-; O.P.M.4, 12/-; O.P.M.12c, 7/-; O.P.M.17c, 8/6; B.8. chokes, 4/- each.

MCMICHAEL Duplex Four A.C. Mains Transportable Receiver, complete with valves and moving coil speaker in self-contained cabinet, no aerial or earth required, listed at £18/18; our price £7/15.

LEWCOS and Wearite Superhet. Coils, 4/- each; Colvern K61, K62, KGr, 12/-; Colvern K41, K42, KGr, 12/-; Colvern KMS1, KMS2, KMS3, 12/-.

COLVERN K21, K22, K23, 14/-; Colverdynes, 7/- each; Lewcos BPF, 4/-; Lewcos TOS/R, 4/-; pair Lissen I.F. transformers, 10/-.

SPECIAL Offer Ferranti B8 I.F. Chokes, inductance 10/35 henrys, resistance 850 ohms, current 50 m. amps.; offered at the very low price of 4/- each.

THE Above Post or Carriage Paid.

PHONE: Terminus 6751.

6, Pentonville Rd., near Angel, London, N.1. Two minutes King's Cross and Euston. Callers invited at our new shop premises. [6652

PREMIER SUPPLY STORES

ANNOUNCE a City Branch, at 165 and 165a, Fleet St., E.C. (next door to Anderson's Hotel), for the convenience of callers; post orders and callers to High St., Clapham.

OFFER the Following Manufacturers' Surplus New Goods at a Fraction of the Original Cost; all goods guaranteed perfect; carriage paid over 5/-, under 5/- postage 6d. extra, I.F.S. and abroad, carriage extra. Orders under 5/- cannot be sent c.o.d. Please send for illustrated catalogue post free.

STUPENDOUS Purchase of Set Manufacturers' Stock.—All electric 3-valve (S.G. det. pen.) set, in walnut cabinet, with moving coil speaker, 200-250 volt 40-60 cycles, chassis built, 200-2,000 metres, with 4 valves; £4/19/6.

ALL-ELECTRIC 3-stage Amplifiers, 200-250v., 40-60 cycles, 10 watts undistorted output, complete with 5 valves, and Magnavox Super 66 energised speaker; £10/10.

TYPE 4480, 9in. diameter, permanent magnet, handles 4 watts, 7 ohms speech coil, 13/6; multi ratio transformer, 4/6 extra.

ELIMINATOR Kits, including transformer, choke, and diagram, 120v. 20 m.a., 20/-; trickle charger, 8/- extra; 150v. 30 milliamps, with 4v. 2-4 amps C.T., L.T., 25/-; trickle charger, 5/6 extra; 250v. 60 milliamps, with 4v. 3-5 amps C.T., L.T., 30/-; 300v. 50 m.a., with 4 volts 3-5 amps, 37/6; 200v. 50 m.a., with 4v. 3-5 amps L.T., 27/6.

PREMIER Chokes, 40 milliamps, 25 hys., 4/-; 65 milliamps, 30 hys., 5/6; 150 milliamps, 30 hys., 10/6; 60 milliamps, 80 hys., 2,500 ohms, 5/6; 25 milliamps, 20 hys., 2/9.

ALL Premier Guaranteed Mains Transformers Have Engraved Terminal Strips, with terminal connections, input 200-250v., 40-100 cycles, all windings paper inter-leaved.

(This advertisement continued on next page.)

Components, Etc., for Sale.—Contd.

(This advertisement continued from previous page.)

PREMIER H.T.7 Transformer, output 135v. 80 m.a., for voltage doubling, 8/6; 4v. 3-5a., C.T. L.T., 2/- extra; with Westinghouse rectifier, giving 200v. 30 m.a., 17/6.

PREMIER H.T.8 and 9 Transformers, 250v. 60 m.a. and 300v. 60 m.a. rectified, with 4v. 3-5a. and 4v. 1-2a., C.T. L.T. and screened primary, 10/-; with Westinghouse rectifier, 18/6.

PREMIER H.T.10 Transformer, 200v. 100 m.a., rectified, with 4v. 3-5a., and 4v. 1-2a., C.T. L.T., and screened primary, 10/-; with Westinghouse rectifier, 19/6.

PREMIER Mains Transformer, output 250-0-250v. 60 m.a., 4v. 3-5a., 4v. 2-3a., 4v. 1-2a. (all C.T.), with screened primary; 10/-.

PREMIER Mains Transformers, output 350-0-350v. 90 m.a., 4v. 3-5a., 4v. 2-3a., 4v. 1-2a. (all C.T.), with screened primary; 10/-.

PREMIER Auto Transformers, 100-110/200-250v., or vice versa, 100-watt; 10/-.

WESTERN ELECTRIC Mains Transformers, 300-0-300v. 65 m.a., 4v. 1-2a., 4v. 2-3a., 6/6; 500-0-500v. 150 m.a., 4v. 3-5a., 4v. 2-3a., 4v. 1-2a., 4v. 1a. C.T., 4v. 1a. C.T., 19/6.

SPECIAL Offer of Mains Transformers, manufactured by Phillips, input 100-200v. or 200-250v., output 180-0-180 volts 40 m.a., 4v. 1 amp., 4v. 3 amps., 4/6; 200-0-200v., 4v. 1a., 4v. 3a., 4/6.

PREMIER L.T. Charger Kits, consisting of Premier transformer and Westinghouse rectifier, input 200-250v. A.C., output 8v. ½ amp., 14/6; 8v. 1 amp., 17/6; 6v. 2 amp., 27/6; 30v. 1 amp., 37/6; 2v. ½ amp., 11/-.

B.T.H. Truspeed Induction Type (A.C. only) Electric Gramophone Motors, 100-250v.; 30/- complete.

SPECIAL Offer B.T.H. Gramophone Motors, A.C. and D.C. 100-250v.; 30/-; listed £3/3.

COLLARO Gramo. Unit, consisting of A.C. motor, 200-250v. high quality pick-up and volume control, 49/-; without volume control, 46/-.

EDISON BELL Double Spring Gramophone Motors, complete with turntable and all fittings, a really sound job; 15/-.

SPECIAL Offer of Wire Wound Resistances, 4 watts, any value up to 50,000 ohms, 1/-; 8 watts, any value up to 15,000 ohms, 1/6; 15 watts, any value up to 50,000 ohms, 2/-; 25 watts, any value up to 50,000 ohms, 2/6.

CENTRALAB Potentiometers, 400 ohms, 1/-; 50,000, 100,000, ½ meg., any value, 2/-; 200 ohms, wire wound, 1/-.

POLAR STAR, manufacturers' model, 3-gang condensers, fully screened; 7/6, with trimmers; unscreened, 5/-.

AMERICAN Triple Gang 0.0005 Condensers, with trimmers, 4/11; Utility bakelite 2-gang 0.0005, screened, with unknob trimmer, 3/6; Polar bakelite condensers, 0.00035, 0.0003, 0.0005, 1/-.

ORMOND Condensers, 0.0005 2-gang semi-shielded, 2/6; brass vanes with trimmers, 3/6; British Radiophone 110 kc/s intermediate, 3/-.

MAGNAVOX D.C. 152, 2,500 ohms, 17/6; D.C. 144, 2,500 ohms, 12/6; D.C. 152 magna, 2,500 ohms, 37/6, all complete with humbucking coils; please state whether power or pentode required; A.C. conversion kit for above types, 10/-; Magnavox P.M., 7in. cone, 16/6.

RELIABLE Canned Coils with Circuit, accurately matched, dual range, iron cored; 3/6.

RELIABLE Intervalve Transformers, 2/-; multi-ratio output transformers, 4/6.

T.C.C. Electrolytic Condensers, 550v. working, 650v. peak, 8 ml., 4/-; 4 ml. or 8 ml. 440v. working, 3/-; 15 ml. 50v. working, 1/-; 25v. working, 25 ml., 1/3; 6 ml. 50v. and 2ml. 100v. working, 6d.; 8-4 ml., 450v. working, 4/-; 50 ml. 50v. working, 2/9; 2,000 ml., 12v., 7/6.

T.C.C. Condensers, 250v. working, 1 mf. 1/3, 2 mf. 1/9, 4 mf. 3/-; 4 mf., 450v. working, 4/-; 4 mf., 750v. working, 6/-.

DUBILIER Condensers, 8 or 4 mfd., dry electrolytic, 450v. working; 3/-; 4+4+2+0.1, 300v. working, 3/-.

VARLEY Constant Square Peak Coils, band-pass type B.P.7, brand new, in maker's cartons, with instructions and diagrams; 2/4.

VARLEY H.F. Intervalve Coils, B.P.8, band-pass, complete with instructions, in original cartons; 2/6.

SCREENED H.F. Chokes, by one of the largest manufacturers in the country; 1/6.

PREMIER British-made Meters, moving iron, flush mounting, accurate, 0-10, 0-15 50 m.a., 0-100, 0-250 m.a., 0-1, 0-5 amps; all at 6/-.

WESTERN Electric Condensers, 250v. working 1 mf., 6d.; 2 mf., 1/-; 4 mf., 2/-; 400v. working, 1 mf., 1/-; 2 mf., 1/6.

WIRE-WOUND Potentiometers, 1,000, 2,500, 15,000, 20,000, 50,000, 90,000, 120,000, 200,000, 500,000, 2/- each; 1,000 ohm. semi-variable, carry 150 m.a., 2/-.

COSMOCORD Pick-ups, complete with arm and volume control, a really good job; 12/-.

LARGE Selection of Pedestal, table and radiogram cabinets, by best manufacturers at a fraction of original cost, for callers.

THE Following Lines 6d. each, or 5/- per dozen.—Chassis valve holders, 5-, 6- or 7-pin, screened screen-grid leads, any value 1-watt wire resistances, wire end condensers 0.0001 to 0.1, Bulgin 3-amp. main switches, Cydon capacitors, double trimmers.

SUPER Moving Coil Speakers, handle 10 watts, energised directly from A.C. mains, manufactured by world famous radio and gramophone company; 40/-.

CONDENSER Blocks, 350v. working, 6+4+2+1+1, 4/6; 4+2+1+1+1+0.5, 3/9; 9+3+2, 3/-.

PREMIER SUPPLY STORES,
20-22, High St., Clapham, S.W.4. Phone: Macaulay 2188. Nearest station: Clapham North, Underground. [6681

SMOOTH, STEADY H.T.



essential for SHORT WAVE reception

Only with a steady source of H.T. can you hope successfully to receive the minute and critical short wave signals. Ever Ready Batteries will assure it for you. The freedom from hum and crackle and the smooth control of reaction that is so essential in short wave reception can be yours by relying on these world-trusted batteries.

THE EVER READY CO.

(Gt. Britain) LTD.

Hercules Place, Holloway, London, N.7.



Components, Etc., for Sale.—Contd.

R.

RYALL'S RADIO, 44, Lamb's Conduit St., London, W.C.1. Nearest tube Holborn; trams 53, 35 pass by. Off Theobalds Rd., quickest approach from Holborn, through Red Lion St., Holborn 3529. Open Saturday afternoon till 5 o'clock, Thursdays 1 o'clock. Hours 11 to 7 p.m.

VARLEY Pentode Nichokes, new, 7/6; R.I. 14/28H chokes, 10/-; second-hand Multitone 4-1 transformer, with graded pot., 14/-; Magna 142 D.C. speaker, 2500 ohms, 35/-; B.T.H. Senior pick-up, with volume control, 20/-; Simpsons' turntable, 20/-; Challis 500v. transformer, 20/-; Gambrell Novotone, type H, 50/-; Ferranti B8 chokes, 5/-.

WEGO, British, condenser blocks, containing 4x4 at 350 v.v., also 1x1x1x0.1x0.1 at 250 v.v., new, 5/- each; Wearite H.F. screened chokes, 2/-; T.C.C. dry electrolytic, 8x4, 400 v.v., 2/9; T.C.C., wet type, 3 mf., 3/3.

TURNER 505 Model 0.50 m.a. Meter, 20/-; Weston 425 type thermo ammeter, guaranteed 0-1.5a. R.F., £2; Ferranti Radio wattmeter, 0-50v. A.C., 2/10/50v., £5; Weston 301 type, 0-15 amps., 15/-; Weston 0-500 m.a., bakelite case, 20/-; Weston pin jack, D/R, 6-200v., 20/-; Hunts' flush 0-20 m.a., 15/-; Hunts' 0-200 m.a., 15/-; Weston centre zero, bakelite cased, 0-100 m.a., 20/-; Sifam 0-300 m.a., 15/-; Turner flush 0-100 m.a., with cut-out, 2½in. type, 15/-; Weston 301 type, 0-100 m.a., £1.

GECOPHONE 3-1 Nickel Core Transformers, listed 21/-, 5/9 to clear; Varley 500,000 ohm wire wound resistances, 3d.; Belling Lee Unit pick-up, new, 17/6; Lewcos S.W. intermediates, 4/-; pairs new Polar thumb drive 0.0005 condensers, with double escutcheon plate, 7/6 pair to clear; Garrard Junior B D/S motor, with unit plate, etc., new, 15/-.

RYALL'S RADIO Offer British-made Mansbridge Condensers, metal cased, brand new, fully guaranteed, 1 mf., 400 v.v., 1/3; 2 mf., 400v., 1/6; 4 mf., 400 v.v., 3/-; 4 mf., 750 v.v., 6/-.

READY RADIO 0.0005 Extensor Condensers, new, 2/6; Vagerphone S.G./Det./Pen. and rectifier chassis, with valves, complete, 65/-; Radiophone Bandpass superhet coil packs, 8/9, post 9d.

FERRANTI A.F.5, 16/6; A.F.7, 16/6; O.P.M.1, 10/-; O.P.M.1c, 15/6; O.P.M.16c, 15/6; O.P.4c, 7/6; O.P.M.11c, 15/6; O.P.3c, 1-1-P.P., 5/9.

HEATBERD W31, with H.T.S. new, 30/-; H.T.7, new, with second-hand R.I. transformer, with 4v. 6 amps., 22/6; Ultra Panther console, £12/12.

POLAR Minor 3-gang Condensers, with "Arcuate," or "Semi Circular" drive, new, list 24/6, 14/6; set three Radiophone coils on base with switch, B.P. Superhet 8/9, post 9d.; Radiophone Radiopaks 2H.F., with volume control, 32/6, post 1/3.

RYALL'S RADIO Offer Reliable Resistances, suitable for all sets where a 1-watt resistance is specified, in values 100, 150, 250, 400, 500, 600, 1,000, 2,000, 5,000, 10,000, 15,000, 20,000, 25,000, 30,000, 40,000, 50,000, 75,000, 100,000, 150,000, 250,000, ½ meg., 1 meg., 2 meg., all values stated in ohms, 4d. each; also 2-3-watt type 400, 700, 800, 1,000, 4,000, 5,000, 6,000, 10,000, 20,000 9d. each, wire ends.

RADIOPHONE Volume Controls with Switch, 5,000, 10,000, 15,000, 20,000, 35,000, 100,000, 2/6; also 10,000 graded 9-1 with 3-P. switch, 25,000 graded 9-1 with 2-P. switch, 3/6 each.

WIRE, new Knifetown, etc., ½lb. reels, 16S.W.G. En., 8d.; ½lb. 18S.W.G. C.C., 8d.; ½lb. 26S.W.G. En., 9d.; ½lb. 32S.W.G. C.C., 1/-; ½lb. 30S.W.G. En., 8d.; 2oz. 30 and 32 C.C., 6d. each.

NEW Garrard No. 11B D/S Motors, 12in. turntable and fully automatic unit plate, all fittings included; less than half price, 20/-.

PAIR Magnacore Class B Universal Driver and Output Transformers, new, 8/9; latest type Hypermn, 10/-; R.I. 250 m.a. output transformer, 15/72-1 second-hand, 12/6; Marconi 250 m.a. output transformer, ratio 8-1, also "line" winding, 15/-; special Parmeko transformer, section wound, primary 200 ohms, secondary 25,000 ohms, 10/-.

T.C.C. 0-1 Non-inductive Tubular Condensers, 10d. each, 350v.; T.C.C. electrolytic 15 mf., 50v. 1/4, new; T.C.C. 0.01 mica, type M, 1/-; T.G.G. 0.0001, type M, 5d.; H.M.V. condenser blocks, 250v. working, 4x4x1x1½ mfd., 4/-; T.C.C. 0.1x0.1, 450v. working, 1/6; T.C.C. 8 mfd., electrolytic, 500v. working, 4/-; Dubilier 2 mid., 250v. working, 1/6.

UNIKNOBS, Polar 2-gang, new, brown, 8/-, with cover, 9/6; R. and A. type output transformers, 18-23-32-1, new, 5/-; Paxolin formers, with guides, 1in., 8d.; R.I. Hypermite transformers, 6/-, second-hand; R.I. Parafed transformers, 5/-, second-hand.

RADIOPHONE Disc Drives, less escutcheon, fit ½in. spindle, read 0-100 from left to right; 1/6 post free.

NEW Lotus D.C. 2v. Sets, D.C. 2/H.L., with D.C. 2/Pen., sensitive and selective original make; £4/10.

R. [6679]

1/6—Cadmium plated chassis, 4-valve, pressed steel, 14x9; post 6d.

4/9—200/250 transformers for H.T.8 or H.T.9, brand new in cartons.

1/9—Viking dual aperture dial in station and degrees with large bronze escutcheon and walnut knob, list 8/6; ditto British Radiophone drum drive, 2/3; cash with order, postage paid.

12/6—Conversion transformer, 20/300 A.C. input, 220v. output 120 watt; 12/6, Everett and Edgecumbe A.C. voltmeter, 0/250, with resistance block; 2/6, G.E.C. 15 amp. ironclad switch and fuses; complete outfit in metal case, 25s.

20/-—A.C. supply unit for P.A. loudspeaker, 400v., 100 m.a., suitable for amplifier mains unit.

27/6—Ediswan D.C. all-electric S.G., detector and Pentode, complete minus valves, breaks up to 50/- worth of parts or converts to A.C.; c.o.d., carriage forward.—Kay, 167, City Rd., London, E.C.1. [6620]

PEARL and PEARL Bargain List A Free—190, Bishopsgate, London, E.C.2. [0421]

TRAINED MEN WANTED

Trained radio men are constantly needed. We give the training that brings success. We have done so for others; we can do the same for you.

Study at home and qualify for well-paid radio work. Our training is praised and recommended by leading radio manufacturers and the Technical Press. Our students write to thank us for helping them to get well-paid employment and promotion.

You cannot hope to succeed unless you know radio thoroughly. You cannot just "pick it up." You must be trained by radio experts who know the sort of knowledge you need. We can put you on the road to success.

TURN YOUR SPARE TIME INTO MONEY

If you do not require full-time employment, we can train you to earn money in your spare time. Set designing, inventing, installation, maintenance, servicing, set building, and many other interesting occupations can bring you in additional money without interfering with your ordinary work. Make your hobby pay; we will teach you how.

Are you ambitious? If so, send at once for free copy of our latest Prospectus and learn how we can train you for success, as we have trained others.

TECHNICAL AND COMMERCIAL RADIO COLLEGE

Cromwell House, High Holborn, London, W.C.1

Post in unsealed envelope, 3d. stamp.

To: T. & C. Radio College, Cromwell House, High Holborn, London, W.C.1.

Please send me free copy of your latest Prospectus

Name.....

Address.....

W.W.11.

Add **70** SHORT-WAVE STATIONS to your log!

An Ealex Short-Wave Converter makes your set an All-Wave Receiver.



Fit an Ealex Short-Wave Converter to your set and know the joys of all-wave all-world radio! There are over 70 stations broadcasting on the short and ultra-short wavebands. Their programmes are yours for the asking—if you fit an Ealex Short-Wave Converter. Simplicity itself to fit and to operate.



Write for full details and copy of booklet C.8. Prices from 52/6

J. J. EASTICK & SONS, 118, BUNHILL ROW, LONDON, E.C.1 (Met. 0314, 6 lines.)

Components, Etc., for Sale.—Contd.

- MONEY** Back Satisfaction Guarantee.
- ALL** Goods Supplied by Olympia Radio, Limited, carry the above guarantee.
- DECONTROLLED** Models.
- EKCO** S.H. 25 Chassis only, complete with valves and speaker, brand new, a wonderful job; our price, £6/15.
- BEAUTIFUL** Walnut Cabinet to Suit the Above Chassis; our price, 25/-
- EKCO** Model 74 Console Superhet, beautiful walnut cabinet, absolutely complete, ready to work from A.C. mains, list price 18 guineas; our price, 13 guineas.
- MARCONI** 2 Valve Battery Receiver, self-contained speaker, all batteries, complete with Marconi valves, H.T. and A.C., list price 4 guineas; our price, 42/6.
- MCMICHAEL** Twin Suprovox 4 Valve A.C. Bandpass Receiver, Westinghouse rectifier, twin energised speaker, interference switch, etc., list price 18 guineas; our price, 13 guineas.
- COLUMBIA** 4 Valve Screen Grid Battery Receiver, complete with all valves and batteries, a remarkable job, list price 16 guineas; our price, £9/5.
- LISSEN** 2 Valve All-electric A.C. Receiver, self contained speaker, beautiful Bakelite cabinet, all complete, just ready to plug in, list price 8 guineas; our price, £3/19/6.
- SPECIAL** Bargain.—Atlas P.M. moving coil speakers, output transformer suitable for pentode or power valve, an astounding bargain, list price 42/-; our price, 14/11.
- THE** Above is only a Small Selection from our Thousands of Receiver and Component Bargains.
- SEND** Your Requirements, we will quote; write for lists, post free on application.
- TERMS**, cash with order, or c.o.d., we pay carriage; everything guaranteed O.K. or money refunded; please mention this paper when replying
- OLYMPIA** RADIO, Limited, Mail Order Dept., 49a, Shudehill, Manchester. Branches in all principal towns. [6640]
- MAINS** RADIO DEVELOPMENT Company.
- M. R. D. Co.** Offer the Following Guaranteed Goods, M. carriage paid or call.—Phone: Tudor 4046. New season list now ready.
- MERSON** 8 mfd. Electrolytics, 500v. peak working, 2/6; T.C.C. 0.1 mfd. condensers, 250v. working, 6d.
- TUBULAR** Condensers, new, wire ends, 800v. test, 0.01, 0.02, 0.05, 0.1 mfd., 6d.; 0.25, 0.5 mfd., 8d.
- KOESTER-BRANDES** H.F. Chokes, high inductance, 6d.; Polymet 0.0001, 0.0002 mfd., 2d.
- DALY** Bakelite L.F. Transformers, terminals, 3-1, 5-1, 1/9; A.T.C. 4 mfd. 350v., working, new, 2/-.
- CYLDON** Capacitors, list 1/9, 6d.; Radiophone toggles, 6d.; Godwinex 5-pin baseboard Bakelite v-holders, 4½d.
- CHASSIS**, cadmium plated three valve, 1½ in. x 7 in. x 2½ in., 1/- chassis v-holders, 4-pin, 1½d.; 5-pin, 2d.; 7-pin, 5d.
- ELECTRAD** Midget Potentiometers, 100,000, 500,000 ohms, 10d.; Rotorohm 10,000 ohm with switch, 1/8.
- FRANKLIN** One Watt, wire wound colour coded resistors, 100 to 100,000 ohms, 4d. each; 3/6 per dozen.
- MAINS** RADIO DEVELOPMENT Company, 4-6, Muswell Hill Road, London, N.6. [6649]
- WOBURN** RADIO Offer Following Bankrupt Stock:—
- POLAR** Midget Condensers, new type, boxed, 0.0005 fully screened, with trimmers, 2-gang 6/6, 3-gang 9/9; Arcuate drives, with lamp holder and escutcheon, 4/-.
- RESISTANCES**—Bargain parcels of 13 wire wound resistances, 1½ watt, made by Truwind, accurate to 1%, values 100 ohms to 100,000; 3/9.
- FORMO** 2 mfd., 1,000v. test, bakelite, 1/3; Wego, 750v. test, 1 mfd. 1/-, 2 mfd. 1/3, 4 mfd. 2/3; tubulars, 0.01, 0.02, 0.1 6d., 0.001, 4d.; Polymet 0.0001 tags, 1/- half dozen; Telsen Tag condensers, boxed, 0.002, 0.0001, 0.0002, 0.0003, 4d.; chassis valve holders, 4-5 pin, 1/3 half dozen; toggles 6d.; Edison condensers, 0.005, 0.006, 3d.; British Radiophone curved drives, with escutcheon and light, 3/9; Columbia L.F. transformers, 3-1 and 5-1, 2/9; Class B drivers and chokes, 8/6 pair; with B.V.A. valve and 7-pin holder, 17/-; Eston iron cored coils, 2/6; Popular iron cored canned coils, 2/6; J.B. condensers, 0.0005, with drive and escutcheon, and light, 3/6; 3-gang condensers, 0.0005, with trimmers, 6/6.
- WESTERN** Electric Microphones, very sensitive, 2/3; microphone transformers for above, ratio 85-1, 2/3; Marconi microphone transformers, ratio 100-1, 3/6; H.F. chokes, snap type, 10d.; binocular chokes, 1/2; S.W.H.F. chokes, 10d.; Wego interference eliminators, few only, 3/6; Westinghouse H.T.9, 8/11.
- W.R.C.** Eliminators, 150v. 30 m.a., 3 positive H.T. tapings, all guaranteed 12 months: D.C. model, 9/6; A.C. model, 21/-; A.C. model with trickle charger (2v. 4v., or 6v. 5 amp.), 32/6 (carriage 1/- extra on all).
- TRADE** List Now Ready, kindly enclose trade heading and stamp.
- WOBURN** RADIO Co., 9, Sandland St., Bedford Row, W.C.1. Holborn 7289. [6554]
- 45/-** Will Buy a Brand New Celestion £6/10 PPM79 De Luxe P.M. speaker (with universal transformer), complete in handsome walnut, mahogany or oak cabinet; this is indeed a remarkable bargain!—Below.
- 13/9** Will Buy New Celestion 37/6 Energised Speaker, 2,500 ohms, 8 in. cone, universal transformer with terminals.—Below.
- 13/6** Will Buy New 22/6 Cosmécord 1934 Pickup, with balanced tone-arm, volume control, rest, etc.—Below.
- EPTON**, 93, New Road, Chingford, E.4. (Cash with order or c.o.d.) [6614]

RADIO DATA CHARTS

A SERIES OF ABACS

providing most of the essential Data required in Receiver Design

By

R. T. BEATTY, M.A., B.E., D.Sc.

Reprinted from "The Wireless World"

(1930)

"Radio Data Charts" provide designers of wireless apparatus with a ready and convenient means of solving problems without having recourse to complicated formulæ and mathematics.

By the use of the charts it is possible to tackle all the more familiar problems in radio receiver design, such as, for example, finding the relationship between inductance capacity and frequency, and working out the design of high frequency transformers. All keen amateurs will appreciate this helpful book.

(39 CHARTS and more than 50 Diagrams)

Price 4/6 net

By post 4/10

Published from the Offices of "THE WIRELESS WORLD"

From all leading booksellers or direct from the Publishers

ILIFFE & SONS LTD. Dorset House, Stamford St., London, S.E.1

W.W.93

Components, Etc., for Sale.—Contd.

SOUTHERN RADIO'S Bargains—Set manufacturers' guaranteed surplus.

VARIABLE Condensers.—Lotus 3-gang 0.0005, 12/6; Lotus 2-gang, 0.0005, 8/6; Lotus Dyblock single, 0.0005, 4/9 (list 9/6); all these condensers are complete with dials, escutcheons, knobs, fully screened with trimmers and boxed; Dubilier 4 mfd. (2+1+1), 1,000v. D.C., 2/9; 4.5 mfd. (2.25+2.25), 1,000v., for mains noise suppression, 3/-; Utility Midget 2-gang variable condensers, 0.0005, with concentric trimmers, 3/5; T.C.C. 0.1x0.1, 1/3 each.

S.T.400 Kits, all specified proprietary components; £2/19/6 (list £4/17/6).

REGENTONE A.C. Eliminators, type W.5A., combined with trickle charger, 20 milliamperes, brand new and sealed, 39/6 (list £4/12/6); Ekco trickle chargers, T.C.1, charging 2, 4, 6 volts at 1/2 amp., 20/- each (list £2/7/6).

IGRANIC Superhet Coils, set of 4 (1 Osc., 2 I.F., with pigtails, 1 L.F. plain); 12/6 (list 50/-).

LISSEN Superhet. 3 Coils Kit, screened, ganged on base with wave change and filament switches; type L.N.5181, for battery or mains; 12/6 (list 30/-).

VARLEY Constant Square Peak Coils, complete with all accessories, new, boxed, B.P.5; 2/4.

FRAME Aerials.—Lewcos dual wave superhet.; 9/- each (list 27/6).

PICK-UPS—Marconi No. 19 (1934), 22/6 each (list 32/6); model 25 (1935), 24/- each.

READY Radio Instantam Transformers, for matching any valve to speaker; Junior model, ratios 1:2, 1:1, 1 1/2:1, 2:1, 3:1, 7/6 (list 27/6); Senior model, ratios 10:1, 12 1/2:1, 14:1, 16:1, 20:1, 25:1, 12/6 (list 37/6).

LISSEN 2-valve A.C. Sets, Universal model, type L.N.8014, for 100-250 volts, complete with valves and speaker, in attractive bakelite cabinet, £2/19/6 each (list £6/6); D.C. model, L.N. 8012, 200-250 volts, as above, £2/19/6.

BOTOLPH Lightweight Portable Receivers, complete with valves, Exide batteries and accumulator, over all size 13in.x11in.x8in.; £2/19/6 (list £8/8); a real suitcase portable.

G.E.C. Osram "Four" A.C. Sets, with 4 Osram valves, floor cabinet and moving coil speaker; brand new; ready to switch on; £6/15 (list £15/15).

SPECIFIED Cabinets for Ready Radio Meteor and "303" Kits; 14/- each.

MISCELLANEOUS—Westinghouse metal rectifiers, H.T.6, 7, 8, 9/3 each; Ferranti chokes, 20 henry 60 m.a., 6/9 each; Lewcos superhet., 8-way bases, complete with valve holders, grid leak, fixed condenser, type "48," 2/- each; Lissen base turntables, 1/6 (list 5/4); Lewcos coils, B.P.F./R., 4/-; T.B.F./C., 3/3; O.S.C./126 (Extensor), 3/3; T.O.S./R., 3/3; Morse tapping keys, with buzzer and flashlight signal, complete with battery and bulb, 2/- each; Lissen general purpose output chokes, 28 henrys, 20 m.a., and 18 henrys 60 m.a., type L.N.5301, 6/- each (12/6 list); Igranic resistance-fed transformer units, 4/6 each (list 10/6).

ALL Goods Guaranteed and Sent Carriage Paid.

BRANCHES at 271-275, High Rd., Willesden Green, N.W.10, and at 46, Lisle St., W.C.2. Please send all post orders to 325, Euston Rd., N.W.1.

SOUTHERN RADIO, 323, Euston Rd., London, N.W.1 (near Warren St., Tube). 'Phone: Museum 6324. [6675]

TELE-RADIO Have Purchased Manufacturers' Surplus; same are being sold at ridiculous prices.

WESTINGHOUSE Rectifiers.—H.T.7, H.T.8, 9/3; H.T.9, 9/6; H.T.10, 10/9; L.T.2, 9/3; L.T.4, 11/3; L.T.5, 11/9; transformers for same from 7/11.

DUBILIER Resistances, 1 watt, wire ends; all sizes in stock from 100 ohms to 2 megs., 7d.

CENTRALAB Resistances, 1 watt, 5d.; auto transformers, step-up or step-down, 100v. to 250v. or vice-versa, 60 watt 10/-, 100 watt 12/11.

A.C. Eliminators, input 200-250v., 150v. 25 m.a., finished in neat crystalline case, 3 positive tapings, fully guaranteed, 19/11, 1/- postage; D.C., 150v. 25 m.a., 10/11, 1/- postage.

A.C./D.C. input, 200-250v., any supply, output 150v. 25 m.a., no switches, 24/11, 1/- postage.

VITAVOX Public Address Speaker, complete with Monitor horn, handles 12 watts undistorted output comfortably, wonderful quality job; £7/15.

M.L. D.C. Generator, input 200-250v. D.C., output 1,000v. 125 m.a., perfect for transmitter or F.A. work, with all smoothing; £5/10.

MAINS Transformers, fully guaranteed 12 months, input 200-250 A.C., 350v.-0-350v. 60 m.a., 4v. 2.5 amp., 4v. 5 amps., screened primary; 13/6.

10 HENRY 120 m.a. L.F. Chokes, 7/11; we can supply any mains transformer or L.F. choke to your own specification, 3-day delivery, all with 12 months' guarantee.

HEAYBERD 3 Transformers, input 200-250v., output 6v. and 8.5v. 1.5 amps., for speaker field, or charger; 8/11.

WE Have a Large Stock of Microphones and Meters by Weston, Ferranti, Turner, also input and output transformers; send us your requirements and send for our full lists; "we are cheaper."

ALL Goods Sent Carriage Paid (except when marked), c.o.d., or cash with order; prompt delivery; part exchange arranged.

TELE-RADIO SUPPLIES, 305, King's Rd., S.W.3. Flaxman 9710. [6660]

COLPAK Model H, unused, £2; Kolster Brandes Universal Gramo turntable, £1.—25, Beaufort Mansions, S.W.3. [6657]

FOR Sale.—Avominor, Pifco electrometer, Pifco battery meter, Multitone Ferranti A.F.5, as new.—Rees, Station, Omore Vale, Glam. [6641]

SHAFTESBURY SUPPLIES

London's Leading Clearing House have some AMAZING OPPORTUNITIES for PUBLIC ADDRESS EQUIPMENT, Etc.

Full approval or cash refunded. All goods carriage paid.

TRUVOX AND **VITAVOX** P.A. M/COIL HORN UNITS, 6 volt field. Standard union. Guaranteed as new, 25 only at 55/- each. **TRUVOX** HORNS to suit above (slightly soiled, callers only), 28/6. Also a few outside Logarithmic Horns, 5ft. Flare, at 30/- each ex depot. G.E.C. 1552 25-watt A.D. **POWER AMPLIFIERS** for 200/250 v. A.C. mains, reconditioned by G.E.C., with 3 new Osram Valves, complete £25 equipment for £5 only. G.E.C. 3182a 50-watt A.D. **POWER AMPLIFIERS** as above, complete £48 equipment with 5 new Osram Valves and trestle stand, £11 only. **MICROPHONE PRE-STAGE AMPLIFIERS** (G.E.C.) with mains transformer and rectifier for A.C. mains 200/250 v., £4/10/-.

These magnificent Amplifiers are sold in perfect order as new and early application is essential. **D.C. GENERATORS** (B.T.H.) 2,000 r.p.m., Output 720 v. 140 m.a., 32/6. **LARGE OUTPUT TRANSFORMERS**, W.V. Specification, 12 ratios from 11:1 to 75:1. Prim. C.T. for P.P. Minimum loss, weight 7 1/2 lbs., brand new, 25/-.

MAINS TRANSFORMERS for W.W. qual. P.P. Amplifier, guaranteed exact spec. (usually 50/-), a few at 25/-.

The **SHAFTESBURY PUBLIC ADDRESS MICROPHONE** is the finest FULL SIZE Senior instrument obtainable. "Wireless World" says: "In every way a first grade instrument—low noise level with high gain—exceptionally good value—very best workmanship." Full technical data and illustrations of Microphone and Stands on request.

55/-

Post Free U.K.

UTILITY 3-Gang 0.0005 CONDENSERS, S.het and Standard, with trimmers, cover drive, etc., 9/6. **UTILITY 2-Gang, 3/11. POWER CHOKES**, 20 henry with 120 m.a. passing, Res 320 ohms, 8/6. 20 henry 75 m.a., 4/11. **MAINS TRANSFORMERS** ex famous makers, 300/300 65 m.a., 4 v. 3 a., 4 v. 2 a., 5/3. Also 250/250 60 m.a., 4 v. 4 a., 4 v. 1 a., fine job, cast brackets, 7/11. Step-down 200/250 to 7, 11 and 15 v., 3 amps., 9/11, also to 3, 5 and 8 v., 0.5 amp., 3/9. **WESTINGHOUSE L.T. RECTIFIERS**, 6 v. 0.5 amp., 4/6. **TRICKLE CHARGER KITS**, Transformer, Westinghouse Rectifier, Chassis, etc., with full instructions, 8/11. **TRIOTRON SEN. M/COIL SPEAKERS**, Perm Mag., 9 inch dia., massive magnet, 75/- model for 29/6. **B.T.H. GRAM. MOTORS**, entirely complete, for 100/250 v. A.C. or D.C., 3 Gns. model for 32/6. **PAILLARD GRAM. MOTORS**, for 100/250 v. A.C. or D.C., complete and new £5/15/- model for 42/-.

NEW BARGAIN LIST now available—GET YOUR COPY.

Head Office and Mail Order Department:

SHAFTESBURY SUPPLIES
224, SHAFTESBURY AVENUE, LONDON, W.G.2
(*Phone: Temple Bar 4175.)

Branches (for Callers):
Southampton: 17, St. Mary Street. Bristol: 61, West Street.

1935 EDDYSTONE SHORT WAVE MANUAL



Fully illustrated with constructional details for building Battery and Mains S.W. Receivers—6v. S.W. Super-het with A.V.C.—All Wave Wavemeter—5-metre Receiver—Simple 5-metre Transmitter—Cross-coupled Aerial System—Battery and Mains S.W. Converters—Amateur Bands Receiver—100 watt Transmitter Eliminators, etc.

COMPILED BY THE LEADING SHORT WAVE SPECIALISTS

PRICE 1/6 Obtainable from your radio dealer, W. H. Smith, or in case of difficulty, direct from STRATTON & CO., LTD., (Dept. 20), Broomsgrove Street, Birmingham. London Service Depot:—Webb's, 14, Soho Street, W.1

Cage Birds BIRD WORLD

The weekly journal for all who keep Canaries, British Hybrids or Foreign Pet Birds.

EVERY FRIDAY 2d. W.W.98

Specimen copy of recent issue free on request from The Publisher (W.W.), Dorset House, Stamford St., London, S.E.1

Components, Etc., for Sale.—Contd.

UTILITY SALES, 27a, Sale St., W.2, offer following special bargains; write for catalogue.

ROTHERMEL 1934-35 Full Sized P.M. M.C., 35/- list, 17/6; Sonochorde, mains energised, 12/-.

TRANSFORMER, Standard Cable, 200/240, 300-0-300, 60 m.a., 4v. 3a. C.T., 4v. 2a.; 8/6, worth 21/-.

IGRANIC Band-pass Iron Core Coils, screened, dual wavelength (33/- list); 14/6, snip.

IRON Core Screened Matched Coils, 3 circuits, 2/6; Lucerne, 2/6, plain, 2/-.

MICROPHONES, Western Electric, hanging 2/6, hand 3/6, transformer 3/6; table model, containing transformer, 8/6, handsome job; diagrams free; buttons, tested, 1/-.

ELECTRIC Soldering Iron, 4/6; De Luxe model, reversible bit, engineer's type, 7/6.

ELECTRIC Wonder Battery Clock, mahogany bakelite, battery lasting year, guaranteed; 15/-.

LOTUS Dyblock 0.0005 Variable Condenser, disc drive, lamp, escutcheon, complete, 4/6; 2-gang, 8/3; 3-gang, 12/3.

COSMOCORD Latest Model, 12/6.

UTILITY SALES, 27a, Sale St., Paddington, London. [6677]

RADIO CLEARANCE, 94, High Holborn, W.C.1, offers the following stupendous bargains; limited quantities only; all goods carriage free.—Phone: Holborn 4631.

RADIO CLEARANCE Offers 5-valve A.C. 200-250-volt Superhet chassis, partly incomplete, with circuit diagram, components worth 50/-; price, post free, 25/-.

RADIO CLEARANCE Offers L.F. Transformers, 3:1 and 5:1, manufacturers' type; 1/6 each, post free.

RADIO CLEARANCE Offers L.F. Transformers, shrouded, 3:1 and 5:1; price, post free, 1/9 each.

RADIO CLEARANCE Offers Magnacore Class B Chokes; price 2/11, post free.

RADIO CLEARANCE Offers Magnacore Q.P.P. Chokes; price, post free, 2/11 each.

RADIO CLEARANCE Offers 1-25th h.p. Motors (Gilbert), 100-115 volts A.C., for television, suitable for 200-250 volts if used with 700-ohm resistor or 30-watt lamp; price 17/6 each, post free.

RADIO CLEARANCE Offers Variable Power Resistances by well known maker, 0-100-ohms; price 3/- each, post free; exceptional value.

RADIO CLEARANCE Offers Plessey Triple Gang Condensers, 2x0.0005 and 110 kc/s oscillator section, complete with knob, drive, and escutcheon; 7/6, post free.

RADIO CLEARANCE Offers Plessey 110 kc/s Intermediate Frequency Transformers; 3/-, post free.

RADIO CLEARANCE Offers 8,000-ohm Volume Controls, log. type, with Q.M.B. switch, by G.E.C.; 2/6, post free.

RADIO CLEARANCE Offers Mains Transformers, unshrouded, manufacturer type, primary 200-250, secondary 320-0-320v. at 70 m.a., 2-0-2v. at 2 1/2 amps., 2-0-2v. at 3 amps.; 8/6, post free.

RADIO CLEARANCE Offers Mains Transformers, shrouded, with terminals, primary 200-250v., secondaries 320-0-320 at 70 m.a., 2-0-2 at 2 1/2a., 2-0-2 at 4 1/2a., 9/6, post free.

RADIO CLEARANCE Offers Mains Transformers, shrouded, with terminals, primary 200-250v., secondaries 320-0-320 at 70 m.a., 2-0-2 at 2 1/2a., 2-0-2 at 6 1/2a., 10/6, post free.

RADIO CLEARANCE Offers Steel Chassis, cadmium plated, drilled ready for use, 3-valve, 5-valve, or 7-valve type; 1/6, post free.

RADIO CLEARANCE Offers Set of Band-Pass Coils, manufacturer's type, with circuit diagram, suitable for tuned grid or tuned anode; set of 3 coils, 4/6, post free.

RADIO CLEARANCE Offers "Centralab" Potentiometers, 25,000, 50,000 ohms; 1/6 each, post free.

RADIO CLEARANCE Offers Set of Super-Het. Coils, comprising band-pass and oscillator 110 kc/s for cathode injection, with circuit diagram; 4/6, post free.

RADIO CLEARANCE Offers Parallel Feed Transformers, ratio 6-1, by well known manufacturer; 3/-.

RADIO CLEARANCE Offers T.C.C. Condensers, 0.5 mid., 800-volt, D.C. working, 1/6 each; T.C.C. condensers, 1 mid., 250-volt, D.C. working, 1/3 each; T.C.C. condensers, 1 mid., 800-volt, D.C. working, 2/- each; T.C.C. condensers, 2 mid., 450-volt, D.C. working, 2/6 each; T.C.C. condensers, 6 mid., 250-volt, D.C. working, 2/6 each; T.C.C. condensers, 6 mid., 350-volt, D.C. working, 3/- each; T.C.C. condensers, 4 mid. block, 0.5, 0.5, 0.5, 0.5, 0.5, and 1 mid., 250-volt, A.C. working, 2/- each.

RADIO CLEARANCE Offers Philips Eliminator Transformers, 150 volts at 30 milliamperes, 4 volts, 1 amp., various inputs, 1/6; Philips smoothing chokes, 14-28 henries, 120 milliamperes, 2/-.

RADIO CLEARANCE Offers Metal Chassis, 2-, 3- and 4-valve type, fitted with valve holders and terminal strip; 2/6 each, post free.

RADIO CLEARANCE, 94, High Holborn, W.C.1. 'Phone: Holborn 4631. [6687]

MICROAMMETERS—New tangent type, 2 1/2 in. dials, 0 to 260 microamps., 12/6, post free with chart.—Crescent Meters, 17, Gillies St., London, N.W.5. Stamp for particulars. [6663]

EXPERIMENTER has Large Quantity Surplus Coils, condensers, transformers, speakers, wires, various materials, both used and unused; also several receivers; bargain price. Genuine. Send for long lists or state requirements; callers invited.—Heaton, 103a, Parchmore Rd., Thornton Heath, Surrey. Livingstone 1164. [6574]



REMARKABLE MAINS UNIT

Here is the remarkable new Mains Unit now marketed by Heyberd the Mains Specialists. Four points of interest:

1. Voltage remains practically constant at 150 volts throughout the whole scale of current.
2. Suitable for any set, ESPECIALLY CLASS "B".
3. Absolutely free from all hum and background.
4. Covered with a THREE YEAR GUARANTEE thus proving the confidence Heyberd have in this new model.

MODEL 15/50—Output 150 volts at 15-50ma. H.T.1 Variable 40-110 volts. H.T.2 Variable 60-130 volts. H.T.3 Fixed 150 volts.

PRICE 88/6



Post Coupon

for Heyberd handbook on Mains Working
I enclose 3d. stamps for New Handbook of Mains Equipment. Packed with Technical Tips, Service Hints and diagrams

Mr.

Address

W.W.

F.C. HEYBERD & Co.,
10 FINSBURY STREET, LONDON. E.C.2
One minute from Moorgate Stn

EPOCH

MOVING COIL SPEAKERS
THE FINEST IN THE WORLD IN EACH OF THEIR PRICE-CLASSES.

Call for a demonstration at Exmouth House and convince yourself.
EPOCH RADIO MANUFACTURING CO. LTD.
Exmouth House, Exmouth St., London, E.C.1

ARE YOU ON THE SHORT WAVES?

If not why not fit the Unit Radio Short-Wave Unit and obtain World-wide Programmes.

For use with any type of receiver, mains or battery, straight or super-het. Built on metal chassis complete in cabinet. No extra batteries. Cash or **39/6** required. Sent for 5/- down. C.O.D. Terminus 5382. Send for illustrated leaflet.

UNIT RADIO, 12, Pulteney St., LONDON, N.1



PERSEUS PROMPT SERVICE for Traders. The Best Selection of Mains Radio, English and American Receivers, Radiograms, 'WIRELESS WORLD' & JOURNAL KITS, Components, Valves, Speakers.

ELECTRIC LAMPS, FITTINGS, CABLES, etc. Prompt Despatch, Personal Supervision, all your requirements from one source. **LISTS FREE.** Illustrated Catalogues.

Radio 6d., Electric 6d. for postage.
PERSEUS RADIO, W.W., Burton-on-Trent

Piano Tone CABINETS
65/- Radio-gram Cabinet for NO MIDDLE PROFITS. Finest Radio Furniture as supplied to B.B.C.
PICKETT'S
Piano Tone
Cabinet (W.W.) Works, Baxleyheat, Near London.

LIST FREE

Components, Etc., for Sale.—Contd.

- BIRMINGHAM RADIOMART**—Sensational purchase of brand new and guaranteed perfect components; value.
- RADIOMART**—Lissen 3-gang band-pass coils, screened and switched on aluminium base with book and circuits, unbroken boxes, listed 26/-, for 7/6; ditto, 2-gang, for 8.G.3, listed 17/6, for 5/11.
- RADIOMART**—Utility super quality 3-gang air-spaced ball-bearing, fully screened with trimmers; list price 24/-, straight or superhet; 6/6.
- RADIOMART**—Utility 2-gangs, as above, 5/10; Utility dials, to suit either, 2/-.
- RADIOMART**—Utility single, 0.0005 or 0.0003, with full size disc drive, walnut knob, escutcheon; 2/-.
- RADIOMART**—Igranic smoothing chokes, 20by. 100 m.a., 260 ohms, heavy stalloy core; 2/9.
- RADIOMART**—Edgewise visual tuning meter, 6 m.a., illuminated, 2 1/2 in. x 3/8 in. only, similar R.G.D.; 5/9.
- RADIOMART**—Radiophone logarithmic potentiometers, 10,000 ohms, wirewound, with mains switch, 2/-; 5,000, no switch, 2/-.
- RADIOMART**—Clarion 10/6 full vision dials, wave-length scales, moving spot light, complete beautiful oxidised escutcheon; 2/9.
- RADIOMART**—Screened ironcored dual range coils, with reaction, circuit, 2/11; Igranic short wave ditto, 3/3.
- RADIOMART**—Igranic Parvo 3 1/2-1, list 8/6, 2/11; Philco Class "B" driver, 2/9; Voltra 8/6 L.F., 2/-; Ericsson 15/- L.F., 1/6.
- RADIOMART**—Centralab, 1-watt colour coded resistances, all values, 6d.; Truwind wirewound colour coded, 2/- dozen, our assortment only.
- RADIOMART**—Cadmium 5-valve chassis, 1/6; grey cellulose, 4-valve, 9d.; postage 6d. extra.
- RADIOMART**—Magnum radiogram dissolvers, 2/9; Hellesen wet 8 mid. electrolytics, 435 v., 2/9.
- RADIOMART**—Metrick H.F. chokes, 9d.; Lewcos screened anode leads, 3d.; Belling Lee plain terminals, 1/- dozen.
- RADIOMART**—Telsen differentials, boxed, complete knob, 0.0001, 0.00015, 1/-; 0.0003, 0.00035, 1/3.
- RADIOMART**—Telsen wirewound potentiometers, 10,000, 50,000, 1/6; Magnum 25,000, 1/6.
- RADIOMART**—Non-inductive tubulars, wire ended, 1,500v. 0.1 mid., 0.01, 0.02, 0.05, 6d.; Philips ditto, 0.0001, 0.001, 2d.; 0.25, 0.5, 9d.; T.C.C. 0.25, 1/-.
- RADIOMART**—Mttvick transformer kit, laminations, clamps sectional bobbin, terminals, complete; 3/6.
- RADIOMART**—Electrad Royalty, 100,000, 250,000, potentiometers, 1/6; 400 ohm potentiometers, 6d.
- RADIOMART**—Utility 1934, mica variables 0.0005, 10d.; 0.0003, 8d.; 0.0002, 0.0001, 6d.; 0.0003, differentials, 1/6.
- RADIOMART**—Brand new condensers, eminent maker, 4 mid., 500v. working, 3/6; 350v. working, 2/9.
- RADIOMART**—Lewcos and Varley spaghetts 500, 600, 1,000, 1,500, 2,000, 3,000, 5,000, 30,000, 40,000, 75,000 4 1/2d., 3/6 doz.
- RADIOMART**—Boxed Lissen 12/6 heavy duty chokes, 25hy., 70m.a.; 32hy., 40m.a.; either, 4/6.
- RADIOMART**—Epoch moving coil speech transformers, 10-1, 12 1/2-1, 18-1, 25-1, any ratio; 2/3.
- RADIOMART**—Cossor 3-valve and rectifier all electric kit, model 347, includes valves cabinet, M.C. speaker, unopened; list £2/19, for £4/19/6.
- RADIOMART**—Fox Industrial 6-valve chassis, A.C. mains, complete less speaker and valves, £2/17/6; ditto 5v. D.C., same price.
- RADIOMART**—McMurdo Silver "Masterpiece" all wave superhet, with giant speaker, 17 watts undistorted, one only; list 50 guineas, new £32/10.
- RADIOMART**—G5N1, short wave specialist, read test report "Wireless World," September 14th.
- RADIOMART**—Short wave H.F. chokes, 9d.; Frequentite valve holders, 6d.; frequentite anode connectors, screened, 1/-.
- RADIOMART**—Microvariables 15, 40, 100 mid., 1/3; super all-brass 0.0001 short wave pigtail, 1/9.
- RADIOMART**—Igranic jacks, with plug, 1/-; jacks only, 3d.; Lewcos 6-way cable, 4d. foot.
- RADIOMART**—Pye loloss short wave valve holders, 4-pin, baseboard, 4d.; Eddystone I.F. transformers, 2/-.
- RADIOMART**—Western Electric 21/- microphones, 2/9; transformer, 2/6; Beehive standoff insulators, 8d.
- RADIOMART**—Milliammeters, flush, nickel, 2 1/2 in., 5/9; super ditto, 2 1/2 in., read A.C. or D.C., all ranges.
- RADIOMART**—List contains hundreds similar bargains, all guaranteed new and perfect in every respect; owing to cost stamp essential; no stunts; no disappointments; no junk.
- RADIOMART**—Orders over 6/- post free.—The Square Dealers, 9, John Bright St., Birmingham. [6676]
- WEST END RADIO STORES** Offer More Astounding Bargains:—Standard telephones, mains transformers, 300-0-300, 60 m.a., 4v. 4a., 4v. 2a.; 4/11.
- WESTINGHOUSE** Rectifiers, 6v. 1/4a., 3/11; with transformer, 8/6; 6v. 1 amp., 4/11; with transformer, 11/6; H.T.7, 7/6.
- PHILIPS** 20h. 180 m.a. Chokes, 4/6; 20h. 60 m.a., 3/6; carbon microphone with transformer, 7/6.
- NEW** Utility 3-gang 0.0005, with dial, screened, 9/11; Wago 6-11 mid. tapped banks, 2/6; T.C.C., 1 mid., 1/-; Dubilier 2 mid., 1,000v., 2/-.
- SONOCHORDE** 2,500 8-inch Energised Speakers, 8/11, postage 1/-; Marconi 75-1 microphone transformers, 4/11; Collaro A.C. motors, 35/-, with pick-up 45/-.
- FAY** Home Recorders, complete, 4/6; discs, 8-inch 5d., 10-inch 8d.; Cosmochoord pick-ups, with vol. control, 15/- model 11/6, 21/- model 15/6.
- MIDGET** Sets:—A.C./D.C., 100/250 volts, Halson, £4/5; M.R.K., £3/10; Inter-Ocean, £6; also Belmont, Sparton, Crossley, etc.; postage extra on all orders.
- WEST END RADIO STORES**, 14, Lisle St., London, W.C.2, and at 382, Coldharbour Lane, Brixton, S.W. [6650]

FOR SPEEDY SERVICING!



Here's a test set to end all your servicing troubles! No complicated switching! No incorrect scale-ranges! This Service Test Set is practically foolproof. Fitted with 3-inch dial, first-grade moving-coil meter, special type "rotary switch" and 2-way switch for both A.C. and D.C. Scales for every necessary current and voltage measurement are included, also Ohms scale to one megohm. Complete with cord adaptor, test prods and full instructions. Send the coupon—NOW!

PRICE NET to dealers, with £6.17.6
1 pair extra adaptors
With 6 pairs of valve adaptors, for £8.0.0
all British Valves, including 7 pin

SER-VICE TEST SET

SEND THIS COUPON NOW!

To Dept. F., SIFAM ELECTRICAL INSTRUMENT Co. Ltd.,
York Works, Browning Street, London, S.E.17.
Kindly send full details of above.

Name

Address

ELECTRADIX BARGAINS

11 lbs. Mechanic's and Inventor's Gadgets, from teleprinters, precision machined, small bevels, worm drives, ratchet clutches, cams, rollers and shaft ball bearing spindles, brackets, levers and 1/2 lb. fine nuts and bolts. 7/6 post free U.K.



CHARGING OR LIGHTING. 240 watt Set Enclosed Dynamo, 12/20 v. 12 amps, Ball Bearings, Vee Pulley. Marine type Switchboard with Ammeter, maximum and minimum Auto Cutout main Switch and Fuses. Field Regulator, etc., 50/-.
STEEL N.I.F.E. 1 VOLT CELLS, 120 A.H., 12/6 each.



THERMOMETERS. 2 1/2" dial 5ft. metal tube. Reads 0/100 Cent., 7/6. Air speed Indicator's Pilot Tube, 17/6.
CAMPASSES. 3 1/2" Floating, on Gimbals, in Mahogany Case, 6 1/2" x 6 1/2", 25/-.
POCKET types from 5/-.
ENGINES. Stuart Turner A.C. 1 h.p. twin opposed on aluminium bed. Light and new, only 88.
GAUGES. Air, Oil and Water Pressure, 2 1/2" dial, 0/60 lbs., 2/6; 0/20 lbs., 2/3. Duplex Test Gauge to 200 lbs., 18/6.
GEARS. Worm drive right-angle 10/1 with flywheel on C.1 base New R.C.A., 1/2 h.p., 15/-.
MORSE silent chains, 30" with 7" and 1 1/2 cogs, for up to 1/2 h.p. drive, new, 25/-.
SKREW-DRIVE gear box, 70 deg., bronze-steel worm, 1/2 shaft, new, 10/-.
ELECTRIC Governors, centrifugal 1,800 r.p.m., 12/6. Remote controls R.A.F. Bowden flex shaft, 4 1/2 foot brass lever and guides, 18 hole position indicator, 7/6.



Powerful Disc Recording Set by S. G. Brown, with special Pick-up type cutter, fitted diamond needle, positive geared traverse, for metal or other Disc recording by Microphone or Amplifier.
Portable model for Cine Societies shows, or home recording, £8/10/-.

ELECTRADIX RADIOS
218, Upper Thames Street, London, E.C.4
Phone: Central 4611.

The Autocar EVERY FRIDAY FOURPENCE

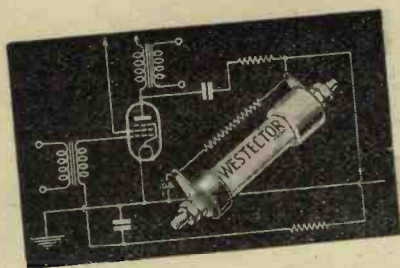

for **TRUE BATTERY ECONOMY**

you need a reliable and efficient rectifier. One that will reduce your current consumption, yet, at the same time, introduce no distortion. Use the best . . . none other is good enough. Use a Westinghouse Westector and halve your high tension bill. The attached coupon and 3d. in stamps will bring you full particulars.

WESTINGHOUSE WESTECTORS

Full details of battery economy schemes please. 3d. in stamps enclosed.

NAME

ADDRESS

The Westinghouse Brake and Saxby Signal Co., Ltd., 82, York Road, King's Cross, London, N.1.



ELECTRIC GRAMOPHONE MOTORS

TRUSPEED-AC

100/250 Volts

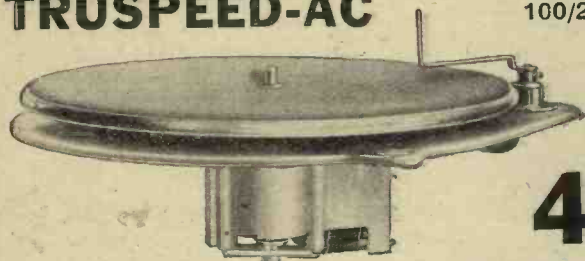

49/6

The most powerful A.C. Machine offered for gramophone work
The only self-starting A.C. motor in which the speed cannot vary

Write for Free Booklet AG. 490

Other models include:—
TRUSPEED-DC for D.C. circuits Price 67/6
UNIVERSAL for A.C. and D.C. circuits Price 99/6
All fitted with automatic stop switches

BTH RUGBY
THE BRITISH THOMSON-HOUSTON COMPANY LIMITED, RUGBY, ENGLAND A1765N

ACCURACY

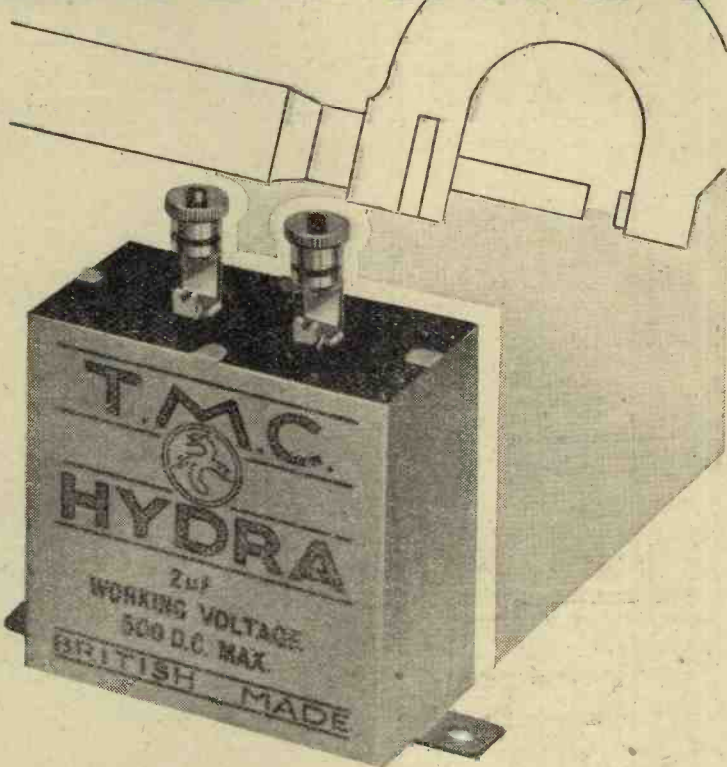

If you could use a micrometer gauge to test the capacity of condensers But why suppose? You have to take condensers on trust. The trouble is that condensers sometimes do not agree with the ratings stamped on their containers. That is one of the reasons why you should insist on T.M.C.-HYDRA condensers. Every one is tested carefully and thoroughly to ensure that it is accurate—and remains accurate.

T.M.C. BRITISH-MADE HYDRA CONDENSERS



The special method of sealing employed in T.M.C.-HYDRA condensers absolutely prevents the penetration of moisture and so maintains their high electrical properties. Your radio dealer sells them, but if you have any difficulty in obtaining supplies write to the Sole Distributors:

T.M.C.-HARWELL (SALES) LTD
Britannia House, 233 Shaftesbury Avenue London, W.C.2. (A few doors from New Oxford Street)

Telephone: Temple Bar 0055 (3 lines)

Made by TELEPHONE MANUFACTURING Co., Ltd.

Revitalise your set

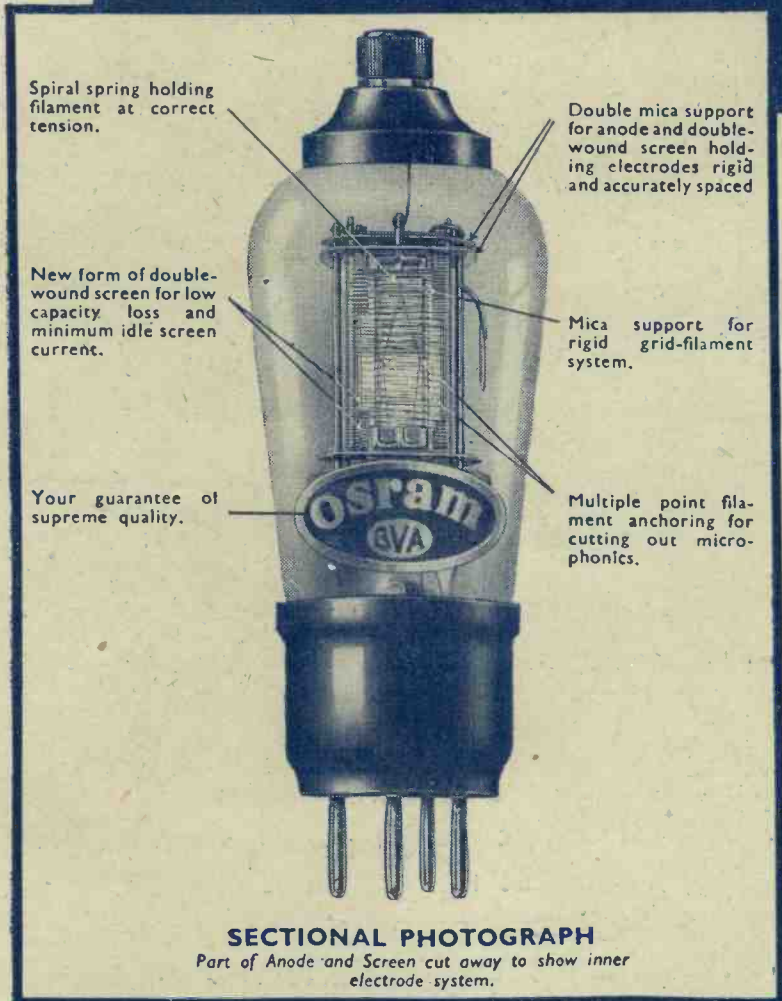

SECTIONAL PHOTOGRAPH
Part of Anode and Screen cut away to show inner electrode system.

3 2-VOLT SCREEN-GRID VALVES

mean —

- 1** GREATER SENSITIVITY WITH COMPLETE STABILITY—owing to low capacity and higher impedance.
- 2** ENTIRE ABSENCE OF MICROPHONICS — due to latest multiple anchored filament.
- 3** H.T. CURRENT CONSUMPTION FROM 1.5 M.A. ONLY.

S23 A low H.T. non-microphonic screen-grid valve for kit sets and portables employing one or more screen-grid valves. Mutual conductance 1.1 ma/volt ... **Price 12/6**

S24 A high slope, non-microphonic screen-grid for all single stage H.F. sets using screened coils. Mutual conductance 1.4 ma/volt ... **Price 12/6**

VS24 A "variable-mu" screen-grid to give full and distortionless control of volume with only a 9 volt bias battery. Mutual conductance 1.5 to 0.01 ma/volt ... **Price 12/6**

These Valves can be supplied metallised or plain.

Osram

2 VOLT BATTERY

Valves

MADE IN ENGLAND

SOLD BY ALL RADIO DEALERS

WRITE for the OSRAM VALVE GUIDE (1934 Edition) sent post free.

4^D

The Wireless World

THE PRACTICAL RADIO JOURNAL

with Complete Foreign Programmes

Friday, October 19th, 1934.



Read what "The Wireless World" says of the



SHORT-WAVE ADAPTOR.

"During the periods of the test the lowest waveband gave best results, at any rate, as far as long distance reception is concerned. Three American stations, Pittsburgh, WBXK, Schenectady, W2XAD, and Bound Brook W3XAL, were received at good strength with only slight fading during the afternoon. On the two higher wavebands all the European amateurs and short-wave broadcasting stations were always available, and as a medium for the exploration of this interesting field the G.A.C. short-wave unit could hardly be bettered. The predominant impression left after handling this equipment is that, by comparison with the ordinary run of mass-produced receivers, it possesses just that extra degree of efficiency that is sought after by the enthusiast for long-distance reception." Designed by Maj. W. I. G. Page, B.Sc. Wavelength: 12-98 metres. Automatic Volume Control. Can be coupled to any Receiver having moderate H.F. amplification without changing wiring or construction of the latter. Advt. of the City Accumulator Co. Ltd., 18/20, Norman's Bldgs., Central St., London, E.C.1. Makers of the famous "AUSTIN" Receivers.

Price: Complete with 3 valves (including rectifier) **£10**

TROPICAL INSULATION THROUGHOUT.

AN INTERESTING GIFT



This instructive catalogue contains numerous circuits and valuable hints and tips for better reproduction. It truthfully describes our 1934 Radio Specialties.

Q.M.B. Switches of all types. 1.23 & 5 Watt Fixed Resistors. Volume, Voltage & Tone Controls. Mains Transformers & Chokes. Etc. Etc.

FREE on request if you mention "The Wireless World."

CLAUDE LYONS, LIMITED

76 OLDHALL STREET, LIVERPOOL.
40 BUCKINGHAM GATE, LONDON, S.W.1.

free!

Blueprints of splendid sets

Colvern have specially designed two brilliant "up to the minute" sets and blueprints of them are being given away free (except for small postage charge). Using the new

COLPAK

(Made under licence from patents, Hans Vogt)

these sets offer the very latest in efficiency, precision and design. Send for blueprints to-day! To COLVERN LTD., Romford, Essex. Please send me full details and blueprint of the COLPAK CLASS B A.C. MAINS SET. Stamps value 3d. to cover postage are enclosed. * Strike out name of blueprint not required.



Name
Address

If you would like a copy of our Ferrocart booklet, please put a X here.....

TELSEN D.R. TRANSFORMER

—the L.F. Transformer with a STRAIGHT LINE

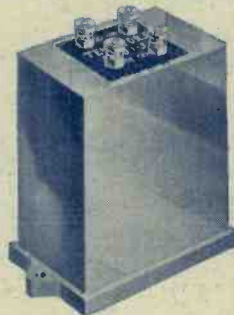

CHARACTERISTIC

which gives UNIFORM AMPLIFICATION over the entire range of audio-frequencies. The spaced layer windings are impregnated with a non-hygroscopic material of very low specific inductive capacity which absolutely eliminates all possibility of shorted turns or breakdowns due to large magnetic surges

D.R.3 (ratio 3-1)
D.R.5 (ratio 5-1) **8'6**

Announcement of the Telsen Electric Co., Ltd., Aston, Birmingham.

TELSEN FOR EVERYTHING IN RADIO



OSRAM S 23

A 2-volt Battery Screen-Grid Valve, especially designed to give stable amplification with increased sensitivity, better selectivity, and Lower H.T. Consumption.

Filament current 0.1 amp.
Mutual conductance 1.1 ma/volt.

PRICE 12/6

Metallized or plain bulb.

**IMPROVES
ALL KIT SETS
& PORTABLES
USING
SCREEN-GRID
VALVES**

To-day there are immense numbers of kit sets and portables existing which are employing one or more screen-grid valves.

Every one of these sets will be improved by fitting an OSRAM S 23 valve.

Give your set the tonic it needs to restore its original purity, volume and tone. Fit the OSRAM S 23 VALVE NOW!

Osram
2 VOLT BATTERY
Valves
MADE IN ENGLAND
SOLD BY ALL RADIO DEALERS

WRITE for
the OSRAM
VALVE GUIDE
(1934 Edition)
sent post free.

The General Electric Co., Ltd., London.

Mention of "The Wireless World," when writing to advertisers, will ensure prompt attention.

The Wireless World

THE
PRACTICAL RADIO
JOURNAL
24 1/2 Year of Publication

No. 790.

FRIDAY, OCTOBER 19TH, 1934.

VOL. XXXV. No. 16.

Proprietors: ILIFFE & SONS LTD.

Editor:

HUGH S. POCOCK.

Editorial,

Advertising and Publishing Offices:
DORSET HOUSE, STAMFORD STREET,
LONDON, S.E.1.

Telephone: Hop 3333 (50 lines).
Telegrams: "Ethaworld, Watloo, London."

COVENTRY: Hertford Street.

Telegrams: "Autocar, Coventry" Telephone: 5210 Coventry.

BIRMINGHAM:

Guildhall Buildings, Navigation Street, 2.
Telegrams: "Autopress, Birmingham." Telephone: 297x Midland (4 lines).

MANCHESTER: 260, Deansgate, 3.

Telegrams: "Iliffe, Manchester." Telephone: Blackfriars 4412 (4 lines).

GLASGOW: 26B, Renfield Street, C.2.

Telegrams: "Iliffe, Glasgow." Telephone: Central 4857.

PUBLISHED WEEKLY. ENTERED AS SECOND
CLASS MATTER AT NEW YORK, N.Y.

Subscription Rates:

Home, £1 1s. 8d.; Canada, £1 1s. 8d.; other
countries, £1 3s. 10d. per annum.

*As many of the circuits and apparatus described in these
pages are covered by patents, readers are advised, before
making use of them, to satisfy themselves that they would
not be infringing patents.*

CONTENTS

	Page
Editorial Comments	309
The Standard AC Three	310
Wireless on the England-Australia Air Race	313
Unbiased	314
Receiver Performance Data	315
Short-waves and the Amateur	317
News of the Week	318
FOREIGN PROGRAMME	
SUPPLEMENT, pp. I—XXIII	
Broadcast Brevities	319
New Apparatus	320
Practical Hints and Tips	321
R.G.D. Auto Radio Gramophone	322
Readers' Problems	324

EDITORIAL COMMENT

Is Broadcasting Overdone?

*B.B.C. Influenced Too Much by
Public Demand*

THOSE who criticise the programme policy of the B.B.C. are constantly inferring that the Corporation takes no heed of the wishes of the public, but endeavours to thrust upon us whatever is considered to be for our ultimate good. Fortunately, there is probably some truth in the idea that the B.B.C. endeavours to maintain a slightly higher standard than might be required if the selection of programme matter were left to a popular vote! Surprising as it may seem, there are some directions in which the B.B.C. appears to have paid too much attention to popular demand instead of following the better course of their own considered judgment. We refer particularly to two directions in which programme policy has developed, namely, the extensive hours of broadcasting and the "fetish" for constant variety of material.

This policy absorbs a great deal of the money available for programmes, and probably deprives us of features of outstanding interest which might otherwise have been financially possible.

On the question of length of hours we cannot help feeling that broadcasting would be more highly valued if it were a little less plentiful, or if direct broadcasts were restricted to a few hours a day and the less important periods devoted to the broadcasting of recorded programmes.

In regard to alternative programmes and variety of items, the idea has been pursued to such a point that only those listeners with almost unlimited leisure can hope to enjoy a reasonable

proportion of the best items broadcast.

This is the worst aspect of the situation, for it leads to so many first-class broadcast items being missed because the listener may be engaged in some other occupation at the particular time when the item comes on. It is very seldom that a play or any other specially prepared performance is repeated from the same station, although it may sometimes be given again once from the alternative transmitter on another night. But two performances of a play which may have taken weeks of rehearsals and preparation seems to be wholly inadequate to satisfy the listening public interested in it.

No Permanent Record

We are constantly meeting with listeners who refer to some play or other item which has been broadcast and which has given great satisfaction, and it is irritating to feel that not only were we unable to participate in the performance, but that we shall, in all probability, never hear it. B.B.C. performances are not discussed like a theatre play, or a film, because when the performance is over there is no record available to the public and it has disappeared as surely as yesterday.

If the public had not been spoiled with the idea that every time a wireless set was turned on something entirely fresh would be available to them we believe that broadcasting might have developed on rather different lines, and we are inclined to think that in the present programme policy popular demand has had too great an influence. Somewhat shorter hours of transmission and more repetition of outstanding performances might seem a retrograde step, but if it resulted in better programmes the idea of a gradual change, even at this stage in development, would justify consideration.

The Wireless World

Standard AC Three

A Straight Set with Iron-cored Coils

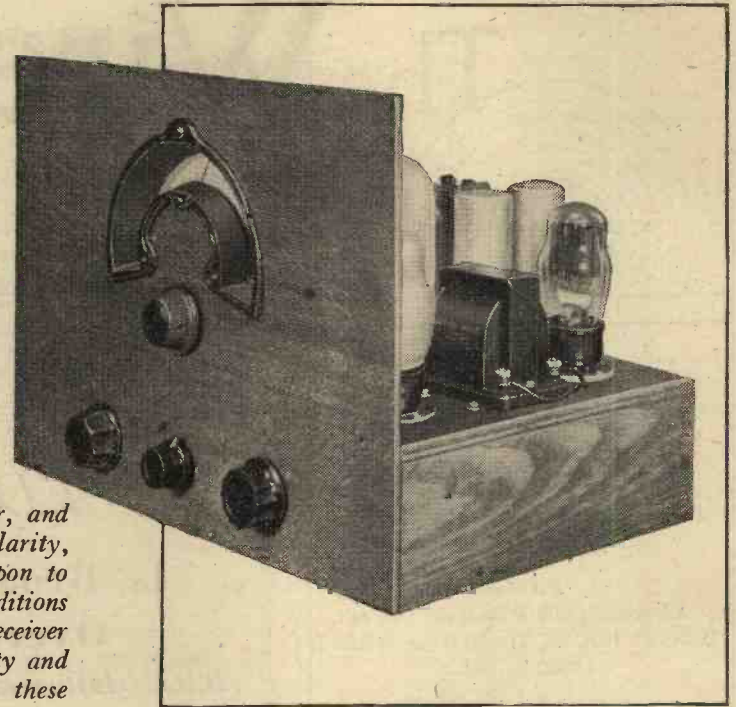

NOT the least of the merits of the three-valve receiver, and one which is probably largely responsible for its popularity, is its suitability for general reception. It can be relied upon to give reception of a number of stations under almost any conditions and it is capable of good quality reproduction. In the receiver described in this article attention has been paid to selectivity and quality and the set reaches a high standard in its class in these important attributes.

THE three-valve receiver still retains much of its popularity, due no doubt largely to its suitability for general reception and its moderate cost. The sensitivity and selectivity of a well-designed set are usually high enough to permit a good choice of foreign transmissions in most localities, and the quality of reproduction obtainable is of quite a high standard.

It must be obvious to everyone that a three-valve set cannot be perfect in all three of the main attributes of sensitivity, selectivity and quality, for otherwise there would be no call for the existence of larger receivers. With three valves at his disposal it is readily possible for the designer to produce a set of sufficient sensitivity for practically every need; the selectivity,

however, would be totally inadequate and the quality likely to be mediocre. Alternatively, he could produce a set capable of outstandingly good quality of reproduction, but it could have only moderate selectivity, and its sensitivity would be suitable only for local reception. Again, the designer might concentrate on selectivity and produce a set good in this respect, but one which failed in the other attributes.

Characteristics of the Receiver

It can be seen, therefore, that the design of a three-valve receiver resolves itself into finding the best compromise between the three conflicting factors of sensitivity, selectivity and quality—factors which are

not necessarily inherently conflicting, but which become so when the receiver is limited to a certain number of valves. Sensitivity and selectivity must usually go hand in hand, for an increase in the former is valueless without a corresponding increase in the latter. Quality must be sacrificed no more than is essential, for since a wireless set is used chiefly for entertainment purposes, most people will agree that it is better to be able to receive a dozen stations with satisfying quality than a hundred with poor reproduction.

In designing the Standard AC Three, therefore, the aim has been to produce a good three-valve set capable of yielding programmes of entertainment value from a moderate number of stations. No attempt has been made to obtain very

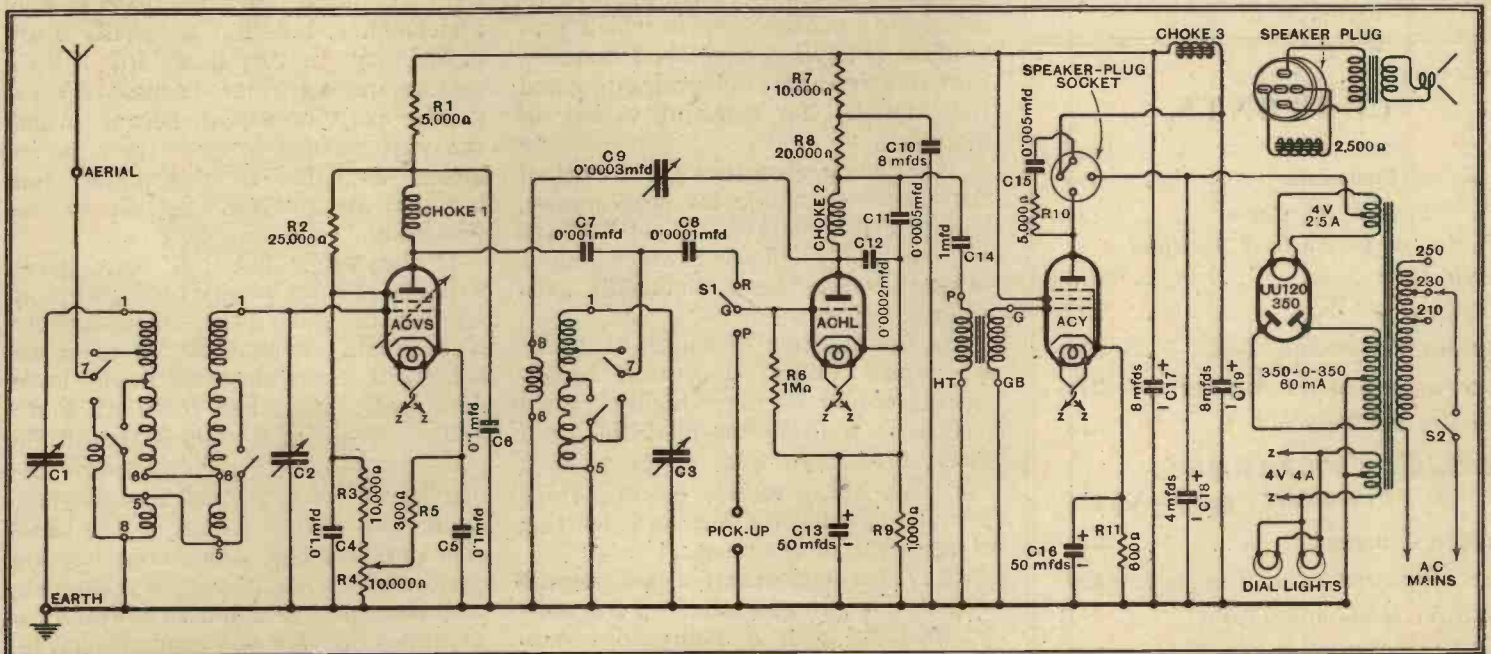

Fig. 1.—The complete circuit diagram of the receiver and mains equipment shows that the design follows standard practice. Iron-cored coils are used and are tuned by a three-gang condenser.

The Standard AC Three—

high sensitivity, but during the normal hours of listening all the chief Continental transmissions can be well received with any reasonably good outdoor aerial. The selectivity is higher than the average for this class of set, so that the receiver is well able to cope with modern broadcasting conditions. While the quality of reproduction naturally does not come up to the standard obtainable with elaborate equipment such as *The Wireless World Push-Pull Quality Amplifier*,¹ it is very acceptable indeed, and it is more in this respect than any other that the set outshines its predecessors.

The complete circuit diagram appears in Fig. 1, and will be seen to be entirely straightforward. The circuit, in fact, differs little from those of older receivers, and the difference in the performance obtained lies in the improvement in certain components and in the careful choice of values and valves. Three tuned circuits are embodied, and two are connected in band-pass form before the HF valve. The third circuit acts as the coupling between the HF and detector valves, and it has reaction applied to it in order to obtain the maximum sensitivity and selectivity and to enable the inevitable detector damping to be offset. In order to keep the damping at a minimum both the anode connection to the HF valve and the grid lead to the detector are tapped well down the coil.

The HF Stage

In the case of the aerial coil a separate winding is provided for the coupling on the medium waveband, but for long wavelengths it suffices to join the aerial to a suitably disposed tapping on the tuned winding. A built-in switch is arranged to transfer the aerial, and the construction of the coils is such that the transferred aerial capacity is the same on both wavebands, thus enabling accurate ganging to be readily achieved. In the intervalve coil, too, the switching alters the tapping point on the two wavebands, so that the stray circuit capacities always have the same effect.

The HF valve is of the variable-mu screen-grid type, and has been chosen in preference to an HF pentode, since it has a lower grid-anode capacity than most specimens of the latter class, and so is inherently more stable. Moreover, the HF pentode would confer no advantage in this receiver, for the screen-grid valve is well able to give the moderate output demanded by the grid detector. The valve chosen is rated for 200 volts anode supply with 80 volts for the screen-grid. The HT line in this set is maintained at 250 volts, so that the anode is fed through the 5,000-ohms resistance R1, and the screen voltage is derived from the voltage divider comprising R2 and R3 in conjunction with the volume control potentiometer R4. Minimum bias for the valve is obtained by inserting a 300-ohms resist-

ance R5 in its cathode lead, and the bias can thus be varied from about -3 volts to -30 volts for volume control purposes.

The detector valve is a triode of the 10,000-ohms resistance type, for this class of valve has been found to make the most generally satisfactory grid detector. When adjusted to give the same quality of reproduction the screen-grid or pentode detector gives little, if any, higher amplification, so that its sole advantage would be the absence of the Miller effect. Since reaction is employed in this receiver, this is of little moment. Two by-pass condensers C12 and C11 and an HF choke Ch2 are included in the anode circuit to enable reaction effects to be obtained, and to prevent, as far as possible, any leakage of HF currents into the LF circuits. The LF coupling to the output valve comprises a resistance-fed transformer of 1-3.5 ratio. The resistance R8 is given a value of 20,000 ohms, and the capacity of the coupling condenser C14 is 1 mfd. Decoupling is provided by the 10,000-ohms resistance R7 in conjunction with

and on gramophone a negative bias of about 4 volts is applied to the valve by the cathode resistance R9 of 1,000 ohms, which is shunted by a 50 mfd. electrolytic condenser. This switch, together with the mains on-off switch S2, is mounted on the same spindle as the wave-change switches; all switching, therefore, is carried out by a single control knob having four positions and giving, with clockwise rotation, Off, Medium waves, Long waves, and Gramophone.

The Output Circuit

The output valve is a pentode rated for an output of 3.4 watts and requiring anode and screen potentials of about 250 volts. Grid bias is derived from the voltage drop across a resistance R11 of 600 ohms connected in the cathode lead, and this is bypassed by a 50-mfd. electrolytic condenser C16 in order to prevent anti-phase feedback from attenuating the bass. The space charge grid is fed directly from the 250-volts line, which is obtained from a

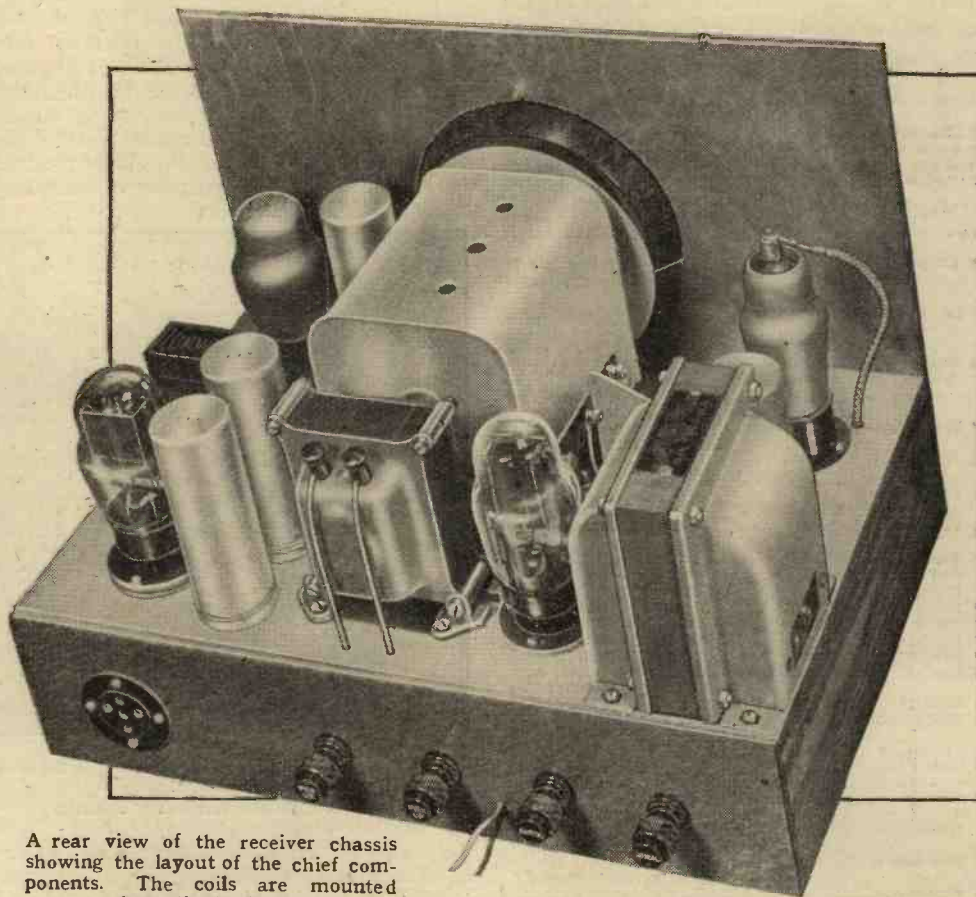

A rear view of the receiver chassis showing the layout of the chief components. The coils are mounted beneath the base.

the 8 mfd. electrolytic condenser C10; it may be remarked that these components also assist in smoothing the detector HT supply.

A grid detector consists fundamentally of a diode detector and an LF amplifier—the grid serving the dual purpose of a diode anode and a control grid. The valve can, therefore, be used as an LF stage when it is required to use a pick-up for the electrical reproduction of gramophone records, and only the simplest alterations to the connections are needed. The switch S1 is included for this purpose,

slightly higher voltage point through the smoothing choke Ch3; an 8-mfd. electrolytic condenser is used at this point to complete the smoothing. The pentode anode, in the circuit of which is connected the output transformer primary, is fed from the output of the main smoothing equipment, which consists of the speaker field and another 8-mfd. electrolytic condenser C19.

The output valve requires a load impedance of some 6,000 ohms, so that the filter connected across its primary is given the suitable values of 5,000 ohms for R10 and 0.005 mfd. for C15. These values

¹ *The Wireless World*, May 11th, 1934.

The Standard AC Three—

well suit the average loud speaker, but some benefit may be derived in certain cases from an alteration.

The mains equipment consists of a mains transformer, an indirectly heated rectifier, and the 4-mfd. reservoir condenser C19. The transformer has secondaries delivering 4 volts at 2.5 amperes for the rectifier heater, 4 volts at 4 amperes for the receiver valves and the dial lights, and 350-0-350 volts at 60 mA. for HT. After rectification a potential of about 360 volts is available across the reservoir condenser C19. The total current of 40 mA. flows through the speaker field which provides the first stage of smoothing, and which is itself energised in the process. The field has a resistance of 2,500 ohms, so that 100 volts are dropped across it and the potential available after it is 260 volts. The anode of the output valve is fed directly from this point, but the current for the space charge grid and for the earlier valves is taken through a choke Ch3 in order that additional smoothing may be obtained.

This arrangement affords a high degree of smoothing in a simple and economical

LIST OF PARTS

- 1 Three-gang condenser, C1, C2, C3 Polar "Minor"
(British Radiophone, J.B., Utility.)
- 1 Slow-motion dial Polar Semi-circular Drive
- 2 Bulbs Bulgin 610
- 1 Mains transformer, primary, 200 to 250 volts, 50 cycles; secondaries, 350-0-350 volts, 60 mA.; 4 volts, 2.5 amps., centre-tapped; 4 volts, 4 amps., centre-tapped Bryce
- (Davenset, Partridge, Rich and Bundy, Sound Sales, Vortexion, Wearite)
- 1 LF choke, Ch3 Wearite H.T.12
(Bulgin, Davenset, Partridge, Rich and Bundy, Sound Sales, Vortexion)
- 1 LF transformer, ratio 1:34 Feranti A.F.8
(Graham Farish, Varley)
- 1 Reaction condenser, 0.0003 mfd., C9 Ormond R.508
- 1 Knob for above Ormond R.355
- 1 Wire-wound potentiometer, 10,000 ohms, R4
Watmel T.6
(Bulgin, Haynes Radio, Wearite)
- 1 Set of Ferrocarril coils with mains switch
Colvern Types 1, 2, and 3
Bulgin H.F.9
- 2 HF chokes, Ch1, Ch2
(Kinva, Wearite)
- 4 Valve-holders, 5-pin
Clix Chassis Mounting Standard Type
- 1 Valve-holder, 7-pin Clix Chassis Mounting Type
(Goltone)
- 1 Fixed condenser, 0.0001 mfd., C8 Dubilier 665
- 1 Fixed condenser, 0.0002 mfd., C12 Dubilier 665
- 1 Fixed condenser, 0.0005 mfd., C11 Dubilier 665
- 1 Fixed condenser, 0.001 mfd., C7 Dubilier 670
- 1 Fixed condenser, 0.005 mfd., C15 Dubilier 670
- 3 Tubular condensers, 0.1 mfd., C4, C5, C6 Dubilier 4503
- 1 Non-inductive condenser, 1 mfd., C14 Dubilier 9200
- 2 Electrolytic condensers, 50 mfd., 12 volts, C13, C16
Dubilier 3001
- 1 Electrolytic condenser, 4 mfd., C18 Polar-N.S.F.
- 3 Electrolytic condensers, 8 mfd., C10, C17, C19
Polar-N.S.F.
(Graham Farish, T.C.C., T.M.C.-Hydra, Telsen)
- 1 5-pin plug Goltone R.19-146
(British Radio Gramophone Co., Bulgin)
- 4 Ebonite shrouded terminals, A.E., pick-up (2)
Belling-Lee "B"
- 1 Resistance, 300 ohms, 1 watt, R5
Graham Farish "Ohmite"
- 1 Resistance, 600 ohms, 1 watt, R11
Graham Farish "Ohmite"
- 1 Resistance, 1,000 ohms, 1 watt, R3
Graham Farish "Ohmite"
- 2 Resistances, 5,000 ohms, 1 watt, R1, R10
Graham Farish "Ohmite"
- 2 Resistances, 10,000 ohms, 1 watt, R3, R7
Graham Farish "Ohmite"
- 1 Resistance, 20,000 ohms, 1 watt, R8
Graham Farish "Ohmite"
- 1 Resistance, 25,000 ohms, 1 watt, R2
Graham Farish "Ohmite"
- 1 Resistance, 1 megohm, 1 watt, R6
Graham Farish "Ohmite"
- (Bryce, Dubilier, Erie, Ferranti, Claude Lyons, Polar-N.S.F., Watmel)
- 1 Length screened sleeving Harbros
- 2 ozs. No. 22 tinned copper wire, 6 lengths Systoflex, wood, etc.
- Wood panel, 14in. by 10in. Peto-Scott
- Plymax baseboard, 14in. by 9in. by 3in. Peto-Scott
- Screen
- Screws: 20 3in. No. 4 R/hd.; 3 3in. No. 4 R/hd.; 8 3in. No. 6 R/hd.; 5 3in. No. 4BA with nuts and washers; 7 3in. No. 6BA with nuts and washers.
- Valves: 1 Hivac ACVS; 1 Hivac ACBL; 1 Hivac ACY; 1 Hivac UU120/350.
- Loud speaker, with Universal transformer, 2,500-ohms Bel3, and hum-bucking coil Magnavox Magna 152

manner, with the result that hum in the receiver is entirely negligible. Since the speaker field is fed from an unsmoothed source, however, it is possible for hum to arise in the loud speaker itself. This may be avoided by fitting the speaker with a hum-bucking coil, and this must be taken as being essential. If it be desired to use a loud speaker which is not so equipped, it will almost certainly be

necessary to fit an additional stage of smoothing preceding the speaker field.

The theoretical considerations underlying the design of the Standard AC Three have now been discussed at some length, and the arrangement adopted has been fully described. It only remains, therefore, to deal with the construction and operation of the receiver, and this will be done in a further article.

The Diary of an Ordinary Listener

IT is curious how often one stumbles on a run of the same music in widely different programmes for several consecutive days. A week or two ago there seemed to be an epidemic of extracts from "Carmen"; this week it has been "Faust." I make no complaint, as I can always listen with the greatest enjoyment to Gounod's tuneful opera.

The programme from Poste Parisien on Friday, October 5th, was largely devoted to music by such varied composers as Spohr, Schumann, Liszt, Gounod and Wagner all inspired by the Faust Legend, and it was most interesting to listen and note the characteristic way each composer treated the subject. Poste Parisien and other stations partly dependent upon advertisements for their revenue suffer from the frequent interludes in their musical programmes for the purpose of extolling

considerable interest to Mahler's 5th Symphony, played by the Concertgebouw Orchestra of Amsterdam, conducted by Bruno Walter, and broadcast from Hilversum. The station suffered at times from fading, so I was unable to hear as well as I wished, and could not decide whether I liked the work.

On Saturday, Kalundborg and Copenhagen transmitted a programme of Sullivan's music, of which I liked the overtures and selections taken directly from "The Mikado" and "H.M.S. Pinafore," but disliked the perversion of the old tunes into waltzes, polkas, gallops and lancers.

Sunday evening was mainly occupied with listening to an excellent rendering of "Faust" from Radio Toulouse. On this occasion the lengths of the intervals were announced, so I was able to fill them in with visits to other stations; first, Hilversum,



THE GERMAN RADIO CENTRE. On the extreme left of this aerial view of Berlin is the semi-circular building which constitutes the headquarters of the German broadcasting system. To the right is the famous "Funkturm"—a small edition of the Eiffel Tower in Paris.

the wares of certain business houses. One is often afraid to switch off or to go over to another station during these interludes for fear of missing the next musical item. A technical friend has tried to devise a discriminator which automatically distinguishes between speech and music and cuts out or in, whichever is desired. I am still waiting for the perfectioning of this invention and look forward to the time when a listener will be able to set an automatic selector to the type of entertainment desired—classical, light, jazz or vocal music, vaudeville or talks—and feel sure that all unwanted items will be excluded. I suggest that my old friend "Free Grid" might tackle this problem, as I have great confidence in his inventive genius, both technical and fictional.

The previous evening I had listened with

where Albert Sandler's orchestra was playing operatic selections, then Huizen, where the K.R.O. orchestra gave a good account of themselves in the march from "Aida," and, lastly, for light music to Luxembourg, where I came in for a pianoforte solo of the jazz type played with that heavy-handed agility characteristic alike of "syncopated" pianists and barrel-organs.

The following evening pianoforte solos of a very different kind were broadcast from Radio Paris, where Jean Doyen gave a beautifully crisp and clear rendering of Schumann's "Variations on the name Abegg," and, later, some further variations by Ladmirault. These last, however, were somewhat overlaid with a background of accordion music which broke through from Droitwich.

CALIBAN.

England-Australia Air Race

THE RADIO-EQUIPPED MACHINES

RADIO will play an important but restricted part in the London-Melbourne air race. Probably three of the many aeroplanes that will start from Mildenhall to-morrow morning (Saturday) will carry transmitting sets. If the demand for petrol space were less pressing many more 'planes would undoubtedly keep in touch with the world by radio.

At the time of going to press it is understood that the radio-equipped 'planes will be Lord Nuffield's Airspeed Envoy, the New Zealand D.H. Dragon-Rapide "Tainui," and the British Airspeed "Viceroy," piloted by Captain T. Neville Stack.

Lord Nuffield's machine will be equipped with a Marconi Type A.D.6M. installation which will be operated by the pilots, Flight-Lieutenant Anderson and Mr. George Lowdell. This well-known receiving and transmitting set is used by Imperial Airways, Ltd., and other companies conducting services in about thirty countries.

The set is capable of both telephony and telegraphy, and covers the band of 550 metres to 1,000 metres reserved for aircraft, and also, of course, the 600 metres band allotted to ship stations. For telegraphy purposes the transmitter, which is operated on a power of about 150 watts, will have a range of about 500 miles. The wavelength to be used will probably be 900 metres, and many English listeners will no doubt be able to hear transmissions during the initial stages of the race.

The New Zealand "Tainui," named after the historic canoe that first brought the Maori from distant Polynesian isles to "Aotearoa," "The Land of the Long White Cloud," will be piloted by Squadron-Leader J. D. Hewitt and Flying-Officer Cyril Kay, and its radio operator will be Mr. F. Stewart.

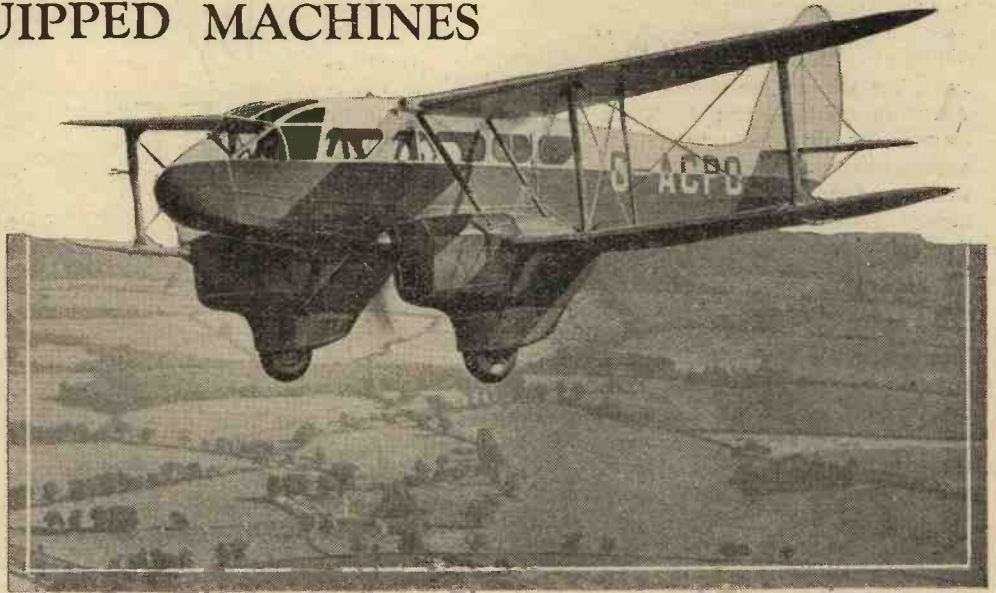

The New Zealand entry, a D.H. Dragon Six, carries special radio gear manufactured by the Plessey Co.

The other British Airspeed "Viceroy" will be piloted by Capt. Neville Stack, and its wireless equipment will be in charge of Mr. McArthur. This set will be identical to that on the "Tainui" and will consist of a Type AC44 transmitting

being lost while the machine is flying low.

The superheterodyne receiver employs automatic volume control on telegraphy and telephony; no reaction control is necessary for reception of C.W., and one tuning control with a calibrated dial is all that is required for operation.

The equipment has a total weight of 60lb. It provides a range of 500 miles on telegraphy and 200 miles on telephony, and the transmitter operates on any four fixed wavelengths between 600 and 1,000 metres. The receiver covers the band 500 to 1,300 metres.

A number of other competitors had wished to carry radio equipment, but the

factors of additional petrol tanks and the need for reducing weight militated against installation.

The three radio-installed 'planes will have the advantages of picking up special weather reports, direction instruction, etc., from the chain of aircraft stations that lines practically the whole route.

Because the start takes place at the early hour of 6.30 a.m. the B.B.C. is unable to give a running commentary, but Squadron-Leader W. Helmore, R.A.F., well known for his commentaries on the Hendon Air Display, will be at Mildenhall Aerodrome. At 1.45 he will broadcast an eye-witness account in the National programme, and this will also be relayed on the different Empire wavelengths.

Special arrangements have been made in Australia by the Australian Broadcasting Commission and the newspaper and private stations for broadcasting the commentaries on the arrival of the ambassadors of the skies.

C. W. L.

*M*ANY listeners will wish that the competitors in the England-Australia Air Race carried short-wave transmitting gear, which would make it possible for enthusiasts in both hemispheres to follow the progress of the race from start to finish. We understand, however, that the three 'planes which are equipped with wireless will confine themselves to the commercial wavelengths between 550 and 1,000 metres. Readers may have an opportunity to follow the 'planes in the early stages by tuning in on 900 metres. The start is from Mildenhall Aerodrome, Suffolk, the first machine taking off at 6.30 a.m.

and receiving equipment made by the Plessey Co., of Ilford, incorporating a number of novel features. For instance, the equipment is built on aluminium chassis which are supported on rubber rings in an enclosed steel crate. This crate may be bolted direct to any aircraft, all insulation from the vibration being self-contained. On the transmitter a special output circuit is employed which avoids all possibility of overloading the amplifier valves in the event of the aerial circuit being detuned or the trailing aerial



Captain Neville Stack's Airspeed "Viceroy,"

By courtesy "Flight."

UNBIASED

"Big Business"

AT the present moment I am feeling a little abashed at a rebuke I have received for describing as pure unadulterated tripe the accounts published in various papers of the enormous amount of money represented by the sets sold at Olympia, an amount which approached the billion mark, and not an American billion either. Whatever the precise amount was, it was so great that a speedy calculation made it clear that either the number of licensees (or pirates) would shortly be doubled, or, alternatively, that existing licence holders were buying about half a dozen sets apiece.

I have been informed, however, that my remarks were quite uncalled for, and that they showed a complete lack of business knowledge. According to the information given me, it appears that, for some esoteric reason, known only to accountants and such-like people, when a figure is given it represents only the "paper" trade value, and that to get at the hard-cash value of it you must divide by five.

I must confess that I don't understand it myself, and can find no accountant who is willing to take me by the hand and explain it all gently to me. At the same time, of course, I must admit that there are a lot of technical things which baffle me, such, for instance, as why pulling the grid leaks out of the resistance-coupled stages of a well-known set makes no difference to its performance. I feel that until I can supply a satisfactory explanation of this to the "Big Business" folk I have no right to expect that they will expound the technical mysteries of their craft to me.

Watchmakers' Harvest

I HAVE frequently complained in these columns about the policy of set manufacturers who still persist in housing the loud speaker in the same cabinet as the set, thus either compelling us to keep bobbing up like a jack-in-the-box every time we want to change the programme, or, alternatively, to place the set by the fireside chair and have the loud speaker bellowing right in our ear.

A correspondent happened to be discussing wireless with a prominent watchmaker who is a reader of this journal, and in the course of the conversation the watchmaker complained rather peevishly that I appeared to be intent on ruining his business by a persistent demand for a return to separate loud speakers.

Pressed for an explanation, the watchmaker stated that immediately the vogue of the modern type of one-piece set started a few years ago he and other members of his craft noticed that their income from the

By FREE GRID

sale and repair of watches rose abruptly and had continued at a very satisfactory level ever since. In nearly every case the trouble with watches brought in for repair had proved to be magnetisation of the works, even in the case of the so-called non-magnetic ones, and "the trade" put this down to the fact that in the process of tuning a wireless set the ubiquitous wrist-watch was brought into close proximity to the powerful magnetic field of the moving-coil loud speaker, a state of affairs which did not exist in the days when the loud speaker was separate from the set and hung up high on a baffle.

In recent months, the watchmaker said, matters had been even more satisfactory from the point of view of himself and his trade friends, this being explained by the greatly increasing popularity of the con-



In the interests of watchmakers.

sole type of set and the radiogramophone. In the latter types of instrument the loud speaker is much nearer to the floor than in the table-top type of receiver, and is about on the level of the watches of listeners seated in their armchairs. In addition, therefore, to getting a strong dollop of magnetism during the tuning-in process, they receive a homœopathic dose all the evening.

The fact that a set is magnetically screened ought to prove a good selling point for next year's exhibition in the case of those manufacturers in need of a new stunt.

Where's the Snag?

JUDGING by the prosperity of book-makers, patent agents, and others who wax fat on the folly of their fellow-creatures, it would appear that the number of people who are chasing the will-o'-the-wisp of making their fortunes is as large as ever.

The latest example of this sort of thing which has been brought to my notice is an attempt to apply the principles of AVC to a sphere other than radio. It appears that a budding Einstein, inspired by a few notes which I wrote in *The Wireless World* dated July 20th, has invented an "AVC home cine projector," in which he claims to have overcome all the variations in the density of the projected picture caused by the fact that most sections of amateur films are either over-exposed or under-exposed. He claims that by means of his invention expensive and troublesome gadgets such as exposure-meters will be avoided, and the amateur enabled to make his "shots" at any old time of the day regardless of lighting conditions.

The *modus operandi* of the device is quite simple. Behind the screen is mounted a suitable photo-electric cell which receives the average value of the light passing through from the projector. According to my informant, the changing value of the light caused by the varying density of the different "shots" affects the cell, which, in its turn, controls the current to an electric motor. The latter device operates a variable resistance controlling the wick of the projector lamp, which gets turned up or down according to the afore-mentioned film density. The film thus adjusts the lighting according to its needs of the moment.

My informant wants me to finance him in the matter, or, at any rate, to use such influence as I possess in order to get any of you to put up the needful to enable him to get the apparatus on the market.

While gladly passing the dope on to you, I feel that I must disclaim all responsibility in the matter.

Light from Sound?

THE Prague station is so short of radio stars that it has had to give auditions to real stars. Vega and the moon have both been tapped by letting their light fall on a photo-electric cell connected to amplifiers, the light thus being converted into symphony concerts or something equivalent.

Now a Sunday journalist friend of mine writes to tell me that he has long used a reversal of this method for lighting a particularly dark patch in his coal cellar, using the sounds from passing omnibuses.

He promises me a complete circuit diagram by to-morrow's post.



(Continued from page
296, October 12th
issue)

Receiver Performance Data

II. Adjacent Channel Selectivity

By W. T. COCKING

THE selectivity of a receiver is an important characteristic under the congested conditions pertaining to modern broadcasting. It is shown in this article that the selectivity can be accurately measured and the method of expressing it is discussed.

AFTER sensitivity, one of the most important characteristics of a receiver is its selectivity—its power of rejecting interfering transmissions. The degree of selectivity necessary depends upon the use to which a receiver is to be put, and is closely related to both sensitivity and quality of reproduction.

The usual procedure in measuring the selectivity of a receiver is to set the Standard Signal Generator to operate at the frequency at which a measurement is required. The receiver is tuned to the generator and the input adjusted until standard output is obtained. The generator is then detuned by a small amount—say, 2 kc/s—and the input increased until standard output is again obtained. The ratio of the two input figures is a measure of the selectivity of the receiver for a definite frequency different from resonance. The process is repeated for a number of frequencies, and the results expressed in the form of a curve, as shown in Fig. 1.

Detector Demodulation

The meaning of such curves is perhaps most clearly realised if it be remembered that when a certain volume level is obtained when the receiver is tuned to a station, the same volume will be given by a station on a frequency 9 kc/s lower than resonance if it be 180 times as strong. This refers to the curve for 200 kc/s, and, as can be seen from the 600 kc/s curve, the selectivity is somewhat lower on the medium waveband.

Curves of this nature, while very valuable, do not tell the whole story regarding the selective properties of a receiver, for they only show the selectivity provided by the tuned circuits. They reveal

nothing of effects which may occur when the receiver is excited not by one signal only but by many. If a set be badly designed, therefore, serious interference may occur through cross-modulation and kindred effects, in spite of it possessing a high degree of selectivity. On the other hand, a well-designed receiver may give less interference than an inspection of its selectivity curve would lead one to expect, owing to the demodulating effect of a strong carrier on a weak in a linear detector.

It is not impossible to measure such

effects, but the procedure is by no means easy, and involves the use of two Standard Signal Generators. Taking ordinary selectivity curves is quite a laborious process if any approach to accuracy is to be obtained, and it is thought that these provide sufficient information at the present time. The modern tendency is towards the use of diode detectors operated at a large input, and under this condition they are rarely non-linear and so usually provide an appreciable demodulating effect. It is sufficient to remember, therefore, that a given increase in selectivity as shown by the curve will usually mean a greater reduction in interference, for the greater disparity of carrier voltages at the detector for which it is responsible increases the demodulating effect.

Selectivity Requirement

The degree of selectivity required depends upon what is expected of a receiver, for it is dependent upon the frequency separation and relative field strengths of the stations involved. If the set is to be used in an area remote from any broadcasting station, and, moreover, if only the stronger stations are required, then a fairly low degree of selectivity will suffice. Under these conditions the desired station will usually be initially stronger than its immediate neighbours, and it will probably suffice if the interference ratio of the receiver is about 100-1 at a frequency of 9 kc/s different from resonance. If the requirements are much the same, but the set is to be used in the service area of a transmitter, then a set of this degree of selectivity will not permit reception of any station within, perhaps, 50 kc/s of the local. In general, the selectivity ratio must be from 1,000-1 to 10,000-1 if reception

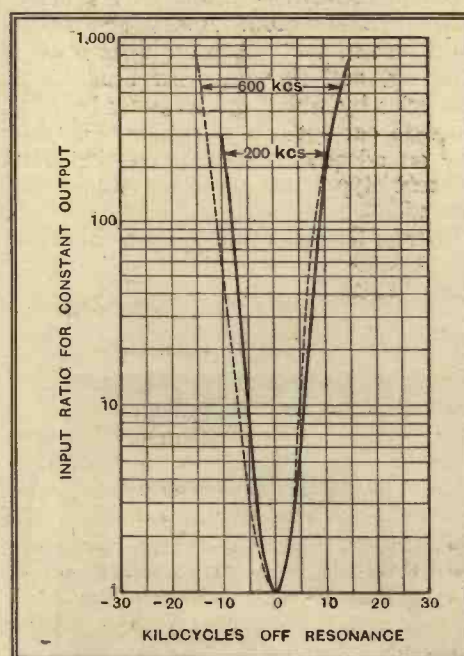

Fig. 1.—Selectivity curves of a typical small superheterodyne at two frequencies. It can be seen that the receiver is slightly more selective on the long waveband than on the medium.

Receiver Performance Data—

is to be free from the local transmission.

It might be thought, therefore, that selectivity could be simply expressed by quoting the ratio of input voltages required for standard output at resonance and at a frequency of 9 kc/s different from resonance. This is not the case, however, for two receivers having the same ratio under this condition may behave very dif-

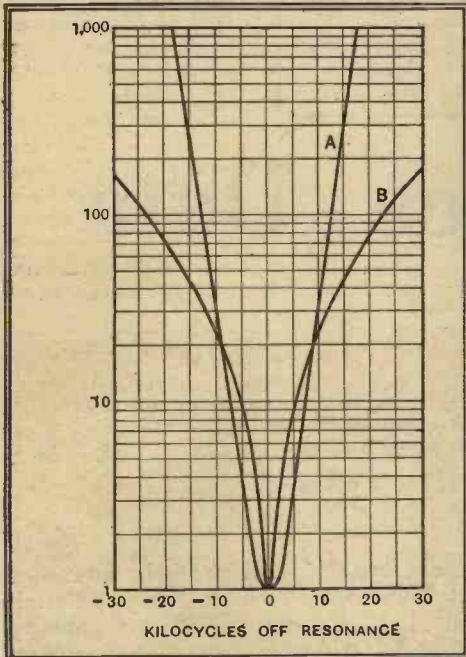

Fig. 2.—The selectivity curves of two different receivers both having the same selectivity at 9 kc/s off resonance. At frequencies farther from resonance one is much more selective than the other.

ferently. Curve A of Fig. 2 shows the type of selectivity curve to be expected of a superheterodyne, while curve B shows the selectivity of a straight set in which a considerable degree of stray regeneration is permitted to assist selectivity. At 9 kc/s off resonance each receiver requires twenty times the resonance input for standard output. At frequencies nearer resonance, however, the superheterodyne is much less selective, and so introduces less sideband cutting. At frequencies farther from resonance the selectivity of the straight set becomes much less than that of the superheterodyne.

FOREIGN BROADCAST GUIDE**MADONA**

(Latvia)

Geographical position: 56° 48' N: 26° 5' E.
Approximate airline from London: 1,170 miles.
Wavelength: 271.7 metres. Frequency: 1,104 kilocycles. Power: 50 kw.
Standard Time: Eastern European (Greenwich Mean Time plus 2 hours).

Main Daily Transmissions.

(Relays Riga): G.M.T. 05.35, news, concert; 10.00 news, weather; 16.00 concert; 18.00 weather, talks; 19.00 news, concert; 20.00 news and main evening entertainment; 21.00-22.00 dance music (Sat.).

Opening Signal: cock crow (for morning broadcasts only.)

Announcers: Man and woman.

Call: *Allo! Latvia, Riga, Madona, Liepaja.*

Interval Signal: Chimes (Latvian folk songs).

**Associated Transmitters:**

Riga, 514.6 m. (583 kcs.), 15 kw.
Liepaja (Libau), 173 m. (1,737 kcs.), 100 watts.

On the basis of a single-figure rating for selectivity these two receivers would be equal, and it is true that neither would have any superiority over the other in regard to interference from a station operating on an adjacent channel. The straight set would be likely to give poorer quality of reproduction than the superheterodyne, however, and a local station would spread considerably, whereas the interference with the superheterodyne would probably be confined to the two adjacent channels. In cases where a selectivity curve cannot be given, however, a two-figure selectivity rating may provide adequate information. It is suggested that one figure be the voltage ratio for 9 kc/s detuning, and the other the number of kilocycles by which the set must be mistuned to cut out a local station. In this way an adequate differentiation between different types of receivers would be secured.

Enough has been said to show that it is

necessary to indicate selectivity by means of a graph. It is not always realised, however, that the selectivity of a receiver varies considerably with the frequency to which the receiver is tuned. Almost invariably the selectivity is lower at high frequencies than at low. It is desirable, therefore, to plot selectivity curves for a number of different frequencies, and for the medium waveband it is usual to select 1,400 kc/s, 1,000 kc/s, and 600 kc/s. With a straight set this variation of selectivity may be very important, but it is not usually so with a superheterodyne, since selectivity is then chiefly obtained at the fixed intermediate frequency. The only receiver which has absolutely constant selectivity throughout the tuning range is one of the single-span type, for only then is there no signal-frequency tuning.

THE RADIO INDUSTRY

THE Principal of The Technical and Commercial Radio College, of Cromwell House, High Holborn, London, has sent us a copy of the new prospectus issued by the College. Although students of all branches of radio are catered for, it is understood that the greatest demand at present is for instruction in modern Servicing methods as applied to broadcast receivers. The activities of the institution are endorsed by several prominent manufacturers.

Reductions in price amounting on an average to nearly 20 per cent. have been made in the prices of many T.C.C. condensers of the dry electrolytic and tubular paper types. Several new patterns have also been introduced.

In last week's issue R. A. Rothermel, Ltd., were incorrectly referred to as agents for the piezo-electric loud speakers made by the American Brush Company. Actually, of course, the Rothermel firm holds the exclusive manufacturing licence for this country, and for some time has been producing piezo-electric instruments in its London factory, where, incidentally, the battery of speakers illustrated last week were made. A photograph of Mr. A. L. Williams, President and Chief Engineer of the Brush Company, appeared in this illustration; his work in developing the piezo-electric principle is well known. Mr. Williams recently visited this country.

At the Motor Show: an Ekco car set is installed on a 40-50 h.p. limousine shown on the Rolls-Royce stand.

A new Philco car radio receiver for 12-volt systems has been produced. Compared with the 16-guinea model, the new set, which costs 24 guineas, has the considerably greater output of 5 watts, and includes an extra valve. A separate speaker is employed.

Two different types of the Champion sparking plugs are now fitted with built-in resistors for suppressing interference. These are known as "No. 7 Radio" for touring cars, and "No. 16 Radio" for sports cars; the price of either type is 7s. 6d.

The Radio Resistor Co., Ltd., 1, Golden Square, London, W.1, have just issued a useful booklet giving a great deal of technical information on the use of Erie Resistances. The more abstruse aspects of the subject, such as temperature rise with load and the effect of voltage on resistance value, are dealt with, and, in addition, comparatively simple problems such as the choice of suitable resistance values and wattage ratings are treated.

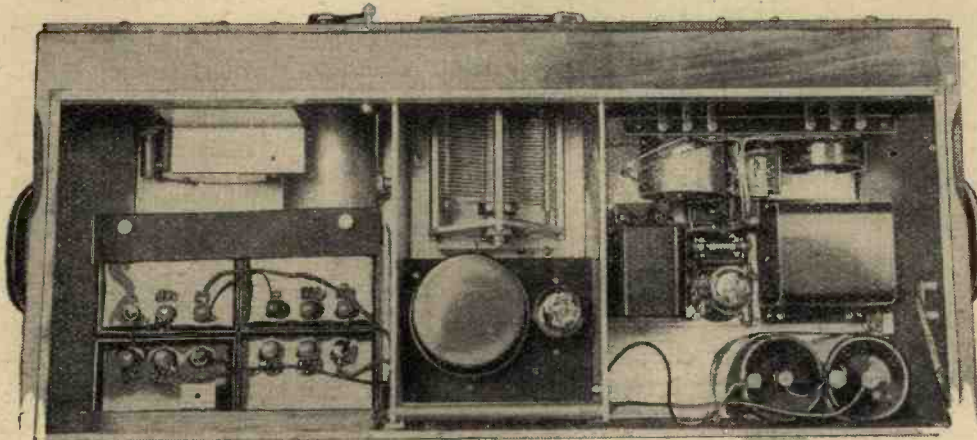

An inside view of a Standard Signal Generator. The HF oscillator can be seen in the centre and the modulation equipment on the right.

Short-Waves and the Amateur

Electrical Noise and Its Effect on Receiver Performance

By G2TD and G5KU

THE chief limiting factor in the reception of radio signals and the ultimate sensitivity of a receiving system is electrical noise.

Atmospherics of various types constitute a source of interference which is not removable. These static disturbances may take the form of intermittent crashes or a continuous rumble. Actually, on wavelengths below 15 metres these forms of disturbances are negligible, excepting in the case of local thunderstorms. On the 20- and 40-metre band the rumbling type of atmospheric is often troublesome when there is a concentration of signal strength from tropical regions. It adopts its most serious form on the 20-metre band during the late afternoon in summer and gradually becomes quite negligible during the approach of winter.

Eliminating, therefore, the influence of such types of external noise, it will be of interest to examine the causes of inherent electrical interference in a receiving system and its influence upon the maximum sensitivity which may be usefully employed for the purpose of receiving a desired but extremely weak signal.

It is well known that the frequency band which must be utilised in order to transmit intelligence depends essentially upon the nature of that intelligence.

Low speed morse may require a band width of only 25 cycles per second; useful speech may be transmitted over a band of 500 cycles. Orchestral music requires at least 7,000 cycles, while high definition television may need a frequency spectrum as high as 500,000 cycles.

If, therefore, a transmitter is modulated by the intelligence in such a way that it occupies a definite frequency spectrum, it is necessary for the receiver to amplify uniformly over an equally wide band to give perfect reproduction. This case is not usually completely satisfied in practice, although it is generally attained to a high degree.

The question of band width has an important bearing upon the noise problem.

Inherent noise in receivers may be due to a variety of causes: bad connections, poor quality resistors in coupling circuits, and valves with electrical leakage between electrodes, while badly insulated aerials may cause it in the form of crackling or "frying." All these types of noise producers are curable, and careful design may eliminate noise of this nature. One cannot, however, disregard the noises due to electronic agitation, which arise from two sources. They may be classified as follows:—

(1) Electron agitation in conductors.

(2) The random electron impulses on valve electrodes (Schrott effect).

It will be of interest to examine them because, at present, it is impossible to eliminate their effect.

Consideration of cause (1) forces us to regard a conductor as a swarm of molecules of the metal of which it is composed. These are theoretically proved to be in ceaseless

random agitation and moving with minute amplitude. Among this pattern a vast congregation of electrons is moving at high velocities. Random collisions of these electrons with molecules produce pulses of electric potential so that a voltage is created between the ends of the conductor. One cannot assign any specific frequency to the voltage because the EMF due to a single collision may be mathematically analysed into an infinite series of frequencies. Since there are myriads of impulses of a random nature, the complexity of the frequencies

duced in the anode circuit load during the period of deceleration of the electron as it arrives at the anode. This pulse may be mathematically analysed into an infinite series of sinusoidal frequencies, and since myriads of electrons are arriving at random time intervals one obtains a similar type of result to that given by the noise of electron agitation in conductors. Here, again, the actual magnitude of the noise depends upon the band width used for reception, and it will be seen that since sharply tuned circuits with effective band widths of less than 3 kc/s. may be obtained with HF tuned circuits, such methods of amplification are to be desired rather than LF amplification, with its greater effective band width.

To summarise, we may say that where high gains are essential for the reception of

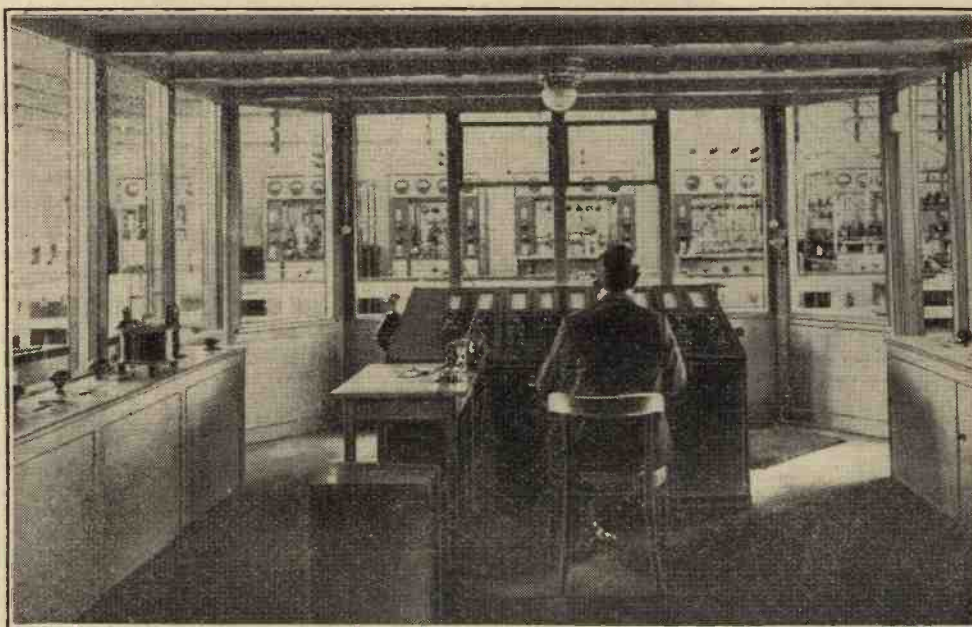

PHI, EINDHOVEN, HOLLAND, as seen from the control desk. This famous station of the Philips' organisation is expected to resume transmissions shortly on the 25- and 16-metre bands.

and phases of the resultant EMF may be well realised. It is sufficient to state that if one takes any given band of frequencies of width n , the voltage is proportional to n , other things being equal. It is significant that of two receivers having equal gain but different selectivity, that of the greater selectivity has the lower noise level, and since the reception of CW telegraphy on short waves is of greatest import, highly selective receivers may be employed on account of the low band width necessary for reproduction of hand speed morse. Such selectivity may be attained by the superheterodyne receiver, which is rapidly increasing in popularity on this score. Actually, it may be thought that the increased sensitivity is mainly responsible for its generally superior performance, but this is not altogether true since the greatly increased selectivity definitely does increase signal-to-noise ratio as predicted by theory.

The second type of electronic agitation is concerned with the valves themselves, and the mechanism of the effect is as follows.

A consideration of a single electron travelling from cathode to anode in a valve shows that a pulse of current will be pro-

duced in the anode circuit load during the period of deceleration of the electron as it arrives at the anode. This pulse may be mathematically analysed into an infinite series of sinusoidal frequencies, and since myriads of electrons are arriving at random time intervals one obtains a similar type of result to that given by the noise of electron agitation in conductors. Here, again, the actual magnitude of the noise depends upon the band width used for reception, and it will be seen that since sharply tuned circuits with effective band widths of less than 3 kc/s. may be obtained with HF tuned circuits, such methods of amplification are to be desired rather than LF amplification, with its greater effective band width.

The first week of October has ended in a glorious display of contacts between all continents, and if there are any 10 watt stations left who are not yet "WAC" they are advised to give up the game. Of course, it is realised that some may be actually carrying out experimental work! The Australian amateurs are evidently keenly interested in their Melbourne Centenary Contest, as large numbers were active on the 40- and 20-metre bands during the first week-end of the contest. Why is it that such a relatively unimportant event in the history of an amateur station is necessary to stir up this enthusiasm to work as many stations as possible? A careful comparison of commercial field strengths and amateur activity reveals a sad lack of keenness in some parts of our Empire.

News of the Week

Current Events in Brief Review

From the Forum

THE Roman Forum will soon be converted into a temporary broadcasting studio. According to the arrangements symphony concerts will be given, the orchestra being conducted by such



RADIO AT THE MOTOR SHOW. Tuning in a broadcast programme in an Essex 1935 caravan at Olympia. The majority of caravans are radio-equipped.

notable musicians as Molonori, de Sabata, Serafin and Mascagni.

Radio on French Cars

THE Paris Car Show, which closed on Tuesday last, was marked by a great increase in the number of radio-equipped cars, writes a correspondent. Many cars which had not sets installed were provided with space for the wireless equipment. In the Citroën cars the wireless set was mounted in such a way that it could be taken out with ease for home use.

A Far-Reaching Stentor

A NEW loud speaker, so powerful it can magnify the human voice a million times and even penetrate a din which would drown out the most powerful sound equipment hitherto available, has been developed by engineers of the Western Electric Co. (writes our Washington correspondent). It was first demonstrated, though at only a part of its full power, during the recent America's Cup races when used by the U.S. Coast Guard to warn shipping off the course.

Clarity is obtained in spite of the tremendous power by sacrificing naturalness to focus on voice frequencies most readily intelligible after filtering out the other frequencies. When the sound is hurled into the air the force is the equivalent of a 50-pound hammer blow.

Old Spanish Custom?

IT is officially stated that the number of licensed listeners in Spain does not exceed 250,000, whereas the number of pirates is known to be considerably in excess of this figure.

Relays in Disfavour

THE Blackpool Town Council has decided to stand by its decision to give notice to end the agreement with the Corporation for the rediffusion of wireless programmes. Councillor A. S. Ashton said that protests against overhead wires had been insistent; in some places there was a regular network of wires.

Subscribers are organising a petition for the continuance of the system.

A Medium-wave Freak

A FREAK reception of the first magnitude is reported from Oslo. The manager of the Frederiksstad relay station, Norway, has received a letter from Mr. T. H. Drew, of Wellington, New Zealand, from which it is clear that although Mr. Drew was unable at the time to identify the station, he did actually hear its transmissions on January 20th and again on January 25th last. Frederiksstad works on a wavelength of 386.6 metres with a power of only 700 watts in the aerial.

The New Zealand listener was using an eight-valve battery-operated superhet of American make.

"High Fidelity" Transmission

A N ethereal game of leap frog" is the description applied by a Washington correspondent to the peculiar trend which radio is taking in America. Not long ago transmission was definitely in advance of reception, but with the introduction of the "high fidelity" receiver the broadcasters, who have repeatedly criticised the manufacturers for low-quality receivers which cut off the extreme notes, now make the admission that improvement is necessary in their own transmitters.

To redress the balance, there enters into the picture, on the side of the broadcasters, what is described as the world's first *bona fide* "high fidelity" station. It bears the call-letters W2XR and is being operated in Long Island City, New York, experimentally with 350 watts power on a frequency of 1,550 kc/s. The operator of the station is the well-known radio engineer John V. L. Hogan, and the station transmits two hours daily from 5 to 7 p.m. (E.S.T.).

Upon the results achieved with this and two other "high fidelity" stations further extensions may be made in the broadcast waveband. The channels are 20 kc/s wide, or twice the breadth of the conventional radio band.

A Vitality Gauge?

FROM Hungary comes the news that Mr. Arbad Strepsy has perfected a thermionic lamp for diagnosis by doctors. The lamp fails to light up if the subject lacks "vibrations."

Recorded Greetings

"GREETINGS by Radio," even when sent across an ocean or around the world, have become commonplace. Officials of the Deutscher Amateure Send-und-Empfangsdienst, the national German amateur radio society, meeting at the Berlin Radio Exhibition, decided to modify the procedure. They recorded their speeches of greeting to a sister society across the seas—the American Radio Relay League—on phonograph records, and sent them over as their messengers in lieu of the fleeting radio waves.

Navy Thanks Canadian Amateur

A N amateur radio station operated by a 73-year-old Canadian doctor is one of the British Empire's outposts in China, according to a letter received by the American Radio Relay League.

Dr. William Malcolm, the amateur in question, is health officer of Chefoo in the Province of Shantung. His most recent feat was the transmitting of first word to the British Legation of the s.s. Shuntien piracy last summer in the Yellow River.

Dr. Malcolm has received an expression of gratitude from the British Navy for the handling of messages to and from the British Fleet in Chinese waters. His station, AC3MA, has been in operation for nearly seven years.

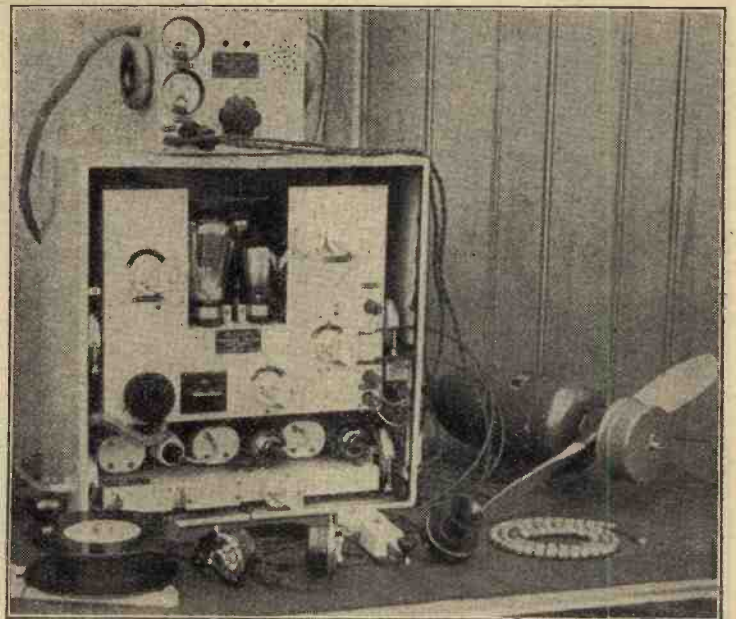

ENGLAND-AUSTRALIA AIR RACE. Plessey radio equipment of the type installed on the New Zealand D.H. Dragon Six and Captain Neville Stack's British Airspeed "Viceroy." The equipment is described on page 313.

Optimistic

GERMANY hopes to have six million registered listeners by the end of the year. On October 1st the total was 5,574,000, an increase of 133,535 over the figure for September 1st.

Radio on Railways

THE Danish State Railways have begun experiments with wireless to replace the usual telegraph communication between stations for signalling purposes. Tests are being carried out on the Slagelse-Kalundborg line.

New American Networks

SO many new radio network projects have been promoted in the United States during the last three or four years that the American broadcasting industry has been inclined to look askance at each new venture, writes our Washington correspondent. It is well known, of course, that the "cream stations" of the country are embraced by the N.B.C. and C.B.S. networks, but there remain a few major stations that belong to neither system. Now comes news that some of these independent stations are to be formed into two rival networks, the first project calling itself the Quality Group. This has started with a network including WOR, Newark, WLW, the 500-kilowatt station at Cincinnati and WGN, the 50-kilowatt station of the *Chicago Tribune*. The second new group carries the ambitious title of the "American Broadcasting System," its key station being WMCA, New York. The aim of this system is to cover America with low-power stations in preference to using a few of high power.

BROADCAST BREVITIES

By Our Special Correspondent

Sir John Reith

THE Director-General of the B.B.C. returns to London during the first week of November.

While the investigation into broadcasting in the Union has served a useful purpose as the published reason for Sir John's trip to South Africa, I believe there are bigger fish frying. Readers need not be surprised if Sir John Reith decides when the B.B.C. Charter expires to accept a high Government office on the plane of a Governor-Generalship.

The B.B.C. Influence

Whether the appointment were South African or Canadian, Sir John would be in a position to watch broadcasting with a fatherly eye. In Canada broadcasting has just started on a new lease of life on the B.B.C. model, as recommended by that pillar of the B.B.C., Mr. Gladstone Murray. In South Africa Sir John Reith's own influence will shortly declare itself.

Armistice Day

THE Armistice Day service will be relayed from the Cenotaph, Whitehall, to all stations of the B.B.C. on Sunday, November 11th, and a relay will be taken in the evening of the British Legion celebration at the Royal Albert Hall. This will be followed by an orchestral concert conducted by Adrian Boult, at which three poems of Laurence Binyon, set to music by Edward Elgar, will be given. Both the Cenotaph service and the British Legion celebration will be heard in the B.B.C. Empire transmissions, while the orchestral concert will be broadcast simultaneously to a part of the Empire.

"Nelson"

NELSON stands before the microphone on October 21st, the 129th anniversary of the Battle of Trafalgar. This day the radio play "Nelson" will be broadcast, with Geoffrey Toone in the name part and a large cast which includes Carleton Hobbs as Napoleon Bonaparte and Jean Sheppard as Josephine Bonaparte.

Does Droitwich Please?

IF silence means consent, assent, content, etc., the B.B.C. may take it that Droitwich is its biggest success since the abolition of 24-hour timing. Scarcely a letter has been received and this is regarded as a good augury.

A Rumour Scotched

The public has learnt the falsity of those tales spread at the time of the Radio Show that Droitwich would "date" all sets not specially adapted to meet the new conditions.

A Word for the "Local"

On the quality count Droitwich is superb, but as a London listener I still hope that the closure of London National may be delayed

as long as possible. Occasionally I have heard morse when tuned to Droitwich and assuredly more atmospheric disturbance, presumably because it is necessary to increase the sensitivity of the receiver in order to pick up the more distant station.

His Majesty's Christmas Broadcast

IT is understood that the King will again speak to the British Empire and the world on Christmas Day. Arrangements are being discussed for securing a still wider audience. How this will be done cannot yet be disclosed.

Dramatising the News

I AM sorry that Professor Coatman has found it necessary to dramatise, or perhaps one should say "theatricalise," the news. The method may hold good for brightening up accounts of village fêtes and race meetings, but not of events entailing bloodshed and death. Such an occasion was

specially erected self-supporting lattice towers each 350 feet high.

Vertical Directivity

The di-poles attached to the older masts happened to be directional for Canada, while those attached to the new lattice masts serve India, the West Indies, and parts of Australia."

The major problem, Mr. Hayes told me, concerned vertical directivity. Signals follow a trajectory, like a bullet, rebounding from the Heaviside layer, coming back to earth in accordance with the angle of reflection. The tests are to discover at what angles the signals should be "shot" to reach as many listeners as possible.

Biggest Audience American

"We gauge the success of each experiment," said Mr. Hayes, "by letters received from broadcasting engineers overseas as well as individual listeners in different parts of the Empire."

Mr. Hayes revealed that the majority of reports on Empire broadcasting came from the United States.

"Empire" Reception in London

I asked him whether the strong reception of GSD in the London area must be attributed to the ground ray. "No," was the answer; "it is doubtful whether the ground ray extends beyond fifteen miles of the Daventry site. Most of the Empire transmissions can be heard by direct ray in London, which, after all, is seventy miles off."

All-wave Sets?

How tragic to think that all these transmissions are going over our heads. It looks as if our own manufacturers will soon have to follow the trend of the all-wave set which already has a firm hold in America.

Provincial Microphones

ALL the provincial B.B.C. stations are now equipped with moving-coil microphones, but lest it should be thought that they are now on equal terms with London, it is worth stating that the B.B.C. Research Department's ribbon "mike" promises to become standard at Broadcasting House.

Then, when the ribbon type finds its way to the provinces, headquarters will presumably be adopting that hush-hush omnidirectional type.

In other matters, such as studios and control rooms, the Provinces are well abreast of the London headquarters.

More About A. J. Alan

I HOPE you are all watching this page for news of the great raconteur. This week I can tell you that A. J. Alan, no doubt influenced by recent distressing breakdowns in the Grid system, always brings a candle, candlestick and boxes of matches to the studio. *Verb. sap.*



BROADCAST DRAMA OUTDOORS. To provide an ideal environment, the Deutschlandsender authorities recently recorded a play in the woods, broadcasting it in the evening programme. The picture was taken during the recording.

the subduing of the Catalonian rebellion, which the B.B.C. News Department saw fit on Sunday, October 7th, to treat as an elocutionary duet by two announcers.

It was an unhappy attempt at "headlining" which jarred at a time when the bodies of the victims had scarcely grown cold.

Short Waves from Daventry

TO tear aside the pall of mystery which has been enwrapping Daventry ever since the Droitwich début on October 7th, I sought and found Mr. Hayes, of the B.B.C., famous for his knowledge of things past, present, and to come in broadcasting history.

"The experiments at Daventry," he told me, "have always been principally concerned with the design of aerials. We began with small directional arrays, then tried horizontal di-poles attached to the 5XX masts, and are now testing with the two

LABORATORY TESTS

New Radio Products Reviewed

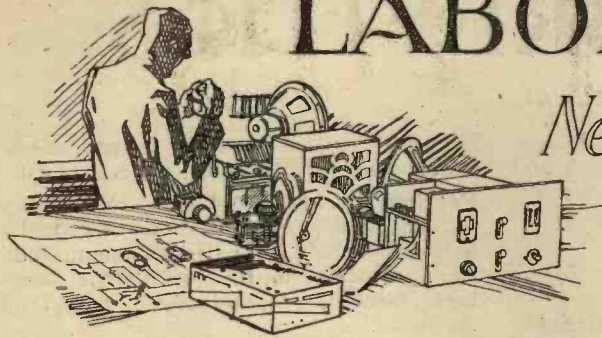

BULGIN POWER RESISTANCES AND 5-AMP. SWITCH

A NEW range of wire-wound power resistances rated at 40 watts dissipation is now made by A. F. Bulgin & Co., Ltd., Abbey Road, Barking, Essex. They are obtainable in values from 100 to 100,000 ohms, the wire being first spirally wound on an asbestos core and then wound on a porcelain former. As in all Bulgin resistances of this type the terminal bands are not used to anchor the turns which are self-positioning, so it is possible by loosening them to slide the bands along the element and thus obtain any resistance value required for a special purpose.

A test was made with a 3,000 ohms 40-watt model, the maximum current carrying capacity of which is given as 117 mA. While the resistance will carry this current indefinitely it should be well ventilated as considerable heat is generated in view of the watts dissipated. For normal use we consider that about 100 mA. should be maximum for this particular size, which gives a voltage-drop of 300.

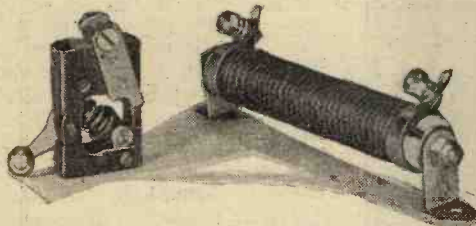

Bulgin 3,000-ohm 40-watt power resistance and new 5-amp. mains switch.

The resistance measures 4in. by 1in. by 1½in. high when mounted horizontally, but a vertical mounting can be supplied if required. The price is 3s. 6d. up to 3,000 ohms and 4s. for the higher values.

The new 5-amp. mains switch is designed so that the make and break of the contacts does not coincide with the "on" position of the fixed contacts, so should any sparking occur the actual contact surfaces are not affected.

The action is very rapid since it is spring controlled, and in normal circuits no arcing was noticed. The switch is of the skeleton pattern, giving good ventilation, and the price of a single-pole "on-off" switch is 1s. 6d.

NEW T.C.C. ELECTROLYTIC CONDENSERS

THE T.C.C. dry electrolytic condensers of the low-voltage type as used in grid bias circuits have hitherto been fitted in moulded cases, but now a new range is available, one style of which has soldering tags while the other is a one-hole chassis fixing model, this serving also as the nega-

tive connection, while a soldering tag on the top is the positive. These condensers are assembled in tubular cases of bakelised material, and are fitted with metal end-caps, the length being

zin. approximately and the diameter ½in. A hole ⅜in. in diameter is needed to clear the fixing bush in the chassis-type model.

This new series includes condensers of from 2 mfd. at 200 volts DC working to

Two new T.C.C. low-voltage dry electrolytic condensers; the type "AT" has soldering tags and the type "C" a chassis fixing bush.

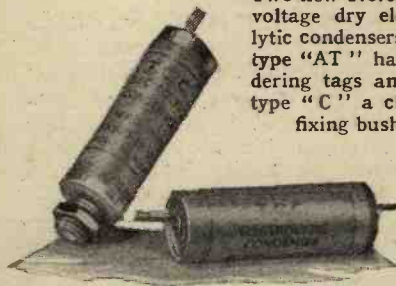

50 mfd. at 12 volts DC working and with either style of fixing. A 25-mfd. 25-volt size costs 2s. 3d. with soldering tags and 2s. 6d. with threaded fixing bush. They are listed as the type "AT" and the type "C" respectively. The makers are The Telegraph Condenser Co., Ltd., Wales Farm Road, North Acton, London, W.3.

USEFUL PROGRAMME RECEPTACLE

SHALLESS & EVANS, LTD., Havelock Street, Forest Hill, London, S.E.23, has introduced a special receptacle for the *Radio Times* so that the wireless programmes may always be to hand when needed. It takes the form of a shallow box fitted with a drawer of the right size for this journal, and a convenient place to keep it would be underneath the receiver. The dimensions are 10in. by 14½in. by 1½in., and the price is 5s.

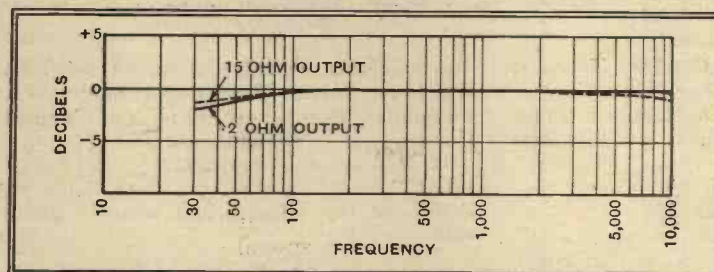

PARTRIDGE OUTPUT TRANSFORMER

AN output transformer designed especially for use with a PP5/400 valve and to feed two loud speakers of different impedances simultaneously has been developed by N. Partridge, Kings Buildings, Dean Stanley Street, London, S.W.1. The sample submitted for test has its secondaries proportioned to give the correct working load with loud speakers of 15 and 2 ohms impedance respectively. Each speaker receives one half the available output, but the correct working load is only obtained

provided both secondaries are in use and one alone must be used.

This transformer overcomes the difficulty of using an extension loud speaker without spoiling the quality of reproduction from the other.

The output measured across a resistance equal to the impedance of the loud speaker that would be joined to each secondary is sensibly constant at all frequencies from 50 to 10,000 cycles and the two curves would be practically identical had we not opened out the decibel scale to show the difference. The two-ohm response curve is 1.7 decibels down at 30 cycles, while the 15-ohm one is a shade over one db. only. At 10,000 cycles the two-ohm curve is 0.3 db. below the mean level, but this increase to -0.7 db. for the 15-ohm secondary. In neither case will the small loss at each end of the audio spectrum be noticeable by the ear on broadcast since the differences are far too small, and for practical purposes the transformer can be said to have a flat characteristic from 30 to 10,000 cycles.

With no DC flowing the primary inductance is 25 henrys and with the working current of 60-mA. it falls to 20.6 henrys. This is about the right value for the valve as the impedance of the primary at 50 cycles is just over twice the working load. Its DC resistance is 270 ohms and the price 18s. 6d.



Partridge output transformer for feeding two loud speakers of different impedances simultaneously, and response curve for 2-ohm and 15-ohm outputs.

The transformer is designed correctly for its purpose and can be confidently recommended. Models to suit any combination of two loud speakers can be supplied.

New Catalogues Received

The National Radio Service Co., 15-16, Alfred Place, London, W.C.1.—Leaflets dealing with S. G. Brown headphones; also leaflets describing the repair and maintenance services conducted by the Company.

British Television Supplies, Ltd.; Bush House, London, W.C.2.—The Telelux Television Neon Lamp.

HINTS and TIPS

IN the interests of simplicity the plan of using a reaction condenser as the sole volume control in a local-station set is an obvious one. The fact that it sometimes works disappointingly in practice is a sign that reaction is normally unsuitable

Reaction as Volume Control.

for controlling sensitivity, and it is clearly impossible by its aid to reduce the strength of an incoming signal

that is already too strong.

It would be possible to adjust matters, say, by drastically loosening aerial coupling to reduce signal strength; reaction would then be available for increasing volume up to the desired level. But tuning would then become rather too critical, and quality would probably suffer.

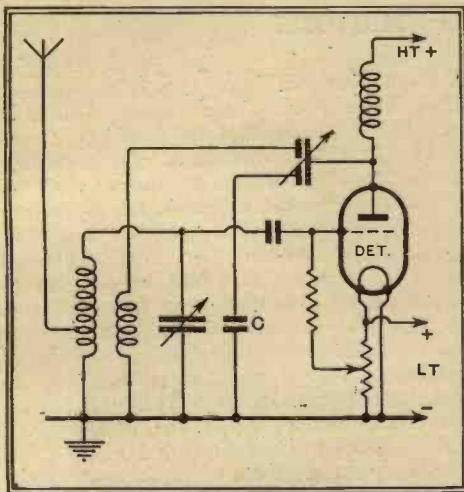

Fig. 1.—Modifying the action of a differential reaction condenser by inserting a fixed capacity C in circuit.

It is suggested that a better method is to reduce apparent detector efficiency by deliberately omitting the usual detector anode by-pass condenser. With the reaction condenser set at zero the apparent efficiency of the detector will be low, for the reason that reversed reaction through the valve capacity will be tending to decrease sensitivity. When reaction is pressed to the limit, however, there will be no obvious falling-off in the sensitivity of the receiver through the omission of the condenser.

As a practical result of this change it will be observed that the effect of the reaction control in varying volume will be much more marked than formerly. There is no reason why, for a local-station set such as that under consideration, this plan should not be combined with a rough readjustment of aerial coupling.

Where a differential condenser is employed much the same result can be brought about by joining a small condenser in series with the earthed section, which actually forms a variable anode by-pass capacity (see Fig. 1).

If the smoothness of reaction control

Practical Aids to Better Reception

should be adversely affected by these changes the usual remedies may be tried; anode voltage may be reduced, or the grid leak may be joined to the slider of the potentiometer, as shown in Fig. 1.

AFTER moving from one house to another it frequently happens on switching on the receiver that sensitivity, and perhaps selectivity as well, seem to have dwindled to a mockery of their former standard.

Before assuming that the internal connections have become deranged during transit, it is as well to remember that some recent receivers are

very sensitive to discrepancies in the ganging of the aerial circuit. It may be that the new aerial has a considerably larger, or smaller, self-capacity than the previous one; the change may be quite enough to throw a fairly sharply tuned aerial circuit entirely out of alignment.

As in most modern receivers the trimmer concerned is usually quite accessibly placed at the back of the gang condenser realignment, and hence the restoration of full signal strength, should be a matter of minutes only.

It is possibly through neglect of this little attention at the time of installation that many commercial sets of well-known makes give a poorer performance than they should.

IT would seem that the practice of fitting safety fuses in the anode feed circuits of receivers is mainly confined to battery sets. So far as mains sets are concerned, the only protection ordinarily considered necessary is that afforded by a fuse in the mains lead, which will "blow" when an excessive current flows either in HT or LT circuits.

Safety Fuses.

The use of special proprietary fuses, which afford protection should the current rise even quite a small number of milliamps above the normal value, is probably most attractive in the case of an experimental receiver, where frequent circuit changes are likely to increase the risk of damage. If the fuse be sensitive enough it will protect not only the valves and the components of the receiver, but also the battery itself, against almost any eventuality except the steady drainage imposed by a slow leakage.

The connection of these sensitive fuses is not quite so straightforward as it might

appear to be. When large by-pass condensers are included in the receiver it will often be found that the sudden rush of charging current into the condenser which takes place when the battery is connected may be responsible for blowing the fuse, even if everything is in order. To avoid this trouble the fuse and HT by-pass condenser C may be connected in the manner shown in Fig. 2 (a) so that the charging current may be diverted from the fuse. The same condition can be brought about in other ways, but it is more than doubtful if this plan is worth while in any case; a sensitive fuse of the kind under consideration is likely to have quite a high resistance, and, as it is no longer by-passed by the condenser, it may be responsible for unwanted inter-circuit couplings.

When the various anode circuits of the receiver are adequately decoupled it would appear to be a much better plan to omit the HT by-pass condenser altogether; its retention in our sets is largely a matter of habit. Admittedly, the by-pass condensers associated with the decoupling scheme will still be charged up when the HT battery is connected, but the maximum current that can flow is then limited by the presence of the decoupling resistance, and ordinarily this limit will be

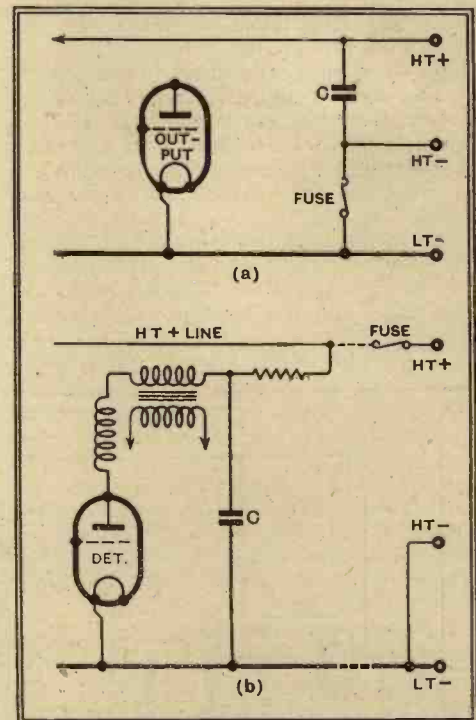
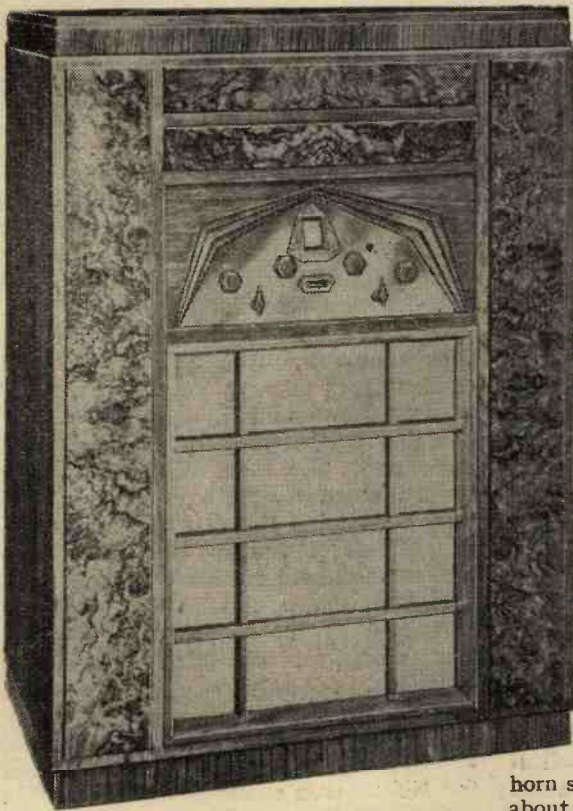

Fig. 2.—Safeguarding a safety device: avoiding the flow of condenser charging current through a fuse.

sufficiently low to avoid the risks of damaging the fuse. This latter arrangement is illustrated in Fig. 2 (b), which shows that the decoupling resistance is in series with the by-pass condenser C, while the fuse is in the common HT+ lead.



R.G.D.

Auto Radio-Gramophone

MODEL 1202

FEATURES.—*Type.*—Superheterodyne radio-gramophone with automatic record changer. *Circuit.*—HF amplifier—triode oscillator—1st detector—IF amplifier—double-diode-triode 2nd detector—1st LF amplifier—pentode noise-suppression valve—paraphase feed valves—push-pull output valves. Full-wave valve rectifier. *Controls.*—(1) Tuning, with meter-type tuning indicator. (2) Volume control. (3) Wave-range switch. (4) Tone control and whistle filter switch. (5) Selectivity control. (6) Noise-suppression switch. (7) Mains switch under lid. **Price.**—107 guineas. **Makers.**—Radio Gramophone Development Co., Ltd., 18/20, Frederick Street, Birmingham, 1.

Audio-frequency Response Up to 10,000 Cycles on Local Stations

IN view of the fundamentally simple and direct design of all R.G.D. receiver chassis it was not to be anticipated that recent developments in multiple-purpose valves would have any influence on the new season's products. The results achieved with the Model 1201,¹ in which separate valves are assigned to every function, including that of the oscillator, suggested that finality had been closely approached in the matter of useful range and selectivity. In the matter of quality, however, although tone correction was included to compensate for the effect of high selectivity, the design was necessarily a compromise. It is in the measures which have been taken to ensure the very best possible quality of reproduction that the principal interest of the new Model 1202 lies.

The frequency range is from 70 to 10,000 cycles and three loud speakers are employed. Two of these are of the normal moving-coil cone type, and the third is a moving-coil

horn specially designed for frequencies from about 2,000 to 10,000 cycles. It goes without saying that this extremely wide frequency response can be used only on the local station or on transmissions where the signal-to-noise ratio is high. It is well known that background noise and "mush" generally contain a large percentage of the higher frequencies, and on distant stations the results would be intolerable from a programme point of view. The makers have arranged, therefore, that when the full audio-frequency range is available the superheterodyne circuit is cut out of action and the receiver functions as a simple HF-det-LF straight set. Simultaneously the tone correction in the LF circuits is adjusted to give exactly the required degree of compensation.

Whistle Filter

It often happens that even when a set is used within a few miles of a B.B.C. station a heterodyne whistle from a foreign station on an adjacent channel is audible. It may be of immeasurably small amplitude, but the high pitch can still be quite irritating

to a sensitive ear. Accordingly the makers have included a whistle filter, which is brought into operation by a switch incorporated in the tone control. Of necessity, the whistle filter, which is adjusted to 9,000 cycles, causes some reduction of the audio-frequencies immediately below this frequency, but, nevertheless, the quality is much better than it would be possible to obtain with full superheterodyne selectivity. To appreciate to the full the capabilities of the instrument from the point of view of quality of reproduction it is necessary to find a strong transmission free from heterodyne interference, when the whistle filter can be cut out of action and the full audio-frequency range of the amplifier employed.

The first thing to be noticed is the extraordinary realism of percussion instruments and transients in general. In fact, if receivers of this type come into general use the B.B.C. Effects Department will have to revise some of its methods, as the clarity of reproduction enables one to "see through" many of its subterfuges. Superficially there does not appear to be a vast improvement in the quality of orchestral music in general,

¹ *The Wireless World*, December 29th, 1934.

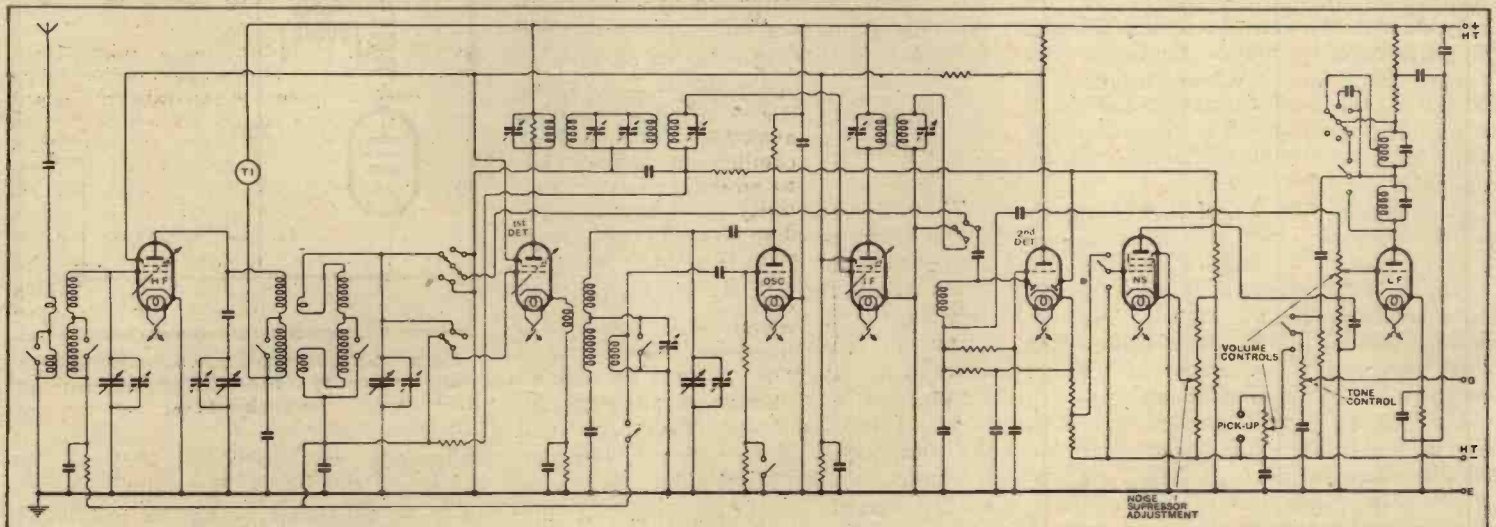

Circuit diagram of the radio chassis. Three degrees of selectivity and tone correction are provided, and a separate pentode stage provides automatic noise suppression between stations.

R.G.D. Auto Radio-Gramophone, Model 1202—
 but, after some further acquaintance with the receiver and referring back to earlier standards of quality, there is an unmistakable improvement in the reproduction of strings, and more especially of the brass section of the orchestra. It does not require a trained ear, however, to appreciate the realistic quality of speech, which is obtained without undue emphasis of the sibilants.

At the two higher positions of the three-way selectivity switch the tone control is automatically adjusted to cut off at approximately 4,000 and 3,000 cycles respectively. These values have been judiciously chosen so that the maximum possible programme value can be abstracted from every station, from the strongest to the weakest.

The makers state that with the selectivity control is position 1—that is, with the simple straight circuit—the range is of the order of fifty miles from a Regional transmitter. This is a conservative estimate, as we found that in Central London the Midland Regional transmitter would fully load the output stage and that the background noise, without having resort to the whistle filter or tone control, was negligible.

Range and Selectivity

At positions 2 and 3 of the selectivity control with the full heterodyne circuit in operation the sensitivity was sufficient to give sixteen foreign programmes on medium waves in daylight. With such high sensitivity the background noise between stations is naturally high, but an automatic noise suppressor, which may be set at any pre-determined level by a control on the back, enables the user to select only those stations which are of programme value under the conditions prevailing at the time and with complete silence between stations. This function is now performed by a pentode valve instead of the relay which was used in the Model 1201. It is perfectly smooth in action and does not produce any unpleasant threshold effects.

At a distance of about fifteen miles from Brookmans Park the two transmitters occupied approximately 12 kc/s, but at only a slightly greater distance complete adjacent channel selectivity would be available. With the selectivity control in position 1 the tuning is, of course, very much broader, but is sufficient to separate all the stations which are likely to give good results

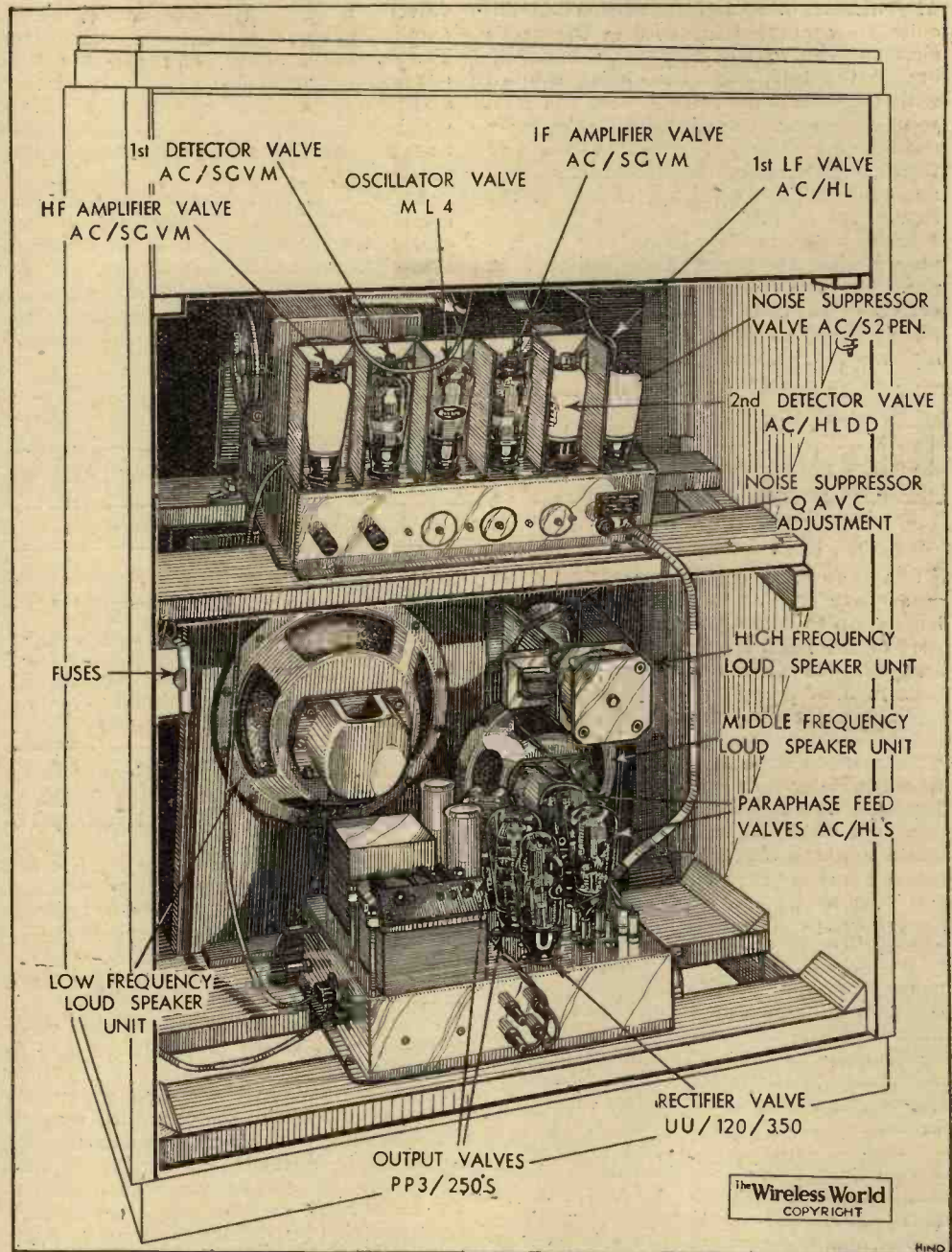

on that range. Second-channel interference was entirely absent on the medium waveband, and only a single self-generated whistle was detected on the long waveband.

With a six-watt output stage and the extension in frequency range an outstanding performance on the gramophone side is available. Special precautions have been taken to ensure that the sensitivity at high frequencies does not introduce excessive surface noise. The pick-up is a piezo-electric type of special design which gives ample bass correction under control. The Garrard record changer is retained, and this component has now been in use long enough to make comment on its reliability superfluous.

Excluding the rectifier there are no fewer than eleven valves in the receiver and amplifier chassis. The signal-fre-

Interior arrangement of the cabinet, showing disposition of the three loud speaker units. The output stages are incorporated in the power-supply unit at the base of the cabinet.

quency HF amplifier has a single tuned input circuit and band-pass coupling to the first detector valve. A separate triode oscillator is employed, and six tuned circuits are associated with the single IF amplifying stage. Four of these are employed in the coupling between the first detector and the IF valve, and the special double intermediate circuit has been found to give important advantages in obtaining a resonance curve of good shape and ease of ganging. The two elements are now directly-coupled instead of through a condenser.

The second detector, the only multiple-purpose valve in the circuit, is of the double-diode-triode type. The diodes are employed in the usual way for rectification and AVC bias supply, but the triode portion, instead of amplifying the audio output, provides a first stage of DC amplification for the noise suppression bias. This is passed to the pentode noise-suppression valve for further amplification before actuating the grid of the first LF amplifier. By this means a clean and rapid cut-off is obtained.

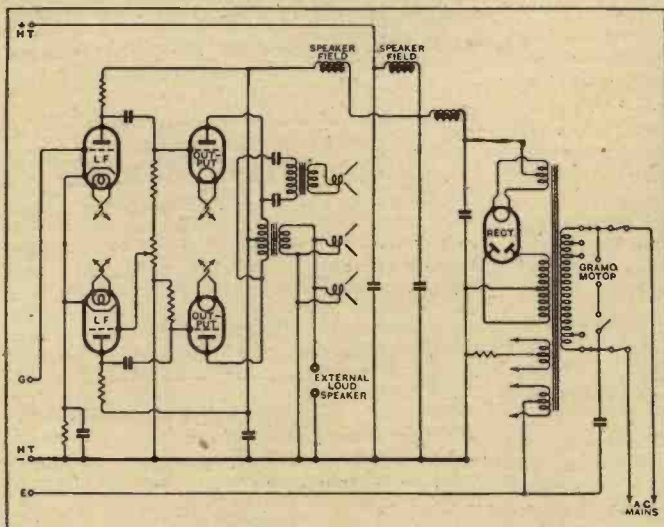

Connections of the power stages and the power supply unit, showing method of feeding the triple loud speakers.

R.G.D. Auto Radio-Gramophone, Model 1202—

The whistle filter and tone-correction circuits are connected in series in the anode circuit of the first LF amplifier, the switching of the tone correction being coupled with the selectivity control. All the foregoing stages are incorporated in the radio chassis, the push-pull output valves and their associated paraphase feed valves being mounted in the amplifying chassis at the base of the cabinet.

Incidentally, the first LF valve is not employed when the gramophone pick-up is in use. The two cone loud speakers are connected in parallel across the secondary of the push-pull output transformer, and the high-frequency horn is fed through two small

condensers from the anodes of the output valves to eliminate destructively large amplitudes due to the lower frequencies. The smoothing of the HF supply is carried out first by a separate choke and condensers and then by the loud speaker fields, one of which carries the current to the radio chassis and the other the current to the output valves.

As becomes an instrument of such outstanding technical quality, the cabinet exemplifies the best of the cabinet maker's art. It is finished in burr walnut, and is so solidly constructed that no wood resonances are detectable even with the large bass amplification developed by the six-watt output.

of parallel-connected valves rated at 2 volts 0.1 amp. in the manner shown in Fig. 1 (a). The chain of valves would be fed from a 4½-volt dry battery, which will be required to deliver a current of 0.2 amp.

This is quite a good plan, but we can see one disadvantage. The useful life of a 4½-volt dry battery is not ended until its voltage falls to about 3 volts, but this will be insufficient to give full emission from the valves. Consequently the battery must be discarded before it is fully exhausted, and so cost of replacement will be heavy.

It occurs to us that the arrangement shown in Fig. 1 (b) might be better. Here a pair of the new midget valves, rated at

READERS' PROBLEMS

Real Long Waves

IT is quite refreshing nowadays to receive a query relating to "man-sized" wavelengths up to 20,000 metres or more. This part of the radio spectrum is almost *terra incognita*, so far as most amateurs are concerned.

The present querist asks where he can obtain information as to the working times of stations on these long wavelengths which transmit meteorological information, weather forecasts, time signals, etc. We think that our best plan is to refer him to the *Admiralty List of Wireless Signals*, published by H.M. Stationery Office.

Morse Interference

SEVERAL users of superheterodyne receivers have recently complained of morse interference, the symptoms being that the same morse station is heard at all positions of the tuning control.

This may be taken as an almost certain indication that the interference is due to a nearby radio-telegraphic station operating on the frequency to which the IF circuits are tuned. The easiest way of overcoming the difficulty would be to make a slight change in the IF frequency by readjustment of the trimming condensers.

This applies to Single-Span sets as well as to more conventional superheterodynes.

Adding AVC

IT is probably true to say that there is no simpler way of adding AVC to an existing receiver not primarily designed for that refinement than is afforded by the use of one of the commercial units which embody a Westector. These devices are especially satisfactory in superheterodynes employing a fairly low frequency in the IF amplifier—roughly in the order of 100 kc/s. The applications of this system of control were discussed in *The Wireless World* for October 20th last year.

This is in answer to a reader who refers to a valve-operated unit which was described in this journal in the early days of AVC. Although that unit would work satisfactorily with his receiver (it provides a form of delayed and amplified AVC), it would nowadays be considered as unnecessarily bulky and expensive.

Aerial Circuits and Interference

IT is asked whether one type of aerial circuit is appreciably better than another from the point of view of minimising the effects of electrical disturbances. This question is prompted by the fact that, under

identical conditions, two receivers of basically similar design, except with regard to the input circuit, are found to be affected to a noticeably unequal extent.

In general, the design of the receiver has little influence on its susceptibility to mains interference. The ratio of intensity between signal and interference is usually the same for all receivers, although, of course, the disturbances appear to be stronger on a highly sensitive set.

It should be added, however, that there is one type of aerial input circuit that in certain circumstances is likely to provoke interference troubles. When the input grid circuit is returned to the earth line through a large condenser, across which a decoupling resistance is effectively in parallel, it may be found that interference is intensified if the aerial-earth circuit is completed through this condenser-resistance combination. Such conditions may arise either with single-circuit tuners or with band-pass filters when the aerial connection is tapped on to the tuned winding. The addition of a separate aerial winding will avoid this risk of trouble.

Dry-cell LT

ALTHOUGH the use of dry cells for supplying LT current to ordinary domestic receivers is almost unthinkable nowadays, it has a certain attractiveness for "special-purpose" sets such as small portables. Even if the battery has a short life, it is replaced without trouble, and the difficulties of accumulator charging are avoided. It is probably true to say, however, that the use of dry cells is only practicable when the receiver is to be used intermittently for comparatively short periods of listening.

The pros and cons of accumulator and dry-cell LT are well brought out by a reader who is planning a compact special-purpose det.-2LF set, which will depend mainly for its sensitivity on reaction. It is with regard to the arrangement of the filament circuits that our advice is sought; our correspondent stipulates that a valve rated at 2 volts 0.2 amp. must be used in the output position, and he asks whether it would be satisfactory to connect this in series with a pair

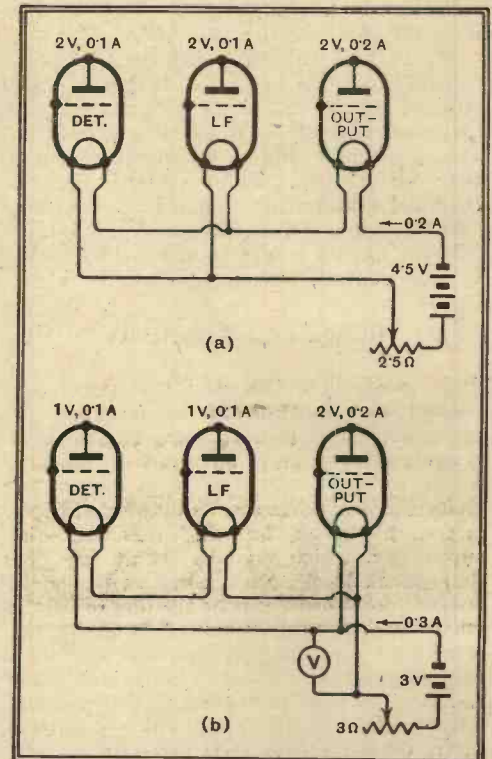

Fig. 1.—Filament circuits for dry-battery supply; the 2½-ohm rheostat in diagram (a) may usually be omitted.

1 volt 0.1 amp., are connected in series with each other and in parallel with the 2-volt 0.2 amp. output valve; this combination could be supplied quite satisfactorily for short periods by a two-cell (3-volt) bicycle lamp battery of the type which nowadays is so readily obtainable almost everywhere. A rheostat will be necessary, and it would be a great convenience to have a voltmeter permanently wired across the filament circuit as shown, in order to avoid the risk of damaging valves, and also as an indication of the condition of the battery.

The Wireless World INFORMATION BUREAU

THE service is intended primarily for readers meeting with difficulties in connection with receivers described in *The Wireless World*, or those of commercial design which from time to time are reviewed in the pages of *The Wireless World*. Every endeavour will be made to deal with queries on all wireless matters, provided that they are of such a nature that they can be dealt with satisfactorily in a letter.

Communications should be by letter to *The Wireless World* Information Bureau, Dorset House, Stamford Street, London, S.E.1, and must be accompanied by a remittance of 5s. to cover the cost of the service.

Personal interviews are not given by the technical staff, nor can technical enquiries be dealt with by telephone.

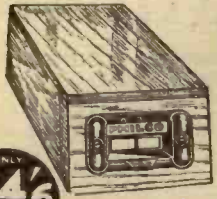

NEW!
PHILCO
SHADOW
TUNING
METER

For any make of set with A.V.C. — A.C., D.C., or Battery.

ONLY **24/6** COMPLETE IN ATTRACTIVE WALNUT CASE

Now you can put Philco Shadow Tuning on any make of A.C., D.C., or Battery set which has A.V.C. This new accessory can be fitted without adjustment and makes this exclusive Philco tuning device available to all. The Shadow Tuning Meter is complete with its own cabinet, decoupling condenser, wire, lamp and full fitting instructions. Or, if desired, can be fitted inside the set's own cabinet. Shadow Tuning shows you when you have hair-line tuning—and therefore pure, undistorted reproduction. Tuning in completely silent. Makes station-finding child's play. Indicates, as well, the comparative signal strength of stations.

AMERICAN TYPE VALVE REPLACEMENTS

Philco valves are suitable for all makes of American Radio sets. They cost less than British valves — and last longer. They can be purchased from any Philco accredited dealer—or write to us for full price list.



ONLY PHILCO VALVES HAVE A 90-DAY GUARANTEE

THE PHILCO RADIO & TELEVISION CORPORATION OF G.T. BRITAIN, LTD., AINTREE RD., PERIVALE, Middlesex.

PHILCO



There was a young lady named Det
Owned a marvellous radio set,
But reception was bad—
It made her quite sad—
NOW it's soldered with FLUXITE—you bet!

See that Fluxite is always by you—in the house—garage—workshop—anywhere where simple, speedy soldering is needed. Used for 30 years in Government works and by the leading engineers and manufacturers. Of all Ironmongers—in Tins 4d., 8d., 1/4 and 2/8.

Ask to see the Fluxite Small-space Soldering Set—compact but substantial—complete with full instructions—7/6. Ask also for Leaflet on Case Hardening Steel and Tempering Tools with Fluxite.

THE FLUXITE GUN

is a handy and economical tool that enables you to put the Fluxite where you want it on the soldering job, and is clean and simple to use. Nothing to remove—no mess—no trouble. Always READY FOR USE.

Also used to project grease into grease cups, bearings, etc.

Just fill the nozzle portion—half fill the cup—put together and press as required. PRICE 1/6.

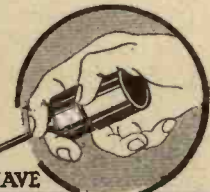

ALL MECHANICS WILL HAVE

FLUXITE

IT SIMPLIFIES ALL SOLDERING

FLUXITE LTD. (Dept. W.W.), DRAGON WORKS, BERMONDSEY STREET, S.E.1.

MAKE EXTRA MONEY IN YOUR SPARE TIME!



With the NEW and IMPROVED
G.T.L. TOOL CHEST
and Home Repairing Outfit

Finest Sheffield Tools

ONLY are included in the New and Improved G.T.L. Tool Chest making it better value than ever. ALL BEST BRITISH

YOUR spare time—these present long winter evenings—can be turned to good account if you've a G.T.L. Tool Chest and Home Repairing Outfit. With it you can make a thousand-and-one useful articles for your home and garden. And it opens up a new and inexpensive way of adding to the comfort, convenience and amenities of your property, while saving you literally pounds a year in repairs for which you would otherwise have to pay. Incidentally, it also affords a new, pleasurable way of adding to your income by making articles to sell. So that—with a G.T.L. Tool Chest—instead of spending money in your leisure hours, you will be making it, saving it, and enjoying it.

NO EXPERIENCE NEEDED

A valuable FREE BOOK of INSTRUCTION containing over 200 working illustrations, is included in the G.T.L. Tool Chest. If you have never handled a tool, you CAN be sure of immediate success because this book tells

you what to make and shows you step-by-step how to make it.

THE NEW AND IMPROVED G.T.L. TOOL CHEST
The New G.T.L. Chest for 1934-5 has been vastly improved by the inclusion of additional Tools and improvements to existing ones. Now there are over fifty high quality articles, all the finest Sheffield Tools; neatly fitted in steel clips, and they come to you direct from the manufacturers after being carefully tested. Everything for every purpose is here, and the G.T.L. Tool Chest stands alone in its quality and completeness. This Chest is the ORIGINAL and only G.T.L. guaranteed Tool Chest.

A few shillings bring the G.T.L. Tool Chest at once. A first payment of a few shillings and the G.T.L. Tool Chest is sent at once to your home CARRIAGE PAID. The balance can be paid by small monthly sums to suit your pocket: meanwhile the Tool Chest is making money for you.

TO READERS OF "WIRELESS WORLD"

A Beautiful 16-page BROCHURE describing the G.T.L. GUARANTEED TOOL CHEST and Home Repairing outfit in detail, and telling how you can save and make money—as tens of thousands of others are already doing.



FREE
Send for this TO-DAY

TO GUARANTEED TOOLS (1933) LIMITED, 12-13 CHISWELL STREET, FINSBURY, LONDON, E.C.1

Please send me by return, free of all cost and obligation, your beautifully illustrated booklet of the G.T.L. Guaranteed Tool Chest and Home Repairing Outfit, together with particulars of price, and how I can obtain it at once for a small first payment.

(PLEASE WRITE CLEARLY. 1d. stamp is sufficient if in an unsealed envelope.)

Name.....

Address.....

W.W./1/34

POST THIS COUPON NOW

Mention of "The Wireless World," when writing to advertisers, will ensure prompt attention.

MISCELLANEOUS ADVERTISEMENTS

NOTICES.

THE CHARGE FOR ADVERTISEMENTS in these columns is 12 words or less, 3/- and 3d. for every additional word

Each paragraph is charged separately and name and address must be counted.

ADVERTISEMENTS for these columns are accepted up to **FIRST POST ON MONDAY MORNING** (previous to date of issue) at the Head Offices of "The Wireless World," Dorset House, Stamford Street, London, S.E.1, or on **SATURDAY MORNING** at the Branch Offices, 19, Hertford Street, Coventry; Guildhall Buildings, Navigation Street, Birmingham, 2; 260, Deansgate, Manchester, 3; 26a, Renfield Street, Glasgow, C.2.

The proprietors retain the right to refuse or withdraw advertisements at their discretion.

Postal Orders and Cheques sent in payment for advertisements should be made payable to **ILIFFE & SONS Ltd.**, and crossed

& Co. Notes being untraceable if lost in transit should not be sent as remittances.

The proprietors are not responsible for clerical or printers' errors, although every care is taken to avoid mistakes.

For particulars of Box Number Advertisements and Deposit System see previous issues.

Set Manufacturers' Surplus, Clearance and Bankrupt Stocks offered in any of these columns may not be Manufacturers' current lines. Radio components advertised at below the list price do not carry any manufacturer's guarantee.

RECEIVERS AND AMPLIFIERS, ETC.

OUR Kit of Parts for "Wireless World" Quality Amplifier, complete in every detail, including valves; amplifier only, £9/10; feeder unit, 36/-.

OUR Kit of Parts for "Wireless World" Olympic S.S. Six, complete in every detail, including valves and loud-speaker; £14/10.

SEND for Detailed List of Components for Either of the Above Kits; carriage paid, cash with order.

WARD, 45, Farringdon St., London, E.C.4. Phone: Holborn 9703. [6402]

HAYNES Quality Ferrocart, Magnavox dual speakers, cost £24, perfect condition; £11, or nearest offer; heard evening—58, Ham Rd., Worthing. [6735]

"ALL-WAVE Monodial", new, A.V.C. and Class B, 2 watts, 7 valves, 150v. H.T.; choice cabinet; trial arranged.—Box 1904, c/o *The Wireless World*. [6736]

EMERSON and CROSLEY 1935 Midgets, car radio, and all American valves, send for wholesale catalogue, importer.—Royal, 5, Buckingham Road, London, E.18. [6654]

1935 Models 4 Valve Superhet Midgets, A.C. or D.C., M.C. speaker, £3/19/6; 5 valves, £4/19/6; car radio, £7/15 including valves.—Lovell Bros., 11, Avon Road, London, E.17. [6655]

MAINS RADIO DEVELOPMENT Company Offer Brand New Alba Three Valve A.C. 200-250v. Receivers, band pass tuning, complete with ring valves, moving coil speaker in handsome walnut cabinet, perfect; £5/15, post free.

MAINS RADIO DEVELOPMENT Company, 4-6, Muswell Hill Road, London, N.6. Phone: Tudor 4046. [6648]

BARGAIN—Manufacturers' stock 1935 model 4-valve A.C. Band Pass sets, Mazda valves, handsome walnut cabinets, Rola speakers, complete, delivered free; £5/15; sent on seven days' approval.—Stott, Clare Hill, Huddersfield. [6670]

PUBLIC Address Amplifiers and High-quality Receivers.—Amplifiers, A.C. mains, and A.C./D.C. from £13; Receivers (6-valve), 5 watts output, from £12; trade supplied; deferred terms.—D. E. Clarkson, B.Sc. (Eng.), 10, Park Rd., Wallington, Surrey. Phone: Wallington 3953. [6689]

"G.E.C." 5v. A.C. All-electric Sets, £6/10 (makers' list price £15/15), fitted in beautiful walnut cabinets, complete with 5 "Osram" valves, and moving-coil speaker; these sets are brand new, and packed in the makers' sealed boxes; this is a marvellous offer of a first-class set, at less than second-hand price; the name G.E.C. is sufficient guarantee for the quality; send for illustrated list.—Radio Supplies, 20, Ramsgrave Drive, Blackburn. [6713]

ARMSTRONG—Latest 5v. bandpass superheterodyne chassis, with fully delayed A.V.C., 7 highly efficient tuned circuits, bandpass input, Marconi Heptode frequency changer, combined 1st detector and oscillator, bandpass I.F. coupled to Marconi H.F. pentode, bandpass coupled to Cossor Double Diode, giving distortionless detection and A.V.C., resistance coupled to Mazda high slope pentode, Marconi bi-phase rectifier, full vision illuminated tuning, calibrated in wavelengths, combined radio and gramophone volume control, corrected pentode output, giving exceptionally good reproduction; £6/18/6, with valves, royalties paid.

ARMSTRONG Universal Superheterodyne, chassis works on A.C. or D.C. mains, specification as superheterodyne model above; £6/18/6, complete with valves, royalties paid.

ARMSTRONG Senior Universal A.C./D.C. Chassis, 3 tuned circuits, full bandpass tuning, 3½ watts double pentode output, massive construction, with valves; £5/18/6.

ARMSTRONG A.C.4 Chassis, incorporating 3 pentodes, 3 tuned circuits, full band-pass, 3 watts output; £5/18/6, with valves.

ARMSTRONG Latest 4v. Battery Chassis, 2 screened stages, 5 tuned circuits single knob tuning, full vision dial calibrated wavelengths, good selectivity with exceptional pulling power; £4/10, with valves.

All Armstrong Chassis are constructed of the Highest Grade Components Throughout, carry 12 months' service free guarantee, and are sent on 7 days' approval, carriage paid.

ARMSTRONG MANUFACTURING Co., 100, King's Rd., N.W.1. Phone: Gulliver 3105. [6688]

PILOT AUTHOR KITS

Exact to Specification

STANDARD A.C.3

KIT "A" Author's Kit of first specified components, including ready-drilled panel and Plymax chassis but less Valves and Speaker.

CASH OR C.O.D. £10 6 6
CARRIAGE PAID.
or 12 monthly payments of 19/-.

KIT "B" As for Kit "A," but including set of specified Valves, less Speaker.

CASH OR C.O.D. £12 5 0
CARRIAGE PAID.
or 12 monthly payments of 22/6.

If Magnavox Speaker is required with above Kits, add £2 2 0 to Cash or C.O.D. price, or 4/6 to each payment.

KIT-BITS You pay the Postman. We pay post charges on all orders over 10/- GREAT BRITAIN ONLY.

- 1 Peto-Scott Plymax baseboard, 14" x 9", with 3" wood runners. Ready drilled - - - - - S. d. 7 0
- 1 Peto-Scott polished plywood panel, 14" x 10". Ready drilled to specification - - - - - 2 0
- 1 Polar Minor 3-gang condenser - - - - - 18 9
- 1 Polar semi-circular slow motion dial - - - - - 5 9
- 1 Bryce mains transformer as specified - - - - - £1 10 0

EXPORT ORDERS Simply send full cash value plus a suitable amount for half carriage charges and any surplus will be immediately refunded. Packed free, we pay half carriage. Air Mail charges extra. **PETO-SCOTT**, established in 1919, are the largest Radio-by-Mail House in the World. Hire-purchase terms are NOT available to Irish or Overseas Customers.

PETO-SCOTT CO. LTD.
77 CITY RD., LONDON, E.C.1 Phone: Clerkenwell 9406/7
West End Showrooms: 62, High Holborn, London, W.C.1. Est. 1919.

ENGINEERS!

Get the right angle on this question of careers

Professor Low says

"The planning of your career is so vitally important that you cannot afford to make any mistake. That is why you should have the advice of a thoroughly sound organization such as the B.I.E.T. There are thousands of opportunities around you, but unless you know just where they are and how to prepare for them, the chances are that your opportunities will pass by unheeded."

If you are ambitious for something more than a "bread and butter" job we want to link up with you. The first step is to send for our Free Hand-book "ENGINEERING OPPORTUNITIES." This is not just a pamphlet, but a unique 256-page guide to modern engineering careers. The book explains how we can, in the privacy of your own home, multiply your earning power. Among other things, the book gives details of all salary-increasing qualifications, such as A.M.I.Mech.E., A.M.I.A.E., A.M.I.E.E., G.P.O., A.M.I.W.T., outlines over 100 courses in all branches of Civil, Mech., Elec., Motor, Radio and Aero Engineering, and shows how our private Employment Department operates.

We Guarantee—"NO PASS—NO FEE."

Even if you go no further in the matter our Free Hand-book must at least put you on the right road to a worthwhile career. Send for your copy to-day, Free and without obligation.

BRITISH INSTITUTE OF ENGINEERING TECHNOLOGY,
387, SHAKESPEARE HOUSE, 29/31, OXFORD ST., W.1.

THE MOTOR CYCLE

Every Thursday 3d.

w.w.15

Receivers and Amplifiers, Etc.—Contd.

£5/5—Band pass 4-valve chassis by Plessey, Magnavox m.c., complete with valves, in high class walnut or oak cabinet, either A.C. or D.C.; ditto radio-gram, £7/10; c.o.d., carriage forward.—Kay, 167, City Rd., London, E.C.1. [6619]

MIDGET Receivers, brand new and guaranteed, carriage paid, S.A.E., with all enquiries; every one complete in every detail, with valve and moving-coil speaker, working off A.C. and D.C. mains, any voltage with line regulator included; Emerson 5-valve 250-500/1,000-2,000 metres, walnut cabinet 10½ x 7½ x 5½, approximately 15 stations, at £4/6/3, the same, less cabinet, at £3/12/6; the following R.C.A. Victor's (H.M.V. in America), all fitted in handsome walnut cabinet, approximately 12 x 8½ x 6, delayed automatic volume control, with manual limitation, fitted pick-up terminals, incorporate 2 ultra modern triple function valves, bringing performance to that of a 9-valve set, 5-valve superhet, covering 250-550/1,000-2,000 metres, approximately 75 stations, at £6/5/9; this model only can be supplied in larger cabinet, 24 x 14 x 12, at £7; 6-valve superhet, as above, approximately 100 stations, at £6/10; also 4 only 6-valve superhets, covering 13-2,000 metres in 3 wavebands, aperiodic H.F. stage, 2 H.F. pentodes, Heptode frequency change, double diode triode, 6in. Magnavox speaker, at £7/15; please note, owing to serious local interference, demonstrations only after 7.30 p.m.—Degallier's, No. 6, Coryton House, 21, Upper Marylebone St., London, W.1. Museum 7795. Near Oxford Circus and Great Portland St. Stations. [6721]

ACCUMULATORS—BATTERIES.

MILNES H.T. Units, all units and speakers in stock; spares, service; demonstration free.—Pearce, 30, King's Cross Rd., W.C.1. [6720]

BATTERY Drudgery Abolished, astounding results, particulars and battery log book free.—Instantbrite, Peebles Works, London, N.W.6. [6587]

MAINS EQUIPMENT.

VORTEXION—See also display advertisement on page 12.

VORTEXION Specified Olympic S.S. 6 Transformer, S.S.352, 5 years' guarantee, 25/-; less terminals and guarantee, 21/-; power chassis, £3/17/6; choke, 12/6; Single Span model, 25/-; power chassis, £3/10.

VORTEXION—Quality Amplifier or Super Monodial, 425-0-425, 120 m.a., 4v. 6-8a. C.T., 4v. 3a. C.T., 4v. 1a., 4v. 1a., super shrouded, core size 2¼in. x 1¼in., 2½% regulation primary engraved insulated terminals, weight 14lb., 26/-; carriage 2/-; normal shrouded, 22/-; open type, 20/-; post 1/3; speaker field replacement choke, 16/-; special output transformer to "W.W." specification, 12/6, post 9d.; state valve and speaker; "W.W." universal output transformer, £1; normal 40h. 50 m.a. primary output transformers, 10/6, post 9d.

VORTEXION 7.50h. 120 m.a. Choke, 215 ohms, in die cast shrouding to match; 12/6.

IMITATED, but unequalled. Good enough for a "Wireless World" specification is good enough for you.

VORTEXION Cost Little More than the Cheapest, but unequalled by the dearest.

VORTEXION Standards Despatched by Return.

VORTEXION A.C./34, used by author in construction of A.V.C. Three, as illustrated; 18/-.

GUARANTEED 12 Months, and within 5% normal and 2½% super models, neat shrouding, with detachable feet, as used by Government Departments, etc., any model guaranteed 5 years at extra cost of 2/-.

ALL Secondaries Centre Tapped.

VORTEXION—250-0-250 60 m.a., 4v. 1 to 2a., 4v. 2 to 4a., open type, 10/-; shrouded, 12/6; post 9d.

VORTEXION—Ferrocart III 350-0-350, 60 m.a., 4v. 2.5 C.T., 4v. 3.5 C.T.; open type 13/6, shrouded 16/-; post 9d.

VORTEXION—Super model for H.T.8 or 9 or 10, 4v. 1 to 2, 4v. 2 to 4, open type 14/6, shrouded 16/6; post 1/-.

VORTEXION—350-0-350, 120 m.a., 4v. 2 to 5a., 4v. 2 to 4a., 4v. 2.5a.; open type 14/6, shrouded 16/6; super shrouded model, weight 11lb., 4 filaments to specification, 21/-; post 1/3.

VORTEXION—400 or 450 or 500v. 120 m.a., 4v. 2 to 5, 4v. 2 to 5, 4v. 2.5a.; open type 19/-, shrouded 23/-.

VORTEXION—400 or 450 or 500, 150 m.a., 4v. 4a., 4v. 2.5, 4v. 2, 4v. 2, core size 2¼ x 1¼in., a super job, 2% regulation, 35/-; shrouded, with terminals; less terminals, 30/-; open type, 26/-; post 1/3.

VORTEXION Auto Transformers to B.E.S.A. Specification, 100, 110, or 120v. to 200, 220, or 240 volts, 60 watts, 9/-; post 9d.; 120 watts, shrouded 12/6, open type 10/6, post 1/-; 200 watts, shrouded 16/6, post 1/-; 2,000 watts, £4/10.

VORTEXION 1,000-watt Transformers; £4/10, carriage free.

VORTEXION 30h. at 60 m.a. Chokes, 5/6; 40h. at 60 m.a., 8/6; 30h. at 150 m.a., 200 ohms, 10/6 open type, 12/6 shrouded.

VORTEXION Transformers Made to Your Specification; price according to wattage, 6v. filaments same price unless wattage grossly exceeded; special quotations by return.

VORTEXION (S. A. BROWN), 182, The Broadway, Wimbledon, S.W.19. Tel.: Liberty 2814. [6561]

P. PARTRIDGE, B.Sc., A.M.I.E.E., A.I.Rad.E.

PARTRIDGE Mains Transformers.—"Certainly above the average... very soundly constructed."—Wireless Trader.

PARTRIDGE Output Transformers.—Officially recommended by Messrs. Tungstam for their 21w. output valves.

PARTRIDGE—See last week's detailed advertisement; delivery from stock; trade enquiries invited.

PARTRIDGE, N., King's Buildings, Dean Stanley St., London, S.W.1. Tel.: Vic. 5035. [6598]

Mains Equipment.—Contd.

BATTERY Chargers.—N. P. chargers, lowest prices yet finest materials, trade lists free.
BATTERY Chargers.—N. P. from 52/- to £15; state your requirements for lowest quotation.—N. P. Electrical, 514, Alum Rock Rd., Birmingham. [6688]

TANTALUM for A.C. Chargers, H.T. and L.T.—Blackwell's Metallurgical Works, Ltd., Garston, Liverpool. [6470]

BATTERY Chargers, A.C. manufacturers' surplus, 50v., 5 amperes output; £5/10.—Jersey, Cumnor Hill, Oxford. [6666]

HOYNE'S Transformers are Manufactured by Engineers with 14 Years' Experience in Radio Transformer Design.

HOYNE'S Transformers, fitted with tapped and screened primaries, filaments, all centre tapped, stout cast aluminium clamps and clearly marked terminal strips are fitted to all models, write for list.

HOYNE'S Components are Guaranteed for One Year; one type only manufactured, the best, as used by many well-known set manufacturers after testing all others.

HOYNE'S—"W.W." transformers under strictly to specification of author: "W.W." test reports, June 22nd: "The insulation is particularly good throughout the transformer is satisfactory in all respects."

HOYNE'S—Push-pull quality amplifier transformer, 25/-, post 1/3; 7/30 henrys choke, 9/6, post 9d.; 20 henrys, 7/6, post 9d.

HOYNE'S—Single span, 15/-, post 1/-; choke, 10 henrys, 7/6, post 9d.

HOYNE'S—Everyman A.C. super transformer, 12/6, post 1/-; choke, 10 henrys, 7/6, post 9d.

HOYNE'S—A.V.C. Straight Four transformer, 18/-, post 1/3; choke, 26 henrys, 12 m.a., 140 ohms, 9/6, post 9d.

HOYNE'S—Push-pull quality amplifier, complete to "W.W." specifications, wired and fully tested, less valves, £5/12/6; complete kit of components including metal chassis, £5/2/6; field replacement choke, 1,250 ohms, 13/6, post 1/-; output transformer, 12/6, post 1/-.

HOYNE'S—250-0-250v. 60 m.a., 4v. 1 to 2a., 4v. 2 to 4a., 10/-, post 9d.; with extra 4v. 1 to 2a. winding, 12/6, post 1/-.

HOYNE'S—Ferrocart III, 350-0-350v., 60-70 m.a., 4v. 2 to 3a., 4v. 2 to 4a., 12/6, post 1/-; with extra 4v. 1 to 2a. winding, 13/6, post 1/-.

HOYNE'S—350-0-350v., 120 m.a., 4v. 2 to 3a., 4v. 4 to 6a., 4v. 1a., 4v. 1b., 18/-, post 1/3.

HOYNE'S—400 or 450 or 500v., 120 m.a., 4v. 2 to 3a., 4v. 2 to 5a., 4v. 1 to 2a., 18/-, post 1/3.

HOYNE'S—500-450-0-450-500v. 140 m.a., 4v. 2 to 4a., 4v. 4 to 6a., 4v. 2a., 4v. 2a., 27/6, post 1/3; weight 11lb.

HOYNE'S Transformers, built to specifications, keenest prices, best materials and workmanship; quotation by return.

M. J. HOYNE, ALL-POWER TRANSFORMER, Ltd., Offices and Works, 8a, Gladstone Rd., Wimbledon, S.W.19. Tel.: Liberty 3303. [6488]

PARAMOUNT Mains Transformers, equal to any, and better than most; try them once and you will always use them!

PARAMOUNT Auto Transformers, 100-120v. up to 200-250 volts, or vice versa, 60 watt, 8/6; 120 watt, 10/-; shrouded 2/- extra, post 9d.

PARAMOUNT—250-0-250v. 60 m.a., 4v. 1 to 2 amp., 4v. 2 to 4a., open type, 9/6; shrouded, 11/6; post 9d.

PARAMOUNT—350-0-350v. 60 m.a., 4v. 2-5a., 4v. 3 to 5a., 13/-; shrouded, 15/-; post 9d.; 120 m.a., 4v. 5 amp., 4v. 4 amp., 4v. 2-5a., with screened primary, shrouded, 16/-; post 1/-.

PARAMOUNT—Single span model, with 1½in. x 1½in. core size, 350-0-350v. 100 m.a., 4v. 5a., 4v. 1a., 4v. 2.5a., shrouded, with screened primary, 2½ regulation, 20/-.

PARAMOUNT—500v. or 450v. or 400v. 120 m.a., 4v. 5a., 4v. 4a., 4v. 2.5a., screened primary, 18/-; shrouded, 21/-, post 1/3; 150 m.a., 4v. 2.5a., 4v. 4a., three 4v. 2a., with 2½in. x 1½in. core size, shrouded, 28/-, post 1/3.

PARAMOUNT—Westinghouse transformers, H.T.8, 9 or 10. with 4v. 2a., 4v. 4a., shrouded, 16/-, post 1/-.

PARAMOUNT—Chokes. 30h. 60 m.a., 5/6; 20h. 120 m.a., 8/6, post 9d.

PARAMOUNT Mains Transformers are Guaranteed for 12 Months.

PARAMOUNT Products are Fitted with Neat Aluminium Frames or Shrouds, all filaments C.T., insulating paper 2½ mils. thick between each layer, and tested thoroughly before leaving our works.

PARAMOUNT Transformers Made to Your Own Specifications; price according to wattage; quotations by return.

PARAMOUNT Guaranteed Electrolytic Condensers, 4-4 mfd., 500v. peak, 3/6, post 3d.

PARAMOUNT Mains Transformers, manufactured by R. H. Salter, 66, Hartfield Rd., Wimbledon, S.W.19 (one minute from Wimbledon Station). Tel.: Liberty 3226. [6315]

14/11—Battery chargers, 1 amp., 2-6v., incorporating Westinghouse L.T.4 rectifier, guaranteed one year; postage 9d.; transformer only, 5/3; list free.—Arden Agency, Wollaston, Wellingborough. [6591]

CABINETS.

MANUFACTURERS' Clearance.

ULTRA "Panther," a modern cabinet, with contrasting figured walnut veneer panel, 20x17x11, 13/6; pedestal type, 35x22x12, 30/-. undrilled; photo sent on request.

SET and Speaker Cabinets; 5/- upwards.

RADIOGRAM Cabinet; 37/6 upwards.

SPEAKER Cabinets; 4/6 upwards.

SEND Particulars of Your Requirements (giving size of set, etc.), or call and make your choice from our stocks of over 100 different types; from 3/6 to £4/10.

REFER to Previous Advs. for Detailed List of Bargains.

H. L. SMITH and Co., Ltd., 287-9, Edgware Rd., London, W.2. Tel.: Padd. 5891. [6052]

SPECIFIED
For the Wireless World
STANDARD A C 3



The World's Standard Resistances
OHMITES

Whenever your attention is attracted by a Circuit of exceptional brilliance, you'll find its Designer pinned his faith to the World's Best Resistances

OHMITES
Better than Wire-Wound

All values 50 ohms to 5 megohms.

1/6 Heavy Duty type
 each **2/3**
 (1½ watts) (3 watts)

GRAHAM FARISH LTD.
BROMLEY, KENT.

GRAHAM FARISH PRODUCTS

DYNAMOS, ETC.

CONVERTER, as new, for radio gramophone, for sale; very reasonable price.—Particulars, Sandor, 25, Haymarket, S.W.1. Whitehall 6871. [6695]

THE Best Dynamo Value Obtainable Anywhere, 12-volt 10-amp. C.A.V., ball-bearing generators, 4-pole, 4-brush, shunt wound, totally enclosed, suitable for charging or lighting, complete with driving pulley, revs. 750, clockwise, every one guaranteed; 14/6, sent carriage forward, cash with order.—Wickham, 6, Gerridge St., S.E.1. [6702]

LOUD-SPEAKERS.

U.S.A. Rola Type F.6, 2,500- or 6,500-ohm field, power or pentode output transformer; 17/6.

MAGNAVOX D.C.152 (8in. cone), 22/6; Magnavox 154 (6½in. cone), 16/3; all with hum-bucking coils, power or pentode transformers, and 2,500- or 6,500-ohm fields; Magnavox P.M.254, 18/-; Magnavox P.M.252, 22/6.

ATTENTION to All Orders Within 24 Hours; carriage paid; cash with order; or c.o.d.
WARD, 2nd Floor, 45, Farringdon St., London, E.C.4. Telephone: Holborn 9703. [6404]

EPOCH Domino, 10½in. J., A.C. D.C., and O.T.O.8, new; bargain, £5/10.—127, Broadway, Cricklewood. [6705]

VITAVOX Public Address Loud-speakers, types and sizes to suit all requirements, any type repaired or re-conditioned.—Vitavox, Acoustics, Ashford Road, Cricklewood, N.W.2. [6592]

10/6 Only!!—Brand new manufacturers surplus moving coil speakers, by one of the best-known British makers; energised, 2,500 or 6,500 ohms field, power or pentode transformer, 8in. cone; 10/6 each.

12/6 Only!!—As above, but 10in. cone; 12/6 each.

15/6 Only!!—Permanent magnet with power or pentode transformer, 8in. cone; 15/6 each.

17/6 Only!!—As above, but with 10in. cone; 17/6 each.

CABINETS for Any of Above, 2/9 each only; secure one of these amazing bargains now; cash with order or c.o.d.—Hulbert, 6, Conduit St., W.1. [6719]

Vauxhall—Magnavox permanent magnets, universal, suitable for Class "B," power or pentode, 7in. cone 17/6, 10in. cone 23/-; mains energised, 2,500 or 6,500, 10in. cone, 22/-; 7in. cone 15/3; brand new, with hum-bucking coils; state power or pentode transformer.

Vauxhall—American Rola, type F.6, 2,500 or 6,500, 8in. cone 16/6; large type, 9½in. cone 24/-; complete with hum-bucking coils, power or pentode; permanent magnets for power, super power, pentode, Q.P.P. or Class B, 8in. cone 25/-; large type 9½in. cone, 33/-; unused manufacturers' stock; immediate delivery, carriage paid, cash with order or c.o.d.—Vauxhall Utilities, 163a, Strand, W.C.2. Temple Bar 9338. [6682]

MOVING-COIL Speakers, for experimenters wanting something different; hear the drums and oboe without resonance, all sealed cartons, brand new, carriage paid; cash with order or c.o.d.; state if power or pentode transformer required; energised speakers incorporate hum-buckers; Rola's (American) Senior models only 9½in. diameter 100-150v. (2,000 ohms), 110-175v. (2,500 ohms), 200-250v. (6,500 ohms), list 47/6, at 23/- each; permanent magnets, same size diaphragms, 9% cobalt magnet, 7,400 lines per sq. cm., list £3, at 33/-, as sensitive as an energised speaker.—Degallier's, No. 21, Upper Marylebone St., London, W.1. [6720]

TRANSMITTING APPARATUS.

PREMIER SUPPLY STORES Offers the Following Brand New Gear: Standard cables, transmitting valves (out of limits), 4211E and 4211D, 15/- each; 4212D, £3; American 866, 20/-; T.C.C. 2 mi., 1,500v., working, 6/-; Standard cables transformers, 1,000-0-1,000v. 250 m.a., 4v. 3a. C.T., 4v. 3a. C.T., 49/6; 2,000-0-2,000v. 150 m.a., 49/6.—Premier Supply Stores, 20, High St., Clapham, S.W.4. 'Phone: Macaulay 2188. [6623]

VALVES.

4/9—Gecovalve U.K.245 American output valves, unopened cartons, list 15/-, cash with order, postage paid.—Kay, 167, City Road, London, E.C.1. [6491]

METROPOLITAN RADIO SERVICE Co. for American Valves with a Guarantee; any type at keenest prices; trade supplied.—1021, Finchley Rd., Golders Green, N.W.11. Speedwell 3000. [6046]

SURPLUS Valves.—All brand new; battery types, 2-volt, H.F.2, L.F.2, L.P.2, 1/9; super power, P.P.2, 2/6; screens and pentodes, 3/9; A.C. mains, 4-volt 1 amp., general purpose, 3/3; power, 4/-; screens and pentodes, 4/6; full wave rectifiers, 3/6; postage paid cash with order, or c.o.d. over 10/-.—Clarion Radio Valve Co., 885, Tyburn Rd., Erdington, Birmingham. [6339]

PREMIER SUPPLY STORES Announce the Purchase of the Complete Stock of a World Famous Continental valve manufacturer all the following standard main types fully guaranteed, 4/6 each; H., H.L., L. power, medium, high, low mag. and variable mu screen grids, one, three and four watt A.C. output, directly heated pentodes, 250v. 60 m.a. full wave rectifiers, D.C. types, 20v. 18 amp., filaments, screen grid H., H.L. power.

THE Following Types, 5/6 each: 350v. 120 m.a., full wave rectifier, 500v. 120 m.a., full wave rectifier, 2½ watt indirectly heated pentode.

THE Following American Types, 4/6: 250, 112, 171, 210, 245, 226, 47, 46, 24, 35, 51, 57, 58, 55, 37, 80.

THE Following Sizes, 6/6 each: 42, 77, 78, 25Z5, 36, 38, 83, 39, 44, 53, 6A7, 6B7, 2A5, 2A6, 2A7, 2B7, 5Z3, 6C6, 6A4, 6D6, 6F7; the following valve: 866, 25/-.

PREMIER SUPPLY STORES, 20 and 22, High St., Clapham, S.W.4. [6622]

ALL Types of Brand New American Valves in Stock, only first-class makes such as Arcturus and R.C.A. stocked, guaranteed for 6 months, 247, 235, 551, 89, 18, 19, 46, 59, 6A7, 15, 42, 41, 38, 39, 78, 75, 57, 58, 224, 44, 36, 235, 83, 43, 5Z3, 12/-; 25Z5, 12Z3, 14/6; UX171, UX199, UX280, UX245, UX226, UX227, 7/6; UX250, UX210, UX281, 17/6; UX867 photocells, 25/-; all other types of American valves in stock; we also stock transmitting valves, post paid, cash with order or c.o.d.

WARD, 45, Farringdon St., London, E.C.4. Telephone: Holborn 9703. [6517]

COMPONENTS, ETC., FOR SALE.

R.
RYALL'S RADIO, 44, Lamb's Conduit St., London, W.C.1. Callers note: we are just off Theobalds Rd., best approach from Holborn through Red Lion St.; Holborn 3529. Hours 11 to 7 p.m. Saturdays 5 p.m. Thursdays 1 o'clock.
VARLEY Pentode Nichokes, 7/- new; Regentone S.60 unit 200v. 30 m.a., 4v. 6a. A.C. 25/-; New Ecko K.25 eliminators, 150v. 20 m.a., with 1/2 amp. trickle charger, 45/-; Sonochorde 2,500 ohm speakers, with tapped transformer, 13/6; Met-Vick 250v. transformers, 4v. 2a., 4v. 5a. input, 200-250v., with terminals, and humdimmer for L.T., 15/-, new.
DECONTROLLED Sets: Columbia 4v. battery, S.G., det., Q.P.P. output, Exide and Marconi batteries, complete, £6/5; McMichael Twin Suprovox receivers for A.C. mains, 2 H.F. with twin speakers, £10; Ultra Pedestal Console, superhet, 6v. and rectifier, £12/10; Ecko 74 superhet pedestal console, £10; Lotus D.C. 2 seats, £4/10; all new, complete, etc.
HEAYBERD Transformers, new, with leading-out wires, 350v. 120 m.a., 4v. 4a., 4v. 5a., 4v. 2 1/2 a., 25/-; Heyaberd 500v. 120 m.a., 4v. 4a., 4v. 6a., 4v. 2 1/2 a., 32/8; both screened primary and input 200-250v.; carriage forward.
SET Colvern Ferrocart 10-11-12-13, 30/-; set 10-11-12-14, 30/-; set Varley 2H.F. on base, 15/-; Ferranti B.P. unit, complete, 32/6; H.T.8 and transformer, 12/6; set Telsen S.330, 10/-.
RYALL'S RADIO Offer Reliable Resistances, suitable for all sets where a 1-watt resistance is specified, in values 100, 150, 250, 400, 500, 600, 1,000, 2,000, 5,000, 10,000, 15,000, 20,000, 25,000, 30,000, 40,000, 50,000, 75,000, 100,000, 150,000, 250,000, 1/2 meg., 1 meg., 2 meg., all values stated in ohms, 4d. each; also 2-3-watt type, 400, 700, £00, 1,000, 4,000, 5,000, 6,000, 10,000, 20,000, 9d. each, wire ends.
RADIOPHONE Volume Controls with Switch, 5,000, 10,000, 15,000, 20,000, 35,000, 100,000, 2/6; also 10,000 graded 9-1 with 3P switch, 25,000 graded 9-1 with 2P switch, 3/6.
WIRE, new Knifetooth, etc., 1/2 reels, 168.W.G. En., 8d.; 1/4lb. 188.W.G. C.C., 8d.; 1/4lb. 268.W.G. En., 9d.; 1/4lb. 328.W.G. C.C., 1/-; 1/4lb. 288.W.G. En., 8d.; 2oz. 30 and 32 C.C., 6d. each.
NEW Garrard No. 11B D/S Motors, 12in. turntable and fully automatic unit plate, all fittings included; less than half price, 20/-.
POLAR Minor 3-gang Condensers, with "Arcuate," or "Semi Circular" drive, new, list 24/6, 14/6.
RYALL'S RADIO Offer British-made Mansbridge Condensers, metal cased, brand new, fully guaranteed, 1 mf., 400 vw., 1/3; 2 mf., 400 vw., 1/6; 4 mf., 400 vw., 3/-; 4 mf., 750 vw., 6/-.
READY RADIO 0.0005 Extensor Condensers, new, 2/6; Yagerphone S.G./Det. Pen. and rectifier chassis, with valves, complete, 65/-; Radiophone Bandpass superhet coil packs, 8/9, most 9d.
WEGO, British, condenser blocks, containing 4x4 at 350 vw., also 1x1x1x0.1x0.1x0.1 at 250 vw., new, 5/- each; Wearite H.F. screened chokes, 2/-; T.C.C. dry electrolytic, 8x4, 400 vw., 2/9; T.C.C., wet type, 8 mf., 3/3.
T.C.C. 0-1 Non-inductive Tubular Condensers, 10d. each, 350v.; T.C.C. electrolytic 15 mfd., 50v., 1/4, new; T.C.C. 0.01 mica, type M. 1/-; T.C.C. 0.0001, type M. 5d.; H.M.V. condenser blocks, 250v. working, 4x4x1x1x1/2 mfd., 3/-; T.C.C. 0.1x0.1, 450v. working, 1/6; T.C.C. 8 mfd., electrolytic, 500v. working, 3/9; Dubilier 2 mfd., 250v. working, 1/6.
UNIKNOBS, Polar 2-gang, new, brown, 8/-, with cover, 9/-; R. and A. type output transformers, 18-23-32-1, new, 5/-; Paxolin formers, with guides, lin., 8d.; R.I. Hypermite transformers, 6/-, second-hand; R.I. Parafced transformers, 5/-, second-hand.
RADIOPHONE Disc Drives, less escutcheon, fit 5-16in. spindle, read 0-100 from left to right; 1/6, post free.
R. [6722]
PREMIER SUPPLY STORES
ANNOUNCE a City Branch at 165 and 165a, Fleet St., E.C. (next door to Anderson's Hotel), for the convenience of callers; post orders and callers to High St., Clapham.
OFFER the Following Manufacturers' Surplus New Goods at a Fraction of the Original Cost; all goods guaranteed perfect; carriage paid over 5/-, under 5/-, postage 6d. extra. I.E.S. and abroad, carriage extra. Orders under 5/- cannot be sent c.o.d. Please send for illustrated catalogue post free.
STUPENDOUS Purchase of Set Manufacturers' Stock.—S. All electric 3-valve (S.G. det. pen.) set, in walnut cabinet, with moving coil speaker, 200-250 volt 40-60 cycles, chassis built. 200-2,000 metres, with 4 valves; £4/19/6.
AL-ELECTRIC 3-stage Amplifiers 200-250v., 40-60 cycles, 10 watts undistorted output, complete with 5 valves, and Magnavox Super 66 energised speaker; £10/10.
TYPE 4480, 9in. diameter, permanent magnet, handles 4 watts, 7 ohms speech coil, 13/6; multi ratio transformer, 4/6 extra.
ELLIMINATOR Kits, including transformer, choke, and diagram, 120v. 20 m.a., 20/-; trickle charger, 8/- extra; 150v. 30 milliamps, with 4v. 2.4 amps C.T., L.T., 25/-; trickle charger, 6/6 extra; 250v. 60 milliamps, with 4v. 3-5 amps C.T., L.T., 30/-; 300v. 60 m.a., with 4 volts 3-5 amps., 37/6; 200v. 50 m.a., with 4v. 3-5 amps. L.T., 27/6.
PREMIER Chokes, 40 milliamps, 25 hys., 4/-; 65 milliamps, 30 hys., 5/6; 150 milliamps, 30 hys., 10/6; 60 milliamps 80 hys., 2,500 ohms, 5/6; 25 milliamps, 20 hys., 2/9.
ALL Premier Guaranteed Mains Transformers Have Engraved Terminal Strips, with terminal connections, input 200-250v., 40-100 cycles, all windings paper interleaved.
PREMIER H.T.7 Transformer, output 135v. 80 m.a., for voltage doubling, 8/6; 4v. 3-5a., C.T. L.T., 2/- extra; with Westinghouse rectifier, giving 200v. 30 m.a., 17/6.
PREMIER H.T.8 and 9 Transformers, 250v. 60 m.a. and 300v. 60 m.a. rectified, with 4v. 3-5a. and 4v. 1-2a. C.T. L.T. and screened primary, 10/-; with Westinghouse rectifier, 18/6.
PREMIER H.T.10 Transformer, 200v. 100 m.a., rectified, with 4v. 3-5a., and 4v. 1-2a., C.T. L.T., and screened primary, 10/-; with Westinghouse rectifier, 19/6.
(This advertisement continued in third column.)

Nothing to Say?

We have been reading other makers' advertisements of late. In one journal we found no less than four entirely different radio-gramophones described as the world's finest. We also heard one of them. Ye Gods!

We started a campaign for truth in reproduction; we should like to start one for truth in advertising.

Write for our literature and try and catch us out. If you buy anything of ours, it will do what we say it will do; if it won't, we'll give you your money back. That's fair enough.

Yours literally SINCERELY,

Hartley Turner Radio Ltd.

THORNBURY ROAD, ISLEWORTH, MIDDLESEX. Telephone: HOUslow 1854.

HARTLEY-TURNER SPEAKERS AND AMPLIFIERS SUPPLIED ON EASY TERMS.

We specialise in the supply of this superb equipment on convenient terms. Please write for full particulars and quotation.

All radio Apparatus supplied promptly and on the lowest terms. PRICE LIST FREE.

The LONDON RADIO SUPPLY COMPANY 11, OAT LANE, NOBLE STREET, LONDON, E.C.2 Phone: National 1977. (Est. 1925).

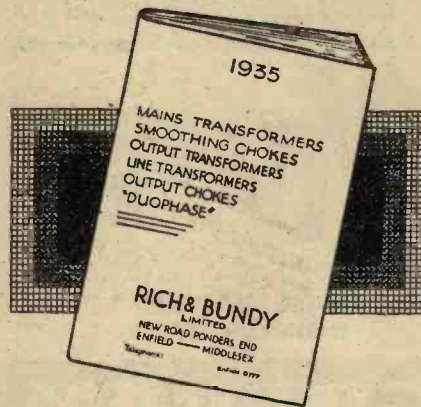

OUR NEW CATALOGUE contains 32 pages of up-to-date technical information on mains equipment and gives characteristic curves and circuits for DUOPHASE TRANSFORMERS. SEND FOR A COPY NOW. Enclose 1d. stamp for postage. RICH & BUNDY LTD. New Road, Ponders End, Middlesex. Telephone: ENfield 0771.

Components, Etc., for Sale.—Contd.

(This advertisement continued from first column.)

PREMIER Mains Transformer, output 250-0-250v. 60 m.a., 4v. 3-5a., 4v. 2-3a., 4v. 1-2a. (all C.T.), with screened primary; 10/-.
PREMIER Mains Transformers, output 350-0-350v. 90 m.a., 4v. 3-5a., 4v. 2-3a., 4v. 1-2a. (all C.T.); with screened primary; 10/-.
PREMIER Auto Transformers, 100-110/200-250v., or vice versa, 100-watt; 10/-.
WESTERN ELECTRIC Mains Transformers, 300-0-300v. 65 m.a., 4v. 1-2a., 4v. 2-3a., 6/6; 500-0-500v. 150 m.a., 4v. 3-5a., 4v. 2-3a., 4v. 2-3a., 4v. 1a. C.T., 4v. 1a. C.T., 15/6.
SPECIAL Offer of Mains Transformers, manufactured by Philips, input 100-200v. or 200-250v., output 180-0-180 volts 40 m.a., 4v. 1 amp. 4v. 3 amps., 4/6; 200-0-200v., 4v. 1a., 4v. 3a., 4/6.
PREMIER L.T. Charge: Kits, consisting of Premier transformer and Westinghouse rectifier, input 200-250v. A.C., output 8v. 1/2 amp., 14/6; 8v. 1 amp., 17/6; 6v. 2 amp., 27/6; 30v. 1 amp., 37/6; 2v. 1/2 amp., 11/-.
B.T.H. Trusped Induction Type (A.C. only) Electric Gramophone Motors, 100-250v.; 30/- complete.
SPECIAL Offer B.T.H. Gramophone Motors, A.C. and D.C. 100-250v.; 30/-; listed £3/3.
COLLARO Gramo. Unit, consisting of A.C. motor, 200-250v. high quality pick-up and volume control, 49/-; without volume control, 45/-.
EDISON BELL Double Spring Gramophone Motors, complete with turntable and all fittings, a really sound job; 15/-.
SPECIAL Offer of Wire Wound Resistances, 4 watts, any value up to 50,000 ohms, 1/-; 8 watts, any value up to 15,000 ohms, 1/6; 15 watts, any value up to 50,000 ohms, 2/-; 25 watts, any value up to 50,000 ohms, 2/6.
CENTRALAB Potentiometers, 400 ohms 1/-; 50,000, 100,000, 1/2 meg., any value, 2/-; 200 ohms, wire wound, 1/-.
POLAR STAR, manufacturers' model, 3-gang condensers, fully screened; 7/6, with trimmers; unscreened, 5/-.
AMERICAN Triple Gang 0.0005 Condensers, with trimmers, 4/11; Utility bakelite 2-gang 0.0005, screened, with uniknob trimmer, 3/6; Polar bakelite condensers, 0.00035, 0.0003, 0.0005, 1/-.
ORMOND Condensers, 0.0005 2-gang semi-shielded, 2/6; brass vanes with trimmers, 3/6; British Radiophone 110 kc/s intermediate, 3/-.
MAGNAVOX D.C. 152, 2,500 ohms, 17/6; D.C. 144, 2,500 ohms, 12/6; D.C. 152 magna, 2,500 ohms, 37/6, all complete with humbucking coils; please state whether power or pentode required; A.C. conversion kit for above types, 10/-; Magnavox P.M. 7in. cone, 16/6.
RELIABLE Canned Coil, with Circuit, accurately matched dual range iron core; 3/6.
RELIABLE Intervalve Transformers, 2/-; multi-ratio output transformers, 4/6.
T.C.C. Electrolytic Condensers, 550v. working, 650v. peak, 8 mf., 4/-; 4 mf. or 8 mf. 440v. working, 3/-; 15 mf. 50v. working, 1/-; 25v. working, 25 mf., 1/3; 6 mf. 50v. and 2mf. 100v. working, 6d.; 8+4 mf., 450v. working, 4/-; 50 mf. 50v. working, 2/9; 2,000 mf., 12v., 7/6.
T.C.C. Condensers, 250v. working, 1 mf. 1/3, 2 mf. 1/9, 4 mf. 3/-; 4 mf., 450v. working, 4/-; 4 mf., 750v. working, 6/-.
DUBILIER Condensers, 8 or 4 mfd., dry electrolytic, 450v. working; 3/-; 4+4+2+0.1, 300v. working, 3/-.
VARLEY Constant Square Peak Coils, band-pass type B.P.7, brand new, in maker's cartons, with instructions and diagrams; 2/4.
VARLEY H.F. Intervalve Coils, B.P.8, band-pass, complete with instructions, in original cartons; 2/6.
SCREENED H.F. Chokes, by one of the largest manufacturers in the country; 1/6.
PREMIER British-made Meters, moving iron, flush mounting, accurate, 0-10, 0-15 50 m.a., 0-100, 0-250 m.a., 0-1, 0-5 amps; all at 6/-.
WESTERN Electric Condensers, 250v. working 1 mf., 6d.; 2 mf., 1/-; 4 mf., 2/-; 400v. working, 1 mf., 1/-; 2 mf., 1/6.
WIRE-WOUND Potentiometers, 1,000, 2,500, 15,000, 20,000, 50,000, 90,000, 120,000, 200,000, 500,000, 2/- each; 1,000 ohm semi-variable, carry 150 m.a., 2/-.
COSMOCORD Pick-ups, complete with arm and volume control, a really good job; 12/-.
ALARGE Selection of Pedestal, table and radiogram cabinets, by best manufacturers at a fraction of original cost, for callers.
THE Following Kits 6d. each, or 5/- per dozen—Chassis valve holders, 5-, 6- or 7-pin, screened screen-grid leads, any value 1-watt wire resistances, wire and condensers 0.0001 to 0.1, Bulgin 3-amp. main switches, Cydon capacitors, double trimmers.
SUPER Moving Coil Speakers, handle 10 watts, energised directly from A.C. mains, manufactured by world famous radio and gramophone company; 40/-.
CONDENSER Blocks, 350v. working, 6-4+2+1+1, 4/6; 4+2+1+1+1+0.5, 3/9; 9+3+2, 3/-.
PREMIER SUPPLY STORES,
 20-22 High St., Clapham, S.W.4. Phone: Macaulay 2188. Nearest station: Clapham North, Underground. [6881]
SCOTT'S Guaranteed Components.
SCOTT'S Resistances.—Dubilier, 1-watt 6d., 2-watt 1/-, 3-watt 1/6.
SCOTT'S Condensers.—T.C.C. Dubilier, 4 mfd., 8 mfd., 500 volt, 50 mfd., 50 volt, 200 mfd., 10 volt, 50 mfd., 12 volt, 3/6.
SCOTT'S Pick-ups.—Cosmocord, 13/-; Marconi K.25, 21/-; Rothermel Piezo electric, 32/-.
SCOTT'S Gramophone Units.—Garrard A.C.4, 52/-; Garrard automatic changer, 27/-.
SCOTT'S Rectifiers.—Westinghouse H.T.8, 9/6; H.T. 9, and 10, 10/-; L.T.4 and 5, 10/9; W.4, W.6, Wx6, 4/-; W.M.24, W.M.26, 6/6.
SCOTT'S Speakers.—Magnavox, Rola, Rothermel, W.B.
SEND for Scott's Radio Price List.—Scott's Radio, 67, Harlesden Gardens, N.W.10. [6733]
NEWPORT SURPLUS STORES Have all Kinds of Components in Stock; electrolytic and fixed condensers of all capacities; every article guaranteed.—24a, Newport Court, Charing Cross Rd., W.C.2. [6711]
DOUGLAS Coil Winder (Automatic), hardly used, perfect, list £25, sell £14; Marconiphone power unit (A.C.), perfect, 46/-; both bargains; stamp.—Adhearn, 61, Hatchford Rd., Olton, Birmingham. [6992]

A New GARRARD Quality Product



A Unit for the Small Set

For assembling to a small cabinet, enabling you to enjoy your own musical selections at will, the Garrard Type B Radio-Gram Unit is ideal.

It can be fitted in a space $14\frac{1}{2}$ x $13\frac{1}{4}$ in. and incorporates Garrard Electric Motor, 12 in. Turntable and Pick-up and arm with automatic starting and stopping.

With A.C. Induction Motor - 62/6 202A - 69/-

U5 Universal Motor - 87/-

Send for full particulars.

GARRARD ENGINEERING AND MANUFACTURING CO., LTD.
SWINDON, WILTS. 17, GRAFTON STREET, W.1.
Telephone: Swindon 534 and 535 (2 lines). Telephone: Regent 7596.

The Autocar

SPECIAL OLYMPIA SHOW REVIEW

dated October 19th

The outstanding feature of this Special Number is the unique survey of the Show by the technical staff in which all developments and improvements are analysed and explained, and the Trend of Design is discussed.

NOW ON SALE

PRICE 6^d.

From all Newsagents and Bookstalls.

WILKINSON & SONS LTD.,
DORSET HOUSE, STAMFORD STREET LONDON, S.E.1

Mention of "The Wireless World," when writing to advertisers, will ensure prompt attention.

CAN YOU RELY on your H.T. supply?

Are you sure that when you invite your friends in to hear your wireless set you will not experience a "mid-programme fade-out"? Do you know that your favourite broadcast will not be spoilt due to a failure of your high tension supply?



A Westinghouse Metal Rectifier never lets you down. It will deliver a constant undeteriorating high tension supply for as long as the set itself is in use . . . and longer. No more rectifier valve renewals. No replacements of any description.

If you are on A.C. Mains you cannot afford to be without a Westinghouse Metal Rectifier. 3d. in stamps will bring you full details in the form of our attractive booklet "The All Metal Way, 1935."

The Westinghouse Brake & Saxby Signal Co., Ltd.,
82, York Road, King's Cross, London, N.1.

YOU CAN IF YOU USE WESTINGHOUSE METAL RECTIFIERS

FERRANTI PRODUCE

TWO FINE NEW SPEAKERS

giving *nearly perfect* reproduction



◀ The M1 +

For many years the Ferranti M1 enjoyed recognition as the best domestic speaker. Even better, however, is the recently introduced Ferranti M1+. Consider these points:—

A nickel aluminium steel Permanent Magnet is used, giving a total flux of 128,000 lines, and 8,000 lines per square C.M. in the gap, excluding leakage. The gap itself has the unusual depth of $\frac{1}{2}$ in. permitting a cone movement of a full $\frac{1}{4}$ in. without the coil coming out of the gap.

A new outside, unbreakable suspension is provided, which permits very free longitudinal motion of the cone whilst completely preventing lateral movement.

It has a 6in. right-angle cone composed of hand-made paper to avoid resonances due to uniform grain and is freely suspended by leather round its periphery.

It has a very light aluminium coil with a mean impedance of 6 ohms and will take an input of up to 7 watts and provides *nearly perfect* reproduction throughout the musical range from 50 to 15,000 ~.

The best domestic speaker money can buy, and the choice of the connoisseur.

Price, chassis only, excluding output Transformer **£7.0.0**

And a still more powerful speaker

▶ The M1 Super

The M1 Super is a more powerful model intended for use where a very great volume is required, particularly for small auditorium and ballroom use. It has one of the most powerful nickel aluminium steel permanent magnets available, providing the extraordinary total flux of 160,000 lines, giving 10,000 lines per square C.M. in the gap, excluding leakage. The gap dimensions, coil impedance and suspension are the same as in the M1 + but an 8in. moulded paper cone with a corrugated edge (treated with a special oil) is provided, giving considerable freedom of movement, accompanied by great volume.

This speaker will handle an input of up to 20 watts and reproduce adequately all frequencies from 50 to 9,000 cycles.

Price, chassis only, excluding output Transformer **£10.0.0**

A new list of Ferranti Speakers has just been issued, giving full details of the complete range, and full of interest and information to the radio experimenter. Its number is Wg 550a and will be sent post free on request.

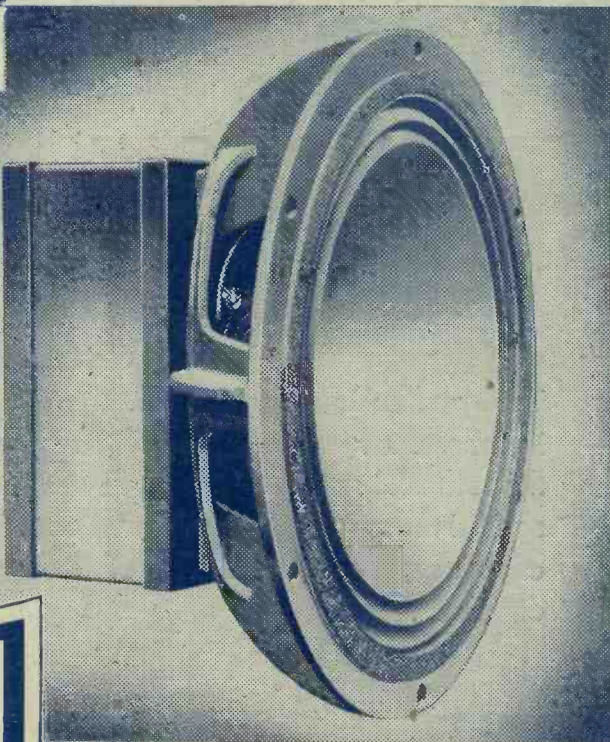

FERRANTI

FERRANTI LTD.
HOLLINWOOD, LANCASHIRE.
London Office
Bush House, Aldwych, W.C.2.

The Wireless World

4^D

THE PRACTICAL RADIO JOURNAL
with

Complete Foreign Programmes

Friday, October 26th, 1934.

BURTON

ALL - MAINS RECEIVERS.

THEY PLEASE BY SIGHT,
ENRAPTURE BY SOUND
AND SAVE YOU POUNDS.

- 2 Valve - - £7. 15. 0
- 3 Valve - - £9. 9. 0
- CONSOLE - 12½ Gns.

ALL-MAINS UNITS
FROM £1. 1. 0.

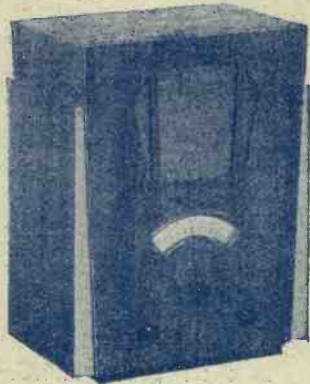

C. F. & H. BURTON, PROGRESS WORKS, WALSALL.

TELSEN D.R. TRANSFORMER

—the L.F. Transformer with a STRAIGHT LINE



CHARACTERISTIC
which gives UNIFORM AMPLIFICATION over the entire range of audio-frequencies. The spaced layer windings are impregnated with a non-hygroscopic material of very low specific inductive capacity which absolutely eliminates all possibility of shorted turns or breakdowns due to large magnetic surges.

D.R.3 (ratio 3-1)
D.R.5 (ratio 5-1) **8'6**

Announcement of the Telsen Electric Co., Ltd., Aston, Birmingham.

TELSEN FOR EVERYTHING IN RADIO

EVERY TEST A.C. AND D.C.

CURRENT • VOLTAGE • RESISTANCE

WITH ONE INSTRUMENT

STILL GREATER ACCURACY AND USEFULNESS

The unrivalled testing facilities of this famous instrument have been still further extended by the addition of two further ranges of A.C. voltage readings for checking mains voltages with absolute accuracy on full scale deflection. The Universal Avometer retains its leadership as the world's most widely used and most accurate combination measuring instrument.

Fully descriptive pamphlet post free.
Automatic Coil Winder & Electrical Equipment Co. Ltd., Winder House, Douglas St., London, S.W.1
Telephone: Victoria 3404/7.



THE 36 RANGE UNIVERSAL AVOMETER

BRITISH MADE
12 Gns.
Deferred Terms if desired.
13-range D.C. Avometer . . . 8 Gns.

FERRANTI

CONSTRUCTOR'S A.C. SUPERHET 5

A Receiver for Long and Medium Wave Reception, having high selectivity and capable of reproduction as good as present day Broadcasting conditions permit. Alternative Output stages are provided, giving 2½, 6, or 12½ Watts respectively.

FERRANTI SUPERHET 5

Write to Dept. A.C.5, FERRANTI Ltd., HOLLINWOOD, LANCASHIRE.

A NEW DIAL

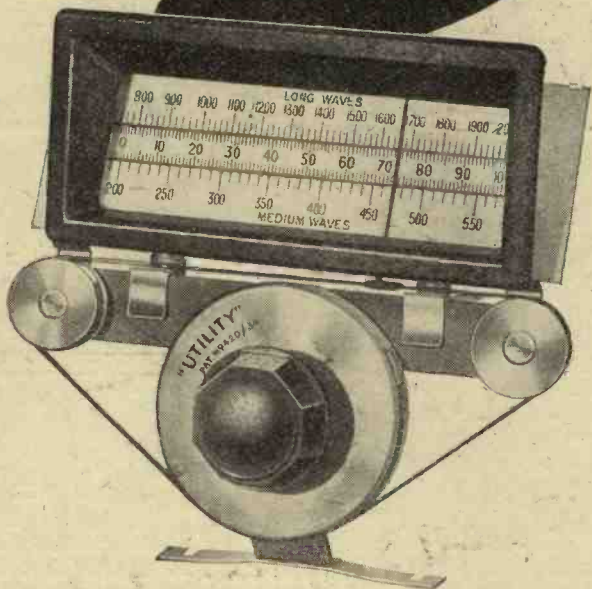

THE high efficiency receiver of to-day makes a good dial imperative if design performance is to be attained.

Here is a new Utility dial that will do justice to the finest receiver made, indeed no better dial is available for exploiting the full possibility of a sensitive super-het. The full vision scale is illuminated by twin lamps and the cursor is so mounted that it remains vertical at all positions.

This new dial is slow motion, 12 to 1 (W 346) as illustrated or can be supplied dual ratio 12 to 1 and 150 to 1 (W 350). Either model can be supplied with wavelength calibrated scale (correct to R.C.M.F. standard induction values and W 347 or W 349 condensers) or with plain 0-100 divisions.

W 346 SLOW MOTION	12 to 1	6/6
W 350 DUAL MOTION		15/-

WILKINS & WRIGHT LIMITED
 UTILITY WORKS, HOLYHEAD ROAD, BIRMINGHAM
 London Agents: E. R. MORTON, LTD., 11, Newman St., Oxford St., W.1.



Belmont.

Mention of "The Wireless World," when writing to advertisers, will ensure prompt attention.



CONDENSERS

MULTI-CAPACITY
 NON-INDUCTIVE
 Tubular Type



MADE IN ENGLAND

Type T.81. 0.1 μ F. + 0.1 μ F. Tested at 1,000 volts D.C. Suitable for 400 volts D.C. working. Retail Price 2/-.
 Type T.82. 0.1 μ F. + 0.1 μ F. Tested at 2,000 volts D.C. Suitable for 600 volts D.C. working. Retail Price 2/3.

HERE is another recent addition to the wide range of these popular condensers.

T.M.C.-HYDRA Multi-Capacity Tubular condensers effect a saving in space, also an economy in price. Like all other T.M.C.-HYDRA Tubular condensers, they are specially suitable for high-frequency circuits, inductance being practically non-existent. The greatest care is taken in every stage of manufacture, and only the finest materials are embodied. The special method of sealing definitely prevents penetration of moisture, and so preserves their high electrical properties.

Low in price, Multi-Capacity condensers can be made to any required combination of capacities.

Write to-day for a copy of the new T.M.C.-HYDRA condenser illustrated price list containing much useful information and advice.

SOLE DISTRIBUTORS:

T.M.C.-HARWELL (SALES) LTD
 Britannia House, 233 Shaftesbury Avenue
 London, W.C.2 (A few doors from New Oxford Street)
 Telephone: Temple Bar 0055 (3 lines)

Made by TELEPHONE MANUFACTURING Co.Ltd.

The Wireless World

THE
PRACTICAL RADIO
JOURNAL
24th Year of Publication



No. 791.

FRIDAY, OCTOBER 26TH, 1934.

VOL. XXXV. No. 17.

Proprietors: ILIFFE & SONS LTD.

Editor:
HUGH S. POCOCK.

Editorial,
Advertising and Publishing Offices:
DORSET HOUSE, STAMFORD STREET,
LONDON, S.E.1.

Telephone: Hop 3333 (50 lines).
Telegrams: "Ethaworld, Watloo, London."

COVENTRY: Hertford Street.
Telegrams: "Autocar, Coventry." Telephone: 5270 Coventry.

BIRMINGHAM:
Guildhall Buildings, Navigation Street, 2.
Telegrams: "Autopress, Birmingham." Telephone: 2971 Midland (4 lines).

MANCHESTER: 260, Deansgate, 3.
Telegrams: "Iliffe, Manchester." Telephone: Blackfriars 4412 (4 lines).

GLASGOW: 26B, Renfield Street, C.2.
Telegrams: "Iliffe, Glasgow." Telephone: Central 4857.

PUBLISHED WEEKLY. ENTERED AS SECOND CLASS MATTER AT NEW YORK, N.Y.

Subscription Rates:
Home, £1 1s. 8d.; Canada, £1 1s. 8d.; other countries, £1 3s. 10d. per annum.

As many of the circuits and apparatus described in these pages are covered by patents, readers are advised, before making use of them, to satisfy themselves that they would not be infringing patents.

CONTENTS

	Page
Editorial Comment	325
The Standard A.C. Three	326
New York Radio Show	330
Unbiased	332
Receiver Performance Data	333
Broadcast Brevities	335
News of the Week	336
FOREIGN PROGRAMME SUPPLEMENT, pp. I—XXIII	
Short Waves and the Amateur	337
Letters to the Editor	338
New Apparatus Reviewed	339
Higgs Superheterodyne, Model 55T	340
Readers' Problems	342

EDITORIAL COMMENT

Announce To-morrow's Items

A New Service to the Listener

VERY few listeners, with the exception, perhaps, of invalids and very lonely people, are in a position to listen continuously to broadcasting—for the most part listeners switch on their sets at irregular times, depending upon the mood of the moment. This sort of indiscriminate listening is, of course, very unsatisfactory and most frequently will lead to dissatisfaction with broadcasting, by creating the impression that the transmissions are seldom to taste.

What can be done to encourage the listener to select his times for broadcasting so that he switches on when, and only when, the programme is to his liking?

We would suggest, first of all, that the B.B.C. should announce special items in the programmes in advance, so that the listener may have the opportunity of making a note of the times. Possibly the best occasion for such advance announcements would be immediately after the News Bulletins which are now transmitted with sufficient regularity as regards time for the public to have formed a habit of tuning in to them.

If after each News Bulletin the B.B.C. briefly announced the outstanding items for the following day, it would, we feel, provide a welcome service to the busy person who has not the time to search out programme items for himself in advance.

In such announcements two considerations are essential. The announcements must be brief, so as

not to become tedious, and they must be made at some regular time, so that the public will know when to listen for them, just as we expect the contents list of a journal or newspaper to appear with regularity in the same position in each issue.

Broadcasting at the Breakfast Table

Suggestion for an Early Session

IN last week's issue we referred to the length of broadcasting hours and suggested that some curtailment of the number of hours might enable the B.B.C. to give us better fare still over shorter times than at present. A contributor to our Correspondence columns urges that there should be a start made by terminating broadcasting at an earlier hour in the evening so as to enable those who wish to do so to retire to rest undisturbed by B.B.C. created distractions from neighbours' loud speakers.

We think there is much to be said for such a suggestion, but we would ourselves propose that to many people it would prove a service if this time were transferred to early morning hours so that we might enjoy a little entertainment in the form of light music or instruction as we dress or as we sit at breakfast. A breakfast broadcast, too, would be an ideal occasion on which to inform us of the broadcasting items of interest prepared for our enjoyment later in the day. An earlier hour for closing down might prove some compensation to the B.B.C. staff who would have to do the early transmission instead of starting at the more luxurious hour of 10.15 as is now usual.

The Wireless World

Standard AC Three

(Concluded from page 312 of last week's issue)

THE theoretical considerations underlying the design of this receiver were considered in a previous article, and the construction and operation of the set are here dealt with in addition to the initial adjustments. The receiver is designed to give a good all-round performance under average conditions.

THE construction of the Standard A.C. Three is straightforward and takes the usual chassis form, since this leads to an arrangement which is sound from the electrical viewpoint, yet mechanically simple. The chassis is built from a piece of aluminium-covered ply-

to obtain a slight clearance. No other points of special importance arise in the construction, which is entirely straightforward, and may be followed from the photographs and drawings which accompany this article. It may be remarked, however, that the small screen between

prove impossible. The material used should be a length of large diameter insulating sleeving covered with metal braiding, and the internal wire should be quite thin—No. 22 wire is suitable. Rubber-covered wire with metal braiding should not be used on account of its high self-capacity, although there is no objection to this material for the pick-up connections.

When putting the receiver into operation it is a wise plan to check the voltages and currents and make sure that they are in reasonable accordance with the figures in the table. Many defects, both of construction and components, reveal themselves by a wide discrepancy of voltage or current at some point, and, should one be unfortunate enough to encounter a fault, it is well to recognise it as soon as possible.

Ganging the Receiver

The only initial adjustments required are to the ganging, and this is best carried out roughly at first by tuning in a station on the medium waveband and adjusting each trimmer for the loudest signals. Then turn down the volume control until the station is only just audible and increase reaction while retuning slightly until the set is just short of oscillating. Signal strength will now be fairly great, and the setting of the volume control can be still further reduced—the aim being to keep the set tuned to a signal while using critical reaction and yet having only a weak signal from the loud speaker. Each trimmer should now be carefully adjusted for maximum signal strength, and it will be found that the trimmer on the intervalve circuit is the most critical.

When the ganging is correctly adjusted the tuning range is 1,500-523 kc/s on the medium waveband and 362.5-139 kc/s on the long waveband. The tuning dial is calibrated in wavelengths and this calibration should hold fairly accurately on the medium wavelengths, but it is not correct on the long waveband, for the dial is arranged for coils of different inductance from those actually employed.

The sensitivity of the receiver varies over the waveband in the usual manner

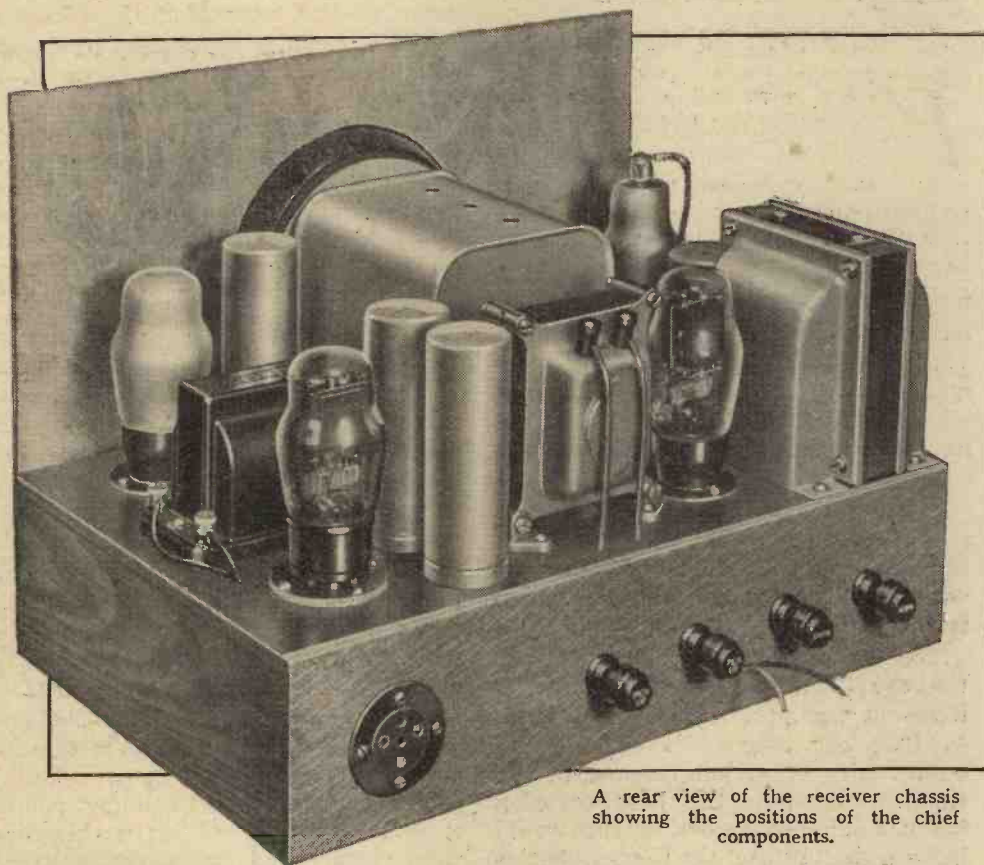

A rear view of the receiver chassis showing the positions of the chief components.

wood, obtainable under the trade name of "Plymax," supported by wooden battens. The gang condenser is mounted on the upper side of the base, but before fixing it in place wires should be soldered to the two lugs making connection with the frame which project through the underside. Connection to the fixed plates of each section is made by the terminals on the side of the condenser, not to the lugs on the underside.

The coil assembly is mounted beneath the base on its side by means of 6 BA nuts and bolts, washers being inserted between the assembly and the baseboard in order

the leads to the two front sections of the gang condenser is necessary in order to avoid coupling between the wires, which would lead to instability. One end of the screen should butt up against the condenser frame in order to reduce coupling between the terminals of the condenser to a minimum.

The detector grid lead in this receiver is long, since it must join the radio-gramophone switch, and it is accordingly screened. It is very important that low-capacity screened cable be used at this point, and also for the anode lead to the HF valve, otherwise correct ganging may

The Wireless World Standard AC Three—for sets of this type. It is greatest at 1,300 kc/s, where it reaches 700 μ V without reaction; when reaction is used, however, a sensitivity of 260 μ V can be reached even at the worst point—523 kc/s. The selectivity is quite high, even when the reaction condenser is set at minimum, as shown by the curves of Fig. 1, and is considerably greater on the long waveband than the medium. This is almost invariably the case with a straight set, and, in spite of it, tuning is flatter on the long wavelengths. This may lead one to believe that the selectivity is lower, but selectivity and sharpness of tuning really bear no relation to one another. On the long waveband the range of frequencies covered by a given movement of the dial is much smaller than on the medium, so that tuning seems flatter in spite of the selectivity being higher.

The application of reaction, of course, greatly increases the selectivity as well as the sensitivity. The sensitivity, however, can also be controlled by the volume control. If it be found, therefore, that signal

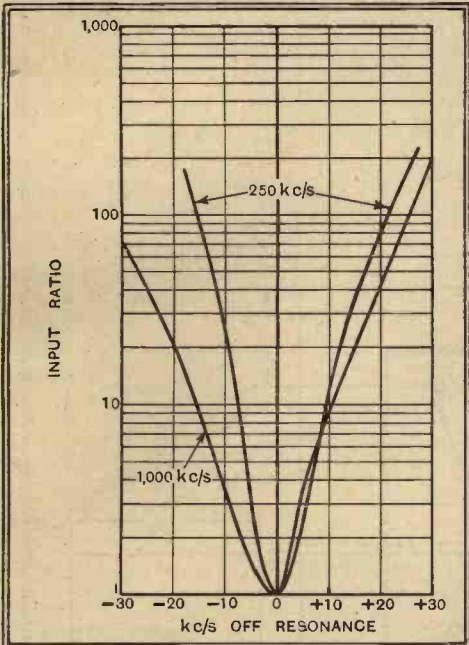

Fig. 1.—The selectivity of the receiver without reaction at 1,000 kc/s and at 250 kc/s is shown by these two curves.

strength is great enough with only a small degree of reaction, but that the station suffers interference from its neighbours, the correct procedure is to reduce the volume by the volume control and then to bring it back to normal again by increasing reaction while retuning slightly. In this way reaction can be used to give greatly increased selectivity without increasing the sensitivity.

The overall response curve of the receiver is shown in Fig. 2, and needs a few words of explanation. It shows that the bass is attenuated about 6 decibels at 50 cycles—quite a small loss for a receiver of this nature. At low and middle frequencies, the curve is truly representative of the performance, but not at high frequencies. At 5,000 cycles the curve shows a loss of 19 db. and this is because the pen-

tode correction filter was left in circuit when measuring the characteristics of the set. Had this filter been disconnected the loss at high frequencies would have been much smaller, but the reproduction would have been very shrill. A pentode output valve in conjunction with a loud speaker greatly accentuates the upper register, and the filter is necessary to correct this. A loud speaker is not used when measuring the receiver performance, however, so that no accentuation of the upper frequencies is then obtained. It can, in fact, be shown that where a pentode output valve is used, a measured response curve similar to that of Fig. 2 is correct for the average loud speaker. This curve is for a carrier frequency of 1,000 kc/s, and at lower frequencies the attenuation of the

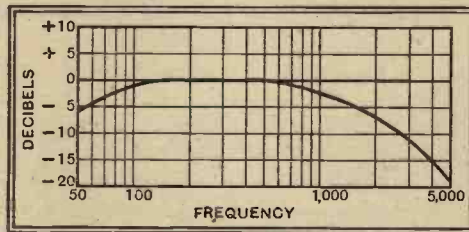
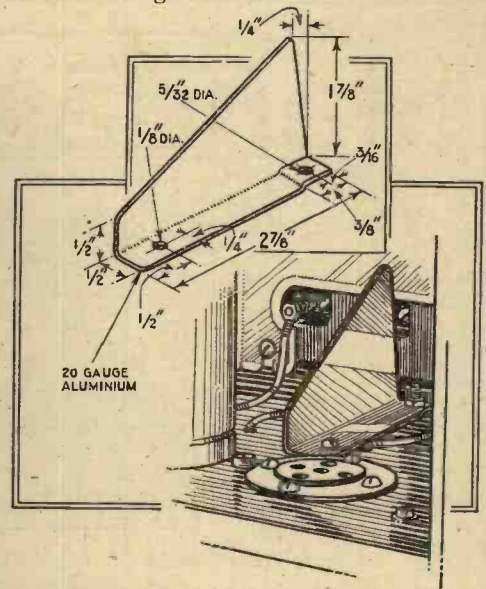

Fig. 2.—The overall frequency response of the receiver is shown by this curve; it should be noted that the connection of a loud speaker compensates for the drop at high frequencies since a pentode output valve is used.

upper audible frequencies is slightly greater owing to the higher selectivity.

Tested on broadcasting the receiver showed itself to be capable of giving a good account of itself. The selectivity proved entirely adequate for the sensitivity and the spread of the local transmitters was confined to a few channels. No difficulty was experienced in receiving Radio Paris clear of Droitwich, but the Deutschlandsender, which is midway

between these two powerful stations, could not be received satisfactorily when both were working.



This drawing clearly shows the construction of the small screen which is mounted between the leads to two sections of the gang condenser.

The sensitivity proved adequate for the purpose for which this receiver has been designed—namely, the reception of the chief Continental transmissions under average conditions—and the quality of reproduction reached a very satisfying standard. The tests, therefore, showed that the set possessed the characteristics which an initial survey of the performance required indicated as desirable. These characteristics were discussed in the first article describing the receiver and there is no point in treating them again here.

Before concluding, it may be as well to make some mention of the matching of the loud speaker to the output valve and

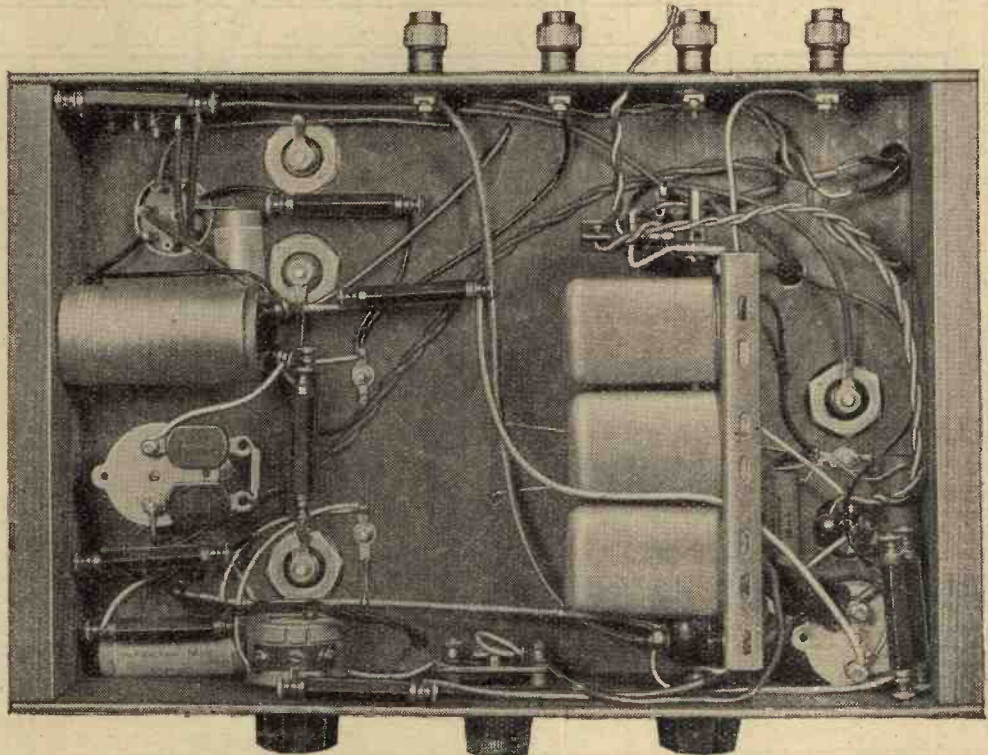

An under-baseboard view of the receiver, showing the coil assembly.

DIAGRAM OF WIRING CONNECTIONS

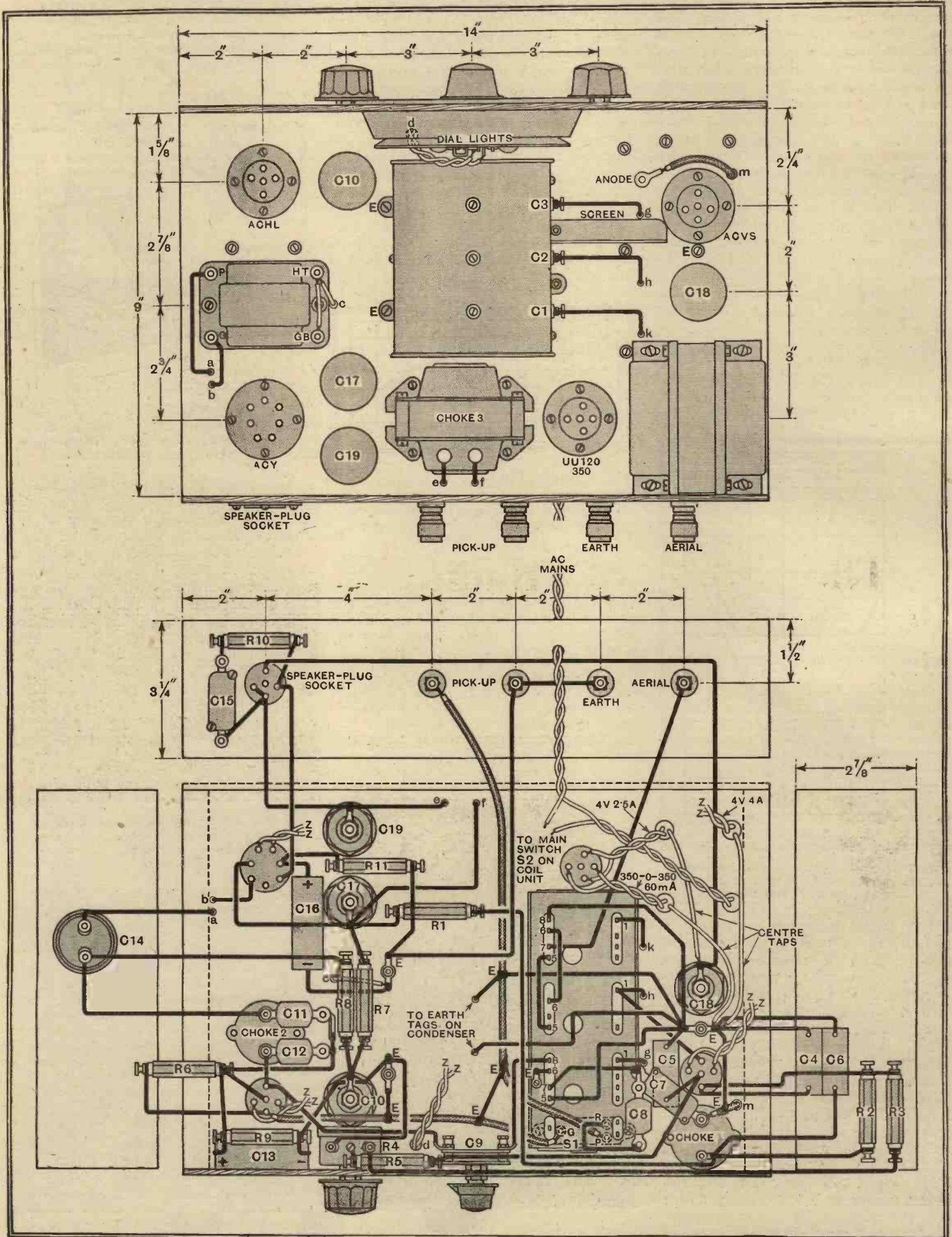

The wiring of the receiver can easily be followed from these drawings, and it will be noted that only a few leads pass through the baseboard.

"The Wireless World" Standard AC Three— of the operation of the set for the reproduction of gramophone records. The output valve is designed for a load impedance of some 6,000 ohms, so that the output transformer ratio should be equal to $\sqrt{(6,000/Z)}$ where Z is the speech coil impedance. If this figure be unknown, it is usually safe to take it as being about 40 per cent. greater than the D.C. resistance. The average pentode transformer, or pentode tapping on a Universal trans-

A full-size blue print of the wiring diagram is available from the Publishers, Dorset House, Stamford Street, London, S.E.1. Price 1s. 6d. post free.

On gramophone only a pick-up and volume control potentiometer are needed in addition to the turntable. The volume control will be almost invariably a potentiometer, and the pick-up makers' recommendations as regards resistance should be adhered to. The two outer terminals

VALVE VOLTAGES AND CURRENTS

Valve.	Anode Volts.	Screen Volts.	Grid Bias.	Anode Current.	Screen Current.
HF. ACVS ..	212	80	-1.9	mA. 4.9	mA. 1.5
Det. ACBL ..	105	—	—	5.5	—
Out. ACY ...	265	260	-19	22.5	3.5

Voltage across C18 = 360 volts.
Voltage across C17 = 260 volts.

Voltage across C19 = 265 volts.
Total current = 40.5 mA.

former, is designed to give a load impedance of 7,000/8,000 ohms, and this is sufficiently near to the correct figure of 6,000 ohms for the difference to be negligible.

of the control should be joined across the pick-up, and one of them also to that PU terminal on the set which is connected on earth, the slider of the potentiometer being joined to the other PU terminal.

A specimen receiver built to the specification described in this article is available for inspection by readers at 116, Fleet Street, E.C.4.

The Stuff of Radio

WE rarely realise how much there is in somebody else's job. The truth becomes known to us when (a) we must perform the job ourselves or (b) the owner of the job describes his duties faithfully and well. In such jobs as, say, bus-conducting or bookmaking, the whole truth is probably never known outside the magic circle; and up till a week or two ago the same might have been said about radio play production. It is one of the features of Mr.

Lance Sieveking's book* that he tells, or appears to tell, the whole truth. Here is no art that conceals art; we are given all the intricate details. We sit in imagination beside the producer, sharing his emotions as he "plays" the dramatic control panel, setting his puppets to perform their blind antics in half a dozen studios.

* "The Stuff of Radio," by Lance Sieveking. Introduction by Richard Hughes. Pp. 414. London: Cassell and Co., Ltd. Price 8s. 6d.

The book is thoroughly alive. Although we may not all share its author's enthusiasm for a medium which possesses, in his own words, "ghastly impermanence," we can acknowledge that the art of radio drama owes its integrity largely to pioneers like himself, Val Gielgud, Tyrone Guthrie, and Richard Hughes.

Sieveking stands or falls by the "multi studio" method. It is the skilful compounding, one gathers, of the sounds proceeding from a dozen different studios which evolves this "stuff" of radio, and that nothing else—no, not even music itself, which constitutes 80 per cent. of all material broadcast—deserves so comprehensive a term. With obvious enjoyment the author introduces us to the technique of the microphone, the



The first picture transmitted last week by phototelegraphy from Australia to London. The photograph is of H.R.H. The Duke of Gloucester.



The Marconi Facsimile transmitter at the Central Telegraph station in London of Cable and Wireless Ltd. A regular phototelegraphy service has been opened between Australia (Melbourne) and London. A picture 9 in. by 9 in. occupies half an hour in transmission. The photoelectric cell is operated by light reflected from the surface of the photograph.

dramatic control panel, and the Effects Department. Radio play production is stripped of its mysteries, and even listening is discussed in its various aspects. Finally, the author helps us to an understanding of the problems involved by reprinting eight of his own microphone plays—all excellent examples of broadcasting technique.

One lays down this somewhat emotional book with a touch of sadness. The "ghastly impermanence of the medium" sticks in the mind with a new significance. Television may still be a long way off, but when it comes what will happen to all this highly specialised stuff of radio? Should we ever wish to listen blindly again? E. C. T.

VARLEY DUO NICORE COILS

IN our issue of October 12th last, where we reviewed these new Varley coils the price was given at 6s. each, but it was not clearly stated that this relates to the seven coils, BP80 to BP83 and BP86 to BP88, the two IF transformers, BP84 and BP85, however, cost 8s. 6d. each.

New York Radio Show

No Rival to Radiolympia

By A. DINSDALE

OUR correspondent records his impressions of a very disappointing New York Radio Show. The Industry has failed to maintain and foster a public interest in their activities—they have suppressed technical enthusiasm to a point where listeners no longer understand or care about such improvements as are introduced. Our correspondent compares this situation with the keenness displayed in this country.

FOR some years I have reported the annual radio show in New York for *Wireless World* readers, but of late the technical-interest matter to be obtained from these shows has rapidly declined. This decline dates back three years, when the radio industry combined with the electrical industry, and the first Radio-Electrical Exhibition was held. The situation is well summed up by Zeh Bouck, a well-known American writer on radio matters, who recently wrote as follows in a New York newspaper:

"We didn't go to the radio show this year. For us, too many ghosts stalked the garden—wan spectres of the days when radio shows were radio shows. To-day, refrigerators are on exhibit in booths once occupied by radio companies with frozen assets. Air conditioning now holds forth where once we battled for a less polluted ether."

No technical information is available on the stands. There are no technical men there to answer questions—only salesmen interested principally in getting together with out-of-town dealers. Such small pamphlets as are available give only the sales points about the sets on display, and these bear little or no relation to the technicalities of the set. The pamphlets don't quote prices.

Midgets Disappear

Last year, midget sets were all the rage and a console set was a rarity. This year the situation is exactly reversed. True, the consoles are very much smaller than of yore, standing no more than 30 to 36 inches high, but at least the console is back, and with it some semblance of good reproduction.

Nearly all sets this year are all-wave, meaning a range of from about 10 to 550 metres, in four bands. The so-called "airplane dial" is almost *de rigueur*. This is a circular dial traversed by a double-ended pointer which revolves through 180 degrees. The top half of the dial has two calibrations to cover two wavebands with one end of the pointer, and the bottom half covers two other bands with the other end of the pointer.

An alternative form of dial takes the form of the familiar slot with a pointer

travelling across a calibrated scale which is automatically changed when the wave-range switch is moved from one wave-band to another. The visual tuning arrangements of former years, with their shadow bands and columns of coloured light, have almost completely disappeared.

The pointers on the aeroplane dials are mostly cheap stampings, with broad points which make accurate logging of dial readings on short wave difficult or impossible. If they ended in knife-edges the idea would be good. Tuning knobs are very small, cheaply made, and often ill-fitted to the condenser shafts. Back-lash was much in evidence. In the case of one receiver the pointer moved an eighth of an inch before the condenser turned. This does not exactly make for easy tuning on short waves. Some tuning knobs turned easily and smoothly on ball bearings. Others were so stiff that the pointer moved in minute jerks. Still others were free and easy at one part of the scale and stiff at others. Most tuning knobs had two speed ratios, one slow speed for short waves, but the above remarks concerning tuning difficulties still apply.

Only a few of the more expensive sets were radio-gramophones.

All sets are superheterodynes, using anywhere from five to twenty-five valves. The 25-valve set,¹ with a roin. aeroplane dial, and three loud speakers, was priced at \$750.

Standardisation has progressed to such an extent that one set looked very much like another, and nearly all looked like tombstones.

Cabinet quality is definitely better this year, but there is still room for an enormous amount of improvement.

As to chassis workmanship, superficial outside examination revealed such an improvement as to warrant the description "good" in about half the sets on display; in many others the workmanship was definitely cheap and nasty. One or two manufacturers had a chassis mounted between bearings so that the underside could be examined. That was definitely a mistake about which the least said the better. Fortunately perhaps for the American manu-

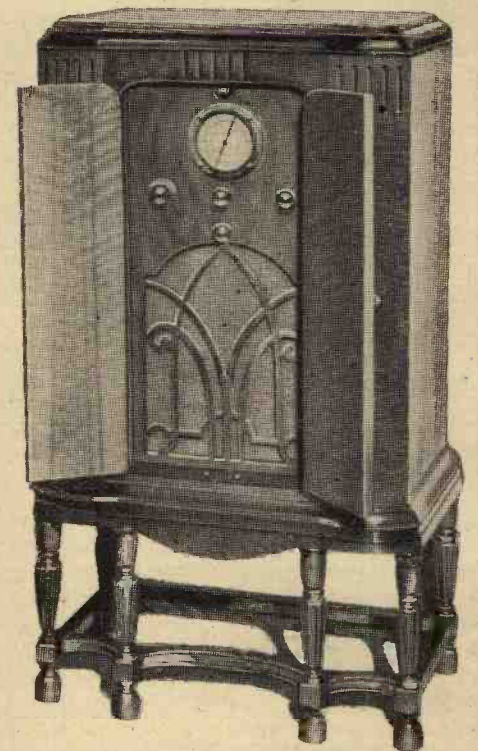

"Last year midget sets were all the rage. . . This year the situation is exactly reversed."

facturers only a minute fraction of the public is interested in, or has any knowledge of, the technicalities of the modern radio receiver. Hence the lack of any technical information, or interest in it or the show by the public.

Perhaps this is the reason why less and less consideration is being given the public at these radio shows, and more and more is being given to dealers. For example, soon after the show opened I walked on to one stand and asked the price of a set which interested me, and which was unmarked. To my amazement the attendant said he didn't know, and went on to explain that they had rushed their latest models to completion in time for the show but had not yet set the price because they had not completed their dealer arrangements. They hoped to settle these matters during the show and announce the prices before the show closed.

Side Shows

In a recent issue of *The Wireless World* a correspondent complained of the dullness of Radiolympia, and suggested that steps be taken to entertain the public. Perhaps the New York radio show at Madison Square Garden would be more to his liking, for there were all kinds of distractions there. The Michigan State Police had an elaborate exhibit of scientific aids to sleuthing. The New York City Police had a radio-equipped police car on their stand and a vast table laid out with a map of the city. Over this map were little brass discs, representing the positions of cruising

¹ Pilot Radio Corporation.

New York Radio Show—

radio cars. At intervals a loud speaker, tuned to the police wave, brought forth instructions to car number so-and-so. Also on the stand were several traffic light standards with lights burning.

The United States Army Signal Corps had an exhibit of modern field telephone and wireless equipment, including direction finders, and also various electrical tricks to amuse the younger generation. During the show, powerful army searchlights on the roof served to advertise the event.

On other stands working models demonstrated various principles of electricity and radio, and, of course, there were the inevitable "crystal studios" from which broadcasts were put on the air from time to time through various metropolitan stations. There was even a television exhibit which never seemed to get beyond the installation stage.

The Show a Disappointment

But "side shows" do not make a Radiolympia. On my first visit I toured the whole place, both the main arena and the vast basement, in a little over an hour, and felt I had seen all there was to be seen. Subsequent visits proved that I was not wrong. I don't think side shows are the answer.

I talked to one exhibitor who knew me, and therefore felt able to talk freely. He expressed the disappointment of exhibitors generally at the poor attendance and lack of public interest, and said business was slow.

"What do you expect?" I replied. "Do you think it's interesting to look at all these silent tombstones and not be able to hear them or find out anything about them?"

"Well," he said, "you can hear them at any dealer's."

I pointed out that few people would be bothered to go to a dealer's just to hear a set and be annoyed by an aggressive salesman, and that also the exhibitor ran the risk that the salesman would end up by selling a competitive set on which, perhaps, he got a greater margin of profit. Having got people to the radio show, that was the time and place to demonstrate the new receivers, because few people realise how poor their old receivers are until they hear an up-to-date one. The radio show presented a golden opportunity.

"We've got demonstration rooms in the basement," said the exhibitor.

"Yes," I replied. "You've got four; three are empty and the fourth is always locked except, perhaps, when a dealer happens to look in at the stand upstairs, and then he's rushed down for a private demonstration. How can you possibly compete for the public's attention when all around you people are being attracted by constant demonstrations of washing machines, refrigerators, vacuum cleaners, etc.? It's unfortunate that your goods can't be demonstrated without making a noise."

The exhibitor finally agreed with me.

I heard only one set demonstrated at the show. By some means or other one exhibitor² had secured space in the basement and set up his own sound-proof demonstration room, which was open to the public. Unfortunately for the popular appeal of his enterprise, he selected his best instrument, which was also the highest priced in the show—\$950. The reproduction was good, but no better than it should have been at that price. It was a radiogramophone, and one would expect the best in gramophones at such a price, but I was sorely disappointed. Needle scratch was very objectionable, and the turntable speed varied at every revolution, thus producing a bad wow.

Otherwise the only interesting feature of this receiver was the dual loud speaker

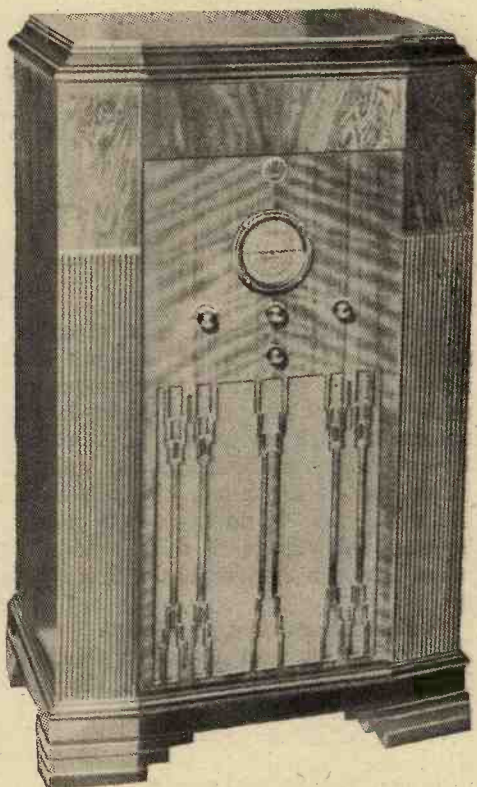

"The so-called 'aeroplane dial' is almost *de rigueur*."

system, which consisted of a 10in. dynamic and a little 3in. cone tweeter. In order to diffuse the sound waves from the latter and overcome the strongly directional characteristics of high frequencies, narrow vertical baffles were mounted in front of it to direct the sound waves to the sides as well as straight in front. Instead of being mounted directly on the cabinet, these speakers were mounted in an acoustically treated box which fitted into the external cabinet.

Very few sets had more than one speaker, it being argued that it is not worth the expense. Broadcasting stations are not supposed to radiate frequencies higher than 5,000 cycles on the basis of a 10 k/cs separation, and most speakers will, according to the manufacturers, reproduce frequencies up to 5,000 cycles without appreciable loss. I don't agree with them, on

the evidence of my ears, but that's their story. Multiple speaker systems never did quite catch on with the American public, partly, one suspects, because of inadequate design, partly because of price considerations, and because nobody went out vigorously to "sell" Uncle Sam on the idea.

However, a change is in sight. There are rumblings of "hi-fidelity," and all the indications point to next year's fad being "hi-fidelity" just as this year's is "all-wave." One manufacturer,³ in fact, has already jumped the gun and come out with both all-wave and what he terms "hi-fidelity," and made a big splash with them at the show.

High fidelity, of course, means that higher frequencies will have to be broadcast, and there's no room for them in the present broadcasting bands. However, special frequency bands are being allocated for high fidelity, and plans are already well under way to build the first high-fidelity broadcasting station. When one or two such stations get going, then the set manufacturers really will have something to think about, but will the public understand?

The habit of short-wave listening, encouraged by the recent appearance of all-wave receivers, is spreading rapidly. For a long time short-wave listening made no headway at all because of fading and local interference troubles. AVC has done much to clear up fading, and local interference has been greatly minimised by noise suppressors in the sets themselves, and by special aerials. The net result is that it is possible much of the time to pull in foreign stations with sufficient freedom from fading and interference to make the programmes really enjoyable. This can be done even in the heart of New York, unless one is in the midst of a maze of electric signs.

Is it Too Late ?

However, it is very difficult for the public to find out about this. The radio show makes no effort to demonstrate either medium- or short-wave reception, and the average dealer's premises are so noisy electrically that interference-free reception on the 200-500 metre band is a rarity, even with screened aerials, and short wave reception is out of the question.

The mistake which the American manufacturer has made is to discourage in every way possible even the smallest technical interest on the part of the public, and now, whatever improvements are introduced, the public doesn't understand them and is consequently indifferent to them. It is now probably too late to attempt to revive public enthusiasm for technical progress, and America can only look with envy upon the position of the English manufacturer, where a technical Press is always at work interesting the public in advance so that every new development becomes a reality and there is no acceptance of finality in any product.

² Stromberg-Carlson Telephone Mfg. Co.

³ Philco Radio & Television Corporation.

UNBIASED

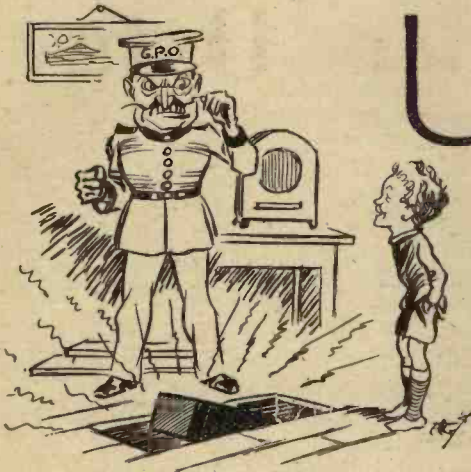

Powerless to do anything.

Reprisals

WHEN I referred the other week to the fact that many honest citizens, rendered desperate and driven wellnigh mad by the spate of loud speaker bellowing which they have to put up with all day and night, had resorted to the deplorable system of reprisals by means of a barrage of violet-ray machines, I little realised that things were as bad as they are.

I greatly fear that my revelations concerning this state of affairs and my protest has merely had the result which it was desired to avoid, certain unprincipled people having used the information to base ends by deliberately purchasing these instruments in order to add their quota to the welter of interference.

In particular, details have been sent me of a particularly flagrant case in which a small boy with a scientific bent used my information to harass and annoy the hard-working interference inspectors of the P.M.G. Purchasing a violet-ray machine, he concealed it in a box lined with cotton-wool, in order to deaden all mechanical noise, and then placed it under the floorboards, a connection being made to a cunningly concealed switch. Having done this he wrote to the G.P.O. complaining of interference to his reception of broadcasting.

Judging by the alacrity with which two engineers arrived a host of other complaints must have been received from the neighbourhood. At any rate, the G.P.O. men diligently set to work to trace the interference, which was switched on spasmodically by the small boy in question. The result is that they have spent several days, and thus wasted much Government time and money, in a wild goose chase, as the noise is never continued long enough for them to get a real line on it. Even if they do eventually unmask the perpetrator of this unseemly practical joke they will, of course, be powerless to do anything about it.

It is high time that legislation was passed to end this Gilbertian state of affairs, although, in my opinion, it is not more farcical than the fact that honest

citizens have their peace disturbed by the irresponsible set-owners who were the subject of my original indictment.

Announcing the Name

THERE seems to have been a lot of potter lately concerning the question of whether a set-maker should or should not stick his wretched name on his product. One great advantage of the name is, of course, that you do know definitely what to avoid when inspecting sets with a view to purchase, and thus much valuable time is saved which would otherwise be wasted in having them demonstrated.

By FREE GRID

However, the whole idea is, of course, ridiculously old-fashioned, and has quite rightly been condemned in certain quarters as savouring of antique and out-of-date instruments such as pianos and violins. Every set-maker should, in my opinion, be compelled to confess his guilt before the world, but in an up-to-date manner befitting the science of radio whose fair name has been dragged in the dust by his set.

Personally speaking, I always "sign" all my products, and set-makers should be forced to confess paternity in the same modern manner which I do. In the case of every set which I make for friends or relations there is included a miniature Blattnerphone arrangement comprising two grooved wheels and an endless steel tape running over them. On this is recorded my name and address and also full technical data concerning the set. It is so arranged that when the set is switched on only the L.F. valves are affected at first, and simultaneously a small electric motor starts to turn the tape, the output of the pick-up coil being, of course, connected to the set in exactly the same manner as an ordinary gramophone pick-up.

After the announcement has been made the Blattnerphone stops itself and a relay switches on the remainder of the valves. The set then commences to work normally and continues to do so until such time as it has been switched off and on again, when the whole cycle of events is repeated.

Needless to say, the arrangement was suggested to me by the old "Edison Bell record" stunt, but I make no charge for that. Manufacturers are quite welcome to adopt the idea, my only condition being that they do not attempt to make sordid gain out of it by deliberately "selling space" on the record to national advertisers, as I for one should object to my enjoyment of chamber music being interrupted by raucous adjurations to try "Tagg's Tonic."

Man-Made Static

ONE has to possess a goodly measure of faith to buy a bottle of hair restorer from a bald-headed barber, or to patronise a doctor who is known to have apprenticed his son to the undertaking business, but not more so, I think, than to buy static-suppressing gear from a manufacturer, the making of whose acquaintance I was given the doubtful pleasure the other day.

The individual in question is the head of a firm. Their activities are very wide, covering components as well as complete sets, and among the former are to be found a comprehensive range of devices for taking the noise out of fans, trams, and other loathsome electrical devices.

Being invited, together with several other despoilers of good paper, to visit their factory the other day, I was astounded to learn that no receiver demonstration could be given, "because of the overwhelming interference from the electric motors in the factory."

I felt so indignant that I immediately



Full technical data.

went home, tore down my screened aerial and threw out various chokes, condensers, and other gadgets made by this firm which I had hitherto used to check the radiation from the multiplicity of electrical devices in my house. At the moment the whole of my laboratory work, besides my ordinary broadcast listening, is held up until I can find adequate substitutes to cut out the appalling row of man-made static.

Receiver Performance Data

III. Quality of Reproduction

By W. T. COCKING

THE measurement of sensitivity and selectivity has been dealt with in the earlier articles in this series, and the author now considers quality of reproduction. It is shown that the overall frequency response is an important factor in the quality given by a set, but that it is not the only attribute deserving consideration.

QUANTITY of reproduction embraces many factors, all of which are not susceptible to accurate and easy measurement. The factor which is most commonly quoted is the overall frequency response, and the curve expressing it is usually termed the fidelity curve. It is a most important, and to many the most important, factor in influencing the choice of a receiver, and it deserves consideration at some length. It will be shown later, however, that undue stress should not be placed upon perfect fidelity, using the word only to denote perfection of frequency response, since there are other factors which may affect quality to an even greater degree.

Since there are so many factors of importance, clear terminology is essential, and throughout this article the phrase "quality of reproduction" will refer to the performance as a whole from the quality viewpoint. The word fidelity will refer only to frequency response, so that it is not a contradiction in terms to say that a set with perfect fidelity may give very poor quality of reproduction, for the possession of a perfect frequency response curve is no guarantee, for instance, that amplitude distortion is absent.

Measurement of Fidelity

In attempting to measure the fidelity of a receiver we at once come up against the problem of the loud speaker in an even more acute form than when determining the sensitivity of a set. So far as the ear is concerned, the fidelity depends as much upon the loud speaker as upon the receiver. The difficulties involved in including the loud speaker in measurements, however, were dealt with when discussing sensitivity, and they occur in even greater measure here. The standard practice in taking a fidelity curve, therefore, is to ignore the loud speaker and to measure only the characteristics of the receiver when it is working into a resistive load. Just as in the other measurements, the loud speaker is replaced by a resistance of such value that the output stage is being operated under the optimum conditions for maximum undistorted power output. The Standard Signal Generator is then adjusted to the wavelength at which a response curve is required and the receiver tuned to it. With the locally generated signal modulated 30 per cent. at 400 cycles, the

aerial input is adjusted until a power of 50 milliwatts is developed in the output load resistance.

The modulation frequency is then varied over the required range, the modulation depth being kept constant at 30 per cent., and the output power noted for each modulation frequency used. The powers obtained are converted to a gain or loss in decibels relative to the power at 400 cycles, and the result expressed in the form of a curve. Actually, of course, the output meter is calibrated directly in decibels in order to save calculation.

Since the selectivity varies with the signal frequency in most receivers, the fidelity varies also, and it is necessary to take a fidelity curve at a number of different frequencies. Moreover, if the set be fitted with a tone control, curves must be taken at both extremes of its range in order to demonstrate its action. Such a family

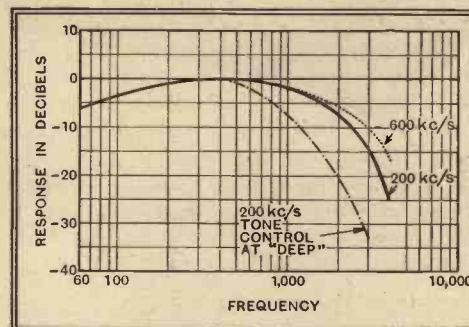

Fig. 1.—The fidelity curves of a typical small superheterodyne showing the effect of the tone control. The variation between the curves for 200 kc/s and 600 kc/s should be noted.

of curves is shown in Fig. 1 for a small superheterodyne of apparently poor fidelity.

The bass response is quite good for an inexpensive receiver, for the loss at 60 cycles is only 6 db., and it is in the treble that the defects are apparent. With the set tuned to 200 kc/s the receiver attenuates a 4,000-cycles note by as much as 25 db. In other words, the power developed in the load resistance at 4,000 cycles is only 0.003162 of that at 400 cycles. When it is remembered that for perfect fidelity the curve should be flat from 30 cycles to 10,000 cycles, the fidelity of this set would appear appalling. An actual listening test, however, reveals that while the reproduction is by no means first class the quality is not nearly as poor as the curve would indicate.

It is important, therefore, to understand where the discrepancy arises. In the first place, the majority of inexpensive loud speakers, and many costly models as well, have a peak in their response curves around 3,000-4,000 cycles, and the magnitude of this peak is often about 10 db. to 20 db. The defect of the loud speaker, therefore, tends to correct for the fault of the receiver. Secondly, this particular set embodied a pentode output valve. The tendency of the pentode to accentuate the upper register is well known, but this only occurs when it is used with a load impedance rising in value with an increase of frequency—such as a loud speaker. With a constant load the pentode characteristic is flat, so that the measured fidelity curve takes no account of the practical tendency of the pentode to accentuate high frequencies.

The consequence of these two effects is to flatten the curve of Fig. 1, and the true overall response, including the loud speaker would be fairly flat up to 4,000 cycles, after which a very sharp cut-off would appear.

It would thus appear that the fidelity curve of the receiver is of little value, but this is not the case provided that it be properly interpreted. In order to gauge the overall fidelity it is necessary only to know two things in addition to the response curve—the type of output stage and the type of loud speaker. For our purposes, output stages can be divided into two classes—pentodes and triodes—but the former will usually include Class "B" and QPP types. Loud speakers also fall into two general categories—small inexpensive models and large "high-quality" types.

The Effect of the Loud Speaker

A small loud speaker with a pentode output stage will give a rising characteristic from about 1,000 cycles to 4,000 cycles, and so a fidelity curve of the type shown in Fig. 1 is the correct one to use with it. Satisfactory reproduction of frequencies much above 4,000 cycles cannot be expected, however. In many cases, of course, a filter circuit is connected across the loud speaker to prevent an accentuation of the upper register, and if the receiver response be measured *without* this, the curve must be more nearly flat for good fidelity.

With the large class of speaker and a triode output stage, the speaker characteristics must be taken as substantially flat, so that a flat fidelity curve is necessary, for curves like those of Fig. 1 would then sound as bad as they look. A large speaker used with a pentode will show a

Receiver Performance Data—

rising characteristic, but it will usually extend beyond 4,000 cycles. The correct fidelity curve, therefore, is a falling one, but not to the degree of Fig. 1, particularly at the very high frequencies. The remaining combination of the inexpensive speaker with a triode output valve really demands a flat curve with a dip around 4,000 cycles, but this will rarely be found.

It will be noted that the fidelity varies somewhat with the signal frequency to which the set is tuned because the selectivity varies. A straight set will usually show a much greater variation than the superheterodyne of Fig. 1, and the only receiver which is unaffected by the signal frequency is one of the single-span type.

In view of the remarks which have been made on the effect of the loud speaker upon the fidelity curve required to give a flat overall response to the ear, it would appear a matter of urgent necessity that a method of including the loud speaker in measurements should be developed. This may be the case, and would undoubtedly be advantageous where a receiver is intended for operation with a particular loud speaker, but it must not be forgotten that the acoustic properties of the room in which the loud speaker is operated may affect the performance to just as great a degree. Where it is anticipated that a receiver will be used with many different types of loud speaker, however, the present fidelity curves are obviously the only type possible.

Other Forms of Distortion

It will be obvious, therefore, that one cannot judge the fidelity of a receiver merely from an inspection of the fidelity curve, and that information as to the type of output stage and loud speaker is also necessary. The quality of reproduction, moreover, depends on more than fidelity, and a receiver which gives perfect fidelity but suffers from other forms of distortion may give less pleasant reproduction than one which has a less perfect frequency response curve, but is freer from amplitude distortion.

The various other forms of distortion, complete freedom from which is needed in addition to perfect fidelity, if perfect reproduction is to be obtained, are chiefly amplitude distortion, phase distortion, and resonances. The last are shown up by the fidelity curve if they occur in the receiver, so that they need not be considered further, save to remark that they are a common defect of the loud speaker. Phase distortion is difficult to measure, and demands special apparatus; moreover, there is little agreement as to its audible effect. Some observers say that it is of no importance whatever, while others consider it to be noticeable, but less important than other forms of distortion. There is no doubt that in an extreme form phase distortion is detectable by the ear, for it amounts to a delay in the reproduction of certain frequencies. Thus, if two notes of different frequency are simultaneously sounded in

the studio, they are not reproduced together if phase distortion is present. With special apparatus giving a very high degree of phase distortion it is possible to conceive that when two notes are sounded together one is reproduced so long after the other that there is a silent interval between them!

The question, therefore, arises not as to whether phase distortion has any audible effect, but whether the amount present in any ordinary receiver is audible. The writer is inclined to believe that it is, but that it has so little effect in comparison with other forms of distortion that it is unnecessary at present to make any attempt to measure it in receivers intended for normal broadcast reproduction.

We now come to amplitude distortion, and here the chief difficulty from the measurement point of view lies in the wide variety of conditions under which a re-

ceiver may be used. No general test has yet been proposed as for sensitivity, selectivity, and fidelity. It is reasonably simple to specify the degree of amplitude distortion occurring in an output valve, or, indeed, in a complete L.F. amplifier, but when a complete receiver is considered the question of modulation depth naturally arises. The distortion for a given output, for instance, may be quite different when the input is modulated 80 per cent. than when 30 per cent. modulation is used and the same output obtained by increasing the input.

It would seem, therefore, that tests for amplitude distortion must be left in abeyance until two things have been determined—a method of measuring harmonic distortion which is simple enough for routine use, and conditions of test which will afford a true representation of the receiver.

The New G.E.C. Battery Receiver

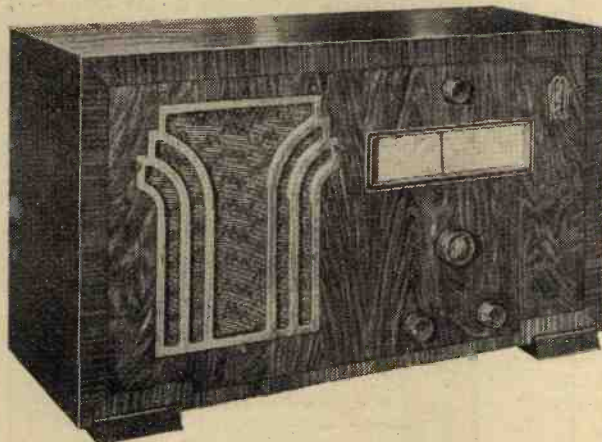

**A Six-valve Superhet.
with Class "B" Output
and AVC**

The price is £14 17s. 6d. and includes 2-volt 40-ampere-hour accumulator and a 150-volt combined HT and grid bias battery.

The Radio Industry

FULLER inert cells, which remain inactive until filled with water, are naturally of special interest to wireless users in localities remote from electrical supplies or charging facilities. Batteries of this type, for both H.T. and L.T. purposes, are described in a leaflet issued by the Fuller Accumulator Co., Ltd., of Woodland Works, Chadwell Heath, Essex.

It has often been urged in these pages that some sort of measuring instrument is essential to every wireless user who takes an intelligent, even if superficial, interest in his set.

The truth of this contention seems at last to be widely appreciated; the makers of the Pifco Rotameter (Messrs. P.I.F. Co., Ltd., of Pifco

TO round off the new season's programme the G.E.C. have introduced a battery superheterodyne designed to give a performance comparable with its AC counterpart, the AVC 5. The new set is housed in a cabinet identical with the "Superhet. DC5," and by skilful design the chassis has been compressed into a small enough space to allow both the HT and LT batteries to be housed inside the cabinet.

A signal-frequency HF amplifier precedes the heptode frequency changer. The IF valve is of the variable-mu type, and the detector a double-diode triode. This is followed by a driver valve feeding a Class "B" output stage capable of delivering 1,200 milliwatts undistorted.

Automatic volume control is, of course, a feature of the circuit, and another important point is the inclusion of a sensitivity control which reduces the overall amplification of the set and consequently background noise. The strength of local stations, owing to the action of AVC, is, however, unaffected by this control.

An extensible internal aerial is included, and provision is made for the addition of an external loud speaker. The internal PM moving coil may be cut out, if desired, by the silencing key provided.

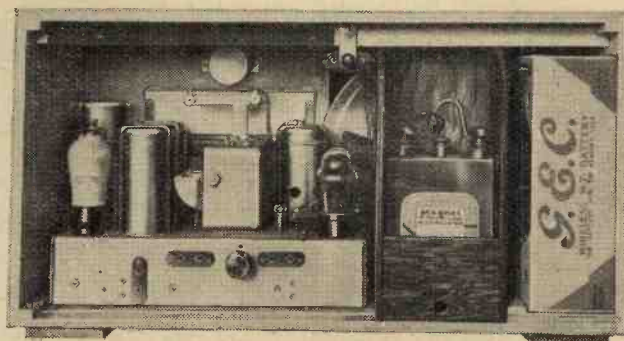

The compact design of the chassis allows the inclusion of both HT and LT batteries in the cabinet of the G.E.C. Superhet. AVC 6 receiver

House, Shudehill, Manchester) tell us that they have been forced to extend their manufacturing facilities to cope with the unexpectedly great demand for the instrument.

BROADCAST BREVITIES

By Our Special Correspondent

Demand for Recorded Programmes

A PROVOCATIVE and therefore interesting letter comes from a Singapore correspondent, who takes me to task for expressing satisfaction because Empire listeners are to have real, as distinct from tinned, music throughout the twenty-four hours. He claims that it is impossible, when listening with a short-wave set under Empire conditions, to distinguish a recorded programme from a "real" one.

"I suggest," he writes, "that several programmes be broadcast consisting of about ten items by the same band, some recorded and some 'real.' If listeners were asked to write in and say which items were recorded, I guarantee no one would give the correct answer."

Daytime Programmes Are Better

My correspondent, supporting the recorded programme idea, claims that it makes for better entertainment, as it is possible to preserve the normal daily programmes for distribution to the Empire at suitable times. Special programme material in the middle of the night, he considers, is rarely up to daytime standard.

What Do Readers Think?

He has made out a good case, but those of us within the high-quality service area of a B.B.C. station know that the best electrical recordings are definitely inferior to the real thing. I can appreciate that when reception falls below a certain standard it matters little whether the original output is good or indifferent, but surely it is not unreasonable to argue that distortion plus distortion cannot produce so good a result as good quality plus distortion. This, however, is a moot point. It would be interesting to have the views of readers. I understand the Editor would welcome letters on the topic.

Short-wave Receiving Aerials

On the question of Empire listening, Mr. L. W. Hayes, of the B.B.C., tells me that the engineers welcome the co-operation of listeners in the Daventry short-wave tests. Much depends on the type of receiving aerial. Glowing reports have come in from listeners using the "Inverted V" aerial. On 20 metres a gain of 3:1 in signal strength is recorded. Picking up W3XAL (Bound Brook) on 16.87 metres, a Londoner found that his inverted V gave a signal five times the strength of that from an ordinary vertical wire type.

What Belfast Thinks

FROM a Belfast correspondent I learn that Ulstermen are by no means happy over the advent of Droitwich. "We have been deprived of the National programme," he writes. "The Belfast station is now a fully fledged Regional centre, and Ulster is left to get its National programme from Droitwich, which station is subject to severe distortion and fading after dark. This is a phenomenon which never occurred with Daventry 5XX."

What the B.B.C. Says

A B.B.C. official, to whom I showed this letter, admitted that Ulster had some cause



BRITAIN'S BIGGEST BROADCASTING STUDIO. The refurbished skating rink at Delaware Road, Maida Vale, which is now in regular use by the B.B.C. The floor area is 110 x 72 feet and the volume is 220,000 cubic feet.

for complaint, but he strongly challenged the accuracy of the last sentence. Apparently Daventry always did fade during the autumn. It so happens that Droitwich has taken over the service at the worst possible time so far as fading is concerned, and, despite having six times the power of 5XX, is showing signs of the old trouble not only in Ulster but in Cornwall.

The Royal Wedding

THE broadcasting of the Royal wedding in Westminster Abbey on November 29th creates a precedent. No wedding, Royal or otherwise, has hitherto been broadcast in this country.

Some trepidation was felt by the Abbey authorities as to whether other sanctions would be required for broadcasting the actual responses. However, the B.B.C.'s official notice has it that "the service will be relayed in its entirety," indicating that the consent of the Duke of Kent and of the Dean and Chapter has been secured.

Concealed Microphones

The B.B.C. "control room" at the Abbey is in a corner of Henry VII's Chapel.

A much more complicated array of microphones will be required on November 29th than for the broadcasting of Evensong on Thursdays. At least eight broadcasting microphones will be used in addition to those necessary for public address. And they must all be concealed.

The B.B.C. engineers will be conducting tests in the Abbey for a week or more before the Royal wedding. One of their problems is to prevent any possible clash between loud speakers and microphones.

Another B.B.C. Innovation

IT will be a novel occasion on November 24th when members of the Historical Association assemble in the Concert Hall of Broadcasting House. They are to hear an electrical recording of "Twenty Years Ago," the vivid programme broadcast on August 4th last narrating the events which led up to the Great War.

Loud Speaker Relay.

For the benefit of the Historical Association the full programme will be relayed on loud speakers and will last an hour and a quarter. This is the first occasion on which the B.B.C. has reproduced a broadcast for the benefit of an organisation.

On Armistice Day

THE broadcast from all stations of the Armistice Day ceremony at the Cenotaph, London, on Sunday, November 11th, will start at 10.30 a.m., when the Brigade of Guards will play appropriate music, including, just before the hour strikes, Chopin's Funeral March.

At 11 a.m. the chime of Big Ben will be heard. This will be taken on the microphone at the Cenotaph and not on the usual microphone installed in the clock tower. This should give the chime an echoing effect. At the end of the silence the "Last Post" will be sounded and a short service conducted by the Bishop of London.

The Portrait Gallery

"THE Director-General," runs the latest B.B.C. staff notice, "wishes to have an album containing photographs of the staff who receive the ten years' bonus. It would also be interesting to have in our archives photographs of the existing staff and of newcomers as they arrive."

Then, adopting a more peremptory tone, the order declares that everybody must supply a portrait or else be photographed in their offices at the B.B.C.'s expense. The pictures are to be card-indexed.

Thumb Prints, Tattoo Marks, and Scars

Why the newcomers should be photographed as they arrive, possibly while bandying words with the taxi-driver, and in any case wearing a look of pardonable apprehension, passes human understanding.

Next week the staff will probably be ordered into the Concert Hall for a thumb-print parade and examined for tattoo marks and scars.

News of the Week

Current Events in Brief Review

French Radio Giants

THE new French Regional scheme will shortly take practical shape with the opening of the Toulouse and Lyons 120-kilowatt stations before the end of the year. Other stations are to be opened in this order: Nice (December), Lille (January), Paris Regional (February), Marseilles (February), Rennes (July).

The average power is 120 kilowatts.

Bath's Clean Record

BATH is the most honest city in the West Country, if the radio licence prosecutions are a criterion. According to the *Bath Chronicle*, proof of the honesty of Bathonians lies in the fact that, although there were fifty wireless prosecutions in Bristol and district in the last quarter, there were none in Bath.

Eiffel Tower Closes Down

"I CONSIDER that Eiffel Tower interferes with the clear audition of broadcasts around it and fails to fulfil modern needs," said M. Mallarmé, the French Postmaster-General, in announcing last week that the station is to cease broadcasting. Eiffel Tower is to be retained as an experimental station.

Short Waves from South America

THE honour of being South America's most powerful broadcasting station apparently rests at present with Radio Prieto, LS2, Buenos Aires, which, according to the "Globe Circler," the official organ of the International DX'ers Alliance, has just installed a new transmitter of 40 kilowatts, the wavelength being 251 metres.

Reports from British amateurs will be welcomed by Radio Prieto S.A. Bolivar 1356, Buenos Aires, Argentina.

The Third Time

RADIO AGEN, the small French station which has already been destroyed twice by fire and flood, is about to return to the ether for the third time, operating on a wavelength of 309.9 metres. It is said that advantage has been taken in rebuilding the transmitter to employ the latest devices for frequency stabilisation, and it is expected also that the station will have a very much wider service area than previously.

New Radio Tax

THERE are many ways of raising the wind in France. The Municipal Council of Rennes in the department of Meurthe-et-Moselle, faced with heavy demands on the Poor Fund, has decided to tax the proprietors of local cafés who use wireless apparatus "which can be heard from the apartment in which the beverages are distributed." The tax, which is 40 francs, is handed over to the deserving poor.

Women and Wireless

MME. BLANCHE VOGT, the French authoress, has increased her popularity among the fair sex by declaring that a wireless set, "though it makes as much noise as a husband, takes up less room."

Franco-British Radio Terms

ONCE more France borrows radio terminology from Britain. It is officially announced that the two large Paris broadcasting stations are to be described as "Paris Regional" and "Paris National."

French listeners express satisfaction at this simplification of station descriptions. According to our Paris correspondent,

Worth Learning Russian?

NEEDY authors are wondering whether it would pay to learn Russian in order to compete for the £1,700 prize offered by the Moscow broadcasting committee for the best musical play specially written for the microphone.

Loud Speakers on Lorries

SOMETIMES lorry drivers, with the best intentions in the world, omit to draw in to allow overtaking. Thanks to the new Philips "Automike" it is possible for an overtaking driver actually to express himself audibly to the lorryman in front. The apparatus consists of a weather-proof microphone directly coupled to a horn loud speaker; the only source of current supply needed can be ob-

Car Radio

JOSEPH LUCAS, LTD., the well-known makers of car electrical fittings, have recently issued a statement defining their attitude towards car radio installations.

It is pointed out that the extra current consumed by the receiver may overload standard equipment. When a receiver is installed the firm cannot therefore accept responsibility for the satisfactory working of their apparatus unless the dynamo is of the compensated voltage control type, and in any case the dynamo output must be sufficient to meet the extra load.

It is stated that in most cases this will involve the replacement of the existing generator by one of the induced ventilation type, and an exchange scheme whereby suitable electrical equipment may be installed is being put into operation.

I.E.E. Wireless Section

MR. S. R. MULLARD, M.B.E., will give the inaugural address as Chairman of the Wireless Section of the Institution of Electrical Engineers, at 6.0 p.m. on Wednesday, November 7th. The meeting will be held at the Institution, Savoy Place, W.C.2.

R.A.F. Radio Dinner

THE Officers' Reunion Dinner in connection with the R.A.F. Electrical and Wireless School is to be held on Saturday, November 17th, at the Royal Air Force Club, 128, Piccadilly, London, W.1. Full information can be obtained from the Hon. Secretary, Mr. J. F. Herd, M.I.E.E., Ditton Corner, Datchet, Slough.

Television Committee on Tour

THE Committee appointed by the P.M.G., under the chairmanship of Lord Selsdon, to consider the development of television, has now almost completed the hearing of the large amount of evidence offered to it. The Committee considers it essential, however, before completing its work and submitting its Report, to obtain first-hand information concerning recent developments in the United States. The Chairman and three other members left for New York on Wednesday, October 24th, and expect to be away till the latter part of November. Meanwhile, other members of the Committee are visiting Germany for a similar purpose.

'Phoning Palestine

THE Radio telephone service to Palestine now includes all places served by telephone. The charge for a call to the Holy Land from any place in England, Scotland or Wales is £1 6s. a minute.

Norway's Licences

NORWEGIAN licensed listeners number 145,346. Oslo holds the lead over other Norwegian cities with 39,459 listeners.

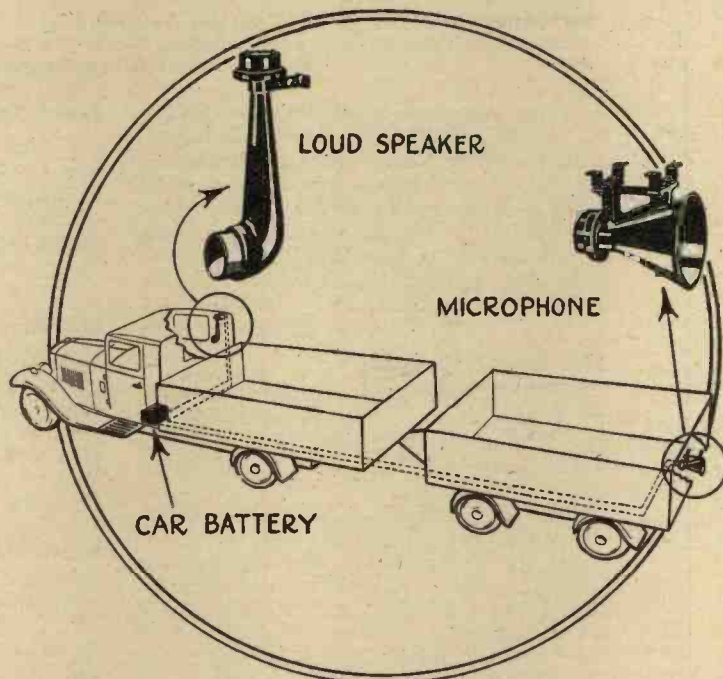

A WORD IN PASSING. The new Philips "Automike" system which enables an overtaking motorist to reveal his presence to the driver of a lorry having one or more trailers.

Parisians have always objected to the welter of station names and initials. They had a particular aversion to the cumbersome "Ecole Supérieure des Postes, Télégraphes and Téléphones."

One of the most notable importations from Britain is the word "self," meaning self-induction coil, which is now embodied in the French language.

Radio-Music

M. ERIC SARNETTE, whose musical instruments specially devised for broadcasting were described in *The Wireless World* of March 16th, 1934, has applied to the French State broadcasting service for permission to demonstrate them on the ether. It is believed that the request will be granted. M. Sarnette believes that microphone technique demands smaller orchestras.

tained from the car battery, a 6-volt tapping being used in the case of a 12- or 20-volt lighting system. The battery consumption is equal to that of a small sidelamp. The microphone is mounted at the rear of the lorry or trailer on the off side.

Wireless Appeal to Doctors

THE Hungarian broadcasting stations recently addressed an appeal to the "doctors of the whole world." A Hungarian lawyer had returned from Asia Minor suffering from a form of blood-poisoning, believed to be due to an unknown bacillus. The broadcast appeal was made in Hungarian, German, English, Danish and French. No fewer than a hundred telegrams and letters of advice were received. Unfortunately, the patient died before treatment could be applied.

Short Waves and the Amateur

THE SUPERHETERODYNE RECEIVER

Part I.—The Frequency Changer

By G2TD and G5KU

CONSIDERATION of the noise generated in a receiving system by thermal agitation in conductors and Schrott effect in valves leads to the conclusion that if a receiver could be operated with zero band-width tuning, using valves with zero anode current and operated at an extremely low temperature, these electronic noises would be so low that there would be no limit to the weakest signal receivable. As a more practical consideration it is found that in a receiver having a band width of 25 cycles, using tuned circuits of a dynamic resistance of 100,000 ohms, the total rms noise voltage will be as low as 0.04 microvolts referred to the input. This is approximately only a hundredth part of the noise which may be generated by the inclusion of a heterodyne to the first detector if the full noise of this device is appreciated.

It is usually the practice, in order to obtain efficient heterodyne detection, to inject practically the full output voltage from the oscillator, while the same order of things is found in the simple oscillating detector circuit. This must lead to the introduction of noise into an otherwise electronically silent receiver, and by ordinary methods can only be overcome by reducing the heterodyne voltage to the same order as that of the signal.

For those who are interested in this problem of quiet heterodyne detection attention must be drawn to the push-pull detector system, which, while utilising full heterodyne voltage, has no noise injected on this account. The circuit of Fig. 1 shows the arrangement. In this system two anode bend detector valves have a symmetrically tuned IF output (or symmetrically by-passed LF) in push-pull. The heterodyne is injected to the two grids in phase, and hence

no noise component appears in the push-pull output circuit. The only effect of the heterodyne is to increase the HT feed from zero, while the HF component circulates through the by-pass capacities.

Similar action takes place when a signal is injected into the push-pull input circuit. Again no detection takes place, since the output is also push-pull. Here the modulation components and the HF components circulate in the by-pass capacities without affecting the output.

On combining the heterodyne and signal voltages detection is accomplished, the output voltage consisting of the beat note with the signal's modulation envelope. It will be seen that the push-pull output circuit is balanced with regard to the heterodyne components in the anode circuit, and also balanced with regard to the modulation of the signal component, either being considered separately. Unbalance is only brought about by simultaneous excitation by signal and heterodyne voltages.

The correct graphical representation of this detector requires a three-dimensional

figure. If the two anode bend push-pull valves are described as in Fig. 2a, the two characteristics are drawn "foot to foot," and a modulated carrier envelope is drawn symmetrically about the bias point. The plate-current variations, although exhibiting rectification, are in the same sense, and therefore a balance in the output circuit results. In Fig. 2b the heterodyne is shown "end on," and a similar effect is found in its effect on

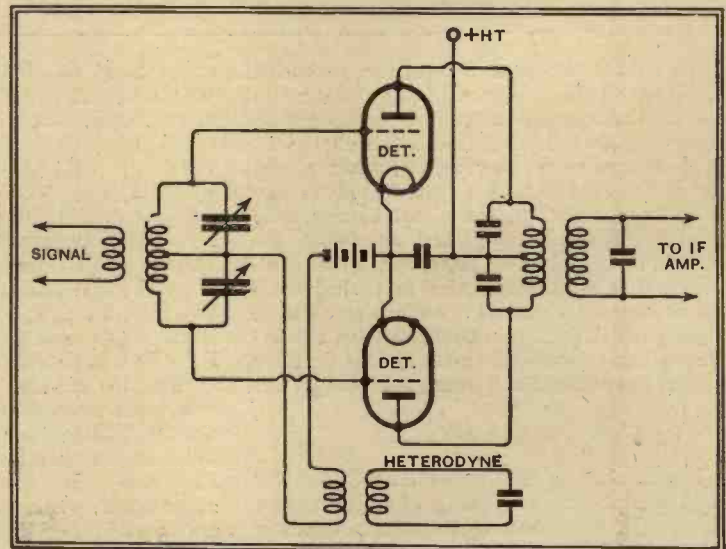

Fig. 1.—Circuit of the push-pull system for quiet heterodyne detection.

the anode current. With the two applied together (2c) it will be found that whenever the phases of the two voltages oppose on one grid they will add on the other, so that for zero beat or any other beat frequency the variations of anode currents will be in opposite sense, and hence produce "push-pull output." The only necessity for phasing

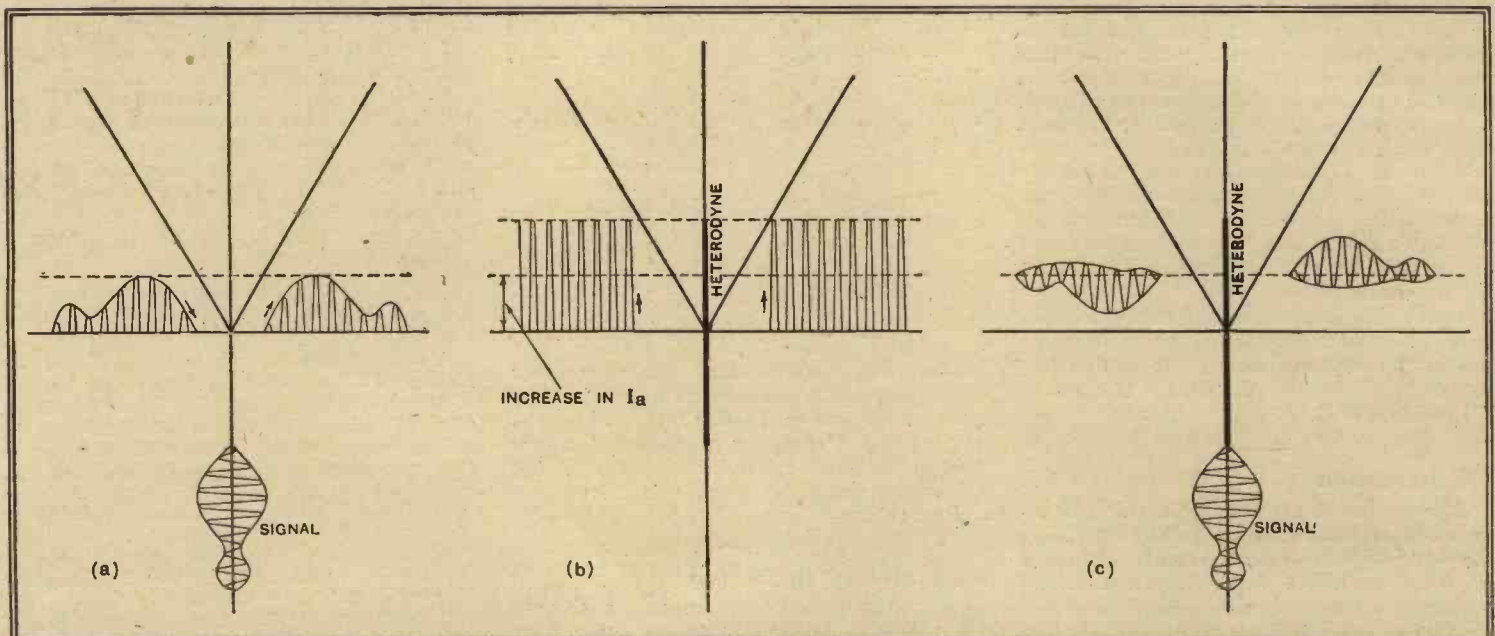

Fig 2.—The detector anode current output for the signal is shown at (a) and that for the heterodyne at (b). The combined output takes the form shown in (c).

SHORT-WAVE TRANSMISSIONS FROM DAVENTRY

The following schedule is at present being observed by the B.B.C. Empire transmitters:—

		Kc/s.	Metres.	G.M.T.
Transmission No. 1	GSD	11,750	25.53	07.15—09.15
	GSB	9,510	31.55	
Transmission No. 2	GSF	15,140	19.82	11.00—14.00
				(12.30—14.00 Sundays)
	GSG	17,790	16.86	11.00—12.30
	GSB	9,510	31.55	12.30—14.00
Transmission No. 3	GSE	11,860	25.29	14.15—15.45
	GSF	15,140	19.82	14.15—15.45
	GSB	9,510	31.55	14.15—17.00
	GSA	6,050	49.59	16.00—17.45
	GSD	11,750	25.53	17.15—17.45
Transmission No. 4	GSD	11,750	25.53	18.00—22.45
	GSB	9,510	31.55	
Transmission No. 5	GSC	9,580	31.32	23.00—01.00
	GSA	6,050	49.59	

arises when zero-beat heterodyne reception is required; this, of course, does not arise in the case of a super-heterodyne or LF amplifying system following the detector.

A curious point now arises; when a carrier is detected in such a system, valve noise is also apparent on the silent carrier, and actually nothing is gained in using the system on telephony. However, when dealing with CW signals, the fact that each morse character carries a certain amount of noise with it does not interfere with the increased signal-to-noise ratio brought about by this very useful and commendable system.

DX Notes

Conditions on 20 metres have fallen off slightly since the beginning of October, and the general level of longer distance signals is low. The second week-end of the Melbourne Centenary Contest has brought to light even more Australian stations, and in the evening after a meagre few on 20 metres, the 40-

metre band was found to be literally full of VK calls, excepting the high-frequency end of the band, where commercial transmitters cause considerable interference. VK2LZ, VK2XU, VK3JQ, VK4BB, VK4EI, and VK4GK were received well on 20 metres, the latter being R.5. Space will not allow for a 40-metre log extract.

Also on 20 metres good signals from W9AGT, W6BBZ, W6BLP, W6AWA, W5COU, VE4AE, VE4DU, and VE9SJ; the latter was heard as early as 11 a.m., while PY2CD was heard at 9 a.m., with no fading at R3, two unusual cases of reception.

Reports from American and Canadian stations indicate that conditions for general DX are comparable with those found in England. The band is now active until 21.30 GMT, when a sudden fade-out occurs, apparently affecting all distances normally covered by reflected rays. The coming winter months should soon reveal good South African reception, where keen activity is known to exist.

Letters to the Editor

The Editor does not hold himself responsible for the opinions of his correspondents

Broadcasting Hours

I WAS interested to read your Leader in the issue of October 19th, and am entirely in agreement with your view that the quantity of broadcasting is overdone, often, no doubt, at the expense of quality.

In one direction, in particular, I believe that a curtailment is overdue. I refer to late hours. Loud speakers are notoriously intrusive, and whilst efforts are being made to lessen street noise at night broadcasting continues unabated. Would it be too much to suggest 11 p.m. as a proper closing hour for broadcasting?

Those who insist on dance music or other entertainment after that hour could make use of gramophone records, if really they must.

EARLY TO BED.

London, W.C.

SW Reception

I AM amazed at the ease with which short-wave stations may be picked up, using the band spread system recently described in *Wireless World*. An hour's listening produced a good crop of U.S.A. stations, all of which were 100 per cent. intelligible. The effect was that of tuning-in Continental stations on a medium wave band. My set

is 2 H.F., Det., Pent., operating from AC main with a SW adaptor, using band spread tuning. "Megacycle" might be interested in the following log for October 10th, 1934:—

	p.m.	m.		
11.0	Moscow RW59	50	R9	Internationale
11.15	W1XA2	31.35	R8	Call.
11.20	W2XAF	31.48	R8	Children's Hour.
11.30	VE9GW	49.22	R8	Market Prices.
11.45	W3XAL	49.18	R9	3 Singing Sisters.
11.50	CP5	49.34	R6	Child Singing and speech.
	a.m.			
12.5	W8XK	48.86	R9	Amos and Andy

all on MC speaker, and also two other Spanish-speaking stations on approximately 49.00 and 48.00 m. at R6, but quality was very bad. Perhaps "Megacycle" might give us a clue to their identity. Many thanks for the band spread system.

Beckenham.

W. H. PIERCE.

Accessibility in Design

AS a humble service-man and a devout reader I should like to say how much I agree with Mr. J. Gibbons in his remarks on your editorial comments on the com-

pactness of commercial receivers. I do not think he is right, however, in his statement, "The majority of radio manufacturers design their sets without any regard to accessibility." It is deliberate!

It seems to me that manufacturers do give a great deal of thought to accessibility with the one idea of avoiding it as much as possible. Apart from the more obvious methods, such as sealing screw heads, they frequently arrange that some final stage in the assembly process comes after the set is in its cabinet, thereby effectively barricading the screws that hold it in. No doubt the factory engineers have special tools to reach the screws on their own sets, but the poor service-man who tries to improvise right-angle spanners with periscope attached, or chain-driven screwdrivers to meet the difficulty, finds himself with a collection of weird implements that is never complete, and the prospect of not reasonably being able to charge for the time spent. In one set the trimmers are readily accessible—by removing the oscillator valve can!

In some industries the manufacturer pursues an active policy of keeping in touch with the commodity after sale.

No so with the radio trade; the only man who comes in contact with the set when it is in use is, normally, the service-man, and he is as often as not treated by the manufacturer as an outsider to be discouraged as much as possible.

The manufacturer wants the set that is not satisfactory sent back to the works even if it only needs a small replacement, and will not supply the service-man with the part, hence owners often have to return sets to the factory, paying carriage both ways, and wait weeks for the job to be done, all of which gives the man in the street a bad taste in the mouth about wireless people generally.

Rapid development and falling prices have led makers to concentrate on selling cheaper sets, but will it always be so? I venture to say that a time will come when the standards will be the reliability, performance, and unbroken service for a reasonable period.

Good servicing is an essential part of the scheme of things to the latter end, so manufacturers should help, not hinder by making everything so enclosed that even the contacts of a wave-change switch cannot be cleaned without partly dismantling the set.

I fear I have taken up too much of your space with the above, but I do think that this matter is of importance, and I very much hope a note will be struck some time, perhaps by yourselves, that will lead to more co-operation between manufacturers and service-men. The absurd crowding of some sets' "innards" is the biggest stumbling-block at present.

Bournemouth.

W. HODGES.

New Commercial Literature

A pamphlet describing the Ekco Car Radio Receiver has just been issued. As many readers are aware, the Ekco set is designed for direct control, and has an independent loud speaker and HT supply unit, which can be mounted in any convenient position. The set costs 20 guineas, plus an installation charge of from 35s., depending on the amount of labour involved.

Aerialite, Ltd., Junction Mills, Whittington Street, Ashton-under-Lyne.—The Aerialite Trapeze Aerial.

Burne-Jones and Co., Ltd., Magnum House, 296, Borough High Street, London, S.E.1.—Radio Components (including special switches, tapped potentiometers, etc.).

New Apparatus Reviewed

Recent Products of the Manufacturers

GOLTONE IRON-CORED COILS

IN the design of the new Goltone iron-cored coils particular care has been taken to achieve as high an efficiency as possible, having regard to the obvious limitations imposed by size and price. The materials are chosen for their good high-frequency properties, as, for example, the use of cellulose acetate bobbins and skeleton construction, allowing ample air spacing to avoid undue dielectric losses.

The coils are, of course, dual range, but waveband switches are not included, and when two or more coils are required they can be supplied assembled on a metal chassis embodying waveband and mains switch.

The specimen tested is the type R11/GIC2, which is an aerial coil having a reaction winding with provision for short-circuiting the long-wave section. There are separate aerial tappings on each coil, and the necessary change-over would be made by the waveband switch.

Our measurements gave the inductance as 156 microhenrys for the medium-wave section and 2,130 microhenrys for the whole coil. Very satisfactory figures were obtained for the HF resistance; at 200 metres it was 23 ohms, at 300 metres 9.5 ohms, and at 500 metres 4.2 ohms. On the long waveband the resistances were 80 ohms at 1,000 metres and 26 ohms at 2,000 metres. These include the tuning condenser losses and those of the test apparatus, so they bear some relation to actual working conditions, though the extraneous losses are admittedly small in this case.

For a practical test the coil was included in a typical det.-LF circuit, and gave excellent results, the sensitivity was surprisingly good for such a simple arrangement

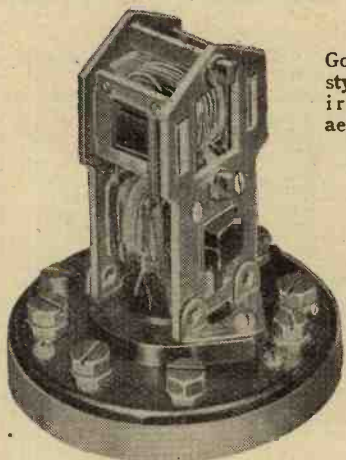

Goltone new-style screened iron-cored aerial coil with reaction.

and quite a high degree of selectivity could be obtained with the one tuned circuit by including a 0.0001 mfd. condenser in the aerial lead, yet the efficiency is so good that signal strength did not fall off appreciably.

It is a particularly good coil and the price is 9s. 6d. There is an HF transformer, band-pass coils, and a superhet. oscillator type among others, and any combination can be obtained on a chassis with switches.

The makers are Ward and Goldstone, Ltd., Frederick Road (Pendleton), Salford 6.

362 VALVES

SAMPLES of valves for the Standard AC Three have been received for test from the 362 Radio Valve Co., Ltd., of 415, Mare Street, Hackney, London, E.8. The ACVS4 is a screen-grid valve with a mutual conductance of 2 mA/v., while the ACHL4 is a triode of 10,000 ohms AC resistance eminently suited for a detector. The output pentode is the ACME4, and there is a full-wave rectifier, the RB41. The valves are of unusually small physical dimensions, and the metallised types are characterised by an aluminium coating.

The valves have been tested in the Standard AC Three and were found to function in an entirely satisfactory manner; they can, therefore, be confidently recommended for use in this set. It should be noted that the output pentode is available in both five- and seven-pin base types. As the receiver is fitted with a seven-pin valveholder, it should be remembered when ordering to specify the seven-pin type.



362 valves for the Standard AC Three.

UTILITY CONDENSERS

ALTHOUGH our tests on the Utility gang condenser Model W349/3 were made with coils of the inductances stated in our issue of October 5th last, it should be known that this season's models are quite suitable for use with the new standard coils, since the inductances of the long-wave sections only have been changed to any extent, and the variable padding condenser ensures correct ganging. The wavelength scale on the dials, however, is correct for coils of 157 and 126.9 microhenrys medium waveband and 2,200 and 1,056 microhenrys long waveband.

BULGIN ELECTROLYTIC SMOOTHING CONDENSERS

BULGIN electrolytic smoothing condensers are of the dry type and assembled in waxed cardboard cases. They are very compact, the 4-mfd. size, for example, measuring 2 3/4 in. x 1 1/4 in. x 1 1/4 in. only. Two rubber covered leads are brought out for connection, and as the condensers are polarised, which is usual with this type, the leads must be connected correctly. Positive and negative leads are indicated by colours, red for the former and black for the latter, but as a further guide positive and negative symbols are printed on the case.

These condensers are designed for a maximum peak potential of 500 volts DC. With smooth DC of this voltage the leakage

current for a 4-mfd. size was of the order of 0.5 mA., but if there is any appreciable ripple giving peaks in excess of this figure the current through the condenser slowly increases. The margin of safety allowed is adequate to take care of momentary surges greater than 500 volts, but the condenser



Bulgin 4-mfd. 500-volt DC peak dry electrolytic smoothing condenser.

should never be used in circuits where the working peak voltage continually rises above the rated maximum.

A safe working voltage when there is a large ripple on the DC is about 480 volts.

These condensers are made in 4- and 8-mfd. sizes, and they cost 3s. 9d. and 4s. 3d. each respectively. The makers are A. F. Bulgin and Co., Ltd., Abbey Road, Bark- ing, Essex.

BELLING-LEE CAR RADIO SUPPRESSOR KITS

INTERFERENCE suppression units for incorporating in the ignition system when a wireless set is installed in a motor car are obtainable from Belling and Lee, Ltd., Cambridge Arterial Road, Enfield, Middlesex, in the form of a kit, and for either four- or six-cylinder engines.

Each kit contains the requisite number of suppression units for the sparking plugs, one for the distributor and two contact suppressors, one to be fitted on the generator and the other for the coil.

An instructional leaflet gives full details of the method of fitting, and the price is 15s. 6d. for a four-cylinder and 20s. for a six-cylinder kit. The various units are



Belling-Lee complete interference suppression kit for a four-cylinder engine.

obtainable separately, and they would give the same immunity to ignition interference when fitted to stationary engines.

Higgs Superheterodyne

MODEL 55T

A Receiver of Unusual Design Incorporating Dual Speakers

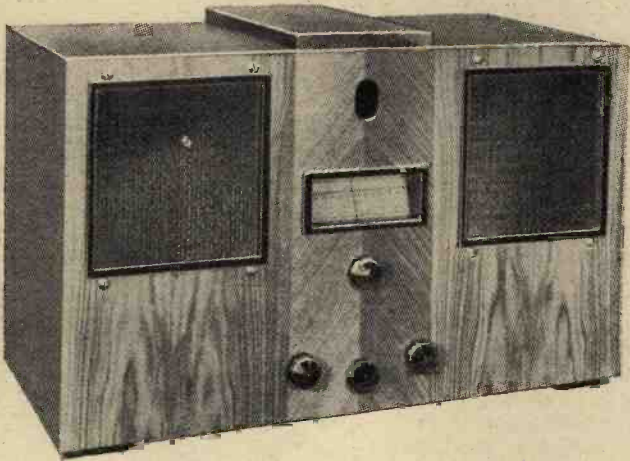

FEATURES.—*Type.*—Horizontal table-model superheterodyne for AC mains. *Circuit.*—Var.-mu pentode HF amplifier—octode frequency changer—IF coupling transformer—anode bend SG second detector—power pentode output valve. Full-wave valve rectifier. **Main Controls.**—(1) Tuning, with oil-damped tuning indicator. (2) Volume control and on-off switch. (3) Continuously variable tone control. (4) Wave-range switch. **Subsidiary Controls.**—(1) AVC delay adjustment. (2) Aerial circuit trimmer. **Price.**—15 guineas. **Makers.**—Charlton Higgs (Radio) Ltd., Westbourne Place, Hove, Sussex

THERE are many features, both in the design and performance, which give this receiver the stamp of originality and make a welcome break from the tendency towards standardisation which is to be observed in medium-priced superheterodynes of to-day.

Looking back on the results of our tests the outstanding impression was made by what we might term the unobtrusiveness of the performance. Reproduction has a smooth quality which is marred neither by harshness in the upper register nor colouration of the bass by resonances. The bass response, in fact, is distributed over an unusually wide band and in orchestral music containing long passages for the double bass, every note in a scale passage is given equal value, a point which will at once be appreciated by those who have had a musical training. It is probable that the dual loud speakers contribute largely to this result, and the unique spacial quality of the reproduction from the dual source adds greatly to the realism of orchestral performances and other transmissions in which

the sound emission is from a wide area.

One of the loud speakers is of the energised and the other of the permanent magnet type, and the moving coils are fed in parallel from a single output transformer in the anode circuit of the $3\frac{1}{2}$ -watt pentode output valve. A continuously variable tone control circuit is connected across the transformer primary, and terminals are provided for connecting an external loud speaker in parallel with this winding. If desired the supply to the internal loud speakers may be interrupted by a switch fitted at the back of the chassis, but it is important to note that this switch must not be opened unless an extension loud speaker is connected, otherwise the output valve may be damaged.

Quiet Background

Although the circuit is sensitive, reception is not marred by excessive background noise. This is probably due to the fact that most of the amplification prior to the second detector is carried out at the signal fre-

quency. The customary IF valve has been omitted, and the only amplification provided at this frequency is that which is given by the octode frequency changer. There are only two tuned IF circuits, but the additional signal-frequency tuned circuit associated with the HF amplifier compensates for any reduction in selectivity which might result. Actually, it was found that the band widths over which the London National and Regional transmitters were capable of causing interference in the Central London area were 30 and 38 kc/s respectively.

Automatic volume control is derived from a full-wave Westinghouse metal oxide rectifier, and the control bias is applied to the HF amplifier. The behaviour of the control is in keeping with the performance in other respects, inasmuch as there is an entire absence of sideband screech and other unpleasant boundary effects as the set is tuned through a station.

The AVC delay voltage may be regulated by a potentiometer control at the back of the chassis. By this means a form of inter-

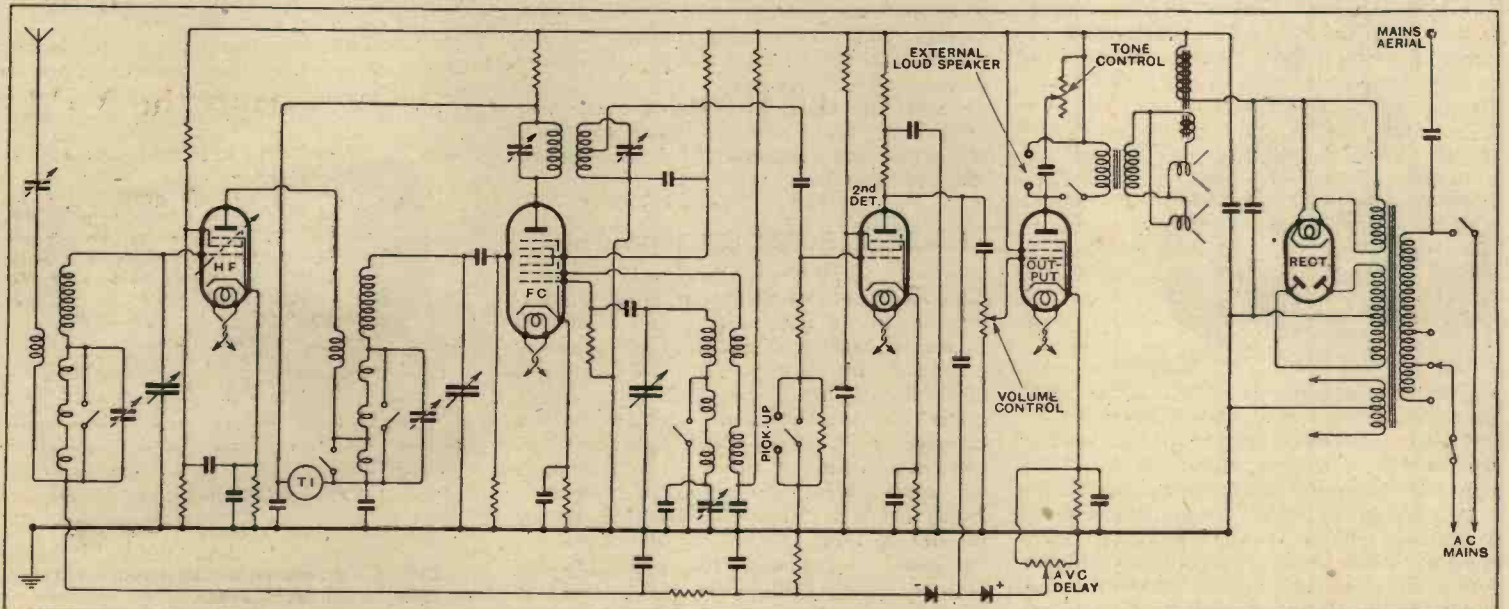

The circuit does not include a separate IF amplifier, but a signal-frequency amplifier stage is provided. AVC is derived through a metal oxide rectifier, and the delay voltage is adjustable.

Higgs Superheterodyne, Model 55T—

station noise suppression is made available to the user. While it does not affect the volume or quality of strong transmissions it has the effect of reducing the effective sensitivity of the set for small inputs.

When the set was first put into operation a large number of second channel whistles were noticeable on the medium waveband, but these were reduced to a level which did not seriously interfere with reception by accurately trimming the aerial circuit. The trimming condenser, which is connected in series with the aerial coupling coil, is accessibly placed at the back of the cabinet and may be adjusted with a screwdriver.

A mains aerial is provided, and the connection is made by a link which can be completely removed from the terminal sockets. This overcomes the trouble which is sometimes experienced where the wander lead is attached to the set and the plug accidentally touches the aerial terminal while an outdoor aerial is in use.

Tuning Indicator

Full advantage has been taken of the dual loud speakers in producing a horizontal cabinet of well balanced design. The controls are well placed, and the tuning dial has separate scales for medium and long waves. A tuning indicator is fitted, and this is of unusual design. The mechanism is of the meter type, and the pointer has a light metal vane working in a vertical glass tube filled with oil. A pilot lamp behind

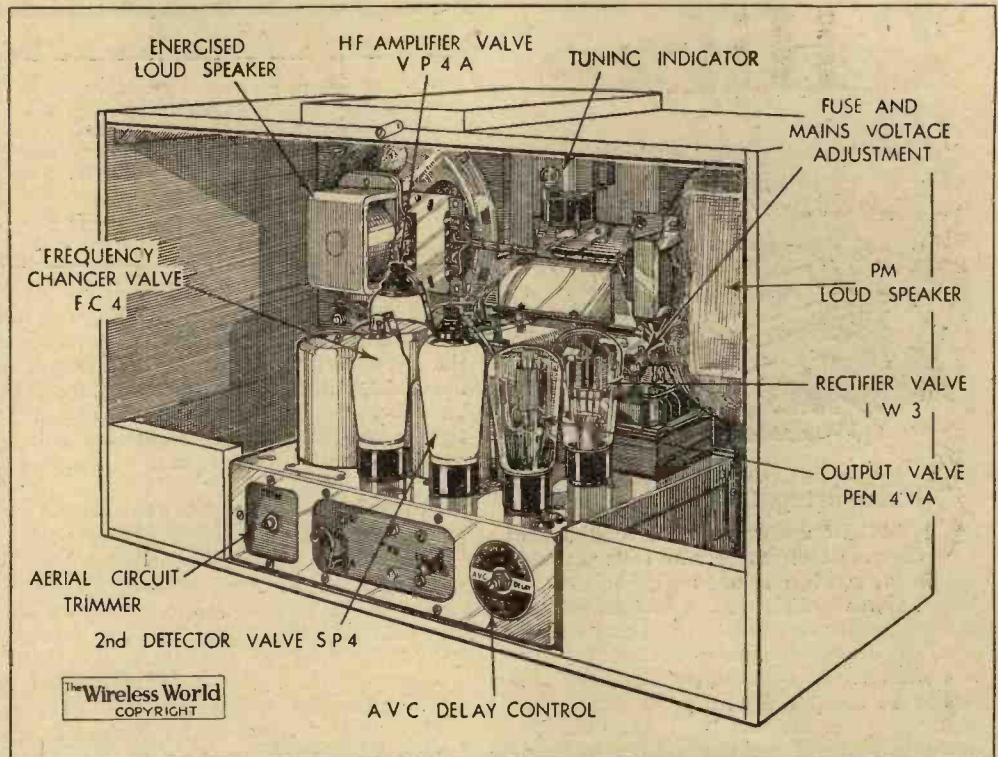

Interior layout of the cabinet. Note the oil-damped tuning indicator and AVC delay control.

the tube throws a dagger of light which lengthens in a downward direction as the signal strength of a station increases. The oil provides efficient damping, and the

action of the indicator is free from "flutter."

In conclusion it is worthy of note that the makers give a two years' guarantee.

DISTANT RECEPTION NOTES

PROBABLY by the time that these notes appear in print the new Government stations at Lyons and Toulouse will be testing. Each of these has an output rating of 120 kilowatts. The Lyons station, Lyons-Tramoyes, will, I understand, replace the old Doua plant which, with a power of only 15 kilowatts, has been well heard in this country ever since the Lucerne Plan came into operation. It is sure to be known amongst DX men as Tramways!

I have not yet heard whether Toulouse-Muret will work on 386.6 metres or on 328.6 metres. The higher wavelength is at present used by a small Government station, the 2-kilowatt Toulouse PTT, and this would seem to be the most likely wavelength for the Muret transmitter.

In either case Toulouse will have to share the wavelength, for 386.6 metres belongs as well to the 10-kilowatt Russian Stalino and the small relay at Fredriksstad; 328.6 metres is shared with Dnepropetrovsk.

Readers have probably noticed that Cologne has been received extraordinarily well for some weeks now. This is mainly due to the fact that the transmitter is working with a power of 100 kilowatts. So little was said about the increase in power that one meets many long-distance enthusiasts who do not know that it has taken place.

At the beginning of the year Leipzig was heterodyned day after day for two months or more. Then the interference disappeared, and during the whole of the summer Leipzig was quite clear. Now the heterodyne has started again; in fact, I have not once found Leipzig free from an accompanying whistle during the whole week prior to the writing of these notes. The offender is difficult to

identify, but I believe that it is Barcelona EAJ1. One hopes that the U.I.R. will be able to effect a cure, for Leipzig with its fine programmes and its excellent quality is a sad loss.

The long waves are still a troubled sea, and so far as one can see there is little hope that any readjustment can straighten matters out. The plain truth is that there are far too many stations at work between 1,000 and 2,000 metres, and there seems to be no likelihood that any of them will be closed down.

An interloper is the Vienna Experimental station which has been working lately on 1,250 metres, just 2 kilocycles away from Kalundborg. Though Vienna is rated at only half a kilowatt, it has heterodyned the Danish station severely at times.

Beromünster, which recently went up to 100 kilowatts, appears to have been having trouble with its plant for some days now, though I have seen no announcement on the subject. Whether it is temporarily using less power I do not know, but I have not been able to receive it for some days.

The only long-wave stations that are completely reliable are Huizen, Radio-Paris and Luxembourg. D. EXER.

Standard Frequency Transmissions from the N.P.L.

FOR some time past a standard frequency transmission has been made from the National Physical Laboratory on the second Tuesday of each month, beginning at 1040 G.M.T. The transmission is in the form of a very accurate 1,000-cycle modulation (correct to 2 parts in 10⁷) of a carrier wave, and it is now announced that in future the carrier will be 396 kilocycles (758 metres) instead of 360 kilocycles (830 metres) hitherto used.

The standard frequency transmission is considerably used by various establishments and experimenters interested in accurate frequency-determinations, and it may be useful to recapitulate here the routine of the transmission. This is as follows:—

- G.M.T. Second Tuesday in Each Month.
- 1040 .. Announcement in morse "CQ de G5HW." Standard frequency emission at 1,000 cycles per second.
- 1045 .. Emission of modulation frequency uninterrupted.

- 1145 .. Modulation frequency changed by minus 2.5 parts in a million.
- 1155 .. Announcement in morse "CQ de G5HW." The correct frequency was 0.999 x or 0.000 y, the figures before the decimal point being omitted, i.e., 0.999x indicates 999.999 x cycles and 0.000 y indicates 1000.000 y cycles per second.
- 1200 .. Programme ends.

In addition to the above a direct emission of a high carrier frequency is made quarterly at 2100 G.M.T. on the first Tuesday in March, June, September and December. This is on 1,780 kilocycles (169 metres). The programme is as follows:—

- G.M.T. First Tuesday, March, June, Sept., Dec.
- 2100 .. Announcement in morse.
- 2102 .. Continuous dash.
- 2115 .. Announcement as at 2100.
- 2117 .. Continuous dash.
- And so on in quarter-hour periods till 2203 G.M.T.

Readers' Problems

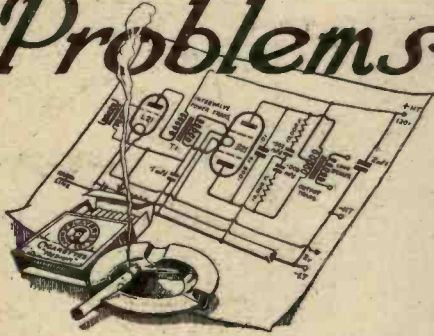

Comparing Coil "Goodness"

A READER is disappointed to find that the result of fitting new coils throughout in his receiver is not nearly so satisfactory as was anticipated. He realises that the new coils are possibly not being used to best advantage, but he would like to make a comparative measurement of their efficiency as compared with those which they replace. We are asked if there is any accurate way of making such a measurement without laboratory apparatus,

If it can be assumed that the coils to be compared are of roughly the same inductance, it is possible to make a comparative test in several very simple ways. We doubt, however, if any method is better than the well-known one which employs the absorption principle; the procedure is to insert the coils under test in a tuned circuit, coupled to an oscillating valve circuit which is tuned to the same wavelength. Energy will be absorbed from this oscillatory circuit, the actual amount being dependent on the "goodness" of the coil in the absorbing circuit, provided that all other conditions remain unchanged through the series of tests.

A convenient method of putting this principle into practical effect is shown in Fig. 1. The circuit LC may be the detector grid circuit of an ordinary receiver with reaction; L₁ is a coupling coil, consisting generally of

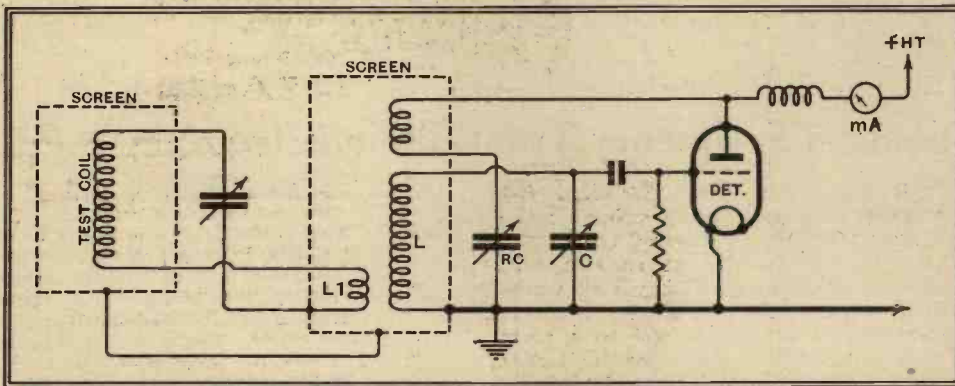

Fig. 1.—Comparative, but not absolute, measurements of the "goodness" of similar tuning coils may be made with the help of the detector valve circuits of an ordinary receiver.

three or four turns, which may be wound round the tuned coil L. This coupling coil is inserted in series with the coil under test and the tuning condenser in the manner shown.

An indication of the amount of energy absorbed from the oscillating circuit is afforded by a milliammeter in series with the anode circuit of the detector valve. This valve is first brought into a state of self-oscillation by manipulation of the reaction

THESE columns are reserved for the publication of matter of general interest arising out of problems submitted by our readers. Readers requiring an individual reply to their technical questions by post are referred to "The Wireless World" Information Bureau, of which brief particulars, with the fee charged, are to be found at the foot of this page.

condenser RC, and the reading of the meter is noted; the condenser controlling the test circuit is then tuned to exact resonance and the change of current is noted; the greater the change the better the coil. Care must be taken that the test circuit is not so tightly coupled that self-oscillation will be stopped entirely at the point of resonance.

Slow-discharge Accumulators

IT should be emphasised that the popular type of accumulator having heavy, thick plates is intended to be discharged at a low rate, and that it is unfair to expect this type of battery to supply a large current. Indeed, one may go so far as to say that it is impossible to obtain a heavy current at the normal rated voltage.

This subject is raised by a reader who complains that the voltage of his cell (a new one) falls to under 1.8 volts when a current estimated at 2 amperes is taken from it. He goes on to say that the accumulator must surely be defective.

With this opinion we can hardly agree. The internal resistance of a mass-type cell is quite appreciable, and is vastly higher than that of a cell with many thin plates designed for heavy discharge rates.

Universal A.C.-D.C. Sets

IN our earlier Show numbers reference was made to the fact that a universal set for operation interchangeably on A.C. or D.C. supplies should work just as well on D.C. as a receiver specifically designed for that type of supply, but that a purely A.C. set is likely to have a better performance on its own type of mains than a "universal." A querist now asks us to elaborate that statement.

limitation is partly overcome, but the set is no longer strictly interchangeable, as its connections must be altered to suit the form of supply on which it is operated.

Separate LT Batteries

IN the "Readers' Problems" section of last week's issue the possibilities of dry-cell LT batteries were discussed. Of course, such a source of supply is only to be considered for special-purpose sets, and particularly for portables, but it seems to interest a number of readers. Possibly the reason that it does so is that, although extremely small accumulator cells are available, they do not seem to survive long when entrusted to the ordinary charging station, which is used to dealing with heavier batteries.

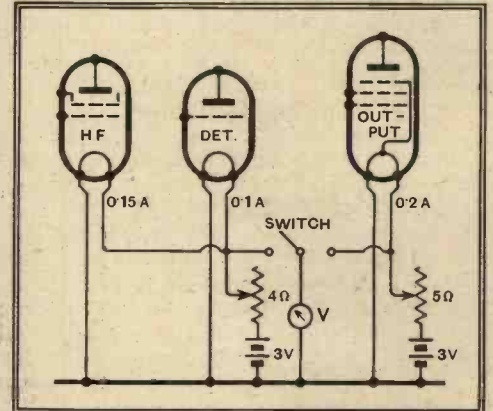

Fig. 2.—Dividing the load: how to use separate dry-cell batteries for LT supply.

Another aspect of the dry-cell LT question is now raised by a reader, who asks whether it would be feasible to employ two separate batteries, one for feeding the HF and detector valves, and the other for the output pentode of his lightweight portable set.

This is quite a practical suggestion, and from some points of view the proposed arrangement is even better than those that have already been discussed. Indeed, there is no basic reason why each individual valve of a set should not be fed from its own LT battery.

To return to our querist's own particular problem, we suggest that the filament circuit should be arranged as in Fig. 2. A filament voltmeter will be almost essential, and we suggest that it should be wired in the manner shown through a change-over switch in order that the rheostats controlling respectively the first two valves and the output valve may be correctly adjusted.

The Wireless World INFORMATION BUREAU

THE service is intended primarily for readers meeting with difficulties in connection with receivers described in *The Wireless World*, or those of commercial design which from time to time are reviewed in the pages of *The Wireless World*. Every endeavour will be made to deal with queries on all wireless matters, provided that they are of such a nature that they can be dealt with satisfactorily in a letter.

Communications should be by letter to *The Wireless World* Information Bureau, Dorset House, Stamford Street, London, S.E.1, and must be accompanied by a remittance of 5s. to cover the cost of the service.

Personal interviews are not given by the technical staff, nor can technical enquiries be dealt with by telephone.

Generally speaking, the H.T. voltage available for a universal set when operated on A.C. is considerably less than the voltage of the mains supply; this is because there is no transformer to step up the voltage to a higher value. Consequently, the power output is likely to be appreciably less than that of an A.C. set employing a transformer. The difference will be especially marked when mains voltage is low.

By using a voltage-doubling rectifier this



A sudden noise—or an equally aggravating silence
inefficiency somewhere in your set!
Take your AvoMinor and find out at once. The
AvoMinor is an investment in permanent security,
for it is a precision instrument, accurate to a
critical degree, and made to stand up to hard
usage and even abuse. It is, in fact, a younger
brother of the famous Avometer, the instrument
used by all the leading manufacturers and their
service engineers. With the AvoMinor you can
test circuits, valves, components, batteries and
power units with the dependable accuracy of the
technical expert.

TEN ACCURATE METERS IN ONE

CURRENT **VOLTAGE**
● 0-6 milliamps ● 0-6 volts
● 0-30 ● 0-120 volts
● 0-120 ● 0-300 "

RESISTANCE
● 0-10,000 ohms ● 0-60,000 ohms
● 0-1,200,000 ● 0-3 megohms

40/-

Size 4" x 3" x 1 1/2".
Total Resistance:
100,000 ohms.
Full scale deflection
on 3 milli-amps.

Deferred Terms if desired.

There is no substitute for the AvoMinor. It is a moving coil combination testing meter—ten accurate instruments in one. Supplied in convenient case with leads and interchangeable testing prods and crocodile clips, and complete instruction booklet adequately illustrated.

Fully descriptive Folder post free from:—

THE AUTOMATIC COIL WINDER & ELECTRICAL EQUIPMENT CO. LTD., Winder House, Douglas Street, London, S.W.1.
Telephone: Vic. 3404/7.

THE D.C. **AVOMINOR** REGD. TRADE MARK
TELLS THE WHOLE TRUTH

"Radio Servicing Simplified"
Everyone should have this invaluable new book. It explains every phase of fault-tracing step by step in non-technical language. The comprehensive information and numerous diagrams make testing a matter of straightforward procedure.
2/6 Post free 2/9

Player's Please

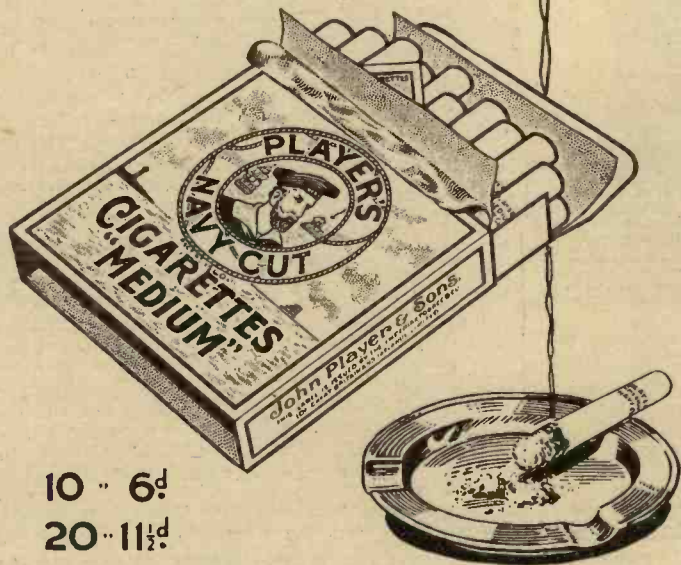

10 - 6d
20 - 11d

"It's the Tobacco that counts"

N.C.C. 230

6 REASONS WHY YOUR CHOICE SHOULD BE THE

Wharfedale
MOVING COIL SPEAKER

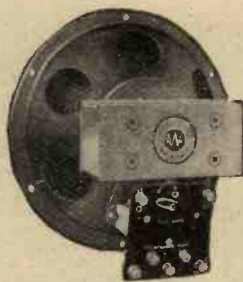

New Bronze Chassis

- We are specialists in Moving Coil speaker production—we make nothing else.
- The magnets, which are the heart of any speaker, are the latest type and the most efficient obtainable from the Sheffield experts.
- Dust covers back and front to preserve the cleanliness of the gap have been a standard Wharfedale fitting for over 18 months.
- Wharfedale speakers achieve quality without sacrificing sensitivity. It is not necessary to buy a special 8 to 12-watt amplifier to drive a Wharfedale speaker.
- Every component part is tested before use. Every stage of construction is inspected and every speaker finally tested on oscillator and signal by skilled men.
- The "Wireless World" says of the Bronze model: "Electro-acoustic efficiency comparable with mains energised units... the general effect is very satisfying to the ear."

CHASSIS MODELS

(all with Universal Transformer)

Junior	32/6
Bronze	42/6
Golden	58/6

CABINET MODELS

(all with Universal Transformer and Volume Control)

Bijou	45/6
Bronzian	65/6
Nubian	75/6
De Luxe	92/6

Ask your dealer to demonstrate or send for catalogue.

WHARFEDALE WIRELESS WORKS, 62, LEEDS RD., BRADFORD

MISCELLANEOUS ADVERTISEMENTS

NOTICES.

THE CHARGE FOR ADVERTISEMENTS in these columns is 12 words or less, 3/- and 3d. for every additional word

Each paragraph is charged separately and name and address must be counted.

ADVERTISEMENTS for these columns are accepted up to FIRST POST on MONDAY MORNING (previous to date of issue) at the Head Offices of "The Wireless World," Dorset House, Stamford Street, London, S.E.1, or on SATURDAY MORNING at the Branch Offices, 19, Hertford Street, Coventry; Guildhall Buildings, Navigation Street, Birmingham, 2; 289, Deansgate, Manchester, 3; 26a, Renfield Street, Glasgow, C.2.

The proprietors retain the right to refuse or withdraw advertisements at their discretion.

Postal Orders and Cheques sent in payment for advertisements should be made payable to LIFFE & SONS Ltd., and crossed

& Co. Notes being untraceable if lost in transit should not be sent as remittances.

The proprietors are not responsible for clerical or printers' errors, although every care is taken to avoid mistakes.

For particulars of Box Number Advertisements and Deposit System see previous issues.

Set Manufacturers' Surplus, Clearance and Bankrupt Stocks offered in any of these columns may not be Manufacturers' current lines. Radio components advertised at below the list price do not carry any manufacturer's guarantee.

RECEIVERS AND AMPLIFIERS, ETC.

BRAND New Battery Single Span Receiver Unit, exact to specification, with valves; £8/10.—E. Eadie, Lisbellaw, Northern Ireland [6754]

OUR Kit of Parts for "Wireless World" Quality Amplifier, complete in every detail, including valves; amplifier only, £8/10; feeder unit, 36/-.

OUR Kit of Parts for "Wireless World" Olympic S.S. Six, complete in every detail, including valves and loud-speaker; £14/10.

SEND for Detailed List of Components for Either of the Above Kits; carriage paid, cash with order.

WARD, 45, Farringdon St., London, E.C.4. Phone: Holborn 9703. [6402]

EMERSON and CROSLEY 1935 Midgets, car radio, and all American valves, send for wholesale catalogue, importer.—Royal, 5, Buckingham Road, London, E.18 [6654]

A.C. "Wireless World" "3" Radiogram, mahogany console, first class components throughout, would suit home constructor; what offers?—Box 1943, c/o The Wireless World. [6744]

1935 Models 4-valve Superhet Midgets, A.C. or D.C., M.C. speaker, £3/19/6; 5 valves, £4/19/6; car radio, £7/15, including valves.—Lovell Bros., 11, Avon Rd., London, E.17. [6655]

£5/5.—Band pass 4-valve chassis by Plessey, Magnavox m.c., complete with valves, in high class walnut or oak cabinet, either A.C. or D.C.; c.o.d., carriage forward.—Kay, 167, City Rd., London, E.C.1. [6619]

BARGAIN.—Manufacturers' stock 1935 model 4-valve A.C. Band Pass sets, Mazda valves, handsome walnut cabinets, Rola speakers, complete, delivered free; £6/15; sent on seven days' approval.—Stott, Clare Hill, Huddersfield. [6670]

SCOTT'S Selection of Parts for Kit Sets.—"Wireless World" Quality Amplifier, complete, including valves and speaker, £8/10; Olympic S.S. Six, complete, including valves and speaker, £14/10; send for details.—Scott's Radio, 67, Harlesden Gardens, N.W.10. [6785]

EDISON BELL Amplifier, less transformer and valves, brand new, 49/-; H.M.V., 12½ wats, undistorted output, brand new, 6 guineas; amplifier, brand new, 2½ wats, £4/10; Philips 18 watt, brand new, 10 guineas; P.A.C., 25 wats, brand new, original price £42, my price £15/10; 5-valve Radiogram chassis, brand new, price £15/10; "Wireless World" Amplifier, brand new, £6/10; electro dynamic converter, 100 watt, D.C. to A.C., £3/10.—M. Donovan, 167, City Rd., London, E.C.1. [6793]

ARMSTRONG.—Latest 5v. bandpass superheterodyne chassis, with fully delayed A.V.C., 7 highly efficient tuned circuits, bandpass input, Marconi Heptode frequency changer, combined 1st detector and oscillator, bandpass coupled I.F. coupled to Marconi H.F. pentode, bandpass coupled to Cossor Double Diode, giving distortionless detection and A.V.U., resistance coupled to Mazda high slope pentode, Marconi bi-phase rectifier, full vision illuminated tuning, calibrated in wavelengths, combined radio and gramophone volume control, corrected pentode output, giving exceptionally good reproduction; £6/18/6, with valves, royalties paid.

ARMSTRONG Universal Superheterodyne, chassis works on A.C. or D.C. mains, specification as superheterodyne model above; £6/18/6, complete with valves, royalties paid.

ARMSTRONG Senior Universal A.C.-D.C. Chassis, 3 tuned circuits, full bandpass tuning, 3½ wats double pentode output, massive construction, with valves; £5/18/6.

ARMSTRONG A.C.4 Chassis, incorporating 3 pentodes, 3 tuned circuits, full band-pass, 3 wats output; £5/18/6, with valves.

ARMSTRONG Latest 4v. Battery Chassis, 2 screened stages, 3 tuned circuits single knob tuning, full vision dial calibrated wavelengths, good selectivity with exceptional pulling power; £4/10, with valves.

ALL Armstrong Chassis are Constructed of the Highest Grade Components Throughout, carry 12 months' service free guarantee, and are sent on 7 days' approval, carriage paid.

ARMSTRONG MANUFACTURING Co., 100, King's Rd., N.W.1. Phone: Gulliver 3105. [6688]

PILOT AUTHOR KITS

Exact to Specification

STANDARD A.C.3

KIT "A" Author's Kit of first specified components, including ready-drilled panel and Plymax chassis but less Valves and Speaker.

CASH OR C.O.D. £10 6 6
CARRIAGE PAID.

or 12 monthly payments of 19/-.

KIT "B" As for Kit "A," but including set of specified Valves, less Speaker.

CASH OR C.O.D. £12 15 6
CARRIAGE PAID.

or 12 monthly payments of 23/6.

If Magnavox Speaker is required with above Kits, add £2 2 0 to Cash or C.O.D. price, or 4/6 to each payment.

KIT-BITS You pay the Postman. We pay post charges on all orders over 10/-, GREAT BRITAIN ONLY.

	s.	d.
1 Peto-Scott Plymax baseboard, 14" x 9", with 3" wood runners. Ready drilled.	7	0
1 Peto-Scott polished plywood panel, 14" x 10". Ready drilled to specification.	2	0
1 Polar Minor 3-gang condenser.	18	9
1 Polar semi-circular slow motion dial.	5	9
1 Bryce mains transformer as specified.	£1	10 0

EXPORT ORDERS Simply send full cash value plus a suitable amount for half carriage charges and any surplus will be immediately refunded. Packed free, we pay half carriage. Air Mail charges extra. PETO-SCOTT, established in 1919, are the largest Radio-by-Mail House in the World. Hire-purchase terms are NOT available to Irish or Overseas Customers.

PETO-SCOTT CO. LTD.
77 CITY RD., LONDON, E.C.1 Phone: Clerkenwell 9406/7
West End Showrooms: 62, High Holborn, London, W.C.1. Est. 1919.

IT WAS THIS FREE BOOK WHICH LED ME TO SUCCESS

ENGINEERS!

JOHN EDWIN AMES AMEE CONSULTING ENGINEER

BE ADVISED IN TIME.

A FEW LETTERS AFTER YOUR NAME WILL MAKE ALL THE DIFFERENCE TO YOUR FUTURE CAREER

This is the day of the specialist. The man who is just a mechanic and skilful with his hands cannot go far. It is the man who can use his head, and has some letters after his name to prove that he can use his head, who gets the well-paid jobs.

Let us show you how, in the privacy of your own home, we can quickly prepare you for those salary-increasing qualifications, such as A.M.I.Mech.E., A.M.I.E.E., A.M.I.A.E., A.M.I.W.T., etc.

We Guarantee "NO PASS—NO FEE."

Send to-day for our unique 256 page Guide "ENGINEERING OPPORTUNITIES." Among a host of interesting matters this guide gives details of all recognized Examinations and outlines over 100 courses in all branches of Civil, Mech., Elec., Motor, Radio and Aero Engineering etc. This book must benefit you. Send for your copy to-day, FREE and without obligation.

BRITISH INSTITUTE OF ENGINEERING TECHNOLOGY,
387, Shakespeare House, 29-31, Orford Street, London.

Every Thursday 3d.

THE MOTOR CYCLE

w.w.25

Receivers and Amplifiers, Etc.—Contd.

PUBLIC Address Amplifiers and High-quality Receivers.—Amplifiers, A.C. mains, and A.C./D.C. from £13; Receivers (6-valve), 5 wats output, from £12; trade supplied; deferred terms.—D. E. Clarkson, B.Sc (Eng.), 10, Park Rd., Wallington, Surrey. Phone: Wallington 3953. [6889]

"G.E.C." 5v. A.C. All-electric Sets, £6/10 (makers' list price £15/15), fitted in beautiful walnut cabinets, complete with 5 "Osram" valves, and moving-coil speaker; these sets are brand new, and packed in the makers' sealed boxes; this is a marvellous offer of a first-class set, at less than second-hand price; the name G.E.C. is sufficient guarantee for the quality; send for illustrated list.—Radio Supplies, 20, Ransgreave Drive, Blackburn. [6713]

MIDGET Receivers, brand new and guaranteed, carriage paid, S.A.E. with all enquiries; every one complete in every detail, with valves and moving-coil speaker, working off A.C. and D.C. mains, any voltage, with line regulator included; Emerson 5-valve, 250-500/1,000-2,000 metres, walnut cabinet 10½x7½x5½, at £4/6/3; the following R.C.A. Victor's (H.M.V. in America), all fitted in handsome walnut cabinets approximately 12x8½x6, delayed automatic volume control, with manual limitation, fitted pick-up terminals, incorporate 2 ultra modern triple function valves, bringing performance to that of a 9-valve set, 5-valve superhet. covering 250-500/1,000-2,000 metres, approximately 75 stations, at £6/5/9; this model supplied in larger cabinet, 24x14x12, at £7; 6-valve superhet, as above, approximately 100 stations, at £6/10; also 4 only 6-valve superhets, covering 13-2,000 metres in 3 wavebands, aperiodic H.F. stage, 2 H.F. pentodes, Hep-tode frequency changer, double anode triode, 6in. Magnavox speaker, at £7/15; please note, owing to serious local interference, demonstrations only after 7.30 p.m.—Degallier's, No. 6, Coryton House, 21, Upper Marylebone St., London, W.1. Museum 7795. Near Oxford Circus and Great Portland St. Stations [6787]

ACCUMULATORS—BATTERIES.

BATTERY Drudgery Abolished, astounding results, particulars and battery log book free.—Instantbrite, Peebles Works, London, N.W.6. [6587]

ACCUMULATORS Direct.—Special introductory offer: 2 volt 45 a.h., direct from makers; 5/6, fully guaranteed; cash with order.—Dresden Accumulator Co., Dresden, Longton, Staffs. [6753]

MAINS EQUIPMENT.

VORTEXION Specified.

STANDARD A.C.3 Transformer, polished die cast, shroudings guaranteed 5 years; see also displayed advertisement on page 12, October 19th.

VORTEXION Specified Olympic S.S. 6 Transformer, S.S.352, 5 years' guarantee, 25/-; less terminals and guarantee, 21/-; power chassis, £3/17/6; choke, 12/6; Single Span model, 25/-; power chassis, £3/10.

VORTEXION.—Quality Amplifier or Super Monodial, 425-0-425, 120 m.a., 4v. 6-8a. C.T., 4v. 3a. C.T., 4v. 1a., 4v. 1a., super shrouded, core size 2¼in.x1½in., 2½% regulation primary engraved insulated terminals, weight 14lb., 26/-; carriage 2/-; normal shrouded, 22/-; open type, 20/-; post 1/3; speaker field replacement choke, 16/-; special output transformer to "W.W." specification, 12/6, post 9d.; state valve and speaker; "W.W." universal output transformer, £1; normal 40h. 50 m.a. primary output transformers, 10/6, post 9d.

VORTEXION 7.30h. 120 m.a. Choke, 215 ohms, in die cast shrouding to match; 12/6.

IMITATED, but unequalled. Good enough for a "Wireless World" specification is good enough for you.

VORTEXION Cost Little More than the Cheapest, but unequalled by the dearest.

VORTEXION A.C./34, used by author in construction of A.V.C. Three, as illustrated; 18/-.

GUARANTEED 12 Months, and within 5% normal and 2½% super models, neat shrouding, with detachable feet, as used by Government Departments, etc., etc., any model guaranteed 5 years at extra cost of 2/-.

ALL Secondaries Centre Tapped.

VORTEXION.—250-0-250 60 m.a., 4v. 1 to 2a., 4v. 2 to 4a., open type, 10/-; shrouded, 12/6; post 9d.

VORTEXION.—Ferrocort III 350-0-350, 60 m.a., 4v. 2.5 C.T., 4v. 3.5 C.T.; open type 13/6, shrouded 16/-; post 9d.

VORTEXION.—Super model for H.T.s or 9 or 10, 4v. 1 to 2, 4v. 2 to 4, open type 14/6, shrouded 16/6; post 1/-.

VORTEXION.—350-0-350, 120 m.a., 4v. 2 to 5a., 4v. 2 to 4a., 4v. 2.5a.; open type 14/6, shrouded 16/6; super shrouded model, weight 11lb., 4 filaments to specification, 21/-; post 1/3.

VORTEXION.—400 or 450 or 500v. 120 m.a., 4v. 2 to 5, 4v. 2 to 5, 4v. 2.5a.; open type 19/-, shrouded 23/-.

VORTEXION.—400 or 450 or 500, 150 m.a., 4v. 4a., 4v. 2.5, 4v. 2, 4v. 2, core size 2¼x1¼in., a super job, 2% regulation, 35/-; shrouded, with terminals; less terminals, 30/-; open type, 26/-; post 1/3.

VORTEXION Auto Transformers to B.E.S.A. Specification, 100, 110, or 120v. to 200, 220, or 240 volts, 60 wats 9/-; post 9d.; 120 wats, shrouded 12/6, open type 10/6, post 1/-; 200 wats, shrouded 16/6, post 1/-; 2,000 wats, £4/10.

VORTEXION 1,000-watt Transformers; £4/10, carriage free.

VORTEXION 30h. at 60 m.a. Chokes, 5/6; 40h. at 60 m.a., 8/6; 30h. at 150 m.a., 200 ohms, 10/6 open type, 12/6 shrouded.

VORTEXION Transformers Made to Your Specification; price according to wattage, 6v. filaments same price unless wattage grossly exceeded; special quotations by return.

VORTEXION (S. A. BROWN), 182, The Broadway, Wimbledon, S.W.19. Tel.: Liberty 2814. [6788]

Mains Equipment.—Contd.

P.
PARTRIDGE, B.Sc.(Eng.), A.M.I.E.E., A.I.Rad.E.
PARTRIDGE Transformers.—“Certainly above the average... very soundly constructed transformers.”—*Wireless Trader*.
PARTRIDGE Transformers.—“Runs perfectly cool sound electrical job... represents very good value.”—*Wireless World*.
PARTRIDGE Transformers.—“Voltage regulation excellent... transformer remained remarkably cool.”—*Radio Trade Review*.
PARTRIDGE Transformers.—Guaranteed 12 months, screened primaries, 200-250v., 50 cycles, all L.T.s centre tapped.
PARTRIDGE Transformers.—250-0-250v., 60 m.a., 4v. 1a., 4v. 2-4a., 11/-; 350-0-350v., 60 m.a., 4v. 2-2½a., 4v. 2-4a., 13/6.
PARTRIDGE.—350-0-350v., 80 m.a., 4v. 2-2½a., 4v. 2-4a., 4v. 1a., 16/6; 350-0-350v., 120 m.a., 4v. 2-2½a., 4v. 3-5a., 4v. 1-2a., 18/6.
PARTRIDGE.—425-0-425v., 120 m.a., 4v. 2-2½a., 4v. 3-5a., 4v. 2a., 20/6; 500-0-500v., 100 m.a., 4v. 2-2½a., 4v. 3-5a., 4v. 2a., 21/-.
PARTRIDGE.—500-0-500v., 120 m.a., 4v. 2-4a., 4v. 3-6a., 4v. 1-2a., 4v. 1-2a., 27/6; larger types supplied to order.
PARTRIDGE.—0-7½-9.11v., 1-3a., 10/-; 0-15-18-22v., 1-2a., 10/-; 240v. (tapped 200v.), 200 m.a., 4v. 2-4a., 12/6.
PARTRIDGE.—Step-up or step-down auto transformers, tapped 0-100-110-200-230-250v., 60w., 10/-; 100w., 12/6.
TRANSFORMER for “W.W.” Single Span, 18/6; for “W.W.” P.P. Quality Amplifier, 27/6; for “W.W.” Olympic S.S. Six, 18/6; for Standard A.C. Three (specified), 15/6.
PARTRIDGE Transformers.—Wound to any specification, accuracy of output guaranteed, competitive prices, quick delivery.
OUTPUT Transformers.—“Partridge” officially recommended by Messrs. Tungstram for their 21w. output valves.
OUTPUT Transformers.—5w. to 100w. speech, no audible distortion, 32-10,000 cycles, designed for any conditions for relay of P.A. work; see “W.W.” test report, Oct. 19, 1934.
PARTRIDGE Chokes.—Give rated inductance at full current; curves supplied on request.
PARTRIDGE Chokes.—140H., 60 m.a., 2,500 ohms, 13/6; 75H., 25 m.a., 1,400 ohms, 7/6; 25H., 60 m.a., 560 ohms, 7/3.
PARTRIDGE Chokes.—22H., 120 m.a., 350 ohms, 9/9; 13H., 200 m.a., 160 ohms, 12/-; 8H., 120 m.a., 225 ohms, 6/9.
PARTRIDGE Chokes.—6H., 500 m.a., 50 ohms, 19/6; 3H., 250 m.a., 70 ohms, 6/6.
ALL Advertisised Lines Supplied from Stock.
PARTRIDGE.—Trade enquiries solicited.
PARTRIDGE, B.Sc.(Eng.), A.M.I.E.E., A.I.Rad.E.
PARTRIDGE, N., Kings Buildings, Dean Stanley St., London, S.W.1. Tel.: Vic. 5035. [6749]
SMOOTHING CHOKES, 50 m.a. 30h.; 4/6.—C., 42, Radcliff Rd., N.21. [6748]
BATTERY Chargers.—N. P. chargers, lowest prices yet finest materials, trade lists free.
BATTERY Chargers.—N. P. from 52/- to £15; state your requirements for lowest quotation.—N. P. Electrical, 514, Alum Rock Rd., Birmingham. [6688]
TANTALUM for A.C. Chargers, H.T. and L.T.—Blackwell's Metallurgical Works, Ltd., Garston, Liverpool. [6470]
HOYNE'S Transformers are Manufactured by Engineers with 14 Years' Experience in Radio Transformer Design.
HOYNE'S Transformers, fitted with tapped and screened primaries, filaments, all centre tapped, stout cast aluminium clamps and clearly marked terminal strips are fitted to all models, write for list.
HOYNE'S Components are Guaranteed for One Year; one type only manufactured, the best, as used by many well-known set manufacturers after testing all others.
HOYNE'S.—“W.W.” transformers wound strictly to specification of author: “W.W.” test reports, June 22nd: “The insulation is particularly good throughout the transformer is satisfactory in all respects.”
HOYNE'S.—Push-pull quality amplifier transformer, 25/-, post 1/3; 7/30 henrys choke, 9/6, post 9d.; 20 henrys, 7/6, post 9d.
HOYNE'S.—Single span, 15/-, post 1/-; choke, 10 henrys, 7/6, post 9d.
HOYNE'S.—Everyman A.C. super transformer, 12/6, post 1/-; choke, 10 henrys, 7/6, post 9d.
HOYNE'S.—A.V.C. Straight Four transformer, 18/-, post 1/3; choke, 26 henrys, 12 m.a., 140 ohms, 9/6, post 9d.
HOYNE'S.—Push-pull quality amplifier, complete to “W.W.” specifications, wired and fully tested, less valves, £5/12/6; complete kit of components including metal chassis, £5/2/6; field replacement choke, 1,250 ohms, 13/6, post 1/-; output transformer, 12/6, post 1/-.
HOYNE'S.—250-0-250v., 60 m.a., 4v. 1 to 2a., 4v. 2 to 4a., 10/-, post 9d.; with extra 4v. 1 to 2a. winding, 12/6, post 1/-.
HOYNE'S.—Ferrocart III, 350-0-350v., 60-70 m.a., 4v. 2 to 3a., 4v. 2 to 4a., 12/6, post 1/-; with extra 4v. 1 to 2a. winding, 13/6, post 1/-.
HOYNE'S.—350-0-350v., 120 m.a., 4v. 2 to 3a., 4v. 4 to 6a., 4v. 1a., 4v. 1a., 18/-, post 1/3.
HOYNE'S.—400 or 450 or 500v., 120 m.a., 4v. 2 to 3a., 4v. 2 to 5a., 4v. 1 to 2a., 18/-, post 1/3.
HOYNE'S.—500-450-0-450-500v., 140 m.a., 4v. 2 to 4a., 4v. 4 to 6a., 4v. 2a., 4v. 2a., 27/6, post 1/3; weight 11lb.
HOYNE'S Transformers, built to specifications, keenest prices, best materials and workmanship; quotation by return.
M. J. HOYNE, ALL-POWER TRANSFORMER, Ltd., Offices and Works, 8a, Gladstone Rd., Wimbledon, S.W.19. Tel.: Liberty 3303. [6488]



Universal VALVES

FOR A.C. / D.C. AND CAR RADIO

Marconi Universal Valves have a 0.3 Amp. 4-Watt heater of humless construction, combining a high slope with exceptional freedom from the modulation hum which is so often troublesome with series-operated filaments. A general performance comparable with that of the best A.C. types is thus obtainable, with maximum outputs up to 3.2 watts.

THE MARCONI UNIVERSAL RANGE

X30	Heptode	20/-
W30	Var.-Mu. H.F. Pen.	17/6
H30	Triode	13/6
DH30	D.-D. Triode	15/6
N30	Pentode	18/6
U30	Rectifier	15/-
301	Barretter	12/6

● A card to The Marconiphone Co. Ltd., Radio House, Tottenham Court Road, W.1. will bring you a copy of the comprehensive new Catalogue of Marconi Valves.

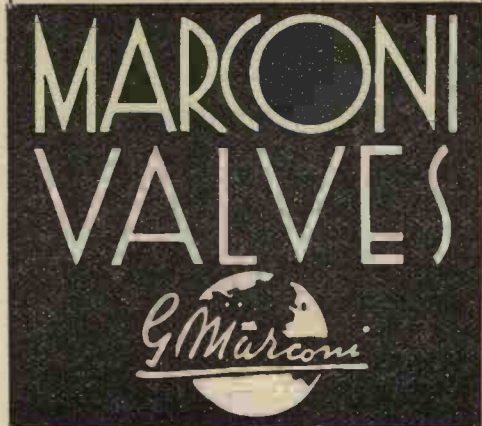

THE CHOICE OF THE EXPERTS

Mains Equipment.—Contd.

BATTERY Chargers, A.C. manufacturers' surplus, 50v. 5 amperes output; £5/10.—Jersey, Cumnor Hill, Oxford. [6666]
PARAMOUNT Mains Transformers, equal to any, and better than most; try them once and you will always use them!
PARAMOUNT Auto Transformers, 100-120v. up to 200-250 volts, or vice versa, 60 watt, 8/6; 120 watt, 10/-; shrouded 2/- extra, post 9d.
PARAMOUNT.—250-0-250v. 60 m.a., 4v. 1 to 2 amp., 4v. 2 to 4a., open type, 9/6; shrouded, 11/6; post 9d.
PARAMOUNT.—350-0-350v. 60 m.a., 4v. 2-5a., 4v. 3 to 5a., 13/-; shrouded, 15/-; post 9d.; 120 m.a., 4v. 5 amp., 4v. 4 amp., 4v. 2-5a., with screened primary, shrouded, 16/-; post 1/-.
PARAMOUNT.—Single span model, with 1½in. x 1½in. core size, 350-0-350v. 100 m.a., 4v. 5a., 4v. 1a., 4v. 2.5a., shrouded, with screened primary, 2½ regulation, 20/-.
PARAMOUNT.—500v. or 450v. or 400v. 120 m.a., 4v. 5a., 4v. 4a., 4v. 2.5a., screened primary, 18/-; shrouded, 21/-, post 1/3; 150 m.a., 4v. 2.5a., 4v. 4a., three 4v. 2a., with 2¼in. x 1½in. core size, shrouded, 28/-, post 1/3.
PARAMOUNT.—Westinghouse transformers, H.T.8, 9 or 10. with 4v. 2a., 4v. 4a., shrouded, 16/-, post 1/-.
PARAMOUNT.—Chokes, 30h. 60 m.a., 5/6; 20h. 120 m.a., 8/6, post 9d.
PARAMOUNT Mains Transformers are Guaranteed for 12 Months.
PARAMOUNT Products are Fitted with Neat Aluminium Frames or Shrouds, all filaments C.T., insulating paper 2½ mils. thick between each layer, and tested thoroughly before leaving our works.
PARAMOUNT Transformers Made to Your Own Specifications; price according to wattage; quotations by return.
PARAMOUNT Guaranteed Electrolytic Condensers, 4+4 mid., 500v. peak, 3/6, post 3d.
PARAMOUNT Mains Transformers, manufactured by R. H. Salter, 66, Hartfield Rd., Wimbledon, S.W.19 (one minute from Wimbledon Station). Tel.: Liberty 3226. [6315]

14/11.—Battery chargers, 1 amp. 2-6v., incorporating Westinghouse L.T.4 rectifier, guaranteed one year, postage 9d., list free.—Arden Agency, Wollaston, Wellingborough. [6750]

LESDEX Chargers, all steel, A.C. and D.C. mains, 2 to 200 cells at low prices; state requirements; dynamos and rotaries in stock, all sizes; battery supersiders for 2-volt input, 80-volt output, 37/6; fractional H.P. and sewing machine motors, 25/-.—Below.
LESDEX Measuring Instruments, 2¼in. bakelite case, flush panel, any reading, A.C. or D.C.; from 6/- each; ask for full range instrument list.—Below.
LESDEX Microphone.—We are makers of 25 types for all uses; Home Radio mikes, solid bakelite body, 5/6; G.P.O. microphones, on stand, with mouthpiece, 7/6; P.A. mikes, 50/-; list free.—Electradix Radios, 218, Upper Thames St., London, E.C.4. [0398]

CABINETS.

MANUFACTURERS' Clearance.
ULTRA "Panther," a modern cabinet, with contrasting figured walnut veneer panel, 20x17x11, 13/6; pedestal type, 35x22x12, 30/-, undrilled; photo sent on request.
SIMILAR Cabinet, 20x18x11, drilled for Polar Arcuate drive, 15/- (with Polar drive 20/-); mains chassis for same, 2/6; transformer, 5/- (Photo).
SET and Speaker Cabinets; 5/- upwards.
RADIOGRAM Cabinet; 37/6 upwards.
SPEAKER Cabinets; 4/6 upwards.
SEND Particulars of Your Requirements (giving size of set, etc.) or call and make your choice from our stocks of over 100 different types; from 3/6 to £4/10.
L. SMITH and Co., Ltd., 287-9, Edgware Rd., H. London, W.2. Tel.: Padd. 5891. [6756]

5/9.—Super moving coil loud-speaker cabinets, octagonal, 18½in. x 6in., baffle hole 7in. diameter; manufacturer's surplus.—Easco, 18, Brixton Rd., London, S.W.9. [044c]

DYNAMOS, ETC.

NELCO Rotary Converter, as new, D.C. 230-250, A.C. 230-250, 100W.; evenings; £4/10.—55, Station Rd., Chadwell Heath, Essex. [6739]
ELECTRO-DYNAMIC Converter and Filter, in sound-proof box, 200v. D.C. 220v. A.C. 90 watt, as new; £6/10.—C., 42, Radcliff Rd., N.21. [6747]

LOUD-SPEAKERS.

U.S.A. Rola Type F.6, 2,500- or 6,500-ohm field, power or pentode output transformer; 17/6.
MAGNAVOX D.C.152 (9in. cone), 22/6; Magnavox 154 (6¼in. cone), 16/3; all with hum-bucking coils, power or pentode transformers, and 2,500- or 6,500-ohm fields; Magnavox P.M.254, 18/-; Magnavox P.M.252, 22/6.
ATTENTION to All Orders Within 24 Hours; carriage paid; cash with order or c.o.d.
WARD, 2nd Floor, 45, Farringdon St., London, E.C.4 Telephone: Holborn 9703. [6404]
HARTLEY TURNER A.C. 8 guinea model, as new, owner buying P.A. model; accept £5; call by appointment.—Sculley, 36, Blythe Vale, Catford, S.E.6. [6795]
MAINS RADIO DEVELOPMENT COMPANY'S Clearance Offer of New Sonochorde Speakers, energised, moving coil, 1934 standard model, pentode output, 2,500, 6,500 ohms; 11/6 each.
MAINS RADIO DEVELOPMENT COMPANY, 4-6, Muswell Hill Rd., London, N.6. Tudor 4046. [6745]
BLUE SPOT Famous 66R 35/- Units, offered at 10/-, in original cartons; Blue Spot chassis for the above, 7/-; cash with order; carriage paid.—M. Zains, 127-9, Lambeth Walk, S.E.11. Reliance 1063. [6765]

Loud-Speakers.—Contd.

- 10/6 Only!!—Brand new manufacturer's surplus moving coil speakers, by one of the best known British makers; energised, 2,500 or 6,500 ohms field, power or pentode transformer, 8in. cone; 10/6 each.
- 12/6 Only!!—As above, but 10in. cone; 12/6 each.
- 15/6 Only!!—Permanent magnet, with power or pentode transformer, 8in. cone; 15/6 each.
- 17/6 Only!!—As above, but with 10in. cone; 17/6 each.

CABINETS for Any of Above, 2/9 each only; secure one of these amazing bargains now; cash with order or c.o.d.—Hulbert, 6, Conduit St., W.1. [6769]

VAUXHALL—Magnavox permanent magnets, universal, suitable for Class "B" power or pentode, 7in. cone 17/6, 10in. cone 23/-; mains energised, 2,500 or 6,500, 10in. cone, 22/-; 7in. cone 15/3; brand new, with hum-bucking coils; state power or pentode transformer.

VAUXHALL—American Rola, type F.6, 2,500 or 6,500, 8in. cone 16/6; large type, 9 1/2in. cone 24/-; complete with hum-bucking coils, power or pentode; permanent magnets for power, super power, pentode, Q.P.P. or Class B, 8in. cone 25/-; large type, 9 1/2in. cone, 33/-; un-used manufacturers' stock; immediate delivery, carriage paid, cash with order or c.o.d.—Vauxhall Utilities, 163a, Strand, W.C.2. Temple Bar 9338 [6682]

NICKEL-ALUMINIUM P.M. Speakers, 27/6!—Reputable manufacturer's cancelled export order; try this wonderfully sensitive new speaker, fitted with newly discovered Alni magnet, which supersedes cobalt, handsomely finished in black and chromium, 8in. cone, universal transformer, sealed and guaranteed; 27/6, genuine bargain, worth at least 45/-; 7 days' approval against cash; also 8in. cobalt P.M.s, 18/6, listed 39/6.—Mountgrove Supplies, 76, Mountgrove Rd., N.5. [6761]

TRANSMITTING APPARATUS.

VALVES, 1,000 volt working, type M.C. 1/60 amplifier, list £8; D.C. 1/60 rectifier, list £3/10; less 50%; guaranteed.—M. Donovan, 167, City Rd., London, E.C.1. [6792]

PREMIER SUPPLY STORES Offers the Following Brand New Gear: Standard cables, transmitting, valves (out of limits), 4211E and 4211D, 15/- each; 4212D, £3; American 866, 20/-; T.C.C. 2 mt., 1,500v., working, 6/-; Standard cables transformers, 1,000-0-1,000v. 250 m.a., 4v. 3a. C.T., 4v. 3a. C.T., 49/6; 2,000-0-2,000v. 150 m.a., 49/6.—Premier Supply Stores, 20, High St., Clapham, S.W.4. Phone: Macaulay 2188. [6623]

VALVES.

4/9—Gecovalve U.X.245 American output valves, un-opened cartons, list 15/-, cash with order, postage paid.—Kay, 167, City Road, London, E.C.1. [6491]

METROPOLITAN RADIO SERVICE Co. for American Valves with a Guarantee; any type at keenest prices; trade supplied.—1021, Finchley Rd., Golders Green, N.W.11. Speedwell, 3000. [0436]

SURPLUS Valves.—All brand new; battery types, 2-volt, H.F.2, L.F.2, L.F.2, 1/9; super power, P.P.2, 2/6; screens and pentodes, 3/9; A.C. mains, 4-volt, 1 amp, general purpose, 3/3; power, 4/-; screens and pentodes, 4/6; full wave rectifiers, 3/6; postage paid cash with order, or c.o.d. over 10/-.—Clarion Radio Valve Co., 895, Tyburn Rd., Erdington, Birmingham. [6339]

PREMIER SUPPLY STORES Announce the Purchase of the Complete Stock of a World Famous Continental valve manufacturer all the following standard main types fully guaranteed, 4/6 each; H, H.L., L, power, medium, high, low mag. and variable mu screen grids, one, three and four watt A.C. output, directly heated pentodes, 250v. 60 m.a. full wave rectifiers, D.C. types, 20v. 18 amp., filaments, screen grid H, H.L. power.

THE Following Types, 5/6 each: 350v. 120 m.a., full wave rectifier, 500v. 120 m.a., full wave rectifier, 2 1/2 watt indirectly heated pentode.

THE Following American Types, 4/6: 250, 112, 171, 210, 245, 226, 47, 46, 24, 35, 51, 57, 58, 55, 37, 80.

THE Following Sizes, 6/6 each: 42, 77, 78, 2525, 36, 38, 83, 39, 44, 53, 6A7, 6B7, 2A5, 2A6, 2A7, 2B7, 5Z3, 6C6, 6A4, 6D6, 6F7; the following valve: 866, 25/-.

PREMIER SUPPLY STORES, 20 and 22, High St., Clapham, S.W.4. [6622]

ALL Types of Brand New American Valves in Stock, only first-class makes such as Arcatrus and R.C.A. stocked, guaranteed for 6 months, 247, 235, 551, 89, 18, 19, 46, 59, 6A7, 15, 42, 41, 38, 39, 78, 75, 57, 58, 224, 44, 36, 235, 83, 43, 5Z3, 12/-; 2525, 1223, 14/6; UX171, UX199, UX280, UX245, UX226, UX227, 7/6; UX250, UX210, UX281, 17/6; UX 867 photocells, 25/-; all other types of American valves in stock; we also stock transmitting valves, post paid, cash with order or c.o.d.

WARD, 45, Farringdon St., London, E.C.4. Telephone: Holborn 9703. [6517]

COMPONENTS, ETC., FOR SALE.

PREMIER SUPPLY STORES ANNOUNCE a City Branch at 165 and 165a, Fleet St., E.C. (next door to Anderson's Hotel), for the convenience of callers; post orders and callers to High St., Clapham.

OFFER the Following Manufacturers' Surplus New Goods at a Fraction of the Original Cost; all goods guaranteed perfect; carriage paid over 5/-, under 5/- postage 6d. extra. I.F.S. and abroad, carriage extra. Orders under 5/- cannot be sent c.o.d. Please send for illustrated catalogue post free.

STUPENDOUS Purchase of Set Manufacturers' Stock.—All electric 3-valve (S.G. det. pen.) set, in walnut cabinet, with moving coil speaker, 200-250 volt 40-60 cycles, chassis built, 200-2,000 metres, with 4 valves; £4/10/6.

ALL-ELECTRIC 3-stage Amplifiers, 200-250v., 40-60 cycles, 10 watts undistorted output, complete with 5 valves, and Magnavox Super 66 energised speaker; £10/10.

TYPE 4480, 9in. diameter, permanent magnet, handles 4 watts, 7 ohms speech coil, 13/6; multi ratio transformer, 4/6 extra.

(This advertisement continued in third column.)

We "roll our own"

Last week we said something about truth in advertising.

In the beginning, we produced the Hartley-Turner loud speaker. It was offered as an improvement over all others. Our customers said it was. We produced Hartley-Turner sets to drive the speakers. Our customers said they were easily the best when it came to considering quality of reproduction.

When, after years of careful thought, we had turned out really satisfying apparatus, honestly designed to distort as little as possible, when we could supply a reproducer, which would bring real pleasure to the music lover, we turned to the professional copywriter to make known our wares. We tried six, and then we got fed up, so we write our own copy.

We object to HARTLEY-TURNER apparatus being described as "perfect" and "marvellous." It is neither, yet it is extremely good. We object to our name being associated with the rapid outpourings of "publicity experts." Our sets and speakers are food enough to advertise themselves. All we are doing is drawing your attention to them. When you have heard them your own opinions will be formed.

That is why our progress is rapid but secure.

Free illustrated literature available on request.

Hartley Turner Radio Ltd.

THORNBURY ROAD, ISLEWORTH, MIDDLESEX. Telephone: HOUnslow 1854.



for the STANDARD A.C. THREE

MAINS TRANSFORMER Model W.W.35

350-0-350v. 60 m.a., 2-0-2 v. 2.5 A. 2-0-2 v. 4.0 A. Completely enclosed in steel shroud and fitted with easy voltage change connector. Price 30/-

METALLISED RESISTANCES 1 Watt Type

Kit of 10 specified resistances. Colour coded and separately boxed. Price 7/6

PEAK CONDENSERS

LIKE ALL BRYCE PRODUCTS ARE GUARANTEED WITHOUT RESERVATION

Other components required for this receiver can also be supplied exactly to specification.

Send for our detailed catalogue.

FREE ON REQUEST.

TO SET MANUFACTURERS

We shall be glad to send quotations for Mains Transformers, Chokes, Resistances and Condensers by return of post upon receipt of your enquiry.

Quality is our first consideration.

W. ANDREW BRYCE & CO.,

LONDON: 3/4, Ashland Place, W.1.

'Phone: Welbeck 1521

BURY: Woodfield Works.

'Phone: Bury 1251

EXPORT: W. R. Everett, 63, Queen Victoria Street, London, E.C.4.

'Phone: City 6633

Components, Etc., for Sale.—Contd.

(This advertisement continued from first column.)

ELIMINATOR Kits, including transformer, choke, Westinghouse metal rectifier, condensers, resistances, and diagram, 120v 20 m.a., 20/-; trickle charger, 8/- extra; 150v. 30 milliamps, with 4v. 2-4 amps C.T., L.T., 28/-; trickle charger, 6/6 extra; 200v. 60 milliamps, with 4v. 3-5 amps. C.T., L.T., 30/-; 300v. 60 m.a., with 4 volts 3-5 amps, 37/6; 200v. 50 m.a., with 4v. 3-5 amps. L.T., 27/6.

PREMIER Chokes, 40 milliamps, 25 hys., 4/-; 65 milliamps, 30 hys., 5/6; 150 milliamps, 30 hys., 10/6; 60 milliamps 80 hys., 2,500 ohms, 5/6; 25 milliamps, 20 hys., 2/9.

ALL Premier Guaranteed Mains Transformers Have Engraved Terminal Strips, with terminal connections, input 200-250v., 40-100 cycles, all windings paper interleaved.

PREMIER H.T.7 Transformer, output 135v. 80 m.a., for voltage doubling, 8/6; 4v. 3-4a., C.T. L.T., 2/- extra; with Westinghouse rectifier, giving 200v. 30 m.a., 17/6.

PREMIER H.T.8 and 9 Transformers, 250v. 60 m.a. and 300v. 60 m.a. rectified, with 4v. 3-5a. and 4v. 1-2a., C.T. L.T. and screened primary, 10/-; with Westinghouse rectifier, 18/6.

PREMIER H.T.10 Transformer, 200v. 100 m.a., rectified, with 4v. 3-5a. and 4v. 1-2a. C.T. L.T., and screened primary, 10/-; with Westinghouse rectifier, 19/6.

PREMIER Mains Transformer, output 250-0-250v. 60 m.a., 4v. 3-5a., 4v. 2-3a., 4v. 1-2a. (all C.T.), with screened primary; 10/-.

PREMIER Mains Transformers, output 350-0-350v. 90 m.a., 4v. 3-5a., 4v. 2-3a., 4v. 1-2a. (all C.T.), with screened primary; 10/-.

PREMIER Auto Transformers, 100-110/200-250v., or vice versa, 100-watt; 10/-.

WESTERN ELECTRIC Mains Transformers, 300-0-300v. 65 m.a., 4v. 1-2a., 4v. 2-3a., 6/6; 500-0-500v. 150 m.a., 4v. 3-5a., 4v. 2-3a., 4v. 2-3a., 4v. 1a. C.T., 4v. 1a. C.T., 18/6.

SPECIAL Offer of Mains Transformers, manufactured by Philips, input 100-200v. or 200-250v., output 180-0-180 volts, 40 m.a., 4v. 1 amp., 4v. 3 amps., 4/6; 200-0-200v., 4v. 1a., 4v. 3a., 4/6.

PREMIER L.T. Charge Kits, consisting of Premier transformer and Westinghouse rectifier, input 200-250v. A.C. output 8v. 1/2 amp., 14/6; 8v. 1 amp., 17/6; 6v. 2 amp., 27/6; 30v. 1 amp., 37/6; 2v. 1/2 amp., 11/-.

B.T.H. Trusped Induction Type (A.C. only) Electric Gramophone Motors, 100-250v.; 30/- complete.

SPECIAL Offer B.T.H. Gramophone Motors, A.C. and D.C. 100-250v.; 30/-; listed £3/3.

COLLAR Gram. Unit consisting of A.C. motor, 200-250v. high quality pick-up and volume control, 49/-; without volume control, 46/-.

EDISON BELL Double Spring Gramophone Motors, complete with turntable and all fittings, a really sound job; 15/-.

SPECIAL Offer of Wire Wound Resistances, 4 watts, any value up to 50,000 ohms, 1/-; 8 watts, any value up to 15,000 ohms, 1/6; 15 watts, any value up to 50,000 ohms, 2/-; 25 watts, any value up to 50,000 ohms, 2/6.

CENTRALAB Potentiometers, 400 ohms, 1/-; 50,000, 100,000, 1/2 meg., any value 2/-; 200 ohms, wire wound, 1/-.

POLAR STAR, manufacturers' model, 3-gang condensers, fully screened; 7/6, with trimmers; unscreened, 5/6.

AMERICAN Triple Gang 0.0005 Condensers, with trimmers, 4/11; Utility bakelite 2-gang, 0.0005, screened, with unknob trimmer, 3/8; Polar bakelite condensers, 0.00035, 0.0003, 0.0005, 1/-.

ORMOND Condensers, 0.0005 2-gang semi-shielded, 2/6; brass vanes with trimmers, 3/6; British Radiophone 110 kc/s intermediate, 3/-.

MAGNAVOX D.C. 152, 2,500 ohms, 17/6; D.C. 144, 2,500 ohms, 12/6; D.C. 152 magna, 2,500 ohms, 37/6, all complete with hum-bucking coils; please state whether power or pentode required; A.C. conversion kit for above types, 10/-; Magnavox P.M., 7in. cone, 16/6.

RELIABLE Canned Coils with Circuit, accurately matched, dual range, iron cored; 3/6.

RELIABLE Intervalve Transformers, 2/-; multi-ratio output transformers, 4/6.

T.C.C. Electrolytic Condensers, 550v. working, 650v. peak, 8 ml., 4/-; 4 ml., 8 ml., 440v. working, 3/-; 15 ml. 50v. working, 1/-; 25v. working, 25 ml., 1/3; 6 ml. 50v. and 2ml. 100v. working, 6d.; 8+4 ml., 450v. working, 4/-; 50 ml. 50v. working 2/9; 2,000 ml., 12v., 7/6.

T.C.C. Condensers, 250v. working 1 mf. 1/3, 2 mf. 1/9, 4 mf. 3/-; 4 ml., 450v. working, 4/-; 4 ml., 750v. working, 6/-.

DUBILIER Condensers, 8 or 4 mf., dry electrolytic, 450v. working; 3/-; 4+4+2+0.1 350v. working, 3/-.

VARLEY Constant Square Peak Coils, band-pass type B.P.7, brand new, in maker's cartons, with instructions and diagrams; 2/4.

VARLEY H.F. Intervalve Coils, B.P.8, band-pass, complete with instructions, in original cartons; 2/6.

SCREENED H.F. Chokes, by one of the largest manufacturers in the country; 1/6.

PREMIER British-made Meters, moving iron, flush mounting, accurate, 0-10, 0-15 50 m.a., 0-100, 0-250 m.a., 0-1, 0-5 amps; all at 6/-.

WESTERN Electric Condensers, 250v. working 1 mf., 6d.; 2 mf., 1/-; 4 mf., 2/-; 400v. working, 1 mf., 1/-; 2 mf., 1/6.

WIRE-WOUND Potentiometers, 1,000, 2,500, 15,000, 20,000, 50,000, 90,000, 120,000, 200,000, 500,000, 2/- each; 1,000 ohm, semi-variable, carry 150 m.a., 2/-.

COSMOCORD Pick-ups, complete with arm and volume control, a really good job; 12/-.

LARGE Selection of Pedestal, table and radiogram cabinets, by best manufacturers at a fraction of original cost, for callers.

THE Following Lines 6d. each, or 5/- per dozen.—Chassis valve holders 5-, 6- or 7-pin, screened screen-grid leads, any value 1-watt wire resistances, wire end condensers 0.0001 to 0.1, Bulgin 3-amp main switches, Cydon capacitors, double trimmers.

SUPER Moving Coil Speakers, handle 10 watts, energised directly from A.C. mains, manufactured by world famous radio and gramophone company; 40/-.

CONDENSER Blocks, 350v. working, 6+4+2+1+1. 4/6; 4+2+1+1+1+0.5. 3/9; 9+3+2, 3/-.

PREMIER SUPPLY STORES, 20-22, High St., Clapham, S.W.4. Phone: Macaulay 2188. Nearest station: Clapham North, Underground. [6681]

Components, Etc., for Sale.—Contd.

R.
RYALL'S RADIO, 44, Lamb's Conduit St., London, W.C.1. Callers note: we are just off Theobald's Rd., best approach from Holborn through Red Lion St.; Holborn 3529. Hours 11 to 7 p.m. Saturdays 5 p.m. Thursdays 1 o'clock.
FERRANTI Transformers, A.F.6, 15/6; A.F.7, 16/6; A.F.5, 16/6; O.P.M.1, 10/-; O.P.M.5c, 15/6; O.P.M.6, 10/-; O.P.4c, 25-1 P.P., 7/6; O.P.c, 2-1 P.P., 5/9; O.P.M.12c, 7/6; O.P.M.16c, 15/6; A.F.11c, 15/6; A.F.15c, 15/6.
VARLEY Constant Inductance Choke, 10/-; R.I. parallel unit, second-hand, 6/9; R.I. 14/28H chokes, 10/-; H.T.7, new with second-hand R.I. transformer, with 4v. 6 amps., 17/6; Heayberd transformer, W31, with H.T.8, new, 30/-; Varley Pentode Nichokes, new, 7/6; Colvern 10/14/8, 20/-.
MULTITONE 4-1 Toco Transformer, with graded pot, 14/-; Challis 500v. transformer, with several 4v. secondaries, 20/-; Gambrell Novotone, type H, 30/-; Ferranti B8 chokes, 5/-; R.I. 300H choke, 7/6, second-hand.
PAIR Magnacore, new, Class B Universal driver and output transformers, new, 5/9; latest type Hypermu, 10/-; Marconi 250 m.a. output transformer, 8-1, with line winding, 15/-; R.I. second-hand output transformer, 17/52-1, 250 m.a., 12/6; Colvern 1/2/8, 20/-.
GARRARD Automatic Record Changer, A.C., £5/15; Colpack V straight, 35/-; Radiophone B.P. and H.P. straight, 35/-; Heayberd D250 eliminator, for 200-250v., output 250v. 60 m.a. 3 var. taps., etc., 65/-; 4 Colvern intermediates, air, 6/- each; Rothermel P.M. speaker, 17/6.
WESTON 425 Type Thermo Ammeter, guaranteed 0-1.5a. R.F., £2; Ferranti Radio wattmeter, 0-50v. A.C. 2/10/50v., £5; Weston 301 type, 0-15 amps., 15/-; Weston 0-500 m.a., Bakelite case, 20/-; Weston pin jack, D7R, 6-200v., 20/-; Hunts' flush 0-20 m.a., 15/-; Hunts' 0-200 m.a., 15/-; Weston centre zero, Bakelite case, 0-100 m.a., 20/-; Siam 0-300 m.a., 15/-; Turner flush 0-100 m.a., with cut-out, 2 1/2 in. type, 15/-.
VARLEY 500,000 ohm Wire Wound Resistances, 9d.; Belling Lee Unit pickup, new, 17/6; Lewcos S.W. intermediates, 4/-; pairs new Polar thumb drive 0.0005 condensers, with double escutcheon plate, 7/6 pair to clear; Garrard Junior B D./S. motor, with unit plate, etc., new, 15/-.
REGENTONE S.60 Unit, 200v. 30 m.a., 4v. 6a. A.C., 25/-; New Ekco K.25 eliminators, 150v. 20 m.a. with 1/2 amp. trickle charger, 45/-; Sonochorde 2,500 ohm speakers, with tapped transformer, 13/6; Met-Vick 250v. transformers, 4v. 2a., 4v. 5a. input, 200-250v., with terminals, and humdimmer for L.T., 15/-, new.
DECONTROLLED Sets: Columbia 4v. battery, S.G. det., Q.P.P. output, Exide and Marconi batteries, complete, £6/5; McMichael Twin Supervox receivers for A.C. mains, 2 H.F. with twin speakers, £10; Ultra Panther superhet, 6v. and rectifier, £10/10; Lotus D.C. 2 sets, £4/10, all new, complete, etc.
HEAYBERD Transformers, new, with leading-out wires, 350v., 120 m.a., 4v. 4a., 4v. 5a., 4v. 2 1/2 a., 25/-; Heayberd 500v. 120 m.a., 4v. 4a., 4v. 6a., 4v. 2 1/2 a., 32/6; both screened primary and input 200-250v.; carriage forward.
RYALL'S RADIO Offer Reliable Resistances, suitable for all sets where a 1-watt resistance is specified, in values 100, 150, 250, 400, 500, 600, 1,000, 2,000, 5,000, 10,000, 15,000, 20,000, 25,000, 30,000, 40,000, 50,000, 75,000, 100,000, 150,000, 250,000, 1/2 meg., 1 meg., 2 meg., all values stated in ohms, 4d. each; also 2-3-watt type, 400, 700, 800, 1,000, 4,000, 5,000, 6,000, 10,000, 20,000, 9d. each wire ends.
RADIOPHONE Volume Controls with Switch, 5,000, 10,000, 15,000, 20,000, 100,000, 2/6; also 10,000 graded 9-1 with 3-P switch, 25,000 graded 9-1 with 2-P switch, 3/6.
WIRE, new Knifetown, etc., 1/2 reels, 16S.W.G. En., 8d.; 1/4lb. 18S.W.G. C.C., 8d.; 1/4lb. 26S.W.G. En., 9d.; 1/4lb. 32S.W.G. C.C., 1/-; 1/4lb. 28S.W.G. En., 8d.; 2oz. 30 and 32 C.C., 6d. each.
NEW Garrard No. 11B D/S Motors, 12in. turntable and fully automatic unit plate, all fittings included; less than half price, 20/-.
POLAR Minor 3-gang Condensers, with "Arcuate," "Horizontal" or "Semi Circular" drive, new, list 24/6, 14/6.
RYALL'S RADIO Offer British-made Mansbridge Condensers, metal cased, brand new, fully guaranteed, 1 mf., 400 vw., 1/3; 2 mf., 400 vw., 1/6; 4 mf., 400 vw., 3/-; 1 mf., 750 vw., 6/-.
READY RADIO 0.0005 Extensor Condensers, new, 2/6.
Yagerphone S.G./Det./Pen. and rectifier chassis, with valves, complete, 65/-.
WEGO, British, condenser blocks, containing 4x4 at 350 vw., also 1x1x1x0.1x0.1x0.1 at 250 vw., new, 5/-; Wearite H.F. screened chokes, 2/-; T.C.C. dry electrolytic, 8x4, 400 vw., 2/9; T.C.C. wet type, 8 mf., 3/-.
T.C.C. 0-1 Non-inductive Tubular Condensers, 10d. each, 350v.; T.C.C. electrolytic 15 mid., 50 v., 1/4, new; T.C.C. 0.01 mica, type M, 1/-; T.C.C. 0.0001, type M, 5d.; H.M.V. condenser blocks, 250v. working, 4x4x1x1 1/2 mid., 3/-; T.C.C. 0.1x0.1, 450v. working, 1/6; T.C.C. 8 mid., electrolytic, 500v. working, 3/9; Dubilier 2 mid., 250v. working, 1/6.
UNIKNOBS, Polar 2-gang, new, brown, 8/-, with cover, 9/-; R. and A. type output transformers, 18-23-32-1, new, 5/-; Paxolin formers, with guides, 1in., 8d.; R.I. Hypermite transformers, 5/-, second-hand; R.I. Parafed transformers, 5/-, second-hand.
RADIOPHONE Disc Drives, less escutcheon, fit 1/2 in. spindle, read 0-100 from left to right; 1/6, post free.
R. [6782]

SCOTT'S Guaranteed Components.

SCOTT'S Resistances.—Dubilier, 1-watt 6d., 2-watt 1/-, 3-watt 1/6.
SCOTT'S Condensers.—T.C.C., Dubilier, 4 mid., 8 mid. 500 volt, 50 mid. 50 volt, 200 mid. 10 volt, 50 mid. 12 volt; 3/6.
SCOTT'S Pick-ups.—Cosmocord, 13/-; Marconi K.25, 21/-; Rothermel Piezo electric, 32/-.
SCOTT'S Gramophone Units.—Garrard automatic changer, £7; with Piezo electric pick-up, £7/15; Garrard type B Radio-Gram unit, 46/-; Collara type 32, with auto. stop, 34/-; Cosmocord model 55 gramo. chassis, with pick-up, volume control and auto. stop, 36/-.
SCOTT'S Rectifiers.—Westinghouse H.T.8, 9/6; H.T. 9 and 10, 10/-; L.T.4 and 5, 10/9; W.4, W.6, W.X6, 4/-; W.M.24, W.M.26, 6/6.
SCOTT'S Speakers.—Magnavox, Rola, Rothermel, W.B.
SEND for Scott's Radio Price List.—Scott's Radio, 67, Harlesden Gardens, N.W.10. [6784]

SMOOTH, STEADY H.T.



essential for SHORT WAVE reception

Only with a steady source of H.T. can you hope successfully to receive the minute and critical short wave signals. Ever Ready Batteries will assure it for you. The freedom from hum and crackle and the smooth control of reaction that is so essential in short wave reception can be yours by relying on these world-trusted batteries.

THE EVER READY CO.

(Gt. Britain) LTD.

Hercules Place, Holloway, London, N.7.



WIRELESS BATTERIES

Components, Etc., for Sale.—Contd.

MILDMAY RADIO EXCHANGE.
MILDMAY RADIO EXCHANGE Offers the Following: Sound and Perfect, cash with order or c.o.d.
G.E.C. "M.C.3" 3 Valve Battery Operated Receivers, complete with moving coil speaker and valves in solid self-contained walnut cabinets, splendid results and good tone, limited number only; offer at the very low price of 57/6 each.
REGENTONE A.C. Mains Units, type W5A, brand new, in sealed boxes, output 150 volts 20 m/amps., having 4 tappings, 2 variable; also trickle charger for 2, 4, or 6 volt accumulators, listed at £4/12/6; our best price, 39/-.
COLLARO Type 32 Combined A.C. Mains Gramophone Motors with Pickup and Volume Control, fitted with fully automatic stop and start plate; 50/- each; listed at £4.
FERRANTI A.F.4, 7/6; A.F.3, 10/6; A.F.5, 18/-; A.F.6, 18/-; A.F.7, 18/6; A.F.7c, 20/-; A.F.5c, 20/-; O.P.1, 1-1 ratio, 7/6; O.P.2, 25-1 ratio, 7/6; O.P.3s, 1-1 ratio P.P., 8/6; O.P.4c, 25-1 ratio P.P., 8/6; O.P.M.1, 10/-; O.P.M.2, 10/-; O.P.M.3c, 12/6; O.P.M.4, 12/-; B.5 choke, 15/-.
WEARITE and Lewcos Superhet Coils, 4/- each; British General tuner, 5/-; British General and pass coils, 4/- each; Wearite I.F. transformers, 5/- each, 110 kc.; Ferrocart F.10, F.11, F.12, F.13, 3c/-.
SPECIAL Clearance Offer Telsen 40 Henry L.F. Chokes, brand new and in sealed boxes, 1/6 each; offer invited to clear stocks approximately 400.
PAIR T.C.C. Condensers, working voltage 1,500, 4 M.F., 22/6 pair; Hypercore L.F. chokes, 8/6 each; R.I. general purpose chokes, 5/- each, second-hand.
R.I. Pentonite L.F. Chokes, 6/6 each, second-hand; Ferranti B.3 chokes, 5/6 each; Lissen I.F. transformers, 126 kc, 5/6 each; set Telsen 350 superhet coils, 10/-; Wearite B.P.1, B.P.2, T.G., 16/- set; Colvern K.M.S.1, K.M.S.2, K.M.S.3, 12/- the set.
SPECIAL Offer Ferranti B.L.F. Chokes, inductance 10-35 Henries, resistance 850 ohms, current 50 m/amps., offer at the very low price of 4/- each.
LISSEN 7 Valve Skyscraper Superhet Receivers, complete with valves, and fitted with moving coil speaker, class "B" output, in solid walnut cabinets; £6 each.
B.T.H. Nickel Type Pickup with Tone Arm, 15/-; Marconi type K.25 pickups, 24/- each; Avomiron meter, 26/-; Epoch 99 type P.M. moving coil speaker, 27/6; Epoch 11 inch type P.M. moving coil speaker, 27/6.
GAMBRELL Senior Type Black Case Novotone, 25/-; Igranic Radiopak band pass with H.F., 37/6; Radiophone 3-gang superhet condensers with trimmers, 10/-.
SPECIAL Clearance Offer of B.T.H. "Panatone" Output, complete with senior type moving coil speaker, B.T.H. Universal gramophone motor, chokes and all smoothing gear, in solid walnut cabinet; £4; cabinet alone worth this (carriage forward).
ALL the Above Post or Carriage Paid.
PHONE: Terminus 6751.
MILDMAY RADIO EXCHANGE, 6, Pentonville Road, near Angel, London, N.1 (2 mins. from King's Cross and Euston). [6794]

SOUTHERN RADIOS Wireless Bargains.
RECEIVERS.—G.E.C. Osram 4-valve (actual) sets, complete with 4 Osram valves, permanent magnet moving coil speaker, magnificent pedestal cabinet, ready to use on all voltages A.C., all Osram proprietary components in original sealed cartons; £6/15 (list £15/15); an exceptional bargain.
CROMWELL 3-valve Battery Sets, complete with three Cosor valves, permanent magnet moving coil speaker in magnificent walnut console cabinet, brand new, in original sealed cartons, £3/12/6 (list £8); same model as above for Class B, £3/17/6.
BOTOLPH Lightweight Portables, complete with 5 valves, Exide batteries and accumulators; £2/19/6 (list £8/8); a real suitcase portable.
KITS.—A few left only of the original Scott-Taggart S.T.400 kits, complete with all specified proprietary components, in sealed cartons; £2/19/6 (list £4/17/6).
COILS.—Igranic superhet, set of four (1 Osc., 2 I.F. with pigtails, 1 L.F. plain), 12/6 (list 50/-); Lissen superhet, 3-coil kit, screened, ganged on base with switch, type L.N.5181, 9/6; same description for band pass or any straight circuit, type L.N.5162, 7/-; Varley constant square peak coils, B.P.5, complete with all accessories in sealed cartons, 2/3; Lewcos B.P.F./R., B.F., O.S.C./126 (extensor) T.O.S./R., all at 3/6 each; a full range of Edison Bell plug-in coils, 2-pin, at 9d. each.
PICK-UPS.—Marconi model K.25 (1935 issue), 22/6 (list 32/6); six only Rothermel Piezo electric pickups, 35/-; four only B.T.H. Senior pick-ups, 32/6.
CONDENSERS.—Lotus 3-gang, 12/6; 2-gang, 8/6; single dyblock, 4/6; all capacities 0.0005, fully screened with trimmers, complete with dials, knobs and escutcheons; special bargain line, Plessey 4-gang condensers, superhet type, fully screened with trimmers (less dials) and standard dial will fit, 10/6 (list 45/-); Dubilier block condensers 4 mid. (2x1x1) 1,000v., 2/9; 4.5 mid. (2.25x2.25), 3/-; T.C.C. (0.1x0.01), 1/3 each.
SPEAKERS.—Rothermel permanent magnet moving coil, universal transformer, 16/- (7in cone); Blue Spot permanent magnet speakers, universal transformer for power, super power, pentode and class B, 23/-; Blue Spot 66R units, brand new and boxed, 10/6 (list 35/-); complete, mounted on Blue Spot chassis, 16/6 (list 45/-).
MISCELLANEOUS.—Westinghouse metal rectifiers, H.T.6, 7, 8, 9/3; Morse tapping keys with flash signal and buzzer, complete with battery and bulb, 2/-; Lissen general purpose output chokes, 20-28 henries, 18-60 m.a., L.N. 5301, 6/- each; Lewcos superhet dual wave frame aerials, 9/-; thousands of other bargains; callers are assured of a tremendous saving in all branches of wireless needs by visiting any of our shops; all 1935 receivers can be supplied on the most favourable hire purchase terms.
ALL Goods Guaranteed and Sent Post Paid.
BRANCHES at 46, Lisle St., W.C.2; 16, Leicester St., W.; 271-275, High Rd., Willesden Green, N.W.10; all mail orders to 323, Euston Rd., N.W.1.
SOUTHERN RADIO, 323, Euston Rd., London, N.W.1 (near Warren St. tube). Phone: Museum 6324. [6781]

Components, Etc., for Sale.—Contd.

MAINS RADIO DEVELOPMENT COMPANY. M.R.D. Co. Offer Startling Bargains. Carriage paid or call. Tudor 4046. Keenly priced bargain list available. LIMIT Reliance Pick-ups, head and arm, superb reproduction and tasteful design, list 25/-; 10/6, as new. DUBILIER Electrolytics, 200 mid., 10v., 3/6; Mershon 8 mid. electrolytics, 500v. working, 2/6. ELECTRAD Midget Potentiometers, 100,000 ohms, 500,000 ohms, 9d.; Ready Radio, 50,000 ohms, 1/3. CYLON Capacitors, list 1/9, 6d.; toggles, 6d.; Godwinex 5-pin baseboard bakelite V-holders, 4 1/2d. T.C.C. 1 mid. Condensers, 250v. working, less fixing, 7d.; Polymet, 0.001 mid., 2d. KOLSTER-BRANDES High Inductance H.F. Chokes, 6d.; New chassis valve holders, 4-pin 1 1/2d., 5-pin 2d., 7-pin 5d. TUBULAR Condensers, new, wire ends, 800v. test, 0.01, 0.02, 0.05, 0.1 mid., 6d.; 0.25, 0.5 mid., 8d. FRANKLIN 1-watt Resistances, colour coded, wire wound, very accurate, 4d. each, 3/6 per dozen; your choice, 100 to 100,000 ohms.

MAINS RADIO DEVELOPMENT COMPANY, 4-6, Muswell Hill Rd., London, N.6. [6746]

PEARL and PEARL Bargain List A Free.—190, Bishopsgate, London, E.C.2. [0421]

1/6.—Cadmium plated chassis, 4-valve, pressed steel, 14x9; post 6d. 12/6.—Conversion transformer, 20/300 A.C. input, 220v. output, 120 watt; Everett and Edgecumbe A.C. voltmeter, 0/250, with resistance block, 12/6; G.E.C. ironclad switch and fuses, 2/6; complete outfit in metal case, 25/-. 20/—A.C. supply unit for P.A. loud-speaker, 400v., 100 m.a., suitable for amplifier mains unit. 27/6.—Ediswan D.C. all-electric S.G., detector and Pentode, complete minus valves, breaks up to 50/- worth of parts or converts to A.C.; c.o.d., carriage forward.—Kxy, 167, City Rd., London, E.C.1. [6726]

WARD for Unparalleled Bargains in Set Manufacturers' Surplus; all goods are guaranteed perfect; immediate delivery.

OLYMPIC S.S. Six Coils, complete to specification, 45/-; A.C. and D.C. eliminators, first class make, tappings S.G., detector and power (150v., 25 m.a.); A.C. type, with Westinghouse rectification, 25/-. D.C. type 12/-. DUBILIER Resistances, 1-watt type 7d., 2-watt type 1/2, 3-watt type 1/9, Dubilier or T.C.C. dry electrolytic condensers, 8 mids or 4 mids., 500v. peak, 50v., 50 mids. or 200 mids. 10v. peak, 3/6. MARCONI K19 or K25 Pick-ups, 21/-; Rothermel piezo electric, 30/-; Cosmocord, 12/-; B.T.H. needle armature pick-ups, 29/-; B.T.H. pick-up tone arms, 3/-; Clix chassis type valve holders, 5-pin 5d., 7- or 9-pin 6d.; T.C.C. type "M" fixed condensers, any size up to 0.001 mids., 6d. WESTINGHOUSE Rectifiers, H.T.8 9/6, H.T.9 10/-, H.T.10, L.T.4, L.T.5, 10/9; transformers (Regentone) for H.T.8 or H.T.9, with 4v. 4a. L.T., 7/-. CARRIAGE Paid, cash with order or c.o.d.; send for list. WARD, 45, Farringdon St., London, E.C.4. Tel.: Holborn 9703. [6516]

UTILITY SALES, 57, Praed St., Paddington, W.2, offer following special bargains: write for catalogue. ROTHERMEL 1934-35 Full Sized P.M. M.C., 35/- list, 17/6; Sonochord mains energised, 12/-. TRANSFORMER, Standard Cable, 200/240, 300-0-300, 60 m.a., 4v. 3a. C.T., 4v. 2a.; 8/6, worth 21/-. IGRANIC Band-pass Iron Core Coils, screened, dual wavelength (33/- list); 14/6, snip. IRON CORE Screened Matched Coils, 3 circuits, 2/6; Lucerne, 2/6, plain, 2/-. MICROPHONES, Western Electric, hanging 2/6, hand 3/6, transformer 3/6; table model, containing transformer, 8/6, handsome job; diagrams free; buttons, tested, 1/-. ELECTRIC Soldering Iron, 4/6; De Luxe model, reversible bit, engineer's type, 7/6. ELECTRIC Wonder Battery Clock, mahogany bakelite, battery lasting year, guaranteed; 15/-. UTILITY SALES, 57, Praed St., Paddington, W.2. [6783]

TELE-RADIO Have Purchased Manufacturer's Surplus; same are being sold at ridiculous prices.

WESTINGHOUSE Rectifiers, H.T.7, H.T.8, 9/3; H.T.9, 9/6; H.T.10, 10/9; L.T.2, 9/3; L.T.4, 11/3; L.T.5, 11/9; transformers for same from 7/11. DUBILIER Resistances, 1-watt wire ends, all sizes in stock from 100 ohms to 2 megs; 7d. A.C. Eliminators, input 200-250v., 150v. 25 m.a., finished in neat crystalline case, 3 positive tappings, Westinghouse rectified, fully guaranteed, 19/11, 1/- postage; D.C. 150v. 25 m.a., 10/11, 1/- postage. WE Have a Large Stock of Microphones and Meters by Weston, Ferranti, Turner; also input and output transformers; send us your requirements and send for our full lists; "we are cheaper." ALL Goods Sent Carriage Paid (except when marked), c.o.d., or cash with order; prompt delivery; part exchange arranged. TELE-RADIO SUPPLIES, 305, King's Rd., S.W.3. Flaxman 9710. [6777]

TELEPHONES, magneto ringing, wall or table, 17/6; pedestal, 7/6; microphones, 4/-; transformers, 2/6.—Below.

BROWNS' Adjustable Read Watch Receivers, 2/6; bridge condensers, high voltage, nine capacities, total over 3 mid., with switches, 15/—Below.

AEROPLANE Speed Meters, make splendid barometers, new, 3/6; new mine exploders, hand plunger type, 15/—Below.

METERS, all sin. dial, 0-3a., 7/6; 0-20a., 12/8; 0-500v., 15/-; small panel, hot wire, 0-500m.a., 4/-; moving coil movements, large, 4/6.—Below.

DYNAMOS for Charging, etc., 50v.-4a., 37/6; 100v.-10a., £3/15; 75v.-15a., £4/10; 30v.-15a., £3; 20v.-6a., 32/6; 2,000v.-500m.a., separate field excitation, £3/10.—Below.

SPARK Coils, 17in., 50/-; mercury break with motor to suit, £3; two inch coil, complete, 17/6; large fluorescent screen, 50/-.—Below.

ALPIN, 75, High Rd., Les, London, S.E.13. Cash with order or c.o.d. [6762]

EASY TERMS

Buy your Radio Apparatus on convenient terms from the Service House which guarantees the efficiency of everything supplied. Illustrated leaflets giving full particulars free upon request.

New Ferranti M1+ P.M. Speaker Unit. Cash or C.O.D. - £7 0 0 or 11/- with order & 11 monthly payments of 12/8.

New Rothermel - Brush Piezo - Electric Pick-up. Cash or C.O.D. - £2 2 0 or 5/6 with order & 8 monthly payments of 5/-.

New Rotameter de Luxe Test Meter. 9 separate meters in one. Cash or C.O.D. - £2 2 0 or 5/6 with order & 8 monthly payments of 5/-.

New Magnavox Double Six A.C. Moving Coil Unit, including multi-ratio transformer. Cash or C.O.D. - £7 17 6 or 15/- with order & 11 monthly payments of 14/-.

Heayberd Eliminators & Special Transformers, also supplied on lowest terms.

All the above sent carriage paid.

LONDON RADIO SUPPLY CO.

(Est. 1925) 11, Oat Lane, Noble St., London, E.C.2

Phone: National 1977.

ELECTRADIX BARGAINS

Home Broadcasting Microphones

Improved pedestal model, bakelite case, containing high-ratio transformer, as illus., 15/-. Write for special Mike instruction leaflet "A." We make 23 types of microphone for all purposes. CROONERS.—Lapel Mikes for dance bands. American model, 12/6.

PARTS FOR HOME CONSTRUCTORS. Microphone Carbon Granules, in glass capsule, enough for four buttons. Grade No. 1, 8d.; No. 2 Medium, 1/-; No. 3, Fine, 1/6; Carbon, solid back blocks, 3d. Mouthpieces, curved or straight, 10d. Carbon diaphragm, 5d.

THE DIX-MIPANTA VEST-POCKET TESTER. A wonderfully versatile moving-iron multi-range meter for service on A/C jobs. No projecting terminals. THREE ranges of volts: 0-7.5, 0-150, 0-300. Used for MILLIAMPS reads: 0-124 mA, and 0-75 mA. In black bakelite case. Measures only 2 1/2 in. by 2 1/2 in. A 2-guinea Tester for 19/6. Complete in case with pair of test leads and plugs.

WIRE. Lead-covered single, 3/029, 15/- 50 yds.; 7/029 ditto, 15/- per 50 yds. L.C. Twin, 1/064, 15/- per 50 yd. coil; L.C. Twin, 1/044, 18/- per 50-yd. coil. Plain V.I.R. Lighting, 1/044, 600 meg., 5/3 per 100 yds.; 9/000 yds., 27/40 1/2 for H.F. coils, 1/- per dozen yds. Heavy Mains Flex, for Electric Heaters and Irons, etc., 4/- per doz. yds., post 6d. Twin Lighting Flex, 2/- per doz. yds., post 4d. Insulated Earth Cable, 1/6 per doz. yds., post 4d. Lead-in Cable, rubber-covered, 2/- doz. yds., post 4d. Red and Black Flex, 1/6 per doz. yds., post 3d. S. G. BROWN'S BATTERY SUPERSEDER makes H.F. from your L.T. 2-volt battery, rectified and smoothed; 3 tappings. A boon to those who are not on the mains. Reduced from £3/15/- New and Guaranteed, 37/6.

FRETS for speaker panel fronts or baffles. Fine 8-in. octagon, in flanged, black, moulded bakelite, as on Brown's 30-guinea set, 1/- only. Post 1/3 COILS. Sovereign dual range 200/2,000 m., new, 2/6 Edison Bell dual range, 1/6. Browne dual range, 1/6. M.I.C. set of 4, 200/1,200 m., 2/8. Varley Square Peak, 2/8.

Gribbed small 1 1/2 in. diameter, 1 in. long, 2d. Star Reaction Tuners, broadcast band, new, 9d. each. Igranite Unitone Couplers usually 2/4, Major and Minor, 9d. each.

PARCELS of experimental odd coils, magnets, wire, chokes, condensers, switches, terminals, etc., post free. 10 lbs., 7/-; 7 lbs., 5/-; 1,000 other Bargains in New Sale List "W."

ELECTRADIX RADIOS

218 Upper Thames Street, London, E.C.4.

M.P.R. ALL-ELECTRIC 3 VALVE A.C. RECEIVER. A wonder set for those wishing to hear the main stations with clarity and pure undistorted reproduction. Handsome walnut cabinet. Output 2 watts. Ask your dealer for demonstration or send for fully illustrated details. £5-17-6 OR 2/6 WEEKLY. M.P.R. LTD. ROMFORD ESSEX.

Components, Etc., for Sale.—Contd.

FERRANTI A.F.5c, 17/6; O.P.M.1c, 12/6; guaranteed perfect.—2, Warmdene Av., Patcham, Brighton. [6752]

MILNES 120v. Unit, 55/-; Ferranti Class B A.F.17.C., O.P.M.17.C., 12/-; Polar V.P. dial, 4/6.—Atkin, 13, Clapham Park Rd., S.W.4. [6763]

WOUBURN RADIO Offer the Following Bankrupt Stock: To save delay send orders without money, we pay c.o.d. charges on orders over 5/-.

POLAR Midget Condensers, new type, boxed, 0.0005 fully screened, with trimmers, 2-gang 6/6, 3-gang 9/9; Radiophone curved drives, 3/9.

RESISTANCES.—Bargain parcels of 13 wire wound resistances, 1 1/2 watt, made by Truwind, accurate to 1%, values 100 ohms to 100,000; 3/9.

FORMO 2 mid., 1,000v. test, bakelite, 1/3; Wego, 750v. test, 1 mid. 1/3, 2 mid. 1/3, 4 mid. 2/3; tubulars, 0.01, 0.02, 0.1, 6d.; 0.001, 4d.; Polymet 0.003 tags, 1/- half dozen; Telsen Tag condensers, boxed, 0.002, 0.0001, 0.0002, 0.0003, 4d.; chassis valve holders, 4-5 pin, 1/3 half dozen; toggles, 6d.; Edison condensers, 0.005, 0.006, 3d.; British Radiophone curved drives, with escutcheon and light, 3/9; Columbia L.F. transformers, 3-1 and 5-1, 2/9; Class B drivers and chokes, 8/6 pair; with B.V.A. valve and 7-pin holder, 17/-; Eston iron core coils, 2/6; Popular iron core canned coils, 2/6; J.B. condensers, 0.0005, with drive and escutcheon, and light, 3/6; 3-gang condensers, 0.0005, with trimmers, 6/6.

WESTERN Electric Microphones, very sensitive, 2/3; microphone transformers for above, ratio 85-1, 2/3; Marconi microphone transformers, ratio 100-1, 3/6; H.F. chokes, snap type, 10d.; binocular chokes, 1/2; S.W.H.F. chokes, 10d.; Wego interference eliminators, few only, 3/6; Westinghouse H.T.8, 8/11.

W.R.C. Eliminators, 150v. 30m.a., 3 positive H.T. tappings, all guaranteed 12 months; D.C. model, 9/6; A.C. model, 21/-; A.C. model with trickle charger, (2v., 4v., or 6v. 5 amp.), 32/6 (carriage 1/- extra on all).

OWING to overwhelming demand, delivery at present cannot be given under 7 days.

TRADE List Now Ready, kindly enclose trade heading and stamp.

WOUBURN RADIO Co., 9, Sandland St., Bedford Row, W.C.1. Holborn 7289. [6554]

A.F.3, 9/6; A.F.5.C, 16/6; O.P.3.C., 12/6; Burndept Screened Four and D.C. eliminator, £2/5 complete; all perfect.—Petty, Clapham, Lancaster. [6770]

WESTERN ELECTRIC Condensers, I.M.F. 400v. working, 9d. each; postage 1/4d.; bargain list free.—Radelec, 83, Denzil Rd., London, N.W.10. [6774]

RADIO CLEARANCE, 94, High Holborn, W.C.1, offers the following stupendous bargains; limited quantities only; all goods carriage free.—Phone: Holborn 4631.

RADIO CLEARANCE Offers 5-valve A.C. 200-250-volt Superhet chassis, partly incomplete, with circuit diagram, components worth 50/-; price, post free, 25/-.

RADIO CLEARANCE Offers L.F. Transformers, 3:1 and 5:1, manufacturers' type; 1/6 each, post free.

RADIO CLEARANCE Offers L.F. Transformers, shrouded, 3:1 and 5:1; price, post free, 1/9 each.

RADIO CLEARANCE Offers Magnacore Class B Chokes; price 2/11, post free.

RADIO CLEARANCE Offers Magnacore Q.P.P. Chokes; price, post free, 2/11 each.

RADIO CLEARANCE Offers 1-25th h.p. Motors (Gilbert), 100-115 volts A.C. for television, suitable for 200-250 volts if used with 700-ohm resistor or 30-watt lamp; price 17/6 each, post free.

RADIO CLEARANCE Offers Variable Power Resistances by well known maker, 0-100 ohms; price 3/- each, post free; exceptional value.

RADIO CLEARANCE Offers Plessey Triple Gang Condensers, 2x0.0005 and 110 kc/s oscillator section, complete with knob, drive, and escutcheon; 7/6, post free.

RADIO CLEARANCE Offers Plessey 110 kc/s Intermediate Frequency Transformers; 3/-, post free.

RADIO CLEARANCE Offers 8,000-ohm Volume Controls, log. type, with Q.M.B. switch, by G.E.C.; 2/6, post free.

RADIO CLEARANCE Offers Mains Transformers, unshrouded, manufacturer type, primary 200-250, secondary 320-0-320v. at 70 m.a., 2-0-2v. at 2 1/2 amps., 2-0-2v. at 3 amps.; 8/6, post free.

RADIO CLEARANCE Offers Mains Transformers, shrouded, with terminals, primary 200-250v., secondary 320-0-320 at 70 m.a., 2-0-2 at 2 1/2a., 2-0-2 at 4 1/2a., 9/6, post free.

RADIO CLEARANCE Offers Mains Transformers, shrouded, with terminals, primary 200-250v., secondary 320-0-320 at 70 m.a., 2-0-2 at 2 1/2a., 2-0-2 at 6 1/2a., 10/6, post free.

RADIO CLEARANCE Offers Steel Chassis, cadmium plated, drilled ready for use, 3-valve, 5-valve, or 7-valve type; 1/6, post free.

RADIO CLEARANCE Offers Set of Band-Pass Coils, manufacturer's type, with circuit diagram, suitable for tuned grid or tuned anode; set of 3 coils, 4/6, post free.

RADIO CLEARANCE Offers "Centralab" Potentiometers, 25,000, 50,000 ohms; 1/6 each, post free.

RADIO CLEARANCE Offers Set of Super-Het. Coils, comprising band-pass and oscillator 110 kc/s for cathode injection, with circuit diagram; 4/6, post free.

RADIO CLEARANCE Offers Parallel Fed Transformers, ratio 6-1, by well known manufacturer; 3/-.

RADIO CLEARANCE Offers T.C.C. Condensers, 0.5 mid., 800-volt, D.C. working, 1/6 each; T.C.C. condensers, 1 mid., 250-volt, D.C. working, 1/- each; T.C.C. condensers, 1 mid., 450-volt, D.C. working, 1/3 each; T.C.C. condensers, 1 mid., 800-volt, D.C. working, 2/- each; T.C.C. condensers, 2 mid., 450-volt, D.C. working, 2/- each; T.C.C. condensers, 6 mid., 250-volt, D.C. working, 2/6 each; T.C.C. condensers 6 mid., 500-volt, D.C. working, 3/- each; T.C.C. condensers, 4 mid. block, 0.5, 0.5, 0.5, 0.5, 0.5, and 1 mid., 250-volt, A.C. working, 2/- each.

RADIO CLEARANCE Offers Philips Eliminator Transformers, 150 volts at 30 milliamperes, 4 volts, 1 amp., various inputs, 1/6; Philips smoothing chokes, 14-28 henries, 120 milliamperes, 2/-.

RADIO CLEARANCE Offers Metal Chassis, 2-, 3- and 4-valve type, fitted with valve holders and terminal strip; 2/6 each, post free.

RADIO CLEARANCE, 94, High Holborn, W.C.1. Phone: Holborn 4631. [6687]

HOW MUCH DO YOU PAY FOR A WIRELESS SET?

Frankly, we're not interested. We don't want to pry into your business. But we would like to stress that if you buy a set equipped with Westinghouse Metal Rectifiers, you get far more for your money. Better value for the same outlay because you are never called upon to replace your rectifier. Instead, you get a constant high tension supply for as long as the set itself is in use.

This means that your set will retain its volume and quality of reproduction and not be subject to a gradual falling off in output. And, too, you need never be afraid to ask your friends in to hear your set. It will never let you down, nor will you experience "mid-programme fade-outs." Westinghouse-equipped receivers are the most reliable and lasting on the market.

THE WESTINGHOUSE BRAKE & SAXBY SIGNAL CO. LTD.
 82, YORK ROAD, KING'S CROSS, LONDON, N.1

STAND YOUR SET HERE

AND HAVE THE BEST RADIO-GRAMPHONE

In these days the ordinary radiogram quickly becomes obsolete. The Apollo bureau playing desk is always up to date. Plus a good set it costs about £3 less than a radiogram, and it has storage for 80 records, scoring in convenience as well as economy. It is a beautiful job in finely polished walnut. With latest silent running Garrard induction motor and Goldring weight-adjusted pick-up as standard.



APOLLO BUREAU PLAYING DESK £5.19.6

Any other motor or pick-up fitted by arrangement. Cabinet only, £2-10-0. Complete, 12 monthly payments of 11/-. Order direct or through dealer or write for further details.

BAXTER STAVRIDI & CRAIES Ltd
 Perseverance Works, Commercial Road, Edmonton, N.18.

Name your Aerial



If you demand an "aerial" you'll just get an aerial; but if you ask for the best aerial you will surely get "RECEPTICON." But to ensure you getting the genuine article

PRICES	
25 ft. . . .	7½d.
50 ft. . . .	1/3
75 ft. . . .	1/10
100 ft. . . .	2/6

ASK FOR

"RECEPTICON"

INSULATED COPPER AERIAL
 The CONCORDIA ELECTRIC WIRE CO., LTD.
 NEW SAWLEY NR. NOTTINGHAM

Exide have perfected the UNSPILLABLE JELLY ACID BATTERY

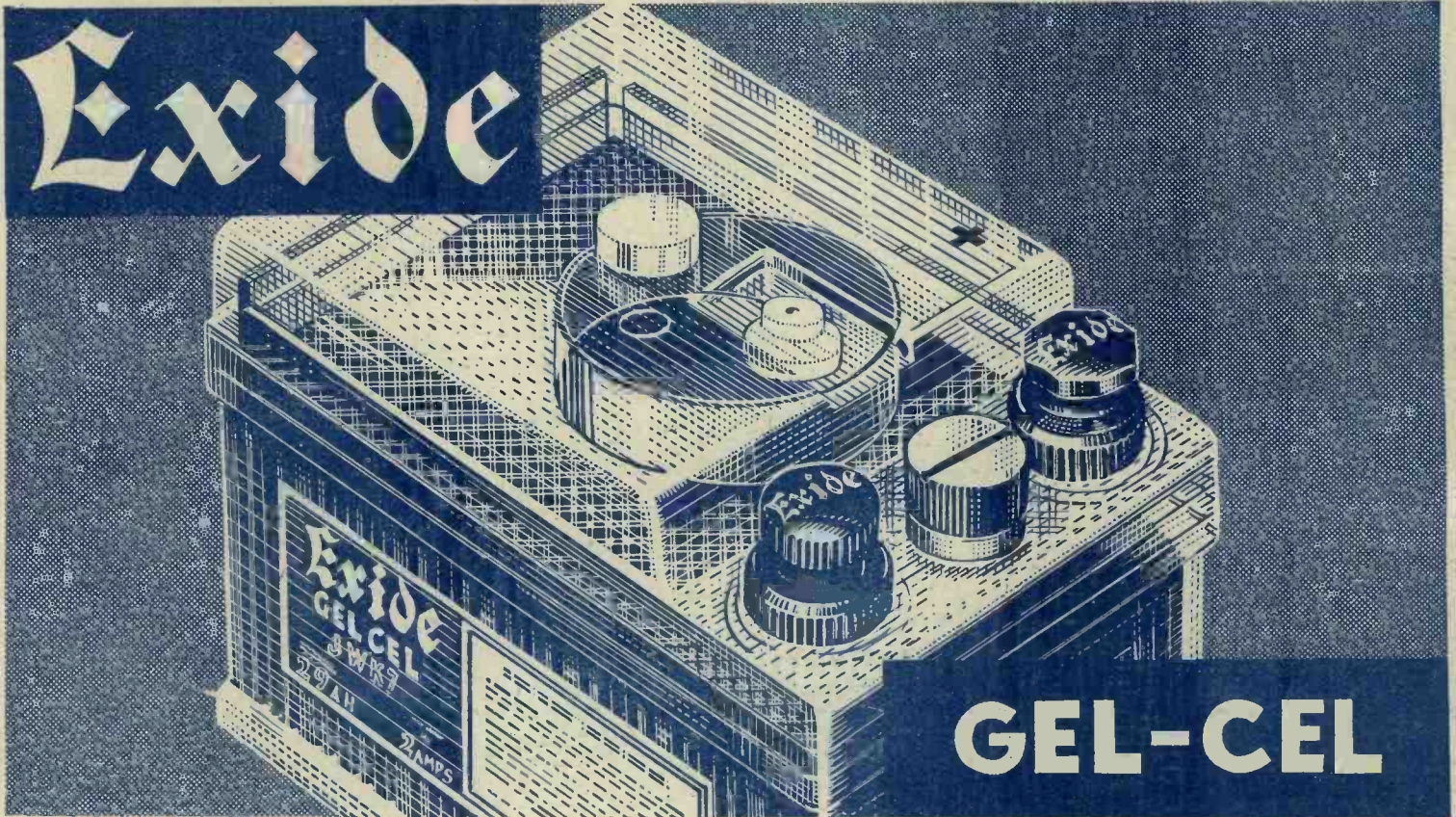
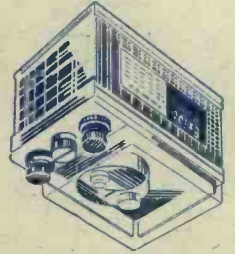
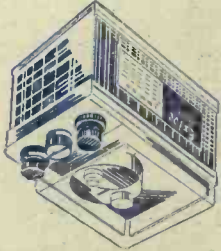

There is a size to suit every set. Prices range from 7/6.

The Exide "Gel-Cel" was the first jelly acid battery to compare in efficiency with the best free acid batteries. And yet it has all the freedom from spilling which jelly acid provides. As an additional safeguard, should there be any residual acid, the "Gel-Cel" has an improved acid

trap, and a strong leak-proof celluloid container which is moulded and seamless and has a double bottom. It is the strongest, most efficient jelly acid battery for portables ever produced. Before you replace your present battery — see the Exide "Gel-Cel."

For Wireless H.T. get

Drydex

the Exide dry battery

"Still keep going when the rest have stopped"

Obtainable from Exide Service Stations or any reputable dealer. * * * Exide Service Stations give service on every make of battery. Exide Batteries, Clifton Junction, near Manchester. Branches at London, Manchester, Birmingham, Bristol, Glasgow, Dublin and Belfast.