



# Designing the VEML6030 Into an Application

By Reinhard Schaar

## HIGH-ACCURACY AMBIENT LIGHT SENSOR: VEML6030

The VEML6030 is a very high sensitivity, high accuracy ambient light sensor in a miniature transparent 2 mm by 2 mm package. It includes a highly sensitive photodiode, low-noise amplifier, 16-bit A/D converter, and supports an easy-to-use I<sup>2</sup>C bus communication interface and additional interrupt feature.

The ambient light read-out is available as a digital value, and the built-in photodiode response is near that of the human eye. The 16-bit dynamic range for ambient light detection is 0 lx to ~140 klx, with resolution down to 0.0042 lx/counts.

Beside 100 Hz and 120 Hz flicker noise rejection and a low temperature coefficient, the device consumes just 0.5 µA in shutdown mode. In addition, another four power-saving modes are available that allow operating current to be reduced down to just 2 µA. The device operates within a temperature range of -25 °C to +85 °C.

The VEML6030's very high sensitivity of just 0.0042 lx allows the sensor to be placed behind very dark cover glasses that will dramatically reduce the total light reaching it. The sensor will also work behind clear cover glass, because even very high illumination - such as direct sunlight - will not saturate the device and read-outs up to 140 klx are possible.

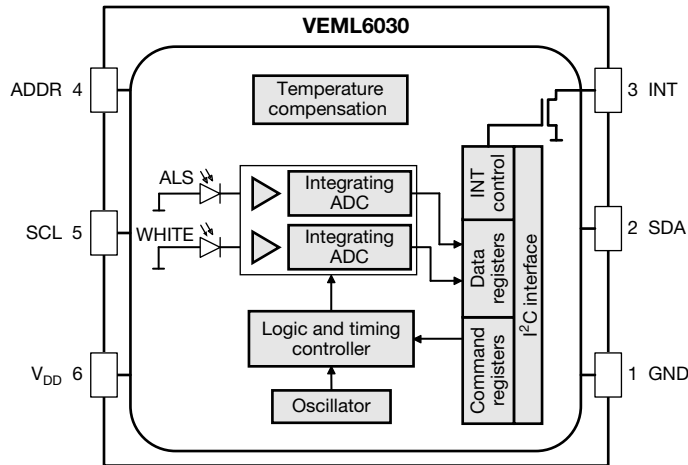
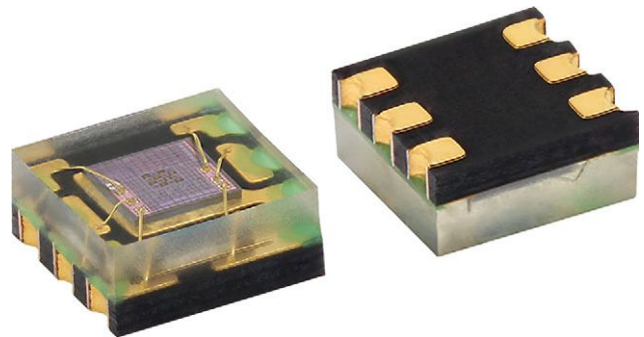

Fig. 1 - VEML6030 Block Diagram

The DNA of tech.®

## Designing the VEML6030 Into an Application

### APPLICATION CIRCUITRY FOR THE VEML6030

The VEML6030 can be connected to a power supply ranging from 2.5 V to 3.6 V. The pull-up resistors at the I<sup>2</sup>C bus lines, as well as at the interrupt line, may also be connected to a power supply between 1.7 V to 3.6 V, allowing them to be at the same level needed for the microcontroller.

Proposed values for the pull-up resistors should be > 1 kΩ, e.g.: 2.2 kΩ to 4.7 kΩ for the R1 and R2 resistors (at SDA and SCL) and 10 kΩ to 100 kΩ for the R3 resistor (at interrupt). The interrupt pin is an open drain output for currents up to 12 mA.

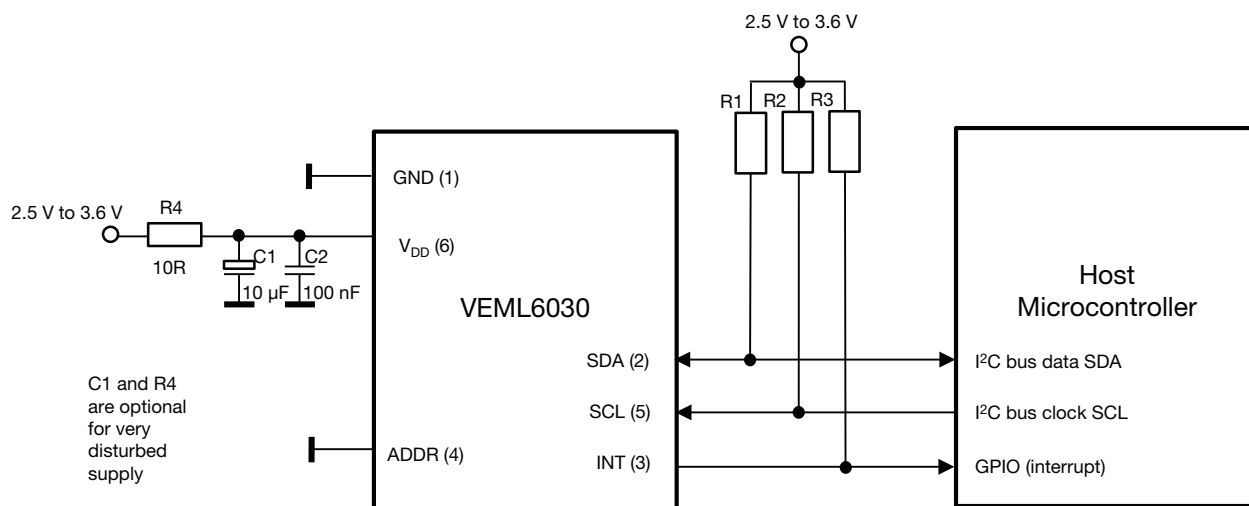

Fig. 2 - VEML6030 Application Circuit

The VEML6030 is insensitive to any kind of disturbances, so a small ceramic capacitor at its supply pin will be enough. Only if the power supply line could be very noisy and the voltage range close to the lower limit of 2.5 V should a R-C decoupler, as shown in the above circuitry, be used.

The ADDR pin allows for two device addresses: pin 4 = high ( $V_{DD}$ ) = 0x48, pin 4 = low (GND) = 0x10.



The DNA of tech.®

## Designing the VEML6030 Into an Application

### REGISTERS OF THE VEML6030

The VEML6030 has six user-accessible 16-bit command codes. The addresses are 00h to 06h (03h not defined / reserved).

COMMAND REGISTER FORMAT				
COMMAND CODE	REGISTER NAME	BIT	FUNCTION / DESCRIPTION	R / W
00	ALS_CONF 0	15 : 0	ALS gain, integration time, interrupt, and shutdown	R / W
01	ALS_WH	15 : 8	ALS high threshold window setting (MSB)	R / W
		7 : 0	ALS high threshold window setting (LSB)	R / W
02	ALS_WL	15 : 8	ALS low threshold window setting (MSB)	R / W
		7 : 0	ALS low threshold window setting (LSB)	R / W
03	Power saving	15 : 0	Set (15 : 3) 0000 0000 0000 0b	R / W
04	ALS	15 : 8	MSB 8 bits data of whole ALS 16 bits	R
		7 : 0	LSB 8 bits data of whole ALS 16 bits	R
05	WHITE	15 : 8	MSB 8 bits data of whole WHITE 16 bits	R
		7 : 0	LSB 8 bits data of whole WHITE 16 bits	R
06	ALS_INT	15 : 0	ALS INT trigger event	R
07	ID	15 : 0	Device ID	R

#### Note

- Command code 0 default value is 01 = devices is shut down

### WAKE-UP OF THE VEML6030

For random measurements, e.g. once per second, the sensor may be switched to shutdown mode, where power consumption is lowest.

BASIC CHARACTERISTICS ( $T_{amb} = 25\text{ }^{\circ}\text{C}$ , unless otherwise specified)						
PARAMETER	TEST CONDITION	SYMBOL	MIN.	TYP.	MAX.	UNIT
Supply voltage		$V_{DD}$	2.5	3.3	3.6	V
Shutdown current (rem_2)	$V_{DD}$ is 3.3 V	$I_{sd}$	-	0.5	-	$\mu\text{A}$
Operation mode current (rem_2)	$V_{DD}$ is 3.3 V, PSM = 11, refresh time 4100 ms	$I_{DD}$	-	2	-	$\mu\text{A}$
	$V_{DD}$ is 3.3 V, PSM = 00, refresh time 600 ms	$I_{DD}$	-	8	-	$\mu\text{A}$
	$V_{DD}$ is 3.3 V, PSM_EN = 0, refresh time 100 ms	$I_{DD}$	-	45	-	$\mu\text{A}$

#### Note

- rem\_1: light source: white LED
- rem\_2: light conditions: dark

This shutdown mode is set with a "1" within bit 0 of the command register:

COMMAND REGISTER FORMAT				
COMMAND CODE	REGISTER NAME	BIT	FUNCTION / DESCRIPTION	R / W
00	ALS_SD	0	ALS shutdown setting 0 = ALS power on 1 = ALS shut down	R / W

When activating the sensor, setting bit 0 of the command register to "0"; a wait time of 4 ms should be observed before the first measurement is picked up, to allow for a correct start of the signal processor and oscillator.

Please also refer to the chapter "Power-Saving Modes."



The DNA of tech.®

Designing the VEML6030 Into an Application

RESOLUTION AND GAIN SETTINGS OF THE VEML6030

The VEML6030 is specified with a resolution of 0.0042 lx/counts. This high resolution is only available for a smaller light range of approximately 0 lx to 230 lx. For this range a high gain factor can be selected. For light levels up to about 140 000 lx, a reduced gain factor of 1/8 would then lead to a possible resolution of 0.0672 lx/counts (with an integration time of 800 ms), respective of 0.5376 lx/counts (with IT = 100 ms).

Command Code ALS\_GAIN

Command code: 00, bits 12 and 11

Table with 4 columns: REGISTER NAME, BIT, FUNCTION / DESCRIPTION, R / W. Row 1: Reserved, 15 : 13, Set 000b, W. Row 2: ALS\_GAIN, 12 : 11, Gain selection (00-11), R / W.

Remark: to avoid possible saturation / overflow effects, application software should always start with low gain: ALS gain x 1/8 or gain 1/4. ALS gain x 2 shows the highest resolution and should only be used with very low illumination values, e.g. if sensor is placed below a very "dark" cover allowing only low light levels reaching the photodiode.

Command Code ALS\_IT

Command code: 00, bits 9 to 6

Table with 4 columns: REGISTER NAME, BIT, FUNCTION / DESCRIPTION, R / W. Row 1: ALS\_IT, 9 : 6, ALS integration time setting (1100-0011), R / W.

Remark: the standard integration time is 100 ms. If a very high resolution is needed, one may increase this integration time up to 800 ms. If faster measurement results are needed, it can be decreased down to 25 ms. For the integration time a tolerance of ± 30 % can be assumed. This tolerance should also be considered during the read out of the measurement results.

READ-OUT OF ALS MEASUREMENT RESULTS

The VEML6030 stores the measurement results within the command code 04. The most significant bits are stored to bits 15 : 8 and the least significant bits to bits 7 : 0.

The VEML6030 can memorize the last ambient data before shutdown and keep this data before waking up. When the device is in shutdown mode, the host can freely read this data directly via a read command. When the VEML6030 wakes up, the data will be refreshed by new detection.

Command Code ALS

Command code: 04, bits 15 : 8 (MSB), bits 7 : 0 (LSB)

Table with 4 columns: REGISTER NAME, BIT, FUNCTION / DESCRIPTION, R / W. Row 1: ALS, 15 : 8, MSB 8 bits data of whole ALS 16 bits, R. Row 2: ALS, 7 : 0, LSB 8 bits data of whole ALS 16 bits, R.



The DNA of tech.®

## Designing the VEML6030 Into an Application

### TRANSFERRING ALS MEASUREMENT RESULTS INTO A DECIMAL VALUE

Command code 04 contains the results of the ALS measurement. This 16-bit code needs to be converted to a decimal value to determine the corresponding lux value. The calculation of the corresponding lux level is dependent on the programmed gain setting and the chosen integration time.

### CALCULATING THE LUX LEVEL

With the standard integration time of 100 ms, one has to just calculate the corresponding light level according to the programmed gain and corresponding resolution. This resolution is most sensitive with gain = 2 and an integration time of 800 ms, specified to 0.0042 lx/step. For each shorter integration time by half, the resolution value is doubled.

The same principle is valid for the gain. For gain = 1 it is again doubled, and for gain = 1/4 it is four times higher, and for gain = 1/8 it is again doubled. At lux levels above 100 lux GAIN level 1 and 2 should not be used as the sensor becomes non-linear.

When using GAIN level 1/4 and 1/8 the correction formula should be used.

The table below shows this factor of “2” for the four gain values:

RESOLUTION AND MAXIMUM DETECTION RANGE									
	GAIN 2	GAIN 1	GAIN 1/4	GAIN 1/8		GAIN 2	GAIN 1	GAIN 1/4	GAIN 1/8
IT (ms)	TYPICAL RESOLUTION (lx / cnt)					MAXIMUM POSSIBLE ILLUMINATION (lx)			
800	0.0042	0.0084	0.0336	0.0672		275	550	2202	4404
400	0.0084	0.0168	0.0672	0.1344		550	1101	4404	8808
200	0.0168	0.0336	0.1344	0.2688		1101	2202	8808	17 616
100	0.0336	0.0672	0.2688	0.5376		2202	4404	17 616	35 232
50	0.0672	0.1344	0.5376	1.0752		4404	8808	35 232	70 463
25	0.1344	0.2688	1.0752	2.1504		8808	17 616	70 463	140 926

#### Note

- For illuminations > 1000 lx a correction formula needs to be applied. Please refer to the section “APPLICATION-DEPENDENT LUX CALCULATION” for further details on how this is done

Example:

If the 16-bit word of the ALS data shows: 0001 0101 1100 1101 = 5581 (dec.), the programmed ALS gain is 1/4, and the integration time is 100 ms. The corresponding lux level is:

light level (uncorrected) = 5581 x 0.2688 = 1500 lx

Correcting the lux value with the help of the correction formula yields:

$$a \times (1500 \text{ lux})^4 + b \times (1500 \text{ lux})^3 + c \times (1500 \text{ lux})^2 + d \times (1500 \text{ lux}) = 1658 \text{ lux}$$

With the polynomial coefficients:

- a = 6.0135<sup>-13</sup>
- b = -9.3924<sup>-9</sup>
- c = 8.1488<sup>-5</sup>
- d = 1.0023

The DNA of tech.®

## Designing the VEML6030 Into an Application

The screen shot below shows the linearity for the four gain factors.

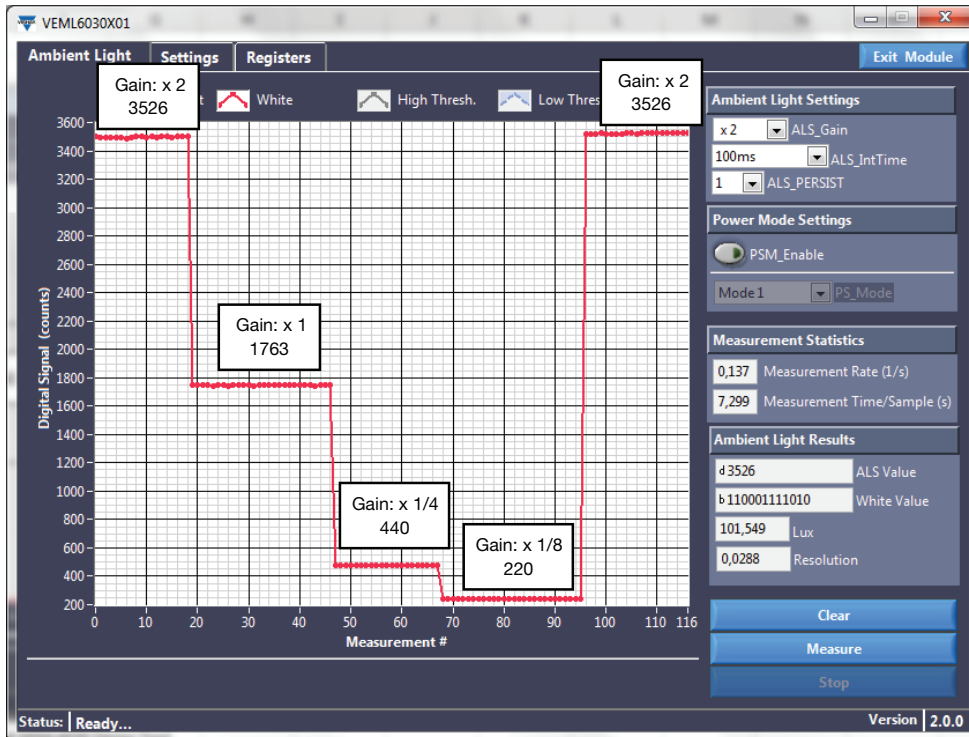

Fig. 3 - VEML6030 Counts vs. Gain

If the light level is very low, or if just a small percentage of outside light reaches the sensor, a higher integration time will need to be chosen.

For just 1 lx, 35 counts are enough with the ALS gain mode: “gain x 2,” but for 0.1 lx just 3.5 counts will remain. With an integration time of 200 ms, this will be doubled to 7 counts, and with 800 ms 28 counts are shown.

This also means that with this high integration time, together with the highest gain, even 0.008 lx will deliver 2 digital counts, resulting in a high resolution of 0.0042 lx/counts.

The DNA of tech.®

## Designing the VEML6030 Into an Application

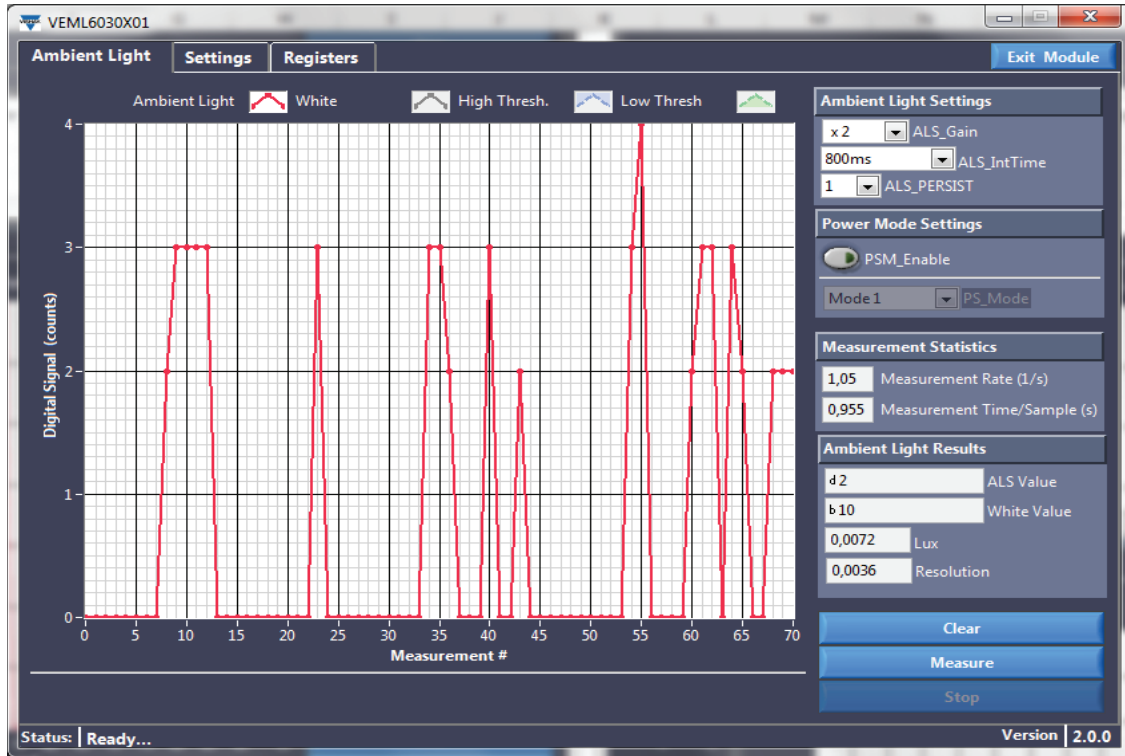

Fig. 4 - VEML6030 Highest Sensitivity

The lowest possible detectable illuminance is 0.008 lx, because with a needed gain of “2” only 2 counts are shown as the lowest result above “0.” Every next step (2, 3, 4, ...) is possible, so the resolution of 0.0042 lx/counts is valid.

The DNA of tech.®

## Designing the VEML6030 Into an Application

### LUX LEVEL MATCHING FOR DIFFERENT LIGHT SOURCES

The VEML6030 shows very good matching for all kinds of light sources. LED light, fluorescent light, and normal daylight show about the same results in a close tolerance range of just  $\pm 10\%$ . Only a halogen lamp with strong infrared content may show higher values.

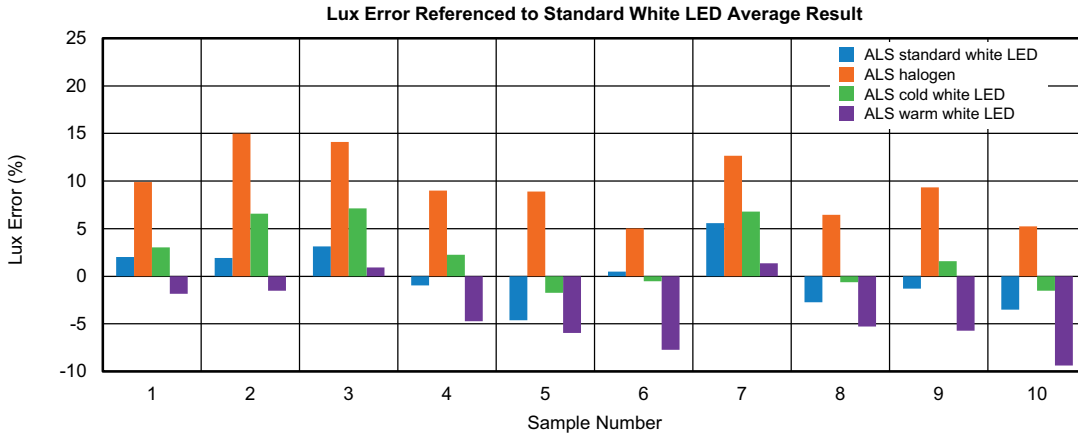

Fig. 5 - Tolerances for Different Light Sources

### LINEARITY OF THE ALS RESULTS

For light levels from 0.0042 lx up to about 1000 lx, the output data is strictly linear for “gain 1/4” and “gain 1/8”.

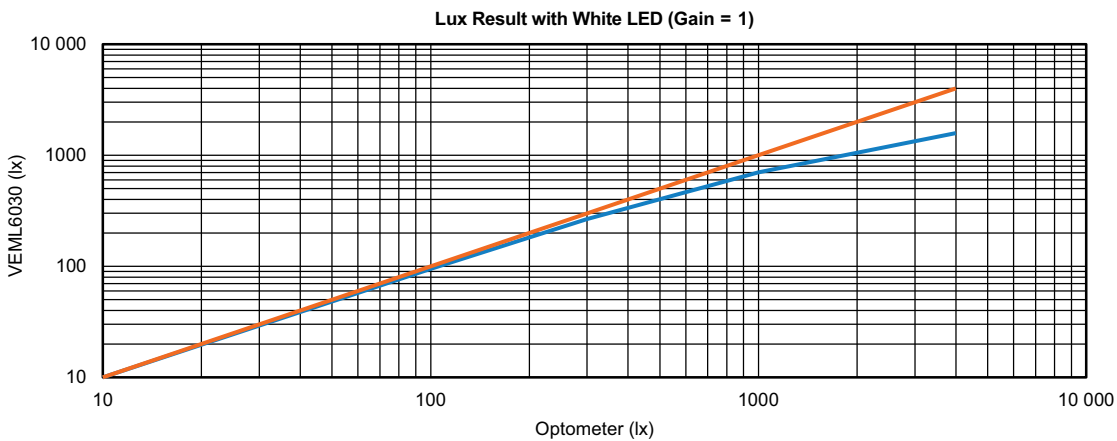

Fig. 6 - Linearity for Gain 1: VEML6030 Lux Value vs. Optometer Lux Value

“gain 1” and “gain 2” will show non-linearity for very high illuminations, so here only “gain 1/4” and “gain 1/8” should be used. Comparison measurements with a calibrated optometer show the same results as the read-out from the VEML6030.





The DNA of tech.®

## Designing the VEML6030 Into an Application

### APPLICATION-DEPENDENT LUX CALCULATION

If the application uses a darkened / tinted cover glass, just 10 % - or even just 1 % - of the ambient light will reach the sensor. For a tinted cover glass where there is 1 lx up to 100 klx of light outside, just 0.01 lx to 1 klx is reaching the sensor, and the application software may always stay with gain x 2.

If the application uses a clear cover glass, nearly all ambient light will reach the sensor. This means even 100 klx may be possible. For this clear cover where < 1 lx to ≥ 100 klx is possible, the application software will need to adapt the gain steps according to light conditions.

As explained before, with “gain 2” and IT = 100 ms, a maximum 2202 lx will be possible before saturation occurs; and with “gain 1” 4404 lx is maximum, but as already explained these high gain modes should only be used for low illuminations < 100 lx.

For unknown brightness conditions, the application should always start with the lowest gain: 1/8 or 1/4. This avoids possible overload / saturation if, for example, strong sunlight suddenly reaches the sensor. To show this high value, an even lower integration time than 100 ms may be needed.

Only for lower illumination levels with too low digital counts the gain should be increased. One possible decision level could be 100 counts (= 54 lx with “gain x 1/8”). After a change to gain = 1/4, this would show then 200 counts. 200 counts x 0.2688 will result in the same lux value of 54 lx.

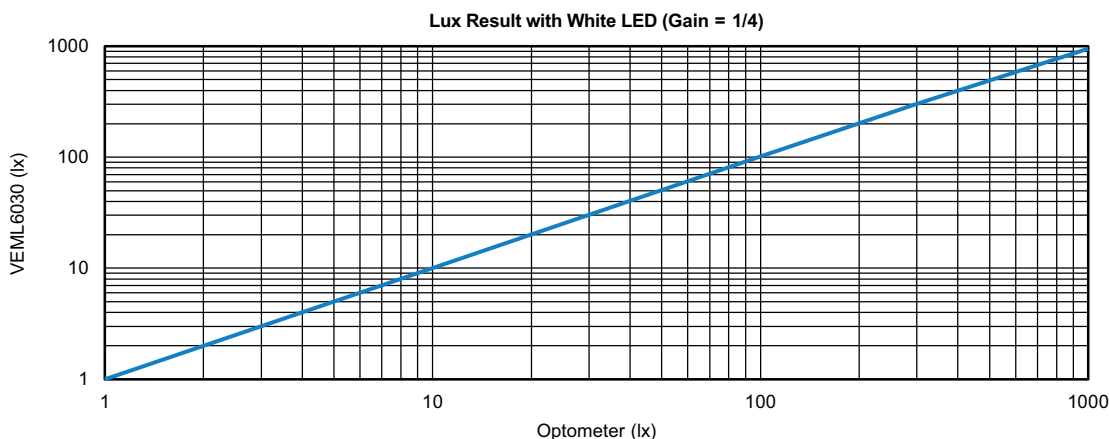

Fig. 7 - Linearity for Gain 1/4: VEML6030 Lux Value vs. Optometer Lux Value

The VEML6030 shows good linear behavior for lux levels from 0.0042 lx to about 1 klx.

A software flow may look like the flow chart diagram at the end of this note:

- Starting with the lowest gain (gain x 1/8), check the ALS counts. If ≤ 100 counts, increase the gain to 1/4.
- Check the ALS counts again. If they are still ≤ 100 counts, increase the gain to 1.
- Check the ALS counts again. If they are still ≤ 100 counts, increase the gain to 2.
- Check the ALS counts again. If they are still ≤ 100 counts, increase the integration time from 100 ms to 200 ms, and continue the procedure up to the longest integration time of 800 ms.

If the illumination value is > 100 counts (started with gain x 1/8), a correction formula may be applied to get rid of small non-linearity for very high light levels.



The DNA of tech.®

## Designing the VEML6030 Into an Application

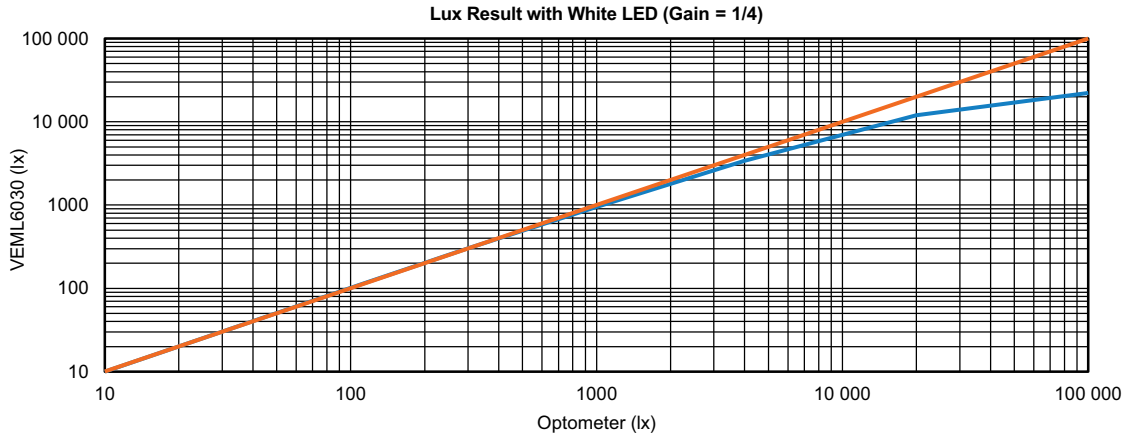

Fig. 8 - Not Corrected VEML6030 Lux Values vs. Optometer Results for Gain 1/4 and Gain 1/8 up to 100 klx

The VEML6030 shows good linear behavior for lux levels from 0.008 lx to about 1 klx.

Illumination values higher than 1000 lx show non-linearity. This non-linearity is the same for all sensors, so a compensation formula can be applied if this light level is exceeded.

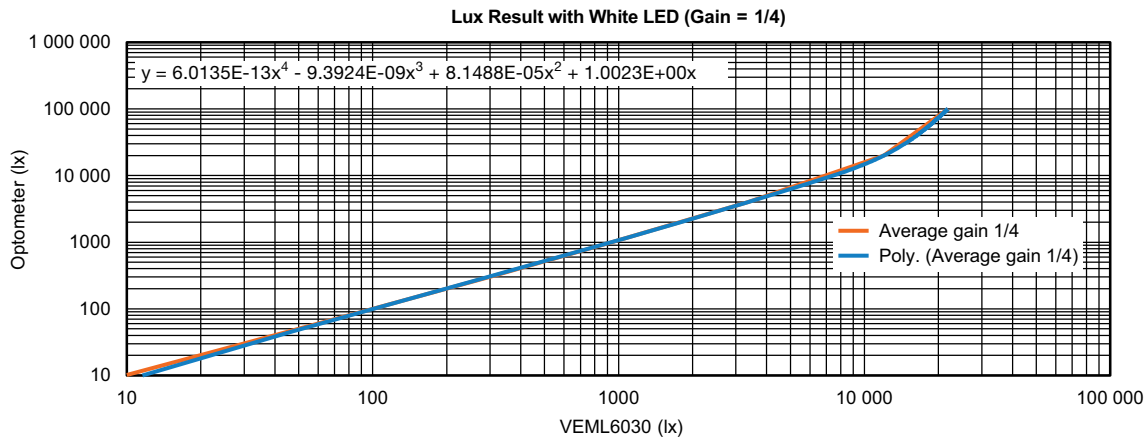

Fig. 9 - Correction Formula for Gain 1/4 and Gain 1/8 for Higher Light Levels than 100 lx

With the help of this correction formula, the VEML6030 shows good linear results up to high lux values even up to around 100 klux. As a correction formula is used, the resolution will also decrease at higher illuminations.

The DNA of tech.®

## Designing the VEML6030 Into an Application

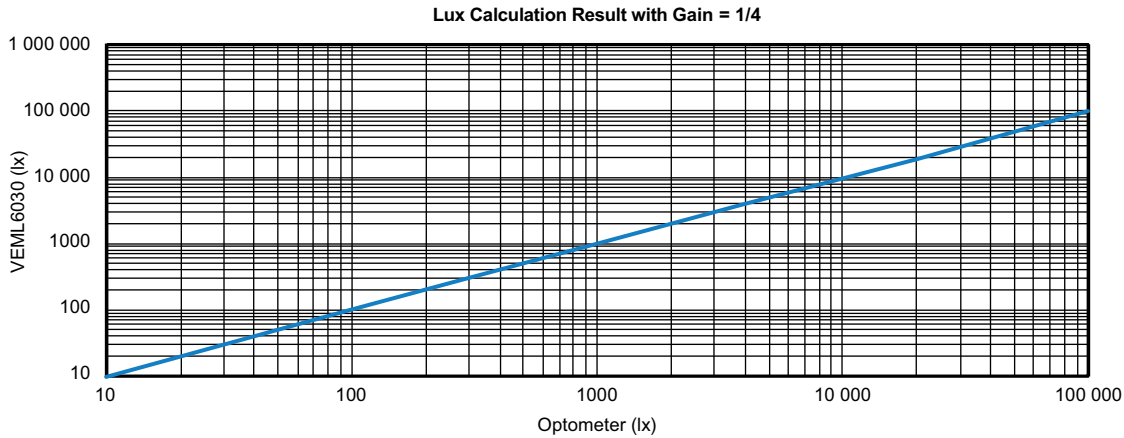

Fig. 10 - Linearity for Gain 1/4 and Gain 1/8 with Applied Correction Formula

For most single photodetectors / ambient light sensor devices, there is a certain discrepancy in the output value for the different light sources. They either do not follow the exact  $v(\lambda)$  curve due to wider sensitivity within the blue area - being not that exact within the red region - or they do not stay at zero for near infrared wavelengths.

The VEML6030 follows a very exact  $v(\lambda)$  curve in all areas. This is the reason that it reproduces the exact same output values under any kind of lighting condition, including fluorescent light, sunlight, halogen light, or LED light.

The maximum deviation to nominal value (as measured with an accurate optometer) is within  $\pm 10\%$ .

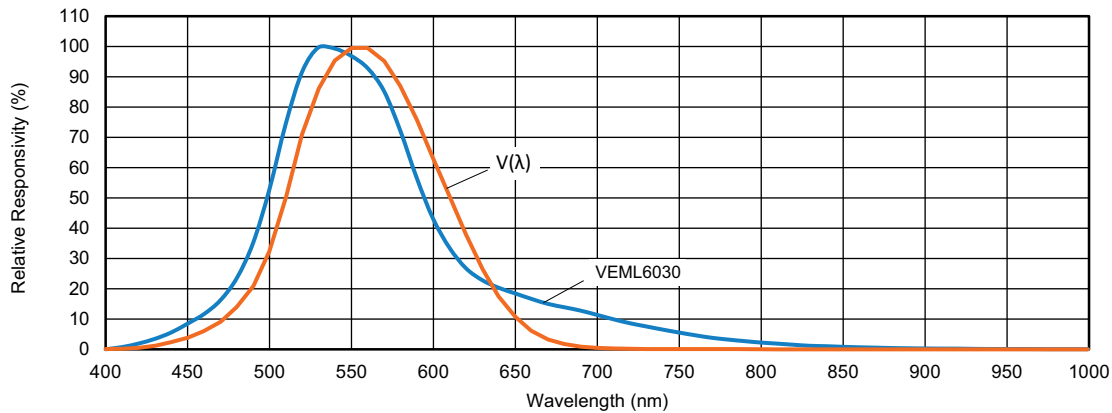

Fig. 11 - Spectral Response ALS Channel

The DNA of tech.®

## Designing the VEML6030 Into an Application

### WHITE CHANNEL

In addition to the ALS channel that follows the so-called human eye curve very well, there is also a second channel available called the white channel, which offers a much higher responsivity for a much wider wavelength spectrum.

This white channel could be used to eliminate the last few tolerance percentages that light sources with strong infrared content are showing at a bit higher values due to this small bump around 750 nm to 800 nm.

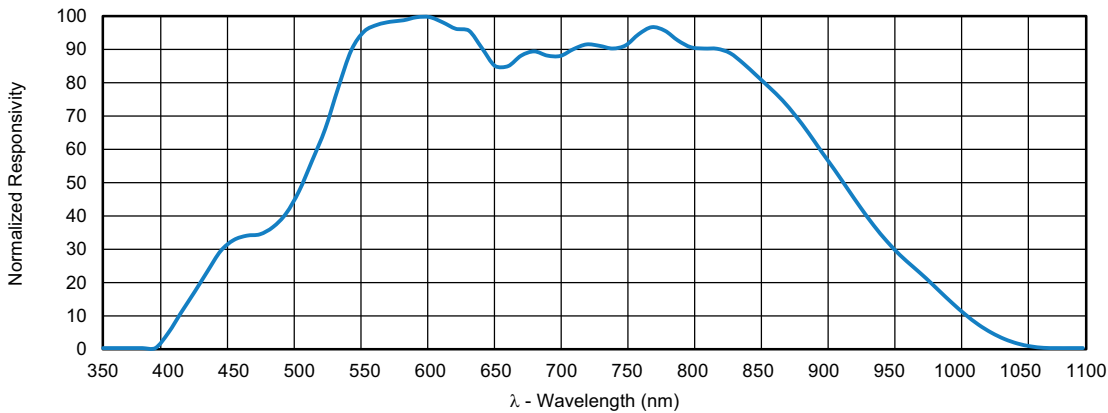

Fig. 12 - Spectral Response White Channel

COMMAND REGISTER FORMAT				
COMMAND CODE	REGISTER NAME	BIT	FUNCTION / DESCRIPTION	R / W
05	WHITE	15 : 8	MSB 8 bits data of whole white 16 bits	R
		7 : 0	LSB 8 bits data of whole white 16 bits	R

The data for this channel is available within the command code 05. Several measurements with many different light sources show that the output data of this channel will lead to higher data, up to 2 times that read from the ALS channel.

All kind of LEDs, as well as fluorescent lights, will deliver output data within a small tolerance window of just  $\pm 10\%$ .

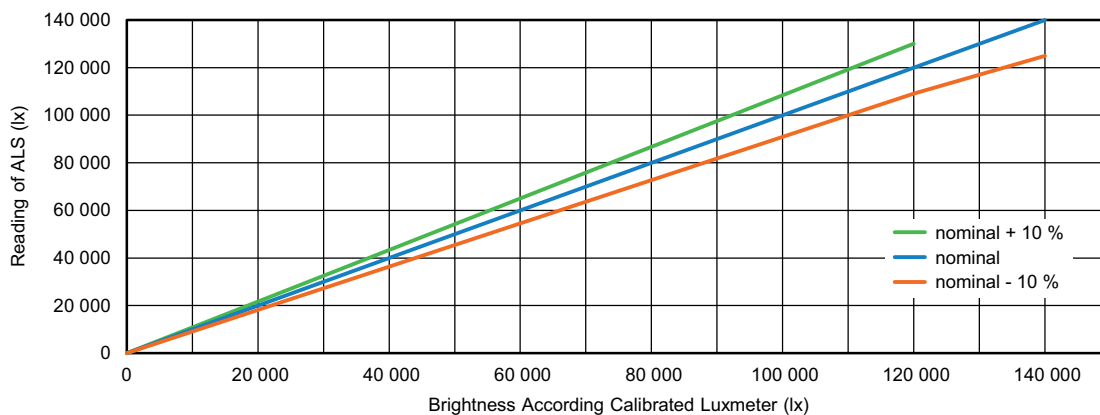

Fig. 13 - ALS Measurement Deviation Between Different Light Sources:  $\leq 10\%$

Only strong light from incandescent or halogen lamps and strong sunlight may show higher tolerances within the ALS channel (see Fig. 6).

## Designing the VEML6030 Into an Application

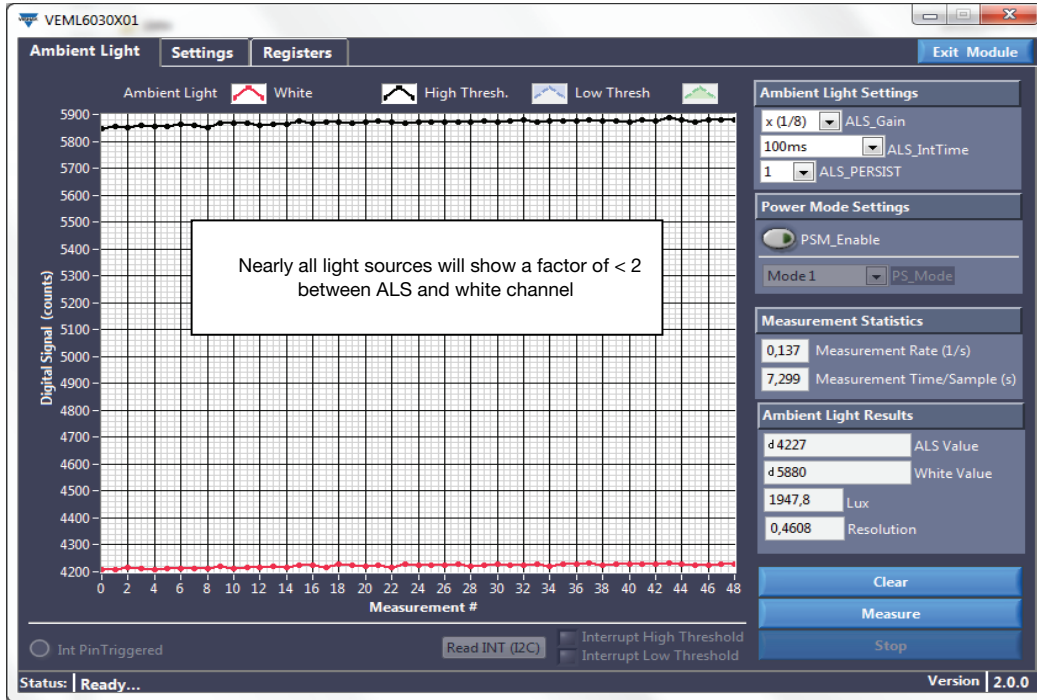

Fig. 14 - White Channel and ALS Channel for Fluorescent and Daylight Spectra

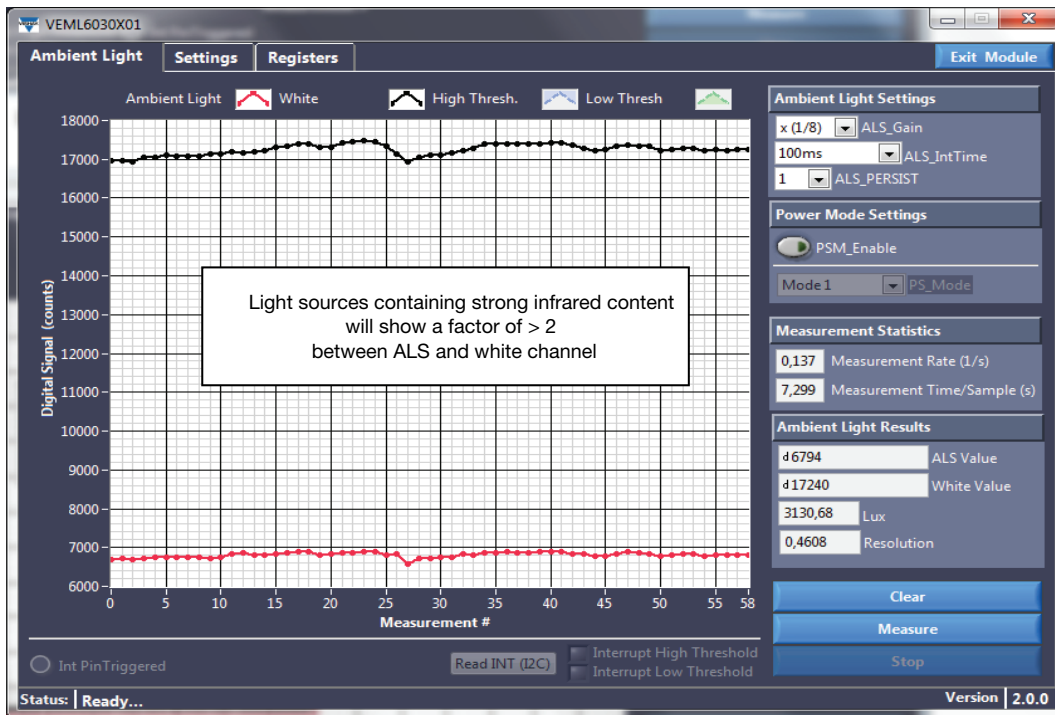

Fig. 15 - White Channel and ALS Channel for Incandescent Lamp Spectra



The DNA of tech.®

## Designing the VEML6030 Into an Application

Knowing that light sources with strong infrared content deliver about > 2 times higher output data at the white channel than all other light sources, which show a maximum factor of about 2, one may use it to optimize the lux conversion now.

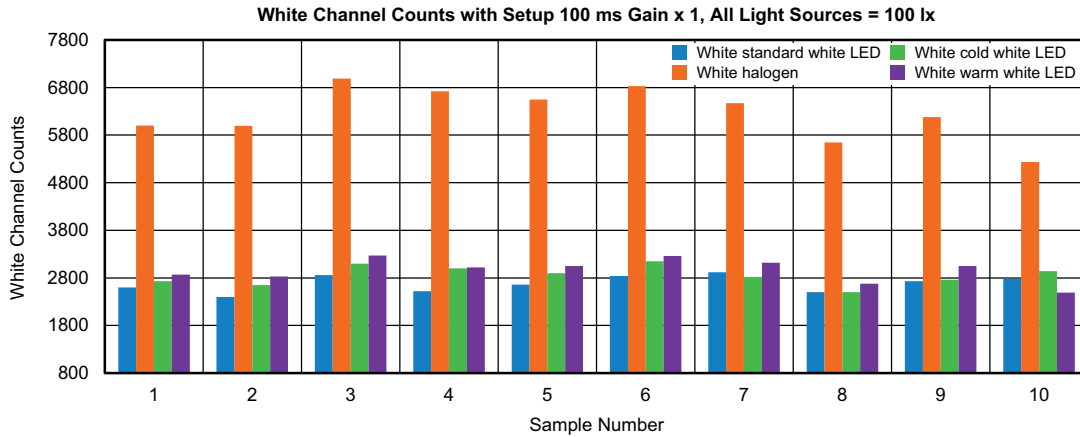

Fig. 16 - White Channel Counts for Different Light Sources

Remark: standard white LED: 5600K, cold white LED: 7500K, warm white LED: 3500K



The DNA of tech.®

## Designing the VEML6030 Into an Application

### POWER-SAVING MODES

The device stays in shutdown mode as long as no measurements need to be done. Once activated with ALS\_SD = 0, measurements are executed.

COMMAND REGISTER FORMAT				
COMMAND CODE	REGISTER NAME	BIT	FUNCTION / DESCRIPTION	R / W
00	ALS_SD	0	ALS shutdown setting 0 = ALS power on 1 = ALS shutdown	R / W

Without using the power-saving feature (PSM\_EN = 0), the controller has to wait before reading out measurement results, at least for the programmed integration time. For example, for ALS\_IT = 100 ms a wait time of ≥ 100 ms is needed.

A more simple way of continuous measurements can be realized by activating the PSM feature, setting PSM\_EN = 1.

COMMAND REGISTER FORMAT				
COMMAND CODE	REGISTER NAME	BIT	FUNCTION / DESCRIPTION	R / W
03	PSM	2 : 1	Power-saving mode; see table "Refresh Time" 00 = mode 1 01 = mode 2 10 = mode 3 11 = mode 4	R / W
	PSM_EN	0	Power-saving mode enable setting 0 = disable 1 = enable	R / W

The default this comes up with is mode 1 = 00 for the bits 2 and 1 within the command code. Depending on the chosen integration time (ALS\_IT), this leads to a certain measurement speed / repetition rate.

For ALS\_IT = 100 ms (0000 for bits 9 : 6 within command register) this is about 600 ms. For 200 ms (0001) it will be 700 ms, for 400 ms (0010) 900 ms, and for 800 ms (0011) about 1300 ms.

PSM	ALS_IT	REFRESH TIME (ms)
00	0000	600
00	0001	700
00	0010	900
00	0011	1300

Other PSM modes will lead to even lower repetition rates. This will also lead to a lower power consumption (see the table on the next page).

The higher the PSM value and the longer the integration time, the lower the current consumption will be. The possible sensitivity also depends on integration time, where the longest (800 ms) will lead to 0.0042 lx/counts, together with the highest gain: ALS\_GAIN = 01 (ALS gain x 2).

All refresh times, corresponding current consumptions, and possible sensitivities are shown in the table on the next page.



The DNA of tech.®

## Designing the VEML6030 Into an Application

REFRESH TIME, I <sub>DD</sub> , AND RESOLUTION RELATION					
ALS_GAIN	PSM	ALS_IT (ms)	REFRESH TIME (ms)	I <sub>DD</sub> (μA)	RESOLUTION (lx/bit)
x2	Mode 1	100	600	8	0.0336
x2	Mode 2	100	1100	5	0.0336
x2	Mode 3	100	2100	3	0.0336
x2	Mode 4	100	4100	2	0.0336
x2	Mode 1	200	700	13	0.0168
x2	Mode 2	200	1200	8	0.0168
x2	Mode 3	200	2200	5	0.0168
x2	Mode 4	200	4200	3	0.0168
x2	Mode 1	400	900	20	0.0084
x2	Mode 2	400	1400	13	0.0084
x2	Mode 3	400	2400	8	0.0084
x2	Mode 4	400	4400	5	0.0084
x2	Mode 1	800	1300	28	0.0042
x2	Mode 2	800	1800	20	0.0042
x2	Mode 3	800	2800	13	0.0042
x2	Mode 4	800	4800	8	0.0042

### INTERRUPT HANDLING

To avoid too many interactions with the microcontroller, the interrupt feature may be used. This is activated with ALS\_INT\_EN = 1.

Only when the programmed threshold is crossed (above / below) consecutively by the programmed number of measurements (ALS\_PERS) will the corresponding interrupt bit (ALS\_IF\_L or ALS\_IF\_H) be set and the interrupt pin pulled down.

COMMAND REGISTER FORMAT				
COMMAND CODE	REGISTER NAME	BIT	FUNCTION / DESCRIPTION	R / W
00	ALS_INT_EN	1	ALS interrupt enable setting 0 = ALS INT disable 1 = ALS INT enable	R / W
00	ALS_PERS	5 : 4	ALS persistence protect number setting 00 = 1 01 = 2 10 = 4 11 = 8	R / W
01	ALS_WH	15 : 8	ALS high threshold window setting (MSB)	R / W
		7 : 0	ALS high threshold window setting (LSB)	R / W
02	ALS_WL	15 : 8	ALS low threshold window setting (MSB)	R / W
		7 : 0	ALS low threshold window setting (LSB)	R / W
06	ALS_IF_L	15	ALS crossing low threshold INT trigger event	R
	ALS_IF_H	14	ALS crossing high threshold INT trigger event	R
	reserved	13 : 0		

APPLICATION NOTE



The DNA of tech.®

## Designing the VEML6030 Into an Application

### MECHANICAL CONSIDERATIONS AND WINDOW CALCULATION FOR THE VEML6030

The ambient light sensor will be placed behind a window or cover. The window material should be completely transmissive to visible light (400 nm to 700 nm). For optimal performance the window size should be large enough to maximize the light irradiating the sensor. In calculating the window size, the only dimensions that the design engineer needs to consider are the distance from the top surface of the sensor to the outside surface of the window and the size of the window. These dimensions will determine the size of the detection zone.

First, the center of the sensor and center of the window should be aligned. The VEML6030 has an angle of half sensitivity of about  $\pm 55^\circ$ , as shown in the figure below.

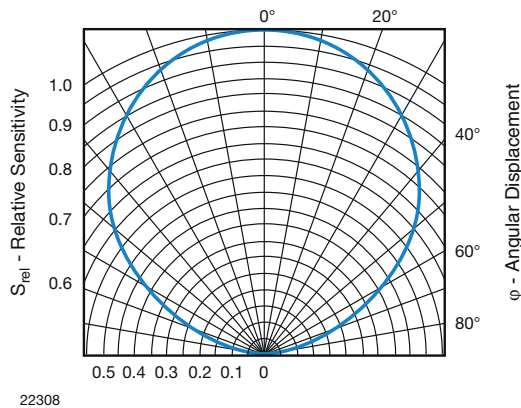

Fig. 17 - Relative Radiant Sensitivity vs. Angular Displacement

**Remark:**

This wide angle and the placement of the sensor as close as possible to the cover is needed if it should show comparable results to an optometer, which also detects light reflections from the complete surroundings.

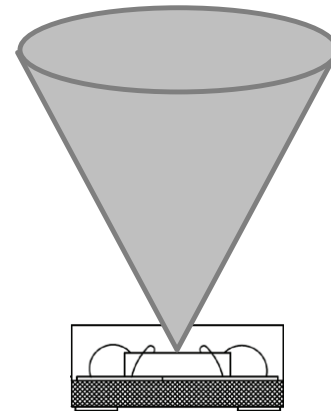

Fig. 18 - Angle of Half Sensitivity: Cone

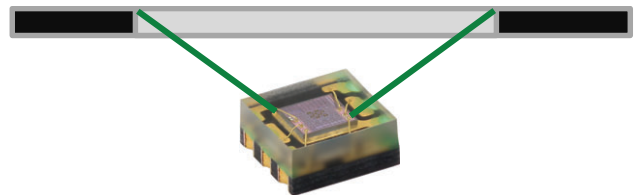

Fig. 19 - Windows Above Sensitive Area

The size of the window is simply calculated according to triangular rules. The dimensions of the device are shown within the datasheet, and with the known distance below the window's upper surface and the specified angle below the given window diameter ( $w$ ), the best results are achieved.

The DNA of tech.®

## Designing the VEML6030 Into an Application

### VEML6030

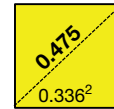
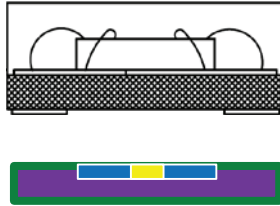
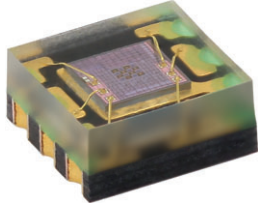

Dimensions (L x W x H in mm): 2 x 2 x 0.87

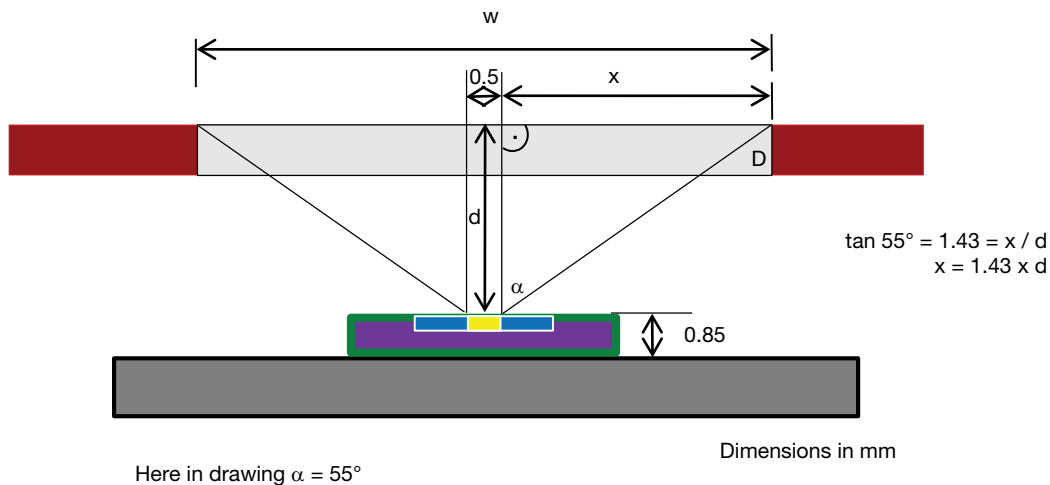

Fig. 20 - Window Area for an Opening Angle of  $\pm 55^\circ$

The calculation is then:  $\tan \alpha = x / d \rightarrow$  with  $\alpha = 55^\circ$  and  $\tan 55^\circ = 1.43 = x / d \rightarrow x = 1.43 \times d$   
Then the total width is  $w = 0.5 \text{ mm} + 2 \times x$ .

$d = 0.5 \text{ mm}$	$\rightarrow$	$x = 0.72 \text{ mm}$	$\rightarrow$	$w = 0.5 \text{ mm} + 1.44 \text{ mm}$	$= 1.94 \text{ mm}$
$d = 1.0 \text{ mm}$	$\rightarrow$	$x = 1.43 \text{ mm}$	$\rightarrow$	$w = 0.5 \text{ mm} + 2.86 \text{ mm}$	$= 3.36 \text{ mm}$
$d = 1.5 \text{ mm}$	$\rightarrow$	$x = 2.15 \text{ mm}$	$\rightarrow$	$w = 0.5 \text{ mm} + 4.30 \text{ mm}$	$= 4.80 \text{ mm}$
$d = 2.0 \text{ mm}$	$\rightarrow$	$x = 2.86 \text{ mm}$	$\rightarrow$	$w = 0.5 \text{ mm} + 5.72 \text{ mm}$	$= 6.22 \text{ mm}$
$d = 2.5 \text{ mm}$	$\rightarrow$	$x = 3.58 \text{ mm}$	$\rightarrow$	$w = 0.5 \text{ mm} + 7.16 \text{ mm}$	$= 7.66 \text{ mm}$
$d = 3.0 \text{ mm}$	$\rightarrow$	$x = 4.29 \text{ mm}$	$\rightarrow$	$w = 0.5 \text{ mm} + 8.58 \text{ mm}$	$= 9.08 \text{ mm}$

A smaller window is also sufficient if reference measurements can be done and / or if the output result does not need to be as exact as an optometer.

The DNA of tech.®

## Designing the VEML6030 Into an Application

### VEML6030

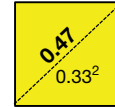
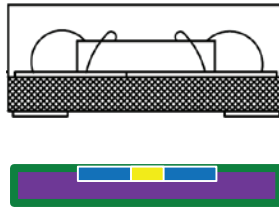
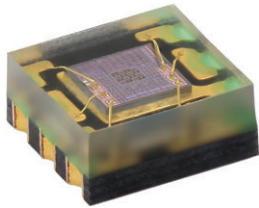

Dimensions (L x W x H in mm): 2 x 2 x 0.87

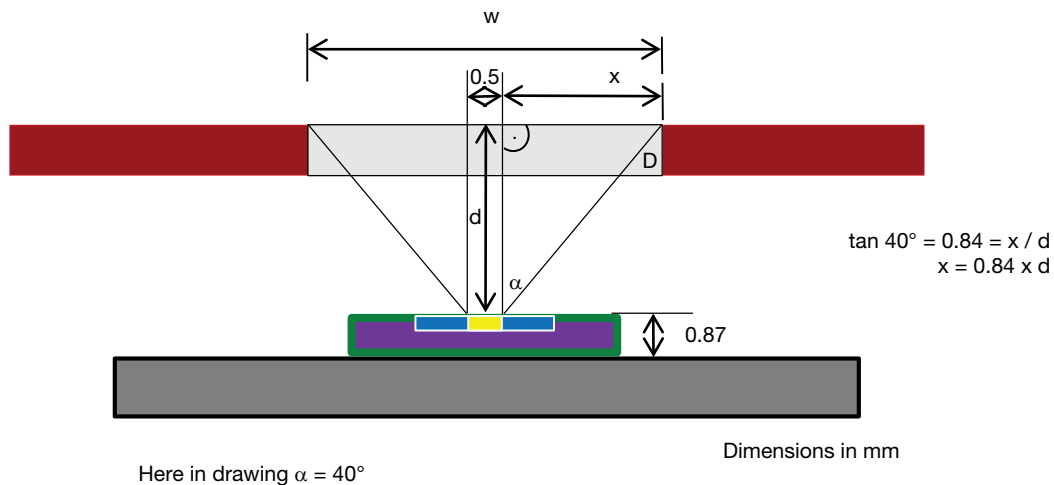

Fig. 21 - Window Area for an Opening Angle of  $\pm 40^\circ$

The calculation is then:  $\tan \alpha = x / d \rightarrow$  with  $\alpha = 40^\circ$  and  $\tan 40^\circ = 0.84 = x / d \rightarrow x = 0.84 \times d$   
Then the total width is  $w = 0.5 \text{ mm} + 2 \times x$ .

$d = 0.5 \text{ mm}$	$\rightarrow$	$x = 0.42 \text{ mm}$	$\rightarrow$	$w = 0.5 \text{ mm} + 0.84 \text{ mm}$	$=$	$1.34 \text{ mm}$
$d = 1.0 \text{ mm}$	$\rightarrow$	$x = 0.84 \text{ mm}$	$\rightarrow$	$w = 0.5 \text{ mm} + 1.68 \text{ mm}$	$=$	$2.18 \text{ mm}$
$d = 1.5 \text{ mm}$	$\rightarrow$	$x = 1.28 \text{ mm}$	$\rightarrow$	$w = 0.5 \text{ mm} + 2.56 \text{ mm}$	$=$	$3.06 \text{ mm}$
$d = 2.0 \text{ mm}$	$\rightarrow$	$x = 1.68 \text{ mm}$	$\rightarrow$	$w = 0.5 \text{ mm} + 3.36 \text{ mm}$	$=$	$3.86 \text{ mm}$
$d = 2.5 \text{ mm}$	$\rightarrow$	$x = 2.10 \text{ mm}$	$\rightarrow$	$w = 0.5 \text{ mm} + 4.20 \text{ mm}$	$=$	$4.70 \text{ mm}$
$d = 3.0 \text{ mm}$	$\rightarrow$	$x = 2.52 \text{ mm}$	$\rightarrow$	$w = 0.5 \text{ mm} + 5.04 \text{ mm}$	$=$	$5.54 \text{ mm}$



The DNA of tech.®

## Designing the VEML6030 Into an Application

### TYPICAL SOFTWARE FLOW CHART

For a wide light detection range of more than seven decades (from 0.007 lx to 120 klx), it is necessary to adjust the sensor. This is done with the help of four gain steps and seven steps for the integration time. To deal with these steps, they are numbered as needed for the application software.

The ALS gain modes are called G1 to G4 and the integration times are called IT:

Sensitivity Mode Selection	G	ALS Integration Time Setting	IT
00 = ALS gain x 1	→ 3	1100 = 25 ms	→ -2
01 = ALS gain x 2	→ 4	1000 = 50 ms	→ -1
10 = ALS gain x (1/8)	→ 1	0000 = 100 ms	→ 0
11 = ALS gain x (1/4)	→ 2	0001 = 200 ms	→ 1
		0010 = 400 ms	→ 2
		0011 = 800 ms	→ 3

Whereas the programmed gain begins with the lowest possible value, in order to avoid any saturation effect the integration time starts with 100 ms: IT = 0.

With this just about 30 klx is possible. If this is not enough due to a wide and clear cover, and the sensor is being exposed to direct bright sunlight, one may also begin with the shortest integration time.

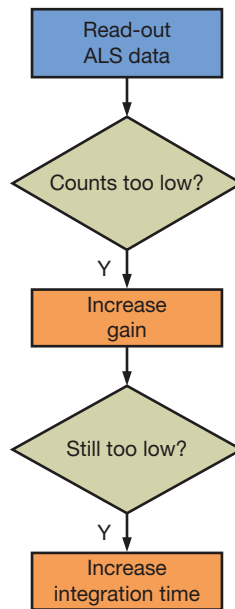

Fig. 22 - Simple Flow Chart View

The DNA of tech.®

## Designing the VEML6030 Into an Application

### TYPICAL SOFTWARE FLOW CHART WITH CORRECTION FORMULA (1)

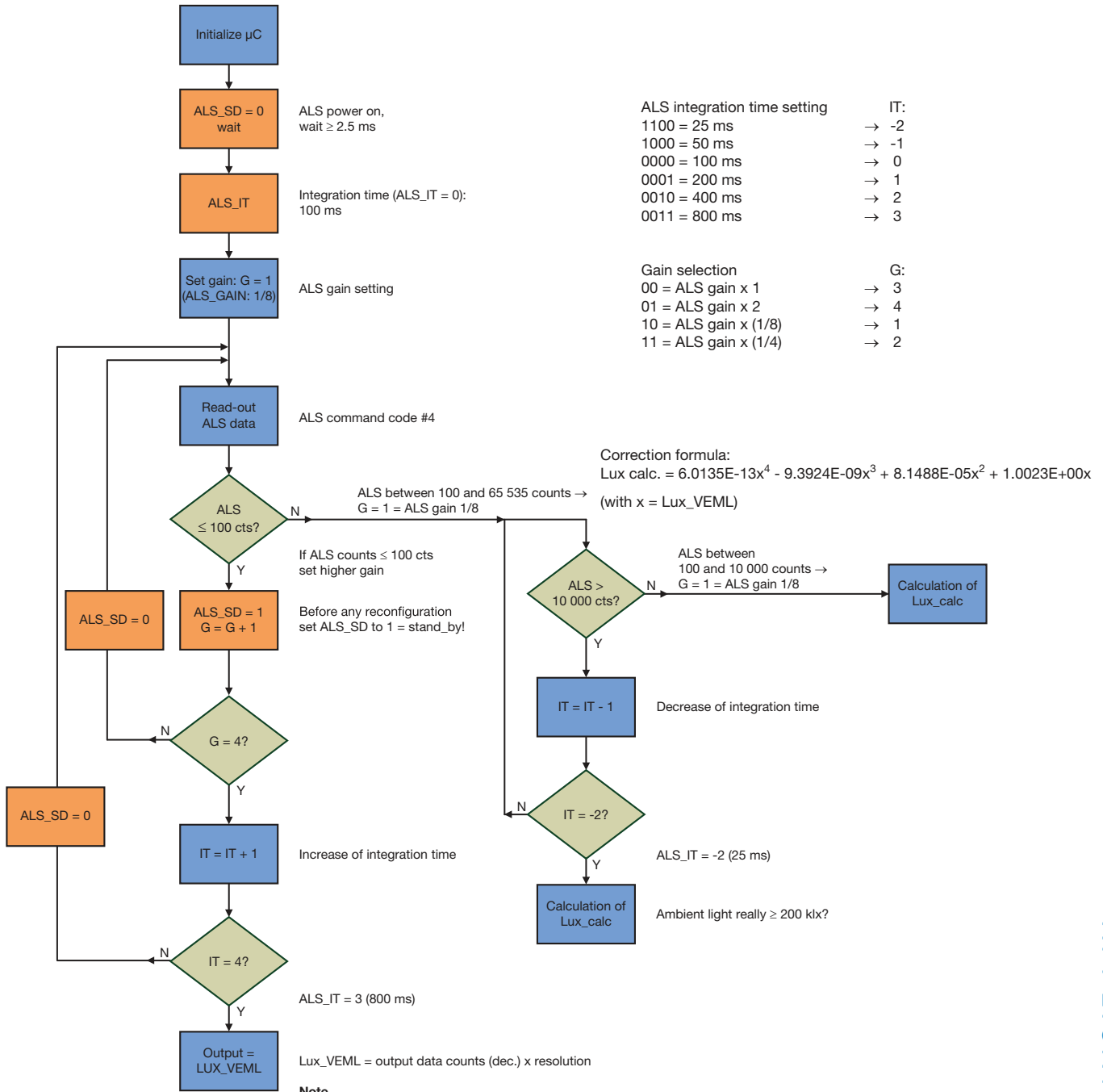

Fig. 23 - Flow Chart with Correction Formula from  $\geq 100$  lx



The DNA of tech.®

# Designing the VEML6030 Into an Application

## TYPICAL LUMINANCE VALUES

Luminance	Example
10 <sup>-5</sup> lx	Light from Sirius, the brightest star in the night sky
10 <sup>-4</sup> lx	Total starlight, overcast sky
0.002 lx	Moonless clear night sky with airglow
0.01 lx	Quarter moon, 0.27 lx; full moon on a clear night
1 lx	Full moon overhead at tropical latitudes
3.4 lx	Dark limit of civil twilight under a clear sky
50 lx	Family living room
80 lx	Hallway / bathroom
100 lx	Very dark overcast day
320 lx to 500 lx	Office lighting
400 lx	Sunrise or sunset on a clear day
1000 lx	Overcast day; typical TV studio lighting
10 000 lx to 25 000 lx	Full daylight (not direct sun)
32 000 lx to 130 000 lx	Direct sunlight

## VEML6030 SENSOR BOARD AND DEMO SOFTWARE

The small blue VEML6030 sensor board is compatible with the SensorExplorer™. Please also see [www.vishay.com/optoelectronics/SensorExplorer](http://www.vishay.com/optoelectronics/SensorExplorer).

After plugging in the VEML6030 sensor board to the USB dongle (both up or down are possible) and activating with the “VEML6030.exe” file, the “Ambient Light” menu appears.

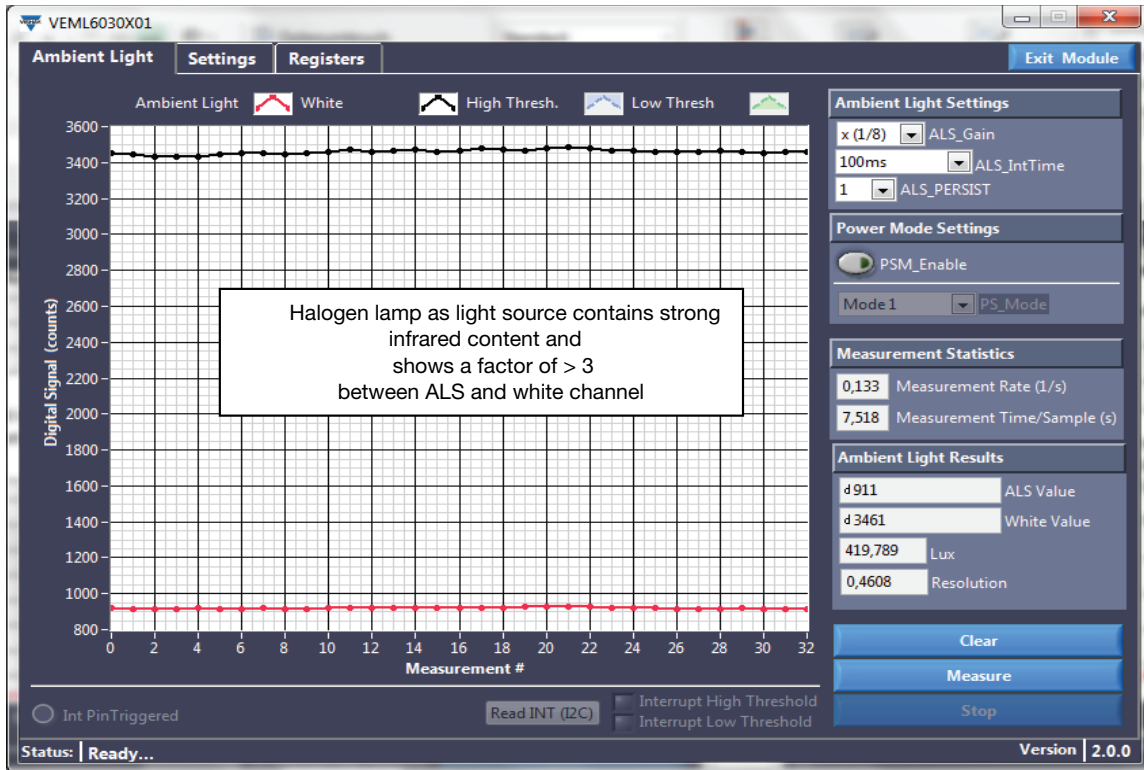

The ALS sensitivity mode is preprogrammed to “gain x 1/8” and integration time to “100 ms.” Self-timed measurements are started by clicking the measure button.

The DNA of tech.®

## Designing the VEML6030 Into an Application

Both, the ALS and the white channel are shown. A channel can be deactivated by clicking within the small white box on top of the graph and clicked again to make visible. In addition, decimal, binary, or hex formats can be selected in the small white boxes on the right side, where the small letters “d” and “b” are shown.

The lux level is calculated according to the rules mentioned above, and the chosen gain and integration time are displayed in the lowest white box “Lux.”

The screen shots below appear when programming the upper and lower thresholds within the “Settings” menu.

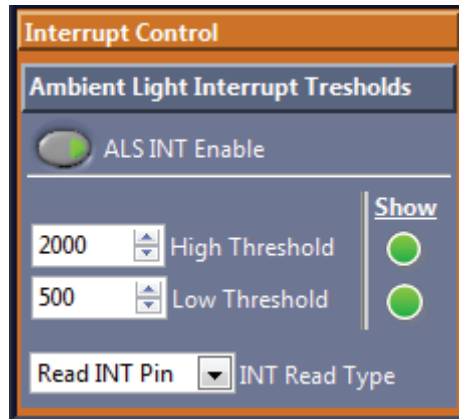

Selecting “ALS INT Enable” and “Show” within the measurement menu will then show the high and low thresholds as blue and green lines, respectively. If the light source changes to that higher or lower value, the below appears.

