

U.S. Fire Administration

Voice Radio Communications Guide for the Fire Service

June 2016



FEMA



U.S. Fire Administration

Mission Statement

We provide National leadership to foster a solid foundation for our fire and emergency services stakeholders in prevention, preparedness, and response.



FEMA



This page intentionally left blank.

Acknowledgment

The U.S. Fire Administration (USFA) is committed to using all means possible for reducing the incidence of injuries and deaths to firefighters. One of these means is to partner with organizations that share this same admirable goal. One such organization is the International Association of Fire Fighters (IAFF). As a labor union, the IAFF has been deeply committed to improving the safety of its members and all firefighters as a whole. This is why the USFA was pleased to work with the IAFF through a partnership supported by the U.S. Department of Homeland Security (DHS), Science and Technology Directorate, First Responders Group, Office for Interoperability and Compatibility to develop this second edition of the “Voice Radio Communications Guide for the Fire Service.” The USFA gratefully acknowledges the following leaders of the IAFF for their willingness to partner on this project:

General President Harold Schaitberger

General Secretary-Treasurer Thomas Miller

Assistant to the General President

Occupational Health, Safety and Medicine Patrick Morrison

International Association of Fire Fighters, AFL-CIO, CLC

Division of Occupational Health, Safety and Medicine

1750 New York Ave., NW

Washington, DC 20006

202-737-8484

www.iaff.org

The IAFF also would like to thank Robert Athanas, Firefighter, Fire Department City of New York; Todd Bianchi, Captain, District of Columbia Fire Department; Jim Brinkley, IAFF Director of Occupational Health and Safety; Joseph Brooks, Radio Supervisor, Boston Fire Department; Thomas Chirhart, DHS; Billy Freeman, Lieutenant, Memphis Fire Department; Missy Hannan, Graphic Artist, International Fire Service Training Association (IFSTA)/Fire Protection Publications, Oklahoma State University; Ron Jeffers, Union City, New Jersey; Christopher Lombard, Captain, Seattle Fire Department; Andy MacFarlane, Phoenix, Arizona; Kevin Roche, FACETS Consulting; Wes Rogers, Lieutenant, Fairfax County Fire and Rescue Department; William Troup, USFA; Mike Wieder, Associate Director, IFSTA/Fire Protection Publications, Oklahoma State University; Cody Worrell, Firefighter, Phoenix Fire Department; and Mike Worrell, Battalion Chief, Phoenix Fire Department, for their efforts in developing this report.

The Federal Emergency Management Agency (FEMA) does not endorse, approve, certify or recommend any contractors, individuals, firms or products. Contractors, individuals or firms shall not claim they or their products are “FEMA approved” or “FEMA certified.”



This page intentionally left blank.



Table of Contents

Acknowledgment	i
Table of Contents	iii
Section 1 — Introduction	1
Purpose.....	1
Why the Fire Service is Different	1
Summary — Fire Service Environment.....	2
Section 2 — Basic Radio Communication Technology	5
Radio Spectrum.....	5
Wavelength	6
Channel Bandwidth	7
Radio Wave Propagation.....	8
Interference.....	9
What Affects System Coverage?	10
Fixed-Site Antennas.....	11
Downtilt.....	13
Portable Radio Position	13
Mobile and Portable Antennas.....	14
Summary — Basic Radio Communication Technology	15
Section 3 — Digital and Analog Radio	17
Analog Radios	17
Digital Radios.....	18
Digital Audio Processing	19
Analog and Digital Comparisons	19
Program 25 History	21
Program 25 Interoperability.....	21
Program 25 Characteristics in High-Noise Environments.....	21
Self-Contained Breathing Apparatus Mask Effect on Communications	22
Program 25 Digital for Firefighting	22
Summary — Digital and Analog Radio	23
Section 4 — Conventional Radio Systems	25
Direct and Repeated Radio Systems	25
Direct/Simplex Communications on the Fireground.....	25
Receiver Voters — Improve Field Unit to Dispatcher Communications.....	26
Repeaters — Improve Field Unit to Dispatch and Off-Scene Units	28
Simulcast Transmitter Systems	30
Alerting.....	31
Summary — Conventional Radio Systems	31
Section 5 — Trunked Radio Systems	33
Basic Trunked Radio Operations	34
Talkgroup Call.....	34
Call Disconnection	35
Designing a Trunked Radio System	35
Capacity Design.....	36
Coverage Design.....	36
Coverage Enhancement Devices	37

Vehicular Repeaters	39
Other Trunking System Features	40
Summary — Trunked Radio Systems	42
Section 6 — Portable Radio Selection and Use	43
General	43
Ergonomics	43
Environmental Technical Standards.....	43
International Electrotechnical Commission Ingress Protection Codes.....	44
Military Standards	44
How Many?	44
NFPA 1561	45
NFPA 1221	45
What Type?	45
Multiband	46
National Institute of Standards and Technology Testing	46
Technical Note 1477	46
Technical Note 1850.....	46
NFPA 1802, <i>Standard on Personal Portable (Hand-Held) Two-Way Radio Communications Devices for Use by Emergency Services Personnel in the Hazard Zone</i>	47
Fire Radio Features.....	47
Portable Radio User Training Guide	48
Human Factors	49
Technical Factors.....	49
Where to Wear Your Radio	50
Coverage	53
Accessories	53
Summary — Portable Radio Selection and Use	53
Section 7 — System Design and Implementation	55
Project Organization	55
Requirements Definition	55
Identify Operational Needs	56
Plan for Change.....	56
Evaluation of Current System	57
Funding	57
Alternative Funding Sources.....	57
Grant Writing.....	58
Evaluation of Proposed Technologies	58
Technical Options and Conceptual Design	58
Should You Hire a Consultant or System Integrator?.....	59
Where to Get Advice	60
Procurement	61
Developing the Request for Proposals	61
Evaluating Request for Proposals Responses	62
Implementation.....	63
Training and Transition.....	63
Implementation Lessons Learned and Feedback	64
Long-Term Operation and Maintenance	64
Summary — System Design and Implementation	65



Section 8 — Interoperability	67
Frequency Coordination.....	67
Interoperability Continuum	67
Day to Day.....	68
Large Incidents	69
Communications Unit.....	69
Summary — Interoperability	71
Section 9 — Radio Spectrum Licensing and the Federal Communications Commission.....	73
Rulemaking.....	73
Licensing.....	74
Federal Communications Commission Actions to Increase Public Safety Spectrum.....	75
Further Narrowbanding.....	77
Public Safety Wireless Advisory Committee	77
700 Megahertz Spectrum Allocation	77
800 Megahertz Reconfiguration	78
T-Band	79
Summary — Radio Spectrum Licensing and the Federal Communications Commission.....	81
Section 10 — First Responder Network Authority or FirstNet	83
History	83
Formation of FirstNet.....	83
Cost.....	86
Accessibility	86
Survivability	87
Security	87
Public Safety Focus.....	87
Possible Fire Service Uses	87
Summary — FirstNet.....	88
Glossary	91
Acronyms.....	97



This page intentionally left blank.

SECTION 1 — Introduction

Purpose

The past few decades have seen major advancements in the communications industry. Portable communications devices have gone from being used mainly in public safety and business applications to a situation where they are in every home and in the hands of almost every American man, woman and child. As users are added, there is more stress on the system, and there is only so much room on the radio spectrum. The communications industry and the government have responded by making changes to the system that mandate additional efficiency.

These advancements have improved radio frequency (RF) spectrum efficiency but have added complexity to the expansion of existing systems and the design of new systems. Some of these advances in technology are mandated by the Federal Communications Commission (FCC), while others are optional. Many users of public safety spectrum have endured the time, effort and costs associated with narrowbanding. This effort created additional capacity in the existing spectrum, but performance of some existing systems was degraded when converted from 25 kilohertz (kHz) to 12.5 kHz. Even with narrowbanding, the appetite for RF spectrum continues to grow, necessitating continued efforts for spectral efficiency. “The migration to 12.5 kHz efficiency technology will require licensees to operate more efficiently, either on narrower channel bandwidths or increased voice paths on existing channels. This will allow creation of additional channels within the same spectrum, thereby supporting more users.”¹ The costs and operational effects of these changes are significant. The actual RF physics associated with moving to narrowband with no other system changes resulted in loss of range.² Navigating through the complex technological and legal options of public safety communications led to the development of this guide to assist the fire service in the decision-making process.

The fire service is diverse. Departments range from those that are very large in size and have multimillion dollar budgets to small departments that rely on pancake breakfasts or bake sales to augment the operating budget. All departments, professional or volunteer, require reliable communications. The size of the budget does not change the physics or RF properties. All departments and firefighters need to understand basic radio principles to remain safe on the fireground and use communications equipment effectively.

Why the Fire Service is Different

The life safety of firefighters and citizens depends on reliable, functional communication tools that work in the harshest and most hostile of environments. All firefighters, professional and volunteer, operate in extreme environments that are markedly different from those of any other radio users. The radio is the lifeline that connects the firefighters to command and outside assistance when in the most desperate of situations. To operate safely in these dynamic environments, it is imperative that firefighters have the ability to immediately communicate information accurately. The importance was not lost by the firefighting community when they adopted the internationally recognized terminology mayday³ to signify an emergency situation. The mayday is often the “last chance” to get outside assistance, and the fire service’s ear is always listening for that call of distress.

Environment

Firefighters operate lying on the floor, in zero visibility, high heat, high moisture, and wearing self-contained breathing apparatus (SCBA) facepieces that distort the voice. The incidents we operate on can be chaotic with an intense amount of fast-paced communications until the incident is stabilized. The fireground is filled with an extraordinary amount of noise. The only way to really understand the amount and intensity of the

¹ <http://transition.fcc.gov/pshs/public-safety-spectrum/narrowbanding-faq.html>.

² http://www.cgwireless.com/images/NARROWBANDING_GUIDE_E_BOOK_JAN_2012.pdf, p. 31.

³ National Fire Protection Association (NFPA) 1561, *Standard on Emergency Services Incident Management System and Command Safety*, 2014 edition, Chapter 6, 6.3.2.1.

noisy environment is to experience it. The engines that drive pumps operating at high rpm, the sound of a circular saw blade sinking into a metal roll-up door, the roaring sound from an operating fire hose nozzle, the distorted high-volume voices straining through the mechanical voice ports of an SCBA facepiece are all part of our operating environment. Along with all of those challenges, we are enduring the prickly sensation of heat on our ears and hands. We adjust our position to “fluff up” the insulation in our turnouts, and even though our environment is hot, we have to keep a “cool head.”

We wear bulky safety equipment to overcome the temperature extremes that we are subjected to. The thermal extremes we encounter drive us to the floor and require us to crawl on our hands and knees or operate while lying down. These positions are not the optimal position to communicate with a device using radio waves. Gloves eliminate the manual dexterity required to operate portable radio controls, hoods and flaps that protect ears affect the ability to hear clearly, vision is diminished by the smoky environment, and SCBA facepieces distort and reduce the field of view. The facepieces impede voice communications, requiring the use of a loud voice to overcome the mechanical voice port unless the facepiece is equipped with some type of voice amplifier. All of the above are barriers to using radios effectively on the fireground. This requires firefighters to be intimately familiar with the radio equipment — being able to feel what the controls are by tactile sense and operating the radio.

Operations are conducted inside of buildings with various types of construction and size. The interiors of buildings can be as open as a warehouse or as confusing as a maze. Buildings can be as simple as a large shed to a multistory, energy efficient high-rise with many floors above and below. The construction type and materials used affect fireground communications by not allowing radio waves to penetrate the buildings. All of these factors must be considered in order to communicate in a safe and effective manner on the fireground.

Radio system manufacturers have designed and developed radios and radio systems that meet the needs of the majority of users in the marketplace.

The fire service is a small part of the public safety communications market and an even smaller part of the overall communications market. This has resulted in one-size-fits-all public safety radios and systems that do not always meet the needs of the fire service as a whole or those of a specific department. When you consider the extreme operating environment and the protective clothing, the fire service is unique among public safety and other municipal communications users.

Fire Service Communications Model

The fire service operates in a staged state with resources located in fire stations. Calls are dispatched to specific units based on their location in relation to the incident. When more than one unit responds to an incident, an on-scene Command structure is established to coordinate fire attack, provide safety and accountability, and manage resources.⁴ The units assigned to these incidents work for the local Incident Commander (IC) who is the focal point of communications on the fireground. During the initial attack, fireground communications are fast-paced and chaotic to the untrained listener. The dispatch center assumes a support role and simultaneously documents specific fireground events, handles requests for additional resources, and may record fireground tactical radio traffic.

Summary — Fire Service Environment

The fire service operates in unique and challenging environments. The fire service recognizes the significance and importance of radio communications. The radio is the lifeline for firefighters in trouble. Use of the mayday term signifies the importance of the radio by using an internationally recognized term when in distress. Factors that separate fire from other disciplines:

- Communications pace — communications on the fireground are fast-paced and may be chaotic.
- Work position — firefighters are often on the floor crawling. This is not the optimal position for radio transmissions.
- Visibility challenges — heavy smoke and dark situations require users to be intimately familiar with the equipment.

⁴NFPA 1561, 2014 edition, Annex G.

- SCBAs pose several challenges:
 - Voice ports on facepieces are difficult to communicate through.
 - Visibility — restricts field of vision.
 - Temperature and humidity:
 - High heat.
 - High humidity.
 - High noise environments — difficult to communicate from the high noise area and difficult to hear in a high noise environment.
 - Gloves and other personal protective equipment (PPE) restrict vision, hearing and the manual dexterity required to operate radio controls.
 - Buildings vary greatly in construction and complexity. All buildings to some degree resist penetration of radio waves. The RF resistance varies on construction type, size and layout.
-



This page intentionally left blank.

SECTION 2 — Basic Radio Communication Technology

When talking about fire department communications systems, usually we are talking about what are traditionally called Land Mobile Radio (LMR) systems. It is important for firefighters and fire officers to have a basic knowledge of radio system technologies to help them during the design, procurement or use of the radio system. By having this basic understanding, you will be able to participate effectively in critical discussions with technical staff, consultants, and manufacturers to get the safest, most effective voice communications system for your firefighters, command staff, and community.

Most radio system users do not need or have a detailed understanding of the technology behind the systems they use. However, such knowledge is important for those involved in procurement of the systems, in developing procedures for the use of the systems, and in training field users to have a more comprehensive understanding of their limitations, capabilities and operation.

All technologies have strengths and weaknesses. Understanding those characteristics is important in making decisions related to the technologies. No matter what a salesperson will tell you during the procurement process, no system is without risk, and all have had users who were not satisfied with some aspect of the system. The key is in understanding the technology enough to ask questions, understand the answers, and make a successful evaluation.

Radio Spectrum

Radio communications are possible because of electromagnetic waves. There are many types of electromagnetic waves, such as heat, light and radio energy waves. The difference between these types of waves is their frequency and their wavelength. The frequency of the wave is its rate of oscillation. One oscillation cycle per second is called one hertz (Hz). The types of electromagnetic energy can be described by a diagram showing the types as the frequency of the waves increases (Figure 2.1).

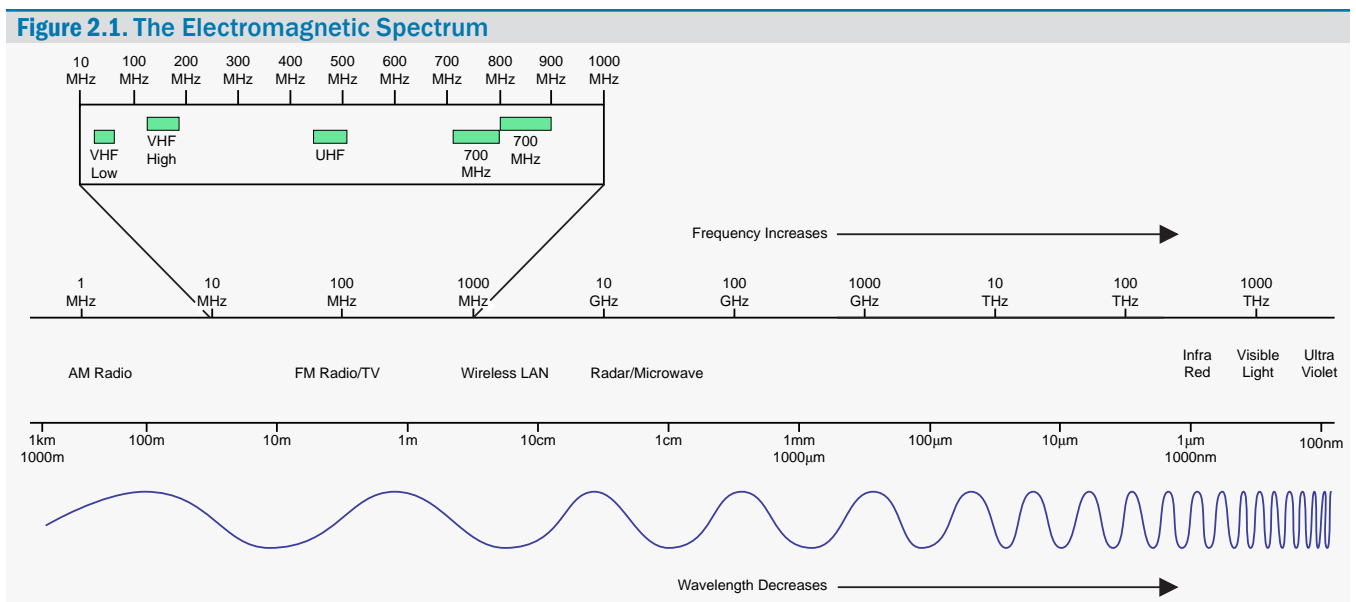

When describing the frequencies used by common radio systems, we use metric prefixes to quantify the magnitude of the frequency. A typical frequency used in fire department radio systems is 154,280,000 Hz. This is a frequency designated by the FCC as a mutual-aid radio channel.⁵ After dividing the frequency by the metric system prefix “mega,” equal to 1,000,000, this becomes 154.280 megahertz (MHz).

Public safety LMR systems are allowed to operate in portions of the radio spectrum under rules prescribed by the FCC.⁶ These portions of the spectrum are called bands, and LMR systems typically operate with frequencies in the 30 MHz (very high frequency (VHF) low), 150 MHz (VHF high), 450 MHz (ultra high frequency (UHF)), 700 MHz, and 800 MHz bands. Also, UHF spectrum in the T-Band, 470-512 MHz, is available to public safety within a 50 mile radius of the eleven largest metropolitan areas.⁷

The wavelength is the distance between two crests of the wave. The frequency and wavelength are inversely related so that as the frequency of the wave increases, the wavelength decreases (**Figure 2.2**).

Figure 2.2. Electromagnetic Wave

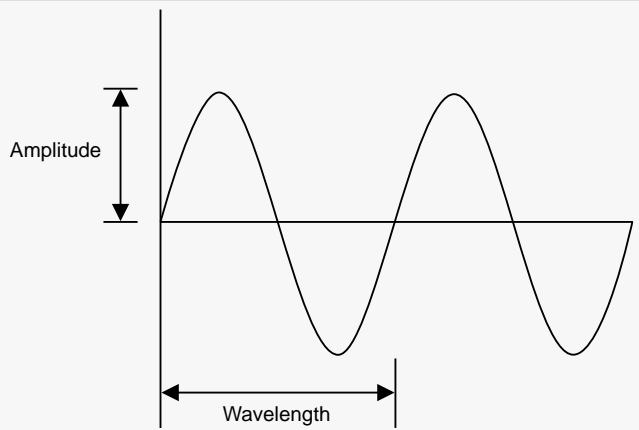

Wavelength

The wavelength of the radio signal is a determining factor in the size and design of the antenna. Wavelength is an actual distance that is usually measured in meters. Ham radio operators often do not refer to

frequency band of the radio but use the wavelength to classify the radio. A VHF radio would be referred to as a 2 meter rig and a UHF radio would be a 70 centimeter (cm) radio (**Figure 2.3**).

Figure 2.3. Radio Signal Wavelengths

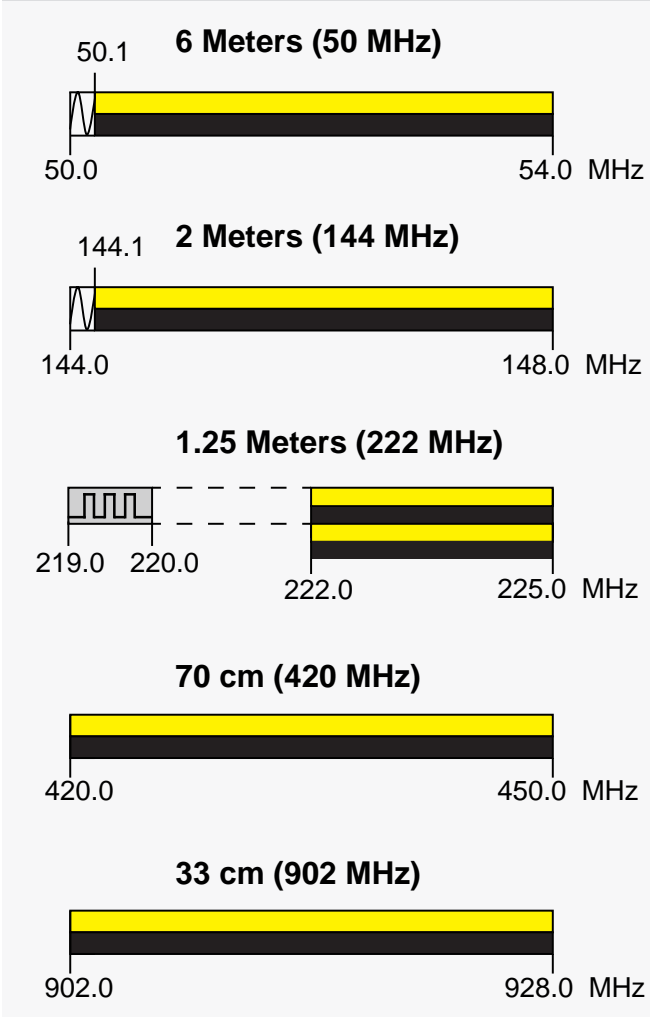

Figure a component of http://www.arri.org/files/file/Regulatory/Band%20Chart/Hambands_bw.pdf

A typical portable radio antenna is tuned to the frequency. We commonly hear the term one-quarter wave or one-half wave antennas. What this means is that the wavelength is multiplied by 0.25 or 0.5 to determine an optimal length for a transmitting or receiving antenna.

The length of a radio antenna is related to the signal wavelength with which the antenna is designed to operate. In general, the higher the frequency of the

⁵ U.S. DHS, Office of Emergency Communications, National Interoperability Field Operations Guide, Version 1.5, January 2014.

⁶ Code of Federal Regulations (CFR), Title 47, Part 90, Subpart B, 90.20.

⁷ The Middle Class Tax Relief and Job Creation Act of 2012 requires the FCC to auction the public safety T-Band spectrum by February 2021, and to clear public safety from the band within two years of conclusion of that auction. (Please see p. 79 of this document for additional information.)

waves used by the radio, the shorter the antenna on the radio. As you can see, the length of the antenna is based on science. The practice of putting a nonapproved longer antenna on a portable radio for a perceived performance improvement can actually damage a radio and should be discouraged. Users should always consult with their radio service provider before making any component change to maintain proper performance.

Channel Bandwidth

The radio spectrum is divided into channels. Each radio channel is designated by a frequency number that designates the center of the channel, with half of the bandwidth located on each side of the center.

Radio channel bandwidth is the amount of radio spectrum used by the signal transmitted by a radio. The greater the bandwidth, the more information that can be carried by the signal in the channel. Minimum channel bandwidth typically is limited by the state of technology and the bandwidth required to carry a given amount

of information. Standard bandwidth has decreased several times in the past to accommodate more users. However, there is a theoretical limit below which the bandwidth cannot be decreased. In addition, the actual width of a channel often is slightly greater than the minimum width, to provide some space on each side of the signal for interference protection from adjacent channels. For the purposes of radio licensing, the FCC sets the maximum and minimum bandwidth for channels in each frequency band.

The bandwidth of channels typically used in LMR is measured in thousands of Hz, or kHz. In an effort to place more communications activity within a limited radio spectrum, permitted bandwidth has been decreasing. Under older licensing rules, some of which are still in effect, typical channel bandwidths were 25 kHz. Rule changes effective Jan. 1, 2013, now require frequencies below 512 MHz to have bandwidths of 12.5 kHz. The narrowbanding of this spectrum increased the channels available for licensing (Figure 2.4).

Figure 2.4. Channel Bandwidth

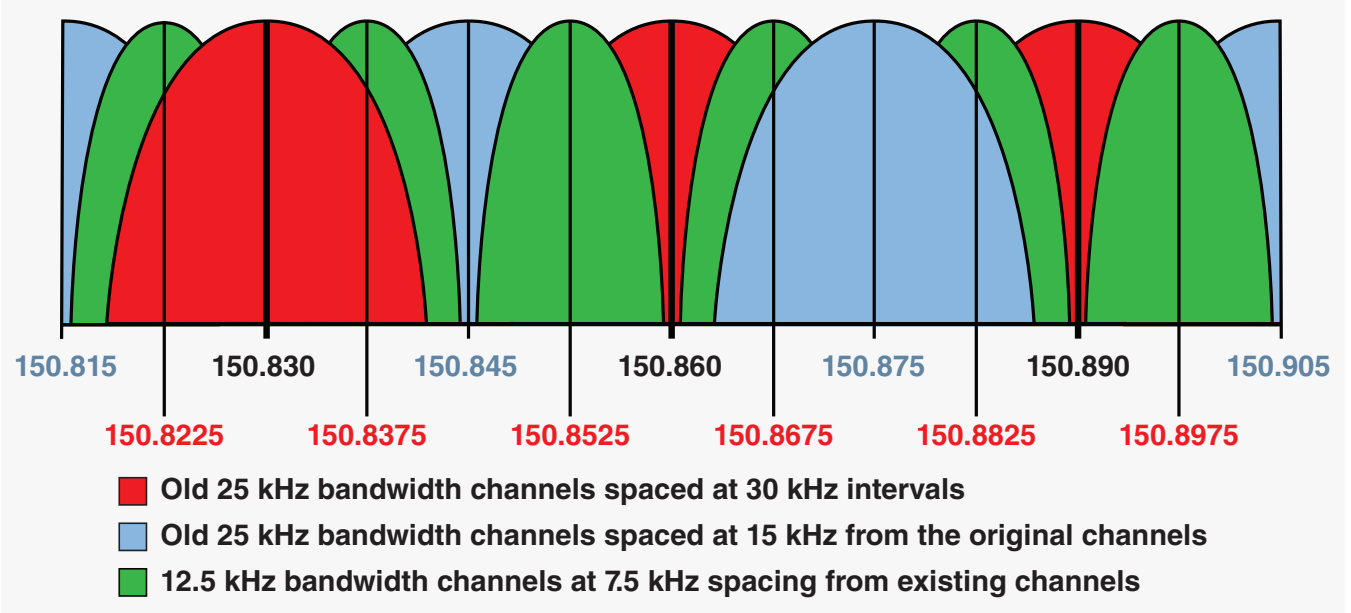
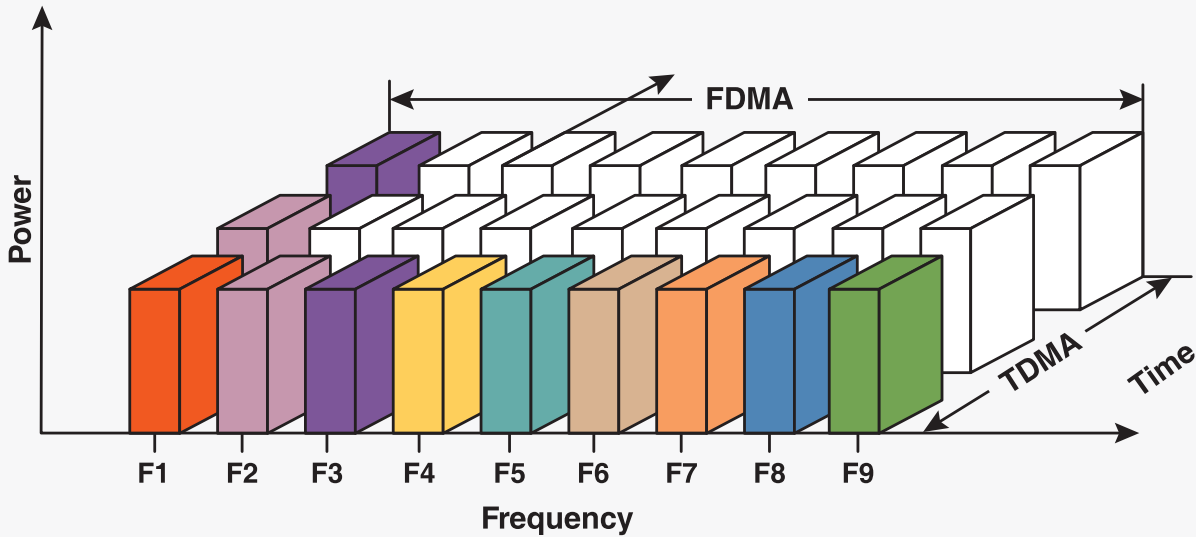

Figure 2.5. Two Slot Time Division Multiple Access



Spectrum efficiency is further improved by creating time slots within the bandwidth allocated thus creating two talk paths. As you can see in **Figure 2.5**, each frequency has two time slots that allow two talk paths on a single frequency. Digital radio technology allows use of frequency division multiple access (FDMA) or time division multiple access (TDMA) technologies. FDMA is being employed on many P25 Phase 1 trunked radio systems using 12.kHz and 25 kHz channels. A newer iteration of P25 — that is, P25 Phase 2 — uses TDMA technology to provide an effective 6.25 kHz bandwidth or in industry terms, a 6.25 kHz equivalent bandwidth. Digital is optional in most bands but is required on interoperability channels in the 700 MHz band.

Radio Wave Propagation

To send a radio signal from a transmitter to a receiver, the transmitter generates electromagnetic energy and sends that energy through a transmission line to an antenna. The antenna converts that energy into electromagnetic radio waves that travel at the speed of light outward from the antenna. If another antenna is located in the path of the waves, it can convert the waves back into energy and send that energy through a transmission line to a receiver (**Figure 2.6**).

Figure 2.6. Electromagnetic Signal Radiation

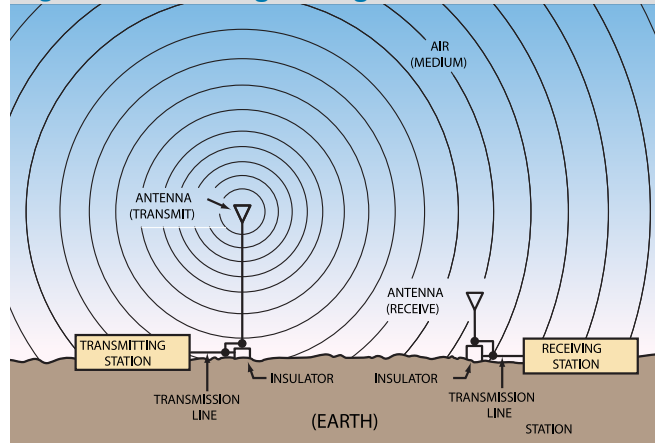

Radio signals emitted from an antenna travel both a direct path to the receiving antenna and a path reflected from the ground or other obstacles. This reflection causes the wave to travel a longer distance than the direct wave, as shown in **Figure 2.7**.

Figure 2.7. Signal Paths

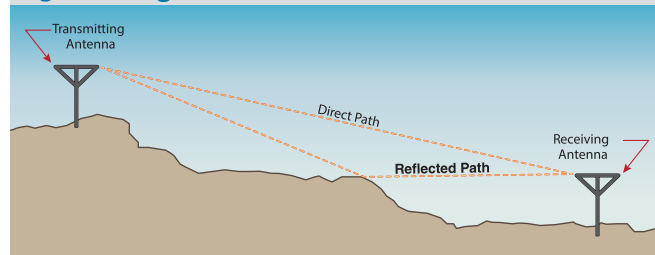

The waves traveling over the reflected path then interfere with the direct waves, causing an effect known as multipath interference. Multipath interference causes a variation in the signal level at the receiver. The signal may be higher or lower than the direct signal depending on the position of the receiver's antenna. As the antenna is moved around, the signal varies, and the user hears a signal that goes from strong and clear to weak and noisy.

Figure 2.8. Atmospheric Ducting

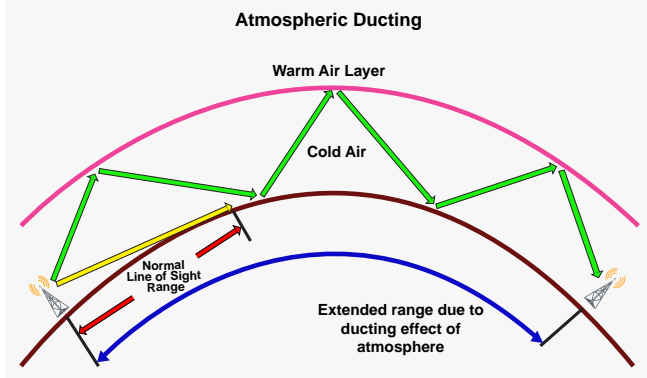

The atmosphere can have an effect on the range of radio waves. While on the surface this might be thought of as good, it is not. RFs are assigned and reassigned with enough geographic separation so they don't interfere. At times, atmospheric layers can form causing a ducting effect (Figure 2.8). The radio waves are usually limited to a line of sight range. When these atmospheric ducts form, the radio wave propagates out and hits the warm air layer and bounces between the warm air and ground, greatly increasing the range. The increased range often is the cause of interference on the far end due to the reuse of the frequencies. This condition is more prevalent in the lower frequency bands.

Radio waves can travel through some materials, such as glass or thin wood, but the strength is reduced due to absorption as they travel through. Materials such as metal and earth completely block the waves due to their composition and density. In addition, some materials will reflect radio waves, effectively blocking the signal to the other side.

Because buildings are built from many types of materials, the radio waves can be passed through some, be reflected by some, and be absorbed by others. This, along with the complex interior design of a building, creates a very complex environment for radio communications inside a building (Figure 2.9).

Figure 2.9. Terrain Blocking

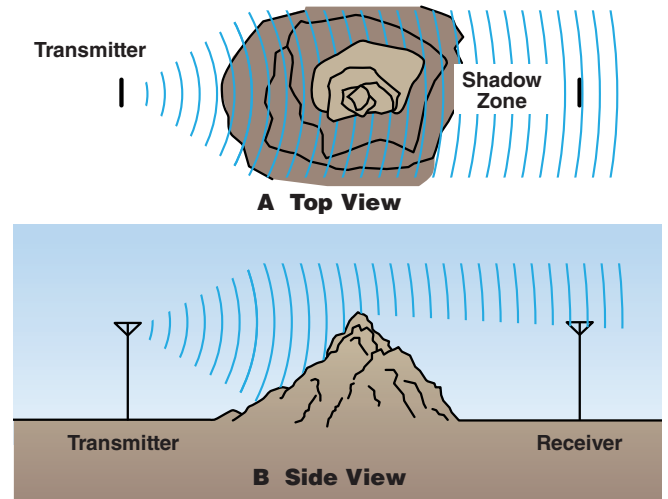

Interference

RF interference can be either natural or man-made. Interference from internal noise occurs naturally in all electronic equipment due to the nature of the electronic circuit itself. Manufacturers take this into account during equipment design, and obtaining a low-noise design is not particularly difficult. In addition, natural noise is produced by sunspot activity, cosmic activity, and lightning storms. This noise usually is of small magnitude and not significant for most LMR communications. The exception to this is the VHF low band that is affected significantly by severe sunspot activity, sometimes to the point of completely prohibiting communications.

More significant to radio communications systems is the interference produced by man-made sources. There are many sources of interference that you may encounter. Some interference sources are expected, such as vehicle ignitions, electric motors, and high-voltage transmission lines, but computers, light ballasts, and new energy efficient bulbs (both compact fluorescent lights (CFLs) and light-emitting diodes (LEDs)) emit radio signals that can interfere with public safety radios.

In general, man-made interference decreases with an increase in frequency. The UHF band and, initially, the 800 MHz band are much less susceptible to man-made interference than the VHF low and high bands. When systems are not subject to significant interference, they are said to be "noise limited," in contrast to "interference limited." The large number of transmitters used by cellular telephone companies has created intense interference in the 800 MHz band.

Although the separation of the channels allocated to cellular companies has reduced this interference, communications problems still can occur when a user is operating close to a cellular transmission facility. This type of interference is particularly a problem when the user is located near a cellular facility and the user's radio system site is located much further away. This creates a situation called "near-far" interference. The user's system signal strength is low, and the cellular signal is high, keeping the user's radio from receiving the desired signal. The 800 MHz band always was regarded as the "cleanest" band with respect to man-made interference, and systems initially were noise limited. However, all systems in the band now must be designed for maximum interference from nearby transmitters, which requires more transmitter locations and higher power, creating more costly systems.

Interference from cellular transmitters is illustrated in **Figure 2.10**. The blue area in the center is the public safety transmitter, and in the center of the gray areas are the cellular transmitters.

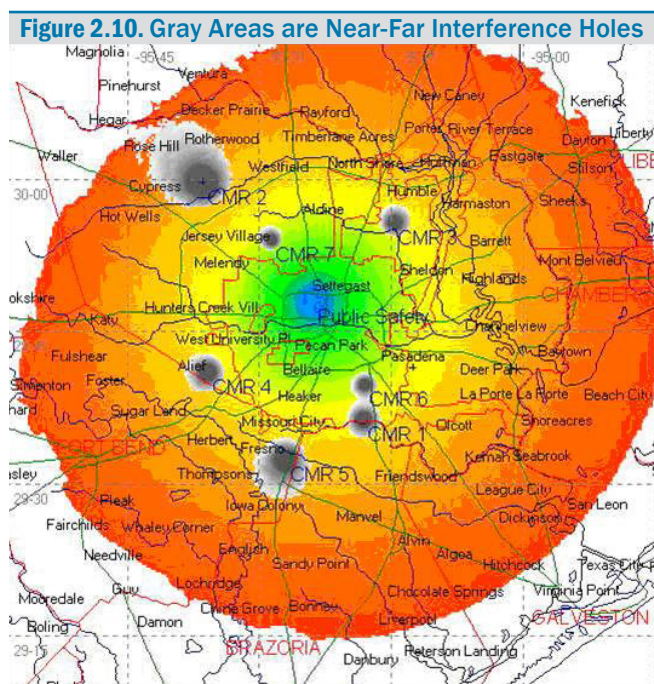

Intermodulation interference is caused directly by the mixing of two or more radio signals. The mixing most commonly occurs inside the receiver or transmitter of a radio. This mixing can create a third signal that is radiated from the antenna out to other radios. The mixing also can occur

outside a radio in the transmission line or through rusty tower bolts or guy wires. Intermodulation can be difficult to identify, due to the large number of frequencies that may be present at large communications sites.

Receiver desensitization interference, also called receiver overload, is caused by nearby high-level transmitter signals that overload the initial parts of the radio's receiver. This overload prevents the receiver from detecting the weaker desired signals, making the receiver nonfunctional. Receiver desensitization occurs near high-power radio sites, such as television and radio stations, and also can occur in poorly designed repeater systems where the transmit and receive frequencies are too close in frequency.

Several things can be done to reduce or eliminate interference. The first is the use of high-quality radio equipment. High-quality equipment has better transmitter and receiver performance that minimizes interference and reduces its effects. The use of receiver multicouplers, transmitter combiners, and repeater duplexers reduce the possibility of intermodulation and receiver overload by filtering the transmitter and receiver signals to ensure only those signals actually used by the system are passed through.

Radio system designers can reduce the possibility of their systems causing interference by selecting appropriate designs. By selecting the appropriate antenna and adjusting transmitter power levels, the system can minimize interference with other users of the same frequency. This allows more efficient use of the available radio spectrum and keeps more resources available for all users.

What Affects System Coverage?

The coverage of a radio communications system generally is described as the useful area where the system can be used reliably. Many factors affect coverage, including the radio power output, antenna height and type, and transmission line losses. However, the factor that most influences system coverage is the height of the antenna above the surrounding ground and structures. As systems age, the coverage of the system can change due to man-made structures that are built.

System designers place antennas on towers or mountain tops to provide a more direct path from the transmitter to the receiver. In the case of one portable radio user transmitting directly to another portable radio user, having the radio antenna as high as feasible (hand-held at shoulder height) significantly improves system coverage.

Antennas have three major properties: operating frequency, polarization, and radiation pattern. In general, these properties apply whether the antenna is used for transmitting or receiving. The operating frequency of an antenna is the frequency at which the antenna acts as specified by its manufacturer. The antenna may operate outside its design frequency, but the performance of the antenna will be reduced.

In LMR systems like those used by public safety, most antennas are vertically polarized. You can see evidence of this with the wire antennas mounted on the roofs of vehicles. Like car antennas designed for FM broadcast radio, they stick up vertically from the surface of the vehicle.

The radiation pattern of the antenna is the shape of the relative strength of the electromagnetic signal emitted by the antenna. This depends on the shape of the antenna. The radiation pattern can be adjusted through antenna selection to provide coverage where desired and to minimize coverage (and interference) in undesired directions.

Fixed-Site Antennas

Fixed-site antennas are mounted on towers or buildings to provide the dispatch or repeater coverage throughout the service area (Figure 2.11). The antennas used must be designed to operate in the system's frequency band and, for best power coupling, should have a center frequency as close as possible to the actual operating frequency.

The radiation pattern for the antenna should be selected to provide a signal in the desired sections of the coverage area and have minimal coverage outside the desired coverage area. This will help ensure that the system is not interfering with other systems unnecessarily. The most basic practical antennas are omnidirectional and have approximately equal coverage for 360 degrees around the antenna. In fire service terms, a nozzle set to a wide angle fog would be equivalent to an omnidirectional antenna (Figures 2.12 and 2.13).

Figure 2.11. Antenna Tower and Antenna



(Photo courtesy Mike Worrell)

Figure 2.12. Fog nozzle set to wide angle sprays in all directions — 150 gpm

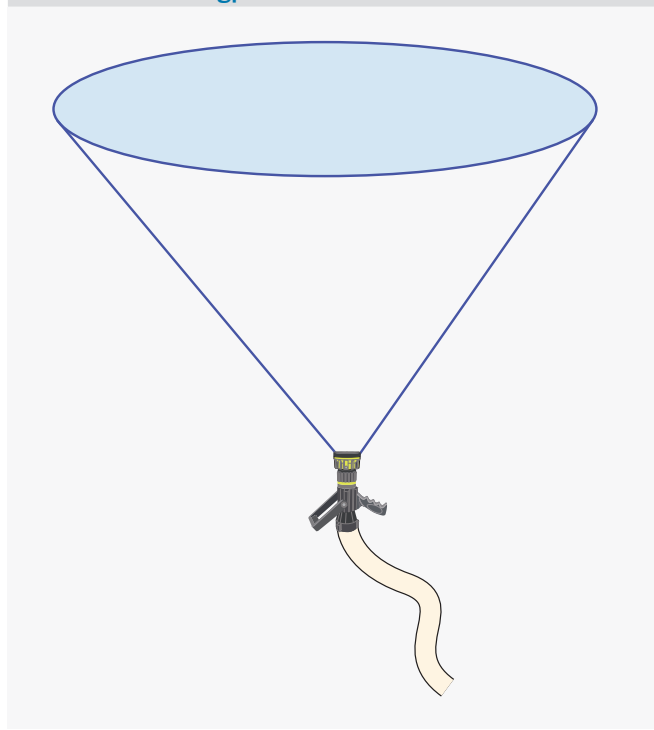



However, as shown in **Figure 2.13**, the antenna pattern is more like a slightly flattened donut. This causes an area immediately under the antenna to have lower signal strength, and less coverage, than farther away from the antenna.

Directional antennas are used to direct the signal toward the users and away from unwanted areas. The antenna is said to have gain over an omnidirectional antenna in the direction of highest signal. If we think of this in fire terms, when we place a fog nozzle to straight stream, we are directing the same gpm in a focused direction as depicted in **Figure 2.14**. There is no increase in energy, but it is now focused in a specific direction. Directional antennas essentially do the same with RF energy. **Figure 2.15** shows a directional antenna called a Yagi, along with its radiation pattern looking down on the antenna. The pattern shows a stronger signal from the front of the antenna and a weaker signal from the back. The signal strength protrusions behind the main signal are called lobes, and, in most cases, antenna designers strive to minimize this unintended signal.

Figure 2.13. Omnidirectional Antenna Pattern

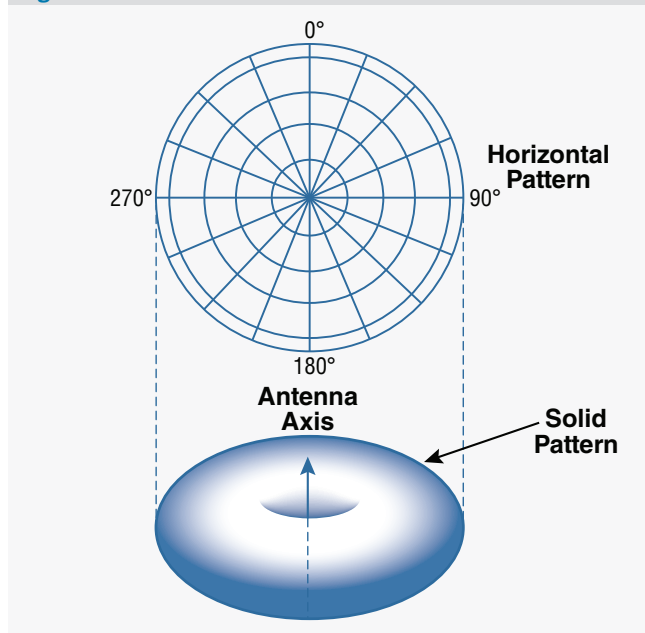

Figure 2.14. Fog nozzle set to straight stream focuses energy in one direction – 150 gpm

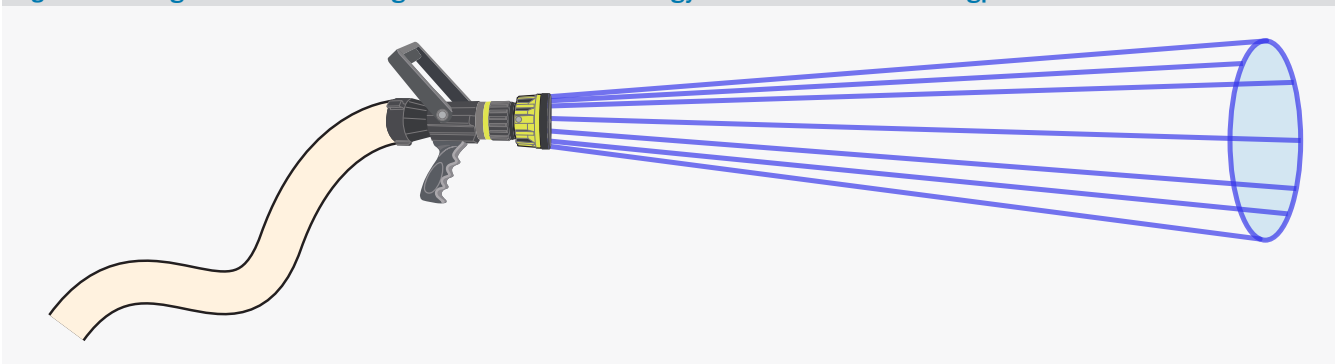
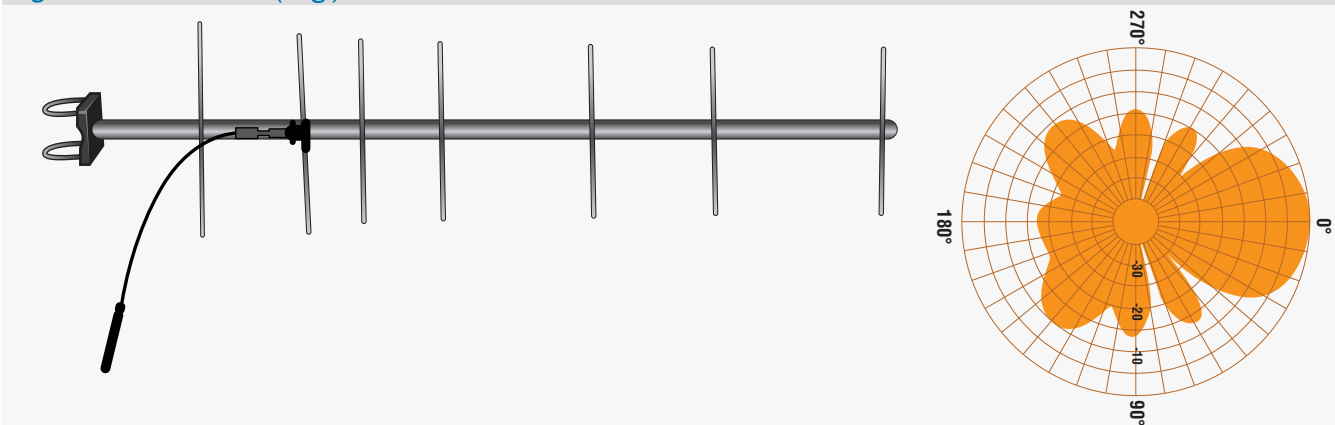

Figure 2.15. Directional (Yagi) Antenna and Pattern



Downtilt

When an antenna is located on top of a mountain or tall building, the coverage loss created by the “hole” in the radiation donut may have a significant impact on coverage in the area immediately around the antenna. To compensate for this, directional antennas can be tilted slightly to direct more of the signal downward (**Figure 2.16**). This tilting is known as mechanical downtilt and increases the energy immediately below the antenna while reducing the maximum distance the signal will travel. Unfortunately, when using an omnidirectional antenna, tilting the antenna down in one direction will result in tilting the pattern up on the opposite side of the antenna. For this reason, special antennas with electrical downtilt are used when omnidirectional coverage is required, such as on a tall building in the center of the coverage area.

Figure 2.16. Downtilt

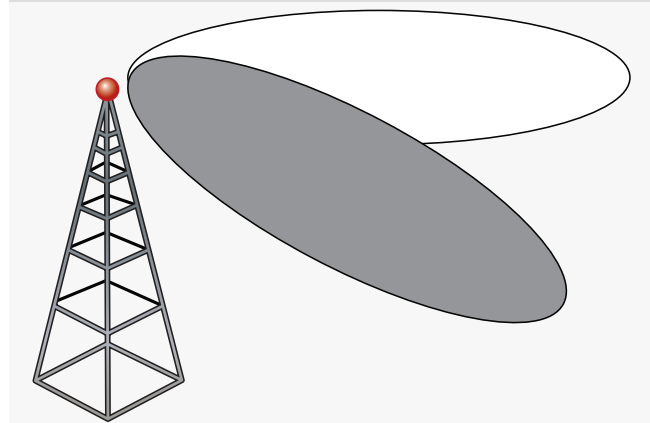

Portable Radio Position

The principles discussed earlier affect the performance of the portable radio. When a user transmits from a portable radio using a speaker microphone and it is against the body, RF energy is blocked altering the omnidirectional radiation pattern. If you place your fog nozzle on wide and place it next to an object, that pattern is altered, and the stream is not directed in the desired direction. The same happens with the RF energy when the radio is against your body. Some energy is absorbed, and the remaining signal is shadowed by your body.

Antennas must be oriented in the correct position for optimal performance. When an antenna is tilted out of vertical, the signal received is not as strong as it would be if vertical. There is no ideal location to wear the radio as a firefighter. As firefighters, we need to be aware of the radio position particularly when having difficulty communicating. As our position is changed, the effectiveness of the radio changes with the new position. We must be educated users and know that we might need to alter our position or move the radio to better communicate. Simply reorienting the radio will often correct a communications problem (**Figure 2.17**).

**Figure 2.17. Radio Antenna Placement**

Signal altered by body.



Radio held vertically for best performance.

Radio position to SCBA voice port is good.
Radio protected in pocket.

(Photos courtesy Cody Worrell)

Mobile and Portable Antennas

In general, all mobile and portable radio antennas are omnidirectional to provide coverage 360 degrees around the radio user.

Vehicle antennas should be mounted so that they are not obstructed by equipment mounted on the top of the vehicle. Light bars, air-condition units, and master-stream appliances are some typical obstructions found on fire service vehicles. Some obstructions, such as aerial ladders on truck companies, cannot be avoided, and the designer must select the best compromise location.

Vehicle antennas mounted on the roof of fire apparatus can be damaged by overhead doors, trees and other obstructions. Ruggedized low-profile antennas often are a better choice, even if they have a lower gain than a normal whip antenna. A properly mounted intact antenna with a lower gain is much better than a damaged antenna of any type.

Portable antennas usually are provided by the portable radio manufacturer and are matched to the radio. In some cases, alternative antennas can be selected for the radio to overcome specific user conditions.

When a portable radio is worn at waist level, such as with a belt clip or holster, the user's body absorbs some of the signal transmitted or received by the radio. In addition, the antenna is at a much lower level than if the user were holding the radio to his or her face for transmitting.

Since the radio system is designed for use with the antenna oriented vertically, the performance of the radio is reduced when the antenna is horizontal. This is particularly important for firefighters, since the radio they use may become oriented horizontally when they are crawling low inside a structure fire.

Summary — Basic Radio Communication Technology

Radio communication takes place using electromagnetic waves that travel from the transmitter to the receiver. These waves are defined by the number of oscillations per second or Hz. Wavelength is an actual length in distance that is determined by the operating frequency. The wavelength is a key factor in the determination of the antenna length. Antennas are tuned to the operating frequency of the radio. The practice of putting a longer antenna on to increase performance should be discouraged and can result in damage to the radio.

Radio channel bandwidth is the amount of radio spectrum used by the signal transmitted by a radio. The greater the bandwidth, the more information that can be carried by the signal in the channel. Minimum channel bandwidth is limited by the state of technology and the bandwidth required to carry a given amount of information. Standard bandwidth has decreased several times in the past to accommodate more users. Rule changes effective Jan. 1, 2013, now require frequencies below 512 MHz to have bandwidths of 12.5 kHz. Digital radio technology allows use of TDMA, and it is being employed on many P25 trunked radio systems to increase capacity, even though it is not mandated. Use of TDMA provides an effective 6.25 kHz bandwidth or in industry terms a 6.25 kHz equivalent bandwidth.

Transmitted radio waves can be reflected or absorbed by materials, such as buildings, the earth or trees, reducing the strength of the wave when it reaches the receiving antenna. Elevating the transmitting or receiving antenna will reduce the likelihood of the wave being affected by buildings or trees because the path to the receiver will be more direct.

Interference from undesired radio waves is always a possibility in a radio system. The potential for natural interference decreases as the frequency band increases, but man-made interference is very high in the 800 MHz band due to the proximity of cellular and other nonpublic safety communications systems. This interference can make it difficult to communicate effectively in the presence of the interference.

When designing radio communications systems, the designers must take into account the presence of reflecting or absorbing materials and interference. This may require constructing taller towers to support the antennas or increasing the power of the transmitters to overcome the loss of signal strength and interference. The system's design must account for local terrain, trees, buildings and the density of interference-generating sources.

Antennas are designed with radiation patterns to direct RF in the desired direction. This is very similar to the use of a fog nozzle on the fireground. The nozzle can be adjusted in a wide pattern to spread a set gpm or can be set to straight stream to focus the same gpm in a specific direction.

When using a portable radio, users must remember that their body absorbs some of the RF energy and the antenna must be oriented properly for the best radio performance. There is no ideal location to wear the radio as a firefighter. As firefighters, we need to be aware of the radio position particularly when having difficulty communicating. As our position is changed, the effectiveness of the radio changes with the position. We must be educated users and know that we might need to alter our position or move the radio to better communicate. Simply reorienting the radio will often correct a communications problem.



This page intentionally left blank.

SECTION 3 —

Digital and Analog Radio

Several different types of radios are used in the fire service. These radios can be classified as mobile, portable or fixed. They operate in either analog or digital mode on direct, repeated or trunked systems. This section discusses the operation of these types of radios and the features, benefits and problems associated with their use in the fire service. All technologies have strengths and weaknesses. It is important for the fire service to understand the strengths and weaknesses of all communications technologies to be able to make informed decisions to keep members safe.

Mobile radios are designed to be mounted in vehicles and get their power from the vehicle's electrical system. They can be of either a one- or two-piece design, with the radio itself separated from the controls. An external antenna is connected to the radio and permanently mounted to the vehicle. Mobile radios usually have better performance than portable radios, including better receivers and more powerful transmitters. One exception to this is that mobile radios used in trunked radio systems may or may not have more powerful transmitters because the systems are designed for portable use, reducing the need for high-powered transmitters.

Portable radios are hand-held radios powered by rechargeable, replaceable battery packs or power sources. They usually have an external rubber antenna attached to the top of the radio.

Mobile and portable radios have similar controls to perform their essential functions. These include things such as changing channels, adjusting the speaker volume, and transmitting. The common names for these controls are the channel (or talkgroup) selector, volume adjustment, and push-to-talk (PTT) switch. Some radios, particularly those intended for fire and police use, will have an orange or red **emergency** button. This button may be programmed to indicate to the radio system and to other users that a user has an emergency. Older radios may have a squelch adjustment knob, but most modern radios have internal control settings or adaptive squelch so that a squelch adjustment knob is no longer necessary.

Base station radios are located at fixed locations and usually are powered by AC utility power. Base stations are generally higher in performance than mobile and portable radios, with higher powered and more stable transmitters and more sensitive and interference-resistant receivers. Some fire departments equip fire stations with base station radios to provide enhanced coverage throughout their service area and to provide backup communications in the event of a primary communications system failure.

Repeaters are similar to base stations, but they can transmit and receive at the same time, retransmitting the signal received by the receiver. Repeaters are used to extend the coverage of portable or mobile radios.

Radio console equipment is used by dispatchers to control base station radios and repeaters and allow the dispatcher to receive and transmit on one or more radios simultaneously. The consoles typically have individual volume and transmit controls for each radio as well as a master volume and transmit control. Headsets can be connected to the consoles along with footswitches, allowing dispatchers to operate the console hands-free so they can operate computer equipment simultaneously.

Analog Radios

The human voice is an analog signal. It is continuously varying in frequency and level. Analog radios have been in use since the invention of voice radio in the early 1900s. The type of analog radio used today was invented in the 1930s to improve on the older radio's poor immunity to noise. These radio systems use FM to modulate the transmitted signal with the user's voice. The main advantage of FM over older radio system types is that FM radios tend to reject (interfering) signals that are weaker than the desired signal.

Analog FM radios operate by causing the transmitting frequency of the radio to change directly with the microphone audio. Initially, the signal is filtered to remove any frequencies above human voice, but no other changes are made to

the signal. **Figure 3.1a** shows an example signal from the microphone, and **Figure 3.1b** shows the resulting change in frequency of the transmitted signal.

Figures 3.1a and b. Frequency Modulation

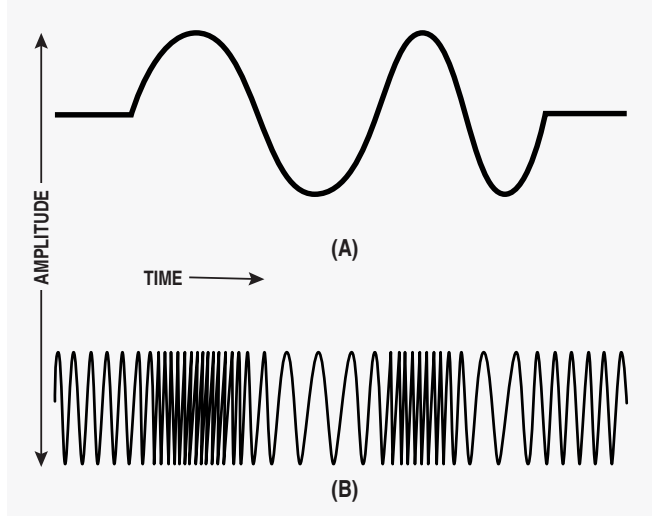

FM radios constantly have a signal at the output of the receiver, and a squelch circuit is used to mute the output of the radio receiver when no desirable signal is present. Squelch circuits mute the output automatically until the signal is strong enough to unmute. Older radios had adjustable squelch level controls, allowing the user to make the radio less sensitive if there was interference. However, most new radios have squelch levels that are adjustable only by radio technicians using radio programming software.

To further reduce received noise and interference, well-designed analog radio systems use Continuous Tone-Coded Squelch System (CTCSS) or Digital-Coded Squelch (DCS). CTCSS is also known by proprietary names such as Private Line™ (PL) or Channel Guard™ (CG).

CTCSS mixes a subaudible tone with the audio from the microphone and transmits the resulting signal. When a radio receives a signal with tone-coded squelch, the CTCSS decoder attempts to match the tone present in the received signal with the desired tone. If the correct tone is present, the receiver is unsquelched, and audio is routed to the speaker.

Digital Radios

To improve audio quality and spectrum efficiency, radio manufacturers introduced digital radios. Digital radio also provides a pathway for the FCC to improve efficiency and to meet the increasing requests for the radio spectrum. This is evidenced by a mandate to narrowband 700 MHz channels to a 6.25 kHz equivalent bandwidth by Dec. 31, 2016. However, this mandate was eliminated by an FCC ruling made October 2014. The FCC stated the following “We conclude that the December 31, 2016 narrowbanding implementation deadline is no longer viable. The record indicates that requiring narrowbanding by December 2016 would force many licensees to modify or replace existing systems well before the end of their useful life. In addition, we share the concerns expressed by many commenting parties about the maturity of 6.25 kilohertz-capable equipment, including the lack of developed open standards governing major system components.”⁸ The FCC recognized that many of the systems affected by the mandate would have been newer systems and that the mandate would require modification of systems that were not near end of life.

Digital radio continues to be plagued with difficulties in processing voice with high background noise. Advancements have been made in the signal processing, but there continues to be instances where digital radios struggle. The prime examples continue to be Personal Alert Safety System (PASS) devices and SCBAs with vibrating regulators that signify low air.

In the digital world, when a user speaks into the microphone the radio samples the speech and assigns the sample a digital value. A vocoder (voice coder) or codec (coder/decoder) in the radio performs the function of converting analog voice to a digital data packet. The digital data packet can vary in the number of bits. The use of digital audio was expected to reduce static and increase the range of radios in weak signal conditions. P25 vocoder manufacturer Digital Voice System Inc. (DVSI) has improved the Enhanced Vocoder’s ability to recognize and suppress high frequency noise. The result is improved voice quality and intelligibility

⁸ FCC Report and Order, October 2014, FCC-14-172.

in high frequency noise such as PASS alarms. These improvements improve the performance of digital radios on the fireground. Radio manufacturers also continue to improve the technology by employing noise canceling features and embedding noise filtering options in the radios.

Digital Audio Processing

In digital radios, analog voice is converted to a digital interpretation from an audio sample received from the microphone (**Figure 3.2**). P25 digital radios have very limited data rates and bandwidth available to transport the digitized voice. P25 digital vocoders are designed to encode and decode the frequency range and elements of human voice. For example, digital radios do not accurately reproduce pure tones. The inability to transmit tones affects departments that use tones to alert firefighters of specific events on the fireground. Human speech is a constant variation in frequency and amplitude. If you attempt to transmit a pure tone, the received audio will not be a true reproduction of the source, and it is noticeably different.

This is a basic explanation of how analog voice is processed by the radio.

Transmitting radio:

1. The user speaks into the microphone.
2. The audio is sampled and converted to a digital interpretation by an analog to digital converter (A/D converter).
3. The vocoder converts the digitized speech into digital data.

4. The modulator modulates the RF with the digital data.
5. The modulated RF signal is boosted in power by transmitter amplifier.
6. The signal is transmitted from the radio antenna.

Receiving radio:

1. The modulated RF is received by antenna.
2. The received RF signal is boosted to a usable level by the receive amplifier.
3. The signal is demodulated by a demodulator. This removes the RF component of the signal leaving the digital data component.
4. Digital data is decoded by the vocoder into digitized speech.
5. Speech data is converted to an analog signal by a digital to analog converter (D/A converter).
6. Analog is sent to the speaker.

Analog and Digital Comparisons

Distance

As the radio user travels further from the transmitting radio, the signal strength decreases. The signal strength directly affects the ability of the radio to reproduce intelligible audio.

In an analog system, the clarity and intelligibility of the transmission, as received by the user, decreases directly as the signal level decreases. The noise (static) in the signal progressively increases in strength, while the desired signal decreases

Figure 3.2. Digital Radio

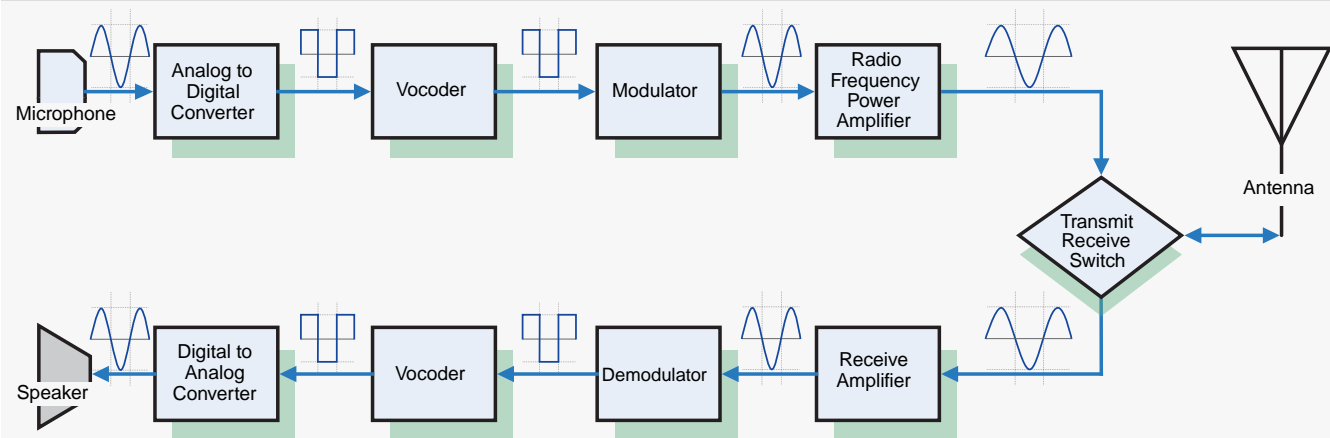

until the transmitting user cannot be heard over the noise. When the signal level is high, the voice quality is high. As the signal level decreases, the voice quality decreases in a predictable manner giving the user hints that the signal is getting weaker. This characteristic adds to the situational awareness allowing the user to make decisions about the environment.

When a digital user transmits to a receiver, the transmitted signal decreases just as the analog signal decreases. However, the digital transmission contains extra data providing error correction and allowing audio to be recovered despite declining signal. As the receiver travels further from the transmitter, the signal level decreases to the point where the error correction cannot correct all errors in the signal. When this point is reached, the receiving users will hear some distortion in the signal and may hear some strange nonspeech noises. These noises are often referred to as **digital artifact**. Once this point is reached, a small reduction in signal level will cause the number of errors to exceed the ability of the system to compensate, and all audio will be lost.

Although digital radios provide a larger range of usable signal levels, the lack of advanced indication of signal level decrease allows users to get closer to complete loss of communication with less warning than an analog radio. As you note in **Figure 3.3**, the analog signal voice quality decreases in a near linear rate as signal level decreases. In comparison, digital voice quality has a steeper degradation when it reaches lower signal levels.

Figure 3.3. Analog Versus Digital Signal

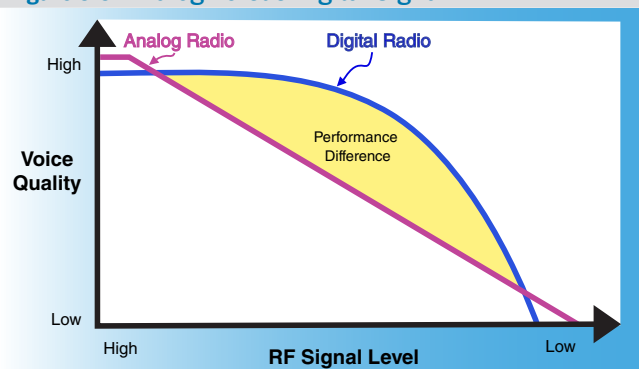

John C. Hardwick, Ph.D., President, DVSI Presentation to NFPA 1802 Technical Committee, Nov. 19, 2014, Tucson, Arizona

Voice Intelligibility

The ability to understand the digital radio transmissions has been a focus of many fire departments. After implementation of P25 digital systems, it was discovered that digital audio was not the same as analog, and the performance differences were most prevalent during fire operations. One of the most significant differences was attempting communications with a vibrating low air alarm or a PASS device alarming.

In 2007, the International Association of Fire Chiefs (IAFC) formed a working group to address potential problems with P25 digital radio. The working group consisted of fire service personnel, other public safety representatives, wireless radio manufacturers, manufacturers of fire apparatus and equipment, and consultants to address potential problems found in digital radios in the presence of loud background noise.⁹ Funding for this effort was provided jointly by the DHS Office of Interoperability and Compatibility, the National Institute of Standards and Technology (NIST) Office of Law Enforcement Standards, and the Federal Partnership for Interoperable Communications (FPIC). As a result of the findings of the IAFC workgroup, the National Telecommunications and Information Administration (NTIA) allocated resources to perform testing of the P25 vocoders in the firefighting environment. NTIA TR-08-453¹⁰ was released in 2008. The report identified performance differences between digital and analog radios. As we move forward in time, technology continues to advance. Emerging technologies and new vocoders, such as the ones used in cellphone technology (4G Long Term Evolution (LTE)), required testing. In response to emerging digital voice technologies, additional testing was performed by the NTIA. NTIA report 13-495¹¹ documents the performance of the different technologies in the firefighting environment. This next section will focus on the performance contrast between digital radio and analog radio.

⁹ <http://www.iafc.org/digitalProject>.

¹⁰ NTIA Technical Report TR-08-453 Intelligibility of Selected Radio Systems in the Presence of Fireground Noise: Test Plan and Results, <http://www.its.bldrdoc.gov/publications/2490.aspx>.

¹¹ <http://www.its.bldrdoc.gov/publications/2720.aspx>.

Program 25 History

The Association of Public Safety Communications Officers (APCO), representing the public safety technical community and the Telecommunications Industry Association (TIA), recognized that there would be a requirement to move to digital technology. This provided an opportunity to develop an open standard that would allow different manufacturers to build equipment that could operate together. The goal was to introduce competition into the market, help control costs, and provide a technology platform for improved interoperability.

Up until the development of this standard, each manufacturer had proprietary digital radios that could interoperate only with like radios. Working with the TIA, APCO coordinated the work of manufacturers to develop the APCO P25 standard for digital radios. Modern public safety digital radios use this standard. P25 is the national standard for public safety digital radios but also is backward compatible for analog use. This standard was developed to allow radios from multiple manufacturers to communicate directly using a common digital language, to define standards for trunked radio systems to allow multiple manufacturers to operate on a common platform, and to provide a roadmap for future features and capabilities.

The TIA Engineering Committee (TR-8) formulates and maintains standards for private radio communications systems and equipment for both voice and data applications. TR-8 addresses all technical matters for systems and services, including definitions, interoperability, compatibility and compliance requirements. The types of systems addressed by these standards include business and industrial dispatch applications as well as public safety (such as police, ambulance and firefighting) applications.

Much of the work of the committee relates to the formulation of the TIA-102 series standards for APCO Project 25. These are standards sponsored by the Association of Public Safety Officials International, the National Association of State Telecommunications Directors (NASTD), and agencies of the federal government. P25 standards

are developed to provide digital voice and data communications suited for public safety and first responder applications.¹²

Program 25 Interoperability

P25 does not address any operational or interoperability needs. P25 also does not provide a fire department with interoperability unless it is planned for. A lone agency on P25 is no more interoperable than being on a UHF system trying to interoperate with a department on VHF. P25 only provides manufacturers with a common digital language for the radios and system infrastructures. The use of the P25 standard has provided a common platform that allows technical interoperability between systems. This, in turn, provides the technical path to provide interoperability for public safety operators.

P25 system standards also were meant to allow radios from different manufacturers to operate on any other P25-trunked radio system. While the intent was to provide complete interoperability between different trunked systems and portable manufacturers, the P25 standard allows manufacturers to implement nonstandard features. So a P25 radio may not have full functionality on a trunked system of a different manufacturer. The trunked systems available today offer many features and have complicated roaming schemes. If you are purchasing devices from a different manufacturer than your trunked system, care must be taken to thoroughly test to ensure all of the features you expect to use are functional.

Program 25 Characteristics in High-Noise Environments

When P25 is used in settings where the background noise level is within limits set in the P25 standard, it provides usable audio. However, the P25 vocoder was not designed to operate in the high-background-noise environments encountered on the fireground. When the P25 vocoder was being developed, the designers tested intelligibility of the digital audio with high ambient noise levels at the receiving radio. The P25 vocoder is unable to differentiate the spoken voice from the high

¹² <http://www.tiaonline.org/all-standards/committees/tr-8>.



background noise and assigns a digital value that does not accurately represent the voice. The result is unintelligible audio or broken audio with digitized noise artifact. Users of P25 radios have been affected by many common fireground noises. The SCBA alerting systems for low air or inactivity and PASS devices have made the audio transmitted from digital radios unusable. P25 radios transmitting from high-noise environments do not perform to the same levels as analog radios.

Self-Contained Breathing Apparatus Mask Effect on Communications

The effect of SCBA masks on the human voice was published by the Institute of Electrical and Electronics Engineers (IEEE) Communications Magazine.

The testing in the IEEE article documents the effects of the SCBA system on voice intelligibility. Based on the testing, the conclusion was that “SCBA systems are frequently used by firefighters and other public service personnel who rely on speech radio communications to perform their work. The SCBA mask acoustically distorts speech and the breathing system produces noises that can detrimentally affect speech communications, especially when a digital speech codec is used in the communications link. Both speech intelligibility and speech quality are detrimentally affected by SCBA equipment use.”¹³

Feedback

The presence of feedback can be affected by the type of system the radio is on. In simplex/direct systems, the presence of feedback is all radios are on the same frequency. If transmitting near many other radios set on high-volume settings, the receiving radios squeal due to a feedback loop that is created. In digital radios, the same conditions exist, but the radios emit what sounds like “crickets.” In both analog simplex and digital simplex, it is important for users to be aware of this characteristic and shield the microphones from the other radios that are nearby.

Simultaneous Transmissions

When on the fireground, communications are often very fast, and many users are often trying to communicate at the same time. This can result in simultaneous transmissions. Simultaneous transmissions can be a hindrance to fireground communications, and there is a difference between analog and digital. In analog simultaneous transmissions, the result is a warble-like tone behind the voice. The technical term for this is heterodyning or mixing of frequencies. In analog, the receivers can hear that two units are transmitting and can ask for a repeat of the transmission. In digital, if the two signals are equal in strength, the receiver may quiet due to a corruption of the data stream. This can occur in any digital simplex/direct or digital repeated system where access is not controlled. Trunked systems only allow one user to transmit at a time, so this situation is highly unlikely.

Program 25 Digital for Firefighting

Fire departments and other emergency service agencies have successfully implemented digital radio systems. However, fire departments around the country have reported difficulties with digital radios.¹⁴ A simple Internet search of “Fire Department Digital Radio Problems” will yield a long list of problems encountered by firefighters using digital technology.¹⁵ To say that all digital is bad would be an incorrect statement. Each instance must be analyzed individually for the cause. What is important is to understand the cause of the communications problem and either design it out of the system or avoid use of the technology when it does not meet operational requirements. This analysis should be done for any technology employed on the fireground. Studies performed by NIST, IAFC and portable radio manufacturers have supported the findings from the field users. Fire departments need to consider the performance differences between digital and analog technologies when researching new communications systems.

¹³ IEEE Communications Magazine, January 2006, “The acoustic properties of SCBA equipment and its effects on speech communication,” William M. Kushner, Member IEEE, S. Michelle Harton, Member IEEE, Robert J. Novorita, Member IEEE, and Michael J. McLaughlin, Fellow IEEE.

¹⁴ http://www.iafc.org/files/digProj_DPWGinterimReport.pdf.

¹⁵ This website is a collection of information on radio system that can be of value: <http://blog.tcomeng.com/index.php/digital-trunked-radio-system-problems/>.

This is supported by NFPA 1221, *Standard for the Installation, Maintenance, and Use of Emergency Services Communications Systems*, (2013 edition). It requires a tactical analog channel for on-scene communications.

9.3.1.3 A communications radio channel, separate from the radio dispatch channel, shall be provided for on-scene communications.

9.3.1.4 At a minimum, the tactical communications channel identified in 9.3.1.3 shall be capable of analog simplex mode.

When fireground noise of high amplitude is introduced, the voice translation ability of the P25 radio decreases and generates audio that is poor or not intelligible. These problems are worsened when the firefighter is speaking into the portable radio through an SCBA facepiece. Bone microphones, throat microphones and microphones in the facepiece minimize the interference caused by background noise by isolating the transmitted voice from background noise. Speaker microphones are subject to the same problems that are found with the microphone on the portable radio.

The configuration of the P25 vocoder is limited in its capability to translate the human voice in the presence of common fireground noise or through a facepiece. The studies performed by NIST and IEEE illustrate that digital radio intelligibility when talking through an SCBA facepiece is degraded. This can pose a safety hazard for fireground operations. To maintain safety, fire departments should consider using portable radios that incorporate analog modulation for operations where the firefighter is using an SCBA.

Radios using the P25 digital technology have performed well for other fire service functions, such as on emergency medical incidents and support functions on the fireground where an SCBA is not required, as well as law enforcement operations. The difficulties presented by the inability of P25 radios to produce intelligible voice messages in the presence of fireground noise is a significant safety concern and should be considered seriously by public safety radio system designers and users.

P25 radio manufacturers recognized the need to filter or cancel background noise in the firefighting

environment. Manufacturers took advantage of digital audio processing to remove the noise or use noise canceling using one microphone to detect the spoken audio and a second to detect the background noise. While these methods can work, it is important to note that this has increased the complexity of programming the radio. A missed check box when programming the radio can have detrimental effects. All new radio configurations must be thoroughly tested to ensure proper operation. The days of just buying an off-the-shelf speaker microphone and it working are gone.

Summary – Digital and Analog Radio

There are multiple radio types in use by the fire service. Mobile radios are usually mounted in vehicles. Mobile radios usually have better performance than portable radios. Mobile radios usually have better receivers and more powerful transmitters. Mobile radios used in trunked radio systems may or may not have more powerful transmitters. Portable radios are hand-held radios powered by rechargeable or replaceable battery packs. They usually have an external rubber antenna attached to the top of the radio. Portable radios have power limitations and suffer performance degradation based on where the user operates from and where the radio is worn. Base station radios are located at fixed locations, and usually are powered by AC utility power. Base station radios generally are higher in performance than mobile and portable radios. Repeaters are similar to base stations, but they can transmit and receive at the same time, retransmitting the signal received by the receiver. Repeaters are used to extend the coverage of portable or mobile radios.

Analog radios have been in use since the invention of voice radio in the early 1900s. The type of analog radio used today was invented in the 1930s to improve on the older radio's poor immunity to noise. These radio systems use FM to modulate the transmitted signal with the user's voice.

To improve audio quality and spectrum efficiency, radio manufacturers introduced digital radios. Digital radio also provides a pathway for the FCC to improve efficiency and to meet the increasing requests for the spectrum.



P25 digital radios have different performance characteristics from analog radios. Digital radio in some environments provides clear voice with no background noise. The fire service environment is a challenging environment to operate in, and digital radios have performance degradation in several areas. The specific areas to be concerned with are:

- Radio use with an SCBA.
- Intelligibility in a high-noise environment.^{16,17}
- PASS device.¹⁸
- Vibrating low-air alarms.
- Feedback.

Fire departments need to consider the performance differences between digital and analog technologies when researching new trunked communications systems.

An analog simplex channel is a requirement in NFPA 1221 (2013 edition). The availability of analog simplex channel(s) for firefighting applications when the firefighter is using an SCBA

is vital. Local fire departments need to test all elements of the communication system to ensure reliability (SCBA, radios, and any accessories such as speaker microphones, in-mask communications systems, etc.).

NFPA 1221 (2013 edition) requires a tactical analog channel for on-scene communications.

9.3.1.3 A communications radio channel, separate from the radio dispatch channel, shall be provided for on-scene communications.

9.3.1.4 At a minimum, the tactical communications channel identified in 9.3.1.3 shall be capable of analog simplex mode.

The P25 standard continues to be the most common radio platform and will be into the foreseeable future. P25 systems offer a common radio language that provides a path to interoperability, but as with any system, interoperability has to be part of the plan.

¹⁶ Position Paper — Background Noise and Radio Performance, http://content.motorolasolutions.com/promo/sayitloud/FRI_Paper_RO-99-2169_3.pdf.

¹⁷ NTIA Technical Report TR-08-453 Intelligibility of Selected Radio Systems in the Presence of Fireground Noise: Test Plan and Results, <http://www.its.bldrdoc.gov/publications/2490.aspx>.

¹⁸ National Public Safety Telecommunications Council (NPSTC) Brief — August 2008: International Association of Fire Chiefs Investigate Fireground Noise and Digital Radio Transmissions.

SECTION 4 —

Conventional Radio Systems

There are a wide variety of radio systems in use today. There are simple systems that use a conventional analog repeater to complex trunked systems that employ the latest technologies. Conventional systems are generally categorized as nontrunked. Conventional systems are not computer controlled systems that require data infrastructure and controllers to manage radio traffic. Trunked systems, on the other hand, do require data infrastructure, and the portable units on a trunked system are infrastructure dependent. It is important that users of the system understand how the system works. This does not mean that they need to know the technical details of the system, but how to make it or adjust it to achieve reliable communications. In today's world, most of us carry a mobile communications device, either a cellphone or smartphone. We may not understand what code division multiple access (CDMA), FDMA, 1XRTT, 3G or 4G are, but we do use these systems and are able to make these systems work for us. An example would be walking inside of a building, and your 4G indication is absent, and the signal level indicator has one bar. You know that these indications mean that you need to move to an area with better cellular coverage. It has become second nature to us, and we need to have the same comfort level with the radio systems when we do the dangerous work of firefighting. The following sections describe some typical system configurations. Each and every system can vary based on how the system is programmed or how the portable radios are programmed. It is incumbent on us to train firefighters on the operational capabilities and limitations of these systems and their ability to provide reliable communications.

Direct and Repeated Radio Systems

Radios communicate when the transmitter sends out a signal that is received by one or more receiving radios. When the signal is received from the radio initially transmitting the signal, the communication is direct. (That is, there is no intervening radio or system.) When one radio transmits and the other radios receive, this type of communication is known as simplex communication. In a repeated system,

the portable radio transmit frequency is received by the repeater and retransmitted on the portable receive frequency at a higher power to extend range or increase penetration.

Direct/Simplex Communications on the Fireground

Using simplex communications maintains positive communications between the IC, exterior on-scene units, and interior units without the reliance on exterior communications systems. Maintaining positive communications is especially important in “mayday” situations. When users on simplex radios are deployed to the interior of a structure, they create a radio receiver network. As more and more radios move into the structure, the strength of the network increases. If Engine 1 calls mayday, the probability of another radio on the interior receiving the transmission is high. If the mayday is not heard by the IC, another radio operator on the interior can act as a human repeater to repeat the message to the IC. In addition, the number of radios in a structure creates redundancy, whereas reliance on a single repeater or trunked system creates a single point of failure. Simplex communications allow direct communications with the initiator of the mayday and other crews on the fireground.

This is an example of direct/simplex communications with no infrastructure (**Figure 4.1**). This means that there is no infrastructure to support receiving and transporting the fireground communications to the dispatch center, and without remote transmitters, the dispatch center is not able to transmit to the fireground. When the radios involved in direct communication are portable radios, the communication distance typically is limited to a few miles; for mobile radios the distance can be 50 to 100 miles. Often this is referred to as “line-of-sight communication,” and this makes direct/simplex radio communication most suitable for tactical use by units on an incident scene. Command systems that use these types of channels often have a command channel. In this type of system, the dispatch center monitors the command channel and the IC relays the relevant information received on the direct/simplex channel onto the command channel.

Figure 4.1. Direct/Simplex Without Transmit/Receive Infrastructure

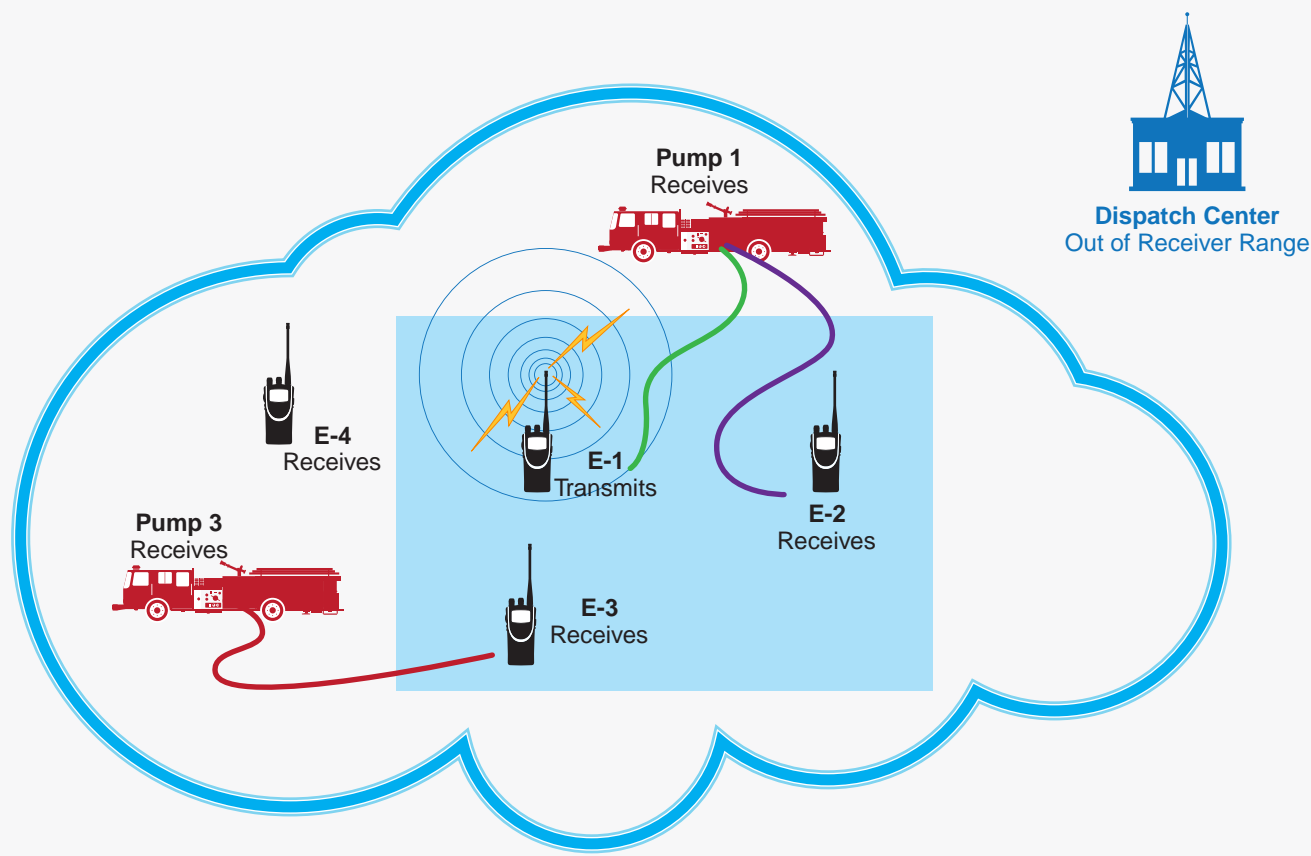

The cloud represents the maximum transit range of the portable radio.

The direct communication method is the simplest form of radio communication and is easily affected by terrain blocking, including man-made structures such as buildings. If an obstruction is between the transmitting and receiving radios, communication may not be possible. Users must be aware that some buildings due to size or construction cause communications difficulty. Many jurisdictions place warnings in computer-aided dispatch (CAD) systems to alert users of structures with known communications difficulties. Users can be advised to use human repeaters to communicate to the IC. Additionally, awareness on the fireground is important; if a communication attempt to the IC from the interior is heard and the IC does not answer, that might be a cue to relay the information. The short-range nature of direct communication also allows one radio channel used by one communicating group to be reused by another group further away. If the

second group is far enough away that it does not hear the first group's communications, then the channel can be reused. This minimizes the number of channels needed by an agency.

When a radio system must cover a larger area, or when terrain or other obstructions limit the distance a system can cover, additional equipment is needed to overcome these limitations.

Receiver Voters – Improve Field Unit to Dispatcher Communications

Dispatch centers connected to high-powered transmitters provide the dispatch center with talk-out capability. Transmitters are elevated to achieve better line-of-sight communications with the service area. High-powered transmitters ensure that the dispatch center transmissions are heard throughout the service area and provide some level of in-building coverage (**Figure 4.2**).

Figure 4.2. Direct/Simplex With Transmitter/Receiver Infrastructure Dispatch Center Transmitting

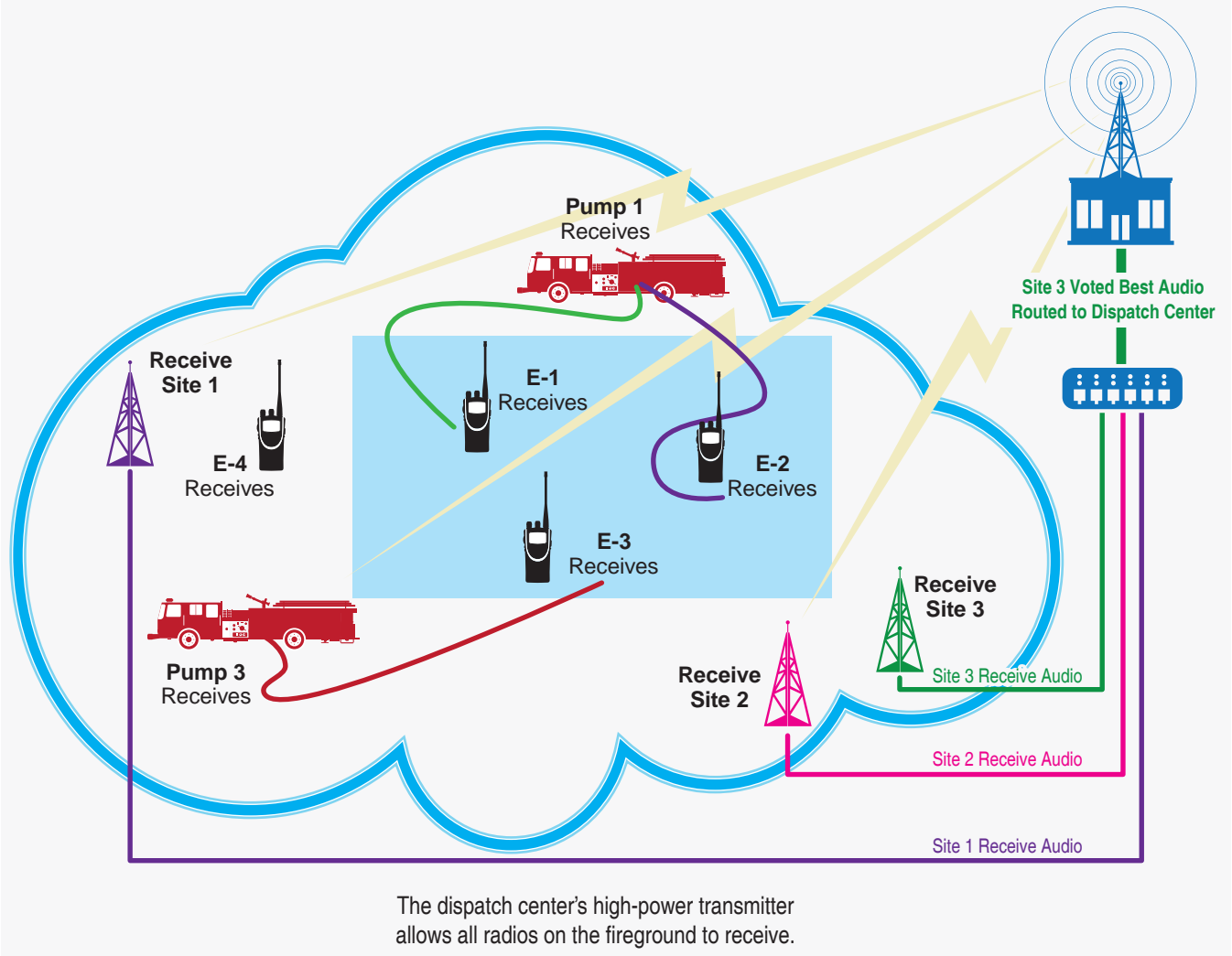

Portable radios have limited power and cannot always transmit a signal strong enough to reach the transmitter sites. To provide a more balanced system, receivers are networked together throughout the service area in a receiver voter system (RVS) (**Figure 4.3**). Comparison of the received audio signal takes place in a receiver voter.

The receiver voter and its network of receivers are referred to as the RVS. The RVS usually is located at the dispatch center. The receiver voter compares the audio from all receivers and routes the audio from the receiver with the best audio quality to the dispatcher. This type of system provides very reliable fireground communications and supports fireground simplex channels.

Figure 4.3. Direct/Simplex Communications With Transmit and Receive Infrastructure Portable Transmitting

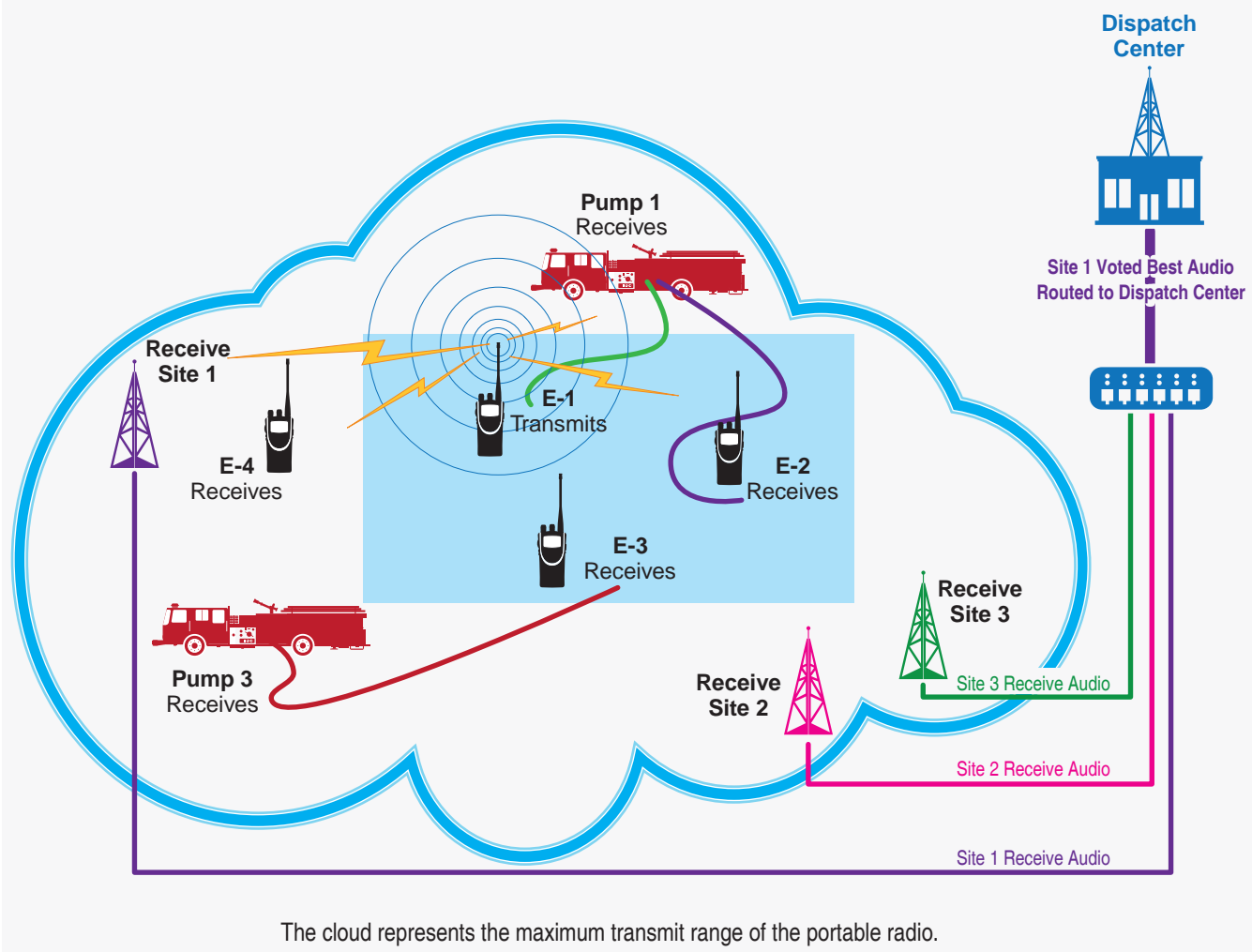

Repeaters – Improve Field Unit to Dispatch and Off-Scene Units

Receiver voters are one solution to get communications from a radio user to the dispatch center, but another solution is needed to get the communication to other radio users. One type of system that can solve this problem is a repeated radio system (Figure 4.4). Repeated radio communication, also known as half duplex

communication, uses two RFs for communication. The transmitting radio transmits on Frequency 1 (F1), and that signal is received by the repeater. The repeater then repeats the transmission on Frequency 2 (F2), and this signal is received by the receiving radio. By locating the repeater on a high building or mountain, the range of transmissions from the transmitting radio can be more than doubled and can reach over obstacles effectively.

Figure 4.4. Repeater System — Portable Transmitting — Fireground Communications

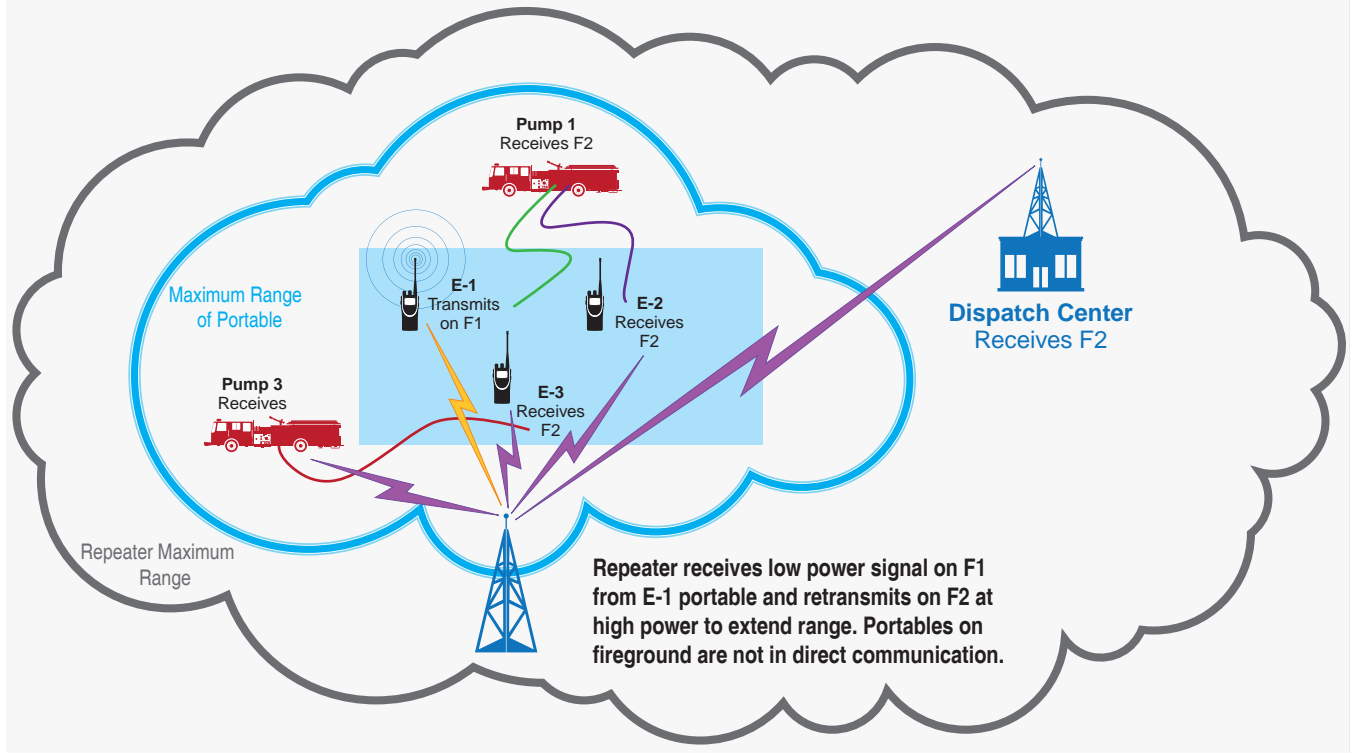

Another solution to improving communication between field units inside buildings or tunnels and dispatch and off-scene units is the bidirectional amplifier (BDA). BDAs can be used with half duplex radio systems to extend coverage from inside the structure to outside the structure and vice versa, but BDAs do not operate with simplex radio systems. BDAs are discussed in more detail in Section 5 — Trunked Radio Systems.

The significant operational difference between direct and repeated communications is that with direct communication, the transmitting radio's signal only needs to reach other radios directly on the incident scene. With a repeated system, the signal must reach the closest repeater location, which may be much further from the incident than the receiving radios.

Figure 4.5 shows a method to overcome this limitation. If unit E-1 is unable to communicate with other units on the fireground using the repeater system, E-1 can switch to talk-around mode on the radio. This mode allows the unit to transmit in direct mode to other radios on the fireground and receive from the units in either direct or repeated mode. Since the radio is not able to reach the repeater, the dispatch center cannot hear the radio, although other radios on the fireground can hear the unit. A unit that switches to talk-around should announce this immediately so other units know that they also may need to switch to communicate with the isolated unit.

Figure 4.5. Repeater System — Portable Transmit Talk-Around — Fireground Communications

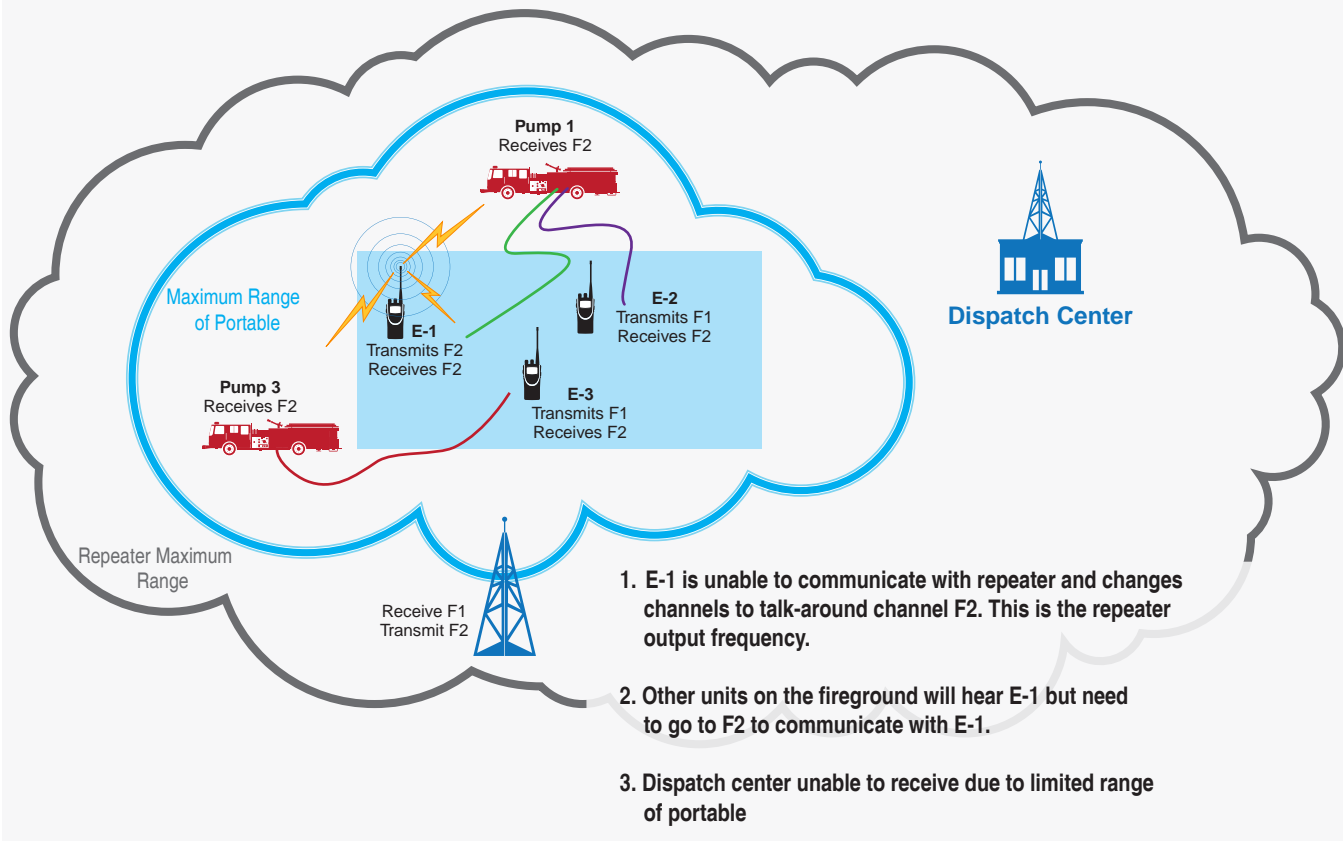

Simulcast Transmitter Systems

When a radio system must cover a large area but the number of available frequencies is limited, a simulcast transmitter system may be the solution (Figure 4.6). With this system, multiple transmitters simultaneously transmit on the same frequency. The transmitters must be precisely synchronized so that the signals they transmit do not interfere with each other.

In addition, the audio source sent to the transmitters must be synchronized so that the radio user hears the same signal from each transmitter. The system consists of a simulcast controller and two or more simulcast transmitters. The advantages of a simulcast system are the coverage of a large area, with high signal levels throughout the area, while using only a single frequency.

Figure 4.6. Simulcast — Dispatch Center Transmit — Fireground Communications

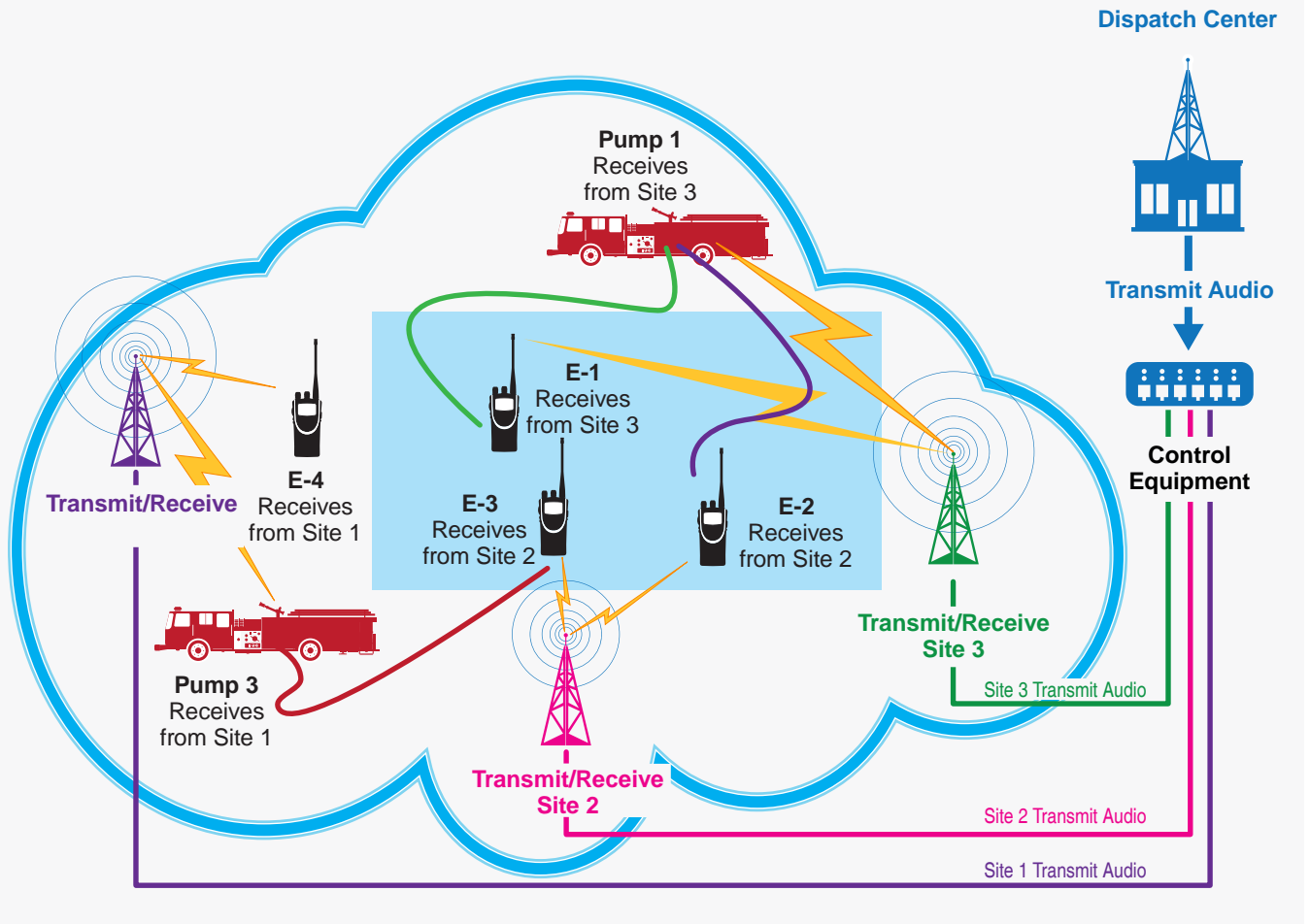

Alerting

Many users of conventional analog systems use paging as a method of alerting personnel or fire stations of an incident or other important information. In an analog system, the use of two-tone paging accomplishes this. This feature has proven to be a low cost method of alerting for professional and volunteer firefighters. Unfortunately, digital radio systems cannot pass the tones required for two-tone alerting. The use of commercial paging services may be required to provide paging services in digital or trunked systems. Recently, companies are providing applications for smartphones that provide the ability to notify smartphone users using commercial data services, if the users' dispatch system feeds the application with the required data. You must be aware that these notifications may not happen in real time and may be delayed by a few seconds to

minutes depending on delays in the commercial data service. If the commercial data system is congested during a disaster, the delays may be significant. Data and phone congestion were identified as a weakness in the Boston Bombing¹⁹ and the Virginia earthquake.²⁰

Summary — Conventional Radio Systems

There are a wide variety of radio systems in use today. There are simple systems that use a conventional analog repeater to trunked systems that employ the latest technologies.

Direct Communications

Radios using direct communications are not dependent on infrastructure to communicate to other units on the fireground. Direct communications are limited in range, so they are commonly used as fireground tactical channels.

¹⁹ April 2013, http://www.huffingtonpost.com/2013/04/15/boston-cell-service_n_3087341.html.

²⁰ August 2011, <http://www.pcmag.com/article2/0,2817,2391635,00.asptrunked-radio-system-problems/>.



Using simplex communications maintains positive communications between the IC, exterior on-scene units, and interior units without the reliance on exterior communications systems. There are limitations in range due to the portable radios having limited power. Awareness on the fireground is important; if a communication attempt to the IC from the interior is heard and the IC does not answer, that might be a cue to relay the information. Dispatch centers can employ receiver voters and high-powered transmitters to allow reliable communications with fireground units.

Repeaters

Provide wide area coverage for portable radios. The portable signal is received and retransmitted at a higher power to extend the range. Communications with repeaters are dependent on the repeater as part of the communications infrastructure. Coverage to the repeater can be degraded when operating on the interior of a building. Use of talk-around allows users to use the output frequency to bypass the repeater. This is referred to as a talk-around frequency.

Simulcast

Simulcast systems are employed when trying to cover a large service area. Simulcasting allows the dispatch centers to transmit simultaneously from multiple transmitters that cover a larger geographic area. The advantages of a simulcast system are the coverage of a large area, with high signal levels throughout the area, while using only a single frequency.

Alerting

Many users of conventional analog systems use paging as a method of alerting personnel or fire stations of an incident or other important information. In an analog system, the use of two-tone paging accomplishes this. Unfortunately, digital radio systems cannot pass the tones required for two-tone alerting. The use of commercial paging services may be required to provide paging services in digital or trunked systems.

SECTION 5 —
Trunked Radio Systems

Trunked radio systems are complex radio systems that were developed to improve the efficiency of the use of available radio spectrum. In conventional (nontrunked) radio systems, an RF is dedicated to a single function or workgroup. When the RF is not in use, it cannot be used by another function or workgroup. Trunking borrows technologic concepts from telephone systems to assign RFs to active calls, improving the efficiency of frequency use.

Like a conventional repeated radio system, trunked radios communicate with each other through two or more repeaters (Figure 5.1). In a trunked system, the radios often are known as **subscriber**

units, and a voice communications exchange is known as a **call**. A basic trunked radio system has a system controller that controls the assignment of the repeaters, called voice traffic repeaters, to individual calls. The radios communicate with the system controller, for example to request the use of a voice traffic repeater, by sending data messages to the system controller on a special dedicated channel called the control channel. The system controller acknowledges these communications and sends information to the radios using the control channel as well. The radios also can communicate some information using the voice traffic channels after a call has been terminated.

Figure 5.1. Trunked Radio System — Dispatch Center Transmitting

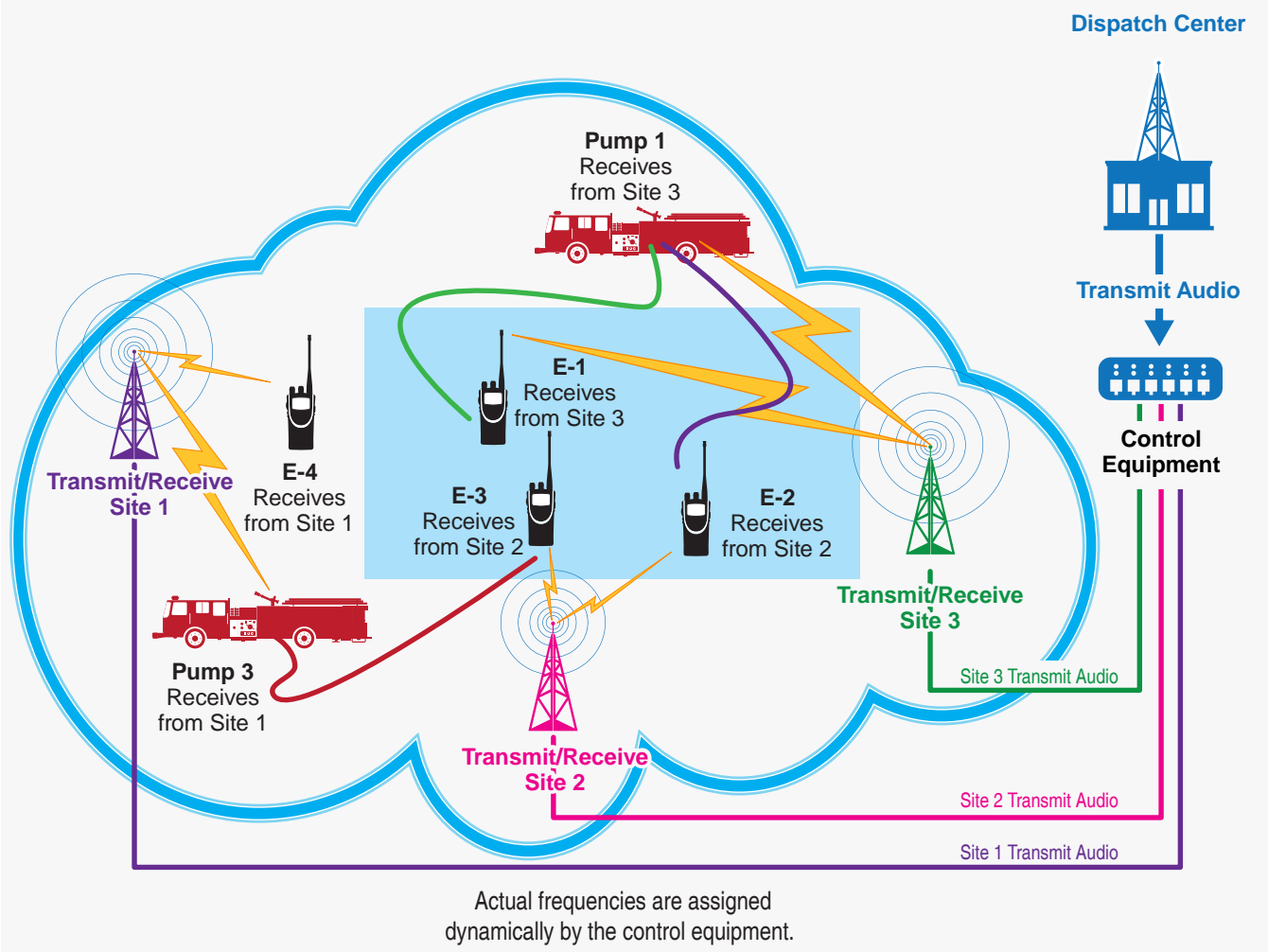



The voice traffic repeaters are shared among all users of the system. They also are known as resources. In complex systems that use encryption and dispatch consoles, other equipment is necessary for the operation of these features, and they are considered shared resources.

The radio industry uses the term “**talkgroup**” to distinguish among physical frequencies or channels used in conventional radio systems. This terminology often is confusing, since from the actual radio user’s point of view, a talkgroup and a conventional channel are the same; they are both communications paths. The distinction is made by the technologists to differentiate a physical channel or frequency from the logical channel or talkgroup.

The system controller and other parts of the trunked radio system maintain a log of all activity that occurs in the system, as well as statistical information on the operation of the system. These system logs can be used in the event of a suspected anomaly in the operation of the system to help determine the cause.

Basic Trunked Radio Operations

Radio On/Off — Registration/Deregistration/Talkgroup Affiliation

When a trunked radio is powered on initially, it begins operation by telling the system controller that it is active, along with the talkgroup currently selected on the radio, using the control channel. If the registration is successful, the radio is registered on the system and now can receive and transmit; if the registration is not successful, the radio will not operate on the system.

Any time that the radio is powered on and the user changes talkgroups, the radio will tell the system the new talkgroup selection, and the system will confirm the selection. In this way, the system tracks the currently selected talkgroup for all radios registered on the system.

When the radio is switched off by the user, the radio transmits a message to the system controller telling the system to deregister the radio. The radio then will wait for an acknowledgment from the system before actually powering off.

Talkgroup Call

When a radio user wishes to transmit on a talkgroup, he or she presses the PTT switch, just as with a conventional radio. The radio then sends the trunking system a request to transmit, using the control channel. The trunking system checks to see if the requested talkgroup is free and if there are available voice traffic repeaters. If these are true, then the system assigns a voice traffic repeater to the call and instructs all radios with the talkgroup selected to change frequencies to the voice traffic repeater frequency. The system also sends a message to the requesting radio telling it that it may proceed with its transmission. This causes the user’s radio to play a tone sequence (typically three short beeps) to tell the radio user that he or she may proceed with the transmission. The radio’s transmission is received by the voice traffic repeater and retransmitted to the other radios on the frequency (**Figure 5.2**).

Figure 5.2. Trunked Radio System — Portable Radio Transmit — Fireground Communications

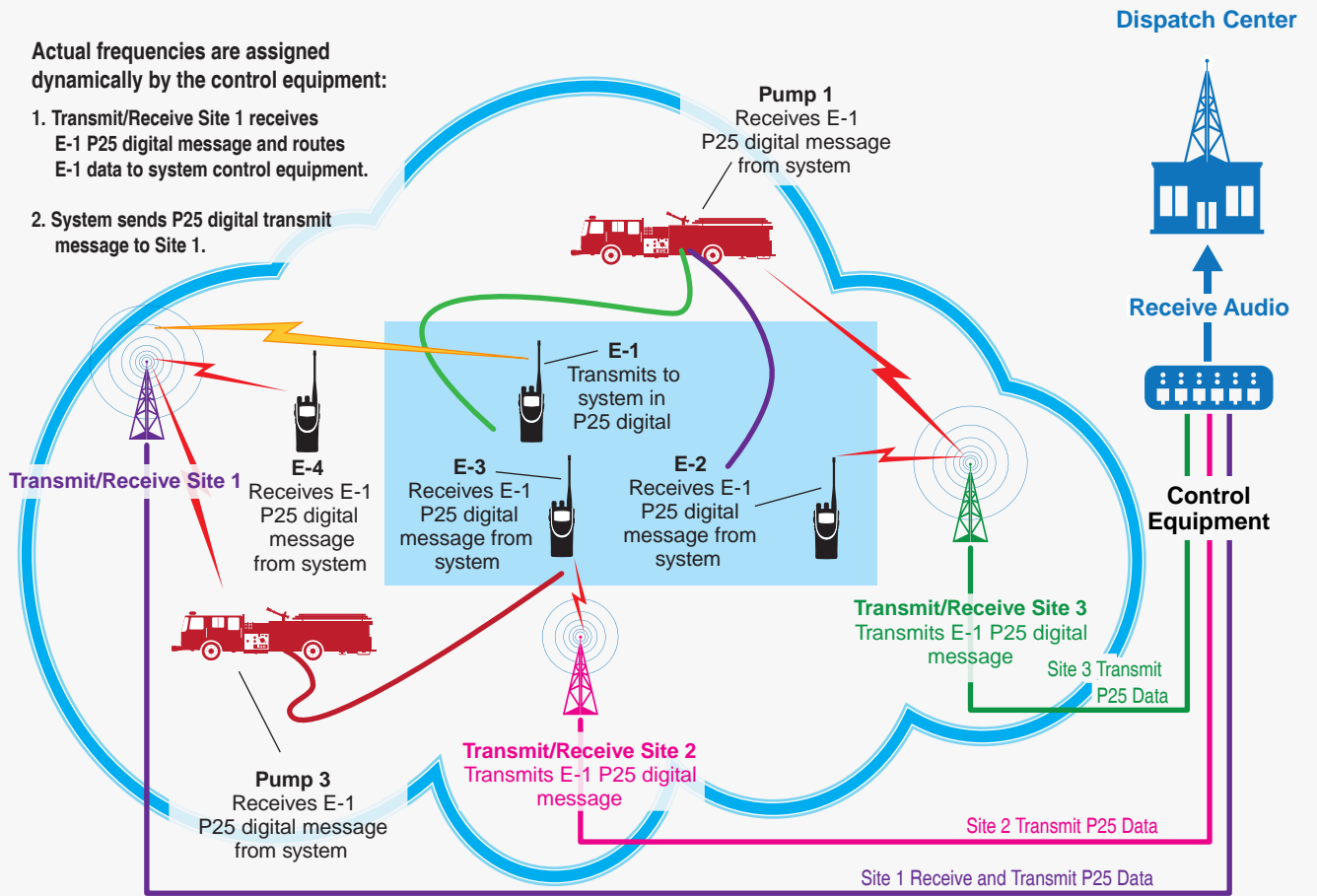

If there are no voice traffic repeaters available for the call, the system will place the request in a busy queue in order of priority, send a busy message to the requesting radio, and wait a short time for resources to become available. If the resources become available, the transmission proceeds. If the resources do not become available before the wait time expires, the system transmits a message to the requesting radio telling it that the request failed. The radio will play a tone (commonly called a “bonk”) to the user, indicating the failure.

Call Disconnection

When the transmitting user is finished with the transmission, he or she will release the PTT switch. This causes the radio to send a message on the control channel telling the system that it can release the resources assigned to the transmission. Depending on the configuration of the talkgroup, the system either waits a few seconds for additional transmission requests before releasing the resources or it releases the resources immediately. Once the

timeout is reached, the system tells all radios on the talkgroup to change channels to the control channel and releases the voice traffic repeater for use for other requests. If another request is received before the resources are released, then the system immediately grants the requesting radio’s transmission request and does not need to tell the other radios to switch frequencies.

Designing a Trunked Radio System

Trunked radio systems are complex combinations of radio equipment with computer control systems and require skilled engineering to design an effective system properly. Trunked radio systems have been in use for over 20 years, and the manufacturers of these systems are fully capable of delivering a system that is technically reliable. These systems are designed and manufactured to be as reliable as conventional radio systems. Trunked systems can be deployed in either analog or digital technologies, depending on the frequency band they are deployed on.



The design of the overall system, including the system's coverage and capacity, involves considerable effort to produce a communications system that is effective for the community and agencies that will use it. The system must have the capacity to accommodate the needs of all of the users of the system and must provide usable coverage in all of the agency's service areas. It is critical to have the end users involved in the specification of these parameters.

Capacity Design

The capacity of a trunked radio system is the amount of communications traffic that the system can support in a given amount of time. The frequencies in the trunked radio system are shared among users and assigned to conversations, as necessary. If there are more talkgroups (i.e., channels) than there are frequencies, which is often the case, then the potential exists for calls to be blocked.

It is most desirable for public safety users to never have a call blocked, although this never can be guaranteed in a system with shared frequencies. Manufacturers use statistical models to estimate the traffic presented to the trunked radio system. These models are based on historical traffic information collected from other customers, along with predictions of usage based on experience with similar agencies. This historical information may not represent operations in your agency. In addition, the traffic information may not represent peak loading but only average loading. If the system is designed and constructed for average loading, and performs as designed with average loads, then it may not be able to provide adequate service when confronted with abnormally high loads. These high loads can occur during natural disasters or large-scale incidents such as train derailments, plane crashes, or multialarm fires.

An important concept is that all users of a trunked radio system affect the system's performance and can affect other users. The channels used by the system are shared among all users of the system, and like any other shared resource, all users must be aware of their impact on other users and must act accordingly. For example, some users may talk excessively and use the trunking system to discuss issues best discussed face to face or on

the telephone. Proper user education and the establishment of a formal communications order model can help prevent unnecessary system load.

Site capacity is determined by the number of radio channels on a site. For instance, a low capacity site might have five radio channels. The five-channel site allows four simultaneous voice calls, and the fifth channel is the control channel (FDMA system). A high capacity site in the system could have 20 channels that would allow 19 simultaneous voice calls and one control channel. If four users being serviced by the low capacity site monitor high volume traffic on four separate talkgroups in the high capacity site, the low capacity site can get busied out due to the users "dragging traffic" onto the low capacity site. System administrators must work with operational personnel to determine the number of wide-area talkgroups that are allowed on the system. Wide-area talkgroups must be used appropriately to minimize busies caused by dragging unwanted traffic into low capacity sites. Other talkgroups may be restricted to specific sites in the system to minimize dragging traffic into unwanted areas. Site restrictions can be done by the user or the talkgroup. This gives the administrators flexibility in being able to meet the needs of responders and maintaining system performance.

Coverage Design

Trunked radio systems that are for firefighting operations must be designed to provide radio coverage inside buildings. System manufacturers estimate what the system will require in terms of radio tower sites and other system components to provide coverage on the street. This becomes the base signal reference level and is referred to as zero decibel (dB). In-building coverage levels are dictated by the construction of the buildings from which the users need to communicate. The heavier the construction, the higher the signal level needed to provide RF penetration into the structure.

During system design, the service area is analyzed, and geographic areas are categorized based on the structures within them (**Figure 5.3**). For example, the central area of a city may have high-rise structures that require the highest penetration signal levels. The area surrounding the high-rise district may consist of midrise and warehouse

Figure 5.3. Coverage Map

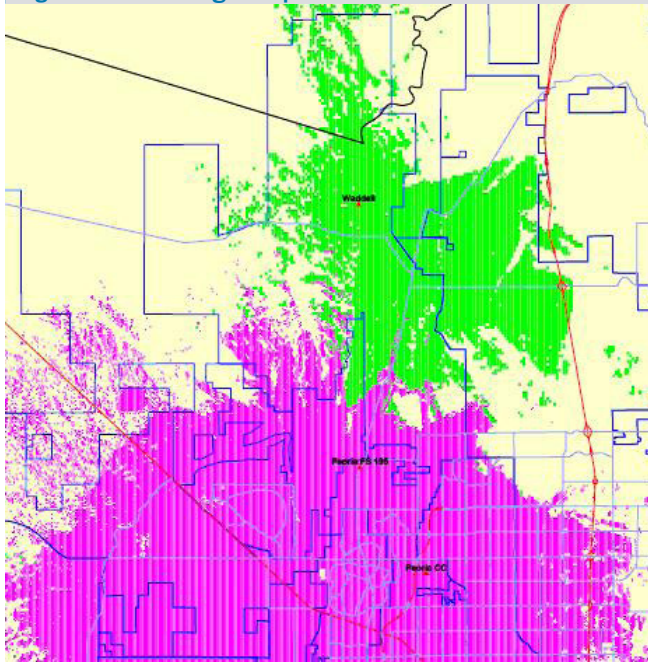

structures requiring less signal level to penetrate the structure. In suburban areas, even less signal generally is required to communicate on the interior of a structure. Areas with the greatest RF penetration demand will have a higher number of radio sites than areas with lesser penetration. When a building such as a hospital or school is built in a predominately suburban area, the radio system will not provide in-building communications because the area was designed for residential structures. Interior radio system coverage is dependent on the ability of the system designer to estimate the signal loss accurately for each building type. During testing performed by NIST, building losses as high as 50 dB were found in a 14-story apartment building.²¹ For reference, a 50 dB loss equals 1/100,000th of the transmitted signal. The actual RF losses encountered are often much higher than the standard recommendations that system manufacturers use. This can result in marginal in-building communications in many structures.

System manufacturers and designers will never guarantee, and it is impractical to expect, 100 percent coverage. It is impossible to guarantee 100 percent coverage in any city. There is always some corner of a building that a radio system does not cover. The problem with no coverage from a

trunked system is very different from a simplex area. In a trunked system, no coverage means no communications.

Since trunked radio systems can have several levels of RF penetration, the users of the system need to be aware that a particular building type in one area of the system may have communications, while the same building in another area may not have communications.

Coverage Enhancement Devices

The following devices are coverage enhancers for trunked and conventional systems. The same theory applies in both trunked and conventional applications. They receive a weak signal and retransmit at a level that allows the system to capture the signal. The coverage enhancement devices have been placed in this section due to being discussed in most trunked system deployments. Trunked systems commonly use these devices to achieve coverage requirements.

Bidirectional Amplifiers

To overcome system in-building coverage difficulties, BDAs often are used to rebroadcast the trunked system in buildings (**Figure 5.4**). BDAs also can be used with conventional duplex radio systems. There are many types of BDAs; all require electrical power and some type of antenna system. The antenna systems are often installed in the plenum spaces of commercial structures. Most BDA systems include battery backup power to keep them operational if a loss of commercial power occurs.

BDAs work well for incidents such as Emergency Medical Services (EMS) calls and law enforcement incidents where there is no fire involvement in the building or building systems. In a structure with active fire, the building and building systems are affected directly. The building environment changes with the introduction of fire. Temperatures rise, and particulate matter is suspended in the atmosphere. Firefighter actions to eliminate the fire can also have a detrimental effect on BDA systems. As water is applied to the fire, steam is generated that may have an effect on electronic

²¹ Radio Propagation Measurements during a Building Collapse: Applications for First Responders, Conclusions and Discussion p. 3, Christopher Holloway, Galen Koepke, Dennis Camell, Kate A. Remley and Dylan Williams.

equipment. Acids are formed when moisture mixes with suspended materials. These acids can cause intermittent failure of exposed electrical contacts over time. As with all electronics, BDAs are subject to failure when exposed to high heat and moisture. Other actions taken during firefighting operations also could destroy the BDA system. Firefighters checking for extension using pike poles may inadvertently tear the BDA antenna system down, rendering the BDA useless and causing loss of communications inside the building.

Figure 5.4. In-Building Communications System

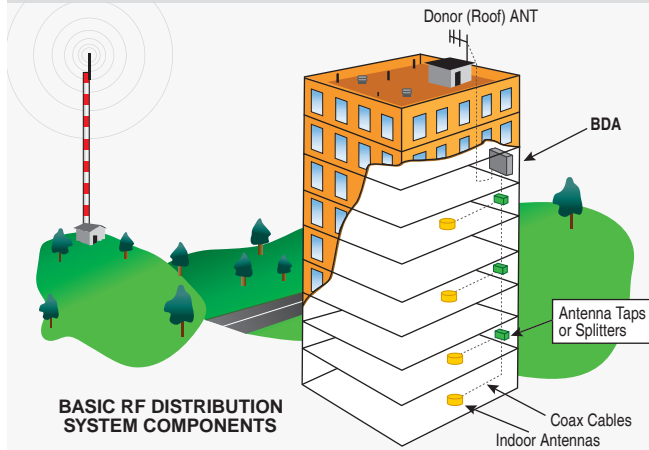

Identifying the buildings that need BDAs and installation of the equipment is a monumental task, especially in fast-growing metropolitan areas. BDAs, like any other transmitters, require periodic maintenance to keep the equipment operating at peak performance. To maintain BDAs in a system requires staffing and technical expertise to keep the equipment operating properly. As building density increases in a given area, a building that did not need a BDA when constructed may need one as it is surrounded by new construction. This requires periodic RF surveys to determine if new BDAs are needed. In 2013, the FCC made changes to the Part 90 rules that require installation by FCC licensees and qualified installers. The revision to Part 90 also requires registration of signal boosters. These actions were taken to control harmful interference.²²

Many municipalities have developed fire codes that require installation of this equipment. The codes often require BDAs when a building exceeds some square footage value, during additions increasing

square footage by some percentage of the original, or in all-new construction. The 2012 International Fire Code (IFC) requires that “All new buildings shall have approved radio coverage for emergency responders within the building based upon the existing coverage levels of the public safety communication systems of the jurisdiction at the exterior of the building.”²³ In addition to requiring radio coverage, IFC, Section 510 specifies technical, installation and maintenance requirements for in-building public safety radio coverage systems.

Figure 5.5. In-Building Distributed Antenna System

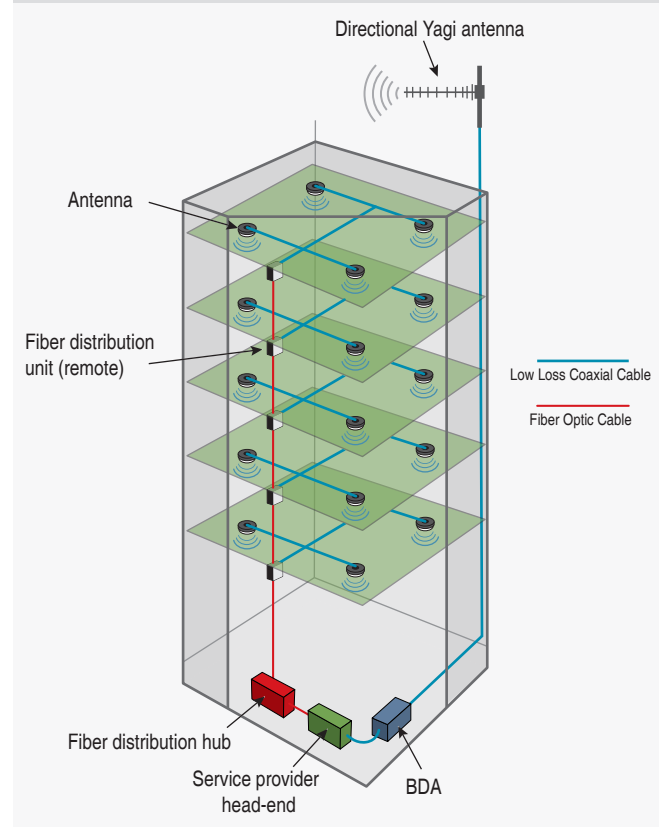

Drawing credit: <http://www.l-com.com/what-is-a-distributed-antenna-system-das>

An array of antennas is installed on each floor in some installations of BDAs (**Figure 5.5**). These systems often provide better coverage due to having more antennas on each floor to bring the signal in for retransmission or redistribution inside. The Distributed Antenna System (DAS) approach is commonly deployed in complex structures, such as high-rise buildings or airport terminals. In **Figure 5.5**, each floor has a DAS that is connected by low loss coaxial cable. The coaxial cable is

²² <http://wireless.fcc.gov/signal-boosters/part-90-boosters/index.html>.

²³ IFC 2012 First Printing, Section 510.

terminated on each floor at a fiber distribution unit. Fiber optic cables run between each floor to connect the fiber distribution units. All of the fiber distribution units are connected to a fiber distribution hub. The hub is connected to the RF head-end and to the BDA and then by coaxial cable to the exterior antenna. These systems can be very complex, and their survivability in a fire is dependent on the standards or codes that they are built to.

Vehicular Repeaters

Some municipalities have recognized the weaknesses in BDA systems and have installed vehicular repeaters (VRs) on fire apparatus to provide in-building coverage that is suitable for firefighting operations. Each apparatus is equipped with a VR that is activated manually prior to entering the involved structure. These repeaters are operated in the repeater mode, meaning that the users transmit from the portable radio, it is received by

the repeater, and then retransmitted to the other portable radios on the fireground (Figure 5.6). The VR retransmits all radio traffic from the repeater (transmit and receive) onto the trunked system talkgroup. Radios that are not in range of the VR are capable of bidirectional communication through the wide-area coverage provided by the trunked system.

In the repeater mode of operation, fireground radios are not communicating directly with one another. The radios are dependent on the repeater for communications. If an interior crew encounters an area where it does not have repeater coverage, it can switch to a talk-around channel to communicate directly with other interior crews.

If the unit on talk-around can hear the repeater but the repeater does not receive the transmitted traffic, the unit on talk-around can transmit — and on the repeater output with units in direct range on the repeater channel. Units on the repeater channel will be receiving the transmissions directly

Figure 5.6. Trunked System — Portable Transmit — Vehicular Repeater

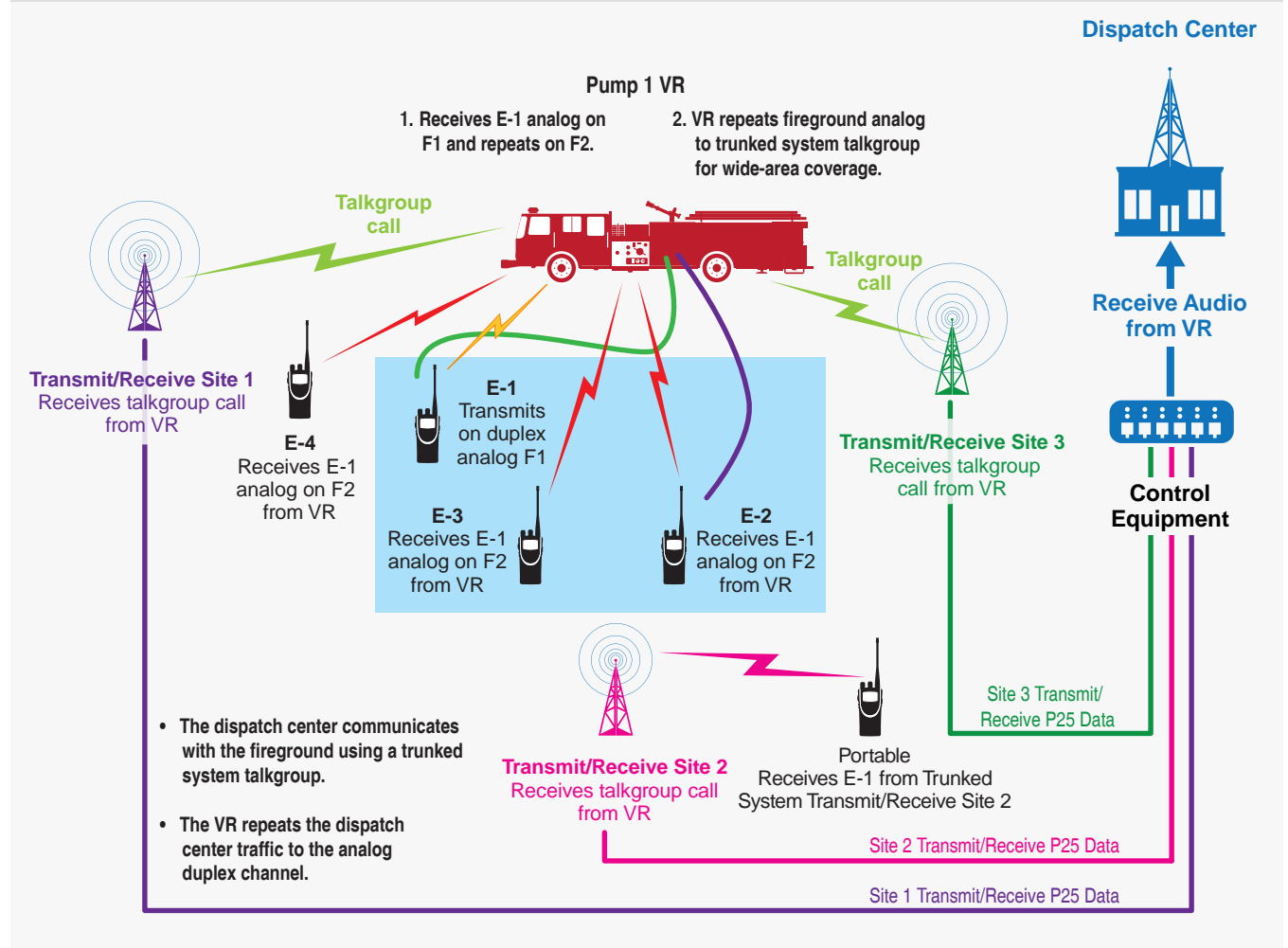



from the talk-around unit. When the units on the repeater channel respond, they will transmit through the repeater, and the talk-around unit will receive the traffic on the repeater output channel.

If the unit on talk-around cannot transmit or receive traffic from the repeater, the unit on talk-around will only be able to transmit to units within range of the portable. The units on the repeater channel will receive the talk-around traffic, but since the talk-around unit cannot hear transmissions from the repeater, the units on the repeater channel will be required to change to the talk-around to have bidirectional communications.

The other interior crews need to change to the talk-around channel to communicate with the out-of-range crew. When talk-around is used, the unit on talk-around can hear radio traffic through the repeater but cannot transmit to other units unless those units also change to talk-around. The talk-around function can cause some confusion unless the unit that switched to talk-around clearly communicates the channel change to other units on the fireground.

Other Trunking System Features

Trunked systems are feature-rich and can provide much more than just voice traffic. Some of the features greatly decrease the labor required to maintain and update fleets of radios. To maintain the ability to have voice traffic, these features must be accounted for in system design to build the capacity to maintain the reliability needed to carry the voice traffic.

Emergency Alarm

There are two different emergency features in trunked radio systems: emergency alarm and emergency call. When a radio user presses the emergency button on the radio, the radio switches to the control channel and transmits an emergency alarm message. This message is processed by the system, and an indication of the activation of the alarm is presented to any dispatchers using radio consoles. The benefit of the emergency alarm feature is that it is possible to send the alarm message even when all repeaters in the system are busy. Thus, even when the talkgroup is in use, an emergency alarm can be sent by a firefighter in trouble.

Emergency Call

An emergency call is similar to a normal talkgroup call or a multigroup call, but the radio initiating the call is in emergency mode after having its emergency button pressed.

Emergency calls are initially processed in the same way as talkgroup calls or multigroup calls. The difference in processing occurs when resources are not immediately available for assignment to the emergency call. If resources are not available, the emergency call can be processed in two ways: top-of-queue or ruthless preemption, depending on the configuration of the trunked radio system.

If the system is configured for top-of-queue, the request for resources is placed on the busy queue in front of all other requests. When the resources become available, the emergency call is assigned the newly available resources immediately.

If the system is programmed for ruthless preemption, the request for resources is not queued, and instead, the voice repeater for the lowest priority existing talkgroup is reassigned to the emergency call. To accomplish this, the receiving radios on the existing lower priority call are instructed to terminate that call, and the radios on the emergency call are instructed to tune to the frequency of that voice repeater. Unfortunately, the transmitting radio on the lower-priority call cannot be instructed to terminate the call. This can cause the emergency radio to compete with the lower-priority radio, resulting in distorted audio or no audio.

Radio Alerting

Individual radios can be alerted to notify the user of incoming traffic. Some agencies use this when dispatching units. A radio or radios assigned to a specific unit will be alerted much like a pager when traffic for them is inbound.

Location Services

Many trunked systems integrate the ability to receive location information from radios in the field if they are equipped with GPS. This feature allows tracking of units when they are receiving GPS signals from the satellites. This location service has severe limitations in the fire service due to loss of signal when entering buildings.

Multigroup Call

A multigroup call is a call that transmits to two or more talkgroups simultaneously. The system can be configured to wait for all talkgroups in the multigroup to become available before initiating the call or configured to begin the call immediately, with busy talkgroups joining when their calls are complete. During the call, all associated talkgroups act as a single talkgroup. Because of this, after the initial multigroup transmission completes, a user in one of the associated talkgroups can call all users in the associated talkgroups. In a busy system, this can keep the multigroup call in progress for a significant amount of time, severely disrupting operational communications.

Dynamic Regrouping

The dynamic regrouping feature allows an authorized system administrator to assign a radio to a specific talkgroup remotely. The purpose of this feature is to allow multiple radios to be grouped together on a talkgroup for operational purposes. This feature is limited in function due to the potential delays while the radio is assigned to the new talkgroup. Because of this, few agencies use this for critical operations.

Over the Air Rekeying

Encryption allows the voice traffic to be unintelligible unless both the transmit radio and receive radio have a common key. While mentioned in the trunked section, encryption is an available option on conventional systems as well. Encrypted operations require the use of a “key” to decode scrambled signals. Trunked system operators that use encryption periodically change the keys to maintain security on the system. The changing of the keys requires that all radios that use the encryption key be changed or rekeyed. Changing keys or rekeying was labor intensive, requiring each radio to be individually rekeyed. Most contemporary trunked systems have over the air rekeying (OTAR) available for encrypted operations. The use of OTAR has greatly decreased the labor required to maintain and rekey the portable radios on a system. The rekeying process in older systems required that each and every radio on a system be manually rekeyed one by one.

Over the Air Programming

The newest systems will soon be offered with over the air reprogramming. Again as with OTAR, over the air programming (OTAP) will allow updates to entire fleets of radios without the need to bring them to a radio technician. Some radios use Wi-Fi to provide the needed bandwidth to provide OTAP. In Wi-Fi-enabled radios, the radio uses the Wi-Fi connection for OTAP. This method of OTAP does not impact trunked radio system performance.

Short Message Service

Since the radios are digital, many trunked systems support sending short messages across the network. This has the possibility to send dispatch information over the network if the radios are equipped with a liquid-crystal display (LCD) screen.

Selective Disabling

This feature allows radios to be disabled if lost or stolen. Radios can be remotely disabled to maintain security of encrypted channels.

Private Call

The private call feature allows one radio to call another radio and to carry on a conversation without any other radios hearing the conversation. The radio user initiating the call must select the called radio from a list or know the numerical ID of the called radio. Some more advanced radios allow the user to change numbers in a cellphone-like phone book, making this feature more usable.

A problem with the private call feature is that it is very difficult to predict the capacity or loading impact of this feature during system design. When the system is in operation, high private call usage can cause other system users to experience more talkgroup busy signals than the design would predict. Some system operators prohibit the use of private call to eliminate the possibility of these calls affecting more critical operations.

Telephone Interconnect

The telephone interconnect feature allows system users to answer or make calls to telephone users from the user’s radio, similar to a cellular phone. The difference between telephone interconnects and a cellphone is that the trunked user cannot transmit and receive simultaneously. Telephone



interconnect was a much more valuable feature before the cellphone became commonplace. In addition, similarly to private call, it is difficult to predict telephone interconnect usage during system design. Telephone interconnect can have adverse effects on system capacity.

Summary – Trunked Radio Systems

Trunked radio systems are the most complex of public safety radio systems. As with all radio systems, the coverage of the trunked radio system is the key to its safe operations for the firefighters. Users can live with systems that lack telephone interconnects, private calling, and paging, but they cannot operate safely inside a hazardous atmosphere with a radio system that does not provide reliable communications.

Basic Trunked Radio Operations

In trunked radio operations, the radios request functions of the system, such as requesting a voice call. These system requests require constant handshaking between all of the units in the system to operate.

The design of a trunked system is a very deliberate process that requires analysis of current communications requirements and forecasting what will be required in the future. When systems are being designed, these are some of the key elements to consider:

- Capacity.
 - Number of users.
 - Number of talkgroups.
 - Peak traffic load.
- Coverage.
 - Geographic area.
 - Levels of coverage.
 - In-building penetration.

Coverage Enhancement Devices

While discussed in the trunked section, coverage enhancement devices can be used in other system types. BDAs are commonly used in trunked system deployments to achieve in-building coverage goals. The systems installed vary in complexity based on the building. An example of a complex installation might be a large airport. Simple installations might be installed to achieve coverage in a specific area of a building, such as a jail. VRs can repeat local signals from the fireground to a wide-area system, such as a trunked system.

Features

Trunked radio systems offer many functions and features not available in conventional systems. During system design, it is important to identify the features that will be used and plan for their implantation when the system is deployed. OTAR and OTAP are features that are extremely helpful in management of radios in the system. Some features can impact the performance of the system, or the feature may not work in the fire service environment.

SECTION 6 —

Portable Radio Selection and Use

General

The success of a fire service radio system project hinges on the performance of the portable radio. If the portable radio has poor performance, the end user relates it to the performance of the radio system as a whole. All the firefighter knows is that when the PTT was pressed, the communications worked or did not work.

Manufacturers offer radios at different price points to meet market need. As with any other product, the options and performance levels increase with the cost. Usually there are three tiers of radios available. At the lowest level are nonruggedized radios meant for users who do not handle radios in a rough manner and do not operate in environmental extremes. The second level of radio is for the user who needs more reliability and performance features. The highest tier radios are focused on the public safety user. They offer the highest levels of performance and reliability and have the most options available. Radios with the most options are typically more complex and require appropriate training and reinforcement to maintain proficiency. At this level, the radios often are submersible and have intrinsically safe options. Submersible radios are a very worthwhile option for the fire service, considering the possibility of radios getting wet or exposed to steam.

Ergonomics

Today's radios are an integral part of firefighting and a key component of fireground safety. The form and fit of the radios for firefighting have not improved much over the past decade. Buttons and knobs have increased in size as compared to the radios of the 1980s and 1990s, but firefighters have the same difficulties operating radios while in PPE. Radio knobs are still difficult to manipulate with a gloved hand, even though it is required as a component of NFPA 1221 (2013 edition) (**Figure 6.1**).

The radios of today can be programmed with hundreds of channels or talkgroups. The large number of channels/talkgroups has made “hard switches” that correspond with a channel/talkgroup impossible. To select channels on radios with added channel capabilities requires LCDs and “soft keys” to provide access. In firefighting, the LCDs are not readable in smoky environments, and the soft keys cannot be pressed with a gloved hand. When programming the radio, take care to make firefighting radio channels easily accessible.

Environmental Technical Standards

Radios are designed to operate in environmental ranges. The harsh environment of firefighting is hard on equipment and personnel. To provide reliable communications, it is common to purchase

Figure 6.1. NFPA 1221 9.3.6.6: Portable radios shall be designed to allow channels to be changed while emergency response personnel are wearing gloves



(Photos courtesy Cody Worrell)



ruggedized communications equipment. The technical specifications and testing protocols used to determine if a device is rugged can be confusing. Manufacturers use several testing protocols to determine if the device is “Public Safety Grade.” Some of the more common standards encountered are Military Standards (MIL-STD) and International Electrotechnical Commission (IEC) standards.

International Electrotechnical Commission Ingress Protection Codes

Ingress Protection (IP) codes are international standards that test for IP into an electrical enclosure. Manufacturers use this code to rate intrusion against solid objects from hands to dust and water in electrical enclosures. The rating consists of the letters “IP” followed by two digits. The standard is intended to provide an objective testing protocol to reduce subjective statements such as “waterproof.” The first digit represents the size of the object that is protected against, and the second digit represents the water protection. More detailed information on this standard can be found at www.iec.ch, International Electrotechnical Committee, IEC 60529.

Military Standards

In the 1970s and 1980s, radios were manufactured to various industry standards for ruggedness and technical stability. In the 1990s, radio manufacturers adopted MIL-STD 810 as a standard for reliability and ruggedness. MIL-STD 810 was developed by the military to provide an environmental test protocol that would prove qualified equipment would survive in the field. MIL-STD 810 is a test protocol written for the military environment, not the firefighting

environment. The specification sheets often reference a letter designation behind the MIL-STD. The letter designation represents the revision level of the MIL-STD being tested to. The latest revision is MIL-STD 810 F. Earlier revisions of MIL-STD 810 were generic up to revision C. Subsequent revisions became more tailored to the actual environment the equipment would operate in. Manufacturers sometimes only perform specific test components of the MIL-STD. For instance, an equipment specification may read “MIL-STD 810 F for water, dust and shock resistance.” When we see MIL-STD 810, we assume that the equipment is ruggedized and will survive the firefighting environment. We need only look to the temperature specification to see that this is questionable. MIL-STD 810F actually has two temperature specifications depending on where the equipment is to be used (**Table 6.1**).

The table shown is the high temperature table from MIL-STD 810F. A similar table is included in MIL-STD 810F for low temperatures. Most manufacturers test to the “Basic Hot” and “Basic Low” temperature levels. This temperature range is from approximately minus 30 C to 60 C (minus 22 F to 140 F). These temperature extremes do not replicate the environments that firefighters encounter. Radios that are available today are still manufactured to this specification.

How Many?

After defining the technical and operational requirements of the radio, the number of radios needed has to be determined. Departments have to identify who needs radios. A portable radio for each firefighter provides the highest level of safety. In addition to firefighters, radios for support and other fire department functions should be considered.

Table 6.1. Military Standard 810F High Temperature Table

Design Type	Location	Ambient Air C (F)	Induced C (F)
Basic Hot	Many parts of the world, extending outward from hot category of the United States, Mexico, Africa, Asia, and Australia, southern Africa, South America, southern Spain, and southwest Asia.	30-43 (86-110)	30-63 (86-145)
Hot	Northern Africa, Middle East, Pakistan and India, southwestern United States and northern Mexico.	32-49 (90-120)	33-71 (91-160)

Additional guidance can be found in the following NFPA standards:

NFPA 1561

6.3 Emergency Traffic.

6.3.1* To enable responders to be notified of an emergency condition or situation when they are assigned to an area designated as immediately dangerous to life and health (IDLH), at least one responder on each crew or company shall be equipped with a portable radio and each responder on the crew or company shall be equipped with either a portable radio or another means of electronic communication.

NFPA 1221

9.3.6 Two-Way Portable Equipment.

9.3.6.1 All Emergency Response Units (ERUs) shall be equipped with a portable radio that is capable of two-way communication with the communications center.

9.3.6.2 Portable radios shall be manufactured for the environment in which they are to be used and shall be of a size and construction that allow their operation with the use of a gloved hand.

9.3.6.10 Spare batteries shall be maintained in quantities that allow continuous operation as determined by the authority having jurisdiction (AHJ).

9.3.6.11 A minimum of one spare radio shall be provided for each 10 units, or fraction thereof, in service.

What Type?

Since radios are tiered based on performance and ruggedness, there can be significant cost savings by buying high-tier radios for responders and the appropriate lower tiered radios for support staff (Figure 6.2).

High-tier: High-tier radios should be provided to each firefighter. This level of radio gives the highest level of performance and reliability that radio manufacturers can provide. Within each tier, there may be options that provide additional capabilities or functions. If using radios for EMS and fire functions, encryption may be required for operations with law enforcement agencies or to comply with the Health Insurance Portability and Accountability Act of 1996 (HIPAA) requirements.

Figure 6.2. Examples of Various Tiered Radios





Mid-tier: Mid-tier radios may be appropriate for users who do not enter into the firefighting environment. This type of radio would be a good choice for EMS functions. Again, encryption may be required to meet HIPAA requirements.

Low-tier: Low-tier radios are an option for some support staff. These radios provide communications for users who are not in harsh environments and may not need all the functionality of the higher tier radios.

Multiband

Multiband radios are now offered and can provide added levels of interoperability or provide flexibility to improve operability. The selection of which multiband radio may require assistance from the spectrum coordinators in your department or area of operation. Depending on the manufacturer of the radio, the radios are commonly triband (VHF, UHF, 700/800 MHz) or dual band. In dual band radios, a decision on which two bands provide the best use in your jurisdiction will have to be decided. The access to multiple bands has the capability of providing interoperability with other jurisdictions or disciplines you interact with. Having access to multiple bands and channels does not create interoperability. Interoperability must be planned, coordinated, agreed upon, trained for and practiced to be effective when you need it.

Having access to multiple bands also can enhance operability. In the metropolitan area of Phoenix, Arizona, use of multiband allows the firefighters in the region to use a 700/ 800 MHz trunked radio system for dispatch and EMS-related calls. Fire calls are run on VHF analog direct channels. This model allows the participating fire departments to use the trunked system for interoperability with law enforcement, meet wide-area communications needs, and use VHF direct for operations with local command, such as at fire incidents. Having two systems has the added benefit of providing redundant systems for increased reliability. Just a few years ago, they had to operate on two different radios.

National Institute of Standards and Technology Testing

NIST has performed testing on portable radios that closely replicates the firefighting environment.

Technical Note 1477

Technical Note 1477²⁴ test results exposed the vulnerability of the portable radios to elevated temperature conditions and emphasized the need to protect the radios when used in firefighting situations. Radios tested inside the turnout gear pocket showed that the turnout gear pocket was able to protect the radios and allow them to operate at the Thermal Class III temperature of 260 C (500 F). This contrasts with tests where the radios were exposed directly to the airflow, in which the radios did not survive at Thermal Class II conditions and beyond. In all but one test, the exposed radios were able to operate properly at the Thermal Class I temperature of 100 C (212 F), above the listed maximum operating temperature of 60 C (140 F). Failure of the electronics due to heating was not permanent for the radios. In all cases where the radio casing was not damaged, the radios regained normal operating function once they had cooled sufficiently. Permanent damage to the casing, such as difficulty turning knobs or pressing buttons, did occur for some radios whose casings experienced melting. Permanent damage also occurred to the external speaker/microphones, especially due to the melting of the connecting cables.

Technical Note 1850

Technical Note 1850²⁵ was released in September 2014. The purpose of this study was to determine the firefighting environment that the radios operate in. While NFPA 1221 states: “Portable radios shall be manufactured for the environment in which they are to be used and shall be of a size and construction that allow their operation with the use of one hand,”²⁶ no standard had been developed to quantify the firefighting environment. Seven radios were tested to measure radio performance at elevated temperatures. At 100 C (212 F), all radios maintained frequency. When the radios were

²⁴ Available at http://www.fire.nist.gov/bfrlpubs/NIST_TN_1477.pdf.

²⁵ Available at <http://nvlpubs.nist.gov/nistpubs/TechnicalNotes/NIST.TN.1850.pdf>.

²⁶ NFPA 1221-13, 9.3.6.2.

Figure 6.3. Various Types of Firefighting Equipment and National Fire Protection Association Temperature Rating

(Figure courtesy Mike Worrell)

subjected to 160 C (320 F) for 15 minutes, all of the radios experienced frequency drift, and some radios completely stopped transmitting. This is quite alarming and clearly indicates the need to protect the radios as noted in Technical Note 1477.

NFPA 1802, Standard on Personal Portable (Hand-Held) Two-Way Radio Communications Devices for Use by Emergency Services Personnel in the Hazard Zone

In response to a line of duty death in San Francisco, the San Francisco Fire Department asked the NFPA Standards Council to approve a new project to develop a standard for portable communications devices used in firefighting. The Council approved the project and assigned its development to the Technical Committee on Electronic Safety Equipment. Committee work on NFPA 1802²⁷ began in March 2013 to establish minimum requirements for the proper function of the communications equipment that operates in hostile thermal, IDLH, and nonhostile emergency scene environments. The goal is to increase the reliability of the communications equipment used by firefighters. The document, when issued, will not address interoperability, and its scope will be limited to the performance of the portable radio in the firefighting environment.

Figure 6.3 is a comparison of equipment used in firefighting. It is easy to recognize that the NFPA temperature rating of the radio does not equal the same capabilities of other equipment in use by firefighters. The working group in cooperation with representatives from many fire departments, NIST, and the equipment manufacturers are working to define the operating environment and develop

tests to create a standard for communications equipment. In addition to defining the environment and developing testing, the group is working to establish ergonomics standards so that the communications equipment is easier to use in the firefighting environment. In addition to defining the environmental requirements and test procedures, the working group is also identifying mandatory safety features of the radio. Most manufacturers have the features available, but the jurisdiction programming the radio must identify and program each feature and select the correct value for the firefighting environment. Often, the function or characteristic of each button varies depending on who is programming the radio. The NFPA 1802 Technical Committee is developing the standard set of safety features.

Fire Radio Features

Many features are available in modern radios. Like automobiles, stripped-down versions of radios are available. When options are added, the cost rises. To identify the desired features, focus and user groups can assist in developing the radio feature sets that meet users' needs. Today's radios are extremely flexible in programming features and the functions of buttons on the radio. Cooperation between the radio vendor and technical provider for your radio system will be instrumental in filtering through all of the programming parameters. Some of the newer features that increase firefighter safety are:

- Voice channel announcement: This feature uses voice prompts to notify the firefighter what channel the radio is on as the channel select knob is moved.

²⁷ <http://www.nfpa.org/codes-and-standards/document-information-pages?mode=code&code=1802>.



- Emergency indications: Radios on the fireground receive an indication of emergency activations on the assigned channel.
- Personnel accountability: There are more radio ID numbers available in new systems. This makes it possible for each radio to have an individual ID code enabling identification of the unit and specific position of the unit on an emergency activation. ID of the individual firefighter is possible if it is tied to roster information in a CAD system.
- Tones: Many radios use tones as an indication of trunked system access, out of range, repeater access, encrypted channel, and other reasons. Use of tones may provide added awareness to the firefighter and increase safety.

For guidance on the minimum feature set a radio should have, refer to NFPA 1221, Section 9.3.6.²⁸

9.3.6 Two-Way Portable Equipment

9.3.6.2 Portable radios shall be manufactured for the environment in which they are to be used and shall be of a size and construction that allow their operation with the use of one hand.

9.3.6.3 Portable radios equipped with key pads that control radio functions shall have a means for the user to disable the key pad to prevent inadvertent use.

9.3.6.4 All portable radios shall be equipped with a carrier control timer that disables the transmitter after a predetermined time that is determined by the authority having jurisdiction.

9.3.6.5 Portable radios shall be capable of multiple-channel operation to enable on-scene simplex radio communications that are independent of dispatch channels.

9.3.6.6 Portable radios shall be designed to allow channels to be changed while emergency response personnel are wearing gloves.

9.3.6.7 Single-unit battery chargers for portable radios shall be capable of fully charging the radio battery while the radio is in the receiving mode.

9.3.6.8 Battery chargers for portable radios shall automatically revert to maintenance charge when the battery is fully charged.

9.3.6.9 Battery chargers shall be capable of charging batteries in a manner that is independent of and external to the portable radio.

9.3.6.10 Spare batteries shall be maintained in quantities that allow continuous operation as determined by the authority having jurisdiction.

9.3.6.11 A minimum of one spare portable radio shall be provided for each ten (10) units, or fraction thereof, in service.

9.3.6.12 Portable radios used by first responders who might encounter hazardous conditions likely to cause fire or explosion because of the release of flammable liquids or gases shall be rated as Intrinsically Safe by a recognized testing authority if determined necessary by the authority having jurisdiction.

Portable Radio User Training Guide

Firefighters often lack the basic knowledge and training of their portable radios, systems, and the capabilities of each. Training is required to form a basic operating knowledge and awareness of their radios. The awareness should include regular training and familiarization with the radio. The IAFF Fire Ground Survival (FGS) program states that “no probationary firefighter should enter the field without having practiced requesting resources and calling a Mayday. Furthermore, fire departments must have an ongoing training program specifically focused on using the radio” (IAFF FGS). Radios are often the only way to communicate on the fireground, especially in the case of an injured or downed firefighter. The next paragraphs will provide a simple and basic understanding of radio operations. It is not a prescriptive answer for every

²⁸ NFPA 1221-13.

situation nor will it go over every single type of radio. The goal is for users to understand how to care for their radio, how to wear their radio, radio discipline, and training.

When a firefighter arrives to the fire station or is checking his or her equipment prior to engaging in work, it usually involves placing his or her gear and equipment in a ready state. Depending on where you work or who you work for, the radio may not be a big part of this routine. If it is not a major part of the routine, then it should be. The radio provides the means to summon help for you or your fellow firefighter. A basic radio check-off would include proper inspection of the radio's physical properties, such as knobs, switches and the antenna as well as the radio's functionality. Users should also have some knowledge and understanding of battery/power supply life, rotation and maintenance. They should also be aware of the effect of temperature on the battery/power supply. Further questions about radios can be answered in this report, your department's technical personnel, or the manufacturer.

Users and their behaviors have an impact on the effectiveness of fireground communications. Human factors, such as the way we speak and organization of reports, affect communications. Technical factors obviously have an impact on fireground communications. Like any other technology, users need to know the limitations of the technology and how to use the tool appropriately.

Human Factors

When we talk on the radio, each of us subconsciously performs a process before we speak. Managing this process will provide more effective communications. Key aspects of managing this process include the following:

- **Organization:** Before speaking, formulate what information is being communicated, and put the information in a standardized reporting template. For instance, a standard situational report might contain Unit ID, location, conditions, actions and needs. This method forces users to fill in the blanks, answer all the necessary questions, and filter out unnecessary information.

- **Discipline:** ICs are often overwhelmed by excess information on the radio. Radio discipline on the fireground will help to determine if information needs to be transmitted on the radio. If face-to-face communications are possible between members of a crew and the information is not needed by the IC, don't get on the radio.
- **Microphone location:** Placing a microphone too close to the mouth or exposing the microphone to other fireground noise may result in unintelligible communications. When transmitting in a high-noise environment, shield the microphone from the noise source. Hold the microphone a couple of inches from the mouth or, when speaking through an SCBA mask, place the microphone near the voice port on the facepiece.
- **Voice level:** Use a loud, clear and controlled voice when speaking into a microphone. When users are excited, their speech often is louder and faster. These transmissions often are unintelligible and require the IC to ask for a rebroadcast of the information, resulting in more radio traffic on the channel.

Managing these human factors will have a positive impact on fireground communications. Reporting should be complete, necessary, and in a controlled, clear voice. These actions will reduce the amount of repeat transmissions on the fireground and reduce air time.

Technical Factors

In some cases, communications problems are caused by a technical issue. Users need to recognize technical problems and take corrective action to improve communications. Training users to understand the system they use, as well as features of the system such as VR and BDA, may help users to more readily recognize communications issues and take corrective action to rectify them. Radio users often blame the radio or system for coverage problems. In many cases, users' actions can improve communications.

Figure 6.4. Radio Placement



(Photos courtesy Cody Worrell)

Where to Wear Your Radio

Now that the radio is ready to be placed into service, the decision of where to wear the radio will have to be made (**Figure 6.4**). Most firefighters haven't given much thought to where the radio should be worn. Not much thought has been given because the limitations are not fully understood. Many firefighters assume that the equipment they are given is bulletproof and tested to all of the same standards. The radios that the fire service uses are far from bulletproof, and where the radio is worn will have an effect on radio performance. In order to decide on where to wear the radio, radio accessories will also need to be looked at since they are a part of the ensemble.

Many users do not use a radio pocket or case. In the middle photo of **Figure 6.4**, the Company Officer's (CO's) radio (left) is clipped to the exterior of the coat, while the firefighter's radio is protected. The trade-off is that the radio is exposed to heat and steam but is in a better transmitting position. When unprotected, the radio may fail to operate when needed. NIST tested seven different radios at a temperature of 320 F for 15 minutes; all radios experienced an issue. After testing concluded, three radios failed to recover, while the other four worked properly after cooling down. When a radio is in a pocket, the temperature reduction is 135 to 167 degrees Fahrenheit cooler, which may keep the radio at the proper operating temperature, which was also tested by a NIST study.

There have been many studies, blogs and articles written on the best practices for carrying your portable radio, the most prevalent being the coat pocket versus the radio strap underneath the coat with the speaker microphone protruding from the top of the firefighter's coat. A number of factors play into the decision on where to carry, with pros and cons to both locations. The takeaway is to understand the limitations of what is issued to you and maximize the performance by your actions. No single location is optimal in **all** situations. A user that understands this limitation can react to a no transmit or no receive situation by changing something (i.e., body position or radio orientation).

Radios in the fire service vary greatly. Many were designed for public safety; however, manufacturers are now offering radios with "fire features." The fire features include larger knobs but still can pose a challenge to manipulate with gloved hands. Take one look at the knobs and buttons on some fire service radios, and it will be obvious that they are not made for firefighters because they are difficult to use with gloved hands. The other agencies that use our same radios don't find themselves transmitting with gloves on in environments that are hot and wet. All radios are susceptible to heat and moisture — to what degree, it may vary. Regardless, all firefighters should follow some basic rules on where to wear their radio. If firefighters are leaving the radio exposed, they are exposing themselves to danger and run the risk of making the radio inoperable. Protect the radio at all costs. Most turnout coats have radio pockets to protect

the radio, but some may not. Many departments use radio harnesses as well to aid in protecting and carrying the radio (**Figure 6.5**).

Figure 6.5. Firefighter on the left with proper wearing of radio in pocket. Note minimal radio speaker microphone cord exposure. Firefighter on the right demonstrates use of the shoulder harness and leather case.



(Photos courtesy Cody Worrell)

An important factor in where the radio is worn depends on the antenna. Portable radio antennas are designed to work in an upright position, so the radio waves can transmit out. All firefighters reading this should have questions popping up in their minds. Firefighters often find themselves crawling on the floor on top of their radio. Being in this position limits the capabilities of the antenna; however, the user should be able to adjust and to help this. Depending on where the radio is will determine what may need to be done. If the radio is in the pocket, the firefighter may need to turn over to transmit. If the radio is worn around the waist, the firefighter may not need to do anything if the radio is exposed. The important thing to note is that the radio needs to be exposed so that it can transmit effectively. The other aspect to carrying a radio will be the accessories used in conjunction with it (**Figure 6.6**).

Figure 6.6. Firefighter crawling in a poor transmit-receive position. In the second picture, the firefighter has adjusted position for better transmit. Note that the body is no longer shielding the antenna.



(Photos courtesy Cody Worrell)

Section 2, Recommendation 5 in the IAFC “Portable Radio Best Practices” states: “When practical consider the use of accessories, such as speaker microphones, throat microphones, and in-ear microphones, to reduce the impact of background noise” (IAFC Best Practices, p.18). Another factor is the use of remote speaker microphones (RSMs) and other accessories that allow the radio to be protected in a harness or pocket from heat. Radio pocket protection has been proven by NIST Technical Note 1477 where temperatures in the pocket were 135 to 167 degrees Fahrenheit cooler than outside the pocket²⁹ (converted to F). Other common radio accessories found in the fire service are remote speaker mics, amplifiers and talk-around systems. RSMs connect to the radio with a pin connection and have a cord that attaches to the speaker and microphone (**Figure 6.7**). The RSM is also commonly referred to as a lapel mic. RSMs have been in use for a long time and are recommended as a best practice by the IAFC³⁰ because they can dramatically reduce the impact of background noise on audio intelligibility. RSM problems were documented in the Houston Fire Department³¹ and San Francisco Fire Department³² line-of-duty deaths (LODDs) reports.

In San Francisco, an LODD report concluded that “victim 1’s remote speaker/microphone failed due to high heat/fire, causing constant transmit condition. This disabled the radio from transmitting

²⁹ NIST 1477, p. 6.

³⁰ http://www.iafc.org/files/digProb_PortableRadioBestPractices.pdf, Section 2, p. 18.

³¹ Houston Fire Dept. Southwest Inn Recovery Committee Final Report and Recommendations Sept. 1, 2014.

³² San Francisco Fire Dept. Safety Investigation Report Line of Duty Deaths 133 Berkeley Way June 2, 2011 Box 8155 Incident #11050532.

or receiving after 60 seconds.” The biggest problem has been the cord that connects the speaker/microphone to the radio body. The cord can melt causing a short. When the short occurs, the radios are sometimes keyed up, unbeknownst to the user, or inoperable. The user needs to protect the cord to help prevent this from happening. The cord can be tucked into the radio pocket or underneath the jacket where temperatures are significantly cooler. It is worth noting that some manufacturers offer cords that can withstand 500 F temperatures, as well as having more firefighter friendly features. These are just two solutions; there is no prescriptive answer. Furthermore, the IAFC recommends that special attention be paid when selecting radio accessories to ensure that they are compatible with the environment that they are to be used in.³³ What the last sentence is saying is that not all cords are created equal, so the user must know the temperature ratings of his or her equipment because they may be different.

Figure 6.7. Remote Speaker Microphone Examples



(Photos courtesy Harris and Motorola Solutions)

Amplifiers are attached to the SCBA facepiece (Figure 6.8). The amplifiers do not connect to the radio; they only amplify the voice of the user out of the SCBA mask. A benefit of the amplifier is that users do not need to significantly raise their voice to be heard. Transmissions sound better and more controlled because the users are not required to yell. The amplifiers operate off batteries that need to be tested and maintained. The amplifiers are

only effective if the user places the radio or RSM in the correct area when speaking. The user will position his or her radio 1 to 2 inches from the audio source when in use as recommended by the IAFC “Portable Radio Best Practices” report. Once again, it is important to note that the temperature rating of the equipment needs to be known.

Figure 6.8. Example of a Self-Contained Breathing Apparatus Voice Amplifier



(Photo courtesy Scott Safety)

The third accessory is a talk-around system. Some SCBA manufacturers produce a talk-around system that attaches to the facepiece. The models may offer multiple talk-around channels that allow users to talk with each other on the fireground. A benefit of this system is that users can talk to each other without tying up airtime on the tactical channel. Airtime is available for important information and maydays. This type of system would aid in mayday situations because interior crews communicate without being on the tactical channel. The systems also can attach to the radio. There is a switch to allow you to talk through the radio. The talk-around system may have a PTT button on the facepiece itself. The RSM cord is the same that is used for this system as well. The dangers listed above in the RSM section apply to this piece of equipment as well.

The question of where to wear the radio depends on all of the factors discussed above. Proper placement should be where the radio transmits and receives reliably. There is no prescriptive answer for where the radio should be. The radio

³³ IAFC “Portable Radio Best Practices.”

should be protected and in a place where the user is comfortable operating it with his or her given equipment. Proper placement of the radio has been a researched topic by multiple agencies and departments. The research has shown that the radio needs to be protected, or it may malfunction.^{34,35} Placing the radio in a turnout coat pocket resulted in a temperature difference of 135 F to 167 F.

Coverage

When communicating on the fireground, some areas of a building may be difficult to communicate from. When encountering these areas, move to a location where communications are possible. Areas that may improve communications are near windows and doors.

Accessories

Many accessories are available for radios. Use of accessories that protect the radio from heat and steam allows the radio to operate in high-heat environments. Each user group may have specific working conditions that require some accessories to make radio communications easier. Common accessories include carrying cases, speaker microphones, ear pieces, chargers, battery types, and optional antennas. A few considerations when evaluating radio accessories are:

- Is the accessory approved for firefighter use in the IDLH environment?
- Does the accessory hinder the firefighter in donning PPE?
- Can buttons/controls be manipulated with PPE?
- Is there a method to disengage accessory in case of snare or malfunction?

User and focus groups will help identify the accessories needed to support your department's needs.

Summary — Portable Radio Selection and Use

Portable radio equipment is what the firefighter sees and has the most impact on fireground communications. Firefighters expect the radio is going to work when the PTT is pressed. Multiple tiers of radios are available at different price points. Select the appropriate radio for entering the hazard zone. Today's radios have better ergonomics than in the past, and firefighters should be able to operate them with a gloved hand.

Radios are currently manufactured to meet MIL-STD 810. Environmental specifications for this standard range from minus 22 F to 140 F. This has proven to be a weakness.

NFPA 1561 and 1221 are guiding documents on the type and capabilities of the radio and should be referenced during radio purchases or system design.

NIST Technical Notes

1477: This study tested radios in the firefighting environment and proved that radios protected from the direct heat increased the survivability of the radios.

1850: This study tested seven radios and subjected the radios to 320 F for 15 minutes. All radios experienced frequency drift, and some completely stopped transmitting.

NFPA 1802

Draft development of this document began in March 2013 with the establishment of minimum requirements for the proper function of the communications equipment that operates in hostile thermal, IDLH, and nonhostile emergency scene environments. Turnouts, thermal imaging cameras (TICs) and PASS units are all rated for 500 F for five minutes. The radio is the only piece of equipment that does not meet the 500 F rating. The standard, **when issued**, will also mandate basic safety functions on the radio.

User Guide

As with any equipment used in the fire service, training is a key factor in successful use of the

³⁴NIST TN 1850.

³⁵NIST TN 1477.



equipment. This is especially true when in high stress situations. Users need to be aware of actions that they can take to successfully communicate:

- Organized thought process.
- Discipline — when to speak, what to speak, controlled voice (speed and amplitude).
- Equipment.
 - Component location — microphones, voice ports, antennas.
 - Position where the radio is worn — **protected**.
- Recognition of coverage (poor transmit or receive):
 - No single location is optimal in **all** situations. A user that understands this limitation can react to a no transmit or no receive situation by changing something (i.e. body position or radio orientation).
 - RSM use.
 - Change radio or body position — get the antenna vertical.
 - Move toward windows or exterior of the building and retransmit.

SECTION 7 —

System Design and Implementation**Project Organization**

Designing and implementing a communications system is an extremely complicated process. It is important to create a structured organization to provide input, carry out decision-making, and conduct implementation work on the project. Get the organization established before beginning the project.

Everyone affected by the fire communications system should have a hand in its selection. This doesn't mean everyone participates at every step, but it does mean stakeholders must be consulted and their needs given serious consideration. If any constituency gets left out of the planning process, those needs may get overlooked, and the result could be a system that fails to meet the requirements and expectations of the entire community.

When creating the project organization, be careful to clearly define the roles various workgroups have in the organization. The term “user” often has different meanings to different people, so using a more descriptive term is best to avoid confusion. Some example roles include:

- Front-line firefighters and the teams that support them in the field.
- Dispatchers and others who provide support away from the scene.
- Operational supervisors.
- Department and other organizational business management.
- Union representatives.
- Elected officials.
- Personnel from other agencies that collaborate with the fire service.

Interoperability is a major concern in today's world. The ability of public safety agencies to communicate with each other is critical when events require them to coordinate a joint response. Many localities are answering this need by designing large networks that will be shared by multiple departments and sometimes by multiple cities and counties.

If your community is working on a communication system that will be shared by other entities in addition to the fire service, you need to be collaborating with representatives of those organizations. You'll face the challenge of giving each agency's needs appropriate weight. The law enforcement component of the system may often drive the overall direction of the project, but it's essential for the fire service to make system designers aware of the needs of the fire service and to make sure that the system is designed to accommodate those needs.

Each community has a different approach to organizing the planning effort. Typical efforts include:

- A steering committee with top leadership setting the overall policy agenda. Every attempt should be made to have fire department management and labor leadership as participants on the steering committee at the project's earliest stages.
- Working groups that are assigned to complete specific tasks and report back to the steering committee. If you are appointed to one of these groups, it sometimes can be difficult to determine exactly what your role is supposed to be — both as a group and as individuals. It is important that fire department management and labor are involved in establishing the goals and expectations for each work group.

Requirements Definition

You may be collaborating with other departments to build a shared multiagency network, or you may go it alone on a system for the fire service only. Either way, the more you learn about your department's needs, the more effectively you can represent the perspective of the fire service in your community.

The design and procurement of radio systems for fire departments is technical and very expensive. Many departments rely on expertise outside of the fire service to advise them on communications technologies. Often these technical experts do not have a complete understanding of the fire service



or special requirements related to fireground communications. As a result, many communications systems are built to design parameters based on incomplete or inaccurate information.

The development of a Requirements Definition provides an opportunity to analyze communications needs based on operational practices and inherent risks associated with fire operations. The Requirements Definition also provides a measurable parameter set to evaluate the current radio system.

Identify Operational Needs

The planning horizon for a new communications system can range from a few months to several years. Once installed, the system could have a life of 10 years or more. The following are some things that must be considered.

Operational needs should be grouped into three different categories based on the frequency of use:

1. Everyday incidents that all departments engage in, including structure fires, vehicle crashes, location of fire facilities, etc.
2. Mutual and automatic aid responses that occur less frequently but are still common.
3. Major incidents like disaster responses requiring long-duration coordination between local, state and federal agencies with heavy logistical support.

When considering the operational needs in these categories, it is important that the everyday incident operations are not compromised for the rare complex incident.

Major disaster response communications can be accommodated by using regional or national resources to supplement the everyday system, just as regional or national resources supplement the response and recovery response. This does not mean that communications planning for large-scale incidents is not necessary, only that you may not need a system that accomplishes all possibilities, no matter how unlikely. A large and complex radio system will be more complex for users, be more costly upfront, and require more operation and maintenance cost than a system designed for routine incidents. Consider the needs of the

community and the risks involved before putting together a plan for the ultimate system.

Plan for Change

Communications needs can change over time due to community changes, such as population growth, density changes, geographic expansion, alliances with other communities, and evolving issues in homeland security and all-hazards management. Any investment you make today should have the potential to grow tomorrow.

Organizational changes like budget constraints, staffing changes, departmental realignments, the creation of new work teams and task forces, greater collaboration with state and federal agencies can also affect communications needs. Will you be hiring more firefighters, opening or closing stations, or fielding specialized teams such as hazardous materials, weapons of mass destruction (WMD), wildland firefighting, technical rescue, or others? There are a number of other things to consider.

- Be prepared with statistics that reinforce your department's importance to the community. This includes how many incidents you handle each year, how many citizens receive service each year, and how many lives are saved. These can be hard to quantify, but some research should produce numbers you can use.
- Be familiar with your department's planning initiatives, and be prepared to talk about anticipated growth, addition of fire stations, potential incidents, and disaster scenarios to demonstrate the importance of fire service preparedness.
- Focus on results. It's not a question of how many antenna towers you have; it's whether firefighters can communicate to coordinate tasks and strategies or hear emergency traffic or a mayday call when they're working inside a building. Emphasize how each decision affects the safety of your personnel and citizens.

With the current focus on interoperability, don't lose sight of the basic mission. It is still more important to be able to respond effectively and safely to the everyday incidents than it is to provide for every possible (and unlikely) disaster scenario.

This is not to say that interoperability is not important, but don't sacrifice a system that you can use for a rarely used feature.

Evaluation of Current System

What is the current state of your fire communications? This is not an easy question to answer. It's not uncommon for a department to use more than one communications system, and even with the same equipment, procedures can vary markedly. Collecting this information and pulling it all together in one place is a necessary step that requires the commitment of time and resources.

An assessment of your current communications will help in identifying gaps in your communications infrastructure and plans, and identifying what it does well will assist in determining the need for a new system, or if updating the old system would be cost effective.

Few departments keep statistics about radio usage and performance, so you'll have to generate much of this information from scratch. Many departments use technical staff, vendors or bring in a consultant at this phase, especially to help with the more technical aspects of the job, such as charting call traffic and measuring grade of service. A consultant also can be helpful in collecting "softer" data. Soft data might include user perception of the current system or where users feel where improvements need to be made. Sometimes it's easier for an outsider to interview users and get their honest feedback on how the system works or doesn't work for them.

It may be beneficial to create scenario descriptions that describe all communications flows for various types of incidents from receipt of the call by the call taker, through dispatching units, unit response, and incident management and logistics support. Consider all aspects of the communications including the use of pagers and station alerting, mobile data, and wide-area and fireground voice communications. The most expensive communications system will be of little use if a major function performed today is left out of the future system.

Finally, consider the state of physical infrastructure, such as communications building condition and susceptibility to weather effects, tower condition,

commercial and backup power sources, and communications backhaul (telephone lines, data circuits, and microwave systems).

Funding

After the needs are identified, the budget can be developed. If the budget is developed too early, the system design may be unduly constrained. When this happens, it is inevitable that functionality and performance will be lost. Once the budget is set, it will be very difficult to get additional funding later to "get it right," especially if other agencies are pushing forward.

One method for getting a rough budget in place is to survey similar agencies with similar needs on the cost of their system or hiring a consultant to make a system design recommendation and cost estimate based on your system needs. Another method is to issue a request for information (RFI) to manufacturers and system integrators describing your operational communications needs and requesting a rough not-to-exceed cost for a system. Regardless of the method used for the estimate, this type of information will be very rough since the system design will be based on incomplete information and limited detail. It is difficult to get a solid cost without going through a complete system design with a specific manufacturer's equipment.

Alternative Funding Sources

Funding is a huge issue, but it should not be your first consideration when assessing your communications requirements. With the renewed focus on public safety and first-response capabilities, more funding is becoming available through federal, state and regional government grants. Examples include:

- State Homeland Security Grant Program (HSGP) and Urban Areas Security Initiative (UASI), administered by DHS through the Office for Domestic Preparedness (ODP) (<https://www.fema.gov/fy-2015-homeland-security-grant-program>).
- Assistance to Firefighters Grant Program, administered by FEMA (<https://www.fema.gov/welcome-assistance-firefighters-grant-program>).



- USFA document “Funding Alternatives for Emergency Medical and Fire Services” (http://www.usfa.fema.gov/downloads/pdf/publications/fa_331.pdf).

In some cases, it may be feasible to participate in joint investments with other agencies or nearby communities. This will allow for networking facilities, such as core systems, repeater systems, fire-alerting systems, and towers. Costs can be shared among several different organizations. This also improves day-to-day interoperability among these organizations.

Explore leasing agreements and other financing alternatives as opposed to immediately committing upfront capital investment. Phased implementation plans and adaptable networks that start small and add more capabilities over time as the funding becomes available are also an option. Do not allow cost to become a barrier that prevents your community from building the fire communications system its citizens and your colleagues deserve.

Grant Writing

If you decide to try to obtain grant funding, it is important that you get started on the grant proposal early and spend the necessary time to get the proposal right. A successful grant proposal is well-prepared, thoughtfully planned, and concisely packaged.

Become intimately familiar with the grant criteria and the eligibility requirements. You must be able and willing to meet these requirements. You might find that eligibility would require providing services otherwise unintended, such as working with particular client groups or involving specific institutions. You may need to modify your concept to fit. Talk to the grant information contact person to determine whether funding is still available, what the applicable deadlines are, and what process the agency will use for accepting applications.

Determine whether any similar proposals have already been considered in your locality or state. Check with legislators and area government agencies and related public and private agencies that currently may have grant awards or contracts to do similar work. If a similar program already exists, you may need to reconsider submitting the proposed project, particularly if duplication of effort may be perceived.

Enlist the support of community leaders. Once you have developed your proposal summary, look for individuals or groups representing academic, political, professional, and lay organizations that may be willing to support the proposal in writing. The type and caliber of community support is critical to your proposal’s ability to survive the initial and subsequent review phases.

You probably can develop the proposal without hiring a grant writer. Most fire grant programs are designed so that an astute member of any fire department can write a successful application. FEMA has a help desk staffed with competent professionals who help applicants through the process. In addition to the help desk, FEMA offers free grant-writing seminars and supports a website with helpful grant information (<https://www.fema.gov/welcome-assistance-firefighters-grant-program>).

Evaluation of Proposed Technologies

After collecting the description of the current communications system, armed with a Requirements Definition and rough budget, a comprehensive evaluation of your current system and proposed technologies can be made. The Requirements Definition becomes the scorecard where the current and proposed technologies can be graded on compliance, partial compliance, or noncompliance. All components of the Requirements Definition may not be compliant in all technologies. Each department will have to evaluate each component of the Requirements Definition and derive an importance factor to determine if noncompliance or partial compliance is acceptable for its department.

Technical Options and Conceptual Design

What technology is available to close the gaps between operational needs, federal, state and local mandates, and the current system? Select the best combination of technologies that close the gaps without compromising the mission. Keep in mind the safety of firefighters, mission effectiveness, and long-term sustainability when making decisions.

New technologies: While you can’t predict every future capability, you can read news reports and technology journals for emerging systems, pilot programs, and development projects. Look for

military spinoffs that will be adapted to the fire service. This is how we got TICs for locating fire victims and missing personnel, GPS location systems, and radios that can operate using different frequency bands and protocols as needed. Radio networks will be able to support a range of new features in the coming years. Even if you don't have the funding to activate these features today, you may choose to invest in a system that will be capable of supporting them later. These may include:

- Voice-activated intercom systems that would allow multiple interior attack firefighters to communicate while keeping their hands free.
- Large, accessible buttons on turnout gear to enable immediate distress signaling.
- Radio-linked PASS devices that alert a Safety Officer if a firefighter remains motionless for too long.
- Encryption to maintain operational security when needed.

As an advocate for the fire service, you can use these tips to help ensure that your concerns will not be lost in the shuffle. While many of these technological improvements will prove to be beneficial to firefighters in the future, this guide is directed primarily at voice communications.

Should You Hire a Consultant or System Integrator?

Consultants can provide technical knowledge about systems — and should have up-to-date knowledge of what various manufacturers can provide to meet differing communications needs — and can provide design and procurement assistance, as well as implementation project management. Manufacturer-neutral system integrators can provide equipment and labor to design and implement a complete system and will typically be responsible for providing the final working system.

Time, staffing and know-how are factors in deciding whether to hire a consultant or integrator. Do you have people with the necessary technical capabilities and an understanding of complex modern communications systems? Does your organization have time to do the job alone? Can you obtain the necessary staff internally? Do your people know

how to perform the assigned tasks? If the answer is “no” to any of these questions, consider getting the assistance of a consultant or integrator.

Even if you have some degree of technical capability in-house, use of an outside contractor brings the benefit of experience. The contractor has (or should have) more experience than you in dealing with communications challenges and providing communications project oversight. Contractors also provide an outsider's viewpoint, which can be valuable when there are conflicting requirements. Contractors can be hired to perform a single, clearly defined task or to take on a more comprehensive role in the project implementation. Often, it's wise to hire a consultant for a small-scale project and see how he or she performs before turning over large-scale responsibility for a major project.

If you decide to use a contractor, ask these questions before you hire:

- Have you worked with other public safety agencies before?
- Have you worked with fire departments before? Discuss some typical issues in fire department operational communications to see how familiar the contractor is with the issues and risks to the fire service.
- Have you worked with fire departments of our size?
- Are you able to provide assistance to overcome budget issues, such as grant writing, understanding the bond process, and creative financing solutions?
- What types of systems have resulted from your work?
- What are some of your successes, what were some of your failures, and how did you overcome them?
- Who are your references, and how can we contact them?
- Investigate relationships between the contractors and vendors.



Where to Get Advice

Whether or not you use a contractor, investigate these alternative sources of assistance and information:

- **Other communities:** Chances are that another agency similar to you has been through this process already. Look at other departments of comparable size, contact their committee members, and arrange a meeting or conference call where you can “pick their brains.”
 - **Conferences:** Attend fire and public safety conferences with an eye for communications sources. Programs, panels, vendor displays, demo projects ... they're all good places to get information and hook up with others who have experience they're willing to share.
 - **Vendors:** Manufacturers and system integrators often can provide brochures, white papers, and similar information resources. This is another place to find information about technical issues. An established vendor understands that well-informed customers are the best customers and that providing accurate information is one way to build a strong, lasting relationship and ensure the customer's long-term satisfaction. Be cautious of vendors who are in business solely to make money, not necessarily to meet your needs. Currently, there is a lack of real competition due to the extremely small number of companies who build these systems. You must have a strong labor/management commitment not to use a system until it is proven to be safe and cost effective and to get the best system performance from the contractor.
 - **Government and professional organizations:** Several national organizations act as clearinghouses for information about public safety communications. Again, a word of caution: While the organizations listed below do good work in the areas of interoperability and system standardization, no other organization outside of the IAFF is focused on the special needs of firefighters involved in interior operations.
- **DHS SAFECOM program:** The SAFECOM program's mission is to help local, tribal, state and federal public safety agencies improve response through more effective and efficient interoperable communications (<http://www.dhs.gov/safecom>).
 - **DHS Science and Technology Directorate, Office for Interoperability and Compatibility Office of Emergency Communications:** This is an operating unit within DHS Science and Technology's First Responders Group (FRG), which provides the science and technology that enables emergency communications and facilitates the seamless exchange of information to protect property and save lives (<http://www.dhs.gov/st-oic>).
 - **SAFECOM provides guidance, tools, and templates on communications-related issues and supports research and testing of communications products for public safety** (<http://www.dhs.gov/safecom>).
 - **APCO is a professional organization whose mission “... provides leadership; influences public safety communications decisions of government and industry; promotes professional development; and, fosters the development of technology for the benefit of the public.”** APCO sponsors the P25 digital radio standards process. APCO's focus is primarily on technical and operational standards relating to communications systems and communications centers (<https://www.apcointl.org>).
 - **The National Public Safety Telecommunications Council (NPSTC)** is a federation of federal, state, and local associations and agencies. It serves as a liaison among the FCC, Congress and appointed officials involved in public safety communications. NPSTC was originally formed to implement the recommendations of the Public Safety Wireless Advisory Committee (PSWAC). NPSTC has taken on a wide range of activities related to spectrum policy coordination and the development of new technologies (www.npstc.org).
-

- NFPA: The mission of the international nonprofit NFPA, established in 1896, is to reduce the worldwide burden of fire and other hazards on the quality of life by providing and advocating consensus codes and standards, research, training, and education. The world's leading advocate of fire prevention and an authoritative source on public safety, NFPA develops, publishes, and disseminates more than 300 consensus codes and standards intended to minimize the possibility and effects of fire and other risks (<http://www.nfpa.org/>).
 - IAFF is the driving force behind nearly every advance in the fire and emergency services in the 21st century. With headquarters in the District of Columbia and Ottawa, Ontario, the IAFF represents more than 300,000 full-time professional firefighters and paramedics in more than 3,100 affiliates. IAFF members protect more than 85 percent of the population in communities throughout the U.S. and Canada (<http://www.iaff.org/>).
 - IAFC represents the leadership of firefighters and emergency responders worldwide. Their members are the world's leading experts in firefighting, EMS, terrorism response, hazardous materials spills, natural disasters, search and rescue, and public safety policy. Since 1873, the IAFC has provided a forum for fire and emergency service leaders to exchange ideas, develop professionally, and uncover the latest products and services available to first responders (<http://www.iafc.org/>).
 - TIA is the leading trade association representing the global information and communications technology (ICT) industry through standards development, policy initiatives, business opportunities, market intelligence and networking events. With support from hundreds of members, TIA enhances the business environment for companies involved in telecom, broadband, mobile wireless, information technology, networks, cable, satellite, unified communications, emergency communications and the greening of technology. TIA is accredited by American National Standards Institute (ANSI) (<http://www.tiaonline.org/>).
 - National Interagency Fire Center (NIFC): The U.S. Department of Agriculture (USDA) and the Department of the Interior provide information on the use of radios in fighting wildland fires. Much of this information also applies to communications on structural fires. The information includes portable and mobile radio testing results, including digital radios, and training on various topics (<https://www.nifc.gov/NIICD/index.html>).
- ### Procurement
- Based on the identified funding and the conceptual design, the next step is to solicit companies to construct the system. The procurement process typically will involve the development of a request for proposals (RFPs). The purchasing itself can often be assisted by using existing procurement agreements, such as state contracts or cooperative purchasing contracts. Be cautious, however, as these purchasing agreements are typically targeted at commodity purchasing and often do not take into account the complexities in purchasing wide-area communications systems. This can make a seemingly simple purchase much more costly as items are purchased "a la carte." System integration costs may dramatically increase the overall system cost. Also, a complex system procurement can include services such as system engineering services, communications building and tower construction, microwave system design and installation, and project management services that cannot be purchased as simple line items from a price sheet.
- ### Developing the Request for Proposals
- The more information about your community, your department, and your needs that you write into an RFP, the better. Vendors need to know about your operational needs and your current systems, so they can propose appropriate solutions. If it's not in the RFP, you can't expect to have it addressed properly in the proposals. Use the labor/management process to document user



requirements for operations as the foundation for all of the designs and studies that will follow. This is not about technologists and engineers telling you what technology you need. This is about you telling local government leaders and vendors what you need to support operations in the field.

It is very important to involve the agency's purchasing personnel early in the purchasing process. This helps ensure that all state and local purchasing requirements are followed and that important contract language is included in the RFP. The RFP should include a summary of all of the steps taken to get to the RFP stage, including the results of the requirements gathering and current system analysis. The more background information you can provide to potential bidders, the closer their proposals will match your needs. In addition, by removing uncertainty from the purchasing process, you reduce the bidder's risk, hopefully reducing the overall price.

The RFP development stage is a good time to have a consultant involved in reviewing the requirements and possibly assisting in the preparation of the RFP itself. Much of the RFP can be tedious to develop, and selecting a consultant who has done this work before will reduce the burden on the agency members.

Evaluating Request for Proposals Responses

Modern radio networks employ many different technologies. The best choice for your community usually boils down to striking the right balance between initial cost and long-term capabilities. You need a system that fits your needs and available resources today, with the potential to grow and add more capabilities tomorrow.

Vendors' responses to your RFP not only should detail the type of system they're proposing but also explain why they're recommending it over the alternatives. Vendors should be ready to answer any questions you have about the reasoning behind the recommended system design. Be sure vendors are recommending this design because it best meets your specific requirements.

Some questions to ask about the proposed system and equipment:

- Does the system cover your routine and automatic/mutual-aid service area?
- What is the vendor's solution for fireground communications where the network doesn't provide 100 percent coverage? What will users do if they are outside the range of your network system or indoors where signals don't penetrate?
- Does the system have enough capacity to handle routine and abnormal incidents? What happens if the system becomes overloaded?
- How do other public safety and nonpublic safety users affect the fire department's use of the system?
- How will the system facilitate interoperability with communications systems used by the departments with whom you have mutual-aid agreements?
- How will it alert units of dispatches in fire stations and when out of the station? Can the system accommodate any paging needs?
- Fire-capable end-user equipment (submersible, etc.) is more costly than the radios commonly recommended for police departments; be sure the quote includes equipment for the usage environment.
- Are the accessories you need included with each radio (battery charger, speaker microphones, etc.)?

Also, look for an understanding that deploying a new network is not just a technical challenge but also a major organizational change that requires a full support structure.

The vendor's response should include:

- Clear identification of how the technology will support your operations and not affect them negatively. Radio systems should be designed and implemented to support your work, not vice versa. Your existing internal procedures should not be affected negatively by the new system.

- A phased rollout plan for gradual transition from your current system to the new one.
- An upgrade/migration plan for making further changes in the future.
- User training information before, during and after implementation. This is far more important than most people realize.
- System testing and acceptance procedures.
- Scenario-based training.
- Life cycle maintenance, network performance monitoring, and repair procedures.
- Software upgrades for radios and the system infrastructure. To evaluate the solution proposed by each vendor, you'll need to understand the relative advantages of the technological choices each are recommending. The next chapter will help.

Implementation

Involve the right people throughout the implementation process. Thoroughly test the system as it is built to ensure that it is meeting needs and expectations.

Successful implementation/integration requires careful attention from the beginning to design compatible links and then test, test and test again. The vendor's engineers must have a detailed plan that identifies all of the systems to be integrated and defines which capabilities will be made to work together and when. The plan also should include schedules and priorities and whether the new network will be made operational before all of the integration is completed.

Encourage everyone to ask questions and make comments. You will want to handle concerns and objections early, before they have the chance to evolve into rumors and long-standing gripes.

Before the contract is signed, ask the vendor or consultant to explain the following and begin to share that information with the rest of your department:

- What operational differences will our users notice between our current system and the

new one? How will their procedures change? What new features will be available? Which, if any, of the old features will change or become unavailable?

- What's different for the dispatchers? For field supervisors? For personnel back at the station? For personnel using the in-vehicle radios? For administrators and network managers?
- Will users still be able to use their old equipment, or will they be required to learn new equipment?
- What successes and pitfalls have been experienced by other fire departments implementing this type of system? What have you learned from previous deployments?

Training and Transition

Ensure that all firefighters and command staff members train with the system often prior to final switch over. Inadequate training is an especially critical problem and could endanger the lives of firefighters and the citizens they protect.

Training is far more than simply knowing how to turn on the radio and which buttons to press. Training must not become a one-time experience. Firefighters need initial exposure, formal training, and opportunities to incorporate radio usage into other training and simulation exercises. The integration plan also may cover interoperability with systems in other departments or jurisdictions. Interoperable communications must be tested with the joint cooperation of these other agencies and, perhaps, their system vendors as well. Training can be broken down into phases, as described below, that lead from general information on the system to specific operational aspects of the system, and finally to periodic refresher training.

- Awareness: This phase provides general information. A series of videos, using a live representative, explains what's different about the new system and expectations for the new equipment. The goal is to create interest, not to provide detailed information, and hopefully begin to create champions within your system.



- **Education:** Additional videos are distributed to provide more detailed information on topics such as how to use your radio and what the direct operational implications are of the new system or subscriber equipment. The videos may be broadcast over the department's video network or local cable public safety access channel and also can be available in the station for firefighters to view at will. Lesson plans should be available on the department's website.
- **Training:** Six months to one year before the system's operational deployment, use of the new radios is integrated into fireground training scenarios and in-building tactical preplan surveys. Training is structured in a three-month cycle. The first month, trainees focus on how to use the radio. In the second month, there's a walk-through. In the third month, the radios are part of a live drill, complete with smoke, while trainees wear full turnouts. After this three-month cycle is completed, a new lesson plan is used in the next quarter, and the cycle continues until the entire set of training classes has been completed.
- **Transition:** By the time the network is operational and transition begins, users will have had six months to one year of hands-on training. Two-thirds of the total training time is hands-on. Mobile radio training takes place at the time of installation of the equipment in the truck.
- **Refreshers:** Quarterly refresher training (with an emphasis on lessons learned) and just-in-time updates should continue to be given, as well as an annual refresher on fireground communications.

Beyond this training program, which was designed to support the rollout of the new radios, there are implications for other training organizations and curricula.

Communications training must be integrated into all phases of recruit training and company training programs:

- Recruit training should incorporate radios from the beginning. In the past, radios were not used during recruit training, and a rookie's first day on the job was the first day he or she was given a radio.

- The engineer's academy, captain's academy, and command officer's academy, as well as special team training, should integrate radio communication throughout the curriculum.

Implementation Lessons Learned and Feedback

During the first few months after the initial cutover to a new system, collect and analyze information regularly on the operation of the system. Share this information among all members of the implementation team and, if issues are found that affect operations, share that with the field users.

All members must be involved in providing feedback on system issues and must be kept involved with the solutions. Get buy-in from the system operator and technical staff to take field user input seriously. Encourage all members to report perceived deficiencies in the system, and follow up with the users with updates on their reports. If it appears to the users that their feedback is not acted on, they will stop providing that feedback. It is important to ensure that management is honest with users about the operation and safety of the system. If something isn't working properly, disclose it, and find a work-around until the solution is found and in place.

Long-Term Operation and Maintenance

Ensure that adequate funding is allocated to the operation and maintenance of the system. Just like fire apparatus, the system must be maintained, and equipment must be replaced as it becomes unable to serve the agency's needs. Continuously solicit feedback to keep on top of any problems that come up with the system over time. Throughout the life of the new network, fire service representatives will need a way to handle such ongoing responsibilities as:

- Answering users' questions and helping them solve problems.
- Operating and maintaining modern radio systems is expensive. Long-term planning is required to maintain software and hardware that is required to keep systems operating at peak levels. This is especially true of trunked radio systems that require frequent software updates/upgrades, and these eventually lead

to required hardware changes. If a decision is made to fall behind and not maintain current software or hardware, the system is at risk of becoming nonsupported.

- Incorporating radio usage into new training programs and exercises, and presenting refresher courses.
- Monitoring the performance of the system and collecting reports of problems, such as buildings that lack coverage or situations in which there were not enough channels or talkgroups available.
- Implementing network interoperability links to support new mutual-aid agreements with other communities.

Summary — System Design and Implementation

Developing and implementing a new communications system can be a complex and expensive project. In the case of a large system, it may be the most expensive and most complex project a department has ever undertaken. These facts make it critical that the project is managed adequately.

- Establish a project team that includes fire department management and labor representation early in the project lifetime.
- Involve all stakeholders and ensure that they continue to participate in the implementation process.

- Gather information on the communications needs of field personnel and compare this to the radio systems they use. This comparison will result in a gap analysis that shows the deficiencies in the current system. The current system description along with the gap analysis can be used to produce a specification for the new radio system.

After the specification is established, a budget can be developed using the requirements and cost estimates developed from similar systems or through talks with potential vendors. Be cautious in reducing the system functionality if the cost is determined to be too large. Removing coverage or features from the system to reduce cost could affect the usability or safety of the entire system.

Once the implementation of the system has begun, familiarization and training should start as well. Early, simple training will provide end users with information on the system in a more controlled manner. If users don't get the information they are seeking, they will find it through another path or will develop their own.

After the new system has been placed into operation, it is critical to follow up with end users on the operation of the system. Over time, users will find design, implementation and performance issues with the system that were not discovered prior to cutover, or that occurred after cutover. Timely resolution of these issues will ensure that your successful project remains successful in the eyes of its users.



This page intentionally left blank.

SECTION 8 — Interoperability

This definition of interoperability is taken from the DHS SAFECOM project:

“The ability of Public Safety responders to share information via voice and data communications systems on demand, in real time, when needed, and as authorized.”

In general, interoperability refers to the ability of emergency responders to work seamlessly with other disciplines, jurisdictions, systems or products without any special effort. Wireless communications interoperability specifically refers to the ability of emergency response officials “to share information via voice and data signals on demand, in real time, when needed, and as authorized” (DHS SAFECOM).

Frequency Coordination

Identifying interoperability frequencies often required research by frequency coordinating bodies or individual frequency coordinators from

a jurisdiction. This task was often too difficult for a single fire department to tackle. The DHS published the National Interoperability Field Operations Guide³⁶ (NIFOG) in 2007. This guide is a comprehensive listing of interoperability frequencies in all frequency bands and identifies both federal and nonfederal frequency listings. It is a common practice and advisable to include these frequencies in standard radio programming templates. This allows interoperability between disciplines, jurisdictions, and multiple levels of government — federal, state, county and local.

Interoperability Continuum

DHS, in collaboration with public safety agencies, developed the Interoperability Continuum to provide a roadmap to achieve interoperability (Figure 8.1). The continuum is a visual depiction of the multidimensional elements of interoperability.

Figure 8.1. Interoperability Continuum

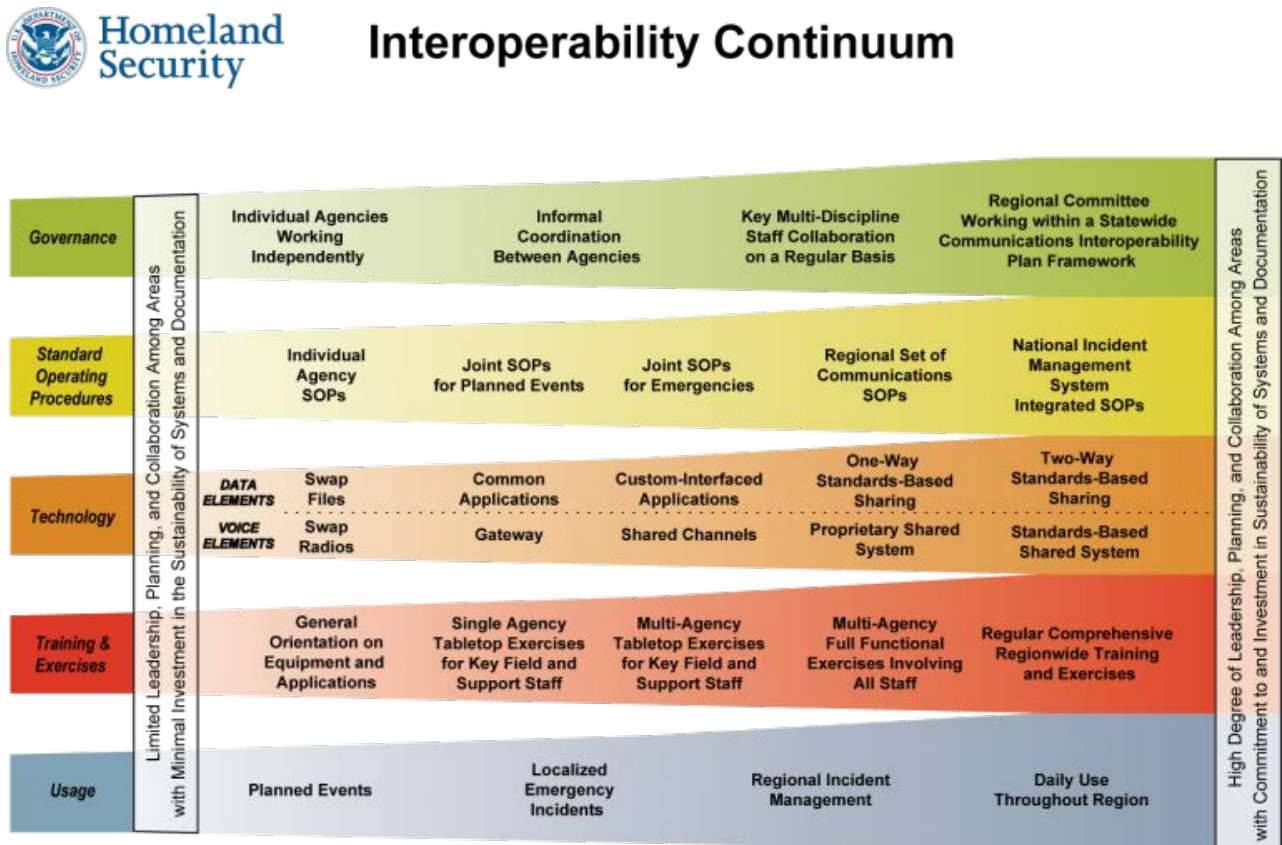

³⁶ <http://www.dhs.gov/national-interoperability-field-operations-guide>.

Each lane in the continuum represents one element needed to attain some level of interoperability. Ideally, the right side of the chart is the highest level of interoperability. When looking at the chart, an organization may have some elements of the continuum on the right with others in the middle or to the left. While ideally the goal is to have all elements on the right side, the reality is the capability in each lane may vary, but the goal is to deliver interoperability as defined by the Office of Emergency Communications (OEC)/SAFECOM.

An example of this would be use of “shared channels” for a planned event, elements of each lane provides a component of the interoperability.

- Governance — regional committee working within a statewide communications interoperability framework. The state has a plan for use of shared channels. This could be use of nationally recognized interoperability channels in the NIFOG.

- Standard operating procedures (SOPs) — agencies have joint SOPs for planned events to use the interoperability frequencies.
- Technology — shared channels from the NIFOG.
- Training and exercises — multiagency tabletop prior to a planned event.
- Planned event.

Day to Day

Most interoperability efforts are driven by the need to meet day-to-day operational requirements (Figure 8.2). In many large urban areas, the responsible fire department may not require day-to-day interoperability, while some departments interoperate on a daily basis. Since Sept. 11, 2001, there has been significant attention toward efforts to expand interoperability past the day-to-day needs of a public safety agency to address extraordinary events and incidents. Interoperability is required and necessary in today’s world. Where and how it happens is based on a logical analysis of operational practices and requirements.

Figure 8.2. Response to a Motor Vehicle Crash

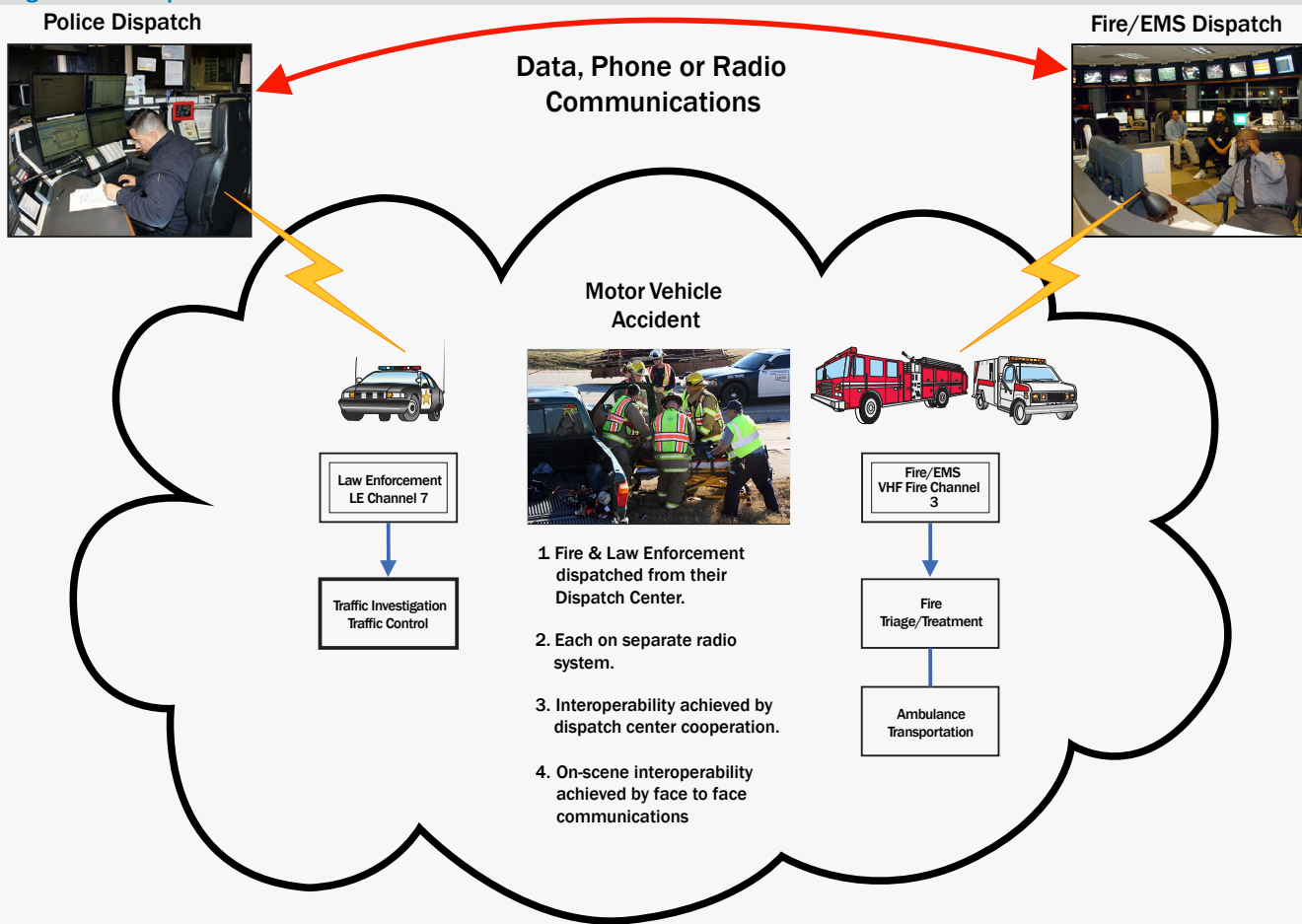

(Figure courtesy Mike Wieder and Ron Jeffers, Union City, New Jersey)

Many fire departments have interoperability with other fire departments. Interoperability between agencies in the same discipline is intradiscipline interoperability. Interdiscipline interoperability is between different disciplines. Intradiscipline interoperability is the easiest to achieve, since there is a common language, terminology and tactical objectives. Interdiscipline interoperability may not share common terminology or have the same tactical objectives. These factors should be considered in determining where interoperability occurs in the command structure. A prime example is when law enforcement responds to a house fire for traffic control. Each discipline has very different tactical objectives. As the fire responders fight the fire using the “common language” of the fire service, this terminology may not be understood by the law enforcement component. In addition, understanding when to talk and when not to talk becomes a safety issue. In these situations, interoperability may be face-to-face coordination with the command element or coordination at the dispatch center level. In the example below, both disciplines respond to a motor vehicle crash — fire/EMS for medical care and law enforcement for traffic investigation and traffic control.

The respective dispatch centers send the appropriate response for each discipline on separate radio channels and maybe even on different systems. Each responds, and when on-scene, they coordinate at the task level face to face. If a shared dispatch center and radio system were used, both units could be assigned on a common channel. SAFECOM would consider this a high level of interoperability.

Large Incidents

As incidents grow, interoperability should be planned for in the Command structure. When developing interoperable Command structures, many interoperability tools may be employed. Technical staff plays a pivotal role in providing these technology tools to meet the operational requirements. The technical staff must be familiar with the operational objectives and Command structure to supply the appropriate technological tools. NFPA 1221 recommends the use of a Communications Officer at all major incidents and a Communications Unit Leader (COML) is part of

the National Incident Management System Incident Command System (NIMS-ICS) Command structure. The technical staff should receive the appropriate training to fulfill these roles successfully. COMLs in the NIMS-ICS Command structure provide a central point of contact to develop a communications plan to meet the interoperability needs on a large incident and manage the Communications Unit to meet the communications needs on an incident.

Communications Unit

The use of a Communications Unit has proven to improve interoperability on incidents. The individuals that fill these roles understand the technology and have a good understanding of operational requirements. The Communications Unit is tasked with supporting all communications needs on the incident. These requirements may be to provide operability in difficult situations where there are limited communications resources or in some instances no communications infrastructure. The Communications Unit consists of:

- COML: This position is tasked with the management of communications on the incident. Responsibilities include:
 - Operational communications.
 - Interoperability.
 - Allocation of communication resources.
 - Developing prioritization of the communications unit.
 - Management of the communications unit.
 - Knowledge of local interoperability plans, area and systems is helpful.
- Communications Technician (COMT): This position is the technical person assigned to implement technologies as directed by the COML. Knowledge of the following is necessary:
 - Radio systems.
 - Gateways.
 - Portable radios.
 - Telephone.
 - Data systems.
 - Knowledge of local area, systems is helpful.
- Incident Communications Manager (INCM): This position manages Radio Operators (RADOs) and communications center functions on incident if required.

- Management of the communications center.
 - Staffing of RADOs to cover operation periods.
 - Monitoring of radio channels as required by the IC or Operations Chief.
 - Recording and routing of messages.
- RADO: This position is responsible for communicating on assigned radio channels.
 - Documenting notable events or radio traffic.

Jurisdictions need to understand the capabilities and resources the Communications Unit provides and develop a deployment plan for incidents or events where a COML would provide benefit. It is important to note that day to day our dispatch centers provide this function. The centers allocate and coordinate frequencies/talkgroups and provide communications resources as needed by operations. The Communications Unit's role is to allow the dispatch centers to maintain normal operations. A Communications Unit may be implemented on large incidents that last many operational periods or special events that require complicated interoperability plans. A good example

of this might be the Super Bowl, the presidential Inauguration Day, or other large special events. It is not always necessary to deploy a Communications Unit. Some events may only require a COML to develop the radio plan. The important takeaway is knowing where this capability is in your area. The state and federal governments have spent a substantial amount of money to train personnel as COML or COMT. Most states have a Statewide Interoperability Coordinator (SWIC). The SWIC in your state can assist you in identifying the COML or COMT personnel in your state.

The example below is a large Command structure where multiple technologies are employed to achieve the appropriate level of interoperability for the incident (Figure 8.3). When interoperating, determining the number of channels needed to support the incident must be a consideration. It is always important to account for the amount of radio traffic on a channel and to reserve some airtime for unforeseen needs such as a mayday. Complex operations that are communications intensive should have their own channel to ensure that there is adequate on-air time and reserve

Figure 8.3. Incident Communications

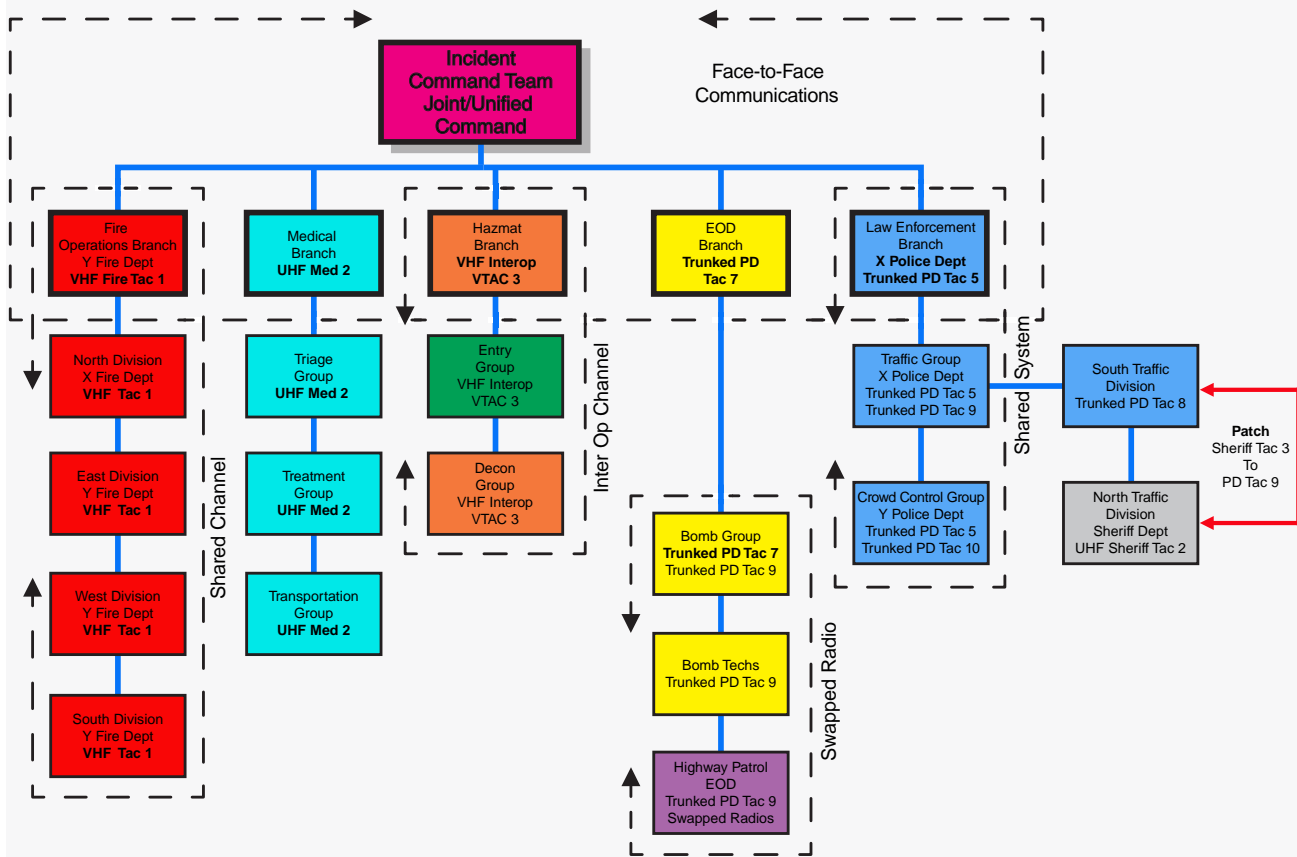

capacity for unforeseen events. Shared or patched channels can be used when there are common tactical objectives. Before patching channels or using gateways that essentially tie channels together, the amount on each of the channels must be considered. If both of the channels are near saturation, the patch or gateway will make communications nearly impossible. Below is an example of a large-scale multidiscipline Command structure where multiple technologies are used to achieve interoperability.

Many technologies are available to achieve interoperability, and often the simplest solutions are overlooked in favor of complex technological solutions. The simple solutions usually are the quickest to implement and easiest to understand. In some instances, face-to-face communications may provide the desired level of interoperability, while in other cases other methods may be necessary. In **Figure 8.3**, a joint Command structure in a common location allowed the use of face-to-face communications for coordination. When a common Command location is not employed, a strategic-level Command channel is an option.

Many technologies are used to achieve interoperability, and many other factors have an impact on interoperability. SAFECOM is a program within the U.S. DHS that is tasked with achieving communications interoperability for local, tribal, state and federal emergency response agencies. SAFECOM has many documents available that will guide and assist in achieving interoperability. SAFECOM documentation is available at <http://www.dhs.gov/safecom>.

Summary — Interoperability

DHS SAFECOM definition: “The ability of Public Safety responders to share information via voice and data communications systems on demand, in real time, when needed, and as authorized.”

Interoperability refers to the ability of emergency responders to work seamlessly with other disciplines, jurisdictions, systems or products without any special effort.

The NIFOG³⁷ is a comprehensive listing of interoperability frequencies. The guide lists frequencies for federal and nonfederal interoperability in all bands. It is a common practice and advisable to include these frequencies in standard radio programming templates. This allows interoperability between disciplines, jurisdictions and multiple levels of government — federal, state, county and local.

The Interoperability Continuum is a tool developed to respond to an event and address all elements needed to achieve optimal interoperability. Interoperability can be intradiscipline or interdisciplinary:

Intradiscipline:

- Like disciplines such as fire department to fire department or law enforcement to law enforcement.
- Common tactical objectives.
- Common language and terminology.
- Easiest to achieve.

Interdiscipline:

- Different disciplines such as fire department to law enforcement.
- Different tactical objectives and priorities.
- Different terminology.

Communications Unit

The use of a Communications Unit has proven to improve interoperability on incidents. The Communications Unit consists of:

- COML: This position is tasked with the management of communications on the incident.
- COMT: This position is the technical person assigned to implement technologies.
- INCM: This position manages the communications center functions.
- RADO: Communicates on assigned radio channels.

³⁷ <http://www.dhs.gov/national-interoperability-field-operations-guide>.



This page intentionally left blank.



SECTION 9 —

Radio Spectrum Licensing and the Federal Communications Commission

The FCC is an independent agency of the U.S. government established by the Communications Act of 1934. It is made up of seven bureaus, organized by function, that are responsible for various communications areas. The bureau that is most involved in public safety issues is the Public Safety and Homeland Security Bureau (PSHSB), which:

... is responsible for developing, recommending, and administering the agency's policies pertaining to public safety communications issues. These policies include 911 and E911; operability and interoperability of public safety communications; communications infrastructure protection and disaster response; and network security and reliability. The Bureau also serves as a clearinghouse for public safety communications information and takes the lead on emergency response issues.

As this description implies, the PSHSB is responsible for rulemaking, licensing, education and outreach to public safety agencies. Portions of the activities of the PSHSB were previously carried out by the Wireless Telecommunications Bureau, particularly the rulemaking and licensing functions. The outreach and coordination functions were added to create a single bureau to handle all public safety issues.

The rules established by the FCC are located in CFR Title 47. The section of these regulations that applies directly to LMR systems used by public safety entities is located in Part 90 of 47 CFR. The Part 90 rules govern the operation of radio systems, as well as the frequencies available for use, what types of agencies are eligible to use the frequencies, and the procedures for licensing these frequencies.

While the FCC provides licensing and spectrum management for nonfederal users, the NTIA is the federal coordinating body. "Many Federal agencies use radio frequency spectrum to perform vital operations. NTIA manages the federal government's use of spectrum, ensuring that America's domestic

and international spectrum needs are met while making efficient use of this limited resource."³⁸ "NTIA is also collaborating with the Federal Communications Commission to make available a total of 500 megahertz of federal and nonfederal spectrum over the next 10 years for mobile and fixed wireless broadband use. This initiative, to nearly double the amount of commercial spectrum, will spur investment, economic growth, and job creation while supporting the growing demand by consumers and businesses for wireless broadband services."³⁹

The use of RFs by the federal government, and those operating under federal authority such as national Urban Search and Rescue teams, is given by the Office of Spectrum Management (OSM) in the NTIA, a part of the Department of Commerce. The FCC does not set rules for use of radio spectrum by federal users but does coordinate use with the NTIA according to international law. While nonfederal agencies are not subject to NTIA regulation, they may be affected by these rules through partnerships and interoperability agreements, and all operations are subject to the authority under which they operate.

Rulemaking

When the FCC believes that a change is needed to the rules, generally it will first issue a Notice of Inquiry (NOI) asking for general information on the issues related to the change. Next, the commission will issue a Notice of Proposed Rulemaking (NPRM) outlining the proposed rule change. The NPRM allows the public to comment on the proposed change and proposed modifications. After the FCC reviews the comments and proposals, it may issue one or more Reports and Orders (R&O) that provide the final details on the rule changes. This process may repeat as necessary to refine the rule change. In addition, a type of appeals process is allowed, known as a Petition for Reconsideration. During the process, public presentations, comment documents, and expert testimony are heard by the FCC. Fire departments and professional organizations may participate in all portions of the process.

³⁸ <http://www.ntia.doc.gov/category/spectrum-management>.

³⁹ <http://www.ntia.doc.gov/category/spectrum-management>.



Licensing

The FCC also governs the licensing of RFs to agencies, and this process is handled separately from the rulemaking process, although issues that arise during the licensing process may result in future rule changes.

The licensing process starts with the agency defining the requirements for communications systems, including the type of radio system, the frequency band needed, the number of users that will use the proposed system, and the number of frequencies or frequency pairs required.

After the requirements are defined, the agency finds the specific frequencies through a frequency search conducted by the agency, a consultant or a manufacturer. The FCC website has tools to help agencies search for frequencies, including the Universal Licensing System (ULS), which is used to search for existing licenses, as well as for processing applications. The ULS also can be used to search for other agency licenses for examples on preparing a new license. Specific design parameters will be required to license the frequencies, including the transmitter locations, tower height, antenna height, and transmitter power output. Transmitter power output must be specified as “Effective Radiated Power,” which increases the actual power output from the transmitter by a gain factor specific to the antenna used in the system.

After all the system parameters and frequencies are determined, an application for license is prepared and sent to a frequency coordinator. The FCC requires that almost all applications for two-way or paging radio station licenses be reviewed by a FCC-certified frequency coordinator before the applications can be submitted to the FCC. The coordinator performs many functions for both the applicant and the FCC. The coordinator can assist the applicant in the selection of channels and equally importantly ensure that all requested channels can be used without causing unacceptable interference to other licensees. The coordinator also reviews the entire application for accuracy, including information about the applicant, the proposed radio site and facilities, and compliance with applicable FCC rules and regulations.

The FCC created two radio service pools of channels, the industrial/business (I/B) pool and the public safety (PS) pool. The FCC recognized that mission critical communications require different coordination standards than general business channels that are heavily shared and certified different coordinators for each pool. To the extent possible, PS channels are coordinated to be either exclusive/semiexclusive in an area or to match regional and state plans for interoperability. Within the PS pool, there are several subcategories: (Each subcategory has been assigned a two-letter identifier.)

- Police (PP).
- Fire (PF).
- Forestry conservation (PO).
- Highway maintenance (PH).
- Special emergency (PS).
- Emergency medical (PM).
- General use channels (PX).

Except for PX channels, the FCC recognizes a home coordinator for each subcategory. The home coordinator has traditionally been the nonprofit association that represents the licensees in each category.

For the PS pool, the FCC has certified four frequency coordinators, as follows:

- PP: APCO.
- PF: IAFC/International Municipal Signal Association (IMSA).
- PO: Forestry Conservation Communications Association (FCCA).
- PH: American Association of State Highway and Transportation Officials (AASHTO).
- PM/PS: IAFC/IMSA.
- PX: Any of the above.

The FCC allows any of the four certified coordinators to coordinate any public safety subcategory, but requires that if the coordinator is not the home coordinator, advice and consent are received from the home coordinator. The coordinators have settled on a \$100 fee **per channel**, called an interservice fee, for the home coordinators’ review. While other coordinators can coordinate a PF channel, the applicant will pay an extra \$100 for that coordination versus having the coordination performed by IAFC.



In addition, the IAFC rate for coordinating a PF channel is the lowest of the rate cards for any of the coordinators. It just makes good economic sense to use IAFC for coordination of fire or general use channels. And, because of its partnership with IMSA, as described below, interservice fees also do not apply to PM/PS channels.

Once the application passes the frequency coordination process, the application is submitted to the FCC through the automated ULS. While the FCC does not charge public safety agencies for licenses, there is a cost associated with the frequency coordination. Agencies can enter the license information into the ULS and track it as it proceeds. The FCC uses a computer system to perform automated checks on the license and then will assign the license request to an examiner who will perform more extensive checks on the details of the application. The examiner then will either grant the license or return it to the applicant for modification or additional documentation. If the request does not conform to FCC rules, it may be rejected outright and will require a reapplication.

If the application does not conform to the FCC rules in Part 90, the applicant may request a waiver of the rules. The waiver process is complicated, and waivers are not granted frequently. An example of a waiver that has been granted is the use of UHF TV Channels 14 and 16 for public safety use in the New York and Los Angeles metropolitan areas. These areas had significant needs for additional frequencies in the 1980s, before the 700 MHz and 800 MHz public safety bands were established. The agencies involved presented the needs along with extensive documentation on why the needs could not be fulfilled with current frequency allocations. Departments that wish to pursue a waiver must present a detailed, well-thought-out case to be successful.

Federal Communications Commission Actions to Increase Public Safety Spectrum

Historically, all public safety systems used frequencies in the VHF low, VHF high, and UHF bands, with the systems progressing to higher frequencies as technology improved. Many fire and police departments in the U.S. still use radio systems in the VHF and UHF bands and have

no plans to move to other bands. However, the population growth in large metropolitan areas has created rising demand for more RFs. In many areas of the country, all available VHF and UHF frequencies are assigned to agencies, leaving no space for growth. The FCC, working with equipment manufacturers and public safety communications organizations, has developed several programs to increase the available frequencies for public safety communications.

National Public Safety Planning Advisory Committee

The first major expansion of frequencies allocated to public safety took place in 1986 when the FCC created the National Public Safety Planning Advisory Committee (NPSPAC) to develop frequency allocations on the 800 MHz band. Prior to the NPSPAC process, public-safety-licensed frequencies in the 800 MHz band were combined with commercial business and cellular companies, and the available frequencies were very limited. The NPSPAC frequencies were put under the control of 55 Regional Planning Committees (RPCs). The RPCs are responsible for creating regional frequency plans that take into account agency needs, including metropolitan, rural, and statewide, and are responsible for initial coordination of applications.

Narrowbanding Below 512 Megahertz

The NPSPAC process provided additional frequency spectrum for new systems operating in the 800 MHz band, but most fire and police departments in the U.S. still operate in the VHF or UHF bands (**Figure 9.1**). To increase the available frequency spectrum for public safety in the VHF and UHF bands, the FCC began investigation into narrowing the bandwidth for frequencies in this band.

In the VHF band, channels were spaced 15 kHz apart, with transmitters operating with 25 kHz bandwidth. In addition, as shown in **Figure 9.1**, adjacent transmitters were separated geographically to minimize interference. It became apparent that as the population served by these departments grew, their spectrum needs would grow as well, and the existing band plan would become inadequate for the needs.



Figure 9.1. Before Narrowbanding

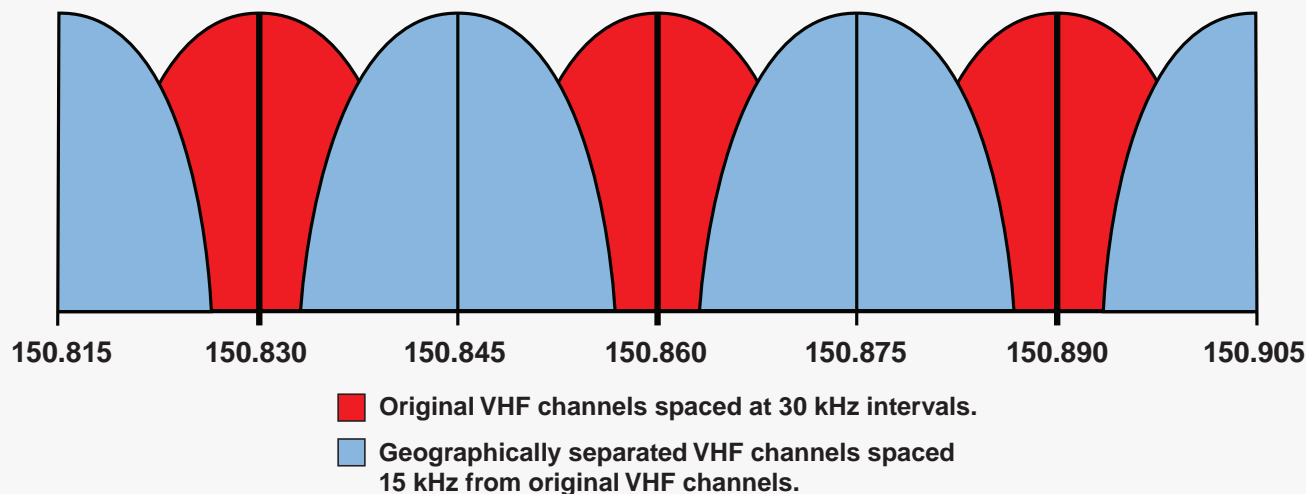

With no unused spectrum available in these bands, the FCC proposed narrowing the bandwidth of the existing frequency assignments, dividing each existing frequency channel in half (**Figure 9.2**).

Each frequency in the new plan was spaced 7.5 kHz from the previous and had a bandwidth limited to 12.5 kHz.

Figure 9.2. After Narrowbanding

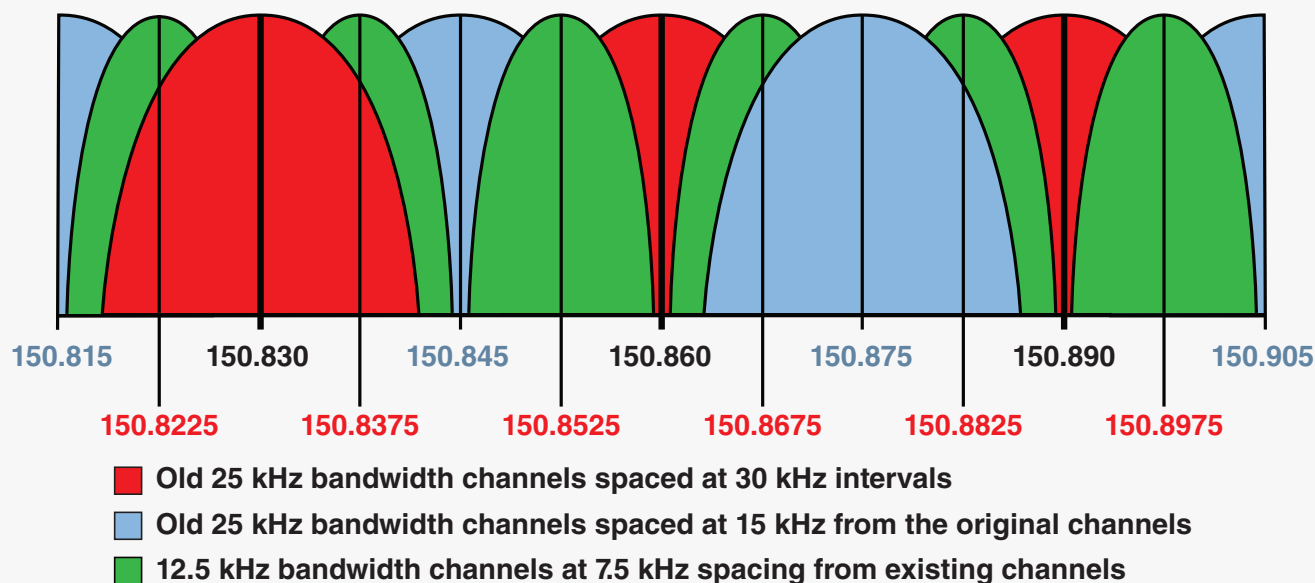

The FCC developed a schedule in 1995 for migration from the current band plan to the new narrowband plan. This plan is often called “refarming” to relate it to changing the crops in a field. The schedule for refarming established by the FCC was divided into phases, with each phase increasingly restricting the use of wideband systems to encourage migration to narrowband.

The first phase began in 1997 with the FCC denying certification for equipment that operated with 25 kHz bandwidth if it did not also operate at 12.5 kHz or equivalent bandwidth. This prevented manufacturers from making equipment that would not be able to be used once the future phases came into effect. The FCC predicted that most (wideband) equipment manufactured before this date would become obsolete and unserviceable before the mandatory narrowband deadline.



At the time of this original order, the FCC also made other orders with respect to expansion of existing systems, creation of new systems, and the manufacture and importation of equipment. These orders staggered the restrictions over several years in an attempt to make the transition to narrowband communications less painful to local agencies. Unfortunately, the complexity of the rules confused many agencies and in 2004, before the new rules took effect, the FCC modified the order to have two deadlines, one in 2011 and the other in 2013.

In January 2011, the FCC stopped accepting applications for new systems, modifications to existing systems, and transmitters that operated using a bandwidth greater than 12.5 kHz or equivalent. In addition, the FCC prohibited the manufacture or import of radio equipment that was capable of operating on a bandwidth greater than 12.5 kHz or equivalent.

The final phase began in January 2013, and it prohibited the operation of radios and radio systems that did not comply with the narrowband requirements. All radios, portable, mobile, repeaters, and base stations that operated in the VHF or UHF bands would be replaced, and the systems they operated in would be redesigned by this date.

The FCC's actions to reform the VHF and UHF bands resulted in perhaps the most confusing set of orders ever from the FCC concerning public safety communications, resulting in many unnecessary system replacements. These replacements included departments transitioning to systems that did not meet their operational needs and were unnecessarily costly to procure, operate and maintain. Agencies were able to keep existing communications systems that were used for years, provided that they modernized the equipment and system design by transitioning to 12.5 kHz bandwidth frequencies and equipment prior to 2013.

Further Narrowbanding

The FCC has proposed further narrowing the bandwidth of channels below 512 MHz to 6.25 kHz bandwidth but has not issued rules related to a forced migration to this narrower bandwidth at the time of this publication. One of the reasons for this is the lack of FDMA subscriber equipment

capable of operating at this narrower bandwidth. In the UHF and 700/800 MHz bands, repeater pairs are preallocated, leading to a simpler TDMA system implementation. In the VHF bands, there are no predefined transmit/receive pairs, making it difficult to aggregate sufficient channels to provide for four- or two-slot TDMA repeated systems. If spectrum use pressure continues, expect that the FCC will again visit the issue of narrowbanding below 512 MHz.

Public Safety Wireless Advisory Committee

Although the NPSPAC process provided additional frequencies in the 800 MHz band, the need for more capacity became evident in the early 1990s. This increasing need for more frequency spectrum was not limited to nonfederal agencies, as the federal government had not made modifications to federal agency needs in many years. The FCC established the PSWAC in 1993 under direction from Congress to address the RF spectrum needs of federal, state and local agencies over the next five years, and over the next 15 years. The goal was to develop a plan to allocate additional spectrum for all users, as well as establish plans for communications interoperability between all levels of government.

The final report of the PSWAC recommended the allocation of 2.5 MHz of spectrum below 512 MHz for federal, state and local public safety interoperability, and the addition of approximately 25 MHz of new spectrum over the next five years and 70 MHz over 15 years for federal, state and local public safety use. Although to date only approximately one-third of the new spectrum requested has been allocated for state and local public safety use, this is more than any request in the last 20 years.

700 Megahertz Spectrum Allocation

As a result of the PSWAC's recommendation that additional spectrum be allocated to public safety, the FCC allocated 24 MHz of new spectrum. This allocation, from 764 MHz through 776 MHz and 794 MHz through 806 MHz, was part of the spectrum previously allocated to TV Channels 60 through 69. This spectrum became available for use by public safety through the transition of television stations to digital systems. This portion of spectrum was chosen because it was adjacent

to the existing 800 MHz band also used for public safety communications, and radio equipment could be designed easily to operate in both bands.

The FCC issued an order that described the rules for the use of the new frequency band, as well as the new band plan in 1998. The order split the allocation of frequencies into four basic classes:

- General-use frequencies.
- State frequencies.
- Interoperability frequencies.
- Wideband frequencies.

The general-use frequencies could be licensed by both state and local entities, and the allocation and use of the channels would be governed by an FCC-approved regional plan developed by stakeholders in the region. The state frequencies would be licensed to each state and would be allocated in any manner the state desired. The interoperability frequencies could be licensed by state, local and, to a limited degree, federal agencies, and the allocation and use of the frequencies would be governed by a plan produced by a State Interoperability Executive Committee (SIEC) in each state. The wideband channels were intended to provide the ability to develop regional and local high-speed data systems.

The FCC reconfigured the 700 MHz band plan in 1997, which modified the public safety narrowband (primarily voice) spectrum to be located at 769-776/799-805 MHz. The previously designated wideband spectrum was reconfigured and redesignated for broadband operation, with a guard band between broadband and narrowband spectrum segments. Subsequently, the public safety community, including the fire service, fought for and successfully obtained an additional 10 MHz of spectrum for broadband operation to support video and data. In summary, the 700 MHz band for public safety now consists of a total of 12 MHz for voice with a total of 20 MHz for broadband high-speed data and imaging, and 2 MHz dedicated to guard band between the voice and broadband operations to help minimize interference.

800 Megahertz Reconfiguration

The initial frequency allocations in the 800 MHz band were made available in 1974 by reallocating

the frequencies used by TV Channels 70 through 83. This spectrum was available for use by public safety, business and industrial users, and cellular systems. The FCC allocated 70 channels to public safety and interleaved these with other channels for business and industrial users. Interleaving means that one channel was allocated to business, the next for industrial, and the next for public safety. This repeated, creating an allocation layered with public safety sandwiched between other users. Every public safety channel had a nonpublic-safety system on either side. Later, many of these channels were allocated to Specialized Mobile Radio (SMR) systems, which are private trunked radio systems used by businesses. **Figure 9.3** shows the interleaved frequency allocation, with SMR systems on either side. The 800 MHz NPSPAC band is the block labeled Public Safety to the right of the Upper 200 Enhanced Specialized Mobile Radio (ESMR) block.

Figure 9.3. 800 MHz Band Before Reconfiguration

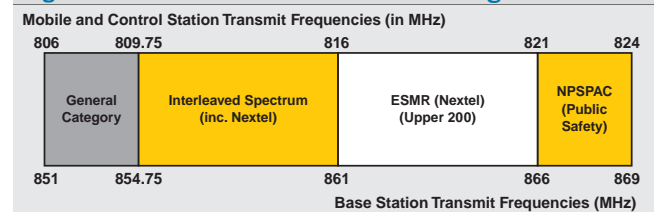

In the early 1990s, FleetCall (later to become Nextel) started to develop a digital SMR network that incorporated the same features as cellular systems. This system used frequencies in the SMR bands, as well as frequencies in the interleaved band. Traditional cellular systems were not allowed to operate in these bands, but FleetCall received waivers from the FCC to operate the new system. At the same time, the deployment of cellular systems was increasing at a rapid pace.

One of the two bands assigned to cellular systems, the Cellular A band, is directly adjacent to the NPSPAC 800 MHz band. The NPSPAC band is also adjacent to the Upper SMR band. With FleetCall systems on both sides of the interleaved band, and this and other systems interleaved — along with SMR systems and cellular sandwiching the NPSPAC band — public safety systems were in a bad place.

Both the FleetCall system and cellular systems are designed with a large number (30 or more) of transceiver sites throughout the system's coverage

area. Compare this with the typical public safety system with one or two sites. The public safety systems were bound to have interference, but none of the system operators that were likely to interfere with the public safety systems recognized the potential.

By the late 1990s, the interference problem with public safety systems in the 800 MHz band had become well-recognized, and agencies were demanding action to restore the ability to communicate on emergency incidents. To its credit, the FCC began a process to classify the problem and find a solution. At that time, the FCC ordered that systems operators in the affected bands must take steps to minimize interference effects in 2004. The FCC also ordered that the 800 MHz band would be reconfigured to further minimize the interference from Nextel and Cellular A band systems under a process known as “rebanding.”

Under the rebanding process, Nextel was to fund the effort of relocating existing systems in an equitable manner and in return would receive additional frequencies in the 1.9 MHz band. To supervise the rebanding process, the FCC appointed an independent consulting company, BearingPoint, as the Transition Administrator (TA). The TA had the responsibility of managing the process, including establishing the schedule, monitoring the process, and facilitating resolution of conflicts. The process was divided into four “waves” that grouped together the regions that would be reconfigured. All waves were scheduled to be reconfigured by the end of the second quarter of 2008 with the exception of Wave 4, which contained U.S./Canada or U.S./ Mexico border areas. The reconfiguration of these areas was subject to treaty negotiations that delayed the process.

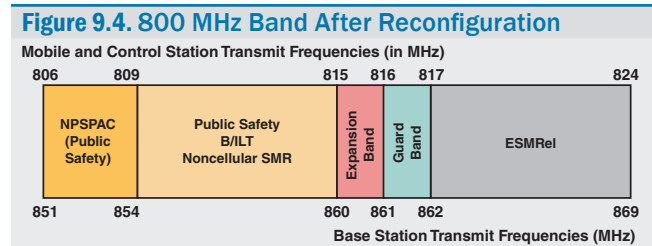

The reconfigured band in **Figure 9.4** shows that the public safety portions of the new band would be isolated from the ESMR portion of the band where Nextel operated. In addition, the NPSAC

band had been relocated away from the Cellular A band and was much less likely to suffer significant interference from nonpublic-safety systems.

T-Band

The T-Band supplies a significant number of channels to support public safety operations as well as regional interoperability to 11 of the largest metropolitan areas. The 11 metropolitan areas are Boston, Chicago, Dallas, Houston, Los Angeles, Miami, New York, Philadelphia, Pittsburgh, San Francisco and the District of Columbia (**Figure 9.5**). The T-Band lies within the UHF spectrum between 470-512 MHz. As a result of the Middle Class Tax Relief and Job Creation Act of 2012, the FCC was ordered to recover and auction the T-Band spectrum by February 2021. Within two years of the auction close (early 2023), the FCC is required to clear public safety operations from this portion of the band. Currently, the FCC has placed a freeze on all new expanded T-Band operations for public safety and industrial and business operations. The challenge now is to remove all public safety off the T-Band, which is proving to be costly and complex due to spectrum allocation.

Figure 9.5. T-Band Locations

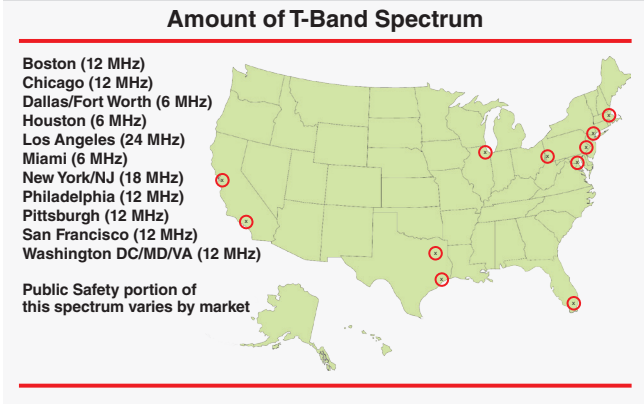

Stu Overby, NPSTC Presentation, APCO Int'l, T-Band Background and NPSTC Report Summary, Aug. 21, 2013

In March 2013, NPSTC convened a T-Band working group to study the giveback and its implications for public safety communications, including the potential costs of relocation efforts. The full report is available on the NPSTC website and cites costs, spectrum alternatives, and limited spectrum gains as potential limitations (SAFECOM T-Band Giveback pp.1-2).

The migration from T-Band presents a number of problems for local jurisdictions and their public safety responders. The two biggest issues are the likelihood that funding generated by the spectrum auction will not be sufficient to pay for the migration and that there may not be sufficient alternate spectrum available in these busy metro areas to migrate to. In the Boston area alone, over 6,000 public safety radios operate on the T-Band.

A 2015 study commissioned by the IAFF concluded that there were over 700 jurisdictions that would be impacted by the changes to T-Band use by their fire, EMS, and law enforcement responders.

A requirement of the act is that proceeds are to assist with spectrum relocation. However, the proceeds will not cover all costs associated with this. An estimate from 2013 expects costs to exceed 5.9 billion dollars for spectrum relocation (**Figure 9.6**). Private sector relocation costs are not considered, which may decrease the percentage of auction funding to be used for public safety spectrum reallocation.

Figure 9.6. Breakdown of the \$5.9 Billion in Costs

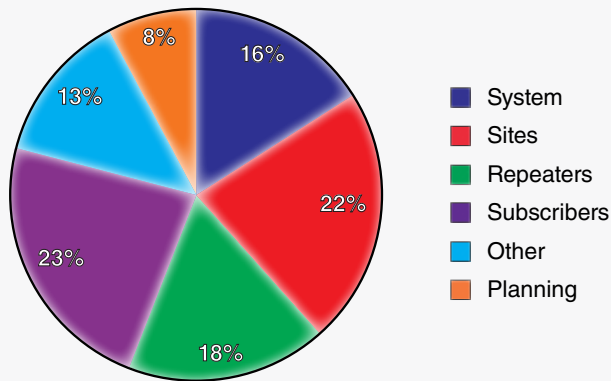

Licensees are required by law to migrate from the T-Band spectrum to another unidentified spectrum. There are limited options for a replacement spectrum. The VHF, UHF and 700/800 MHz bands have few available channels. However, in response to Public Law 112-96, the FCC issued rules and guidance related to the required T-Band transition.

On Oct. 17, 2014, the FCC released the narrowband reserve channels (24 12.5 kHz channels) to general use under the administration of the RPC for the benefit of state and local public safety users. Public safety users still rely on LMRs for communication. At the time of this publication, Voice over LTE (VoLTE) and the National Public Safety Broadband Network (NPSBN) are not suitable options for mission critical voice for public safety users.

FCC Public Notice Jan. 9, 2015.

- A five-year priority access window for T-Band incumbents to license the former reserve spectrum (from Jan. 9, 2015 to Jan. 9, 2020).
- The date for filing RPC Plan Amendments to incorporate the former reserve spectrum (June 2, 2015).
- The date by which certain licensees must reprogram their deployable trunked systems to operate on the former reserve channels. (See FCC Public Notice DA 15-34 for specific dates.)

The FCC requires that T-Band incumbents seeking reserve channels (1) commit to returning to the Commission an equal amount of T-Band spectrum and (2) obtain RPC concurrence.

Grant Guidance

OEC encourages states to update Statewide Communications Interoperability Plans (SCIPs) to address FCC directives affecting current or planned public safety communications systems, including T-Band migration, and has advised grantees to consult the FCC, their SWIC, and their frequency coordinator during project planning to ensure projects or upgrades planned for systems operating in the T-Band are coordinated and align with the state's migration plans.

The following (**Figure 9.7**) is an example timeline providing proposed steps for transitioning to a new system.

Figure 9.7. Sample T-Band Giveback Transition Timeline

SAMPLE T-BAND GIVEBACK TRANSITION TIMELINE

The following is an example timeline providing proposed steps for transitioning to a new system.

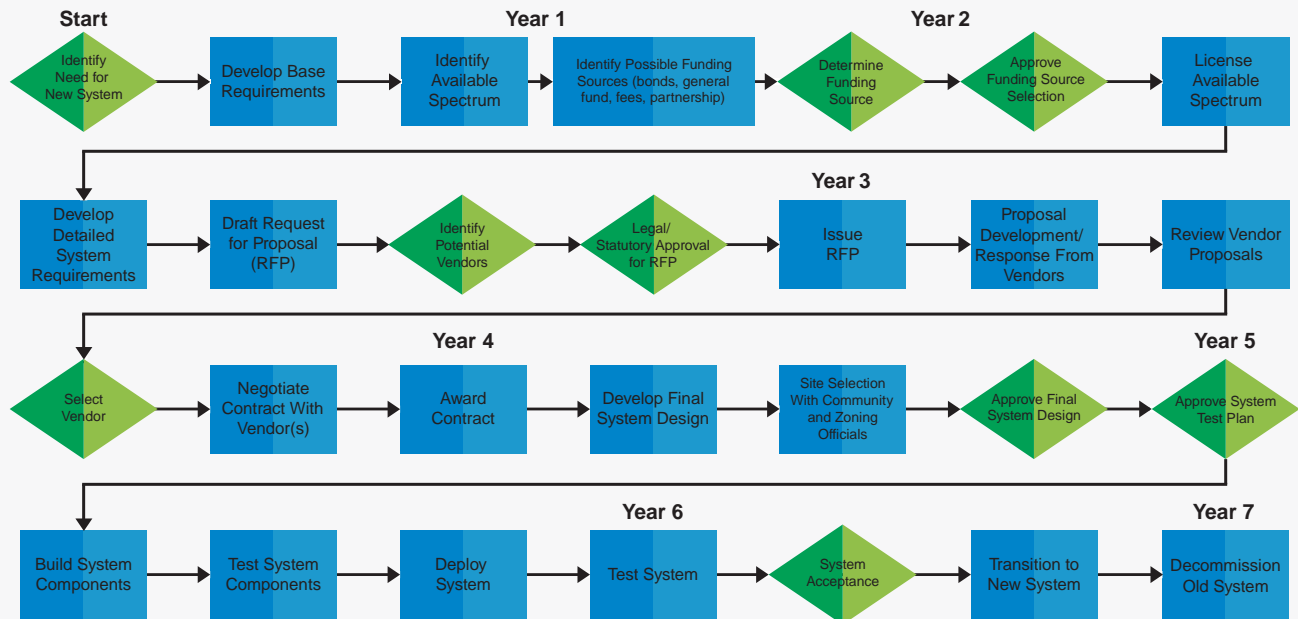

Summary – Radio Spectrum Licensing and the Federal Communications Commission

One problem that is common to all recommendations for increasing the spectrum allocated to public safety agencies is accurately defining “public safety agencies.” Another lies in the politics of the allocations. Many state and local governments, and their communications managers in particular, lobbied to include “public service” or “public safety support” agencies in those eligible to license spectrum allocated to public safety.

The result of this is that agencies that do not support the emergency response aspect of public safety are eligible for licenses under the new rules. This includes such diverse groups as school bus companies, road and highway maintenance crews, and public solid-waste disposal agencies. In essence, any state or local government workgroup is eligible for licensing spectrum allocated to public safety, no matter how removed the agency is from emergency response activities. The benefit to state and local governments is that they can build communications systems that support all divisions with spectrum allocated to public safety. Unfortunately, this is done by exploiting the public’s understanding of what falls under the umbrella of public safety and ultimately reducing the spectrum available for emergency response.

Not all of the responsibility for the lack of adequate spectrum for public safety response lies with the FCC or the various coordinating agencies. Public safety agencies themselves often perpetuate this inadequacy through their actions (or inactions). The insistence by many agencies to maintain “stovepipe” communications systems that duplicate the coverage of other systems and do not operate with neighboring agencies is one of the most egregious examples. The efficiency of frequency use could be increased dramatically if all agencies were committed to cooperative system development with the goal of maximum frequency use among all agencies in a system.

The FCC and communications equipment industry are driven by the need to accommodate additional users in a limited amount of radio spectrum and economic forces. Any technical change to spectrum use requirements has the possibility to affect the operational performance of a radio system, negatively or positively. The fire service has an opportunity to be a part of the solution to this issue through coordinated, organizational participation in the process. If the fire service cannot communicate its needs, or if the fire service voice is fragmented, then a solution will be imposed by others, and it is unlikely that that solution will meet all the operational needs of the service.



The FCC was ordered to recover and auction the T-Band spectrum by February 2021. Within two years of the auction close (early 2023), the FCC is required to clear public safety operations from this portion of the band.

- A five-year priority access window for T-Band incumbents to license the former reserve spectrum (from Jan. 9, 2015 to Jan. 9, 2020).
- The date for filing RPC Plan Amendments to incorporate the former reserve spectrum (June 2, 2015).

- The date by which certain licensees must reprogram their deployable trunked systems to operate on the former reserve channels. (See FCC Public Notice DA 15-34 for specific dates.)

The T-Band supplies a significant number of channels to support public safety operations as well as regional interoperability to 11 of the largest metropolitan areas. The 11 metropolitan areas are Boston, Chicago, Dallas, Houston, Los Angeles, Miami, New York, Philadelphia, Pittsburgh, San Francisco and the District of Columbia.

SECTION 10 —

First Responder Network Authority or FirstNet

History

Nationwide Public Safety Broadband Network

In December 2006, the FCC made a statement of opinion in an NPRM:

We believe that the time may have come for a significant departure from the typical public safety allocation model the Commission has used in the past ... While this system has had significant benefits for public safety users, in terms of permitting them to deploy voice and narrowband facilities for their needs, the system has also resulted in uneven build-out across the country in different bands, balkanization of spectrum between large numbers of incompatible systems, and interoperability difficulties if not inabilities.

This statement predicted the activities that would occur in April and June 2007, with the FCC's Proposed Rulemaking and Second Report and Order on the 700 MHz band. In this rulemaking, the FCC proposed to create a nationwide public safety broadband data system by rebanding the 700 MHz public safety band to reallocate the 10 MHz wideband frequency allocation and combine this with 10 MHz of new spectrum that would be auctioned. The FCC would allow a single nationwide licensee for the reallocated 10 MHz of existing spectrum and would auction the other 10 MHz of new spectrum, known as the D Block.

The auction would seek to find a bidder that would purchase the rights to the 10 MHz of D Block spectrum and would then have the rights to combine this with the 10 MHz of public safety spectrum to form a nationwide commercial and public safety network. The FCC rules stated that the network must meet the requirements of public safety agencies and appointed the Public Safety Spectrum Trust (PSST) Corporation to represent the interests of public safety. The PSST developed a Bidder Information Document (BID) that outlined the requirements the new system must meet. These specifications included

priority access for public safety users, backup power and networking requirements, and other features necessary to provide a high-reliability system. The PSST also became the licensee for the 10 MHz of reallocated public safety spectrum.

The D Block auction occurred along with other auctions in the first quarter of 2008. There was one bidder for the D Block, but the reserve price (minimum bid) set by the FCC was not met, and D Block was not auctioned successfully. After the auction, there was some discussion that the requirements for the system set forth in the BID created too much uncertainty as to the cost of constructing the system. This, along with the uncertainty of how many public safety agencies would participate, may have led to the unsuccessful auction.

In January 2015, the AWS-3 radio spectrum auction was held and generated \$44.9 billion. The proceeds of the auction provided the funding for FirstNet and will finance technological upgrades to 911 emergency systems and contribute over \$20 billion to deficit reduction.

When the nationwide broadband network is successfully built, it will be the first system of its size built specifically for public safety requirements and could serve as an evaluation model for a possible nationwide voice system in the future.

Formation of FirstNet

FirstNet⁴⁰ is an independent authority within the U.S. Department of Commerce's NTIA. "Signed into law (P.L. 112-96, Title VI) on February 22, 2012, the Middle Class Tax Relief and Job Creation Act created the First Responder Network Authority (FirstNet). The law gives FirstNet the mission to build, operate and maintain the first high-speed, nationwide wireless broadband network dedicated to public safety. FirstNet will provide a single interoperable platform for emergency and daily public safety communications"⁴¹ (**Figure 10.1**).

⁴⁰ <http://www.firstnet.gov/about>.

⁴¹ <http://www.firstnet.gov/about>.

Figure 10.1. FirstNet Beginnings

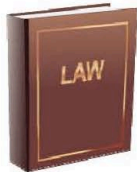

THE LAW

2.22.12

FirstNet becomes law
PL 112-96

FUNDING



\$7B authorized to build the FirstNet network. Funded by spectrum auctions through 2022.

GOVERNANCE



The FirstNet Board has **15** members, including those with telecommunications and public safety backgrounds.

Each Governor appoints **1** Single Point of Contact (SPOC) and governing body to represent the State's interests to FirstNet.

40 member Public Safety Advisory Committee (PSAC) advises FirstNet on public safety intergovernmental matters.

BAND CLASS (BC) 14

20MHz of bandwidth has been dedicated to public safety in the prime upper **700MHz** frequency range.

BC 17		BC 17		BC 17		BC 17		BC 17		BC 17		BC 17	
BC 12	BC 29	BC 12	BC 13	BC 14	LMR	BC 13	BC 14	LMR	BC 12	BC 13	BC 14	LMR	BC 12
AT&T	AT&T Dish	AT&T	Verizon	PS Broadband	PS Narrowband	Verizon	PS Broadband	PS Narrowband	AT&T	Verizon	PS Broadband	PS Narrowband	AT&T
UL	DOWNLINK	DL	DOWNLINK	DOWNLINK	DOWNLINK	UPLINK	UPLINK	DOWNLINK	UL	DOWNLINK	UPLINK	DOWNLINK	UL
6 MHz	12 MHz	6 MHz	12 MHz	10 MHz	6 MHz	11 MHz	10 MHz	6 MHz	6 MHz	11 MHz	10 MHz	6 MHz	6 MHz

1 MHz Guard Bands

As noted in Figure 10.1, FirstNet is managed by a 15-member board of directors. The FirstNet board consists of:

- Secretary of Homeland Security (or designee).
- Attorney general of the U.S. (or designee).
- Director of Office of Management and Budget (or designee).
- Twelve individuals to be appointed by the Secretary of Commerce.
- The appointments shall have:
 - Not fewer than three individuals to represent collective interests of states, localities, tribes and territories.
 - Not fewer than three individuals who have served as public safety professionals.

The board is responsible for the strategic decisions regarding the direction of FirstNet.

In **Figure 10.1**, there is a 40-member PSAC that reports to the board on specific issues related to public safety operations. The members of this committee represent the voice of public safety and should be contacted regarding public safety issues. The listing of PSAC members can be found at <http://www.firstnet.gov/about/public-safety-advisory-committee>.

Figure 10.2. FirstNet Organization With Appointees

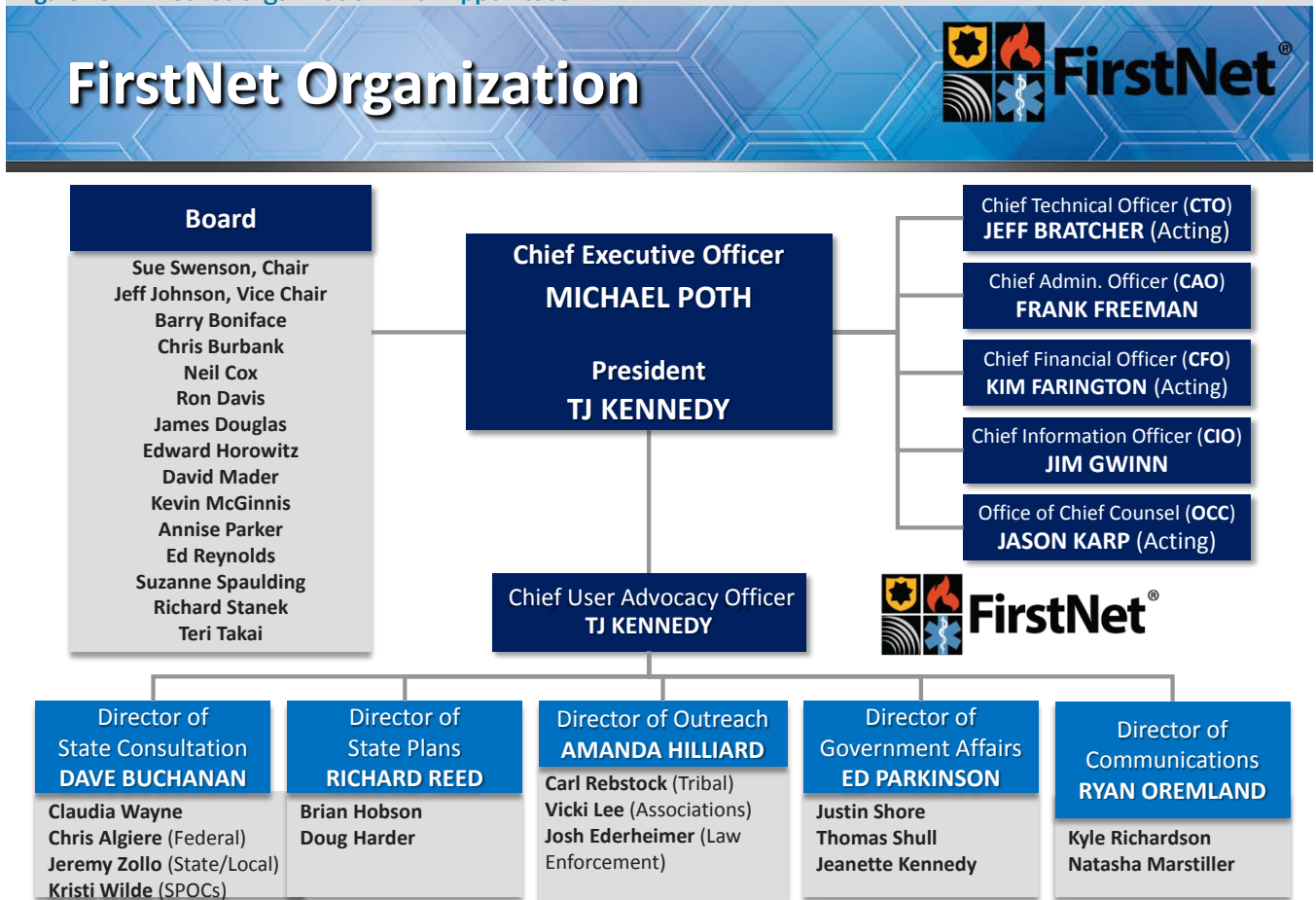

Sept. 30, 2015

As of Sept. 30, 2015, the FirstNet general manager reports the business of FirstNet to the board (Figure 10.2). The FirstNet organization is similar to a commercial telecommunications company.

As part of the act, FirstNet was allocated 20 MHz of frequency spectrum to manage for deployment of the Radio Access Network that is part of the FirstNet system.

As you can see in Figure 10.3, the frequencies allocated are near some of the commercial carriers. Part of the cost reduction and containment strategy is investigating options that would allow FirstNet to share access of the assigned spectrum with commercial providers. At present, it is being looked at as a creative way to maximize the use of the spectrum and create funding streams for future sustainment. It is important to note that if shared, provisions in the new LTE standards would provide

Figure 10.3. Public Safety Allocation in the 700 MHz Band

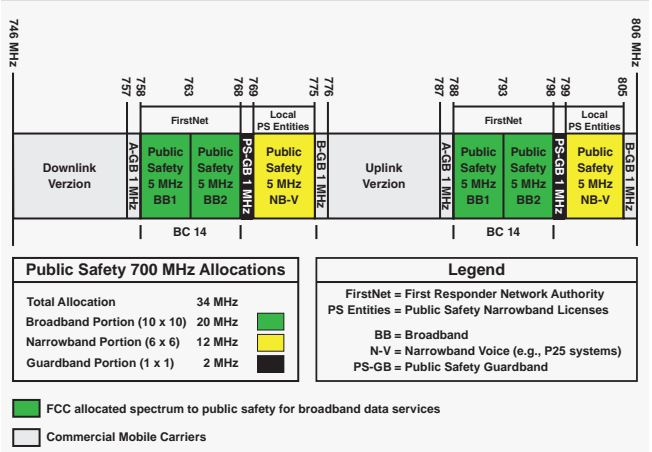

FirstNet Frequency Allocation⁴²

a mechanism to remove nonpublic safety from the frequencies in time of emergency. Public safety would always maintain priority in the system.

⁴² <http://www.anritsu.com/en-US/Products-Solutions/Solution/Effectively-testing-700MHz-public-safety.aspx>.

“FirstNet was created to be a force-multiplier for first responders — to give public safety 21st century communication tools to help save lives, solve crimes and keep our communities and emergency responders safe. To do that, FirstNet will build a new Band Class 14 network designed to be reliable, functional, safe and secure, and provide optimal levels of operational capability at all times. For the first time, public safety communications will be based on commercial standards. This will bring the benefits of lower costs, consumer-driven economies of scale and rapid evolution of advanced communication capabilities.”⁴³

In the future, FirstNet may provide a single interoperable platform for emergency and daily public safety communications. The FirstNet network will fulfill a fundamental data transport need of the public safety community as well as the last remaining recommendation of the 9/11 Commission.

FirstNet is a data system being developed to meet the needs of first responders. It is envisioned as a 4G LTE system for public safety designed to be:

- Competitively priced.
- Highly survivable and accessible.
- Secure.
- Public safety focused. Provide public safety functionalities, such as Mission Critical Voice.

Cost

FirstNet has been allocated \$7 billion for the build-out of the system. Telecommunications experts have differing opinions on the approach FirstNet will take to deploy the system, which will impact the system cost. While \$7 billion is a large sum of money, it is a fraction of the cost that commercial carriers have invested in infrastructure. FirstNet is working with each state to develop requirements, inventory and available resources to share and identify the state stakeholder groups. FirstNet hopes to use sharing agreements to help contain build-out costs.

FirstNet, like the commercial providers, will be a subscriber-based system. Public safety is **not** mandated to move data transport to FirstNet. FirstNet will be in direct competition with the

commercial providers and will have to demonstrate the added value to warrant additional cost to the public safety community. FirstNet is mandated to be self-sustaining. This will require it to charge subscription fees like the commercial carriers to maintain, operate and upgrade the network. The FirstNet tenet states “To offer services that meet the needs of public safety at a cost that is competitive and compelling to users.”

Accessibility

FirstNet is being designed to provide data access for public safety in times of emergency anywhere in the U.S. or U.S. territories. In recent history, the commercial systems have failed to provide connectivity when overwhelmed by spikes in usage from the general public. Current systems do not have priority built in to ensure public safety access during these high-traffic periods (**Figure 10.4**). This was documented during the Boston Marathon Bombing (April 2013) and the Virginia earthquake (August 2011). In both incidents, the cell systems were unable to handle the intense demand for services. FirstNet will move public safety off the commercial systems and be designed to handle public safety traffic during similar events or incidents.

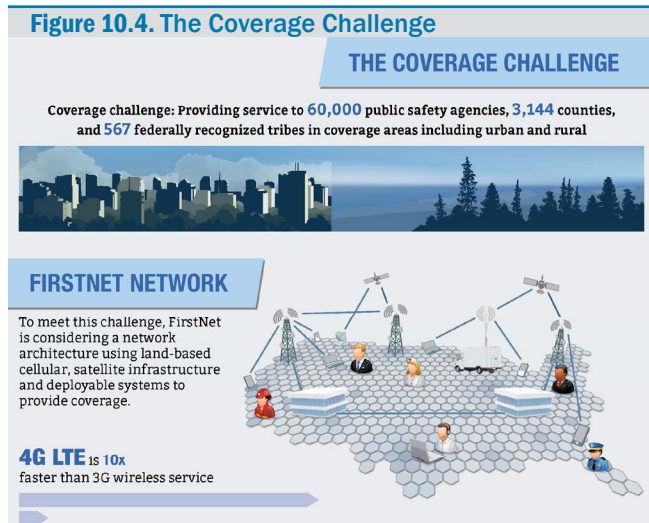

A component of accessibility is system coverage. The system is required to cover all population centers as well as rural and wilderness areas. System design will include fixed infrastructure and deployable infrastructure to achieve the coverage goals. Options to achieve the coverage

⁴³ <http://www.firstnet.gov/network>.

goals also include possible spectrum sharing with commercial carriers, but no specifics will be available until the system design is completed.

Survivability

Being a public safety system, FirstNet is being designed to survive extreme weather and seismic events. Public safety radio systems are expected to be operable when these events happen to maintain the ability to respond to the needs of the public. This equates to building the infrastructure to public safety standards that require redundant power sources, hardened sites, towers that will survive extreme weather, and back haul connections that will remain intact. The NPSTC recently released a document “Defining Public Safety Grade Systems and Facilities”⁴⁴ that describes the Public Safety Grade. The document covers physical properties of the radio sites, antenna masts, connectivity requirements, redundant power sources, and many others. The document is a good reference for building voice radio systems sites as well.

Security

In this age of computer hacking, denial of service attacks, and data breaches, security is a key element of FirstNet. The system is being designed to provide data service for the law enforcement community as well as many other disciplines that have data security requirements. FirstNet is envisioned as a secure wireless data network with the security needed to allow transport of sensitive information. The elements of security are being developed but will be in place when FirstNet is deployed.

Public Safety Focus

Mission Critical Voice is a capability that is under development. Mission Critical Voice was presented as a replacement for LMR systems. This is a capability that is being worked on and is not currently available. There are no definite dates for completion, and FirstNet has not been built. Based on these two factors, it is recommended to maintain current LMR systems until FirstNet and Mission Critical Voice are deployed. A component of Mission Critical Voice to be watchful for is off-network capabilities. FirstNet will operate a lot

like the commercial systems today. We all realize that if we do not have system coverage, we do not have connectivity. Off-network communications is mandatory in the fire service application. If the system does not cover the interior of all buildings, which is a certainty, then off-network capability is required to maintain communications with all personnel on the fireground. The reason we use LMR systems is that they, in general, provide communications where commercial networks do not. For FirstNet Mission Critical Voice to replace LMR systems, it must either provide coverage everywhere or provide an off-network capability that would allow units to communicate directly without infrastructure.

The primary application for FirstNet is data transmission and Internet access. FirstNet could replace commercially provided data access needed for mobile computing used in CAD systems. Another application might be the data connectivity needed for fire station alerting.

Possible Fire Service Uses

- Data connectivity for mobile computing/CAD.
- Hot spot for vehicles.
- Electronic patient care reporting.
- Application based.
 - CAD.
 - Hand-held dispatch.
 - Accountability and location.
 - Monitoring.
 - EMS.
 - Protocols.
 - Drug doses.
 - Pharmacological ID.
 - Fire.
 - Accountability and location of personnel.
 - Reference material (Emergency Response Guidebook, SOPs).
 - Extrication (where to cut vehicles).

When smartphones entered the market, the number of applications was small when compared to present. Like the explosion of applications in the private sector, a similar explosion will occur when public safety embraces this technology platform (**Figure 10.5**).

⁴⁴ http://www.npstc.org/download.jsp?tableId=37&column=217&id=3066&file=Public_Safety_Grade_Report_140522.pdf.

Figure 10.5. Public Safety Communications Evolution

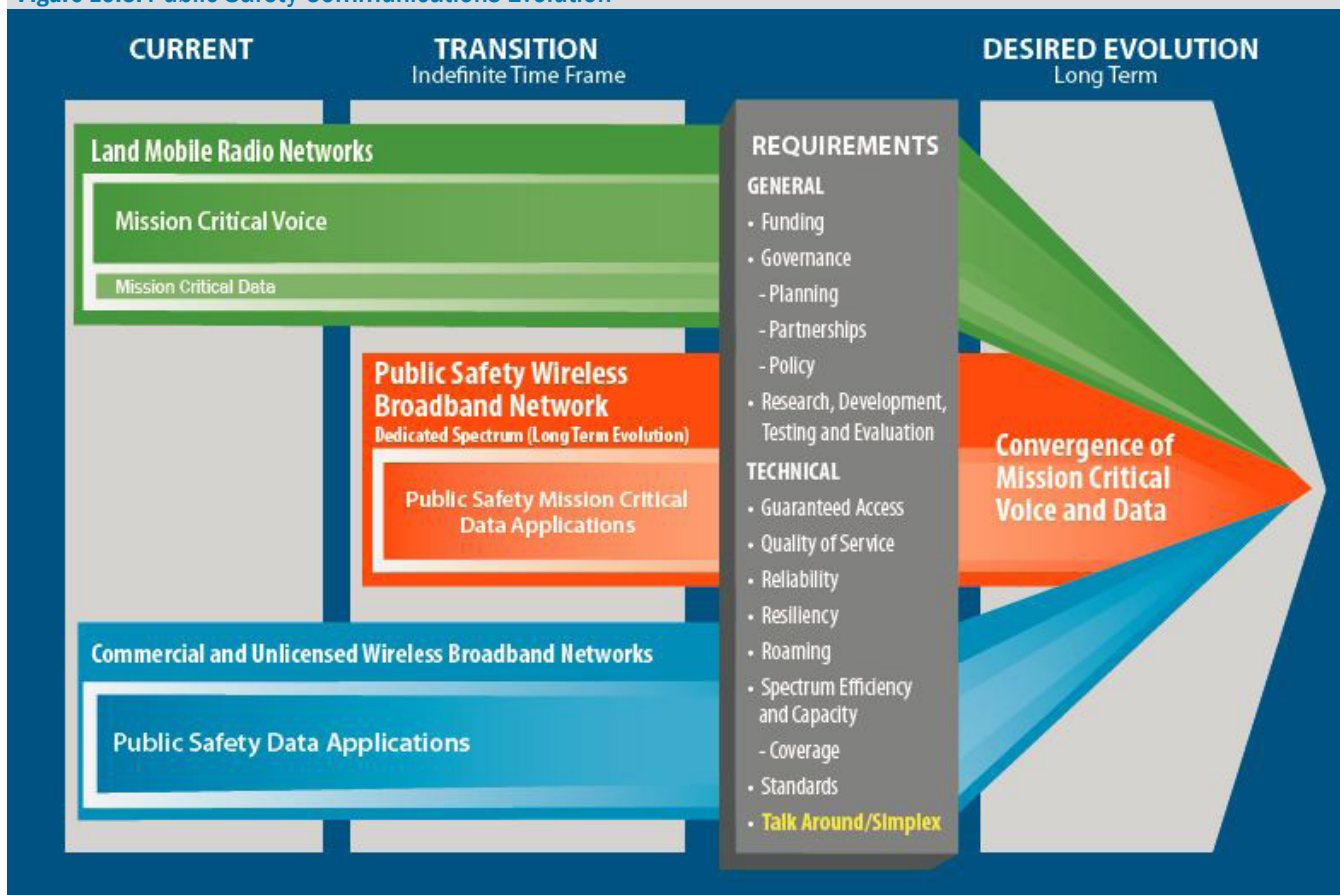

Public Safety Communications Evolution, May 2014, Department of Homeland Security, SAFECOM

Long term, it is envisioned that FirstNet will provide a technology convergence in the future. This concept would merge current data transport and LMR functions into the FirstNet technology platform as depicted in **Figure 10.5**. The convergence of technology is possible, but the fire service will need to validate and verify that the systems being proposed provide the capabilities needed to operate in the firefighting environment. We also need to require capabilities that provide the safety margins required to operate safely on the fireground. Ruggedized devices must also be available to withstand the rigors of the firefighting environment.

Summary – FirstNet

Signed into law on Feb. 22, 2012, the Middle Class Tax Relief and Job Creation Act created FirstNet. The law gives FirstNet the mission to build, operate and maintain the first high-speed, nationwide wireless broadband network dedicated to public safety. FirstNet was allocated 20 MHz of frequency spectrum in the 700 MHz band to manage for deployment of the Radio Access Network that is part of the FirstNet system.

FirstNet in the future may provide a single interoperable platform for emergency and daily public safety communications. The FirstNet network will fulfill a fundamental data transport need of the public safety community as well as the last remaining recommendation of the 9/11 Commission.

FirstNet is a data system being developed to meet the needs of first responders. It is envisioned as a 4G LTE system for public safety designed to be:

- Competitively priced.
- Highly survivable and accessible.
- Secure.
- Public safety focused. Provide public safety functionalities.
- Mission Critical Voice: Off-network communications capability is **mandatory**. FirstNet has stated that Mission Critical Voice, which is most important to the fire service, will be one of the **last** elements to be brought on line.

FirstNet is being designed to provide data access for public safety in times of emergency anywhere in the U.S. or U.S. territories. In recent history, the commercial systems have failed to provide connectivity when overwhelmed by spikes in usage from the general public.

FirstNet is being designed to survive extreme weather and seismic events. Public safety radio systems are expected to be operable when these events happen to maintain the ability to respond to the needs of the public. FirstNet is also being designed with security features that will meet the needs of the fire service and more stringent requirements of law enforcement.

The primary application for FirstNet is data transmission and Internet access. FirstNet could replace commercially provided data access needed for mobile computing used in CAD systems.

Long term, it is envisioned that FirstNet will provide a technology convergence in the future. This concept would merge current data transport and LMR functions into the FirstNet technology platform. Maintaining current LMR systems is necessary until FirstNet technology is deployed, tested, and proven reliable in the fire service environment and equivalent coverage needed by the fire service is attained. As of the development of this report, FirstNet has not yet made decisions on the actual design of either the broadband network or the costs public safety agencies will incur for its use.



This page intentionally left blank.

Glossary

Analog FM Radio: operates by causing the transmitting frequency of the radio to change directly with the microphone audio. The transmitter frequency variations are proportional to the amplitude of the input audio.

Association of Public Safety Communications Officers (APCO): serves the needs of public safety communications practitioners worldwide and the welfare of the general public as a whole by providing complete expertise, professional development, technical assistance, advocacy and outreach.

Atmospheric Ducting: a horizontal layer in the lower atmosphere in which the vertical refractive index gradients are such that radio signals are guided or ducted and tend to follow the curvature of the Earth.

Base Station Radio: located at fixed locations and usually powered by AC utility power.

Bidirectional Amplifier (BDA): used to extend radio coverage within structures to the outside of structures.

Channel Bandwidth: the amount of radio spectrum used by the signal transmitted by a radio.

Continuous Tone-Coded Squelch System (CTCSS): mixes a subaudible tone with the audio from the microphone and transmits the resulting signal. When a radio receives a signal with tone-coded squelch, the CTCSS decoder attempts to match the tone present in the received signal with the desired tone. If the correct tone is present, the receiver is unsquelched and audio is routed to the speaker.

Decibel: a logarithmic unit used to express the ratio between two values of a physical quantity, often power or intensity.

Directional (Yagi) Antenna: an antenna that radiates or receives greater power in one direction allowing for increased performance and reduced interference from unwanted sources.

Direct Radio System: When the signal is received from the radio initially transmitting the signal, the communication is direct. (That is, there is no intervening radio or system.)

Downtilt Antenna: directional antenna tilted to increase energy immediately below the antenna while reducing the maximum distance the signal will travel.

Dynamic Regrouping: allows an authorized system administrator to assign a radio or radios to a specific talkgroup remotely.

Emergency Alarm: When a user presses the emergency button on the portable, an emergency message is sent to any dispatchers using radio consoles.

Emergency Call: a call that is initiated by an “emergency alarm” activation. The “emergency call” is a high-priority voice transmission in the trunked system. The emergency call elevates the talkgroup to a high priority to ensure communications with the initiator of the call.

Federal Communications Commission (FCC): a federal governmental board charged with regulating broadcasting and interstate communication by wire, radio and television.

Feedback: when radios operating in close proximity receive the transmitted signals from the receiving radios nearby. This creates a loop effect and introduces unwanted interference in the communications system. This is very common when operating on direct/simplex channels when the transmit and receive frequency is the same.



First Responder Network Authority (FirstNet): an independent federal government authority tasked with cost-effectively creating a nationwide broadband data network and providing wireless services to public safety agencies across the country. FirstNet is an independent authority within the U.S. Department of Commerce's NTIA.

Fixed-Site Antenna: antennas mounted on towers or buildings to provide the dispatch to or repeater coverage throughout the service area.

Frequency Coordination: a technical and regulatory process that is intended to remove or mitigate RF interference between different radio systems that use the same operational frequency.

Half-Duplex Communication: uses two RFs for communication. The transmitting radio transmits on Frequency 1, and that signal is received by the repeater. The repeater then repeats the transmission on Frequency 2, and this signal is received by the receiving radio.

IAFF Fire Ground Survival (FGS) Program: The purpose of the FGS program is to ensure that training for mayday prevention and mayday operations are consistent between all firefighters, COs and chief officers.

Institute of Electrical and Electronics Engineers (IEEE): promotes the engineering process of creating, developing, integrating, sharing and applying knowledge about electro- and information technologies.

Interference: unwanted RF signals disrupt the use of your radio.

Intermodulation: frequency variation of two or more electromagnetic waves transmitted simultaneously through a nonlinear electronic system.

International Electrotechnical Commission (IEC) Standards Ingress Protection (IP) Codes: IP codes are international standards that test for IP into an electrical enclosure.

International Municipal Signal Association (IMSA): designated as the frequency coordinator for all public safety agencies.

Interoperability: the ability of public safety responders to share information via voice and data communications systems on demand, in real time, when needed, and as authorized.

Land Mobile Radio (LMR): wireless communications system intended for use by users in vehicles (mobiles) or on foot (portables).

Military Standard 810 (MIL-STD): a standard for reliability and ruggedness, developed by the military, to provide an environmental test protocol that would prove qualified equipment would survive in the field.

Mobile Radio: Mobile radios are designed to be mounted in vehicles and get their power from the vehicles' electrical system. Generally, these radios have better antennas, receivers and provide higher power when transmitting from a vehicle.

Modulation: Modulation is the process of varying a higher frequency carrier wave to transmit information.

Multigroup Call: a call that transmits to two or more talkgroups simultaneously.

Narrowbanding: an effort to ensure more efficient use of the VHF and UHF spectrum by requiring all VHF and UHF public safety and Industrial/Business LMR systems to migrate to at least 12.5 kHz efficiency technology by Jan. 1, 2013.

National Association of State Telecommunications Directors (NASTD): a member-driven organization whose purpose is to advance and promote the effective use of information technology and services to improve the operation of state government.

National Fire Protection Association (NFPA): a U.S. trade association, albeit with some international members, that creates and maintains private, copyrighted, standards and codes for usage and adoption by local governments.

National Institute of Standards and Technology (NIST): the federal technology agency that works with industry to develop and apply technology, measurements and standards.

National Public Safety Telecommunications Council (NPSTC): a volunteer federation of 15 public safety organizations, whose mission is to improve public safety communications and interoperability through collaborative leadership. NPSTC's members are the organizations representing fire, EMS, law enforcement, transportation, and other telecommunications organizations (<http://www.npstc.org/>).

National Telecommunications and Information Administration (NTIA): executive branch agency that is principally responsible by law for advising the president on telecommunications and information policies. NTIA is responsible for federal frequency coordination.

NFPA 1221: *Standard for the Installation, Maintenance, and Use of Emergency Services Communications Systems.*

NFPA 1561: *Standard on Emergency Services Incident Management System and Command Safety.*

NFPA 1802: *Standard on Personal Portable (Hand-Held) Two-Way Radio Communications Devices for Use by Emergency Services Personnel in the Hazard Zone.*

NIST Technical Note 1477: *Testing of Portable Radios in a Firefighting Environment.*

NIST Technical Note 1850: *Performance of Portable Radios Exposed to Elevated Temperatures.*

Office of Emergency Communications (OEC): supports and promotes communications used by emergency responders and government officials to keep America safe, secure and resilient. The office leads the nation's operable and interoperable public safety and national security and emergency preparedness communications efforts.

Omnidirectional Antenna: a class of antenna that radiates radio wave power uniformly in all directions in one plane.

Over the Air Programming (OTAP): allows system administrators to program radios over the air.

Over the Air Rekeying (OTAR): allows system administrators to rekey encryption codes over the air.

Personal Alert Safety System (PASS): monitors an emergency responder's motion and automatically emits an audible signal to summon aid in the event that the user becomes incapacitated or needs assistance.

Portable Radio: hand-held radios powered by rechargeable, replaceable battery packs.

Private Call: allows one radio to call another radio and to carry on a conversation without any other radios hearing the conversation.

Project 25 (P25): a suite of standards for digital radio communications for use by federal, state/province, and local public safety agencies in North America to enable them to communicate with other agencies and mutual-aid response teams in emergencies.

Radio Alerting: feature that allows radios to be alerted to notify the user of incoming traffic.

Radio Console Equipment: used by dispatchers to control base station radios and repeaters and allow the dispatcher to receive and transmit on one or more radios simultaneously.



Radio Frequency (RF): any frequency within the electromagnetic spectrum associated with radio wave propagation.

Radio Spectrum: the range of electromagnetic frequencies used in radio transmission, lying between 10 kHz and 300,000 MHz.

Receiver Desensitization Interference/Receiver Overload: caused by nearby high-level transmitter signals that overload the initial parts of the radio's signals.

Receiver Multi-Coupler: a device for connecting several receivers or transmitters to one antenna in such a way that the equipment impedances are properly matched to the antenna impedance.

Receiver Voters: compares the audio from all receivers and routes the audio from the receiver with the best audio quality to the dispatcher.

Remote Speaker Microphone (RSM): a corded radio accessory that has a speaker/microphone combination that can attach closer to the user's mouth.

Repeated Radio System: the portable transmit frequency is received by the repeater and retransmitted on the portable receive frequency at a higher power to extend range or increase penetration.

Repeater Duplexer: a tuned electronic device that permits the use of the same antenna for transmitting and receiving.

Request for Proposal (RFP): a solicitation, often made through a bidding process, by an agency or company interested in procurement of a commodity, service or valuable asset to potential suppliers to submit business proposals.

SAFECOM: mission is to improve designated emergency response providers' interjurisdictional and interdisciplinary emergency communications interoperability through collaboration with emergency responders across federal, state, local, tribal, and territorial governments, and international borders.

Selective Disabling: allows radios to be remotely disabled if lost or stolen.

Short Message Service (SMS): Since the radios are digital, many trunked systems support sending short messages across the network.

Simplex Communication: when one radio transmits and the other radio receives on the same RF channel.

Simulcast Transmitter Systems: multiple transmitters simultaneously transmit on the same frequency to increase the coverage footprint or provide in-building penetration.

Simultaneous Transmissions: multiple users trying to talk at the same time causing communications interference.

Squelch Circuit: used to mute the output of the radio receiver when no desirable signal is present and unmute when a signal of the appropriate strength is present.

Talk-Around System: a radio accessory that attaches to the SCBA facepiece, may offer multiple talk-around channels that allow users to talk with each other in the hazard zone.

Talkgroup: equivalent of a channel on a conventional system. In a trunked system, there may be more talkgroups than RF channels. The design is based on the probability that not all channels are required simultaneously.

Telecommunications Industry Association (TIA): represents manufacturers and suppliers of global communications networks through standards development, policy and advocacy, business opportunities, market intelligence, and events and networking.

Telephone Interconnect: allows users to answer or make calls to telephone users from the radio.

Terrain Blocking: materials such as metal and earth completely block radio waves due to their composition and density. Radio waves can travel through some materials such as glass or thin wood but the strength is reduced.

Time Division Multiple Access (TDMA): a channel access method for trunked radio systems. It allows several users to share the same frequency channel by dividing the signal into the different time slots.

Transmitter Combiner: allows multiple transmitters to connect to a single antenna.

Trunked Radio Systems: trunking borrows technologic concepts from telephone systems to assign RFs to active calls, improving the spectrum efficiency.

Ultra High Frequency (UHF): designation for the range of RFs in the range between 300 MHz and 3 gigahertz.

Vehicular Repeater: a repeater that is mounted in a vehicle and is often used to enhance system coverage. This can be to provide more range or in-building penetration.

Very High Frequency (VHF): designation for the range of RFs in the range between 30 MHz to 300 MHz.

Vocoder/Codec: the algorithm and electronic components that perform the function of converting analog voice to a digital data packet and also provide the decoding of the signal as well.

Voice Amplifier: a PPE accessory that attaches to the SCBA facepiece and amplifies the user's voice.

Wavelength: the distance between the crests of an electromagnetic wave. Wavelength is a factor in determining antenna length.



This page intentionally left blank.

Acronyms

AASHTO	American Association of State Highway and Transportation Officials	FEMA	Federal Emergency Management Agency
AHJ	authority having jurisdiction	FGS	Fire Ground Survival
ANSI	American National Standards Institute	FirstNet	First Responder Network Authority
APCO	Association of Public Safety Communications Officers	FM	frequency modulation
BDA	bidirectional amplifier	FPIC	Federal Partnership for Interoperable Communications
BID	Bidder Information Document	FRG	First Responders Group
CAD	computer-aided dispatch	gpm	gallons per minute
CDMA	code division multiple access	GPS	Global Positioning System
CFLs	compact fluorescent lights	HIPAA	Health Insurance Portability and Accountability Act
CFR	Code of Federal Regulations	HSGP	Homeland Security Grant Program
CG	Channel Guard™	Hz	hertz
cm	centimeter	IAFC	International Association of Fire Chiefs
CO	Company Officer	IAFF	International Association of Fire Fighters
COML	Communications Unit Leader	I/B	industrial/business (radio service pool)
COMT	Communications Technician	IC	Incident Commander
CTCSS	Continuous Tone-Coded Squelch System	ICT	information and communications technology
DAS	Distributed Antenna System	ID	identification
dB	decibel	IDLH	immediately dangerous to life and health
DCS	Digital-Coded Squelch	IEC	International Electrotechnical Commission
DHS	U.S. Department of Homeland Security	IEEE	Institute of Electrical and Electronics Engineers
DVSI	Digital Voice System Inc.	IFC	International Fire Code
EMS	Emergency Medical Services	IFSTA	International Fire Service Training Association
ERU	Emergency Response Unit	IMSA	International Municipal Signal Association
ESMR	Enhanced Specialized Mobile Radio		
FCC	Federal Communications Commission		
FCCA	Forestry Conservation Communications Association		
FDMA	frequency division multiple access		



INCM	Incident Communications Manager	OTAP	over the air programming
IP	Ingress Protection	OTAR	over the air rekeying
kHz	kilohertz	PASS	Personal Alert Safety System
LCD	liquid-crystal display	PL	Private Line™
LED	light-emitting diode	PPE	personal protective equipment
LMRs	Land Mobile Radios	PS	public safety (radio service pool)
LODD	line-of-duty death	PSAC	Public Safety Advisory Committee
LTE	Long Term Evolution	PSHSB	Public Safety and Homeland Security Bureau
MHZ	megahertz	PSST	Public Safety Spectrum Trust
MIL-STD	Military Standards	PSWAC	Public Safety Wireless Advisory Committee
NASTD	National Association of State Telecommunications Directors	PTT	push-to-talk
NFPA	National Fire Protection Association	RADO	Radio Operator
NIFC	National Interagency Fire Center	R&O	Reports and Orders
NIFOG	National Interoperability Field Operations Guide	RF	radio frequency
NIMS-ICS	National Incident Management System Incident Command System	RFI	request for information
NIST	National Institute of Standards and Technology	RFP	request for proposal
NOI	Notice of Inquiry	RPC	Regional Planning Committee
NPRM	Notice of Proposed Rulemaking	rpm	revolutions per minute
NPSBN	National Public Safety Broadband Network	RSMs	remote speaker microphones
NPSPAC	National Public Safety Planning Advisory Committee	RVS	receiver voter system
NPSTC	National Public Safety Telecommunications Council	SCBA	self-contained breathing apparatus
NTIA	National Telecommunications and Information Administration	SCIPs	Statewide Communications Interoperability Plans
ODP	Office for Domestic Preparedness	SIEC	State Interoperability Executive Committee
OEC	Office of Emergency Communications	SMR	Specialized Mobile Radio
OSM	Office of Spectrum Management	SOPs	standard operating procedures
		SWIC	Statewide Interoperability Coordinator
		TA	Transition Administrator
		TDMA	time division multiple access



TIA	Telecommunications Industry Association	USFA	U.S. Fire Administration
TICs	thermal imaging cameras	VHF	very high frequency
UASI	Urban Areas Security Initiative	VoLTE	Voice over LTE
UHF	ultra high frequency	VR	vehicular repeater
ULS	Universal Licensing System	Wi-Fi	wireless fidelity
USDA	U.S. Department of Agriculture	WMD	weapons of mass destruction
