



AN1017: Zigbee® and OpenThread Coexistence with Wi-Fi®

This application note describes methods to improve coexistence of 2.4 GHz IEEE 802.11b/g/n Wi-Fi and IEEE 802.15.4-based radios such as Zigbee® and OpenThread. This application note assumes you have a basic understanding of the concepts and principles of Wi-Fi coexistence with 802.15.4 radios and how Wi-Fi coexistence is implemented on EFR32 devices. For more information, see *UG103.17: Wi-Fi® Coexistence Fundamentals*.

This application note describes EFR32 Zigbee and OpenThread coexistence support for EmberZNet PRO 6.9.0.0 and OpenThread 1.1.0.0 versions and above. See [5 Document Revision History](#) for a summary of key changes in previous revisions of this application note.

For additional details about the implementation of managed coexistence are included in *AN1243: Timing and Test Data for EFR32 Coexistence with Wi-Fi*, available under non-disclosure from Silicon Labs Sales.

KEY POINTS

- Configure Wi-Fi coexistence for Zigbee and OpenThread using Component Editor
- Use coexistence CLI commands for Zigbee and OpenThread
- Order the Coexistence Backplane Evaluation Board

Contents

Contents	1
1. Introduction	2
2. Configuring Wi-Fi Coexistence	3
2.1. PTA Software Setup with AppBuilder (Zigbee)	3
2.2. PTA Software Setup with the Component Editor (Zigbee and OpenThread).....	5
2.3. Coexistence Configurations	8
2.3.1. REQUEST	8
2.3.2. GRANT	9
2.3.3. Abort Transmission Mid Packet If GRANT Is Lost	9
2.3.4. ACK Disable	10
2.3.5. PRIORITY	10
2.3.6. PWM.....	12
2.3.7. Radio Hold Off.....	13
2.3.8. Directional PRIORITY	13
2.3.9. RX Active.....	16
2.3.10. Signal Identifier (EFR32xG24)	17
2.4. Run-Time PTA Re-configuration	17
2.4.1. PTA Option Descriptions	18
2.4.2. SoC Application API (using AppBuilder for Zigbee)	19
2.4.3. SoC Application API (using Component Editor for Zigbee and OpenThread).....	20
2.4.4. Zigbee Network Coprocessor Application using EZSP API	21
2.5. Coexistence Configuration Setup Examples for Different Wi-Fi/PTA Applications (Zigbee).....	22
3. Coexistence CLI Commands	28
3.1. Coexistence CLI Commands (using AppBuilder for Zigbee).....	28
3.2. Coexistence CLI Commands (using Component Editor for Zigbee and OpenThread)	28
3.3. PTA-specific Debug Counters	30
3.3.1. OpenThread specific Debug Counters	31
4. Coexistence Backplane Evaluation Board (EVB)	33
5. Document Revision History	34

1. Introduction

This application note includes the following sections:

- [2 Configuring Wi-Fi Coexistence](#) describes how to configure the Silicon Labs Packet Traffic Arbitration (PTA) using AppBuilder for Zigbee and the Simplicity Studio® (SSv5) Component Editor for Zigbee and OpenThread.
- [3 Coexistence CLI Commands](#) describes how to use Command Line Interface (CLI) commands for Zigbee and OpenThread.
- [4 Coexistence Backplane Evaluation Board \(EVB\)](#) explains how to order the EVB for evaluating the Silicon Labs EFR32 software coexistence solution and introduces the Silicon Labs Wi-Fi Coexistence Learning Center.

2. Configuring Wi-Fi Coexistence

2.1. PTA Software Setup with AppBuilder (Zigbee)

GPIO interrupt numbers are based on the GPIO pin numbers and not the port. This can cause conflicts if the same pin is selected for different ports—for example, SPI_CS on PB01 will conflict with GRANT on PC01 because they will both have 1 as an interrupt number. Silicon Labs recommends avoiding these conflicts. If the conflict exists in hardware, you can add the following coexistence macros in the Additional Macros section of the Simplicity IDE tab:

- BSP_COEX_GNT_INTNO
- BSP_COEX_PRI_INTNO
- BSP_COEX_PWM_REQ_INTNO
- BSP_COEX_REQ_INTNO
- BSP_COEX_RHO_INTNO

Use the Configurator DefaultMode PORTIO map as a guide to determine which interrupt number to use in the Additional Macros Value column by avoiding port pin numbers in use by other GPIO interrupts.

The steps to set up PTA Software for Zigbee using AppBuilder are described below. These steps assume you have installed Simplicity Studio 5 and the EmberZNet SDK (Software Development Kit) and that you have a project open in the Simplicity IDE (Integrated Development Environment).

1. Select the **Radio Coexistence** plugin under the **RAIL** section of the **Plugins** tab. Under the Utility section selecting the **Radio Coexistence CLI** plugin is optional but recommended.

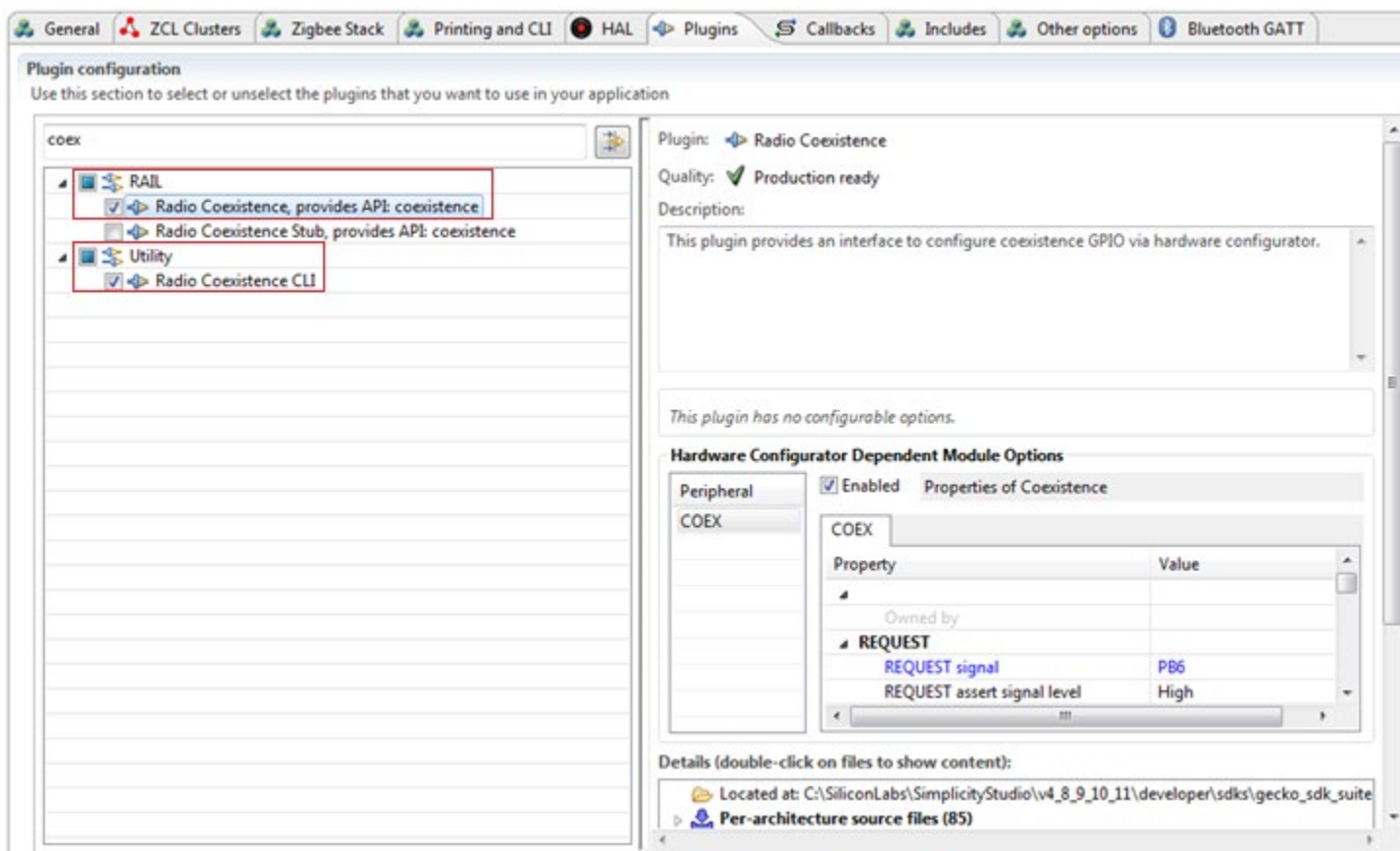

2. Open the project's .hwconf file in Hardware Configurator and select **Default Mode Peripherals** view.
3. Select **Coexistence** in the **Radio** section to open coexistence properties and ensure **Coexistence** is enabled.

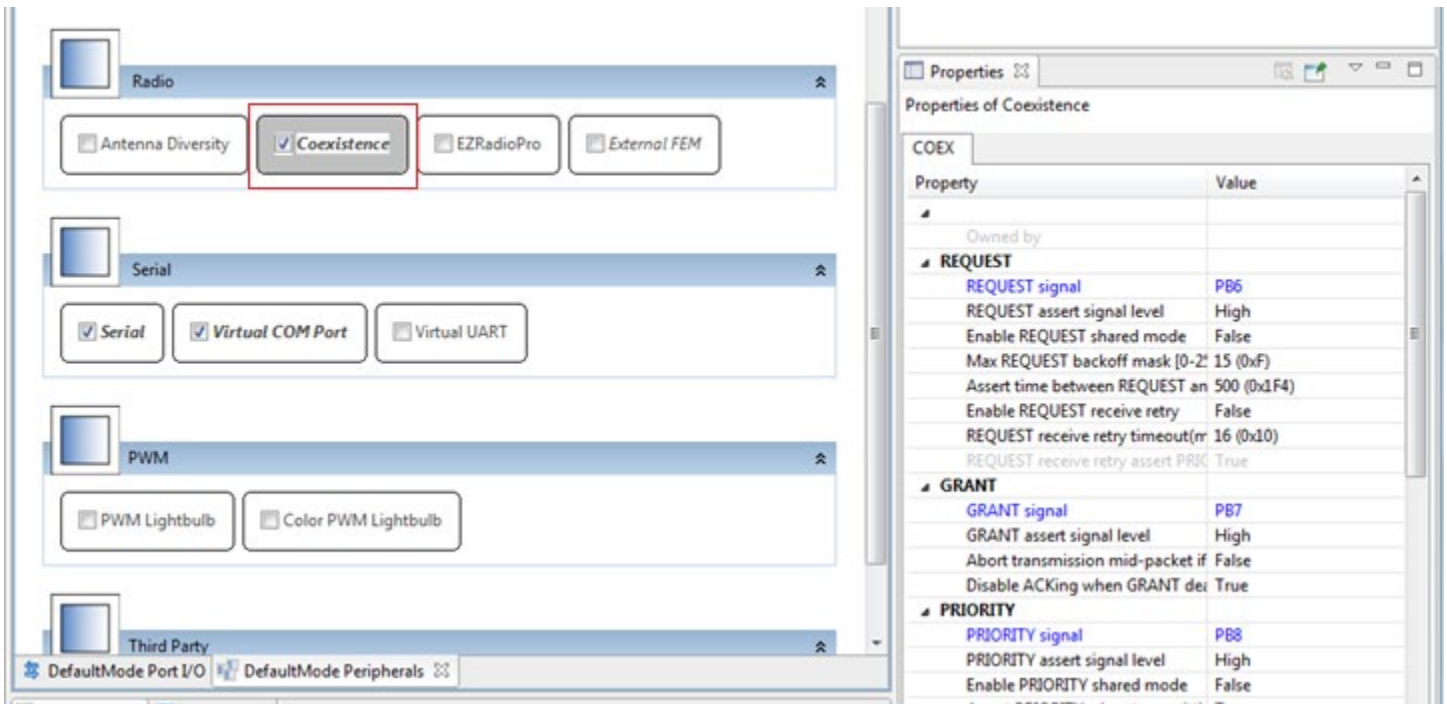

AppBuilder displays the Properties of Coexistence as shown in the following figure.

Properties of Coexistence	
COEX	
Property	Value
▶	
▶ REQUEST	
REQUEST signal	PB6
REQUEST assert signal level	High
Enable REQUEST shared mode	False
Max REQUEST backoff mask [0-255]	15 (0xF)
Assert time between REQUEST and RX/TX start (us) [BLE only]	500 (0x1F4)
Enable REQUEST receive retry	False
REQUEST receive retry timeout(ms)	16 (0x10)
REQUEST receive retry assert PRIORITY	True
▶ GRANT	
GRANT signal	PB7
GRANT assert signal level	High
Abort transmission mid-packet if GRANT is lost	False
Disable ACKing when GRANT deasserted, RHO asserted, or REQUEST not secured (shared REQUEST only)	True
▶ PRIORITY	
PRIORITY signal	PB8
PRIORITY assert signal level	High
Enable PRIORITY shared mode	False
Assert PRIORITY when transmitting packet	True
Assert PRIORITY when receiving packet	True
Include TX PRIORITY Escalation	True
CCA/GRANT TX PRIORITY Escalation Threshold	4 (0x4)
MAC Fail TX PRIORITY Escalation threshold	0 (0x0)
▶ PWM	
PWM REQUEST signal (shared REQUEST only)	Disabled
PWM REQUEST signal level (shared REQUEST only)	High
Enable PWM REQUEST at startup	False
PWM REQUEST Period (0.5ms)	78 (0x4E)
PWM REQUEST Duty-Cycle (%)	20 (0x14)
Assert PRIORITY when PWM REQUEST asserted	Low
▶ Radio Hold Off	
RHO signal	PB10
RHO assert signal level	High
▶ Directional PRIORITY	
Enable Directional PRIORITY	True
Directional PRIORITY Timer	None
Directional PRIORITY pulse width	20 (0x14)
Directional PRIORITY PRS channel	Disabled
PRS channel output pin	
Inverted REQUEST PRS channel	CH10
▶ Radio Blocker Optimization	
Optimize for Wi-Fi Blocker	True
Enable Runtime Control	False
Optional 'Wi-Fi Select' Control of Blocker Optimization	PC0
Assert	High
Timeout (ms)	100 (0x64)
▶ RX Active	
RX active PRS channel	CH5
PRS channel 5 output pin	PD13
RX active assert signal level	High

2.2. PTA Software Setup with the Component Editor (Zigbee and OpenThread)

The steps to set up PTA Software for Zigbee and OpenThread using the Component Editor are described below. These steps assume you have installed Simplicity Studio 5, EmberZNet SDK 7.x, and the OpenThread SDK, and that you have a project open in the Simplicity IDE.

1. On the SOFTWARE COMPONENTS tab, search for *coex* in the **component's name** search field (at the top right).
 For Zigbee, under Platform->Radio components, select and install the **RAIL Utility, Coexistence** component directly under Platform components.

- For OpenThread, under **OpenThread** components, select the **Coexistence** component and click **Install** as shown in the following figure. Installing the Coexistence component will install the RAIL Utility, Coexistence component for your project.
Note: For Silicon Labs OpenThread SDK releases prior to 1.2.0.0, select and install the **RAIL Utility, Coexistence** component directly under Platform components.

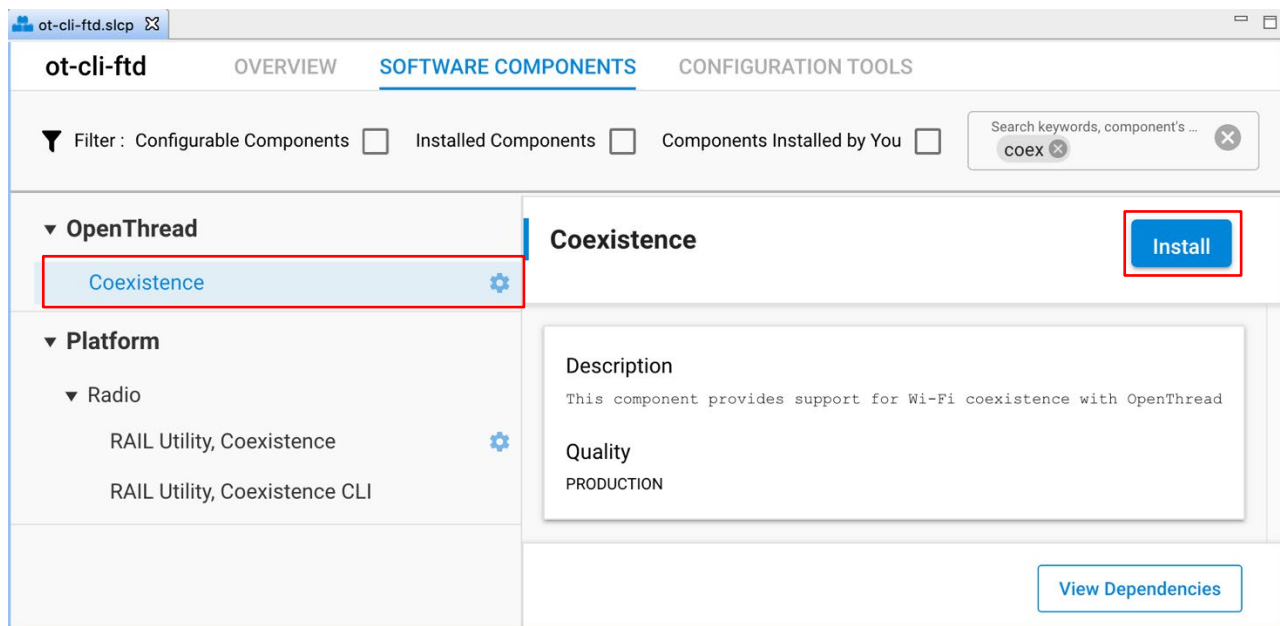

- Once the relevant coexistence component(s) are successfully installed, click **Configure** or the configure symbol next to the **RAIL Utility, Coexistence** component name to open the coexistence properties as shown in the following figure.

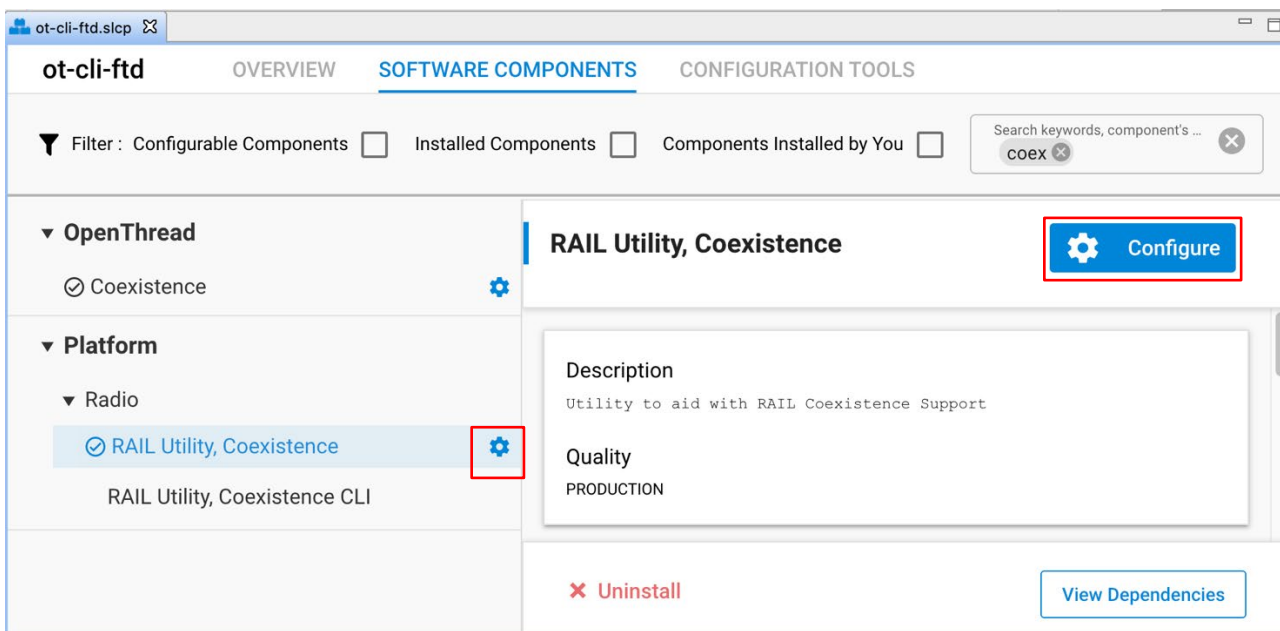

The following figure shows the different coexistence properties in the Component Editor. For more information on coexistence properties, see [2.3 Coexistence Configurations](#).

Coexistence Configuration

Abort transmission mid-packet if Grant when GRANT deasserted, RHO asserted, or REQUEST not secured (shared REQUEST only)

IEEE802.15.4 Only Configuration

Disable ACKing when GRANT deasserted, RHO asserted, or REQUEST deasserted

REQUEST

REQUEST assert signal level

Enable REQUEST shared mode

Max REQUEST backoff mask [0-255]

BLE Only Request Configuration

Specify the number of microseconds between asserting Request and starting RX/TX

IEEE802.15.4 Only Request Configuration

Enable REQUEST receive retry

GRANT

GRANT assert signal level

PRIORITY

PRIORITY assert signal level

Enable PRIORITY shared mode

BLE Only Priority Configuration

Default Enabled/Disabled

IEEE802.15.4 Only Priority Configuration

Assert PRIORITY when transmitting packet

Assert PRIORITY when receiving packet

Include TX PRIORITY escalation packet

CCA/GRANT TX PRIORITY Escalation Threshold

MAC Fail TX PRIORITY Escalation threshold

PWM REQUEST

Radio Hold-off

RHO assert signal level

Directional PRIORITY

RX active

Figure 2.1. Coexistence Properties in the Component Editor

2.3. Coexistence Configurations

The following subsections describe the coexistence configurations in detail.

For coexistence configurations using EmberZNet PRO 6.10.x and below, follow the guidance in [2.1 PTA Software Setup with AppBuilder \(Zigbee\)](#).

Note: To configure GPIO pins for a coexistence signal in the Component Editor, use the equivalent **SL_RAIL_UTIL_COEX <signal>** section of the configuration header.

2.3.1. REQUEST

REQUEST signal enabled

- If selected, REQUEST is mapped to GPIO pin and is used by PTA implementation.
- If not selected, REQUEST is not mapped to GPIO pin.

REQUEST signal is shared

- If selected, REQUEST is shared and implements open-drain or open-source I/O for multi-EFR32 radio applications.
- If active low, REQUEST is open-drain and an external $1\text{ k}\Omega \pm 5\%$ pull-up is required.
- If active high, REQUEST is open-source and an external $1\text{ k}\Omega \pm 5\%$ pull-down is required.
- If not selected, REQUEST is not shared and implements a push-pull output for single EFR32 radio applications.

REQUEST signal active high

- If selected, REQUEST GPIO pin is driven high ($> V_{oh}$) when REQUEST is asserted.
- If not selected, REQUEST GPIO pin is driven low ($< V_{ol}$) when REQUEST is asserted.

REQUEST signal GPIO port and REQUEST signal GPIO pin

- Select REQUEST port and pin matching circuit board configuration.
- To configure GPIO port and pin for the REQUEST signal in the Component Editor, use the **SL_RAIL_UTIL_COEX_REQ** section of the configuration header.

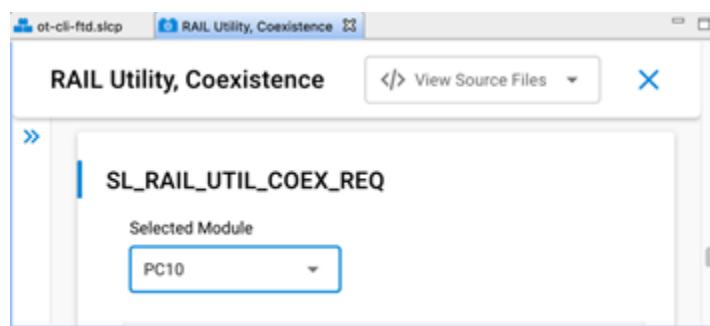

Figure 2.2. REQUEST signal in the Component Editor

REQUEST signal max backoff mask [0-255]

- REQUEST signal max backoff determines the random REQUEST delay mask (only valid if REQUEST signal is shared).
- Random delay (in μs) is computed by masking the internal random variable against the entered mask.
- The mask should be set to a value of $2^n - 1$ to insure a continuous random delay range.

2.3.1.1. Receive Retry

Receive retry REQUEST enabled

- If selected, REQUEST is held after a corrupted receive packet or after a successful receive packet with GRANT denied until timeout expires, or another packet is received.

Note: This feature is useful to hold 2.4 GHz band clear while the remote device re-transmits a packet, maximizing the opportunity to receive an uncorrupted retry packet from the remote device, reducing 2.4 GHz RF traffic and improving battery life.

- If not selected, REQUEST is not held after a corrupted receive packet or after a successful receive packet with GRANT denied.

Receive retry timeout (milliseconds) [0-255]

- Selects the timeout for REQUEST hold after a corrupted receive packet.

Notes:

1. 16ms is recommended to allow for maximum 802.15.4 packet duration and MAC retry random delay.
2. Many Wi-Fi/PTA implementations have a maximum GRANT timeout, which should be set to received retry timeout plus 6ms to allow for maximum size corrupted packet, maximum random delay, and maximum size retry packet.
3. The Receive Retry timeout is used by the 802.15.4 Signal Identifier for EFR32xG24 as the timeout after asserting REQUEST from signal identifier.

REQUEST high PRIORITY on receive retry

- If selected, PRIORITY is asserted during REQUEST hold after a corrupted receive packet or after a successful receive packet with GRANT denied.
- If not selected, PRIORITY is de-asserted during REQUEST hold after a corrupted receive packet or after a successful receive packet with GRANT denied.

2.3.2. GRANT

GRANT signal enabled

- If selected, GRANT is mapped to GPIO pin and is used by PTA implementation.
- If not selected, GRANT is not mapped to GPIO pin and GRANT is always asserted.

GRANT signal active high

- If selected, GRANT is asserted when GRANT GPIO pin is high ($> V_{ih}$).
- If not selected, GRANT is asserted when GRANT GPIO pin is low ($< V_{il}$).

GRANT signal GPIO port and GRANT signal GPIO pin

- Select GRANT port and pin matching circuit board configuration.
- To configure GPIO port and pin for the GRANT signal in the Component Editor, use the **SL_RAIL_UTIL_COEX_GNT** section of the configuration header.

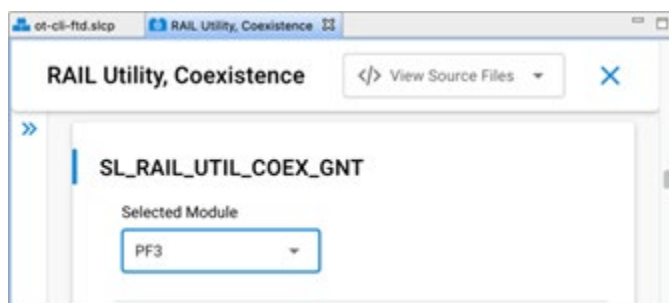

2.3.3. Abort Transmission Mid Packet If GRANT Is Lost

- If selected, losing GRANT during an 802.15.4 TX will abort the 802.15.4 TX.
- If not selected, losing GRANT after the initial evaluation at end of CCA will not abort the 802.15.4 TX.

Note: In the Component Editor, this option has been moved from the GRANT section to the common section of the configuration header.

2.3.4. ACK Disable

Disable ACKing when GRANT de-asserted, RHO asserted, or REQUEST not secured (shared REQUEST only)

- If selected, the ACK to a valid RX packet, requiring an ACK, is **not** transmitted if GRANT is de-asserted, RHO is asserted, or REQUEST is not secured (shared REQUEST only).

Note: This feature allows completing an 802.15.4 message, regardless of PTA signals, to minimize additional retries from remote device, reducing 2.4 GHz RF traffic and improving battery life.

- If not selected, the ACK to a valid RX packet requiring an ACK is transmitted regardless of GRANT, RHO, or REQUEST state.

Note: In the Component Editor, this option has been moved from the GRANT section to the common (IEEE802.15.4 Only Configuration) section of the configuration header.

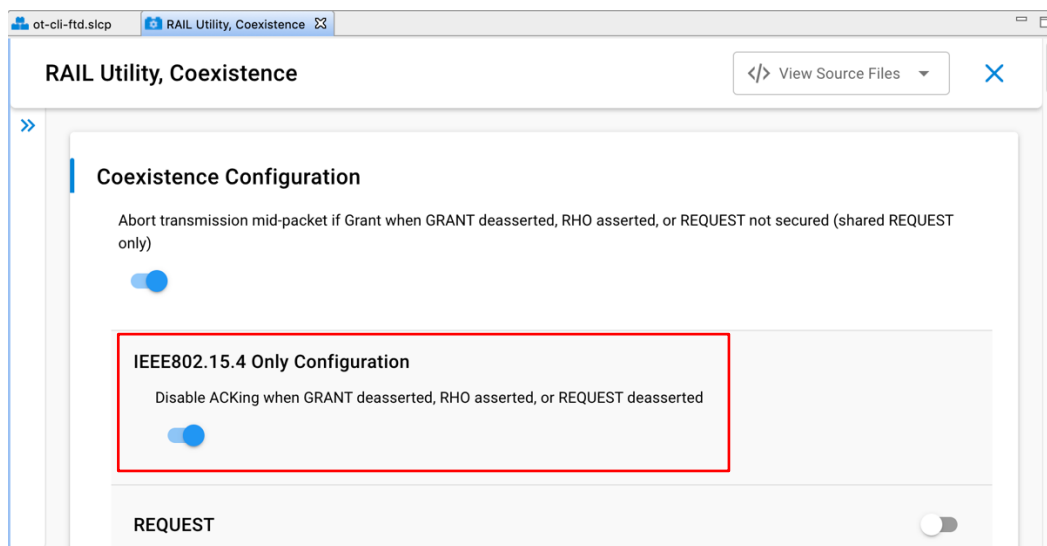

2.3.5. PRIORITY

PRIORITY signal enabled

- If selected, PRIORITY is mapped to GPIO pin and is used by PTA implementation.
- If not selected, PRIORITY is not mapped to GPIO pin.

PRIORITY signal active high

- If selected, PRIORITY GPIO pin is driven high ($> V_{oh}$) when PRIORITY is asserted.
- If not selected, PRIORITY GPIO pin is driven low ($< V_{ol}$) when PRIORITY is asserted.
- If Enable Directional PRIORITY equals True, PRIORITY assert signal level must be set to High.

PRIORITY signal GPIO port and PRIORITY signal GPIO pin

- Select PRIORITY port and pin matching circuit board configuration.
- To configure GPIO port and pin for the PRIORITY signal in the Component Editor, use the **SL_RAIL_UTIL_COEX_PRI** section of the configuration header.

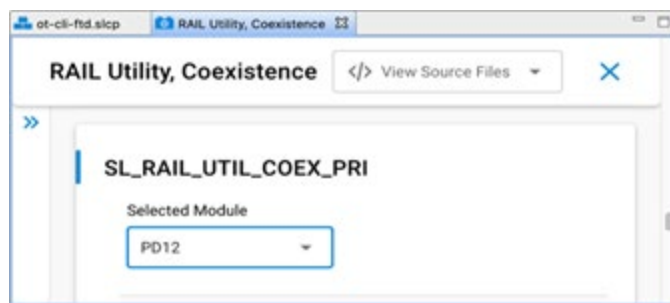

Enable PRIORITY shared mode

- If enabled, PRIORITY is shared and implements open-drain or open-source I/O for multi-EFR32 radio applications.
- If active low, PRIORITY is open-drain and an external 1 k Ω \pm 5% pull-up is required.
- If active high, PRIORITY is open-source and an external 1 k Ω \pm 5% pull-down is required.
- If not enabled, PRIORITY is not shared and implements a push-pull output for single EFR32 radio applications.

TX high PRIORITY

- If selected, PRIORITY is asserted during 802.15.4 TX.
- If not selected, PRIORITY is de-asserted during 802.15.4 TX.

RX high PRIORITY

- If selected, PRIORITY is asserted during 802.15.4 RX.
- If not selected, PRIORITY is de-asserted during 802.15.4 RX.

Include TX PRIORITY Escalation

- If enabled, TX PRIORITY Escalation feature is compiled into firmware.
- If not enabled, TX PRIORITY Escalation feature is not compiled into firmware and CCA/GRANT TX PRIORITY Escalation Threshold and MAC Fail TX PRIORITY Escalation Threshold must be set to 0 when writing to ptaOptions via run-time API.

CCA/GRANT TX PRIORITY Escalation Threshold

- If set to 0 (000b, default):
- CCA/GRANT TX PRIORITY Escalation is disabled.
- PRIORITY during TX is asserted as per “TX high PRIORITY” setting.
- If set between n=1 (001b) to 7 (111b) [requires “TX high PRIORITY” set to low priority (0)]:
- CCA/GRANT TX PRIORITY Escalation is enabled.
- PRIORITY during TX becomes asserted high after n MAC failures due to four CCA and/or GRANT denial failures.
- PRIORITY during TX remains asserted high until a successful MAC TX and RX ACK.

MAC Fail TX PRIORITY Escalation Threshold

- If set to 0 (00b, default):
- CCA/GRANT TX PRIORITY Escalation is disabled.
- PRIORITY during TX is asserted as per “TX high PRIORITY” setting.
- If set to n=1 (01b) to 3 (11b) [requires “TX high PRIORITY” set to low priority (0)]:
- CCA/GRANT TX PRIORITY Escalation is enabled.
- PRIORITY during TX is asserted high after n MAC failures due to CCA (four CCA failures) or MAC ACK fails (four MAC TX and RX ACK failures).
- PRIORITY during TX remains asserted high until a successful MAC TX and RX ACK.

2.3.6. PWM

PWM REQUEST signal (shared REQUEST only)

- If REQUEST signal is NOT shared, PWM REQUEST signal must be set to “Disabled”.
- If REQUEST signal is shared, the REQUEST GPIO pin is used to arbitrate REQUEST between multiple EFR32 radios and a second GPIO is required to drive REQUEST||PWM. PWM REQUEST signal specifies the REQUEST||PWM GPIO.

PWM REQUEST signal level (shared REQUEST only)

- If PWM REQUEST signal is “Disabled”, then PWM REQUEST signal level selection is ignored. Else, PWM REQUEST signal is shared and implements open-drain or open-source I/O for multi-EFR32 radio applications.
- If active low, PWM REQUEST is open-drain, an external 1 k Ω \pm 5% pull-up is required, and PWM REQUEST GPIO pin is driven low (< V_{ol}) when REQUEST||PWM is asserted.
- If active high, PWM REQUEST is open-source, an external 1 k Ω \pm 5% pull-down is required, and PWM REQUEST GPIO pin is driven high (> V_{oh}) when REQUEST||PWM is asserted.

PWM REQUEST signal GPIO port and PWM REQUEST signal GPIO PIN

- To configure GPIO port and pin for the PWM REQUEST signal in the Component Editor, use the **SL_RAIL_UTIL_COEX_PWM_REQ** section of the configuration header.

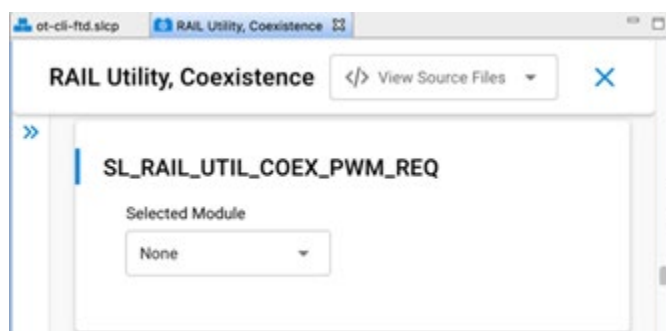

Enable PWM REQUEST at startup

- If enabled, PWM REQUEST is enabled at firmware startup as per specified period, duty-cycle, and priority.
- If not enabled, PWM REQUEST is enabled at firmware startup, but can be enabled via run-time API.

PWM REQUEST Period (0.5 ms)

Note: PWM REQUEST Period selection cannot be an integer sub-multiple of the Wi-Fi beacon or a significant number of consecutive Wi-Fi beacons may be missed, causing AP to collapse Wi-Fi network or STA to disassociate. Silicon Labs achieves <1% 802.15.4 message receive loss with PWM REQUEST set to 39 ms (or 78 half-ms) period, 20% duty-cycle, and high priority, which results in ~30% reduction in Wi-Fi TCP throughput over MCS0 to MCS7 and 20 or 40 MHz bandwidth.

- Sets PWM REQUEST Period from 5 ms (10) to 109 ms (218) in 0.5 ms steps.

PWM REQUEST Duty-Cycle (%)

Note: Large PWM REQUEST Duty-Cycle selection will substantially impact the Wi-Fi throughput as it reserved more time for 802.15.4 listening. Silicon Labs achieves <1% 802.15.4 message receive loss with PWM REQUEST set to 39 ms (or 78 half-ms) period, 20% duty-cycle, and high priority, which results in ~30% reduction in Wi-Fi TCP throughput over MCS0 to MCS7 and 20 or 40 MHz bandwidth.

- Sets PWM REQUEST Duty-Cycle from 1% to 95% in 1% steps.

Assert PRIORITY when PWM REQUEST asserted

- Sets PWM REQUEST PRIORITY to assert or not when PWM REQUEST asserts.

2.3.7. Radio Hold Off

RHO (Radio Hold Off) signal enabled

- If selected, RHO is mapped to GPIO pin and is used by PTA implementation.
- If not selected, RHO is not mapped to GPIO pin and RHO is always de-asserted.

RHO (Radio Hold Off) active high

- If selected, RHO is asserted when RHO GPIO pin is high ($> V_{ih}$).
- If not selected, RHO is asserted when RHO GPIO pin is low ($< V_{il}$).

RHO (Radio Hold Off) signal GPIO port and RHO (Radio Hold Off) signal GPIO pin

- Select RHO port and pin matching circuit board configuration.
- To configure GPIO port and pin for the RHO signal in the Component Editor, use the `SL_RAIL_UTIL_COEX_RHO` section of the configuration header.

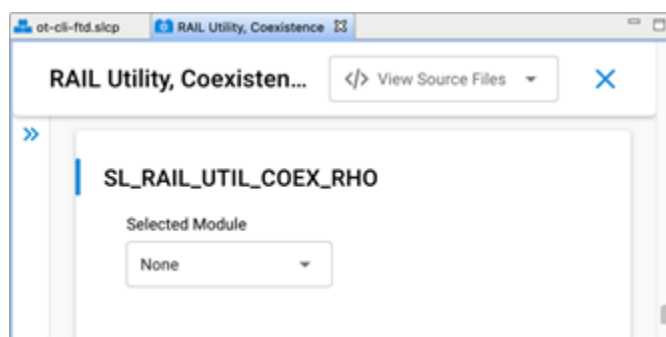

2.3.8. Directional PRIORITY

Enable Directional PRIORITY

- If True:
 - Directional PRIORITY signal is connected to the Wi-Fi PTA and multiplexes priority state and radio state information.
 - Allows the Wi-Fi PTA master to obtain radio state information from the EFR32 using the Directional PRIORITY signal.
 - When requesting network airtime, the EFR32 will assert a pulse on the Directional PRIORITY line depending on the requirement of that transaction and then switch to communicating the state of the radio on the same Directional PRIORITY line.
 - The Directional PRIORITY line is held low when the radio is in receive mode and is held high when the radio is in transmit mode.
 - The PRIORITY signal is not assigned a GPIO and is set to Disabled, has no physical connection to the Wi-Fi PTA and is used as Static PRIORITY input to the Directional PRIORITY logic block with the remaining PRIORITY signal configuration options described in section 2.3.5 PRIORITY applied.

Note: Hardware Configurator PRIORITY configuration fields are disabled and therefore not editable when Enable Directional PRIORITY is set to True. A workaround is to assign any GPIO to PRIORITY signal, edit the PRIORITY configuration options, and then set PRIORITY signal to Disabled.

- If False:
 - The Directional PRIORITY signal is not used or connected to the Wi-Fi PTA.
 - The PRIORITY signal is connected to the Wi-Fi PATA and operates as Static PRIORITY and is either high or low during REQUEST asserted for the transmit or receive operation.

Directional PRIORITY Timer (AppBuilder)

To configure the Directional PRIORITY Timer in AppBuilder:

1. Choose an unused Timer. TIMER1 is recommended for most EmberZNet PRO applications because TIMER0 is used by the IEEE 802.15.4 software stacks.

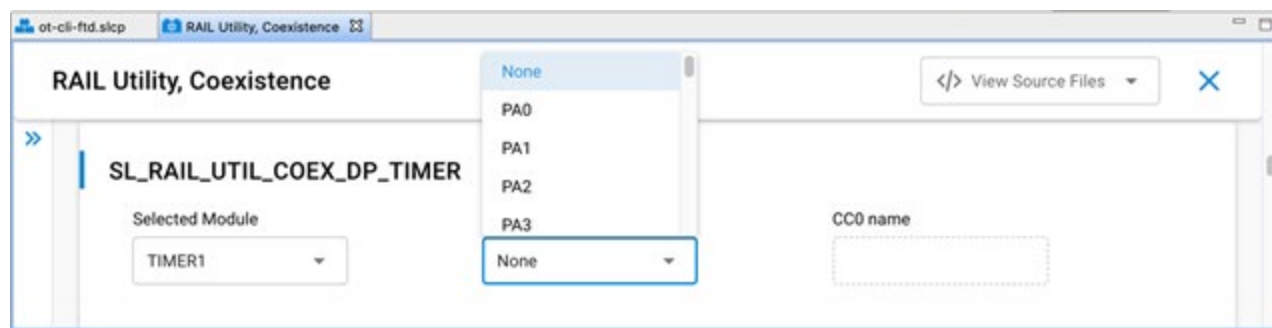

Note: For EFR32xG2x devices, the **Timer Compare / Capture Channel** is selected by the stack code. However, for EFR32xG1x devices, the stack code does not select the Timer Compare / Capture Channel pin.

Directional PRIORITY Pulse Width [0-255]

- Set to 20 (0x14) by default.
- Selects the hold time of the Directional PRIORITY RX Priority pulse in microseconds for a range of 1 to 255 depending on the requirement of the Wi-Fi PTA. Silicon Labs recommends the default of 20 microseconds for typical Wi-Fi PTA implementations.
- Set to 0 to bypass Directional PRIORITY.

Directional Priority PRS Channel

To configure the Directional PRIORITY PRS Channel:

1. Choose any group of four PRS channels (EFR32xG2x) or five PRS channels (EFR32xG1x) not currently used by the SDK stack software, other plugins, or custom code.
2. Assign the highest PRS channel number from this group to the Directional Priority PRS Channel value.

Note: The External FEM plugin is recommended to be enabled for monitoring the EFR32 radio TX activity and radio RX activity for the custom coexistence application test and development purposes and can use up to two additional PRS channels.

The SDK stack software automatically selects the preceding three PRS channels from the group.

Example: For EFR32xG2x, the designer selects PRS channel 2 as the Directional Priority PRS Channel value. From the designer's choice, the SDK stack software automatically selects PRS channel 1, PRS channel 0 and PRS channel 11 for use in the Directional Priority PRS Channel group. In this example, the SDK stack software automatically wraps around from the lowest PRS channel number to the highest PRS channel number until all three additional required PRS channels are assigned.

To configure the Directional PRIORITY PRS Channel in SSV5 Component Editor:

1. Use the **SL_RAIL_UTIL_COEX_DP_OUT** section of the configuration header.
2. Selecting the **Directional PRIORITY PRS Channel** displays the **PRS Channel Output Pin** configuration option.

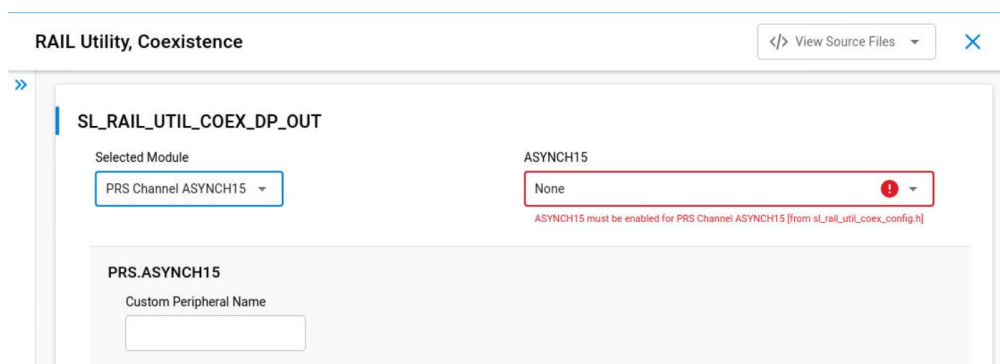

PRS Channel Output Pin

- Directional PRIORITY output GPIO pin
- Connects to the Wi-Fi PTA

Inverted Request PRS Channel

For EFR32xG2x Series 2 EFR32 devices, the **Inverted Request PRS Channel** is selected by the stack code. However, the stack code does not select the Inverted Request PRS Channel for EFR32xG1x Series 1 EFR32 devices.

- Choose any PRS channel not used by the SDK stack software, other plugins, custom code, or the Directional Priority PRS Channel option.
- For EFR32xG2x, leave this option Disabled.
- To configure the Inverted Request PRS Channel in the Component Editor, use the **SL_RAIL_UTIL_COEX_DP_REQUEST_INV** section of the configuration header.

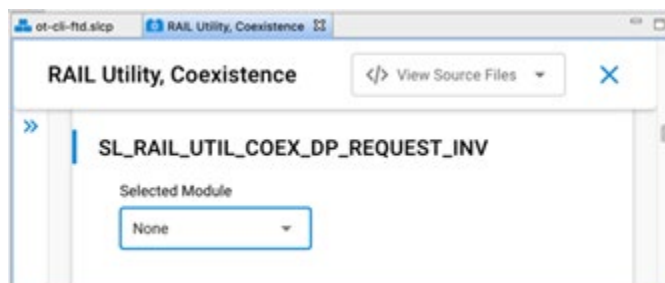

2.3.9. RX Active

RX active signal enabled

- If selected, MODEM_FRAME_DETECT is mapped to GPIO pin using a PRS channel.
- If not selected, MODEM_FRAME_DETECT is not mapped to GPIO pin and does not use a PRS channel.

RX active assert signal level

- Selecting High results in a high signal output when the receive packet is detected and a low output otherwise.
- Selecting Low results in a low signal output when the receive packet is detected and a high output otherwise.

RX active PRS channel

- Selects PRS channel used to assign MODEM_FRAME_DETECT signal to an output GPIO.

PRS channel output pin

- Choose the GPIO to output the MODEM_FRAME_DETECT signal.

Notes:

1. The RX Active feature passes the 802.15.4 MODEM_FRAME_DETECT radio signal to a GPIO pin using a PRS channel. In AppBuilder, the GPIO port, pin, and assert level are selected in Hardware Configurator. The signal output from the selected GPIO is then used to drive the RHO pin on other radios.
2. To configure the GPIO port and pin in the Component Editor use the **SL_RAIL_UTIL_COEX_RX_ACTIVE** section of the configuration header as shown in the following figure.



This completes the Coexistence Configurator setup. In AppBuilder, complete other AppBuilder application setups and generate. The coexistence configuration is saved in the application's .h file. When working in the Component Editor, the configurations are automatically saved and the generate step is not required. The coexistence configurations are saved in `sl_rail_util_coex_config.h` and `sl_rail_util_coex_common_config.h`

2.3.10. Signal Identifier (EFR32xG24)

Enable coexistence IEEE802.15.4 signal identifier

- If selected, the signal identifier feature is enabled to trigger REQUEST when an 802.15.4 signal is detected.
- If not selected, the signal identifier feature is not enabled.

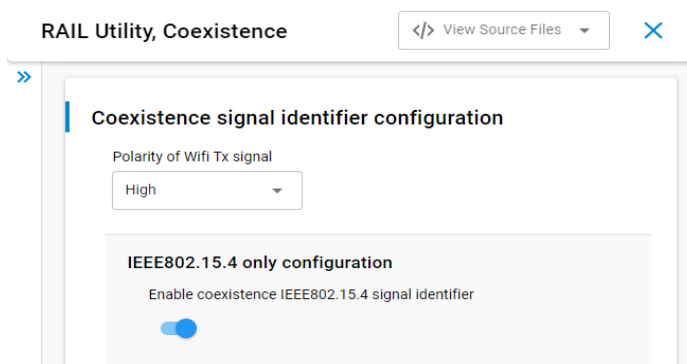

Polarity of Wi-Fi TX signal

- If set to high, Wi-Fi TX PAEN is asserted when the GPIO pin is high ($> V_{ih}$).
- If set to low, Wi-Fi TX PAEN is asserted when the GPIO pin is low ($< V_{il}$).

Wi-Fi TX signal GPIO port and GPIO pin

- Select Wi-Fi TX port and pin matching circuit board configuration.
- To configure GPIO port and pin for the Wi-Fi TX signal in the Component Editor, use the `SL_RAIL_UTIL_COEX_WIFI_TX` section of the configuration header.
- If configured, signal detector will be restarted when Wi-Fi TX is de-asserted

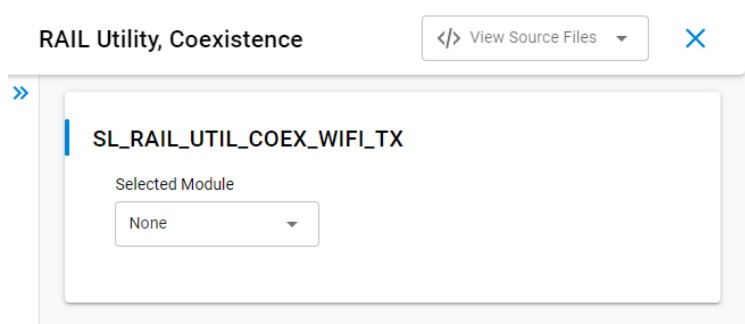

2.4. Run-Time PTA Re-configuration

The following PTA options, which can be configured at compile time, can also be re-configured at run-time:

- Receive retry timeout (milliseconds) [0-255]
- Disable ACKing when GRANT de-asserted, RHO asserted, or REQUEST not secured (shared REQUEST only)
- Abort transmission mid packet if GRANT is lost
- TX high PRIORITY
- RX high PRIORITY
- REQUEST high PRIORITY on receive retry

- Receive retry REQUEST enabled
- RHO (Radio Hold Off) signal enabled
- CCA/GRANT TX PRIORITY Escalation Threshold
- MAC Fail TX PRIORITY Escalation Threshold
- PWM REQUEST

The following PTA options cannot be configured during compile time and can only be configured at run-time:

- Enable or disable PTA
- Disable REQUEST (force holdoff)
- Synch MAC to GRANT (MAC holdoff)
- REQUEST/PRIORITY Assert (Preamble/Synch or Address Detection)

For descriptions of the above PTA options fields, see [2.4.1 PTA Option Descriptions](#).

For OpenThread using the Component Editor, the Synch MAC to GRANT (MAC holdoff) option has been added as a configuration option under the **OpenThread Coexistence** component so you can configure it at compile time. This requires that you have already installed the **Coexistence** component as a part of your project.

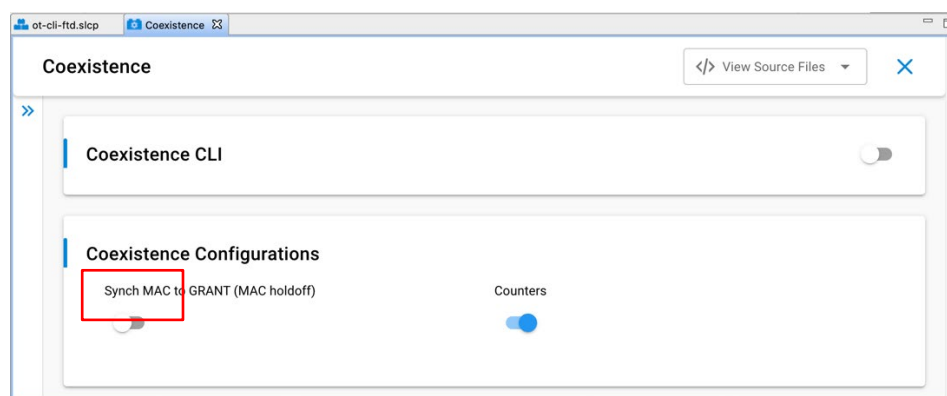

Note: For Silicon Labs OpenThread SDK releases prior to 1.2.0.0, the Synch MAC to GRANT (MAC holdoff) configuration option is available under the **OpenThread Platform Abstraction** component.

2.4.1. PTA Option Descriptions

The descriptions of the above PTA options fields follow.

Disable REQUEST (force holdoff)

- If not set (default), REQUEST operates per the description in *UG103.17: Wi-Fi® Coexistence Fundamentals*.
- If set, REQUEST stays disabled, effectively halting all radio TX/RX functions.

Synch MAC to GRANT (MAC holdoff)

- If not set (default), Synch MAC to GRANT is disabled for 802.15.4-compliant random MAC delays.
- If set, MAC CCA/TX is delayed until GRANT is asserted, synching all TX operations with GRANT.
- Synch MAC to GRANT is not strictly 802.15.4 compliant as it prevents random MAC delay execution.
- Synch MAC to GRANT should only be enabled during known, higher priority, Wi-Fi or BT interfering activity and disabled as soon as such activity completes.

REQUEST/PRIORITY Assert (Preamble/Synch or Address Detection)

- If set to 0 (00b, default and recommended):
- REQUEST during RX is asserted at Preamble/Synch.
- PRIORITY during RX is asserted at Preamble/Synch, as per “RX high PRIORITY” setting.
- If set to 1 (01b) or 3 (11b) [requires “RX high PRIORITY” set to high priority (1)]:

- REQUEST during RX is asserted at Address Detection (for this radio).
- PRIORITY during RX is asserted at Address Detection (for this radio).
 - If set to 2 (10b) [requires “RX high PRIORITY” set to low priority (0)]:
- REQUEST during RX is asserted at Preamble/Synch.
- PRIORITY during RX is asserted at Address Detection (for this radio).

Notes:

1. For Zigbee, the API function calls for re-configuring coexistence PTA vary based on SoC or EZSP application.
2. For OpenThread, the API functions for re-configuring coexistence PTA is currently supported on SoC only.
3. For Run-Time API options not supported by selected EmberZNet PRO or OpenThread releases, the corresponding ptaOptions bit fields are RESERVED and must be written to 0.

2.4.2. SoC Application API (using AppBuilder for Zigbee)

To avoid warnings and errors at build time associated with the API function calls in this section, add the following # include into the application's <xxx>-callbacks.c file.

```
#include "platform/radio/rail_lib/plugin/coexistence/protocol/ieee802154/coexistence-802154.h";
```

The following two SoC API function calls enable and disable the PTA at run-time:

```
bool halPtaIsEnabled(void);
EmberStatus halPtaSetEnable(bool enabled);
```

The following two SoC API function calls re-configure the PTA at run-time:

```
HalPtaOptions halPtaGetOptions(void);
EmberStatus halPtaSetOptions(HalPtaOptions options);
```

Where HalPtaOptions is a uint32_t with the following bitmap definition.

PTA Feature	Bit Position	Size (bits)
Receive retry timeout (milliseconds) [0-255]	0	8
Disable ACKing when GRANT de-asserted, RHO asserted, or REQUEST not secured (shared REQUEST only)	8	1
Abort transmission mid packet if GRANT is lost	9	1
TX high PRIORITY	10	1
RX high PRIORITY	11	1
REQUEST high PRIORITY on receive retry	12	1
RHO (Radio Hold Off) signal enabled	14	1
Reserved (Reserved bits MUST be written 0)	15	1
Disable REQUEST (force holdoff)	16	1
Synch MAC to GRANT (MAC holdoff)	17	1
REQUEST/PRIORITY Assert (Preamble/Synch or Address Detection)	18	2
CCA/GRANT TX PRIORITY Escalation Threshold	20	3
Reserved (Reserved bits MUST be written 0)	23	2
MAC Fail TX PRIORITY Escalation Threshold	25	2
Reserved (Reserved bits MUST be written 0)	27	5

The following two SoC API function calls re-configure the PWM REQUEST at run-time:

```
const HalPtaPwmArgs_t *halPtaGetRequestPwmArgs(void);
EmberStatus halPtaSetRequestPwm(halPtaReq_t ptaReq, halPtaCb_t ptaCb, uint8_t dutyCycle, uint8_t periodHalfMs);
```

Where:

```
typedef struct HalPtaPwmArgs {
    halPtaReq_t req;
    uint8_t dutyCycle;
    uint8_t periodHalfMs;
} HalPtaPwmArgs_t;
```

and

```
ptaReq/req:    0x00 => PWM REQUEST disabled
               0x80 => PWM REQUEST enabled at low priority
               0x82 => PWM REQUEST enabled at high priority
ptaCb:        NULL
dutyCycle:    PWM REQUEST duty-cycle from 5% to 95% in 1% steps
periodHalfMs: PWM REQUEST Period from 5 ms (10) to 109 ms (218) in 0.5 ms steps
```

The following two SoC API function calls re-configure the Directional PRIORITY at run-time:

```
dp_pulse = halPtaGetDirectionalPriorityPulseWidth();
halPtaSetDirectionalPriorityPulseWidth(dp_pulse);
```

Where:

```
uint8_t dp_pulse: Pulse width (0 to disable, 1-255µs)
```

When multiple EFR32s are connected to Wi-Fi/PTA, TX PRIORITY Escalation can be controlled at run-time via “CCA/GRANT TX PRIORITY Escalation Threshold” and “MAC Fail TX PRIORITY Escalation Threshold” fields of PTA Options. When using this feature, “TX high PRIORITY” field must be set to 0 to avoid driving PRIORITY high on all TX messages.

2.4.3. SoC Application API (using Component Editor for Zigbee and OpenThread)

To avoid warnings and errors at build time associated with the API function calls in this section, add the following # include into the application’s <xxx>-callbacks.c file.

```
#include "platform/radio/rail_lib/plugin/coexistence/protocol/ieee802154_uc/coexistence-802154.h";
```

The following two SoC API function calls enable and disable the PTA at run-time:

```
bool sl_rail_util_coex_is_enabled(void);
sl_status_t sl_rail_util_coex_set_enable(bool enabled);
```

The following two SoC API function calls re-configure the PTA at run-time:

```
sl_rail_util_coex_options_t sl_rail_util_coex_get_options(void);
sl_status_t sl_rail_util_coex_set_options(sl_rail_util_coex_options_t options);
```

Where sl_rail_util_coex_options_t is a uint32_t with the following bitmap definition.

PTA Feature	Bit Position	Size (bits)
Receive retry timeout (milliseconds) [0-255]	0	8
Disable ACKing when GRANT de-asserted, RHO asserted, or REQUEST not secured (shared REQUEST only)	8	1
Abort transmission mid packet if GRANT is lost	9	1
TX high PRIORITY	10	1
RX high PRIORITY	11	1
REQUEST high PRIORITY on receive retry	12	1
RHO (Radio Hold Off) signal enabled	14	1
Reserved (Reserved bits MUST be written 0)	15	1
Disable REQUEST (force holdoff)	16	1
Synch MAC to GRANT (MAC holdoff)	17	1
REQUEST/PRIORITY Assert (Preamble/Synch or Address Detection)	18	2

PTA Feature	Bit Position	Size (bits)
CCA/GRANT TX PRIORITY Escalation Threshold	20	3
Reserved (Reserved bits MUST be written 0)	23	2
MAC Fail TX PRIORITY Escalation Threshold	25	2
Reserved (Reserved bits MUST be written 0)	27	5

The following two SoC API function calls re-configure the PWM REQUEST at run-time:

```
const sl_rail_util_coex_pwm_args_t *sl_rail_util_coex_get_request_pwm_args(void);
sl_status_t sl_rail_util_coex_set_request_pwm (sl_rail_util_coex_req_t ptaReq,
sl_rail_util_coex_cb_t ptaCb, uint8_t dutyCycle, uint8_t periodHalfMs);
```

Where:

```
typedef struct sl_rail_util_coex_pwm_args {
    COEX_Req_t req;
    uint8_t dutyCycle;
    uint8_t periodHalfMs;
} sl_rail_util_coex_pwm_args_t;
```

and

```
ptaReq/req:    0x00 => PWM REQUEST disabled
               0x80 => PWM REQUEST enabled at low priority
               0x82 => PWM REQUEST enabled at high priority
ptaCb:        NULL
dutyCycle:    PWM REQUEST duty-cycle from 5% to 95% in 1% steps
periodHalfMs: PWM REQUEST Period from 5 ms (10) to 109 ms (218) in 0.5 ms steps
```

The following two SoC API function calls re-configure the Directional PRIORITY at run-time:

```
uint8_t sl_rail_util_coex_get_directional_priority_pulse_width(void);
sl_status_t sl_rail_util_coex_set_directional_priority_pulse_width(uint8_t pulseWidthUs);
```

Where:

```
pulseWidthUs: Pulse width (0 to disable, 1-255µs)
```

When multiple EFR32s are connected to Wi-Fi/PTA, TX PRIORITY Escalation can be controlled at run-time via "CCA/GRANT TX PRIORITY Escalation Threshold" and "MAC Fail TX PRIORITY Escalation Threshold" fields of PTA Options. When using this feature, "TX high PRIORITY" field must be set to 0 to avoid driving PRIORITY high on all TX messages.

2.4.4. Zigbee Network Coprocessor Application using EZSP API

The following two EZSP (EmberZNet Serial Protocol) API function calls enable and disable the PTA, re-configure the PTA, and reconfigure the PWM REQUEST at run-time:

```
EzspStatus ezspGetValue(EzspValueId valueId, uint8_t *valueLength, uint8_t *value);
EzspStatus ezspSetValue(EzspValueId valueId, uint8_t valueLength, uint8_t *value);
```

Where valueId and valueLength have the following PTA related options.

EZSP Value ID	Value	Length (bytes)	Description
EZSP_VALUE_ENABLE_PTA	0x31	1	Enable (1) or disable (0) packet traffic arbitration.
EZSP_VALUE_PTA_OPTIONS	0x32	4	Set packet traffic arbitration (PTA) configuration options.
EZSP_VALUE_PTA_PWM_OPTIONS	0x35	3	Configure PWM REQUEST options.

EZSP_VALUE_PTA_DIRECTIONAL_PRIORITY_PULSE_WIDTH	0x36	1	Pulse width (0 to disable, 1-255µs)
---	------	---	-------------------------------------

Where PTA configuration options are a `uint32_t` with the following bitmap definition.

PTA Feature	Bit Position	Size (bits)
Receive retry timeout (milliseconds) [0-255]	0	8
Disable ACKing when GRANT de-asserted, RHO asserted, or REQUEST not secured (shared REQUEST only)	8	1
Abort transmission mid packet if GRANT is lost	9	1
TX high PRIORITY	10	1
RX high PRIORITY	11	1
REQUEST high PRIORITY on receive retry	12	1
Receive retry REQUEST enabled	13	1
RHO (Radio Hold Off) signal enabled	14	1
Reserved (Reserved bits MUST be written 0)	15	1
Disable REQUEST (force holdoff)	16	1
Synch MAC to GRANT (MAC holdoff)	17	1
REQUEST/PRIORITY Assert (Preamble/Synch or Address Detection)	18	2
CCA/GRANT TX PRIORITY Escalation Threshold (requires additional application code)	20	3
Reserved (Reserved bits MUST be written 0)	23	2
MAC Fail TX PRIORITY Escalation Threshold (requires additional application code)	25	2
Reserved (Reserved bits MUST be written 0)	27	5

PWM REQUEST configuration options is a three-byte `uint8_t` array:

```
{uint8_t ptaReq, uint8_t dutyCycle, uint8_t periodHalfMs}
```

Where:

- `ptaReq`: 0x00 => PWM REQUEST disabled
 0x80 => PWM REQUEST enabled at low priority
 0x82 => PWM REQUEST enabled at high priority
- `dutyCycle`: PWM REQUEST duty-cycle from 5% to 95% in 1% steps
- `periodHalfMs`: PWM REQUEST Period from 5 ms (10) to 109 ms (218) in 0.5 ms steps

and the Directional PRIORITY parameter is:

```
uint8_t dp_pulse: Pulse width (0 to disable, 1-255µs)
```

When multiple EFR32s are connected to Wi-Fi/PTA, TX PRIORITY Escalation can be controlled at run-time via "CCA/GRANT TX PRIORITY Escalation Threshold" and "MAC Fail TX PRIORITY Escalation Threshold" fields of PTA Options. When using this feature, "TX high PRIORITY" field must be set to 0 to avoid driving PRIORITY high on all TX messages.

2.5. Coexistence Configuration Setup Examples for Different Wi-Fi/PTA Applications (Zigbee)

Example 1: Configure EFR32 PTA support to operate as single EFR32 with typical 3-Wire Wi-Fi/PTA

- Single EFR32 radio
- RHO unused
- REQUEST unshared, active high, PC10
- Compatible 3-Wire Wi-Fi PTA devices sometimes refer to this signal as RF_ACTIVE or BT_ACTIVE (active high).
- GRANT, active low, PF3

- Compatible 3-Wire Wi-Fi PTA devices sometimes refer to this signal as WLAN_DENY (deny is active high, making grant active low).
- PRIORITY, active high RX and TX (escalation disabled), PD12
- Compatible 3-Wire W-Fi PTA devices sometimes refer to this signal as RF_STATUS or BT_STATUS (active high).

Note: PRIORITY is static, not directional. If operated with a 3-Wire PTA expecting directional:

- Static high PRIORITY is interpreted as high PRIORITY and always in TX mode, regardless of actual TX or RX.
- Static low PRIORITY is interpreted as low PRIORITY and always in RX mode, regardless of actual TX or RX.
- PWM REQUEST disabled.
- Other options enabled to maximize 802.15.4 performance:
 - 802.15.4 RX and TX both at high priority
 - Receive retry REQUEST enabled with 16ms timeout and high priority.
 - Enabled ACKing when GRANT de-asserted.

COEX	
Property	Value
Owned by	
REQUEST	
REQUEST signal	PC10
REQUEST assert signal level	High
Enable REQUEST shared mode	False
Max REQUEST backoff mask [0-255]	15 (0xF)
Assert time between REQUEST and RX/TX start (us) [BLE only]	500 (0x1F4)
Enable REQUEST receive retry	True
REQUEST receive retry timeout(ms)	16 (0x10)
REQUEST receive retry assert PRIORITY	True
GRANT	
GRANT signal	PF3
GRANT assert signal level	Low
Abort transmission mid-packet if GRANT is lost	False
Disable ACKing when GRANT deasserted, RHO asserted, or REQUEST not secured (shared REQUEST only)	False
PRIORITY	
PRIORITY signal	PD12
PRIORITY assert signal level	High
Enable PRIORITY shared mode	False
Assert PRIORITY when transmitting packet	True
Assert PRIORITY when receiving packet	True
Include TX PRIORITY Escalation	False
CCA/GRANT TX PRIORITY Escalation Threshold	4 (0x4)
MAC Fail TX PRIORITY Escalation threshold	0 (0x0)
PWM	

Figure 2.3. EFR32 PTA Support Configured to Operate as Single EFR32 with Typical 3-Wire W-Fi PTA using AppBuilder for Zigbee

The logic analyzer capture in the following figure shows the PTA interface, Wi-Fi radio state, and EFR32 radio state for an EFR32 radio configured for typical 3-Wire Wi-Fi/PTA.

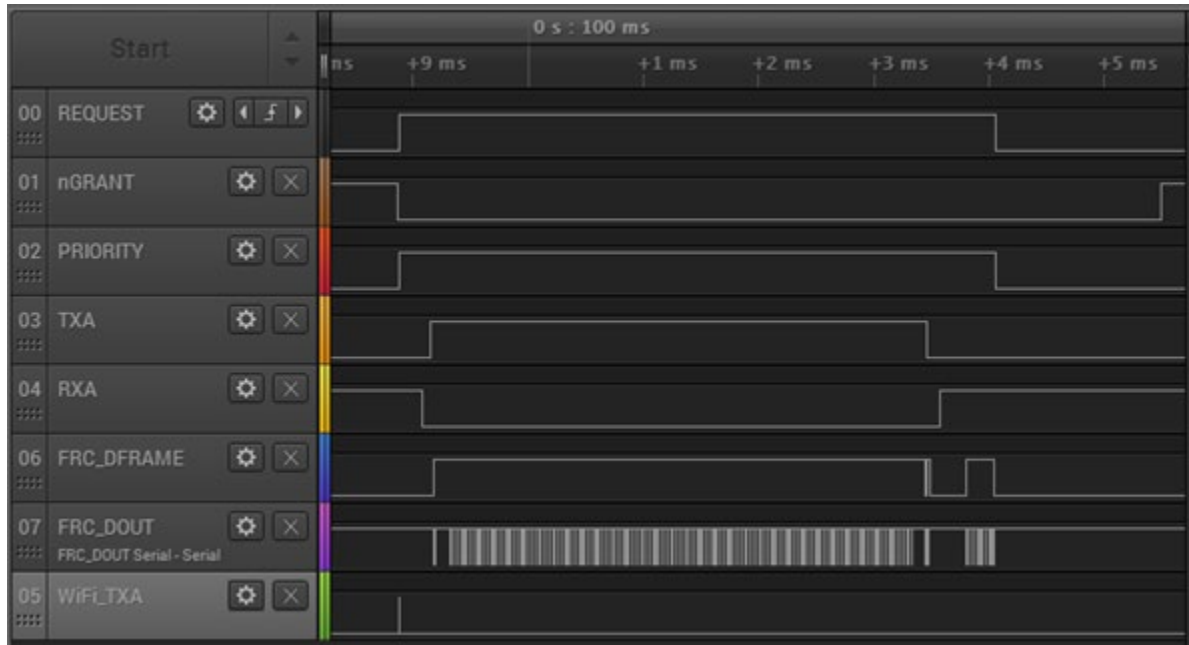

Figure 2.4. Example 802.15.4 TX for Single EFR32 typical 3-Wire Wi-Fi/PTA Logic Analyzer Capture

Where:

- **REQUEST:** active high, push-pull REQUEST output
- **nGRANT:** active low GRANT input
- **PRIORITY:** active high PRIORITY output
- **TXA:** EFR32 FEM TX Active control signal (configured via FEM Control plugin)
- **RXA:** EFR32 FEM RX Active control signal (configured via FEM Control plugin)
- **FRC_DFRAME:** EFR32 Frame Control Data Frame signal (packet trace frame/synch)
- **FRC_DOUT:** EFR32 Frame Control Data Out signal (packet trace data)
- **WiFi_TXA:** Wi-Fi TX Active signal

This logic analyzer sequence shows:

1. Wi-Fi starts a transmit but is immediately pre-empted (WiFi_TXA pulse) by higher priority 802.15.4 transmit asserting REQUEST and PRIORITY.
2. GRANT is asserted by Wi-Fi/PTA.
3. EFR32 radio completes CCA and CCA passes, and GRANT is asserted.
4. EFR32 radio proceeds with transmit (RXA de-asserts, followed by TXA assert).
5. After transmitting, EFR32 waits for ACK (TXA de-asserts, followed by RXA assert).
6. EFR32 receives ACK (second FRC_DFRAME pulse). <= 802.15.4 TX message successfully completed
7. EFR32 de-asserts PRIORITY and REQUEST.
8. Wi-Fi/PTA de-asserts GRANT.

Example 2: Configure EFR32 PTA support to operate with multi-radio 2-Wire Wi-Fi/PTA with active-low REQUEST

- Multiple EFR32 radios (external 1 kΩ ±5% pull-up required on REQUEST)
- RHO unused
- REQUEST shared, active Low, PC10
- GRANT, active Low, PF3
- PRIORITY unused
- PWM REQUEST disabled
- Other option settings to maximize 802.15.4 performance:
- Enable REQUEST to receive retry with 16ms timeout.
- Do not Disable (Enable) ACKing when GRANT is de-asserted RHO asserted, REQUEST not secured.

REQUEST	
REQUEST signal	PC11
REQUEST assert signal level	Low
Enable REQUEST shared mode	True
Max REQUEST backoff mask [0-255]	15 (0xF)
Assert time between REQUEST and RX/TX start (us) [BLE only]	500 (0x1F4)
Enable REQUEST receive retry	True
REQUEST receive retry timeout(ms)	16 (0x10)
REQUEST receive retry assert PRIORITY	True
GRANT	
GRANT signal	PF3
GRANT assert signal level	Low
Abort transmission mid-packet if GRANT is lost	False
Disable ACKing when GRANT deasserted, RHO asserted, or REQUEST not secured (shared REQUEST only)	False
PRIORITY	

Figure 2.5. EFR32 PTA Support Configures to Operate with Multi-radio 2-Wire Wi-Fi/PTA with active-low REQUEST using AppBuilder

The logic analyzer capture in the following figure shows the PTA interface, Wi-Fi radio state, and EFR32 radio state for an EFR32 radio configured for multi-radio 2-Wire PTA with active-low REQUEST:

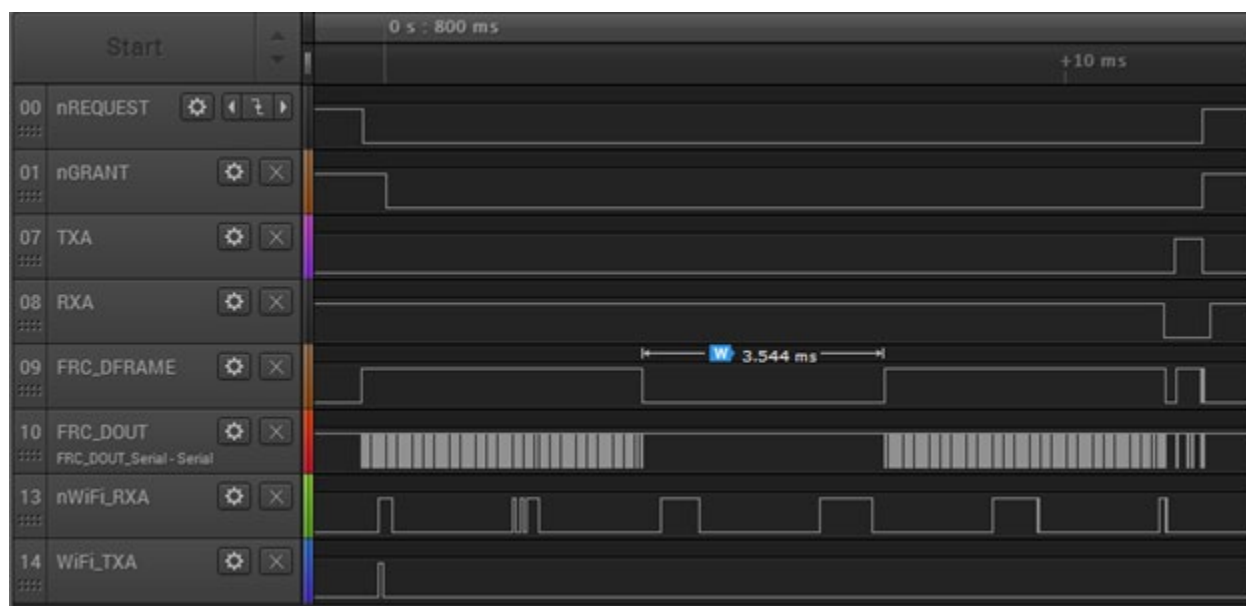

Figure 2.6. Example 802.15.4 RX for Multi-EFR32 2-Wire Wi-Fi/PTA with active-low REQUEST Logic Analyzer Capture

Where:

- **nREQUEST**: active low, shared (open-drain) REQUEST input/output
- **nGRANT**: active low GRANT input
- **TXA**: EFR32 FEM TX Active control signal (configured via FEM Control plugin)
- **RXA**: EFR32 FEM RX Active control signal (configured via FEM Control plugin)
- **FRC_DFRAME**: EFR32 Frame Control Data Frame signal (packet trace frame/synch)
- **FRC_DOUT**: EFR32 Frame Control Data Out signal (packet trace data)
- **nWiFi_RXA**: Wi-Fi RX Active signal
- **WiFi_TXA**: Wi-Fi TX Active signal

This logic analyzer sequence shows:

1. 802.15.4 packet is detected (FRC_DFRAME asserted) while Wi-Fi is receiving a packet (nWiFi_RXA asserted).
2. Shared REQUEST signal is tested and found not asserted by another EFR32 radio, so receiving EFR32 radio asserts REQUEST.
3. Wi-Fi ACK is transmitted (WiFi-TXA asserted) during 802.15.4 receive (no Wi-Fi TX pre-emption or higher priority Wi-Fi activity).
4. After Wi-Fi ACK completes, GRANT is asserted by Wi-Fi/PTA.
5. 802.15.4 receive is completed but CRC failed as packet was corrupted by co-located Wi-Fi ACK transmit during receive.
6. Since PTA configured with *Receive retry REQUEST enabled* using 16ms timeout, REQUEST is held up to 16ms for 802.15.4 retry with 2.4 GHz quiet (Wi-Fi held off).
7. Wi-Fi continues to receive packets (nWiFi_RXA asserts) but does not ACK while 802.15.4 radio has GRANT.
8. After 3.5 ms gap for end-node ACK timeout and MAC random delay, the 802.15.4 retry packet arrives and is received without error.
9. 802.15 ACK is transmitted (TXA asserted). <= *802.15.4 RX message successfully completed*.
10. After 802.15.4 ACK completes, REQUEST is de-asserted, followed by GRANT de-assert.

Example 3: Configure EFR32 PTA support to operate with multi-radio typical 3-Wire Wi-Fi/PTA

- Multiple EFR32 radios (external 1 kΩ ±5% pull-down required on REQUEST and external 1 kΩ ±5% pull-down required on PRIORITY)
- RHO unused
- REQUEST shared, active High, PC10
- GRANT, active Low, PF3
- PRIORITY shared, active high RX and TX (escalation disabled), PD12
- PWM REQUEST disabled
- Other option settings to maximize 802.15.4 performance:
- Enable REQUEST to receive retry with 16ms timeout.
- Do not Disable (Enable) ACKing when GRANT is de-asserted RHO asserted, REQUEST not secured.

REQUEST	
REQUEST signal	PC11
REQUEST assert signal level	High
Enable REQUEST shared mode	True
Max REQUEST backoff mask [0-255]	15 (0xF)
Assert time between REQUEST and RX/TX start (us) [BLE only]	500 (0x1F4)
Enable REQUEST receive retry	True
REQUEST receive retry timeout(ms)	16 (0x10)
REQUEST receive retry assert PRIORITY	True
GRANT	
GRANT signal	PF3
GRANT assert signal level	Low
Abort transmission mid-packet if GRANT is lost	False
Disable ACKing when GRANT deasserted, RHO asserted, or REQUEST not secured (shared REQUEST only)	False
PRIORITY	
PRIORITY signal	PD12
PRIORITY assert signal level	High
Enable PRIORITY shared mode	True
Assert PRIORITY when transmitting packet	True
Assert PRIORITY when receiving packet	True
Include TX PRIORITY Escalation	False
CCA/GRANT TX PRIORITY Escalation Threshold	4 (0x4)
MAC Fail TX PRIORITY Escalation threshold	0 (0x0)

3. Coexistence CLI Commands

The Coexistence CLI commands can support run-time console control of PTA enable/disable, PTA run-time configuration (ptaOptions), and PTA debug counters. These custom CLI commands are not only useful in manual testing of various coexistence configurations, but also support run-time reconfiguration.

3.1. Coexistence CLI Commands (using AppBuilder for Zigbee)

For Zigbee, the Coexistence CLI commands are currently supported in both Host and SoC applications.

The following figure shows a partial listing of the coexistence plugin commands. For more details about the CLI commands and parameters, refer to **coexistence-cli.c**.

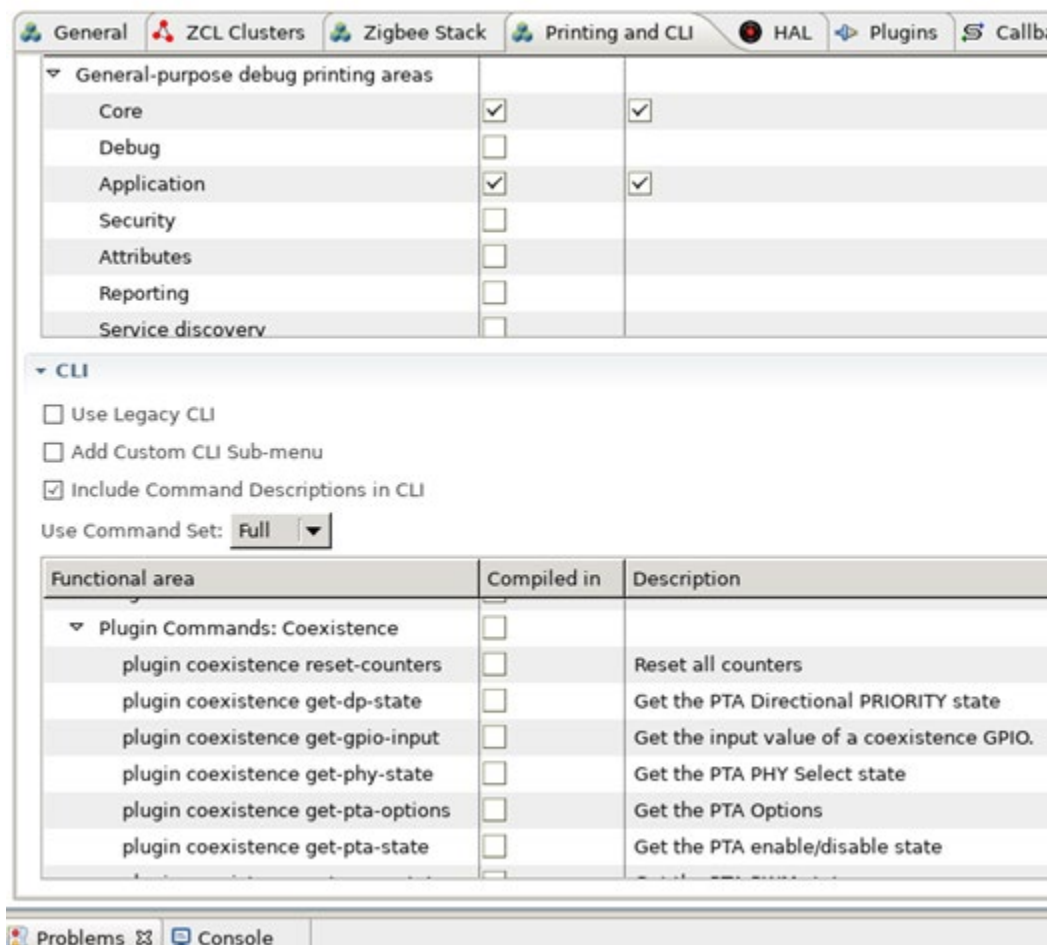
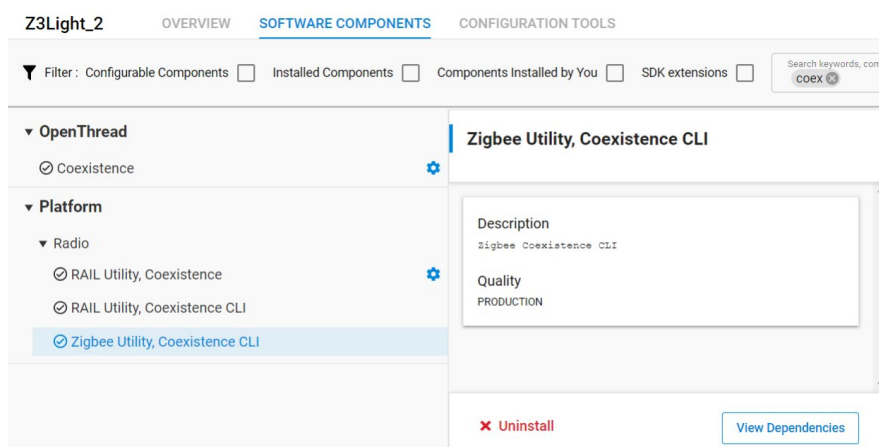

Figure 3.1. Coexistence CLI Console Commands (partial listing)

3.2. Coexistence CLI Commands (using Component Editor for Zigbee and OpenThread)

For Zigbee, support for Coexistence CLI is enabled by installing the **Zigbee Utility, Coexistence CLI** component under **Platform > Radio components**.



For OpenThread, support for Coexistence CLI is:

- Enabled by default for all applications.
- Available as a configuration option on the **OpenThread Coexistence** component.
- Requires that you have already installed the **OpenThread CLI** and the **Coexistence** components in your project.

For Silicon Labs OpenThread SDK releases prior to 1.2.0.0, the Coexistence CLI commands are:

- Supported in SoC applications only and,
- Available as a configuration option on the OpenThread CLI component.

The complete list of support commands is summarized in the following table. For more details about the CLI commands and parameters, refer to `sl_zigbee_coexistence_cli.c` for Zigbee and `coexistence_cli.c` for OpenThread.

Table 3.1. Coexistence CLI Commands

Command	Command Description	API Function
coexistence get-dp-state	Returns the Directional PRIORITY state along with pulse width (μ s).	sl_rail_util_coex_get_directional_priority_pulse_width
coexistence set-dp-state	Set Directional PRIORITY state.	sl_rail_util_coex_set_directional_priority_pulse_width
coexistence get-gpio-input	Returns GPIO Input override from console.	sl_rail_util_coex_get_gpio_input_override
coexistence set-gpio-input	Sets GPIO Input override from console.	sl_rail_util_coex_set_gpio_input_override
coexistence get-phy-state	Returns PHY select state.	sl_rail_util_coex_get_phy_select_timeout
coexistence set-phy-state	Sets PHY select timeout.	sl_rail_util_coex_set_phy_select_timeout
coexistence get-pta-options	Returns ptaOptions.	sl_rail_util_coex_get_options
coexistence set-pta-options	Sets ptaOptions.	sl_rail_util_coex_set_options
coexistence get-pta-state	Returns PTA state.	sl_rail_util_coex_is_enabled
coexistence set-pta-state	Sets PTA state.	sl_rail_util_coex_set_enable
coexistence get-pwm-state	Returns PWM state from console with period and duty cycle.	sl_rail_util_coex_get_request_pwm_args
coexistence set-pwm-state	Sets PWM State.	sl_rail_util_coex_get_request_pwm_args
coexistence reset-counters	Clears coex counters.	efr32RadioClearCoexCounters
coexistence get-counters	Returns the PTA-specific debug counter values.	efr32RadioGetCoexCounters

Note: For Zigbee, the coexistence CLI command to get the PTA specific debug counters is *coexistence result-counters*.

To disable Coexistence CLI support:

1. Open the configuration options of the OpenThread Coexistence component.

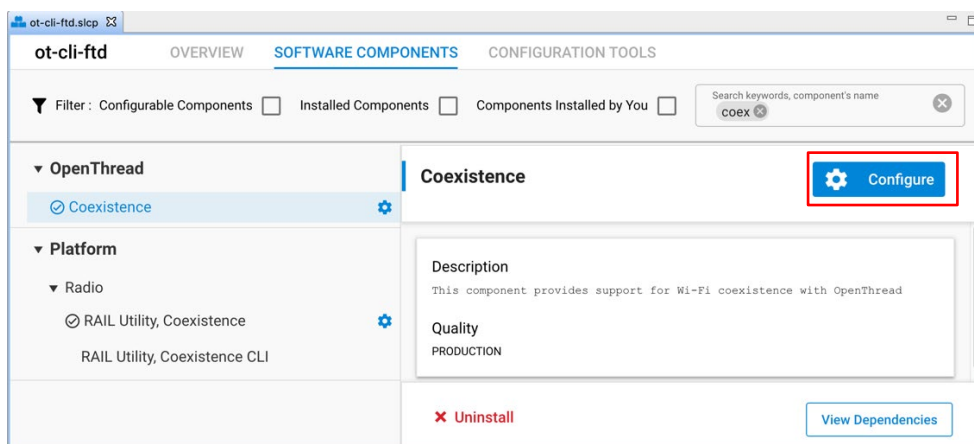

2. Disable the option.

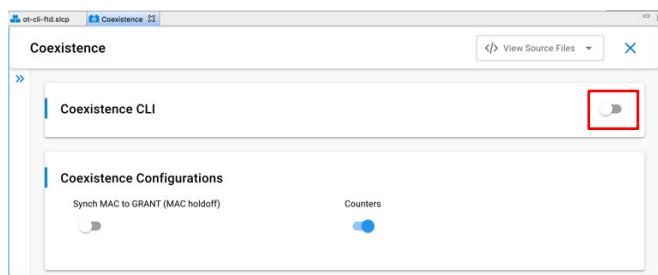

Note: For Silicon Labs OpenThread SDK releases prior to 1.2.0.0, disable the Coexistence CLI configuration option on the OpenThread CLI component.

3.3. PTA-specific Debug Counters

For Zigbee, MAC and APS stack counters are documented in the stack API documentation and can also be accessed via CLI. The following table describes the six coexistence PTA-specific debug counters.

Table 3.2. PTA-specific Debug Counters (Zigbee)

Counter Index	Meaning
EMBER_COUNTER_PTA_LO_PRI_REQUESTED	Occurrences of REQUEST asserted with low priority.
EMBER_COUNTER_PTA_HI_PRI_REQUESTED	Occurrences of REQUEST asserted with high priority.
EMBER_COUNTER_PTA_LO_PRI_DENIED	Occurrences of GRANT denied with low priority REQUEST.
EMBER_COUNTER_PTA_HI_PRI_DENIED	Occurrences of GRANT denied with high priority REQUEST.
EMBER_COUNTER_PTA_LO_PRI_TX_ABORTED	Occurrences of TX aborted by GRANT de-asserted with low priority REQUEST.
EMBER_COUNTER_PTA_HI_PRI_TX_ABORTED	Occurrences of TX aborted by GRANT de-asserted with high priority REQUEST.

For OpenThread, support for coexistence PTA-specific debug counters are:

- Enabled by default.
- Available as a configuration option on the **OpenThread Coexistence** component.
- Requires that you have already installed the **OpenThread Coexistence** component in your project.

The following table describes the six coexistence PTA-specific debug counters for OpenThread.

Table 3-1. PTA-specific Debug Counters (OpenThread)

Counter Index	Meaning
SL_RAIL_UTIL_COEX_EVENT_LO_PRI_REQUESTED	Occurrences of REQUEST asserted with low priority.
SL_RAIL_UTIL_COEX_EVENT_HI_PRI_REQUESTED	Occurrences of REQUEST asserted with high priority.
SL_RAIL_UTIL_COEX_EVENT_LO_PRI_DENIED	Occurrences of GRANT denied with low priority REQUEST.
SL_RAIL_UTIL_COEX_EVENT_HI_PRI_DENIED	Occurrences of GRANT denied with high priority REQUEST.
SL_RAIL_UTIL_COEX_EVENT_LO_PRI_TX_ABORTED	Occurrences of TX aborted by GRANT de-asserted with low priority REQUEST.
SL_RAIL_UTIL_COEX_EVENT_HI_PRI_TX_ABORTED	Occurrences of TX aborted by GRANT de-asserted with high priority REQUEST.

3.3.1. OpenThread specific Debug Counters

OpenThread offers several coexistence debug counters to help with development. These are enabled by default when **OpenThread Coexistence** component is pulled into an application.

The following table describes OpenThread specific debug counters.

Table 3-2. OpenThread specific Debug Counters (OpenThread)

Counter Index	Meaning
mNumTxRequest	Number of Tx Requested = mNumTxGrantImmediate + mNumTxGrantWait.
mNumTxGrantImmediate	Number of tx requests while grant was active.
mNumTxGrantWait	Number of tx requests while grant was inactive.
mNumTxGrantWaitActivated	Number of tx requests while grant was inactive that were ultimately granted.
mNumTxGrantWaitTimeout	Number of tx requests while grant was inactive that timed out.
mNumTxGrantDeactivatedDuringRequest	Number of tx that were in progress when grant was deactivated.
mNumTxDelayedGrant	Number of tx requests that were not granted within 50us.
mAvgTxRequestToGrantTime	Average time in usec from tx request to grant.
mNumRxRequest	Number of rx requests.

Counter Index	Meaning
mNumRxGrantImmediate	Number of rx requests while grant was active.
mNumRxGrantWait	Number of rx requests while grant was inactive.
mNumRxGrantWaitActivated	Number of rx requests while grant was inactive that were ultimately granted.
mNumRxGrantWaitTimeout	Number of rx requests while grant was inactive that timed out.
mNumRxGrantDeactivatedDuringRequest	Number of rx that were in progress when grant was deactivated.
mNumRxDelayedGrant	Number of rx requests that were not granted within 50us.
mAvgRxRequestToGrantTime	Average time in usec from rx request to grant.

4. Coexistence Backplane Evaluation Board (EVB)

For evaluating the Silicon Labs EFR32 software coexistence solution, order EFR32MG Wireless SoC Starter Kit (WSTK) #SLWSTK6000B and Coexistence Backplane EVB (#SLWSTK-COEXBP). Detailed instructions for using the Starter Kit and Backplane EVB are found in *UG350: Silicon Labs Coexistence Development Kit (SLWSTK-COEXBP)*. To see a demonstration of Wi-Fi coexistence, access links for ordering the WSTK and EVB, and to download additional coexistence documentation, visit the [Silicon Labs Wi-Fi Coexistence Learning Center](#).

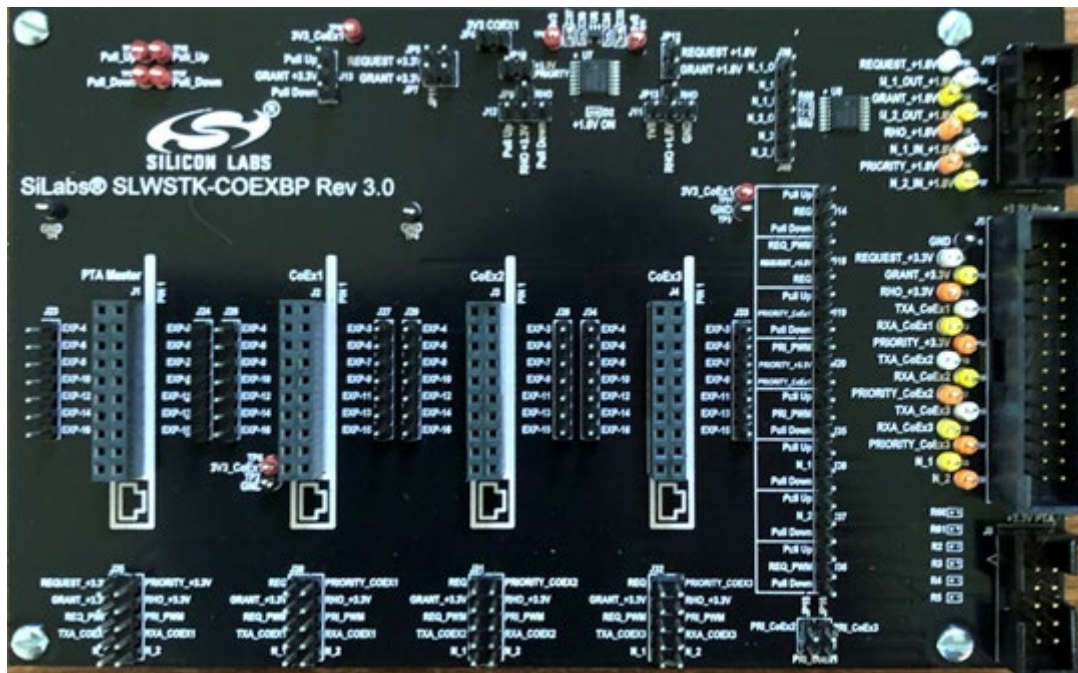

Figure 4.1. Coexistence Backplane EVB (#SLWSTK-COEXBP)

5. Document Revision History

Revision 2.9

August 2024

- Added section 3.3.1, OpenThread specific Debug Counters.

Revision 2.8

June 2024

- Removed section 2.3.9 on Radio Blocker Optimization, which only applies to EFR Series 1 chips.

Revision 2.7

- Changed text to reflect that the Coexistence CLI is enabled by default on all applications beginning with 1.2.0.0.

Revision 2.6

- Added PTA Software Setup using Component Editor for Zigbee
- Added configuration for Signal Identifier feature (EFR32xG24)

Revision 2.5

January 2022

SDK versions

EmberZNet PRO: 6.10.1.0

OpenThread: 2.0.1.0

- Added text and screenshot in section [3.2 Coexistence CLI Commands \(using Component Editor for Zigbee and OpenThread\)](#).

Revision 2.4

July 2021

SDK versions

EmberZNet PRO: 6.10.1.0

OpenThread: 1.2.1.0

- Updated text and screenshots for OpenThread Coexistence component.
- Updated text and screenshots for RAIL Utility, Coexistence component (OpenThread).
- Added text when configuring the port and pin for specific radio signals.

Revision 2.3

April 2021

SDK versions

EmberZNet PRO: 6.9.2.0

OpenThread: 1.1.2.0

- Updated section 2.7.3 to clarify the configuration options for Zigbee and OpenThread.

Revision 2.2

December 2020

SDK versions

EmberZNet PRO: 6.9.0.0

OpenThread: 1.1.0.0

- Moved from Revision 2.1 to *UG103.17: Wi-Fi® Coexistence Fundamentals*:
- Section 2 Wi-Fi Impact on Zigbee/Silicon Labs Thread (and renamed to Wi-Fi Impact on Bluetooth and 802.15.4 Radios)
- Section 3 Unmanaged Coexistence
- Section 4 Managed Coexistence
- Section 5 Conclusions
- Section 2 Configuring Wi-Fi Coexistence: upgraded content for all Zigbee sub-sections by adding more technical details; added new content for all OpenThread sub-sections by adding technical details and supporting screenshots.
- Section 3.1 Coexistence CLI Commands (Zigbee): updated content for Zigbee

- Section 3.2 Coexistence CLI Commands (OpenThread): added new content for OpenThread
- Section 3.2.1 PTA-specific Debug Counters: updated content for Zigbee and added new content for OpenThread
- Section 4 Coexistence Backplane Evaluation Board (EVB): added sentence and link to the to Silicon Labs Wi-Fi Coexistence Learning Center.

Revision 2.1

March 2020

EmberZNet PRO version: 6.7.3.0

Silicon Labs Thread version: 2.10.1.0

- Removed the requirement to assign a GPIO to PRIORITY when Directional PRIORITY is enabled thereby eliminating the need for an additional GPIO for Directional PRIORITY.

Revision 2.0

February 2020

EmberZNet PRO version: 6.7.2.0

Silicon Labs Thread version: 2.10.1.0

- Deleted all text dealing with the test results being available in an expanded version of this application note, AN1017-NDA and replaced it with text to instead reference *AN1243: Timing and Test Data for EFR32 Coexistence with Wi-Fi*, available under non-disclosure from Silicon Labs technical support. In prior revisions, this content resided in *AN1017-NDA: Zigbee® and Silicon Labs Thread® Coexistence with Wi-Fi* which has been deprecated.
- Updated guidance for resolving GPIO interrupt conflicts in section 4.2 PTA Software Setup.
 - Removed Optional “Wi-Fi Select” detail from the Optimize for Wi-Fi Blocker feature description.

Revision 1.9

January 2020

EmberZNet PRO version: 6.7.1.0 Silicon Labs Thread version: 2.10.1.0

- Updated Directional PRIORITY logic diagrams: replaced RACLNAEN with RACPAEN.
 - Deleted Inverted RACLNAEN PRS Channel from all figures and associated text.

Revision 1.8

December 2019

EmberZNet PRO version: 6.6.1.0

Silicon Labs Thread version: 2.10.1.0

- Added SL Thread notice on first page.

Revision 1.7

July 2019

EmberZNet PRO version: 6.6.1.0

Silicon Labs Thread version: 2.10.1.0

- Tied this application note to specific SDK versions of EmberZNet PRO and Silicon Labs Thread. Removed references to all earlier versions of each SDK and Table 2.
- Application code coexistence extensions moved to EmberZNet PRO SDK. Deleted all text related to application code and entire section 5.
- Coexistence CLI commands added to EmberZNet PRO SDK. Added new section 5.
- Removed all references to EM35x/EM358x.
 - Updated section 4.1.16 PWM for High Duty Cycle Wi-Fi.

Revision 1.6

April 2019

EmberZNet PRO version: 6.5.4.0

Silicon Labs Thread version: 2.9.4.0

- Explained the different implementations of the Timer Compare / Capture Channel, the Inverted Request PRS Channel, and the Inverted RACLNAEN PRS Channel for EFR32xG2x and EFR32xG1x devices.
- Added Figures 15–19 with associated text.
 - Updated Table 2.

Revision 1.5

February 2019

EmberZNet PRO version: 6.5.0.0

Silicon Labs Thread version: 2.9.0.0

- Added Directional PRIORITY timing diagrams.
- Directional PRIORITY and Passive Configuration are both integrated within the SDK.
- Updated Table 2.
- Added new section on how to implement Directional PRIORITY.
- Added new section on Passive Configuration.
- Added note in section 4.2.2.1 SoC Application for how to avoid warnings and errors at build time.
- Added section 5, Application Code Coexistence Extensions.
 - Updated Table 2.

Revision 1.4

September 2018

EmberZNet PRO version: 6.4.0.0

Silicon Labs Thread version: 2.8.0.0

- Updated Table 2.

Revision 1.3

May 2018

EmberZNet PRO version: 6.3.0.0 Silicon Labs Thread version: 2.7.0.0

- TX PRIORITY Escalation and PWM for High Duty Cycle Wi-Fi are both integrated within the SDK. Application sample code is not required.
- REQUEST GPIO pin and PRIORITY GPIO pins are always configured as push-pull regardless of the shared setting and should not be used in multi-EFR32 configurations.
- GRANT de-asserts occurring in the initial stages or slightly before a TX event may not be detected and the TX event can continue unaborted.
- Updated Table 2
 - Replaced Figure 2 and revised associated text.

Revision 1.2

February 2018

EmberZNet PRO version: 6.2.0.0

Silicon Labs Thread version: 2.6.0.0

- PRIORITY signal can be implemented as static or directional (renamed from time-shared).
 - Updated Table 2.

Revision 1.1

December 2017

EmberZNet PRO version: 6.1.0.0

Silicon Labs Thread version: 2.5.0.0

- EFR32 PRIORITY signal is implemented directly in the SDK and can be configured as “shared” with Hardware Configurator. There is no need for additional application code.
- Removed instructions for adding custom CLI commands from AppBuilder and placed the instructions in pta-custom-cli.c.
- Removed instructions from AppBuilder for adding an always active event to an application and placed the instructions in prevent-idle-sleep.c.
- Removed instructions from AppBuilder for adding TX PRIORITY Escalation to an application and placed the instructions in tx-priority-escalation.c.
- Application code to add PWM run-time control is available in pta-pwm.c.
 - Updated Table 2.

Revision 1.0

September 2017

EmberZNet PRO version: 6.0.0.0

Silicon Labs Thread version: 2.4.0.0

- Initial release
- Moved coexistence feature setup from the Coexistence Configuration plugin to Hardware Configurator.
 - Updated Table 2.

Simplicity Studio

One-click access to MCU and wireless tools, documentation, software, source code libraries & more. Available for Windows, Mac and Linux!



IoT Portfolio
www.silabs.com/IoT



SW/HW
www.silabs.com/simplicity



Quality
www.silabs.com/quality



Support & Community
www.silabs.com/community

Disclaimer

Silicon Labs intends to provide customers with the latest, accurate, and in-depth documentation of all peripherals and modules available for system and software implementers using or intending to use the Silicon Labs products. Characterization data, available modules and peripherals, memory sizes and memory addresses refer to each specific device, and "Typical" parameters provided can and do vary in different applications. Application examples described herein are for illustrative purposes only. Silicon Labs reserves the right to make changes without further notice to the product information, specifications, and descriptions herein, and does not give warranties as to the accuracy or completeness of the included information. Without prior notification, Silicon Labs may update product firmware during the manufacturing process for security or reliability reasons. Such changes will not alter the specifications or the performance of the product. Silicon Labs shall have no liability for the consequences of use of the information supplied in this document. This document does not imply or expressly grant any license to design or fabricate any integrated circuits. The products are not designed or authorized to be used within any FDA Class III devices, applications for which FDA premarket approval is required or Life Support Systems without the specific written consent of Silicon Labs. A "Life Support System" is any product or system intended to support or sustain life and/or health, which, if it fails, can be reasonably expected to result in significant personal injury or death. Silicon Labs products are not designed or authorized for military applications. Silicon Labs products shall under no circumstances be used in weapons of mass destruction including (but not limited to) nuclear, biological or chemical weapons, or missiles capable of delivering such weapons. Silicon Labs disclaims all express and implied warranties and shall not be responsible or liable for any injuries or damages related to use of a Silicon Labs product in such unauthorized applications.

Trademark Information

Silicon Laboratories Inc.[®], Silicon Laboratories[®], Silicon Labs[®], SiLabs[®] and the Silicon Labs logo[®], Bluegiga[®], Bluegiga Logo[®], EFM[®], EFM32[®], EFR, Ember[®], Energy Micro, Energy Micro logo and combinations thereof, "the world's most energy friendly microcontrollers", Redpine Signals[®], WiSeConnect, n-Link, EZLink[®], EZRadio[®], EZRadioPRO[®], Gecko[®], Gecko OS, Gecko OS Studio, Precision32[®], Simplicity Studio[®], Telegesis, the Telegesis Logo[®], USBXpress[®], Zentri, the Zentri logo and Zentri DMS, Z-Wave[®], and others are trademarks or registered trademarks of Silicon Labs. ARM, CORTEX, Cortex-M3 and THUMB are trademarks or registered trademarks of ARM Holdings. Keil is a registered trademark of ARM Limited. Wi-Fi is a registered trademark of the Wi-Fi Alliance. All other products or brand names mentioned herein are trademarks of their respective holders.



Silicon Laboratories Inc.
400 West Cesar Chavez
Austin, TX 78701
USA

www.silabs.com