



MADE IN THE USA

INSTALLATION MANUAL

STEP SLIDER BD-SS-200-JL4



Description	Quantity
Electric Step Slider (Pair)	2
Bump stop plate with VHB backing	2
Wiring harness (2 piece)	1
Double sided adhesive squares	12
Door sensor	4
Magnets	4
Alcohol wipes	4
Rocker cutoff switch	1
Anti-seize packet	1
Circuit board	1
5/16" - 18 nylock nut	8
5/16" stainless steel washer	8
1/4" - 20 nylock nut	4
1/4" - 20 stainless steel washer	4
1/4" - 20 X 1" grade 8 hex head bolt	24
1/4" SAE yellow zinc washer	24
Front bracket (drop style)	2
Middle bracket (short style)	2
Rear brackets (long style)	2

Front Bracket



Middle Bracket



Rear Bracket



Tools Required	
10 mm socket	7/16" socket
18 mm socket	1/2" socket
Breaker bar	Wrench with 3-4" extension
7/16" Box end ratchet-	1/2" Box end ratcheting
**Optional for quicker install	
Torx Gun with adapters	Heavy Duty Torx Gun with 1/2" driver

Notes and Maintenance

Before you begin installation, read all instructions thoroughly.

Proper tools will improve the quality of installation and reduce the time required.

No maintenance required on waterproof harness or water-resistant motors. If mud or dirt is built up on the steps, simply spray them off and let them air dry.

Mild automotive detergent may be used to clean the product. Do not use dish detergent, abrasive cleaners, abrasive pads, wire brushes or other similar products that may damage the finish.

Periodic inspection of all wires and connections should be performed to ensure there is no visible damage or loose connections.

Refer to the last page of this manual for troubleshooting, warranty and product registration information.

Wiring Locations

Driver	Door sensor, rear	Purple / Orange
	Door sensor, front	Yellow / Orange
	LED light	Brown / Dark brown
	Actuator	Black / Red
Passenger	Door sensor, rear	White / Blue
	Door sensor, front	Grey / Green
	LED light	Pink / Brown
	Actuator	Black / Red

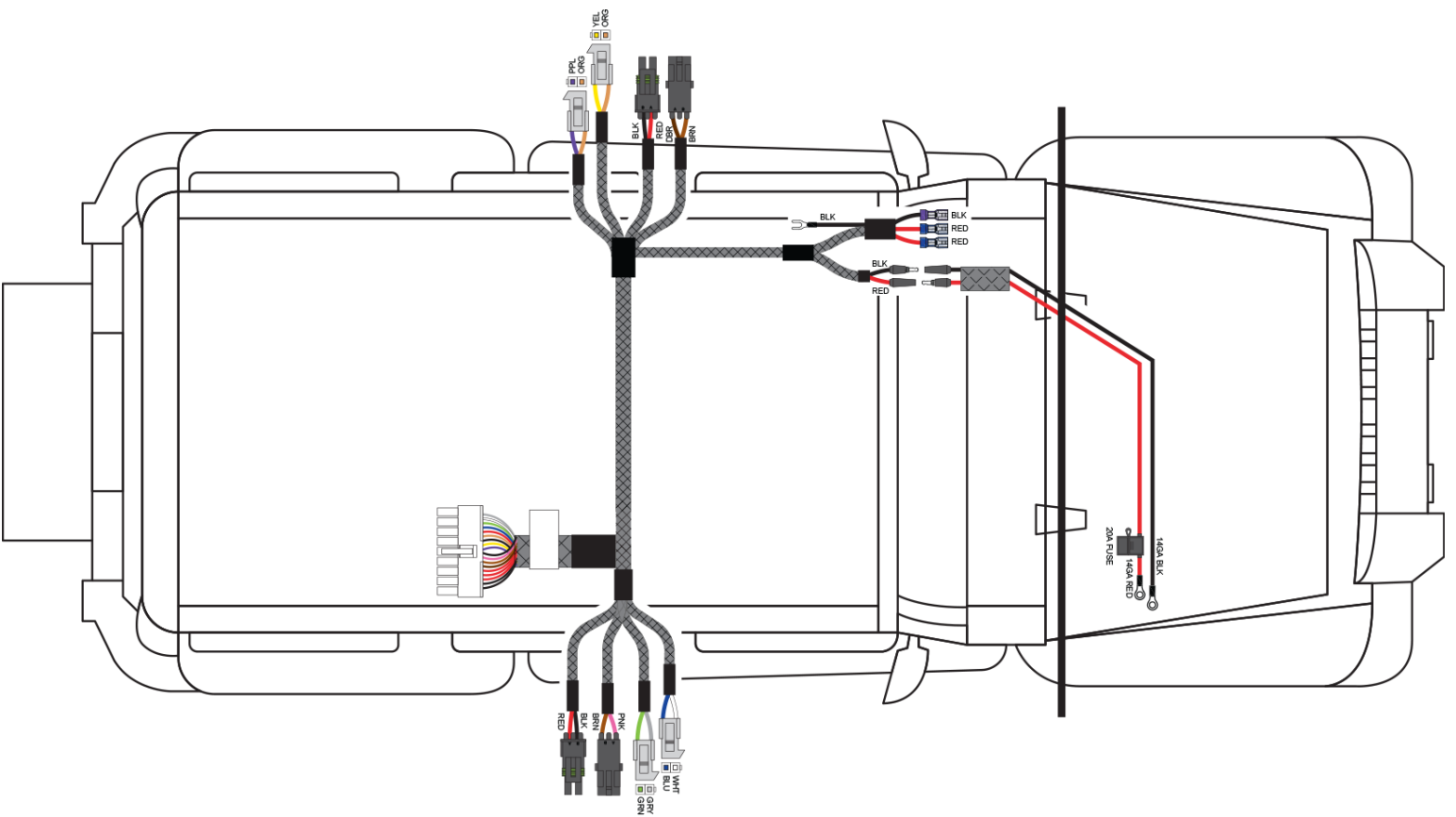
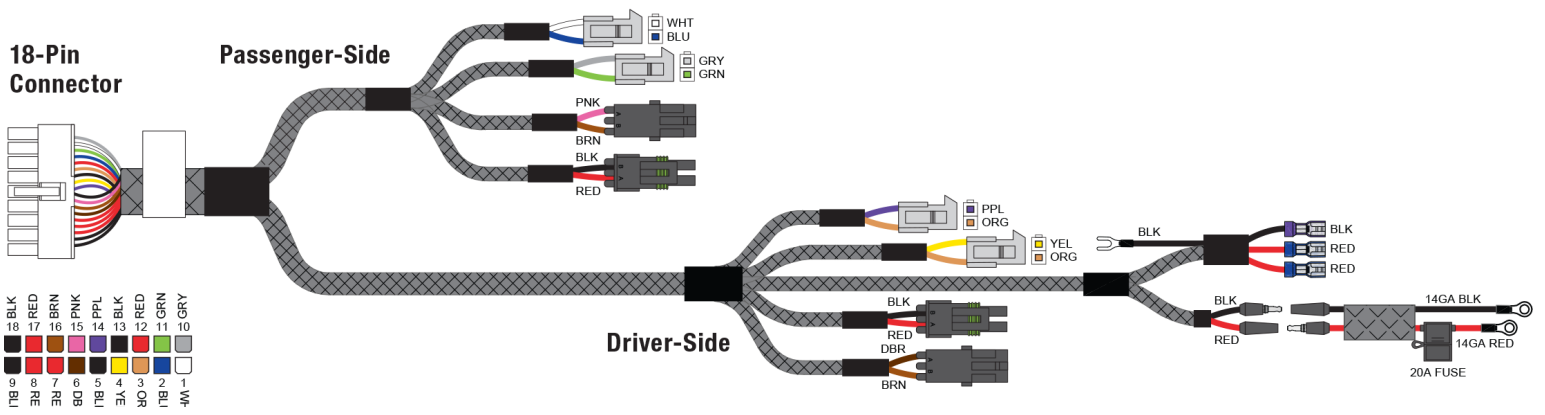

Step 1

Start on the drivers side.

Remove two front pinch seam bolts using a 10mm socket and wrench. Leave the holes open.

Keep the hardware as you will re-install it in the final step



Step 2

Starting on the driver side, locate the three body bolts on the underside of the vehicle. Back the three body bolts about 1/4" to allow free movement of the washer up and down.

**Breaker bar may be required to loosen the body bolts.

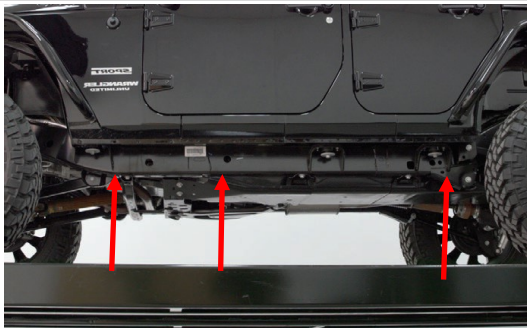

Step 3

With each body bolt loose, slide each bracket between the bolt head and the washer in their correct positions. Install the rear and middle brackets in straight.

Rear—Long Bracket

Middle—Short Bracket

** In some cases the washer doesn't allow enough gap you will have to remove that bolt completely, use a small file or Dremel tool to remove the two-three threads closest to the washer, and re-install the bolt.



Step 4

Install the front bracket at a 45 degree angle to the jeep, with the bracket between the head and washer, and twist straight so the bracket faces towards the side of the jeep.

Front—Tall Bracket



Step 5

Install bumper strap onto the side of the vehicle where the bend just under the door is located:

Test fit the bumper strap by lining up the strap straight across the jeep bend with the little notch towards the rear of the jeep over the seam facing down. The top of the bumper strap should be about a 1/2", or index finger width from the top bend.

Once you have the correct location, pull the VHB plastic and adhere to the jeep in the desired test fit location

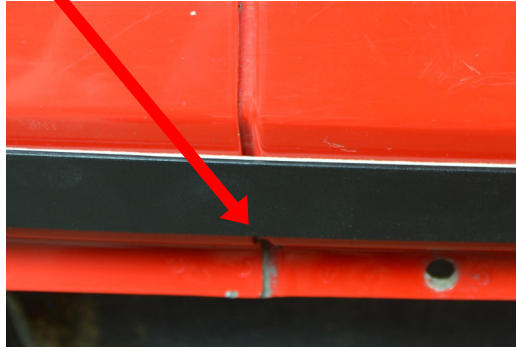

Step 6

Pull the motor wire out from the hosing so it sits out of the back of the step slider.

Mount step sliders on the driver side of the vehicle.

Line up the step with the pinch seam holes and slide the step studs through the pinch seam. The brackets mounted earlier should slide above the body. There should be some play in the brackets to allow up and down movement to slide above the body.

Once mounted, the step should hang on to the pinch seam by itself.

**Do NOT apply weight to the step yet as it is unsecured)

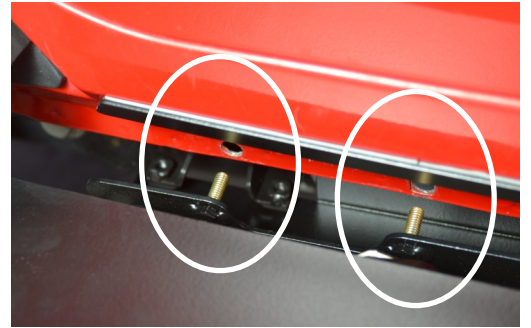
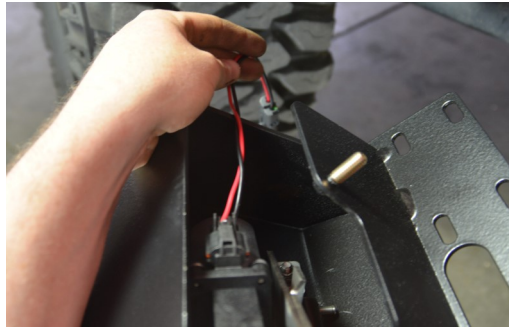

Step 7

Start to secure Step Slider to the pinch seam using:

Use **TWO** (per side) 1/4"-20 nylock nuts and stainless steel washers on the first bolt in the first window, and the 2nd bolt from the rear in the last window.

Use **FOUR** (per side) 5/16" -18 nylock nuts and washers on 2nd from the front bolt, center two bolts and last bolt.

Tighten down about halfway.



Step 8

Install 12 5/16" - 18 x 1" with a hex head bolts with yellow SAE washers into the bracket through the slots on the underside of the step slider.

Install bolts halfway.



Step 9

Once all bolts and nuts have been started, tighten down pinch seam nuts:

Use a 1/2" socket and wrench with a 3-4" extension for the 5/16" - 18 nuts.

Use a 7/16" socket and wrench with a 3-4" extension 1/4 - 20 nuts.

OR use a box end ratchet.

Torque 5/16" nuts to 18 ft. lbs.

Torque 1/4" nuts to 9 ft. lbs.

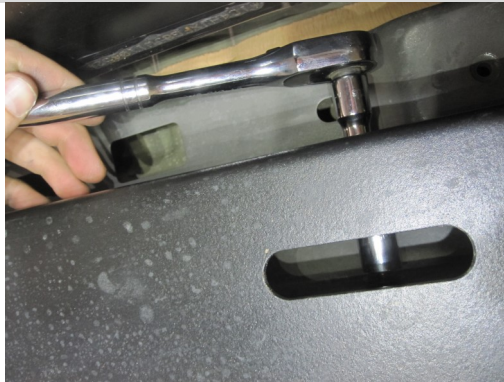

Step 10

Tighten down 5/16" hex hex using a 1/2" socket and wrench.

Torque to 18 ft. lbs.

**For a quicker install, use a torx gun with an adapter for a 1/2" socket.



Step 11

Tighten down body bolts last.

Torque to 80 ft. lbs.

Repeat steps 1-11 on the passenger side

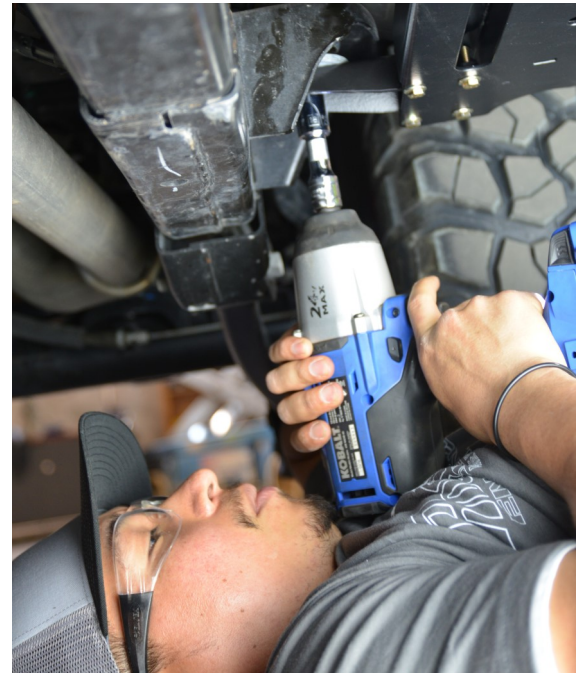

⚠ WARNING

Improper electrical installation may result in personal injury. Unless you are familiar with the installation and handling of electrical systems, have this step performed by someone who has that familiarity.

Step 12

Remove floor mats from the jeep.

Loosen front kick panel.



Remove center panel to allow access for wires.



Step 13

Remove fuse from harness.

Attach RED—POSITIVE and the BLACK—NEGATIVE.

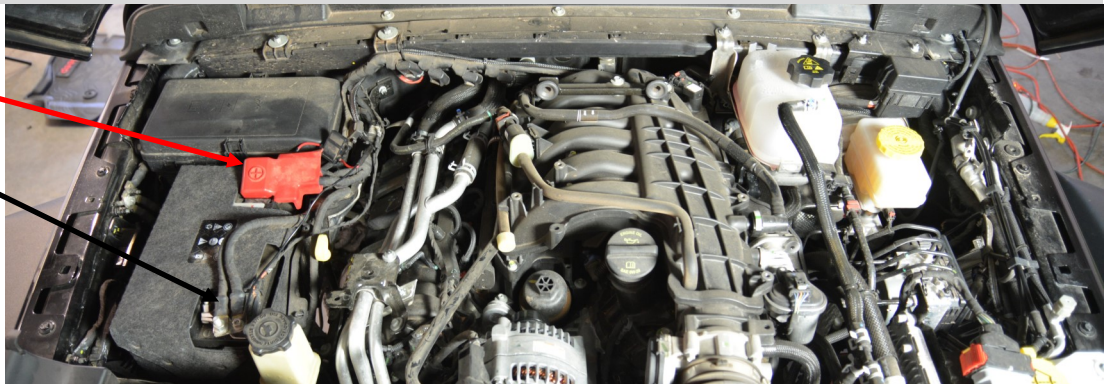

Route the harness across the engine bay and through the firewall.

We recommend drilling through the 2.5" diameter plasti

Secure into place using zip ties.



Step 14

Unravel the large harness in the rear seat and route the connectors to the front of the vehicle under the removed panels.



Step 15

Remove floor plug.

Run motor connector through the open hole.

**If installing optional light kit, run light connector down through the hole.

Run circuit board plug and passenger side connectors under the carpet to the passenger side of the vehicle.



Remove plug on the passenger side of the vehicle.

Route motor wire through the hole.

**If installing optional light kit, run light connector down through the hole.



Step 16

Refer to diagram below and **page 2** for sensor location and wire color.

Plug sensors into harness. Route sensor to door jam. Install on each door under the latch as shown.



Wiring Locations

Driver	Door sensor, rear	Purple / Orange
	Door sensor, front	Yellow / Orange
	LED light	Brown / Dark brown
	Actuator	Black / Red
Passenger	Door sensor, rear	White / Blue
	Door sensor, front	Grey / Green
	LED light	Pink / Brown
	Actuator	Black / Red



Step 17

Install magnets using double sided tape. Align them over the sensors to ensure the steps activate correctly.



Step 18

Locate a spot to install the power switch. We recommend the kick panel or lower left dash panel.

Use a 3/4" bit to drill a hole to install the cutoff rocker switch. If the hole is too tight, increase hole size until the switch installs easily.



Plug the blue female wire into the silver male ends and the red female wire into the bronze male end.

Install rocker switch into dash or chosen spot.

Ensure to ground black wire onto the jeep body.



Step 19

Once all sensors are installed and the wiring has been run, plug the small wiring harness into the large harness.

Plug in circuit board to the large harness and secure it under

Reinstall fuse into harness

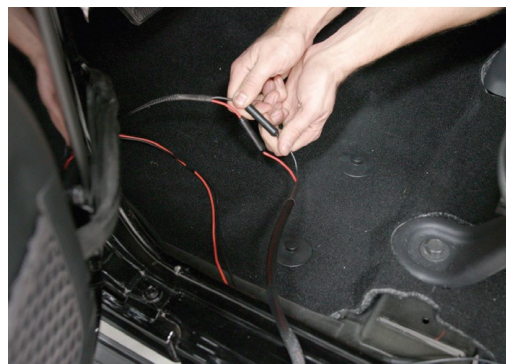

Step 19

Re-install the panel bolts removed in step 1.





TROUBLESHOOTING YOUR STEP SLIDERS:

<p>I just installed my steps and they are not coming down when I open the door.</p>	<p>Double check the connections. Check the fuse to make sure it is plugged in. Is the on / off switch getting power? Is the circuit board plugged in? Are the door sensors plugged in?</p>
<p>My switch is getting power, but the light stays on in both positions.</p>	<p>The light is only supposed to be on when the system is turned on. If it is lit in both positions simply switch the red wires on the back. Will this kill my battery with the light constantly lit? This will not kill your battery unless you leave it lit for a month with no use.</p>
<p>Everything is plugged in and the switch is turning on and off, but the steps still won't deploy.</p>	<p>Two things may be causing this issue:</p> <p>Check the motor first. Simply unplug it from the wiring harness and apply external 12V power to the leads. One position will make them deploy. Switch the leads again to make them retract. If this works, plug the motor back into the harness. We test each and every motor that leaves our factory by hand along with assembling your step slider by hand. These may fail, but it is extremely rare after we send them after having tested them. If you test the motor and all you hear is a clicking sound but nothing happens, there is likely internal damage.</p> <p>Check the sensors. Unplug both of them from the wiring harness, and plug one back in. Manually test your sensors by putting a magnet really close (but not touching) to the sensor. Does it make the step retract? When the magnet is away, the step should deploy. If the steps deploy right after installation, more than likely your magnets just need to be aligned. Do this one by one with each sensor by the method above. Install one sensor, test, align the magnet on the door, test, and then mark the position of the magnet so if for some reason they do move out of place you can easily realign them. The sensors should have a label with MP###802 or MP###902.</p>
<p>I tested the motor, and it works. I checked the sensors individually, and the system still won't work. The steps don't deploy unless I do it manually with 12V power.</p>	<p>In rare circumstances, the circuit board that runs the system may be faulty.</p> <p>Call our support team for a warranty help at 435-752-4580</p>
<p>I opened my door a bunch of times and the system just shut off. What happened?</p>	<p>Our systems have built-in protection against quick cycling like this to prevent damage. Simply turn your on / off switch to off, wait 5 seconds, and then turn it on again. This will reset the system and allow it to work normally again.</p>
<p>Everything is working now. But I want to take my doors off and have the steps still work.</p>	<p>We sell a door delete kit you can replace those sensors with. Part# SL-DD-100 comes with everything you need for two doors. If you want to install a delete kit on the rear doors as well, you will need to purchase two kits.</p>
<p>The steps deployed and won't retract. What is going on?</p>	<p>Chances are your magnets are misaligned. To diagnose which door needs to be adjusted, unplug the rear sensors with the front doors closed. If your steps come up, then it was the rear doors that need to be aligned with your magnet. If the step stays down, the front door needs to be aligned. Open your door, shift the magnet in a direction, and shut it again. Repeat until the step comes up when the door is shut. Mark the magnet placement on the front door. Plug the rear door sensor in, shut the rear door and front door, and see if it comes up. If not, the rear door is misaligned (Since we just aligned the front door we know it's the rear door now). Repeat the previous process of opening your door, shifting your magnet, and shutting your door until the step comes up. It may take a few tries.</p>
<p>I was off-roading, left my system on, someone left the door ajar and I ripped my step off on a rock. What now?</p>	<p>We can replace these parts for you at cost. You will have to remove the step off your vehicle to replace the innards. Call us and we'll figure out what you need exactly! If you prefer us to do the repair we will do that for you! You will have to cover shipping to us and the cost of the parts, but we will ship it back to you (from our warehouse to your house) on our account.</p>

PRODUCT INFORMATION:

WARNING: Neither the seller nor the manufacturer will be liable for any loss, damage, or injury directly or indirectly arising from the use of or inability to determine the use of these products. Before using, the user shall determine the suitability of the products for its intended use, and the user shall assume all responsibility and risk in connection therewith.

REFUNDS / RETURNS: Products returns are possible if: A) the product is returned in its original packaging, in perfect condition and the return shipping is pre-paid. B) the product is incorrect due to a shipping error on behalf of Rock Slide Engineering. The original purchaser may, within 30 days of the date of purchase, exchange an item if it is returned in its original unaltered condition. Returns must be accompanied by a sales receipt to verify proof of purchase.

PRIVACY POLICY: We believe in 100% privacy. Your information is shared with NO other companies or individuals. For more info click on the Customer Service button in footer menu.

SHIPPING DAMAGE: If the product was damaged during shipping, you must report such damage to Rock Slide Engineering with 24 hours. In such case all the packaging materials must be retained so Rock Slide Engineering can process a damage claim with the carrier.

WARRANTY POLICY: Rock-Slide Engineering warrants Rock-Slide Engineering products to the original retail purchaser on the vehicle originally installed to be free of defects in material and workmanship for 36 months on electrical / mechanical and 12 months on powder coating.

This warranty does not cover improperly installed or applied products, improperly maintained products, products used for racing or competition or damage due to abuse, neglect, or damage caused while off-roading.

Warranty does **not** cover labor costs.

We strongly recommend consumers to purchase from an authorized Rock-Slide Engineering reseller. Please note, if Rock-Slide Engineering product(s) are purchased from an unauthorized reseller, the unauthorized reseller may or may not honor our warranty and the consumer runs the risk of receiving a counterfeit product.

RETURNS: All returns must be accompanied by an original invoice. It is the customer's responsibility to remove the product from the vehicle. Inbound shipping charges (from you to us) are the responsibility of the customer. Rock-Slide Engineering Inc. will pay the outbound (to you from us) freight.

VOIDING WARRANTY

Any installation that has been modified, changed, altered, or otherwise customized voids any and all warranty on electrical components and step slider finish. Splicing into the jeep wiring, harness, ignition, power cables, door switches, or any modification voids warranty.

Our warranty extends only to products that have been installed per manufacture instructions.

We do not recommend altering the installation of the harness, steps, or control module as this could cause the steps to malfunction, fails, or behave erratically.

PATENT INFORMATION:

This product is covered by multiple US issued patents.

PAT US 9,771,024 B2

PAT US 8,833,781B2

PAT US D718,1955

Tech Support / General Support

435-752-4580

8 A.M.—5 P.M. MST