



Definition: A short, curved, air-filled projection on the hull of a boat, imparting stability in the water.

Sponsons on this boat are utilized to help stabilize the craft in choppy water or high wind conditions, or both.

The unique sponsons described and outlined in this document are used to add lateral buoyancy to a narrow beam boat, specifically the TOTER 2 Sailing version. The concept is simple, increase the beam by joining a sponson to each side of the main hull module, thereby dramatically increasing the righting buoyancy of the entire craft. The plans as defined can also be incorporated into other small boat hulls, with little modification, and at a low cost.

The picture at right is of an assembled, but unfinished, sponson. It is constructed of 1/8 inch plywood, with internal baffles. It is all glued together, sanded, and the seams finished using the Tape & Glue process. This produces a strong, sealed, yet lightweight (2 lbs) structure.

It is crucial that the sponsons be easily attached, and removed, from the boat. Not everyone will need them. Because the cross-section of the sponson is a triangle, it is simply a matter of using it's dovetail qualities to align and secure the bottom edge to the hull. Locking the upper end to the hull is provided by push-in locking pins located along the gunwale rubrails.

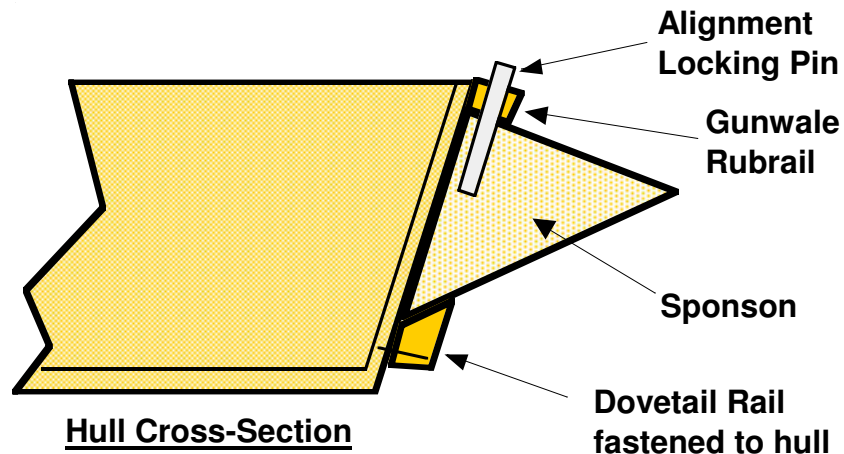

The total cost of building these sponsons (2) is about \$20, if you have left over materials from building the boat. If this is an only build, the cost should be less than \$40. These sponsons add an additional 24 inches to the beam of the TOTER 2 hull, providing an all weather experience.

The plans can be scaled up, or down, for application on other craft. However, caution must be taken regarding the possible over-stressing of the thin plywood on larger boats. The use of 1/4 inch ply can easily be substituted.

SPONSON PLANS and ASSEMBLY

Murphy's Law of boat building:
The glue dries before the mistake is found.

Knowing this ahead of time will save hours of frustration.

Boat builders credo: Measure twice, cut once.

Now, start by laying out a Sponson Top Panel. Do this by laying the plywood sheet against the side of the hull, and trace the outline of the Gunwale. Add the 24 inch radius to the bow end at the 45" length, and cut out the panel. Do this for both top panels, and mark them port and starboard. Refer to the photos on the following page for additional information. In assembly, the good side of the plywood is always the outside.

Next, cut the Side Panels from the plywood. Remember, if you use a jig saw, it's best to cut with the good side of the plywood facing down. Lightly sand the cut edges to remove splinters.

Follow the pictorial assembly steps, on the following pages, to complete the construction of the 2 sponsons.

The one common theme must be accuracy. Double check fits prior to gluing, and insure all seams are completely sealed. The glue recommended is TiteBond 3, a waterproof wood glue that dries hard, is non-toxic, and easy to apply. Follow the directions for the Tape & Glue Process that can be downloaded free from: www.PortableBoatPlans.com

Finishing of the completed sponsons is as important as the construction. I recommend the use of Marine Spar Varnish, as it provides a waterproof, UV stabilized and a good looking finish. However, exterior or marine grade paint can also be applied, and that is the builders choice.

Good luck with your project.

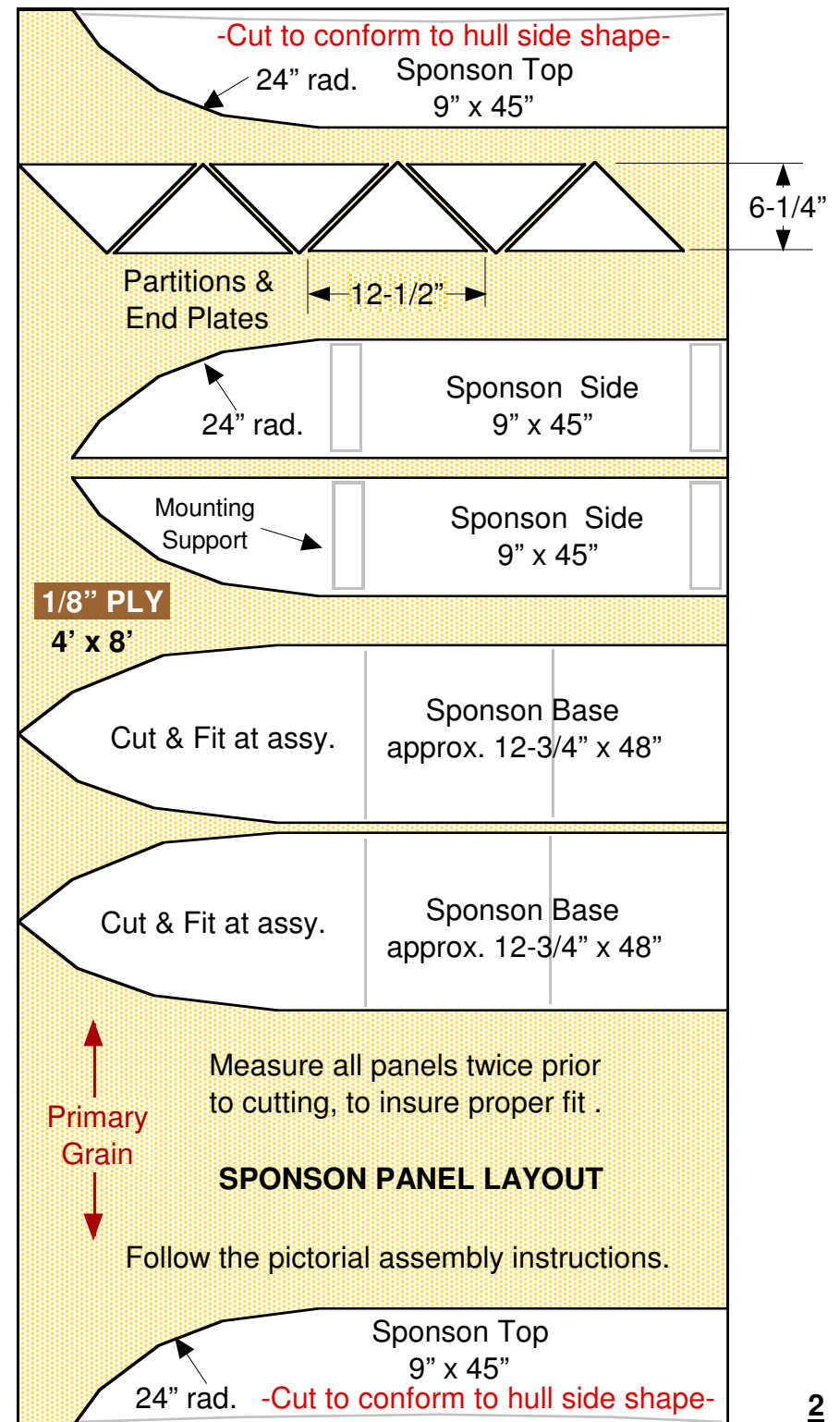
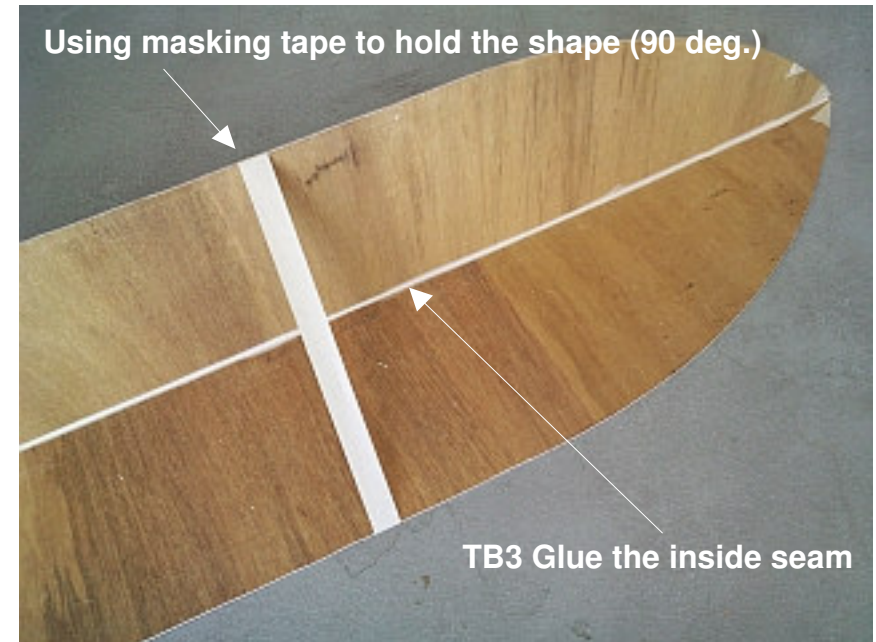
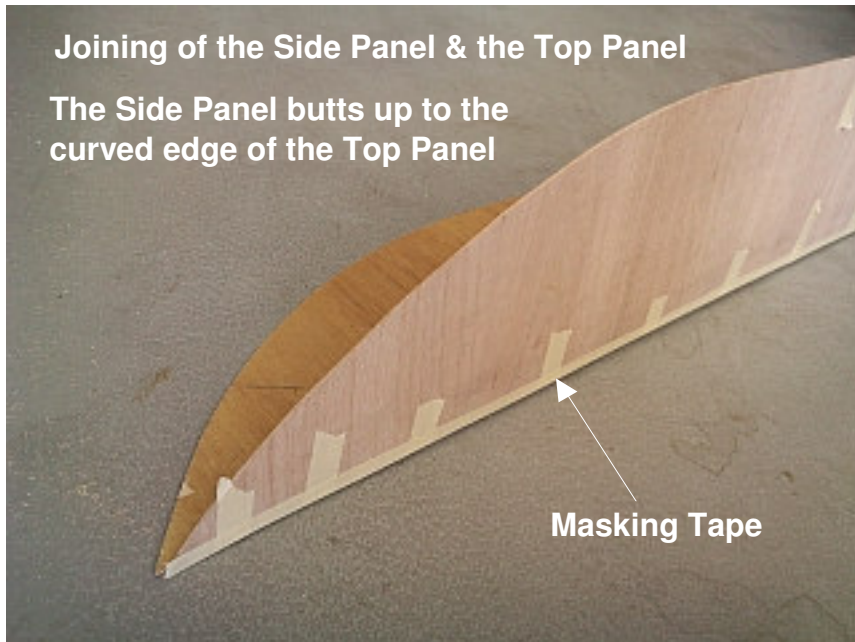
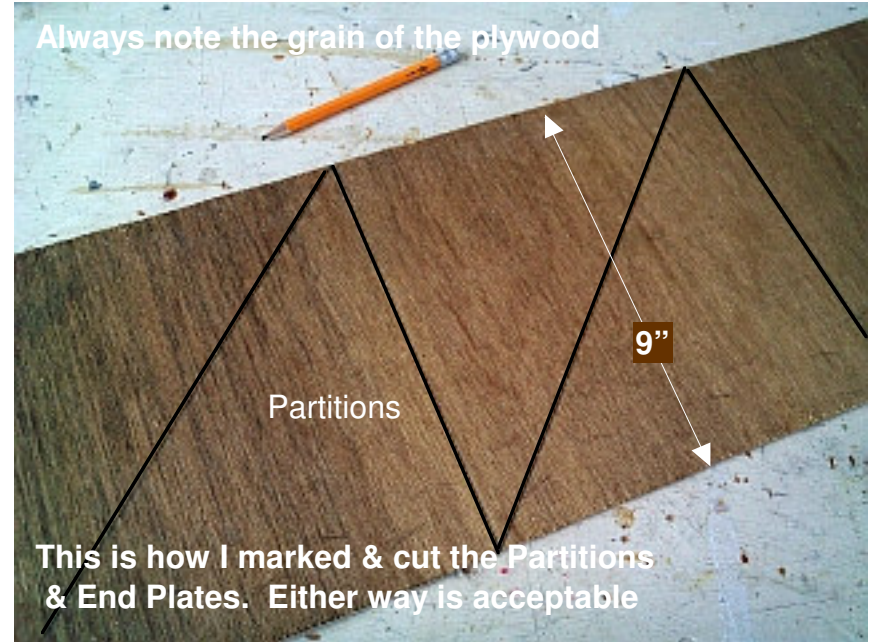
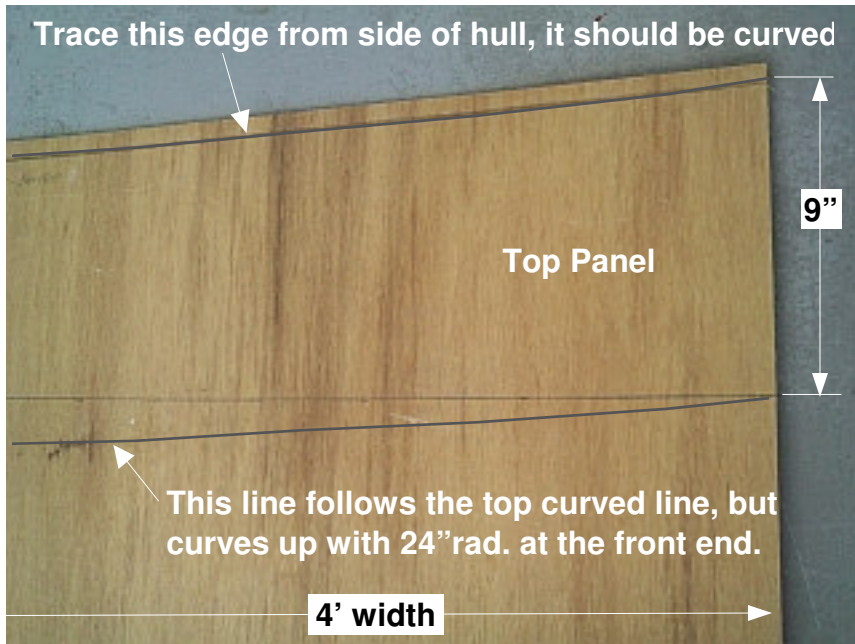
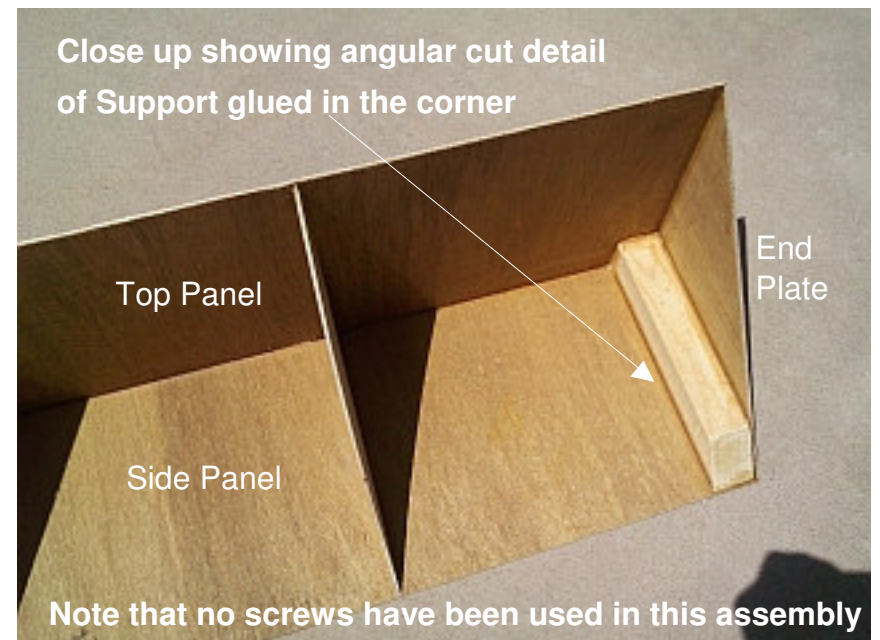
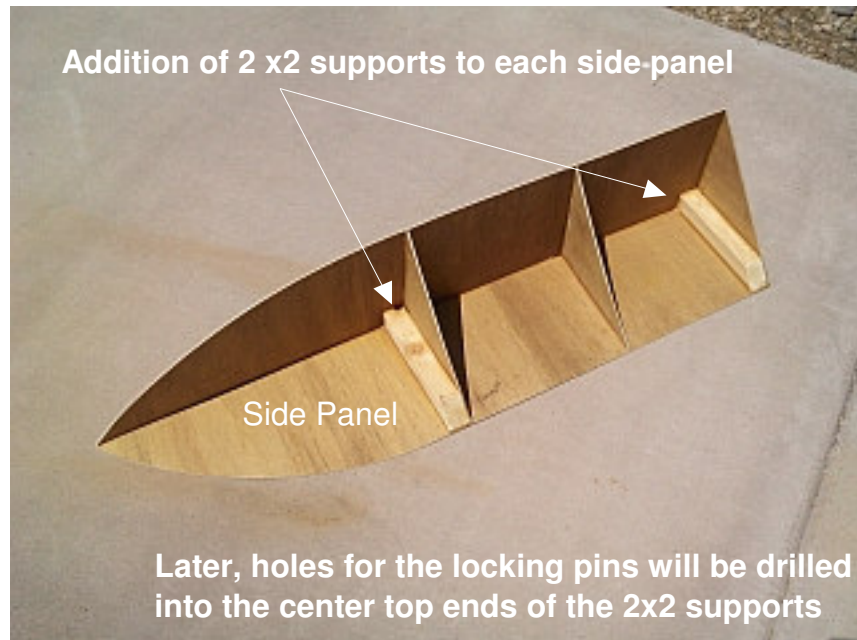
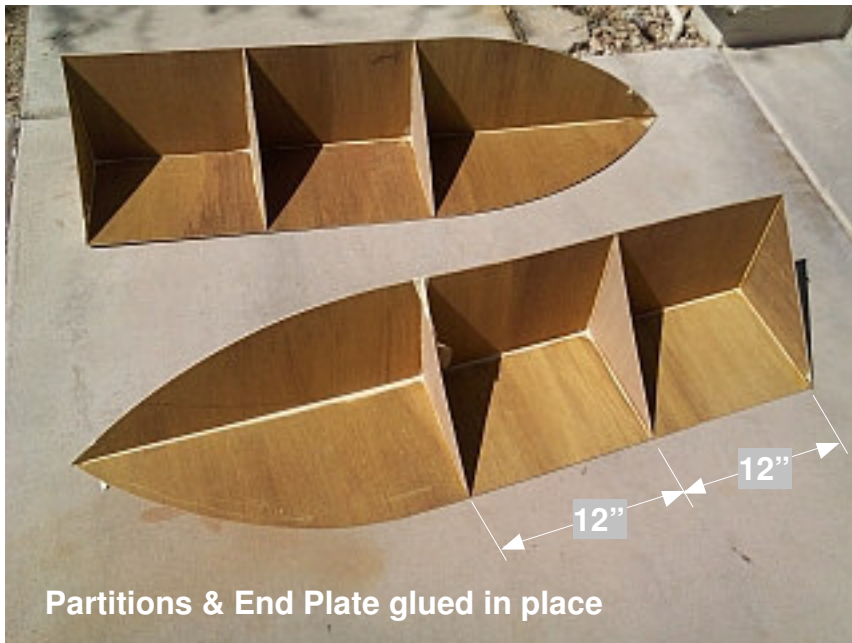

PHOTO ASSEMBLY SEQUENCE



Use masking tape to hold everything together while glue is curing.

INITIAL SPONSON ASSEMBLY



Insure that partitions fit flush to edges of the panels. Trim if necessary.

SPONSON BASE ASSEMBLY

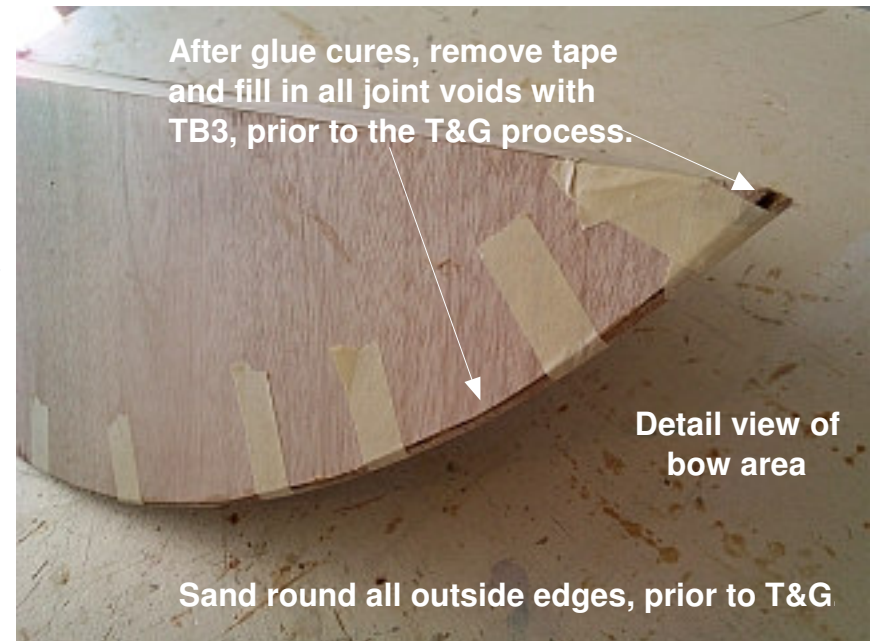
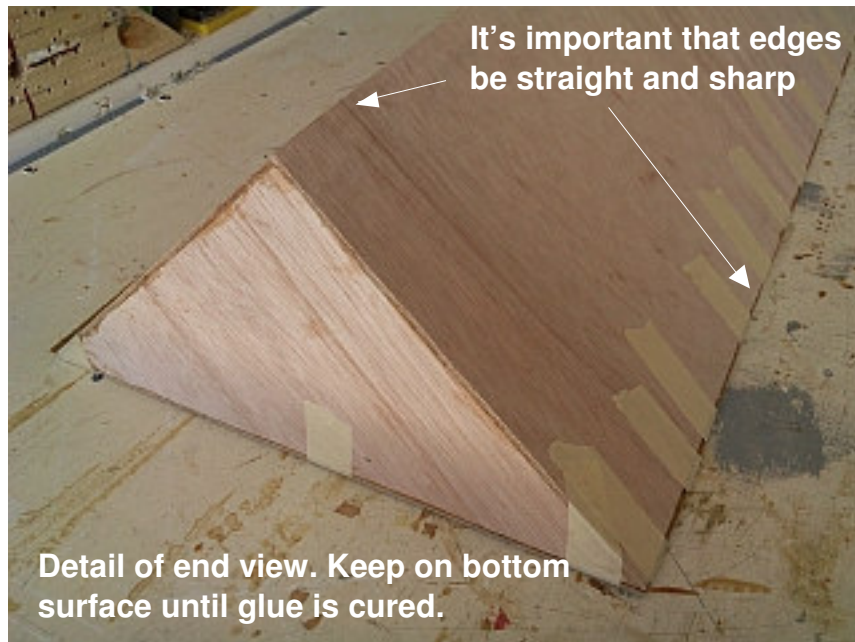
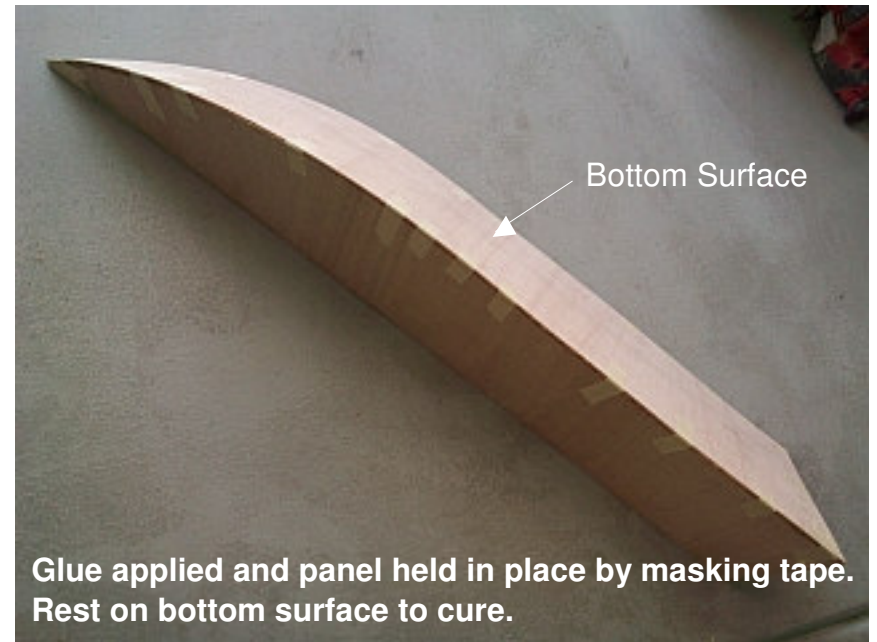
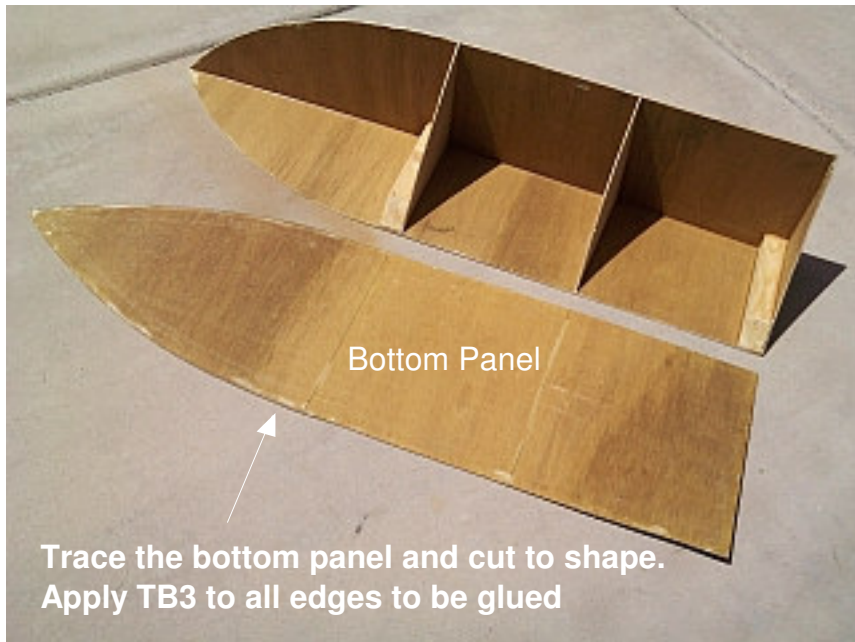

Allow glue to cure at least 6 hours at room temperature.

DOVETAIL RAIL ASSEMBLY

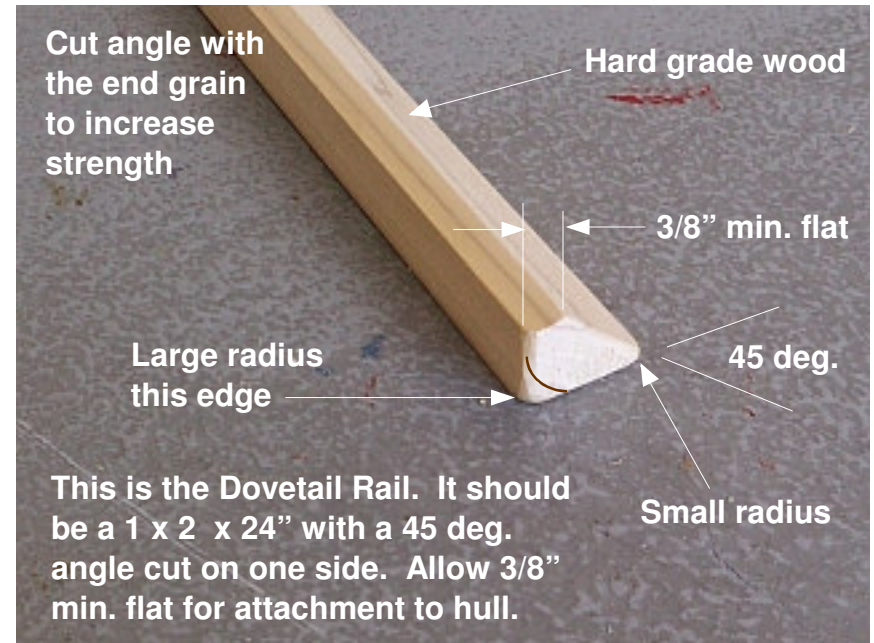

You will notice that no screws were used in the assembly of the sponsons.



Fitting, gluing and screwing the Dovetail Rail is very critical to the overall integrity of the assembly. An End Stop should also be added to help in final assembly alignment. Glue and screw (#6 x 3/4") from the inside the Dovetail Rail, only after fitting the Sponson in place, and marking the rail base location. Then mark, glue and apply screws every 3" from inside. The fit should not be too loose. Allow for finish. After the glue is cured, again fit the Sponson in place, and drill the 1/4" holes for the locking pins. The pins are 4-1/2" long, and should go into the center of the sponson support to a depth of 2-1/2", allowing a 1/2" to protrude above the rubrail, enough to grab and pull the pin out for disassembly. Refer to assembly sketch on page 1.

Typical assembly of the Sponson to hull: First place it into the Dovetail Rail, align to End Stop, then push it under the Gunwale Rubrail. Finally, press in the Locking Pins to secure the assembly.

ASSEMBLY PHOTOS

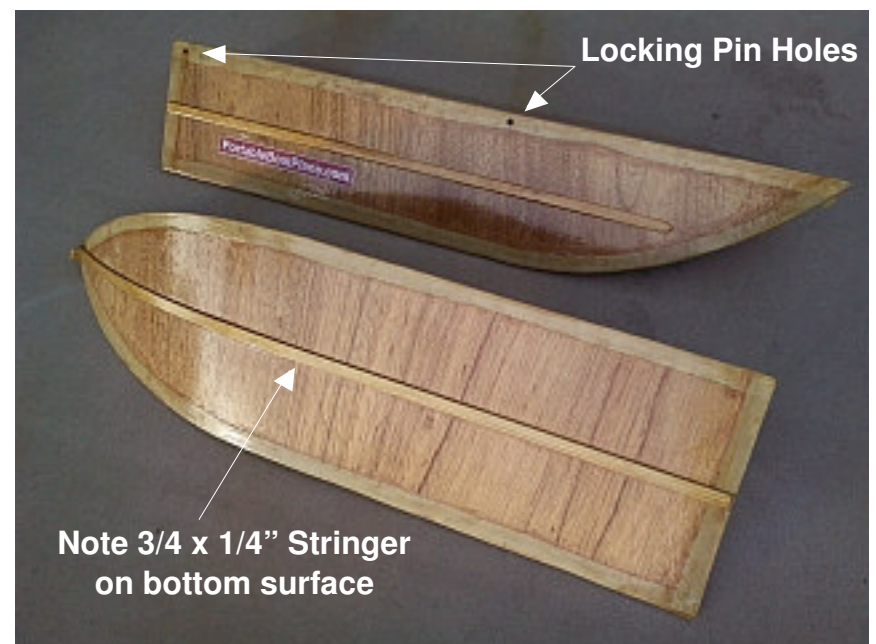
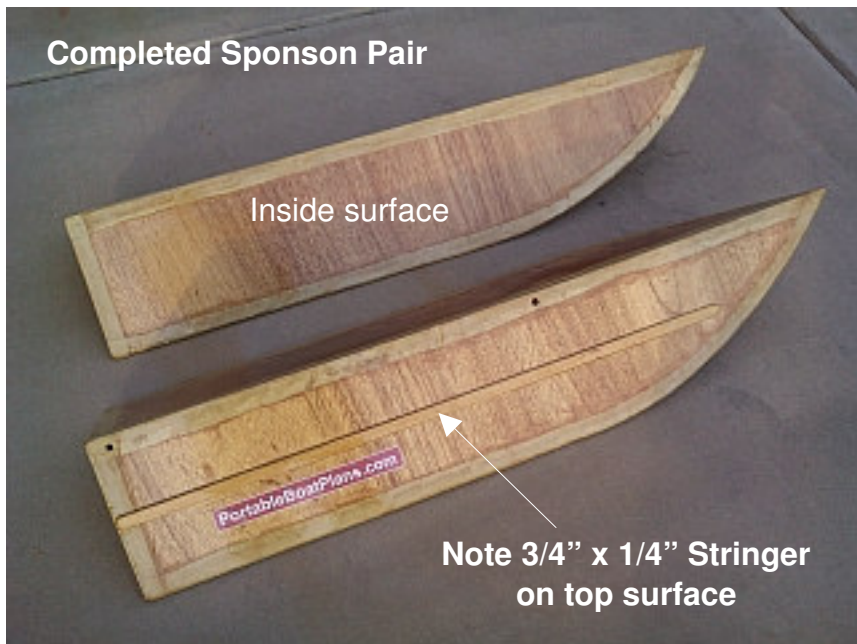
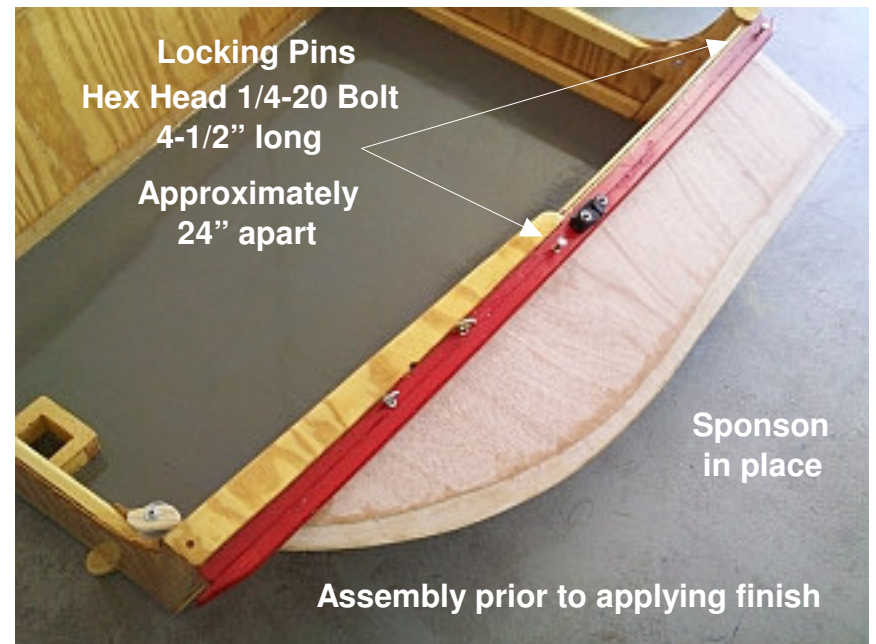
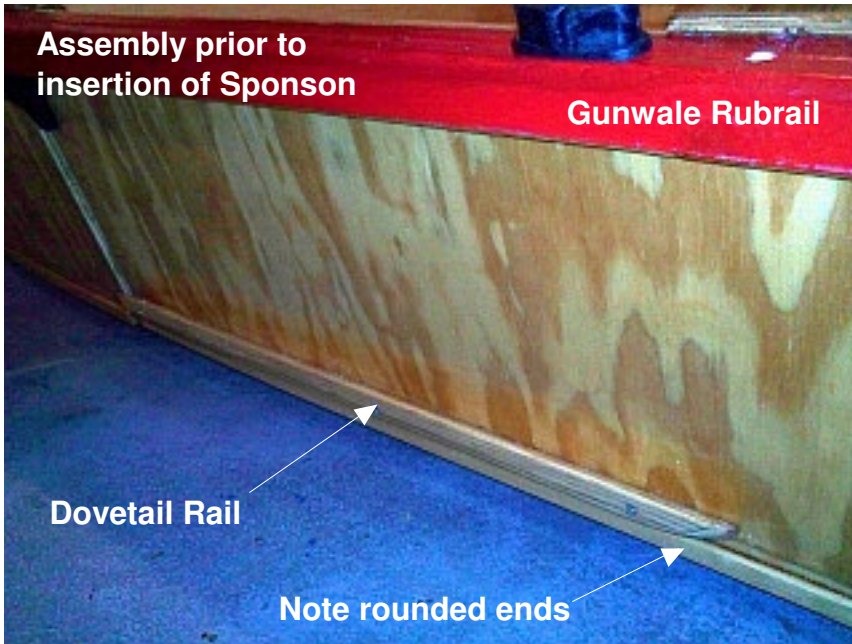

For transport, the Sponsons together occupy only a square foot wide by 45 inches in length.

SPONSON FINAL PHOTOS

The sponsons have had very little effect on the forward speed of the boat, however they do provide an abundance of lateral stability to the narrow craft. It's now possible to stand in the boat without fear, and fishermen could even cast from that position. Overall, the sponsons have proven to be a great asset, not only to the sailing version of Toter 2, but also to the motorized version.



Notice the added paint scheme to match the hull

