



Carbon Dioxide (CO₂)

OCHMO-TB-004

Rev C

Executive Summary

On Earth, physiological Carbon Dioxide (CO₂) levels are managed by our lungs and environment. Our lungs collect vital oxygen (O₂) through inhalation, circulate O₂ throughout our body and to vital organs via the bloodstream, and then upon exhale, release CO₂ into the environment. When our respiratory system does not function nominally, either from physical or environmental limits, CO₂ can build-up in our bodies (hypercapnia) and cause symptoms such as headache, dyspnea, fatigue, and in extreme cases, death. Our environment naturally eliminates CO₂ through photosynthesis of plants and trees, weathering, and other experimental CO₂ removal processes. Humans in space face hostile, enclosed environments (including vehicles and suits) that do not have the benefit of natural CO₂ removal, relying on CO₂ removal equipment (e.g., the Carbon Dioxide Removal Assembly (CDRA), lithium hydroxide, and amine systems) to help regulate CO₂ levels in the environment and help decrease risk of negative consequences of elevated CO₂ exposure.



Relevant Technical Requirements

NASA-STD-3001 Volume 1, Rev C

- [V1 3003] In-Mission Preventive Health Care
- [V1 3004] In-Mission Medical Care
- [V1 5002] Crewmember Training
- [V1 5009] Physiological Exposure Mission Training

NASA-STD-3001 Volume 2, Rev D

- [V2 4015] Aerobic Capacity
- [V2 6001] Trend Analysis of Environmental and Suit Data
- [V2 6004] Nominal Vehicle/Habitat Carbon Dioxide Levels
- [V2 6006] Total Pressure Tolerance Range for Indefinite Crew Exposure
- [V2 7041] Environmental Control During Exercise
- [V2 6020] Atmospheric Data Recording
- [V2 6021] Atmospheric Data Displaying
- [V2 6022] Atmospheric Monitoring and Alerting Parameters
- [V2 6107] Nominal Vehicle/Habitat Atmospheric Ventilation
- [V2 6108] Off-Nominal Vehicle/Habitat Atmospheric Ventilation
- [V2 11034] Suited Atmospheric Data Recording
- [V2 11035] Suited Atmospheric Data Displaying
- [V2 11036] Suited Atmospheric Monitoring and Alerting
- [V2 11037] EVA Suited Metabolic Rate Measurement
- [V2 11038] EVA Suited Metabolic Rate Display
- [V2 11039] Nominal Spacesuit Carbon Dioxide Levels

Background

Main Symptoms of CO₂ Toxicity (Hypercapnia)

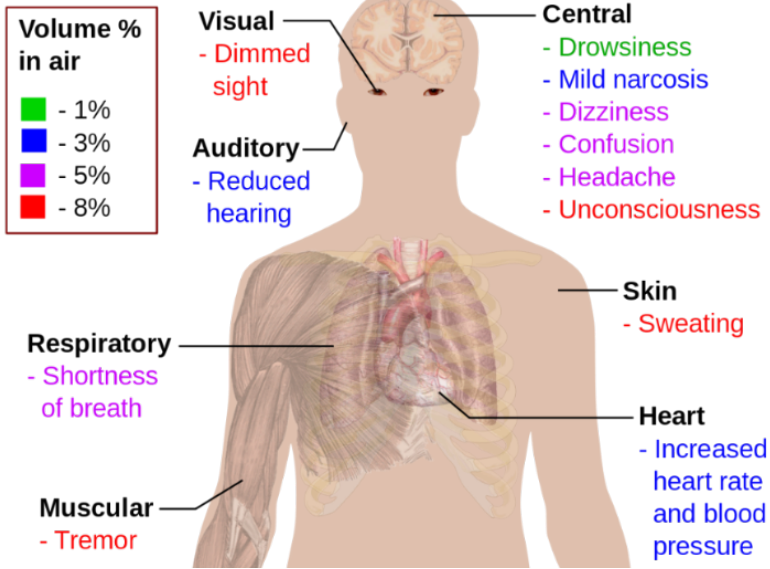

These symptoms represent potential side-effects of hypercapnia, however it is important to note that most of these symptoms have never been observed during spaceflight.

- The most common symptoms experienced during spaceflight are headaches and vision changes (Spaceflight Associated Neuro-ocular Syndrome [SANS]).
- These two symptoms are commonly linked to fluid shifts and potential increase in intra-cranial pressure (ICP) due to the microgravity environment in spaceflight.

Fluid shift

Microgravity Induced Fluid shift - Due to decreased Venous & Lymphatic Drainage

Microgravity → ICP >6 mmHg

CO₂

Exposure to Elevated CO₂ Levels

CO₂ ↑ by 1 mmHg → ICP ↑ 1-3 mmHg

Greenberg JH et al: Local cerebral blood volume response to carbon dioxide in man. *Circ Res* 43: 324-331, 1978

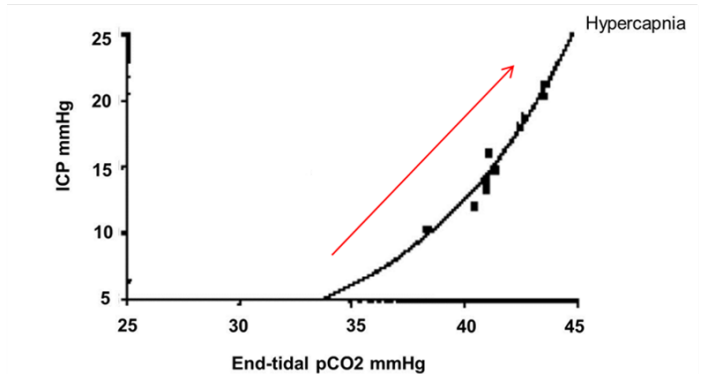
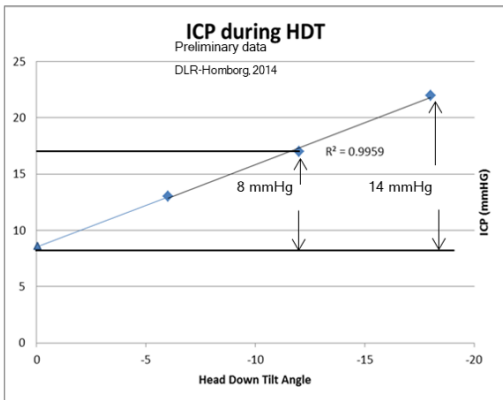

*Paul RL, et al: Intracranial pressure responses to alterations in arterial carbon dioxide pressure in patients with head injuries. *J Neurosurg* 36:714-720, 1972



Background

Effects of CO₂ on Cognitive Functioning

Prior research offers conflicting data on CO₂ exposure and the effects on cognitive functioning, including memory, concentration, decision-making, and task performance. However, several recent terrestrial studies have shown the CO₂ exposure at levels currently maintained onboard spacecraft and submarines does not reduce cognition and performance in astronaut-like subjects or submarine officers.

- *Effects of acute exposures to carbon dioxide on decision-making and cognition in astronaut-like subjects* (Scully et al., 2019). Findings state “There were no clear dose-response patterns for performance on either Strategic Management Simulation or Cognition”.
- *Acute Exposure to Low-to-Moderate Carbon Dioxide Levels and Submariner Decision Making* (Rodehe et al., 2018). Findings state “There were no significant differences for any of the nine Strategic Management Simulation measures of decision making between CO₂ exposure conditions”.
- *Effects of -12° head-down tilt with and without elevated levels of CO₂ on cognitive performance: the SPACECOT study* (Basner et al., 2017). Findings state “There were no statistically significant time-in-CO₂ effects for any cognitive outcome”.

Effects of -12° head-down tilt (HDT) with and without elevated CO₂ on cognitive performance

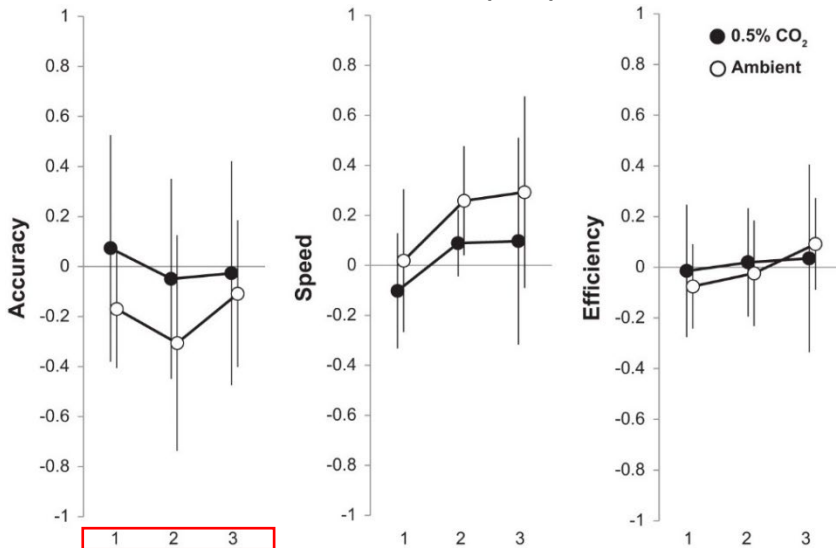

The chart represents a summary of results from a subset of tests from a widely used and validated neurocognitive battery, the Penn Computerized Neurocognitive Battery, as well as a number of additional tests that have either been used extensively in spaceflight or that assess cognitive domains of particular interest in spaceflight (including spatial orientation, emotion recognition, and risk decision making).

1=0.1 hours
2= 5.2 hours
3= 21 hours
into HDT

Displayed data reflect Standard Deviation (SD) units. Error bars reflect 95% confidence intervals. A confidence interval that does not include 0 indicates a statistically significant difference relative to baseline data collection (BDC) at $P < 0.05$. The only outcomes with a significant time-in-HDT main effect in both the discrete and the continuous exposure duration models were physical exhaustion ($P = 0.0012$ and $P = 0.0043$, respectively) and mental fatigue ($P = 0.0328$ and $P = 0.0205$, respectively). The severity of these symptoms increased with increasing exposure duration. $0.5\% \text{ CO}_2 = 3.8 \text{ mmHg CO}_2$.

Source: Basner et al., 2017.



Background

Key Historical CO₂ Concentrations

% CO ₂	PPCO ₂ (mm Hg)	Note ^[Reference]
0.03%	0.23	Ambient outdoor CO ₂ level on Earth
	2	Relief of symptoms on Expedition 6 ^[1]
0.3-0.7%	2.3-5.3	Typical spacecraft CO ₂ concentrations ^[2]
0.5%	3.4	New NIOSH Recommended Exposure Limit ^[3]
	>4	Lethargy, malaise, listlessness, and fatigue on Expedition 6 ^[1]
	4.9	Derived threshold corresponding to 90% negative predictive value for CO ₂ -related symptoms ^[4]
	5	Safe chronic CO ₂ level in terms of performance ^[3] Empiric threshold established by flight surgeons
	2.7 to <6	Headaches on STS-112/ISS-9A ^[1]
	Up to 7.5	Headache on STS-113/ISS-11A ^[1]
1%	7.5	NIOSH Permissible Exposure Limit ^[6]
	8	EMU EVA termination limit with baseline Caution and Warning System ^[7]
1.2%	9	Slight performance decrement after chronic exposure ^[5]
	10	Orlan EVA termination limit with crew at rest ^[8]
	12.4	EMU EVA termination limit with enhanced Caution and Warning System ^[7]
1.99%	14.9	Maximum CO ₂ concentration on Apollo 13 ^[9]
2%	15	Headache, exertional dyspnea start ^[10] ISS Off-Nominal ppCO₂ Level ^[11]
	20	ISS Emergency ppCO₂ Level ^[11] Orlan EVA termination limit ^[8]
3%	23	Sweating, resting dyspnea start ^[10] NIOSH Short-Term Exposure Limit ^[3]
4%	30	NIOSH Immediately Dangerous to Life or Health limit ^[3]
4-5%	30-38	Dizziness, lethargy, uncomfortable dyspnea start ^[10]

Current NASA-STD-3001 Volume 2 Rev D [V2 6004] limits the average 1-hour CO₂ partial pressure (ppCO₂) in the habitable volume to no more than 3 mmHg. Previous requirements accepted a larger range (3.8 to 7.5 mmHg) that has been lowered to 3 mmHg due to evidence from observed operational and research data.

Anecdotal evidence from previous spaceflight missions have found the following associations between CO₂ levels and symptomology:

- Headaches at levels between 2.8-4.5 mmHg; worsening with increasing levels of CO₂ accompanied by fatigue and malaise flushing.
- Fatigue malaise, decreased sleep, and nausea reported at levels above 4.5 mmHg.
- 5th cranial nerve dysesthesia at 4.5-5.0 mmHg.
- Chronic cough, poor sleep, blurred vision, and frontal headaches reported at 3.5 mmHg.

*Referenced New NIOSH Recommended Exposure Limit dated 2005.

See source (NASA/TP-2010-216126) for listed references



Background

CO₂-Induced Headaches

Research and past historical data has revealed an association between reported headaches and CO₂ levels among crewmembers.

- A study of data collected from Expeditions 2 to 31 (N=49) found that CO₂ level, age at launch, time in-flight, and data source were significantly associated with reported headaches on the ISS.
- 19 of the 49 astronauts reported experiencing headaches (~38.7%).
- To keep the risk of headache below 1%, average 7-day CO₂ needs to be maintained below 2.5 mmHg (current ISS range: 1 to 9 mmHg; 3001 standard requires ≤3 mmHg).
- Most experienced headaches were moderate intensity, requiring the use of analgesics in many cases.
- A retrospective analysis of the case reports found a total of 46 days with reported headaches and 1,670 days of non-reports (no headaches observed).
- Based on this data, the current NASA-STD-3001 Volume 2 Rev D [V2 6004] limits the average 1-hour CO₂ partial pressure (ppCO₂) in the habitat volume to no more than 3 mmHg to keep incidence of headaches below 1.4%.

Figure: Predicted probability of headache on the basis of average 7-day CO₂ levels

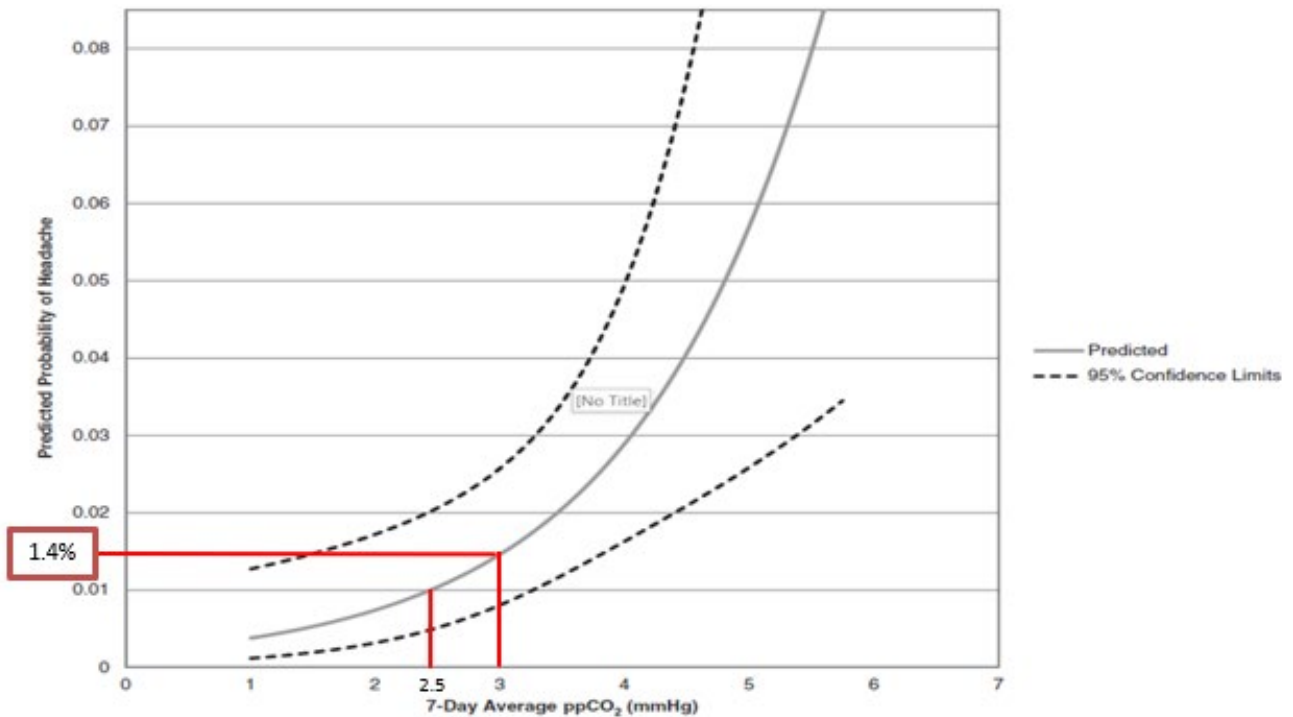

Some observations suggest that what appears to be increased CO₂ sensitivity during spaceflight may actually be attributed to individual predisposition to CO₂ retention, adaption to microgravity, and local fluctuations of CO₂ that are not measured by fixed sensors (Law, Watkins, & Alexander, 2010). Fluid shift due to decreased venous and lymphatic drainage in microgravity largely contributes to symptoms similar to CO₂ over-exposure, including headaches.

Reference Information

Contributors to CO₂ Levels During Spaceflight

- On earth, average indoor air contains CO₂ concentrations between 0.08% to 0.1% (0.608 to 0.76 mmHg).
- NASA-STD-3001 Volume 2 Rev D [V2 6004]: The system shall limit the average one-hour CO₂ partial pressure (ppCO₂) in the habitable volume to no more than 3 mmHg.

Crew-Induced Metabolic Loads for a Standard Mission Day with Exercise

Crewmember Activity Description	Duration of Activity (hr)	O ₂ Consumption kg/min 10-4 (lbm/min 10-4)	CO ₂ Output kg/min 10-4 (lbm/min 10-4)
Sleep	8	3.60 (7.94)	4.55 (10.03)
Nominal	0.25	5.68 (12.55)	7.2 (15.87)
Exercise 0-15 min at 75% VO ₂ max	0.25	39.40 (86.86)	49.85 (109.90)
Exercise 15-30 min at 75% VO ₂ max	0.25	39.40 (86.86)	49.85 (109.90)
Recovery 0-15 min post 75% VO ₂ max	0.25	5.68 (12.55)	7.2 (15.86)
Recovery 15-30 min post 75% VO ₂ max	0.25	5.68 (12.55)	7.2 (15.86)
Recovery 30-45 min post 75% VO ₂ max	0.25	5.68 (12.55)	7.2 (15.86)
Recovery 45-60 min post 75% VO ₂ max	0.25	5.68 (12.55)	7.2 (15.86)
Total Per Day	24	0.82 (1.80)	1.04 (2.29)
Total Per Day (no exercise)	24	0.72 (1.59)	0.91 (2.00)

Source: *Human Integration Design Handbook (HIDH) NASA (2014)*

- Respiratory quotient (RQ) is used in calculations of basal metabolic rate when estimated from CO₂ production. It is calculated from the ratio of CO₂ produced to O₂ consumed by the body ($RQ = \text{CO}_2 \text{ eliminated} / \text{O}_2 \text{ consumed}$). The RQ value is linked to intake of macronutrients (carbohydrates and fats). An RQ of 0.92 is assumed for the O₂ consumption and CO₂ output determinations in the table above. Modifying crew diet can help lower the environmental CO₂ output levels (example: consuming more fats and less carbohydrates). See *Da Poian, et al. (2010). Nutrient Utilization in Humans: Metabolism Pathways.*



Application

Existing Technology

Carbon Dioxide Removal Assembly (CDRA) on the ISS (International Space Station):

- CDRA continuously removes six person-equivalent of CO₂, when operating with both CO₂ removal beds (dual beds functioning).
- Minimum ISS CO₂ removal rate is based on the equation for human equivalent unit (HEU) with the CO₂ partial pressure ranging from 2.0 to 3.9 mmHg.
- The CDRA houses a four-bed molecular sieve (4BMS) that utilize zeolite crystals composed of silicon, aluminum, and oxygen to remove excess carbon dioxide exhaled by the crew.

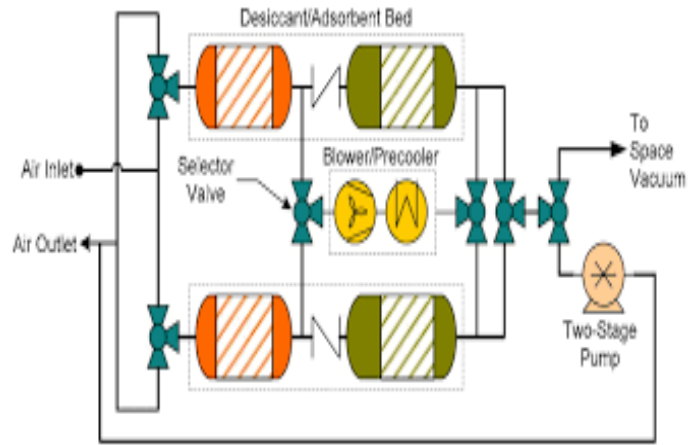

ISS CO₂ Removal Assembly (CDRA)

Process:

- Air enters CDRA, it passes through 1st bed where water is removed via desiccant portion of Bed 1.
- The Dry air is then routed to the zeolite portion of Bed 2 for CO₂ removal.
- The Scrubbed air flows over the previously saturated desiccant portion of Bed 2 absorbing previously removed moisture and returning it to cabin.
- Simultaneously, the isolated Adsorbent portion of Bed 1 is exposed to space vacuum and heated, causing the adsorbed CO₂ to be released and vented to space.
- When the adsorbent portion of Bed 2 becomes saturated the valves are reconfigured and the beds switch roles allowing the saturated Bed 2 to replace Bed 1 and vent CO₂ into space.

Advantages/Disadvantages:

- Pros – Closed loop (does not require consumables other than power); conserves water while removing CO₂.
- Cons – Significant volume, replacement parts, and maintenance required. Risk of zeolite dust potentially affecting seals and mechanical parts/function.



Crewmember performing maintenance on ISS CDRA

Application

Existing Technology

Vozdukh Russian CO₂ Removal System:

- Primary Russian segment CO₂ removal system aboard ISS (located in Service Module).
- Has two desiccant beds and three adsorbent beds.
- Cabin air is drawn into Vozdukh, passed through the desiccant beds, moisture is removed, and CO₂ is absorbed.
- As one bed becomes saturated, second bed is placed in line. The saturated bed is heated, and captured CO₂ is released to space.
- If necessary, two beds can be used simultaneously and a third bed acts in CO₂ regeneration mode.
- ISS utilizes both Vozdukh and CDRA in CO₂ removal capacity.



Vozdukh

Lithium Hydroxide (LiOH):

- Primary CO₂ removal system aboard Apollo and the Space Shuttle, and currently used as backup CO₂ removal system on ISS (CDRA is primary CO₂ removal system on ISS).
- Currently used as one option for CO₂ removal during space walks (regenerative Metal Oxide – METOX is the other method).
- The removal of carbon dioxide is accomplished by a chemical reaction using lithium hydroxide (LiOH) adsorbent. This method relies on the exothermic reaction of lithium hydroxide with carbon dioxide gas to create more innocuous compound lithium carbonate (Li₂CO₃) solid, and water (H₂O).
- LiOH material arranged in air-permeable canisters such that cabin air flowing through canisters facilitates removal of CO₂.

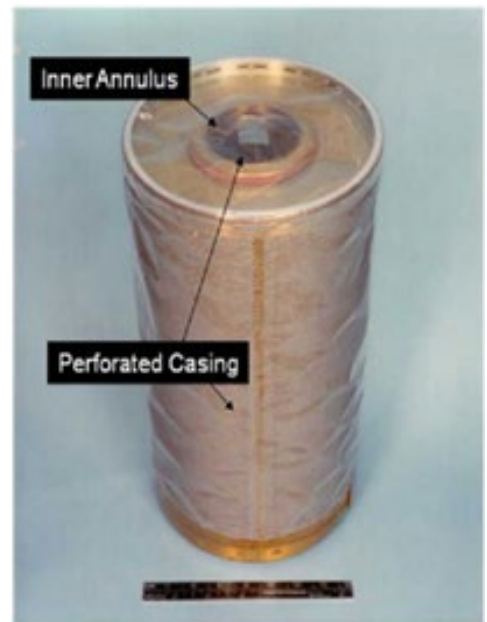

LiOH cartridge

Advantages/Disadvantages:

- Pros – Simple and effective; highly reliable.
- Cons – Canisters are not regenerated so may only be used once (mass, stowage volume).

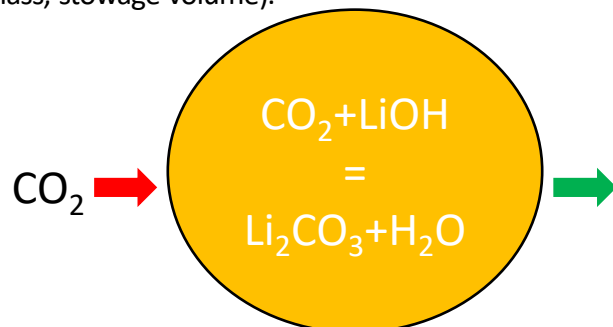

CO₂ and LiOH Chemical Reaction



Lithium Hydroxide cartridge exchange

Application

Emerging Technology

Thermal Amine Scrubber (TAS):

CO₂ removal system based on thermally regenerated solid amine adsorbent. TAS cycles between one adsorbing bed and one desorbing bed to remove CO₂ and regenerate bed simultaneously. Desorbing bed is isolated from the process air and exposed to vacuum during thermal regeneration.

- Water locker has passive water save desiccant canister and can recover 90% of incoming humidity in process air stream, secondary desiccant wheel increases humidity recovery to 97%.
- CO₂ locker receives dry air and splits flow between 2 CO₂ removal beds.
- CO₂ is removed from one bed containing solid amine while the other bed is regenerated.
- During regeneration cycle the non-adsorbing bed is exposed to vacuum to purge CO₂.
- 96% of ullage air from adsorbing bed is evacuated using scroll compressor; removal rate of CO₂ is 3.7 kg/day at 2 mmHg partial pressure.

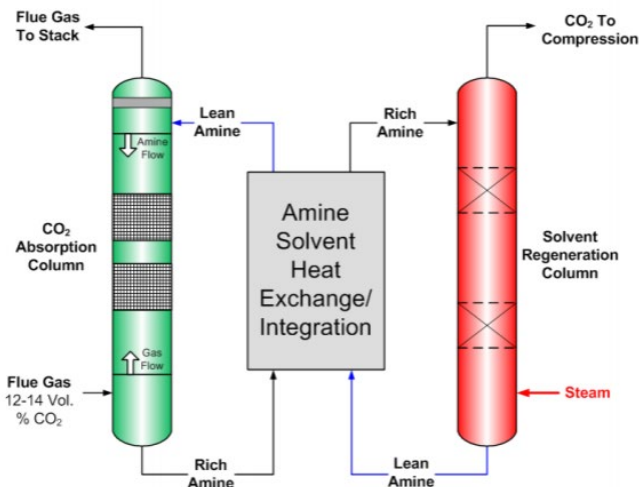
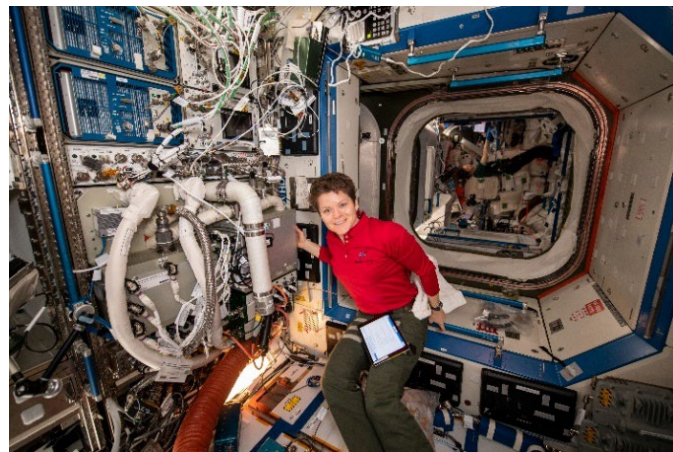

Figure 1-3. Schematic of Amine-Based Post-Combustion CO₂ Capture Process



Thermal Amine Scrubber

Carbon Dioxide & Moisture Removal Amine Swing-bed (CAMRAS):

- Pair of interleaved-layer beds filled with SA9T, a sorbent system, of highly porous plastic beads coated with an amine. SA9T is an effective CO₂ sorbent and has an affinity for water vapor.
- A linear multi ball valve rotates 270 degrees back and forth to control flow of air and vacuum to adsorbing and desorbing beds.
- Air flows into the Amine Swing bed, a regenerable desiccant wheel dries and heats the air; air is later re-cooled by noncondensing heat exchangers.
- Scrubbed air comes out of the CAMRAS and flows back into the double locker; flows through a blower, through an electric heater, and through the opposite side of the desiccant wheel for cooling and rehydration.
- Air is returned to cabin through another filter and long hose that routes return air away from supply air inlet to prevent short circuiting of process air.
- CAMRAS sorbent beds are regenerated by exposure to space vacuum via direct connection to the ISS vacuum system.



Amine based filter beads

Application

Existing Technology

Extravehicular Mobility Unit (EMU) CO₂ Removal:

- When astronauts go on a Spacewalk/EVA (extravehicular activity), they build up CO₂ levels from breathing into a small closed space.
- The spacesuit has a backpack system aboard called the Portable Life Support System (PLSS), which controls the environment of the spacesuit.
- One of the key functions of the PLSS is to remove and control CO₂ delivered to the crewmember. CO₂ washout is a method in which CO₂ levels are controlled within the spacesuit helmet to limit the amount inhaled by a crewmember.
- The PLSS utilizes LiOH or METOX cartridges to absorb and eventually disperse the excess CO₂.
- The lithium hydroxide cells are not regenerable and are exchanged after each EVA.
- The METOX cells are regenerable. They contain CO₂ absorbent material. After each EVA they are placed into a vehicle oven that heats off the CO₂ from adsorbent beds and vents it to the vehicle.
- The CDRA then absorbs the CO₂ from the vehicle and vents into space.
- The spacesuit helmet also has an emergency purge valve to vent CO₂ in emergency situations. This can adversely affect the O₂/CO₂ balance.



Portable Life Support System (PLSS)



Portable Life Support System (PLSS)



EMU Helmet Assembly

- Consists of: Transparent shell, Neck Ring, Vent Pad, Purge Valve and adjustable Valsalva Device.
- The Vent assembly diffuses incoming gas over the astronaut's face.
- Under the EMU helmet, astronauts wear the communications carrier assembly, A.K.A. Snoopy Cap.

Application

CO₂ Washout System

- Carbon Dioxide washout describes the process of removing CO₂ in an enclosed space. For the purpose of this brief, we are discussing CO₂ washout in a spacesuit and space helmet.
- CO₂ is a significant concern as the consequence of inadequate CO₂ removal can result in hypercapnia and related symptoms ranging from headache and fatigue to impaired cognitive function and death.
- CO₂ removal in a space helmet is challenging as it is difficult to ensure the quantity of CO₂ that is removed from the suit and not forming pockets in any area of the suit or helmet. It is also important to ensure when CO₂ is purged, it does not disrupt the critical breathable oxygen balance.
- Fresh air outlet from the PLSS is located at the rear base of the helmet. Air flow is directed from the back of the crewmember's head over their head and face into the suit where it exits the suit and flows into the PLSS for filtration. This provides a continuous airflow, so the exhaled CO₂ is entrained with the fresh air loop from the PLSS. This mixed air then flows down into the suit to where it exits the suit and flows back into the PLSS.
- Exhaled air including CO₂ is flowed through an adsorbent charcoal bed and contamination control cartridges composed of either LiOH or METOX. This removes CO₂, trace gases, and odors. The LiOH cartridges are stored on the vehicle and replaced on the ground, the METOX cartridges can be regenerated on orbit. Either of these are installed in the PLSS prior to EVA.
- To address the life support challenges, especially when considering future, longer space missions, NASA is developing an advanced portable life support system (APLSS) spacesuit for exploration. The ventilation loop of the APLSS is designed to assist with CO₂ washout using a regenerable rapid cycle amine (RCA) removal system, efficient fan and heat exchange systems, and trace contaminant control (TCC) unit placed inside the suit hatch that allows for easy filter exchange.
- NASA has also developed a new system called the Integrated Ventilation Test System (IVTS) designed to study CO₂ washout.
- The IVTS has a ventilation test loop as found in APLSS and suited manikin test apparatus (SMTA). The purpose is to supplement human testing, optimize CO₂ removal efficiently, validate CO₂ washout, evaluate spacesuit nitrogen efficiencies, and optimize the rapid cycle amine (RCA) performance for scrubbing CO₂.

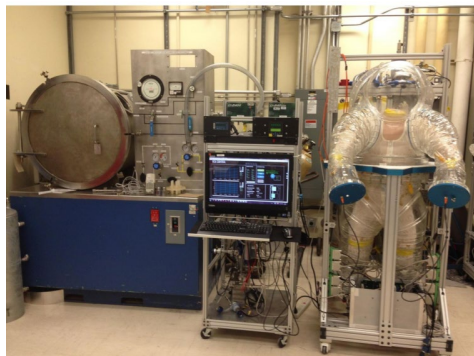

Integrated
Ventilation Test
System

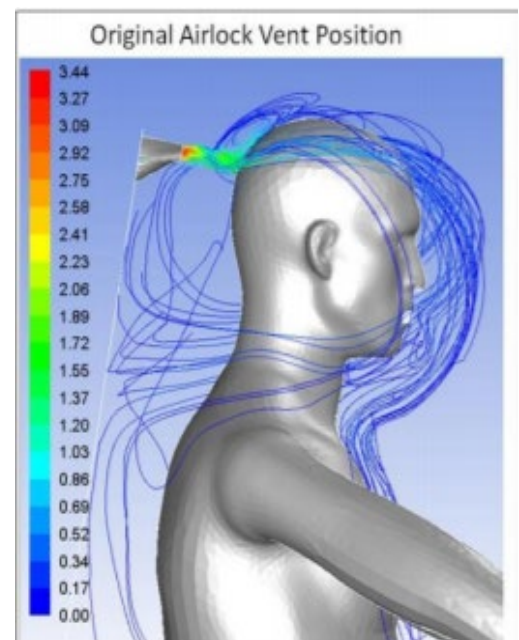

Mishaps

Apollo 13 – April 11-17, 1970

- Apollo 13 began their mission to land on and discover new information about the moon on April 11, 1970.
- Two days into their mission, a stir of the Service Module (SM) oxygen tank resulted in an electrical short causing the tank to explode, leaving the crew without adequate life support.
- The Lunar Module (LM), originally supplied for 2 of the crew to use for 2 days on the lunar surface, became a lifeboat supporting 3 crew for 4 days due to the SM's inability to power the CM.
- CO₂ levels quickly rose (14.9 mmHg) and it became apparent the LM did not have enough LiOH cylinders to support the crew for 4 days.
- Ground support identified that the CM had usable remaining LiOH cartridges, but they were not the same type/shape as the LM filters.
- The astronauts were instructed to use plastic bags, duct tape, and a suit hose to modify the filters, enabling them to absorb CO₂ and support the 3-person crew. The CO₂ levels dropped to 1 mmHg.
- The crew rationed supplies and water and used the minimum amount of power possible, allowing them to survive in the cold, dark LM for 4 days during their return to Earth.
- The objective of visiting the moon was aborted, but with significant ground support planning, the crew was able to transfer back to the CM and safely land.

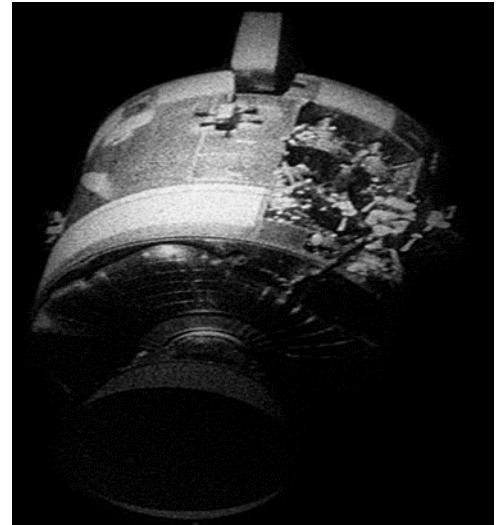

Damaged Apollo 13 Service Module

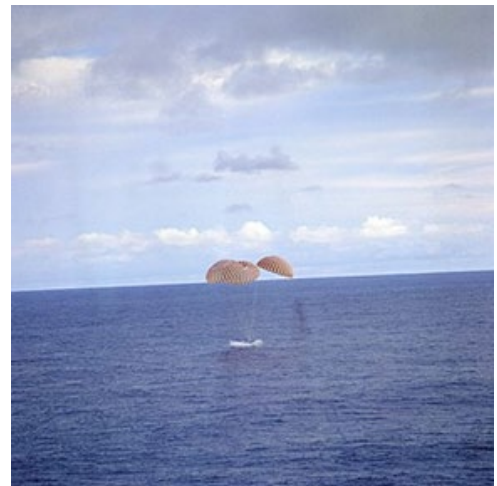

Apollo 13 safe landing!

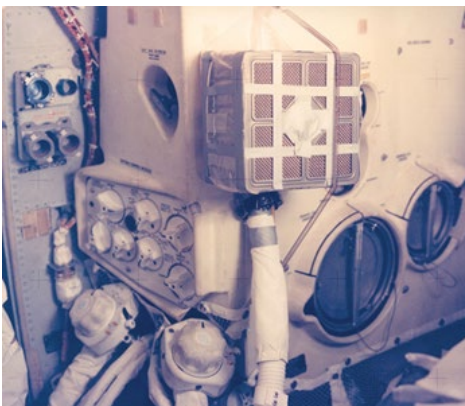

Apollo 13 re-designed CO₂ filter

Relevant Technical Requirements

[V2 6004] Nominal Vehicle/Habitat Carbon Dioxide Levels The system shall limit the average 1-hour CO₂ partial pressure (ppCO₂) in the habitable volume to no more than 3 mmHg.

[V2 9001] Crew Interface Commonality Hardware and equipment performing similar functions shall have commonality of crew interfaces.

[V2 10005] Crew Interface Consistency The system shall provide crew interfaces that are consistent in appearance, arrangement, location, and operation throughout systems.

From: NASA-STD-3001 Volume 2, Rev D

Mishaps

Soyuz 23 – October 14, 1976

- The Soyuz 23 had an automatic docking system malfunction during the final approach to Salyut 5 due to an electronics failure.
- Cosmonauts had less than two days of battery power remaining and missed the landing opportunity for the day, so they powered down systems to conserve power.
- A blizzard was active in the landing zone forcing a lake rather than land landing.
- The descent module lowered in the dark on a single parachute which rocked as it entered the high winds of the landing area.
- They splashed down into the freezing water of Lake Tengiz, making recovery efforts extremely difficult.
- The cosmonauts stayed in the capsule with systems shut off to save power.
- As the capsule floated, the pressure equalization valve above the waterline provided air.
- The salt water from the lake caused the secondary chutes to deploy by shorting out the sensors, the parachute filled with water and dragged the capsule below the surface.
- The ventilation had to be closed to prevent water entering the vehicle.
- Finally, a helicopter, which could not lift the capsule due to water weight, was able to drag Soyuz 23 to the lake edge.
- The crew was found alive but incapacitated due to high CO₂ levels inside the capsule.



Relevant Technical Requirements

[V2 6004] Nominal Vehicle/Habitat Carbon Dioxide Levels The system shall limit the average 1-hour CO₂ partial pressure (ppCO₂) in the habitable volume to no more than 3 mmHg.

[V2 6006] Total Pressure Tolerance Range for Indefinite Crew Exposure The system shall maintain the pressure to which the crew is exposed to between 34.5 kPa < pressure ≤ 103 kPa (5 psia < pressure ≤ 15.0 psia) for indefinite human exposure without measurable impairments to health or performance.

From: NASA-STD-3001 Volume 2, Rev D



Back-Up



Major Changes Between Revisions

Rev B → Rev C

- Updated information to be consistent with NASA-STD-3001 Volume 1 Rev C and Volume 2 Rev D.

Rev A → Rev B

- Updated to new template format.
- Added additional information on Standard background and application.

Original → Rev A

- Updated information to be consistent with NASA-STD-3001 Volume 1 Rev B and Volume 2 Rev C.



View the current versions of NASA-STD-3001 Volume 1 & Volume 2 on the [OCHMO Standards website](#)

Referenced Technical Requirements

NASA-STD-3001 Volume 1 Revision C

[V1 3003] In-Mission Preventive Health Care All programs shall provide training, in-mission capabilities, and resources to monitor physiological and psychosocial well-being and enable delivery of in-mission preventive health care, based on epidemiological evidence-based probabilistic risk assessment (PRA), individual crewmember needs, clinical practice guidelines, flight surgeon expertise, historical review, mission parameters, and vehicle derived limitations. These analyses consider the needs and limitations of each specific vehicle and design reference mission (DRM) with particular attention to parameters such as mission duration, expected return time to Earth, mission route and destination, expected radiation profile, concept of operations, and more. In-mission preventive care includes, but is not limited to: (see NASA-STD-3001 Volume 1 Rev C for full technical requirement).

[V1 3004] In-Mission Medical Care All programs shall provide training, in-mission medical capabilities, and resources to diagnose and treat potential medical conditions based on epidemiological evidence-based PRA, individual crewmember needs, clinical practice guidelines, flight surgeon expertise, historical review, mission parameters, and vehicle-derived limitations. These analyses consider the needs and limitations of each specific vehicle and design reference mission (DRM) with particular attention to parameters such as mission duration, expected return time to Earth, mission route and destination, expected radiation profile, concept of operations, and more. In-mission capabilities (including hardware and software), resources (including consumables), and training to enable in-mission medical care, and behavioral care, are to include, but are not limited to: (see NASA-STD-3001 Volume 1 Rev C for full technical requirement).

[V1 5002] Crewmember Training Beginning with the astronaut candidate year, general medical training, including, but not limited to, first aid, cardiopulmonary resuscitation (CPR), altitude physiological training, carbon dioxide exposure training, familiarization with medical issues, procedures of space flight, psychological training, and supervised physical conditioning training shall be provided to the astronaut corps.

[V1 5009] Physiological Exposure Mission Training Physiological training shall be provided to assist crewmembers with pre-mission familiarization to in-flight exposures including but not limited to: carbon dioxide [CO₂] exposure training, hypoxia training/instruction, centrifuge, and high-performance aircraft microgravity adaptation training in preparation for each mission.

NASA-STD-3001 Volume 2 Revision D

[V2 4015] Aerobic Capacity The system shall be operable by crewmembers with the aerobic capacity as defined in NASA-STD-3001, Volume 1.

[V2 6001] Trend Analysis of Environmental and Suit Data The system shall provide environmental and suit monitoring data in formats compatible with performing temporal trend analyses.

[V2 6004] Nominal Vehicle/Habitat Carbon Dioxide Levels The system shall limit the average one-hour CO₂ partial pressure (ppCO₂) in the habitable volume to no more than 3 mmHg.

[V2 6006] Total Pressure Tolerance Range for Indefinite Crew Exposure The system shall maintain the pressure to which the crew is exposed to between 34.5 kPa < pressure ≤ 103 kPa (5 psia < pressure ≤ 15.0 psia) for indefinite human exposure without measurable impairments to health or performance.



View the current versions of NASA-STD-3001 Volume 1 & Volume 2 on the [OCHMO Standards website](#)

Referenced Technical Requirements

NASA-STD-3001 Volume 2 Revision D

[V2 7041] Environmental Control During Exercise The system environmental control shall accommodate the increased O₂ consumption and additional output of heat, CO₂, perspiration droplets, odor, and particulates generated by the crew in an exercise area.

[V2 6020] Atmospheric Data Recording For each isolatable, habitable compartment, the system shall automatically record pressure, humidity, temperature, ppO₂, and ppCO₂ data continuously.

[V2 6021] Atmospheric Data Displaying The system shall display real-time values for pressure, humidity, temperature, ppO₂, and ppCO₂ data to the crew locally and remotely.

[V2 6022] Atmospheric Monitoring and Alerting Parameters The system shall alert the crew locally and remotely when atmospheric parameters, including atmospheric pressure, humidity, temperature, ppO₂, and ppCO₂ are outside safe limits.

[V2 6107] Nominal Vehicle/Habitat Atmospheric Ventilation The system shall maintain a ventilation rate within the internal atmosphere that is sufficient to provide circulation that prevents CO₂ and thermal pockets from forming, except during suited operations, toxic cabin events, or when the crew is not inhabiting the vehicle.

[V2 6108] Off-Nominal Vehicle/Habitat Atmospheric Ventilation The system shall control for ppO₂, ppCO₂, and relative humidity during off-nominal operations, such as temporary maintenance activities in areas not in the normal habitable volume.

[V2 11034] Suited Atmospheric Data Recording Systems shall automatically record suit pressure, ppO₂, and ppCO₂.

[V2 11035] Suited Atmospheric Data Displaying Suits shall display suit pressure, ppO₂, and ppCO₂ data to the suited crewmember.

[V2 11036] Suited Atmospheric Monitoring and Alerting Suits shall monitor suit pressure, ppO₂, and ppCO₂ and alert the crewmember when they are outside safe limits.

[V2 11037] EVA Suited Metabolic Rate Measurement The system shall measure or calculate metabolic rates of suited EVA crewmembers.

[V2 11038] EVA Suited Metabolic Rate Display The system shall display metabolic data of suited EVA crewmembers to the crew.

[V2 11039] Nominal Spacesuit Carbon Dioxide Levels The spacesuit shall limit the inspired CO₂ partial pressure (P_iCO₂) in accordance with Table 11.3-1—Spacesuit Inspired Partial Pressure of CO₂ (P_iCO₂) Limits.



Reference List

1. NASA-STD-3001 Volume 2, Revision B. (2009).
https://www.nasa.gov/sites/default/files/atoms/files/NASA-std-3001_vol_2_rev_b.pdf
2. Law J, Watkins S, Alexander D. (2010). In-Flight Carbon Dioxide Exposures and Related Symptoms: Association, Susceptibility, and Operational Implications. *NASA Scientific and Technical Information (STI) Program Office*. NASA Internal Document NASA/TP–2010– 216126.
3. Lee AG, Mader TH, Gibson CR, Tarver W, Rabiei P, Riascos RF, Galdamez LA, Brunstetter T. (2020). Spaceflight associated neuro-ocular syndrome (SANS) and the neuro-ophthalmologic effects of microgravity: a review and an update. *NPJ Microgravity*, 6(7): 3771.
4. Evidence Report: Risk of Spaceflight Associated Neuro-ocular Syndrome (SANS). (2017). *Human Research Program – Human Health Countermeasures Element*. NASA Internal Document.
5. Basner M, Nasrini J, Hermsillo E, McGuire S, Dinges DF, Moore TM...& Bershad EM. (1985). Effects of 12° head-down tilt with and without elevated levels of CO₂ on cognitive performance: the SPACECOT study. *Journal of Applied Physiology*, 124(3): 750-760.
6. Scully RR, Basner M, Nasrini J, Lam CW, Hermsillo E, Gur RC...& Ryder VE. (2019). Effects of acute exposures to carbon dioxide on decision making and cognition in astronaut-like subjects. *NPJ Microgravity*, 5(127).
7. Rodeheffer CD, Chabal S, Clarke JM, Fothergill DM. (2018). Acute Exposure to Low-to-Moderate Carbon Dioxide Levels and Submariner Decision Making. *Aerospace Medicine and Human Performance*, 89(6): 520-525.
8. Demontis GC, Germani MM, Caiani EG, Barravecchia I, Passino C, Angeloni D. (2017). Human Pathophysiological Adaptations to the Space Environment. *Frontiers in Physiology*, 8: 547.
9. James JT. Chapter 7: Carbon Dioxide. In: *Spacecraft Maximum Allowable Concentrations for Selected Airborne Contaminants*. Volume 5 (2008), *National Research Council of the National Academies*.
10. Astronaut Health and Performance. https://www.nasa.gov/centers/johnson/pdf/584739main_Wings-ch5d-pgs370-407.pdf
11. Law J, Van Baalen M, Foy M, Mason SS, Mendez C, Wear ML, Meyers VE, Alexander D. (2014). Relationship between carbon dioxide levels and reported headaches on the International Space Station. *Journal of Occupational and Environmental Medicine*, 56(5): 477-483.
12. Widmaier EP, Hershel R, Strang KT. (2016). *Vander's Human Physiology: The Mechanisms of Body Function* (14th ed.). New York: McGraw Hill. ISBN 9781259294099.
13. Chullen,C, Conger,B Korona,A, Kanne,B Mcmillin,S, Paul,T, Norcross,J, Alonso,J, Swickrath,M, Utilizing a Suited Manikin Test Apparatus and spacesuit Ventilation Loop to Evaluate Carbon Dioxide Washout. JSC-CN-33276, Report Paper International Conference on Environmental Systems. July 12,2015
14. NASA Extravehicular Mobility Unit (EMU) LSS/SSA Data Book. September 2017 UTC Aerospace Systems.
15. Da Poian, A. T., El-Bacha, T. & Luz, M. R.M.P. (2010) Nutrient Utilization in Humans: Metabolism Pathways. *Nature Education*, 3(9):11.