

MTS TESTLINE **IDEA BOOK**

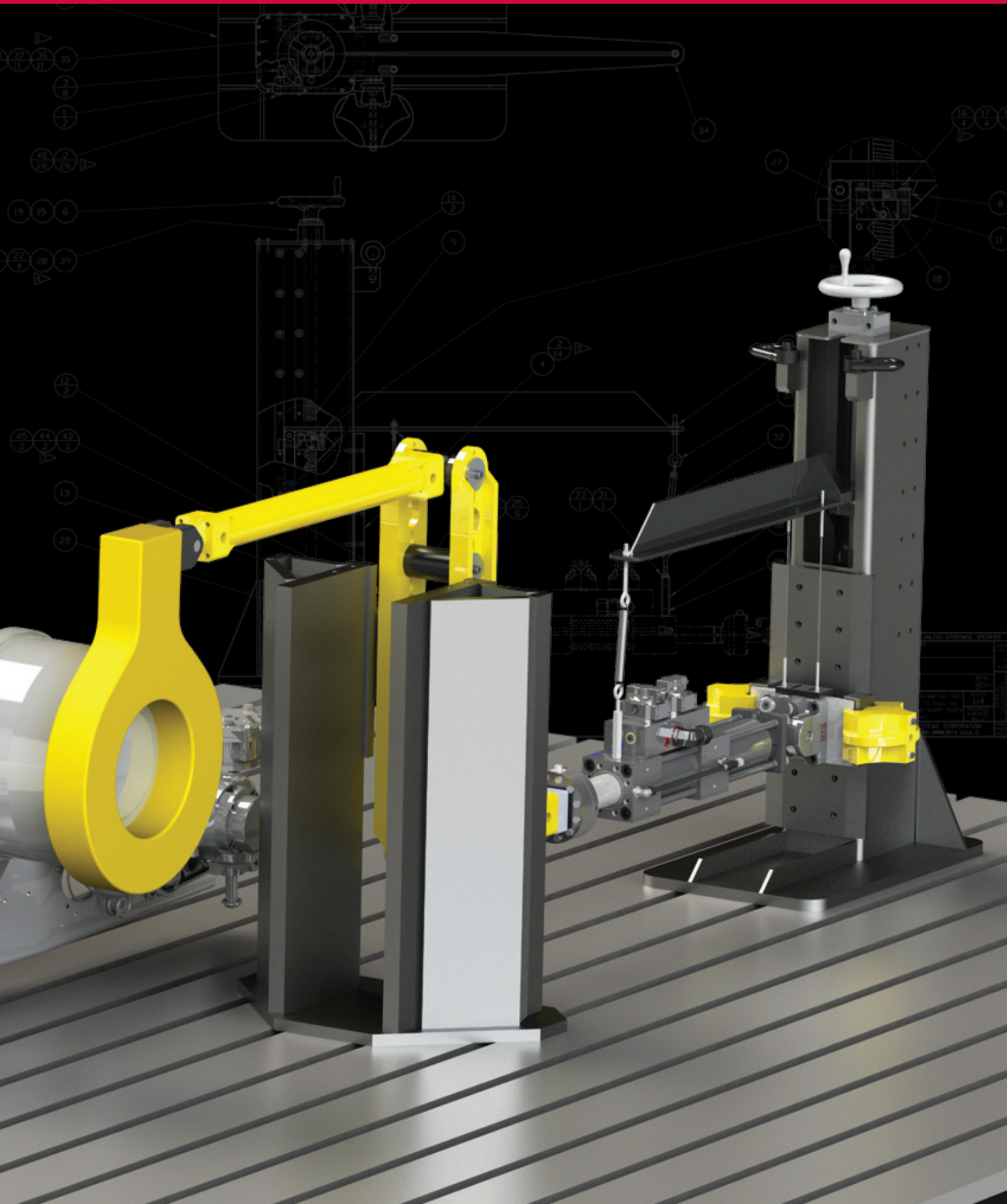

What are MTS TestLine Solutions?

MTS TestLine Solutions are a selection of components that help you build modular test systems that can be reconfigured as your needs change. MTS provides the premium-quality products and components — you provide the imagination.

The TestLine philosophy is focused on you. Recognizing that your mechanical testing needs are frequently as unique as your products, MTS developed TestLine Solutions as a way for you to engineer a test system that's specific to your needs, yet modular enough to accommodate changing requirements.

TestLine Solutions comprise a versatile and reliable set of standard products, test components and software tools that enable you to create a cost-effective test system. If you have the in-house experience and design capability, MTS can equip you with the proven, high-quality TestLine components to build your test solution right the first time. The products, components and software used in a TestLine Solution are the same as those integrated into the most advanced MTS custom test systems. They are precision-engineered to the highest quality and designed for seamless integration.

TestLine Solutions are widely used in many industries, including automotive, aerospace, off-road, and rail testing. These products and components have also been used to test wire rope, bicycles, tools, seats, bones, bearings, bolsters and more. If you need to do mechanical testing, it is highly likely you can build your test system with a TestLine Solution.

The following pages offer just a few examples of the premium-quality products and components that can be a part of a TestLine Solution. But when you use your imagination, the possibilities are endless.

TESTING IDEA #1

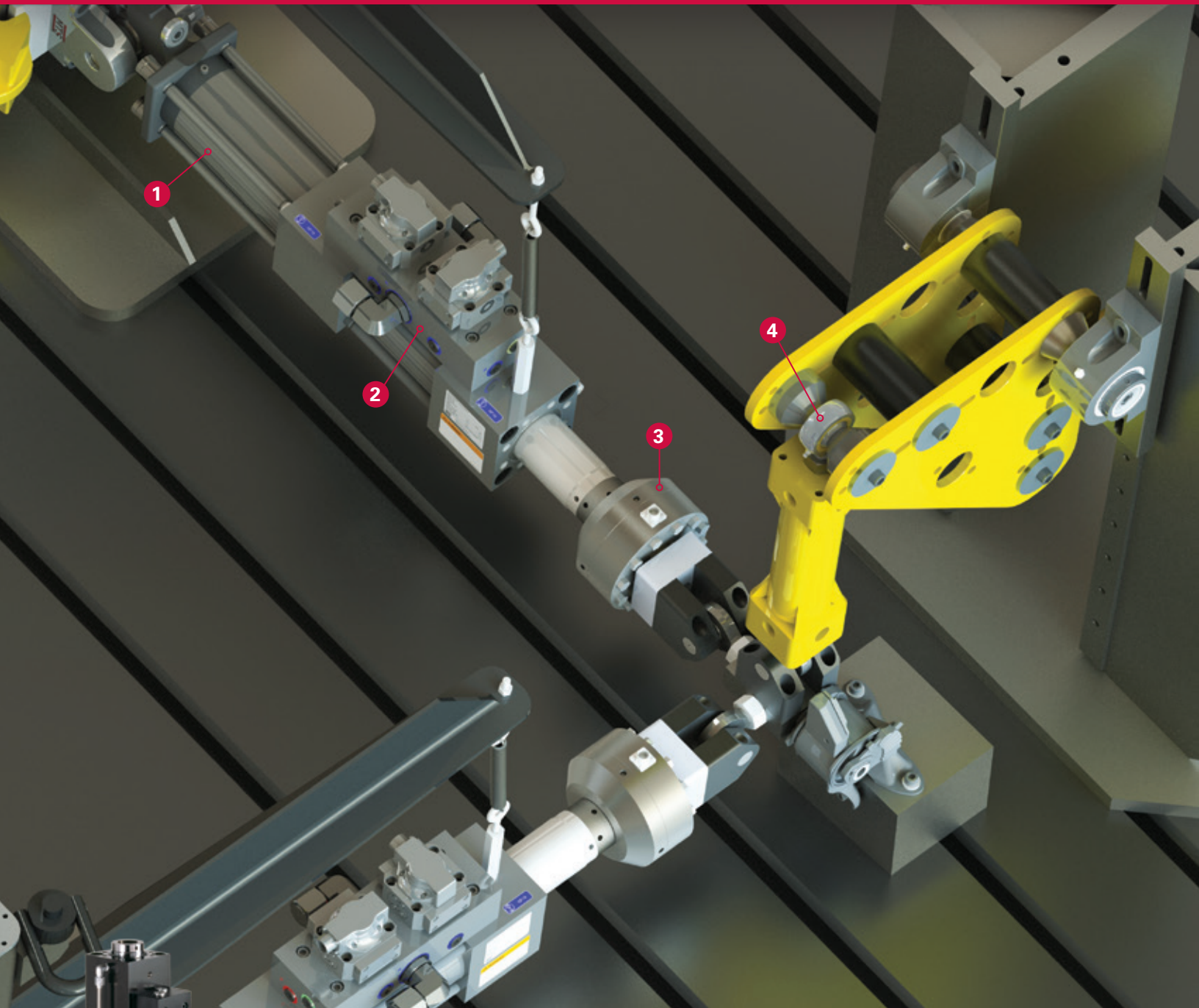

1 Actuators

The family of MTS actuators ranges from Series 244 actuators for precise control of high-frequency motions and forces, to the economical Series 201 actuator for static or low-frequency testing, to heavy-duty rotary actuators that deliver reliable torque generation.

Force ratings range from:

- » Series 201 - Tension: 32 kN (7 kip) to 1775 kN (400 kip)
Compression: 63 kN (14 kip) to 2595 kN (590 kip)
- » Series 242 - 2.7 kN (0.6 kip) to 14.7 kN (3.3 kip)
- » Series 244 - 15 kN (3.3 kip) to 250 kN (55 kip)
- » Series 248 - 10 kN (2.2 kip) to 160 kN (35 kip)

Rotary actuator torque ratings range from:

- » Series 215 - 226 N-m (2000 lbf-in) to 11.300 N-m (100,000 lbf-in)

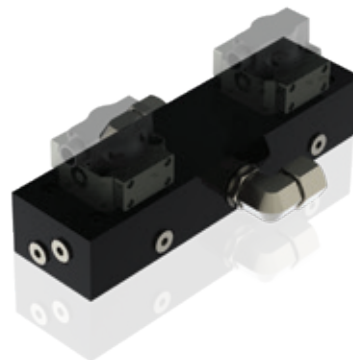

2 Servovalve Manifold Assembly

Installed between the servovalve and actuator, the servovalve manifold makes it simpler to swap out servovalves without having to disconnect hoses.

Motor Mount Test

SYSTEM DESCRIPTION:

This motor mount test system is an example of a three-axis (X, Y, Z) test configuration. Three actuators configured with load cells and rod end swivels are mounted on adjustable horizontal base assemblies. Two actuators apply direct load to the specimen. A reaction stand with bellcrank converts lateral force from a third actuator into vertical force applied to the specimen.

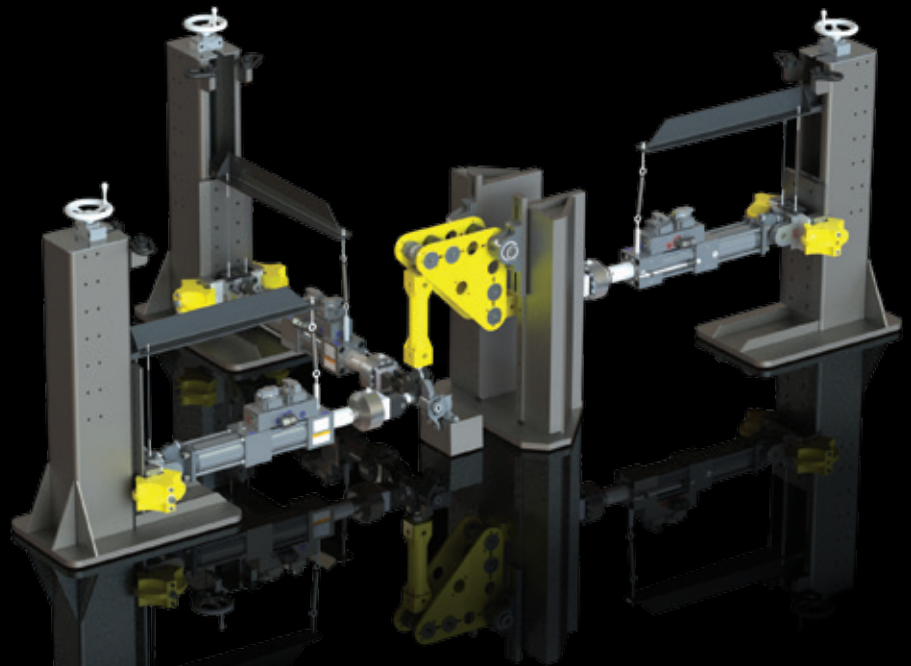

3 Load Cell

Dynamic fatigue-rated load cells reduce errors caused by extraneous side loads or loading changes from geometry shifts in the specimen.

- » Low deflection and high stiffness for better dynamic performance
- » High output for excellent resolution and reading accuracy
- » Simple mounting makes installation and removal easy
- » Variety of sizes for versatility



4 Rod End Spacer Assembly

TestLine rod end and solid spacers are used in bellcrank and lever assemblies. The swivel spacer provides a pivoting and rotating connection to actuators, struts, or other components.

- » Force Rating: 50 kN (11 kip)
- » Weight: 4 kg (8.7 lb)
- » Rod end thread: M24X2

TESTING IDEA #2

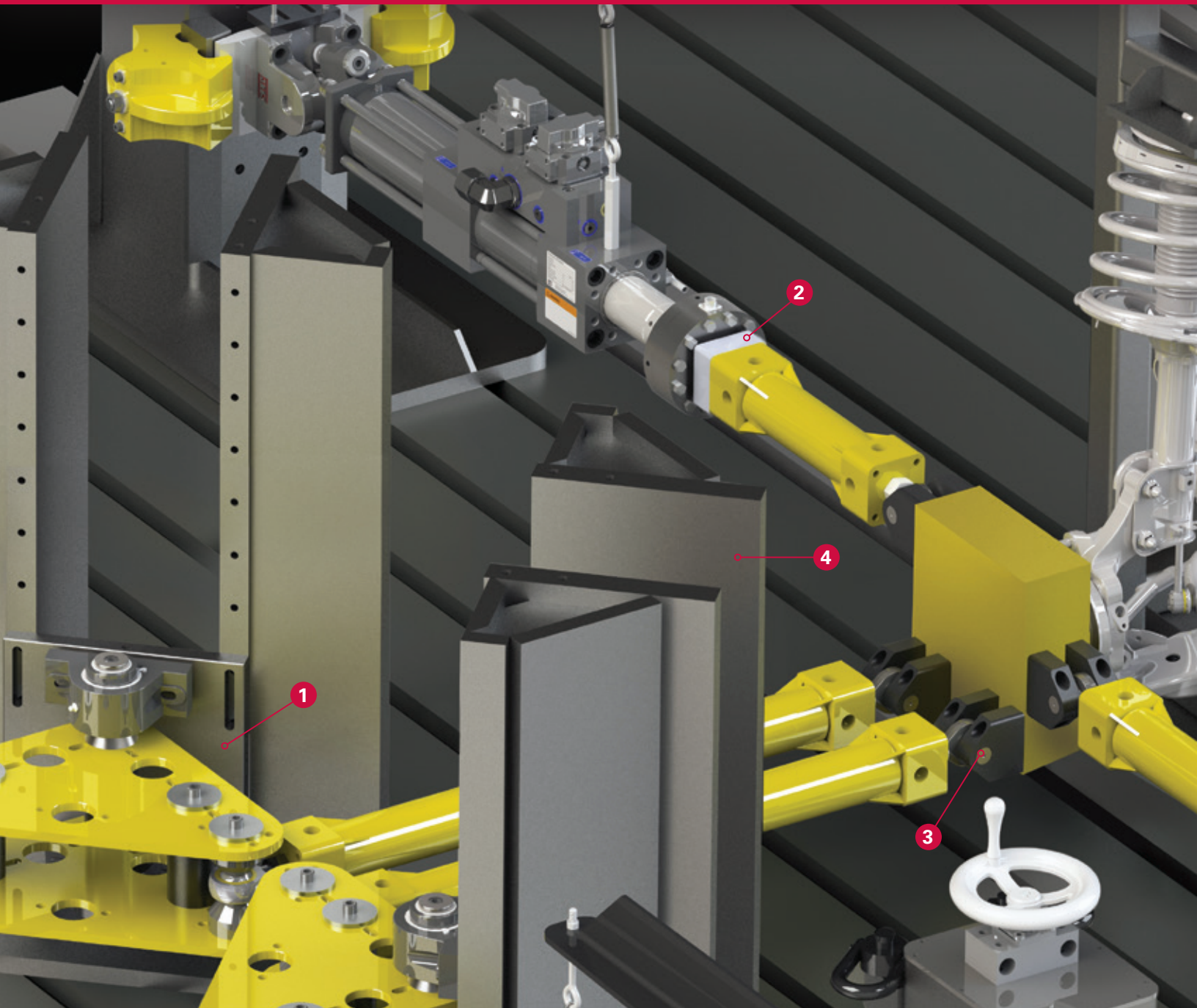

1 Bellcrank Mounting Plate

This horizontal mounting plate is used to mount a bellcrank or lever to a reaction stand in a horizontal orientation. The slotted holes allow for precise height adjustments when mounted on the reaction stand.

- » Force Rating: 50 kN (11 kip) (shown)
160 kN (35 kip) also available
- » Weight: 22.5 kg (49 lb)

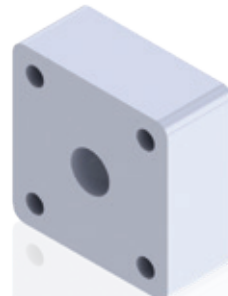

2 Adapter Block

This adapter with M24X2 center hole and four M12X1.75 tapped holes can connect to either end of the strut assembly, as a means of connecting the strut to other components such as load cells or actuators using a threaded stud (included).

- » Force Rating: 50 kN (11 kip) (shown)
160 kN (35 kip) also available
- » Weight: approx. 2.7 kg (6 lb)

Knuckle Test

SYSTEM DESCRIPTION:

This example shows a common configuration for struts, bellcranks and reaction stands in a TestLine system. Bellcranks can be used to redirect forces from an actuator to save space in the test lab, or to apply forces in places where there is insufficient space for an actuator. *Note: This example is intended only to illustrate the use of individual TestLine components.*

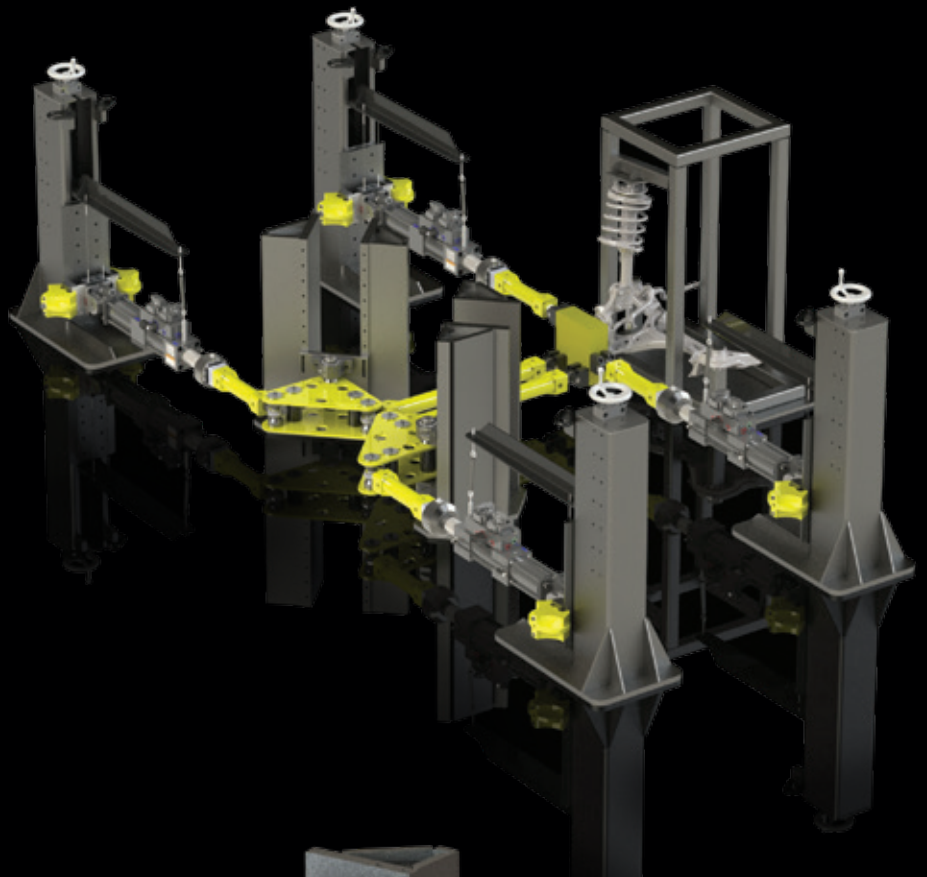
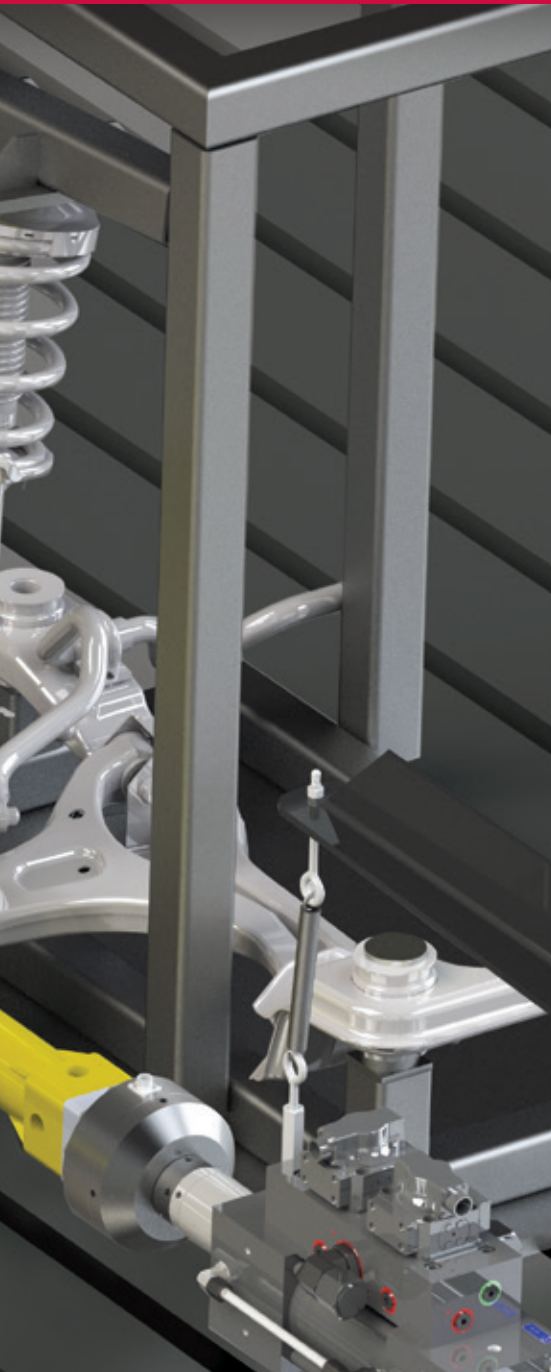

3 Rod End Block Assembly

This rod end block assembly allows struts, actuators, and other fixturing to be mounted to a reaction mass, structural base or bedplate.

- » Force Rating: 50 kN (11 kip) (shown)
Higher capacities available with MTS Series 249 Swivels
- » Weight: approx. 3.5 kg (8 lb)

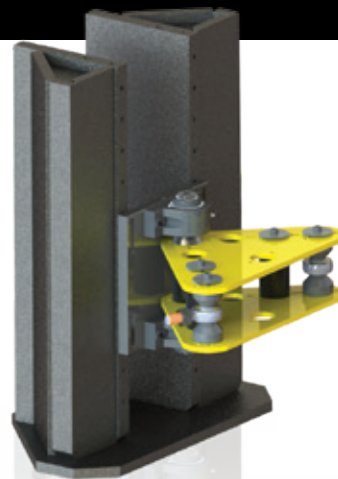

4 Reaction Stand Assembly

This reaction stand is configured with a bellcrank mounting plate, two pillow blocks and a bellcrank assembly with rod end spacer assemblies.

- » Force Rating: 50 kN (11 kip) (shown)
160 kN (35 kip) also available

TESTING IDEA #3

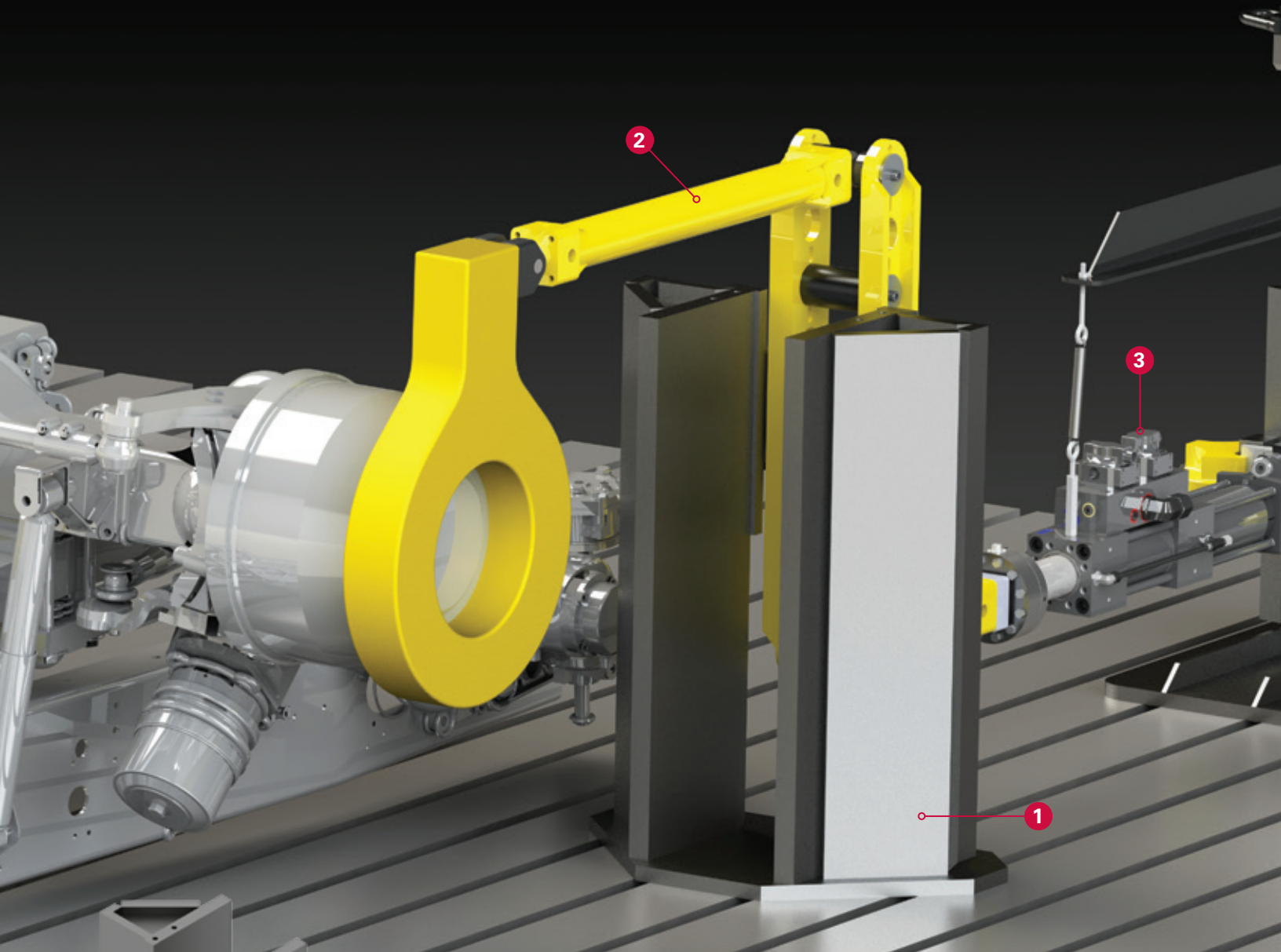

1 Reaction Stand Weldment

Reaction stands are used to support bellcranks as well as other parts or assemblies. A series of holes in the stand allows for multiple height adjustments.

- » Force Rating: 50 kN (11 kip) (shown)
160 kN (35 kip) also available
- » Weight: 382 kg (840 lb)



2 Universal Struts

These components are primarily used to transfer loads in the axial direction of the strut. However, the universal ends allow additional struts or actuators to be connected perpendicular to the axis of the strut for biaxial loads or motion.

- » Lengths: 500 mm (19.68 in),
1000 mm (39.37 in) &
1800 mm (70.87 in)
- » Force Rating: 50 kN (11 kip) (shown)
160 kN (35 kip) also available

Axle Torque Test

SYSTEM DESCRIPTION:

In this example, a torsion load is applied to an axle. The reaction stand, lever assembly and strut are used to transmit force from the actuator to a lever on the specimen. The lever allows for the load to be applied a greater distance from the floor without the need for a taller reaction base.

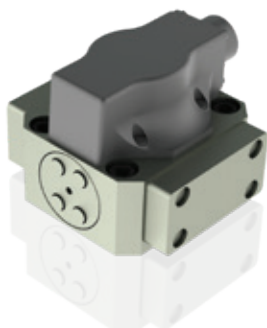
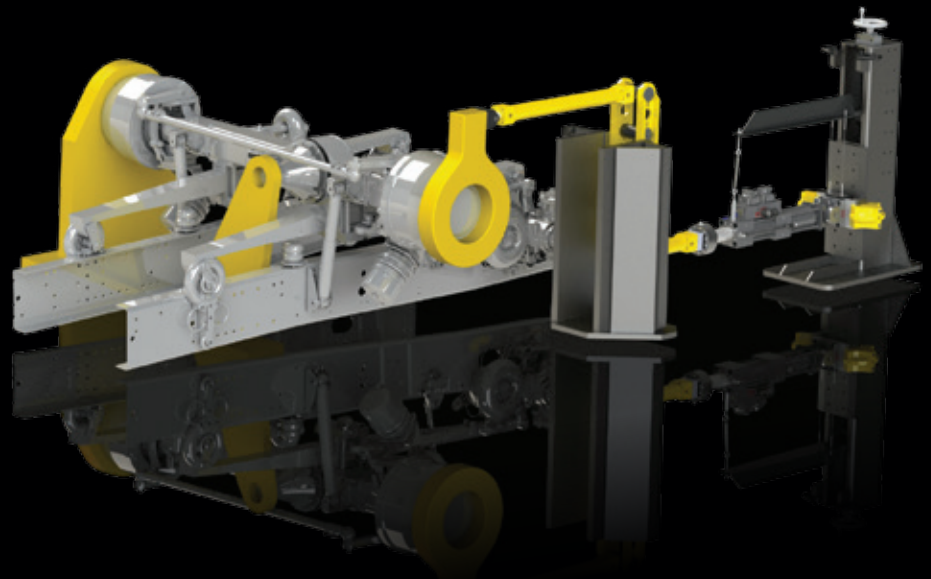
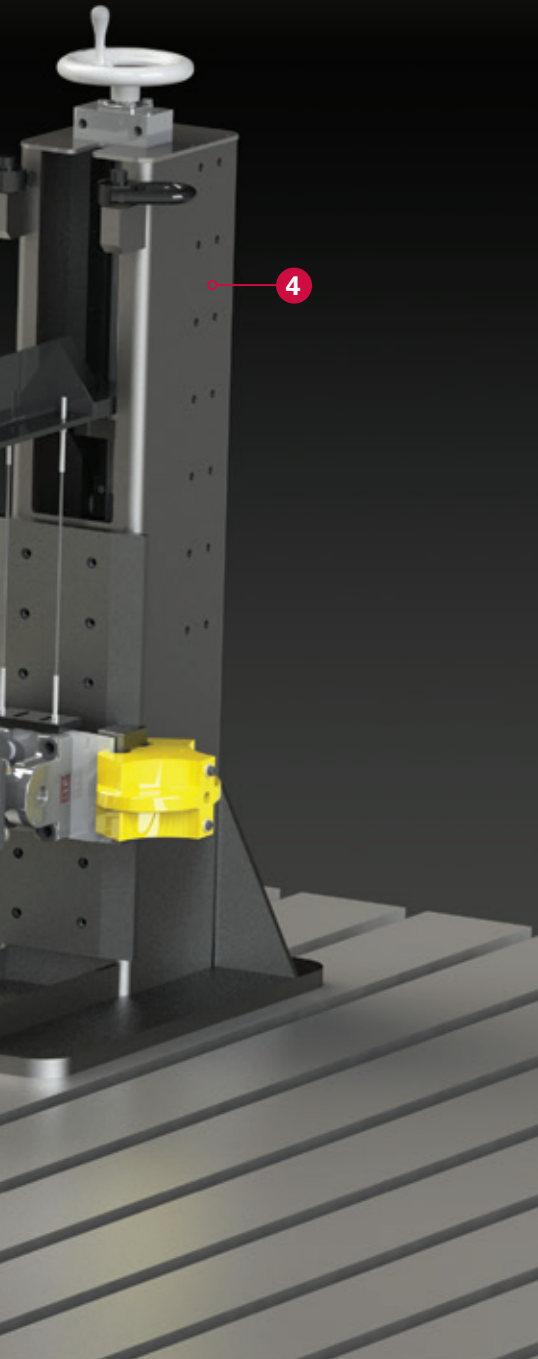

3 252 Servovalve

These two-stage, four-way-valve servovalves are designed specifically for servocontrol of hydraulic systems. These high-performance components are available in variety of flow rates ranging from 4 – 227 lpm (1–60 gpm).

- » High resolution and low hysteresis for precise flow control
- » 31 MPa (4500 psi) maximum operating pressure
- » Internal filtration protects nozzle orifices from contamination

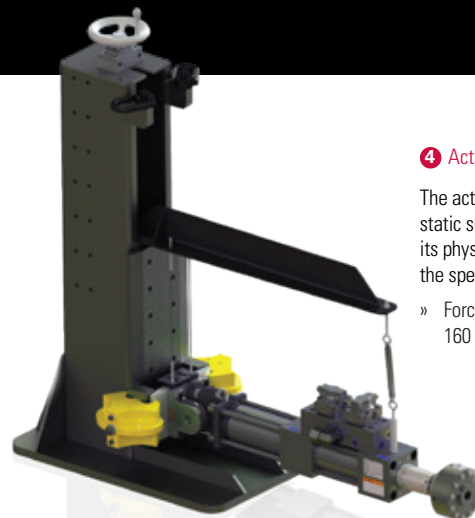

4 Actuator Base Assembly

The actuator base assembly provides static support to the actuator so that its physical weight is not applied to the specimen.

- » Force Rating: 50 kN (11 kip) (shown)
160 kN (35 kip) also available

TESTING IDEA #4

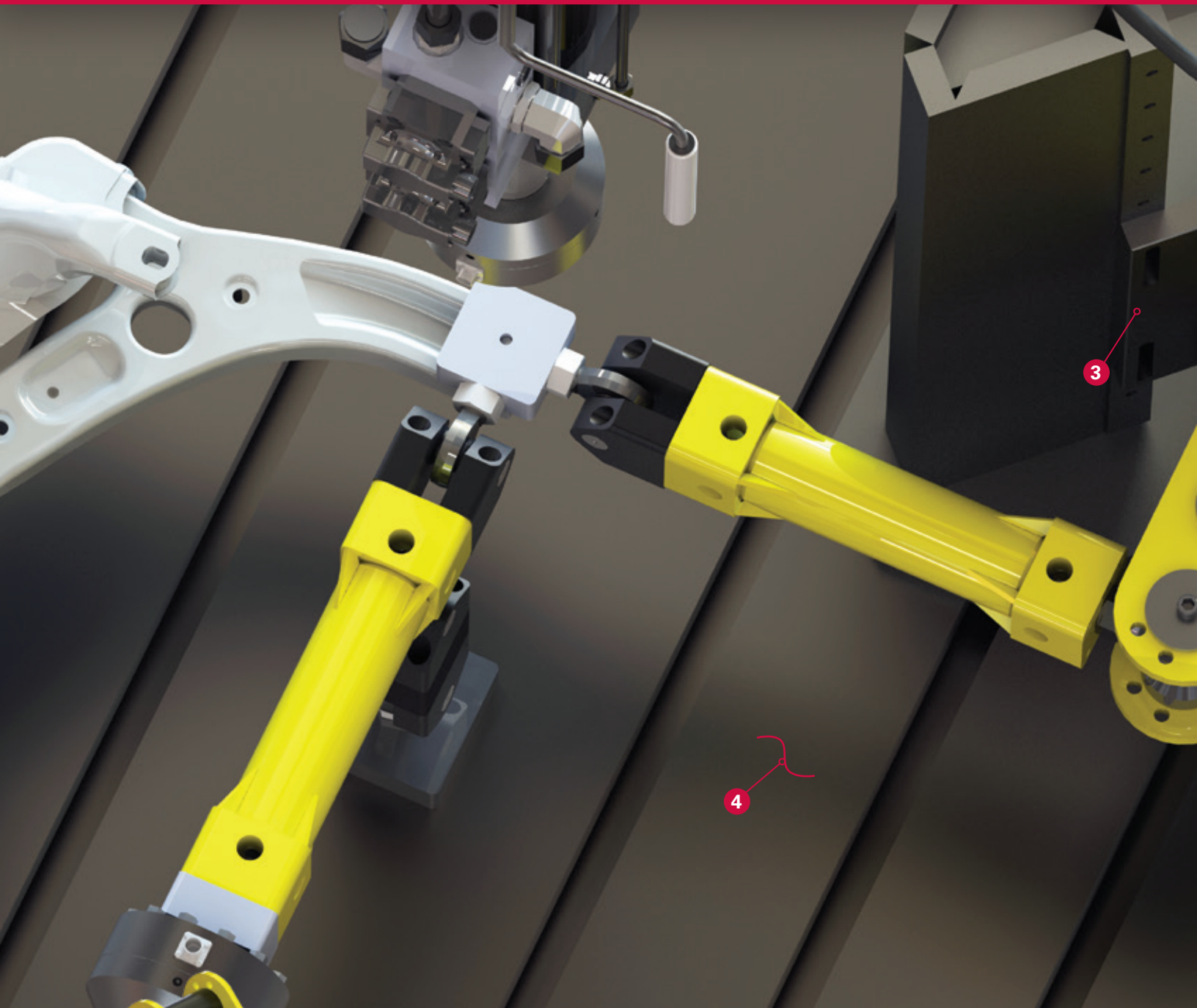

1 Bellcrank Assembly

This durable, versatile component features multiple connection points to accommodate a variety of bellcrank mechanical ratios. The bellcrank assembly includes two swivel rod ends and two pillow block bearings with 25 mm (one inch) mounting spacers.

» Force Rating: 50 kN (11 kip) (shown)
160 kN (35 kip) also available

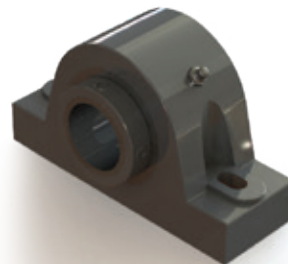

2 Pillow Block Bearing

This self-aligning bearing is used to securely and precisely mount bellcranks and levers to a reaction base or stand. Bearings can be mixed and matched with bellcranks, struts and levers to create a robust custom test system.

» Force Rating: 50 kN (11 kip) (shown)
160 kN (35 kip) also available

Lower Control Arm Test

SYSTEM DESCRIPTION:

Shown here is a three-axis test utilizing a portal frame and bellcrank assembly. The portal frame allows the vertical force to be applied directly by an actuator above, and the bellcrank allows a lateral load to be applied where there would otherwise not be enough space for an actuator.

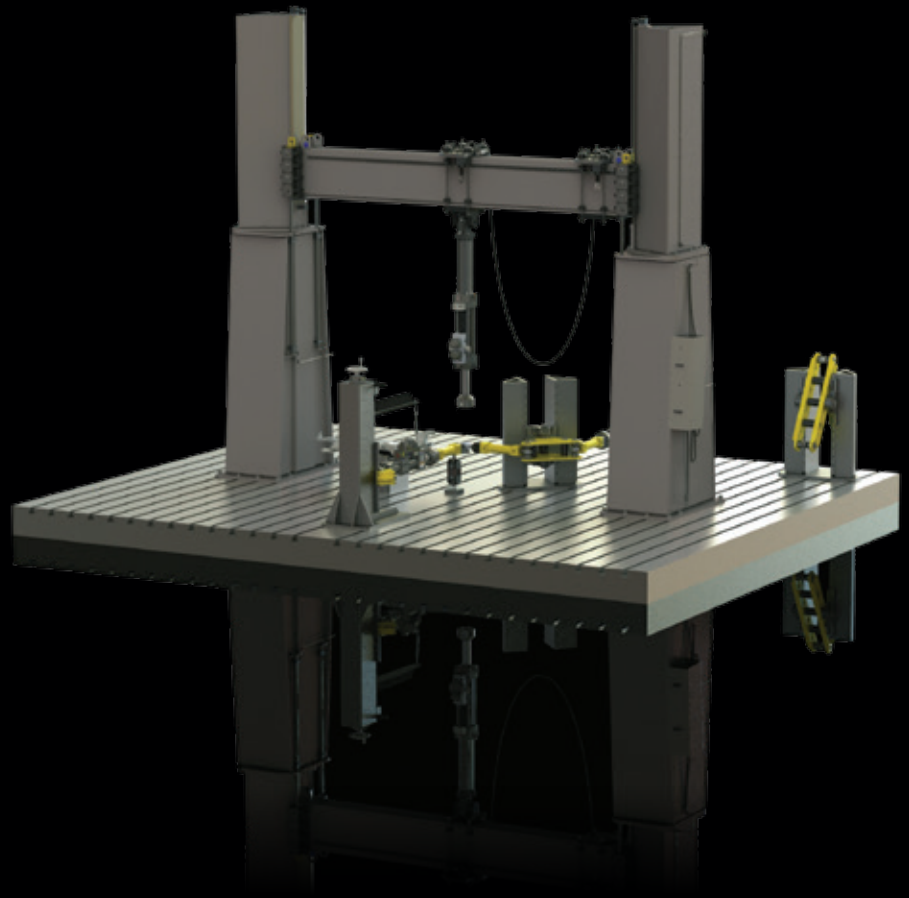
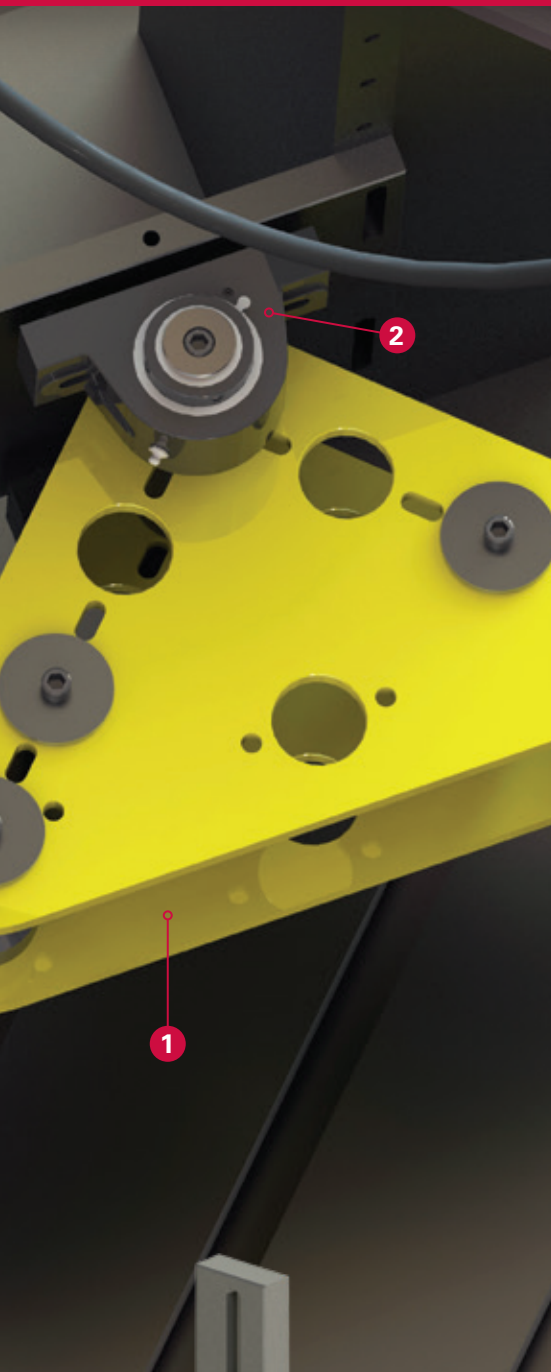

3 Vertical Bracket - Pillow Block

Plates and hardware for mounting bellcrank or lever assembly vertically on reaction stand.

- » Force Rating: 50 kN (11 kip) (shown)
160 kN (35 kip) also available



4 Tee-Slot Bedplate

Steel bed plates provide secure mounting surfaces for test fixtures and reaction brackets to help ensure safe and efficient testing. Slots in the bed plate allow for convenient placement of test fixtures. Bedplates can rest on rubber isolation pads or be anchored with grouting to a concrete floor. A seismic mass is not required.

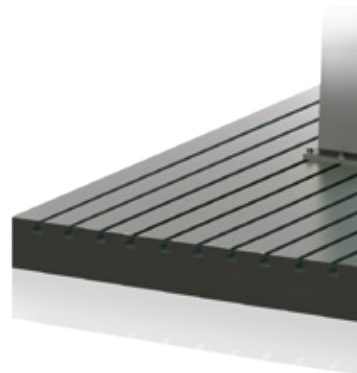

TESTING IDEA #5

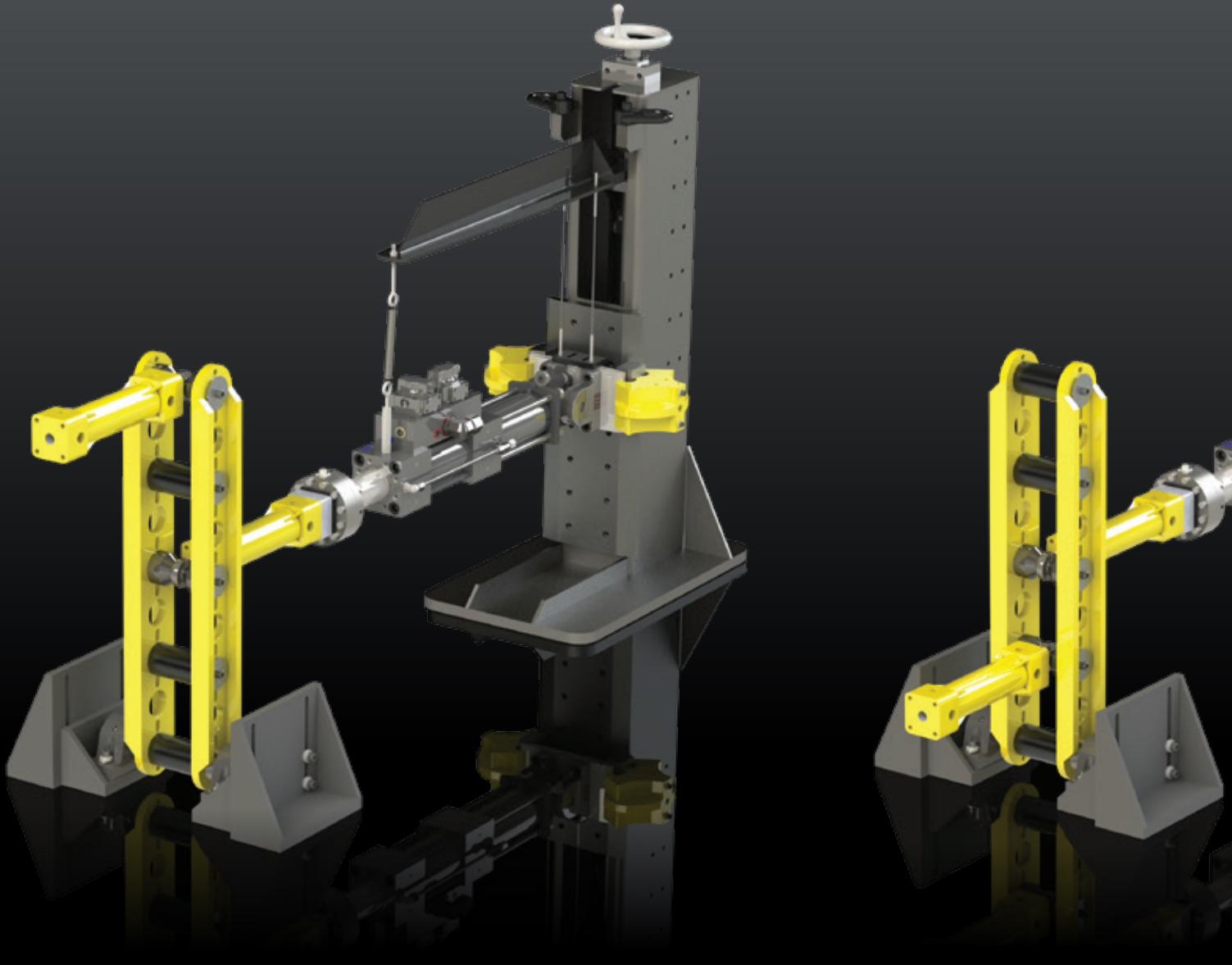

Other Available Components

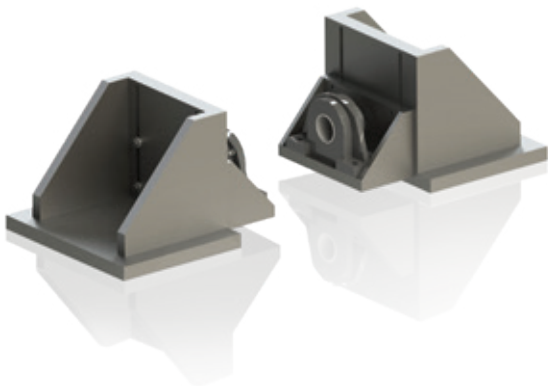

Adjustable Height Mounting L Brackets with Pillow Block Bearing

Low mount assembly is used to mount pillow block bearings near the floor level. Brackets can be adjusted vertically for precise locating of test components.

- » Force Rating: 50 kN (11 kip) (shown)
160 kN (35 kip) also available

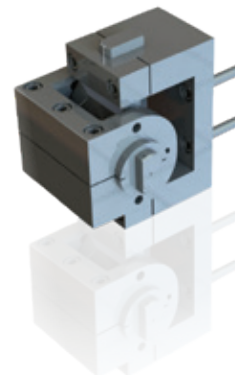

U-Joint Assembly

Universal joint allows rotation in two axes while restraining the third twist axis.

- » Force Rating: 50 kN (11 kip) (shown)
160 kN (35 kip) also available
- » Weight: 15 kg (32 lb)

Configure it your way

The examples on the left show an adjustable actuator base assembly paired with a lever and low-mount assembly, which can be configured in many ways to fulfill different testing needs. In the example on the far left we've placed the output strut further from the pivot point to increase stroke and velocity capacity while reducing force capacity. The example on the right shows the lever configured as a force multiplier by placing the output strut closer to the pivot point than the actuator. *Note: This output force should not exceed the capacity of any component connected to it.*

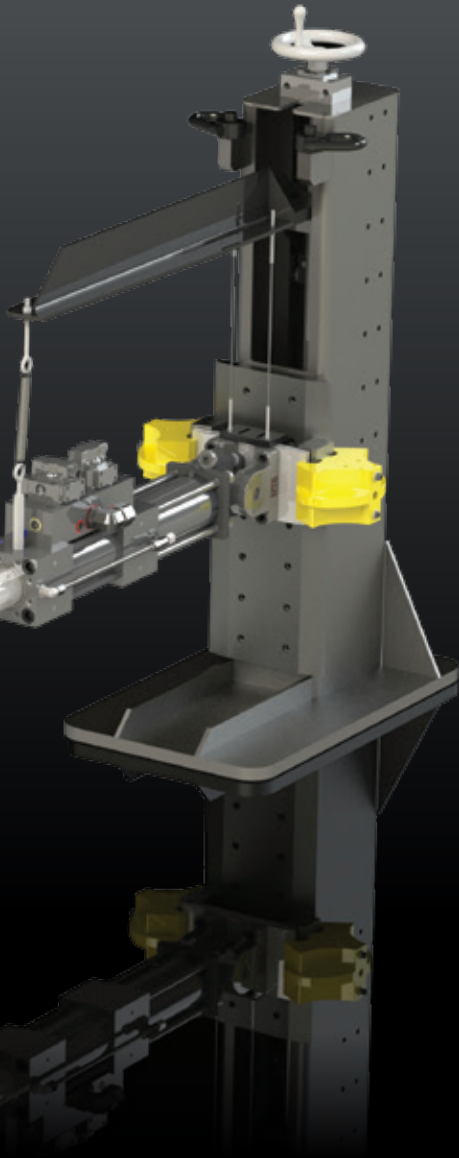

Lever Assembly

This component is typically used to obtain a mechanical advantage in either force or displacement, while isolating actuators from moments and side loads. It can also be used to change load direction or multiply force, velocity or displacement. When used as a force multiplier, output should not exceed rated force. The assembly includes two swivel rod ends and two bearings.

- » Force Rating: 50 kN (11 kip) (shown)
160 kN (35 kip) also available



Rod End Spacer

Rod end spacer for use with 11 kip bellcrank and lever assemblies.

STANDARD PRODUCTS

MTS Standard Products

MTS complements the TestLine offering with an array of standard MTS products — the same products used by industry-leading test professionals worldwide — to help you build the custom system you need from a single, trusted resource.



MTS SilentFlo™ 515 Hydraulic Power Units

Operating at or below sound levels commonly found in labs and factory floor environments, the SilentFlo HPU can be deployed directly in the lab, eliminating the need for costly pump housing facilities and reducing supply line length and space requirements.

With features that maximize electrical efficiency and minimize water consumption, and options for remote monitoring of pressure, temperature and fluid level, these HPUs will help reduce facility energy costs. For additional energy savings, the larger units can be equipped with a run-on-demand option that reduces electrical power and cooling water consumption when the system is not running at full capacity.



MTS Hydraulic Service Manifolds

MTS Hydraulic Service Manifolds (HSMs) provide independent pressure regulation for precise control, isolation and distribution of hydraulic fluid to test stations. By installing MTS HSMs into the hydraulic lines between the HPU and servovalve, you can turn each hydraulic circuit on or off and independently set low-pressure levels. This allows convenient, efficient test setup, operation and maintenance of individual test systems without disturbing other systems.

MTS HSMs also minimize the effects of the rapid application and removal of high pressure, reducing unexpected actuator movement that could damage the test article or the test system. They also provide rapid pressure reduction to ensure safety, as well as store energy for transient events that require peak performance.



MTS Hydraulic Actuators

All MTS hydraulic actuators feature fatigue-rated designs, which means they are built to exceed their rated loads for millions of cycles. You can expect highly reliable performance over a long functional life, helping to maximize your uptime and minimize total cost of ownership.

MTS actuators are engineered for precision. They deliver exceptional fidelity over the full range of motion, along with a superior ability to react to and counteract multiaxial forces. Proprietary materials and processes minimize friction for excellent reliability, wear-resistance and energy-efficiency.

MTS Software

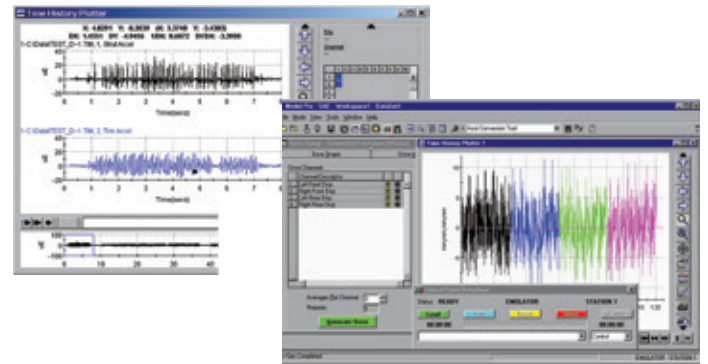
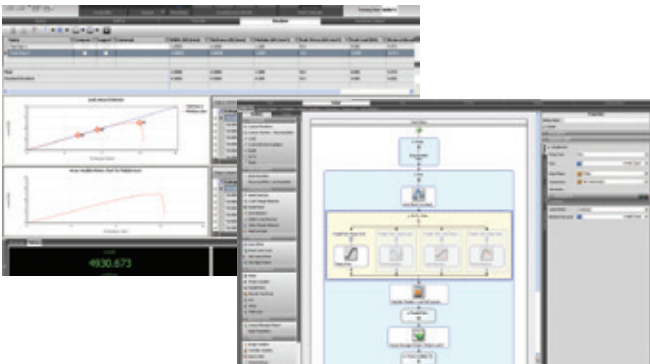

Take control of your testing with **MTS TestSuite™ Multipurpose Software**. With modules and options that are designed to be adaptable to your evolving needs. MTS TestSuite offers an intuitive, graphical depiction of workflow, making it easy to create and modify tests, and to view and edit the underlying calculations. This single environment allows you to create the right test to meet your objectives.

Easy-to-use **component RPC Pro software** is ideally suited for low-channel-count applications and component testing. In addition, this software's modular design allows for an affordable and scalable solution to meet your specific simulation requirements. Preconfigured templates, interactive wizards, informative graphical displays, integrated data management and context-sensitive online help guide all users through the testing process.



MTS FlexTest® Digital Controllers

MTS FlexTest digital controllers deliver the tools you need to define and automate virtually any material, component or structural test. This versatile, modular family of controllers provides high-speed closed-loop control, function generation, transducer conditioning and data acquisition for a full range of testing needs.

The MTS FlexTest offering features higher speeds and channel densities to keep pace with evolving test demands, and all models share common hardware boards and user interface tools, helping to simplify test standardization and optimization. Centralized processors and test resource boards can also be easily upgraded in the field, giving you flexibility to meet new future test requirements as they arise.

Regional Business Centers

THE AMERICAS

MTS Systems Corporation

14000 Technology Drive
Eden Prairie, MN 55344-2290
USA

Telephone: 952-937-4000
Toll Free: 800-328-2255
E-mail: info@mts.com
Internet: www.mts.com

EUROPE

MTS Systems France

BAT EXA 16
16/18 rue Eugène Dupuis
94046 Créteil Cedex
France

Telephone: +33-(0)1-58 43 90 00
E-mail: contact.france@mts.com

MTS Systems (Germany) GmbH

Hohentwielsteig 3
14163 Berlin
Germany
Telephone: +49-(0)30 81002-0
E-mail: euroinfo@mts.com

MTS Systems S.R.L. a socio unico

Strada Pianeza 289
10151 Torino
Italy
Telephone: +39-(0)11 45175 11 sel. pass.
E-mail: mtstorino@mts.com

MTS Systems Norden AB

Datavägen 37b
SE-436 32 Askim
Sweden
Telephone: +46-(0)31-68 69 99
E-mail: norden@mts.com

MTS Systems Limited

98 Church Street,
Hunslet,
Leeds
LS102AZ
United Kingdom
Telephone: +44 (0) 113 270 8011
E-mail: mtsuksales@mts.com

ASIA/PACIFIC

MTS Japan Ltd.

Raiden Bldg. 3F 3-22-6,
Ryogoku, Sumida-ku,
Tokyo 130-0026
Japan
Telephone: +81 3 5638 0850
E-mail: mtsj-info@mts.com

MTS Korea, Inc.

2nd F, Bundang Yemiji Building, 31, Hwangsae-ul-ro 258beon-gil,
Bundang-gu, Seongnam-si,
Gyeonggi-do, 13595
Korea
Telephone: +82-31-728-1600
E-mail: mtsk-info@mts.com

MTS Systems (China) Co., Ltd.

Floor 34, Building B,
New Caohejing International
Business Center,
No.391, Guiping Road,
Xuhui District
Shanghai 200233
P.R.China
Telephone: +021-24151000
Market: +021-24151111
Sales: +021-24151188
Service: +021-24151198
E-mail: MTSC-Info@mts.com

MTS Testing Solutions India Pvt Ltd.

No. 38, Ground Floor, Donata Radiance,
1st Cross, Tavarekere Main Road,
DRC Post, Krishna Nagar Industrial Layout,
Kormangala, Bangalore – 560 029
India
Telephone: + 91 80 46254100
Email: mts.india@mts.com



MTS Systems Corporation

14000 Technology Drive
Eden Prairie, MN 55344-2290 USA