

AN ANALYSIS OF THE  
AIRFLOW AROUND THE MGA ROADSTER

By  
J. J. Cornish, III

Research Note No. 19

October, 1963

Aerophysics Department  
Mississippi State University

## TABLE OF CONTENTS

	<u>Page</u>
<u>List of Figures</u> -----	iii
Introduction -----	1
Discussion of Apparatus and Experimental Techniques -----	2
Discussion of Results -----	3
Concluding Remarks -----	8
Figures -----	10

## LIST OF FIGURES

<u>Figure</u>		<u>Page</u>
1	MGA Open Roadster -----	10
2	Tufts on Full Scale MGA -----	11
3	Scale Model in Smoke Tunnel -----	11
4	Tape for Measuring Static Pressure on Hood and Photomanometer Mounted in Cockpit -----	12
5	Boundary Layer Rake on Hood -----	13
6	Airflow over MGA Windshield -----	14
7	Areas of Separated Flow -----	15
8	Schematic Diagram of Engine Compartment -----	15
9	Pressure Reduction in Engine Compartment Below Freestream Static Pressure -----	16
10	Flow Velocity over Hood of MGA -----	16
11	Non-dimensional Velocity over Hood -----	17
12	Pressure Differential Across Hood -----	17
13	Boundary Layer Development on Hood -----	18
14	Tufts Showing Separated Flow Ahead of Windshield-----	18
15	Tufts Showing Effects of Cross-wind -----	19
16	Location of Windshield Washer Jets -----	20
17	Stains on Hood from Washer Fluid -----	20
18	Pressure Reduction in Cockpit Below Freestream Static Pressure -----	21
19	Tufts and Diagram Showing Flow over Rear of MGA -----	22
20	Velocity of Reversed Flow Behind Cockpit -----	23
21	Powder Entrained in Wake of MGA -----	24

## AN ANALYSIS OF THE AIRFLOW AROUND THE MGA ROADSTER

### Introduction

The problem of designing a vehicle whose contours offer the minimum resistance to its passage through the air has long been recognized by the builders of airplanes, airships, and other flying machines. Because the air resistance or "drag" increases as the cube of the velocity, vehicles which travel at relatively high speeds must, of necessity, be designed to produce as low a drag as possible to avoid excessive power requirements. The art and science of producing "streamlined", low-drag shapes has become highly developed in the aircraft industry and, of more or less recent date, has been considered by the manufacturers of automobiles. With only a few notable exceptions, however, these latter attempts have been singularly unsuccessful. The questionable benefits of such "eyeball aerodynamics" must certainly be restricted to an esthetic illusion of higher speed and often produce unnecessary disturbances to the airflow. These excursions into aerodynamic design are generally harmless, however, since the power required to accelerate these heavy vehicles at an acceptable rate is usually more than sufficient to allow speeds well above legal limitations. Furthermore, many owners of automobiles appear prepared to accept, however reluctantly, the resulting penalty of very low gas mileage.

There are, however, aerodynamic problems other than drag reduction which result in annoying characteristics when the automobile is in motion. The "drumming" or resonance which occurs at certain speeds in some vehicles, the inflow of exhaust gases or dust into the rear windows of station wagons, poor engine and passenger ventilation, and high aerodynamic noise levels are all factors which detract from the pleasure and, indeed, the utility of the automobile. It is primarily toward these problems, rather than drag reduction, that a study was directed by the Aerophysics Department of Mississippi State University.

The present paper, as a part of the overall study, is concerned with the flow of air around a typical open sports roadster, the MGA. The purpose of this work is to define the general flow field around the vehicle and to isolate those undesirable characteristics which thereby become apparent. Several specific items have been singled out for particular attention and more detailed, quantitative measurements have been made in these cases. It is intended that subsequent corrective measures will be made to reduce or eliminate the characteristics so defined.

### Discussion of Apparatus and Experimental Techniques

As previously mentioned, the test vehicle employed in the present investigation is the MGA open roadster shown in detail in Figure 1. Because of the severe buffet and undesirable reversed flow in the open cockpit at almost all speeds, the study was conducted in the "top down" or open condition. Two automobiles were actually used in the investigation, a white 1959 MGA and a red 1960 MGA 1600.

Several techniques were used to define the general flow around the vehicle. The flow over the immediate surface was visualized by means of numerous three-inch tufts of nylon yard attached to the automobile with bits of plastic adhesive tape as shown in Figure 2. By photographing the automobile while underway from a remotely mounted camera or from a chase car, the flow directions at the surface could be easily determined. Areas of reversed, separated, or disturbed flow were readily isolated in this manner and could then be studied in detail.

The flow patterns determined were also used to justify a correlation between the full scale automobile and a scale model subsequently studied in the Aerophysics smoke tunnel as shown in Figure 3. By means of the smoke tunnel, the flow field away from the surface could be visualized, thus affording a more complete knowledge of the overall flow pattern.

In addition to the scale model smoke studies, full scale visualization of the flow at the rear and behind the automobile was accomplished both by releasing a white powder from the automobile while underway and

by running over stripes of powder laid down on the roadway. The clouds of white powder so entrained were photographed to determine the pattern of the flow in the wake of the automobile.

The flow in the boundary layer on the hood and at the base of the windshield were of particular interest and measurements of the local velocity distribution were made in these regions. A flexible plastic tape consisting of twenty tubes joined together was taped to the hood. It extended from the base of the windshield along the hood, across the center of the grill and bumper and under the automobile for about one foot. The end of the tape nearest the windshield was passed into the cockpit where the tubes were connected to a bank of water-filled U-tube manometers. At the other end of the tape the tubes were sealed shut. Tiny holes cut in the tape, one in each tube, allowed the static pressure to be measured at various locations along the hood. A Kiel-type total head tube mounted on a support so as to be well above the influence of the automobile was connected to the opposite sides of the bank of U-tube manometers so that the resulting deflections indicated the local velocity at the location of each hole in the tape. These velocities were measured at various automobile speeds and were plotted as a function of the distance ahead of the windshield.

Essentially the same system was used to measure the boundary layer at various stations along the hood. A "rake" of total head tubes was attached in a similar fashion to the multi-tube photomanometer and the velocities within the boundary layer were measured. This equipment is shown in Figures 4 and 5.

### Discussion of Results

The flow over the MGA as tested with the top down is characterized by the separated wake caused by the windshield. This region of reversed flow behind the windshield constitutes the largest and, therefore, the most obvious aerodynamic disturbance in the flow field around the automobile. It is also the most annoying aerodynamic feature of the automobile. As

seen in Figure 6, the flow separates from the top of the windshield, passes over the cockpit and causes a wake of considerable magnitude to be generated behind the automobile. The reversed flow within the wake of the windshield flows back into the cockpit, over the rear deck and trunk lid, and results in a considerable buffeting of the passengers even at moderate speeds.

Although the flow behind the windshield is the largest region of separated flow, it is, by no means, the only region. Perhaps the most interesting area of separated or reversed flow occurs ahead of the windshield. As the flow of air over the hood approaches the windshield, it enters a region of higher pressure since, due to the presence of the relatively steep windshield, the air is slowed down. Also, during the passage of the air across the hood, a boundary layer is built up due to the skin friction between the flow and the hood. This boundary layer, moving into the high or adverse pressure region, separates before reaching the windshield, causing a relatively strong vortex to be developed at the base of the windshield. This vortex, also seen in Figure 6, causes the air near the base of the windshield to actually flow forward in the direction of motion of the automobile.

Another region of interest is the flow beneath the automobile. In this region, the relatively high velocity air flowing between the car and the road surface results in a low pressure beneath the car which causes the air flowing along the sides of the car to be sucked under the car (see Figure 2).

Other regions of separated flow exist at the very rear of the automobile and on the fenders just behind each wheel. These regions can also be seen in Figure 2. Figure 7 shows a schematic diagram of the general flow field around the MGA wherein the regions of separated flow are marked with cross hatching.

With the general flow field defined, more detailed measurements were made in several specific areas which were uncovered by this preliminary analysis. As a first point of interest, in following the passage of air across the automobile, the flow into the radiator grill was examined. The MGA grill consists of a number of vertically oriented strips of metal placed at approximately

45° to the direction of motion as shown in Figure 8. These strips cause the incoming flow to be deflected inward toward the radiator. This deflection, however, makes the air flow across rather than into the duct which is supposed to supply fresh air to the carburetter intakes. As a result, only a negligible amount of air flows into these ducts. Since engine performance is affected to a considerable degree by the inlet temperature, consideration should be given to the adverse effects of this ducting inefficiency.

The air which passes into the engine compartment through the radiator flows over the engine and then out the open bottom of the automobile into the low pressure region which exists there. This low pressure beneath the car lowers the pressure inside the engine compartment. The variation with automobile velocity of this pressure in the engine compartment, measured with respect to ambient static pressure, is shown in Figure 9. In addition, as mentioned previously, this low pressure beneath the car sucks down the flow of air along the sides of the automobile, Figure 2. The effects upon the wake of this flow beneath the car will be discussed later.

Much of the flow approaching the front of the car does not, of course, flow through the grill and radiator, instead, it passes over the top of the hood. The velocity of this air as it flows over the hood toward the windshield is shown in Figure 10. Notice, in particular, the peaks in the velocity distribution caused by the bumper and the emblem or "marque" at the upper part of the grill. It can also be seen that the velocity gradually decreases as the windshield is approached, giving rise to an adverse pressure gradient along most of the hood. The velocity distributions at different speeds are plotted in non-dimensional form in Figure 11 from which it can be seen that the local velocity varies directly with automobile velocity.

With this knowledge and knowing the pressure inside the hood, the pressure difference across the hood can be calculated. This calculation is presented for two speeds in Figure 12 and shows that the pressure is higher outside the hood than inside the engine compartment. If outlet vents are installed to allow an escape for the hot air inside the engine compartment,



they should be placed in a region where the pressure inside the compartment is higher than that outside. The presently installed vents on the MGA are placed rather far aft and are in a region where a higher pressure exists outside the hood. As a result, air flows in rather than out of these vents and further reduces the fresh air supplied to the carburetors. Furthermore, the pressure differential increases drastically with speed.

As the air flows over the hood, a boundary layer is developed as a result of the friction between the hood and the air. The velocity profiles within the boundary layer were measured at various locations along the hood and are presented in Figure 13. This boundary layer, moving into the adverse pressure gradient ahead of the windshield, separates or leaves the hood before reaching the base of the windshield causing a strong vortex to be developed there. This stagnation vortex is a common feature of flows moving into the adverse pressure gradient caused by the presence of an obstacle. The vortex is seen in Figure 6 which shows a model of the MGA mounted in the smoke tunnel. Further evidence of its existence is shown in Figure 14 where it can be seen that the tufts near the base of the windshield are indicating a reversed flow direction. It is of interest to note the similarity of the dimensions of the vortex on the model and that on the full scale automobile. The presence of this reversed flow on the windshield causes an annoying accumulation of large rain droplets when driving through even moderate rain showers. The windshield wipers must be operated for quite some time after a shower has passed to clear the windshield of droplets which are blown back off of the hood. Droplets on other portions of the windshield are carried away by the relatively high velocity undisturbed air stream.

Another problem which arises from the presence of this vortex results from the extreme instability of the flow in this region to cross-flows. When driving in a cross-wind, the flow pattern shown by the tufts in Figure 14 is altered, depending upon the direction of the cross-wind, as illustrated in Figure 15. Here it can be seen that the stagnation area is shifted to the downwind side of the windshield. This shift causes the pressure distribution

across the base of the windshield to vary according to the wind direction and velocity. For example, with a wind from the left, the pressures on the right side of the base of the windshield are higher than those on the left. This, in itself, would be no cause for concern were it not for the fact that the windshield washer jets are located symmetrically at the base of the windshield (Figure 16). When the pressure across the base is also symmetrical, that is, no cross-wind, there is the same pressure on each washer jet. However, in a cross-wind when the pressure across the base is altered, there is a higher pressure on one jet than exists on the other. In this condition, the windshield washer fluid is forced out of the connecting tubing, through the jet, and flows out onto the hood. It then is carried away by the airflow in this region. No real problem results unless some type of "bug solvent" is mixed with the washer water, which then causes unsightly stains to develop on the hood each time the car is driven in gusty air (Figure 17). These gusts may even be caused by the passage of approaching trucks on the highways.

Most of the air flowing toward the windshield does not become involved in the vortex at the base but instead flows over the windshield. Because of the high velocity of this air at the top of the windshield and because of the sharp discontinuity there, the air, obviously, cannot flow down behind the windshield but separates and passes back over the cockpit as shown previously in Figure 6. As a result of the relatively high velocity of this separated air-stream, there exists a pressure in the cockpit which is lower than the ambient static pressure. The variation of this pressure with the forward velocity of the automobile is shown in Figure 18.

Having passed over the cockpit, the flow then turns downward and finally impinges on the rear of the car at about the center of the trunk lid. From this point, part of the stream flows down the back of the trunk and hence off into the wake. A considerable amount, however, is drawn forward into the low pressure region existing in the cockpit. The nature of this flow on the rear of the car is shown in Figure 19. The velocity of the flow moving into the cockpit from the rear is rather high and it results in an extreme

buffeting within the cockpit. Air is also drawn into the cockpit over the tops of the doors as shown by the tufts in that region in Figure 2. The distribution of the magnitude of this reversed flow is given in Figure 20. This reversed flow, mixing into the high velocity flow over the top of the cockpit forms a strong vortex behind the windshield and is the predominant disturbance to the flow over the automobile. Such flow is, no doubt, a characteristic of most open roadsters. Despite its strength, however, this vortex does not affect the air well down in the cockpit. The air beneath the instrument panel and near the floor remains almost absolutely quiescent. Temperatures developed in this region after protracted driving become uncomfortably high because fresh air cannot enter to carry away heat from the engine and transmission.

As mentioned, the air which does not flow back into the cockpit passes over the rear of the automobile and subsequently joins with the air which has come under the car to form the wake. These streams, together with those from the sides of the car, converge at a point approximately five feet behind the rear bumper. The extremely turbulent nature of this wake is easily seen by the large cloud of dust generated by the passage of the car over a three foot wide stripe of powder laid down perpendicular to its path (Figure 21).

### Concluding Remarks

It should first be emphasized that this analysis is not intended as a criticism of any particular design or of automobile designs in general. Instead, it is intended to demonstrate the potential of well-developed techniques of flow visualization and measurement in improving the aerodynamic characteristics of automobiles. It is obvious that shortcomings in the aerodynamic design of automobiles can readily be rectified only if a clear understanding of the flow patterns around these automobiles can be obtained. The techniques illustrated in this analysis were primarily developed to aid in the study of airflow around various aircraft and have proven to be of invaluable assistance in making modifications to existing designs. Similarly,

it is felt that the present analysis has defined a number of aerodynamic shortcomings and that it will greatly facilitate the design of modifications to allievate the problems so defined.

In particular, the following specific aerodynamic problems were isolated and defined.

- (a) The MGA grill alters the course of the flow entering the front of the car in such a manner as to deflect it away from the entrance to the carburetter air duct and the heater duct.
- (b) The high velocity air passing beneath the car reduces the pressure within the engine compartment to the extent that it is lower than the pressure on the hood.
- (c) The air outlets on the hood are located in a position at which the pressure outside is higher than that inside the hood. As a result, air flows in rather than out of these ducts.
- (d) A strong stagnation vortex exists at the base of the windshield. This vortex disturbs the flow over the windshield giving rise to problems with rain and the operation of the windshield washers.
- (e) A strong reversed flow of air enters the cockpit from the rear causing severe buffeting in that region.
- (f) Insufficient ventilation or circulation is provided near the bottom of the cockpit causing high temperatures to develop in that region after protracted driving.
- (g) The disturbed flow beneath the car, joining with the flow from above, produces a large wake of entrained flow behind the automobile.
- (h) The noise level due to flow separation and other aerodynamic sources is particularly high.

As a conclusion to the present study, modifications are being designed to eliminate or allieviate these aerodynamic problems.

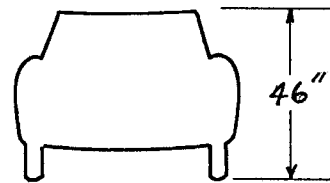
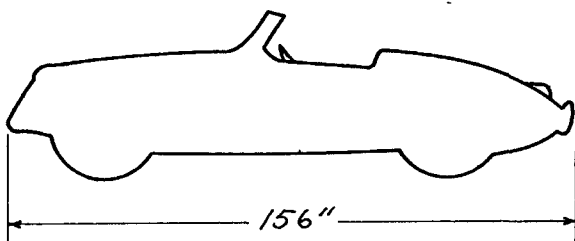
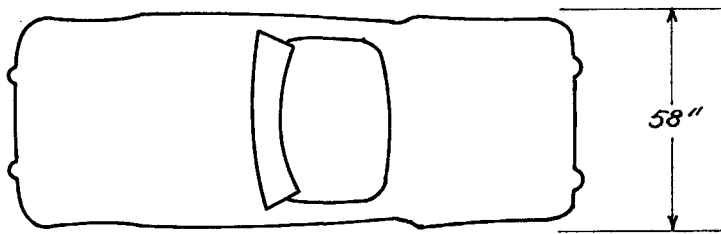

Figure 1. MGA Open Roadster .

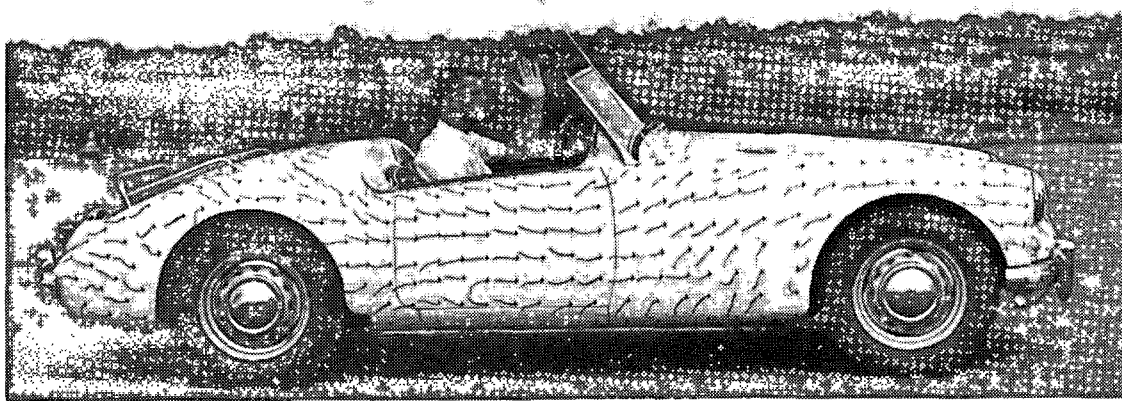

Figure 2. Tufts on Full Scale MGA.

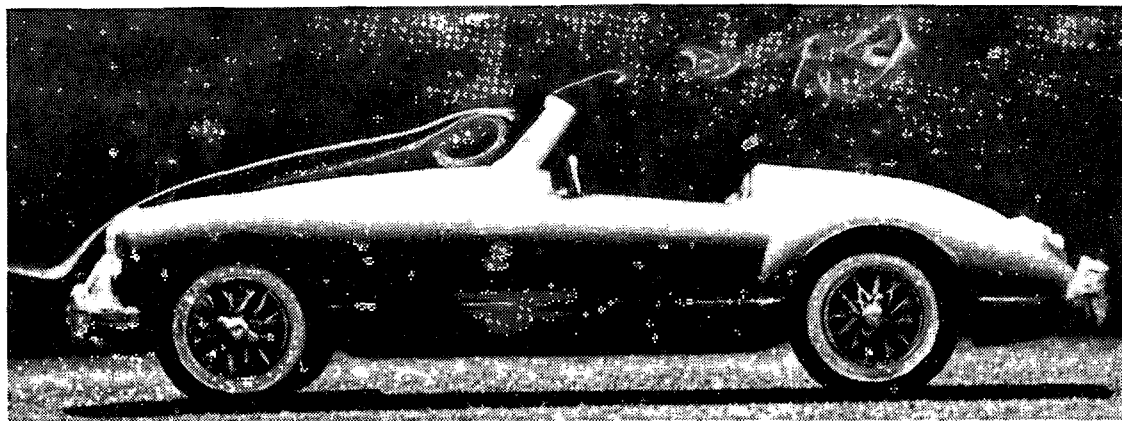
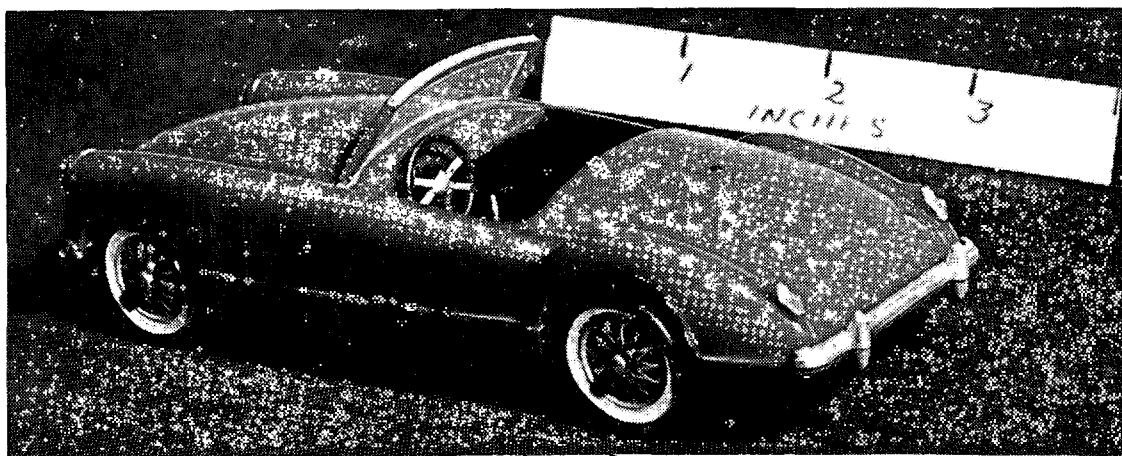

Figure 3. Scale Model in Smoke Tunnel.

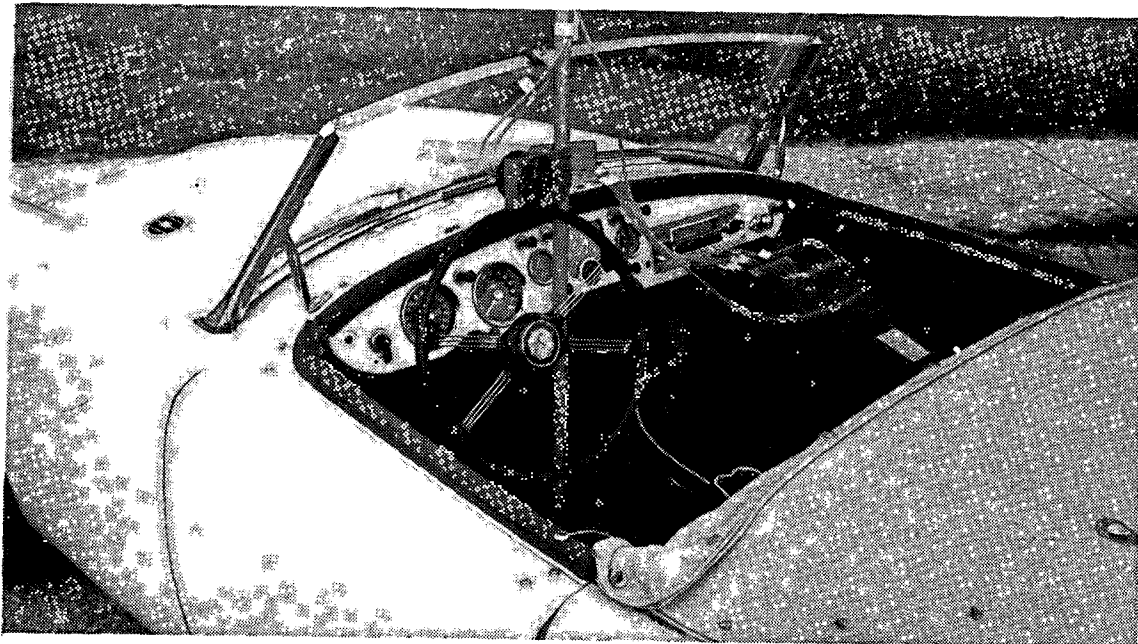
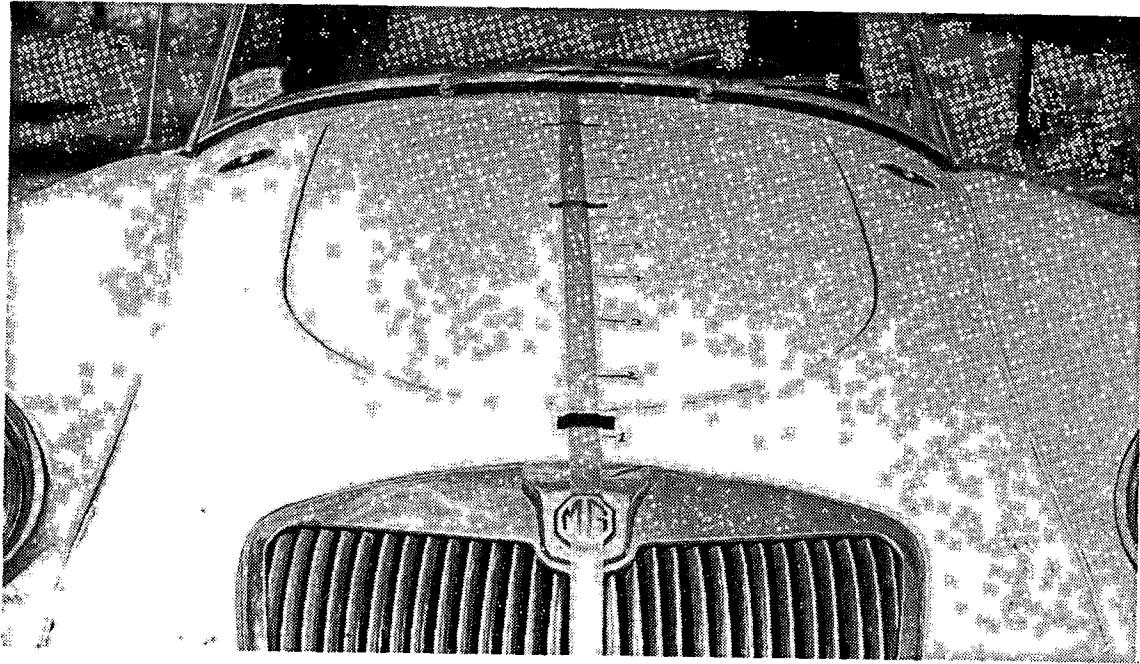

Figure 4. Tape for Measuring Static Pressure on Hood (upper photo) and Photomanometer Mounted in Cockpit (lower photo).



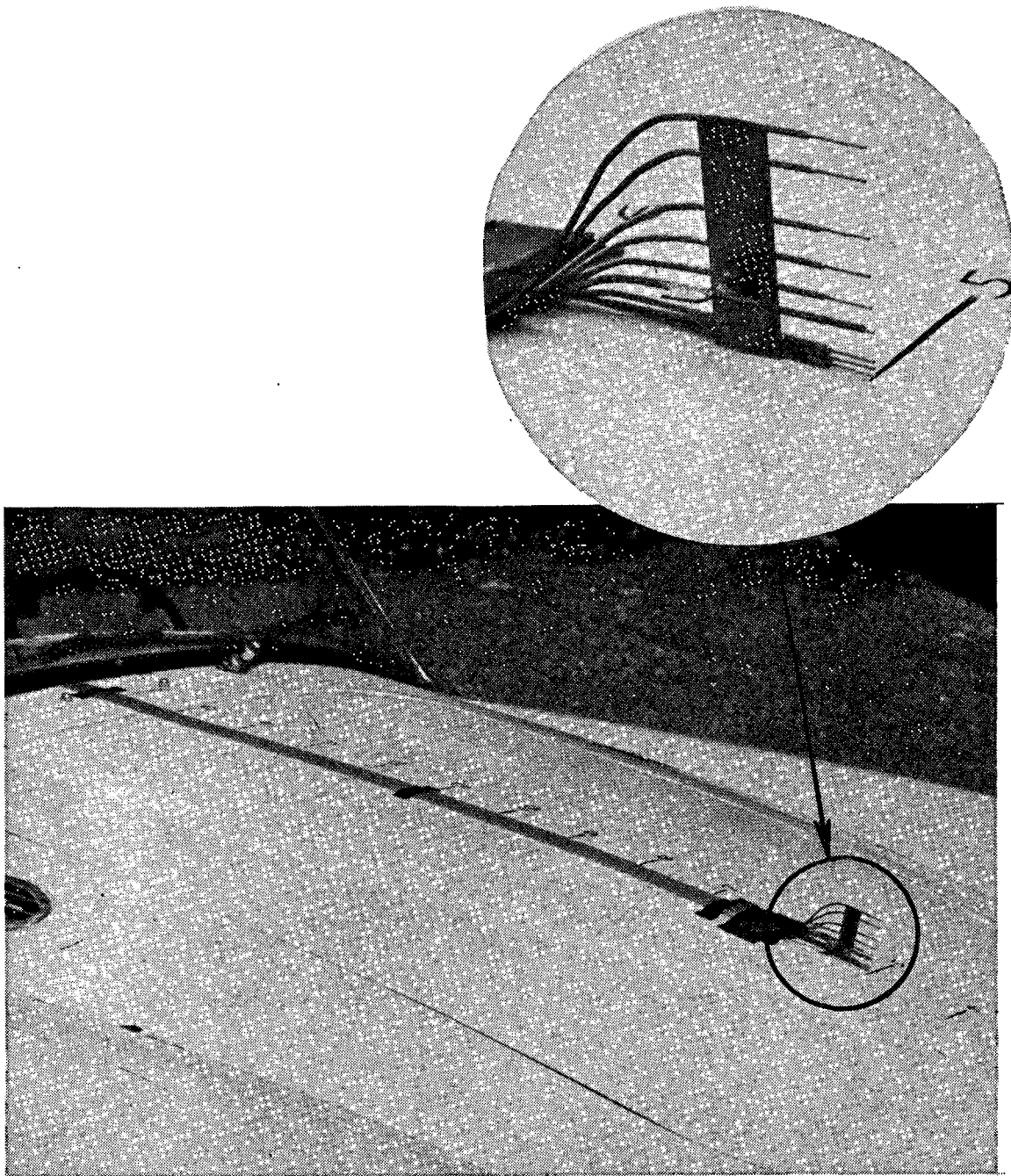

Figure 5. Boundary Layer Rake on Hood.



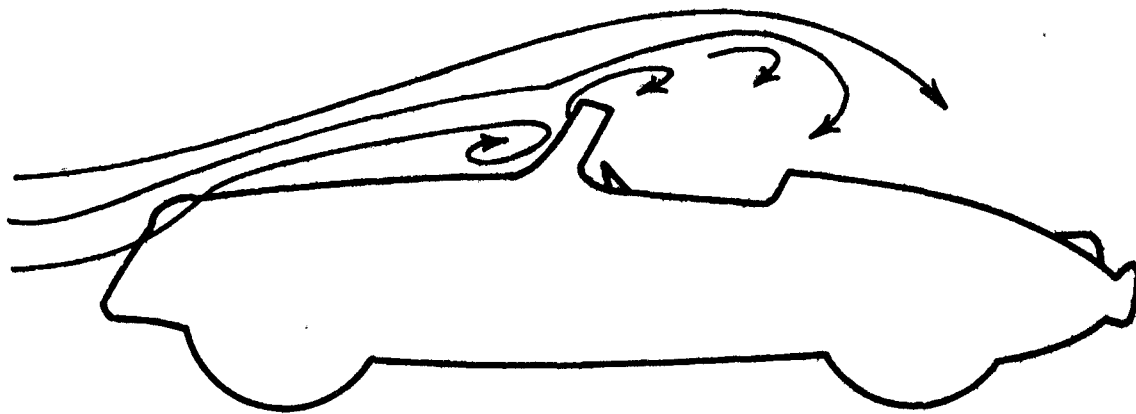
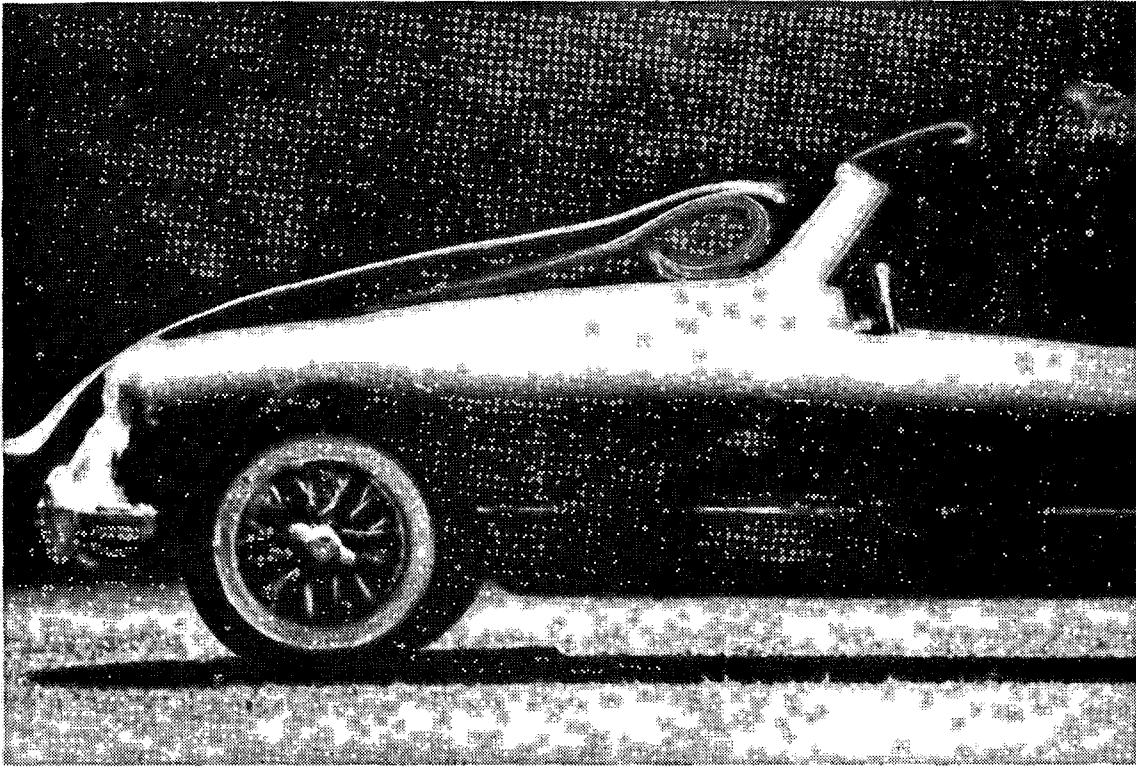

Figure 6. Airflow over MGA Windshield.

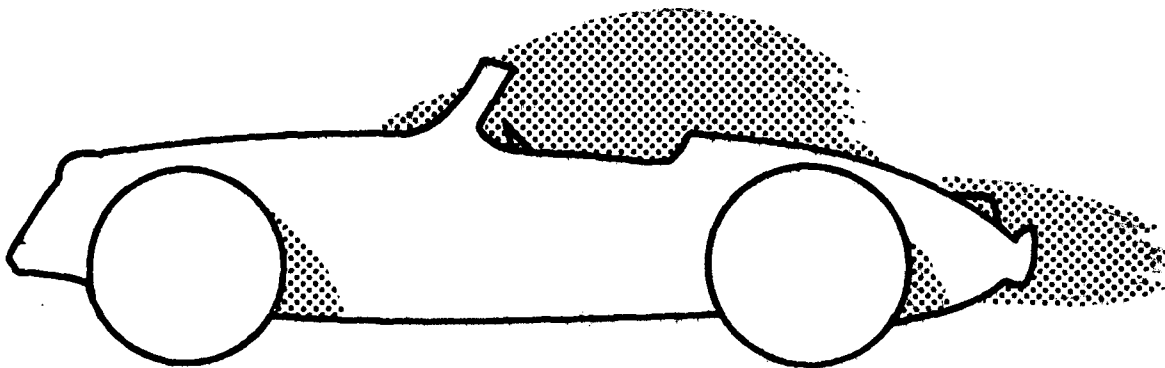

Figure 7. Areas of Separated Flow.

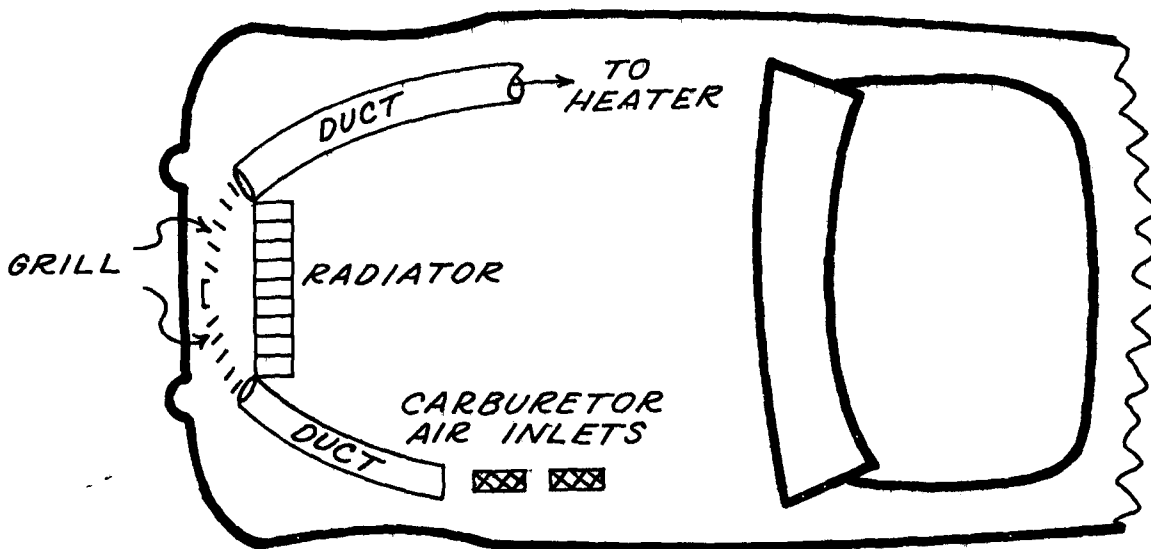

Figure 8. Schematic Diagram of Engine Compartment.

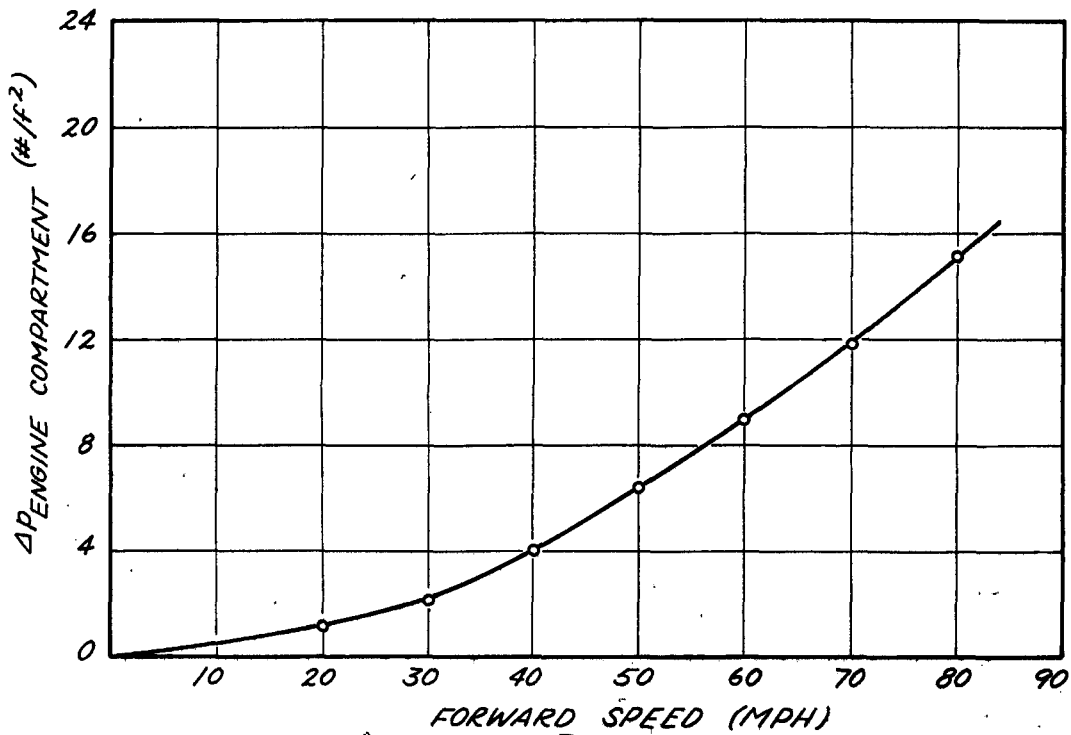

Figure 9. Pressure Reduction in Engine Compartment Below Freestream Static Pressure.

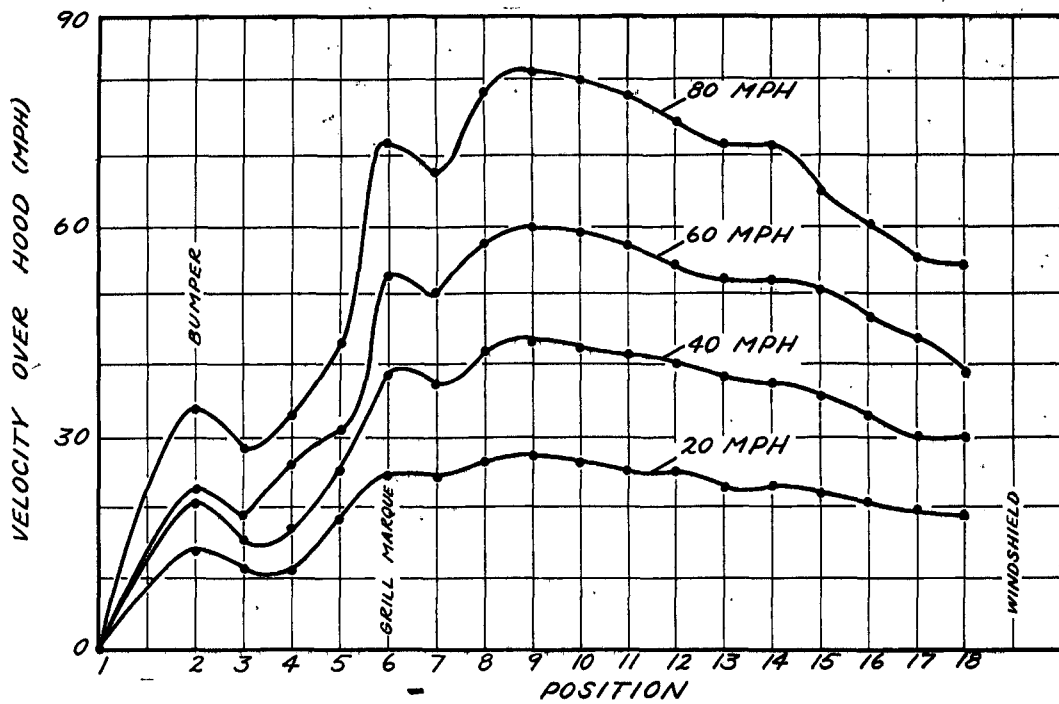

Figure 10. Flow Velocity over Hood of MGA.

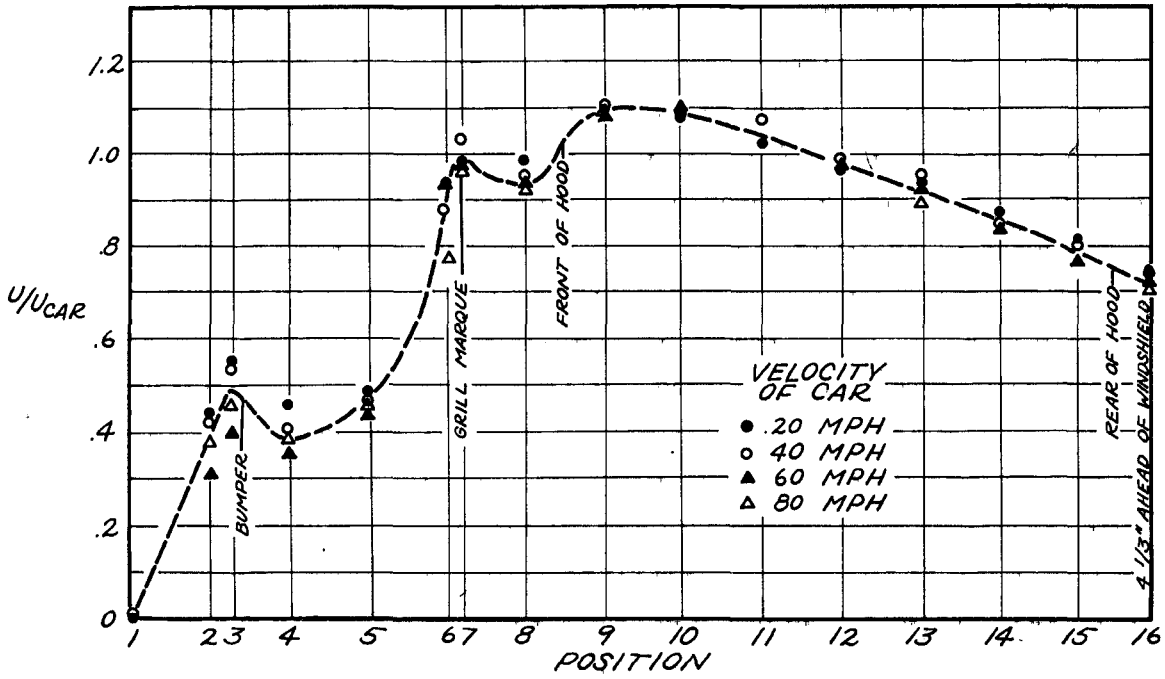

Figure 11. Non-dimensional Velocity over Hood.

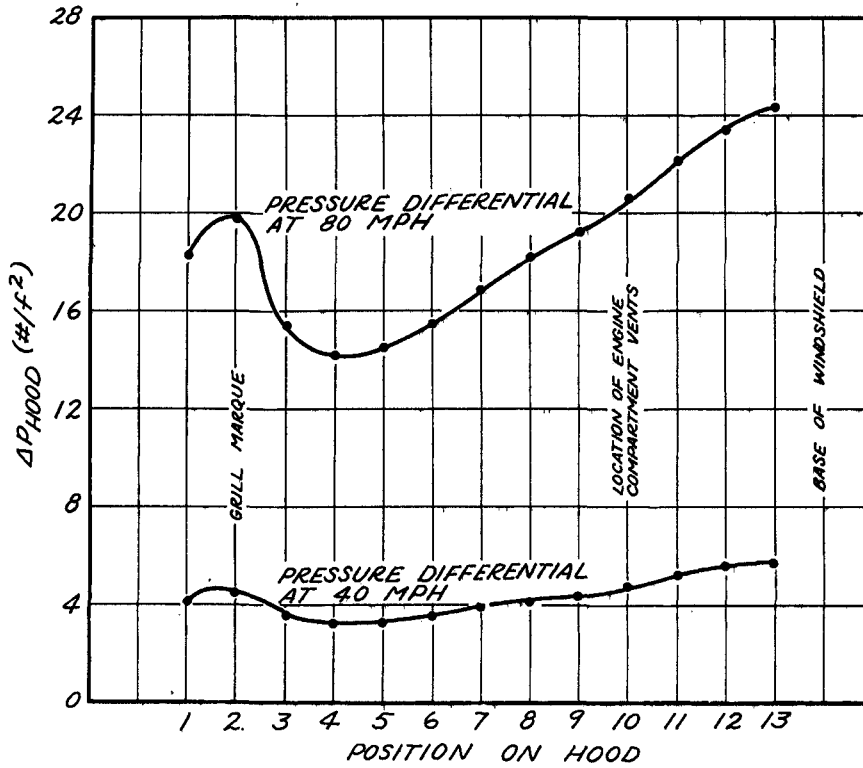

Figure 12. Pressure Differential Across Hood.

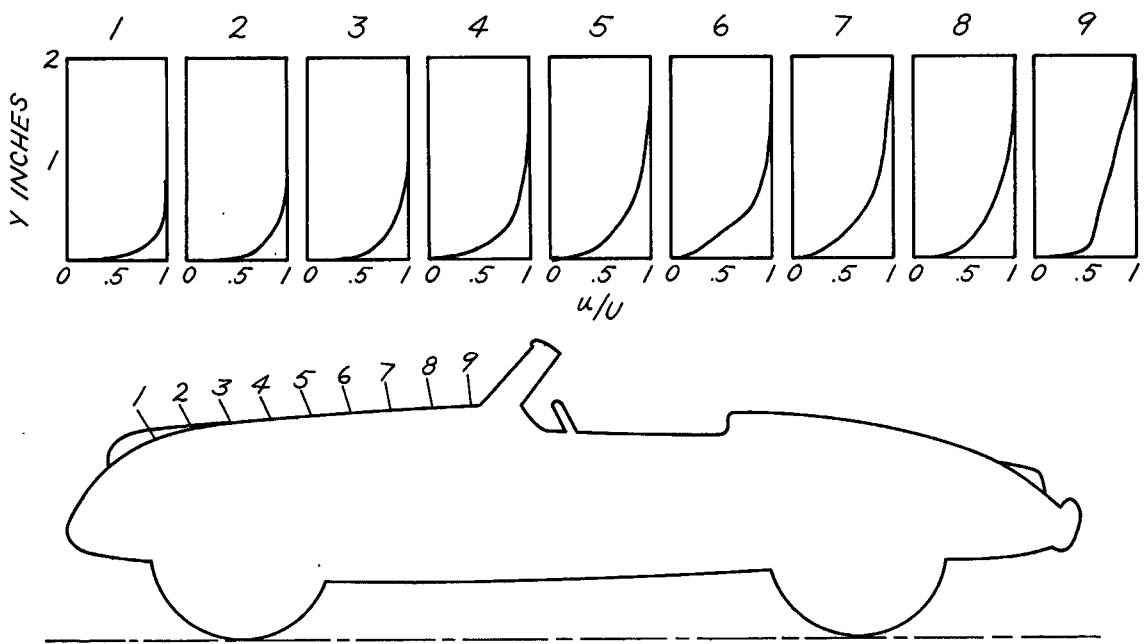

Figure 13. Boundary Layer Development on Hood.

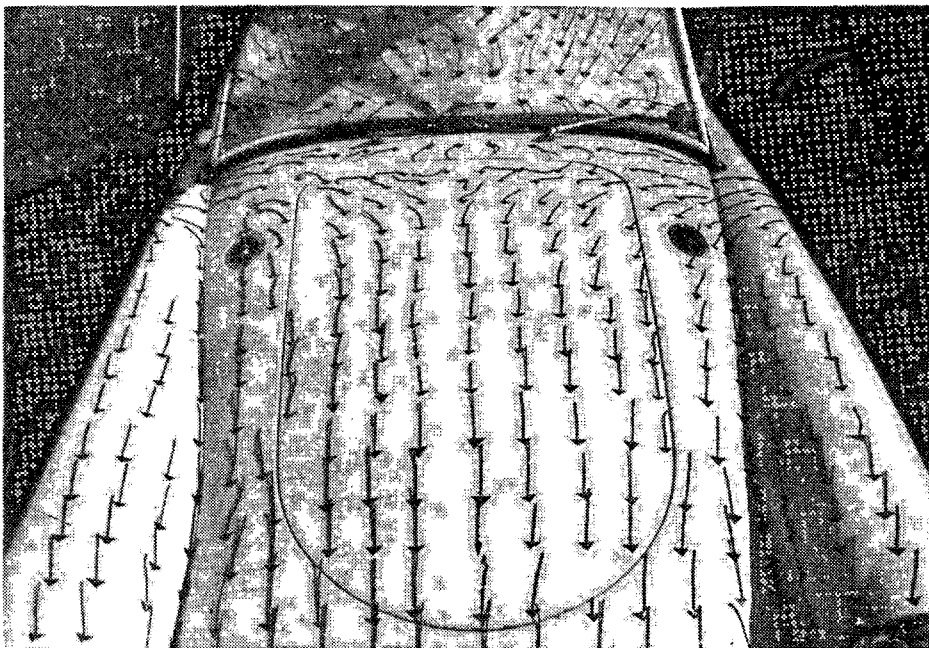
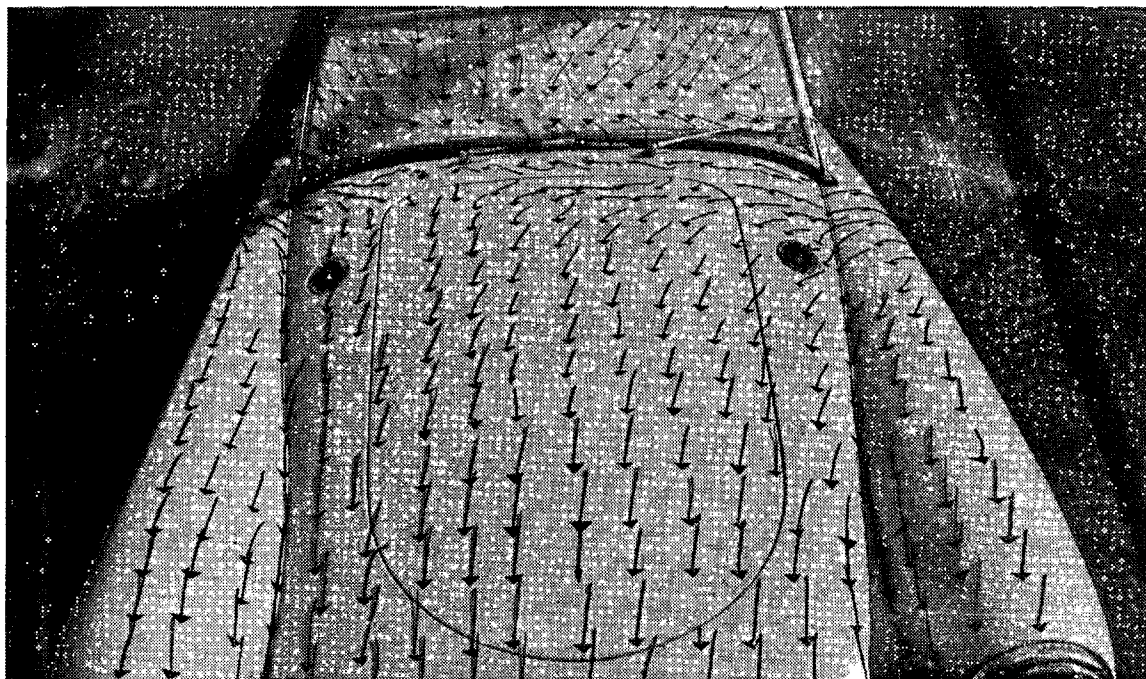
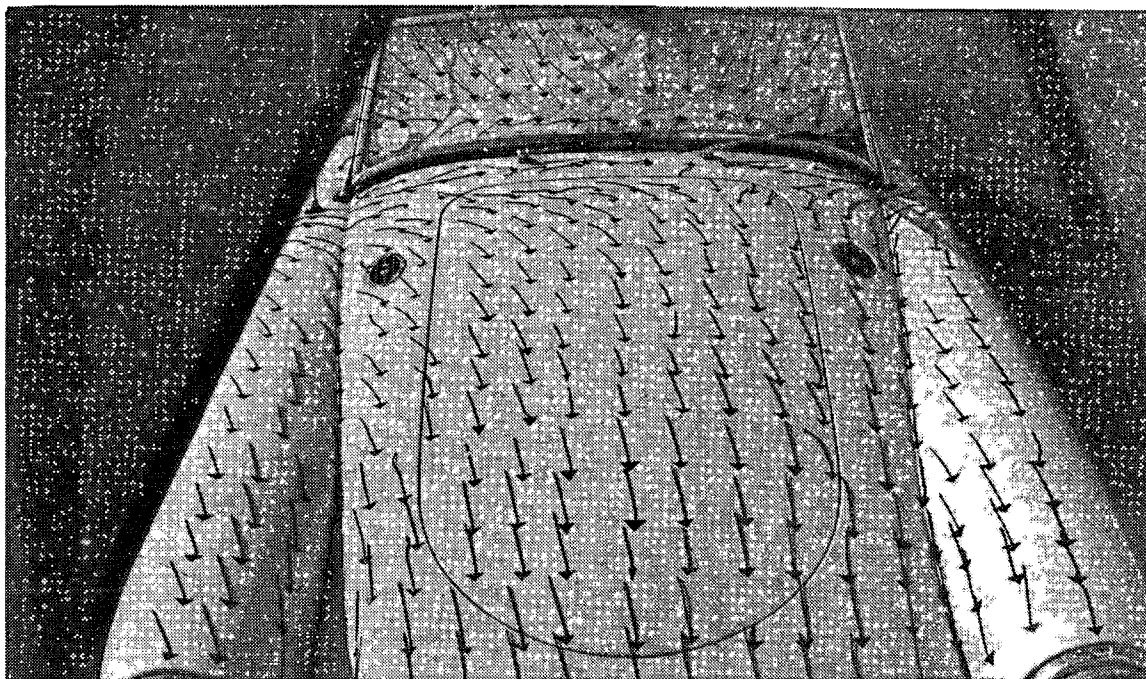

Figure 14. Tufts Showing Separated Flow Ahead of Windshield.



Cross-wind from Right of Car.



Cross-wind from Left of Car.

Figure 15. Tufts Showing Effects of Cross-wind.



Figure 16. Location of Windshield Washer Jets.

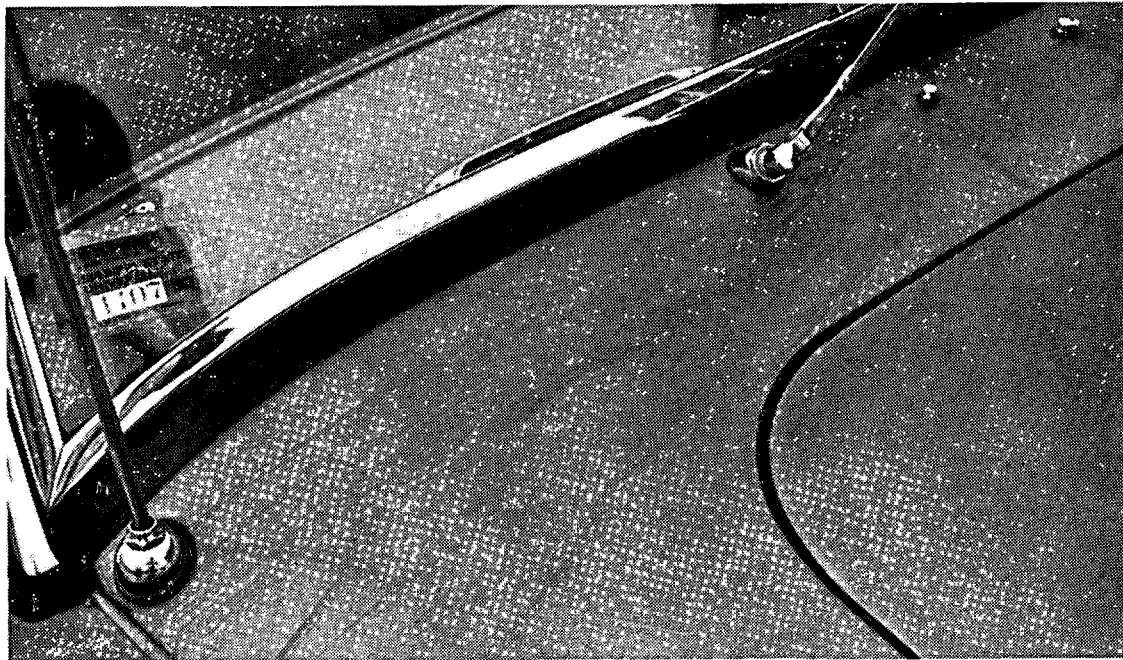

Figure 17. Stains on Hood from Washer Fluid.



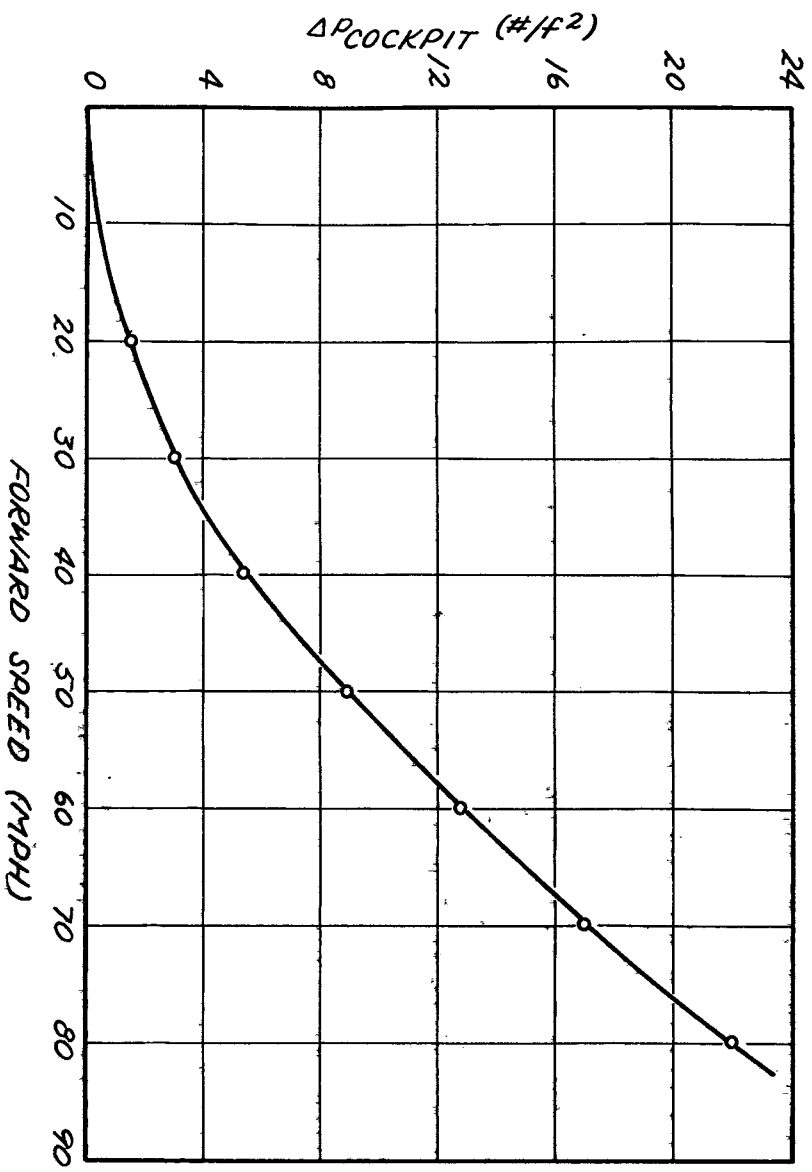

Figure 18. Pressure Reduction in Cockpit Below Freestream Static Pressure.



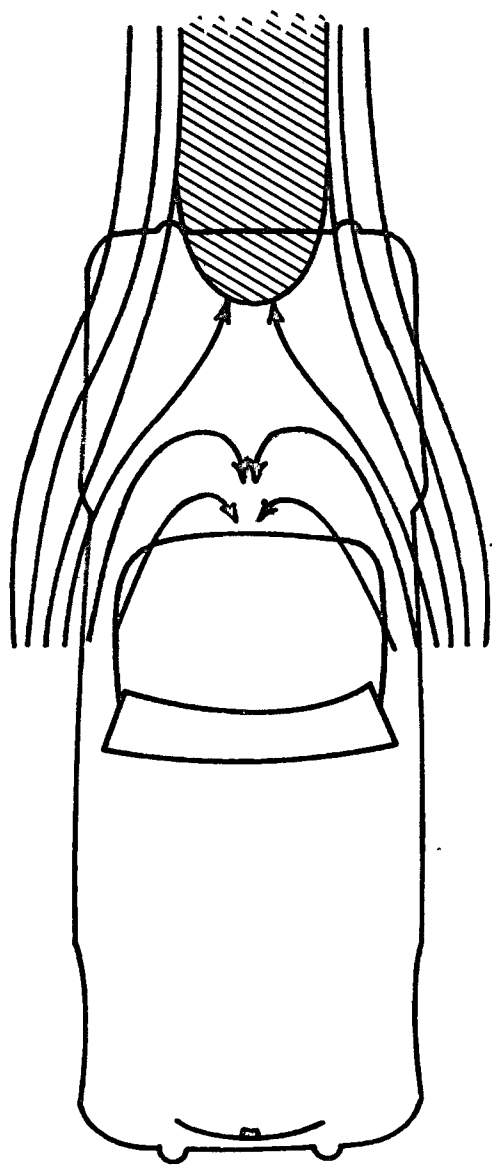
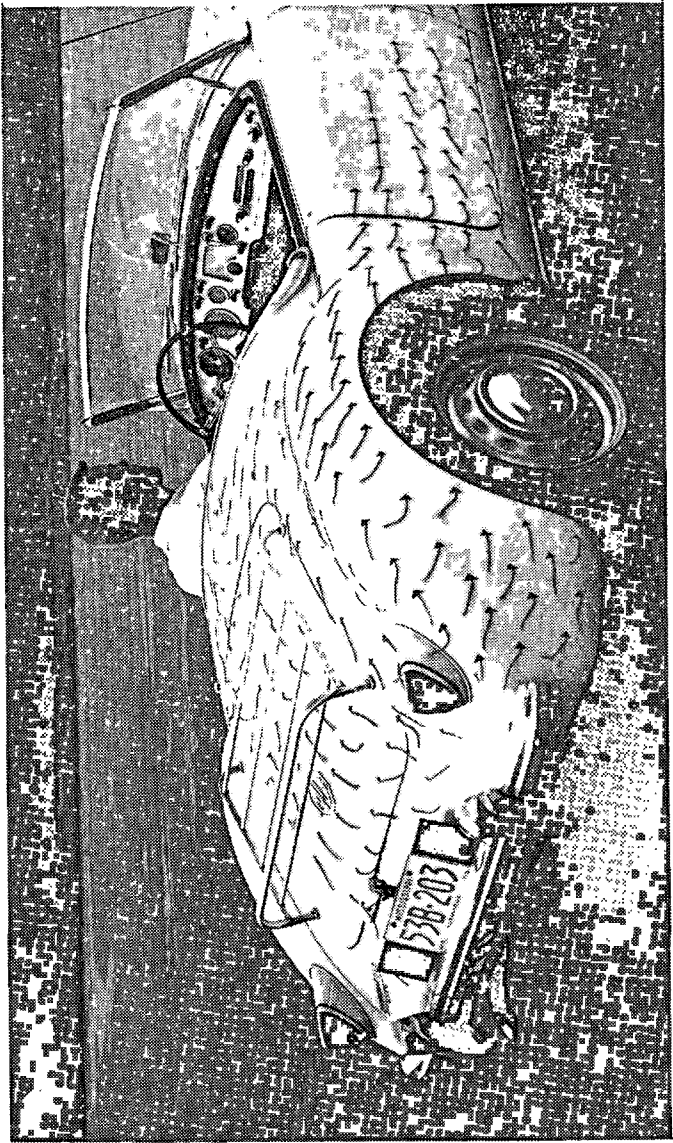

Figure 19. Tufts and Diagram Showing Flow over Rear of MGA.

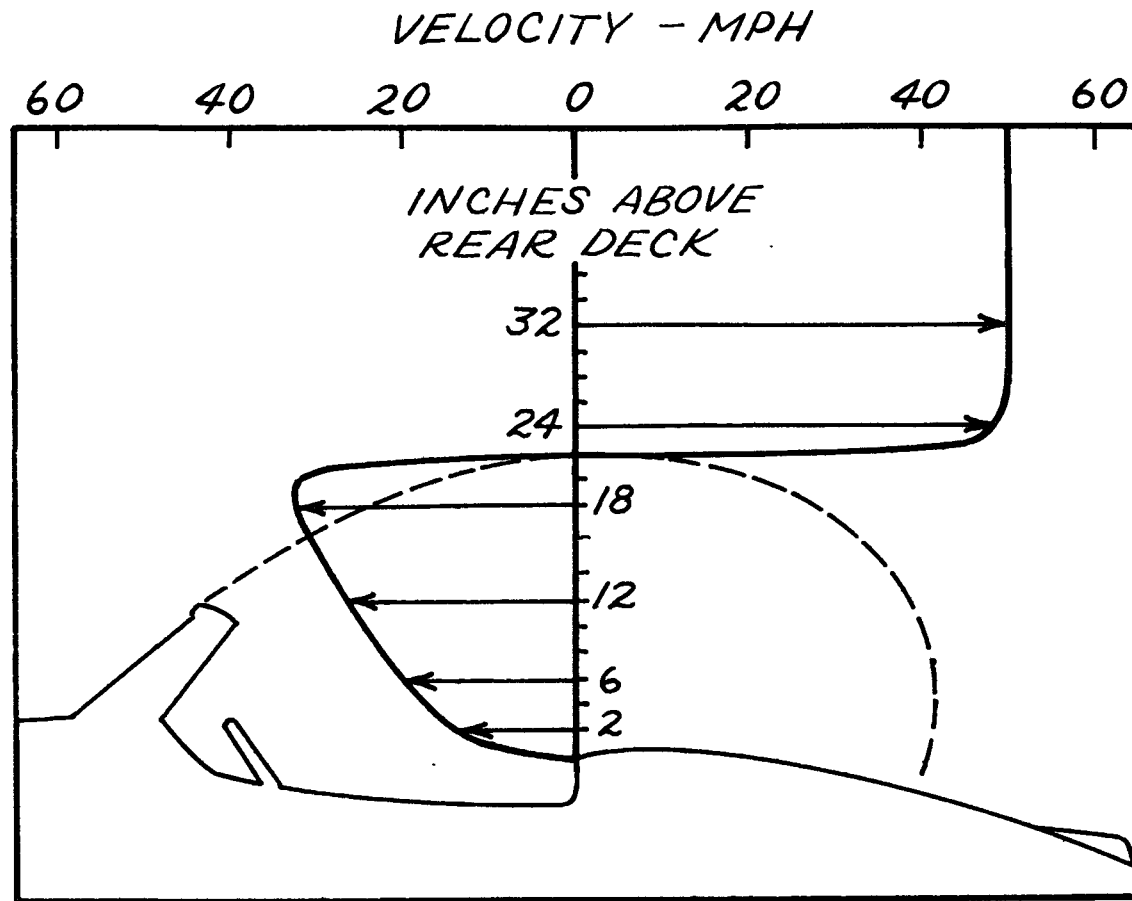
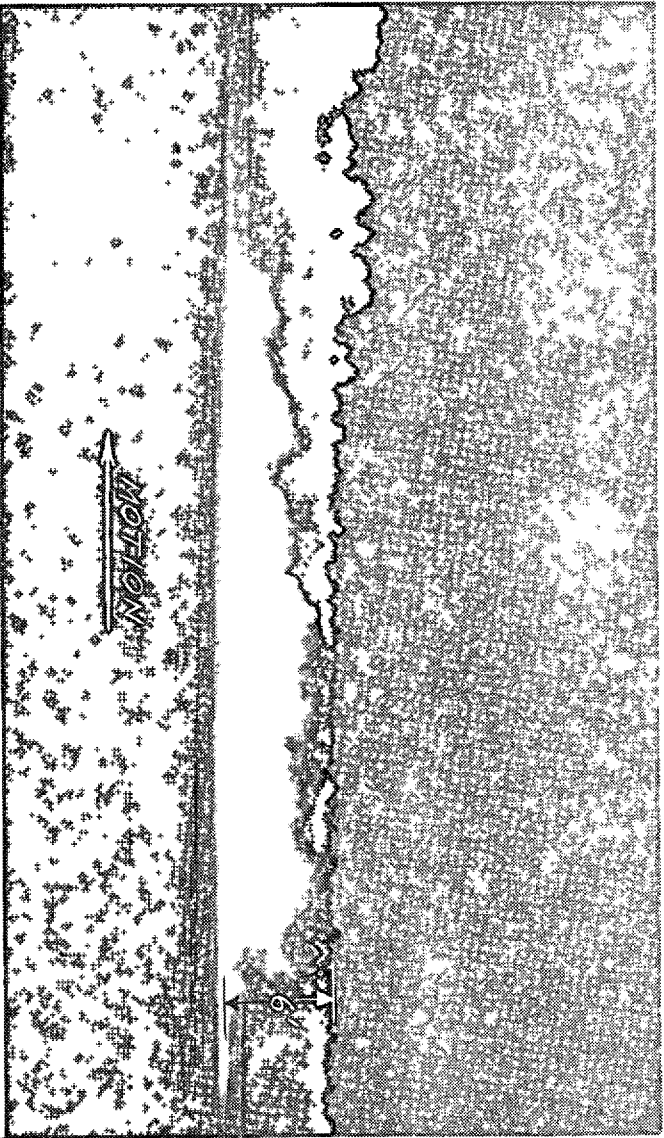
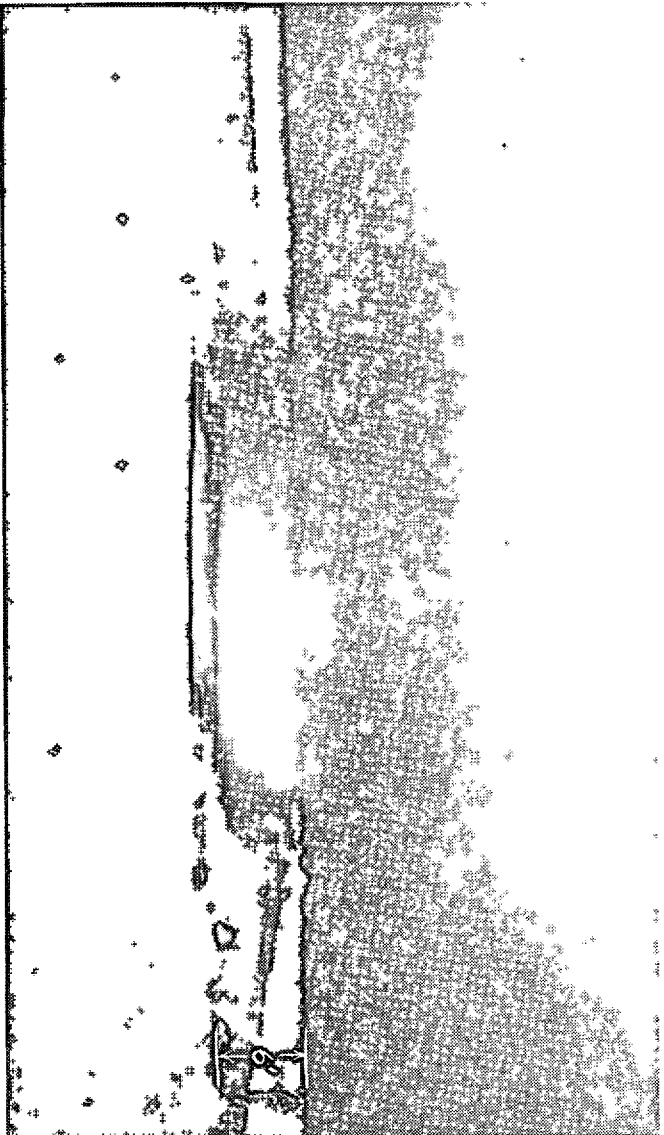

Figure 20. Velocity of Reversed Flow Behind Cockpit.



Side View



Rear View

Figure 21. Powder Entrained in Wake of MGA.