

Japanese Bandplans

(Revised: September 25, 2023)

Occupied Bandwidth

NB: Narrow-Band
(up to 3kHz and A3E(≤ 6kHz))
WB: Wide-Band (more than 3kHz)

The occupied bandwidth shall be less than 3 kHz in NB All Modes section except for A3E with 6 kHz band width.

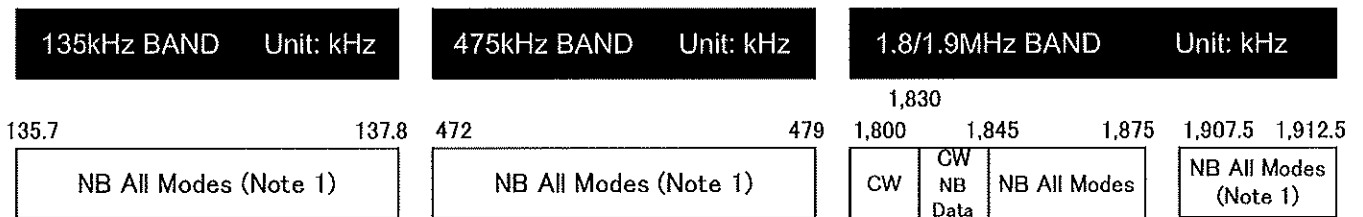

Note 1: The occupied bandwidth shall be less than 500 Hz including NB Data.

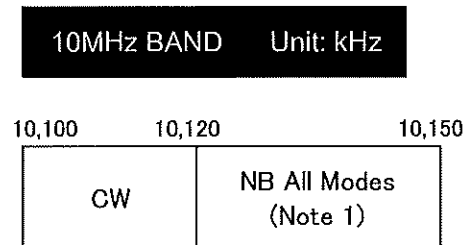
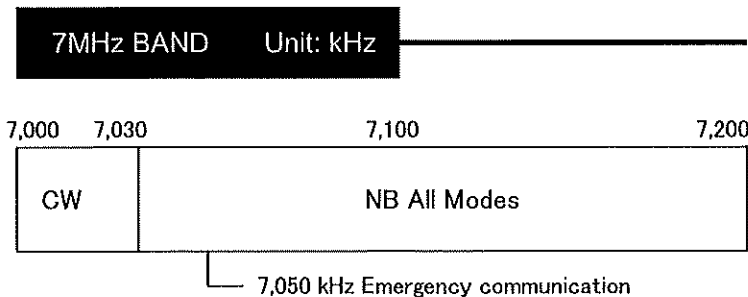
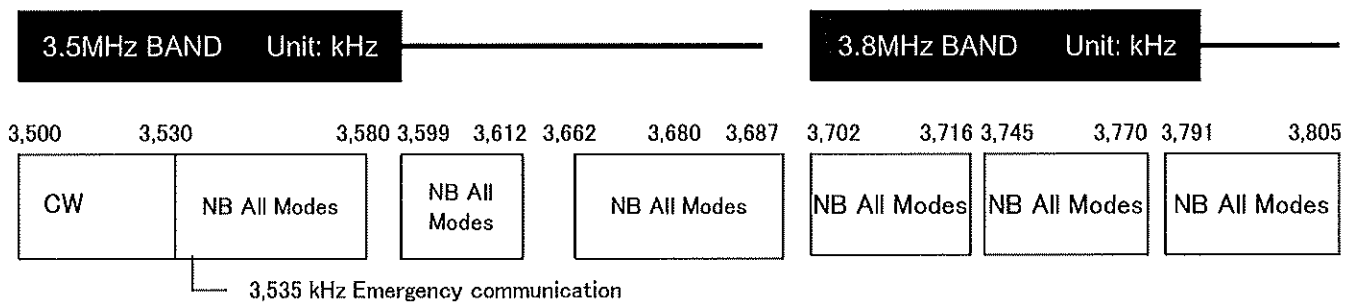

Note 1: The occupied bandwidth shall be less than 2 kHz.

The occupied bandwidth shall be less than 3 kHz in NB All Modes section except for A3E with 6 kHz band width.

14MHz BAND Unit: kHz

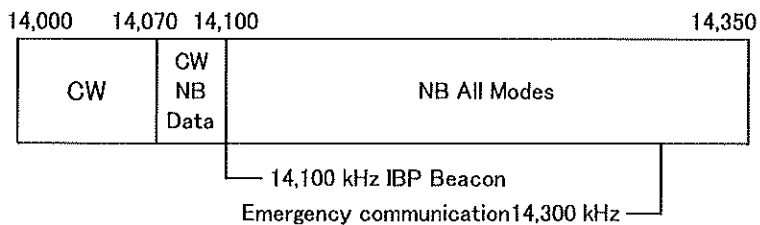

18MHz BAND Unit: kHz

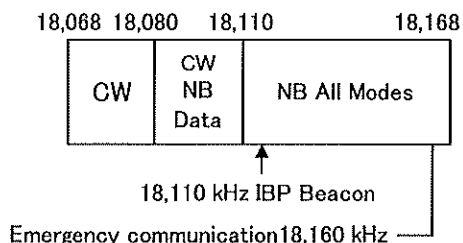

21MHz BAND Unit: kHz

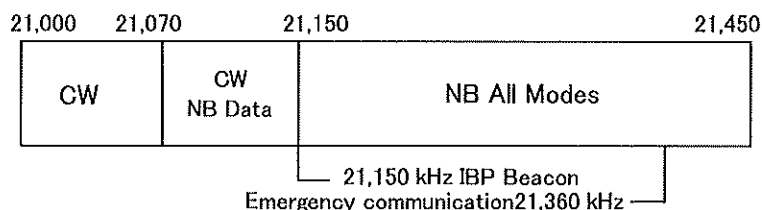

24MHz BAND Unit: kHz

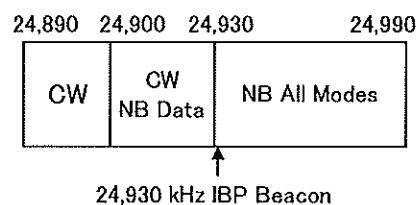

28MHz BAND Unit: MHz

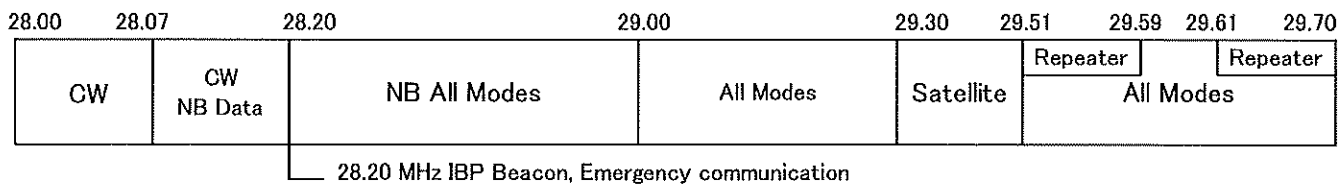

50MHz BAND Unit: MHz

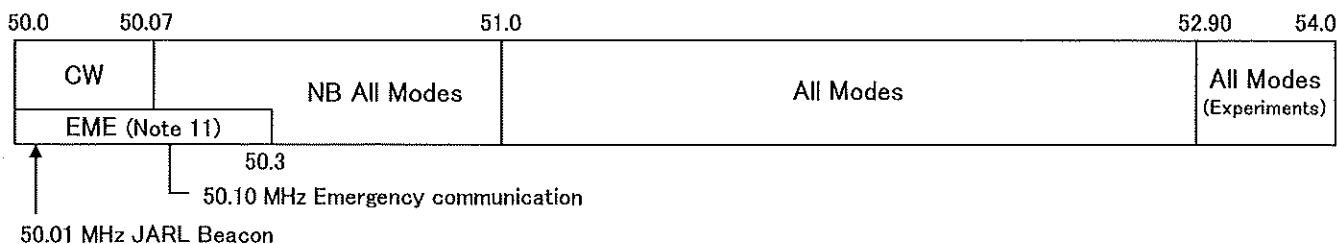

144MHz BAND Unit: MHz

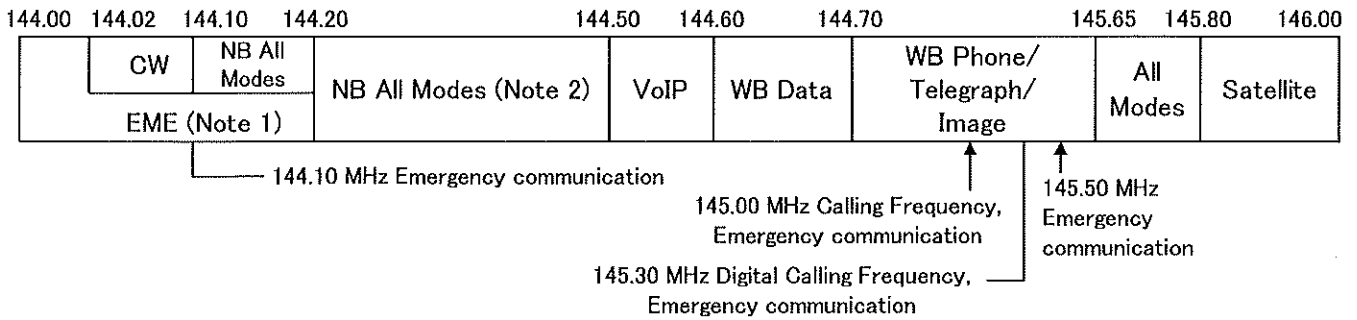

Note 1: EME communication can use NB All Modes.

Note 2: 144.30 MHz to 144.50 MHz segment can be used for WB Phone/Telegraph/Image communications with International Space Station (ISS) only.

430MHz BAND Unit: MHz

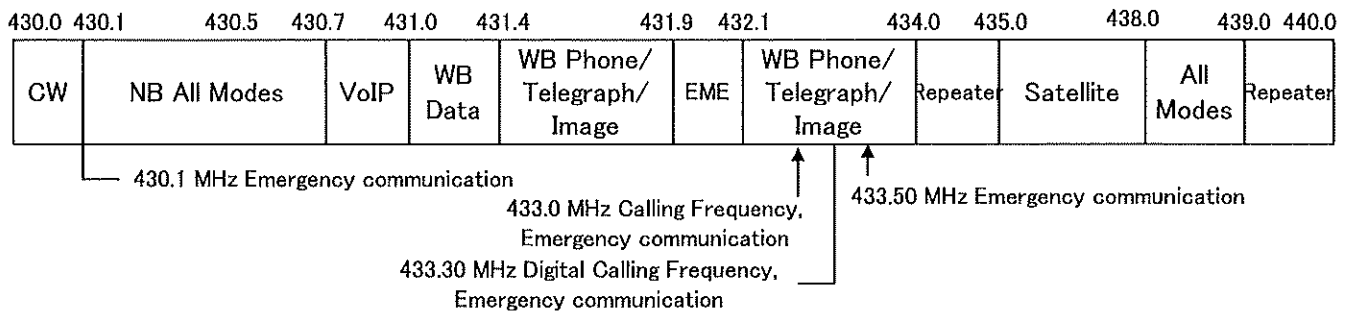

1,200MHz BAND Unit: MHz

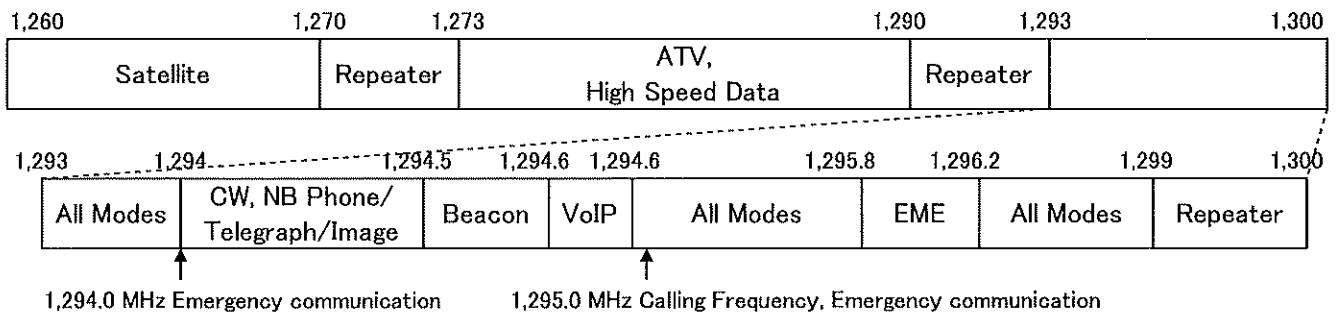

2,400MHz BAND Unit: MHz

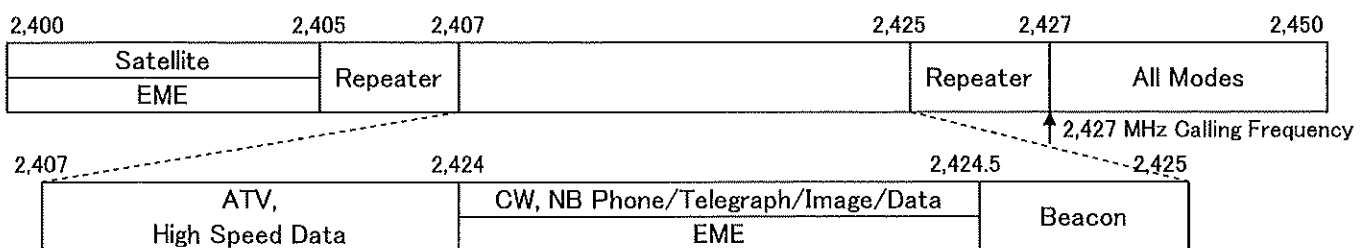

5,600MHz BAND Unit: MHz

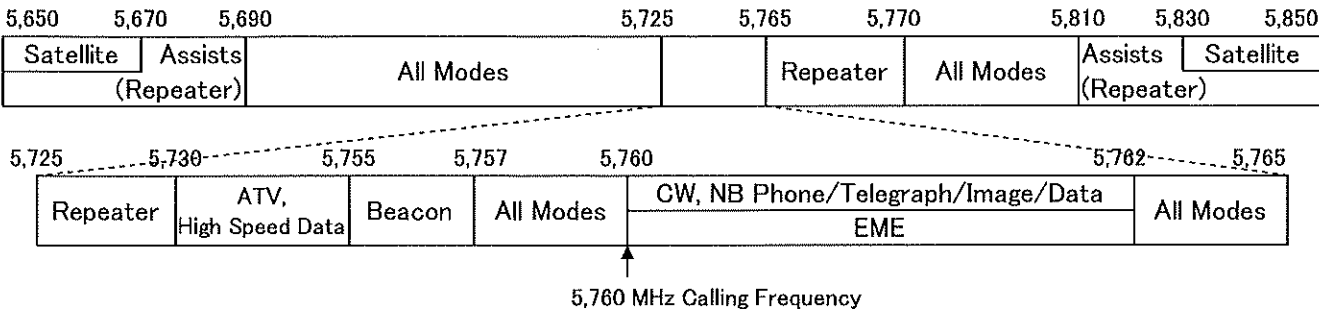

10.1GHz BAND Unit: GHz

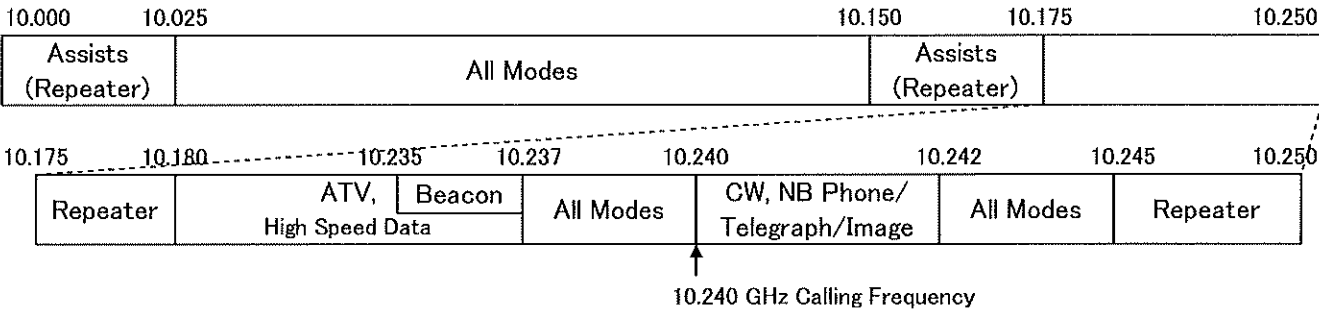

10.4GHz BAND Unit: GHz

