

FÉDÉRATION INTERNATIONALE DE GYMNASTIQUE

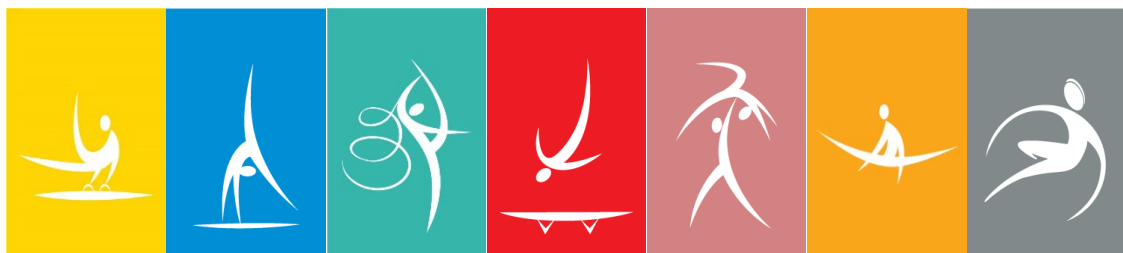

Changes in red

FIG APPARATUS NORMS



Edition **2023**





EDITORIAL

In its commitment to serve its partners and performers ever better at the international competition level, the International Federation of Gymnastics (FIG) is exceptionally pleased to introduce the new edition of the *Apparatus Norms* for gymnastics. This publication is based on the revision of the 2021 edition and has been in effect since **15.03.2023**.

This document is the result of a team effort led by the members of the FIG Apparatus Commission in close cooperation with the concerned Technical Committees and the Anti-doping/Medical/Scientific Commissions. Mr. Daniel Fesser, from the FIG Apparatus Testing Institute in Freiburg – GymLab (Germany) **has accompanied** this process **intensively**.

The contents of this FIG Apparatus Manual offer a didactical approach, which allows the readers to learn about the particular functions of each apparatus and about the intricate process that surrounds certification and approval. This publication also serves as a source of official information for all National Federations and lays the foundation of the collaboration between the FIG and the apparatus manufacturers.

The concept of these regulations' layout makes it possible to update the specific data pertaining to each apparatus used in the various gymnastic disciplines. It allows the technicians, the organizers, and above all the apparatus manufacturers to be kept abreast immediately on the latest developments in this important area. The drafting of these norms has taken into consideration our Technical Regulations, Codes of Points and Media Regulations.

With this publication, the FIG is renewing its commitment to the absolute necessity of providing standards for the apparatus used in official events and to guaranteeing that consistent testing and certification procedures are provided by fully neutral institutes delivering certificates in due form. In this respect, the FIG is pleased to further contribute to the improvement of our gymnasts' safety and to remain vigilant about fair play in competition.

We wish to thank everyone who has contributed to the publication of this document. The FIG wishes to all of them much success and a prosperous future at the service of the gymnasts and their managers.

With our compliments,

INTERNATIONAL FEDERATION OF GYMNASTICS

Morinari Watanabe
President

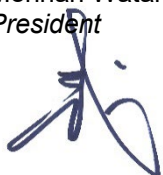

Nicolas Buompane
Secretary General

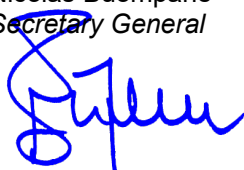

Ludwig Schweizer
Apparatus Commission President



Division of chapters

- I General part
- II Apparatus Norms
- III Certificates and diplomas

Appendix

Impressum

- IV Testing procedures

I	<i>Line 1</i>
TRA 18	<i>Line 2</i>
01.01.2018	<i>Line 3</i>

Explanations concerning the structure / systematic of the apparatus Norms FIG

- Line 1 Number of the chapter
- Line 2 Discipline and number of apparatus
- Line 3 Date of validity

SUMMARY

EDITORIAL	3
SUMMARY	5
I GENERAL PART	7
1. Introduction / Layout	9
2. Purpose and Principles	9
3. Validity of the Apparatus Norms FIG Certificate compulsory for all Apparatus	10
4. Guarantee for quality	10
II APPARATUS NORMS	11
1. Overview of the apparatus of the FIG disciplines	15
1.1. Mens' artistic Gymnastics MAG	17
1.2. Womens' artistic Gymnastics WAG	18
1.3. Rhythmic Gymnastics RG.....	19
1.4. Trampoline Gymnastics TRA.....	20
1.5. Acrobatic Gymnastics ACRO	21
1.6. Aerobic Gymnastics AER	22
1.7. Parkour PK.....	23
III. CERTIFICATES AND DIPLOMAS	165







I. GENERAL PART

1. Introduction / Layout	9
2. Purpose and Principles	9
3. Validity of the Apparatus Norms FIG Certificate compulsory for all Apparatus	10
4. Guarantee for quality	10



I
01.01.2018

1. Introduction / Layout

The present booklet has four parts.

PART I. General part and contains the aim of these Rules, the introduction, the layout and general principles.

Part I is aimed at all users.

PART II. Contains the actual Apparatus Norms with drawings, measurements, description of functional properties and testing norms.

Part II is also aimed at all users.

PART III. Contains the procedures for how to obtain FIG Certificates and Diplomas.

Part III is mainly oriented to the apparatus manufacturers.

PART IV. contains the detailed description of the testing procedures and is directed to the apparatus manufacturers and the FIG recognised Testing Institutes.

2. Purpose and Principles

- The purpose of these Apparatus Norms is first, to have equivalent apparatus at all competitions. It is essential for the competitors to have the same, optimal conditions for the preparations for competitions and at competitions all over the World. This is necessary for practical reasons, for competition fairness and comparison and for safety.
- All apparatus used at official FIG events; the Olympic Games and the World Games must have a valid FIG Certificate. This Certificate will be issued by the FIG, provided the apparatus has been tested successfully.
- The controlled certification by the FIG and the testing procedures guarantee, that the Apparatus Norms are respected. With the Diplomas issued by the FIG, a partnership between the FIG and the apparatus manufacturers is created.
- The choice of material and construction must be left to the manufacturers, to allow the apparatus to adapt to progress, development and new construction techniques. Therefore, the FIG only prescribes measurements, functional properties, norms for testing and testing procedures.
- The FIG recognises neutral Testing Institutes, which have to follow the testing procedures decided by the FIG to test the functional properties, the norms and measurements of the apparatus.
- The testing procedures must be constantly developed with the purpose to have meaningful testing procedures for all apparatus and further develop existing procedures. It is important to develop testing procedures which guarantee, that the apparatus fulfil the norms also after intensive use.
- To enforce the Apparatus Norms and to guarantee the quality of apparatus after intensive use, the FIG may, before, during or after an event, control the apparatus and make re-tests at the Testing Institute.
- In case of contradictions between the Apparatus Norms and the Code of Points, the Apparatus Norms prevail.



I
01.03.2021

3. Validity of the Apparatus Norms FIG Certificate compulsory for all Apparatus

These Apparatus Norms were decided by the FIG Executive Committee and are valid from 1st May 2021.

They replace all previous editions as well as all previous decisions and publications regarding apparatus norms from the Executive Committee, Technical Committees and the Apparatus Commission of the FIG.

They are compulsory for all FIG events, as well as at the Olympic Games, World Games, Commonwealth Games, Asian Games, Pan-American Games, University Games and other multi-sport Games with International participation. At all those events, no apparatus which does not have a valid FIG Certificate may be used.

The FIG strongly recommends that at all other national and international events, organised independently by its member federations or unions, only apparatus which have a valid FIG Certificate may be used.

At international events, apparatus without a valid FIG Certificate may only be used provided all participating member federations have agreed in writing and bear the full responsibility and liability for the use of such uncertified apparatus. The FIG waives all responsibility in the cases where apparatus without a valid FIG Certificate are used.

4. Guarantee for quality

To guarantee equal quality and fairness for the competitors and to guarantee their safety and health, testing procedures for the quality of apparatus are necessary. Those testing procedures are defined in the Apparatus Norms part II and IV.

These apparatus norms as well as the requested norms and functional properties must not only be fulfilled at the time of the test at the Testing Institute. The apparatus manufacturers must guarantee to produce their apparatus in such a quality that the apparatus also fulfil the requested norms, functional properties and safety aspects after intensive use e.g. after a World Championship.



II. APPARATUS NORMS

Content

1. Overview of the apparatus of the FIG disciplines	15
1.1. Mens' artistic Gymnastics MAG	17
1.2. Womens' artistic Gymnastics WAG	18
1.3. Rhythmic Gymnastics RG.....	19
1.4. Trampoline Gymnastics TRA.....	20
1.5. Acrobatic Gymnastics ACRO.....	21
1.6. Aerobic Gymnastics AER	22
1.7. Parkour PK.....	23
2. Apparatus of the FIG disciplines – Construction and material description, dimensions	25
2.1 MAG Men’s artistic gymnastics	27
MAG 1 Floor	28
MAG 2 Pommel Horse	30
MAG 3 Rings	33
MAG 4 Vaulting table	36
MAG 5 Parallel Bars	41
MAG 6 Horizontal bar	43
MAG 11/12 Landing mats	45
MAG 13 Supplementary mats.....	47
MAG 14 Vaulting board.....	48
MAG 15 Vaulting board safety collar (Round off vaults).....	51
MAG 16 Mat for Hands (Vault).....	52
MAG 18 Tension Control Sensor for Rings, High Bars and Uneven Bars - TCS	53
2.2 WAG Women’s artistic gymnastics	55
WAG 1 Vaulting Table	57
WAG 2 Uneven Bars	62
WAG 3 Balance Beam	65
WAG 4 Floor	67
WAG 11 Landing Mats 20 cm	69
WAG 13 Supplementary Mats (10 cm).....	71
WAG 14 Vaulting Board.....	72
WAG 15 Vaulting Board safety collar (Round off vaults)	75
WAG 16 Mat for Hands (Vault).....	76
WAG 17 Spotter mat (Uneven Bars).....	77
WAG 18 Tension Control Sensor for Rings, High Bars and Uneven Bars - TCS	78

2.3	RG Rhythmic gymnastics	80
	RG 1 Performance Area	82
	RG 2 Rope.....	84
	RG 3 Hoop	84
	RG 4 Ball	84
	RG 5 – Clubs	85
	RG 6 – Ribbon.....	85
	RG 7 – Ribbon cane	85
	RG 10 Measurement Table for RG with Balance	88
2.4	TRA Trampoline Gymnastics	90
	TRA 1 Trampoline.....	92
	TRA 2 Double Mini-Trampoline.....	96
	TRA 3 Tumbling track.....	101
	TRA 11 Safety mat (20 cm): Trampoline, Double Mini-Trampoline.....	103
	TRA 12 Spotter mat: Trampoline, Double Mini-Trampoline	104
	TRA 13 Supplementary mat: Tumbling	105
	TRA 14 Vaulting Board - Tumbling.....	106
	TRA 15 Time measurement device for trampoline competitions - TMD.....	108
	TRA 16 Horizontal Displacement Measurement Device for.....	112
	TRA 17 Landing mat (30 cm): Double Mini-Trampoline + Tumbling	115
2.5	ACRO Acrobatic Gymnastics	116
	ACRO 1 Floor	118
	ACRO 11 Landing Mat	120
2.6	AER Aerobic Gymnastics	122
	AER 1 Performance area.....	124
	AER 2 Aerobic Step.....	126
2.7	PK Parkour	128
	PK 1 Track.....	130
	PK 2 Obstacles.....	133
	01.03.2020.....	137
	PK 3 Scaffolding	138

3. Surfaces of apparatus, clearance zones, total surfaces

4. Competition area

5. Apparatus Control Forms

6. Required Equipment for FIG – Competition MAG/WAG/RG/TRA





1. Overview of the apparatus of the FIG disciplines







1.1. Mens' artistic Gymnastics MAG	17
1.2. Womens' artistic Gymnastics WAG	18
1.3. Rhythmic Gymnastics RG.....	19
1.4. Trampoline Gymnastics TRA.....	20
1.5. Acrobatic Gymnastics ACRO.....	21
1.6. Aerobic Gymnastics AER	22
1.7. Parkour PK.....	23

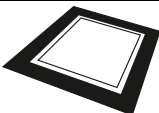

1.1. Mens' artistic Gymnastics MAG





II
MAG
01.09.2019

Number	Apparatus	Pictogram	Description Construction Material	Test	
				Institute	Competition
APPARATUS					
MAG1	Floor		II MAG1	IV MAG1	yes
MAG2	Pommel horse		II MAG2	IV MAG2	yes
MAG3	Rings		II MAG3	IV MAG3	yes
MAG4	Vaulting table		II MAG4	IV MAG4	yes
MAG5	Parallel bars		II MAG5	IV MAG5	yes
MAG6	Horizontal bar		II MAG6	IV MAG6	yes
SUPPLEMENTARY APPARATUS					
MAG11	Landing mat 20cm		II MAG11	IV MAG11	yes
MAG12	Landing mat 10cm		II MAG12	IV MAG12	yes
MAG13	Supplementary mat 10cm		II MAG13		yes
MAG14	Vaulting board		II MAG14	IV MAG14	yes
MAG15	Vaulting Board safety collar (Round off vaults)		II MAG15		yes
MAG16	Mat for hands (vault)		II MAG16		yes
MAG18	TCS		II MAG18	IV MAG18	yes



1.2. Womens' artistic Gymnastics WAG

II
WAG
01.09.2019

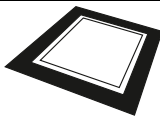





Number	Apparatus	Pictogram	Description Construction Material	Test	
				Institute	Competition
APPARATUS					
WAG1	Vaulting table		II WAG1	IV WAG1	yes
WAG2	Uneven bars		II WAG2	IV WAG2	yes
WAG3	Balance beam		II WAG3	IV WAG3	yes
WAG4	Floor		II WAG4	IV WAG4	yes
SUPPLEMENTARY APPARATUS					
WAG11	Landing mat 20cm		II WAG11	IV WAG11	yes
WAG13	Supplementary mat 10cm		II WAG13		yes
WAG14	Vaulting board		II WAG14	IV WAG14	yes
WAG15	Vaulting Board safety collar (Round off vaults)		II WAG15		yes
WAG16	Mat for hands (vault)		II WAG16		yes
WAG17	Spotter mat (Uneven Bars) for training and warming up		II WAG17		yes
WAG18	TCS		II WAG18	IV WAG18	yes

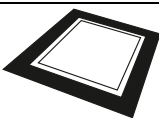

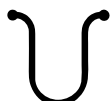
1.3. Rhythmic Gymnastics RG

II
RG
01.09.2019

Number	Apparatus	Pictogram	Description Construction Material	Test	
				Institute	Competition
RG1	Floor		II RG1	IV RG1	yes



Number	Apparatus	Pictogram	Description- Construction Material	Test	
				Institute	Competition
APPARATUS					
RG2	Rope		II RG2	yes	yes*
RG3	Hoop		II RG3	yes	yes*
RG4	Ball		II RG4	yes	yes*
RG5	Clubs		II RG5	yes	yes*
RG6	Ribbon		II RG6	yes	yes*
RG7	Ribbon cane		II RG7	yes	yes*
RG10	Measurement Table with Balance		II RG10	yes	

* Test with measuring table according to the directives of the competition

1.4. Trampoline Gymnastics TRA



II
TRA
01.05.2021

Number	Apparatus	Pictogram	Description- Construction Material	Test	
				Institute	Competition
APPARATUS					
TRA1	Trampoline		II TRA1	IV TRA1	yes
TRA2	Double Mini-Trampoline		II TRA2	yes	yes
TRA3	Tumbling track		II TRA3	IV TRA3	yes
SUPPLEMENTARY APPARATUS					
TRA 11	Safety mat for TRA, DMT (20 cm)		II TRA11	IV TRA11	yes
TRA 12	Spotter mat Trampoline Gymnastics DMT		II TRA12		yes
TRA 13	Supplementary mat 10cm for TUM		II TRA13		yes
TRA 14	Vaulting board Tumbling		II TRA14	IV TRA14	yes
TRA 15	Time measurement device for Trampoline competitions (TMD)		II TRA15	IV TRA15	yes
TRA 16	Horizontal Displacement measurement device for Trampoline competitions (HDMD)		II TRA16	IV TRA16	yes
TRA 17	Landing mat 30cm for DMT, TUM		II TRA 17	yes	yes



1.5. Acrobatic Gymnastics ACRO

II
ACRO
01.01.2009

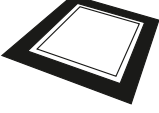
Number	Apparatus	Pictogram	Description Construction Material	Test	
				Institute	Competition
APPARATUS					
ACRO1	Floor		II ACRO1	IV ACRO1	yes
SUPPLEMENTARY APPARATUS					
ACRO11	Landing mat 20 cm		II ACRO11	IV ACRO11	yes



1.6. Aerobic Gymnastics AER

II
AER
01.01.2015

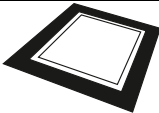
Number	Apparatus	Pictogram	Description Construction Material	Test	
				Institute	Competition
APPARATUS					
AER1	Floor		II AER1	IV AER1	Yes
AER2	Aerobic Step		II AER2		Yes



1.7. Parkour PK

II
PK
01.05.2021

Number	Apparatus	Pictogram	Description Construction Material	Test	
				Institute	Competition
APPARATUS					
PK1	Track		II PK1	IV PK1	Yes
PK2	Obstacles		II PK2	IV PK2	Yes
PK3	Scaffolding		II PK3	IV PK3	Yes

Manufacturer must submit for the certification of **obstacles** and **scaffoldings**:

- Technical drawings with all norm-relevant dimensions
- A confirmation that all requirements of FIG Apparatus Norms Part II PK2/3 have been complied with (except for 4.6.2 slip resistance and 4.6.3 tilt resistance):

„We confirm that the Obstacle / Scaffolding ___ (insert name and/or product number) meets the requirements of FIG Apparatus Norms Part 2, PK 2 (obstacles) and/or PK 3 (scaffolding). Proof of this is attached in the form required by the standard. Excluded from this are explicitly points 4.6.2 slip resistance and 4.6.3 tilt resistance, as they depend on the respective installation situation.“

For the approval of **tracks** and **courses** the supplier must submit before the first athlete touches the equipment to the competition management:

- Technical drawings with all norm-relevant dimensions
- A confirmation that all requirements of the standard have been complied with:

„We confirm that all tracks, obstacles and scaffoldings used at ___ (insert name and event ID) meet the requirements of FIG Apparatus Norms Part 2.7 Parkour and had been installed accordingly. Particular attention was paid during design and installation to compliance with the functional properties (point 4). Proof of this is attached in the form required by the standard.“





2. Apparatus of the FIG disciplines – Construction and material description, dimensions

2.1	MAG Men’s artistic gymnastics	27
2.2	WAG Women’s artistic gymnastics	55
2.3	RG Rhythmic gymnastics.....	80
2.4	TRA Trampoline Gymnastics	90
2.5	ACRO Acrobatic Gymnastics.....	116
2.6	AER Aerobic Gymnastics.....	122
2.7	PK Parkour	128





2.1 MAG Men's artistic gymnastics

MAG 1 Floor	28
MAG 2 Pommel Horse	30
MAG 3 Rings	33
MAG 4 Vaulting table	36
MAG 5 Parallel Bars	41
MAG 6 Horizontal bar	43
MAG 11/12 Landing mats	45
MAG 13 Supplementary mats	47
MAG 14 Vaulting board	48
MAG 15 Vaulting board safety collar (Round off vaults)	51
MAG 16 Mat for Hands (Vault)	52
MAG 18 Tension Control Sensor for Rings, High Bars and Uneven Bars -TCS	53

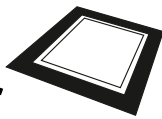

Floor

Men's Artistic Gymnastics

Construction / Description of material, measurements

1. Form

- 1.1. The Performance Area shall have a square format. The surface must be horizontal, even and without gaps. All plates of the under construction within the Performance Area shall have the same arrangement of elastic elements.
- 1.2. All elements of the floor have to be connected firmly to prevent slipping.
- 1.3. Edge: Horizontal and even, at the same height as the Performance area
- 1.4. Edge's variant: Width 50 cm, horizontal and even, at the same height as the Performance area, additional 50 cm inclination edge, slope may not exceed 25 %.
- 1.5. Clearance zone: The clearance zone shall be kept totally free as a surrounding zone around the performance area and the edge. It shall be horizontal, even and without gaps. (See Definition: II, chapter 3. Surfaces of apparatus, clearance zones, total surfaces)

2. Measurements

- | | | |
|--|-------------------|----------------------|
| 2.1. Performance area | 1200 cm x 1200 cm | Tolerance +/- 3 cm |
| 2.2. Diagonals of the performance area: | 1697 cm +/- 5cm | |
| 2.3. Edge | 100 cm, min. | |
| 2.4. Edge as a variant | | |
| 2.4.1. Horizontal Area, Width | 50 cm, min. | |
| 2.4.2. Slope max. 25 %, Width | 50 cm, min. | |
| 2.4.3. Height of outer edge at the very end | 3,5 cm, max. | |
| 2.5. When there is a delimitation strip between the Performance area and the edge: | | |
| 2.5.1. Delimitation strip width | 5 cm, | Tolerance +/- 0,5 cm |
| 2.6. The delimitation strip is part of the Performance area. | | |

3. Functional Properties of the performance area and edge

- 3.1. Equal elasticity on the surface as well as dampening.
- 3.2. When in use it should not have any hindering motion energy
- 3.3. Elasticity and dampening must be balanced in such a way that they guarantee the gymnast stability and freedom of movement. It must not restrict turns and slide movements.
- 3.4. The surface cover of the Performance area must provide a balance between anti-skid and slippage. It must not cause skin burns.
- 3.5. The floor must not produce disturbing sound during the execution of an exercise. It must assure a low noise level.

4. Of plain colour which choice is left to the manufacturer's discretion. Dark colours are not allowed. For certain events the FIG may stipulate the colours. The delimitation shall have a clear contrast to the performance area.

Norms / Functional properties: Regarding tests carried out by FIG Tests Institutes – please see chapter IV

Floor

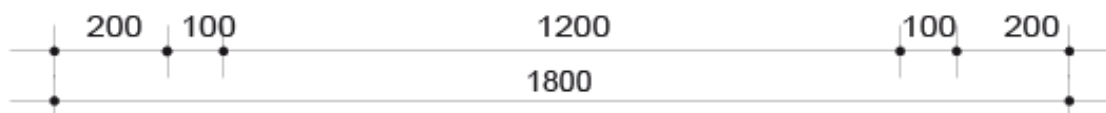
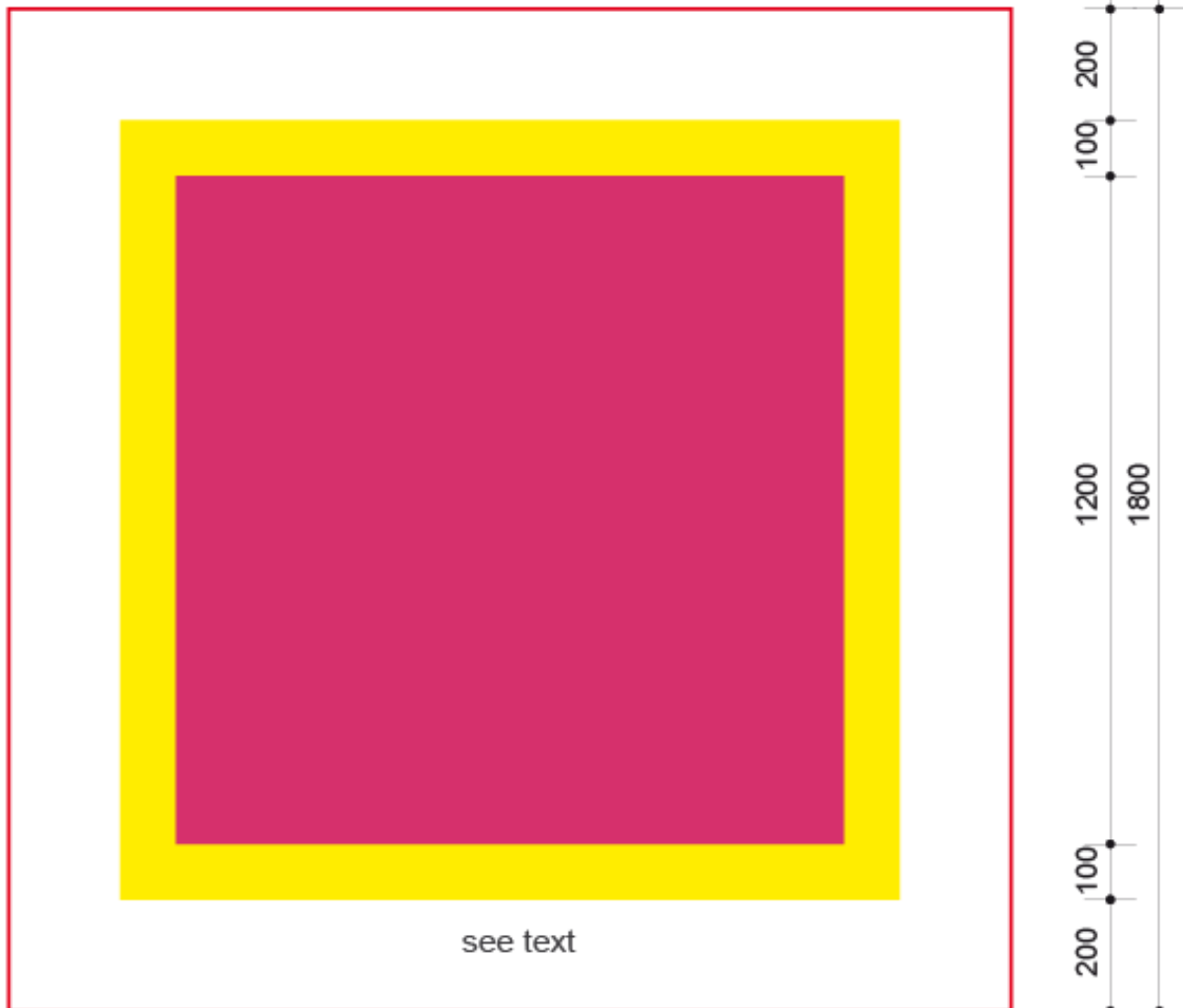

- competition area
- edge
- clearance zone

profile - variants A, B, C

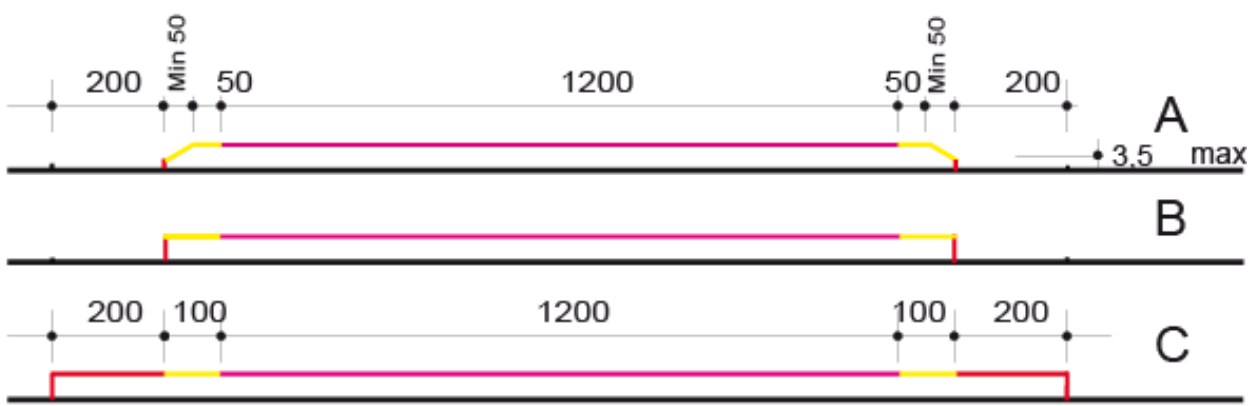



Pommel Horse

Men's Artistic Gymnastics

Construction / Description of material, measurements

1. Form

- 1.1.** The apparatus consists of a prismoid body which is placed horizontally onto a base. On the upper surface of the body, two pommels are attached crossways.
- 1.2.** The Horse Body:
- 1.2.1. Its sides - viewed from the two length and two front sides - slant inward.
 - 1.2.2. In cross section the upper surface shows an arch, in length section, it is horizontal, and even, and without gaps, except for the points of attachments.
 - 1.2.3. All corners and edges are rounded.
 - 1.2.4. The profile of the pommel horse's body shall lie within a ± 1 cm pipe at the top and a $\pm 0,5$ cm pipe at the side (red lines) around the specifications (in green) in the draw. The profile of the pommel horse's body shall not include any kinks at the transitions from one radius to another (see draw). The top of the horse's body shall be curved uniformly convex and shall not be flat.
- 1.3.** The Pommels:
- 1.3.1. They are circular in profile, rise from their bases and then make a slight circular transition to the horizontal.
 - 1.3.2. The base which serves as a support conforms to arched upper surface of the horse body.
- 1.4.** The Base:
- 1.4.1. Forms and conception do not have any prescriptions. It must assure stability of the body and the horizontal position of its length and cross axis; all technical safety rules must be observed.

2. Measurements

- 2.1.** Body:
- 2.1.1. Length at top 160 cm * 1 cm/¹
 - 2.1.2. Length at bottom 155 cm * 1 cm/²
 - 2.1.3. Width at top 35 cm * 1 cm/¹
 - 2.1.4. Width at bottom 30 cm * 1 cm/²
 - 2.1.5. Height 28 cm * 1 cm
 - 2.1.6. Height from upper surface to the floor: 115 cm * 1 cm
- 2.2.** Pommels:
- 2.3.** Inner vertical diameter ≥ 7 cm
- 2.4.** Width at base 31 cm * 0,5 cm
- 2.5.** Height 12 cm * 0,5 cm
- 2.6.** Profile diameter (at the nearly horizontal part) 3,4 cm * 0,1 cm
- 2.7.** Span of the nearly
- 2.8.** Horizontal part 15 cm * 0,2 cm
- 2.9.** Distance between Pommels:
- 2.9.1. Minimum ≤ 40 cm
 - 2.9.2. Maximum ≥ 45 cm

* refers to the tolerance, +/-,

¹ and ² are measurements linked to each other. In case of variation, they must move in the same direction, e.g. if width at top is 355 mm, the width at the bottom must be 305 ± 10 mm.

Adjustments:

Pommels: The distance between the two pommels, inside measurement, must be continuously adjustable from 40 cm to 45 cm

Pommel Horse

3. Functional Properties

3.1. Body:

- 3.1.1. Its support area must be elastic and absorbing.
- 3.1.2. The side surfaces, as well as corners and edges must have a dampening effect.
- 3.1.3. Indentations caused by support may not hinder turns of the palms.
- 3.1.4. The tear proof cover material, which tightly covers the body, may not slip or wrinkle.
- 3.1.5. The upper surface must offer the ability to glide, but not be slippery.
- 3.1.6. The cover material must be moisture absorbing and not cause skin burns.
- 3.1.7. The vertical and cross axis of the horse must be horizontal. During use, the horse must remain static.

3.2. Pommels:

- 3.2.1. In principle, they are made of stiff materials.
- 3.2.2. A slight flexibility, which must not affect support stability, is provided by the padded upper surface of the body.
- 3.2.3. The anchoring to the body must assure immobility.
- 3.2.4. The upper surface is slip proof, but must allow the palms to turn and slide in support.
- 3.2.5. The pommels must be moisture absorbent and neutral to the use of magnesia.

3.3. Base:

- 3.3.1. It must allow exact levelling of the body, and assure its immobility.
- 3.3.2. Floor anchoring for stabilization purposes is permitted, as well as anti-skid, dampening floor covering.
- 3.3.3. With exception of parts on the floor (feet) the base may not protrude from the body of the horse. The height of the feet must allow an even, horizontal mat covering.
- 3.3.4. No parts of the base may show sharp corners or edges, nor rough surfaces.
- 3.3.5. Since the body is attached to the base, the stability of the apparatus depends on it as well. This is also one of the most important requirements for safety.

4. Colours

- 4.1. Are left to the manufacturers' discretion. It is strongly recommended that the colour of the pommel horse's surface and the colour of the mats have sufficient contrast.
- 4.2. For certain events the FIG may choose the colour.
- 4.3. Based on practical tests and considered allowed are:
 - 4.3.1. For the body: The natural colour of leather, even when synthetic materials are used for the revetment
 - 4.3.2. For the pommel: Natural wood colour, or a light neutral shade, if synthetic materials are used
 - 4.3.3. For the base: Varnished colour

5. Mats

- 5.1. The mats used for pommel horse must have a height of 10cm (MAG 11/12)

Norms / Functional properties: Regarding tests carried out by FIG Tests Institutes – please see chapter IV



Rings

Men's Artistic Gymnastics

Construction / Description of material, measurements

1. Form

- 1.1. The apparatus consists of two circular rings, attached to cables suspended on a frame.
- 1.2. The rings have a uniform, circular profile.
- 1.3. The cables have a pivoting mechanism at their suspension point on the frame. In the still position, the cables must hang in the vertical.
- 1.4. The frames consist of two supports and a horizontal beam which contains the attachment devices of the cables.
- 1.5. The frame is held upright by four tension cables, anchored to the floor. (Max. Ø 1 cm)
- 1.6. To distribute the pressure, the supports have widened floor plates.

2. Measurements

2.1. Rings:

2.1.1. Inner diameter	18 cm	* 0,1 cm
2.1.2. Diameter of profile	2,8 cm	* 0,1 cm
2.1.3. Pendulum length below suspension device:		
2.1.4. Distance from point of attachment to lower inner		
2.1.5. side of the rings	300 cm	* 1 cm
2.1.6. Distance of lower inner side of the rings to floor	290 cm	* 0,5 cm

2.2. Straps:

2.2.1. Length	70 cm	* 1 cm
2.2.2. Width	4 cm	* 1 cm
2.2.3. Distance between the 2 points of attachment on the frame	50 cm	* 0,5 cm

2.3. Frame:

2.3.1. Height of attachment point at horizontal beam to the floor	590 cm	* 1 cm
2.3.2. Inner Distance of supports on the floor	260 cm	min
2.3.3. At height of 330 cm (point of indentation)	280 cm	min
2.3.4. Length of horizontal beam	120 cm	min
(Measured 30cm under the attachment point)		

2.4. Distance of tension cables:

2.4.1. in vertical direction of apparatus	550 cm	* 5 cm
2.4.2. in cross section to apparatus	400 cm	* 5 cm

* Tolerance, +/-

Rings

3. Functional Properties

- 3.1. The suspension device and the rings must be able to swing out freely in all directions. With the exception, of course, of the cable's direction.
- 3.2. Even submitted to tension, the rings must rotate easily. For this purpose, the pivoting device exists.
- 3.3. Under load both rings shall have the same height above the ground.
- 3.4. The rings must guarantee a sure grip and therefore must not be slippery.
- 3.5. The rings must absorb moisture.
- 3.6. The rings as such are made of a stiff material; in effect however, the apparatus must have a certain elasticity, to protect the gymnast's joints. This is done partly through form and the method by which the frame is held and can be helped by an elastic dampening device on the suspension cables.
- 3.7. This device however may not produce springy or counter swings.
- 3.8. Rings are either made of wood or synthetic material.
- 3.9. Except for sanding, the rings' upper surfaces receive no other treatment. The material must remain natural in order to absorb magnesia and moisture so as to assure a sure grip.
- 3.10. The pivoting mechanism, the elastic dampening device and the stepless height regulator are connected to the hanging points.
- 3.11. The cables are protected by a smooth synthetic cover material
- 3.12. The straps, to which the rings are attached, are made of leather or of a sturdy equivalent material.
- 3.13. Aside from the required resistance of materials, the stability of the apparatus must be assured.
- 3.14. During the exercise, the frame and the suspension device must not move or cause hindering sways or vibrations.
- 3.15. The required elasticity of the suspension device must not produce springy or counter swings.
- 3.16. Sharp corners and edges and rough surfaces are to be avoided.
- 3.17. The ring cables and fixations must be such that no shortening of the ring cables and straps can occur during the exercises of the gymnasts

4. Colour

- 4.1. The rings retain the natural colour of the material.

Norms / Functional properties: Regarding tests carried out by FIG Tests Institutes – please see chapter IV

Rings

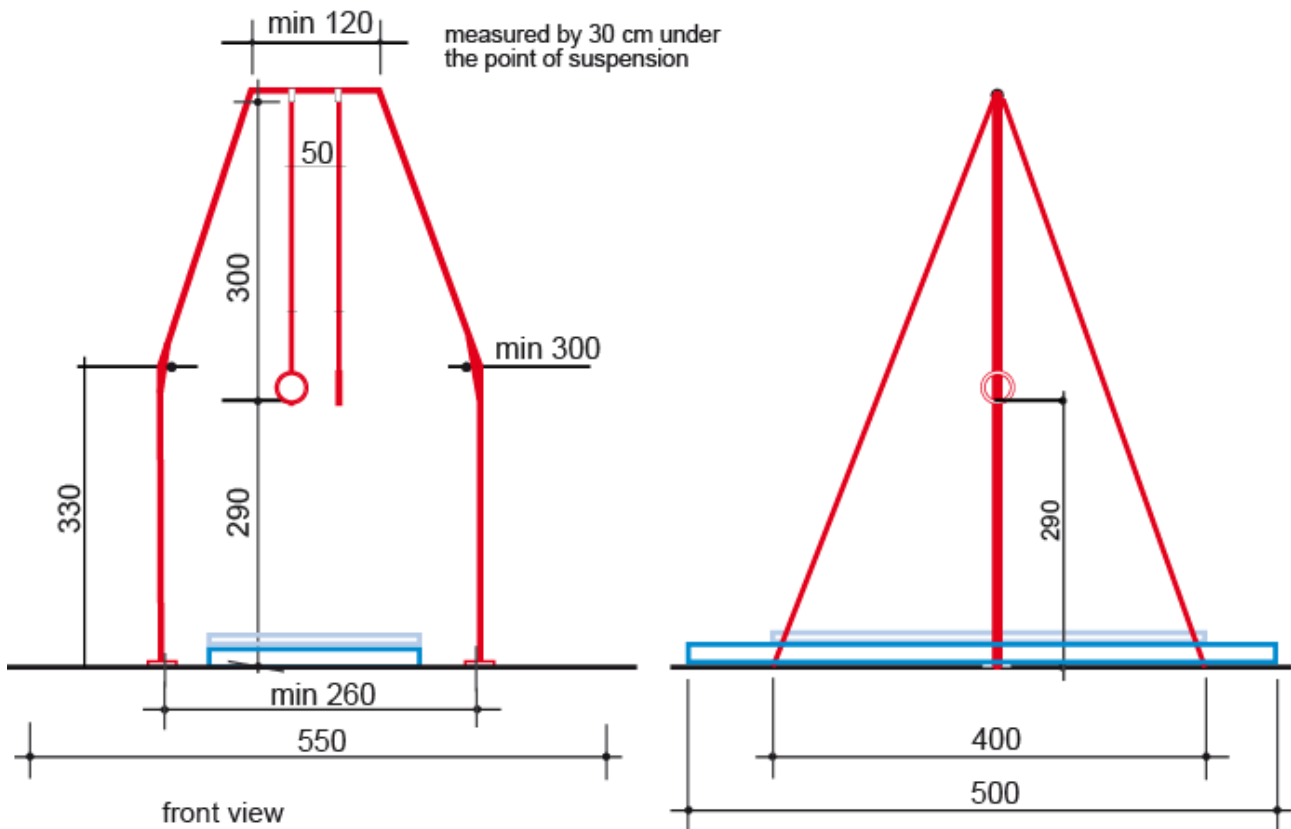

supplementary mat (MAG13) can be removed by making an official request (for gymnast height)

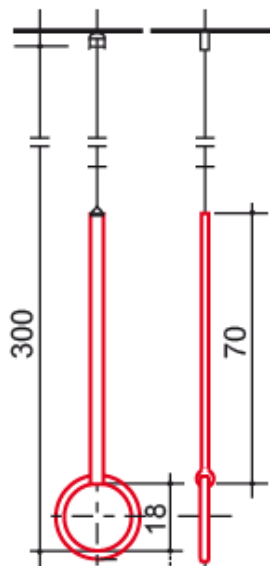

detail

rings + suspension



diameter of ring profile

dimensions: mandatory;
design: at your discretion;
drawing: typical example

Vaulting table

Men's Artistic Gymnastics

Construction / Description of material, measurements

1. Form

- 1.1. The apparatus consists of a slightly inclined table body which is mounted onto a “monostand” bottom frame. The table body consists of a front surface (A) which, seen from the direction of the vault, is inclined to 8° to the vertical and merges into two arched bends (B1 and B2) and then into a linear cover surface (C) which is inclined 3° to the horizontal. The table body is divided into a bounce area (A) and a push away area (B and C) with a clear colour contrast. The different surfaces merge into each other without any gaps in between. The push away area is slightly rounded in transversal direction (D).
- 1.2. All corners and edges are rounded. The bottom frame must offer the table body a stable and secure supporting surface and must guarantee the abidance by the technical safety regulations. The bottom frame with cushioning may not present any parts that protrude from under the vaulting table's body except on the landing side. As a collision protection dangerous metal parts of the support must be cushioned.
- 1.3. Recommendation: All levers and locking mechanisms should be incorporated into the under construction.
- 1.4. At the landing side the legs of the bottom frame must be cushioned at the same height level as the landing mat (20cm, Tolerance +10cm).
- 1.5. The vaulting table including the cushioning of the bottom frame must represent a “monostand” - construction.

2. Measurements

- | | |
|---|-----------------|
| 2.1. Table body: | |
| 2.1.1. length: | 120 cm +/- 1 cm |
| 2.1.2. width: | 95 cm +/- 1 cm |
| 2.2. Height at the given measurement point (see drawing)) ¹ : | 135 cm +/- 1cm |
| 2.3. Upper height at the bounce area (see drawing)) ¹ : | 122 cm +/- 1 cm |

Remark: For competitions the vaulting table must be positioned on a rigid board which has the same height as the run-up area (see below)

)¹: In competitions the apparatus height must correspond to the top level of the run-up area.

- 2.4. Maximal orthogonal deviations from the given profile lines in longitudinal and transversal directions: < 1 cm
- 2.5. Protrusion of the leg construction below the table body on the landing side (only allowed with appropriate cut-outs in the landing mat): 15 cm maximal
- 2.6. Height of the leg frame 8 cm maximal
- 2.7. Circumference of the (cushioned) bottom frame including all levers and fixation devices between the height of 50 cm up to 85 cm 1828m minimal

- 2.8.** Distance between the (cushioned) leg construction including all levers and fixation devices and the projection of the table body on all four sides between the height of 50 cm up to 85 cm
25 cm minimal
- 2.9.** The adjusted height of the vaulting table must be clearly signed at the side. Additional Measurements see drawing. The profile lines towards A, B1, B2 and D are to be respected as indicated in the drawing. Maximum deviations < 1 cm – measured at a right angle to the profile line.

3. Functional properties

- 3.1.** The push away area must be shock-absorbing so that shoulders and wrists are protected.
- 3.2.** The rebound properties must be guaranteed to be as homogeneously as possible for all the possible impact points on the table body.
- 3.3.** Extended time-shift for rebounding energy at the impact points caused by extreme deflections is not acceptable.
- 3.4.** The table body must be evenly cushioned over the entire push away area. The cover material must be non-slippery but not rough. It may not cause a burning sensation on sliding.
- 3.5.** The bounce area must be cushioned with a high-quality material in order to provide a good collision protection.
- 3.6.** Recommendation: Any protruding items covered by the cushioning of the stand should be avoided or sufficiently covered to prevent perforation through the cushioning during accidental impact.
- 3.7.** In order to avoid swaying, vibrations and shifting, the apparatus must have a device for fastening it to the floor.

4. Colour

- 4.1.** The colour of the surface material may be chosen according to taste. For certain events the colour may be determined by the FIG

5. Run-up area

- 5.1.** The run-up area is composed of a run-up mat and a rigid board underneath the vaulting board.
- 5.2.** The run-up mat shall be positioned so the carpet threads open in the opposite direction of the gymnast run, offering the greatest friction between the feet and run up mat. The orientation of the run-up mat shall be the same in the training halls, warm-up halls, and competition hall.
- 5.3.** The start of the run-up (2500 cm) shall be marked by a block, attached at the start of the vault run-up mat length (measured from the vertical projection of the beginning of the vaulting table, see “reference point” in the drawing, to the inner side of the block):
- | | |
|---|--------------|
| | 2500 + 10 cm |
| 5.3.1. width (run-up mat) | 100 +/- 1 cm |
| 5.3.2. width (rigid board underneath) | 100 cm min |
| 5.3.3. height (same height for run-up mat and board underneath) | max 2,5 cm |
| 5.3.4. length of the rigid board underneath the vaulting board | 320 +/- 1 cm |
- 5.4.** The colour of the run-up area must have a clear contrast to the colour of the vaulting board. The whole run-up area (run-up mat and the rigid board underneath) shall have the same colour

6. Authorized landing zone

- 6.1.** Marking on the supplementary mat above the landing mat (see drawing).
- | | |
|---|----------------|
| 6.1.1. Width of the landing corridor at the table site: | 95 cm |
| 6.1.2. Width of the landing corridor (end of 600 cm landing mat): | 150 cm |
| 6.1.3. When the authorized landing zone is marked out by stripes: marking strip width on the supplementary mat: | 5 cm +/-0.5 cm |
| 6.1.4. Additional marking strip width in the centre of the landing corridor (see drawing): | 5 cm +/-0.5 cm |

Remarks concerning the drawings:

- Bottom frame construction schematized.
- All dimensions in cm
- Tolerances for all dimensions: +/- 1cm
- Maximal Orthogonal Deviations from the given profiles in longitudinal and transversal directions: <1cm
- Dimensions binding; Construction may be different– drawing as example.

Norms / Functional properties: Regarding tests carried out by FIG Tests Institutes – please see chapter IV



Vaulting table

A; B1; B2; C; D:
see text

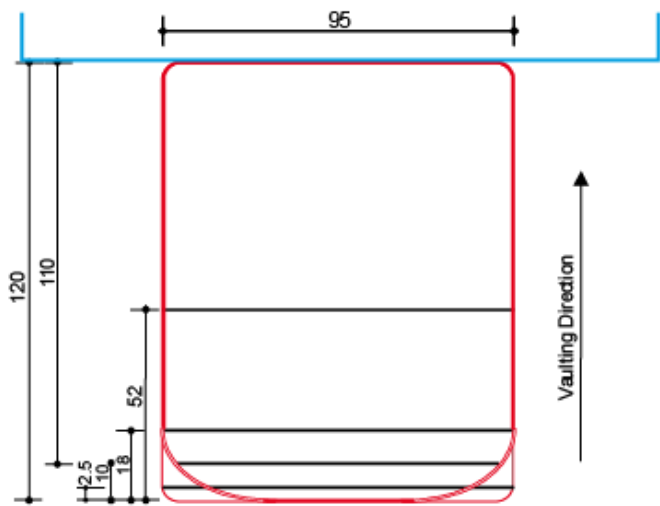
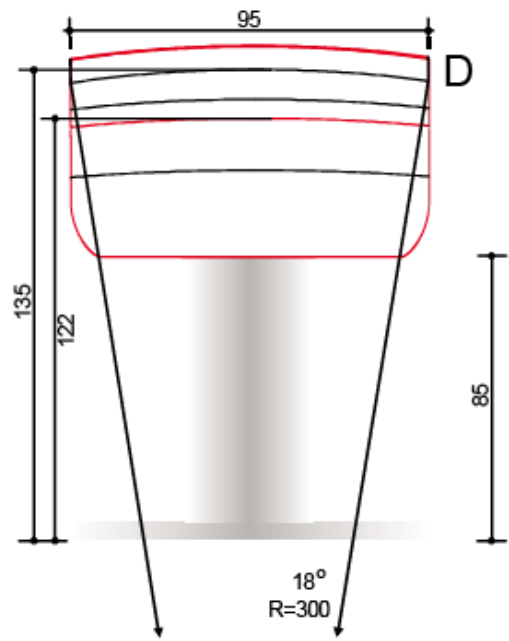
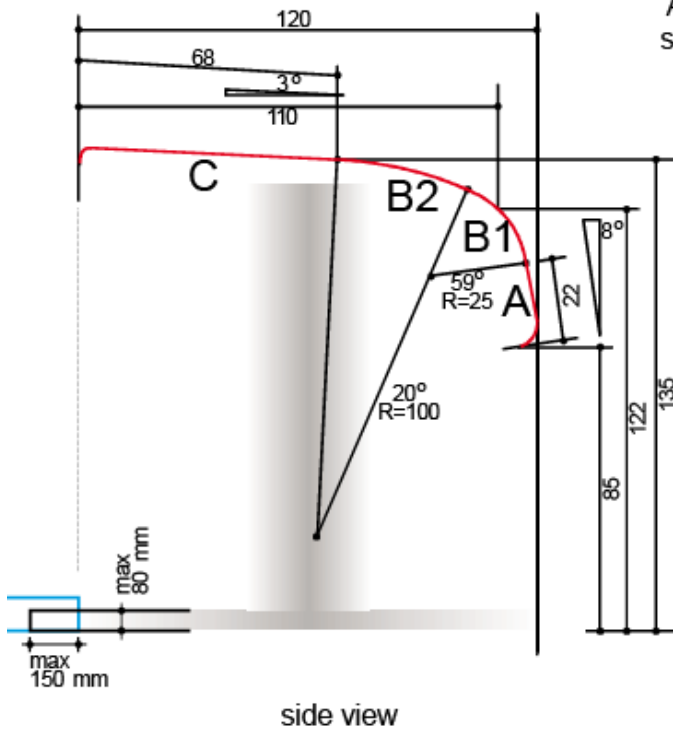

dimensions: mandatory;
design: at your discretion;
drawing typical example

Vaulting table

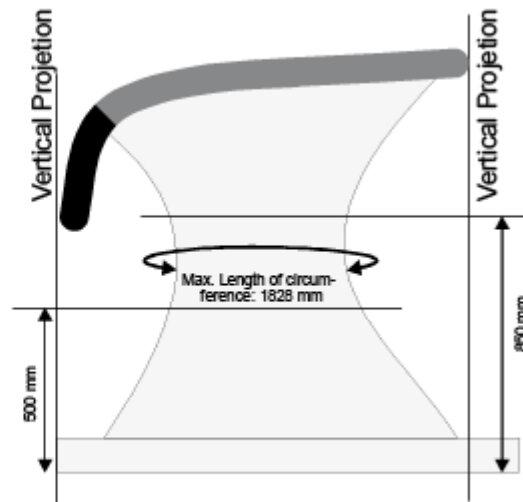
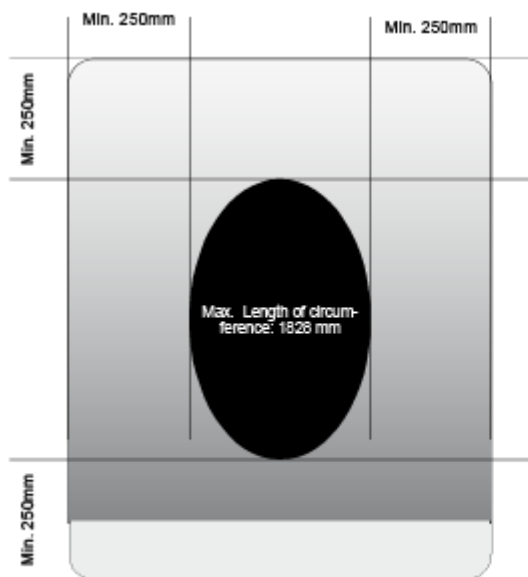

dimensions: mandatory;
 design: at your discretion;
 drawing: typical example

Vaulting table

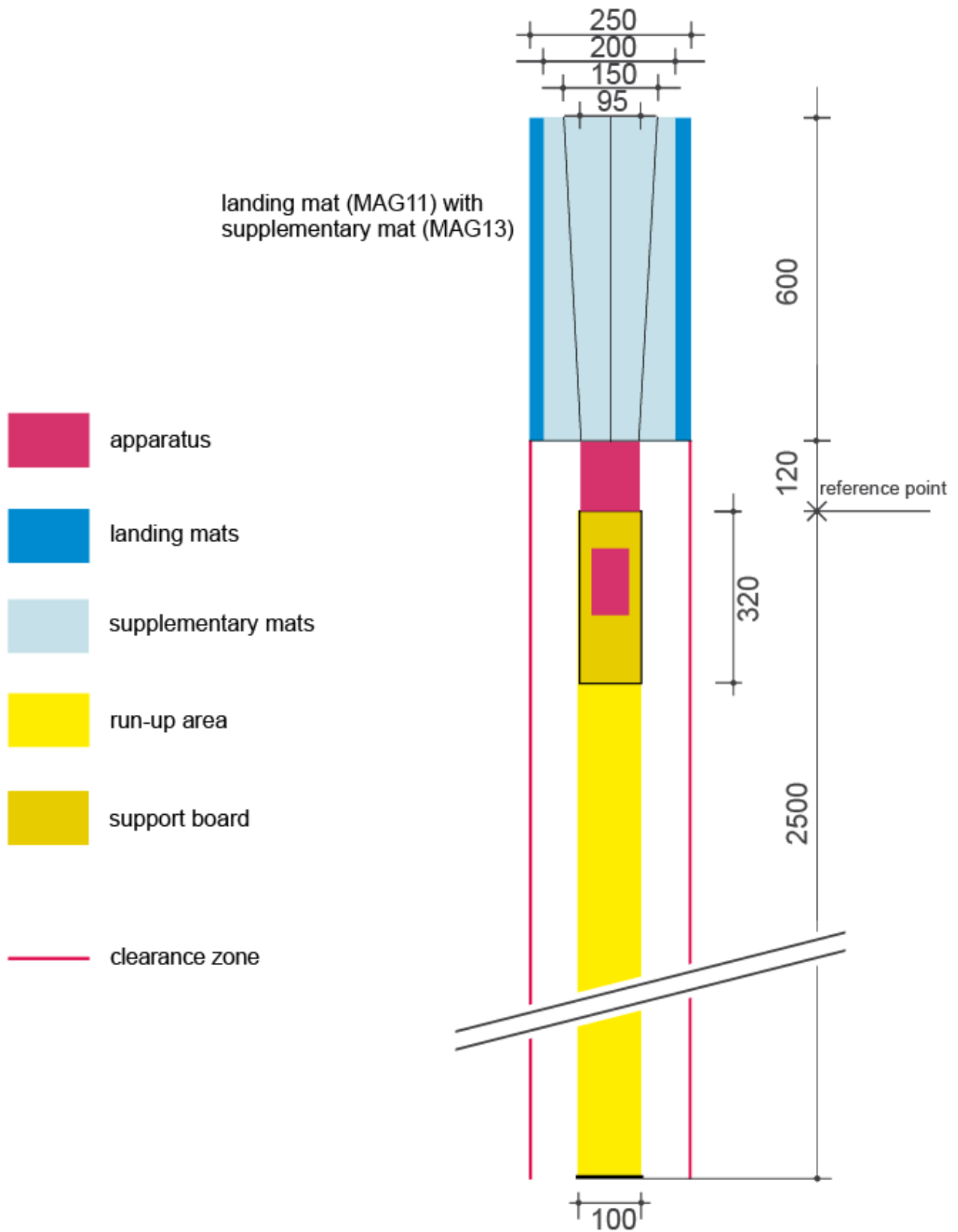



Parallel Bars

Men's Artistic Gymnastics

II
MAG 5
01.01.2017

Construction / Description of material, measurements

1. Form

- 1.1. The apparatus consists of two bars of equal dimensions, which run parallel and at the same height.
- 1.2. The position of the bars is parallel; pre-stressing is allowed.
- 1.3. Each bar is supported by two upright supports, which stand on a stable base frame.
- 1.4. The uprights consist of a static and mobile part, that allow the height and width adjustment of the bars.
- 1.5. In cross section, bars present a drop like profile, which remains unchanged for their entire length.
- 1.6. The profile of the bars shall lie within a $\pm 0,5$ mm pipe around the specifications in the draw. The profile of the bars shall not include any kinks at the transitions from one radius to another (see draw)

2. Measurements

2.1. Bars:

2.1.1. Length	350 cm	* 1 cm
2.1.2. Vertical axis of profile	5 cm	* 0.1cm
2.1.3. Horizontal axis of profile	4 cm	* 0.1cm
2.1.4. Height of upper edge measured from the floor near to the supports	200 cm	* 1 cm
2.1.5. Distance between points of attachment	230 cm	* 1 cm
2.1.6. Distance between bars from	42 cm to 52 cm	
2.1.7. Distance between the columns at adjustment levels, min.48 cm		
2.1.8. Heights of mats	20 cm	* 1 cm

* Tolerance +/-

Width adjustment: continuous adjustment of the distance between bars from at least 42 cm to 52 cm must be possible

3. Functional properties

- 3.1. The bars must have elasticity.
- 3.2. To assure the efficiency of this elasticity the fixing points of the bars on the uprights must be articulated.
- 3.3. No significant swaying of bars in the longitudinal and transversal sense must occur.
- 3.4. The entire apparatus must be stable. Incident vertical and transversal forces must not move the apparatus.
- 3.5. The upper surface of the bars must be hygroscopic, and not be slippery.
- 3.6. The surface of the bars must be made of wood or of other material with similar behaviour. If it is made of wood, it shall be free of errors (knots, fissure, etc.). Except for sanding, it receives no other treatment.
- 3.7. The rails must be secured against breaking through.
- 3.8. The apparatus must not have sharp corners of edges or any protruding parts.
- 3.9. Rough surfaces are to be avoided.
- 3.10. The adjustment screws must be warranted against unintended adjustments.
- 3.11. The adjustment devices must be double locked to assure that they do not cede during use.
- 3.12. The base girders as well as the space between them must be covered by mats. They must be even and without gaps and of the same height as the surrounding mats, forming a uniform surface, from which only the uprights rise.

4. The rails retain the natural wood colour.

Norms / Functional properties: Regarding tests carried out by FIG Tests Institutes – please see chapter IV

Parallel Bars

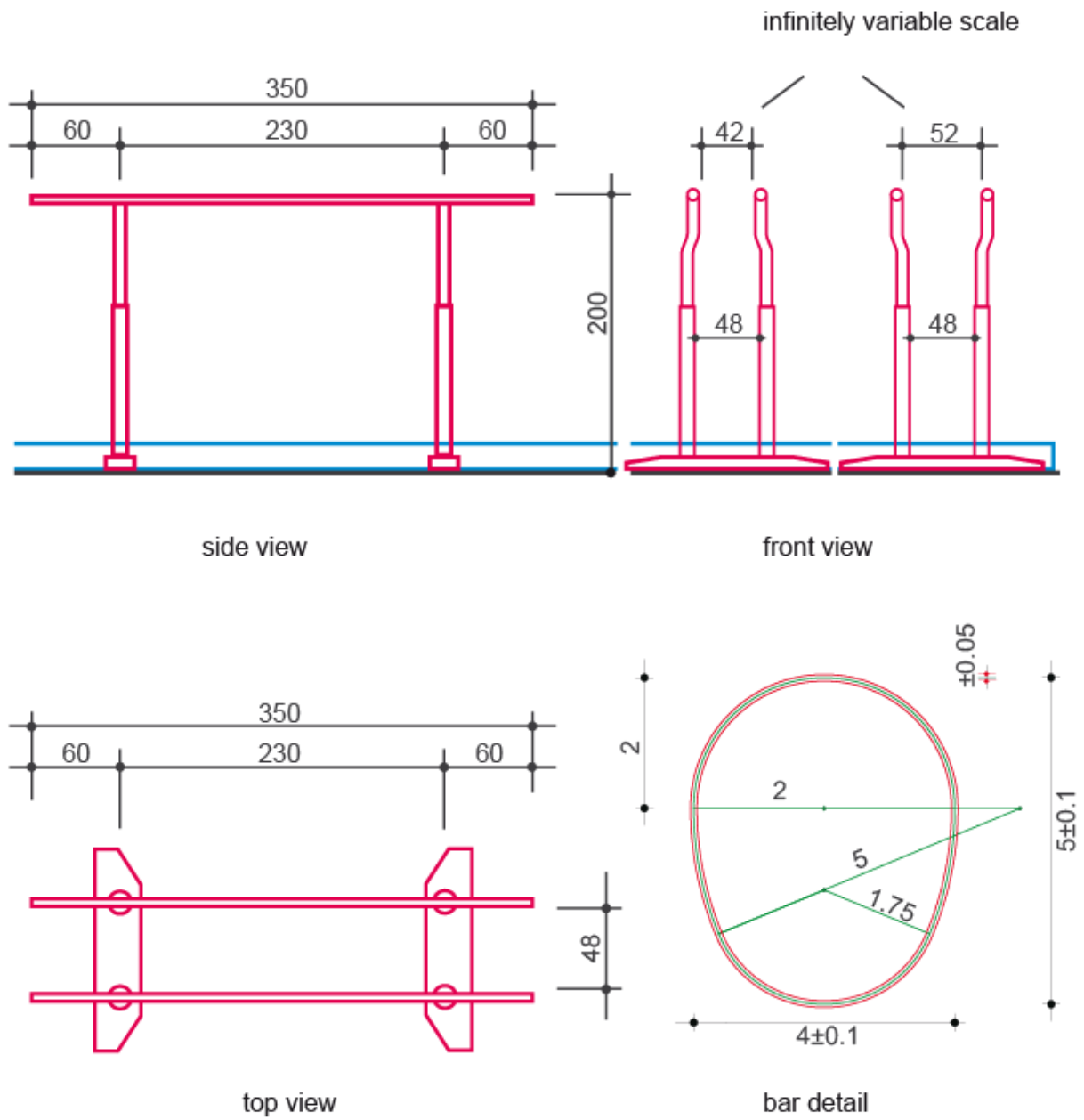

dimensions: mandatory;
 design: at your discretion;
 drawing: typical example

Horizontal bar

Men's Artistic Gymnastics



II
MAG 6
01.01.2014

Construction / Description of material, measurements

1. Form

- 1.1. The Horizontal bar consists of a round bar with a constant diameter, which is held horizontally by two supports.
- 1.2. The supports stand erect on the floor and have additional floor plates for displacing force.
- 1.3. They are held upright by tension cables (\varnothing max. 1 cm), connected to four floor anchors.

2. Measurements

2.1. Horizontal bar:

- | | | |
|--|------------|-----------|
| 2.1.1. Diameter | 2,8 cm | * 0.01 cm |
| 2.1.2. Length between attachment points | 240 cm | * 1 cm |
| 2.1.3. Distance between the sockets | min 200 cm | * 1 cm |
| 2.1.4. Height of upper edge: measured from floor | 280 cm | * 1 cm |
- 2.1.5. The height of the horizontal bar must be adjustable for additional 10 cm to the standard height (280+10 cm * 1 cm).
- 2.1.6. Height changes at competitions to 280+10 cm must be possible by devices at the supports above the upper surface of the landing mat (20 cm). Wires and chains shall be long enough to increment the height.
- 2.1.7. Height increases of 10 cm shall be allowed in competitions for gymnasts who touch the mat with their feet during the exercise. This must be announced to the organizers at the time of the nominative entry and verified by the President or a member of the Superior Jury during the training.
- Equipment suppliers / Organizers must provide trained staff for a safe, fast and competent height increment if necessary.

2.2. Distance of floor anchors:

- | | | |
|-------------------|--------|--------|
| 2.2.1. Lengthwise | 550 cm | * 5 cm |
| 2.2.2. Crosswise | 400 cm | * 5 cm |
- * Tolerance +/-

3. Functional properties

- 3.1. The horizontal Bar must be elastic, and be secured against breaking through.
- 3.2. The elasticity is not just determined by the bar but also by the apparatus, acting as a whole. That is why the placement of the floor anchors, the supports and the tension cables, as well as the degree of tension must be strictly observed to insure uniform elasticity.
- 3.3. The bars attachment to the uprights must be articulated, to assure the effectiveness of its elasticity.
- 3.4. The bar must allow turn and glide movements without slipping.
- 3.5. The apparatus must be stable. The supports must not move or sway during use.
- 3.6. Neither the bar nor the tension cables should produce disturbing sounds during use.
- 3.7. Preferably such materials should be used which guarantee a slim form and should not block the view

4. Colours

- 4.1. The bar retains the colour of natural polished steel.
- 4.2. Colours or designs of the remaining parts are left to the discretion of the manufacturer. The FIG may designate the colour for specific events

Norms / Functional properties: Regarding tests carried out by FIG Tests Institutes – please see chapter IV

Horizontal bar

measurement point with variantes of supports

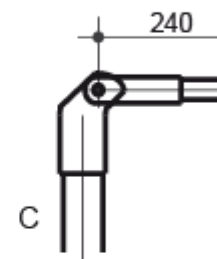
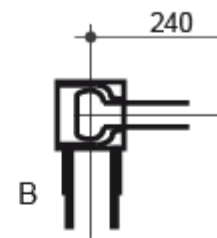
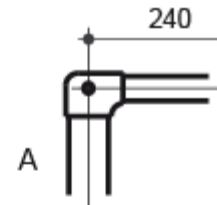
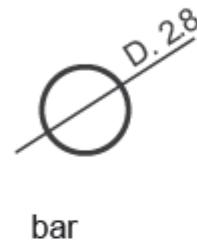
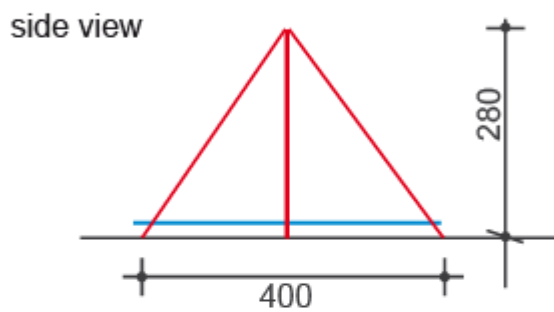
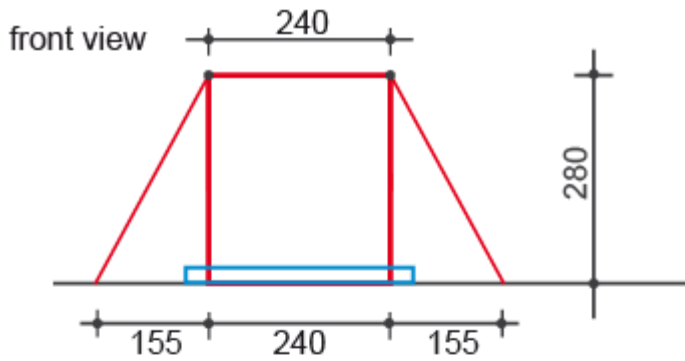

top view

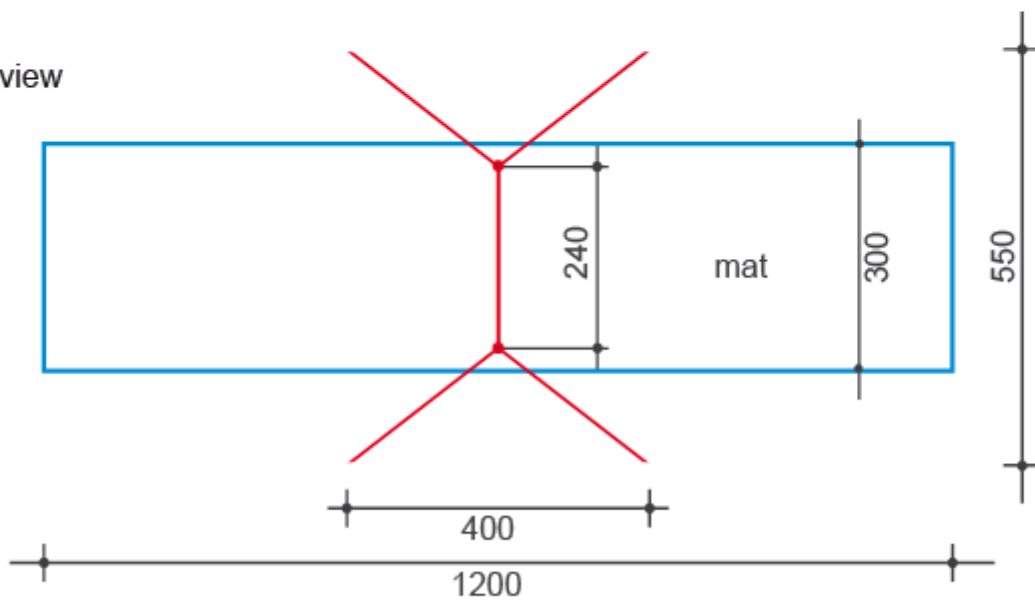

floor area for apparatus 550 x 1200

dimensions: mandatory;
design: at your discretion;
drawing: typical example

Landing mats

Men's Artistic Gymnastics

Construction / Description of material, measurements

1. Form

- 1.1. Their upper surface must be horizontal, even and without gaps.
- 1.2. Specially designed mats must be used to cover the basis of the apparatus evenly

2. Measurements

- 2.1. Height of the landing mats (MAG 3, 4, 5, 6): 20 cm * 1 cm
- 2.2. Height of the landing mats pommel horse (MAG 2): 10 cm * 1 cm

* Tolerance +/-
lengths and widths see drawing

3. Functional properties

- 3.1. Absorbency:
 - 3.1.1. Mats must absorb motion energy in order to reduce the reaction transmitted to the body of the landing gymnast to a tolerable proportion.
 - 3.1.2. They must respond to increased penetration with an evenly increasing resistance.
- 3.2. Stability and Freedom of Movement:
 - 3.2.1. Absorbency of the mats must be balanced in order to guarantee standing, walking stability and freedom of movement.
- 3.3. Indentations caused by the incidence of compressive forces must not encase the body parts, thereby hindering freedom of movements. They may not be too deep or narrow.
- 3.4. If a cover is used, such cover may not plaid and create hindering folds. The mats' upper surface material must offer a balance between anti-slip and slippage. It should be neither slippery nor possess inhibiting resistance.
- 3.5. By no means should mats be dislocated during performances. An anti-skid cover on the mats' underside may provide this condition.
- 3.6. The border zones of the mats which are pushed together should practically have the same functional properties as the remaining surface. Impacts on the border zones should not cause different indentations than on the remaining surface. For this purpose, and to bridge joints, continuous runners are permitted.

4. Colour

- 4.1. Preference should be given to uniform colours.
- 4.2. The upper surface must not show optically disturbing patterns or insignia.
- 4.3. The FIG may designate the colour for certain events

Norms / Functional properties: Regarding tests carried out by FIG Tests Institutes – please see chapter I

Landing mats

minimum dimensions in cm

MAG 2
pommel horse

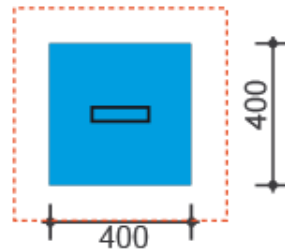

----- Boundary clearance zone:
600 * 600 cm

MAG 3
rings

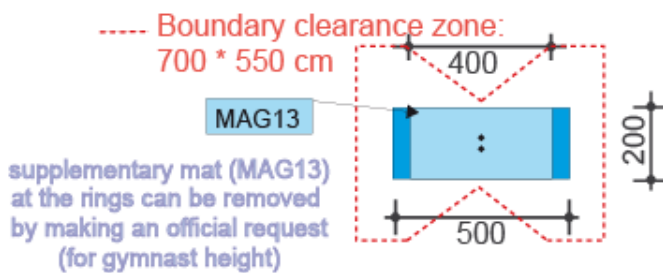

----- Boundary clearance zone:
700 * 550 cm

PLUS: MAG13 (200*200*10)

For: Training and Warming up Hall
Podium Training
Warming up in Apparatus
Finals on Podium

MAG 4
vault

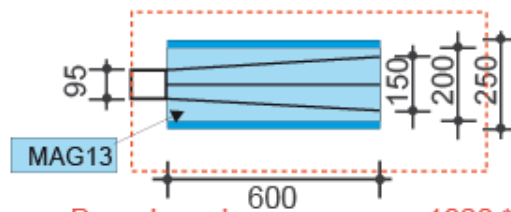

----- Boundary clearance zone: 1020 * 450 cm

PLUS: MAG13 (200*200*10)

For: Training and Warming up Hall
Podium Training
Warming up in Apparatus
Finals on Podium

MAG 5
parallel bars

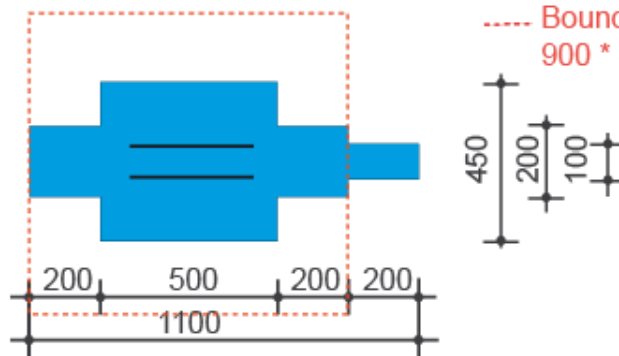

----- Boundary clearance zone:
900 * 850 cm

MAG 6
horizontal bar

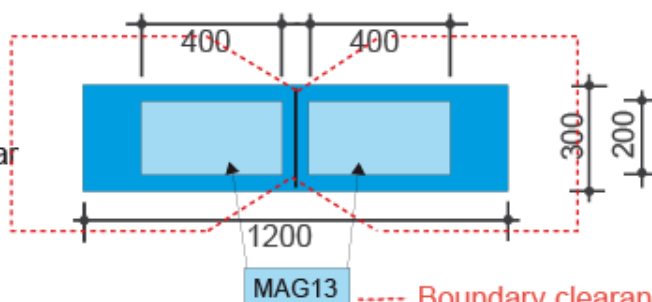

----- Boundary clearance zone: 1600 * 550 cm

PLUS: MAG13 (200*200*10)

For: Training and Warming up Hall
Podium Training
Warming up in Apparatus
Finals on Podium

Supplementary mats

Men's Artistic Gymnastics

Construction / Description of material, measurements

1. Use

- 1.1. The use of a supplementary mat is compulsory in competition for the athletes on the Rings (400 x 200 cm), Vault (600 x 200 cm) and on Horizontal Bar (two, 400 x 200 cm).
- 1.2. The supplementary mat at the Rings can be removed by making an official request (for gymnast height).
- 1.3. For training (in the training hall and during podium training) and in the warming up hall (correspondingly during the warming up session on the podium before the Apparatus Finals) an additional supplementary mat (200 x 200 cm) shall be available at the Floor, Vault and Horizontal Bar.

2. Form

- 2.1. Their upper surface must be horizontal, even and without gaps.
- 2.2. The supplementary mats have to be laid on the landing mats (MAG11). At the vault the supplementary mat (600 x 200 cm) shall be attached (i.e. using Velcro).

3. Measurements

- | | | |
|--|--------------|--------|
| 3.1. Height of the supplementary mats: | 10 cm | * 1 cm |
| 3.2. Vault (MAG4): | 600 x 200 cm | * 1 cm |
| 3.3. For the marking of the landing zone see MAG4. | | |
| 3.4. Rings (MAG3), Horizontal bar (MAG6, at both sides): | 400 x 200 cm | * 1 cm |
| 3.5. Additional supplementary mat for training and warming up: Floor (MAG1), Vault (MAG4), Horizontal bar (MAG6) | 200 x 200 cm | * 1 cm |

* Tolerance +/-

4. Functional properties

- 4.1. The foam of the supplementary mats shall have a density of 25 kg / m³ (+/- 2,5 kg / m³). The ultimate tensile strength of the foam (ISO 1798: 2008) shall be ≥ 115 kPa, the compression stress value 40% shall be 4,0 (+/- 1,0) kPa (ISO 3386-1 – Amd1: 2010).
- 4.2. By no means should mats be dislocated during performances. At the vault the supplementary mat (600 x 200 cm) shall be attached to the landing mat.

5. Colour

- 5.1. Preference should be given to uniform colours.
- 5.2. The upper surface must not show optically disturbing patterns or insignia.
- 5.3. The FIG may designate the colour for certain events.

Vaulting board

Men's Artistic Gymnastics

- Vault (MAG4) – “hard” and “soft”
- Parallel bars (MAG5) – “soft”

Construction / Description of material, measurements

1. Form

- 1.1. The profile of the vaulting board must adhere exactly to the respective blue print.
- 1.2. Its upper surface rises in an arched form, approaching the horizontal between 75 cm and 95 cm, measured from the frontal angle. The height reached at this point, may not be exceeded. After this point, the upper surface may continue horizontally or slope downward.
- 1.3. The rise of the arch is 3.5 cm +/- 0,5 cm.
- 1.4. For competitions a “soft” and a “hard” vaulting board shall be available. The “hard” board shall be marked with a dot on the surface.

2. Measurements

2.1. Length	120 cm	* 1 cm
2.2. Width	60 cm	* 1 cm
2.3. Height	20 cm	* 1 cm
2.4. Height (run-up side)	max 3 cm	
2.5. Cushion Cover	2 cm	* 0,5 cm
2.6. Total height with cushion cover	22 cm	* 1,5 cm
2.7. Free space between floor and the lower edge of the vaulting board at the run-up side	max. 1 cm	

*Tolerance +/-

- 2.8. The stipulated length and height refer to the vertical projection of the upper plate, i.e. the take-off plate.
- 2.9. The base may be larger, but cannot extend more than 2 cm beyond the projection of the board.
- 2.10. Labelling of the “hard” vaulting board on the surface by a dot with clear contrast on the longitudinal midline:
 - 2.10.1. Distance to the side of run up 5 cm
 - 2.10.2. Diameter 8 cm

3. Functional properties

- 3.1. The functional properties of the vaulting board (hardness, damping, elasticity) shall not be adjustable (i.e. springs must be fixed so that they cannot be easily removed by hand).
- 3.2. The elasticity of the vaulting board must be most effective in the area between 75 cm and 95 cm, measured horizontally from the frontal angle.
- 3.3. The vaulting-board must dampen the counter pressure, i.e. reduce motion energy. Elasticity and absorbency must be evenly distributed, so that the effect of the vaulting board differs only slightly, regardless whether the force of the impact is at the middle axis, or away from it.
- 3.4. The upper surface of the vaulting board must offer slip resistance.
- 3.5. The vaulting board must not produce disturbing sounds during its use.
- 3.6. The board shall not slide at the time of impact of the athlete. This shall be achieved by anti-slip devices at the bottom side of the board or at the board underneath the vaulting board. The slip resistance shall be provided especially when the board bottoms out at the middle part.
- 3.7. The vaulting board and its base may not have any sharp corners, edges and no protruding parts. Mainly the upper and under edge of the upper part of the Vaulting board towards the apparatus side (Vaulting Table, Balance Beam of Uneven Bars) shall be cushioned and rounded.

II
MAG 14
01.01.2016

4. Colour

- 4.1. The choice of colour is left to the discretion of the manufacturer.
- 4.2. With exception of the dot for “hard” vaulting boards optically disturbing patterns, stripes or insignia on the upper surface are not permitted.
- 4.3. The FIG may designate the colour for certain events.

Norms / Functional properties: Regarding tests carried out by FIG Tests Institutes – please see chapter IV

Vaulting board

lowering variant

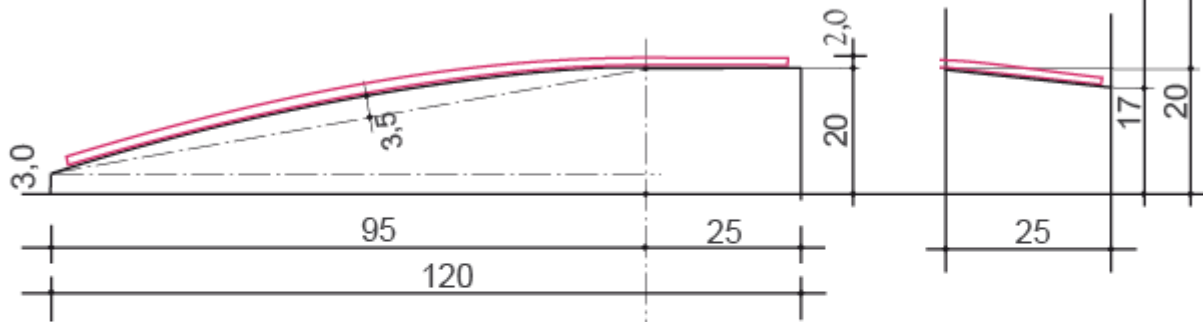

profile

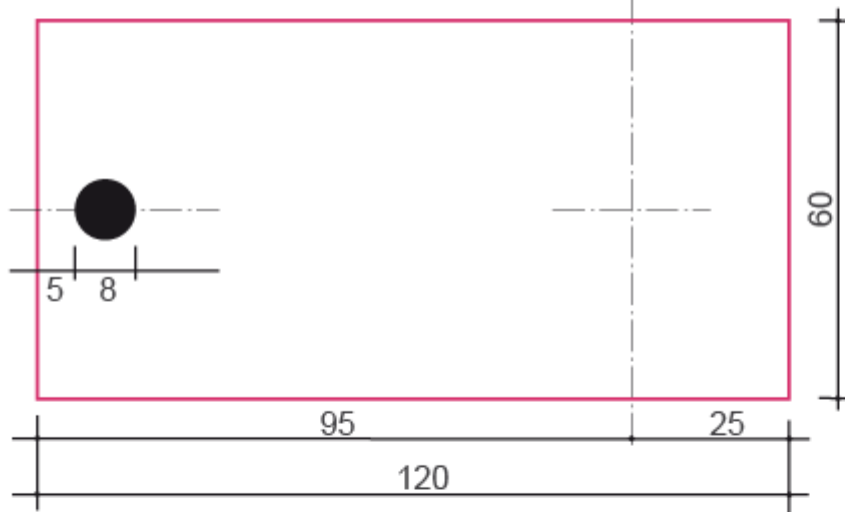

top view

mark for the hard board

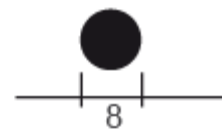

dimensions mandatory;
design: at your discretion;
drawing typical example

Vaulting board safety collar (Round off vaults)

Men's Artistic Gymnastics

7

Construction / Description of material, measurements

1. Use

- 1.1. The usage of the safety collar around the vaulting board is compulsory for round-off entries at the vault. It is not allowed to place the safety collar on the foot of the vaulting table or underneath the vaulting table.

2. Form

- 2.1. The safety collar is "u-shaped" and surrounds the vaulting board at the sides and the front toward the vaulting table. At the sides of the vaulting board its upper surface rises in an arched form in the same level as the vaulting board. At the front side of the vaulting board the surface of the safety collar is horizontal and even.
- 2.2. The whole surface of the safety collar and the corresponding surface of the vaulting board need to be of the same height level.

3. Measurements

- 3.1. Overall length: 120 cm (± 20 cm)
- 3.2. Minimal width at the side of the vaulting board: 20 cm
- 3.3. Length at the front part of the vaulting board: 20 cm ($\pm 0,5$ cm)
- 3.4. Maximal Difference between the height of the safety collars' and the boards' surface (respecting the arched form): ± 1 cm
- 3.5. Maximal gap between the safety collar and the vaulting board on all three sides: 0,5 cm

4. Functional Properties

- 4.1. The safety collar has to provide a safe area around the vaulting board in case of an athlete misses the board for a take-off towards the vaulting table, therefore the safety collar must provide sufficient stability and cushioning at the whole upper surface. The bottom side shall have an "anti-slip" surface (i.e. Velcro) to prevent the safety collar from slipping away.
- 4.2. The safety collar shall not hinder the vaulting board in its functional properties neither by restricting the airflow during the compression of the vaulting board nor hindering the movement of the upper parts during foot contact.

5. Colour

- 5.1. The upper surface must not show optically disturbing patterns or insignia.
- 5.2. The colour must be uniform and in contrast to the vaulting board.
- 5.3. The FIG may designate the colour for certain events.

Mat for Hands (Vault)

Men's Artistic Gymnastics

Construction / Description of material, measurements

1. Use

1.1. A mat for hands can be used by the athletes for round-off entries on the vault

2. Form

2.1. The upper surface must be horizontal and even. The mat for hands can be laid on the run-up area to cushion the hand contact during round-off entries onto the vaulting board.

3. Measurements

3.1. Length in direction of the run-up:	120 cm	* +10 cm
3.2. Width:	100 cm	* ±1 cm
3.3. Height of the mat for hands:	3 cm	*±0,5 cm

* Tolerance

4. Functional Properties

4.1. The cover material must be non-slippery but not rough. It may not cause a burning sensation. If a cover is used, such cover may not be bulged and create hindering folds.

4.2. The bottom side shall have an "anti-slip" surface (i.e. Velcro) to prevent the mat for hands from slipping away.

5. Colour

5.1. The upper surface must not show optically disturbing patterns or insignia.

5.2. The colour must be uniform and in contrast to the run-up area.

5.3. The FIG may designate the colour for certain events.

Tension Control Sensor for Rings and High Bars ~~and Uneven Bars~~ - TCS

II
MAG 18
15.3.2023

Construction / Description of material, measurements

1. Use

- 1.1. Helping device for the adjustment of an individual tension at the cables of the Rings and the High Bars ~~and Uneven bars~~ in MAGWAG competitions.
- 1.2. The use is not mandatory for FIG competitions, but highly recommended ⁽¹⁾ to protect the athletes from an unexpected breakdown of the gymnastics equipment due to too low cable tension or by damaging parts of the apparatus especially the ground anchors due to too high cable tension. Furthermore, the use serves the coaches and athletes to set the same individual tension on the cables in the training halls, the warming up hall and the competition hall. For the last aspect, the use of TCS makes sense only if devices are provided at all Rings and High Bars in the training halls, the warm-up hall and the field of play for the competition in question.

2. Requirements

- 2.1. The device must be able to measure and digitally display the tension at the cables in Newtons with 100 N increments. The TCS should be applicable to the tensioning of all FIG approved Rings and High bars and shall be implemented at the chains (or cables). If used, Tension Control Sensors should be installed at all of these apparatuses in the training halls, the warmup hall and the competition site.
- 2.2. A visible warning lamp will avoid dangerous cable adjustments by overload or underload in the tension of the equipment.
- 2.3. With TCS athletes and coaches should have the possibility to adjust the same individual tension at the cables for the training, warming-up and competition apparatuses.
- 2.4. A TCS shall be easy adjustable between chain or wires by shackles at all FIG approved equipment.

3. General Functions

- 3.1. The TCS shall contain a clearly legible, digital display showing the tensile force between the attachment points in Newtons at 100 N increments. ⁽²⁾
The unit Newton must be indicated by the letter "N".
- 3.2. The digital display of the tensioning force and a clear visible warning light (if over- or underload occurs; see 3) shall only appear for a measurement time interval between 10 and 15 seconds after pressing an easily accessible START- button.
- 3.3. The warning lamp shall light up during the measurement time interval if there is an over- or underload. This is the case for a tension of $x > 5000\text{N}$ and $x < 1000\text{N}$.
- 3.4. The mass of a TCS including its shackles shall be lower than 0,9 kg.
- 3.5. The effective inner length between the two shackles as attachment between the chains or cables shall not exceed 0.18m.
- 3.6. The measurement range shall be 0 – 10000N (displayed until 5000N in steps of 100N).
- 3.7. The strength of a TCS including shackles shall be $x > 15000\text{ N}$.
- 3.8. A TCS shall have no wired power supply. Only batteries or load cells with enough capacity ($> 5 * 24\text{h}$) and with easy charging are allowed.

(1) The use will be regulated as follows from 2025:
- Compulsory for Olympic Games, Youth Olympic Games, World Championships (senior and Junior), World Cups and World Challenge Cups.
- highly recommended for all other competitions

(2) Additional remark:
The one and ten digits, which are always 0 due to the rounding, do not have to be displayed variably but can be fixed on the housing. The combined reading of the variable display and the firmly imprinted digits shall result in Newton values.

Tension Control Sensor for Rings, High Bars and Uneven Bars - TCS

II
MAG 18
15.03.2023

- 3.9. A suitable charger must be included with the TCS. If this is not the case, standard connections (e.g., USB, Micro-USB, USB Type C etc.) shall be used and a clear message shall be sent to the customer when purchasing a TCS that he himself has to take care of the charger, power bank or similar.
- 3.10. The TCS shall come with an English written documentation containing a user's guide and all necessary technical descriptions (including installation procedures). Furthermore, this documentation shall contain the following recommendation for mounting of a TCS:

4. Recommendations for mounting of TCS

- 4.1. In general, only one single TCS on one of the four tension cable sides of the gymnastic apparatus is enough. However, two TCSs are required for special asymmetrical constructions of the Uneven Bars.
- 4.2. A TCS should be installed at a cable where the desired tension for the gymnastic apparatus can be adjusted. In addition, the TCS must always be installed towards the head judge of the gymnastic apparatus.
- 4.3. When measuring with TCS at the ~~Uneven Bars~~ Rings or High Bar, it is particularly important that all equipment in the training halls, the warm-up hall and the competition hall is set up with exactly the same distances between the ground anchors and the equipment stands, as otherwise different measured values may occur with the same functional property of the gymnastic equipment.
- 4.4. A sufficient battery charge must be ensured for the entire duration of the competitions. In addition to a full charge at the beginning, this must be done during longer competitions by charging with the corresponding chargers during the periods of no use (e.g. overnight. If chargers or Powerbanks are not included in the scope of delivery, the user must ensure that they are available in sufficient numbers.
- 4.5. If the use of TCS is planned, it is advisable to contact the manufacturer of the gymnastics equipment in good time in order to ensure that the additional length by the TCS will not cause any problems with the cables and chains. If necessary certain suitable accessories need to be ordered from the supplier(s).



2.2 WAG Women’s artistic gymnastics

WAG 1 Vaulting Table - Women’s Artistic Gymnastics	57
WAG 2 Uneven Bars	62
WAG 3 Balance Beam	65
WAG 4 Floor	67
WAG 11 Landing Mats 20 cm	69
WAG 13 Supplementary Mats (10 cm)	71
WAG 14 Vaulting Board	72
WAG 15 Vaulting Board safety collar (Round off vaults)	75
WAG 16 Mat for Hands (Vault)	76
WAG 17 Spotter mat (Uneven Bars)	77
WAG 18 Tension Control Sensor for Rings, High Bars and Uneven Bars - TCS	78



Vaulting Table

Women's Artistic Gymnastics

Construction / Description of material, measurements

1. Form

- 1.1. The apparatus consists of a slightly inclined table body which is mounted onto a “monostand” bottom frame. The table body consists of a front surface (A) which, seen from the direction of the vault, is inclined to 8° to the vertical and merges into two arched bends (B1 and B2) and then into a linear cover surface (C) which is inclined 3° to the horizontal. The table body is divided into a bounce area (A) and a push away area (B and C) with a clear colour contrast. The different surfaces merge into each other without any gaps in between. The push away area is slightly rounded in transversal direction (D).
- 1.2. All corners and edges are rounded. The bottom frame must offer the table body a stable and secure supporting surface and must guarantee the abidance by the technical safety regulations. The bottom frame with cushioning may not present any parts that protrude from under the vaulting table's body except on the landing side. As a collision protection dangerous metal parts of the support must be cushioned.
- 1.3. Recommendation: All levers and locking mechanisms should be incorporated into the under construction.
- 1.4. At the landing side the legs of the bottom frame must be cushioned at the same height level as the landing mat (20cm, Tolerance +10cm).
- 1.5. The vaulting table including the cushioning of the bottom frame must represent a “monostand” - construction.

2. Measurements

- | | |
|--|--------------------------------|
| 2.1. Table body: | |
| 1.5.1. length: | 120 cm +/- 1 cm |
| 1.5.2. width: | 95 cm +/- 1 cm |
| 2.2. Height at the given measurement point (see drawing) ¹ : | 135 125 cm +/- 1cm |
| 2.3. Upper height at the bounce area (see drawing) ¹ : | 122 112 cm +/- 1 cm |

Remark: For competitions the vaulting table must be positioned on a rigid board which has the same height as the run-up area (see below)

)¹: In competitions the apparatus height must correspond to the top level of the run up area.

- 2.4. Maximal orthogonal deviations from the given profile lines in longitudinal and transversal directions: < 1 cm
- 2.5. Protrusion of the leg construction below the table body on the landing side (only allowed with appropriate cut-outs in the landing mat): 15 cm maximal
- 2.6. Height of the leg frame 8 cm maximal
- 2.7. Circumference of the (cushioned) bottom frame including all levers and fixation devices between the height of 50 cm up to 85 cm 1828m minimal
- 2.8. Distance between the (cushioned) leg construction including all levers and fixation devices and the projection of the table body on all four sides between the height of 50 cm up to 85 cm

2.9. 25 cm minimal

2.10. The adjusted height of the vaulting table must be clearly signed at the side. Additional Measurements see drawing. The profile lines towards A, B1, B2 and D are to be respected as indicated in the drawing. Maximum deviations < 1 cm – measured at a right angle to the profile line.

3. Functional properties

- 3.1. The push away area must be shock-absorbing so that shoulders and wrists are protected.
- 3.2. The rebound properties must be guaranteed to be as homogeneously as possible for all the possible impact points on the table body.
- 3.3. Extended time-shift for rebounding energy at the impact points caused by extreme deflections is not acceptable.
- 3.4. The table body must be evenly cushioned over the entire push away area. The cover material must be non-slippery but not rough. It may not cause a burning sensation on sliding.
- 3.5. The bounce area must be cushioned with a high-quality material in order to provide a good collision protection.
- 3.6. Recommendation: Any protruding items covered by the cushioning of the stand should be avoided or sufficiently covered to prevent perforation through the cushioning during accidental impact.
- 3.7. In order to avoid swaying, vibrations and shifting, the apparatus must have a device for fastening it to the floor.

4. Colour

4.1. The colour of the surface material may be chosen according to taste. For certain events the colour may be determined by the FIG

5. Run-up area

- 5.1. The run-up area is composed of a run-up mat and a rigid board underneath the vaulting board.
- 5.2. The run-up mat shall be positioned so the carpet threads open in the opposite direction of the gymnast run, offering the greatest friction between the feet and run up mat. The orientation of the run-up mat shall be the same in the training halls, warm-up halls, and competition hall.
- 5.3. The start of the run-up (2500 cm) shall be marked by a block, attached at the start of the vault run-up mat length (measured from the vertical projection of the beginning of the vaulting table, see “reference point” in the drawing, to the inner side of the block): 2500 + 10 cm

5.3.1. width (run-up mat)	100 +/- 1 cm
5.3.2. width (rigid board underneath)	100 cm min
5.3.3. height (same height for run-up mat and board underneath)	max 2,5 cm
5.3.4. length of the rigid board underneath the vaulting board	320 +/- 1 cm
- 5.4. The colour of the run-up area must have a clear contrast to the colour of the vaulting board. The whole run up area (run-up mat and the rigid board underneath) shall have the same colour

6. Authorized landing zone

- 6.1. Marking on the supplementary mat above the landing mat (see drawing).

6.1.1. Width of the landing corridor at the table site:	95 cm
6.1.2. Width of the landing corridor (end of 600 cm landing mat):	150 cm
6.1.3. When the authorized landing zone is marked out by stripes: marking strip width on the supplementary mat:	5 cm +/-0.5 cm

The marking strip is part of the authorized landing zone.
- 6.1.4. Additional marking strip width in the centre of the landing corridor (see drawing): 5 cm +/-0.5 cm

Remarks concerning the drawings:

- Bottom frame construction schematized.
- All dimensions in cm
- Tolerances for all dimensions: +/- 1cm
- Maximal Orthogonal Deviations from the given profiles in longitudinal and transversal directions: <1cm
- Dimensions binding; Construction may be different– drawing as example.

Norms / Functional properties: Regarding tests carried out by FIG Tests Institutes – please see chapter IV

Vaulting Table

A; B1; B2; C; D:
see text

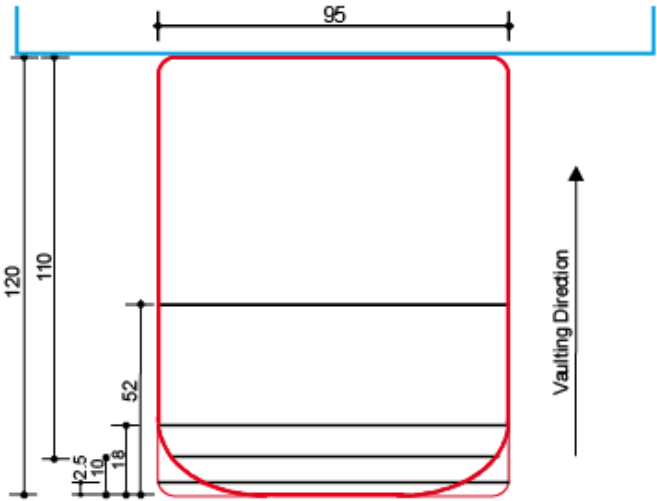
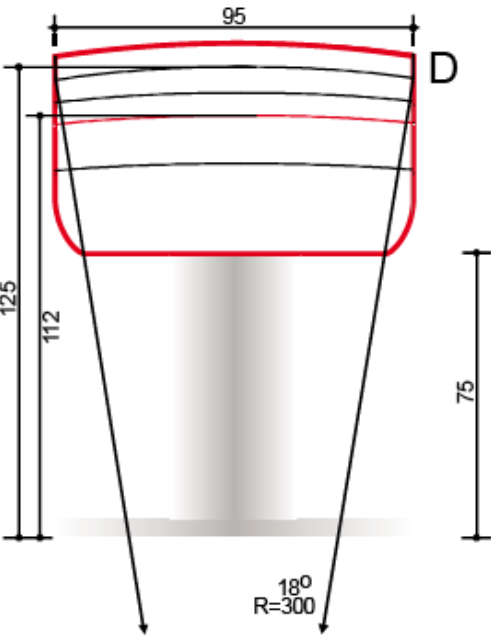
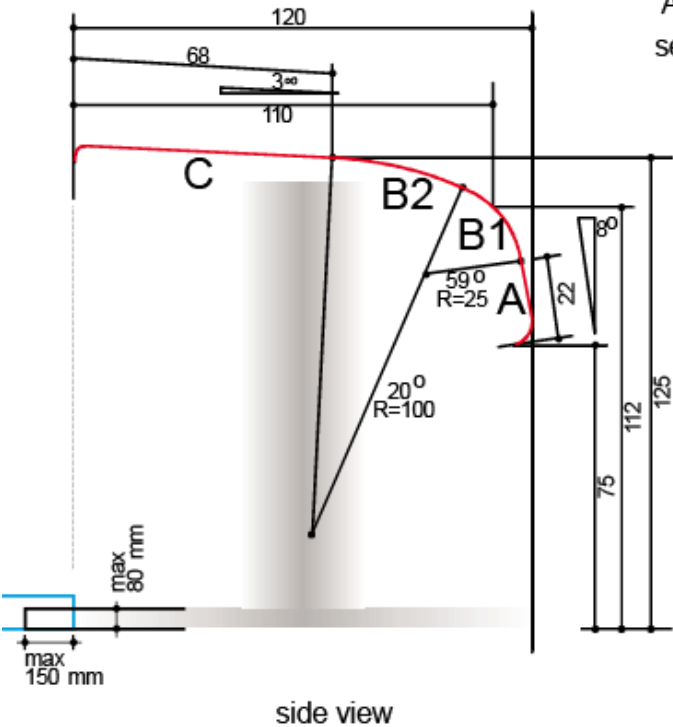

dimensions: mandatory;
design: at your discretion;
drawing: typical example

Vaulting Table

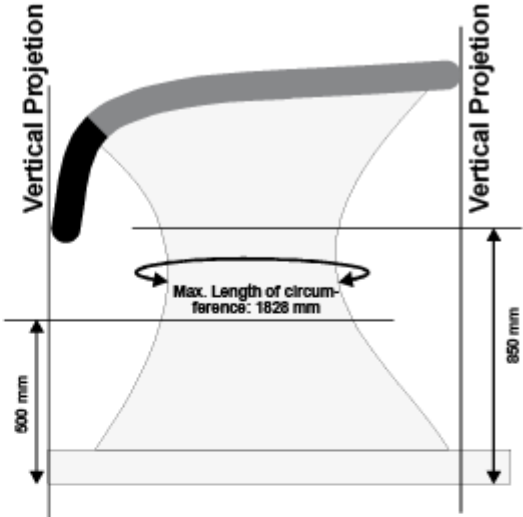
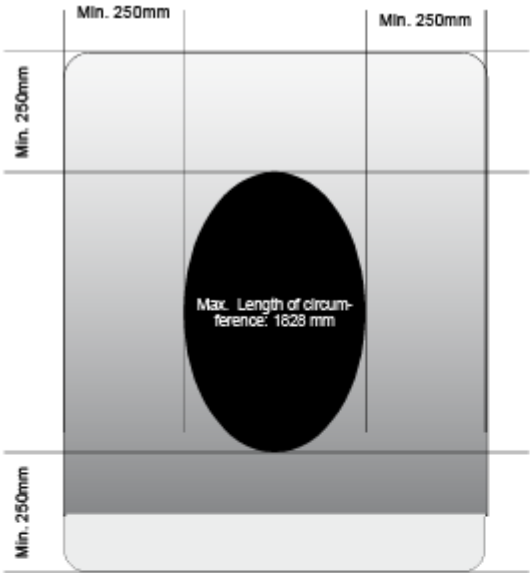

dimensions: mandatory;
design: at your discretion;
drawing: typical example

Vaulting Table

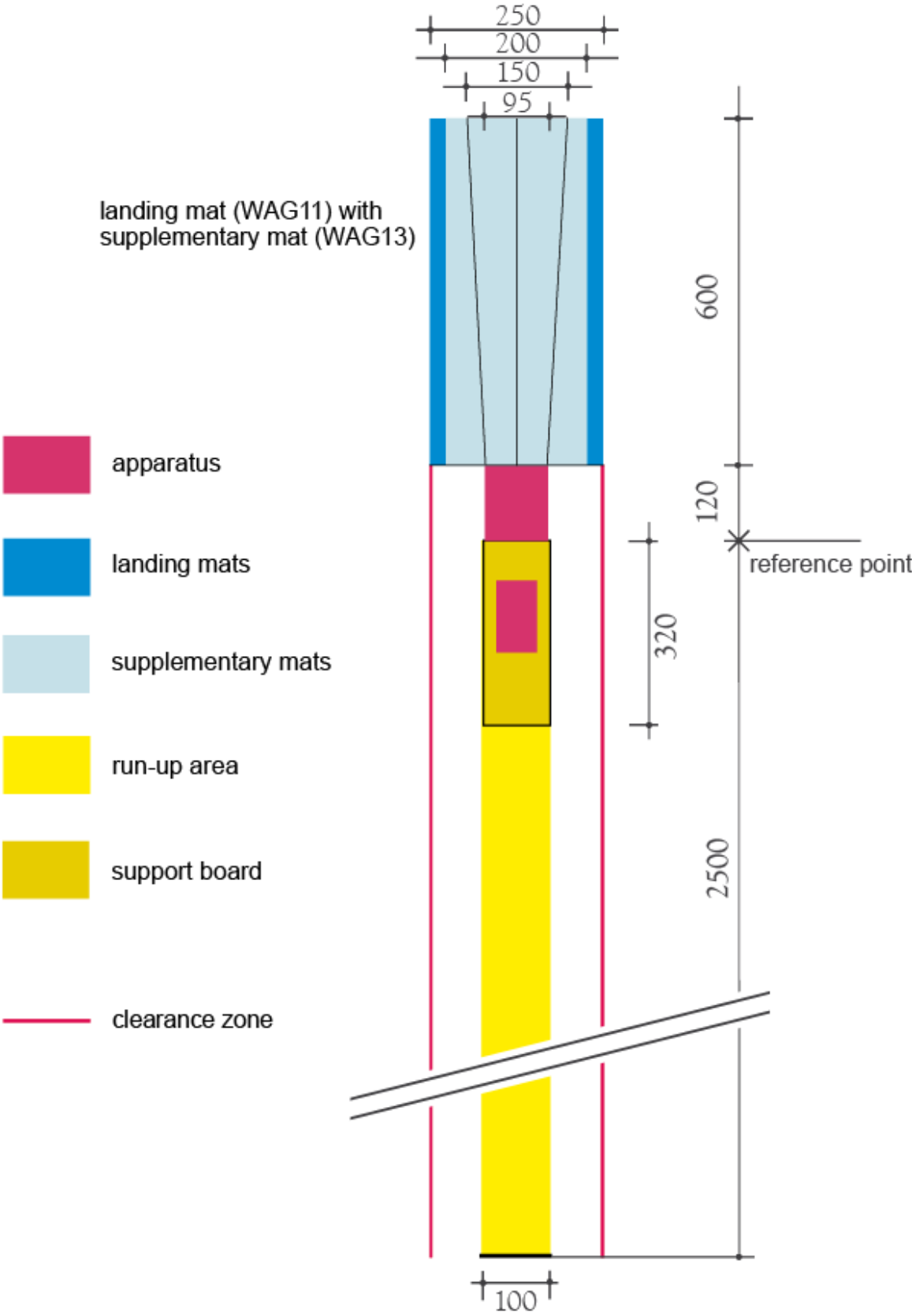

Uneven Bars



Women's Artistic Gymnastics

Construction / Description of material, measurements

1. Form

- 1.1. The apparatus consists of two bars with circular profile, running parallel, but at different heights. The bars are carried by a support base.
- 1.2. The support base has four uprights, which are held by tension cables (\varnothing max 1 cm) anchored to the floor.
- 1.3. Each bar is carried by 2 supports.
- 1.4. One low and one high support are connected to a floor device and a width adjustment device.

2. Measurements

2.1. Bars:

- | | | |
|-------------------------------------|------------|----------------------------|
| 2.1.1. Diameter | 4,0 cm | $3,92 \leq x \leq 4,04$ cm |
| 2.1.2. Length | 240 cm | * 1,0 cm |
| 2.1.3. Distance between the sockets | min 200 cm | * 1,0 cm |

2.2. Height of the upper edge of the bars in inner diagonal position 181 cm:

- | | | |
|---------------------------------|--------|----------|
| 2.2.1. upper bar (to the floor) | 255 cm | * 1,0 cm |
| 2.2.2. lower bar (to the floor) | 175 cm | * 1,0 cm |

- | | | |
|---|------------------|--------------|
| 2.2.3. Inner diagonal distance (see drawing) between the 2 bars adjustable from | min 130 - 181 cm | max * 1,0 cm |
|---|------------------|--------------|

2.2.4. The diagonal distance must be adjustable continuously or with increments of max 2 cm.

2.2.5. The diagonal distance (expressed in cm) must be shown on a scale at the distance adjustment device (for the heights prescribed in 2.2.1 and 2.2.2).

2.2.6. The height of the bars must be adjustable for additional 5 cm (lower bar: 175+5 cm; upper bar: 255+5 cm * 1cm; inner diagonal distance: not more than 182max * 1cm) and 10 cm (lower bar: 175+10 cm; upper bar: 255+10 cm * 1cm; inner diagonal distance: not more than 183max * 1cm) to the standard height.

2.2.7. Height increases of 5 cm or 10 cm shall be allowed in competitions for gymnasts who touch the mat with their feet during exercise. This must be announced in time according to the regulation in the CoP. The required height change shall be made as follows: For 5 cm: Completely at the stands; for 10 cm: Completely at the stands, provided that this technical solution is homologated by passed FIG standardization tests. If the latter condition is not met: With 10 cm blocks underneath the base of the Uneven Bars during a transition period defined in 2.2.9.

2.2.8. Equipment suppliers / Organizers must provide trained staff for a safe, fast and competent height increment if necessary.

2.2.9. Transition periods for different technical solutions and maximal inner diagonal distances between the bars for 10 cm height increase to the standard height, upon request of taller athletes only:

Transition period	10 cm Height Adaption by	Maximal inner diagonal Distance between Bars (cm)
From 2023-01-01 to 2025-12-31	a) 10 cm Blocks underneath the base b) 10 cm height increase at the stands)*	183± 1 cm
From 2026-01-01 on	10 cm height increase at the stands)*	183± 1 cm

* : provided that this technical solution is homologated by passed FIG standardization tests

2.3. Distance of floor anchors:

- | | | |
|-------------------|--------|--------|
| 2.3.1. lengthwise | 550 cm | * 5 cm |
| 2.3.2. crosswise | 400 cm | * 5 cm |

3. Functional properties

- 3.1.** Both bars must have the same, uniform elasticity. To assure this, their supports must be articulated.
- 3.2.** The bar surface must provide a good glide and turn capability but may not be slippery.
- 3.3.** To ensure grip stability, the bars' surface must absorb moisture.
- 3.4.** The bars must be secured (reinforced) against breaking through.
- 3.5.** A safeguard system must prevent an unintended release of the movable components of the apparatus.
- 3.6.** When the apparatus is used for performances, no hindering sways or vibrations and counter swings should occur.

4. Colour

- 4.1.** The bars retain the natural colour of wood. They are neither lacquered, nor polished.

Norms / Functional properties: Regarding tests carried out by FIG Tests Institutes – please see chapter IV

Uneven Bars

measurement point with variantes of supports

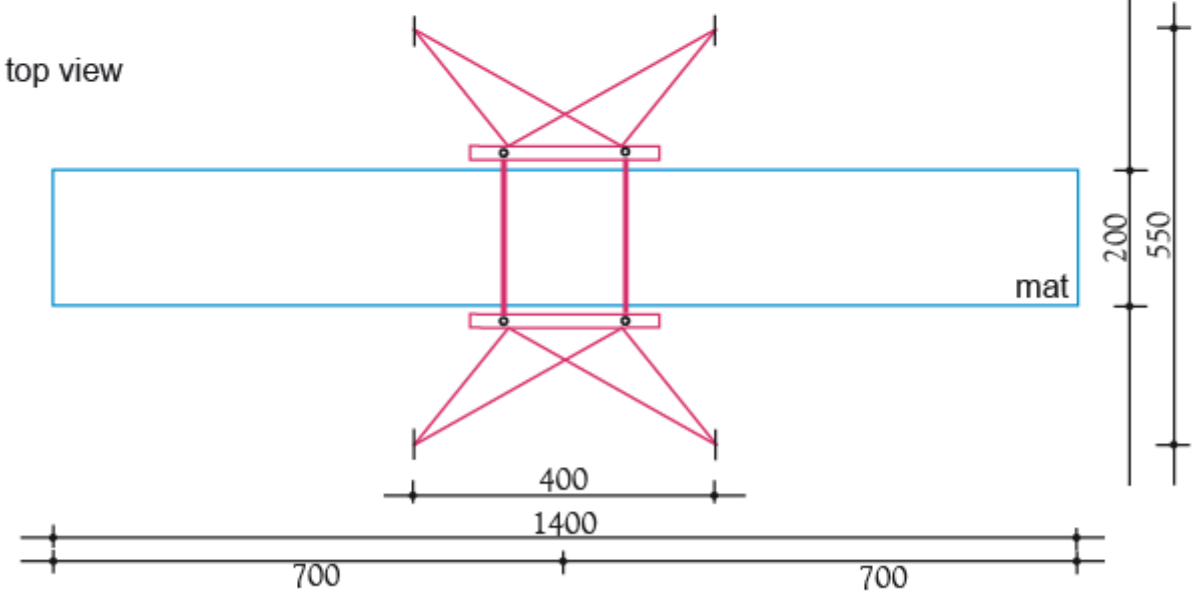
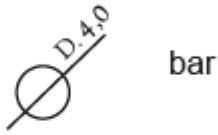
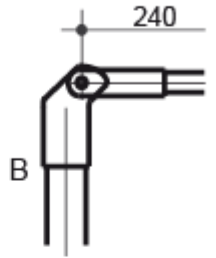
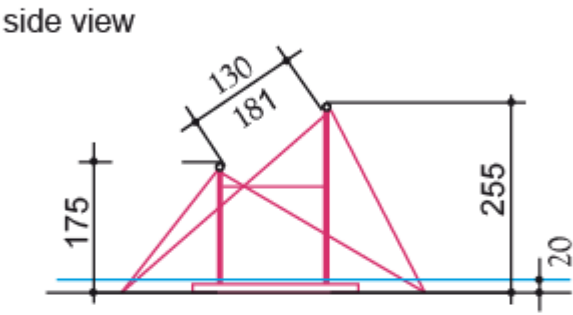
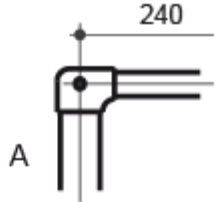
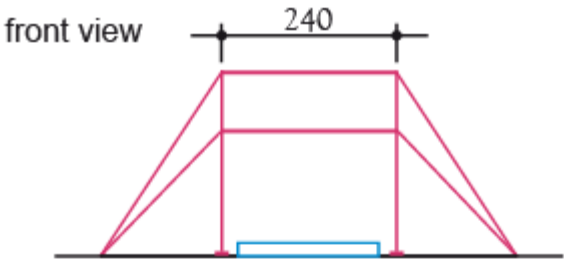

floor area for apparatus 550 x 1400

dimensions: mandatory;
design: at your discretion;
drawing: typical example;

Balance Beam



Women's Artistic Gymnastics

II
WAG 3
01.01.2011

Construction / Description of material, measurements

1. Form

- 1.1. The apparatus consists of a beam, which is held by a base consisting of 2 supports.
- 1.2. Lengthwise, the beam shall be straight and its upper surface and axis shall be even and horizontal.
- 1.3. Viewed in cross section, the sides of the beam are arched.
- 1.4. The base design is not prescribed. However, its legs may not protrude beyond the projection of the beam in its longitudinal direction. The supports of the beam must be cushioned. The cushioned parts shall not protrude the vertical projection of the beam.
- 1.5. The front parts of the beam must be cushioned by rounded, damping padding. The padding must reach the top edge of the beam, but the radius of the rounding must begin immediately at the end of the beam to guarantee that the padding does not prolong the total length of the beam (examples see drawing)

2. Measurements

- 2.1. Beam:
 - 2.1.1.Length 500 cm * 1 cm
 - 2.1.2.Cross section:
 - 2.1.2.1. Upper surface 10 cm * 0,5 cm
 - 2.1.2.2. Horizontal axis 13 cm * 0,5 cm
 - 2.1.2.3. Vertical axis 16 cm * 0,5 cm
 - 2.1.2.4. Bottom surface 10 cm * 0,5 cm
 - 2.1.3.Height of upper surface measured from the floor 125 cm * 1 cm
- 2.2. Legs of base:
 - 2.2.1.Distance max. 500 cm
 - 2.2.2.Width max. 125 cm
- 2.3. Cushioning of the supports:
 - 2.3.1.Thickness min. 15 mm
 - 2.3.2.Width of the supports incl. cushioning max. 13 cm
- 2.4. Cushioning of the front parts of the beam:
 - 2.4.1.Thickness min. 15 mm up to max. 30 mm
- 2.5. The Beam might have a height adjustment. It can be continuous or in 5 cm increments. However, the prescribed height of 125 cm * 1cm shall be observed at competition site.
- 2.6. Continuous height adjustment is recommended for levelling purposes.

3. Functional properties

- 3.1. The surface must have impact absorbent characteristics to protect the gymnast's joints and limbs. It should also have elasticity to support the jumps.
- 3.2. One of the most important properties of the beam is that it must be step safe. Elasticity must be equally distributed and must not disturb a sure step.
- 3.3. The upper surface material of the beam must permit effortless gliding and turning, but not be slippery.
- 3.4. The front parts of the beam must be padded.
- 3.5. The cover material must not produce skin burns.
- 3.6. The upper edge of the padding at the front parts of the beam shall not be harder than the surface of the beam.
- 3.7. All protruding parts, especially screws underneath the balance beam shall be cushioned or hidden.
- 3.8. During an exercise, the beam may not move, topple or sway

4. Colour

- 4.1. The colour of the beam must distinctly differ from the colour of the mats.

Norms / Functional properties: Regarding tests carried out by FIG Tests Institutes – please see chapter IV

Balance Beam

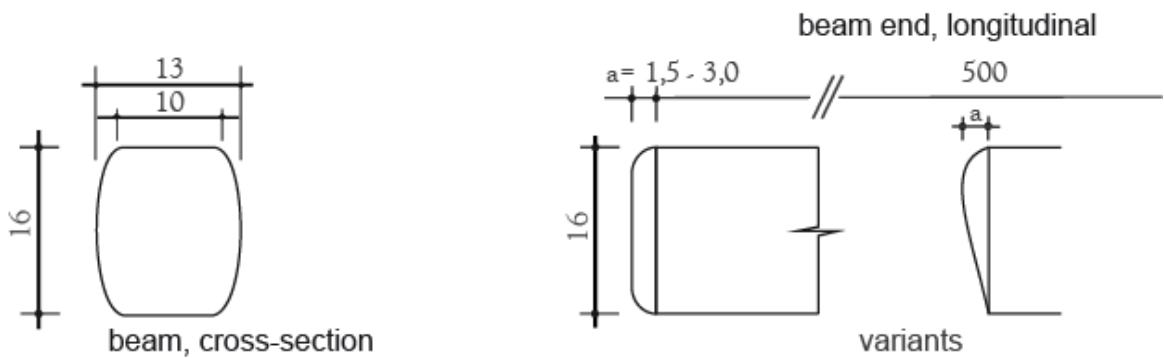
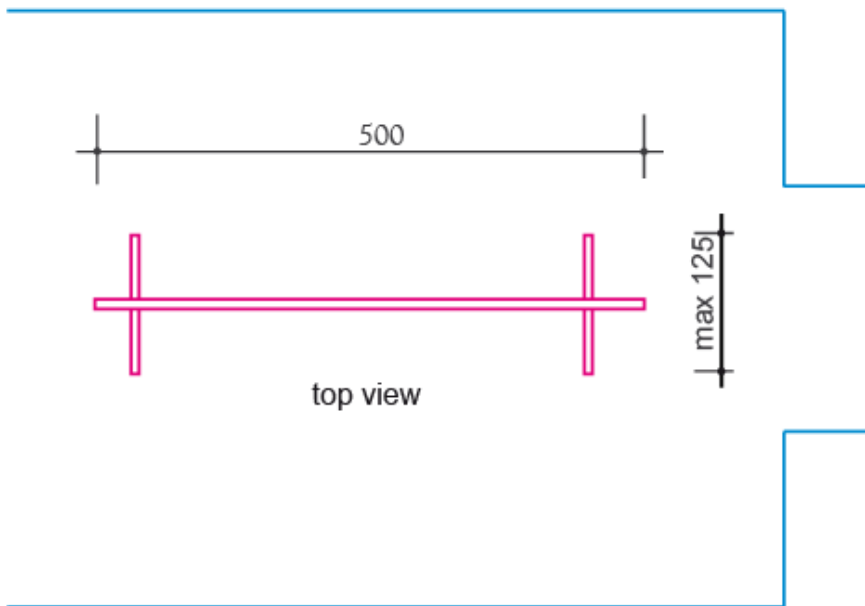
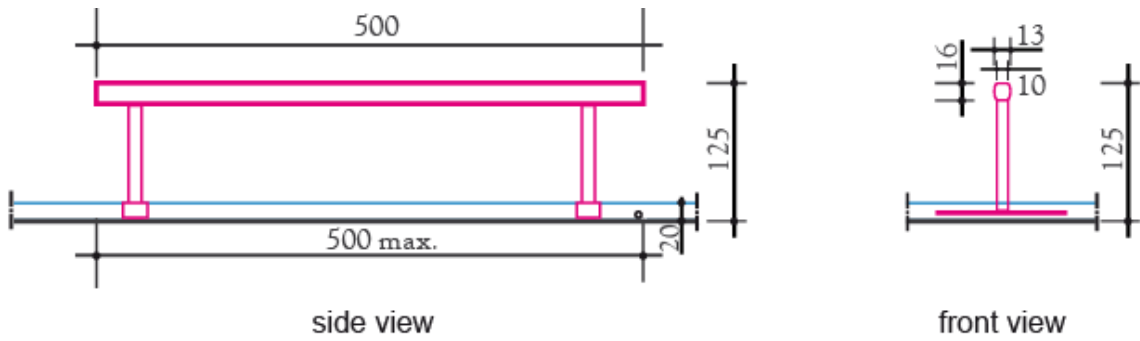

dimensions mandatory;
design: at your discretion;
drawing typical example

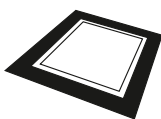

Floor

Women's Artistic Gymnastics

Construction / Description of material, measurements

1. Form

- 1.1. The Performance Area shall have a square format. The surface must be horizontal, even and without gaps. All plates of the under construction within the Performance Area shall have the same arrangement of elastic elements.
- 1.2. All elements of the floor have to be connected firmly to prevent slipping.
- 1.3. Edge: Horizontal and even, at the same height as the Performance area
- 1.4. Edge's variant: Width 50 cm, horizontal and even, at the same height as the Performance area, additional 50 cm inclination edge, slope may not exceed 25 %.
- 1.5. Clearance zone: The clearance zone shall be kept totally free as a surrounding zone around the performance area and the edge. It shall be horizontal, even and without gaps. (See Definition: II, chapter 3. Surfaces of apparatus, clearance zones, total surfaces)

2. Measurements

- | | | |
|--|-------------------|----------------------|
| 2.1. Performance area | 1200 cm x 1200 cm | Tolerance +/- 3 cm |
| 2.2. Diagonals of the performance area: | 1697 cm +/- 5cm | |
| 2.3. Edge | 100 cm, min. | |
| 2.4. Edge as a variant | | |
| 1.5.1. Horizontal Area, Width | 50 cm, min. | |
| 1.5.2. Slope max. 25 %, Width | 50 cm, min. | |
| 1.5.3. Height of outer edge at the very end | 3,5 cm, max. | |
| 2.5. When there is a delimitation strip between the Performance area and the edge: | | |
| 2.5.1. Delimitation strip width | 5 cm, | Tolerance +/- 0,5 cm |
| 2.6. The delimitation strip is part of the Performance area. | | |

3. Functional Properties of the performance area and edge

- 3.1. Equal elasticity on the surface as well as dampening.
- 3.2. When in use it should not have any hindering motion energy
- 3.3. Elasticity and dampening must be balanced in such a way that they guarantee the gymnast stability and freedom of movement. It must not restrict turns and slide movements.
- 3.4. The surface cover of the Performance area must provide a balance between anti-skid and slippage. It must not cause skin burns.
- 3.5. The floor must not produce disturbing sound during the execution of an exercise. It must assure a low noise level.

4. Of plain colour which choice is left to the manufacturer's discretion. Dark colours are not allowed. For certain events the FIG may stipulate the colours. The delimitation shall have a clear contrast to the performance area.

Norms / Functional properties: Regarding tests carried out by FIG Tests Institutes – please see chapter IV

Landing Mats 20 cm

Women's Artistic Gymnastics

Construction / Description of material, measurements

1. Form

- 1.1. Their upper surface must be horizontal, even and without gaps.
- 1.2. Specially designed mats must be used to cover the basis of the apparatus evenly

2. Measurements

- 2.1. Height of the landing mats (WAG 1, WAG2 and WAG3): 20 cm * 1 cm

* Tolerance +/-
lengths and widths see drawing

3. Functional properties

- 3.1. Absorbency:
 - 3.1.1. Mats must absorb motion energy in order to reduce the reaction transmitted to the body of the landing gymnast to a tolerable proportion.
 - 3.1.2. They must respond to increased penetration with an evenly increasing resistance.
- 3.2. Stability and Freedom of Movement:
 - 3.2.1. Absorbency of the mats must be balanced in order to guarantee standing, walking stability and freedom of movement.
- 3.3. Indentations caused by the incidence of compressive forces must not encase the body parts, thereby hindering freedom of movements. They may not be too deep or narrow.
- 3.4. If a cover is used, such cover may not plaid and create hindering folds. The mats' upper surface material must offer a balance between anti-slip and slippage. It should be neither slippery nor possess inhibiting resistance.
- 3.5. By no means should mats be dislocated during performances. An anti-skid cover on the mats' underside may provide this condition.
- 3.6. The border zones of the mats which are pushed together should practically have the same functional properties as the remaining surface. Impacts on the border zones should not cause different indentations than on the remaining surface. For this purpose, and to bridge joints, continuous runners are permitted.

4. Colour

- 4.1. Preference should be given to uniform colours.
- 4.2. The upper surface must not show optically disturbing patterns or insignia.
- 4.3. The FIG may designate the colour for certain events

Norms / Functional properties: Regarding tests carried out by FIG Tests Institutes – please see chapter IV

Landing Mats

minimum dimensions in cm

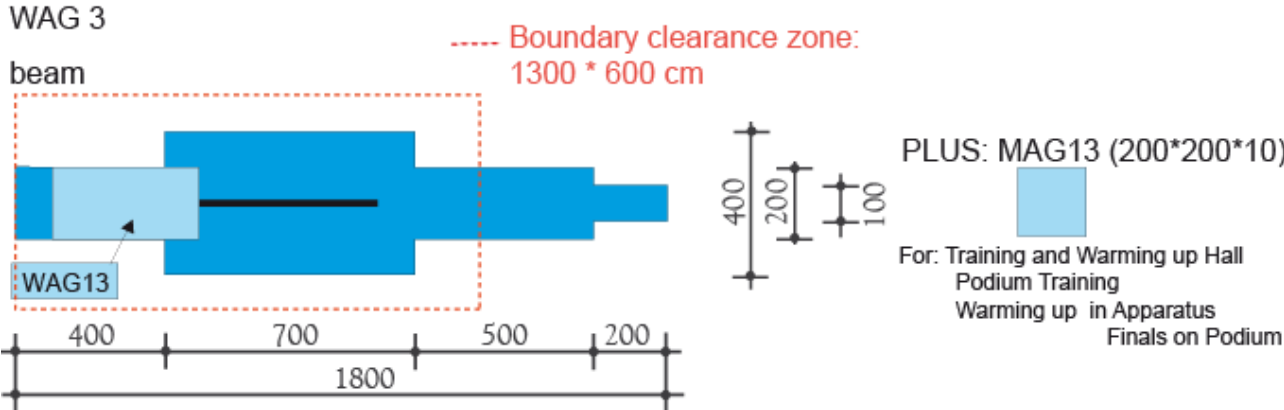
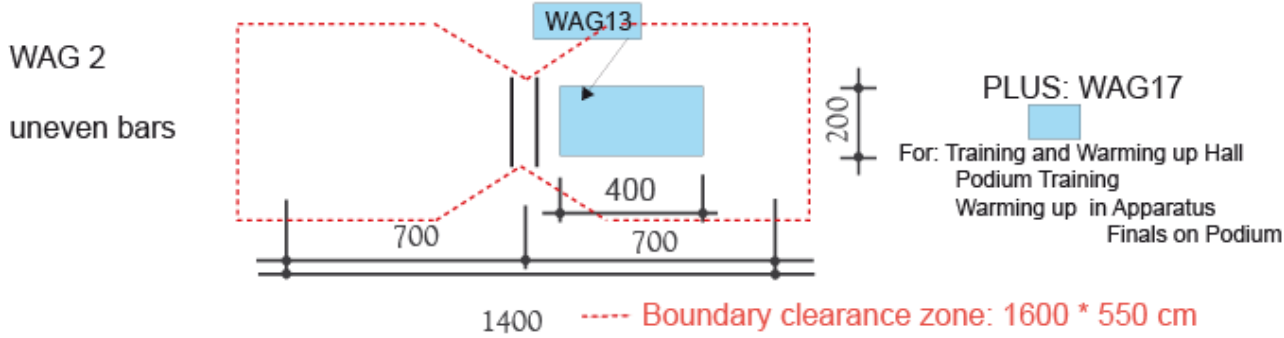
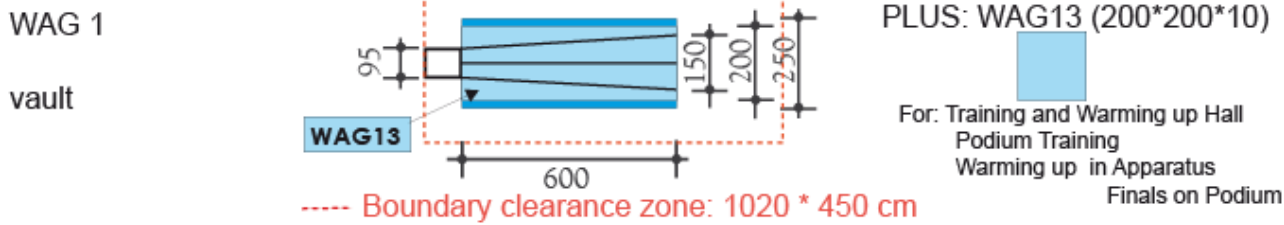

For interpretation of the clearance zones see: chapter II 3.2.
Outlined Boundary clearance zones (red dashed lines) for Training halls and warming up hall.

Supplementary Mats (10 cm)

Women's Artistic Gymnastics

Construction / Description of material, measurements

1. Form

- 1.1. The usage is compulsory in competition for the athletes at Uneven Bars, Balance Beam (400 x 200 cm) and at the vault (600 x 200 cm).
- 1.2. For training (in the training hall and during podium training) and in the warming up hall (correspondingly during the warming up session on the podium before the Apparatus Finals) an additional supplementary mat (200 x 200 cm) shall be available at the Vault, Balance Beam and Floor

2. Form

- 2.1. Their upper surface must be horizontal, even and without gaps.
- 2.2. The supplementary mats have to be laid on the landing mats (WAG11). At the vault the supplementary mat (600 x 200 cm) shall be attached (i.e. using Velcro)

3. Height of the supplementary mats:

- | | |
|--|---------------------|
| | 10 cm * 1 cm |
| 3.1. Vault (WAG1): | 600 x 200 cm * 1 cm |
| 3.2. For the marking of the landing zone see WAG1. | |
| 3.3. Uneven Bars, Balance Beam (WAG2, WAG 3): | 400 x 200 cm * 1 cm |
| 3.4. Additional supplementary mat for training and warming up: | |
| 3.5. Vault (WAG4), Balance beam (WAG3), Floor (WAG4), | 200 x 200 cm * 1 cm |

* Tolerance +/-

4. Functional properties

- 4.1. The foam of the supplementary mats shall have a density of 25 kg / m³ (+/- 2,5 kg /m³). The ultimate tensile strength of the foam (ISO 1798: 2008) shall be ≥ 115 kPa, the compression stress value 40% shall be 4,0 (+/- 1,0) kPa (ISO 3386-1 – Amd1: 2010)
- 4.2. By no means should mats be dislocated during performances. At the vault the supplementary mat (600 x 200 cm) shall be attached to the landing mat
- 4.3. Preference should be given to uniform colours.
- 4.4. The upper surface must not show optically disturbing patterns or insignia.

5. Colour

- 5.1. The FIG may designate the colour for certain event.

Vaulting Board

Women's Artistic Gymnastics

- Vault (WAG1) – “hard” and “soft”
- Uneven bars (WAG2) – “soft”
- Balance beam (WAG3) – “soft”

Construction / Description of material, measurements

1. Form

- 1.1. The profile of the vaulting board must adhere exactly to the respective blue print.
- 1.2. Its upper surface rises in an arched form, approaching the horizontal between 75 cm and 95 cm, measured from the frontal angle. The height reached at this point, may not be exceeded. After this point, the upper surface may continue horizontally or slope downward.
- 1.3. The rise of the arch is 3.5 cm +/- 0,5 cm.
- 1.4. For competitions a “soft” and a “hard” vaulting board shall be available. The “hard” board shall be marked with a dot on the surface.

2. Measurements

- | | | |
|---|-----------|----------|
| 2.1. Length | 120 cm | * 1 cm |
| 2.2. Width | 60 cm | * 1 cm |
| 2.3. Height | 20 cm | * 1 cm |
| 2.4. Height (run-up side) | max 3 cm | |
| 2.5. Cushion Cover | 2 cm | * 0,5 cm |
| 2.6. Total height with cushion cover | 22 cm | * 1,5 cm |
| 2.7. Free space between floor and the lower edge of the vaulting board at the run-up side | max. 1 cm | |

*Tolerance +/-

- 2.8. The stipulated length and height refer to the vertical projection of the upper plate, i.e. the take-off plate.
- 2.9. The base may be larger, but cannot extend more than 2 cm beyond the projection of the board.
- 2.10. Labelling of the “hard” vaulting board on the surface by a dot with clear contrast on the longitudinal midline:

2.10.1. Distance to the side of run up	5 cm
2.10.2. Diameter	8 cm

3. Functional properties

- 3.1. The functional properties of the vaulting board (hardness, damping, elasticity) shall not be adjustable (i.e. springs must be fixed so that they cannot be easily removed by hand).
- 3.2. The elasticity of the vaulting board must be most effective in the area between 75 cm and 95 cm, measured horizontally from the frontal angle.
- 3.3. The vaulting-board must dampen the counter pressure, i.e. reduce motion energy. Elasticity and absorbency must be evenly distributed, so that the effect of the vaulting board differs only slightly, regardless whether the force of the impact is at the middle axis, or away from it.
- 3.4. The upper surface of the vaulting board must offer slip resistance.

Vaulting Board

- 3.5. The vaulting board must not produce disturbing sounds during its use.
- 3.6. The board shall not slide at the time of impact of the athlete. This shall be achieved by anti-slip devices at the bottom side of the board or at the board underneath the vaulting board. The slip resistance shall be provided especially when the board bottoms out at the middle part.
- 3.7. The vaulting board and its base may not have any sharp corners, edges and no protruding parts. Mainly the upper and under edge of the upper part of the Vaulting board towards the apparatus side (Vaulting Table, Balance Beam of Uneven Bars) shall be cushioned and rounded.

4. Colour

- 4.1. The choice of colour is left to the discretion of the manufacturer.
- 4.2. With exception of the dot for “hard” vaulting boards optically disturbing patterns, stripes or insignia on the upper surface are not permitted.
- 4.3. The FIG may designate the colour for certain events.

Norms / Functional properties: Regarding tests carried out by FIG Tests Institutes – please see chapter IV

Vaulting Board

lowering variant

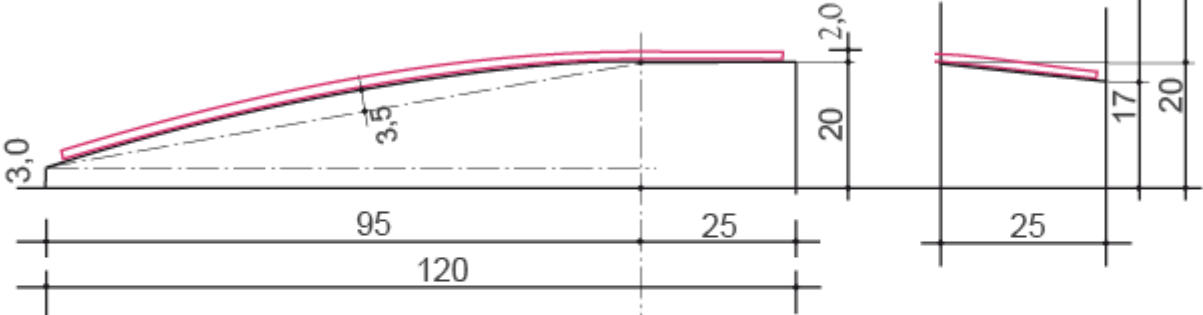

profile

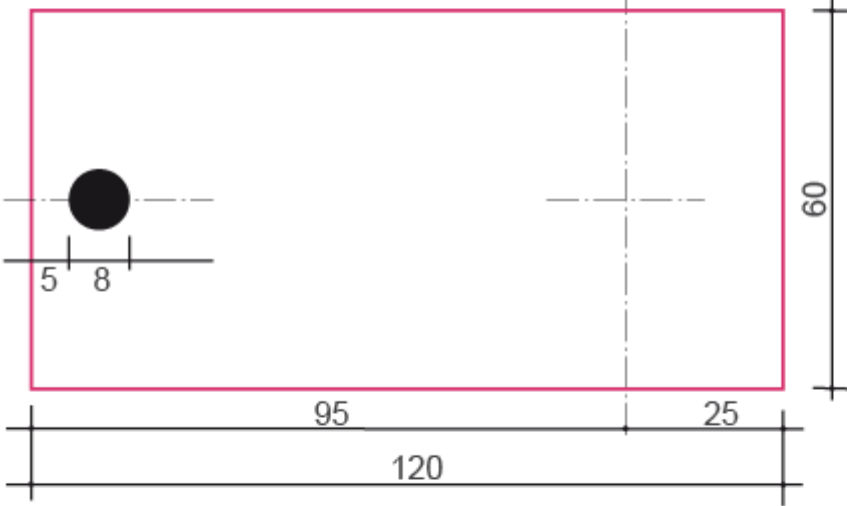

top view

mark for the hard board

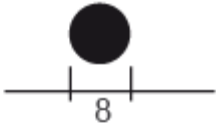

dimensions: mandatory;
 design: at your discretion;
 drawing: typical example

Vaulting Board safety collar (Round off vaults)

Women's Artistic Gymnastics

Construction / Description of material, measurements

1. Use

- 1.1. The usage of the safety collar around the vaulting board is compulsory for round-off entries at the vault. It is not allowed to place the safety collar on the foot of the vaulting table or underneath the vaulting table.

2. Form

- 2.1. The safety collar is "u-shaped" and surrounds the vaulting board at the sides and the front toward the vaulting table. At the sides of the vaulting board its upper surface rises in an arched form in the same level as the vaulting board. At the front side of the vaulting board the surface of the safety collar is horizontal and even.
- 2.2. The whole surface of the safety collar and the corresponding surface of the vaulting board need to be of the same height level.

3. Measurements

- 3.1. Overall length: 120 cm (± 20 cm)
- 3.2. Minimal width at the side of the vaulting board: 20 cm
- 3.3. Length at the front part of the vaulting board: 20 cm ($\pm 0,5$ cm)
- 3.4. Maximal Difference between the height of the safety collars' and the boards' surface (respecting the arched form): ± 1 cm
- 3.5. Maximal gap between the safety collar and the vaulting board on all three sides: 0,5 cm

4. Functional Properties

- 4.1. The safety collar has to provide a safe area around the vaulting board in case of an athlete misses the board for a take-off towards the vaulting table, therefore the safety collar must provide sufficient stability and cushioning at the whole upper surface. The bottom side shall have an "anti-slip" surface (i.e. Velcro) to prevent the safety collar from slipping away.
- 4.2. The safety collar shall not hinder the vaulting board in its functional properties neither by restricting the airflow during the compression of the vaulting board nor hindering the movement of the upper parts during foot contact.

5. Colour

- 5.1. The upper surface must not show optically disturbing patterns or insignia.
- 5.2. The colour must be uniform and in contrast to the vaulting board.
- 5.3. The FIG may designate the colour for certain events.

Mat for Hands (Vault)

Women's Artistic Gymnastics

Construction / Description of material, measurements

1. Use

1.1. A mat for hands can be used by the athletes for round-off entries on the vault

2. Form

2.1. The upper surface must be horizontal and even. The mat for hands can be laid on the run-up area to cushion the hand contact during round-off entries onto the vaulting board.

3. Measurements

3.1. Length in direction of the run-up:	120 cm	* +10 cm
3.2. Width:	100 cm	* ±1 cm
3.3. Height of the mat for hands:	3 cm	*±0,5 cm

* Tolerance

4. Functional Properties

4.1. The cover material must be non-slippery but not rough. It may not cause a burning sensation. If a cover is used, such cover may not be bulged and create hindering folds.

4.2. The bottom side shall have an "anti-slip" surface (i.e. Velcro) to prevent the mat for hands from slipping away.

5. Colour

5.1. The upper surface must not show optically disturbing patterns or insignia.

5.2. The colour must be uniform and in contrast to the run-up area.

5.3. The FIG may designate the colour for certain events.

Spotter mat (Uneven Bars)

Women's Artistic Gymnastics

Construction / Description of material, measurements

1. Form

- 1.1. Spotter mats must be covered with a material which will slide easily.
- 1.2. The mats must be provided with at least two handles or one long handle on the two long sides of the mat.

2. Measurements

- | | | |
|----------------|--------|---------|
| 2.1. Length | 200 cm | - 50 cm |
| 2.2. Width | 150 cm | - 50 cm |
| 2.3. Thickness | 15 cm | - 5 cm |

3. Functional properties

- 3.1. The foam of the spotter mats shall have a density of 20 kg / m^3 ($\pm 2 \text{ kg / m}^3$). The ultimate tensile strength of the foam (ISO 1798: 2008) shall be $\geq 90 \text{ kPa}$, the compression stress value 40% shall be $2,5$ (± 0.5) kPa (ISO 3386-1: 1986 – Amd1: 2010).

4. Colour

- 4.1. Preference should be given to uniform colours.
- 4.2. The upper surface must not show optically disturbing patterns or insignia.
- 4.3. The FIG may designate the colour for certain events.

Remark: The specifications for the spotter mat are the same as for the spotter mat in Trampoline Gymnastics (TRA12).

Tension Control Sensor for ~~Rings, High Bars~~ Uneven Bars - TCS

Women's Artistic Gymnastics

II
WAG 18
15.03.2023

Construction / Description of material, measurements

1. Use

- 1.1. Helping device for the adjustment of an individual tension at the cables of ~~the rings, High Bars and~~ the Uneven Bars in **MAG/WAG** competitions.
- 1.2. The use is not mandatory for FIG competitions, but highly recommended ⁽¹⁾ to protect the athletes from an unexpected breakdown of the gymnastics equipment due to too low cable tension or by damaging parts of the apparatus especially the ground anchors due to too high cable tension. Furthermore, the use serves the coaches and athletes to set the same individual tension on the cables in the training halls, the warming up hall and the competition hall. For the last aspect, the use of TCS makes sense only if devices are provided at all Uneven Bars in the training halls, the warm-up hall and the field of play for the competition in question.

2. Requirements

- 2.1. The device must be able to measure and digitally display the tension at the cables in Newtons with 100 N increments. The TCS should be applicable to the tensioning of all FIG approved Uneven Bars and shall be implemented at the chains (or cables). If used, Tension Control Sensors should be installed at all of these apparatuses in the training halls, the warmup hall and the competition site.
- 2.2. A visible warning lamp will avoid dangerous cable adjustments by overload or underload in the tension of the equipment.
- 2.3. With TCS athletes and coaches should have the possibility to adjust the same individual tension at the cables for the training, warming-up and competition apparatuses.
- 2.4. A TCS shall be easy adjustable between chain or wires by shackles at all FIG approved equipment.

3. General Functions

- 3.1. The TCS shall contain a clearly legible, digital display showing the tensile force between the attachment points in Newtons at 100 N increments.¹
The unit Newton must be indicated by the letter "N".
- 3.2. The digital display of the tensioning force and a clear visible warning light (if over- or underload occurs; see 3) shall only appear for a measurement time interval between 10 and 15 seconds after pressing an easily accessible START- button.
- 3.3. The warning lamp shall light up during the measurement time interval if there is an over- or underload. This is the case for a tension of $x > 5000\text{N}$ and $x < 1000\text{N}$.
- 3.4. The mass of a TCS including its shackles shall be lower than 0,9 kg.
- 3.5. The effective inner length between the two shackles as attachment between the chains or cables shall not exceed 0.18m.
- 3.6. The measurement range shall be 0 – 10000N (displayed until 5000N in steps of 100N).
- 3.7. The strength of a TCS including shackles shall be $x > 15000\text{ N}$.
- 3.8. A TCS shall have no wired power supply. Only batteries or load cells with enough capacity ($> 5 * 24\text{h}$) and with easy charging are allowed.

(¹) **The use will be regulated as follows from 2025:**
- Compulsory for Olympic Games, Youth Olympic Games, World Championships (senior and Junior), World Cups and World Challenge Cups.
- highly recommended for all other competitions

(²) Additional remark:
The one and ten digits, which are always 0 due to the rounding, do not have to be displayed variably but can be fixed on the housing. The combined reading of the variable display and the firmly imprinted digits shall result in Newton values.

Tension Control Sensor for Uneven Bars - TCS

II
WAG 18
15.03.2023

- 3.9.** A suitable charger must be included with the TCS. If this is not the case, standard connections (e.g. USB, Micro-USB, USB Type C etc.) shall be used and a clear message shall be sent to the customer when purchasing a TCS that he himself has to take care of the charger, power bank or similar.
- 3.10.** The TCS shall come with an English written documentation containing a user's guide and all necessary technical descriptions (including installation procedures). Furthermore, this documentation shall contain the following recommendation for mounting of a TCS:

4. Recommendations for mounting of TCS

- 4.1.** In general, only one single TCS on one of the four tension cable sides of the gymnastic apparatus is enough. However, two TCSs are required for special asymmetrical constructions of the Uneven Bars.
- 4.2.** A TCS should be installed at a cable where the desired tension for the gymnastic apparatus can be adjusted. In addition, the TCS must always be installed towards the head judge of the gymnastic apparatus.
- 4.3.** When measuring with TCS at the Uneven Bars, it is particularly important that all equipment in the training halls, the warm-up hall and the competition hall is set up with exactly the same distances between the ground anchors and the equipment stands, as otherwise different measured values may occur with the same functional property of the gymnastic equipment.
- 4.4.** A sufficient battery charge must be ensured for the entire duration of the competitions. In addition to a full charge at the beginning, this must be done during longer competitions by charging with the corresponding chargers during the periods of no use (e.g. overnight). If chargers or Powerbanks are not included in the scope of delivery, the user must ensure that they are available in sufficient numbers.
- 4.5.** If the use of TCS is planned, it is advisable to contact the manufacturer of the gymnastics equipment in good time in order to ensure that the additional length by the TCS will not cause any problems with the cables and chains. If necessary certain suitable accessories need to be ordered from the supplier(s).

Norms / Functional properties: Regarding tests carried out by FIG Tests Institutes – please see chapter IV



2.3 RG Rhythmic gymnastics

RG 1 Performance Area	82
RG 2 Rope	84
RG 3 Hoop	84
RG 4 Ball.....	84
RG 5 Clubs	85
RG 6 Ribbon	85
RG 7 Ribbon cane	85
RG 10 Measurement Table for RG with Balance.....	88



Performance Area

Rhythmic Gymnastics

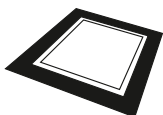

II
RG 1
01.08.2022

Construction / Description of material, measurements

1. Form

- 1.1. The Performance Area shall have a square format. The surface must be horizontal, even and without gaps.
- 1.2. Edge:
 - 1.2.1. Horizontal, even, and at the same height as the performance area.
- 1.3. Clearance zone:
 - 1.3.1. The clearance zone shall be kept totally free as a surrounding zone around the performance area and the edge. It shall be horizontal, even and without gaps. (See Definition: II, chapter 3. Surfaces of apparatus, clearance zones, total surfaces)
- 1.4. Direction of carpet seams:
 - 1.4.1. If the surface is composed of several parallel carpet rolls, the seams shall be perpendicular to the direction of the judges' tables.
- 1.5. The performance area shall be composed by a damping under – construction and an overlying carpet

2. Measurements

- 2.1. Performance area 1300 x1300 cm
Tolerance +/- 3 cm
- 2.2. Diagonals of the performance area: 1838 cm +/- 5cm
- 2.3. Edge (25 + 25) 50 cm
- 2.4. Clearance zone 200 cm
- 2.5. Edge as a variant
 - 2.5.1. Horizontal Area, Width 25 cm
 - 2.5.2. Slope max. 20 %, Width 25 cm
- 2.6. When there is a delimitation strip between the performance area and the edge:
 - 2.6.1. Width of the delimitation strip 5 cm +/- 0,5 cm
 - 2.6.2. The delimitation strip is part of the performance area.
- 2.7. Performance area and edge:
 - 2.7.1. Equal elasticity on the surface as well as dampening.
 - 2.7.2. When in use it should not have any motion energy.
 - 2.7.3. Elasticity and dampening must be balanced in such a way that they guarantee the gymnast stability and freedom of movement. It must not restrict turns and slide movements.
 - 2.7.4. The surface cover of the performance area must provide a balance between anti-skid and slippage. It must not cause skin burns.
 - 2.7.5. The performance area must not produce disturbing sound during the execution of an exercise. It must assure a low noise level.

3. Colour

- 3.1. Of plain colour which choice is left to the manufacturer's discretion. Dark colours are not allowed. For certain events the FIG may stipulate the colours. The delimitation shall have a clear contrast to the performance area

Norms / Functional properties: Regarding tests carried out by FIG Tests Institutes – please see chapter IV

Performance Area

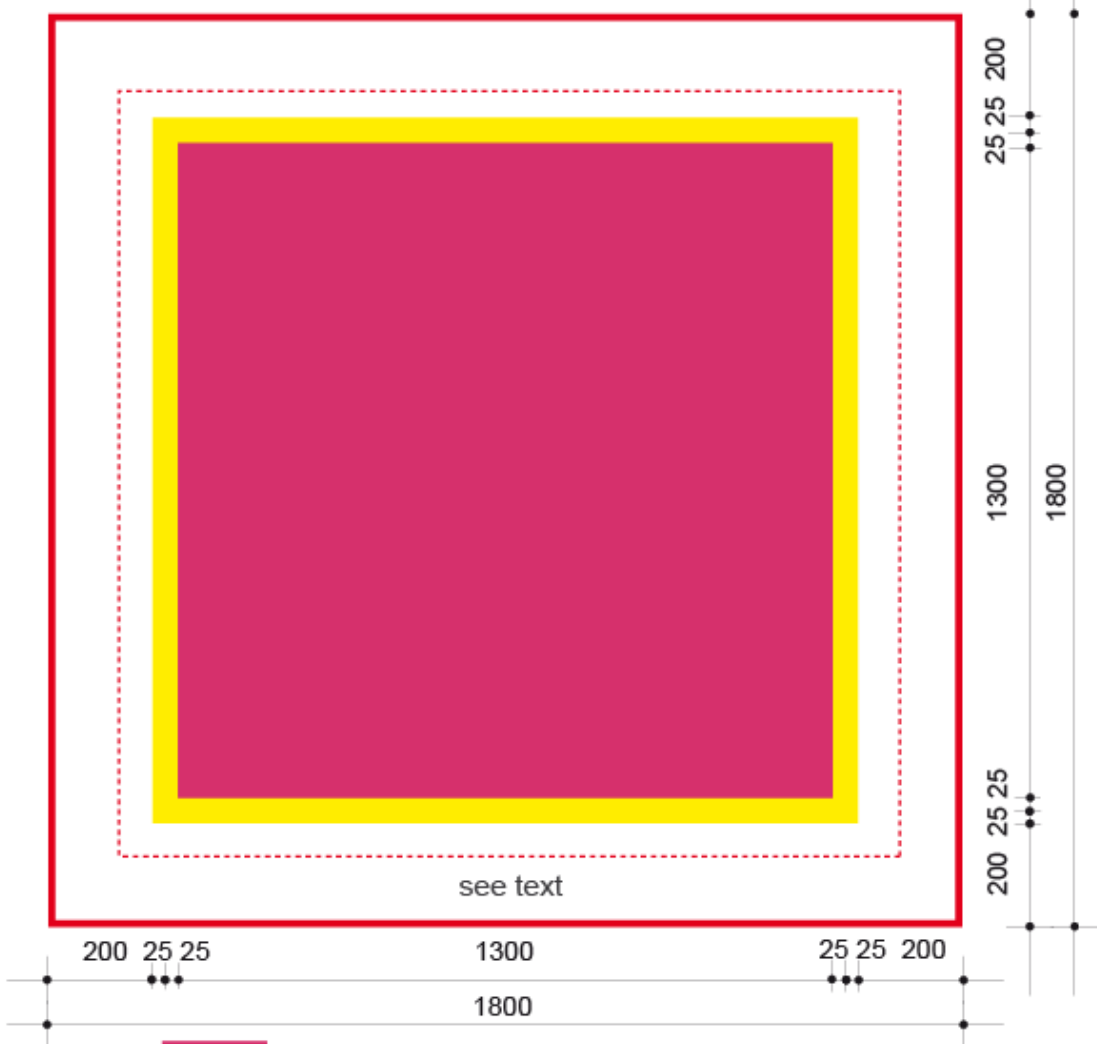

- competition area
- edge
- clearance zone training- and warmup halls
- clearance zone field of play

profile - variants A, B, C

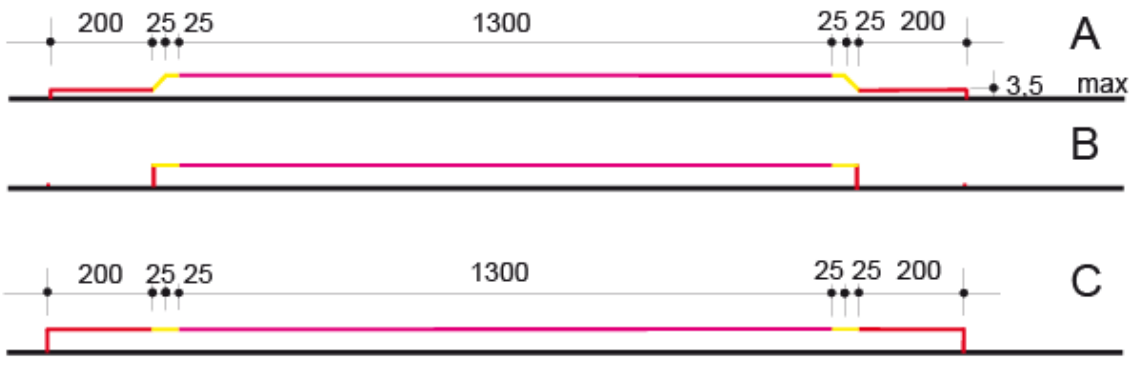

Rope, Hoop, Ball, Clubs, Ribbon

Rhythmic Gymnastics

All hand apparatuses which are supposed to be used at FIG sanctioned events shall have markings according to FIG rules. The markings shall not be removable.

At FIG sanctioned events only FIG approved hand apparatuses shall be used.

Construction / Description of material, measurements

RG 2 – Rope

1. Material: Hemp or similar suitable material
2. Length: Optional for Senior and Junior Gymnasts
3. Thickness: Uniform or reinforced in the centre.
4. Shape: Both rope-ends, with or without knots. Without wooden handle. May be wrapped with a thin non-slip material in a length corresponding to the width of a hand.
5. Colour: Optional. Bright colour preferred

RG 3 – Hoop

1. Material: Wood or synthetics
2. Weight:
 - 2.1. 300 g. minimum
 - 2.2. 260 g. minimum for JuniorsThe weight specification shall be fulfilled unwrapped.
3. Inner diam.:
 - 3.1. 800 – 900 mm Senior Gymnasts (equals 2513 – 2827 mm inner circumference)
 - 3.2. 700 – 900 mm Junior Gymnasts (equals 2199 – 2827 mm inner circumference)Can be wrapped
4. Colour: Optional. Bright colour preferred.

RG 4 – Ball

1. Material: Rubber or soft plastic, antistatic
2. Weight: 400 g. minimum
3. Diameter: 180 – 200 mm Senior and Junior Gymnasts (equals 565 – 628 mm circumference)
4. Colour: Optional. Bright colour preferred.

RG 5 – Clubs



1. Material: Wood or synthetics
2. Length: 400 – 500 mm Senior and Junior Gymnast
3. Weight: 150 g. min.
The weight specification shall be fulfilled unwrapped.
4. Shape: Bottle shape
5. Diameter of the head: 30 mm max.
6. Colour: Optional. Bright colour preferred. Can be wrapped.
(The head of the clubs must be fixed firmly to the neck of the apparatus. It shall not rotate)

RG 6 – Ribbon



1. Material: Satin or similar
2. Length: Total length 6 m (min) in one piece (5 m min for Juniors). The part at which the ribbon is attached to the cane is doubled in a length of 1 m \pm 0,1 m.
3. Weight: 35 g. minimum, without the cane (30 g. min. for Juniors)
4. Width: 40 – 60 mm
5. Colour: Optional. Bright colour preferred.

RG 7 – Ribbon cane

1. Cane
 - 1.1. Material: Wood, bamboo, fibreglass, aluminium, or synthetics
 - 1.2. Length: 500 – 600 mm
 - 1.3. Diameter: maximum 10 mm at the thickest point.
 - 1.4. Shape: cylindrical or conic. The handle may be wrapped in a thin anti-slip material with a length of 100 mm max.
 - 1.5. Colour: Optional.
2. Fixture:
 - 2.1. Material: cord, nylon-thread or similar item, or moveable ring resp. a swivel attached to the cane.
 - 2.2. Length: 70 mm maximum

Rope, Hoop, Ball

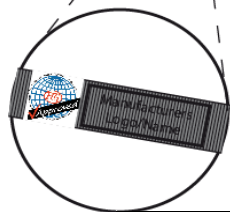
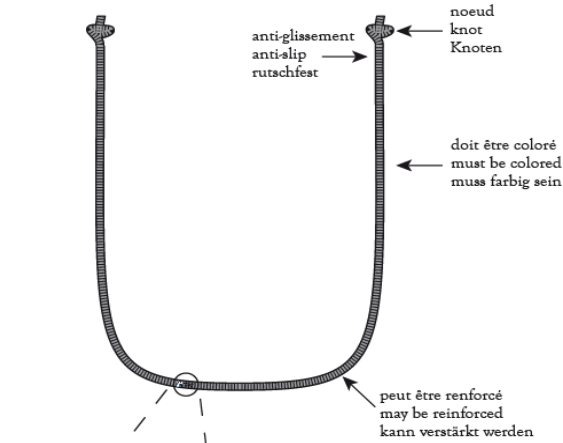

For the size of the logos see:
FIG Advertising Rules
/ Apparatus chart

Rope: Size of Logos

"Manufacturers Logo/Name"		
(all values in mm)	value	Tolerance ±
width	10 mm	± 2 mm
length	32 mm	- 24 mm

"FIG Approved"		
(all values in mm)	value	Tolerance ±
width	10 mm	± 2 mm
length	10 mm	± 2 mm

Remark: The FIG Logo can be turned to arrange the same orientation as the Manufacturers Logo/Name

Hoop: Size of Logos

"Manufacturers Logo/Name"		
(all values in mm)	value	Tolerance ±
width	10 mm	± 2 mm
length	32 mm	- 24 mm
Position on the right side and on the middle axes	at the inner side of the hoop	-

"FIG Approved"		
(all values in mm)	value	Tolerance ±
width	10 mm	± 2 mm
length	10 mm	± 2 mm
Position on the left side and on the middle axes	at the inner side of the hoop	-

Remark: The FIG Logo can be turned to arrange the same orientation as the Manufacturers Logo/Name

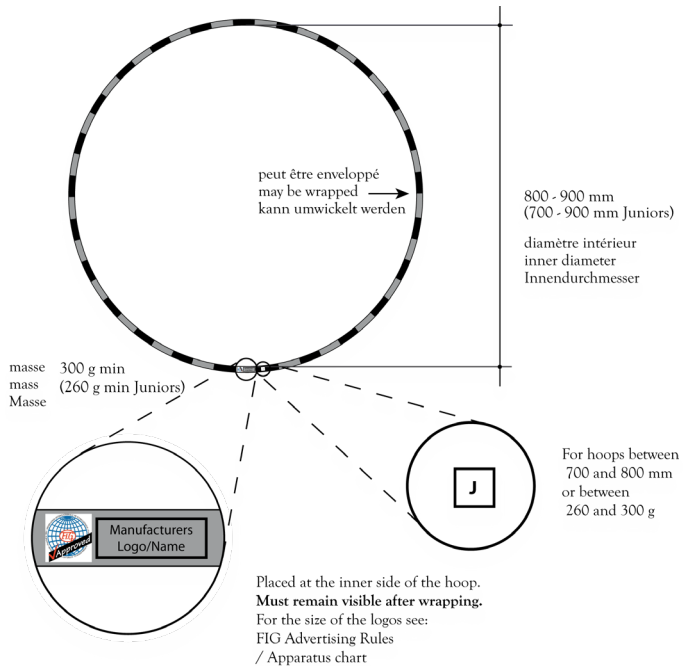

For hoops between 700 and 800 mm or between 260 and 300 g

Placed at the inner side of the hoop.
Must remain visible after wrapping.
For the size of the logos see:
FIG Advertising Rules
/ Apparatus chart

Ball: Size of Logos

"Manufacturers Logo/Name"		
(all values in mm)	value	Tolerance ±
width	10 mm	± 2 mm
length	32 mm	- 24 mm
Distance from the valve	10 mm	± 5 mm

Remark: The Manufacturers Logo can be rectangular or curved as indicated in the drawing.

"FIG Approved"		
(all values in mm)	value	Tolerance ±
width	10 mm	± 2 mm
length	10 mm	± 2 mm
Distance from the valve	10 mm	± 5 mm

Remark: The FIG Logo can be turned to arrange the same orientation as the Manufacturers Logo/Name.

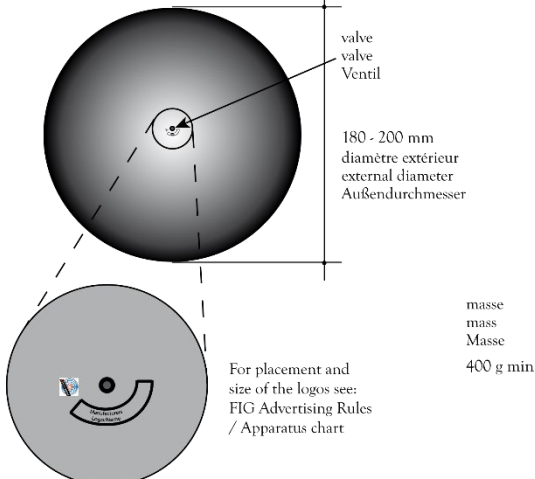

For placement and size of the logos see:
FIG Advertising Rules
/ Apparatus chart

Clubs, Ribbon

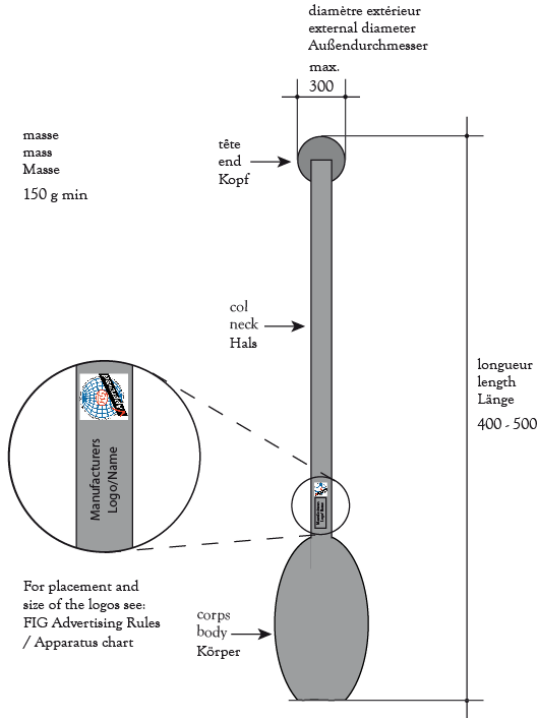

toutes longueurs en mm
all lengths in mm
alle Längen in mm

Clubs: Size of Logos

"Manufacturers Logo/Name"		
(all values in mm)	value	Tolerance ±
width	10 mm	± 2 mm
length	32 mm	- 24 mm
Distance to the body	20 mm	± 15 mm

"FIG Approved"		
(all values in mm)	value	Tolerance ±
width	10 mm	± 2 mm
length	10 mm	± 2 mm

Remark: The FIG Logo can be turned to arrange the same orientation as the Manufacturers Logo/Name

Ribbon: Size of Logos

"Manufacturers Logo/Name"		
(all values in mm)	value	Tolerance ±
width	10 mm	± 2 mm
length	32 mm	- 24 mm

"FIG Approved"		
(all values in mm)	value	Tolerance ±
width	10 mm	± 2 mm
length	10 mm	± 2 mm

Position at the beginning of the Ribbon (Cane's side) and at the end of the Ribbon		
Distance from the end	100 mm	± 20 mm
Distance from the beginning	50 mm	± 10 mm

Remark: The FIG Logo can be turned to arrange the same orientation as the Manufacturers Logo/Name

Ribbons Cane: Size of Logos

"Manufacturers Logo/Name"		
(all values in mm)	value	Tolerance ±
width	10 mm	± 2 mm
length	32 mm	- 24 mm

"FIG Approved"		
(all values in mm)	value	Tolerance ±
width	10 mm	± 2 mm
length	10 mm	± 2 mm
Distance to the 100 mm reinforcement	10 mm	± 2 mm

Remark: The FIG Logo can be turned to arrange the same orientation as the Manufacturers Logo/Name

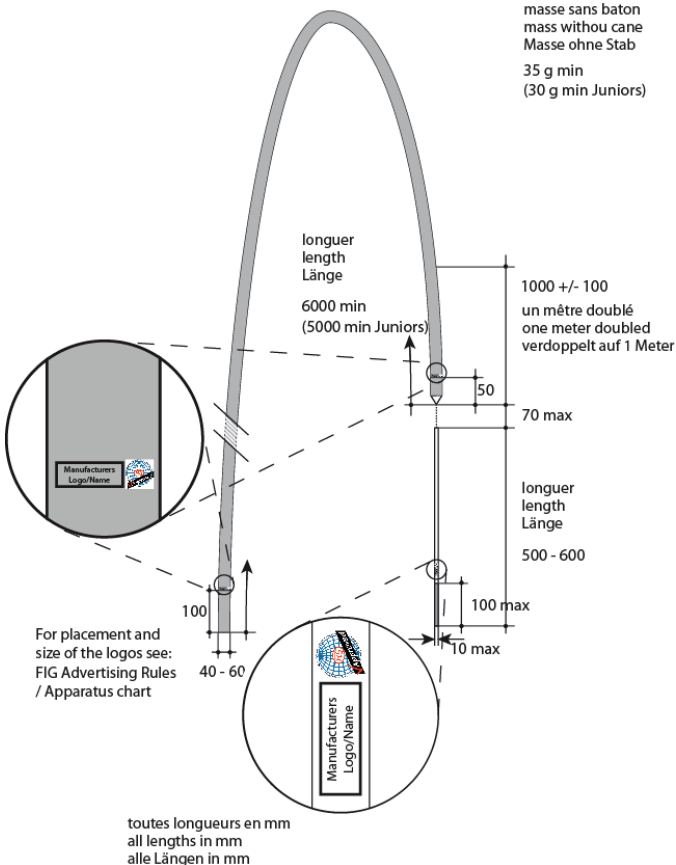

Measurement Table for RG with Balance

Rhythmic Gymnastics

for testing prescriptions of RG 3,4,5,6,7

Construction / Description of material, measurements

1. Form

- 1.1. The apparatus consists of a table or a plate which can be placed on a table with special trays and tools for controlling prescribed parameters of RG equipment during the competition. An additional, suitable balance is needed.

2. Measurements:

- 2.1. The device should be suitable for measuring:
- | | |
|--|------------------|
| 2.1.1.interior diameter of hoops (RG3) (Senior): | 800 – 900mm |
| 2.1.2.interior diameter of hoops (RG3) (Junior): | 700 – 900mm |
| 2.1.3.diameter of balls (RG4): | 180 – 200mm |
| 2.1.4.diameter of the end of clubs (RG5): | 30mm max. |
| 2.1.5.diameter of the cane of gymnastic ribbons (RG6): | 10mm max |
| 2.1.6.length of clubs (RG5): | 400 - 500mm |
| 2.1.7.length of ribbons (RG6) (Senior): | 6000mm min. |
| [can be measured as 6 * 1000mm] | |
| 2.1.8.length of ribbons (RG6) (Junior): | 5000mm min. |
| [can be measured as 5 * 1000mm] | |
| 2.1.9.length of the doubled part of ribbons (RG6): | 1000mm (+/- 100) |
| 2.1.10.length of the cane of gymnastic ribbons (RG6): | 500 - 600mm |
| 2.1.11.length of the optional handle part | |
| of the cane of gymnastic ribbons (RG6): | 100mm max. |
| 2.1.12.length of the fixture of gymnastic ribbons (RG6): | 70mm max. |
| 2.1.13.width of ribbons (RG6): | 40 - 60mm |
- 2.2. The balance should be suitable for measuring the following weights (“masses”) with a precision of +/- 1 g:
- | | |
|--|-----------|
| 2.2.1.hoops (RG3): | 300g min. |
| 2.2.2.balls (RG4): | 400g min. |
| 2.2.3.clubs (RG5): | 150g min. |
| 2.2.4.gymnastic ribbons without the cane (RG6, Seniors): | 35g min. |
| 2.2.5.gymnastic ribbons without the cane (RG6, Juniors): | 30g min. |
- 2.3. The measurement trays for diameters of Hoops for measuring diameters shall control the whole circles, not only segments of the circles (“hoops shall not be bent during measurements”). Each Tray of 700mm, 800mm & 900 mm, must have a thickness minimum of 15mm.
- 2.4. All measures shall be indicated unmistakably on labels.
- 2.5. The weight of hoops shall be measured in a hanging position of the hoops.

Measurement Table for RG with Balance

Example for positioning of trays and tools for controlling the prescribed parameters:

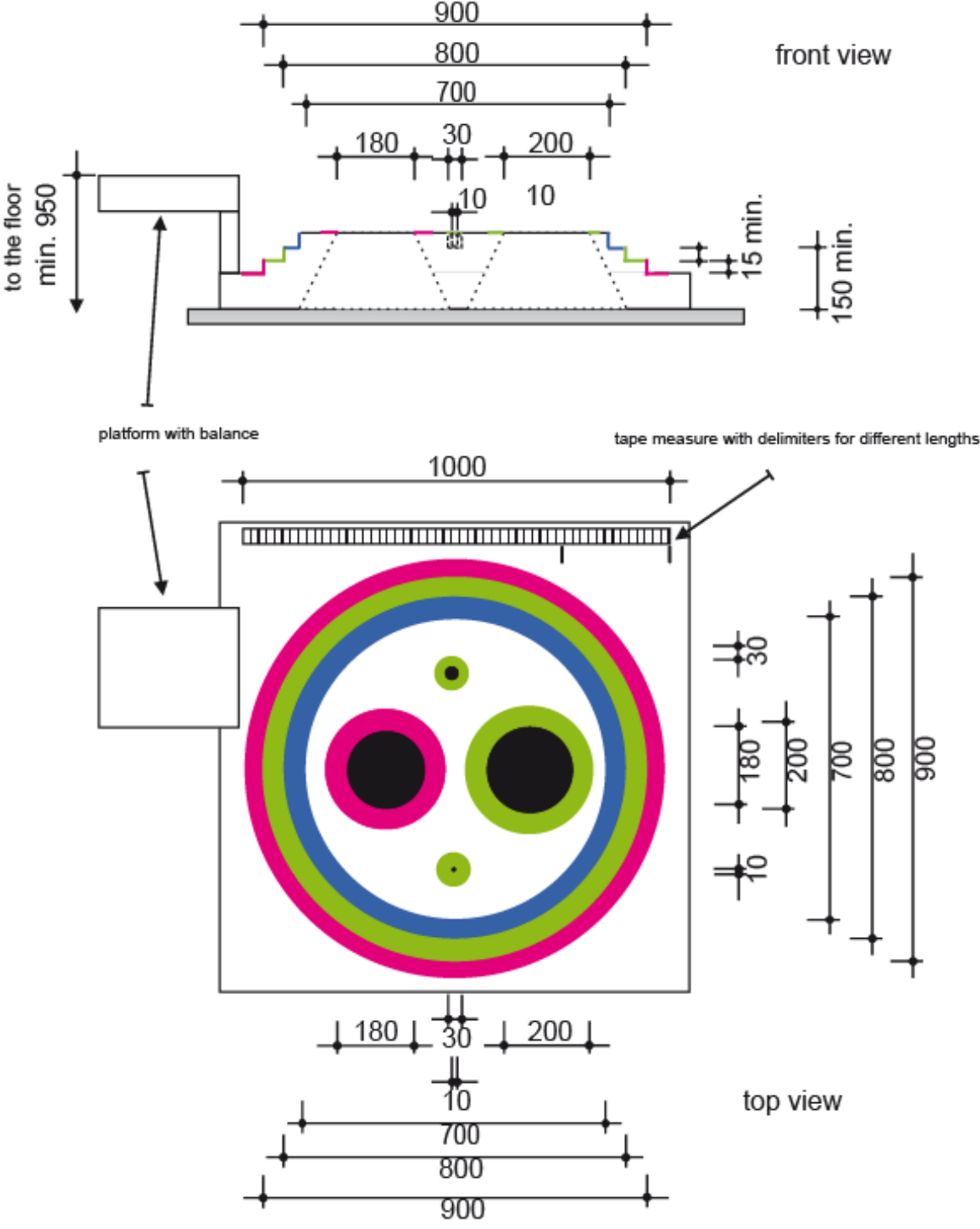

dimensions: mandatory;
 design: at your discretion;
 drawing: typical example



2.4 TRA Trampoline Gymnastics

TRA 1 Trampoline	92
TRA 2 Double Mini-Trampoline	96
TRA 3 Tumbling track.....	101
TRA 11 Safety mat (20 cm): Trampoline, Double Mini-Trampoline.....	103
TRA 12 Spotter mat: Trampoline, Double Mini-Trampoline	104
TRA 13 Supplementary mat: Tumbling	105
TRA 14 Vaulting Board - Tumbling	106
TRA 15 Time measurement device for trampoline competitions - TMD.....	108
TRA 16 Horizontal Displacement Measurement Device for	112
TRA 17 Landing mat (30 cm): Double Mini-Trampoline + Tumbling.....	115



Trampoline

1. Frame

- 1.1. Interior measurements of the frame, with bed under tension, but without frame pads:
- 1.1.1.Length 505 cm +/-6 cm
- 1.1.2.Width 291 cm +/-5 cm
- 1.2. For safety reasons the profile of the frame must have rounded edges. The radius must be min 15mm. The profile of the frame may also be oval or round, but in these cases, it must be guaranteed, that coaches are able to stand on the frame safely in order to give the necessary support to the athletes. Special attention must be given to the padding of the frame.

2. Trampoline Bed

- 2.1. The height of the bed, measured from the floor, shall meet all of the following three specifications:
- 2.1.1.At least one of the heights h_1 ; h_2 ; h_3 or h_4 (see figure) 115,5 cm +/-0,5 cm
- 2.1.2.All heights h_1 ; h_2 ; h_3 and h_4 (see figure) $\geq 115,0$ cm
- 2.1.3.The heights h_1 ; h_2 ; h_3 and h_4 shall be adjusted, so that the bed is horizontal in all longitudinal and transversal directions with all four feet of the trampoline in firm contact to the ground.
- 2.2. Dimensions² of the bed under tension ready for use, including attachment straps:
- Length (bl_1 , bl_2 ; bl_3 , see figure) 428 cm +/-6 cm
with: $\max(bl_1, bl_2; bl_3) - \min(bl_1, bl_2; bl_3) < 3$ cm
- Width (bw_1 ; bw_2 ; bw_3 ; see figure) 214 cm +/-5 cm
with: $\max(bw_1, bw_2; bw_3) - \min(bw_1, bw_2; bw_3) < 3$ cm
- 2.3. The bed must be constructed from light coloured bands, webs, strings etc., which must be held together in such a way that they are not displaced during use.
- 2.3.1.Web Construction:
- 2.3.1.1. Width of web under tension 0,55 cm +/- 0,15 cm
- 2.3.1.2. Distance between any two webs 1,6 cm (max.)
- 2.3.2.String Construction:
- 2.3.2.1. Width of strings under tension 0,3 cm +/- 0,1 cm
- 2.3.2.2. Distance between any two strings no greater than 1 cm
- 2.4. The bed must be strong enough to withstand wear, and not tear when in use.
- 2.5. Two rectangular areas¹ must be marked out clearly in red lines. Each area must be symmetrically oriented to the middle of the bed. The width of the delimitation lines must be between 13 and 24 mm. The lines belong to the marked areas:
- 2.5.1. Area A (rectangle 215 * 108):
- 2.5.1.1. the delimitation lines for area A shall not only define the rectangle area of 215 * 108 cm, but shall also be continued to the end of the bed (see figure).
- 2.5.1.2. Length (cl_1 , cl_2 , cl_3 , see figure) 215 +/- 4 cm
with: $\max(cl_1, cl_2, cl_3) - \min(cl_1, cl_2, cl_3) < 2$ cm
- 2.5.1.3. Width (dw_1 , dw_2 , dw_3 , see figure) 108 +/- 4 cm
with: $\max(dw_1, dw_2, dw_3) - \min(dw_1, dw_2, dw_3) < 2$ cm
- 2.5.2. Area B (quadratic 108 * 108):
- 2.5.2.1. Length (el_1 , el_2 , el_3 , see figure) 108 +/- 4 cm
with: $\max(el_1, el_2, el_3) - \min(el_1, el_2, el_3) < 2$ cm
- 2.5.2.2. Width (dw_1 , dw_2 , dw_3 , see figure) 108 +/- 4 cm
with: $\max(dw_1, dw_2, dw_3) - \min(dw_1, dw_2, dw_3) < 2$ cm
- 2.5.3. The center of the bed must be indicated by a red cross.
- 2.5.3.1. Dimensions 70 cm +/- 3 cm

² Trampoline beds are subject to considerable changes in dimensions due to the high tensions. All length specifications shall be fulfilled at the following instant of times:

Competition: At the time of the officially announced apparatus control before the competitions and thereafter.

During other official apparatus controls (i.e. test at a FIG test institute): After a period of 24h with the trampoline unfolded, ready for use and preconditioned with $20^\circ \pm 3^\circ$ C and a humidity of $< 60\%$.

3. Suspension

The bed must be suspended with springs in such a way as to present no danger to users. The tension on the bed should be such that the bed stabilises within a second after contact.

II
TRA 1
01.01.2017

4. Area free of obstruction beneath the bed

The trampoline must be constructed so that the competitor will not touch any part of the frame beneath the bed.

5. Safety Padding

- 5.1. The frame and springs must be entirely covered by a shock absorbing padding, the thickness of which must be between 3,0 cm and 5,0 cm at the edge near the bed. At the edge over the frame the thickness must not be necessarily the same: It can increase up to 10 cm, however the maximum slope between the two edges shall not be higher than 10 degrees from horizontal plane. The padding must not touch any part of the bed. The padding may extend over the bed by up to 6 cm, but the available unobstructed jumping area may not be smaller than the minimum bed size (422 cm x 209 cm).
- 5.2. The padding should be firmly fixed to the frame without hindering the normal action of the bed and springs. It should not cause noise through flapping.
- 5.3. The bottom of the padding, at the side of the bed, should not protrude above the level of the bed by more than 6 cm. The padding must be stable enough to allow for a person to stand on it without protruding into the spaces between the springs.
- 5.4. The foam of the safety padding shall have a density of 30 kg / m³ (+/-3,0 kg /m³). The ultimate tensile strength of the foam (ISO 1798: 2008) shall be ≥ 260 kPa, the compression stress value 40% shall be 70,0 (+/- 15,0) kPa (ISO 3386-1 – Amd1: 2010).

6. Safety Platform

- 6.1. Platforms must be placed at both ends of the trampoline. The platform must be made of a framework which is firmly attached to the trampoline. The platforms must be constructed so that it is shock absorbent, and the surface must be covered with a shock absorbing mat, firmly fixed to the platforms.
 - 6.1.1. The mats must have the following dimensions:

6.1.1.1. Width:	300 cm +/-2,5 cm
6.1.1.2. Length (including wedge, 40 cm)	240 cm +/-2,5 cm
6.1.1.3. Thickness at the bedside	7,5 cm +/-0,5 cm
6.1.1.4. Thickness at the end	20 cm +/-2,0 cm
 - 6.1.2. The platforms dimensions must be such, that the mats are sufficiently supported to ensure, that on landing, it supports the weight of the competitor without collapsing or folding.
 - 6.1.3. The foam of the mats shall have a density of 25 kg / m³ (+/-2,5 kg /m³). The ultimate tensile strength of the foam (ISO 1798: 2008) shall be ≥ 130 kPa, the compression stress value 40% shall be 4,0 (+/- 1,0) kPa (ISO 3386-1 – Amd1: 2010).
- 6.2. The mat covering the platform shall end between inner and outer edge of the frame pad. The distance to the inner edge of the frame pad shall be 5 to 8 cm. (see figure).

7. Safety mats on the ground: Mats shall rest on the ground around and between the trampolines for safety reasons. All mats shall be of the same height and type. One of the following two types shall be used:

- a) Mats which satisfy the specifications of MAG11/WAG11/TRA11. (Measures: Height: 20 cm, Width: 200cm, Tolerance: +/- 1 cm).
- b) Mats with a core which shall have a density of 25 kg / m³ (+/-2,5 kg /m³). The ultimate tensile strength of the foam (ISO 1798: 2008) shall be ≥ 130 kPa, the compression stress value 40% shall be 4,0 (+/- 1,0) kPa (ISO 3386-1 – Amd1: 2010). Ultimate tensile strength (ISO 1798: 2008) of the cover material shall be 560-600 kPa. (Measures: Height: 20 cm min, Width: 200cm, Tolerance: +/- 1 cm).

Norms / Functional properties: Regarding tests carried out by FIG Tests Institutes – please see chapter IV

Trampoline

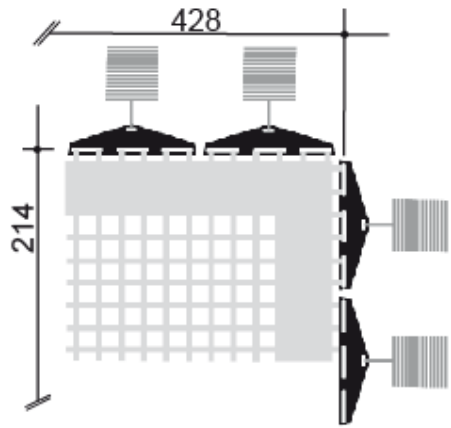
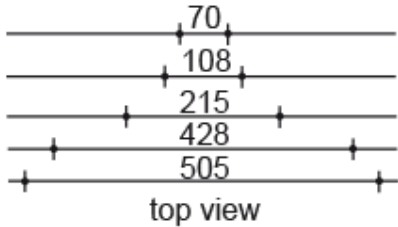
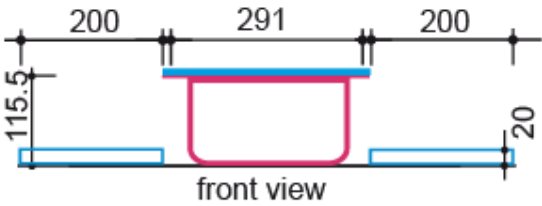
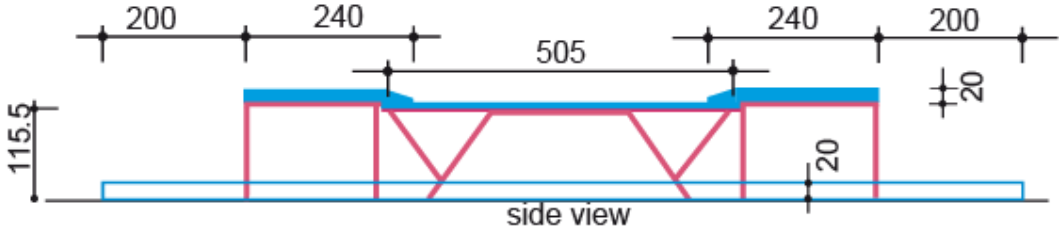

boundary for the bed includ. straps

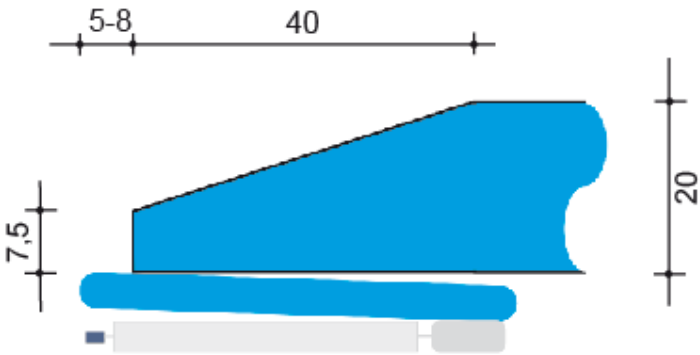

Detail
 mat covering the platform

dimensions: mandatory;
 design: at your discretion;
 drawing: typical example

Trampoline

Specifications:
 height, length and width measurements of the bed

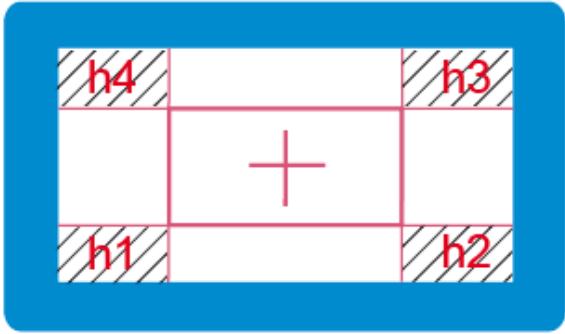

areas for height measurement

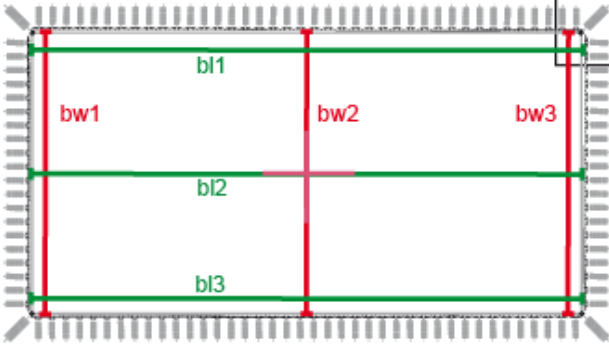
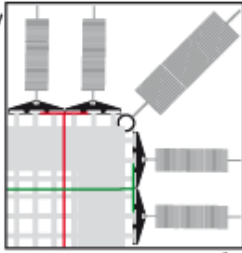

bed: Length and width measurements

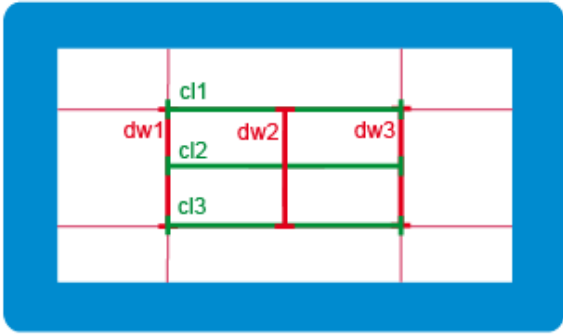

jumping zones:

area A: Length and width measurements

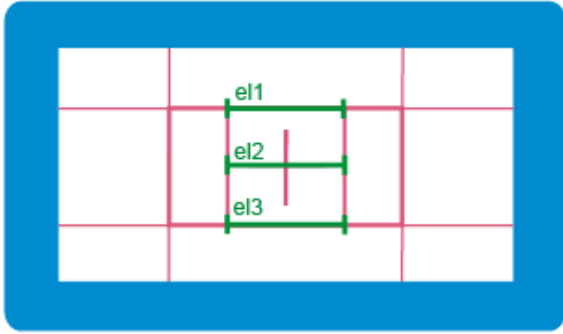

area B: Length measurements

dimensions: mandatory;
 design: at your discretion;
 drawing: typical example

Double Mini-Trampoline

1. Frame

- 1.1. For safety reasons no metal bars or other firm fixings are allowed across the ends of the Double Mini-Tramp other than at floor level.
- 1.2. For safety reasons the profile of the frame must have rounded edges. The radius must be minimum 15mm.
- 1.3. Safety Padding
 - 1.3.1. The frame and springs shall be entirely covered by shock absorbing padding, the maximum Thickness of which shall be greater or equal 30mm and not be greater than 55mm. The padding must not cover any part of the bed.
 - 1.3.2. The padding should be firmly fixed to the frame without hindering the normal action of the bed and the springs. Nor should it cause noise through flapping.
 - 1.3.3. The bottom of the padding at the side of the bed should not protrude above the level of the bed by more than 6 cm.
 - 1.3.4. The bars beneath the bed must be padded.
 - 1.3.5. The frame ends on the dismount end must be covered with at least 50mm pads firmly joined together with the other padding.

2. Bed

- 2.1. The bed must be constructed from light coloured bands, webs, strings etc., which must be held together in such a way that they are not displaced during use.
- 2.2. Dimensions³ of the bed under tension
 - 2.2.1. Length bl_1 ; bl_2 ; bl_3 (see figure), edge to edge of included end markers 285 cm +/- 5 cm with:
 $\max(bl_1, bl_2; bl_3) - \min(bl_1, bl_2; bl_3) < 10$ cm
 - 2.2.2. Width (bw_1 ; bw_2 ; bw_3 ; see figure), including attachment straps: 92 cm +/- 4 cm
with: $\max(bw_1, bw_2; bw_3) - \min(bw_1, bw_2; bw_3) < 2$ cm
- 2.3. Height of bed, measured from the floor with bed under tension:
 - 2.3.1. Mounting End 45 cm +/- 1,5 cm
 - 2.3.2. Dismounting End 70 cm +/- 1,5 cm
- 2.4.
 - 2.4.1. Width of web under tension: 0,4 cm min. 1,3 cm max.
 - 2.4.2. Width of strings under tension: 0,3 cm +/- 0,1 cm
- 2.5. The strands of webbing (or string) must be sewn together, and the distance between any two strands must not be greater than 1, 8 cm (max: 1 cm with string-construction).
- 2.6. The bed must be strong enough to withstand wear, and not tear when in use.
- 2.7. The Penalty Zones must be marked in red on the bed. The dimensions of these zones are:
 - 2.7.1. End markers 13 cm +/- 2 cm
 - 2.7.2. Centre zone 39 cm +/- 1 cm
 - 2.7.3. Distance of the Centre Zone 90 cm +/- 2 cm
(Measured from the mounting end)

³ Double Mini Trampoline beds are subject to considerable changes in dimensions due to the high tensions. All length specifications shall be fulfilled at the following instant of times:

Competition: At the time of the officially announced apparatus control before the competitions and thereafter.

During other official apparatus controls (i.e. norm-control by TC members): After a period of 24h with the double mini trampoline unfolded, ready for use and preconditioned with $20^\circ \pm 3^\circ$ C and a humidity of < 60%.

Double Mini-Trampoline

3. Landing Area

3.1. The landing area shall be covered with a landing mat (TRA17) which is shock absorbent, and which allows a stable landing on the feet. Dimensions of the landing area must be:

- | | |
|---------------------------------------|-----------------|
| 3.1.1.Length (landing mat, TRA 17) | 600 cm +/- 1 cm |
| 3.1.2.Width (landing mat, TRA 17) | 300 cm +/- 1 cm |
| 3.1.3.Thickness (landing mat, TRA 17) | 30 cm +/- 1 cm |

3.2. Additional safety mat behind the landing area

3.2.1.An additional safety mat with the minimum dimensions of 300 * 200 * 20 cm must be placed directly behind the landing area.

3.3. Landing Zones

3.3.1.Two landing zones must be marked out in the landing area, with either the whole zone in a contrasting colour or, with lines 50mm wide in a contrasting colour. If lines are used, they have to belong to their zones.

3.3.2.Landing Zone C: The size of landing zone C is identical to the size of the Landing Area (see 3.1 above)

3.3.3.Landing Zone B: The outer edge of the landing zone (or lines) marks the boundary of the landing zone, the dimensions of which must be:

- | | |
|-----------------|-----------------|
| 3.3.3.1. Length | 400 cm +/- 1 cm |
| 3.3.3.2. Width | 200 cm +/- 1 cm |

3.3.4.Landing Zone A: The outer edge of the landing zone (or lines) marks the boundary of the landing zone, the dimensions of which must be:

- | | |
|-----------------|-----------------|
| 3.3.4.1. Length | 250 cm +/- 1 cm |
| 3.3.4.2. Width | 100 cm +/- 1 cm |

3.3.5.For certain events the FIG may stipulate the colours of the different zones.

4. Run-up

4.1. Floor mats shall be used on the run-up:

- | | |
|---------------------|-----------------|
| 4.1.1.Length | 2000 cm+ 250 cm |
| 4.1.2.Minimum Width | 100 cm |
| 4.1.3.Thickness | 2,5 cm+/-0,5 cm |

5. **Safety mats on the ground:** On the two sides of the DMT a mat shall rest on the ground for safety reasons (measures: Height: 20 cm, Width: 200cm, Tolerance: +/- 1 cm). They have to satisfy the specifications of TRA11.

Double Mini-Trampoline

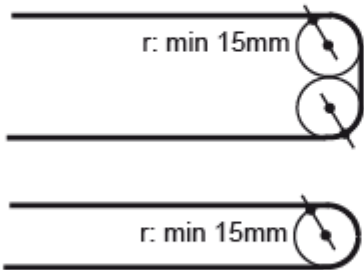
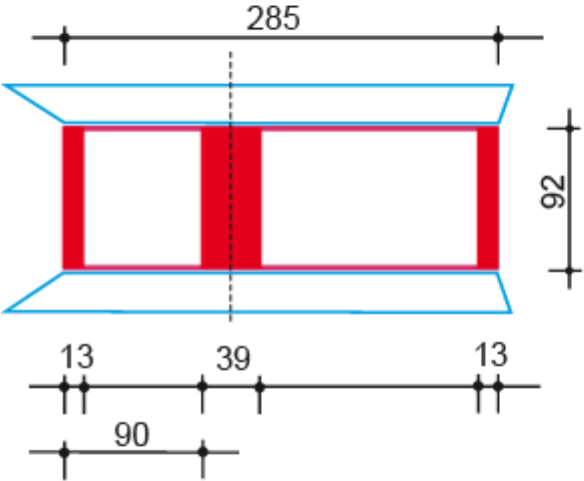
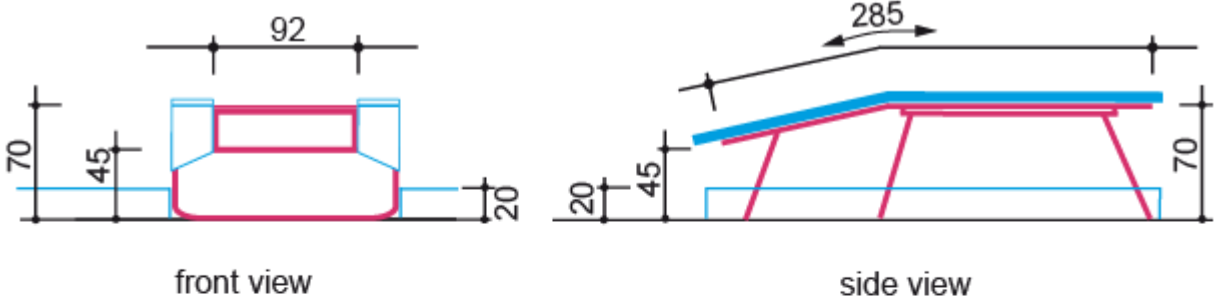

variants - detail profile of the frame

dimensions: mandatory,
 design: at your discretion;
 drawing: typical example

Double Mini-Trampoline

bed: Length and width measurements

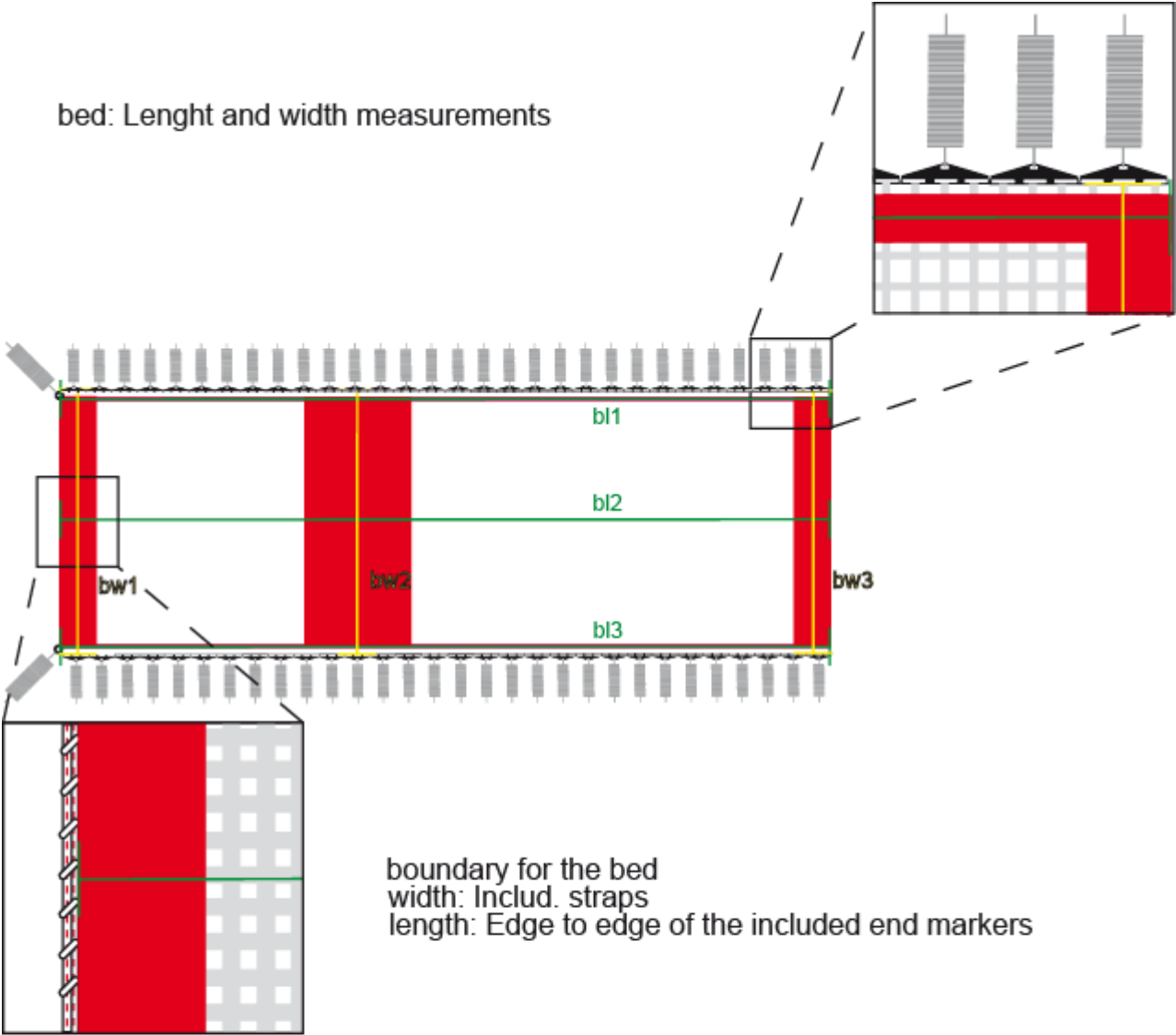

boundary for the bed
 width: Includ. straps
 length: Edge to edge of the included end markers

dimensions: mandatory,
 design: at your discretion;
 drawing: typical example

Double Mini-Trampoline

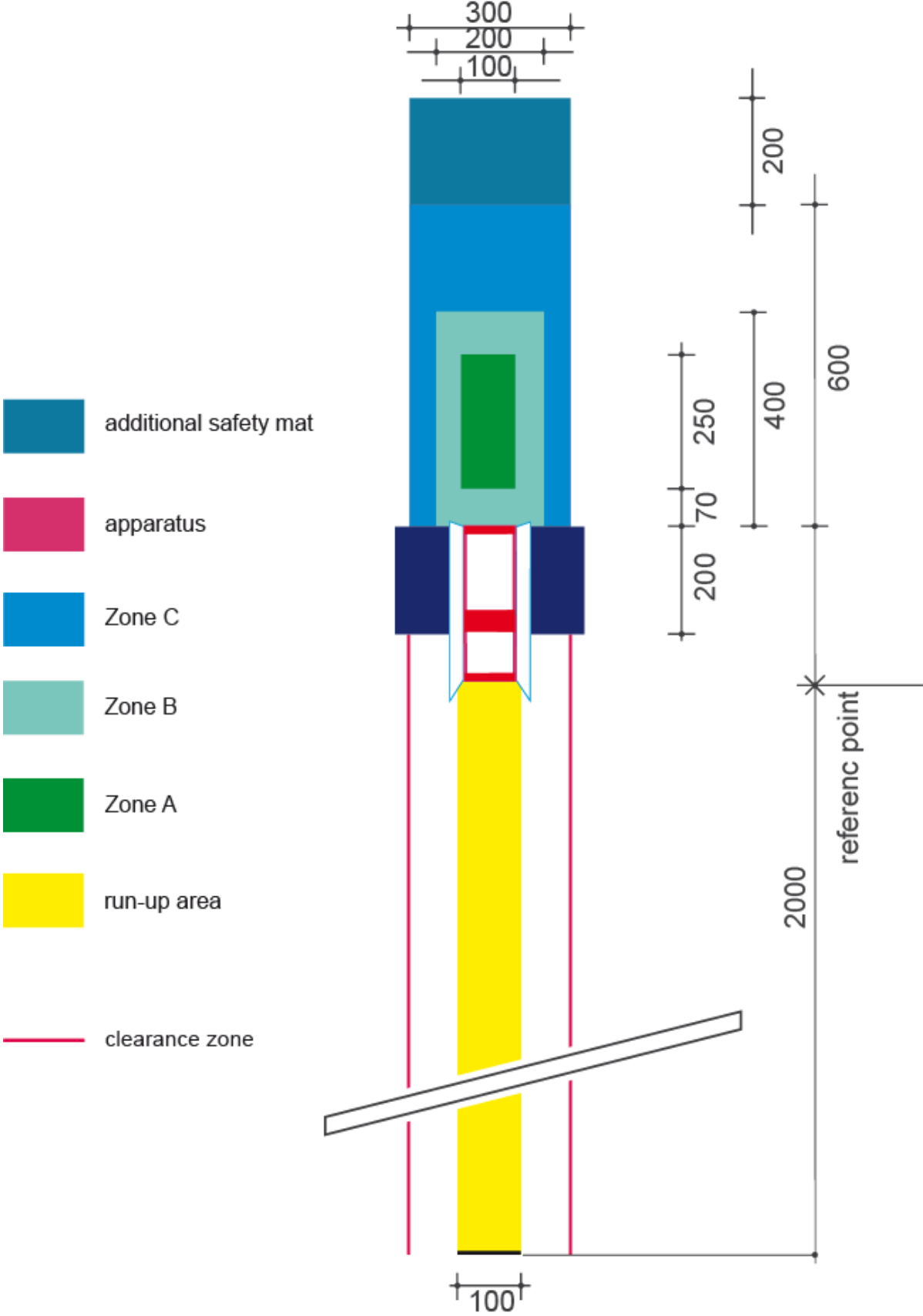

Tumbling track

1. Tumbling Track

1.1. The tumbling track must be constructed with a sprung surface, which must be padded. If constructed of several units these must be firmly fixed together as so not to separate in use and showing no space between them.

1.2. Dimension:

1.2.1.Length	2500 cm	+ 100 cm
1.2.2.Height	30 cm max (from 1.1.2012: ± 1 cm)	
1.2.3.Width of construction	200 cm	± 5 cm

1.3. Markings

1.3.1. Two lines, 50mm wide in a contrasting colour must mark the outer edge (boundary) of the track.

1.3.2. Distance (incl. lines): 150 cm +/- 1 cm

1.3.3. A centre line, 5 cm wide, in a contrasting colour, must mark the centre line of the tumbling track.

2. Landing Area

2.1. The landing area shall be covered with a landing mat (TRA17) which is shock absorbent, and which allows a stable landing on the feet. The height of the landing mat shall be equal to the height of the tumbling track.

2.2. Dimensions of the landing area must be:

2.2.1.Length (landing mat TRA 17)	600 cm +/- 1 cm
2.2.2.Width (landing mat TRA 17)	300 cm +/- 1 cm
2.2.3.Thickness (landing mat TRA 17)	30 cm +/- 1 cm

2.3. Additional safety mat behind the landing area

2.3.1. An additional safety mat with the minimum dimensions of 300 * 200 * 20 cm must be placed directly behind the landing area.

2.4. Landing Zone

2.4.1. A landing Zone must be marked out in the landing area, with either the whole zone in a contrasting colour or, with lines 50mm wide in a contrasting colour. The outer edge of the landing zone (or lines) marks the boundary of the landing zone, the dimensions of which must be:

2.4.1.1. Length	400 cm +/- 1 cm
2.4.1.2. Width	200 cm +/- 1 cm

2.4.1.3. A non-compulsory supplementary mat in the same dimension as the landing zone can be used (TRA13). In this case the supplementary mat must be attachable to the landing mat (i.e. using Velcro). The colour of the supplementary mat must be in contrast with the landing mat and the tumbling track or with lines according to the description above.

3. There must be a run up area (same level as tumbling track) prior to the tumbling track.

3.1. Dimensions:

3.1.1.Length	1000 cm+100 cm
3.1.2.Minimal width	100 cm

4. There must be a hard and a soft Vaulting Board available which meets the specifications of TRA 14.

Norms / Functional properties: Regarding tests carried out by FIG Tests Institutes – please see chapter IV

Tumbling track

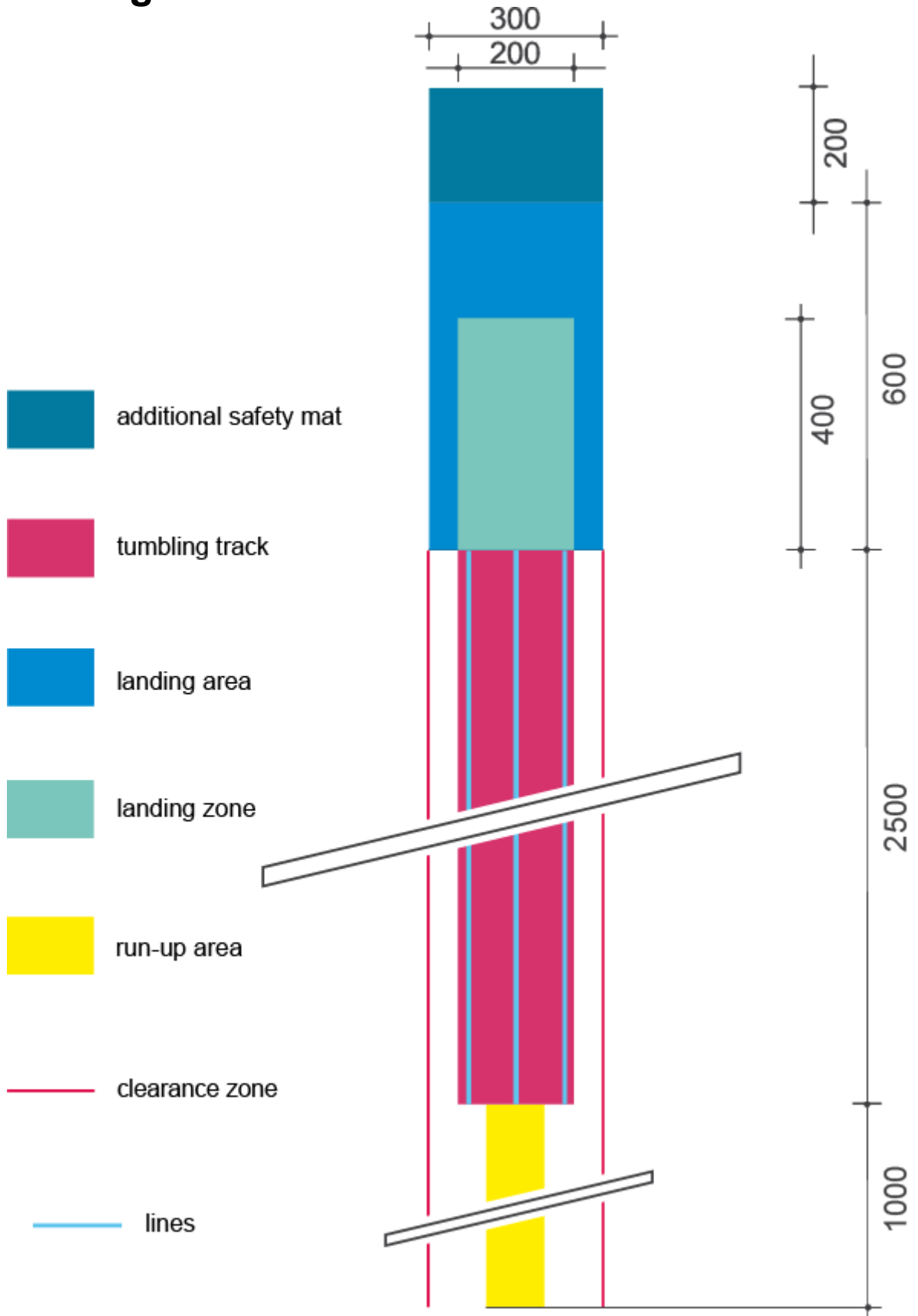

Safety mat (20 cm): Trampoline, Double Mini-Trampoline

Double Mini-Trampoline; Tumbling; Trampoline

Construction / Description of material, measurements

1. Form

- 1.1. The surface must be horizontal, even and without gaps. To arrange the whole area several mats can be composed.

2. Measurements

- 2.1. Height safety mat Trampoline; DMT (TRA1, TRA2): 20 cm +/- 1 cm

3. Functional properties

- 3.1. Absorbency:
 - 3.1.1. The mats must absorb motion energy, in order to reduce the reaction transmitted to the body of the landing gymnast, to a tolerable proportion.
 - 3.1.2. They must respond to increased penetration with an evenly increasing resistance.
- 3.2. Stability and Freedom of Movement:
 - 3.2.1. Absorbency of the mats must be balanced in order to guarantee standing, walking stability and freedom of movement; there must be an equal balance between elasticity and absorbency properties.
- 3.3. Indentations caused by the incidence of compressive forces must not encase the body parts, thereby hindering freedom of movements mainly of rolling a part of the body.
- 3.4. If a cover is used, such cover may not cause any hindering folds. The mats' upper surface material must offer a balance between anti-slip and slippage. It must be neither slippery nor possess inhibitory resistance.
- 3.5. By no means should mats be dislocated during performances. An anti-ski cover on the mats' underside may provide this condition.
- 3.6. The border zones of the mats which are pushed together should practically have the same functional properties as the remaining surface. Impacts on the border zones should not cause different indentations than on the remaining surface. For this purpose, and to bridge joints, continuous runners are permitted.

4. Colour

- 4.1. Preference should be given to uniform colours.
- 4.2. The upper surface must not show optically disturbing patterns or insignia.
- 4.3. The FIG may designate the colour for certain events.

Norms / Functional properties: Regarding tests carried out by FIG Tests Institutes – please see chapter IV

Spotter mat: Trampoline, Double Mini-Trampoline

Trampoline; Double Mini-Trampoline

Construction / Description of material, measurements

1. Form

- 1.1. Spotter mats must be covered with a material which will slide easily.
- 1.2. The mats must be provided with at least two handles or one long handle on the two long sides of the mat.

2. Measurements

- | | |
|----------------|----------------|
| 2.1. Length | 175 cm - 25 cm |
| 2.2. Width | 125 cm - 25 cm |
| 2.3. Thickness | 12 cm ± 2 cm |
| 2.4. Weight | 8,5 kg max |

3. Functional properties

- 3.1. The foam of the spotter mats shall have a density of 20 kg / m³ (+/-2 kg /m³). The ultimate tensile strength of the foam (ISO 1798: 2008) shall be ≥ 90 kPa, the compression stress value 40% shall be 2,5 (+/- 0.5) kPa (ISO 3386-1: 1986 – Amd1: 2010).

4. Colour

- 4.1. Preference should be given to uniform colours.
- 4.2. The upper surface must not show optically disturbing patterns or insignia.
- 4.3. The FIG may designate the colour for certain events

Supplementary mat: Tumbling

Tumbling

Construction / Description of material, measurements

1. Use

1.1. A supplementary mat must be available for the landing area in Tumbling. The usage is not compulsory.

2. Form

2.1. Their upper surface must be horizontal, even and without gaps. It shall have the size of the landing zone. The supplementary mat can be laid on the landing mats (TRA11), if used it must be attachable to the landing mat (i.e. using Velcro).

3. Measurements

3.1. Height of the supplementary mat:

10 cm * 1 cm

3.2. Surface:

400 x 200 cm * 1 cm
* Tolerance +/-

4. Functional properties

4.1. The foam of the supplementary mats shall have a density of 25 kg / m³ (+/- 2,5 kg /m³). The ultimate tensile strength of the foam (ISO 1798: 2008) shall be ≥ 115 kPa, the compression stress value 40% shall be 4,0 (+/- 1.0) kPa (ISO 3386-1: 1986 – Amd1: 2010).

4.2. Their upper surface must be horizontal, even and without gaps.

4.3. The supplementary mats have to be laid on the landing mats. The supplementary mat shall be attachable (i.e. using Velcro).

5. Colour

5.1. The colour of the supplementary mat must be in contrast to the landing mat and the tumbling track or with lines according to the description of the landing zone (see TRA3).

5.2. The upper surface must not show optically disturbing patterns or insignia.

5.3. The FIG may designate the colour for certain events

Vaulting Board - Tumbling

- “Hard” and “Soft”

II
TRA 14
01.01.2016

Construction / Description of material, measurements

1. Form

- 1.1. The profile of the vaulting board must adhere exactly to the respective blueprint.
- 1.2. Its upper surface rises in an arched form, approaching the horizontal between 75 cm and 95 cm, measured from the frontal angle. The height reached at this point, may not be exceeded. After this point, the upper surface may continue horizontally or slope downward.
- 1.3. The rise of the arch is 3.5 cm +/- 0,5 cm.
- 1.4. For competitions a “soft” and a “hard” vaulting board shall be available. The “hard” board shall be marked with a dot on the surface.

2. Measurements

- | | | |
|---|-----------|----------------|
| 2.1. Length | 120 cm | * 1 cm |
| 2.2. Width | 60 cm | * 1 cm |
| 2.3. Height | 20 cm | * 1 cm |
| 2.4. Height (run-up side) | max 3 cm | |
| 2.5. Cushion Cover | 2 cm | * 0,5 cm |
| 2.6. Total height with cushion cover | 22 cm | * 1,5 cm |
| 2.7. Free space between floor and the lower edge of the vaulting board at the run-up side | max. 1 cm | *Tolerance +/- |
| 2.8. The stipulated length and height refer to the vertical projection of the upper plate, i.e. the take-off plate. | | |
| 2.9. The base may be larger, but cannot extend more than 2 cm beyond the projection of the board. | | |
| 2.10. Labelling of the “hard” vaulting board on the surface by a dot with clear contrast on the longitudinal midline: | | |
| 2.10.1. Distance to the side of run up | 5 cm | |
| 2.10.2. Diameter | 8 cm | |

3. Functional properties

- 3.1. The functional properties of the vaulting board (hardness, damping, elasticity) shall not be adjustable (i.e. springs must be fixed so that they cannot be easily removed by hand).
- 3.2. The elasticity of the vaulting board must be most effective in the area between 75 cm and 95 cm, measured horizontally from the frontal angle.
- 3.3. The vaulting-board must dampen the counter pressure, i.e. reduce motion energy. Elasticity and absorbency must be evenly distributed, so that the effect of the vaulting board differs only slightly, regardless whether the force of the impact is at the middle axis, or away from it.
- 3.4. The upper surface of the vaulting board must offer slip resistance.
- 3.5. The vaulting board must not produce disturbing sounds during its use.
- 3.6. The board shall not slide at the time of impact of the athlete. This shall be achieved by anti-slip devices at the bottom side of the board or at the board underneath the vaulting board. The slip resistance shall be provided especially when the board bottoms out at the middle part.
- 3.7. The vaulting board and its base may not have any sharp corners, edges and no protruding parts. Mainly the upper and under edge of the upper part of the Vaulting board towards the apparatus side (Vaulting Table, Balance Beam of Uneven Bars) shall be cushioned and rounded.

4. Colour

- 4.1. The choice of colour is left to the discretion of the manufacturer.
- 4.2. With exception of the dot for “hard” vaulting boards optically disturbing patterns, stripes or insignia on the upper surface are not permitted.
- 4.3. The FIG may designate the colour for certain events.

Norms / Functional properties: Regarding tests carried out by FIG Tests Institutes – please see chapter IV



Vaulting Board

lowering variant

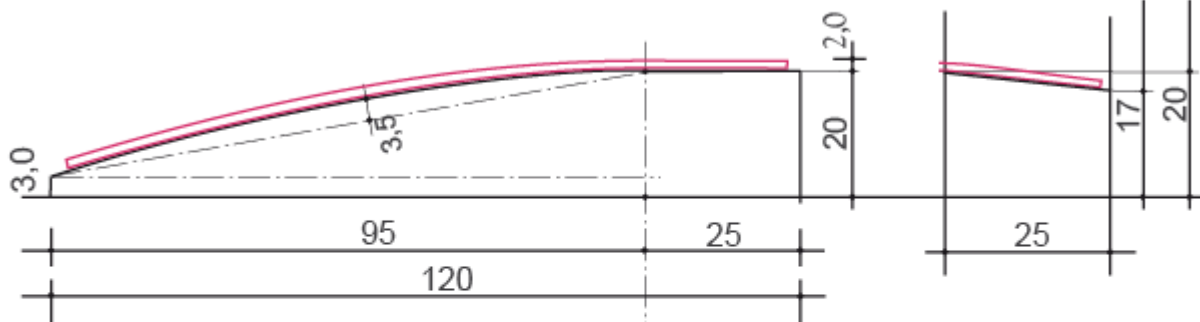

profile

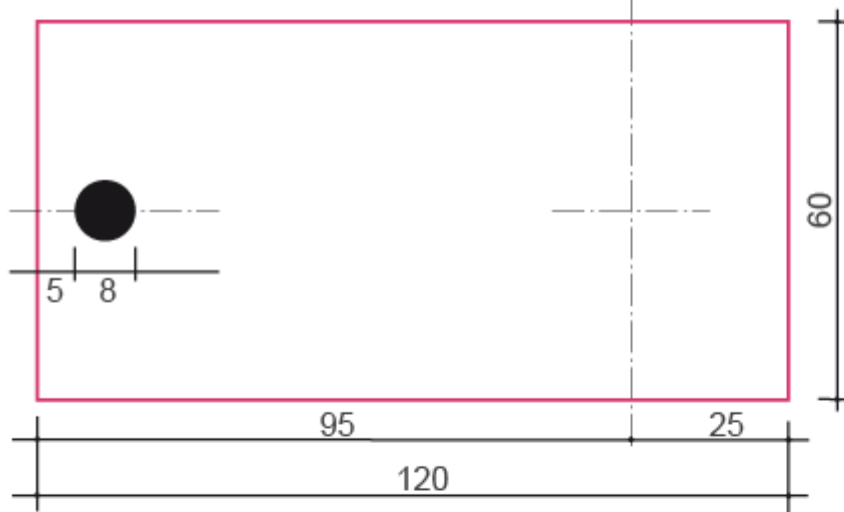

top view

mark for the hard board

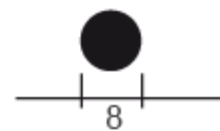

dimensions: mandatory;
design: at your discretion;
drawing: typical example

Time measurement device for trampoline competitions - TMD

II
TRA 15
01.01.2022

Trampoline – Device for judging individual and synchronized competitions

Construction / Description of material, measurements

1. General requirements

- 1.1. The device must be able to measure a sum of the flight times for the skills in individual competitions as well as deductions due to asynchronous landing in synchronized competitions.

2. Variants: Different measuring methods result in two variants of the TMD:

- 2.1. *Variant A:* Measurements up to 10 cm below the unloaded trampoline bed (e.g., through photoelectric barriers along defined measurement lines).
- 2.2. *Variant B:* Measurements relative to the unloaded surface of the trampoline bed. This variant can be used, for example, in combination with other measuring devices (HDMD - TRA 16).

3. General functions

- 3.1. Mode for individual competitions: The device is installed at the trampoline which is used for the competition. It has to be administrated by a specialized judge. After a “Start” during the flight phase of the first element the device shall register all time intervals between take-offs and the landings of the gymnast (flight times) including the flight time of the first element. At the end of the routine the device has to calculate, to indicate and to memorize the flight times of the elements as well as their sum (up to 10 skills).
- 3.2. Mode for synchronized competitions: The device is installed at the two trampolines which are used for the competition. It has to be administrated by a specialized judge who is responsible for the evaluation of the score of synchronization (S). After a “Start” during the flight phase of the first element the device shall register all time intervals between the landings of the gymnasts. After the end of the routine the device has to calculate, to indicate and to memorize the deductions for each skill and the total score for synchronization according to a conversion ratio between time intervals and deductions (TRA Code of Points).

4. Definitions

4.1. *Valid for TMD Variant A*

- 4.1.1. Measurement Lines for Time of Flight and Synchronization Evaluation: At least three parallel lines along the longitudinal side of the trampoline’s bed. The lines are arranged ≤ 100 mm below the underside of the unloaded bed installed at a trampoline which is ready for use. One line (center line) shall be exactly below the longitudinal middle axis of the jumping zone and at least two others are running in a distance of $540 (\pm 5)$ mm to the center of the bed directly below the lateral boundaries of the jumping zone (see drawing).
- 4.1.2. Starting point of the flight phase: The point in time of the release of the gymnast from all Measurement Lines by taking off from the trampoline’s bed. At that time a measurable signal for the TMD shall be provoked.
- 4.1.3. Ending point of the flight phase: The point in time of the first contact of the gymnast with at least one of the Measurement Lines by impacting the trampoline’s bed. At that time a measurable signal for the TMD shall be provoked.

4.2. *Valid for TMD Variant B*

- 4.2.1. Measurement Plane for Time of Flight and Synchronization Evaluation: The surface of the unloaded trampoline’s bed.
- 4.2.2. Starting point of the flight phase: The point in time of the release of the gymnast from the Measurement Plane by taking off to a flight phase.
- 4.2.3. Ending point of the flight phase: The point in time of the first contact of the gymnast with the Measurement Plane after a flight phase.

4.3. Valid for TMD variants A and B

4.4.

- 4.4.1. Time of Flight: Time interval during the flight phase of a jump between a *Starting point of the flight phase* and a succeeding *Ending point of the flight phase*, expressed in seconds rounded down to the next lower multiple of 0,005 s. (e.g.: All values less than 0.005 s are rounded to 0.000 s, all values equal or higher than 0.005 s and less than 0.01 s are rounded to 0.005 s).
- 4.4.2. Time of Flight Score (T-Score): Sum of all measured Time of Flights during an exercise of an individual competition beginning with the first skill, rounded down to 1/100 seconds, expressed in points.
- 4.4.3. Time Difference in Landing: Time interval at the landing after the same synchronous jump between the *Ending point of the flight phase* of the first athlete and the *Ending point of the flight phase* of the second athlete, expressed in seconds rounded down to the next lower multiple of 0,005 s (e.g.: All values less than 0.005 s are rounded to 0.000 s, all values equal or higher than 0.005 s and less than 0.01 s are rounded to 0.005 s).
- 4.4.4. Start: The point in time fixed by a switch-key to be pressed by a specialized judge during the flight phase of the first element; from this time on the TMD records signals at landings of the athlete on the trampolines bed. For individual competitions the device must remember the preceding *Starting point of the flight phase* to register the Time of Flight of the first element.
- 4.4.5. Stop: The point in time fixed by a switch-key to be pressed by a specialized judge, from this time on the TMD no longer takes any further measurements into account for determining the deductions.
- 4.4.6. Deduction for unsynchronized Landing: Deduction in points for the synchronization of each element according to a conversion from the Time Difference in Landing according to the TRA Code of Points.

Example 1: Table with examples to determine the Deduction for an unsynchronized Landing with a factor of 2.5, rounded down to 1/100 and a special treatment () (**) for more than 0,4 s (TRA Code if points):*

<i>Time difference in landing (s) – rounded down to next 5/1000s</i>	<i>Deduction (pts)</i>
0,010	0,02 pts
0,025	0,06 pts
0,075	0,18 pts
0,125	0,31 pts
0,175	0,43 pts
0,215	0,53 pts
0,355	0,88 pts
(*) if $0,4 \leq x < 0,5$ then $x := 0,4$ s and deduction := 1,00 pts	
(**) if $x \geq 0,5$ routine should be stopped	

- 4.4.7. Sum of Deduction for synchronized competitions: The time differences in landing (rounded down to next 5/1000s) should be accumulated after each landing, multiplied by 2,5 and then rounded down to the next 1/100 pts to give a Sum of Deduction for all previous skills.
- 4.4.8. Synchronization Score: The Synchronization Score should be shown as maximum 10,0 pts minus the Sum of deductions in case of 10 skills (see example 2). Otherwise, the maximum score equals the number of the counted skills (for example 5,0 pts for 5 skills). The device shall automatically detect how many skills were performed synchronously and stop judging if the time difference in landing is equal or exceeds 0,5 seconds.

Example 2: Calculation for the Sum of deduction and the Synchronization Score for a full exercise with 10 skills.

	Time differences in landing (s) (rounded down to next 5/1000 s)	Accumulated time difference (s)	Calculated Sum of Deduction (pts)
1 st skill	x:= 0,015	0,015	0,0375 → 0,03 pts
2 nd skill	x:= 0,035	0,050	0,1250 → 0,12 pts
3 rd skill	x:= 0,120	0,170	0,4250 → 0,42 pts
4 th skill	x:= 0,295	0,465	1,1625 → 1,16 pts
5 th skill	x:= 0,430	0,865	2,1625 → 2,16 pts
6 th skill	x:= 0,030	0,895	2,2375 → 2,23 pts
7 th skill	x:= 0,005	0,900	2,2500 → 2,25 pts
8 th skill	x:= 0,115	1,015	2,5375 → 2,53 pts
9 th skill	x:= 0,005	1,020	2,5500 → 2,55 pts
10 th skill	x:= 0,010	1,030	2,5750 → 2,57 pts
Synchronization Score :=			7,43 pts

5. Flowcharts for internal calculations:

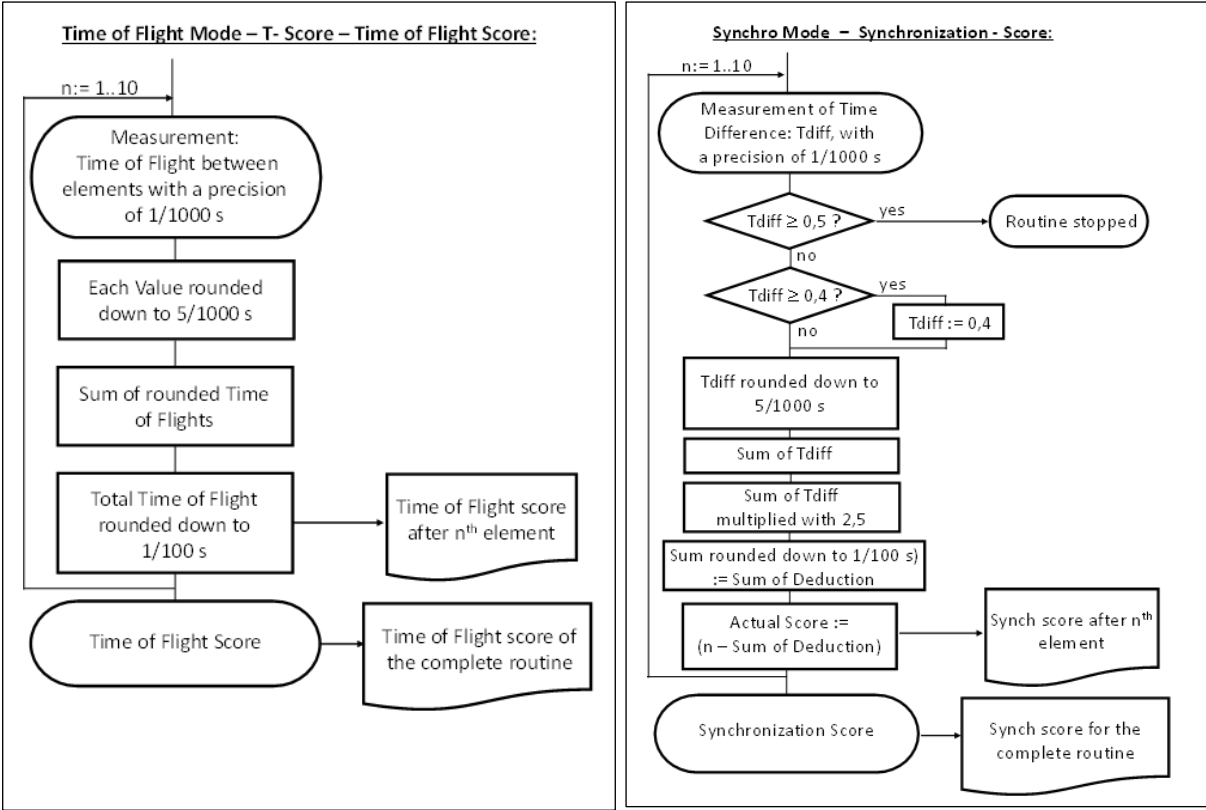

6. Specific requirements

- 6.1. The device shall not interfere with the performance of the athletes, nor shall it provoke any restriction of the functional properties of the trampoline.
- 6.2. The detectors for the Starting and Ending Points of the flight phases shall be installable at any standardized trampoline. The fixation shall be below the apparatus (trampoline with padding and safety platform) with no protruding parts. If there are cable connections, they must be long enough to reach the displacement specifications given for the "Arena for Trampoline Competitions" (see: Part II 4. Competition area; TRA). All other components of the device shall be out of the area of the safety mats on the ground.
- 6.3. If emitters of sound, light or radio waves are used, they shall not harm participants, judges, spectators or other staff.
- 6.4. If the device needs external power, it must be provided with backup power, providing a battery life for at least 5 minutes after disconnecting the external power source.

- 6.5. The system must provide time measurements with an error lower than $\pm 0,005$ s.
- 6.6. The TMD shall come with an English written documentation containing a user's guide and all necessary technical descriptions.

7. Technical features

- 7.1. The control device or the control of the computer-program shall contain a set of switches, indicators and components with the following features:
- 7.1.1. SELECT MODE – individual or synchronized competition
- 7.1.2. RESET – Preparation for a new measurement
- 7.1.3. START – start the measurement of an exercise, indicated by a sound
- 7.1.4. STOP – stop the measurement of an exercise
- 7.1.5. VIEW – MODE – with the following possibilities:
- 7.1.5.1. Synchronized competition mode: Selection for each skill (from 1 to 10) with the calculated deductions for unsynchronized landing as well as the Synchronization Score for the whole exercise.
- 7.1.5.2. Individual competition mode: Selection for each skill (from 1 to 10) with the registered Times of Flight as well as the Time of Flight Score for the whole exercise.
- 7.1.6. Possibilities for a manual change of the Preliminary Synchronization Score with an increment of 0,2 points.
- 7.1.7. Components to ensure proper function of the sensors.
- 7.1.8. Components to indicate proper function of the power supply.
- 7.1.9. All data collected by the device shall be transferable to a personal computer using a standard method of data transmission (USB, Firewire etc.).
- 7.1.10. Software to memorize and print all data on a personal computer with the following details:
- 7.1.10.1. Time Differences in Landing and corresponding Deductions for unsynchronized Landing for all skills (from 1 to 10) as well as the Total Synchronization Score for the whole exercise for synchronized competitions.
- 7.1.10.2. Times of Flight for all skills (from 1 to 10) as well as the Time of Flight Score for the whole exercise for individual competitions.

8. Procedures for approval

- 8.1. The approval of a TMD shall include the following steps (according to FIG Apparatus Norms Part III, clause 4):
- 8.1.1. Valid for TMD Variant A
- 8.1.1.1. Presentation at a testing institute (forwarding a full technical documentation written in English and the complete equipment, if necessary, with a special adapter according to: FIG Apparatus Norms Part IV TRA15 - TMD)
- 8.1.2. Valid for TMD Variant B
- 8.1.2.1. Documented report by a TC member ordered by the FIG-TC-TRA-President about the functional status during a FIG competition. The testing procedure should consist of a video recording of at least 10 routines each of an individual and a synchronized FIG sanctioned Trampoline competition (selected by the FIG Secretary General). The video recording to evaluate Time of Flight Score and Synchro Deductions should be done with at least 400 fps and resolution at least 720p. This confirmation must include in particular the check of all calculation steps required by the TRA Code of Points. The maximum deviation of the results of the device and the video analysis may not exceed 0.2 points per exercise.
- 8.1.3. Confirmation by a member federation of the FIG.
- 8.2. With successful fulfilment of all procedures the certification shall be given by the General Secretary

Norms / Functional properties: Regarding tests carried out by FIG Tests Institutes – please see chapter IV

Horizontal Displacement Measurement Device for Trampoline competitions - HDMD

Trampoline – Device for judging individual and synchronized competitions

Construction / Description of material

1. General requirements

- 1.1. The device must be able to determine the place of landing of the gymnast(s) to the trampolines bed. The device must evaluate the place of landing in individual and synchronized competitions in scores depending on the zone of landing at the trampoline's bed according to the TRA Code of Points. The proper functioning of the device must be ensured for all certified trampolines at the time of the test of the device (especially in the case of constructional differences, e.g. in the base frames)

2. General functions

- 2.1. Mode for individual competitions:
 - 2.1.1. The device has to be administrated by a specialized judge.
 - 2.1.2. After a "Start" during the flight phase of the first element the device shall register all horizontal displacements of the landings at bed contact for every skill and the complete routine (from 1st to 10th skill).
 - 2.1.3. Subsequently the device must determine deductions according to the TRA Code of Points for each skill and for the complete routine.
- 2.2. Mode for synchronized competitions:
 - 2.2.1. The device must be administrated by a specialized judge who is responsible for the evaluation of the score of synchronization (S).
 - 2.2.2. After a "Start" during the flight phase of the first element, the device shall register each trampoline equivalent to the recording during an individual competition.
 - 2.2.3. After the end of the routine, the device must calculate, to indicate and to memorize the deductions for each skill and the total score separately for each trampoline and the synchronized routine according to the specifications of the TRA Code of Points.

3. Definitions

- 3.1. Horizontal Displacement at bed contact: Depending on the measurement technology used there are two variants:
 - 3.1.1. Area measurement: Set of all contact points between athlete's body and the trampoline's bed determined 20 ms after first contact. The contact points must be given in a resolution of 1 cm and represented in coordinates.
 - 3.1.2. Point measurement: Horizontal coordinates of the Center of Pressure at the bed contact during landing after a skill. The center of pressure is defined as intersection of a vector representing the direction of the movement of the athlete's center of mass and the bed of the trampoline. The values shall be expressed as xy – coordinates in cm for a horizontal Cartesian coordinate system with the center of the bed as origin.
- 3.2. Start: The point in time fixed by a switch-key (Judge) which must be pressed during the flight phase of the first element; from this point in time forward the HDMD records signals at landings of the athlete on the trampoline's bed.
- 3.3. Stop: The point in time fixed by a switch-key (Judge), from this point in time forward the HDMD records no more signals at landings of the athlete on the trampoline's bed.
- 3.4. Horizontal Displacement Score: A value determined according to the TRA Code of Points.

4. Specific Requirements

- 4.1. The device shall not interfere with the performance of the athletes, nor shall it provoke any restriction of the functional properties of the trampoline.
- 4.2. The detectors for measurements shall be installable at any certified trampolines at the time of the test of the device. If necessary, for competitions, appropriate adapters (or other technical solutions) must be available. The construction of the device shall not interfere with the specifications for trampolines in Part 2 (i.e. mats, padding, safety platforms etc.). If the height of the trampoline changes due to the use of the device, a tolerance of +4cm applies. If there are cable connections, they must be long enough to reach the distance specifications given for the "Arena for Trampoline Competitions" (see Part II; TRA; P 115). All other components of the device shall be out of the area of the safety mats on the ground.
- 4.3. The functionality of the device must be ensured at any time of the competition. Especially vibrations or sliding of the trampoline's feet shall not lead to dysfunctions.
- 4.4. If emitters of radio waves are used, they shall not have a capacity of more than 0,01 watts in a frequency range of 27 megahertz and above.
- 4.5. If the device needs external power, it must be provided with backup power, providing a battery life for at least 5 minutes after disconnecting the external power source.
- 4.6. When tested according to PART 4 TRA16 the system must provide horizontal displacement measurements with an error lower than ± 10 cm.
- 4.7. The HDMD shall come with an English written documentation containing a user's guide and all necessary technical descriptions (including detailed calibration and installation procedures).
- 4.8. The device shall be delivered with a dedicated procedure to ensure the proper functionality after installation and calibration of the system. This procedure must be done and documented by a nominated FIG representative (specialized judge, TRA TC member, FIG Apparatus Commissioner etc.) prior to the competition.
- 4.9. The supplier of a device is free to choose the method of the measurement of the trampoline competitions parameters as long as all specifications are fulfilled.

5. Technical features

- 5.1. The control device shall contain a set of buttons, indicators and components with the following features:
 - 5.1.1. SELECT MODE – individual or synchronized competition / selection of trampoline (if there is no automatic detection available)
 - 5.1.2. START – start the measurement of an exercise, indicated by a sound
 - 5.1.3. STOP – stop the measurement of an exercise
 - 5.1.4. VIEW – MODE – with the following possibilities:
 - 5.1.4.1. *Individual competition mode*: Selection for each skill (from 1 to 10) with the registered horizontal displacements, deductions and the total score for the whole exercise.
 - 5.1.4.2. *Synchronized competition mode*: Selection for each skill (from 1 to 10) with the registered horizontal displacements, deductions for both trampolines and the total score for both exercises (according to the TRA Code of Points)
- 5.2. Possibility to adjust the size of the zones to the real dimensions (measured on site every day before the competition).
- 5.3. A graphical presentation of the trampoline bed(s) and the Horizontal Displacement at the bed contacts of landing for each skill.
- 5.4. Components to ensure proper function of the sensors.
- 5.5. Components to indicate proper function of the power supply.
- 5.6. Connection devices and software to transfer all data to a personal computer. The data shall be available in a standard data format (i.e.csv, pdf, etc.).
- 5.7. Software to memorize and print all data on a personal computer for each skill and the complete exercises.
- 5.8. If specific reference points or lines at the sensors are essential for the calibration process, they shall be indicated unmistakably at the devices.

6. Procedures for approval

- 6.1. The approval of a HDMD shall meet the following requirements (according to FIG Apparatus Norms Part III, clause 4):
 - 6.1.1. Presentation at a testing institute (forwarding a full technical documentation written in English and the complete equipment, if necessary, with a special adapter according to: FIG Apparatus Part IV, TRA16 - HDMD)
 - 6.1.2. Confirmation by a TC member ordered by FIG-TC-TRA-President about the functional status during a FIG competition. This confirmation must include in particular the check of all calculation steps required by the TRA Code of Points.
 - 6.1.3. Confirmation by a member federation of the FIG.
- 6.2. With successful fulfilment of all procedures the certification shall be given by the General Secretary.

Norms / Functional properties: Regarding tests carried out by FIG Tests Institutes – please see chapter IV

Landing mat (30 cm): Double Mini-Trampoline + Tumbling

Construction / Description of material, measurements

1. Form

- 1.1. Their upper surface must be horizontal, even and without gaps.
- 1.2. Specially designed mats must be used to cover the basis of the apparatus evenly

2. Measurements

- 2.1. Height of the landing mats DMT, TUM): 30 cm±1 cm

3. Functional properties

- 3.1. Absorbency:
 - 3.1.1. Mats must absorb motion energy in order to reduce the reaction transmitted to the body of the landing gymnast to a tolerable proportion.
 - 3.1.2. They must respond to increased penetration with an evenly increasing resistance.
- 3.2. Stability and Freedom of Movement:
 - 3.2.1. Absorbency of the mats must be balanced in order to guarantee standing, walking stability and freedom of movement.
- 3.3. Indentations caused by the incidence of compressive forces must not encase the body parts, thereby hindering freedom of movements. They may not be too deep or narrow.
- 3.4. If a cover is used, such cover may not plaid and create hindering folds. The mats' upper surface material must offer a balance between anti-slip and slippage. It should be neither slippery nor possess inhibiting resistance.
- 3.5. By no means should mats be dislocated during performances. An anti-skid cover on the mats' underside may provide this condition.
- 3.6. The border zones of the mats which are pushed together should practically have the same functional properties as the remaining surface. Impacts on the border zones should not cause different indentations than on the remaining surface. For this purpose, and to bridge joints, continuous runners are permitted.

4. Colour

- 4.1. Preference should be given to uniform colours.
- 4.2. The upper surface must not show optically disturbing patterns or insignia.
- 4.3. The FIG may designate the colour for certain events

Norms / Functional properties: Regarding tests carried out by FIG Tests Institutes – please see chapter IV



2.5 ACRO Acrobatic Gymnastics

ACRO 1 Floor	118
ACRO 11 Landing Mat	120



Floor

Acrobatic Gymnastics

Construction / Description of material, measurements

1. Form

- 1.1. The Performance Area shall have a square format. The surface must be horizontal, even and without gaps. All plates of the under construction within the Performance Area shall have the same arrangement of elastic elements.
- 1.2. All elements of the floor have to be connected firmly to prevent slipping.
- 1.3. Edge: Horizontal and even, at the same height as the Performance area
- 1.4. Edge's variant: Width 50 cm, horizontal and even, at the same height as the Performance area, additional 50 cm inclination edge, slope may not exceed 25 %.
- 1.5. Clearance zone: The clearance zone shall be kept totally free as a surrounding zone around the performance area and the edge. It shall be horizontal, even and without gaps. (See Definition: II, chapter 3. Surfaces of apparatus, clearance zones, total surfaces)

2. Measurements

- | | | |
|--|----------------------------|--------------------|
| 2.1. Performance area | 1200 cm x 1200 cm | Tolerance +/- 3 cm |
| 2.2. Diagonals of the performance area: | 1697 cm +/- 5cm | |
| 2.3. Edge | 100 cm, min. | |
| 2.4. Edge as a variant | | |
| 2.4.1. Horizontal Area, Width | 50 cm, min. | |
| 2.4.2. Slope max. 25 %, Width | 50 cm, min. | |
| 2.4.3. Height of outer edge at the very end | 3,5 cm, max. | |
| 2.5. When there is a delimitation strip between the Performance area and the edge: | | |
| 2.5.1. Delimitation strip width | 5 cm, Tolerance +/- 0,5 cm | |
| 2.6. The delimitation strip is part of the Performance area. | | |

3. Functional Properties of the performance area and edge

- 3.1. Equal elasticity on the surface as well as dampening.
- 3.2. When in use it should not have any hindering motion energy
- 3.3. Elasticity and dampening must be balanced in such a way that they guarantee the gymnast stability and freedom of movement. It must not restrict turns and slide movements.
- 3.4. The surface cover of the Performance area must provide a balance between anti-skid and slippage. It must not cause skin burns.
- 3.5. The floor must not produce disturbing sound during the execution of an exercise. It must assure a low noise level.

4. **Of plain colour** which choice is left to the manufacturer's discretion. Dark colours are not allowed. For certain events the FIG may stipulate the colours. The delimitation shall have a clear contrast to the performance area.

Norms / Functional properties: Regarding tests carried out by FIG Tests Institutes – please see chapter IV

Floor

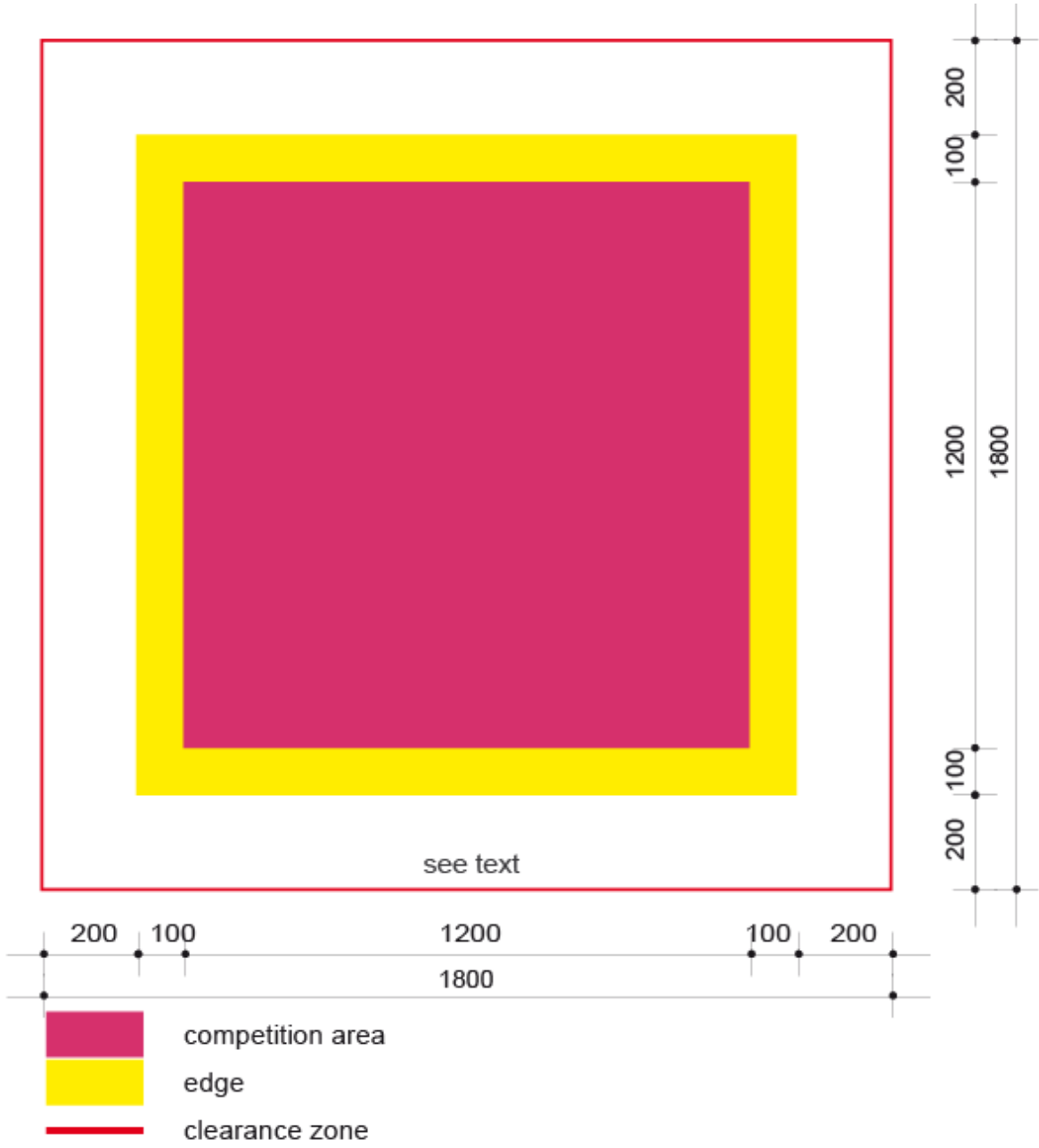

profile - variants A, B, C

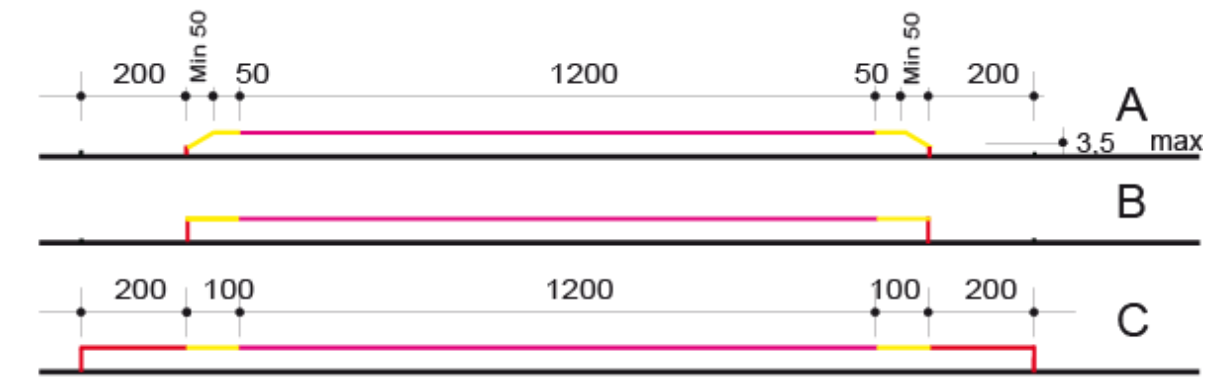

Landing Mat

Acrobatic Gymnastics

Construction / Description of material, measurements

1. Use

1.1. For landing a mat shall be available. The use is not compulsory.

2. Form and functional properties

2.1. The functional properties of the landing mat must be identical to those of the landing mats MAG 11 and WAG 11.

3. Measurements

3.1. The minimum size of the landing mat is 200 cm x 150 cm x 20 cm





2.6 AER Aerobic Gymnastics



AER 1 Performance area	124
AER 2 Aerobic Step	126



Performance area

Aerobics Gymnastics

Construction / Description of material, measurements

1. Form

- 1.1. The Performance Area shall have a square format. The surface must be horizontal, even and without gaps. Under load there shall not occur steps at the border of the plates.
- 1.2. Edge:
- 1.3. Horizontal and even, at the same height as the performance area
- 1.4. Clearance zone:
 - 1.4.1. The clearance zone shall be kept totally free as a surrounding zone around the performance area and the edge. It shall be horizontal, even and without gaps. (See Definition: II, chapter 3. Surfaces of apparatus, clearance zones, total surfaces)
- 1.5. Delimitation strip:
 - 1.5.1. The competition area shall be surrounded by a black delimitation strip.
 - 1.5.2. The delimitation strip is part of the performance area.

2. Measurements

- 2.1. Performance area: 1000 cm x 1000 cm
Tolerance +/- 3 cm
- 2.2. Diagonals of the performance area: 1414 cm +/- 5cm
- 2.3. Width of the black delimitation strip 5 cm,
Tolerance +/- 0,5 cm
- 2.4. Edge 100 cm
- 2.5. Clearance zone 100 cm

3. Material

- 3.1. Parquet flooring – laminate or synthetics

4. Functional properties

- 4.1. Performance area and edge:
 - 4.1.1. Equal elasticity and dampening.
 - 4.1.2. When in use no unrequested counter movements shall occur.
 - 4.1.3. Elasticity and dampening must be balanced in such a way that they guarantee the gymnast stability and freedom of movement. It must not restrict turns and slide movements.
 - 4.1.4. The surface cover of the Performance area must provide a balance between anti-skid and slippage. It must not cause skin burns.
 - 4.1.5. The floor must not produce disturbing sound during the execution of an exercise. It must assure a low noise level.

5. Colour and gloss

- 5.1. Of plain colour, not shiny. The choice is left to the manufacturer's discretion. Dark colours are not allowed.
- 5.2. Gloss – measurements according to International Standards (ISO 2813; ASTM D 523; DIN 67530) with a standardized reflectometer at an angle of illumination of 85° shall show gloss values of R'85 ≤ 30 GU and may also not be shiny under competition conditions. (For detailed description of the reflectometer procedure see: Part IV AER1)
- 5.3. The competition area shall be surrounded by a black delimitation strip.

Norms / Functional properties: Regarding tests carried out by FIG Tests Institutes – please see chapter IV

Performance area

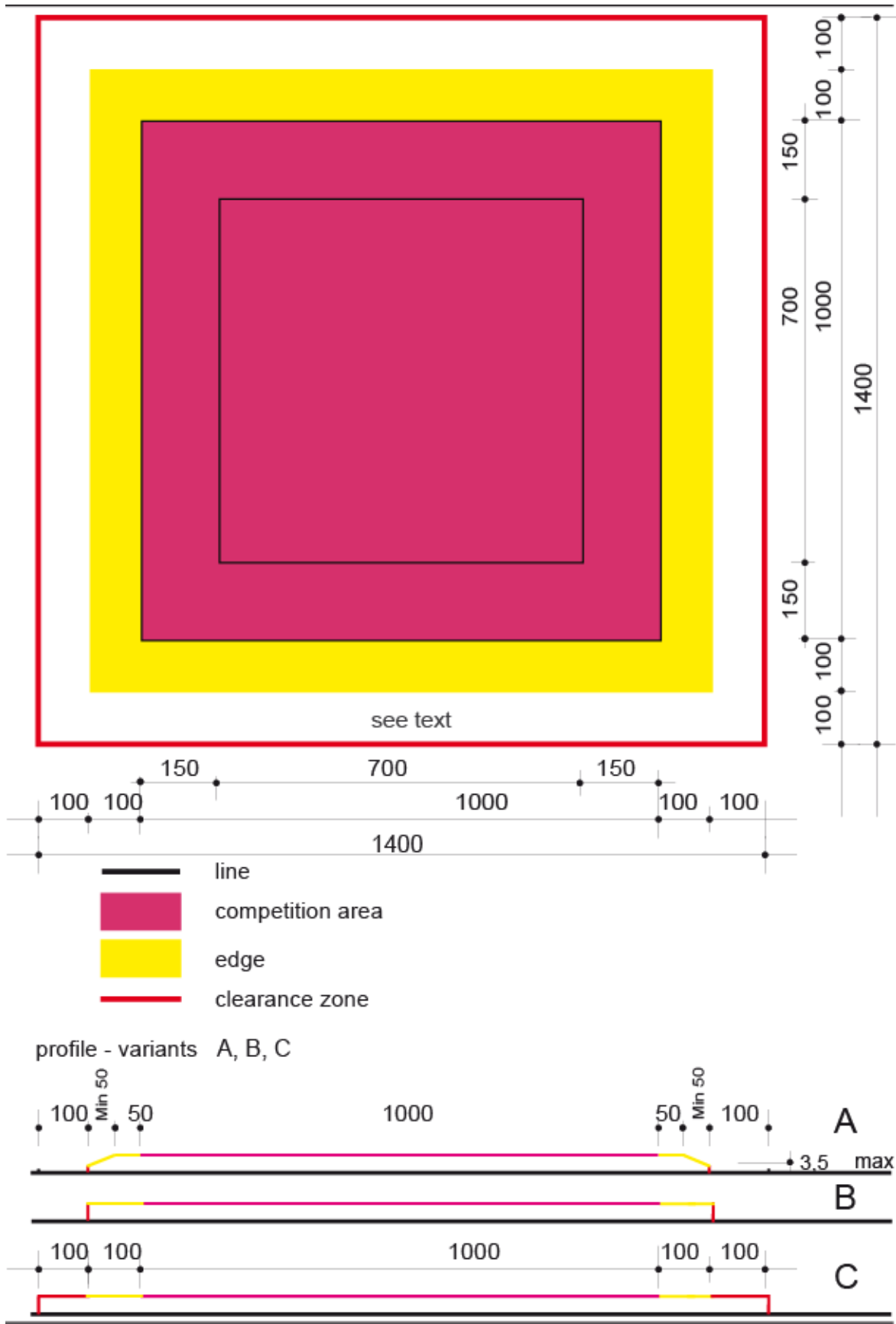

Aerobic Step

Aerobics Gymnastics

Construction / Description of material, measurements

1. Form

- 1.1. The surface of the Step must be horizontal and not slippery. It can be covered by an anti-slip layer. To avoid injuries the Step shall not exhibit any sharp corners or edges that could be reached during regular use in a competition.

2. Measurements

- | | |
|--|------------------|
| 2.1. Height of the Step | 150 mm +/- 10 mm |
| 2.2. Length of the horizontal upper part of the surface: | 885 mm +/- 15 mm |
| 2.3. Width of the horizontal upper part of the surface: | 275 mm +/- 10 mm |
| 2.4. Length of the Step at the base: | 970 mm +/- 10 mm |
| 2.5. Width of the Step at the base: | 370 mm +/- 10 mm |
| 2.6. Mass of the Step: | ≥ 5,0 kg |

3. Material

- 3.1. Body of the Step: Plastics or other synthetic material
 3.2. Anti-slip covering: Plastics or other synthetic material
 3.3. The body and the anti-slip covering do not have to be of the same material.

4. Functional properties

- 4.1. The surface of the Step must provide a sufficient slip resistance when it is used under competition conditions (with sneakers).
 4.2. The contact area between Step and floor must provide a sufficient slip resistance.
 4.3. The Step must not produce disturbing sound during the execution of an exercise. It must assure a low noise level.
 4.4. The support must not be separable from the body of step.
 4.5. The contact area between the Step and the floor must be such, that the Aerobic Floor is not damaged with scratches

Norms / Functional properties: Regarding tests carried out by FIG Tests Institutes – please see chapter IV

Aerobic Step

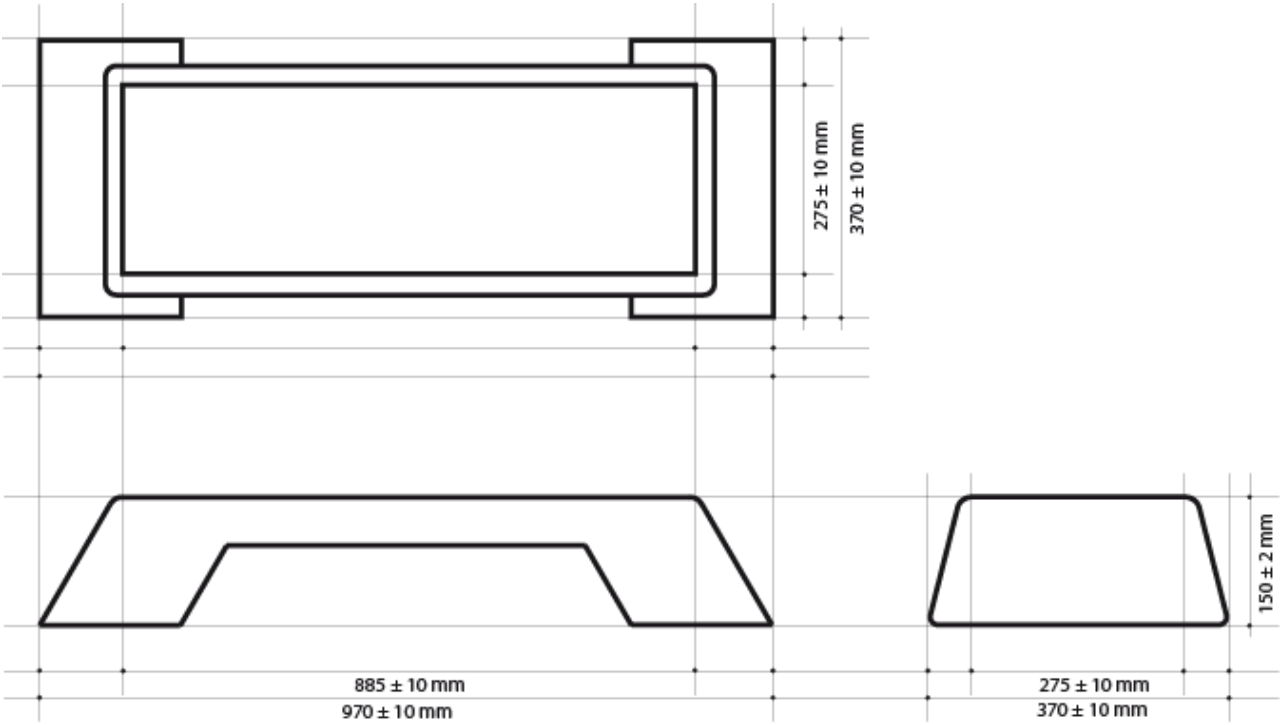



2.7 PK Parkour



PK 1 Track	130
PK 2 Obstacles.....	133
PK 3 Scaffolding	138



Track

Parkour

Construction / Description of material, measurements

1. Form

- 1.1. The track provides the base to install a course for Parkour. The course is a combination of different obstacles that shall provide at least 8 different heights of body support and up to 2 scaffolding structures. In addition to the course an obstacle or scaffolding structure can be installed for start and finish.
- 1.2. The competition track can either be set up on ground level (Type A) or on a podium (Type B).
- 1.3. The shape of the track is usually rectangular but can also take other shapes depending on special requirements or restrictions.
- 1.4. Depending on whether and how Speed Run is part of the competition, the track has to provide different conditions:
- 1.5. If the Speed Run is organized as a parallel competition between several athletes, the following requirements apply:
 - 1.5.1. *For the rectangular shape*, the track is composed of at least five parts for one on one: two competition lanes and three clearance zones (in case of more than two parallel starters it has to be extended accordingly). The clearance zones are placed on the left and right side of the track and between the competition lanes. The placement of the competition lanes and clearance zones can vary depending on the basic shape of the track.
 - 1.5.2. Irrespective of the form, the track must guarantee all competitors the same running distance and the equivalent course.
- 1.6. Deviations from the requirements mentioned in this standard may be accepted under certain circumstances. Above all, this is conceivable regarding to the integration of natural (rocks, trees, ...) or urban (benches, stairs, ramps, ...) structures into the competition. Any solution that goes in this direction is the subject of a case-by-case decision that must be made by and in close consultation with the FIG.

2. Measurements

- 2.1. At least one of the following two requirements (1 and / or 2) shall be met:

2.1.1. Minimum Length	40 m
Minimum Width	10 m
2.1.2. Minimum space requirement	400 m ²
- 2.2. Height

2.2.1. Type A	ground level
2.2.2. Type B	800 mm ± 200

Track

3. If a boundary strip is used to mark the transition between competition lane and clearance zone and/or start and finish:

- 3.1.** Delimitation strip width 50 mm ± 5
The delimitation strips are not part of the competition lanes.

4. Functional properties

- 4.1.** For Type B the surfaces of the track shall not be too slippery and not overly abrasive whether dry or wet.
- 4.2.** Changes in the functional properties due to extreme temperatures or other weather influences must be kept as low as possible by suitable measures (coatings, organisational (e.g. tents, roofing), ...).
- 4.3.** Podiums (only Type B) and Anchors must meet the FIG “Requirements for Podiums and Anchors” (see Apparatus Norms Part 2, 4 competition area, requirements for podiums and anchors).

5. The colour is to the free choice of the manufacturer except for the following requirements:

- 5.1.** Unicoloured
- 5.2.** There must be a distinctive contrast between the colour of the obstacle and the competition track.
- 5.3.** For certain events, the FIG can specify the colour.
- 5.4.** The start line, finish line and the outer edges of the competition lanes and clearance zones must be marked in a contrasting colour.

Track

Parkour

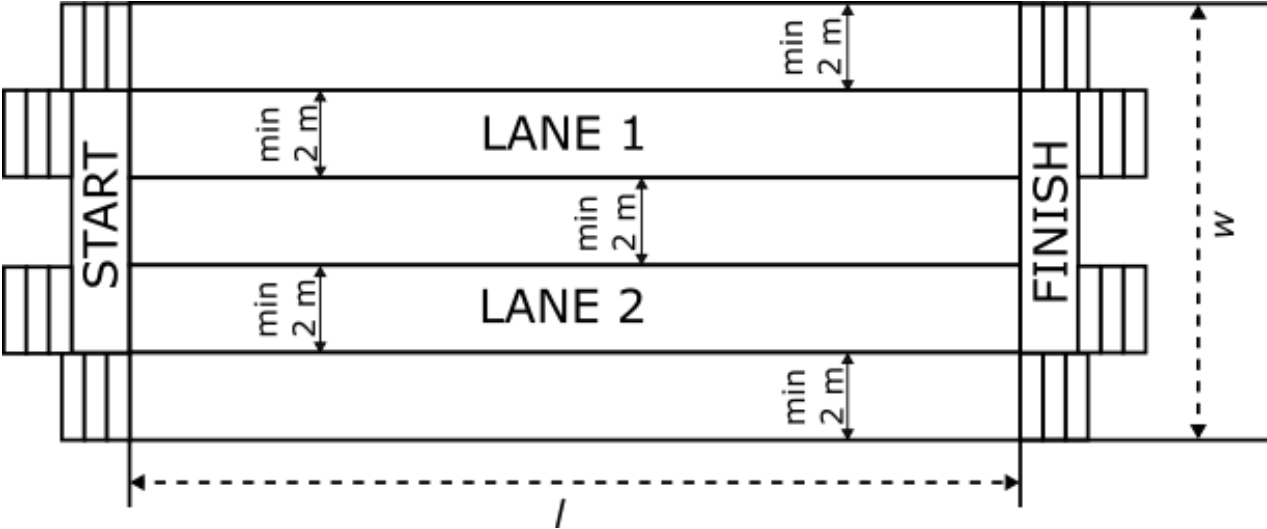

Key

$l \geq 40 \text{ m}$
 $w = \text{here } 10 \text{ m}$

FIGURE 1 Example of a track type B for 2 parallel starters in Speed Run. Plan view

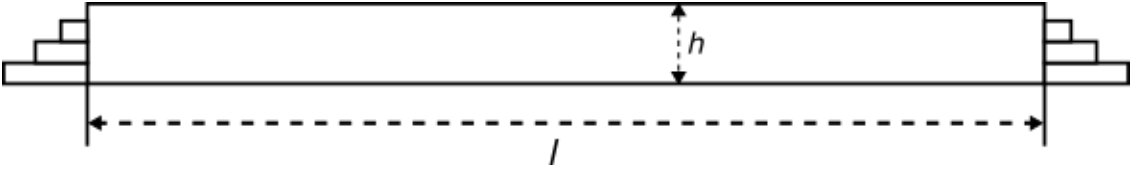

Key

$l \geq 40 \text{ m}$
 $h = 0,8 \text{ m} \pm 0,2$

FIGURE 2 Example of a track type B. Side view

Obstacles

Parkour

II
PK 2
01.03.2020

Construction / Description of material, measurements

1. Form

- 1.1. An obstacle is an element of the course that athletes can overcome, jump over or land on. The geometric shape is not limited except for the construction guidelines listed below. The obstacle should be accessible to the athletes from multiple sides and offer them several possibilities to proceed. Its general shape should have a challenging character that encourages the creativity of the athletes.
- 1.2. Bars and rails are a variation of obstacles. An obstacle can be completely or partly made of bars and rails. These constructions are typically made of round steel tubes which, in addition to the above, allow the athletes to hang, swing on or jump from them.
- 1.3. Structures with a height of less than 500 mm are considered accessories. They are not included in the number of obstacles required but shall also meet the functional and colour requirements

2. Terms

2.1. Low landing area:

An area below the body support (standing running hanging) on which an athlete is allowed to land after a jump down or can be hit by an athlete after a fall.

2.2. Free-falling height:

Greatest vertical distance between the body support (standing, running, hanging) and a low landing area.

2.3. Critical tilting edge:

The tilting edge with the smallest horizontal distance d_{hor} to the obstacles centre of mass. See Figure 3

3. Measurements

- 3.1. Width 2000 mm -50
free for exclusive free run competitions
- 3.2. Length free
- 3.3. Minimum height 500 mm
- 3.4. Boundary strip to mark the edges of the obstacles: min 50 mm
- 3.5. The following measurements apply only to Bars and Rails:
 - 3.5.1. Diameter of the tubing: 30 mm - 50 mm
 - 3.5.2. Profile of the tubing: round
- 3.6. Maximum free-falling height (fh_{max}): 2500 mm
- 3.7. For free-falling heights ≤ 1000 mm (see fh_1 in Figure 1):
 - 3.7.1. Low landing area width (see w_1 in Figure 1): min. 400 mm
 - 3.7.2. Low landing area length (see l_1 in Figure 1): min. 400 mm
- 3.8. For free-falling heights (fh) from 1000mm to 2500mm (see fh_2 in Figure 1): the minimum length (l) and width (w) of the low landing area is calculated as follows:

$$l, w = \frac{2}{3}fh + 500mm \quad [1]$$

Obstacles

- 3.9.** Free fall heights of more than 2500 mm are possible but are treated separately in the competition rules (see Parkour Code of Points). Edges that border on a free-falling height of more than 2500mm must be clearly marked (see section Colours). The absolute maximum is 3500mm.

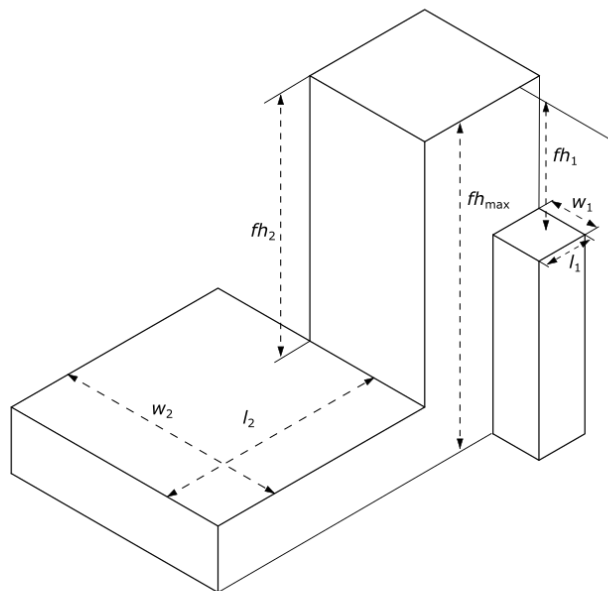

Key

fh_i : $i=(1,2,max)$: free falling height

$fh_1 \leq 1000$ mm (free-falling height)

$1000 \text{ mm} < fh_2 \leq 2500$ mm (free-falling height)

$fh_{max} \leq 2500$ mm (maximum free-falling height)

l_i : $i=(1,2)$: minimum length of low landing area corresponding to fh_i

w_i : $i=(1,2)$: minimum width of low landing area corresponding to fh_i

$l_1, w_1 \geq 400$ mm (minimum length and width of low landing area corresponding to fh_1)

l_2, w_2 see formula [1] (minimum length and width of low landing area corresponding to fh_2)

FIGURE 1 FREE-FALLING HEIGHTS AND CORRESPONDING LOW LANDING AREAS

4. Functional properties

- 4.1.** There shall be no protruding screws, nails or sharp-edged components. Protruding bolt threads within any accessible part of the equipment shall be permanently covered, e.g. by dome-headed nuts.
- 4.2.** Finishes shall be free from sharps and galvanizing spur.
- 4.3.** The edges shall have at least rounding with a radius of 3 mm or a bevel of 3 mm.
- 4.4.** The surfaces of the obstacle shall not be too slippery and not overly abrasive whether dry or wet. This requirement does not apply to Bars and Rails.
- 4.5.** Changes in the functional properties due to extreme temperatures or other weather influences must be kept as low as possible by suitable measures (coatings, organisational (e.g. tents, roofing), ...).
- 4.6.** Special requirements apply regarding structural integrity (4.6.1.), slip resistance (4.6.2.) and tilt resistance (4.6.3.).

Obstacles

4.6.1. Structural integrity: The obstacles must remain dimensionally stable under the pressure assumptions mentioned below and no permanent deformations shall occur.

The proof can be provided either by a static calculation, a test and / or by presentation of corresponding certifications by the material manufacturer (e.g. load capacity of a plywood panel).

4.6.1.1. Pressure assumptions for a mathematical proof:

4.6.1.1.1. Vertical pressure:	5.0 kN / m ²
4.6.1.1.2. Horizontal pressure:	1.5 kN / m ²

4.6.1.2. Additionally, the obstacles must be secured with suitable measures against b) slipping and c) tipping over. These measures can be:

- 4.6.1.2.1. By anchoring to the ground.
- 4.6.1.2.2. By own weight (or by ballast provided at relevant points)
- 4.6.1.2.3. By cross connections with other elements or surrounding bodies (e.g. walls)

4.6.1.3. Due to the possibly very different installation conditions the proof of the suitability of the measures taken cannot be provided in a laboratory test. Instead, it must be carried out at the place of installation. As these procedures are not laboratory tests, the necessary tests are described here and not in FIG Apparatus Norms Part IV.

4.6.2. Slip resistance

4.6.2.1. What is required is a suitable fastening option on the obstacle (belt; provided thread with eye bolt; ...), a load cell with the option of signal recording (minimum measuring frequency 100 Hz; minimum measurement range ± 5000 N) and an aid for applying a tensile force of at least 2000 N (increase rate of 150 N/s must be possible).

4.6.2.2. Mount a suitable attachment to the obstacle maximal 100mm (h_S) above the ground. Beginning at 0 N, apply a horizontal force (F_S ; see Figure 2) and increase it at a maximum rate of 150 N/s (not jerky) until either 1600 N is reached or the obstacle begins to slip.

- 1600 N reached without slipping? → tested passed
- obstacle slips before 1600N is reached? → check peak force
 - peak force < 1500 N → NOT passed
 - peak force \geq 1500 N → passed

Obstacles

4.6.2.3. Run this test in four perpendicular horizontal directions (starting with the main direction of use). If the result is passed for all four directions, sufficient slip resistance is proven.

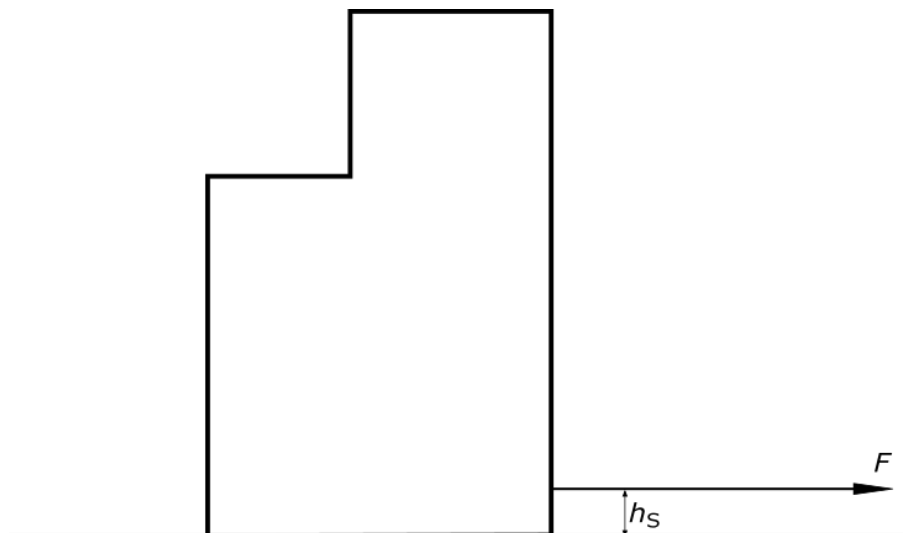

Key

F = horizontal test force

h_s = distance between ground and mounting point of the horizontal test force (≤ 100 mm)

FIGURE 2 SETUP FOR SLIP RESISTANCE TEST

4.6.3. Tilt resistance

4.6.3.1. What is required is a suitable fastening option on the obstacle (belt; provided thread with eye bolt; ...), a load cell with the option of signal recording (minimum measuring frequency 100 Hz; minimum measurement range ± 5000 N), an aid for applying a tensile force of at least 2000 N (increase rate of 150 N/s must be possible) and a possibility to fixate a suitable block in order to prevent the obstacle from slipping during the tilt resistance test.

4.6.3.2. Mount a suitable attachment to the obstacle maximal 100mm (h_T) underneath the highest point of the obstacle.

4.6.3.3. When horizontal pulling is possible: Beginning at 0 N, apply a horizontal force (F) and increase it at a maximum rate of 150 N/s (not jerky) until either 1100 N is reached or the obstacle begins to tilt.

- 1100 N reached without slipping? → tested passed
- obstacle tilts before 1100N is reached? → check peak force
 - peak force < 1000 N → NOT passed
 - peak force ≥ 1000 N → passed

4.6.3.4. When horizontal pulling is not possible: Beginning at 0 N, apply a force (F) in an angle α and increase it at a maximum rate of 150 N/s (not jerky) until either $1100/\cos(\alpha)$ N is reached or the obstacle begins to tilt. α must be 50° or less.

- $1100/\cos(\alpha)$ N reached without slipping? → tested passed
- obstacle tilts before $1100/\cos(\alpha)$ N is reached? → check peak force
 - peak force < $1000/\cos(\alpha)$ N → NOT passed
 - peak force $\geq 1000/\cos(\alpha)$ N → passed

Obstacles

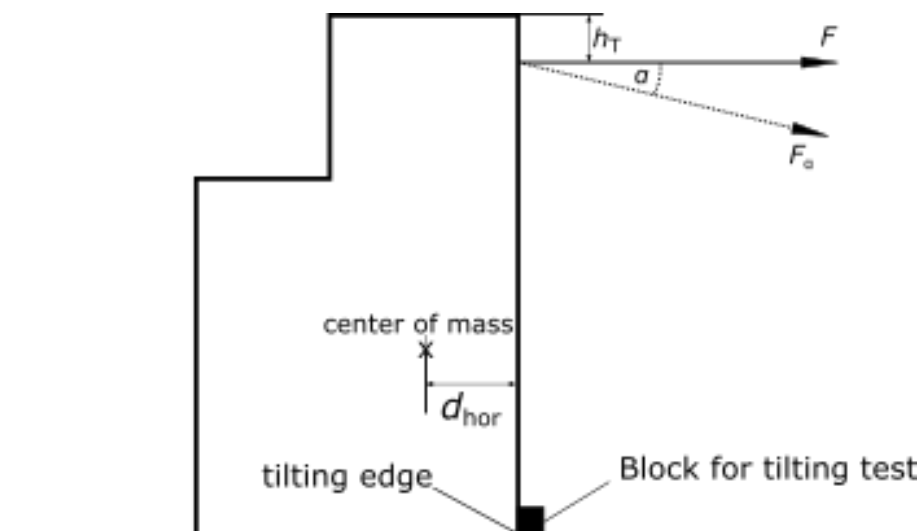

Key

F = horizontal test force

F_α = test force in an angle α (equivalent to F ; $\alpha \leq 50^\circ$)

α = deviation of the force vector of the test force from the horizontal in degrees ($\alpha \leq 50^\circ$)

d_{hor} = horizontal distance of the centre of mass from the tilting edge

FIGURE 3 SETUP FOR TILT RESISTANCE TEST

4.6.3.5. If the *critical tilting edge* is known (e.g. provided by manufacturer), you must do this test only in this direction. Otherwise repeat this test for all possible tilting edges. If the result is passed for all tests, sufficient tilt resistance is proven.

4.7. All materials used must be weatherproof or be made weatherproof by appropriate treatment.

4.8. Suitable measures must be taken to prevent the dangers arising from possible entrapment points. EN 913 can be used as a guide.

5. Colours

5.1. The colour is to the free choice of the manufacturer except for the following requirements:

5.1.1. Predominantly unicoloured

5.1.2. There must be a distinctive contrast between the colour of the obstacle and the competition track.

5.1.3. For certain events, the FIG can specify the colour.

5.2. The edges of the obstacles must be clearly marked in a contrasting colour, this does not apply for Bars and Rails.

5.3. Edges that border to a free-falling drop height of more than 2500mm shall be marked in black yellow cross striped.

Scaffolding

Construction / Description of material, measurements

1. Form

- 1.1. A scaffolding structure is an element of the course that athletes can overcome, jump over or land on. Depending on the type of construction (are platforms used or not?) athletes can also hang, swing or jump off them.
- 1.2. Scaffolding structures are industrial mass products from the construction industry. They are subject to a large number of country-specific regulations (national standards), which is why only the minimum functional requirements are mentioned here.

2. Terms

- 2.1. **Low landing area:**
An area below the body support (standing running hanging) on which an athlete is allowed to land after a jump down or can be hit by an athlete after a fall.
- 2.2. **Free-falling height:**
Greatest vertical distance between the body support (standing, running, hanging) and a low landing area.
- 2.3. **Critical tilting edge:**
The tilting edge with the smallest horizontal distance d_{hor} to the obstacles centre of mass. See Figure 3.

3. Measurements

- 3.1. Width 200 cm -5
free for exclusive free run competitions
- 3.2. Length free
- 3.3. Minimum height 500 mm
- 3.4. Boundary strip to mark the edges of the obstacles: min 50 mm
- 3.5. Maximum free-falling height (fh_{max}): 2500 mm
- 3.6. For free-falling heights ≤ 1000 mm (see fh_1 in Figure 1):
 - 3.6.1. Low landing area width (see w_1 in Figure 1): min. 400 mm
 - 3.6.2. Low landing area length (see l_1 in Figure 1): min. 400 mm
- 3.7. For free-falling heights (fh) from 1000mm to 2500mm (see fh_2 in Figure 1): the minimum length (l) and width (w) of the low landing area is calculated as follows:

$$l, w = \frac{2}{3}fh + 500mm \quad [1]$$

Scaffolding

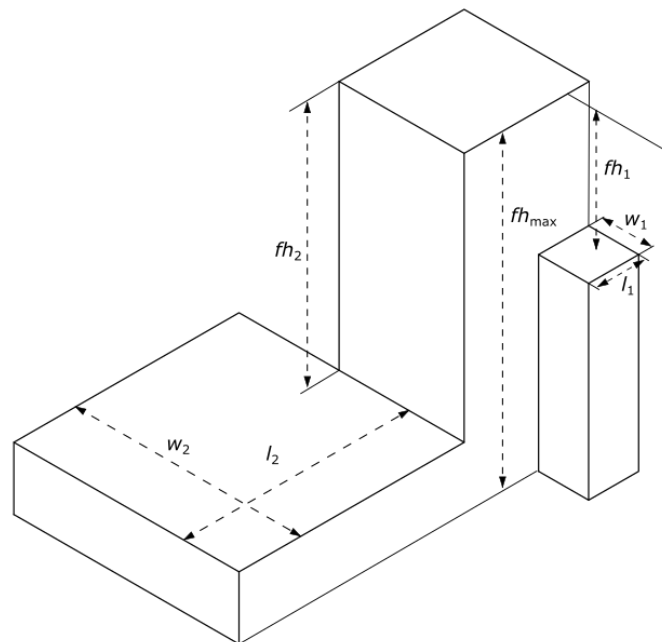

Key

fh_i : $i=(1,2,max)$: free falling height

$fh_1 \leq 1000$ mm (free-falling height)

$1000 \text{ mm} < fh_2 \leq 2500$ mm (free-falling height)

$fh_{max} \leq 2500$ mm (maximum free-falling height)

l_i : $i=(1,2)$: minimum length of low landing area corresponding to fh_i

w_i : $i=(1,2)$: minimum width of low landing area corresponding to fh_i

$l_1, w_1 \geq 400$ mm (minimum length and width of low landing area corresponding to fh_1)

l_2, w_2 see formula [1] (minimum length and width of low landing area corresponding to fh_2)

FIGURE 1 FREE-FALLING HEIGHTS AND CORRESPONDING LOW LANDING AREAS

4. Functional properties

4.1. Finishes shall be free from sharps and galvanizing spur.

4.2. Special requirements apply regarding structural integrity (4.2.1.), slip resistance (4.2.2.) and tilt resistance (4.2.3.).

4.2.1. Structural integrity:

4.2.1.1. The scaffolding structure must remain dimensionally stable under the pressure assumptions mentioned and no permanent deformations shall occur.

4.2.1.2. The proof can be provided either by a static calculation, a test and / or by presentation of corresponding certifications by the material manufacturer (e.g. load capacity of a plywood panel).

4.2.1.3. Pressure assumptions for a mathematical proof:

4.2.1.3.1. Vertical pressure: 5.0 kN / m²

4.2.1.3.2. Horizontal pressure: 1.5 kN / m²

Scaffolding

4.2.1.4. Additionally, scaffolding structures must be secured with suitable measures against b) slipping and c) tipping over. These measures can be:

- By anchoring to the ground.
- By own weight (or by ballast provided at relevant points)
- By cross connections with other elements or surrounding bodies (e.g. walls)

4.2.1.5. Due to the possibly very different installation conditions the proof of the suitability of the measures taken cannot be provided in a laboratory test. Instead, it must be carried out at the place of installation. As these procedures are not laboratory tests, the necessary tests are described here and not in Apparatus Norms Part IV.

4.2.2. Slip resistance

4.2.2.1. What is required is a suitable fastening option on the scaffolding structure (belt; provided thread with eye bolt; ...), a load cell with the option of signal recording (minimum measuring frequency 100 Hz; minimum measurement range ± 5000 N) and an aid for applying a tensile force of at least 2000 N (increase rate of 150 N/s must be possible).

4.2.2.2. Mount a suitable attachment to the obstacle maximal 100mm (h_S) above the ground. Beginning at 0 N, apply a horizontal force (F_S ; see Figure 2) and increase it at a maximum rate of 150 N/s (not jerky) until either 1600 N is reached or the obstacle begins to slip.

- 1600 N reached without slipping? → tested passed
- obstacle slips before 1600N is reached? → check peak force
 - peak force < 1500 N → NOT passed
 - peak force \geq 1500 N → passed

4.2.2.3. Run this test in four perpendicular horizontal directions (starting with the main direction of use). If the result is passed for all four directions, sufficient slip resistance is proven.

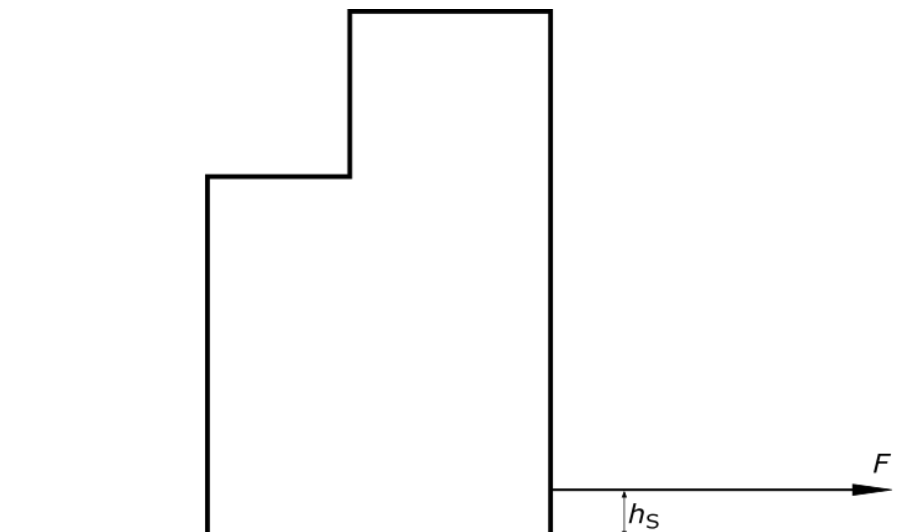

Key

F = horizontal test force
 h_K = maximum 100 mm

FIGURE 2 SETUP FOR SLIP RESISTANCE TEST

Scaffolding

4.2.3. Tilt resistance

4.2.3.1. What is required is a suitable fastening option on the scaffolding structure (belt; provided thread with eye bolt; ...), a load cell with the option of signal recording (minimum measuring frequency 100 Hz; minimum measurement range ± 5000 N), an aid for applying a tensile force of at least 2000 N (increase rate of 150 N/s must be possible) and a possibility to fixate a suitable block in order to prevent the obstacle from slipping during the tilt resistance test.

4.2.3.2. Mount a suitable attachment to the obstacle maximal 100mm (h_T) underneath the highest point of the obstacle.

4.2.3.3. When horizontal pulling is possible:

Beginning at 0 N, apply a horizontal force (F) and increase it at a maximum rate of 150 N/s (not jerky) until either 1100 N is reached or the obstacle begins to tilt.

- 1100 N reached without slipping? → tested passed
- obstacle tilts before 1100N is reached? → check peak force
 - peak force < 1000 N → NOT passed
 - peak force \geq 1000 N → passed

4.2.3.4. When horizontal pulling is not possible:

Beginning at 0 N, apply a force (F) in an angle α and increase it at a maximum rate of 150 N/s (not jerky) until either $1100/\cos(\alpha)$ N is reached or the obstacle begins to tilt. α must be 50° or less.

- $1100/\cos(\alpha)$ N reached without slipping? → tested passed
- obstacle tilts before $1100/\cos(\alpha)$ N is reached? → check peak force
 - peak force < $1000/\cos(\alpha)$ N → NOT passed
 - peak force $\geq 1000/\cos(\alpha)$ N → passed

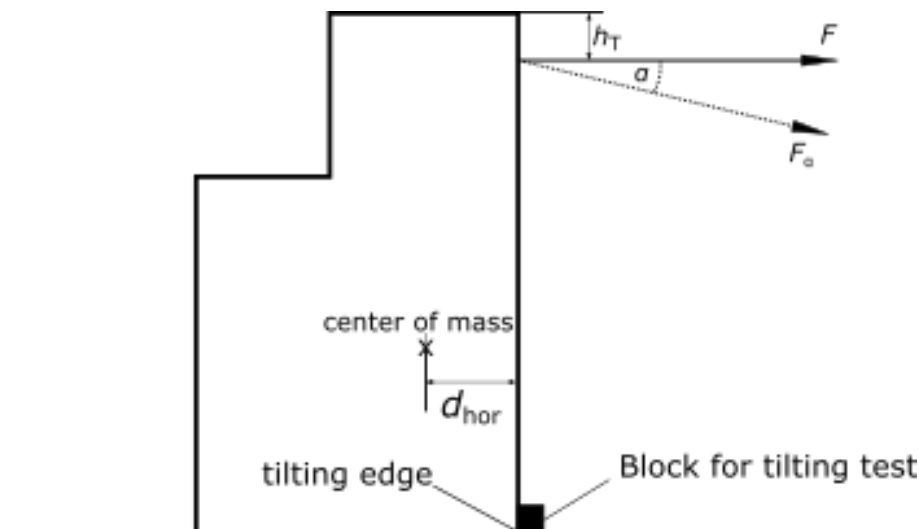

Key

F = horizontal test force

F_α = test force in an angle α (equivalent to F ; $\alpha \leq 50^\circ$)

α = deviation of the force vector of the test force from the horizontal in degrees ($\alpha \leq 50^\circ$)

d_{hor} = horizontal distance of the centre of mass from the tilting edge

FIGURE 3 SETUP FOR TILT RESISTANCE TEST

Scaffolding

5. Colour

5.1. The colour is to the free choice of the manufacturer except for the following requirements:

5.1.1. Predominantly unicoloured

5.1.2. There must be a distinctive contrast between the colour of the scaffolding structures and the competition track.

5.1.3. For certain events, the FIG can specify the colour.

5.2. If platforms are part of the scaffolding structures, the edges must be clearly marked in a contrasting colour.



3. Surfaces of apparatus, total surfaces, clearance zones



3.1 Surfaces of apparatus, total surfaces

Discipline	Apparatus	Area (meters)	Height of hall Minimum (if so, from Podium) (meters)	Height of hall Recommended (if so from Podium) (meters)
MAG Men's Artistic Gymnastics	MAG 1 Floor	18.00 x 18.00	7.00	8.00 – 10.00
	MAG 2 Pommel Horse	4.00 x 4.00		
	MAG 3 Rings	6.00 x 6.00		
	MAG 4 Vaulting Table	5.00 x 35.00		
	MAG 5 Parallel Bars	6.00 x 12.00		
	MAG 6 Horizontal bar	6.00 x 12.00		
WAG Women's Artistic Gymnastics	WAG 1 Vaulting Table	5.00 x 35.00	6.00	8.00 – 10.00
	WAG 2 Uneven Bars	6.00 x 14.00		
	WAG 3 Balance Beam	6.00 x 18.00		
	WAG 4 Floor	18.00 x 18.00		
RG Rhythmic Gymnastics	RG 1 Performance area	18.00 x 18.00	10.00	10.00 (min.)
TRA Trampoline Gymnastics	TRA 1 Trampoline (synch.)	15.00 x 15.00	10.00 8.00 (age groups)	10.00 (min.)
	TRA 2 Double Mini Trampoline	5.00 x 35.00	6.00	8.00 – 10.00
	TRA 3 Tumbling Track	5.00 x 45.00	6.00	
ACRO Acrobatic Gymnastics	ACRO 1 Performance area	18.00 x 18.00	8.00	10.00 – 12.00
AER Aerobic Gymnastics	AER 1 Performance area	18.00 x 18.00	6.00	8.00 – 10.00

3.2 Clearing zones:

Clearance zones are areas around each gymnastics apparatus (gymnastics equipment with associated landing mats or competition floors) which must meet certain requirements. They shall provide additional, unobstructed space when an athlete is forced to leave the equipment area in an uncontrolled manner.

In addition to the section above, in the field of play clearance zones shall also ensure an unobstructed view of the athletes for the judges.

To meet all these requirements, a clearance zone shall generally be horizontal, even, without gaps and kept totally free from objects or obstacles. Microphones and other media devices can be used in the clearance zones in the field of play, refer to: "FIG-Recommendations for Microphones and other media devices".

The “edge” specified for all competition floor surfaces belongs to the floor and is not part of the clearance zone.

The safety requirements for the athletes are basically the same in the field of play and in the training/warming up halls. However, regarding the field of vision, it is possible to make compromises. Therefore, for field of play and training and warm-up areas, different dimensions for the clearing zones are acceptable:

In training and warming up halls clearance zones from different equipment may overlap.

For the clearance zones in training and warm-up areas, objects or obstacles sometimes cannot be avoided or removed: They are only permitted if the surfaces are smooth and without protruding, sharp-edged parts and if additional, adequate safety measures such as sufficient cushioning, clear marking with contrasting colours etc. are implemented. The objects or obstacles (if necessary, well padded) shall not fall over or constitute obstacles to stumble when the athlete falls or runs against them. The assessment as to whether these additional measures are enough requires considerable experience with the requirements of the concerned gymnastics discipline and should be coordinated with the FIG when planning the competition venue.

It should be noted that the space above the clearance zones must also be kept free of objects for the safety of the athletes (spider cams, racks with cameras and lighting etc.). The height requirements for competition halls according to table above apply.

4. Competition area,

Recommended Standards.
For FIG Events the Placement
of the Apparatuses and Podiums
has to be approved by the FIG



Arena – Men's Artistic Gymnastics

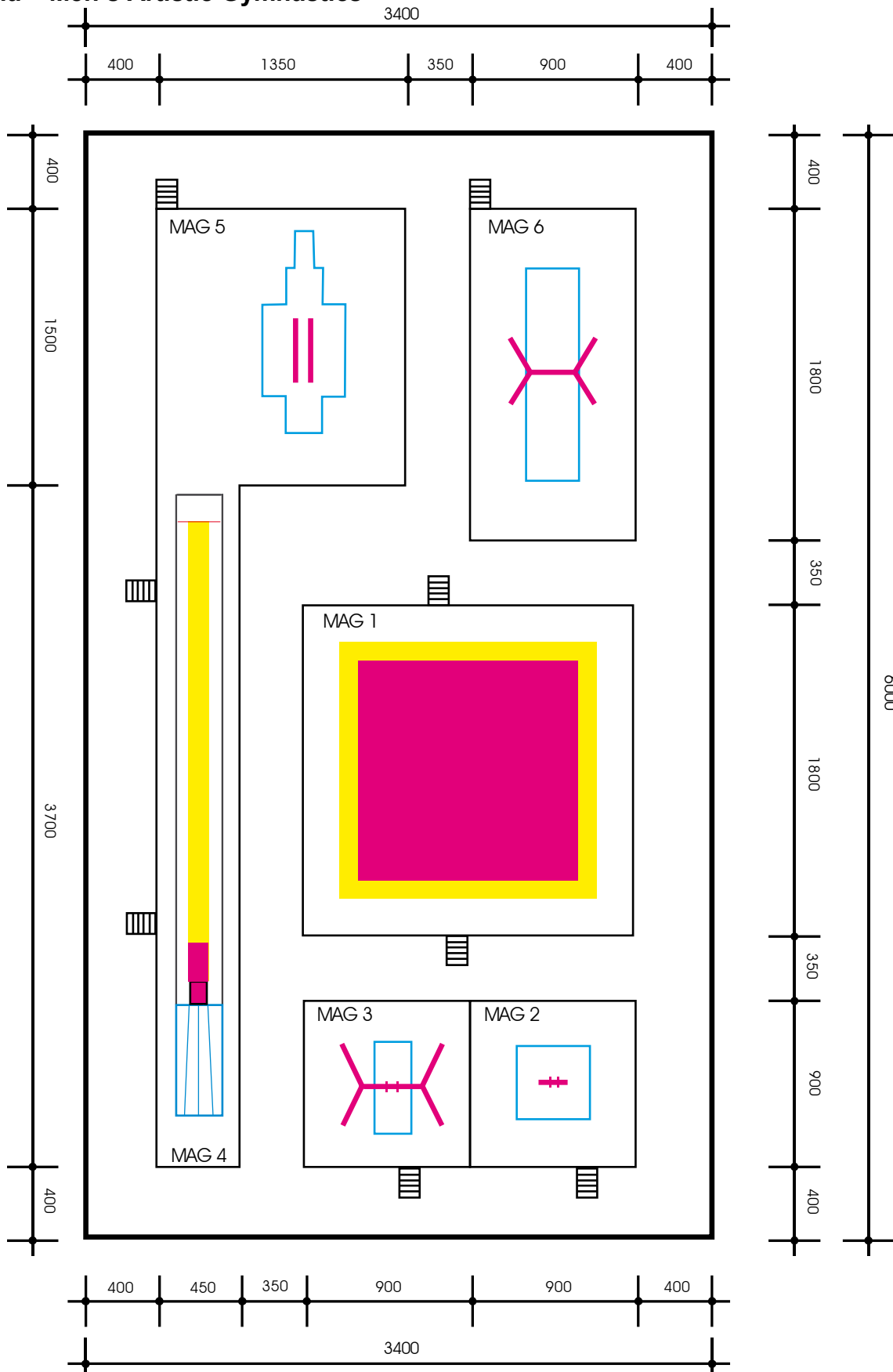

Arena – Women’s Artistic Gymnastics

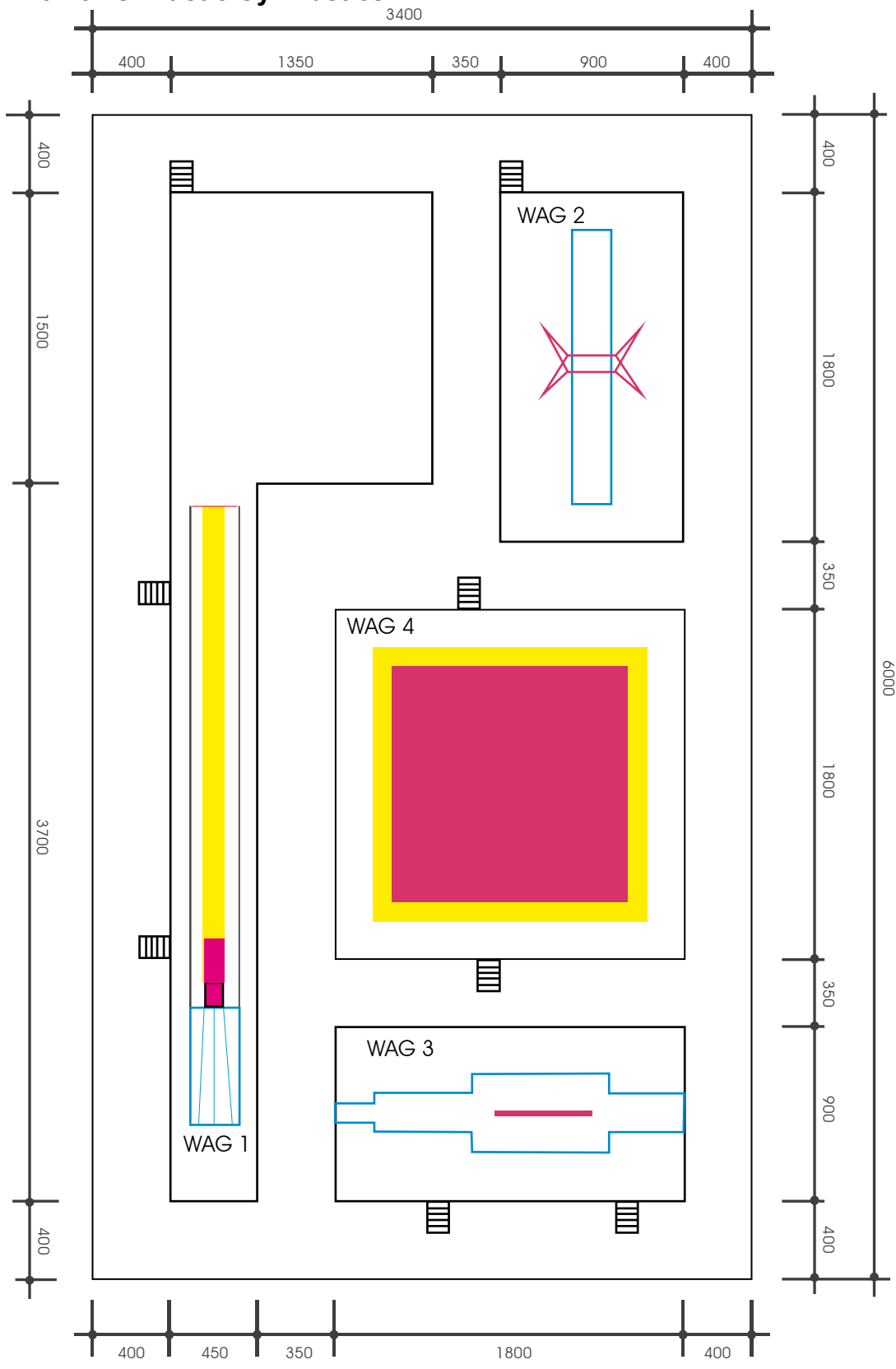

Requirements for Podiums, Anchors and connecting parts between floor anchors and gymnastic equipment at MAG and WAG Competitions

Construction / Description of material, measurements

1. Measurements

- 1.1. Size of the podiums: See recommended standards on the proceeding pages.
- 1.2. Height: 80 to 100 cm

2. Requirements

- 2.1. The podiums must be stable enough to withstand the forces which are transmitted by the installed equipment during use.
- 2.2. During competition, no disturbing vibrations and movements shall occur in the podium.
- 2.3. Special devices (i.e. additional, heavy supporting plates with sufficient area) should be used if the ground below the podiums is not hard enough.
- 2.4. Additional columns shall be placed directly below the podium zones with high loads (i.e. below all contact parts the stands of the gymnastics apparatuses at least according to the table below).

MAG		WAG	
Floor	-	Floor	-
Pommel Horse	4	Balance Beam	4
Rings	2		
Vault	6 - 8	Vault	6 - 8
Parallel Bars	4		
High Bar	2	Uneven Bars	4
TRA			
Trampoline (TRA 1)		4 (per Trampoline)	

- 2.5. Floor anchors and equipment attachments⁴ on the ground shall be controlled by the local organizer of the competition before establishing the gymnastic equipment and podium. All attachments shall withstand a static force of 8000 N (+20N) in the pulling direction⁵. This requirement must be fulfilled for both competition site and training sites.
- 2.6. *If connecting parts/fasteners (e.g., shackles) are used in the tensioning of the device with the floor, they shall be rated to at least 10kN.*
- 2.7. The stairs to the podium shall not have rails. This regulation can be overruled by the FIG if necessary, for example if the railing of the stairs is part of the course at Parkour.

⁴Equipment attachments are all devices which do not belong to the homologated standard parts of the apparatus (i.e. Horizontal bar, ring frame etc.)

⁵ "pulling direction" means: The direction of the cable at a correctly mounted equipment. After the application of a static force as described for 1 min (+10s) in pulling direction, no permanent deformation shall be observed at the anchors and/or the equipment attachments

Arena – Trampoline, Double Minitrampoline, Tumbling

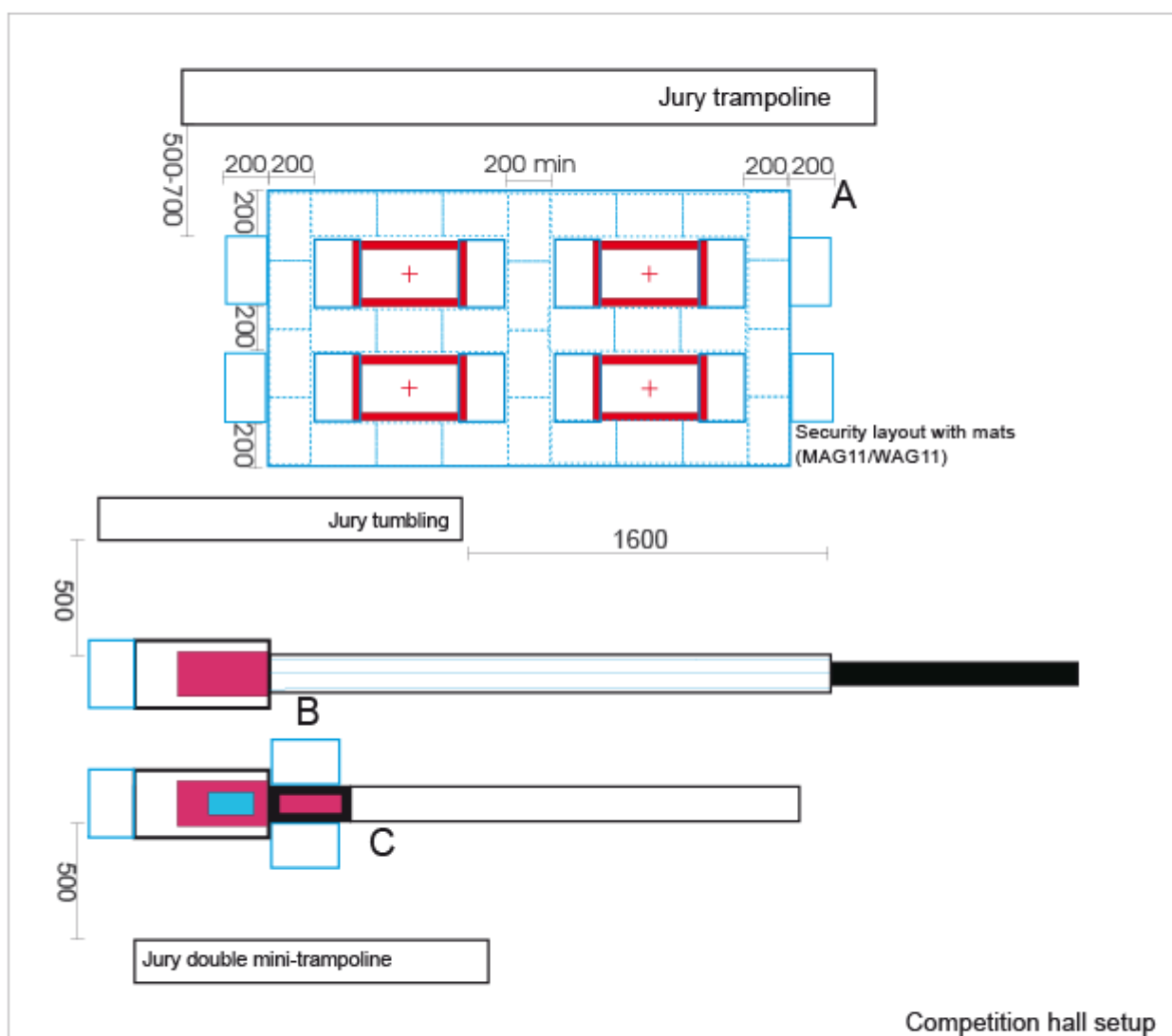

- A trampoline
- B tumbling
- C double mini-trampoline

5. Apparatus Control Forms



II
01.01.2014

Apparatus Control Forms – MAG, WAG, RG and TRA Forms A and Forms B

Prior to every FIG Event in MAG, WAG, TRA and RG an apparatus control shall be scheduled before the first contact of athletes with the equipment. The completed forms have to be reported to the TC President or if he is not at the competitions site to the FIG Event Delegate and to the President of the FIG Apparatus Commission. According to the FIG event, different forms shall be used:

Form A: (FIG TC Delegate)

Competitions: World Cups, Continental Games (without FIG Apparatus Manager)

Main aspects for the apparatus control with form A:

- To be performed 1-2 h prior to the first contact of the athletes with the equipment.
- To be done for training hall (every set), warming up hall and competition hall.
- Control of specifications of the FIG Apparatus Manual.
- Judgment of non-described safety relevant aspects.
- Control of all adjustable heights, lengths etc. at the apparatuses.
- Control of all security relevant parts (fixings, stability and mats displacement).
- If necessary, monitoring of apparatus relevant ad hoc decisions of the TP / TC or other FIG Authorities.

Form(s) B: (FIG Apparatus Manager)

Competitions: World Championships and Olympic Games (with FIG Apparatus Manager)

Main aspects for the apparatus control with forms B:

(IC) Intensive Control (FIG Apparatus manager):

- To be done for training hall (every set), warming up hall and competition hall
- To be performed 1-2 h prior to the first contact of the athletes with the equipment
- Control of accordance of equipment with the tested Specimen
- Control of all specifications of the FIG Apparatus Manual
- Judgment of non-described safety relevant aspects
- Report of the results to the Technical President
- If necessary, monitoring of apparatus relevant ad hoc decisions of the TP / TC or other FIG Authorities

(FC) Final Control (Technical Committee Member(s), FIG Apparatus Manager and President of the FIG Apparatus Commission):

- To be performed 1/2h prior to the competition or the podium training.
- Control of all adjustable heights, lengths etc. at the apparatuses.
- Control of all security relevant parts (fixings, stability and mats displacement).

(LC) Daily Light Control (FIG Apparatus Manager):

- To be performed every day in all training and warming up halls.
- Control of accordance of the equipment with the time of the extensive control.
- Control of all adjustable heights, lengths etc. at the apparatuses.
- Control of all security relevant parts (fixings, stability and mats displacement).

Remark: Forms B are published in FIG Apparatus Norms Part IV



MAG – Apparatus Control Form A
(Forms B: see FIG Apparatus Norms Part IV)

	APPARATUS CONTROL A - MAG GYMNASTICS	Competition Logo
Apparatus: MAG	Competition: Name of the Competition	Date:
Note: Measurements taken from the floor to the top of the apparatus		
Floor	Stipulation	Result - Action
Surface area	12x12m including delimitation line	
Elasticity of floor		
Chalk box for feet		
Pommel Horse	Stipulation	Result - Action
Height of horse	115 cm +/- 1cm, measured from floor	
Levers and knob covered	Protection of anchor and floor support	
Height of landing mats	10 cm +/- 1 cm	
Dimension of mat surface	min. 400 cm x 400 cm	
Rings	Stipulation	Result - Action
Height of rings	290 cm +/- 1 cm, measured from floor	
Dimension of mat surface	min. 200 cm x 500 cm	
Core and surface of mat	visual and tactile control of the landing area under the rings. Damages?	
Vaulting Table	Stipulation	Result - Action
Height	135 cm +/- 1 cm measured 68cm from landing end	
Levers and knob covered		
Protection of anchor and floor supports under apparatus		
Protection for space between landing mat and vaulting table		
Safety collar: different color from carpet of spring board		
Enhanced color of round-off hand placement mat		
Dimension of mat surface	min. 250 cm x 600 cm	
Parallel Bars	Stipulation	Result - Action
Height of bars	200 cm +/- 1 cm from floor	
Distance between bars	42 cm to 52 cm	
Mat between bases	Total mat surface horizontal, even, without gaps	
Dimension of mat surface	min. 450 cm x 1100 cm	
Horizontal Bar	Stipulation	Result - Action
Height of bars	280 cm +/- 1 cm, measured from floor	
Dimension of mat surface	min. 300 cm x 1200 cm	
Dedicated pad for prep of the bar		
Springboards	Stipulation	Result - Action
Height	20 cm +/- 1 cm, Cushion cover 2 cm +/- 0,05 = Total 22 cm +/- 1,5 cm	
1 hard and 1 soft board at the vault	hard board marked with a dot springs fixed	
1 soft board at the parallel bars	springs fixed	
Mats	Stipulation	Result - Action
Height of all landing mats	20 cm +/- 1 cm (except pommel horse -10 cm)	
Height of all extra soft landing mats	10 cm	
Mats surface	horizontal, even, without gaps	
Extra soft landing mat at the rings	400 cm * 200 cm	
Extra soft landing mat at the vault	600 cm * 200 cm ; with lines	
2 extra soft landing mats at high bar	400 cm * 200 cm	

Podium training
 Qualification round
 Final
 Team Final

Signature

Time & date

WAG – Apparatus Control Form A
(Forms B: see FIG Apparatus Norms Part IV)

 APPARATUS CONTROL A - WAG GYMNASTICS		Competition Logo
Apparatus: WAG Competition: Name of the Competition Date:		
Note: Measurements taken from the floor to the top of the apparatus		
Vaulting Table	Stipulation	Result - Action
Height	125 cm +/- 1 cm measured 68cm from landing end	
Levers and knob covered		
Protection of anchor and floor supports under apparatus		
Protection for space between landing mat and vaulting table		
Safety collar: different color from carpet of spring board		
Enhanced color of round-off hand placement mat		
Dimension of mat surface	min. 250 cm x 600 cm	
Uneven Bars	Stipulation	Result - Action
Height of low bar	171 cm +/- 1 cm from under rail	
Height of high bar	251 cm +/- 1 cm from under rail	
Distance between bars	181 cm diagonal (maximum)	
Protection between bases and 2 m matting under UB		
Dimension of mat surface	min. 200 cm x 1400 cm	
Balance Beam	Stipulation	Result - Action
Height of beam	125 cm +/- 1 cm	
Length of beam	500 cm	
Width of beam	10 cm	
Permanent coverings on ends		
Cushioning of the stands		
Dimension of mat surface	min. 400 cm x 1800 cm	
Floor	Stipulation	Result - Action
Surface area	12x12m including delimitation line	
Elasticity of floor		
Chalk box for feet		
Springboards	Stipulation	Result - Action
Height	20 cm +/- 1 cm, Cushion cover 2 cm +/- 0,05 = Total 22 cm +/- 1,5 cm	
1 hard and 1 soft board at the vault	hard board marked with a dot springs fixed	
1 soft board at the uneven parallel bars	springs fixed	
1 soft board at the beam	springs fixed	
Mats	Stipulation	Result - Action
Height of all landing mats	20 cm +/- 1 cm	
Height of all extra soft landing mats	10 cm	
Mats surface	horizontal, even, without gaps	
Extra soft landing mat at the vault	600 cm * 200 cm; with lines	
Extra soft landing mat at the Uneven Bars	400 cm * 200 cm	
Extra soft landing mat at the beam	400 cm * 200 cm	

Podium training
 Qualification round
 Final
 Team Final

Signature

Time & date

RG – Apparatus Control Form A
(Forms B: see FIG Apparatus Norms Part IV)



APPARATUS CONTROL A - RG GYMNASTICS

Competition
Logo

Apparatus RG	Competition: Name of the Competition	Date:
---------------------	---	-------

RG1 Floor	Stipulation	Result - Action
Surface area	width A (1300 ± 3 cm)	
(delimiter lines belong to the competition area)	width B (1300 ± 3 cm)	
	diagonal A (1838 ± 5 cm)	
	diagonal B (1838 ± 5 cm)	
horizontal, even, without gaps		
Seams' direction	Towards Judges (Training: Towards Coaches)	
Border	horizontal (50cm); with slope (25-25cm)	
Clearance zone	(200 cm)	
Delimitation strip	contrast, width (5 ± 0.5 cm)	
Minimum height of the hall	1000 - 1200 cm min	
RG10 Measurement Table	Stipulation	Result - Action
suitable for measurement of diameter		
hoops	800 - 900 mm	
measurement of whole circle?		
balls	180 - 200 mm	
end of clubs	max. 30mm	
cane of ribbons	max. 10mm	
suitable for measurement of lengths:		
clubs	400 - 500 mm	
ribbons	5000mm Juniors (6000mm min. Seniors)	
doubled part of the ribbon	1000mm +/- 5 mm	
cane of ribbons	500 - 600 mm	
optional handle part of cane of ribbon	max. 100mm	
fixture of ribbons	70mm max.	
width of ribbons	40 - 60 mm	
suitable balance:		
precision	+/- 1g	
Hoops measurement	hanging position	
hoop / balls / clubs / ribbons without	min. 300 / 400 / 150 / 35 g (30g Juniors)	
Indication	all measures indicated unmistakably	

Signature

Time & date

TRA – Apparatus Control Form A
(Forms B: see FIG Apparatus Norms Part IV)



APPARATUS CONTROL A - TRA GYMNASTICS

Competition
Logo

Competition: **Name of the Competition**

Apparatus: **Trampoline** Individual Synchro

Trampoline	Stipulation	Result - Action
Height of the bed	115,5 cm +/-0,5 cm (from the floor)	
Length of the bed	428 cm +/- 6 cm (under tension)	
Width of the bed	214 cm +/- 5 cm (under tension)	
Jumping zone	215 (+/- 4) x 108 (+/-4) cm; cross: 70 (+/-3) cm	
Bed construction	Web: 0,55 cm +/- 0,15 cm; max distance 1.6 cm Strings: 0,3 cm +/- 0,1 cm; max distance 1 cm	
Safety padding	Shock absorbing padding; thickness: 3,0-5,0 cm The padding may not touch any part of the bed The padding may extend over the bed by up to 3 cm The bottom of the padding not to protrude above the level of the bed by more than 6 cm Padding firmly fixed to the frame without hindering the normal action of the bed and springs	
Level	The frame and bed must be level	
Springs	Safely attached	
Area beneath	Construction: the competitor will not touch any part of the frame beneath the bed	
Safety platform mats	Stipulation	Result - Action
Width	300 cm +/-2,5 cm	
Length	240 cm +/-2,5 cm (including wedge, 40 cm)	
Thickness at bedside	7,5 cm +/-0,5 cm	
Thickness at the end	20 cm +/-2,0 cm	
Density		
Safety mats (on the floor)	Stipulation	Result - Action
Width	200 cm +/- 1 cm	
Height	Type a): 20 cm Type b): min. 20 cm	
Type	All mats must be of the same height and type	
Density		
Spotter mats	Stipulation	Result - Action
Material	Must be covered with a material which will slide easily	
Handles	Must be provided with at least 2 handles or one long handle on the two long sides of the mat	
Length	200 cm - 50 cm	
Width	150 cm - 50 cm	
Thickness	15 cm - 5 cm	
Density		

Podium training

Qualification round

Team Final

Signature

Time & date

6. Required Equipment for FIG Competitions MAG / WAG / RG / TRA



Competition Equipment for Men's Artistic Gymnastics (including training and warm up hall)

<i>For World Championships and Olympic Games</i>		Quantity Arena	Quantity warm-up hall	Quantity for each training hall	Remarks
Floor Exercise					
Free exercise floor	MAG 1	1	1	1	
Magnesia stand for feet (filled with magnesia)		4	2	2	
Magnesia stand for hands (filled with magnesia)		1	1	1	
Supplementary mat 200x200x10 cm	MAG 13	1)*	2	2)*Only for Podium Training, Warming up session of the Apparatus Finals
Pommel Horse					
Pommel horse (including anchoring system to the floor)	MAG 2	1	2	2	
Set of landing mats 10 cm, surface according to Apparatus Norms	MAG 12	1	2	2	
Magnesia stand for hands (filled with magnesia)		1	2	2	
Rings					
Ring frame	MAG 3	1	1	1	
Set of landing mats 20 cm, surface according to Apparatus Norms	MAG 11	1	1	1	
Ring hook		1	1	1	
Magnesia stand for hands (filled with magnesia)		1	1	1	
Hard foam block approx. 90 x 50 x 70 cm for preparation of the rings		1	1	1	
Supplementary mat 400x200x10 cm	MAG13	1	1	1	
Vault					
Vaulting table (including anchoring system to the floor and 20 cm high padding of the feet)	MAG 4	1	1	1	
Runway with clear markage block at 25 meters		1	1	1	
Set of landing mats 20 cm, surface according to Apparatus Norms	MAG 11	1	1	1	
Supplementary mat 600x200x10 cm with marked landing area (two diverging lines and one central line)	MAG 13	1	1	1	Compulsory use
Soft crash mat 300x200x30 cm			1	1	
Additional supplementary mat 200x200x10 cm	MAG13	1)*	1	1)*Only for Podium Training, Warming up session of the Apparatus Finals
Vaulting board 'hard' (with fixed springs)	MAG 14	1	1	1	
Vaulting board 'soft' (with fixed springs)	MAG 14	1	1	1	
Vaulting board Safety Collar	MAG 15	1	1	1	Compulsory use with round-off vaults
Mat for hands 120x100x3 cm	MAG 16	1	1	1	Use not compulsory
Tape measure 25 meters		1	1	1	
Magnesia stand for feet (filled with magesia)		1	1	1	
Magnesia stand for hands (filled with magnesia)		1	1	1	
Parallel Bars					
Parallel bars (if necessary with anchoring system to the floor / podium)	MAG 5	1	2	2	
Set of landing mats 20 cm, surface according to Apparatus Norms	MAG 11	1	2	2	
Vaulting board 'soft' (with fixed springs)	MAG 14	1	2	2	
Magnesia stand for hands (filled with magesia)		1	2	2	
Supplementary mat 200x200x10 cm			2	2	
Horizontal Bar					
Horizontal bar (including anchoring system to the floor)	MAG 6	1	1	1	
Set of landing mats 20 cm, surface according to Apparatus Norms	MAG 11	1	1	1	
Supplementary mat 400x200x10 cm	MAG 13	2	2	2	Compulsory use
Additional supplementary mat 200x200x10 cm	MAG13	1)*	1	1)*Only for Podium Training, Warming up session of the Apparatus Finals
Magnesia stand for hands (filled with magesia)		1	1	1	
Hard foam block, approx. 50x50x50 cm for preparation of rails		1	1	1	
Dedicated pad for the preparation of the bar		1	1	1	a sufficient number of replacements must be provided

Spare parts such as rails, vaulting boards, pommels etc. at the discretion of the Organiser

Please note that for all FIG sanctioned events the apparatuses shall have a valid FIG-certificate and the FIG must be informed in due time of the official apparatus manufacturer and the exact product. It is allowed to have more than one apparatus manufacturer, but it must be guaranteed that the same product is used in the training- warm-up- and competition hall.

Deviations in the colors of the equipment due to event-oriented specifications, advertising stickers or for the delimiting lines on the competition surfaces to improve contrast are permitted for the FoP (Field of Play) after consultation with the FIG.

Competition Equipment for Women's Artistic Gymnastics (including training and warm up hall)

Competition Equipment for Women's Artistic Gymnastics

For World Championships and Olympic Games					
		Quantity Arena	Quantity warm-up hall	Quantity for each training hall	Remarks
Vault					
Vaulting table (including anchoring system to the floor and 20 cm high protection of the feet)	WAG 1	1	1	1	
Set of landing mats 20 cm, surface according to Apparatus Norms	WAG 11	1	1	1	
Runway with clear markage at 25 meters		1	1	1	
Supplementary mat 600x200x10 cm with marked landing area (two diverging lines and one central line)	WAG 13	1	1	1	Compulsory use
Soft crash mat 300x200x30 cm			1	1	
Additional supplementary mat 200x200x10 cm	WAG13	1)*	1	1)*Only for Podium Training, Warming up session of the Apparatus Finals
Vaulting board 'hard' (with fixed springs)	WAG 14	1	1	1	
Vaulting board 'soft' (with fixed springs)	WAG 14	1	1	1	
Vaulting board Safety Collar	WAG 15	1	1	1	Compulsory use with round-off vaults
Mat for hands 120x100x3 cm	WAG 16	1	1	1	Use not compulsory
Tape measure 25 meters		1	1	1	
Magnesia stand for feet (filled with magesia)		1	1	1	
Magnesia stand for hands (filled with magnesia)		1	1	1	
Uneven Bars					
Uneven bars	WAG 2	1	2	2	
10 cm support plates		1	1	1	
Set of landing mats 20 cm, surface according to Apparatus Norms	WAG 11	1	2	2	
Supplementary mat, 400x200x10 cm	WAG 13	1	2	2	compulsory use
Additional spotter mat	WAG17	1)*	2	2)*Only for Podium Training, Warming up session of the Apparatus Finals
Vaulting board 'soft' (with fixed springs)	WAG 14	1	2	2	
Magnesia stand for feet (filled with magesia)		1	0	0	
Magnesia stand for hands (filled with magesia)		1	2	2	
Hard foam block, approx. 50x50x50 cm for preparation of rails		1	2	2	
Balance Beam					
Balance beam with padded legs	WAG 3	1	2	2	All knobs and levers padded or removed
Set of landing mats 20 cm, surface according to Apparatus Norms	WAG 11	1	2	2	
Supplementary mat, 400x200x10 cm	WAG 13	1	2	2	Compulsory use
Additional safety mat 200x200x10 cm	WAG13	1)*	2	2)*Only for Podium Training, Warming up session of the Apparatus Finals
Vaulting board 'soft' (with fixed springs)	WAG 14	1	2	2	
Magnesia stand for feet (filled with magesia)		1	2	2	
Magnesia stand for hands (filled with magesia)		1	2	2	
Floor Exercise					
Free exercise floor	WAG 4	1	1	1	
Magnesia stand for feet (filled with magesia)		4	2	2	
Magnesia stand for hands (filled with magesia)		2	1	1	
Supplementary mat 200x200x10 cm	WAG13	1)*	2	2)*Only for Podium Training, Warming up session of the Apparatus Finals

Spare parts such as rails, vaulting board etc. at the discretion of the Organiser

Please note that for all FIG sanctioned events the apparatuses shall have a valid FIG-certificate and the FIG must be informed in due time of the official apparatus manufacturer and the exact product. It is allowed to have more than one apparatus manufacturer, but it must be guaranteed that the same product is used in the training-warm-up- and competition hall.

Deviations in the colors of the equipment due to event-oriented specifications, advertising stickers or for the delimiting lines on the competition surfaces to improve contrast are permitted for the FoP (Field of Play) after consultation with the FIG.

Competition Equipment for Rhythmic Gymnastics (including training and warm up hall)

Competition Equipment for Rhythmic Gymnastics					
<i>For World Championships and Olympic Games</i>					
		Quantity Arena	Quantity warm-up hall	Quantity for each training hall *	Remarks
Rhythmic Gymnastics					
RG Floor	RG 1	1	max2		9 floors for OG 12 floors for World Championships in the year following the Olympic Games
Minimum clearance zone **		2,0 m	0,5 m	0,5 m	
Acoustic separations between the floors			between the floors	between the floors	
Music devices		1	1 per floor	1 per floor	
Ballet Bar and mirror				1 per warm- up zone	
Device to iron ribbons			1	1	
Measurement Table for RG with balance	RG 10		1		

*= according to the size of the hall

** = additional to the edge (0,5m)

Please note that for all FIG sanctioned events the apparatuses shall have a valid FIG-certificate and the FIG must be informed in due time of the official apparatus manufacturer and the exact product.

It must be guaranteed that the same floor from one manufacturer (same reference) is used in the training-warming-up- and competition hall. Deviations due to advertising stickers or for the color of the delimiting lines on the competition floor (FoP – Field of Play) to improve contrast are permitted after consultation with the FIG.

Competition Equipment for Trampoline Gymnastics (including training and warm up hall)

Competition Equipment for Trampoline Gymnastics

For World Championships and Olympic Games

		Quantity Arena	Quantity warm-up hall	Quantity for each training hall **	Remarks
Trampoline					
Trampolines	TRA 1	4	4	4	
Safety platforms (see TRA 1, Art. 6)		8	8	8	
Platform mats with wedges (see TRA 1, Art. 6)		8	8	8	
Stability plates *		16	16	16	
Spotter mats (see TRA 1, Art. 7)	TRA 12	4	4	4	
Safety mats on the ground (see TRA 1, Art. 8)	TRA 11	30	30	30	30 mats of 300x200x20 cm
Time Measurement Device	TRA 15	2 sets	2 sets *	2 sets *	
Magnesia stands (filled with magnesia)		2	2	2	
Double Mini-Trampoline					
Double Mini-Trampoline	TRA 2	1	1	1	
Run-up (see TRA 2, Art. 4)		1	1	1	
Spotter-mat (see TRA 2, Art. 5)	TRA 12	1	1	1	
Landing mats with marking of landing zones (see TRA 2, Art. 3)	TRA 11	1	1	1	
Additional safety mat 300x200x20 cm (see TRA 2, Art. 3.2)		1	1	1	Placement: behind the landing area
Safety mats besides the DMT (see TRA 2, Art. 6)	TRA 11	2	2	2	
Set of Safety mats (min. 50 cm wide; 5 cm thickness) *		1	1	1	Placement: around the landing area
Magnesia stands (filled with magnesia)		1	1	1	
Tumbling					
Tumbling track	TRA 3	1	1	1	
Run-up (see TRA 3, Art. 3)		1	1	1	
Landing mats with marking of landing zone (see TRA 3, Art. 2)	TRA 11	1	1	1	
Supplementary mat 400x200x10 cm	TRA 13	1	1	1	With marking of landing zone
Additional safety mat 300x200x20 cm (see TRA 3, Art. 2.2)		1	1	1	Placement: behind the landing area
Vaulting board 'hard'	TRA 14	1	1	1	
Vaulting board 'soft'	TRA 14	1	1	1	
Set of Safety mats (min. 50 cm wide; 5 cm thickness) *		1	1	1	Placement: around the landing area
Magnesia stands (filled with magnesia)		1	1	1	

* = not compulsory

** = if applicable

Spare parts at the discretion of the Organiser

Please note that for all FIG sanctioned events the apparatuses shall have a valid FIG-certificate and the FIG must be informed in due time of the official apparatus manufacturer and the exact product. It is allowed to have more than one apparatus manufacturer, but it must be guaranteed that the same product is used in the training-warm-up- and competition hall. The only exceptions to this rule are the safety mats around the trampoline. The mats can be different in the venues (training, warm up and competition hall) as long as they meet the requirements in TRA 1; 7.a) or b). Within one venue, differences between the safety mats are not allowed. Deviations in the colors of the equipment due to event-oriented specifications, advertising stickers or for the delimiting lines on the competition surfaces to improve contrast are permitted for the FoP (Field of Play) after consultation with the FIG.





III. CERTICATES AND DIPLOMAS

III
01.09.2019

Content

- | | |
|--|-------|
| 1. Each apparatus must have a valid FIG Certificate§
Erreur ! Signet non défini. | III/3 |
| 2. Validity of the Certificate
Erreur ! Signet non défini. | III/3 |
| 3. Rights of the Apparatus Manufacturer with a valid FIG Certificate
Erreur ! Signet non défini. | III/3 |
| 4. Procedure to obtain a FIG Certificate
Erreur ! Signet non défini. | III/3 |
| 4.1 Recognition of the FIG Statutes, Rules and Regulations,
Applicable law and arbitration, Code of Auto discipline | |
| 4.2 Declaration concerning harmful substances | |
| 4.3 Testing by a FIG recognised Testing Institute | |
| 4.4 Practical Test | |
| 4.5 Issuing of FIG Certificate | |
| 5. Testing fees of the FIG recognised Testing Institutes
Erreur ! Signet non défini. | III/5 |
| 6. Fee for the Certificate
Erreur ! Signet non défini. | III/5 |
| 7. Publication of the FIG Certificates
Erreur ! Signet non défini. | III/5 |
| 8. Renewal of Certificates
Erreur ! Signet non défini. | III/6 |
| 9. Obtaining a certificate without testing for apparatus produced by another manufacturer
Erreur ! Signet non défini. | III/6 |
| 10. Official FIG Partners
Erreur ! Signet non défini. | III/6 |
| 11. Reward for the suppliers of World Championships and World Cup Finals
Erreur ! Signet non défini. | III/7 |
| 12. New Apparatus, Modified Apparatus, New Developments
Erreur ! Signet non défini. | III/7 |
| 13. FIG Sticker «FIG APPROVED»
Erreur ! Signet non défini. | III/7 |
| 14. Control of Apparatus at the competitions
Erreur ! Signet non défini. | III/8 |
| Re-testing of apparatus by the FIG at the Testing Institute
Erreur ! Signet non défini. | III/8 |

15. FIG recognised Testing Institutes	III/8
Erreur ! Signet non défini.	
16. Publicity and apparatus manufacturer’s logo on the apparatus	III/9
Erreur ! Signet non défini.	
17. Waiver of Liability	III/9
Erreur ! Signet non défini.	
18. Current Fees for FIG Certificates	III/9
Erreur ! Signet non défini.	
19. Code of Auto discipline	III/9
Erreur ! Signet non défini.	
Appendix 1	174
Appendix 2	179
Appendix 3	180
Appendix 4	181
Appendix 5	183
Appendix 6	190

III
01.09.2019

Content

Appendix 1	Directives for the Use of Official FIG Designations and Logos	III/10
Appendix 2	FIG Recognised Testing Institutes Addresses and Contact Persons	III/14
Appendix 3	FIG Recognised Testing Institutes What can be tested where?	III/15
Appendix 4	Testing Fees of the FIG Recognised Testing Institutes	III/16
Appendix 5	Code of Auto discipline	III/18
Appendix 6	Intermediate Rules	III/26

Content

1. Each apparatus must have a valid FIG Certificate

The definition of «Apparatus» for these Apparatus Norms is: All apparatus used at FIG competitions and listed in these Apparatus Norms.

Each apparatus, including all hand apparatus used in Rhythmic Gymnastics, must have its own, valid Certificate, to be used at FIG events, Olympic Games, World Games and international events.

For Olympic Games, World Championships, World Games and other multi-sports games (e.g. Commonwealth Games, Asian Games, Panam Games, University Games), the apparatus must have a valid certificate at least 1 year prior to the competitions. For all other competitions, the certificates must be valid at the latest at the moment of the invitation. Example: World Cup / World Challenge Cup: 3 months prior to the competitions.

2. Validity of the Certificate

The Certificates have a validity of two years. The expiry date is indicated on the certificate. The FIG may, at any time, prolong or shorten the validity of issued Certificates or withdraw a Certificate.

3. Rights of the Apparatus Manufacturer with a valid FIG Certificate

When receiving a FIG Certificate, the apparatus manufacturer obtains the following rights:

- The right that the respective apparatus may be used at all official events of the FIG, its Continental Unions and member federations, as well as at the Olympic Games and World Games.
- The right to use the designation and the logo «FIG Approved» together in the catalogue and other publicity material, as prescribed in the respective directives of the FIG. (see Appendix 1)
- The use of the sticker « FIG Approved » on the respective apparatus.
- **The list of certified apparatus is published on FIG's website.**
- **One free advertisement (1 page, black and white) in the FIG Bulletin.**

4. Procedure to obtain a FIG Certificate

From 1st July 2020, the manufacturers should pass the FIG Apparatus platform for the certification of all apparatus. The manufacturers should follow the platform user guide step by step:

- The manufacturer has to register the Apparatus on the FIG Apparatus database and to create a request on the FIG apparatus platform
- FIG approval of the request
- Declaration to be bound by the FIG's Statutes, Rules and Regulations as well as the provisions concerning governing law and arbitration has to be approved electronically on the FIG apparatus platform
- Declaration of safety regarding chemical additives and any other harmful material or substances has to be approved electronically on the FIG apparatus platform
- Issuing an invoice for the testing fee by FIG
- Upon receipt of the payment, testing at one of the FIG recognised Testing Institutes
- Practical test
- Issuing of an invoice for the certificate

- Issuing of the Certificate by the FIG

Apparatus manufacturers who wish an FIG Certificate have to confirm that they recognise and strictly follow the FIG Statutes, Rules and Regulations.

For their relationship with the FIG, the Testing Institutes, FIG's member federations, the Continental Unions and the organising committees, the apparatus manufacturer must accept to be governed by Swiss law and in case of disputes, to resolve such disputes to the exclusion of the ordinary courts by arbitration.

Apparatus manufacturers who wish to obtain a certificate, must to confirm the following in the Apparatus registration process:

“We herewith confirm unequivocally to respect and strictly follow the FIG Statutes, Technical Regulations, Code of Points, Apparatus Norms including the Code of Auto discipline, the Rules for Advertising and Publicity the Accreditation Rules, the Directives and Work plans of the competitions and all other Rules and Regulations published on FIG’s website. This commitment is valid as long as we have a valid Certificate.

All disputes arising out of or in connection with the Apparatus Norms, the testing and/or certification of our apparatus and in the relationship with the FIG, or one of their recognised Testing Institutes, Member Federations or Organising Committees shall be resolved, to the exclusion of the ordinary courts by an Arbitration Tribunal constituted in accordance with the Statutes and Regulations of the Court of Arbitration of Sport in Lausanne, Switzerland. We hereby undertake to comply with the said Statutes and Regulation, and to enforce in good faith the award to be rendered. The decision of the Arbitration Tribunal shall be final and binding on the parties.”

4.1. Declaration of safety regarding chemical additives and any other harmful material or substances

Apparatus manufacturers who wish to obtain a certificate, must to confirm the following in the Apparatus registration process:

“We herewith confirm that all our products do not contain any known hazardous or harmful substances, material, and chemical additives, including phthalates in a concentration exceeding the maximum concentrations admitted by the Swiss and EU legislation for products manufactured in Switzerland or within the European Economic Area and that they are of no health risk whatsoever for the intended use.

We hereby agree to defend, indemnify and hold harmless the FIG, its representatives, employees, consultants and members from and against all claims, demands, losses, costs including judicial and extrajudicial costs arising from any legal action, damages, actions, suits or proceedings and by whomever made, bought, or prosecuted and in any manner based upon resulting from any misrepresentation or breach of this declaration by us, our representatives, employees, agents, suppliers or sub-contractors”.

4.2. Testing by a FIG recognised Testing Institute

Following the procedure of register the Apparatus to be tested in FIG Apparatus database, the equipment should be sent to the chosen test institute recognised by the FIG.

All costs in connection with the testing (transport and testing fee) are the responsibility of the apparatus manufacturer and have to be paid prior to the tests. (Testing fees see Appendix 4).

Only after the FIG Headquarters has confirmed the completeness of the documentation and the payments is the applicant and the Test Institute granted permission to initiate all further preparations for the laboratory test (authorization given through FIG Apparatus database).

The Testing Institute tests the apparatus following the norms and testing procedures and prepares and uploads a test report in the FIG Apparatus database. Manufacturers can raise an objection against descriptions and dimensions of their equipment in the test report within a period of 2 weeks after receiving the report.

For equipment with no existing test procedures the testing is done by the responsible Technical Committee after presentation of the confirmation according to 4.4. All costs are the responsibility of the apparatus manufacturer. The testing shall be announced to the FIG Secretary General.

4.3. Practical Test

After a successful laboratory test, the apparatus needs to be tested practically by gymnasts and coaches in order to get a FIG certificate. For this purpose, the FIG Apparatus database assigns ten several FIG's member federations. The manufacturers should choose between them one country to conduct the practical test. The test should be conducted in a training centre by elite gymnasts. The apparatus must be tested under competition conditions. The manufacturer must upload a confirmation signed by the President or Secretary General of the respective member federation(s) to FIG Apparatus database, containing the following:

"We confirm to have tested apparatus X under competition conditions at our training centre and/or at competitions. The apparatus is of the best quality, safe and suitable to be used at international competitions. We recommend that the FIG initiates the necessary procedures that this apparatus may be used at future international events."

4.4. Issuing of FIG Certificates

The FIG Certificate will be issued by the Secretary General, provided the following conditions are met:

- Confirmation / declaration from the manufacturer to recognise the FIG Statutes, Rules and Regulations and confirmation concerning applicable law and arbitration (see 4.1)
- Declaration of safety regarding chemical additives and any other harmful material or substances (see 4.2)
- A positive test report from one of the FIG recognised Testing Institutes (see 4.3).
- The confirmation/recommendation from a member federation concerning the practical test (see 4.4).
- Payment of the test fee and the Certificate fee.

5. Testing fees of the FIG recognised Testing Institutes

The testing fees must be approved by the FIG and must be identical at all FIG recognised Testing Institutes. The testing fees valid at this time are published in Appendix 4.

The Testing Institutes invoice the Apparatus Manufacturer directly with the testing fees and taxes and must be prepaid.

6. Fee for the Certificate

The fee to be paid to the FIG to obtain a Certificate and the attached rights are listed in Part III, [point 18](#).

This fee is decided by the Executive Committee and may be adjusted every two years if necessary.

This fee must be paid by the Apparatus Manufactures in advance to the FIG.

7. Publication of FIG certificates



The FIG regularly publishes a list of the valid Certificates including the period of validity.

8. Renewal of the Certificates

After the first period of validity (2 years) a Certificate may be prolonged maximum twice for another period of two years by paying the fee without testing, provided the norms and/or testing procedures for the respective apparatus have not changed in the meantime and that the apparatus has not led to any complaints during the validity of the Certificate.

If the construction of the apparatus or the functional properties have changed, the apparatus has to undergo a practical test (see 4.4) as well as by a Testing Institute (see 4.3).

In case of small modifications which do not affect the functional properties or would not lead to a different test results, the FIG may dispense the apparatus manufacturer from practical testing. In cases of doubt, the Secretary General takes a final decision in consultation with the FIG Test Institute and the President of the Apparatus Commission.

To renew a certificate the apparatus manufacturer should make the request through to the FIG Apparatus platform. This request must include the confirmation of the following three statements:

“We confirm that the construction of the apparatus and the functional properties have not changed since the last successful test!”

“We confirm that the materials used are the same and have the same functional properties as those used for the last successful test!”

“We confirm that our apparatus has been adapted to the apparatus norms valid today!”

The FIG may require a re-test or refuse the prolongation.

9. Obtaining a certificate without testing for apparatus produced by another manufacturer

Apparatus manufacturers and retailers may obtain an FIG certificate in their name to sell apparatus produced by another manufacturer according to the following conditions:

- Written approval from the apparatus manufacturer who has produced and tested his apparatus and has a valid certificate.
- Payment of the fee to the FIG for the requested certificate as per Art. 18 of Part III of the FIG Apparatus Norms
- The validity of the certificate cannot exceed the expiry of the original certificate of the manufacturer who has tested the apparatus
- The manufacturer who produces the apparatus may withdraw his approval at any time with written notification to FIG
- The certificate cannot be extended without approval from the manufacturer who produces the apparatus

The description of the apparatus on the certificate must contain the name of the apparatus and an article number which is identical to the one listed in the catalogue. It must also bear the name of the manufacturer as well as the article number and name of the respective apparatus

10. Official FIG Partners

10.1. Requirements

To be an Official FIG Partner the Manufacturer shall fulfil one of the following requirements:

- To be in possession of 12 or more valid Certificates. The manufacturer remains Official FIG Partner as the manufacturer has 12 or more valid Certificates
- To have supplied equipment for at least two Olympic Games and six World Championships in the last four Olympic cycles.



10.2. Rights of FIG Official

- The right to have two VIP accreditations to the official FIG Competitions
- The right to attend the FIG Congress (2 accreditations)
- The right to bear the designation «Official FIG Partner» and to use this on his letter head and promotional material
- The right, to use the FIG Logo in accordance to the Appendix 1
- A free advertisement in the FIG Bulletin (1 page)
- To be mentioned in a composite page together with Official FIG Partners and Official Sponsors, this is published in the Code of points of all disciplines, in the online Bulletin, in the Apparatus Norms, in the Yearbook, in the Directory and on the FIG website

11. Reward for the suppliers of World Championships

Apparatus manufacturers who have supplied the apparatus for the World Championships alone or with a maximum of one other manufacturer may request a confirmation from the FIG as «Official Supplier of the «World Championships XXX»»). This confirmation may be used for publicity purposes, following the respective Directives of the FIG, (see Appendix .1)

12. New Apparatus, Modified Apparatus, New Developments

Those are defined as follows:

- New apparatus which are not included in the Apparatus Norms
- Apparatus which are listed in the Apparatus Norms, but which have been significantly modified in their form, functional properties or development

Before the manufacturer constructs a prototype, the FIG recommends that the President of the Apparatus Commission and/or the respective TC President be contacted to find out if such a new apparatus is desired.

If this is confirmed, a prototype can be constructed and presented to the FIG.

Upon recommendation of the respective TC and the Apparatus Commission, the Executive Committee may decide on a general practical test. For such a test, the EC invites manufacturers to produce prototypes and to have those tested at the same time in 4-5 training centres chosen by the FIG. The costs are the responsibility of the apparatus manufacturers interested in the project. After analyses of the test results the Apparatus Commission - in cooperation with the respective TC and the other FIG Commissions - makes the necessary proposals to the EC for the further procedure regarding the possible introduction of the new apparatus.

13. FIG Sticker «FIG APPROVED»

Apparatus manufacturers who are in possession of a valid FIG Certificate have the right to stick or print the « FIG Approved » sticker on the respective apparatus. The sticker can be received from the FIG free of charge. «FIG Approved» is also available by electronic support. For colours and size see Appendix 1.

14. Control of Apparatus at the competitions

Re-testing of apparatus by the FIG at the Testing Institute

At the official events of the FIG, as well as at the Olympic Games and World Games, the apparatus are officially controlled on site. This control mainly consists of checking the measurements, making sure that the apparatus used at the competition is identical to the tested one, as well as a control of the layout, safety zones and matting. The apparatus manufacturer is responsible that those delivered apparatus are 100% identical to the one tested in respect of the material used as well as the construction. The apparatus manufacturers are fully responsible that the norms are strictly respected; the correct setting up of the apparatus is the responsibility of the organising committee.

The FIG has and reserves the right to re-test apparatus before, during and after an event at the nearest recognised Testing Institute. In case the testing report is positive, all costs are at the charge of the FIG. In case the report is negative, the costs are at the charge of the apparatus manufacturer. Furthermore, the validity of the Certificate is immediately withdrawn. The Disciplinary Commission decides about the duration of a ban against the respective manufacturer. Afterwards, the manufacturer may apply Certificate to be issued by the FIG **in accordance with the present rules**

15. FIG recognised Testing Institutes

The following Testing Institutes are recognised by the FIG at this time:

- GymLab (GER)
- Tokyo Institute of Technology (JPN)

For addresses, contact person, delivery addresses etc. see **Appendix 2**

All Testing Institutes charge the same testing fee. (See Appendix 4)

The testing fees must be approved by the FIG.

The Testing Institutes are absolutely neutral and must strictly follow the FIG testing procedures. Testing equipment and conditions must be equal at all Testing Institutes.

It is the goal that all Testing Institutes are able to test all apparatus.

Appendix 3 lists which institute can test which apparatus.

Part IV of the Apparatus Norms also gives the necessary information about how many apparatus, m2 or m of the respective apparatus must be supplied for testing purposes.

16. Publicity and apparatus manufacturer's logo on the apparatus

See FIG Rules for Advertising and Publicity.

17. Waiver of Liability

With these Apparatus Norms, the FIG and its member federations, as well as the Testing Institutes are in no way responsible for the apparatus. The FIG, its member federations and the Testing Institutes waive all liability in connection with the use of apparatus described in these Apparatus Norms.

18. Current Fees for FIG Certificates

The following fees for Certificates are applied:

The fee to be paid to issue a Certificate for the first time or to renew a Certificate depends on the number of valid Certificates a manufacturer already has

Number of Certificates held Fee in EURO per Certificate

1	6'500
2 - 3	5'200
4 - 5	3'900
6 - 7	2'600
8 - 9	1'300
10 - 11	1'040
12 and more	780

19. Code of Auto discipline

A "Code of Auto discipline" has been elaborated by the Apparatus Commission and approved by the FIG Executive Committee in order to determine the rules, concerning the manufactures relations with the FIG and between themselves.

The rules envisaged in the Auto discipline Code are applied automatically to each infraction of the Apparatus Norms in force.

See Appendix 5

III
01.01.2016

APPENDIX 1

DIRECTIVES / REGULATIONS FOR THE USE OF OFFICIAL FIG DESIGNATIONS AND LOGOS

1. General Principles

- 1.1. The designations and logotypes/logos which are presented in this document are property of the *Fédération Internationale de Gymnastique (FIG)*. Their use requires the FIG's authorization. Any illegal use or non-conformity with these directives will be prosecuted and results in the withdrawal of the certificate or diploma.
- 1.2. The **acquisition** conditions for these designations which are reserved for the FIG partners are included in the brochure "Apparatus Norms" published by the FIG.
- 1.3. The **use** of these designations and logotypes/logos which are reserved for the FIG partners is prescribed in this appendix.
- 1.4. The general graphic prescriptions are defined in the FIG Graphics Chart.
- 1.5. The graphic prescriptions reserved for the use of the FIG apparatus manufacturers are included in this appendix.
- 1.6. The use of any designation or logotype/logos other than those mentioned in this appendix is strictly prohibited.
- 1.7. Any other reference to "FIG", use of the abbreviation "FIG" (or "Fédération Internationale de Gymnastique" in any language) as well as wordings such as "following FIG Norms", "in the process to be tested" etc. are strictly prohibited.

2. Definitions

These directives regulate the different rights of the three apparatus manufacturer categories as follows:

- 2.1. Holder of the "**FIG-Certificate**"
- 2.2. Holder of the "**FIG-Diploma**"
- 2.3. Holder of an FIG confirmation as
"Official Supplier of the World Championships"





Appendix 1

3. Holder of the FIG-Certificate

The holder of the "FIG Certificate" may use the logotype "**FIG Approved**" respecting the following conditions:

- 3.1. The logotype may only and exclusively be associated with only one element respectively one single article, apparatus or accessory duly certified by the FIG.
- 3.2. It may be used on an article respectively an apparatus or an accessory itself or it may be integrated in any type of advertising or publicity but only **in direct connection or relation** with the respective certified apparatus. The logotype may also appear in a description of the certified apparatus (advertisement, publicity leaflet etc.)
- 3.3. **It may not be used as an isolated element, separate from the apparatus.**
- 3.4. Consequently, it may not appear on letter heads, cover pages of catalogues, or in editorial articles with advertising purposes, nor in any other institutional documents containing general information.

3.5. Graphics

3.5.1. Logotype FIG Approved: (respect the size as per 3.6.1)



3.5.2. Colours

According to the range defined by the FIG Graphics Chart.

- **Black**
- **Blue Pantone 3005 U**
- **Red Warm red CV**

3.6. Use and size / Maximum dimensions

3.6.1.

On printed matters

	Formats: A5	14.8 x 21.0 cm	ø 08 mm max.
	A4	21.0 x 29.7 cm	ø 12 mm max.
	A3	29.7 x 42.0 cm	ø 18 mm max.
	A2	42.0 x 59.4 cm	ø 35 mm max.
A1	59.4 x 84.1 cm	ø 60 mm max	

III
01.01.2016

Appendix 1

3.6.2. On the apparatus

The logotype "**FIG Approved**" may only be applied to the support surfaces (supports, legs of apparatus) of the apparatus. Maximum diameter is 35 mm.

On the floor and on the mats the logotype may appear in one of the four corners with a maximum distance of 5 cm to the corner or on the side of the floor/mat with the exception of the surfaces which are reserved for advertising purposes as defined in the "FIG Rules for Advertising and Publicity ". Maximum diameter is 35 mm.

On the apparatus for rhythmic gymnastics the logotype/sticker "**FIG Approved**" is described in RG, 2, 3, 4, 5, 6 and 7 pages 70/71 in chapter II of the FIG Apparatus Norms.

4. Holder of the FIG Diploma

- 4.1. The right to use the designation "**Official FIG Partner**" subject to article 1.5 of the "FIG Rules for Advertising and Publicity".
- 4.2. The right to use the **FIG Logo** for advertising purposes only, strictly respecting the FIG Graphics Chart.

In addition to the rights listed in chapter 3, the holder of a FIG Diploma obtains:

FIG Logo:



- 4.3. The title "Official FIG Partner" and the FIG logotype may by no means be used directly attached to or with a product but only with the **company name or identity** of the holder of the FIG Diploma. (e.g.: letter heads, envelopes, cover pages of catalogues, various kinds of printed material, newsletters, "give aways" etc.)

III
01.01.2016

Appendix 1

Holder of an FIG confirmation as "Official Supplier for the World Championships"

1. The apparatus manufacturer who has been duly confirmed by the FIG may use the designation

"Official Supplier of the World Championships X"

2. The use of the above-mentioned designation (for advertising purposes only) can only be associated with the supplied apparatus and also with the company name of the manufacturer. (e.g.: letter heads, envelopes, cover pages of catalogues, various kinds of printed material, newsletters, "give aways" etc.)
3. The above-mentioned designation may be used together with the FIG logotype according to the regulations of the FIG Graphics Chart and within the following dimensions:
4. Formats:

A5	14.8 x 21.0 cm	Ø 8 mm max.
A4	21.0 x 29.7 cm	Ø 12 mm max.
A3	29.7 x 42.0 cm	Ø 18 mm max.
A2	42.0 x 59.4 cm	Ø 35 mm max.
A1	59.4 x 84.1 cm	Ø 60 mm max.

Recommendation

We strongly recommend that the holder of a certificate should send his drafts of all printed matters to the FIG to be proof-read prior to printing.

III
01.01.2019

APPENDIX 2

Fig Recognised Testing Institutes Addresses and Contact Persons

GymLab GmbH
 Fritz-Schieler-Strasse 1
 D-79331 TENINGEN
 Germany

e-mail daniel.fesser@gymlab.com

Contact Person Daniel Fesser

Tokyo Institute of Technology
 Faculty of Engineering
 Department of Architecture and Building Engineering
 FIG Norm Testing Laboratory (Ono Lab.)
 2-12-1 O-okayama
 Meguro-ku
 Tokyo 152-8552
 Japan

Fax +81 3 5734 3164

Phone +81 3 5734 3164

E-mail mikami@mei.titech.ac.jp

Contact Person Takamasa Mikami

APPENDIX 3

FIG RECOGNISED TESTING INSTITUTES

What can be tested where?

MAG	Apparatus	Code	Test Procedure	GymLab	Tokyo
	Floor	MAG1	Complete Test	√	√
	Pommel Horse	MAG2	Complete Test	√	√
		MAG2-1	Shock Absorption	√	√
		MAG2-2	Top Friction of Horse Body	√	√
		MAG2-3	Pos. Stability of Pommels	√	√
		MAG2-4	Friction of Pommels	√	√
	Rings	MAG3	Complete Test	√	√
	Vaulting Table	MAG4	Complete Test	√	√
	Parallel Bars	MAG5	Complete Test	√	√
		MAG5-1	Static traction stress	√	√
		MAG5-2	Stress by pendulum swing	√	√
		MAG5-3	Oscillation damping	√	√
		MAG5-4	Lateral stability	√	√
	Horizontal Bar	MAG6	Complete Test	√	√
		MAG6-1	Static traction stress	√	√
		MAG6-2	Stress by pendulum swing	√	√
		MAG6-3	Oscillation damping	√	√
	Landing Mat 20cm	MAG11	Complete Test	√	√
	Landing Mat 10cm	MAG12	Complete Test	√	√
	Vaulting Board	MAG14	Complete Test	√	√
	Tension Control Sensor	MAG18	Complete Test	√	√
WAG	Apparatus	Code	Test Procedure	GymLab	Tokyo
	Vaulting Table	WAG1	Complete Test (see MAG4)	√	√
	Uneven Bars	WAG2	Complete Test	√	√
		WAG2-1	Static traction stress	√	√
		WAG2-2	Stress by pendulum swing	√	√
		WAG2-3	Oscillation damping	√	√
	Balance Beam	WAG3	Complete Test	√	√
		WAG3-1	Shock Absorption	√	√
		WAG3-2	Top Friction	√	√
	Floor	WAG4	Complete Test (see MAG1)	√	√
	Landing Mat 20cm	WAG11	Complete Test (see MAG11)	√	√
	Vaulting Board	WAG14	Complete Test (see MAG14)	√	√
	Tension Control Sensor	WAG18	Complete Test (see MAG18)	√	√
RG	Apparatus	Code	Test Procedure	GymLab	Tokyo
	Floor	RG1	Complete Test	√	√
		RG1-1	Shock Absorption	√	√
		RG1-2	Static stiffness	√	√
		RG1-3	Top Friction	√	√
	Hand Apparatus	RG2,3,4,5,6,7	Complete Test (each app)	√	√
TRA	Apparatus	Code	Test Procedure	GymLab	Tokyo
	Trampoline	TRA1	Complete Test	√	√
	Double mini-trampoline	TRA2	Complete Test	√	√
	Tumbling Track	TRA3	Complete Test	√	√
		TRA3-1	Shock Absorption	√	√
		TRA3-2	Top Friction	√	√
	Landing Mat 20cm	TRA11		√	√
	Vaulting Board	TRA14	Complete Test (see MAG14)	√	√
	TMD	TRA15	Complete Test	√	√
	HDMD	TRA16	Complete Test	√	√
	Landing mats 30 cm	TRA 17	Complete Test	√	√
ACRO	Apparatus	Code	Test Procedure	GymLab	Tokyo
	Floor	ACRO1	Complete Test (see MAG1)	√	√
	Landing Mat 20cm	ACRO11	Complete Test (see MAG11)	√	√
AER	Apparatus	Code	Test Procedure	GymLab	Tokyo
	Floor	AER1	Complete Test	√	√
	Aerobic Step	AER2	Complete Test	√	√

APPENDIX 4

TESTING FEES OF THE FIG RECOGNISED TESTING INSTITUTES

Apparatus	Code	Test Procedure	Charge
Floor	MAG1		€ 5200.-
Pommel Horse	MAG2	Complete Test	€ 4680.-
	MAG2-1	Shock Absorption	€ 2600.-
	MAG2-2	Top Friction of Horse Body	€ 780.-
	MAG2-3	Pos. Stability of Pommels	€ 520.-
	MAG2-4	Friction of Pommels	€ 780.-
Rings	MAG3		€ 2600.-
Vaulting Table	MAG4		€ 4680.-
Parallel Bars	MAG5	Complete Test	€ 6760.-
	MAG5-1	Static traction stress	€ 780.-
	MAG5-2	Stress by pendulum swing	€ 2600.-
	MAG5-3	Oscillation damping	€ 2600.-
	MAG5-4	Lateral stability	€ 780.-
Horizontal Bar	MAG6	Complete Test	€ 7410.-
	MAG6-1	Static traction stress	€ 780.-
	MAG6-2	Stress by pendulum swing	€ 4420.-
	MAG6-3	Oscillation damping	€ 2210.-
Landing Mat 20cm	MAG11		€ 2600.-
Landing Mat 10cm	MAG12		€ 2600.-
Vaulting Board	MAG14		€ 3900.-
Tension Control Sensor	MAG18		€ 1750.-
Apparatus	Code	Test Procedure	Charge
Vaulting Table	WAG1		See MAG4
Uneven Bars	WAG2	Complete Test	€ 8840.-
	WAG2-1	Static traction stress	€ 1040.-
	WAG2-2	Stress by pendulum swing	€ 5200.-
	WAG2-3	Oscillation damping	€ 2600.-
Balance Beam	WAG3	Complete Test	€ 3380.-
	WAG3-1	Shock Absorption	€ 2600.-
	WAG3-2	Top Friction	€ 780.-
Floor	WAG4		See MAG1
Landing Mat 20cm	WAG11		See MAG11
Vaulting Board	WAG14		See MAG14
Tension Control Sensor	WAG18		See MAG18
Apparatus	Code	Test Procedure	Charge
Floor	RG1	Complete Test	€ 5200.-
	RG1-1	Shock Absorption	€ 2600.-
	RG1-2	Static stiffness	€ 520.-
	RG1-3	Top Friction	€ 2080.-
Hand Apparatus	RG2,3,4,5,6,7	Complete Test (each apparatus)	€ 650.-
Apparatus	Code	Test Procedure	Charge
Trampoline	TRA1		€ 5200.-
		Spring test (1 Spring)	€ 325.-
Double mini-trampoline	TRA2	Complete Test	€2000.-
Tumbling Track	TRA3		€ 4420.-
	TRA3-1	Shock Absorption	€ 3120.-
	TRA3-2	Top Friction	€ 1300.-
Landing Mat 20cm	TRA11		See MAG11
Vaulting Board	TRA14	Complete Test (see MAG14)	See MAG14
TMD	TRA15	Complete Test	€ 2600.-
HDMD	TRA16	Complete Test	€4000.-
Landing Mat 30cm	TRA17	Complete Test	€ 2600.-
Apparatus	Code	Test Procedure	Charge
Floor	ACRO1		See MAG1
Landing Mat 20cm	ACRO11		See MAG11
Apparatus	Code	Test Procedure	Charge
Floor	AER1		€ 2600.-
Aerobic Step	AER2		€ 650.-

Prices indicated net of Value Added Tax (VAT). Invoicing is made according to the applicable VAT regulation



Appendix 4

TESTING FEES OF THE FIG RECOGNISED TESTING INSTITUTES

Firms can obtain a discount on the testing fees provided that they own 4 or more certificates from the FIG. The percentage of discount depends on the number of certificates:

Number of Certificates	Discount
4 - 5	10%
6 - 7	20%
8 - 9	30%
10 - 11	40%
12+	50%

III
01.01.2018

APPENDIX 5

Code of Auto discipline

I. General

- The present code has been elaborated by the Apparatus Commission and approved by the FIG Executive Committee in order to determine the rules, concerning the manufactures relations with the FIG and between themselves. The following should also be taken into account: The Technical Regulations, the manual «FIG Apparatus Norm, Part I-IV», the Code of Ethics and the Advertising and Publicity Rules.
- The rules envisaged in the Auto discipline Code are applied automatically to each infraction of the rules in force. Modifications to the present code may only be made by the FIG Executive Committee, upon request of the TCs, the Apparatus Commission or the FIG Partners.

IV. List of possible infractions against the FIG Apparatus Norms and other FIG Rules and Regulations and Sanctions applied by the FIG

General Infractions:

- Selling and/or offering certified apparatus without a valid certificate (certificate expired) (1st offence)
*Written warning +
Rectify the offer (notification of the customer(s) by the manufacturer with copy to the FIG +
Fine of Euro 2,000.-*
- Same as above but 2nd offence.
*Rectify the offer (notification of the customer by FIG) +
Fine of Euro 5,000.-*

III
01.01.2018

Appendix 5

Code of Auto discipline

- Selling and/or offering certified apparatus without a valid certificate (certificate not yet or never issued)
*Written warning +
Rectify his offer (notification of the customer(s) with copy to FIG)+
FIG may inform client(s) +
Fine of Euro 2,000. - +
Publication of the sanction*
- Same as above, but 2nd offence.
*Written warning +
Rectify his offer (notification of the customer(s)+
FIG informs client(s) +
Fine of Euro 5,000. - +
Publication of the sanction +
If FIG Partner, loss of status for 1 year*

- Testing an apparatus and selling and/or deliberately offering a different apparatus or construction or modified apparatus than the tested prototype.
Withdrawal of the respective certificate for 1 year +
New test required +
Fine of Euro 5'000.- +
Publication of the sanction.
- Same as above, but 2nd offence.
Withdrawal of certificates for 2 years +
New tests required +
Fine of Euro 10,000.- +
Publication of the sanction.
- Wrong statements to FIG concerning “unchanged” equipment
Withdrawal of the respective certificate for one year +
New test required +
Fine of Euro 5,000.- +
Publication of the sanction.
- Same as above, but 2nd offence.
Withdrawal of certificates for 3 years +
New tests required +
Fine of Euro 10,000.- +
Publication of the sanction.

Infractions committed at FIG events

- Selling, renting, sponsoring, offering, delivering, installing etc, not certified apparatus (not certified at all, expired certificate or different apparatus from the tested one) for use at an FIG event and events where FIG Certified equipment is requested.
Immediate rectification whenever possible +
Withdrawal of the respective certificate for one year +
New test required +
Fine of Euro 3,000.- +
Publication of the sanction.

III
01.01.2018

Appendix 5

Code of Auto discipline

- Same as above but 2nd offence.
*Immediate rectification whenever possible +
Withdrawal of certificates for 2 years +
New tests required +
Fine of Euro 6,000.- +
Publication of the sanction.*
- Lack of quality of apparatus used at FIG events
FIG may take the apparatus and send it for testing
- Lack of quality of apparatus used at FIG events (Apparatus does not pass the test after an event)
*Withdrawal of the respective certificate for one year +
New test required +
Fine of Euro 2,000.- +
Publication of the sanction.*
- Same as above but 2nd offence
*Withdrawal of the respective certificate for 2 years +
New test required +
Fine of Euro 5,000.- +
Publication of the sanction.*
- Infraction against size of Manufacturers Logo and/or Advertising on apparatus
*Immediate rectification +
Written warning*
- Same as above but 2nd offence
*Immediate rectification +
Written warning +
Fine of Euro 500.-*
- Infraction against placement of Manufacturers Logo on apparatus
*Immediate rectification+
Written warning*
- Same as above but 2nd offence
*Immediate rectification +
Written warning +
Fine of Euro 500.-*
- Repeated infractions against size and / or placement of Manufacturers Logo
(3rd and more cases)
*Immediate rectification +
Fine of Euro 5,000.-*
- Placement of Manufacturers Logo or anything else in the Advertising Area.
*Immediate rectification +
Written warning*
- Same as above but 2nd offence
*Immediate rectification +
Written warning +
Fine of Euro 1,000.-*

III
01.01.2018

Appendix 5

Code of Auto discipline

- Distribution of presents, PR, or other advertising and publicity items to competitors and or officials (FIG or Member Federations) without written approval of FIG at FIG events.
*Immediate stop of action +
Written warning*
- Same as above but 2nd offence
*Immediate stop of action +
Written warning +
Fine of Euro 2,000.-*
- Placing of advertising and publicity in the competition hall other than the standard advertising boards as foreseen in the Rules for Advertising and Publicity without the written approval of FIG
*Immediate stop of action and rectification +
Written warning*
- Same as above but 2nd offence
*Immediate stop of action and rectification +
Written warning +
Fine of Euro 1,000.-*
- Other infractions against the Rules for Advertising and Publicity
Similar sanctions as mentioned above, depending on the severity of the infraction.

Catalogues / Publicity / Flyers / Printed Matters / Advertising etc.

- Using the abbreviation FIG in any way for not FIG certified apparatus, suggesting or giving the wrong impression of a relationship with FIG.
*Immediate stop of action, rectification and notification of the customers with copy to the FIG +
FIG may notify customer(s) +
Written warning*
- Same as above, but 2nd offence.
*Immediate stop of action, rectification and notification of the customers
With copy to the FIG +
Written warning +
FIG to notify customers +
Fine of Euro 5,000.-*
- Using the FIG logo without being an FIG partner
*Immediate stop of action, rectification and notification of the customers with copy to the FIG +
Written warning*
- Same as above, but 2nd offence.
*Immediate stop of action, rectification and notification of the customers with copy to the FIG +
Written warning +
Fine of Euro 5,000.-*
- Using the logo “FIG Approved” for not certified apparatus.
*Immediate stop of action, rectification and notification of the customers with copy to the FIG +
Written warning*
- Same as above, but 2nd offence.
*Immediate stop of action, rectification and notification of the customers with copy to the FIG +
Written warning +
Fine of Euro 5,000.-*

III
01.01.2018

Appendix 5

Code of Auto discipline

- Not respecting the size of the FIG logo or FIG Approved logo.
*Immediate stop of action and rectification +
Written warning*
- Same as above, but 2nd offence.
*Immediate stop of action and rectification+
Written warning+
Fine of Euro 500.-*
- Repeated offence as mentioned above.
(3 and more cases)
*Immediate stop of action and rectification+
Written warning +
Fine of Euro 2,000.--*
- Not using the FIG Approved logo directly attached to the respective product, thus giving the impression that other not certified products could also be FIG Approved.
*Immediate stop of action, rectification and notification of the customers with copy to the FIG +
Written warning*
- Same as above, but 2nd offence.
*Immediate stop of action, rectification and notification of the customers with copy to the FIG +
Written warning +
Fine of Euro 5,000.-*
- Infractions of clients (retailers) of an FIG Manufacturer or FIG Partner misusing the word FIG, the FIG Logo or the logo FIG Approved
*Immediate stop of action, rectification and notification of the customers with copy to the FIG +
Written warning +
FIG informs the FIG Manufacturer*
- Same as above, but 2nd offence or not following FIG's requests at the time of the 1st Offence,
*Immediate stop of action, rectification and notification of the customers with copy to the FIG +
Written warning+
Fine of Euro 1,000.- +
FIG requests FIG Manufacturer to no longer sell their products to the respective client. Manufacturer's Certificate will be withdrawn by FIG if the problem remains.*
- Giving the impression of FIG approval or certification by using misleading wording such as e.g. "meets FIG specs", or "following FIG rules" or similar.
*Immediate stop of action, rectification and notification of the customers with copy to the FIG +
Written warning*
- Same as above, but 2nd offence.
*Immediate stop of action, rectification and notification of the customers with copy to the FIG +
Written warning +
Fine of Euro 1,000.-*
- Reference to "old" and/or no longer valid certificates or former Diplomas
*Immediate stop of action, rectification and notification of the customers with copy to the FIG +
Written warning*

III
01.01.2018

Appendix 5

Code of Auto discipline

- Same as above, but 2nd offence.
*Immediate stop of action, rectification and notification of the customers with copy to the FIG +
Written warning +
Fine of Euro 5'000.- +
Possible withdrawal of other certificates*
- Using falsified certificates
*Immediate stop of action, rectification and notification of the customers with copy to the FIG +
FIG may inform customer(s)
Fine of Euro 10,000.-
Publication of the sanction*
- Same as above, but 2nd offence.
*Immediate stop of action, rectification and notification of the customers +
Fine of Euro 20,000.- +
Withdrawal of all Certificates for a time to be defined by FIG.
Publication of the sanction*
- NOT FOLLOWING OR RESPECTING SANCTIONS
Action and further sanctions to be taken at the discretion of FIG.
- Infractions not listed above
The FIG will take action and sanctions as deemed necessary at its discretion, following in principle similar cases listed above

In addition to all the fines and sanctions listed above, the FIG reserves the right to take additional action as deemed necessary.

V. Procedure in case of Infractions and Sanctions

Infractions may be observed by all concerned (Apparatus Manufacturers, FIG Officials and third parties). Such observations must be given in writing to the FIG Secretary General.

The Secretary General will then take the necessary actions.

Written warnings are treated and decided by the Secretary General.

Immediate actions and decisions for infractions committed during FIG events are taken by the Secretary General and in his absence by his representative or the President of the Superior Jury. If he deems necessary, he will then forward the case to the FIG Disciplinary Commission for further action.

The Secretary General will report all warnings to the Apparatus Commission.

Offences with fines are treated by the FIG Disciplinary Commission.

The FIG Secretary General will keep a list of all offences warnings and sanctions. This list will include the date of the offence.

The 1st offences will be considered as deleted after the following time period:

- Written warnings and offences with up to and including Euro 1,000.-
- after 1 Olympic Cycle.
- Offences with fines up to and including Euro 5,000.- after 2 Olympic cycles
- Offences with fines over Euro 5,000.- after 3 Olympic cycles

All fines will be credited to the FIG Development Fund.

III
01.01.2018

Appendix 5 Code of Auto discipline

VI. Appeal against Sanctions

- Warnings decided by the FIG Secretary General:

The Apparatus Manufacturers may make an appeal against decisions of the Secretary General to the FIG Disciplinary Commission.

No further appeal is possible. The decision of the FIG Disciplinary Commission is final.

- Decisions taken by the FIG Secretary General for concerning infractions during an FIG event:

The Apparatus Manufacturers may make an appeal against decisions and actions taken by of the Secretary General to the Jury of Appeal of the respective competition.

No further appeal is possible. The decision of the Jury of Appeal is final.

- Sanctions decided by the FIG Disciplinary Commission

The Apparatus Manufacturers may make an appeal against the decision taken by the FIG Disciplinary Commission as follows:

instance of appeal: FIG Appeal Tribunal

Appeals must be made in writing within 21 days and sent to the President of the instance concerned with a copy to the FIG Secretary General.

Depending on the outcome of the appeal, the Disciplinary Commission and the Appeal Tribunal will decide who has to bear the costs.

The procedures and costs for appeals to the Disciplinary Commission and the FIG Appeal Tribunal are ruled in the FIG Code of Discipline.

VII. Rules for the distribution of the Letter of Recognition

- FIG Letter of Recognition to be given to the official manufactures for the excellence of their work.
- A special FIG diploma will be given to the official supplier of 3 World Championships in 2 Olympic cycles.
- A special recognition FIG plate is to be attributed for service rendered to the development of gymnastics in the capacity of FIG partner and for the good relations with the other manufactures.

III

APPENDIX 6

Intermediate Rules

MAG/WAG 18: TCS

The use will be regulated as follows from 2025:

- Compulsory for Olympic Games, World Championships and World Cups.
- Highly recommended for all other competitions.

WAG 2: Uneven Bars:

Transition periods for different technical solutions and maximal inner diagonal distances between the bars for 10 cm height increase to the standard height, upon request of taller athletes only:

Transition period	10 cm Height Adaption by	Maximal inner diagonal Distance between Bars (cm)
<i>From 2023-01-01 to 2025-12-31</i>	<i>a) 10 cm Blocks underneath the base b) 10 cm height increase at the stands)*</i>	<i>183± 1 cm</i>
<i>From 2026-01-01 on</i>	<i>10 cm height increase at the stands)*</i>	<i>183± 1 cm</i>

* : provided that this technical solution is homologated by passed FIG standardization tests

Impressum

Edition 2023:

Publisher Fédération Internationale de Gymnastique

Responsible FIG - Apparatus Commission

Drawings GymLab / Daniel Fesser / Ludwig Schweizer

© Fédération Internationale de Gymnastique

