



# PURELAB<sup>®</sup> Innovation and Flexibility

Lab Water Purification Solutions  
for your Research Needs



At ELGA we are experienced in meeting the challenges that arise during the development, installation and servicing of single point-of-use purification systems as well as large projects involving consultation, consultants and clients.

## ELGA. The LabWater Specialists

We are the LabWater Specialists. We have been working with scientists since 1937 to guarantee ultrapure and pure water for their experiments and lab work. We resource science and healthcare markets for a better world by bringing the world's leading scientists a critical reagent.

*Why choose ELGA as your laboratory water partners?*

- ✓ **Customer-focused – what we create is for our customer**  
Our commitment to developing and providing you with ultrapure water means that you can focus and concentrate on obtaining accurate and reliable results.
- ✓ **Innovative – the keystone of our thinking**  
Our UK R&D facilities are always looking to provide products dedicated to supplying you with the right water quality for your application.
- ✓ **Sustainable – at the forefront of all of our activities**  
Our products are designed to have the lowest possible impact on the environment at all stages: manufacture, in service and at end of life. We can calculate the carbon value of all our products through their lifetime.
- ✓ **British Engineered – the standard for all our products**  
All our systems are manufactured in the UK and we are accredited to ISO:9001 and ISO:14001 standards.

### Our Awards



reddot design award  
winner 2011



dba design effectiveness  
award winner



GOOD DESIGN  
AWARD 2014

## A trusted brand delivering you choice

We understand how important it is for scientists to obtain a choice of water qualities that range from RO grade for simple routine washing and rinsing, through to ultrapure water for the most critical applications.

With this in mind, we have applied our expertise, gained since 1937 in water purification innovation to design the unrivalled PURELAB range. Our reliable water purification systems are constructed from the highest quality components to ensure optimal purity, while a rapid and easy sanitization program contributes towards an uninterrupted workflow. Built-in economical processes results in the lowest consumables costs with the highest water quality and precision.

At ELGA we do not speculate or work on assumptions about your water quality. On our first visit to your laboratory we will carry out a test, on site, that analyzes your feed water quality.

We understand that future needs change and so we have developed a unique and modular set of solutions that can grow as you and your lab grow. You do not need to feel restricted to one solution for the next 10 years.

## The Range



PURELAB Chorus 1 & Halo Dispenser



PURELAB Chorus 1 Complete



PURELAB Chorus 2+



PURELAB flex 1 & 2



PURELAB Chorus 2 & 3



PURELAB flex 3 & 4

*Type I+	Type I	Type II+	Type II	Type III
Resistivity <b>18.2 MΩ.cm</b>	Resistivity <b>&gt;18 MΩ.cm</b>	Resistivity <b>&gt;10 MΩ.cm</b>	Resistivity <b>1-10 MΩ.cm</b>  Conductivity <b>1-0.1 μS/cm</b>	Conductivity <b>1-50 μS/cm</b>
PURELAB Chorus 1	PURELAB Chorus 1 Complete  PURELAB flex 1, 2, 3 & 4	PURELAB Chorus 2+ (RO/EDI/UV)  PURELAB Chorus 2+ (RO/DI/UV)	PURELAB Chorus 2 (RO/DI)  PURELAB flex 1	PURELAB Chorus 3  PURELAB flex 1, 3 & 4

\*PureSure Technology/In-line filtration/Variety of purification packs

The various technologies used in ELGA equipment are able to remove impurities from water down to extremely low levels; some technologies focus on specific contaminants while others have a broader spectrum of targets. To achieve the correct water purity for a particular application, in a cost effective manner, technologies must be arranged in combination and their operation optimized.

## Activated Carbon

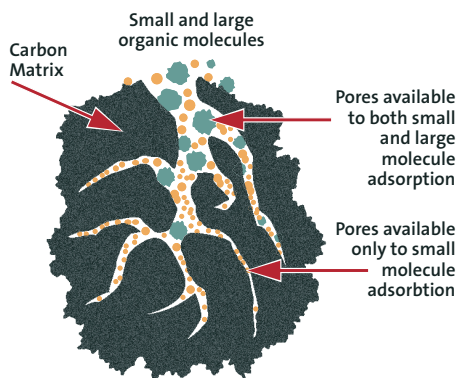

Contains a maze of tiny pores with sizes ranging from  $<0.1$ – $2.9$ nm and a surface area of about 1000 square meters per gram. The nature of this surface allows adsorption of organic impurities from the water and catalytic decomposition of free chlorine and, more slowly, chloramines.

It is applied in:

- Pre-treatment cartridges
- Composite Vent filters
- Final Purification cartridges

## Microporous Depth Filter

Pre-filtration using microporous depth filters, provides an entrapment/adsorption barrier for the removal of large suspended particles and some colloids from the water entering the ELGA purification process. Typically rated at  $5 - 10\mu\text{m}$  and combined with an activated carbon treatment, these filters act to protect subsequent RO systems from fouling and blockage.

## Reverse Osmosis

Reverse osmosis (RO) is a process where pressure is used to push water through a membrane filter in a cross-flow fashion. RO-membranes are extremely fine filters and reject water contaminants that are less than 1nm diameter. Typically  $>95\%$  of ionic impurity, most organic impurity, and nearly all particulates, bacteria and bio-molecules are removed from the permeate water; these are carried out of the RO module in a waste or concentrate water stream.

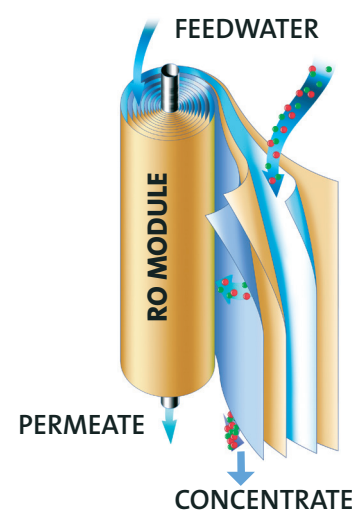

## Ion Exchange

---

Ion exchange resins are often used as part of a final treatment step. Single-use purification packs typically use a mixture of ion-exchange resins and other media. When used to deionize water, charged impurities are retained on these resins, while  $H^+$  and  $OH^-$  ions (which combine to form water) are released to replace them. This is a highly efficient process and can remove ions to give product-water resistivity of up to 18.2 M $\Omega$ .cm.

## Electrodeionization

---

Electrodeionization (EDI) combines ion-exchange resins and ion-selective membranes, which are used to move ionic impurities into a waste or concentrate water stream leaving purified product-water. As impurities leave via the concentrate water stream, their build-up does not exhaust the resin, and therefore prolongs resin lifespan. A single EDI unit may operate for many years before a replacement is required. Typically product water resistivity of >10 M $\Omega$ .cm is consistently achieved using this process. This technology can be used as an alternative to single-use purification cartridges.

## Ultraviolet (UV) Light

---

Treatment of water with UV-C light is used to photo-oxidise organic impurities and/or inactivate micro-organisms. Photo-oxidation of organic impurities results in polar or charged species that can subsequently be removed by ion-exchange processes. Typically the UV lamp forms part of a 'polishing' treatment loop including ion-exchange, through which water is repeatedly circulated to maintain quality. Water with Total Organic Carbon (TOC) of <5ppbC and bacteria at <1CFU/ml can be achieved in ELGA products that use this approach.

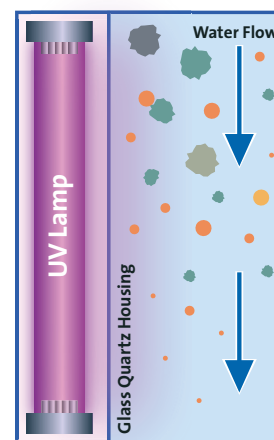

## Sub-Micron Filtration

---

Sub-micron filtration, including micro, ultra-micro and ultra filters (30–3000nm) are used as part of a 'polishing' loop or at the point-of-use. Fine filtration is applied to remove bacteria (live or dead) and biologically active molecules. These absolute filters have pores smaller than their intended target and can retain the impurity while allowing water to pass through. Impurities that are removed by sub-micron filtration, include bacteria, colloids, enzymes, endotoxins and particulates.

## Type I+ Water

Liters per day:  
Depends on feedwater

18.2 MΩ.cm

## Key Features

- ✓ Real-time TOC
- ✓ Fully re-circulating
- ✓ Integrated filtration
- ✓ Multiple dispensing
- ✓ PureSure technology

## Ideally suited for:

- Mass Spectrometry
- Ion Chromatography
- Ultra trace Analyses
- Qualitative Analyses
- Gas Chromatography
- Molecular Biology
- Cell Cultures
- Electrochemistry
- Immunochemistry
- Atomic Spectroscopy

## Flexible. Configurable. Simple.

Delivering the ultimate in water purity for absolute confidence in your results

When you require the ultimate in water purity, PURELAB Chorus 1 provides the perfect solution. Consistently delivering water purity of 18.2 MΩ.cm (Type I+/I) and underpinned by the advanced PureSure® deionization system, the PURELAB Chorus 1 enables you to focus on attaining accurate results while ensuring an uninterrupted work flow.



Model shown is PURELAB Chorus 1 with Advanced Halo Dispense

## Advanced PureSure Deionization

A twin-bed ion-exchange process with inter-stage resistivity monitoring allows retention of any impurity released during exhaustion of a primary cartridge, by the secondary polishing cartridge. This method gives guaranteed, optimum, product-water quality, advanced warning of consumable change, and extended consumable service life.

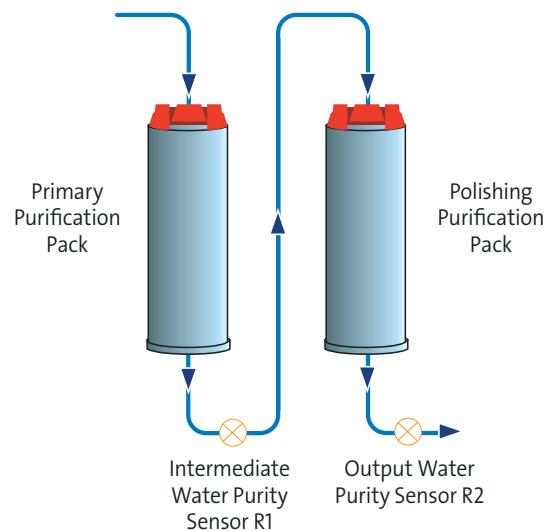

## Integrated Filtration

Ultrafiltration or microfiltration filters out endotoxins, proteins, nucleases and particulates.

## Full Spectrum UV Treatment

## Data Capture

Data capture via USB for system performance validation and software updates.

## Fully Recirculating

Ensuring microbial purity and guaranteeing pure water at the point-of-use.

## Real-time TOC Monitoring

Provides complete confidence in organic purity.

## Process Flow PURELAB Chorus 1 Analytical Research

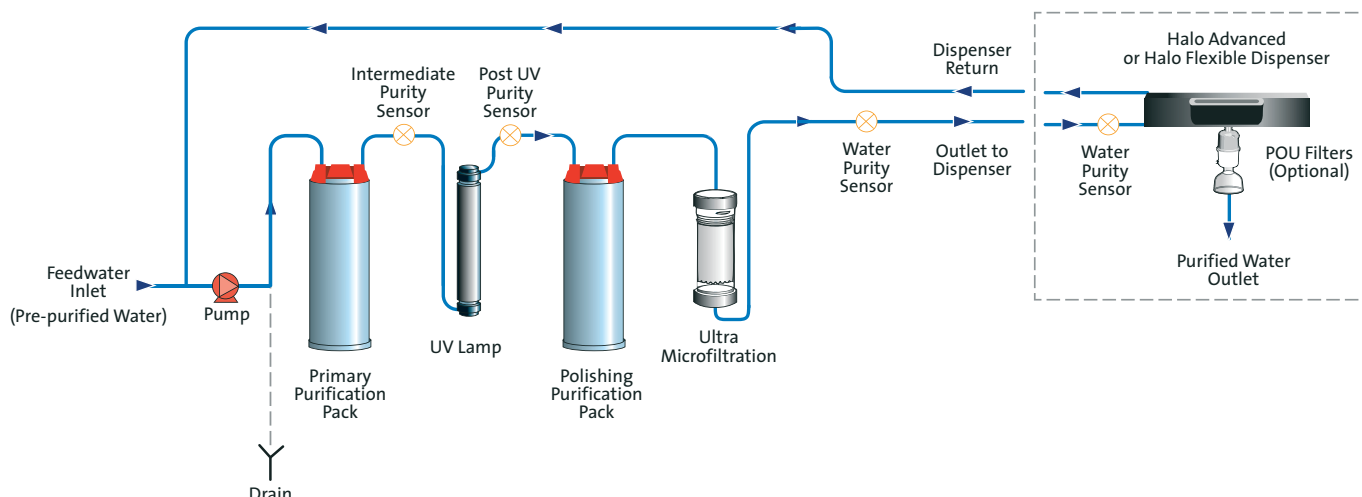

## Specifications

TREATED WATER SPECIFICATIONS

APPLICATION	LIFE SCIENCE	ANALYTICAL RESEARCH	GENERAL SCIENCE
Dispense Flowrate	Up to 2.0 l/min <sup>†</sup>	Up to 2.0 l/min <sup>†</sup>	Up to 2.0 l/min <sup>†</sup>
Inorganics @25°C	18.2 MΩ.cm	18.2 MΩ.cm	18.2 MΩ.cm
Total organic carbon (TOC)	1-3 ppb*	1-3 ppb*	3-10 ppb*
Bacteria	<0.001 CFU/ml <sup>°</sup>	<0.001 CFU/ml <sup>°</sup>	<0.001 CFU/ml <sup>°</sup>
Bacterial Endotoxin	<0.001 EU/ml	<0.001 EU/ml <sup>‡</sup>	<0.001 EU/ml <sup>‡</sup>
pH	Effectively neutral	Effectively neutral	Effectively neutral
Particles (filtration)	<0.01 μm	<0.05 μm	0.2 μm <sup>°</sup>
RNase	<1 pg/ml	<1 pg/ml	
DNase	<5 pg/ml	<5 pg/ml	
Purification pack capacity	Liters to 18.2 MΩ.cm = 94,100/(μS/cm + (2.3 x ppm CO <sub>2</sub> ))		

\* Dependant on feed water – recommended feed <50 ppb TOC ° With LC134/145/197 POU filter/Biofilter

<sup>†</sup>When connected to Halo, Advanced or flexible <sup>‡</sup> With LC197 Biofilter

FEEDWATER REQUIREMENT

Source – originally from potable supply, then pretreated	Preferably RO produced by PURELAB Chorus 3 or filtered service deionization (SDI) or distilled. Note: mixed bed or twin bed deionized supplies should be cation limited at exhaustion
Fouling index (max)	1 for all models. A 5-10 micron membrane prefilter is recommended for all non-RO feeds
Service deionization (SDI) – MΩ.cm	1 MΩ.cm minimum resistivity at exhaustion
Reverse Osmosis (RO) – μS/cm	Recommended <30 μS/cm
Free Chlorine	0.05 ppm max
TOC	<50 ppb max (RO feed)
Carbon dioxide	30 ppm (max recommended)
Silica	2 ppm (max recommended)
Particulates	Filtration down to 5-10 micron advisable to protect internal and/or point of use filters
Temperature	1-35°C (Recommend 10-15°C)
Flowrate (maximum requirement)	130 l/hr (34 USG)
Drain requirements	Up to 2 l/min (0.5 USG)
Feedwater pressure	0.7 bar (10 psi) maximum; 0.07 bar (1 psi) minimum

\* Fit LA652 Pressure Regulator where feedwater pressure exceeds specified limits

Dimensions	Height 435mm, Width 375mm, Depth 340mm		
Weight	19 kg (42 lbs)	19 kg (42 lbs)	18 kg (40 lbs)

# PURELAB Chorus 1 Complete

## Type I Water

Liters per day:  
Up to 480

18.2 MΩ.cm

## Key Features

- ✓ Tap-to-ultrapure
- ✓ Fully re-circulating
- ✓ Integrated filtration
- ✓ Multiple dispensing

## Ideally suited for:

- Mass Spectrometry
- Molecular Biology
- Electrochemistry
- Atomic Spectroscopy
- Liquid Chromatography
- Gas Chromatography
- Immunochemistry
- General Laboratory
- Spectrophotometry

## Flexible. Configurable. Simple.

### One complete solution for the laboratory

PURELAB Chorus 1 Complete provides a complete solution from potable tap water supply to ultrapure water, and is ideal for laboratories needing up to 480 liters of 18.2 MΩ.cm ultrapure water. With its easy to use ergonomic design, water can be measured and dispensed with confidence directly from the system or from a choice of additional Halo Dispensers.

### Fully Recirculating

Recirculation of purified water through our modular reservoir to maintain consistent peak water purity at 18.2 MΩ.cm.

### ELGA Biofilter (optional)

When fitted, PURELAB Chorus 1 Complete produces water which is free from biologically active impurities.

### Single System Solution

Perfect single system solution for analytical and life science applications requiring 18.2 MΩ.cm.

### Reduced Maintenance Times

Quick and easy replacement of consumables as well as semi-automated sanitization to reduce maintenance times.

### Space Saving Design

Designed to be modular and stackable to save space, whether wall-mounted or under the bench.

### Data Capture

Data capture via USB for system performance validation and software updates.

### Economical

Optional CO<sub>2</sub> removal from the purified water (post RO) increasing the life of downstream consumables.





## Process Flow PURELAB Chorus 1 Complete

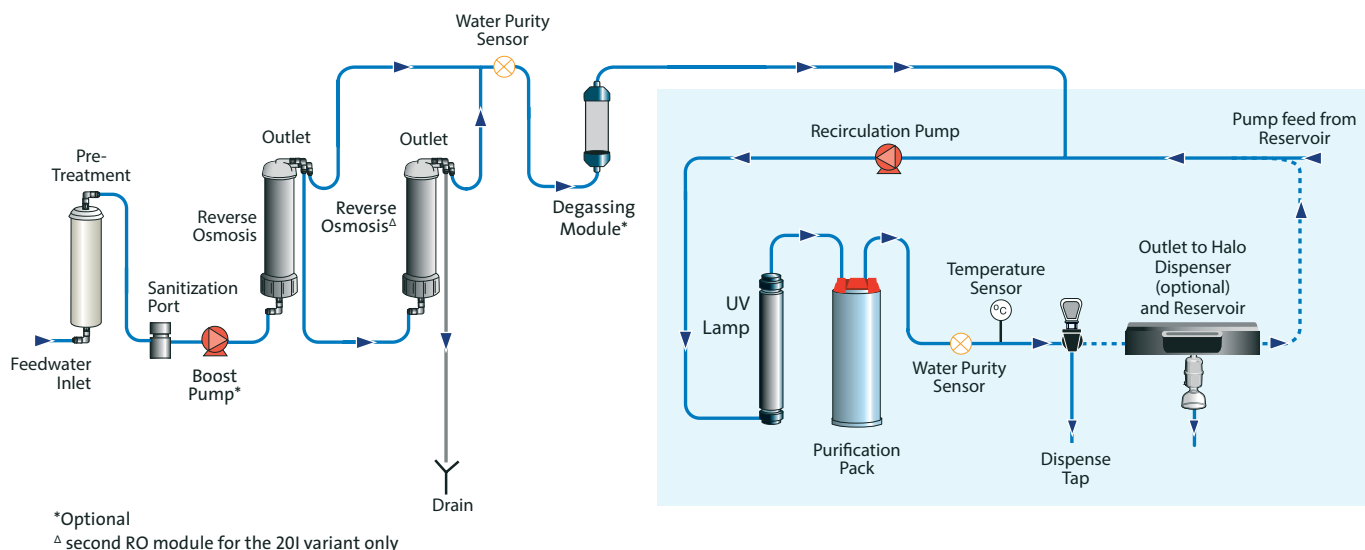

## Specifications

TREATED WATER SPECIFICATIONS

APPLICATION	PURELAB Chorus Complete	
Nominal output at 15°C	10 l/hr	20 l/hr
Dispense Flowrate	>1.5 l/min	>1.5 l/min
Inorganics @25°C	18.2 MΩ.cm	18.2 MΩ.cm
Total organic carbon (TOC)	<5 ppb	<5 ppb
Bacteria	<0.001 CFU/ml <sup>◊</sup>	<0.001 CFU/ml <sup>◊</sup>
Bacterial Endotoxin	<0.001 EU/ml <sup>‡</sup>	<0.001 EU/ml <sup>‡</sup>
pH	Effectively neutral	Effectively neutral
Particles (filtration)	0.2 μm <sup>!</sup>	0.2 μm <sup>!</sup>
RNase	<1 pg/ml	<1 pg/ml
DNase	<5 pg/ml	<5 pg/ml
Purification pack capacity	Liters to 18.2 MΩ.cm = 94,100/(μS/cm + (2.3 x ppm CO <sub>2</sub> ))	

◊ With LC134/145/197 POU filter/Biofilter ‡ With LC197 Biofilter ! With LC134/145 POU filter

FEEDWATER REQUIREMENT

Source	Potable mains water supply
Fouling index (max)	<10
Free Chlorine	0.5 ppm max
Carbon dioxide	Ideally <20 ppm
Silica	30 ppm (max recommended)
Temperature	1-35°C (Recommend 10-15°C)
Flowrate (maximum requirement)	130 l/hr (34 USG)
Drain requirements	Up to 2 l/min (0.5 USG)
Feedwater pressure	4.0 bar (60 psi) min; 6 bar (90 psi) max* <b>With boost pump: flooded suction (min) to 2.0 bar (30 psi) max</b>

\* Fit LA652 Pressure Regulator where feedwater pressure exceeds specified limits

Dimensions	Height 679mm, Width 376mm, Depth 353mm	
Weight (with boost pump)	17 kg (38 lbs)	18 kg (40 lbs)
Weight	15 kg (33 lbs)	16 kg (36 lbs)

# PURELAB Chorus 2<sup>+</sup>

(RO/EDI/UV)

## Type II<sup>+</sup> Water

Liters per day:  
Up to 216

>10 MΩ.cm

## Key Features

- ✓ Tap to Type II
- ✓ Fully re-circulating
- ✓ Multiple dispensing

## Ideally suited for:

- Electrochemistry
- Cell Culture
- Spectrophotometry
- Feed to Ultrapure Water
- Media / Buffer Preparation
- General Chemistry

## Flexible. Configurable. Simple.

### One complete solution for the laboratory

PURELAB Chorus 2<sup>+</sup> (RO/EDI/UV) features our patented recirculating EDI technology: the only EDI system on the market that is able to fully recirculate to achieve >10 MΩ.cm.

The PURELAB Chorus 2<sup>+</sup> provides additional bacteria and inorganic quality for sensitive analytical and life science applications above that of basic laboratory work. With its simple design and ease of use, water can be measured and dispensed with confidence from the system or from a choice of additional Halo Dispensers.



### Fully Recirculating EDI

ELGA's patented fully recirculated EDI provides a constant supply of high purity that guarantees a minimum of 10 MΩ.cm water at all times.

### Ideal for High Volume Labs

A cost-effective solution for laboratories requiring higher output volumes thanks to the incorporated EDI technology.

### Single System Solution

Perfect single system solution for analytical and life science applications.

### Reduced Maintenance Times

Quick and easy replacement of consumables as well as semi-automated sanitization to reduce maintenance times.

### Space Saving Design

Designed to be modular and stackable to save space, whether wall-mounted or \*under the bench.

### Economical

Optional CO<sub>2</sub> removal from the purified water (post RO) increasing the life of downstream consumables.

### Data Capture

Data capture via USB for system performance validation and software updates.

\*If fitted with Halo dispenser

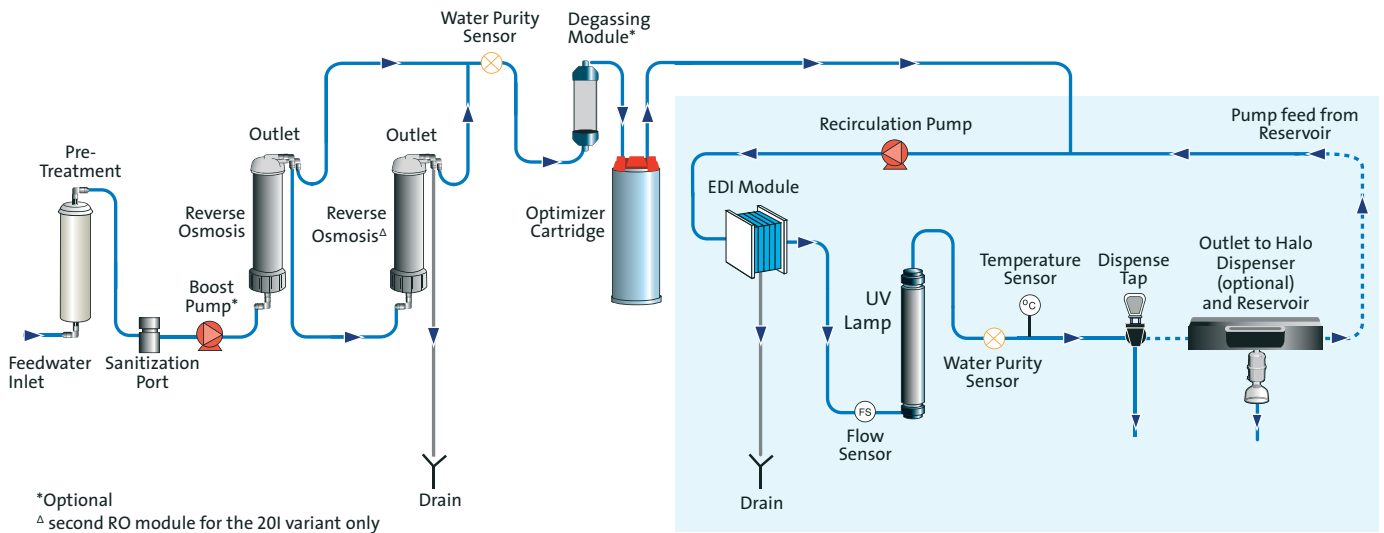
Process Flow PURELAB Chorus 2<sup>+</sup> (RO/EDI/UV)

## Specifications

TREATED WATER SPECIFICATIONS

APPLICATION	PURELAB Chorus 2 <sup>+</sup> (RO/EDI/UV)	
Nominal output at 15°C	10 l/hr*	20 l/hr*
Nominal daily output	216 l/day	216 l/day
Inorganics @25°C	10 to >15 MΩ.cm	
Organics (MW>200 Dalton)	>99% rejection	
Total organic carbon (TOC)	<10 ppb	
Bacteria	<0.001 CFU/ml <sup>o</sup>	
pH	Effectively neutral	
Particles (filtration)	0.2µm <sup>l</sup>	

\* Standard conditions are 4 bar inlet pressure at 15°C, fed with potable water and a clean pre-treatment cartridge. Refer to flow tables outside these conditions. <sup>l</sup> With LC134/145 POU Filter

FEEDWATER REQUIREMENT

Source	Potable mains water supply	
Fouling index (max)	<10	
Conductivity	<1400 µS/cm	
Free Chlorine	0.5 ppm max	
Heavy Metals (max)	0.05 ppm	
Silica	30 ppm	
Temperature	1-35°C	
Flowrate (maximum requirement)	100 l/hr (27 USG)	
Drain requirements	80 l/hr (21 USG)	
Feedwater pressure	4.0 bar (60 psi) min; 6 bar (90 psi) max* With boost pump: flooded suction (min) to 2.0 bar (30 psi) max	

\*Fit LA652 Regulator where feedwater pressure exceeds specified limits

Dimensions	Height 679mm, Width 376mm, Depth 353mm	
Weight (with boost pump)	21 kg (46 lbs)	22 kg (49 lbs)
Weight	18 kg (40 lbs)	19kg (42 lbs)

## Type II<sup>+</sup> water

Liters per day:  
Up to 480

>10 MΩ.cm

## Key Features

- ✓ Tap-to-Type II
- ✓ Fully re-circulating
- ✓ Multiple dispensing

## Ideally suited for:

- Electrochemistry
- Spectrophotometry
- Feed to Ultrapure Water
- Media / Buffer Preparation
- General Chemistry
- Cell Culture

## Flexible. Configurable. Simple.

### One complete solution for the laboratory

PURELAB Chorus 2<sup>+</sup>(RO/DI/UV) provides pure water (Type II<sup>+</sup>) from potable tap water supply for laboratories requiring up to 480 liters per day and is able to fully recirculate to achieve >10 MΩ.cm at all times. It provides additional bacteria and inorganic quality for sensitive analytical and life science applications above that of basic laboratory work. With its simple design and ease of use, water can be measured and dispensed with confidence from the system or from a choice of additional Halo Dispensers.

### Fully Recirculating

In addition to simple composite vent filtration, the PURELAB Chorus 2<sup>+</sup> is the only fully recirculating Type II<sup>+</sup> pure water system on the market, maintaining consistent peak water purity at >10MΩ.cm.

### Configuration

Ability to configure multiple systems to increase flow rate and save space through stackable solutions that can be wall mounted, on or \*under the bench.

### Reduced Maintenance Times

Quick and easy replacement of consumables as well as semi-automated sanitization to reduce maintenance time.

### Data Capture

Data capture via USB for system performance validation and software updates.

### Economical

Optional CO<sub>2</sub> removal from the purified water (post RO) increasing the life of downstream consumables.

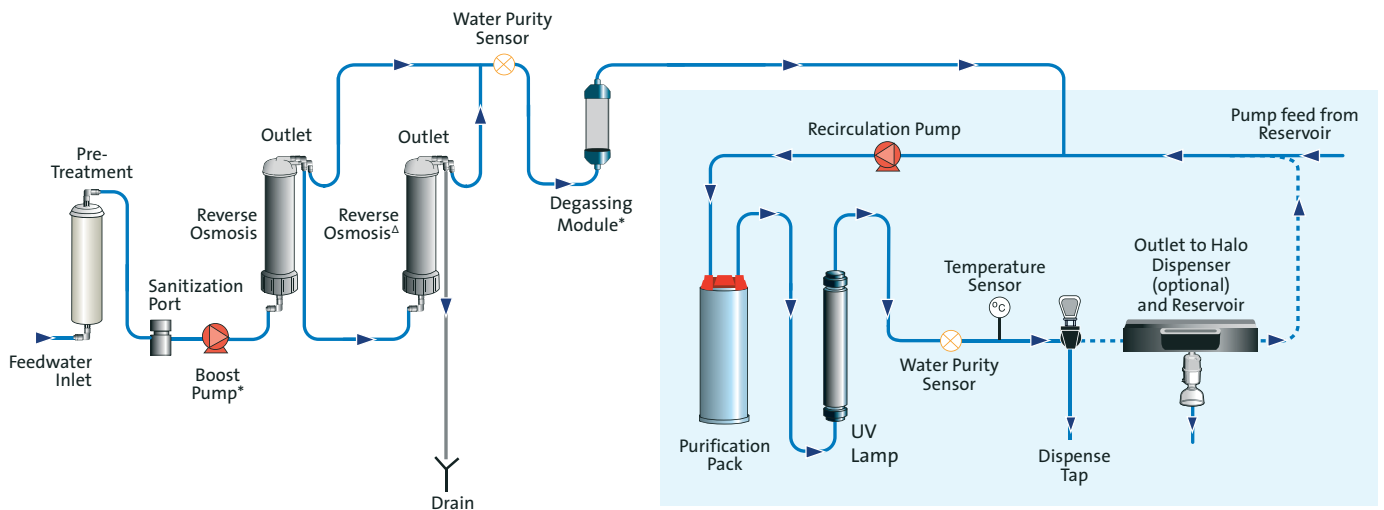

\*If fitted with Halo dispenser

Process Flow PURELAB Chorus 2<sup>+</sup> (RO/DI/UV)

\*Optional

^ second RO module for the 20l variant only

## Specifications

TREATED WATER SPECIFICATIONS

APPLICATION	PURELAB Chorus 2 <sup>+</sup> (RO/DI/UV)	
Nominal output at 15°C	10 l/hr*	20 l/hr*
Nominal daily output	240 l/day	480 l/day
Inorganics @25°C	1 to >15 MΩ.cm	
Organics (MW>200 Dalton)	>99% rejection	
Total organic carbon (TOC)	<10 ppb	
Bacteria	<0.001 CFU/ml <sup>°</sup>	
pH	Effectively neutral	
Particles (filtration)	0.2µm <sup>°</sup>	
Purification pack capacity	Liters to 15 MΩ.cm = 74,700/(µS/cm + (2.3 x ppm CO <sub>2</sub> ))	

\* Standard conditions are 4 bar inlet pressure at 15°C, fed with potable water and a clean pre-treatment cartridge. Refer to flow tables outside these conditions. <sup>°</sup> With LC134/145 POU filter

FEEDWATER REQUIREMENT

Source	Potable mains water supply	
Fouling index (max)	<10	
Conductivity	<2000 µS/cm	
Free Chlorine	0.5 ppm max	
Heavy Metals (max)	0.05 ppm	
Silica	30 ppm	
Temperature	1-35°C	
Flowrate (maximum requirement)	100 l/hr (27 USG)	
Drain requirements	80 l/hr (21 USG)	
Feedwater pressure	4.0 bar (60 psi) min; 6 bar (90 psi) max* With boost pump: flooded suction (min) to 2.0 bar (30 psi) max	

\*Fit LA652 Regulator where feedwater pressure exceeds specified limits

Dimensions	Height 679mm, Width 376mm, Depth 353mm	
Weight (with boost pump)	17 kg (37 lbs)	18 kg (40 lbs)
Weight	15 kg (33 lbs)	16kg (35 lbs)

# Halo Dispense Solutions

The Halo Dispenser offers dispensing and monitoring solutions to customers enabling the ultimate flexibility when using PURELAB Chorus 1, Chorus 1 Complete & Chorus 2+.

A choice of three dispensing solutions is available to suit different applications, budget and configuration. With Halo Dispenser you have the ultimate flexibility.

## Clear Display

Prioritized information displayed at all times (system status, alarm) for absolute confidence as you dispense.

## Multiple Positioning

Position the dispenser independent from the water purification system. Optimize your lab space.

## Flexible Dispensing

- ✓ Variable flow
- ✓ Auto-volume dispense
- ✓ Hands free
- ✓ Locked dispense
- ✓ Hand-held dispensing
- ✓ Profile dispense

## Halo Glow

The unique glow changes colour and flashes alerting you to changes in system performance.

## Real-Time TOC Monitoring\*

Water purity is monitored right up to the point of use for complete peace of mind with real-time TOC monitoring for critical applications.

Halo Dispenser	Halo Advanced Dispenser	Halo Flexible Dispenser
Fixed	Fixed	Flexible
<ul style="list-style-type: none"> <li>✓ Variable flow rate dispense</li> <li>✓ Drop-by-drop control</li> <li>✓ Locked dispense</li> </ul>		
<ul style="list-style-type: none"> <li>✓ Purity monitoring to point-of-use</li> <li>✓ Auto volume dispense</li> <li>✓ Profile dispense</li> </ul>		
<ul style="list-style-type: none"> <li>✓ Flexible handset</li> </ul>		

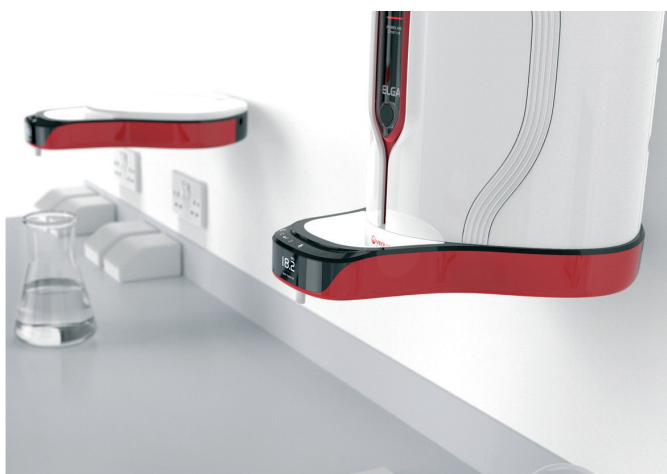

\* Only on PURELAB Chorus 1

**Type II****Liters per day: Up to 480****10 MΩ.cm****Key Features**

- ✓ Easy configurability
- ✓ Modular

**Ideally suited for:**

- Stills Replacement
- Buffer Preparation
- pH solution Preparation
- Washing / Rinsing
- Autoclaves
- General Chemistry
- Hydroponics
- Steam Generators
- Sterilizer Feed
- Feed to Type I Polishers

**Modular. Flexible. Reliable.****Reliable delivery of Type II water purity**

When Type II water is all you need, then PURELAB Chorus 2 (RO/DI) is the reliable solution with the flexibility to suit your requirements. It dispenses up to 480 liters of pure water per day from a potable water supply for general laboratory applications.

**Deionization**

The Reverse Osmosis feed contains optimized resin mixes to maximize consumables capacity.

**Simplicity**

Simple to install, operate and maintain with prioritized information displayed at all times (system status, alarm) for absolute confidence as you dispense.

**Economical**

Optional CO<sub>2</sub> removal from the purified water (post RO) increasing the life of downstream consumables.

Option to reduce water consumption for low hardness feed waters.

**Modular**

Multiple PURELAB Chorus 2 units can feed into one reservoir and systems can be expanded post-installation. As such, the cost of future upgrades is minimized. Duplex systems also guarantee maximum uptime.

**Data Capture**

Data capture via USB for system performance validation and software updates.

**Reduced Maintenance Times**

Quick and easy replacement of consumables as well as simple sanitization to reduce maintenance time.

Type III water

Liters per day:  
Up to 720

RO water

## Key Features

- ✓ Easy Configurability
- ✓ Auto rinse
- ✓ Modular

## Ideally suited for:

- Buffer Preparation
- Washing / Rinsing
- Autoclaves
- General Chemistry
- Hydroponics
- Steam Generators
- Sterilizer Feed
- Feed to Type I polishers

## Modular. Flexible. Reliable.

### Reliable delivery of Type III water purity

When general laboratory grade water is all you need, then PURELAB Chorus 3 is the reliable solution with the flexibility to suit your requirements. It can also be used as a feed to other ELGA water systems.



### Configuration

Ability to configure multiple systems to increase flow rate.

### Simplicity

Simple to install, operate and maintain with prioritized information displayed at all times (system status, alarm) for absolute confidence as you dispense.

### Auto Rinse

Maintains purity of water during periods of low use.

### Economical

Optional CO<sub>2</sub> removal from the purified water (post RO) increasing the life of downstream consumables.

Option to reduce water consumption for low hardness feed waters.

### Modular

Multiple PURELAB Chorus 3 units can feed into one reservoir and systems can be expanded post-installation. As such, the cost of future upgrades is minimized. Duplex systems also guarantee maximum uptime.

### Data Capture

Data capture via USB for system performance validation and software updates.

### Reduced Maintenance Times

Quick and easy replacement of consumables as well as semi-automated sanitization to reduce maintenance time.



## Process Flow PURELAB Chorus 2 (RO/DI)

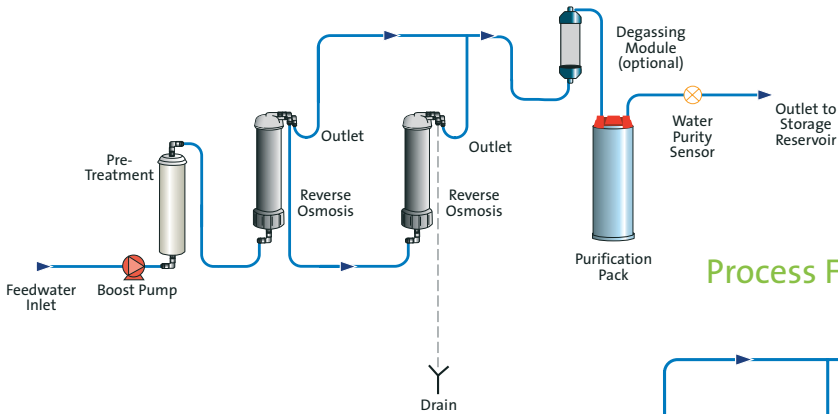

## Process Flow PURELAB Chorus 3 (RO)

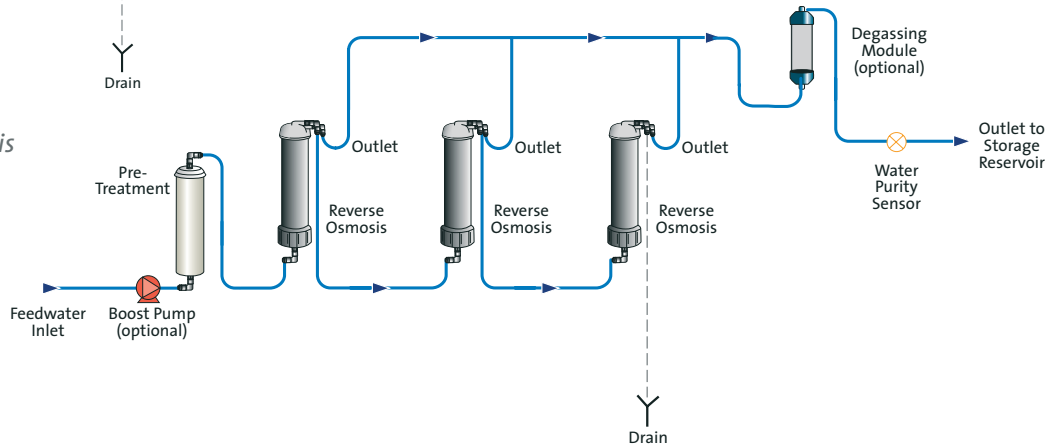

Quantity of Reverse Osmosis Modules dependent on Chorus Model.

## Specifications

APPLICATION	PURELAB Chorus 2 (RO/DI)		PURELAB Chorus 3 (RO)		
Nominal output at 15°C	10 l/hr	20 l/hr	10 l/hr	20 l/hr	30 l/hr
Nominal daily output	240 l/day	480 l/day	240 l/day	480 l/day	720 l/day
Inorganics @25°C	1 to >10 MΩ.cm		>95% rejection		
Organics (MW>200 Dalton)	>99% rejection		>95% rejection		
Total organic carbon (TOC)	<30 ppb		<50 ppb		
Bacteria*	<5 CFU/ml		<50 CFU/ml		
pH	Effectively neutral		Effectively neutral		
Particles	>99% rejection		>99% rejection		
Purification pack capacity	Liters to 1MΩ.cm = 103,200/(μS/cm + (2.3 x ppm CO <sub>2</sub> ))		N/A		

Standard conditions are 4 bar inlet pressure at 15°C, fed with potable water and a clean pre-treatment cartridge. Refer to flow tables outside these conditions. \* Bacterial specification is before the water goes into the reservoir

Source – originally from potable supply, then pretreated	Potable mains water supply	Potable mains water supply
Fouling index (max)	10	10
Conductivity	<2000 μS/cm	<2000 μS/cm
Free Chlorine	0.5 ppm max	0.5 ppm max
Heavy Metals (max)	0.05 ppm	0.05 ppm
Silica	30 ppm	30 ppm
Temperature	1-35°C	1-35°C
Flowrate (maximum requirement)	100 l/hr (27 USG)	100 l/hr (27 USG)
Drain requirements	80 l/hr (21 USG)	80 l/hr (21 USG)
Feedwater pressure	2.0 bar (30 psi) maximum; 0.5 bar (7.5 psi) minimum**	2.0 bar (30 psi) maximum; 0.5 bar (7.5 psi) minimum**

\*\*Fit LA652 Regulator where feedwater pressure exceeds specified limits

Dimensions	Height 435mm, Width 376mm, Depth 340mm				
Weight (with boost pump)	19 kg (42lb)	20 kg (44 lbs)	17 kg (37 lbs)	18 kg (40 lbs)	19 kg (42lb)
Weight	17 kg (37 lbs)	18 kg (40 lbs)	15 kg (33 lbs)	16 kg (35 lbs)	17 kg (37 lbs)

TREATED WATER SPECIFICATIONS

FEEDWATER REQUIREMENT

# Storage Reservoirs



Our unique range of storage solutions are designed to maintain optimum purity of stored water and provide effective protection against airborne contaminants.

They are designed to accommodate PURELAB Chorus water purification systems by maximizing the space in a single integral, compact unit or to sit independently to suit the layout of your laboratory.

## Multiple positioning

Multiple positioning / mounting options to suit your laboratory layout.

## Polyethylene construction

Inert opaque polyethylene construction with smooth inner surface.

## Dispense tap

Positioned to minimize accidental operation or damage (choice of positions).

## Advanced vent filtration

Prevents the ingress of airborne bacteria, particulates, organic vapours and CO<sub>2</sub>.

## Auto fill

Monitoring of reservoir water levels with automated refill ensures purified water is always available.

## Hygienic Overflow

Hygienic overflow in the unlikely event of water system malfunction.

## Easy display

Direct display of stored purified water on the front of the reservoir for easy identification.

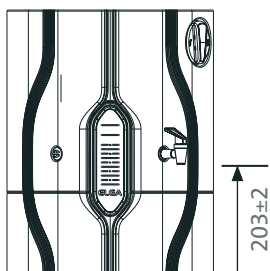

**Capacity:** 15 liters  
**Dimensions (mm):**  
470 (h) x 376 (w) x 340 (d)  
**Flow Rate:** 6 l/min

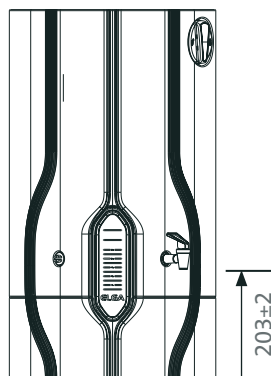

**Capacity:** 30 liters  
**Dimensions (mm):**  
660 (h) x 376 (w) x 340 (d)  
**Flow Rate:** 8 l/min

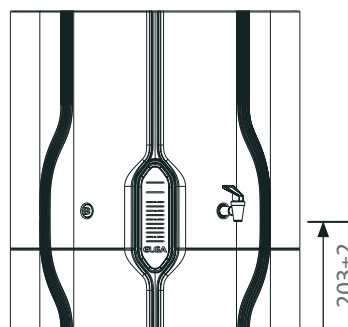

**Capacity:** 60 liters  
**Dimensions (mm):**  
570 (h) x 532 (w) x 522 (d)  
**Flow Rate:** 10 l/min

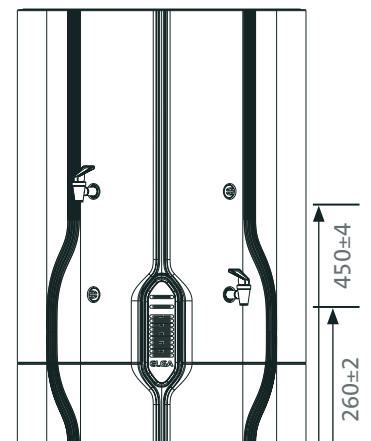

**Capacity:** 100 liters  
**Dimensions (mm):**  
806 (h) x 532 (w) x 522 (d)  
**Flow Rate:** 10 l/min

Type I, II & III dependent  
on use of DI pack

Liters per day:  
Dependent on feed  
water

### Key Features

- ✓ Flexible dispensing
- ✓ Customise settings
- ✓ Fully re-circulating
- ✓ Integrated filtration

### Ideally suited for:

- General Lab
- Type II Applications
- Dispensing with DI pack

## Simplicity and Elegance.

### The best dispenser for your distribution system

The PURELAB flex 1 is designed as a dispensing and monitoring system when connected to a reservoir or distribution loop. It also works as a simple deionization system.



### Customized Settings

Be in control of your PURELAB flex by customizing the settings to suit your application.

### Simplicity

Simple to install, operate and maintain with prioritized information displayed at all times (system status, alarm) for absolute confidence as you dispense.

### Easy to Use

Ergonomic design with features including auto volumetric dispense and height adjustability.

### Data Capture

Data capture via USB for system performance validation and software updates

### Space Saving

Space saving and compact dispenser which can be placed on the bench or wall mounted

### Type I water

Liters per day:  
Dependent on  
feedwater

18.2 MΩ.cm

### Key Features

- ✓ Real-time TOC
- ✓ Fully re-circulating
- ✓ Customize settings
- ✓ Integrated filtration
- ✓ Adjustable dispensing

### Ideally suited for:

- Mass Spectrometry
- Molecular Biology
- Electrochemistry
- Atomic Spectroscopy
- Liquid Chromatography
- Gas Chromatography
- Immunochemistry
- Spectrophotometry
- Media / Buffer Prep
- General Chemistry

## Designed for the laboratory of today.

### Reliable delivery of Type I water purity

The PURELAB flex is designed to deliver accuracy, flexibility and ease-of-use. The award winning system produces ultrapure type I (18.2 MΩ.cm) water from a pre-purified feed, which is ideal for analytical and life science applications. It allows focus on routine test work without concern about the water quality affecting test results.



### Guaranteed Water Purity

Full recirculation through the UV lamp and purification pack right to the point of use for peace of mind.

### Intuitive Flexible Dispense

Clear water purity display for absolute confidence as you dispense.

### Real-time TOC Monitoring

Provides complete confidence in organic purity by reducing the level of organics for critical applications.

### Easy To Maintain

Easy access to the consumables as well as well as quick easy automated sanitization to minimize downtime.

### Data Capture

Data capture via USB for system performance validation and software updates.

### Space Saving

Space saving and compact dispenser which can be placed on the bench or wall mounted.

Process Flow PURELAB flex 2

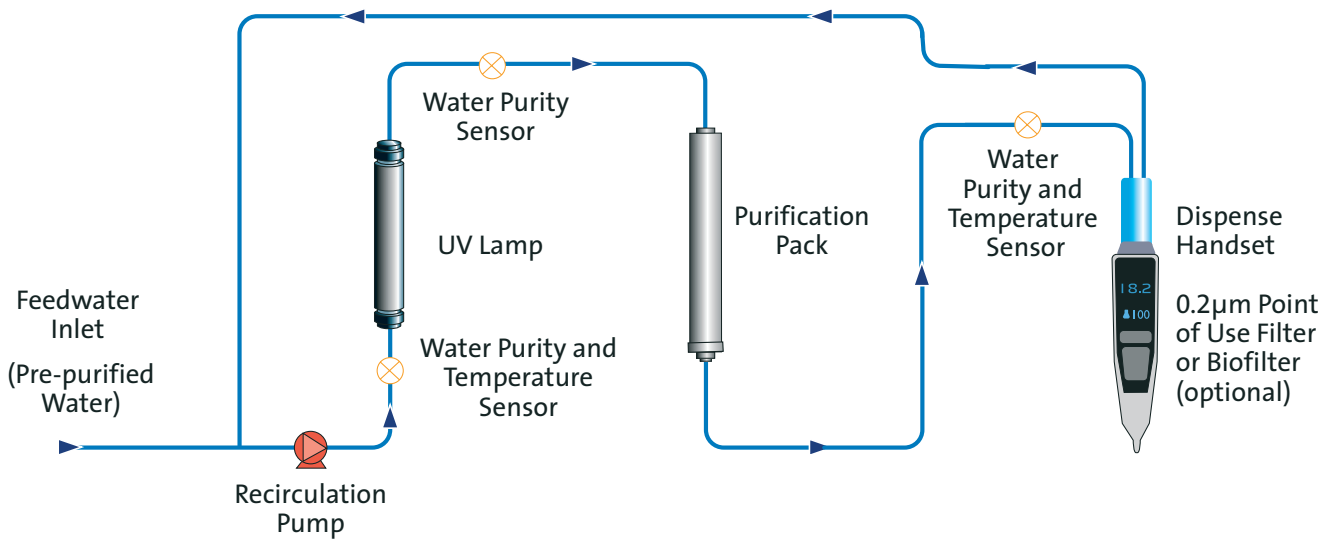

Specifications

TREATED WATER SPECIFICATIONS

APPLICATION	PURELAB flex 1	PURELAB flex 1 (with purification pack)	PURELAB flex 2
Daily volume	>10 liters	>10 liters	>10 liters
Dispense Flowrate	Up to 2.0 l/min	Up to 2.0 l/min	Up to 2.0 l/min
Inorganics @25°C	As per feedwater	18.2 MΩ.cm	18.2 MΩ.cm
Total organic carbon (TOC)	Dependent on feedwater		
Bacteria	<0.1 CFU/ml <sup>°</sup>	<0.1 CFU/ml <sup>°</sup>	<0.001 CFU/ml <sup>°1</sup>
Bacterial Endotoxin	N/A	<0.001 EU/ml <sup>‡</sup>	<0.001 EU/ml <sup>‡</sup>
RNase	N/A	N/A	<1 pg/ml
DNase	N/A	N/A	<5 pg/ml

<sup>°</sup> With C134/145/197 POU filter/Biofilter <sup>‡</sup> With LC197 Biofilter <sup>1</sup> Dependent on feedwater

FEEDWATER REQUIREMENT

Source	Originally from potable supply, then pretreated. Preferably reverse osmosis (RO) or filtered service deionization (SDI) or distilled.
Fouling index (max)	<1 for all models
Free Chlorine	<0.05 ppm max
TOC	N/A
Carbon dioxide	<0.1 ppm
Silica	<2 ppm
Particulates	5-10 µm
Temperature	4-40°C (Recommend 10-15°C)
Flowrate (maximum requirement)	>2 l/min (0.5 USG)
Drain requirements	None required
Feedwater pressure	1.5 bar (22 psi) maximum; Flooded suction minimum

\* Fit LA652 Pressure Regulator where feedwater pressure exceeds specified limits

Dimensions	Height 900-1020mm, Width 236mm, Depth 374mm		
Weight	10 kg (22 lbs)	10.5 kg (23.1 lbs)	11 kg (24.2 lbs)
Installation	Bench / wall		

### Type I water

Liters per day: < 10

18.2 MΩ.cm

### Key Features

- ✓ Real-time TOC
- ✓ Fully re-circulating
- ✓ Integrated filtration
- ✓ Adjustable dispensing

### Ideally suited for:

- Mass Spectrometry
- Molecular Biology
- Electrochemistry
- Atomic Spectroscopy
- Liquid Chromatography
- Cell Culture
- Gas Chromatography
- Immunochemistry
- Spectrophotometry
- Media / Buffer Prep
- General Chemistry

## Power and flexibility.

### A small unit with big power capabilities

The PURELAB flex 3 is the ultimate system providing Type 1 (ultrapure water) from potable tap water in one single unit.

### Space Saving Design

The compact unit can be placed on the bench or can be wall mounted and has an integrated 7 liter reservoir filled by a 10 l/hr RO membrane, ensuring that water is always available.

### Fully Recirculating

Ensuring the highest microbial purity and guaranteeing pure water, as recirculation of the water occurs from the reservoir right to the point-of-use.

### Real-time TOC Monitoring

Provides complete confidence in organic purity and clear display at all times. The final quality sensor is placed at the entry of the flexible dispenser giving you peace of mind.

### Flexible Dispenser

The intuitive dispenser offers a clear display of the water purity for absolute confidence as you dispense.

### Simplicity

Simple to install, operate and with a quick semi-automated sanitization to minimize downtime.

### Data Capture

Data capture via USB for system performance validation and software updates.



**Type I water****Liters per day: < 10****18.2 MΩ.cm****Key Features**

- ✓ Real-time TOC
- ✓ Fully re-circulating
- ✓ Integrated filtration
- ✓ Adjustable dispensing

**Ideally suited for:**

- Mass Spectrometry
- Molecular Biology
- Electrochemistry
- Atomic Spectroscopy
- Liquid Chromatography
- Cell Culture
- Gas Chromatography
- Immunochemistry
- Spectrophotometry
- Media / Buffer Prep
- General Chemistry

**Flexible elegance.****An independent system**

PURELAB flex 4 produces ultrapure (Type I) water from pre-purified water, with its manual-filling capability, it is able to operate independently from a fixed water source in temporary locations. It has an integrated 7 liter reservoir, ensuring that water is always available and is particularly suited for small volumes of water where TOC levels are critical and must remain stable.

**Space Saving Design**

The compact unit can be placed on the bench or can be wall mounted and has an integrated 7 liter reservoir, ensuring that water is always available.

**Fully Recirculating**

Ensuring the highest microbial purity and guaranteeing pure water, as recirculation of the water occurs from the reservoir right to the point-of-use.

**Portable System**

Access on the top of the system gives the option to fill the reservoir with pre-purified water. This means that it can be moved at any time as the lab environment evolves.

**Real-time TOC Monitoring**

Provides complete confidence in organic purity and clear display at all times.

**Flexible Dispenser**

The intuitive dispenser offers a clear display of the water purity for absolute confidence as you dispense.

**Simplicity**

Simple to install, operate and with a quick semi-automated sanitization to minimize downtime.

**Data Capture**

Data capture via USB for system performance validation and software updates.



## Process Flow PURELAB flex 3

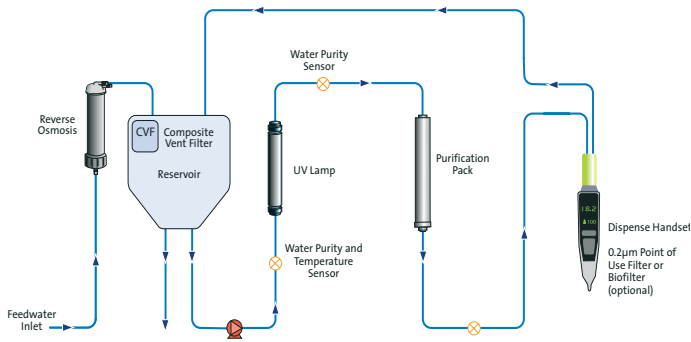

## Process Flow PURELAB flex 4

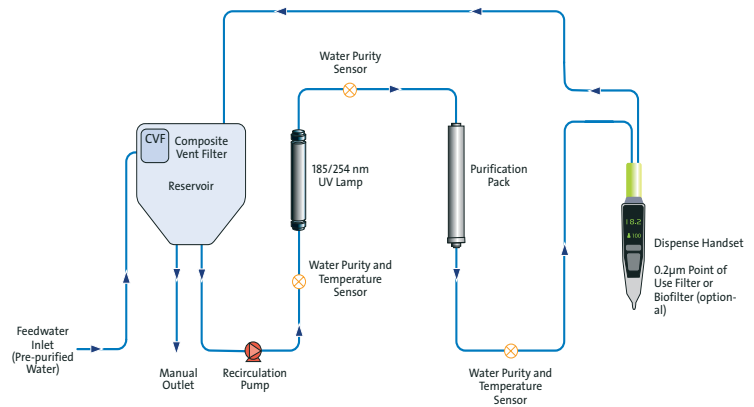

## Specifications

TREATED WATER SPECIFICATIONS

APPLICATION	PURELAB flex 3	PURELAB flex 4
Daily volume	<10 liters	<10 liters
Dispense Flowrate	Up to 2.0 l/min	Up to 2.0 l/min
Reverse osmosis make up flow rate at 15°C	10 l/hour	N/A
Inorganics @25°C	18.2 MΩ.cm	18.2 MΩ.cm
Total organic carbon (TOC)	<5 ppb	<5 ppb*
Bacteria	<0.001 CFU/ml <sup>◊</sup>	<0.001 CFU/ml <sup>◊</sup>
Bacterial Endotoxin	<0.001 EU/ml <sup>‡</sup>	<0.001 EU/ml <sup>‡</sup>
RNase	<1 pg/ml	<1 pg/ml
DNase	<5 pg/ml	<5 pg/ml

\* Dependant on feed water ◊ With C134/145/197 POU filter/Biofilter ‡ With LC197 Biofilter

FEEDWATER REQUIREMENT

Source	Potable tap water	Originally from potable supply, then pretreated. Preferably reverse osmosis (RO) or filtered service deionization (SDI) or distilled.
Fouling index (max)	<10	<1
Free Chlorine	<0.5 ppm max	<0.05 ppm max
TOC	<2 ppm	<50 ppb recommended
Carbon dioxide	<30 ppm (recommended <20 ppm)	
Silica (recommended max)	<30 ppm	<2 ppm
Particulates	-	5-10µm
Temperature	4-40°C (Recommend 10-15°C)	
Flowrate (maximum requirement)	Up to 75 l/hr (20 USG)	Up to 75 l/hr (20 USG)
Drain requirements	<90 l/hr (23 USG)	<70 l/hr (18 USG)
Feedwater pressure	6 bar (90 psi) max; 2 bar (30 psi) min	6 bar (90 psi) max; 0.07 bar (1 psi) min

\* Fit LA652 Pressure Regulator where feedwater pressure exceeds specified limits

Dimensions	Height 900-1020mm, Width 236mm, Depth 470mm	
Weight	23 kg (57.3 lbs)	23 kg (57.3 lbs)
Installation	Bench / wall	



# Find your product



	PURELAB Chorus 1				PURELAB Chorus 2 & 3				PURELAB flex			
	Life Science	Analytical Research	General Science	Complete	2+ (RO/DI/UV)	2+ (RO/DI/UV)	2 (RO/DI)	3 (RO)	flex 1	flex 2	flex 3	flex 4
<b>Water Type</b>												
Ultrapure Type I	✓	✓	✓	✓					✓*	✓	✓	✓
Pure Type II					✓	✓	✓		✓*			
RO Type III									✓*		✓	✓
<b>Impurities to remove</b>												
Nucleases	✓	✓	✓	✓	✓	✓				✓	✓	✓
Endotoxins / Pyrogens	✓	✓ <sup>o</sup>	✓ <sup>o</sup>	✓ <sup>o</sup>	✓ <sup>o</sup>	✓ <sup>o</sup>					✓ <sup>o</sup>	✓ <sup>o</sup>
Inorganics	✓	✓	✓	✓	✓	✓	✓	✓	✓	✓	✓	✓
Organics	✓	✓	✓	✓	✓	✓	✓	✓	✓	✓	✓	✓
Bacteria	✓	✓	✓	✓	✓	✓	✓	✓	✓ <sup>Δ</sup>	✓	✓	✓
Particulates	✓	✓	✓ <sup>Δ</sup>	✓	✓	✓	✓	✓	✓ <sup>Δ</sup>	✓ <sup>Δ</sup>	✓ <sup>-</sup>	✓ <sup>-</sup>
<b>Features</b>												
PureSure <sup>®</sup>	✓	✓	✓									
Real time TOC monitoring	✓	✓									✓	✓
Potable tap water				✓	✓	✓					✓	✓
Wall mounting	✓	✓	✓	✓	✓	✓	✓	✓	✓	✓	✓	✓
Floor mounting	✓	✓	✓	✓	✓	✓	✓	✓				
Purity monitoring to POU	✓	✓	✓	✓	✓	✓			✓	✓	✓	✓
Halo Dispense compatible	✓	✓	✓	✓	✓	✓						
Auto Volume Dispense	✓ <sup>†</sup>	✓ <sup>†</sup>	✓ <sup>†</sup>	✓ <sup>†</sup>	✓ <sup>†</sup>	✓ <sup>†</sup>			✓	✓	✓	✓
Variable flow rate dispense	✓ <sup>†</sup>	✓ <sup>†</sup>	✓ <sup>†</sup>	✓ <sup>†</sup>	✓ <sup>†</sup>	✓ <sup>†</sup>			✓	✓	✓	✓
Drop-by-drop control	✓ <sup>†</sup>	✓ <sup>†</sup>	✓ <sup>†</sup>	✓ <sup>†</sup>	✓ <sup>†</sup>	✓ <sup>†</sup>			✓	✓	✓	✓
Locked dispense	✓ <sup>†</sup>	✓ <sup>†</sup>	✓ <sup>†</sup>	✓ <sup>†</sup>	✓ <sup>†</sup>	✓ <sup>†</sup>			✓	✓	✓	✓
USB connection	✓	✓	✓	✓	✓	✓	✓	✓	✓	✓	✓	✓
Full product validation	✓	✓	✓	✓	✓	✓	✓	✓	✓	✓	✓	✓

#With DI cartridge \* No DI cartridge <sup>o</sup> With LC197 POU filter <sup>Δ</sup> With LC134/145 POU filter <sup>-</sup> 0.2mm <sup>†</sup> When fitted with a Halo dispenser solution

# Find your product



	PURELAB Chorus 1				PURELAB Chorus 2 & 3				PURELAB flex			
	Life Science	Analytical Research	General Science	Complete	2+ (RO/EDI/UV)	2+ (RO/DI/UV)	2 (RO/DI)	3 (RO)	flex 1	flex 2	flex 3	flex 4
<b>Ideal solution for</b>												
<i>Systems also have wider applicability. Speak to your local ELGA specialist for further information.</i>												
Cell culture	✓			✓						✓ <sup>Δ</sup>	✓ <sup>Δ</sup>	✓ <sup>Δ</sup>
Liquid Chromatography (HPLC, UHPLC)	✓	✓		✓						✓	✓	✓
Microbiological Analysis	✓	✓		✓						✓	✓	✓
Genetic (PCR, DNA/RNA sequencing, DNA, Nucleic acid)	✓											
Gas Chromatography		✓		✓						✓	✓	✓
Electrochemistry		✓	✓	✓	✓	✓				✓	✓	✓
Immunochemistry	✓			✓						✓	✓	✓
Atomic Spectroscopy (Flame AA, GFAA, ICP-AE)		✓	✓	✓						✓	✓	✓
Mass Spectrometry (ICP-MS, GC-MS, LC-MS)	✓	✓		✓						✓	✓	✓
General lab water requirement (glassware washing, heating baths, autoclave filling)				✓			✓	✓	✓*		✓	
Spectrophotometry (inc. UV, IR, nearUV, nearIR)				✓	✓	✓				✓	✓	✓
Feed to ultrapure water system					✓	✓	✓	✓				
Media / buffer preparation (inc pH solution)					✓	✓	✓					
General chemistry (inc Titrimetry)			✓	✓	✓	✓	✓	✓	✓	✓	✓	✓

## PURELAB Chorus 1

Part Number	Description
PC1ANRXM2	PURELAB Chorus 1 Analytic Research Ultrapure System
PC1LSCXM2	PURELAB Chorus 1 Life Science Ultrapure System
PC1GSCXM2	PURELAB Chorus 1 General Science Ultrapure System

Unit is supplied as standard with: Fitted / Included: Appropriate consumables (including 2 x LC232 - see list below), MANU39998/MANU39997/MANU40001 Operator Manual, GUID39864 Light Guide, GUID40005 Quick Reference Guide, INST40012 Quick Start Guide, LA762 basic installation kit, LC233 x 2 bypass block.

## PURELAB Chorus 1 Complete

Part Number	Description
PC110COXXM1	PURELAB Chorus 1 Complete 10 l/hr System
PC110COBPM1	PURELAB Chorus 1 Complete 10 l/hr System with Boost Pump
PC120COXXM1	PURELAB Chorus 1 Complete 20 l/hr System
PC120COBPM1	PURELAB Chorus 1 Complete 20 l/hr System with Boost Pump

Unit is supplied as standard with: Fitted / Included: Appropriate quantity LC240, 1 x LC241, 1 x LC275, 1 x LC272, 1 x LC210, MANU40932 Operator Manual, GUID39864 Light Guide, LA762 Basic installation Kit.

## PURELAB Chorus 2+ RO/EDI/UV

Part Number	Description
PC210EUXXM1	PURELAB Chorus 2+ RO/EDI/UV 10 l/hr System
PC210EUBPM1	PURELAB Chorus 2+ RO/EDI/UV 10 l/hr System with Boost Pump
PC220EUXXM1	PURELAB Chorus 2+ RO/EDI/UV 20 l/hr System
PC220EUBPM1	PURELAB Chorus 2+ RO/EDI/UV 20 l/hr System with Boost Pump

Unit is supplied as standard with: Fitted / Included: Appropriate quantity LC240, 1 x LC241, 1 x LC243, 1 x LC272, 1 x LC285, 1 x LC233, MANU40932 Operator Manual, GUID39864 Light Guide, LA762 Basic installation Kit

## PURELAB Chorus 2+ RO/DI/UV

Part Number	Description
PC210DUXXM1	PURELAB Chorus 2+ RO/DI/UV 10 l/hr System
PC210DUBPM1	PURELAB Chorus 2+ RO/DI/UV 10 l/hr System with Boost Pump
PC220DUXXM1	PURELAB Chorus 2+ RO/DI/UV 20 l/hr System
PC220DUBPM1	PURELAB Chorus 2+ RO/DI/UV 20 l/hr System with Boost Pump

Unit is supplied as standard with: Fitted / Included: Appropriate quantity LC240, 1 x LC241, 1 x LC272, 1 x LC274, 1 x LC285, MANU40932 Operator Manual, GUID39864 Light Guide, LA762 Basic installation Kit.

## PURELAB Chorus Halo Dispensers

Part Number	Description
LA754	Halo Dispenser
LA755	Advanced Halo Dispenser
LA56	Flexible Dispenser

Each supplied with GUID40007 or GUID40006 Quick Reference Guide, INST40011 or INST40013 Quick Start Guide, LA774 Installation Kit (plus for LA756: MANU40002 Operator manual)

## PURELAB Chorus 2 RO/DI

Part Number	Description
PC210DIXXM3	PURELAB Chorus 2 RO/DI 10 l/hr System
PC210DIBPM3	PURELAB Chorus 2 RO/DI 10 l/hr System with Boost Pump
PC220DIXXM3	PURELAB Chorus 2 RO/DI 20 l/hr System
PC220DIBPM3	PURELAB Chorus 2 RO/DI 20 l/hr System with Boost Pump

Unit is supplied as standard with: Fitted / Included: Appropriate quantity LC240 RO, 1 x LC241, 1 x LC234, MANU40003, Operator Manual, GUID39864 Light Guide, GUID40005 Quick Reference Guide, INST40009 Quick Start Guide, LA762 basic installation kit, LC233 bypass block

## PURELAB Chorus 3

Part Number	Description
RO310XXM3	PURELAB Chorus 3 RO 10 l/hr
RO310BPM3	PURELAB Chorus 3 RO 10 l/hr with Boost Pump
RO320XXM3	PURELAB Chorus 3 RO 20 l/hr
RO320BPM3	PURELAB Chorus 3 RO 20 l/hr with Boost Pump
RO330XXM3	PURELAB Chorus 3 RO 30 l/hr
RO330BPM3	PURELAB Chorus 3 RO 30 l/hr with Boost Pump

Unit is supplied as standard with: Fitted / Included: Appropriate quantity LC240 RO, 1 x LC241, GUID39864 Light Guide, GUID40004 Quick Reference Guide, INST40008 Quick Start Guide, LA762 basic installation kit

## PURELAB Chorus Reservoirs

Part Number	Description
LA757	15 Liter Reservoir
LA758	30 Liter Reservoir
LA759	60 Liter Reservoir
LA760	100 Liter Reservoir

Each reservoir supplied with LA773 Installation Kit & LC216 Composite Vent Filter

## PURELAB flex

Part Number	Description
PF1XXXXM1	PURELAB flex 1 (optional Purification Pack)
PF2XXXXM1	PURELAB flex 2 (Purification Pack + UV + TOC)
PF3XXXXM1	PURELAB flex 3
PF4XXXXM1	PURELAB flex 4
PF5XXXXM1	PURELAB flex 5
PF6XXXXM1	PURELAB flex 6

Unit is supplied as standard with: All units: Quick Reference Guide & user manual, certificate of conformity, bypass pack. Flex 2: 1 x LC210. Flex 3 & 5: 1 x LC217, 1 x LC210, 1 x LC216. Flex 4 & 6: 1 x LC210, 1 x LC216.



# The LabWater Specialists

ELGA is an integral part of Veolia, the global leader in optimized resource management. Veolia has a worldwide team of over 200,000 people and is renowned for its capabilities in providing water, waste and energy management solutions that contribute to the sustainable development of communities and industries.

The ELGA team focuses exclusively on water and its purification. It continually contributes to the unique technical and scientific applications and expertise developed for over 80 years. We are experienced in meeting the challenges that arise during the development, installation and servicing of single point-of-use water purification systems as well as large projects involving consultation with architects, consultants and clients.

## Commitment to Sustainability

The ELGA products are designed to have the lowest possible impact on the environment at all stages: manufacture, in service and at end of life.

We can calculate the carbon value of all our products throughout their lifetime and we make this information available to our customers and partners.

Visit: [www.elgalabwater.com/sc](http://www.elgalabwater.com/sc) for more details.

## Contact us:

ELGA offices and distributors are located in more than 60 countries and are fully trained in all ELGA systems.

To find your nearest ELGA representative, go to [www.elgalabwater.com](http://www.elgalabwater.com) and select your country for contact details.

### ELGA Global Operations Centre

tel: +44 (0) 203 567 7300

fax: +44 (0) 203 567 7205

[info@elgalabwater.com](mailto:info@elgalabwater.com)

[www.elgalabwater.com](http://www.elgalabwater.com)

### Connect with us:

[www.linkedin.com/elga-labwater](http://www.linkedin.com/elga-labwater)

Tweet us @sciencewater

[www.elgalabwater.com/blog](http://www.elgalabwater.com/blog)

Your local ELGA representative



Scan this QR code with your smart mobile phone to find out more about ELGA and to contact your local representative.

ELGA is the global laboratory water brand name of Veolia. The information contained in this document is the property of VWS (UK) Ltd, trading as ELGA LabWater, and is supplied without liability for errors or omissions. © VWS (UK) Ltd. 2019 – All rights reserved.

ELGA®, PURELAB®, PURELAB Chorus® and PureSure® are registered trademarks of VWS (UK) Ltd.