

SLAM 'N JAM '95

5 ON 5 FAST-BREAK ACTION puts you courtside for all the 3D thunder jams.

PLAY LARGE! In-your-face hoops with players 2X as large as 16-bit games. Rotoscoped moves give the twine scorching three-pointers an incredible sense of realism

- Make roster substitutions, set screens, and picks
- Replay the highlights from multiple angles
- Track players, teams, games, and season stats
- High-octane commentary by Van Earl Wright



63060-M



Crystal Dynamics, GEX, the GEX character, and Slam 'n Jam '95 are trademarks of Crystal Dynamics. 3DO, the 3DO logos and Interactive Multiplayer are trademarks of The 3DO Company. This game is licensed for home play on the 3DO Interactive Multiplayer system. Unauthorized copying, reproduction, rental, public performance or broadcast of this game is a violation of applicable laws. ©1995 Crystal Dynamics. All Rights Reserved. This product contains video compressed using Duck TrueMotion®. Duck TrueMotion® is a registered trademark of the Duck Corporation. Developed and manufactured in the USA.

CRYSTAL DYNAMICS™

GEX™

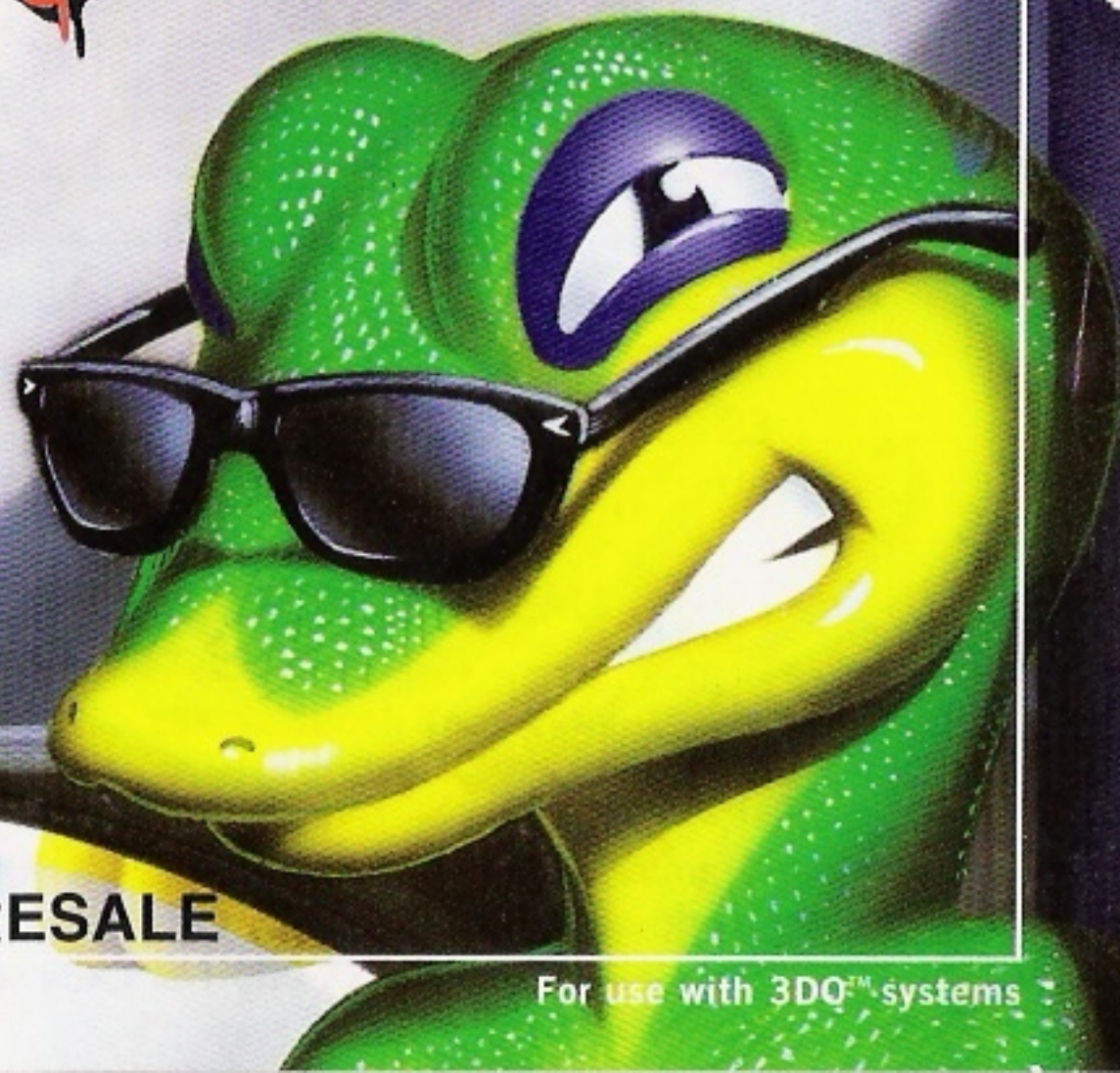

NOT FOR RESALE

For use with 3DO™ systems

GEX 99 Lives - pause Then hold R and Press
 LT, C, DN, DN, RT, A, C, UP, LT, A
 STAGE SELECT - AT MAP SCREEN - pause Then HOLD R Button
 and Press LT, C, DN, LT, RT, RT, UP, RT, RT/a menu should
 appear - some options may cause the 3DO to Reboot
 MAY FIND SOME UNFINISHED STAGES THAT DIDNT MAKE IT

CONTENTS



Game Set-Up	2
Choosing Game Options	3
A Bad TV Day	4
Network Mascot . . . NOT!	10
Play Controls	13
Cool Gecko Moves	14
Heads-Up Display	16
Power-Ups	17
Snapshot Milestones	19
Running Out of Lives	19
Maps	20
Handling Games	21
Saving Games	21
Resuming & Erasing Saved Games	22
Clues	23
GEX Is Brought to You By . . .	24

FOR MORE GEX GAME HINTS, CALL

1-900-737-4SOS (4767)

\$0.85/minute - 18+ - Touch Tone Only

Presented by Crystal Dynamics of Palo Alto, California

This product has been rated by the Entertainment Software Rating Board. For information about the ESRB rating or to comment about the appropriateness of the rating, please contact the ESRB at 1-800-771-3772.



GAME SET-UP

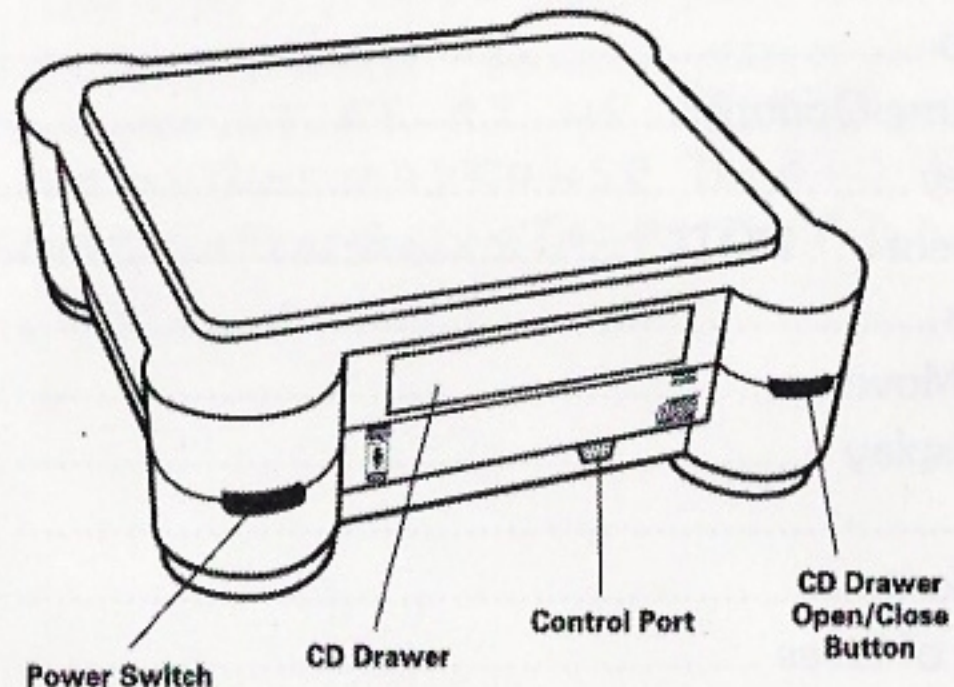

1. Set up your 3DO™ Interactive Multiplayer™ and plug your controller into the control port.
2. Press the power switch to turn the unit ON.
3. Press the Open/Close button to open the CD drawer, place the game CD into the drawer, label side up, and then press the button again to close the drawer.
4. Press the **X Button** on the controller to start.

CHOOSING GAME OPTIONS



1. Press the **Directional Pad UP/DOWN** to highlight an option.
2. If an option has different settings, press the **Directional Pad LEFT/RIGHT** to change the setting.
3. Press any button to start the game or go on to the next menu.

TITLE SCREEN

Start: Start a new game.

Options: Go to the Options menu.

Previews: Check out the incredible new games from Crystal Dynamics.



OPTIONS MENU

Sound & Music: Toggle the sound effects and tunes ON or OFF.

Sound Test & Music Test: Select a track and press any button to preview it.

Controls: Rearrange the play controls. Select an action, and then press a controller button to link the action with that button. Each controller button can be linked to only 1 action.

Exit: Leave the Options menu and return to the Title screen.



Ah, Hawaii. A lush tropical paradise, famous for many things: Magnum P.I., Hawaiian Eye, that TV show starring Jack Lord's hair, and most importantly, the world's largest population of gecko lizards. That's right, geckos. And one family of geckos in particular had a very special problem

Deep in a valley on Maui lived a gecko family that was just trying to make ends meet. Mom had her paws full raising three and a half kids (their numbers were dependent upon their regenerative powers) while Dad was away doing research for NASA. GEX, the oldest offspring, was a bright lad who would spend his days with his friends, surfing, playing the ukulele and throwing poi parties down on the beach with the local lady lizards.

That all changed, though, the day his mother got a call from NASA telling her the tragic news. The rocket containing Dad and 10 other volunteers, chosen to see if they would eat tapioca pudding in zero gravity, had exploded on the launch pad due to a band-aid floating in one of the fuel tanks. The family's carefree upper-middle-class life was shattered!

While the rest of the family dealt with their grief in the usual manner (crying, infighting and rummaging through Dad's stuff), GEX bottled up his feelings. He took refuge in front of the only thing in the house that had always provided him with undemanding comfort: the TV.

GEX found out that in his time of need, all his old and sometimes forgotten friends were still there, ready to take his mind off his troubles. There was Kimba the white lion, eager to take him on an adventure through the African savannas. The Six Million Dollar Man would stop by with a quick bionic pick-me-up. The Partridge Family would play a song, and then shake

their heads at the wacky antics of Mr. Reuben Kincaid. These were GEX's true friends, and he was willing to spend the rest of his life in their groovy company.

Try as she might, GEX's mom could not pry her son away from the boob tube. So, after consulting with the family minister and the weird guy at work, she decided it was time for a change of scenery. They were going to leave Hawaii and start a new life . . . in California.



One week later, a moving van pulled up in front of the family's new ranch-style home in Encino, California, surrounded by white picket fences and white supremacists. As the moving men unloaded a crate containing GEX and his beloved TV, his mother exclaimed that she was excited about the family's new beginning. GEX just laughed and told her that was exactly what Maude said to her husband after she went through menopause. GEX was still having trouble dealing with his father's death, but Mom thought she knew just what to do.

That night, the doorbell rang, and a burly older lizard came in carrying a basket of treats. He said his name was Harv and he lived next door and wanted to welcome the new neighbors. As he passed out various chocolate-covered bugs to GEX's siblings, Harv mentioned a little too loudly that he had one spot left on his Saturday All-Pro Girl Watching Team, and was wondering if there was someone around to fill it. GEX told him, from in front of the TV, that Jack Tripper was available, but only if he could get out of the *two* dates he had made for the same night.





Harv seemed a little confused. He whispered something to Mom, and then took a seat next to the tuned-out gecko. Then Harv asked GEX straight out if *he* would like to take that spot on the team. GEX replied that he'd love to, but had promised Bosley that he would watch the Angels for him all week. Harv chuckled, and suggested that maybe GEX was watching a little *too much* TV, and needed to get outside. Without taking his eyes off the set, GEX explained that the last time he had gone outside, his dad blew up, surrounded by gallons of burning tapioca.

Completely out of ideas, Harv bid Mom an exasperated farewell and left. Now what was a concerned mother to do? . . .

The next morning, GEX came running downstairs, expecting to have breakfast with the Banana Splits as usual, when he froze in his tracks. The TV was gone! This must be some kind of joke! Was it out for repairs? Did someone break in and steal it? C'mon, man, this isn't funny! The room began to spin . . . GEX needed a TV fix . . . the little suction cups on his hands were beginning to twitch . . . WHAT THE HECK WAS GOING ON?

Just then, his mother came in the room. "If you're looking for the TV, I gave it away to some gypsies early this morning," she said. She told him that enough was enough, and he needed to start doing things like a normal gecko. "Go catch some flies, practice walking up walls, enter a tongue-lashing contest. But for cripes sake, stop watching TV!"

GEX couldn't believe this. The one thing in his life that had meaning was gone, and his mother was behind it. Exploding with rage, GEX announced that he was never setting foot inside this TV-less house again, and stormed out the front door. Mom ran after him, begging him to stay, but it was too late. She had done the unthinkable, and this was the result.



The next few months were a blur. GEX hooked up with some local punks and spent his days skateboarding to the mall, hanging out in comic stores and blaring music through his Walkman™ on a cliff overlooking the city. He slept in a friend's garage and made pocket money "doing errands" for frustrated housewives. His entire existence became one long, aimless haze, with none of his TV friends around to help out. This seemed to be how he would spend the rest of his life. Or was it . . .



One day, as he was skateboarding along talking to his invisible buddy, "The Mayor" (life on the streets does things to a gecko), a long black limo pulled up. GEX was about to have His Honor go insult the driver, when the rear window rolled down, and he saw his mother!

Mom told GEX she was so glad to have finally found him, because she had fantastic news! Three days after he had left, GEX's great uncle Charlie had kicked the bucket and left his entire estate to the family. The amazing part was that, unbeknownst to the family, Uncle Charlie was the original model for the Izod™ shirt logo. He had invested his meager modeling salary back into company stock. At the time of his passing into the great beyond, Uncle Charlie's estimated worth was over 20 billion dollars! The family was rich!

Shocked out of his mind, GEX jumped up in the air, told The Mayor he had just been impeached, and hopped into Mom's limo. The hard times were over. He was going to start living life right!

For the next few weeks, the entire family went on a mad spending spree, buying houses, cars, local judges and politicians. Mom purchased 51 percent ownership in NASA, and then fired everybody, sold the rockets to some third world countries, and converted Mission Control into a theme restaurant featuring robotic dancing chimps wearing space suits.



GEX

GEX's siblings said they had always wanted to see Australia, so they bought it. GEX, on the other hand, was not into all the cars, jewels and other extravagances. He took his share of the fortune, tucked it into his pants pocket, and went for a walk. He walked and walked and walked, wondering what to do with his share. Then it hit him. He would use the cash to fulfill a longtime dream!

Exactly one hour later, GEX called his mother down at her restaurant, "Space Monkeys," and told her good-bye. He was going back to Hawaii. He was going to buy the biggest house on Maui, fill it with the world's largest TV set and enough food for decades, and then seal himself inside. He was going to spend the rest of his life watching all his old TV friends getting into outrageous situations or amazing adventures.

Mom wished him the best of luck, and then ran off to rewire some faulty chimps. GEX hung up the phone, and headed out to build his dream

In a few days, GEX was parked in front of his TV, munching from a nearby bowl of flies. He was in the middle of flipping through channels to see what was on. "Nope, nope, nope," he droned, as he clicked the remote again and again, surfing through reruns of kung fu theater, a wacky cartoon and an old Indiana Jones movie. Those shows were so boring.

He'd already seen all of them at least a million times. He was ready for something different.

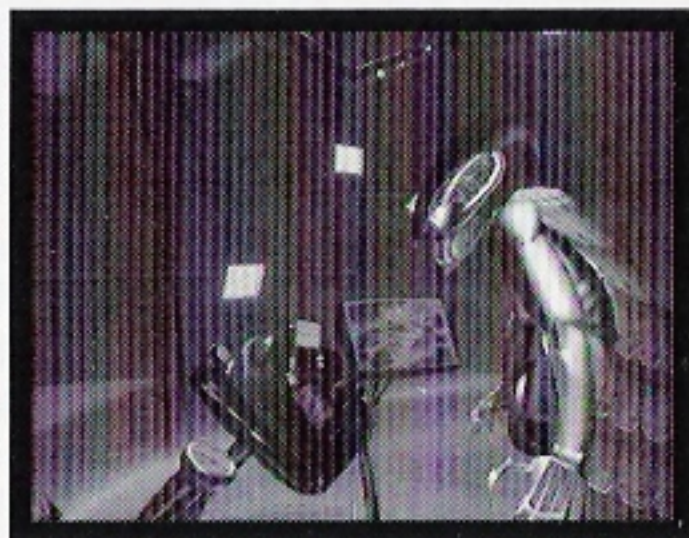

Frustrated, GEX started clicking all the remote's buttons rapid-fire, speeding through the channels in a super-fast blur. While he was clicking and kicking back, a fly buzzed by. GEX flicked out his tongue and – gulp! – down it went. But the fly was in reality a metallic transmitter. GEX was "bugged."



Suddenly, GEX's remote jammed and the TV blanked. A huge hand shot out of the screen, grabbed GEX by the neck and . . . ZZZZZZTTTTTTT!

Just like that, GEX had been yanked through his TV into the Media Dimension. The cold claw belonged to Rez, who had hooked GEX with a bugged fly.

Rez was the lord of the Media Dimension. He now intended to make GEX the new network mascot. "Out with the peacock, in with the gecko!"

GEX could only escape by getting his paws on the remote controls hidden throughout the Media Dimension. Once he had the remotes, he could destroy the TV sets that blocked the exits and were the portals into the next worlds. GEX had to find the last remote, blow up the last TV in the last world and make it home . . . or spend the rest of his gecko life as a bronzed network mascot!

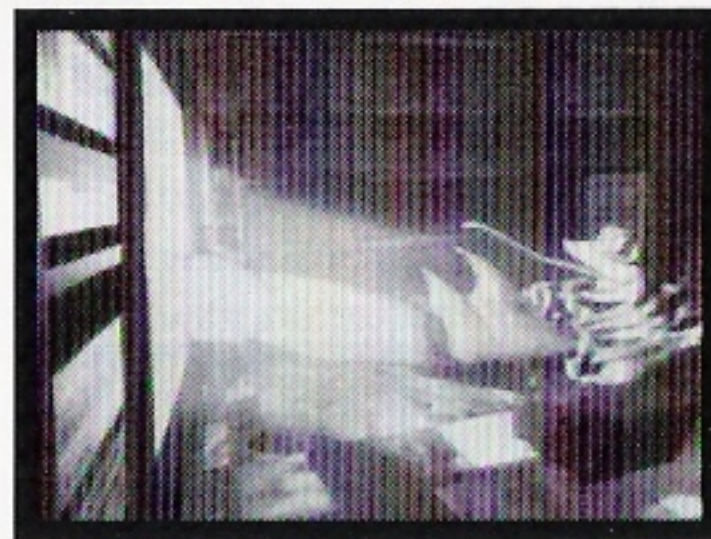

Without knowing it, GEX has been practicing all his life for this gig! He's got that tail whip down, thanks to years of batting pineapples around with his local ball club, the Molokai Scalpers. And how about that tongue lash? Slick, eh? You don't get that good without racking up the hours at the Poi Boy sushi bar, (especially if the sushi's got 8 legs). Jumping, wall crawling, face stick — GEX's natural talents have been honed by years of hanging out with his lizard pals from Diamond Head. Yep, GEX is ready . . . for the most whacked-out TV episode of his life!

GRAVEYARD WORLD

GEX hurtles through the Media Dimension, back to the time and place when Abbott and Costello met Frankenstein. GEX is caught in a creepy horror flick alive with Franken-geckos, mad slashers, crazy tomatoes and other Fright Night foes. Slime, fog . . . an exorcism in the offing! Better check your calendar, 'cuz you're stuck on Friday the 13th.

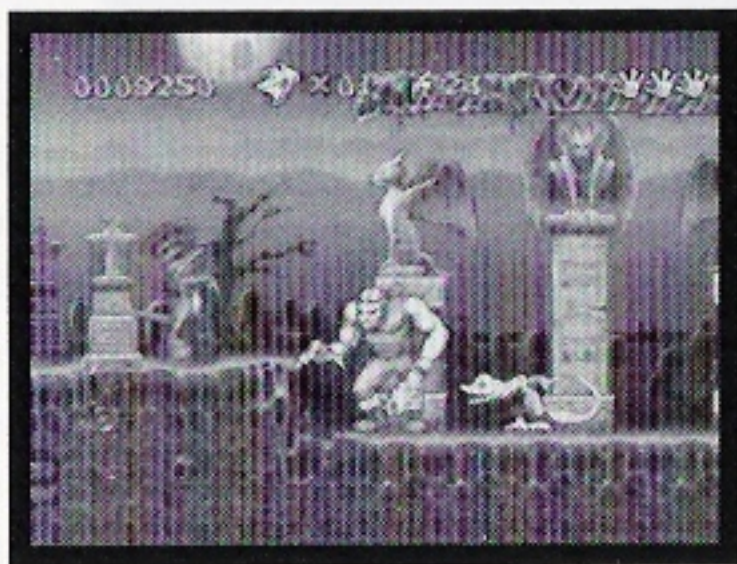

KUNG FU WORLD

There's nothing like getting hung up in Channel 26. Fighting your way through moronic martial arts scenes is bad enough, but can't they get that voice track in sync? It's Big Trouble in Little China with ninjas, samurai geckos, sumo wrestlers . . . enough is enough. Walk softly, little grasshopper, and whip a fast tail!

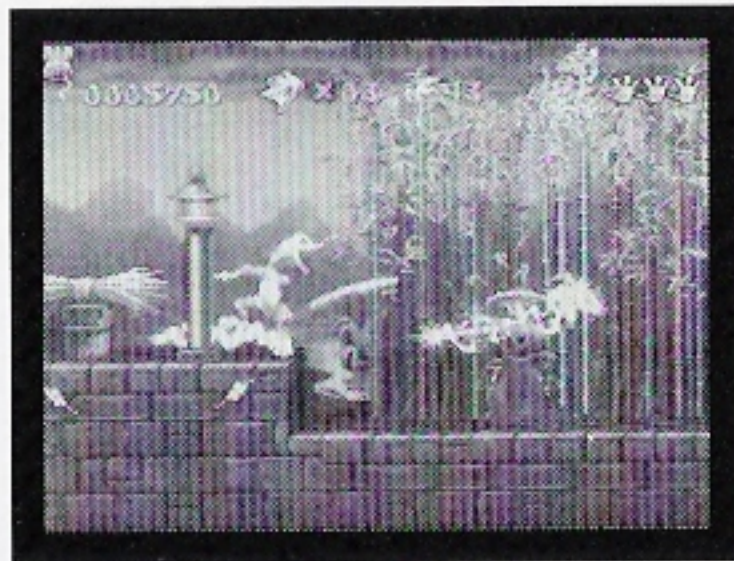

CARTOON WORLD

Toon Town this ain't! GEX battles cheesy characters from crack-of-dawn Saturday a.m. cartoons. Retired heroes and out-of-work 'toon slouchers line up to take a swipe at GEX. There's nothing like getting a safe dropped on your head. Itchy & Scratchy, eat each other's heart out!

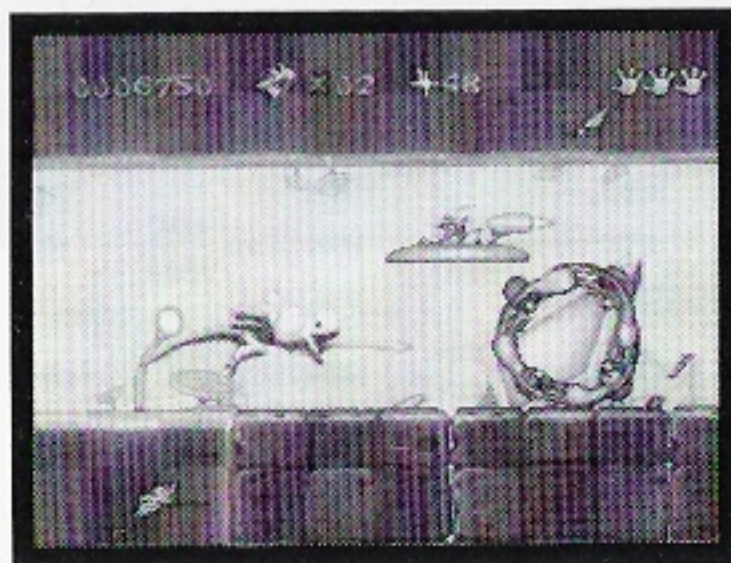

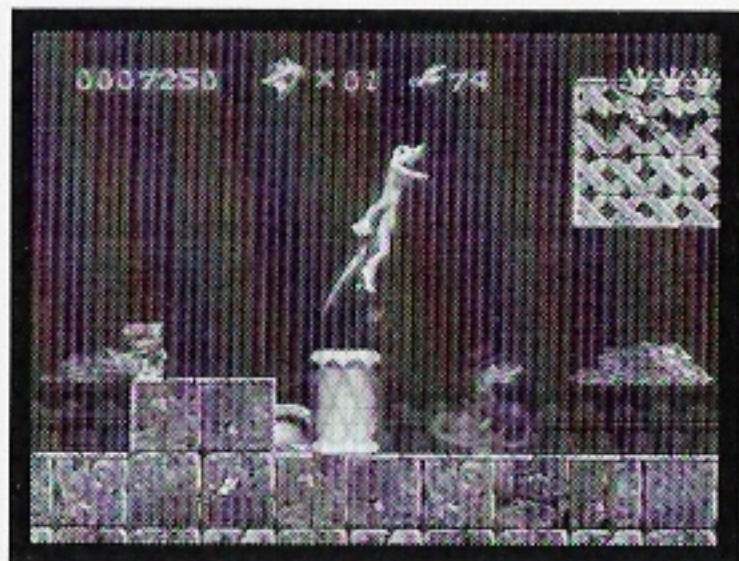

JUNGLE WORLD

Go native! Feel the beat of the bongos. GEX stalks through a malaria factory packed with carnivores and cannibals (who like the taste of gecko better than chicken), moving walls, hidden booby traps and breakaway bridges. You may have named the dog Indy . . . but there's a gecko with the same hat.

REZ'S NERVE CENTER

A world beyond insanity takes center stage. Vast installations of alien hi-tech circuitry fume with electrical force! Energy geysers leap from pulsating waves of liquid television. This is the twisted reality where network programs are chosen. At last, GEX confronts Rez himself in a battle that will decide the fate of the universe . . . and more importantly, whether a gecko will be next season's network mascot!

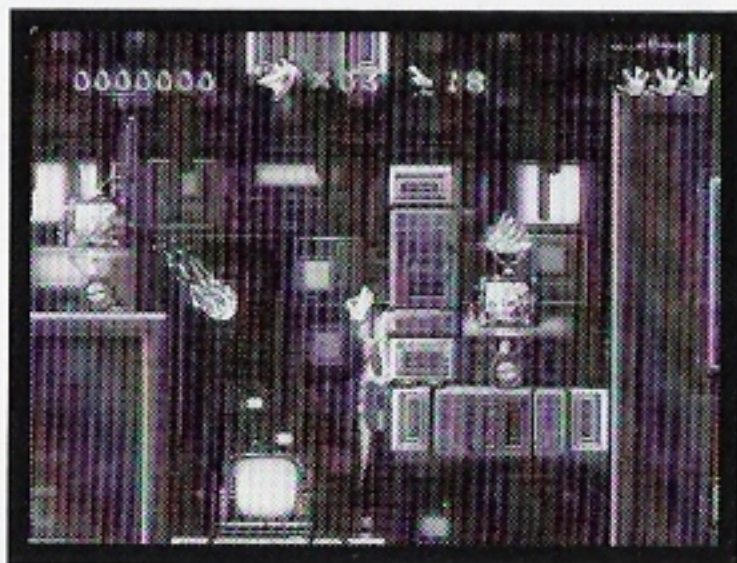

PLAY CONTROLS

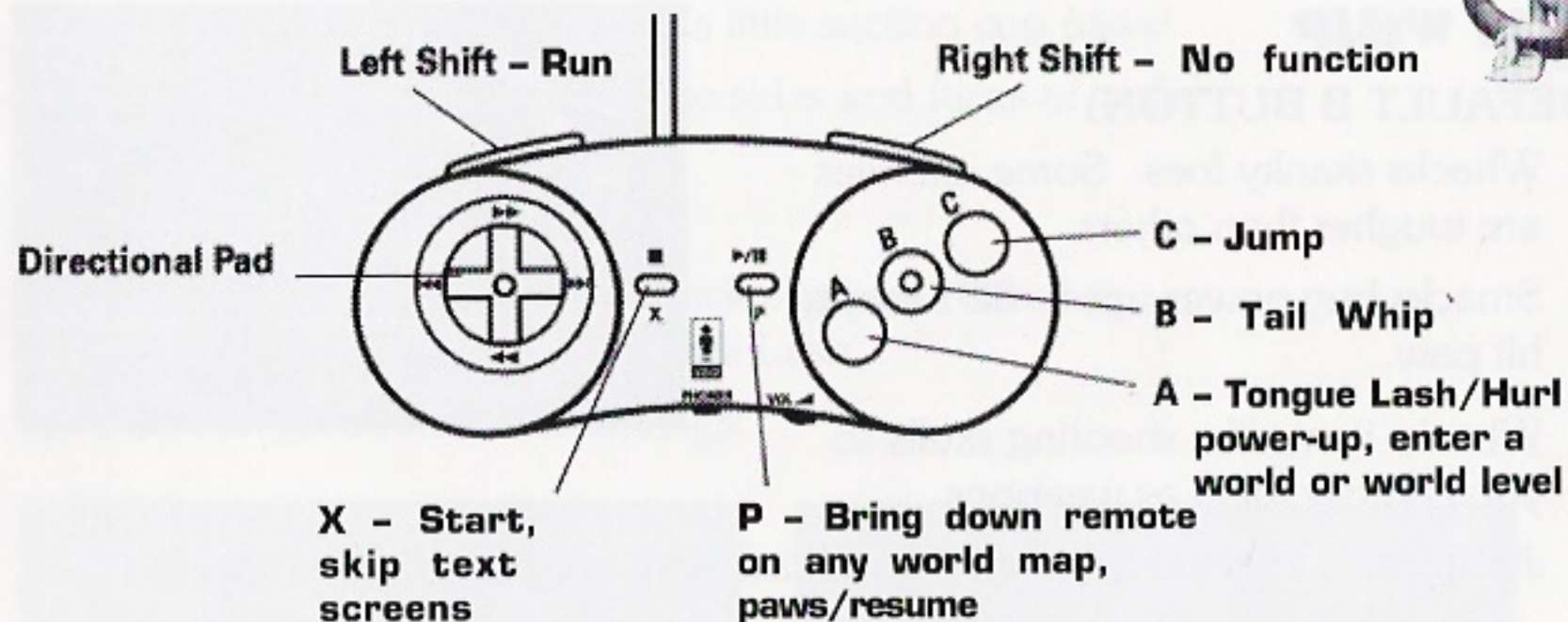

- X (Stop) Button** Start play; skip or exit text screens
- Directional Pad** UP/DOWN selects options; LEFT/RIGHT changes settings; any direction moves GEX
- A Button** Tongue lash/hurl power-up; enter a world or world level on a map
- B Button** Tail whip
- C Button** Jump
- P Button** Bring down remote on world map; paws/resume game
- Left Shift** Run

NOTE: These button actions are the default controls. You can change the controls on the Options menu (see page 3).

TAIL WHIP

(DEFAULT B BUTTON)

- ✗ Whacks skanky foes. Some enemies are tougher than others.
- ✗ Smacks bug power-ups to fill 1 empty hit paw.
- ✗ Whacks items like shooting skulls so you can use them as weapons.
- ✗ Jump, then execute a tail whip for an awesome display of gecko power.



TONGUE LASH

(DEFAULT A BUTTON)

- ✗ Snags flies and power-ups in mid-air.

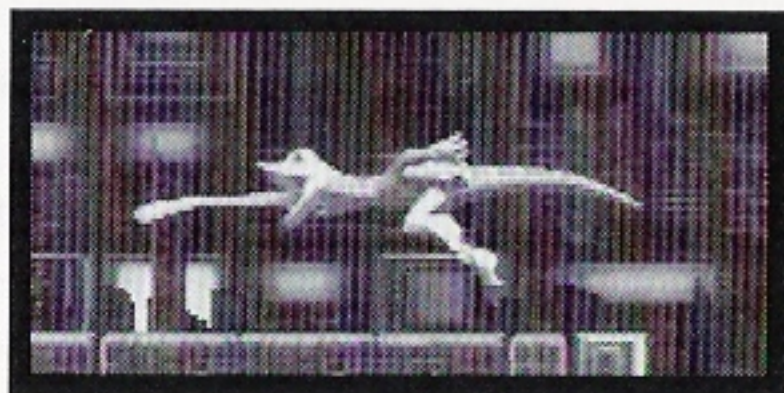

HURL

(DEFAULT A BUTTON)

- ✗ Spits out a power-up, such as a fire ball or ice ball, depending on the last power-up you swallowed.

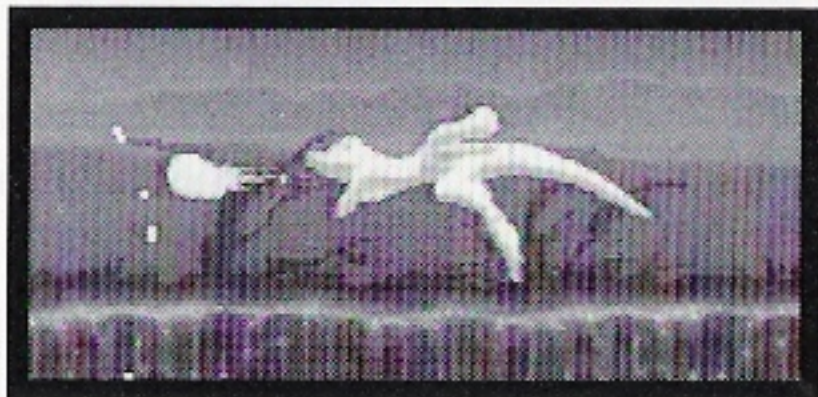

WALL STICK

- ✗ Jump while pressing the **Directional Pad** against a wall's surface and GEX sticks with his little suction cup paws!
- ✗ GEX can stick and crawl up the sides and faces of walls and buildings.
- ✗ GEX can spin while sticking.
- ✗ Snag power-ups from a wall stick position. Use the **Directional Pad** plus a Tongue Lash.
- ✗ Don't forget about those ceilings!



HEADS-UP DISPLAY**SCORE**

You gain points by destroying enemies.

LIVES

You start with 3 GEX lives. Pick up 100 golden flies, and you'll gain an extra life. Lose all your hit paws and you lose a life; lose all your lives and you lose the game.

POWER-UPS

GEX snags balls o' bug to power up with extra weapons, attributes and hit paws. The power-up he's currently using shows up here.

GOLDEN FLIES

Who left the door open! Every time you collect 100 golden flies, GEX receives a bonus life.

HIT PAWS

You start the game with 3 GEX hit paws. You can gain up to 6 paws by picking up the right power-up. You lose 1 paw per hit. (If you have bug power-ups, you lose those first, and then you lose hit paws.) Lose all of your paws and you lose a life . . . lose all your lives and you lose the game . . . you know the drill.

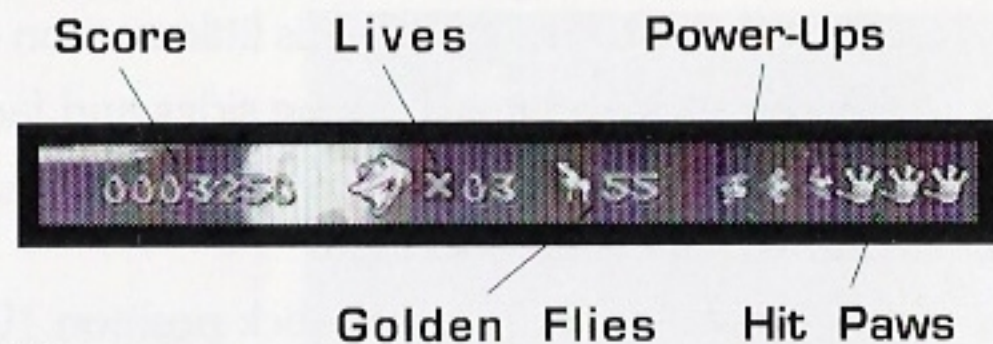
**POWER-UPS**

Power-ups are balls o' bug with juicy gecko snacks inside. You can use them in 2 ways:

- ✘ As health power-ups. Smack any bug ball with a tail whip to fill up 1 empty hit paw.
- ✘ Catch power-ups with a tongue lash to gain their powers. Bugs will appear to the left of your hit paws, to show which power-ups you have. You can collect multiple power-ups this way, always using the last one you caught.

Some power-ups take effect right away; others let go with fire balls, ice balls or bolts of electricity when you hurl. Also, some power-ups, like invulnerability, are timed, while others are lost when GEX takes damage.

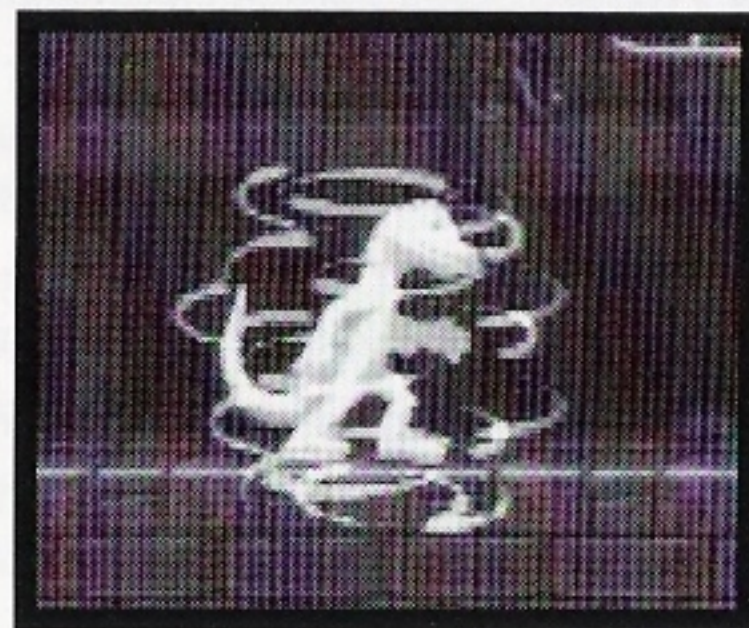

POWER-UP BUGS

- ✘ **Amber Balls:** Fill 1 empty hit paw. Immediate effect.
- ✘ **Ladybug:** Fill all empty hit paws. Immediate effect.
- ✘ **Flea:** Fill all empty hit paws and add one. Immediate effect.
- ✘ **Butterfly:** Gain an extra life. Immediate effect.
- ✘ **Blue Firefly:** Hurl ice balls. Immediate effect; lasts until hit.
- ✘ **Red Firefly:** Hurl fire balls. Immediate effect; lasts until hit.
- ✘ **Yellow Firefly:** Hurl bolts of electricity. Immediate effect; lasts until hit.
- ✘ **Grasshopper:** Jump higher and farther. Immediate effect; lasts until hit.
- ✘ **Centipede:** Kick GEX into overdrive! Immediate effect; lasts until hit.
- ✘ **Caterpillar:** Laugh at danger with invincibility. Immediate effect; lasts for a short time.

SNAPSHOT MILESTONES



Run past a polaroid camera and hit it with a tail whip. The camera will take a snap of GEX.

The snapshot is a milestone. If GEX loses a life, you will return to the level from that milestone spot, instead of having to restart from the beginning.

If GEX loses all his lives, the milestones don't make any difference. You knew that.

RUNNING OUT OF LIVES

Your goal is to get your paws on the remote control hidden somewhere in each world. (On the map screen, press the **P Button** to bring down the remote, select the remote you want, and press the **A Button** to go to the next available level.)

You start out with 3 lives. If you take too much damage and lose all your hit paws, you lose 1 of your lives.

When you lose a life, you will restart the level from the beginning. If you lose all lives, including any bonus lives you've collected, the game ends and Rez takes one more step toward bronzing a gecko as the network mascot!

Remember to save your games (up to 3) so you don't always have to start from the beginning (see page 21).

Rez's secret maps of the Media Dimension have fallen into GEX's paws. These are the very same maps that Rez uses to zing around his empire. Now GEX has 'em. So make 'em work for you! They show everything but Liberace's cabana.

To use a map:

1. Move GEX with the **Directional Pad** to any entrance on the map.
2. Press the **A Button** to enter that world or world level.
3. Select the VCR to save, load or erase games (see pages 21-22).

MEDIA DIMENSION MAP

The first map you'll see is a global view of the Media Dimension. Use this map to choose your world destination.

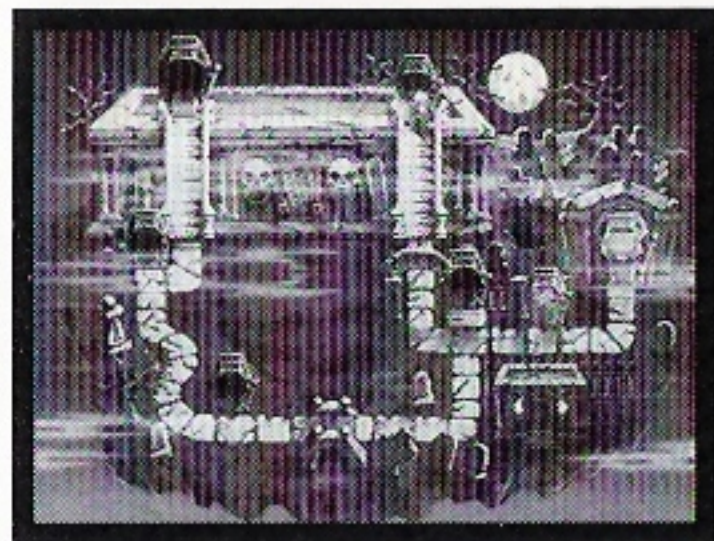
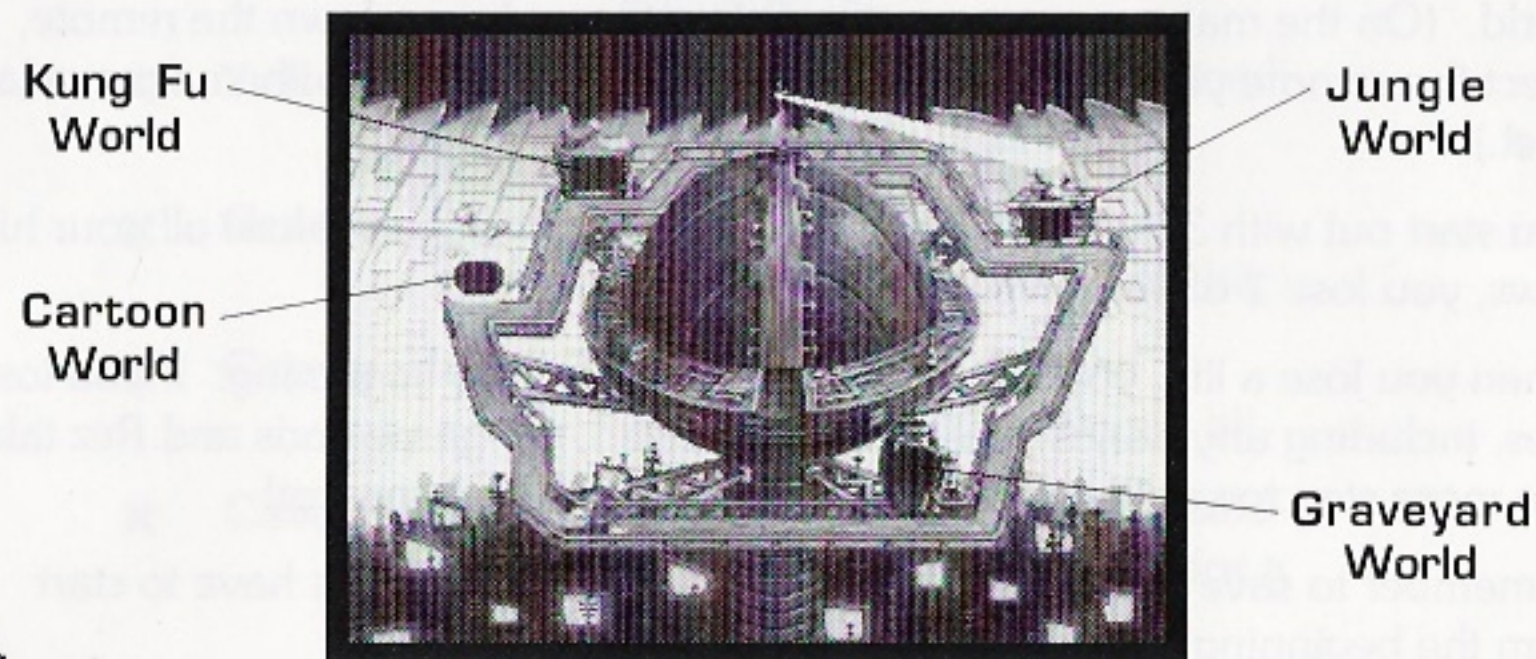

WORLD MAPS

Once you're in a world, you can choose your next level from its map. Press the **P Button** to bring down the remote, select the remote you want with the **Directional Pad**, and press the **A Button** to enter the next available level.



HANDLING GAMES

SAVING GAMES

You can save your place in GEX in 2 different ways:

1. Beat the boss at the end of a world, and the game will be automatically saved.
2. Some levels have hidden video tapes that look like a VCR tape. When you find one, it stays with you until you finish the level and return to the world map. Then, the game scales the video tape into the VCR, labeled "Game Saved," and automatically saves the game.

RESUMING & ERASING SAVED GAMES

To resume a saved game, move GEX to the VCR on any world map and press the **A Button**. You'll go to the Video Deck screen.



1. Press the **Directional Pad UP/DOWN** to select Video Deck 1, 2 or 3, depending on which game you want.
2. Press the **Directional Pad RIGHT/LEFT** to select your action:
 - Play:** Load the saved game and begin play from the point where you saved it.
 - Erase:** Delete the saved game.
 - Copy:** Save your current game to that video deck.

You have room to save up to 3 separate games at the same time. To save additional games, first ERASE games you no longer want to keep.

CLUES



✗ The flying TVs are compliments of Rez. When you whack these aerial bombs with a tail whip, they start a countdown. Don't be in the way when they explode.

✗ Find the special tricks in each world to overcome the tough spots. For example, slap the floating skulls with a tail whip to knock out Rez's TVs.

✗ Movie cameras are switches. Activate them with a tail whip to start up some special mechanism. Then look around to see what's changed, for instance, a bridge has fallen into place or a door has opened.



✗ Ride the rafts across shooting geysers. Jump, duck and tail-whip from your safe flotation device, but hang on!

✗ Conveyor belts travel horizontally and vertically. Some are grounded, others float in the air. Stick on them and you'll be whisked away to other places.

✗ The Media Dimension has other surprises in store, such as deadly pools of liquid Rez and secret levels. Find 'em, Dano.

✗ Each world's boss is rough and tough to beat. Each one can be destroyed if you figure out his secret. For instance, it might have to do with something the boss likes to eat or drink.

✗ Find a remote control in each world and whap it with a tail attack to gain ownership. Figure out how to use the remote to escape to the next level.

GEX IS BROUGHT TO YOU BY . . .

GEX CONCEPT

Lyle Hall

GEX CORE TEAM

G-Man, Justin Norr, Mira F. Ross, Lyle Hall

PROGRAMMING

G-Man Lead Programmer
Daniel Chan Bosses & AI System
Mei Yu Li BLT, Maps & Glue Screens
Troy D. Gillette Stunt Coding

ART

Mira F. Ross Lead Artist
Steve Kongsle GEX & Rez Character Design & 3D Models
 GEX Character Animation
Steve Suhy Stunt Animator
Shawn McLean Boss Animation
Silicon Knights Enemy Character Design & Animation
Kirk Henderson Map Screens & Jungle World Backgrounds

GAME DESIGN

Justin Norr Lead Designer
J. Epps Designer
Evan Lindsay Wells Designer
Richard Lemarchand Designer

AI SCRIPTING

Susan Michele, Jeremy Bredow, Adrienne M. Canfil

MUSIC COMPOSED & PRODUCED BY

Webtone Productions

SOUND FX

Greg Weber, Steve Henifin

INTRO & OUTRO 3D ANIMATION

Windlight Studios

Mira F. Ross, Steve Kongsle, Lyle Hall, Scott Steinberg

PRODUCER

Lyle Hall

WRITER

Robert Cohen

GEX VOICE & WRITER

Dana Gould

MARKETING DIRECTOR

Scott Steinberg

ADDITIONAL DESIGN

Noah Hughes

ADDITIONAL ART

Jean Z. Xiong

TOOL SUPPORT

Sean Vikoren IGOT

VIDEO COMPRESSION

Dan Brazelton

TEST MANAGER

Ben Szymkowiak

LEAD TESTER

Steve Groll

TESTERS

Dusty Bedford, Seth Carus, Phillip Chou, Chris Colón, Riley Cooper, Charles Geiwitz, Egan Hirvela, Tim Jordan, Scott Matt, Laurence Monji, Alex Ness, Richard Niedzwiecki, Kurt Tindle, Jeff Todd, Gerald Vera, Mark Ybarra

MANUAL

Carol Ann Hanshaw

SPECIAL THANKS TO

Juan Ruiz, Dan Arey, Madeline Canepa, Jon Horsley, Ted Fitzgerald, Chang Fadel, Dan Dorosin, Jennifer Bulka, Alan Chaplin, Denis Dyack, Susan Bowman, Rob Dyer, Chip Blundell



This product contains video compressed using Duck TrueMotion®.
TrueMotion® is a registered trademark of The Duck Corporation.



END USER NOTICE

THE 3DO COMPANY SHALL NOT BE LIABLE TO THE END USER FOR ANY LOSS OF DATA, LOST PROFITS, COST OF SUBSTITUTE GOODS OR OTHER CONSEQUENTIAL, INCIDENTAL, SPECIAL, PUNITIVE OR OTHER DAMAGES OF ANY KIND ARISING OUT OF THE USE OF OR INABILITY TO USE THE SOFTWARE.

THE 3DO COMPANY MAKES NO WARRANTIES, EXPRESS, IMPLIED OR STATUTORY, REGARDING THE SOFTWARE, INCLUDING WITHOUT LIMITATION THE IMPLIED WARRANTIES OF MERCHANTABILITY AND FITNESS FOR ANY PARTICULAR PURPOSE, OR ANY EQUIVALENT WARRANTIES UNDER THE LAWS OF ANY JURISDICTION.

DO NOT USE A FRONT OR REAR PROJECTION TELEVISION WITH THIS PRODUCT. YOUR PROJECTION TELEVISION SCREEN MAY BE PERMANENTLY DAMAGED IF STATIONARY SCENES OR PATTERNS ARE PLAYED ON YOUR PROJECTION TELEVISION. SIMILAR DAMAGE MAY OCCUR IF YOU PLACE THIS PRODUCT ON HOLD OR PAUSE. IF YOU USE YOUR PROJECTION TELEVISION WITH THIS PRODUCT, NEITHER THE 3DO COMPANY NOR CRYSTAL DYNAMICS WILL BE LIABLE FOR ANY RESULTING DAMAGE. THIS SITUATION IS NOT CAUSED BY A DEFECT IN THIS PRODUCT OR THE 3DO SYSTEM; OTHER FIXED OR REPETITIVE IMAGES MAY CAUSE SIMILAR DAMAGE TO A PROJECTION TELEVISION. PLEASE CONTACT YOUR TV MANUFACTURER FOR FURTHER INFORMATION.

THE EXECUTION OF SOFTWARE WITH THE 3DO SYSTEM INVOLVES THE USE OF PATENT RIGHTS, GRANTED OR APPLIED FOR, IN CERTAIN COUNTRIES. A PURCHASER OF THE 3DO SYSTEM IS LICENSED TO USE SUCH PATENT RIGHTS WITH SOFTWARE LICENSED BY THE 3DO COMPANY. NO LICENSE, IMPLIED OR OTHERWISE, IS GRANTED FOR THE EXECUTION OF OTHER SOFTWARE.

EPILEPSY WARNING

A very small percentage of people may experience epileptic seizures when exposed to certain light patterns or flashing lights, including those that appear on a television screen and while playing video games. If you, or anyone in your family, has an epileptic condition, consult your physician prior to playing. **If you experience any of the following symptoms while playing a video game — dizziness, altered vision, eye or muscle twitches, disorientation, loss of awareness, any involuntary movement or convulsions — IMMEDIATELY discontinue use and consult your physician before resuming play.**

CRYSTAL DYNAMICS LIMITED WARRANTY

Crystal Dynamics warrants to the original purchaser of the computer software product, for a period of 90 days from the date of original purchase (the "Warranty Period") that under normal use, the magnetic media and the user documentation are free from defects in materials and workmanship.

WARRANTY CLAIMS

To make a warranty claim under this limited warranty, please return the product to the point of purchase, accompanied by proof of purchase, your name, your return address and a statement of defect. OR send the disc(s) to us at Crystal Dynamics, 87 Encina Avenue, Palo Alto, CA 94301, within 90 days of purchase. Include a copy of the dated purchase receipt, your name, your return address and a statement of defect. Crystal Dynamics or its authorized dealer will, at our option, repair or replace the product and return it to you (postage prepaid) or issue you with a credit equal to the purchase price.

To replace defective media after the 90-day warranty period has expired, send the original disc(s) to the Crystal Dynamics address given above. Enclose a statement of defect, your name, your return address, and a check or money order for \$10.00.

The foregoing states the purchaser's sole and exclusive remedy for any breach of warranty with respect to the software product.

LIMITATIONS

THIS WARRANTY IS IN LIEU OF ALL OTHER WARRANTIES AND NO OTHER REPRESENTATIONS OR CLAIMS OF ANY NATURE SHALL BE BINDING ON OR OBLIGATE CRYSTAL DYNAMICS. ANY IMPLIED WARRANTIES APPLICABLE TO THIS SOFTWARE PRODUCT, INCLUDING WARRANTIES OF MERCHANTABILITY AND FITNESS FOR A PARTICULAR PURPOSE, ARE LIMITED TO THE 90-DAY PERIOD DESCRIBED ABOVE. IN NO EVENT WILL CRYSTAL DYNAMICS BE LIABLE FOR ANY SPECIAL, INCIDENTAL, OR CONSEQUENTIAL DAMAGES RESULTING FROM POSSESSION, USE OR MALFUNCTION OF THIS CRYSTAL DYNAMICS SOFTWARE PRODUCT.

Some states do not allow limitations as to how long an implied warranty lasts and/or exclusions or limitations of incidental or consequential damages, so the above limitations and/or exclusions of liability may not apply to you. This warranty gives you specific rights, and you may also have other rights which vary from state to state.

SCORE \$1,000 GRAND PRIZE!

Every 3 months a sweepstakes drawing will randomly determine the \$1,000 Grand Prize Winner. Sweepstakes ends December 31, 1995.

RULES & REGULATIONS — NO PURCHASE NECESSARY

1. You are automatically entered in the \$1,000.00 Sweepstakes for the 1995 calendar quarter in which you've entered by completing the registration card on the next page and mailing it to: Crystal Dynamics™ Sweepstakes Registration, P.O. Box 7046, San Francisco, CA 94120-9324, no later than December 31, 1995.
2. If you do not wish to purchase this product but want to enter the sweepstakes, you can enter by handprinting your name, address and zip code on a plain 3" x 5" piece of paper and mailing to the same address above. Enter as often as you wish, but each entry must be mailed separately. Each entry will be good only for the calendar quarter in which it is received. Mechanically reproduced entries will not be accepted.
3. Winners will be selected in quarterly random drawings from all product registration cards and 3" x 5" entries received. Judgings will be conducted quarterly, January 1, 1995 through December 31, 1995, on the last day of the month of that quarter, by Little & King Co., Inc., an independent judging organization whose decisions are final on all matters relating to this sweepstakes. Odds of winning are based on the total number of qualified entries received during the quarter of the drawing in which you are entered. Prizes (each quarter): Grand (1) \$1,000.00, retail value \$1,000.00 each; First (5) Subscription to Die Hard Game Fan Magazine, retail value \$24.99 each. Second (10) Crystal Dynamics T-shirt, retail value \$9.95 each. All prizes will be awarded and winners will be notified by mail. Only one prize to an individual or household. Prizes are non-transferable and no substitutions are allowed. Sponsor and its agencies assume no responsibility or liability for damages, losses or injury resulting from acceptance or use of prizes. Taxes, if any, are the responsibility of the individual winners. Winners may be required to execute an affidavit of eligibility and release within 14 days of notification attempt or we reserve the right to randomly select a new winner. No responsibility is assumed for lost, misdirected, illegible or late mail. Entry constitutes permission to use winners' names and likenesses for publicity purposes without further compensation.
4. Sweepstakes open to residents of the U.S. except employees and their families of Crystal Dynamics, and Little & King Co., Inc., their affiliates, subsidiaries and agencies. This offer is void wherever prohibited, and subject to all federal, state and local taxes.
5. For a list of winners, send a stamped, self-addressed envelope to: \$1,000.00 Winners, C/O Little & King Co., Inc., 140 Broadway, Amityville, NY 11701.

DON'T MISS OUT!

To Enter: Fill out the bottom portion of this page and place it in a stamped envelope addressed to: Crystal Dynamics, P.O. Box 7046, San Francisco, CA 94120-9324 to ensure that you are entered in the Crystal Dynamics Registration Card Sweepstakes. \$1,000 could be yours!

CRYSTAL DYNAMICS REGISTRATION CARD

1. Who is the primary player of the game?

First Name

Last Name

Address

City

State

Zip Code

()

Phone

1 Male 2 Female

Date of birth / /
mo. day year

When did you purchase this product? /
mo. year

2. Who purchased this product?

- 1 Primary Player 2 Friend
 3 Parent/Guardian 4 Relative
 5 Another Household Member

3. Please place a check next to the retailer where you purchased this product:

- 1 Babbage's 2 Electronics Boutique
 3 Software Etc. 4 Best Buy
 5 Circuit City 6 WalMart
 7 Other _____

63060 - R

4. What other gaming systems do you own? PLEASE CHECK EVERY SYSTEM OWNED.

- 1 Game Gear 2 Game Boy
 3 Atari Lynx 4 Sega Genesis
 5 Super Nintendo Entertainment System
 6 Nintendo Entertainment System
 7 Phillips CD-1 8 Sega CD
 9 TurboGrafx CD
 10 IBM/Compatible PC
 11 Macintosh Computer
 12 IBM/Compatible PC with CD-ROM unit
 13 Macintosh Computer with CD-ROM unit
 14 3DO Interactive Multiplayer
 15 Sega Genesis 32X
 16 Sega Saturn
 17 Sony PSX/PlayStation
 18 Other _____