

Cybercrime In The Deep Web

Marco Balduzzi, Vincenzo Ciancaglini
Black Hat Europe 2015



About us

Dr. Marco BALDUZZI

- ◎ MSc in Computer Engineering
- ◎ Ph.D. in System Security with ~15 peer-reviewed papers
- ◎ 13+ years experience in IT Security -- Consultant, engineer and researcher
- ◎ Turned my hobby into my profession
- ◎ Sr. Research Scientist for Trend Micro
- ◎ Bridge scientific research and industry needs
- ◎ Veteran speaker in major conferences with 50+ talks

Dr. Vincenzo CIANCAGLINI

- ◎ M.Sc. in Telecommunication Engineering
- ◎ Ph.D. in Computer Networking, Peer to peer networks and next generations protocols
- ◎ 10+ years experience in R&D
- ◎ Sr. Research Scientist for Trend Micro
- ◎ Development of novel proof of concepts and complex systems



Roadmap

◎ Introduction

◎ Deep Web Analyzer (DeWA)

- Data collection
- Data enrichment
- Storage and indexing

◎ Illegal Trading

◎ Data Analysis

◎ Malware

◎ Conclusions

◎ **Deep Web:** *Internet not indexed by traditional search engines.*

◎ **Dark Net:** *Private overlay network.*

◎ **Dark Web:** *WWW hosted on Dark Nets.*





“

The Deep Web is vast. Thousands of times larger than the surface web.

Alex Winter, Deep Web Documentary, 2015

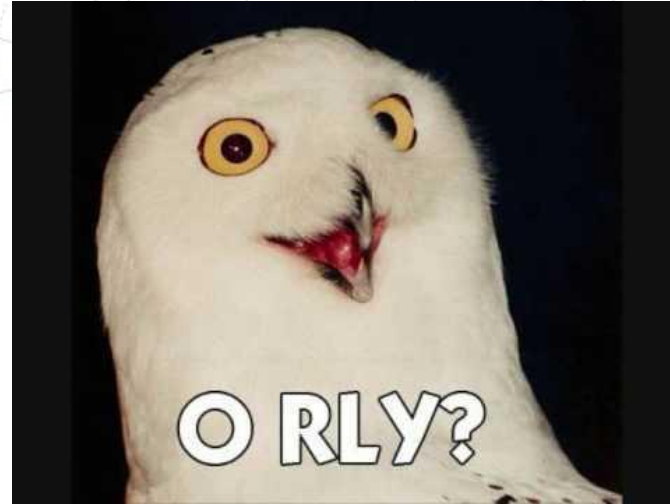

The Deep Web is vast. Thousands of times larger than the surface web.

Alex Winter, Deep Web Documentary, 2015

Our research focus

- Infrastructure resilient to LE takedowns
- Marketplaces for cybercrime goods
- Safe haven for information exchange and coordination

Cesidian Root

Cyberterra Mean Time
Saturday 22 Kurosawa 2015 @ 535



Rogue TLDs

- Cesidian Root
- OpenNIC
- NewNations
- ...

Dark Web

- TOR
- I2P
- Freenet



Custom DNS

- Namecoin
- Emercoin

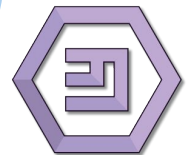

TOR

- First alpha in 2002
- Initially used to browse anonymously the Surface Web
- Hidden services -> effective Dark Web
- Onion routing: multihop routing with with host key encryption.

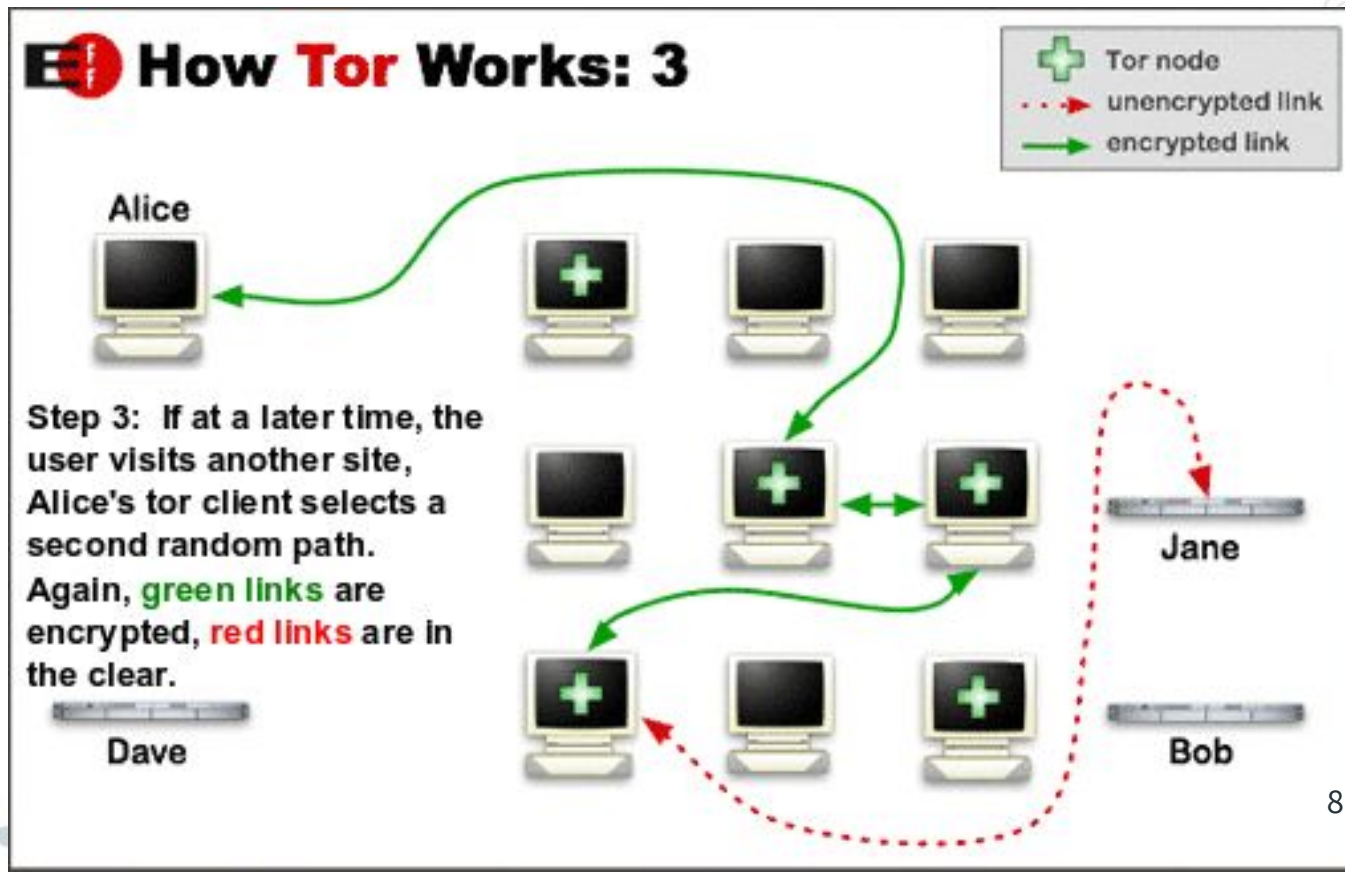

I2P

- First beta in 2003
- Full Dark Net, no anonymous browsing to the Surface Web
- Garlic routing: multiple encrypted tunnels, multiple layers of encryption (transport, tunnel, path)

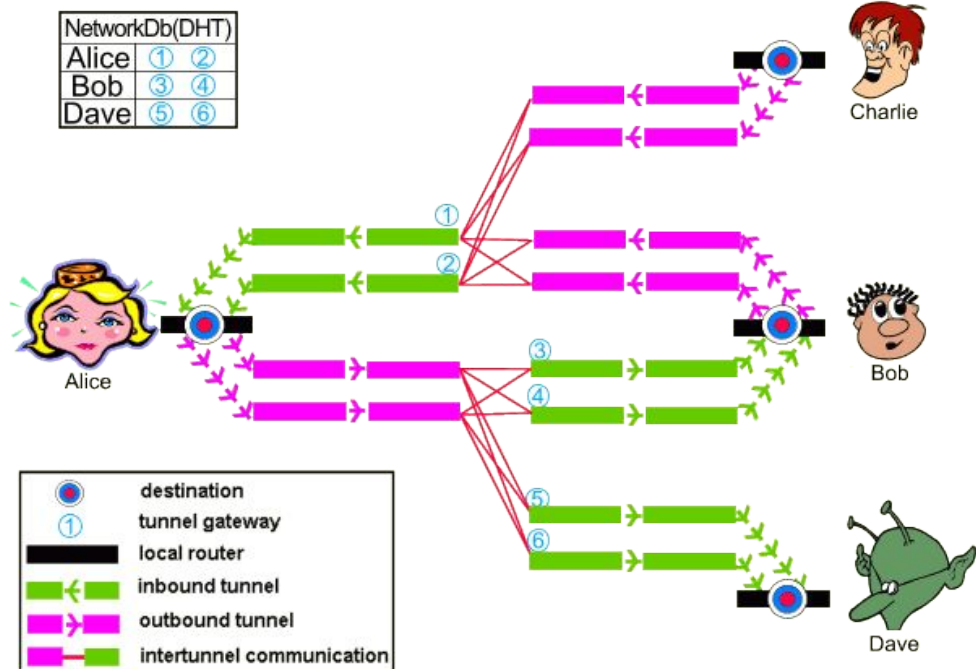

Freenet

- Oldest one: summer of 1999 (father of I2P)
- Content distribution and discovery, no service hosting
- Gossip protocol to lookup a resource (i.e. web page)

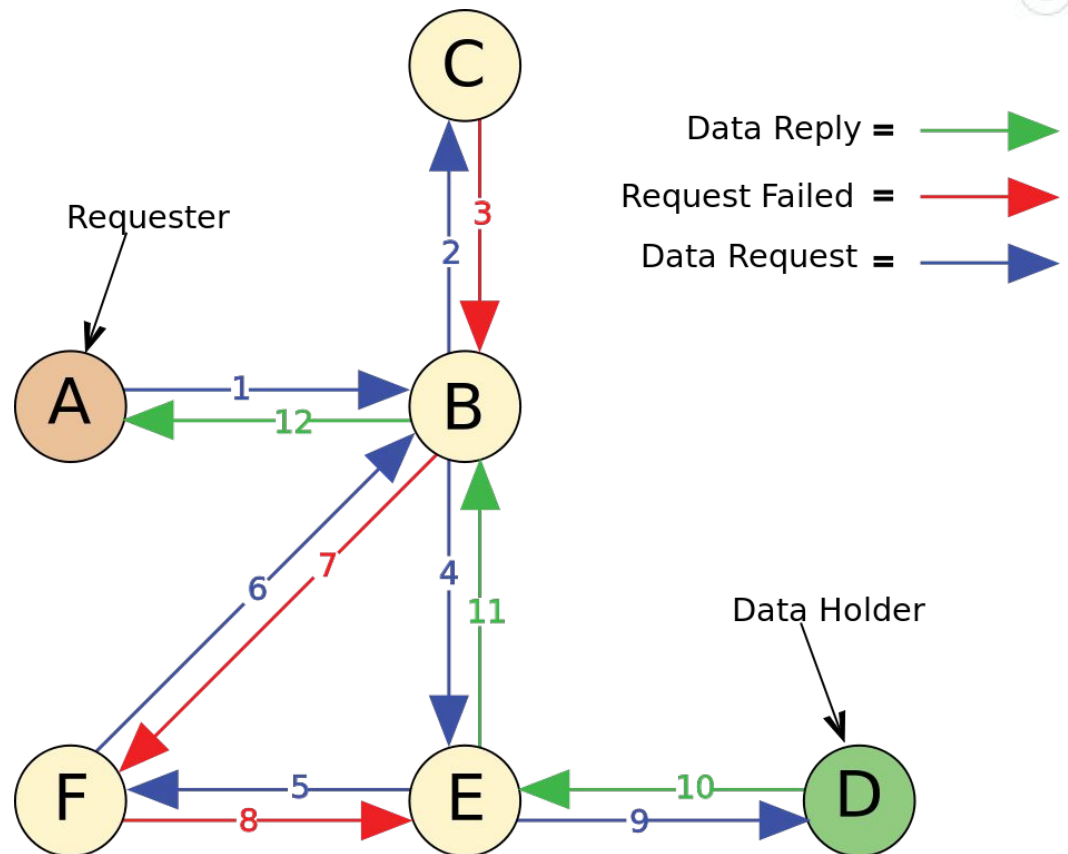

Namecoins, Emercoins

- ⊙ Blockchain-based domain name server
- ⊙ Think bitcoins, but instead of payment transactions, DNS registrar transaction

- ⊙ Distributed
- ⊙ Decentralised
- ⊙ No regulating institution

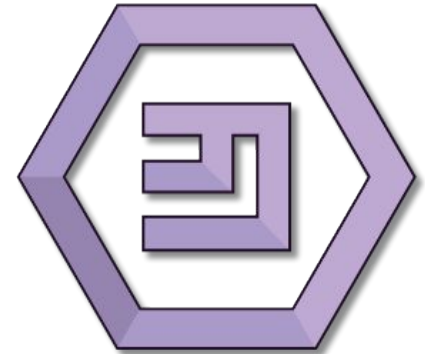

RogueTLDs & PrivateDNSes

Plain old DNS, but with custom servers

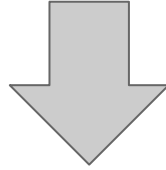

Custom registrars

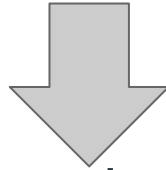

Custom domains

Cesidian Root

Cyberterra Mean Time
Saturday 22 Kurosawa 2015 @ 535



Roadmap

○ Introduction

◎ **Deep Web Analyzer (DeWA)**

- Data collection
- Data enrichment
- Storage and indexing

○ Illegal Trading

○ Data Analysis

○ Malware

○ Conclusions

System Overview

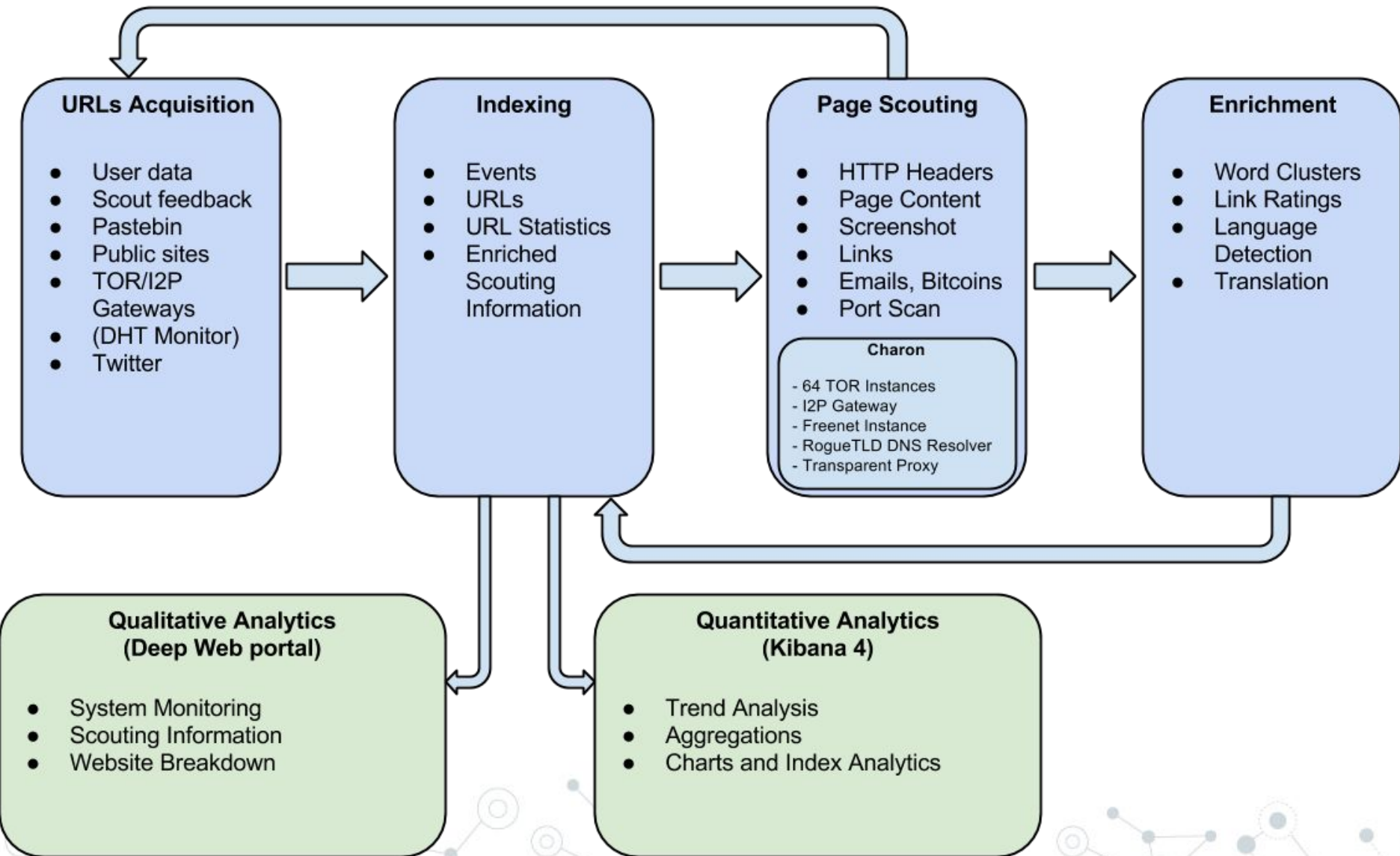

Data Sources

User data

Pastebin sites

**Twitter
(1% feed)**

Reddit

URL listing sites

TOR gateways

I2P host files

Scouting feedback

Deep Web Gateway

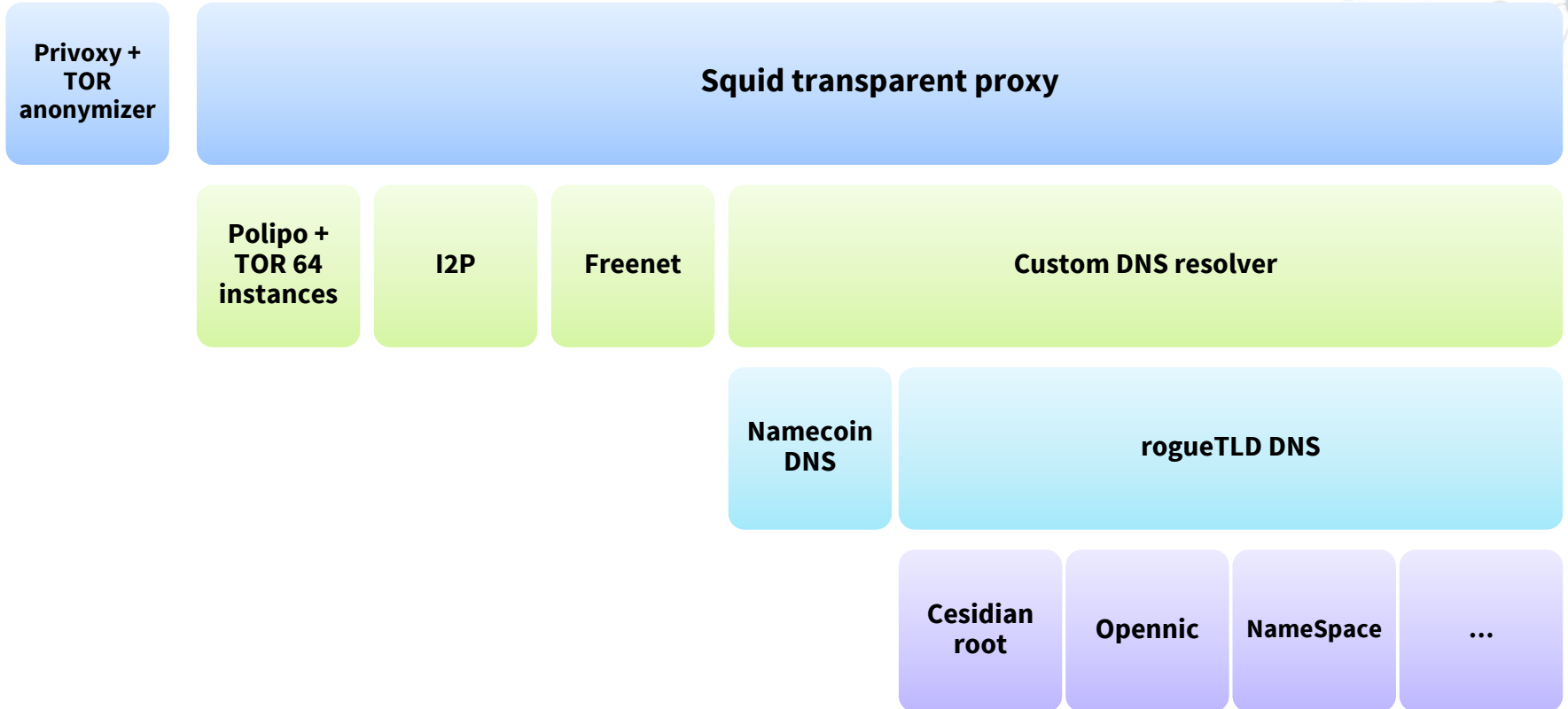

Page Scouting



Headless Browser

- Scrapinghub's Splash
 - QTWebkit browser
 - Dockerized
 - LUA scriptable
 - Full HTTP traces
- Crawler based on Python's Scrapy + multiprocessing + Splash access
 - Headers rewrite
 - Shared queue support
 - Har log -> HTTP redirection chain
- Extract links, emails, bitcoin wallets

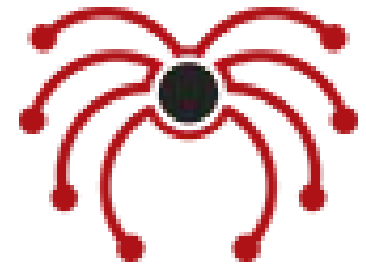

Data Enrichment



Embedded links classification (WRS)

- Surface Web links
- Classification and categorisation

Page translation

- Language detection
- Non-English to English

Significant wordcloud

- Semantic clustering
 - Custom algorithm
- 

Significant Wordcloud

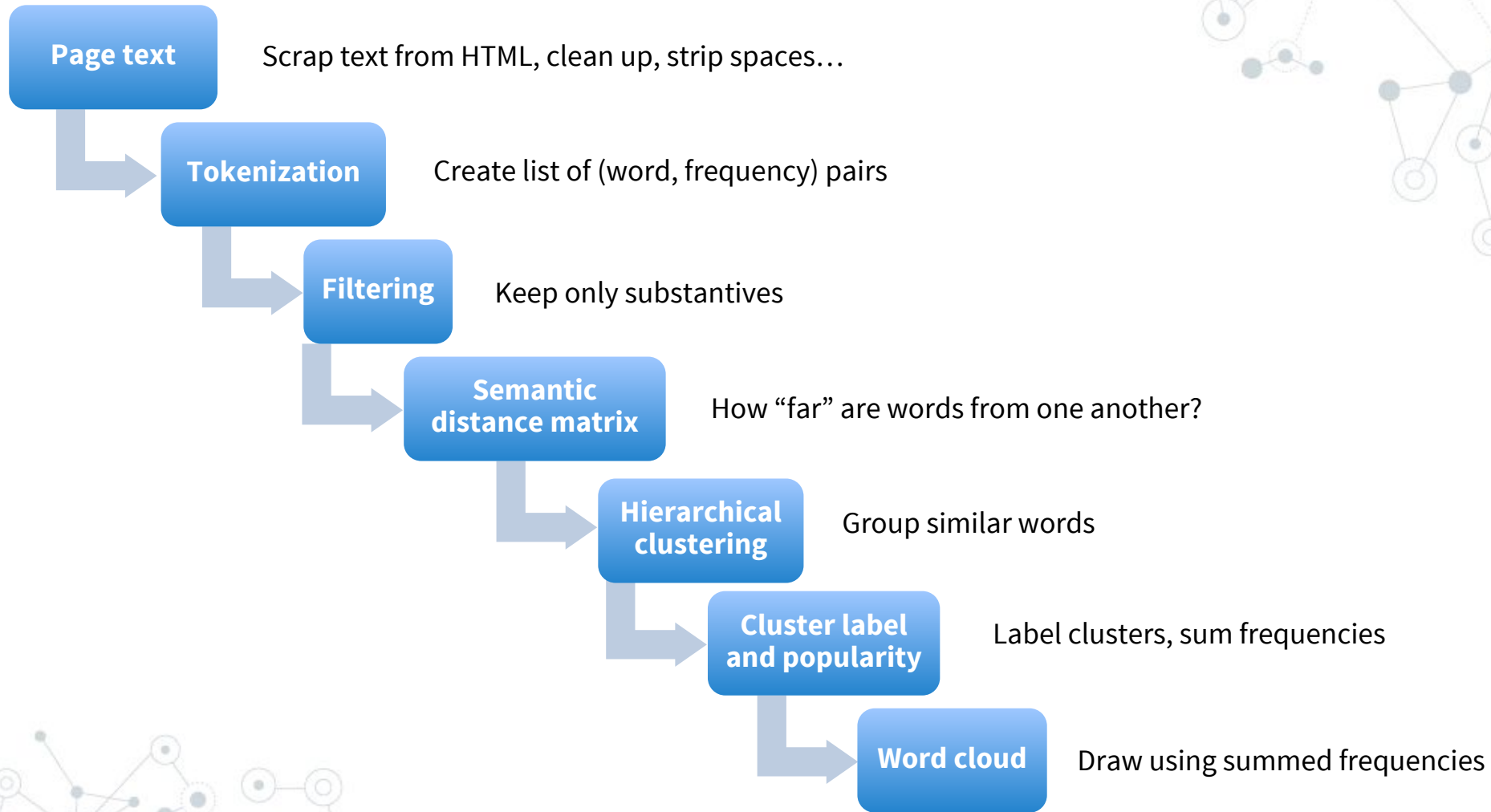

Example: Russian Forum

General information

Title	Правила — Регистрация — Russian Silkroad
Page MD5	3707c80ccd99134678d6ad611bdee86f
Page size	6911

Wordcloud (Top 20 words)



Russian Silkroad

Анонимная автоматическая торговая площадка



Форум Правила Регистрация Вход

Вы не вошли. Пожалуйста, войдите или зарегистрируйтесь.

Новости

Futurama - Bender's Game. Угадай курс биткоина и получи приз от магазина!

Kushmann's Ganja - **Москва** - Шиски Royal Canadian Haze - один из любимых сортов Snoop Dogg и Dr. Dre. Готовые клады в центре Москвы.

Night City Light's - **Москва** - Амфетамин. Готовые клады.

Внимание - Приглашаем продавцов ПАВ с качественным товаром. Для тех, кто уже работает на других площадках, специальные условия. По вопросам открытия магазинов пишите в личку RuSilk

[Russian Silkroad](#) → [Регистрация](#) → [Правила](#)

Регистрация на Russian Silkroad

Для регистрации необходимо согласиться с правилами форума ниже.

Правила ресурса

Форум и его сервисы полноценно работают **без использования JavaScript**.

Продажи производятся через систему автогаранта, требуйте от продавцов её использование. Для покупателей услуга бесплатна.

Данный ресурс предназначен для покупки,продажи любых товаров, кроме явно запрещенных.

При помощи партнерской программы любой участник ресурса может зарабатывать на привлечении покупателей, получая в последствии процент с каждой совершенной покупки привлеченным рефералом.

Запрещено

1. Разжигание межнациональной вражды.
2. Внос информации из закрытых разделов форума.
3. Политика в любом ее проявлении.
4. Попытки продажи одного ПАВ под видом другого.
5. Оставление отзывов без реальной покупки через торговую систему площадки.
6. Регистрация провокационных, а также схожих с никами администрации и других пользователей.
7. Оскорбление других пользователей. Провоцирование ругани (трололо в любых вариантах).
8. Обсуждение действий администрации ресурса и его правил.

Торговля разрешена всем, кроме:

Collected Data

- ⊙ Running since **11/2013 (2 years)**
- ⊙ **40.5 M** Events
- ⊙ **611,000** URLs
- ⊙ **20,500** domains

Collected Data

Source	# events/hour	# events/day	total events	first seen	last seen
Scouter	649	649	38,578,152	2014-06-06, 16:09	2015-10-12, 10:22
TOR Gateways	21,228	21,228	779,169	2015-05-08, 13:00	2015-10-11, 18:10
I2P Registries	1,280	1,280	368,015	2015-05-08, 15:58	2015-10-11, 18:10
SPN data	48	456	341,333	2013-11-12, 18:29	2015-10-12, 10:53
Pastebin	1	27	16,685	2013-11-19, 15:32	2015-05-11, 07:48
Reddit	543	543	15,466	2015-05-07, 20:03	2015-10-12, 10:54
Twitter	1	5	70	2015-05-08, 20:00	2015-10-11, 18:10



Demo time!

Roadmap

- Introduction
- Deep Web Analyzer (DeWA)
 - Data collection
 - Data enrichment
 - Storage and indexing
- ◎ **Illegal Trading**
- Data Analysis
- Malware
- Conclusions

Guns

UK Guns and Ammo Store

Products Info

Login Registration

Guns



Product	Price	Quantity
Glock 19 - 9mm - new and unused	1.418 ₺	<input type="text" value="1"/> X Buy now
Walther P99 - 9mm - new and unused	1.843 ₺	<input type="text" value="1"/> X Buy now

Ammo

Product	Price	Quantity
100 x 9mm Bullets for Glock 19	0.142 ₺	<input type="text" value="1"/> X Buy now
100 x 9mm Bullets for Walther P99	0.142 ₺	<input type="text" value="1"/> X Buy now

Drugs! Drugs! Drugs!



CRYSTAL METH 7gram

฿ 1.61

BUY



COKE From PERU 93%, 7 gram,
FINALIZE EARLY

฿ 2.37

BUY



COKE From PERU 93%, 3 gram

฿ 1.27

BUY



Crystal Meth - 2g

฿ 0.85

BUY

SHOW STIMULANTS CATEGORY

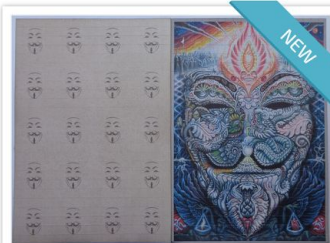

LSD Anonymous 140µg, 50 blotters

฿ 1.1

BUY



1 OZ Super Stong Mushrooms

฿ 0.59

BUY



1oz Cubensis Mushrooms

฿ 0.61

BUY



!! SPECIAL OFFER 1oz DRY PSILOCYBIN
CUBENSIS SHROOMS!!

฿ 0.42

BUY

Passports and Fake IDs



Pricing

Country	Price for Passport	Price for Passport + Driving license	Price for Passport + ID card	Price for Passport + Driving license + ID card
Australia	600 Euro	700 Euro	700 Euro	800 Euro
Belgium	500 Euro	600 Euro	600 Euro	700 Euro
Brazil	400 Euro	-	-	-
Canada	600 Euro	700 Euro	700 Euro	800 Euro
Ireland	500 Euro	600 Euro	600 Euro	700 Euro
Italia	550 Euro	650 Euro	650 Euro	750 Euro
Finland	500 Euro	600 Euro	600 Euro	700 Euro
France	600 Euro	700 Euro	700 Euro	800 Euro
Germany	600 Euro	700 Euro	700 Euro	800 Euro
Malaysia	450 Euro	550 Euro	550 Euro	650 Euro
Netherlands	600 Euro	700 Euro	700 Euro	800 Euro
Norway	650 Euro	750 Euro	750 Euro	850 Euro
Poland	500 Euro	600 Euro	600 Euro	700 Euro
Portugal	500 Euro	600 Euro	600 Euro	700 Euro
Spain	550 Euro	650 Euro	650 Euro	800 Euro
Switzerland	650 Euro	750 Euro	750 Euro	850 Euro
Sweden	550 Euro	650 Euro	650 Euro	750 Euro
United Kingdom	650 Euro	750 Euro	-	-
USA	700 Euro	800 Euro	800 Euro	900 Euro

For some countries we have an unique option to register passports in official government department databases. To get more details please contact with our manager: documents.service@safe-mail.net

Additional services	Price for one unit
Documents duplicating	extra 100 Euro
Visa/stamps affixion	extra 25-110 Euro

Prices on specific services like producing passports and documents for countries not listed above, duplicates, stamps, diplomatic passports and others should be discussed with our operator and may be variable.

Passports:



pricing...



Counterfeit Money



HQER - High Quality Euro Replicas / Counterfeits

[Products](#) [Info](#) [Login](#) [Register](#)

Counterfeit 50 Euro Bills



Our notes are produced of cotton based paper. They pass the pen test without problems. UVI is incorporated, so they pass the UV test as well. They have all necessary security features to be spent at most retailers.

FREE EXPRESS SHIPPING! We are shipping from france!

Product	Price	Quantity
25 x 50 Euro Bills	1.128 €	<input type="text" value="1"/> X Buy now
60 x 50 Euro Bills	2.256 €	<input type="text" value="1"/> X Buy now
120 x 50 Euro Bills	4.286 €	<input type="text" value="1"/> X Buy now

HQER

Credit Cards

- Higher balance = higher price

Please enter the amount you wish to purchase below and fill in the form.
(BTC value updates periodically via BTPAY)



USA VISA CREDIT CARD BALANCE \$2,000

Accepted at ATM worldwide
\$500 daily withdraw limit

\$90 (0.4001 BTC)

amount



USA VISA CREDIT CARD BALANCE \$5,000

Accepted at ATM worldwide
\$1,000 daily withdraw limit

\$170 (0.7557 BTC)

amount



EU VISA CREDIT CARD BALANCE €5,000

Accepted at ATM worldwide
€1,000 daily withdraw limit

\$210 (0.9335 BTC)

amount

Paypal & Ebay Stolen Accounts

We get new lists every day!

80%+ working guarantee, we will replace if more than 20% dont work!

Product	Price	Quantity
100 PayPal accounts	100 USD = 0.434 ₺	<input type="text" value="1"/> X Buy now
100 Ebay accounts	100 USD = 0.434 ₺	<input type="text" value="1"/> X Buy now
100 CCs with CVV2	150 USD = 0.652 ₺	<input type="text" value="1"/> X Buy now

Doxing

[Post Entry](#) | [Old](#) [Archive](#) [Fail](#)

Bill and Hillary Clinton

William J. Clinton

Sarah Palin

DOB: 02/11/1964

Phone Number's: 9

Address:

Previous Addresses:

Hillary Clinton

DOB: 10/26/1947

Address:

Previous Addresses:

1600 Pennsylvania Ave Washington, DC 20599

PO Box 2741 Little Rock, AR 72203

1600 Pennsylvania Ave NW # 214 Washington, DC 20006

1600 Pennsylvania Ave NW Washington, DC 20500

Joseph R Biden Jr

DOB: 11/20/1942

Phone Number:

Address:

Previous Addresses:

1.

2. 1

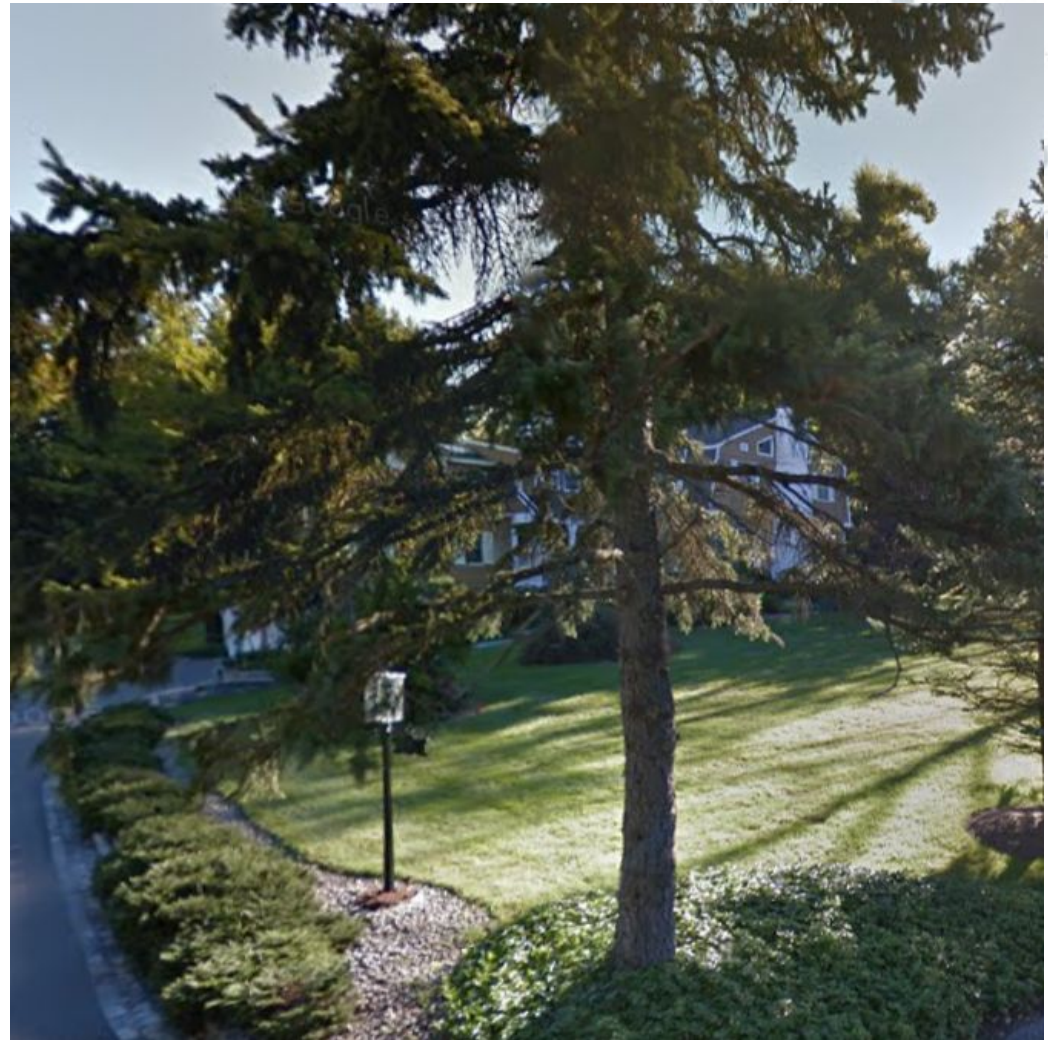

Assassins

ASSASSIN's COMMUNITY

KILLERS LIST ABOUT INFO CONTACT Logout

SELECT VICTIM's LOCATION:

Europe • North America • Asia • South America • Australia • Africa

EUROPE

5000 € / person HIRE



Blacklord

Confirmed Victims: (100+)

Age	16+
Gender	ANY
Extended Suffering	+
Photo/Video	+
CONTINENT	EUROPE, ASIA, AFRICA

POLITICIANS

(TOP-10)	-
(TOP-100)	-

7500 € / person HIRE

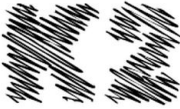

K2

Confirmed Victims: (70+)

Age	20+
Gender	ANY
Extended Suffering	+
Photo/Video	+
CONTINENT	EUROPE, ASIA, AFRICA

POLITICIANS

(TOP-10)	-
(TOP-100)	-

3000 € / person HIRE



HITMAN

Confirmed Victims: (70+)

Age	ANY
Gender	ANY
Extended Suffering	+
Photo/Video	+
CONTINENT	EUROPE, ASIA

POLITICIANS

(TOP-10)	-
(TOP-100)	-

10000 € / person HIRE



Rodger D.

Confirmed Victims: (20+)

Age	16+
Gender	ANY
Extended Suffering	+
Photo/Video	+
CONTINENT	EUROPE, ASIA

POLITICIANS

(TOP-10)	-
(TOP-100)	-

Crowdfunding evil



The concept is simple:

1. Someone adds a name to the list with background information.
2. People add money to the dead pool to entice would be assassins.
3. Assassins and speculators predict when the person will die, but the content of the prediction stays hidden until after the fact.
4. Correct predictions get the pool.

The List

Name	Country	Status	Pool Size
<u>Barack Hussein Obama II</u>	United States of America	Alive	฿0
<u>Ben Shalom Bernanke</u>	United States of America	Alive	฿0
<u>Hugh Grant (business executive)</u>	United States of America	Alive	฿0
<u>Justin Drew Bieber</u>	United States of America	Alive	฿0

Roadmap

- Introduction
- Deep Web Analyzer (DeWA)
 - Data collection
 - Data enrichment
 - Storage and indexing
- Illegal Trading
- ◎ **Data Analysis**
- Malware
- Conclusions

Protocols (no HTTP/S)

By publicly sourced URLs

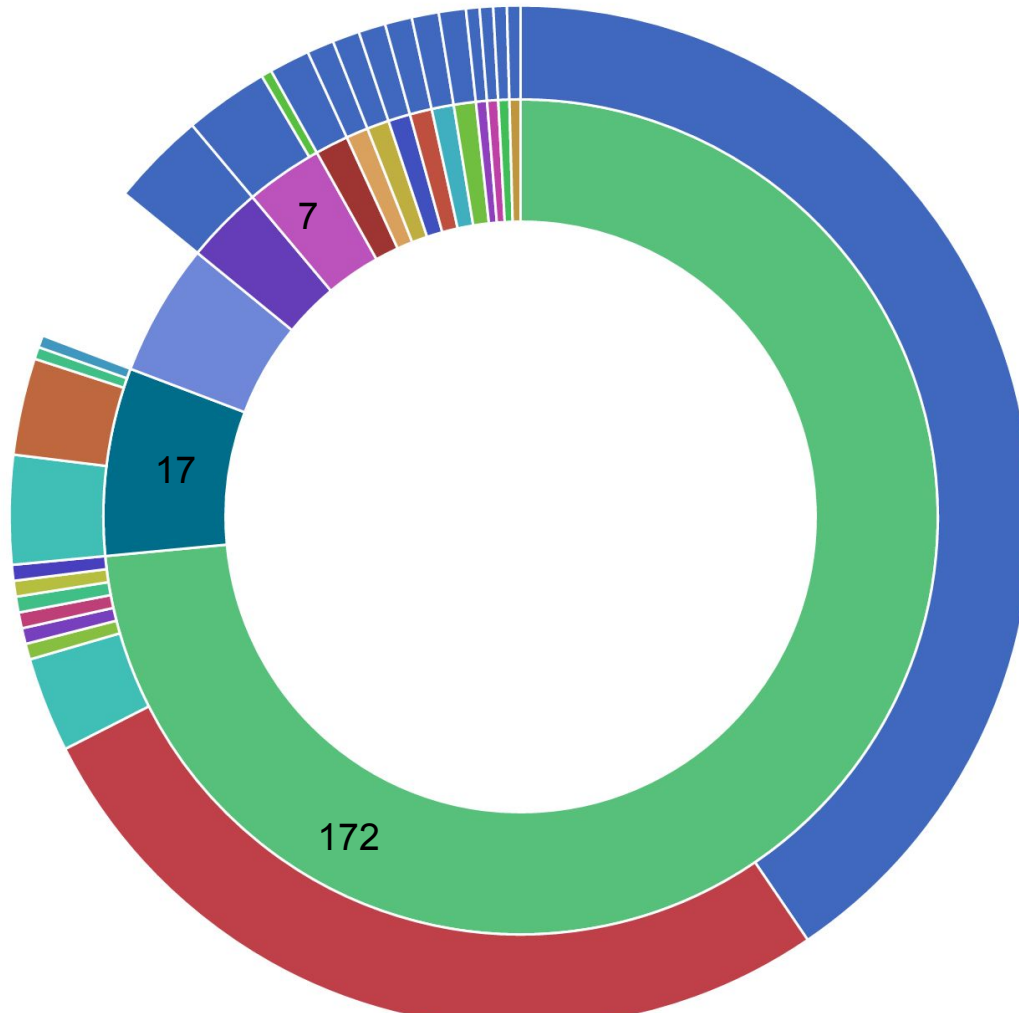

Protocol breakdown

Legend ↻

- irc
- ircs
- magnet
- gopher
- xmpp
- telnet
- ftp
- git
- mailto
- news
- rhttp
- webcal
- imap
- mumble
- pop
- smtp
- 80
- 35
- 6,667

Active Portscan

IRC	IRCS	SSH
49	31	855



- * - We are based on anarchistic control so nobody haz power certainly not power over the servers or
- * - domains who ever says that this or that person haz power here, are trolls and mostly agents of factions
- * - that haz butthurt about the concept or praxis where the CyberGuerrilla Anonymous Nexus stands for.

#freeanons 15 [+Cnt] This channel is created to **support arrested Anons** and act with **solidarity in Anons**. No MoneyFags, No Famefags, No PowerManiacs, No LeaderFags! Another Anons was arrested in France: <http://www.ladepeche.fr/article/2015/10/10/2194982-enquete-de-la-dgsi-sur-du-piratage-informatique.html>

Languages per domain

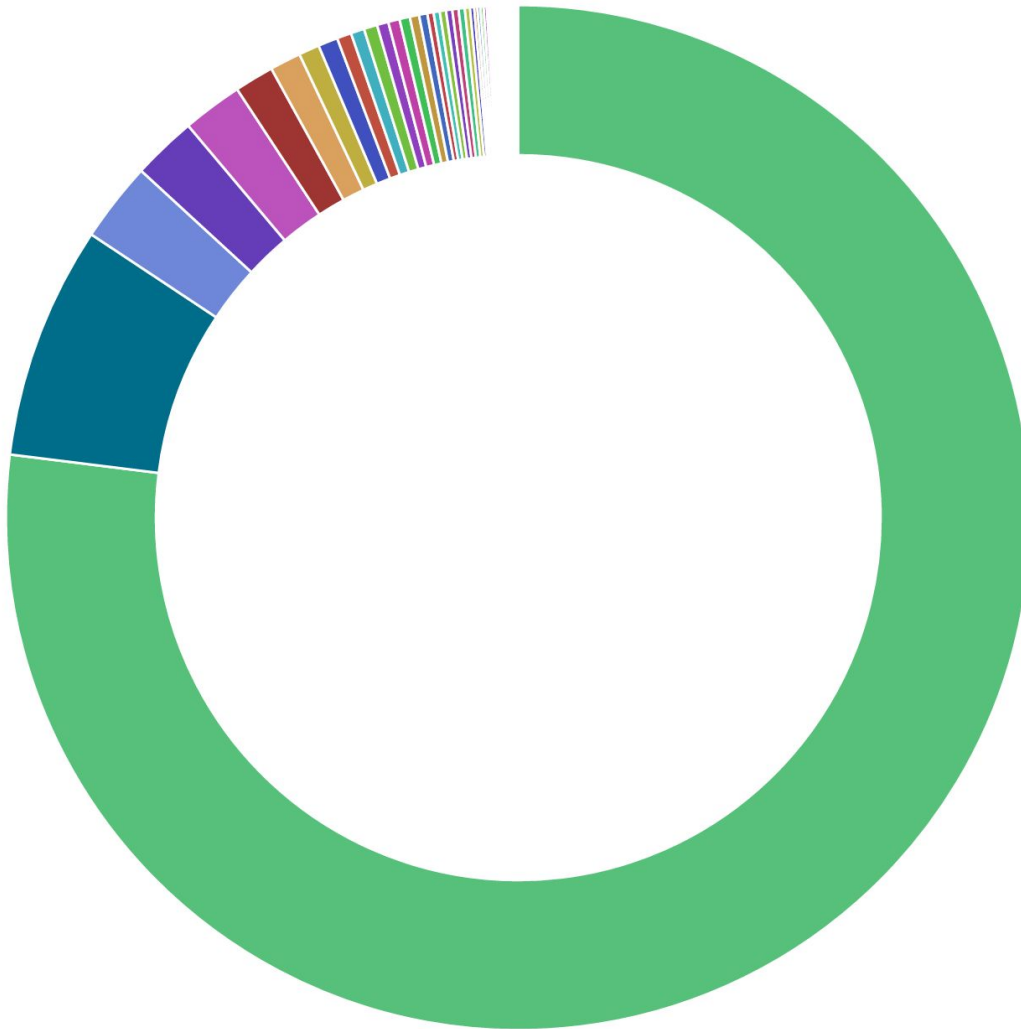

Language breakdown domains

Legend ↗

- English
- Russian
- French
- German
- Catalan
- Portuguese
- Italian
- Polish
- Spanish
- Finnish
- Bulgarian
- Japanese
- Dutch
- Danish
- Chinese
- Swedish
- Spanish; Castilian
- Romanian

Languages per domain (2)

Language breakdown domains

Legend ↕

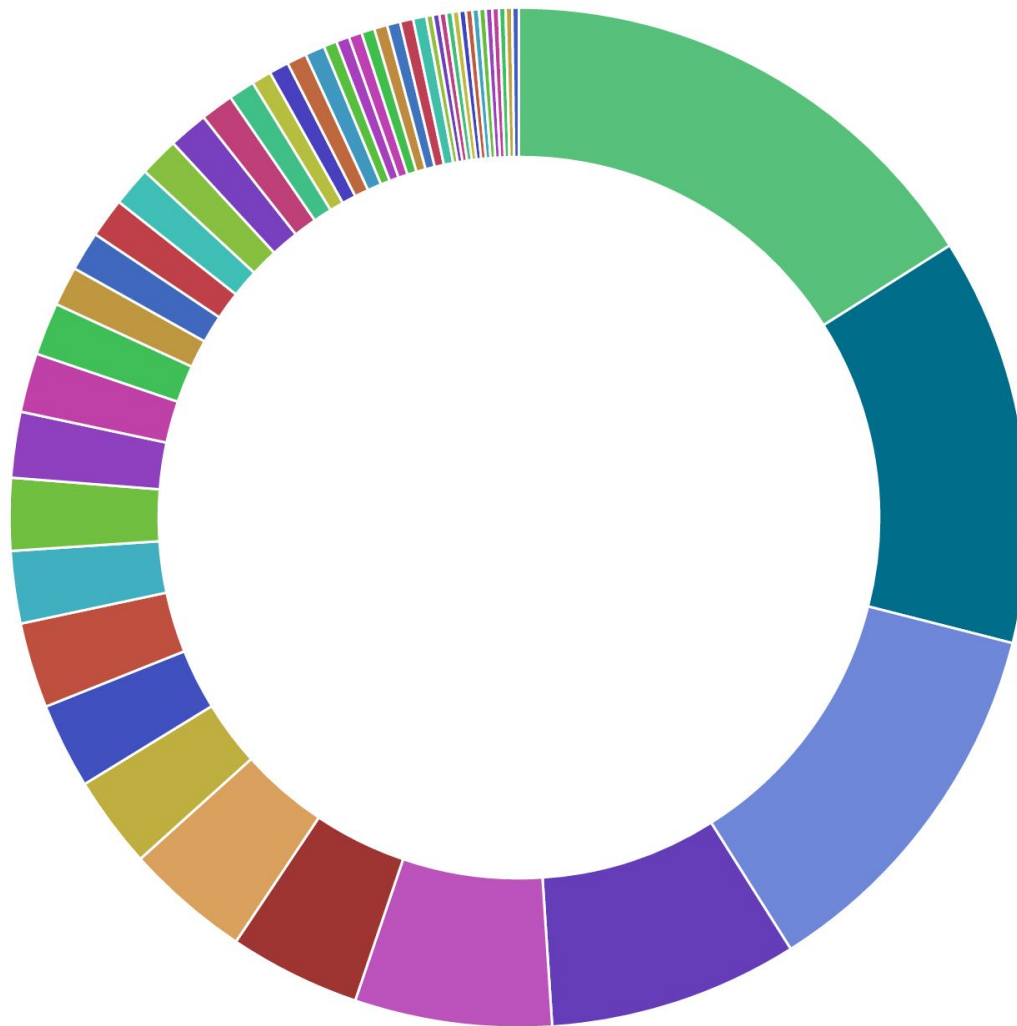

French forum: Weapon sale

Le Trollodrome

[Accueil](#) [Liste des membres](#) [Recherche](#) [Inscription](#) [Identification](#)

Vous n'êtes pas identifié(e).

Contributions : [Récentes](#) | [Sans réponse](#)

Annonce

Le trollodrome est un espace de discussion libre, sans modération ni censure et entièrement anonyme.

L'inscription n'est pas nécessaire

Merci de poster dans la bonne section, votre message pourrait être supprimé sans préavis.

Vous seuls faites évoluer le trollodrome

[Accueil](#) » [SHOP](#) » [Vente arme + billet de banque](#)

Pages : **1**

2015-04-28 22:23:18

#1

Lord of war
Invité

Réputation: 12

Bonsoir à tous, compagnons du trollôdrome.
Je me permet de rebondir sur une réponse donnée sur un fil pour faire une promotion.

Niveau arme je met en vente un colt .45 1911.
Fonctionel mais rouillé et chien cassé (piece que je peux réparer).
Niveau rouille je peux tremper les pièces dans un bain de vinaigre puis le polir (ponceuse entourée de vieux vêtement + blanc d'espgane)
200 munitions

Billets
- 20 euros (pas trop mauvaise facture)
- 50 euros (pour les plus téméraires, ils font foirés!)

Je connais mal le deep, mais je propose de passer par un escrow d'un site reconnu ici (de votre choix).

Annnonce sérieuse, et "mini prix"

contact: h12g3af1q2ks2dc@torbox3uiot6wchz.onion

tchao

0

L'administrateur du forum a désactivé l'usage du système de réputation pour le membre de ce groupe.

Pages Embedding Suspicious Links

Mr. TwoFaces
Newbie



Posts: 17
Karma: +1/-0

7 Cracked Paid Keyloggers
« on: November 25, 2014, 05:03:09 pm »

[h]Collection of Cracked Paid Keyloggers[/h]

*I'd like to present to you my list of cracked paid Keyloggers.
Please PM me if any download link isn't working, I will provide a new one for you.*

Format:

Name (Thread Design)
Download Link

Predator Pain v14 (<http://www.predatorpain.com/bronxfiles/iI9bX2b.png>)
https://mega.co.nz/#!yQADFjzC!cf_NyRyGY_jgJBYf0XZi27o_AM9K5IMNSF6TAk85feE

Autologger 2.0 (<http://i1.minus.com/ibfxq2rWIKVyjr.jpg>)
<http://adfoc.us/22069339665199>

Hades Logger (<https://i.imgur.com/ice0pyQ.jpg>)
<http://adf.ly/rvnpl>

Galaxy Logger & Stealer (<https://i.imgur.com/9DQRD0J.jpg>)
<https://mega.co.nz/#!2ZoQQDha!GP8hd4dmL0RtT8z7RNIaltHR3Gt9r4fkK8o2mZuQ4CE>

Tasty Logger (<https://puu.sh/4FatG.png>)
<https://mega.co.nz/#!HRQFQTJY!GgoeZ0rNxO...rpdpoUviC8>
Password: <http://DeceptiveEngineering.info>

Email Identification

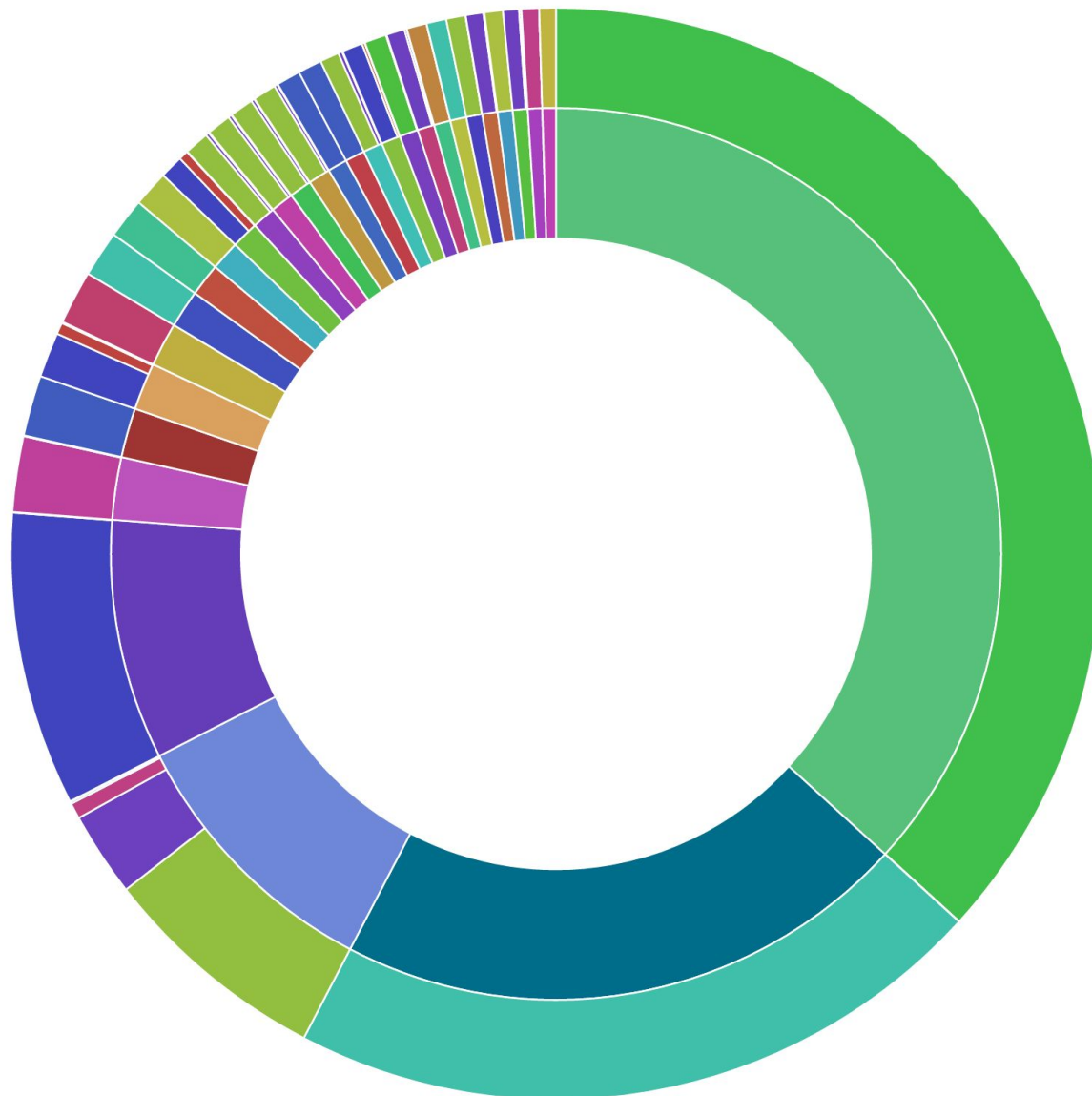

Legend

- zenow@riseup.net
- odim@safe-mail.com
- ***@onionmail.in
- kay.sievers@vrfy.org
- TriPh0rce@riseup.net
- pozabankowe@gmail...
- zzz@mail.i2p
- 48596@qq.com
- Jokerv@safe-mail.net
- doublec@epwvnnhpj6...
- admin@soylentnews.org
- kytv@mail.i2p
- username@i2pmail.org
- username@mail2tor.com
- username@torbox3uio...
- username@ruggedinb...
- spw@wolomin.sr.gov.pl
- konrad.wojciechowski...
- username@safe-mail.net
- killyourtv@i2pmail.org
- philipkdick@riseup.net
- t0xicp0ison@yahoo.com
- mail@rospravosudie.c...
- bankofamerica@mail2t...
- format at www.floridas...
- myjob@ruggedinbox.c...
- themightybuzzard@so...

bankofamerica@mail2tor

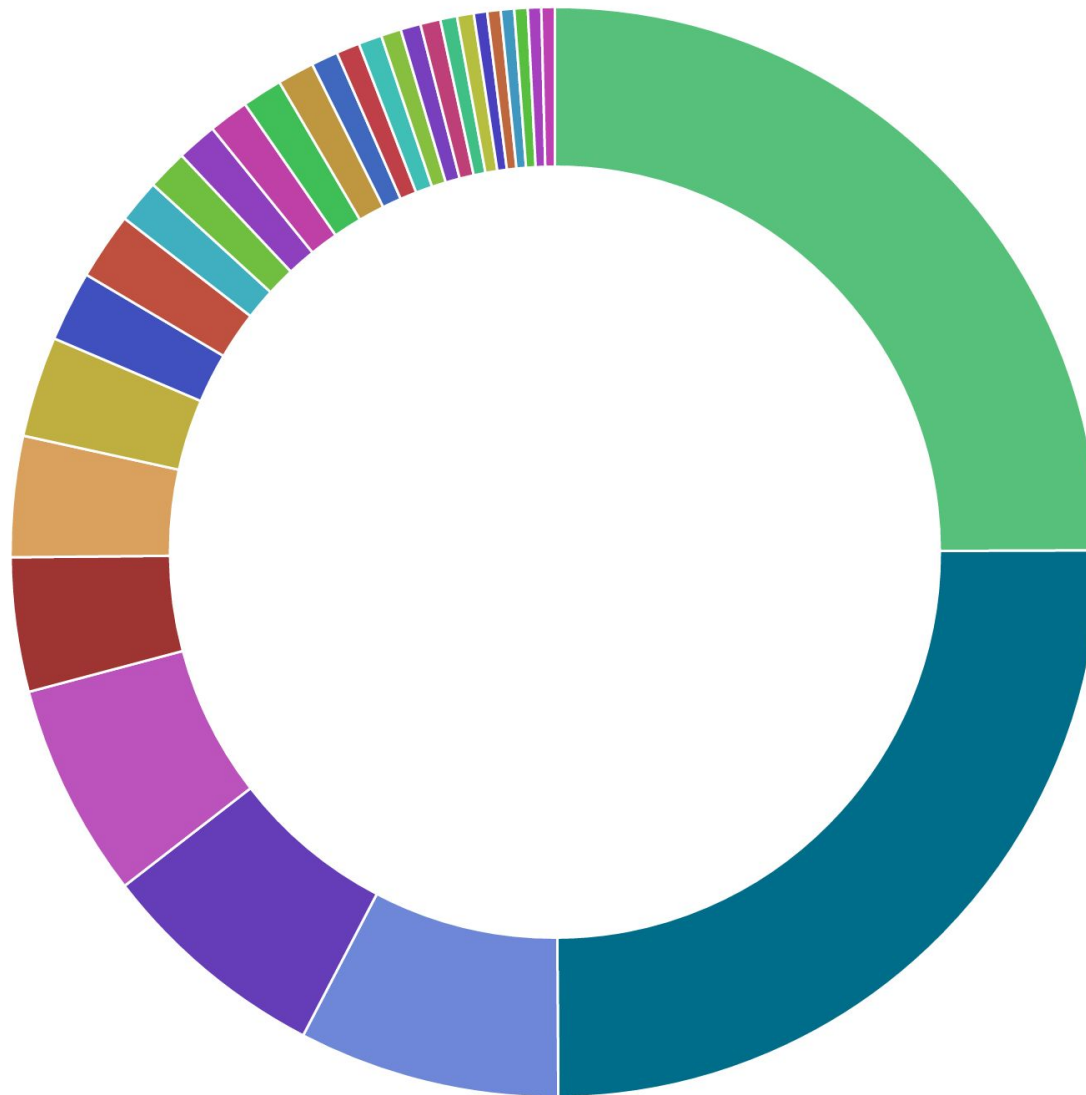

Legend ↕

- bankofamerica@mail2t...
- odim@safe-mail.com
- Jokerv@safe-mail.net
- hurry9@mail2tor.com
- NullCode@Mail2Tor.com
- awaydepetropolis@ma...
- psykotyko@mail2tor.c...
- axlink@sigaintevyh2r...
- zerolinez@mail2tor.com
- gus133@mail2tor.com
- gatuno@mail2tor.com
- CLONER@MAIL2TOR...
- cloner@mail2tor.com
- codered@mail2tor.com
- diploma@mail2tor.com
- InfoCCBrasil@mail2tor...
- iloading@mail2tor.com
- creditorenovado2012...
- voidspace@Mail2Tor.c...
- ebobv@mail2tor.com

Exilio forum 1/2

🔍 Pizzas gratis [NullCode - 0x00] [mensagem #4246]



NullCode

Senior Member

Mensagens: 433

Registado: fevereiro 2015

Karma: 120

Eis algumas pizzas que foram APROVADAS hoje (01/03/2015)...

BANDEIRA: Mastercard

TIPO DO CARTAO: Platinum / Itau Unibanco

NUMERO DO CARTAO: 541555018763XXXX

DATA DE VALIDADE: 10/16

CODIGO DE SEGURANCA: 953

NOME NO CARTAO: Humberto Alcantara

DATA DE NASCIMENTO: 26/10/1964

TELEFONE:

CPF: 440.645.528-06

STATUS: Debitado

BANDEIRA: Mastercard

TIPO DO CARTAO: Gold / Itau Unibanco

Exilio forum 2/2

Res: Pizzas gratis [NullCode - 0x00] [mensagem #4536 é uma resposta a mensagem nº 4532]

 [bankofamerica](#)

Senior Member

Mensagens: 238

Registado: novembro 2014

Karma: -58

“ batman escreveu em Ter, 03 março 2015 19:47

NullCoder, eu clico no +1 (vaaarias vezes) mas não acontece nada. clico clico clico clico mas nada Man!! TOTAL!! Quer

Se ainda tiver um pedaço pra mim... tive que sair rapidinho da net e só voltei agora.

Outra coisa, alguns sites que tentei pedem o endereço. Como eu chuto qualquer endereço, acho que é por isso que alguns

Lá em cima do seu navegador possui um ícone S com um bloqueio, habilite-o temporariamente que você consegue.

É só pra liberar script, eu particularmente deixo o bloqueio habilitado o tempo todo.. mas temporariamente só pra dar um ajuda tanto, eu acho que compensa..

Torchat: 64rpss4mb24vsfz6

bankofamerica@mail2tor.com 

Automated Bitcoin Identification

1200+ bitcoin wallets found in our data (not counting the obfuscated ones)

Bitcoin Tumblers



WELCOME TO TUMBLY

Tumbly is the bitcoin tumbler with the lowest fees in the whole darknet. Many happy customers and fast transactions make us to a number one choice for all your bitcoin washing needs.

Features



Clean your Bitcoins

Whether you buy drugs, weapons or some cheesy pizza our coins can't be tracked back to you!



Low fees

Tumbling Bitcoins is no magic, we think the usual fees are way to high for that. Our fees: **0% to 1%**!

Bitcoin Multiplier 1/2

More Than 5500 BTC Paid ! The Original and Verified That Works Multiply 100x Your Coins - HackMastersTrust -

<http://tfsux6hiihj7qvxh.onion/> - HackMastersTrust@Safe-Mail.net



How to multiply your Bitcoins hundredfold in a day?

No matter how secure and innovative Bitcoins are, they are just some bytes on a digital storage medium and they can be copied as well as any digital information. We've thoroughly studied the Bitcoin client from within and have found an almost imperceptible but very significant flaw (associated with the commission), using it we have committed a Bitcoin transaction in which the recipient has received more Bitcoins than the sender has sent. Unfortunately, the difference is not so great (about 1%) and if you make only one transaction by a small amount your capital will not increase much, but if you make transactions permanently and by a large amount, you can get rich very quickly.

We've discovered this flaw recently and have managed to win a lot, but every day we multiply our money hundredfold times and want to do it more. We all understand that such a freebie can not continue for a lot of time and this flaw will be found and corrected in the near future, but until that happens, we want to win as much as possible. That is why we have launched this website, where you can make an investment and we will multiply it twenty times. Half of this money we will give to you, it means that your investment will be returned to you hundredfold in the next 24 hours.

All you have to do is to transfer some Bitcoins to address listed below (we do not accept investments below 0.01 Bitcoins) and your investment will be multiplied hundredfold and will be transferred to your wallet within 24 hours.

Pay 0.01 BTC today, get 1 BTC tomorrow

Custom Bitcoin Deposit Addresses

[1XBTcyUWtaPDwXMfzBn6q7VHDAFJ47MCB](#)

Send some Bitcoins and multiply them hundredfold in just one day!

(Minimum To Deposit > 0.01 BTC)

Pay 0.01 BTC today, get 1.00 BTC in 24 hours

Pay 0.1 BTC today, get 10.00 BTC in 24 hours

Maximum Amount To Deposit: 10 Bitcoin

Bitcoin Multiplier 2/2

Some History

Date	Deposited	Returned	Return address	Transaction
08/10/15	0.01 BTC	1 BTC	157H3quvaBovcKkaRcwozNxu72ZRTBoEb7	a42c37ad189f07cd5405e433fb1ebb6c88a4e05f8761
08/10/15	0.045 BTC	4.5 BTC	1j7Dkq8yXaAcWBF7PpzcGrbpsah1mkaUDK	4d0d5c800039e68034e7bdbe622478b5eadc778bbdc
07/10/15	0.2 BTC	20 BTC	3NkkQeZDrhgzQKP99pRU71j4HcwXTmw5VS	7e2de327913b8b3c644afbab0d4c2ea68e7c1492718a
06/10/15	0.06 BTC	6 BTC	13EhGy3yuTC6Es9g5a6Fnzo9fLuPzkFvFg	6261d13329f19f0f44d1fb96a0ad3e9ef95d5b86f3899
06/10/15	0.15 BTC	15 BTC	13wdrfBxUShsMASGxGwZ68bH8XC7XrCqzC	8c86c0e8107286eb1b696c5a5d198cdd10aeb3cf343f
05/10/15	0.1 BTC	10 BTC	1sCHh9zH7g1yx7S4h4q9uqxCDLnm7Lke	fc766fc6c180ae162a5cc845d8a4f156ffe988b667fde
04/10/15	0.07 BTC	7 BTC	1LsSAPNm9ZkPv2CSpx6wgUFRVxEJC1rQmR	366cfda3ad9bd2b8fda43baca2d6799252dee492b268
04/10/15	0.01 BTC	1 BTC	12a5RQoSs2u71MeSBu68cbV62aLccpr3i6	767c8c51c63b00520e930596dfe0a64411c39876595t
04/10/15	0.10 BTC	8 BTC	1DgDiL4weX45XbyH3rT9HckbgDCcSgoTMz	aa23f7d56ac53b4f585670225fd70681e7de0685eb1d
04/10/15	0.6 BTC	60 BTC	1EmYzDnLB3QCTebzuvUuj4d32j235LGktC	db157cb915b8ea1dd8cc5ca5b5be22a796c146a35039
03/10/15	0.25 BTC	25 BTC	1BJWYQ7dM2ecPWbB5eody9ikBY52JGf122	4637cfbd20d862cd5156991d327cc18ccbf4a7aded70
29/09/15	0.035 BTC	3.5 BTC	1AT66aPVe5u418S26BYFXRmxCn1XJB2PWg	4da13ece015a49c8765cd27c3a4009bea73df5a11e3f
28/09/15	0.01 BTC	1 BTC	1H5oYxmRyAJ2b13tuZkCLY3cscfyKx7Aq7	f2af8b3bc57dae2c8c7853b5b8564c65e5fcd38e7caf

Roadmap

- Introduction
- Deep Web Analyzer (DeWA)
 - Data collection
 - Data enrichment
 - Storage and indexing
- Illegal Trading
- Data Analysis
- ◎ **Malware**
- Conclusions

Malware: Its adoption in the Deep Web

- Modern malware is network-dependent
 - @ infection-time: Exploit kits
 - @ propagation-time: 2nd stage malware
 - @ operational-time: C&C servers
- Goals :
 - Make botnets resilient against LEA operations, e.g. takedowns
 - Conceal payment pages
 - Untraceable money transfers
- *Additional readings:*
 - Brown in Defcon 18*
 - Hunting Down Malware on the Deep Web (infosec institute)*

SkyNet

- Malware with DDoS, bitcoin mining and banking capabilities (©G-Data/Rapid7)
 - ZeuS bot
 - Bitcoin mining tool (CGMiner)
 - GPU libraries for hash cracking
- TOR client per Windows
- Use `/gate.php` as landing page to store the harvested credentials
- Path monitoring

🔍 /gate.php	367	2013-12-09	2014-04-25		
Domain breakdown					
Scheme	Hostname	Port	# Rep	First seen	Last seen
-	egzh3ktnywjwabxb.onion	80	213	2013-12-09...	2014-01-17...
http	akmfve5eifqygwr.onion	80	154	2014-02-23...	2014-04-25...

SkyNet: Dynamic TOR-based C&Cs

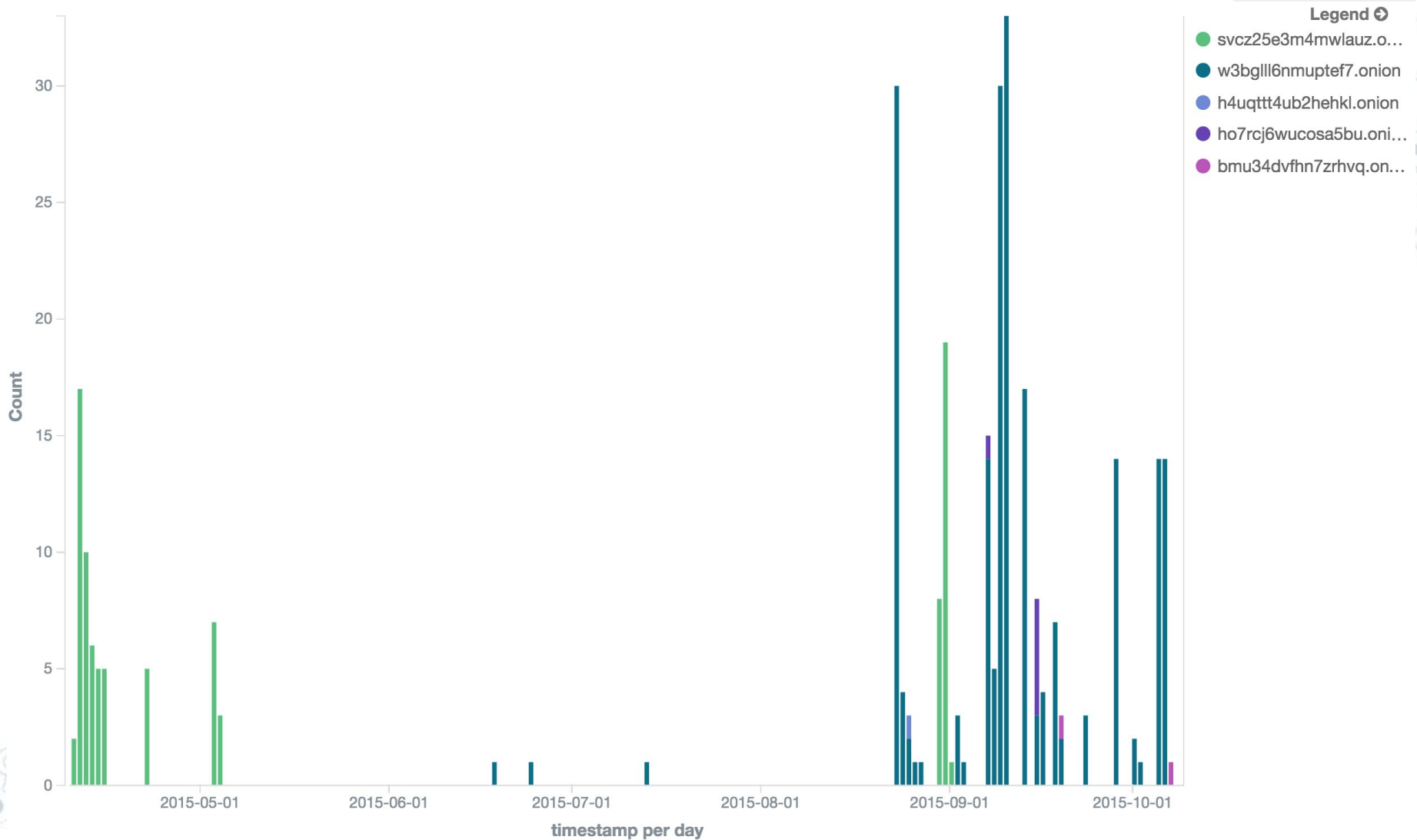

Dyre Banking Trojan

- BHO that MiTMs online-banking pages at browser-level
- Back-connects from victim to attacker (kind-of reverse-shell approach)
- DGA generation of C&C domains on Clearnet
- Use I2P as backup option (:80/443)
 - `nhgyzrn2p2gejk57wveao5kxa7b3nhtc4saonjpsy65mapycaua.b32.i2p` (already known to SecureWorks on 17 December 2014)
 - `oguws7cr5xvl5jlrhyxjktcdi2d7k5cqeu4mdl75xxfwmhgnsq.b32.i2p`
 - `4nhgyzrn2p2gejk57wveao5kxa7b3nhtc4saonjpsy65mapycaua.b32.i2p`

Dyre's Infection Evolution

April 9th 2015, 16:34:42.033 - October 9th 2015, 16:34:42.033 — [by day](#)

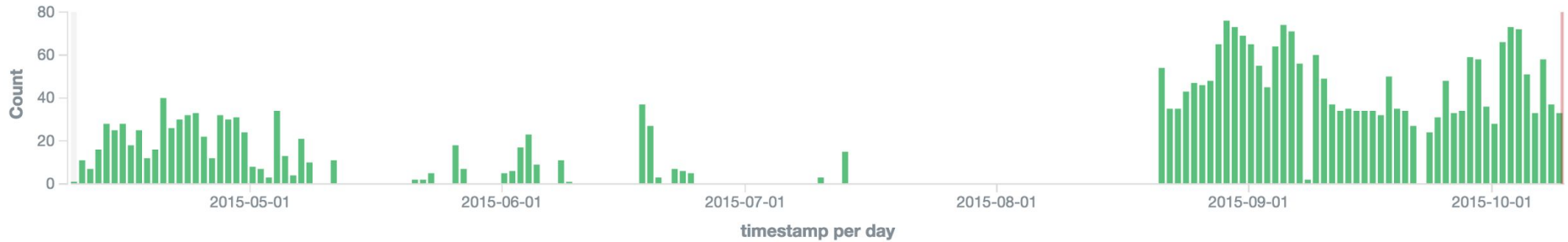

Time ▾	url.@raw
▶ October 9th 2015, 16:23:10.455	http://oguw57cr5xv15j1rhyxjktcdi2d7k5cqeulu4md175xxfwmhgnsq.b32.i2p:80/
▶ October 9th 2015, 15:41:56.468	http://oguw57cr5xv15j1rhyxjktcdi2d7k5cqeulu4md175xxfwmhgnsq.b32.i2p:80/
▶ October 9th 2015, 14:53:07.007	http://oguw57cr5xv15j1rhyxjktcdi2d7k5cqeulu4md175xxfwmhgnsq.b32.i2p:80/
▶ October 9th 2015, 13:59:50.718	http://oguw57cr5xv15j1rhyxjktcdi2d7k5cqeulu4md175xxfwmhgnsq.b32.i2p:80/
▶ October 9th 2015, 13:18:03.211	http://oguw57cr5xv15j1rhyxjktcdi2d7k5cqeulu4md175xxfwmhgnsq.b32.i2p:80/
▶ October 9th 2015, 12:52:27.011	http://nhgyzrn2p2gejk57wveao5kxa7b3nhtc4saoonjpsy65mapycaua.b32.i2p:80/
▶ October 9th 2015, 12:23:43.690	http://oguw57cr5xv15j1rhyxjktcdi2d7k5cqeulu4md175xxfwmhgnsq.b32.i2p:80/
▶ October 9th 2015, 12:16:03.639	http://nhgyzrn2p2gejk57wveao5kxa7b3nhtc4saoonjpsy65mapycaua.b32.i2p:80/

Vawtrack Banking Trojan

- Spreads via phishing emails
- C&C servers (IPs) are retrieved by downloading the '*favicon.ico*' icon-file from websites hosted on the TOR network
- IPs are steganographically hidden

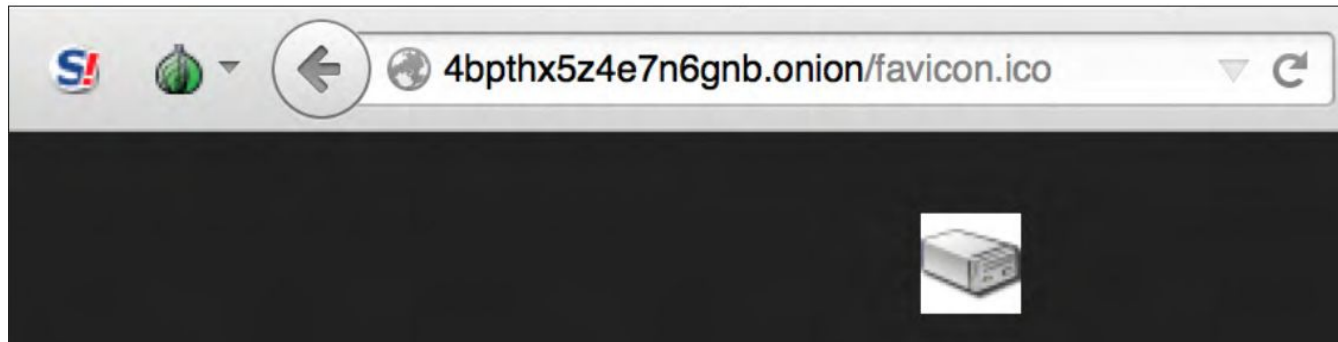

Vawtrack Banking Trojan (cont.)

- Runs 'openresty/1.7.2.1' as web-server
- Return code on 'favicon.ico' is 403 Forbidden

x-cache-lookup	miss from charon:3128
server	openresty/1.7.2.1
last-modified	wed, 18 feb 2015 14:45:29 gmt

- `ws='openresty\1.7.2.1' && ∃ ('favicon.ico') && retcode=403` returns a list of 23:

<http://3jix4qbhr6tw2juk.onion:80/>

<http://4bpthx5z4e7n6gnb.onion:80/>

<http://6hts7b7onuh653ha.onion:80/>

<http://76gwp6wc7tozarog.onion:80/>

<http://a3bjairfwlwopnst.onion:80/>

<http://gxi4unnw363epeow.onion:80/>

<http://ipx5qhsbgddvqilb.onion:80/>

<http://iuykahksh3bbtkj2.onion:80/>

<http://marf7pvfg2icacwr.onion:80/>

<http://max6gtszig6i4rjt.onion:80/>

<http://onqtcjzw6b6bfeto.onion:80/>

<http://otsaa35gxbcwvrqs.onion:80/>

<http://oxrml5ihgfbce2r.onion:80/>

<http://pt3ayo2bn7inhq6o.onion:80/>

<http://q6knv6pe25cxjv2s.onion:80/>

<http://sws5qec3n7v7bxei.onion:80/>

<http://t3uqe5gge23wtjhq.onion:80/>

<http://ucxapuqzخانجivqw.onion:80/>

<http://w3kjcq6svuucwb6o.onion:80/>

<http://w3qsdpr5gb3ltln3.onion:80/>

<http://wdmcadcfn6hsrgz7.onion:80/>

<http://y5fry2qwxcm5pwb2.onion:80/>

<http://ytfvajhmcjwyhnoj.onion:80/>

Vawtrack Banking Trojan (cont.)

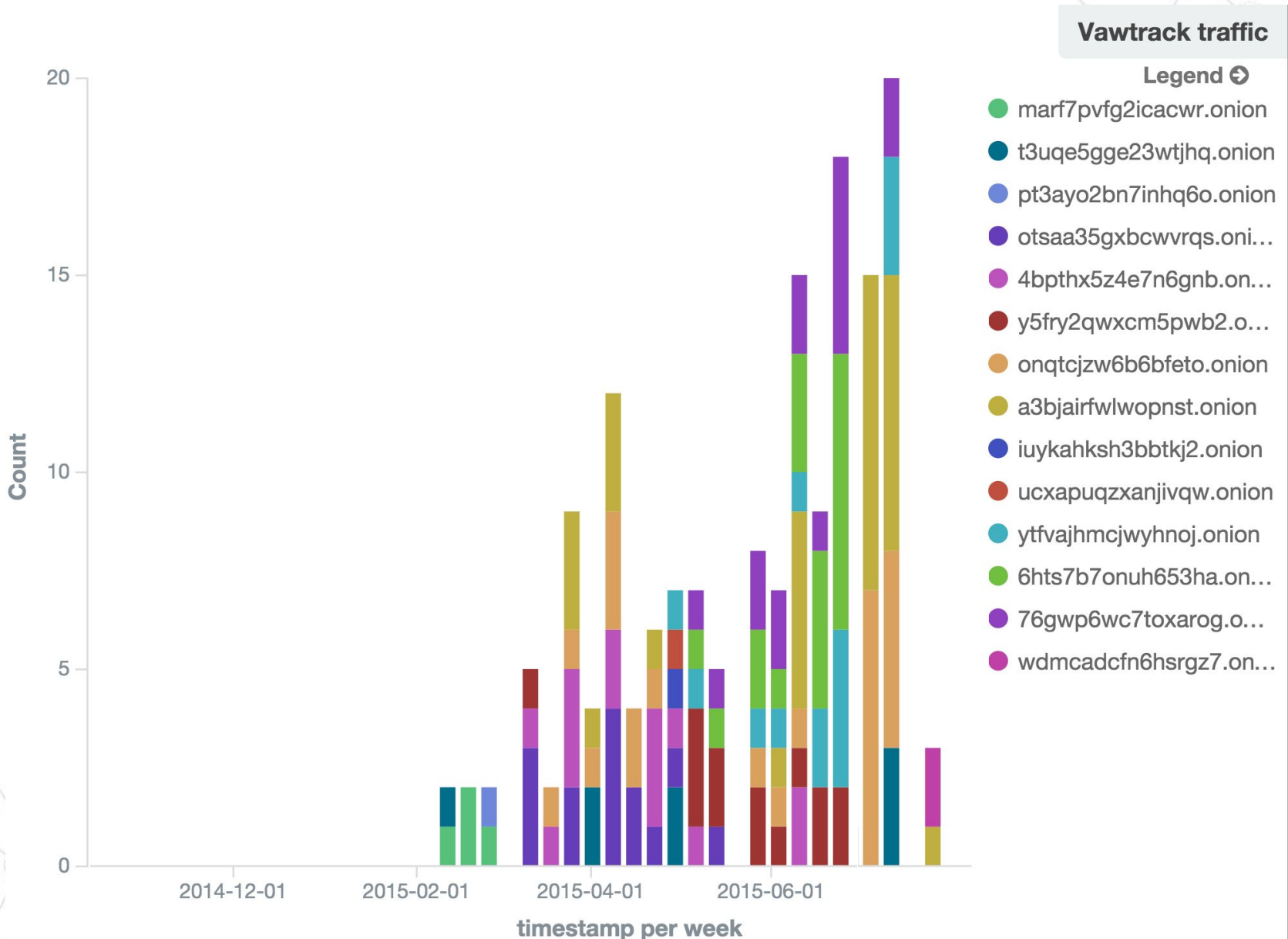

Ransomware in the Deep Web

- Ransomware seem to love the Deep Web
- It provides a hidden and robust “framework” for cashouts and illicit money transfers

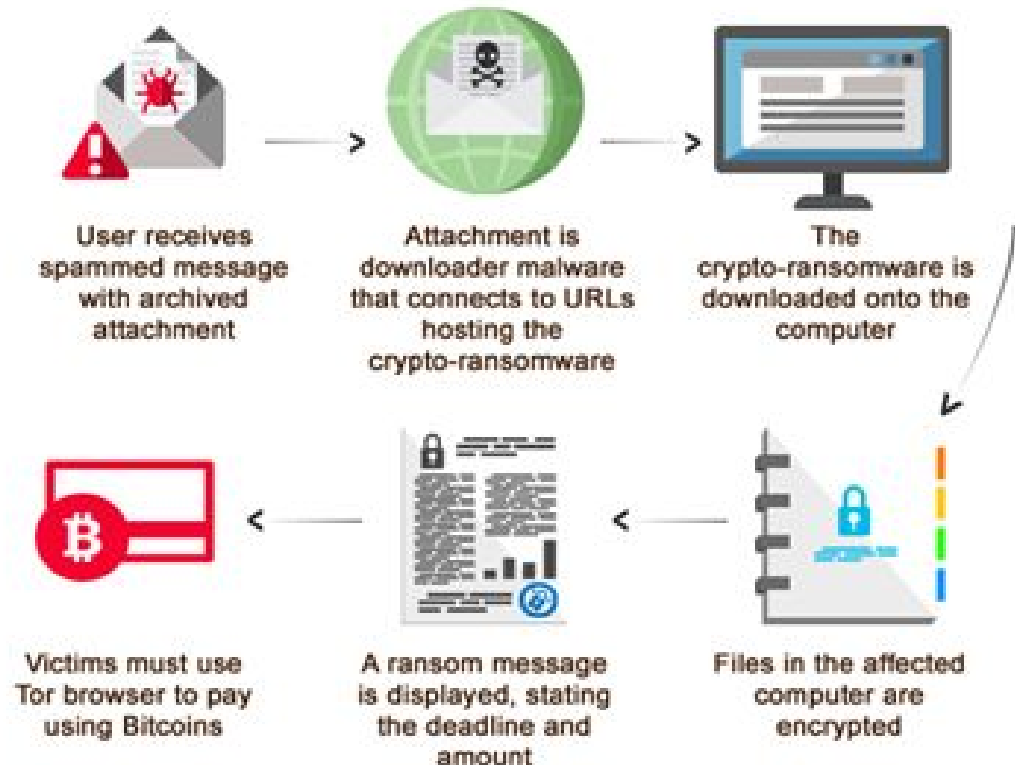

TorrentLocker

- A variant of cryptolocker
- Payment page hosted in the Deep Web
- Cashout via Bitcoins

Buy decryption and get all your files back



Buy decryption for **640 AUD** before **2015-10-13 19:16:06**

OR buy it later with the price of **1280 AUD**

Time left before price increase: **120:00:00**

Current price: **1.941408 BTC (around 640 AUD)**

Paid until now: **0 BTC (around 0 AUD)**

Remaining amount: **1.941408 BTC (around 640 AUD)**

Buy Decryption with **bitcoin**

What is Bitcoin?

Bitcoin is the virtual currency used in Internet.

1 Buy Bitcoins

You can buy Bitcoins from Exchangers **OR** Marketplaces.

1 Buying from Exchangers

Use one of the following exchange services to buy Bitcoins with cash over the counter via bank-teller at one of the partner banks.

Use in "Your Bitcoin wallet address" field when placing your order.

- www.coinloft.com.au - Buy Bitcoins via with bank deposit. Supports all four major Australian banks.
- buyabitcoin.com.au - Buy Bitcoins via with bank deposit.
- www.igot.com - Buy Bitcoins via with bank deposit. Available across 100+ Banks.
- www.hardblock.net - Buy Bitcoins with Westpac and Commbank.
- forepost.net - Buy Bitcoins with Westpac, Commbank and NAB.

2 Buying from Marketplaces

Sign up on one of the following websites. Enter your name and address details then get your account verified with GreenID®. You will need to provide some basic forms of identification such as a drivers license number, passport number, or electoral roll details.

- btcmartets.net - You can use direct bank transfer from any Australian bank account. Deposits are automatically processed at 6am following a business day and any deposits made over the weekend do not clear until Tuesday morning. Also, you can deposit directly at any Westpac branch in Australia. Branch deposits will clear same day, within an hour.
- www.coinjar.com - You can use BPAY from any Australian bank account. Only make BPAY transfers from a transaction account with available funds. BPAY transfers typically reach Coinjar within 1-3 business days and will be added to your Cash Account. For best results, be sure to make your BPAY transfer within regular business hours, Melbourne local time.

Also see the whole list of places where to buy bitcoins: howtobuybitcoins.info

2 Send Bitcoins to us

If you buy Bitcoins from one of the exchangers please use the following amount and address when placing your order.
If you buy Bitcoins from one of the marketplaces please withdraw the exact amount to the address specified below.

Amount: **1.941408 Bitcoin (around 640 AUD)**
Bitcoin Address:

It is possible to split the amount into several payments.

3 Inform us

Click on "Verify Payment" button. If you have send the Bitcoin payment you should receive decryption software download link. Please download the software and run it on the encrypted PC. All your encrypted files will get decrypted automatically.

Verify Payment

TorrentLocker (cont.)

Malware generates univocal IDs

wzaxcyqroduouk5n.onion/axdf84v.php/ **user_code**=qz1n2i&**user_pass**=9019

wzaxcyqroduouk5n.onion/o2xd3x.php/**user_code**=8llak0&**user_pass**=6775

Tracking on specific query string's parameters

`path='/[a-z0-9]{6}.php/user_code=[a-z0-9]{6}&user_pass=[0-9]{4}'`



CryptoLocker 购买解密软件 免费解密一个文档 常见问题 支持页面

购买解密软件以便还原所有加密文档

 **2015-10-13 19:29:15**前购买解密软件只需**11900 TWD**
或之后购买价格为**23800 TWD**
价格上涨前剩余时间: **119:59:59**
加密文档数量: **24661**

现行价格: **1.561875 比特币 (约 11900 TWD)**
已支付: **0 比特币 (约 0 TWD)**
余款: **1.561875 比特币 (约 11900 TWD)**

使用  **bitcoin** 来购买解密软件

比特币到底是什么？

比特币(BTC, Bitcoin) – 互联网上使用的虚拟货币。

- 1 购买比特币**
您可在网站上购买比特币以便在台湾兑换货币

Breakdown by victims and country

TorrentLocker languages

Legend ↻

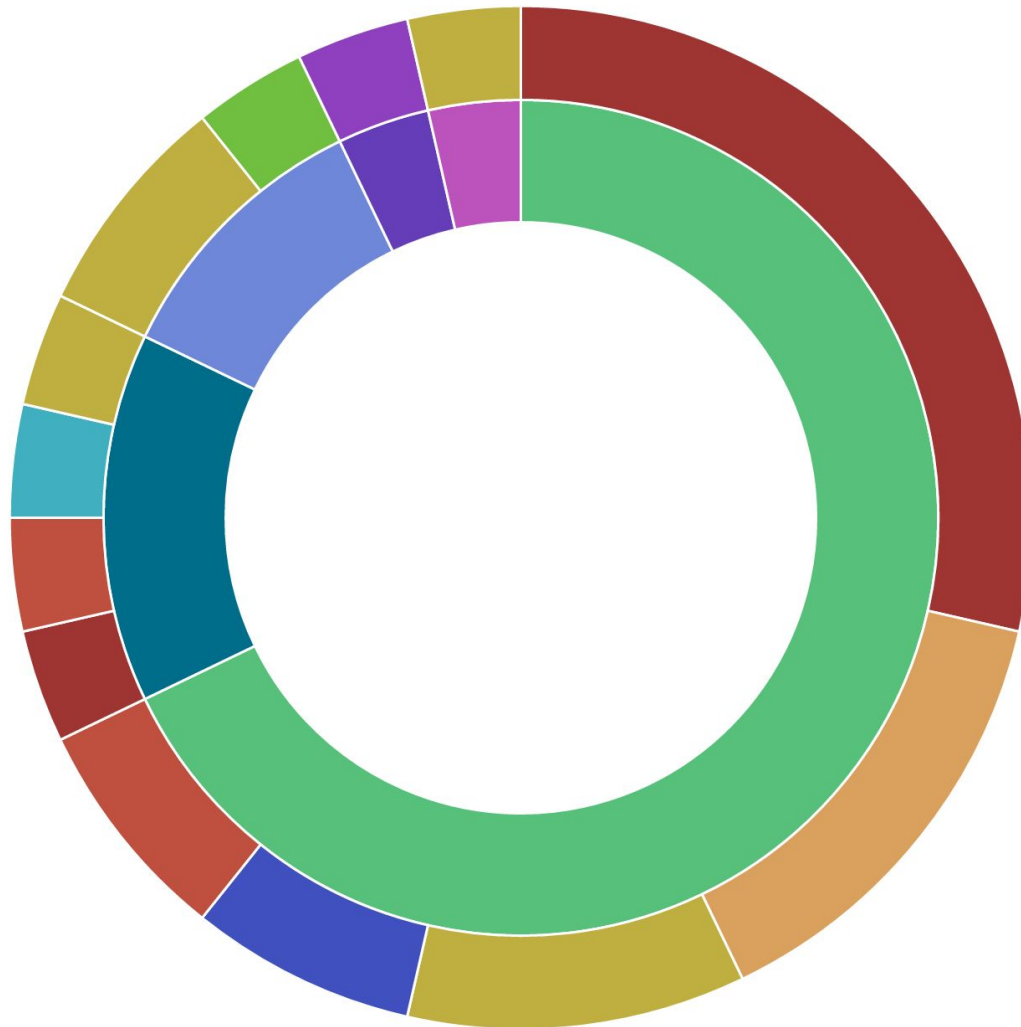

- English
- Turkish
- French
- Chinese
- Italian
- 6o4xqbd4cpmumytk.o...
- xf7kegtgitykjoom.onion
- ndvgtf27xkhdvezr.onion
- 3xo7axbmkttd4qlx.onion
- ergdzsjgpvsc5rvj.onion
- gumuj7unxtiai2a3.onion
- bica3zjnlv6fxkqf.onion
- wzaxcyqroduouk5n.on...

NionSpy

- Steals confidential information like keystrokes, passwords and private documents
- Records video and audio, suitable for espionage programs
- Detection Feature:
- Popularity in the number of values associated to parameters (in the query string)

Automated Detection

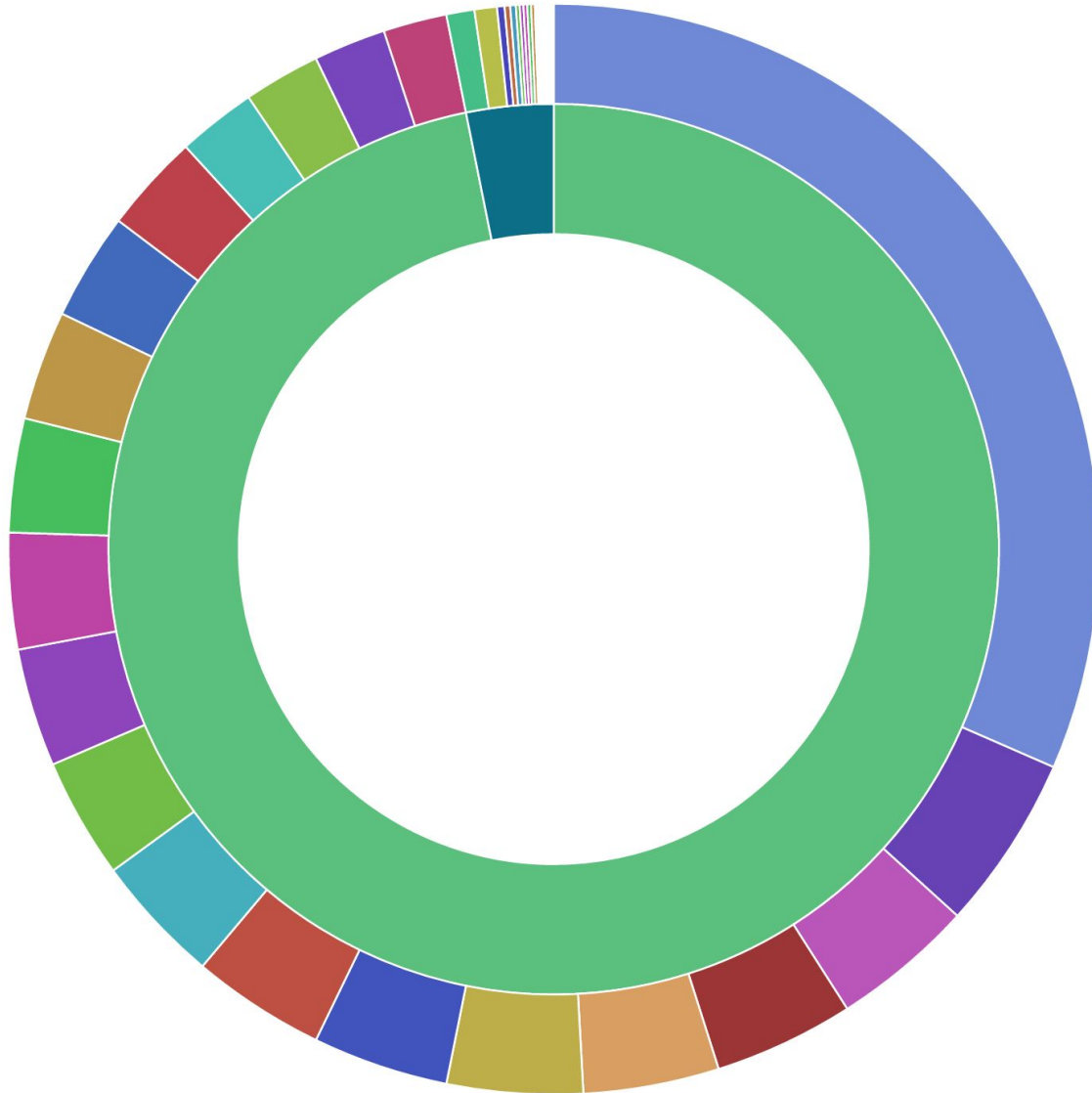

Legend ↻

- xu
- xd
- xu=%e0%ee%a8%e5...
- xu=%e0%ee%a8%e5...
- xu=%e0%ee%a8%e5...
- xu=%e0%ee%a8%e5...
- xu=%e0%ee%a8%e5...
- xu=%e0%ee%a8%e5...
- xu=%e0%ee%a8%e5...
- xu=%e0%ee%a8%e5...
- xu=%e0%ee%a8%e5...
- xu=%e0%ee%a8%e5...
- xu=%e0%ee%a8%e5...
- xu=%e0%ee%a8%e5...
- xu=%e0%ee%a8%e5...
- xu=%e0%ee%a8%e5...
- xu=%e0%ee%a8%e5...
- xu=%e0%ee%a8%e5...
- xu=%e0%ee%a8%e5...
- xd={"news_index":""}
- xd={"f6226":""}
- xd={"f155": "180.62.10...

NionSpy: GET's query string analysis

- `xu` experienced a quick surge in popularity: 1700+ values
- `si.php?xu=%e0%ee%a8%e5%f2%e9%e5%e4%f2[...]`
- URL-encoded binary blob representing the leaked data
- `si.php?xd={"f155":"MACHINE_IP", "f4336":"MACHINE_NAME", "f7035":"5.9.1.1", "f1121":"windows", "f2015":"1"}`
- Reports a new infection

NionSpy: New victims and leakages

- Blue (xd): # of new victims / day
- Green (xu): amount of leaked information (bytes)

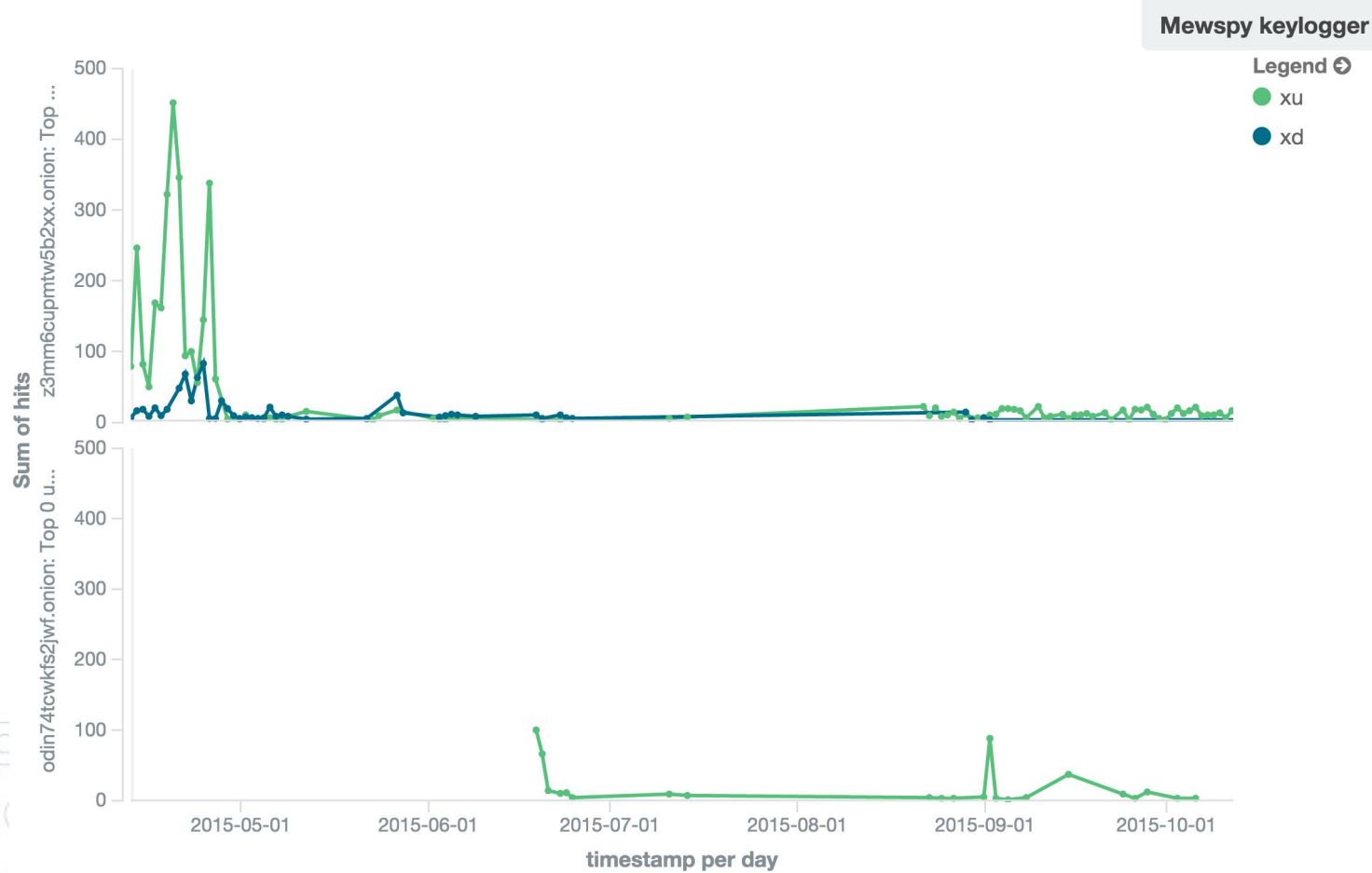

Black Hat Sound Bytes

- ① We built a system for data collection and analysis in the Deep Web.
- ① We used it to quickly identify cybercriminal activities, such as trading of illegal goods, underground marketplaces, scams and malware infrastructures.
- ① We run it operationally and automatically to detect new threats.

Thanks! Q&A time...

Marco Balduzzi -- @embyte

Vincenzo Ciancaglini -- @ziovic

