



Ambient Pressure Diving Ltd.

Back Mounted Counterlungs

User Instruction Manual

## Contents

Important Information .....	2
Introduction .....	3
Rebreather Configuration .....	4
Assembly.....	5
Upgrade Kit Components .....	6
BMC Inflators .....	8
BMC Inflator Configuration .....	9
Counterlung + Harness .....	10
Harness Size Guide .....	10
BMC Diluent and Oxygen Inflators .....	10
Over-Pressure Exhaust Valve .....	12
Automatic Diluent Valve (ADV).....	13
Conversion Instructions.....	14
Cleaning and Disinfecting the Unit.....	15
Manufacturer: .....	15
EC TYPE Approval:.....	15
EC PPE Article 11B Approval: .....	15

## Important Information

- Always carry out a full positive and negative pressure check of the breathing loop before diving. Do the positive pressure check with **both** variable dump valves in the 'Pre Dive' position (fully clockwise)
- Always ensure **both** variable dump valves are "clicked" into the 'Dive' position (fully anti-clockwise) before you start your dive
- Check the operation of the manual inflators and ADV (if fitted) to ensure that there is a good supply of gas to the counterlungs
- DO NOT begin a dive with faulty valves or a leaking breathing loop
- NOTE: Any modification to the rebreather such as substitute harnesses and back plates can adversely affect the back mounted counterlungs breathing performances and is therefore not recommended. Modifications will also invalidate the rebreather's CE Approval.

## Introduction

The APD Back Mounted Counterlungs have been specially developed for use with the APD range of rebreathers: the Inspiration, Evolution and Evolution+. They are intended as an option in place of the 'Over-the-Shoulder' counterlungs.

The lungs sit between the divers back and the existing rebreather unit. They stop at the top of the shoulder allowing the breathing loop hoses to be identical to those used on the 'Over-the-Shoulder' counterlungs. (Convoluting hoses and inflator hoses are re-used when a conversion is made).

The harness and counterlungs are combined which eliminates extra straps and holds the counterlungs securely in the correct position.

The optional Back Mounted Counterlungs are available in two sizes: Standard and small. The lung volume is the same in both sizes and has a sufficient volume for anyone. In order to fit different body sizes its position can be adjusted vertically by using the alternative mounting holes. These counterlungs have sufficient breathing volume for anyone. It is essential to keep the counterlungs against your back and upper rear shoulder to avoid excessive breathing pressures.

The Back Mounted Counterlungs upgrade kit comprises of several sub-assemblies sold separately:

# Rebreather Configuration

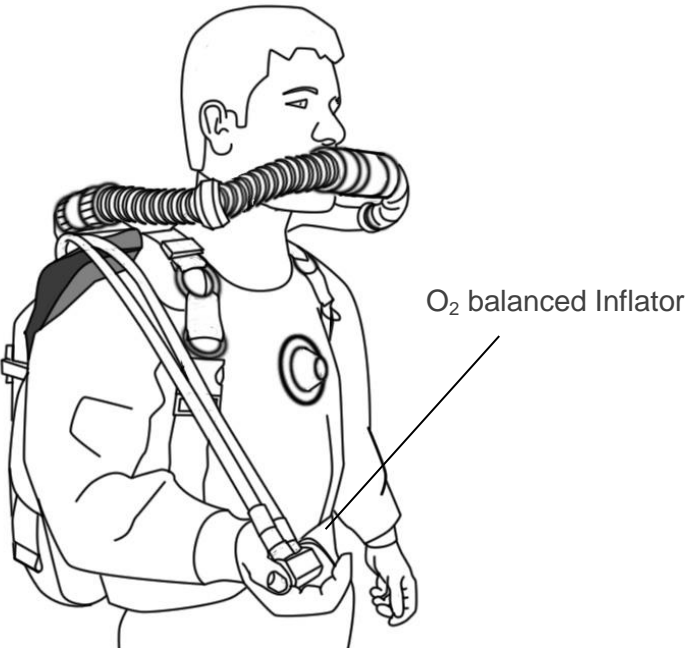
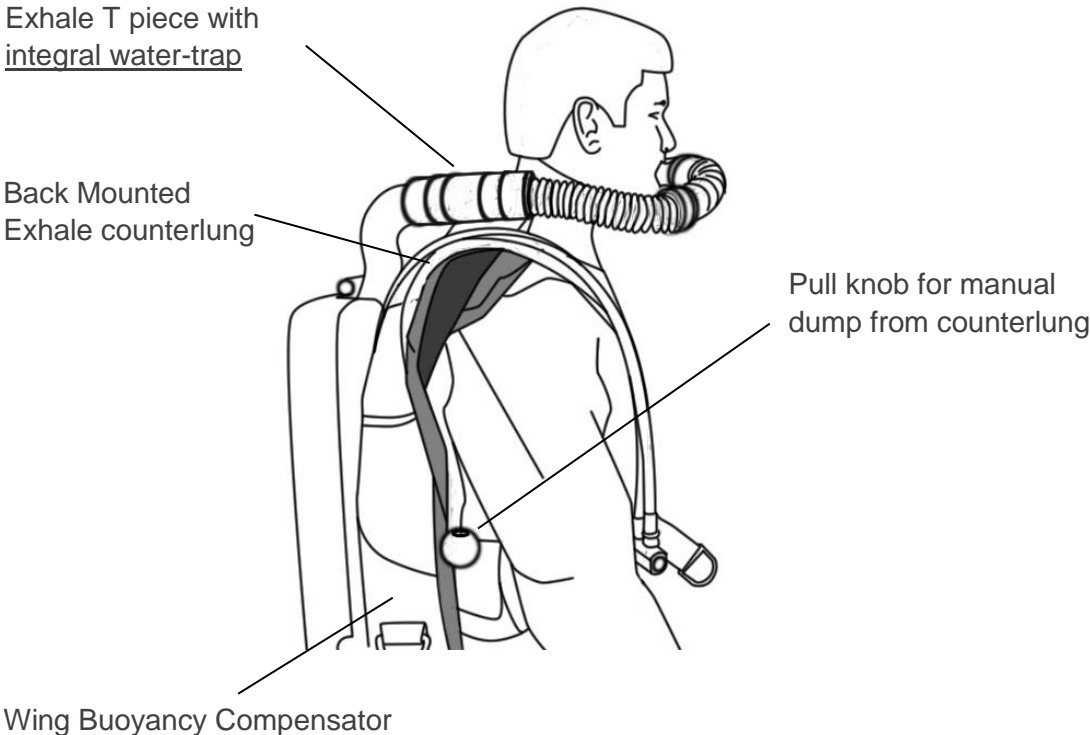

Assembly





- RBV05/04 – Counterlung Connection Post

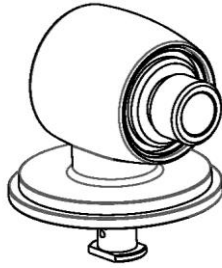

- RBV05 - Diluent Balanced Inflator



- AP300 - Diluent medium pressure hose (length specific to unit size)

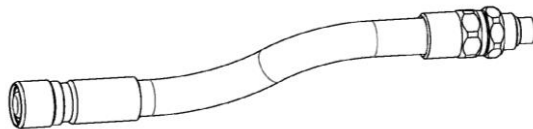

- RBV05A - Oxygen Balanced Inflator



- AP300A - Oxygen medium pressure hose (length specific to unit size)

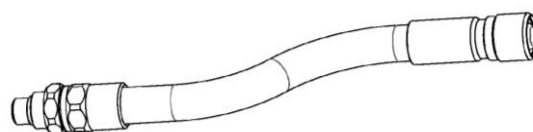

## BMC Inflators

The Back Mounted Counterlungs use the low pressure, hose mounted, balanced inflators RBV05 (diluent) and RBV05A (oxygen), where the gas from the standard quick disconnect hose is fed back to the counterlungs via a fixed MP hose. The valve is operated by pressing the button on the side and releasing for the gas flow to stop.

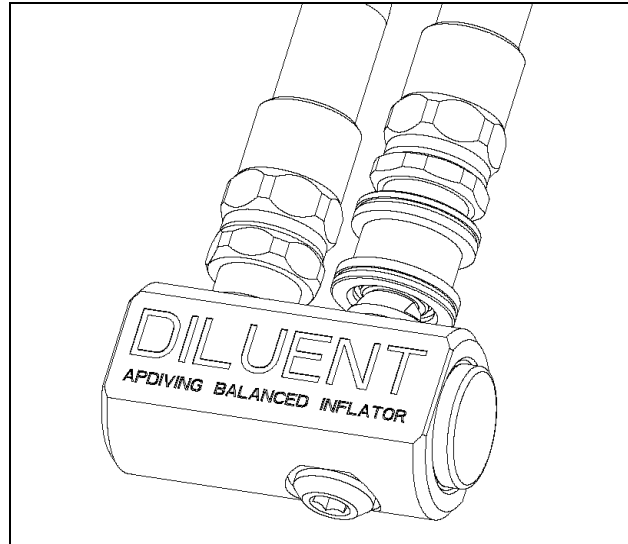

The connection port on the counterlung can be unscrewed for rinsing out the counterlung. Please take care not to lose the O ring and be sure to refasten securely.

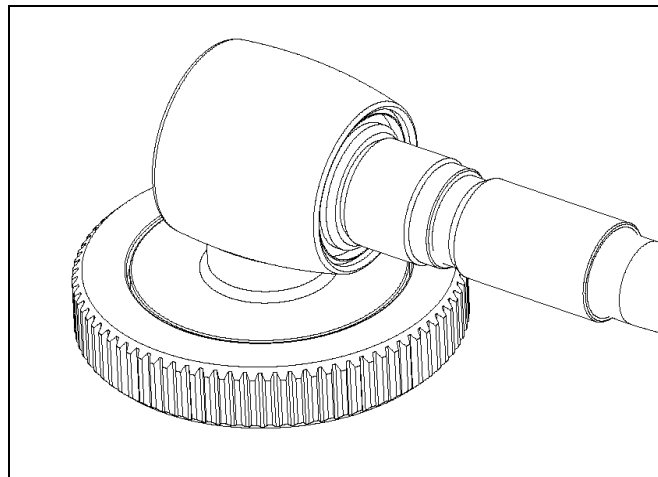



# BMC Inflator Configuration

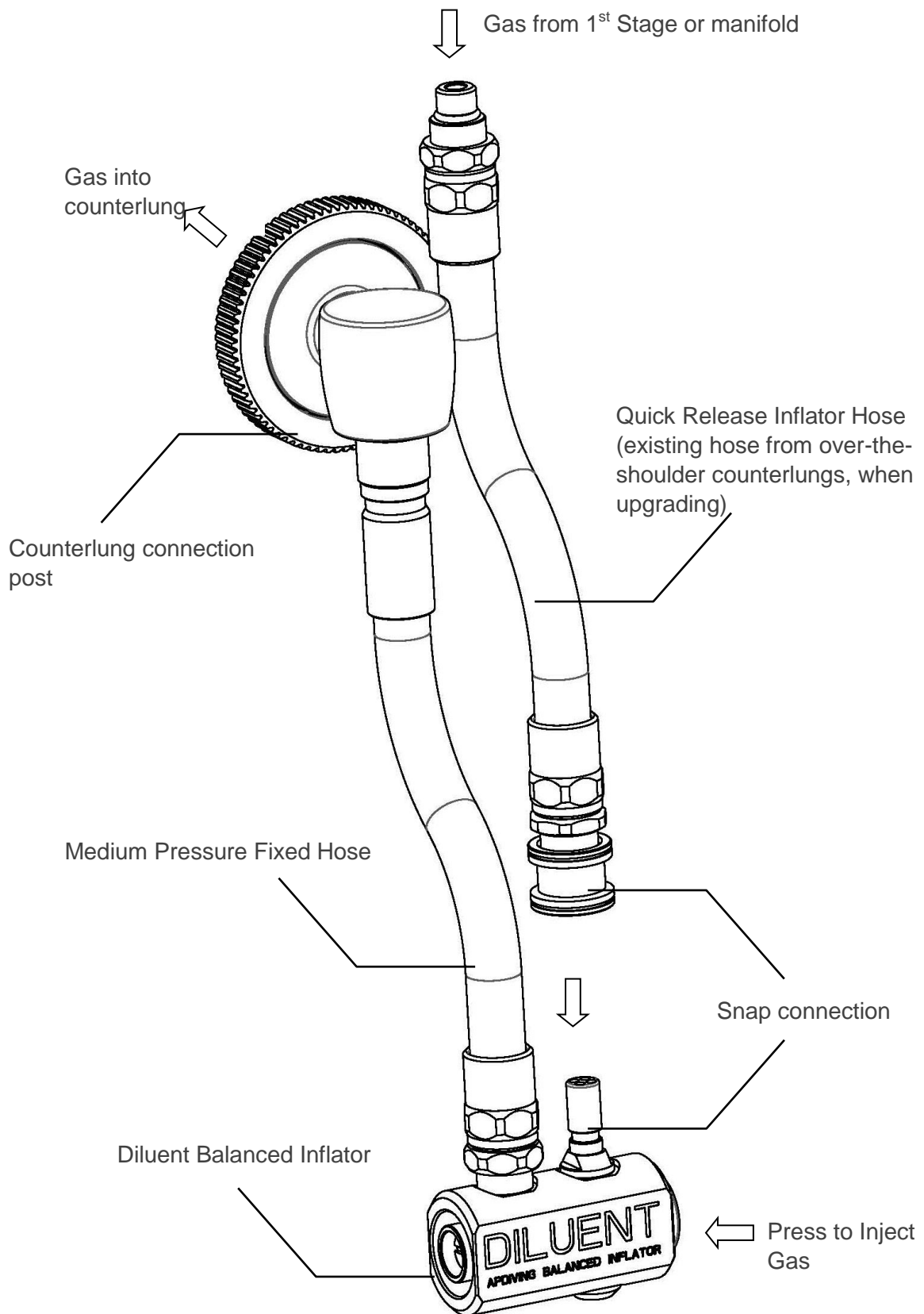

## Counterlung + Harness

### Assembly 1. Counterlung (2 sizes, 2 colour options) + Harness (4 sizes)

The Back Mounted Counterlungs are offered in either yellow & black or grey & black to match existing APD rebreather colour schemes.

The new harness is designed specifically for use with the Back Mounted Counterlungs only. N.B. the current harness cannot be used with the new lungs. The new harness features APD weight-pockets, multiple stainless D rings, and a crotch strap. It also includes a new, larger comfort pad.

### Harness Size Guide

Choose the harness size according to your waist measurement with dive suit.

**Existing owners:** You can choose the size based on your current harness' size. (See table below). The exception to this is if you currently have a Small harness you will need to order a Medium new harness.

[N.B. The new Medium harness will fit exactly the same around the waist as the current Small and Medium. We have been able to combine the Small with the Medium because of the removal of the shoulder straps from the new harness structure]

Existing Owner's Harness Size	Waist Measurement (with dive suit)	Back Mounted C/Lung Harness Size
S	25"/63cm - 34"/86cm	M
M	32"/81cm - 39"/99cm	M
L	39"/99cm - 44"/112cm	L
XL	42"/107cm - 50"/127cm	XL
XXL	50" + /127cm +	XXL

## BMC Diluent and Oxygen Inflators

### Assembly 2: BMC Diluent Inflator, Hose & Connection Post

### Assembly 3: BMC Oxygen Inflator, Hose & Connection Post

The manual BMC diluent inflator is included with every Back Mounted Counterlung. The manual BMC oxygen inflator is optional.

Each BMC inflator consists of two hoses: a quick release hose which feeds gas from the cylinder supply to the inflator and a fixed hose which returns the gas to a counterlung fitting.

The diluent feeds into the inhale counterlung which is on the diver's left side and the oxygen feeds into the exhale counterlung on the diver's right.

## **BMC Inflator Fixed Feed Hose Size Guide**

The inflator's fixed hoses are offered in 3 sizes (70,76 & 84cm) to be compatible with existing rebreather, quick release, inflator hoses; the lengths of which are determined by your existing over-the-shoulder counterlung size. (If you are not sure of the size of your counterlung, you'll see the size label when you unbolt the counterlungs, alternatively contact the factory for advice).

*\*New Customers* - measure as follows: wearing trousers with a belt and a T-shirt, measure from the lower edge of the belt at the front, over-the-shoulder and down to the belt at the back. Take the measurement on inhale.

Please contact the factory on +44 (0)1326 563834 or email: [sales@apdiving.com](mailto:sales@apdiving.com) with your height, waist and chest measurements if you need further advice on sizing.

Rebreather	Existing Unit OTS Counterlung Size	New User Measurement (see details above)*	BCM Inflator Assembly	
			O <sub>2</sub>	Diluent
Evolution	Medium	Under 110cm/43.3"	RBV05A/70 70cm Hose	RBV05/70 70cm Hose
	Large & XL	Over 110cm/43.3"	RBV05A/76 76cm Hose	RBV05/76 76cm Hose
Evolution +	Medium	Under 110cm/43.3"	RBV05A/70 70cm Hose	RBV05/70 70cm Hose
	Large & XL	Over 110cm/43.3"	RBV05A/76 76cm Hose	RBV05/76 76cm Hose
Inspiration	Medium	Under 110cm/43.3"	RBV05A/76 76cm Hose	RBV05/76 76cm Hose
	Large & XL	Over 110cm/43.3"	RBV05A/84 84cm Hose	RBV05/84 84cm Hose

## Hose Length Adjustment

All hoses use the AP screw-together fittings which allow you to shorten the hose to suit your preference.

1. Remove the hose from the inflator block using a 17mm spanner. Clamp the hexagon closest to the hose, the ferrule, in a vice and unscrew (anti-clockwise) the 3/8" UNF end, the inner, from the ferrule, removing the end fitting.
2. Remove the ferrule from the hose by turning the hose CLOCKWISE (the ferrule has a left handed internal thread).
3. Cut the hose squarely with a Stanley knife to the required length.
4. Refit the hose to the end fitting held in the vice by screwing the hose into it ANTI-CLOCKWISE as far as it will go.
5. Ensuring the hose does not push out, push the inner into the ferrule until the threads start and then tighten (clockwise) using the 17 mm spanner until the two fittings meet.

## Over-Pressure Exhaust Valve

This is a two-position valve with an additional manual override. In both the fully open (dive) and fully closed (pre-dive) positions there is a mechanical stop and "click" lock. Fully closed (clockwise) is the high-pressure setting, used for detecting leaks on the system and for providing positive buoyancy when at the surface with the mouthpiece closed. Fully open (anticlockwise) is the low-pressure setting, used throughout the dive. On this setting the loop pressure is kept below the maximum lung overpressure of 40 mbar. During the ascent, this setting may be too high for comfortable exhalation so exhale around the outside of the mouthpiece during the ascent or breathe out through your nose. It is essential to keep the counterlungs against your back and upper rear shoulder to prevent the over-pressure valve operating continuously.

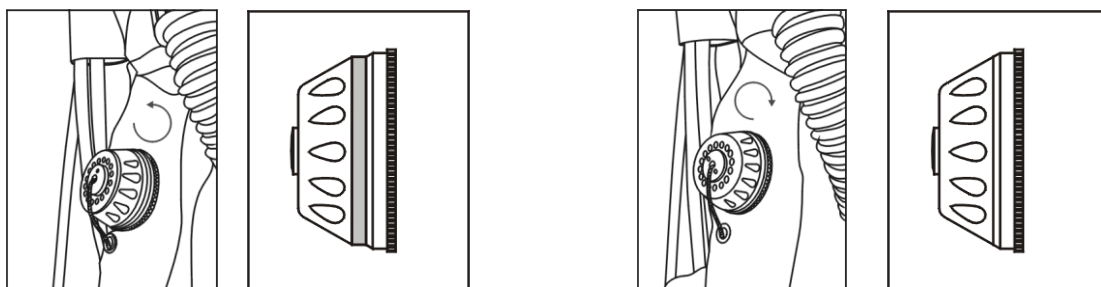

Low Pressure  
Setting - DIVE

High Pressure  
Setting: PRE-DIVE  
for leak testing

Extreme care must be taken during uncontrolled buoyant ascents when gas must be vented around the mouthpiece to ensure your lungs are protected from over expansion.

## Automatic Diluent Valve (ADV)

The ADV is an optional feature. It replaces the inhale T-piece on the left shoulder counterlung and is usually fitted with the diaphragm facing the diver's head. The ADV is activated by a pressure differential across the diaphragm and it supplies gas to the loop (breathing circuit) whenever a substantial negative pressure is experienced within the inhale counterlung.

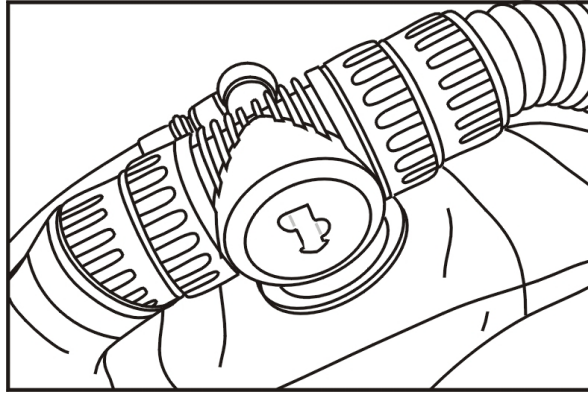

The gas supply hose connects with a 3/8"UNF thread to the low pressure port on a first stage or into the diluent portion of the manifold and connects to the ADV's 300° swivel. The swivel allows for the hose to be fed from the rear e.g. from the manifold, or from the front, from a side mounted diluent cylinder. If the side mounted cylinder needs to be removed in water the optional in-water quick release connector is available. The ADV is an upstream valve and can be used with 1st stages delivering 7 to 11 bar (nominal 9.5 bar) above ambient and requires no adjustment. The elastomeric diaphragm cover allows manual gas addition.

During descents it is normal for the ADV to add gas on nearly every inhalation. However, this is most abnormal during all other phases of the dive. Normally the ADV adds gas to make the counterlung volume breathable and then stops.



**WARNING:** If the ADV operates on every inhalation this is an indication of either poor rebreather diving practice like exhaling through the nose or is a sign of some other leak from the loop. Any extra diluent addition usually has the effect of reducing the  $ppO_2$  within the breathing circuit and would be countered by the oxygen controller adding oxygen to regain the setpoint. The danger of inadvertently using excess gas from both diluent and oxygen cylinders is higher when using an ADV and extra monitoring of cylinder contents gauges should take place.

Located on the left shoulder, rolling left side down may force the ADV to add gas to the loop as will rotating head down, when the gas in the counterlungs migrates upwards away from the ADV and causes a negative pressure on the inside of the diaphragm. Whenever these manoeuvres are undertaken you may need to run the counterlungs with a higher gas volume than normal.

## Conversion Instructions

Follow these instructions to convert an APD 'Over-the-Shoulder' counterlung rebreather to Back Mounted Counterlung:

1. Make sure all cylinders are turned off and that all hoses are purged of any pressure.
2. Unscrew all the convoluted hoses from the T-pieces in order to remove the canister and mouthpiece assemblies from the rebreather.
3. Disconnect the medium pressure hoses from the manual inflators and ADV if fitted. Unthread these hoses from the counterlung hose retainers so they are free.
4. Remove the existing comfort pad by undoing the velcro loops and pulling away from the unit.
5. Undo the harness nuts that hold the harness, lung and wing to the rebreather case using a 13mm spanner and a 5 and 6mm allen key.
6. Remove the lungs and harness, but leave the wing in place.
7. Place the back mounted counterlungs over the harness screws, followed by the back mounted counterlung harness. N.B. There are two sets of mounting holes for the lungs to allow adjustment to fit different body types. Using the lower holes will raise the counterlungs to suit a larger frame.
8. Replace the harness nuts and tighten with a 13mm spanner and a 5 and 6mm allen key.
9. Fit the new comfort pad using the Velcro loops. Connect all the fastex buckles for the waistband, shoulder straps and chest strap. (The chest strap is removable and can be taken off if found not to be required for your particular build)
10. **To fit a Manual Diluent Inflator:** first remove the blanking plate from the inhale counterlung cylinder post and place the locking ring over a counterlung connection post.
11. Screw the Diluent medium pressure hose onto the connection post, tightening by hand only.
12. Then screw the opposite end of Diluent medium pressure hose into the diluent balanced inflator. This time tightening with a 17mm spanner.
13. Place the connection post into the counterlung cylinder post base (making sure the o ring is still in the base). With the medium pressure hose in the vertical position as if to go over your shoulder when worn. Secure the post in place by screwing down the locking ring.
14. Hang the inflator to the front of the unit and connect the original manual inflator medium pressure hose to the inflator nipple using the snap connector end.
15. Secure the hoses in place using the hose retainer clips on the shoulder D rings.
16. **To fit a Manual Oxygen Inflator:** Repeat steps 10 to 15 for the oxygen inflator on the exhale counterlung side.
17. Re-connect the medium pressure hose to the ADV if fitted.
18. Re-connect the mouthpiece assembly and the canister to the rebreather
19. Screw down both variable dump valves to the 'Pre-Dive' position and carry out a positive and negative pressure test to check the assembly for leaks.

## Cleaning and Disinfecting the Unit

We advise users to disinfect their rebreather after each day of use. Only in this way can its cleanliness be ensured. However, disinfecting involves some disassembly and if not carried out with care, leaks may be introduced into the system during reassembly. It is important that leaks are rectified if the reliability and integrity of the system is to be restored. If the rebreather is shared with another diver the system should be thoroughly disinfected before use.

After each dive the mouthpiece should be rinsed in fresh water, taking care not to allow large quantities of water to enter the loop. Providing the rebreather is standing upright, all the water will enter the exhale counterlung and this is easily drained. Take care not to allow too much to enter while the scrubber hoses are still connected.

At the end of each day's diving remove the hose and the mouthpiece as an assembly, rinse in a disinfectant solution such as BUDDY Clean and rinse thoroughly in fresh water.



**WARNING!** Do not use solutions of Milton or other baby bottle sterilising solutions. These discolour and rot the inner and outer bags.

After every 6 hours total diving; disinfect the mouthpiece, hoses, counterlungs and inside the canister. Inspect the counterlungs for foreign matter; the outer bag of each counterlung has a zip to aid inspection of the inner. It is necessary to allow the components to soak for 10 mins in a 100:1 (Water : Buddy Clean) diluted solution. Please note: Buddy Clean is supplied undiluted and requires dilution for use. Do not leave components soaking in cleaning solution for more than 30 minutes. Rinse thoroughly afterwards with fresh water, preferably sterilized water (pre-boiled and cooled) and then allow to dry.

### Manufacturer:

Manufactured in the UK by Ambient Pressure Diving Ltd, Unit 2C, Water-ma-Trout Industrial Estate, Helston, Cornwall TR13 0LW.

Telephone: +44 (0)1326 563834    FAX: +44 (0)1326 573605

### EC TYPE Approval:

EC Type approved by SGS United Kingdom Ltd, Unit 202b, Worle Parkway, Western-Super-Mare, Somerset, BA22 6WA. Notified Body number 0120.

The "Inspiration", "Evolution" and "Evolution+" [with back mounted counterlungs] are CE approved to 40m using an air diluent and 100m using a Heliox or Trimix (with a max. END of 30m at 70m, reducing to an END of 24m at 100m). The EC Type Approval was granted on the APD Manufacturer's Technical Specification and satisfactory user trials. The Technical Specification was based on the "Respiratory equipment-Self-contained re-breathing diving apparatus" standard EN14143:2003 excluding clauses 5.6.1.3 (peak respiratory pressures at higher breathing rates) and 5.8.8.(hose elongation test). It was considered that the products met the Basic Health and Safety Requirements (Annex II) of the PPE Directive 89/686/EEC.

### EC PPE Article 11B Approval:

The ongoing certification to allow CE marking under Article 11B Directive 89/686/EEC is granted by Lloyd's Register Quality Assurance Ltd. CE0088.

Designed and Manufactured by:



AP Diving Ltd  
Water-ma-Trout Industrial Estate,  
Helston, Cornwall, Great Britain.  
TR13 0LW.  
Telephone: +44(0)1326 563834  
Fax: +44(0)1326 573605  
[www.apdiving.com](http://www.apdiving.com)

For spares and accessories visit:  
[www.apdivingdirect.com](http://www.apdivingdirect.com)