

a m e r i c a n d r e w™

# PROFILES

f u r n i t u r e d e s i g n e d f o r l i v i n g

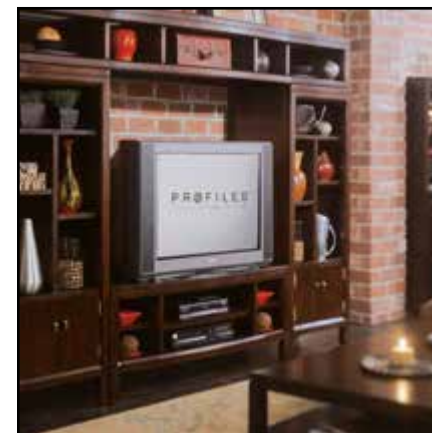

a m e r i c a n  d r e w®  
a L A Z B O Y company

4310 Regency Drive, Suite 101  
High Point, NC 27265  
www.americandrew.com  
© 2010 by American Drew

AD/FCC/WCP/06-10/5M

## TRIBECCA

SERIES 912

# PROFILES™

furniture designed for living

Subtle style references and approachable scale enable you to reflect a unique sense of personal style while satisfying your desire for comfort, convenience, and quality. And, like a clean canvas, PROFILES invites an infinite range of accessorization, allowing you to add the accessories and personal possessions that express who you are, fashioning the perfect home for your individual life.

That's what PROFILES is all about—  
furniture that fits your life!



## TRIBECCA

Tribecca mixes it up with modern, Art Deco, and Asian influences. Lighter scaled, with classic clean lines and pared down forms, Tribecca's inviting textures and deep, rich wood tones could be just the fresh yet warm look you've been trying to imagine for the new condo on the shore or a trendy city loft.

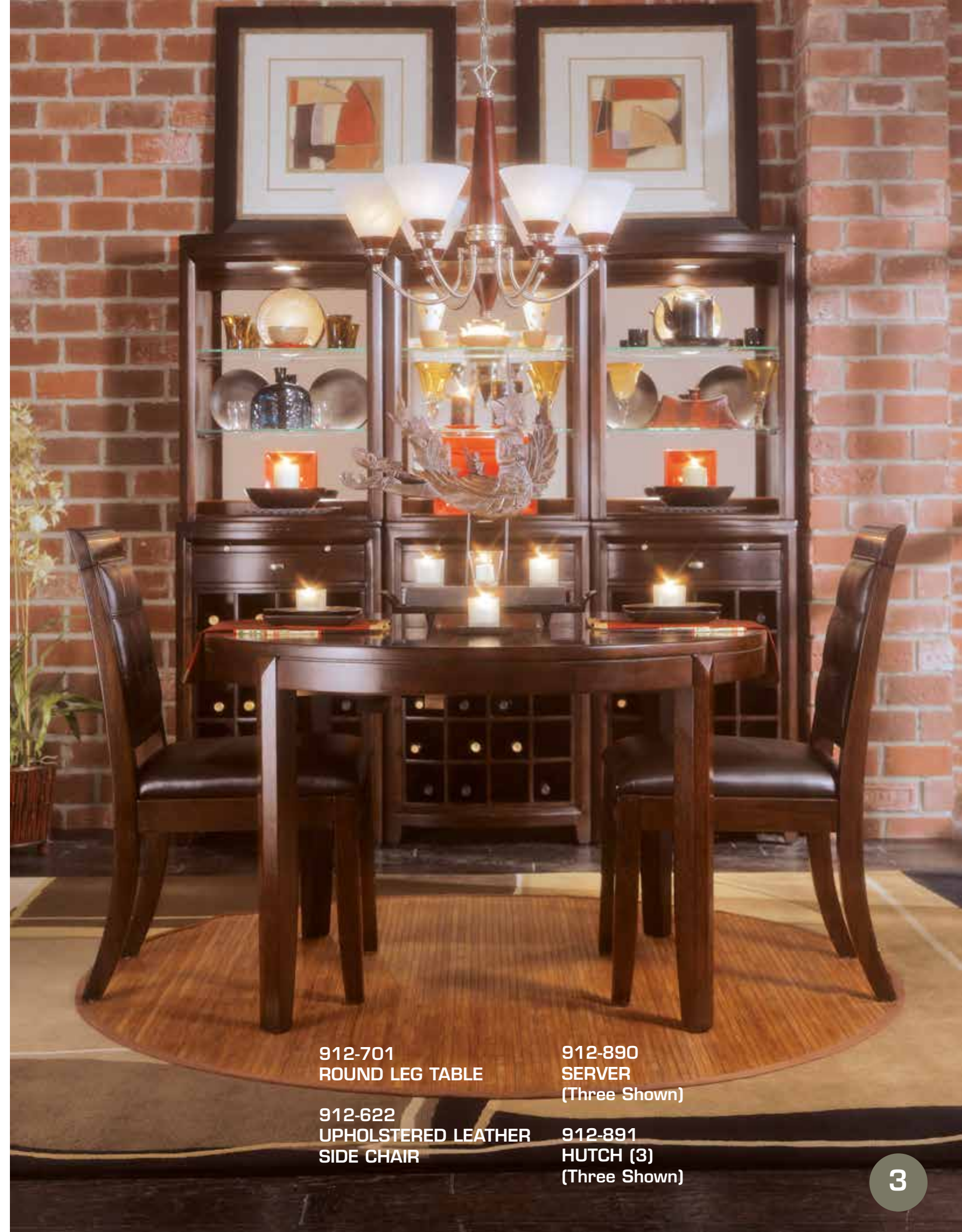

912-701  
ROUND LEG TABLE

912-622  
UPHOLSTERED LEATHER  
SIDE CHAIR

912-890  
SERVER  
(Three Shown)

912-891  
HUTCH (3)  
(Three Shown)

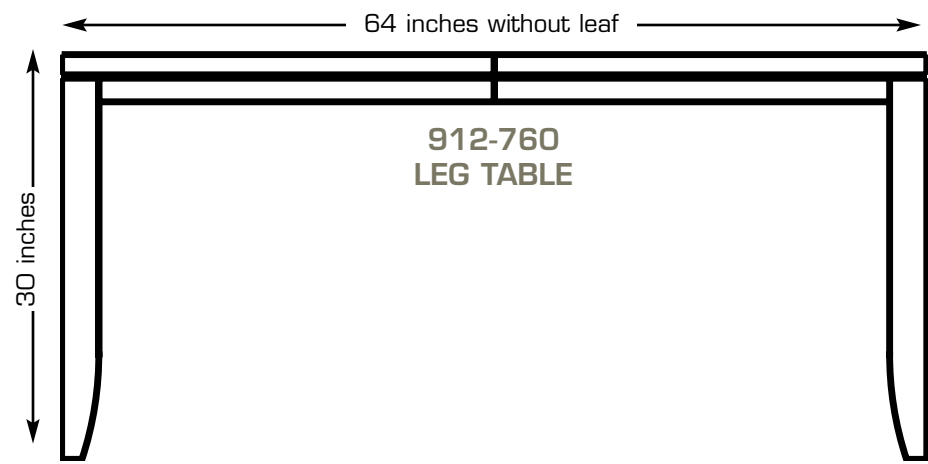

Table Top Detail  
Without Leaf



Table Top Detail  
With Leaf

**912-622**  
**UPHOLSTERED LEATHER**  
**SIDE CHAIR**  
W20 D24 H39  
Seat H20

**912-623**  
**UPHOLSTERED LEATHER**  
**ARM CHAIR**  
W22 D24 H39  
Seat H20 Arm H25

**912-760**  
**LEG TABLE - RTA**  
L64 W44 H30  
(1) 16" Leaf  
Extends Table to 80"  
(Shown with leaf)

**912-830R**  
**CHINA COMPLETE**  
W60 D19 H80  
*Consists of:*  
**-831 China Deck**  
W60 D19 H50  
**-830\* China Base**  
W60 D19 H30



"Our son and his wife are actually jealous of our new Tribeca furniture."



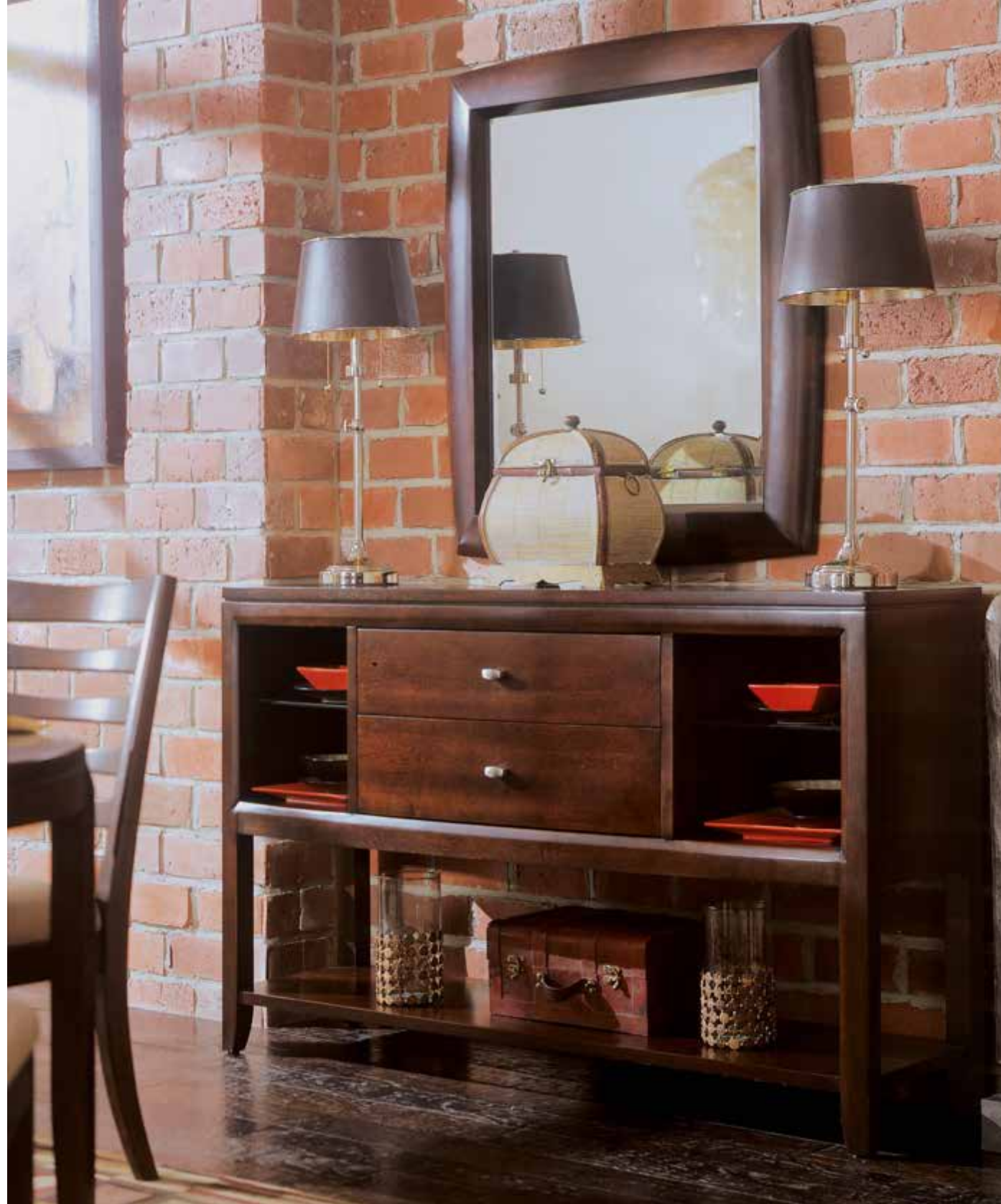

**912-040  
ACCENT MIRROR**  
W37 D3 H42  
Beveled Mirror.  
(Can be hung vertical or  
horizontal)

**912-850  
SIDEBOARD/CREDENZA**  
W60 D18 H38  
2 Glass Shelves, 2  
Drawers, Silver Tray.



**912-830R  
CHINA COMPLETE**  
W60 D19 H80  
*Consists of:*  
**-831 China Deck**  
W60 D19 H50  
2 Doors, 6 Adjustable Glass  
Shelves, 3 Can Light System,  
Touch Lighting.  
**-830\* China Base**  
W60 D19 H30  
2 Doors, 3 Drawers,  
1 Adjustable Shelf behind  
each door, Silver Tray.

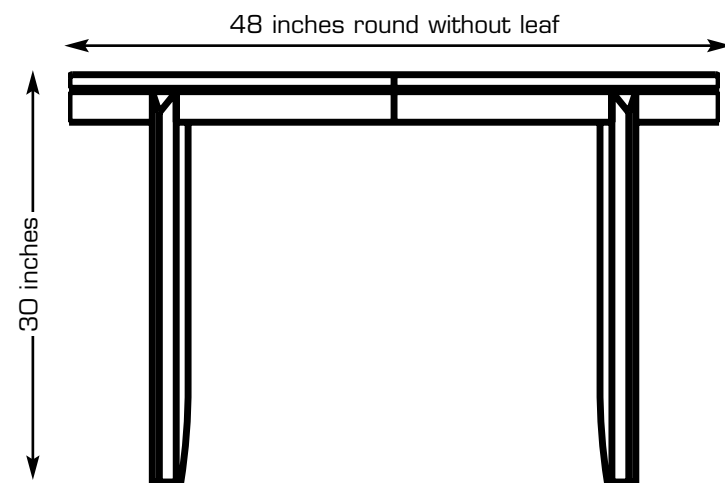

**912-701**  
ROUND LEG TABLE

**912-701**  
ROUND LEG TABLE  
L48 W48 H30  
(1) 16" Leaf  
Extends Table to 64"  
(Shown with leaf)



Table Top Detail  
Without Leaf



Table Top Detail  
With Leaf

**912-636**  
SPLAT SIDE CHAIR  
W20 D23 H39  
Seat H20

**912-040**  
ACCENT MIRROR  
W37 D3 H42

**912-850**  
SIDEBOARD/CREDENZA  
W60 D18 H38



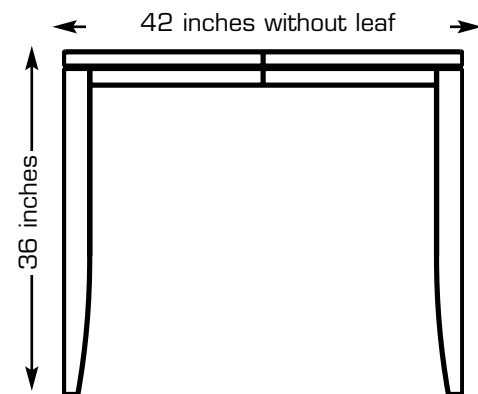

**912-705  
GATHERING TABLE**

**NOTE:** The 705 Gathering Table can make a great office desk set up as well.  
(Shown above with 690 Splat Back Bar Stools)

*Right:*  
**912-705  
GATHERING TABLE**  
L60 W42 H36  
(1) 18" Leaf  
Extends Table to 60" x 60"  
(Shown without leaf)

**912-691  
UPHOLSTERED LEATHER  
BAR STOOL**  
W18 D21 H40  
Seat H25

**912-890  
SERVER**  
W25 D14 H39

**912-891  
HUTCH**  
W25 D14 H35



Table Top Detail  
With Leaf



Table Top Detail  
Without Leaf





**NOTE:** The 890 Server and 891 Hutch gives you much needed storage and display, without taking up much floor space.



**NOTE:** The 890 Server can be used as a stand alone piece.

*Right:*  
**912-890  
 SERVER**  
 W25 D14 H39  
 Wine Storage, 1 Drawer,  
 1 Pullout Shelf, Silver Tray.  
 (Three Shown)

**912-891  
 HUTCH**  
 W25 D14 H35  
 2 Adjustable Glass Shelves,  
 Can Light, Touch Lighting.  
 (Three Shown)

**NOTE:** Group several 890 Servers and 891 Hutches together to create a larger wine storage and bar cabinet.



*Right:*  
**912-706**  
**COUNTER HEIGHT PUB**  
**TABLE - RTA**  
W42 D42 H36  
1-20" Leaf, Extends to 62".  
(Shown without leaf)

**912-690**  
**SPLAT BACK BAR STOOL**  
W18 D19 H38  
Seat H25

**912-890**  
**SERVER**  
W25 D14 H39  
Wine Storage, 1 Drawer,  
1 Pullout Shelf, Silver Tray.  
(Two Shown)

**912-891**  
**HUTCH**  
W25 D14 H35  
2 Adjustable Glass Shelves,  
Can Light, Touch Lighting.  
(Two Shown)



"The Tribeca Server and Hutch together worked great for displaying my favorite wines and eclectic collection of dishes."





*Right:*  
**912-589**  
**FLIP TOP BAR**  
W39 D22 H43  
Black Laminate on Flip Tops, 2  
Doors with Bottle Storage,  
Wine Storage, 1 Drawer on  
RSF, Stemware Holders, RSF  
Opening:  
W18 D16 H10,  
LSF 2 Fixed Shelves,  
Top Opening:  
W18 D16 H8,  
Bottom Opening:  
W18 D16 H15

**912-707**  
**BAR TABLE - RTA**  
W42 D42 H42  
1-20" Leaf,  
Extends to 62".  
(Shown without leaf)

**912-692**  
**BAR HEIGHT STOOL - KD**  
W19 D21 H46  
Seat H30





*Above & Left:*  
**912-589**  
**FLIP TOP BAR**  
 W39 D22 H43  
 Black Laminate on Flip Tops, 2 Doors with Bottle Storage, Wine Storage, 1 Drawer on RSF, Stemware Holders, RSF Opening: W18 D16 H10, LSF 2 Fixed Shelves, Top Opening: W18 D16 H8, Bottom Opening: W18 D16 H15

**912-623**  
**UPHOLSTERED LEATHER**  
**ARM CHAIR**  
 W22 D24 H39  
 Seat H20  
 Arm H25

**912-691**  
**UPHOLSTERED LEATHER**  
**BAR STOOL**  
 W18 D21 H40  
 Seat H25

**912-622**  
**UPHOLSTERED LEATHER**  
**SIDE CHAIR**  
 W20 D24 H39  
 Seat H20

**912-637**  
**SPLAT ARM CHAIR**  
 W23 D23 H39  
 Seat H20  
 Arm H25

**912-690**  
**SPLAT BACK BAR STOOL**  
 W18 D19 H38  
 Seat H25

**912-636**  
**SPLAT SIDE CHAIR**  
 W20 D23 H39  
 Seat H20



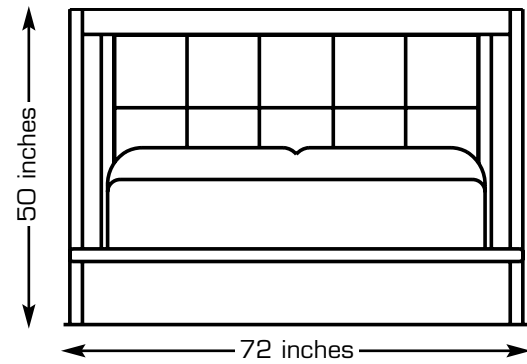

**912-333R**  
**PLATFORM BED 5/0**

**NOTE:** Platform Bed can be used without Platform Boxes.

**NOTE:** Platform Bed Available in Additional Sizes. See Page 47 for details.

*Shown Right:*  
**912-040**  
**ACCENT MIRROR**  
 W37 D3 H42

**912-220**  
**DRESSING CHEST**  
 W64 D20 H39

**912-333R**  
**PLATFORM BED 5/0**

*Consists of:*

**-333 Platform Headboard 5/0**  
 W72 D6 H50  
 Bored for Frame.

**-P34 Platform 5/0**  
 W71 D86 H2

**-S34 Support Box 5/0**  
 W67 D81 H10

**912-334**  
**PLATFORM BOXES 5/0-6/6**  
**(1 SIDE)**

W22 D77 H11  
 Three Drawers.

**NOTE:** Use two 334 Platform Boxes for storage on either side of the bed.

Platform Boxes Detail

**912-420**  
**NIGHTSTAND**  
 W28 D18 H28



**912-230**  
**CORNER CHEST**  
W42 D26 H50  
2 Doors, 3 Drawers.  
Opening: W38 D25 H11



“The pieces in Tribeca are the perfect size for our open loft apartment.”

**912-215**  
**DRAWER CHEST**  
W42 D21 H54  
5 Drawers.



**912-020**  
**LANDSCAPE MIRROR**  
W40 D3 H35  
(Shown Hung Vertically)

**912-220**  
**DRESSING CHEST**  
W64 D20 H39

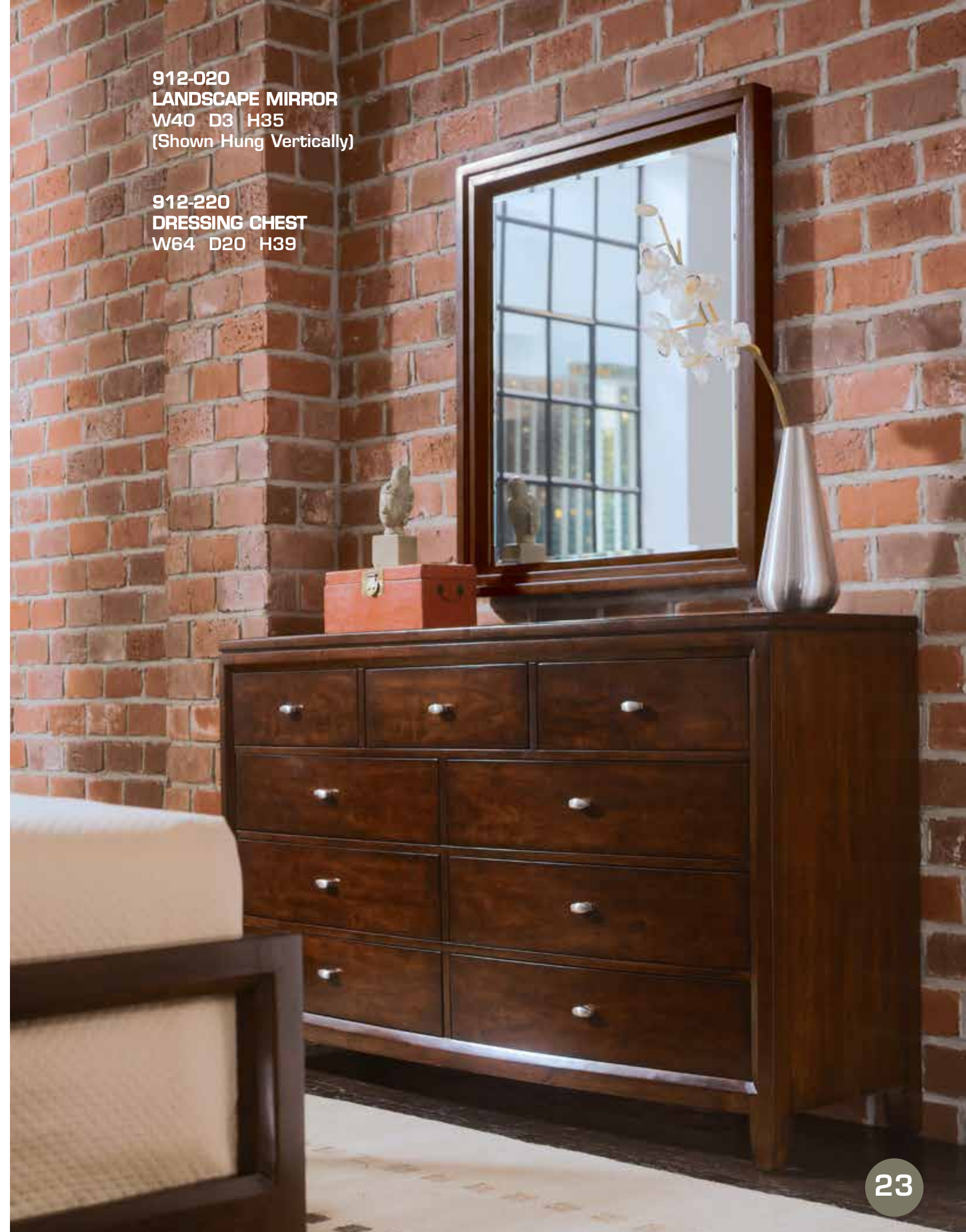

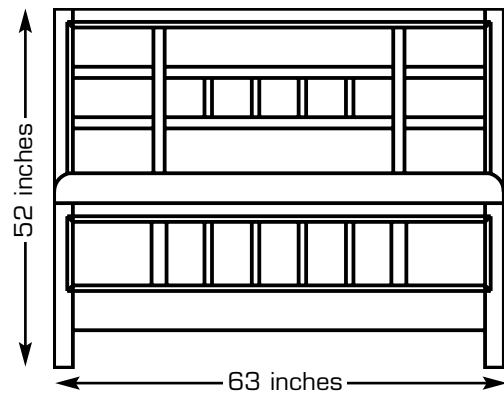

**912-323R**  
**SLAT BED 5/0**

**NOTE:** Platform Bed Available  
 in Additional Sizes.  
 See Page 47 for details.

*Shown Right:*  
**912-400**  
**LEG NIGHTSTAND**  
 W24 D18 H26

**912-323R**  
**SLAT BED 5/0**

*Consists of:*

- 323 Slat Headboard 4/6 - 5/0  
 W63 D2 H52  
 Bored for Frame
- 324 Slat Footboard 4/6 - 5/0  
 W63 D2 H22
- R42 Wooden Rails 5/0 - 6/6  
 W82 D2 H8
- SK1 Mattress Support System

**912-020**  
**LANDSCAPE MIRROR**  
 W35 D3 H40

**912-220**  
**DRESSING CHEST**  
 W64 D20 H39



*Right:*  
**912-320R**  
**SLAT BED 3/3**  
W42 D80 H48  
*Consists of:*  
**-320 Slat Headboard 3/3**  
W42 D2 H48  
Bored for Frame.  
**-321 Slat Footboard 3/3**  
W42 D2 H22  
**-R40 Wooden Rails**  
**with Slats 3/3**  
W77 D2 H6

**912-020**  
**LANDSCAPE MIRROR**  
W35 D3 H40

**912-221**  
**DRESSER**  
W56 D20 H39  
9 Drawers.

**912-400**  
**LEG NIGHTSTAND**  
W24 D18 H26

**NOTE:** Platform Bed Available  
in Additional Sizes.  
See Page 47 for details.



*Right:*  
**912-040**  
**ACCENT MIRROR**  
W37 D3 H42

**912-220**  
**DRESSING CHEST**  
W64 D20 H39

**912-343**  
**BOOKCASE HEADBOARD**  
4/6 - 5/0  
W67 D14 H52  
Bored for Frame.  
2 Sliding Doors,  
Opening: W34 D6 H11  
4 Puck Light Touch System,  
Outside Openings:  
W12 D7 H11

**912-402**  
**BOOKCASE NIGHTSTAND**  
W24 D14 H52  
1 Shelf, 1 Drawer,  
1 Adjustable Shelf on Bottom.

**NOTE:** Bookcase Bed Available  
in Additional Sizes.  
See Page 48 for details.



**912-270R**  
**ARMOIRE**  
Shown as Entertainment.



**912-270R**  
**ARMOIRE**  
W42 D24 H72  
*Consists of:*  
**-271 Armoire Deck**  
W42 D24 H47  
2 Wraparound Doors,  
2 Adjustable Shelves,  
Clothes Rod,  
Sliding Back Panel,  
1 Fixed Shelf,  
2 Open Compartments:  
W20 D19 H6  
TV Outlet Box.  
TV Opening:  
W40 D19 H35  
**-270\* Armoire Base**  
W42 D24 H25  
2 Drawers.



**912-270R**  
**ARMOIRE**  
Shown as Storage.

**912-270R**  
**ARMOIRE**  
W42 D24 H72







“One of our favorite things is relaxing and watching tv. The Tribeca Entertainment Center is ideal for our tv and storing our huge selection of movies.”

**NOTE:** Multiple pieces used to create a full wall unit.

**Overall Dimensions as shown:**

Width: 96"  
Depth: 22"  
Height: 79"

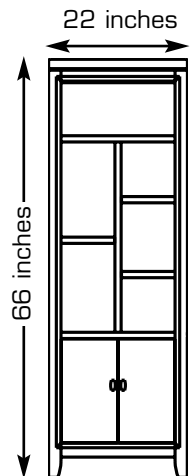

**912-580**  
Wall Unit

**NOTE:** Two 912-580 Wall Units used.

*Shown Right:*

**912-580**

**WALL UNIT**

W22 D20 H65

2 Doors with 1 Adjustable Shelf,  
Center Upright with 2 Adjustable  
Shelves, Fixed Shelf, 1 Open  
Compartment in Top.  
(2 Shown)

**912-585**

**51" ENTERTAINMENT CENTER**

W51 D22 H21

1 Adjustable Shelf in each  
Compartment,  
3 Open Compartments:  
Inside Compartment: W26 H12  
Outside Compartments :W9 H12

**912-586**

**STORAGE BRIDGE**

W96 D22 H13

5 Open Compartments.

Left & Right Outside:

W19 H8

Left & Right 2nd from Center:

W11 H8

Center:

W25 H8

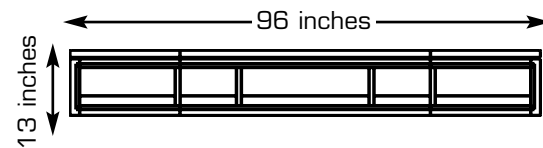

**912-586**  
**STORAGE BRIDGE**

**NOTE:** Storage Bridge offered  
in larger size as 912-587.  
See Page 35 for details.

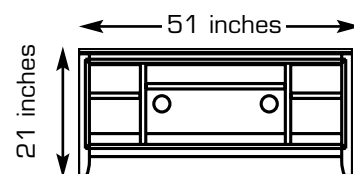

**912-585**  
**51" ENTERTAINMENT CENTER**

**NOTE:** Entertainment Center  
offered in larger size as 912-581.  
See Page 35 for details.



Shown Right:

**912-590**

**ETAGERE PIER**

W23 D18 H67

1 Fixed Shelf, 2 Adjustable

Shelves, Top Opening:

W19 D21 H42,

Bottom Opening:

W19 D21 H16

**912-591**

**OPEN ENTERTAINMENT**

**CONSOLE 50"**

W50 D18 H25

1 Fixed Shelf,

Top Opening:

W46 D16 H7,

Bottom Opening:

W46 D16 H10

**NOTE:** Entertainment Center offered in larger size as 912-592. See Page 50 for details.





Above:  
**912-925**  
**SOFA TABLE**  
 W52 D19 H32  
 2 Drawers, 4 Open Compartments.  
 Top Open Compartments: W30 D19 H6  
 Bottom Open Compartments: W23 D19 H11



**912-915**  
**END TABLE**  
 W25 D28 H26  
 2 Drawers,  
 1 Open Compartment on Bottom:  
 W17 D27 H5  
 Magazine Opening on Left:  
 W3 D27 H19

**912-910**  
**COCKTAIL TABLE**  
 W50 D30 H20  
 2 Drawers, 2 Fixed Shelves.  
 Each Opening: W28 D30 H7



*Above:*  
**912-913**  
**ROUND COCKTAIL TABLE - RTA**  
 Dia.36 H19  
 1 Fixed Shelf,  
 Opening: Dia.34 H6

**912-916**  
**END TABLE - RTA**  
 W20 D22 H26  
 1 Drawer, 1 Fixed Shelf,  
 Opening:  
 W16 D22 H13



*Right:*  
**912-926**  
**BOOKCASE CONSOLE**  
 W44 D14 H32  
 4 Adjustable Shelves,  
 Top Outside:  
 W11 D13 H11,  
 Center Top:  
 W17 D13 H7,  
 Bottom Outside:  
 W11 D13 H13,  
 Center Bottom Two:  
 W17 D13 H9



**912-400  
LEG NIGHTSTAND**  
W24 D18 H26

**912-915  
END TABLE**  
W25 D28 H26

**912-420  
NIGHTSTAND**  
W28 D18 H28

**NOTE:** Nightstands and End Tables can be interchanged.



“Just because I am a single guy doesn’t mean I can’t have stylish furniture.”

**912-939  
ETAGERE**  
← 56 inches →

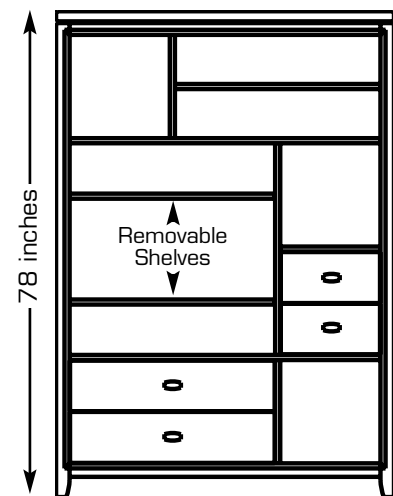

*Shown Right:*  
**912-939  
ETAGERE**  
W52 D18 H73

**NOTE:** Etagere has two removable shelves above the bottom two drawers for TV and entertainment set up.

Etagere is finished on back with false drawer fronts and hardware so it can be used as a room divider.





*Above Left:*  
**912-940**  
**WALL STORAGE**  
 W35 D19 H76  
 5 Shelves.



*Below Left:*  
**912-938**  
**SERVING CART**  
 W25 D20 H36  
 2 Fixed Shelves  
 with Gallery Rail,  
 Castered.



**912-916**  
**END TABLE - RTA**  
 W20 D22 H26  
 1 Drawer, 1 Fixed Shelf,  
 Opening: W16 D22 H13

**912-913**  
**ROUND COCKTAIL**  
**TABLE - RTA**  
 Dia.36 H19  
 1 Fixed Shelf,  
 Opening: Dia.34 H6

**912-595**  
**ENTERTAINMENT UNIT 72"**  
 W72 D20 H24  
 2 Drawers RSF, 2 Sliding  
 Doors with 1 Adjustable Shelf  
 Behind Each,  
 Opening: W23 D17 H15



*Shown Above & Right:*  
**912-588**  
**DESK - RTA**  
 W51 D24 H30  
 3 Drawers.

**912-941**  
**FILE CADDY**  
 W16 D22 H22  
 2 Drawers,  
 File Storage in  
 Bottom Drawer,  
 Casters.

**912-622**  
**UPHOLSTERED LEATHER**  
**SIDE CHAIR**  
 W20 D24 H39  
 Seat H20

*Shown Right:*  
**912-580**  
**WALL UNIT**  
 W22 D20 H65  
 2 Doors with 1 Adjustable  
 Shelf, Center Upright with 2  
 Adjustable Shelves, Fixed Shelf,  
 1 Open Compartment in Top.  
 (2 Shown)

**912-586**  
**STORAGE BRIDGE**  
 W96 D22 H13  
 5 Open Compartments.  
 Left & Right Outside:  
 W19 H8  
 Left & Right 2nd from Center:  
 W11 H8  
 Center: W25 H8



# TRIBECCA



## 912 ROOT BEER COLOR FINISH CRAFTED FROM CHERRY VENEERS & SELECT HARDWOODS

Finishes ordered at different times are not guaranteed to match. Woods have grain and color variations due to growth patterns of each tree. The result is a beautiful and unique piece. Due to these variations, finishes on individual pieces are not guaranteed to match. The finish shown here has been reproduced as accurately as photographic and printing technologies allow.

For the truest representation, please contact your American Drew dealer.

## CARE & CLEANING

### CARE OF FINE FINISHES

American Drew finishes are naturally resistant to minor everyday hazards and accidents; however, some precautions are necessary to maintain the beauty of your wood furniture.

- Dust with a soft clean cloth slightly moistened with water, and then dry completely with another clean cloth. Always rub in the direction of the wood grain.
- Avoid cigarettes, hot dishes, moisture and harsh solvents such as nail polish and alcohol.
- Do not place beverages directly on furniture.
- Use pads beneath accessories when writing or eating.
- Remove spills and smudges immediately.
- Pliable materials should not be left on a wood surface; they can damage the finish.
- Furniture should not be placed near heat, outlets, windows, or in direct sunlight.

### CARE OF DECORATIVE HARDWARE

The decorative hardware on this furniture has been protected with a clear lacquer coat. The use of harsh detergents or brass polish in an attempt to clean or obtain higher luster will result in the removal of the protective lacquer and will damage the finish of the hardware. Use a soft damp cloth to remove dust.

All illustrations and specifications in this catalog are based on the latest product information available at the time of printing. American Drew reserves the right to discontinue items without notice and to make changes to colors, materials, equipment and specifications at any time. Quotes contained in this catalog are from fictional consumers. This catalog is intended to be distributed to authorized dealers, and possession does not constitute authority to purchase.

\* Indicates: Cannot be sold separately.  
"R" Indicates merchandise shipped in more than one carton and must be used to order complete item.

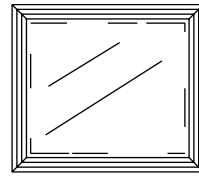

**912-020**  
**LANDSCAPE MIRROR**  
W40 D3 H35 (102 x 8 x 89cm)  
Beveled Mirror.  
Mirror Supports Not Included.  
Can be used vertical or horizontal.  
Pages: 23, 24/25, 26/27

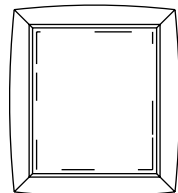

**912-040**  
**ACCENT MIRROR**  
W37 D3 H42 (94 x 8 x 107cm)  
Beveled Mirror.  
Mirror Supports Not Included.  
Can be used vertical or horizontal.  
Pages: 6, 8/9, 20/21, 28/29

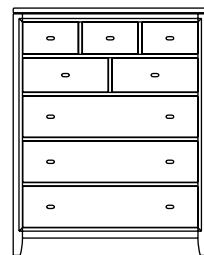

**912-215**  
**DRAWER CHEST**  
W42 D21 H54  
(107 x 53 x 137cm)  
5 Drawers.  
Page: 22

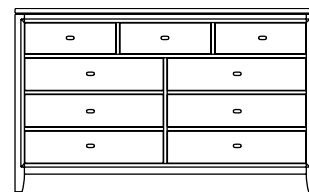

**912-220**  
**DRESSING CHEST**  
W64 D20 H39  
(163 x 51 x 99cm)  
9 Drawers.  
Pages: 20/21, 23, 24/25, 28/29

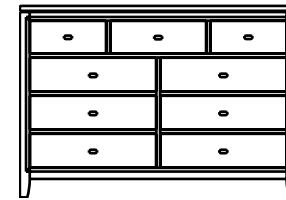

**912-221**  
**DRESSER**  
W56 D20 H39 (142 x 51 x 99cm)  
9 Drawers.  
Pages: 26/27

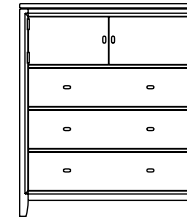

**912-230**  
**CORNER CHEST**  
W42 D26 H50  
(107 x 66 x 127cm)  
2 Doors, 3 Drawers.  
Opening:  
W38 D25 H11  
(97 x 64 x 28cm)  
Page: 22

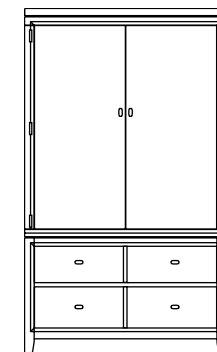

**912-270R**  
**ARMOIRE**  
W42 D24 H72  
(107 x 61 x 183cm)  
Consists of:  
**-271 Armoire Deck**  
W42 D24 H47  
(107 x 61 x 119cm)  
2 Wraparound Doors,  
2 Adjustable Shelves,  
Clothes Rod, Sliding Back  
Panel, 1 Fixed Shelf,  
2 Open Compartments:  
W20 D19 H6  
(51 x 48 x 15cm)  
TV Outlet Box.  
TV Opening:  
W40 D19 H35  
(102 x 48 x 89cm)  
**-270\* Armoire Base**  
W42 D24 H25  
(107 x 61 x 64cm)  
2 Drawers.  
Pages: 30/31

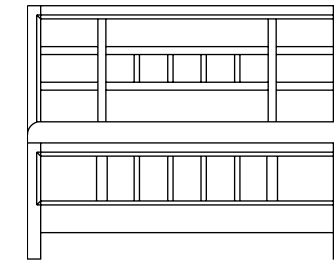

**912-320R**  
**SLAT BED 3/3**  
W42 D80 H48 (107 x 203 x 122cm)  
Consists of:  
**-320 Slat Headboard 3/3**  
W42 D2 H48 (107 x 5 x 122cm)  
Bored for Frame.  
**-321 Slat Footboard 3/3**  
W42 D2 H22 (107 x 5 x 56cm)  
**-R40 Wooden Rails with Slats 3/3**  
W77 D2 H6 (196 x 5 x 15cm)  
Pages: 26/27

**912-323R**  
**SLAT BED 5/0**  
W63 H52 (160 x 132cm)  
Consists of:  
**-323 Slat Headboard 4/6 - 5/0**  
W63 D2 H52 (160 x 5 x 132cm)  
Bored for Frame.  
**-324 Slat Footboard 4/6 - 5/0**  
W63 D2 H22 (160 x 5 x 56cm)  
**-R42 Wooden Rails 5/0 - 6/6**  
W82 D3 H8 (208 x 8 x 20cm)  
**-SK1 Mattress Support System**  
Pages: 24/25

Available in additional sizes:  
**912-322R**  
**SLAT BED 4/6**  
W63 H52 (160 x 132cm)  
Consists of:  
**-323 Slat Headboard 4/6 - 5/0**  
W63 D2 H52 (160 x 5 x 132cm)  
Bored for Frame.  
**-324 Slat Footboard 4/6 - 5/0**  
W63 D2 H22 (160 x 5 x 56cm)  
**-R41 Wooden Rails 4/6**  
W76 D3 H8 (193 x 8 x 20cm)  
**-SK1 Mattress Support System**

**912-326R**  
**SLAT BED 6/6**  
W79 H52 (201 x 132cm)  
Consists of:  
**-326 Slat Headboard 6/6 - 6/0**  
W79 D2 H52 (201 x 5 x 132cm)  
Bored for Frame.  
**-327 Slat Footboard 6/6 - 6/0**  
W79 D2 H22 (201 x 5 x 56cm)  
**-R42 Wooden Rails 6/6**  
W82 D3 H8 (208 x 8 x 20cm)  
**-SK1 Mattress Support System**

**912-327R**  
**SLAT BED 6/0**  
W79 H52 (201 x 132cm)  
Consists of:  
**-326 Slat Headboard 6/0 - 6/6**  
W79 D2 H52 (201 x 5 x 132cm)  
Bored for Frame.  
**-327 Slat Footboard 6/0 - 6/6**  
W79 D2 H22 (201 x 5 x 56cm)  
**-R44 Wooden Rails 6/0**  
W86 D3 H8 (218 x 8 x 20cm)  
**-SK1 Mattress Support System**

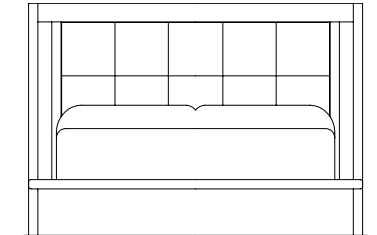

**912-333R**  
**PLATFORM BED 5/0**  
W72 D92 H50 (183 x 234 x 127cm)  
Consists of:  
**-333 Platform Headboard 5/0**  
W72 D6 H50 (183 x 15 x 127cm)  
Bored for Frame.  
**-P34 Platform 5/0**  
W71 D86 H2 (180 x 218 x 5cm)  
**-S34 Support Box 5/0**  
W67 D81 H10 (170 x 206 x 25cm)  
Works with the 334 Platform Boxes.  
Pages: 20/21

Available in additional sizes:  
**912-336R**  
**PLATFORM BED 6/6**  
W86 D92 H50 (218 x 206 x 25cm)  
Consists of:  
**-336 Platform Headboard 6/6**  
W86 D6 H50 (218 x 15 x 127cm)  
Bored for Frame.  
**-P36 Platform 6/6**  
W85 D86 H2 (216 x 218 x 10cm)  
**-S36 Support Box 6/6**  
W81 D81 H11 (206 x 206 x 28cm)  
Works with the 334 Platform Boxes.

**912-337R**  
**PLATFORM BED 6/0**  
W82 D92 H50 (208 x 206 x 25cm)  
Consists of:  
**-337 Platform Headboard 6/0**  
W82 D6 H50 (208 x 15 x 127cm)  
Bored for Frame.  
**-P37 Platform 6/0**  
W85 D90 H2 (216 x 229 x 10cm)  
**-S37 Support Box 6/0**  
W77 D81 H11 (196 x 206 x 28cm)  
Works with the 335 Platform Boxes.

**912-334**  
**PLATFORM BOXES 5/0-6/6 (1 SIDE)**  
W22 D77 H11 (56 x 196 x 28cm)  
Use with 333R or 336R Platform Bed.  
3 Storage Drawers on 1 Side.  
Use 2 for Storage on Either Side of Bed.  
Pages: 20/21

Available in additional size:  
**912-335**  
**PLATFORM BOXES 6/0 (1 SIDE)**  
W22 D81 H11 (56 x 206 x 28cm)  
Use with 337R Platform Bed.  
3 Storage Drawers on 1 Side.  
Use 2 for Storage on Either Side of Bed.



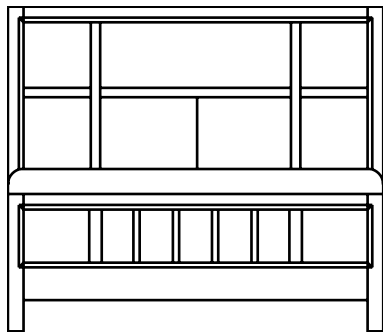

**912-340R**  
**BOOKCASE BED COMPLETE 3/3**  
W44 D92 H52 (112 x 234 x 132cm)

*Consists of:*

- 340 Bookcase Headboard 3/3**  
W44 D14 H52 (112 x 36 x 132cm)  
Bored for Frame.  
1 Door, Opening:  
W17 D7 H11 (43 x 18 x 28cm)  
3 Puck Light Touch System,  
Outside Openings:  
W9 D7 H11 (23 x 18 x 28cm)
- 321 Slat Footboard 3/3**  
W42 D2 H22 (107 x 5 x 56cm)
- R40 Wooden Rails with Slats 3/3**  
W77 D2 H6 (196 x 5 x 15cm)

**912-343R**  
**BOOKCASE BED COMPLETE 4/6**  
W67 D98 H52 (170 x 249 x 132cm)

*Consists of:*

- 343 Bookcase Headboard 4/6 - 5/0**  
W67 D14 H52 (170 x 36 x 132cm)  
Bored for Frame.  
2 Sliding Doors, Opening:  
W34 D6 H11 (86 x 15 x 28cm)  
4 Puck Light Touch System,  
Outside Openings:  
W12 D7 H11 (30 x 18 x 28cm)
- 324 Slat Footboard 4/6 - 5/0**  
W63 D2 H22 (160 x 5 x 56cm)
- R41 Wooden Rails 4/6**  
W76 D3 H8 (193 x 8 x 20cm)
- SK1 Mattress Support System**  
Pages: Headboard Only 28/29

**912-344R**  
**BOOKCASE BED COMPLETE 5/0**  
W67 D98 H52 (170 x 249 x 132cm)

*Consists of:*

- 343 Bookcase Headboard 4/6 - 5/0**  
W67 D14 H52 (170 x 36 x 132cm)  
Bored for Frame.  
2 Sliding Doors, Opening:  
W34 D6 H11 (86 x 15 x 28cm)  
4 Puck Light Touch System,  
Outside Openings:  
W12 D7 H11 (30 x 18 x 28cm)
- 324 Slat Footboard 4/6 - 5/0**  
W63 D2 H22 (160 x 5 x 56cm)
- R42 Wooden Rails 5/0 - 6/6**  
W82 D3 H8 (208 x 8 x 20cm)
- SK1 Mattress Support System**

**912-346R**  
**BOOKCASE BED COMPLETE 6/6**  
W84 D98 H52 (213 x 249 x 132cm)  
*Consists of:*

- 346 Bookcase Headboard 6/0 - 6/6**  
W84 D14 H52 (213 x 36 x 132cm)  
Bored for Frame.  
2 Sliding Doors, Opening:  
W49 D6 H11 (124 x 15 x 28cm)  
4 Puck Light Touch System,  
Outside Openings:  
W13 D7 H11 (33 x 18 x 28cm)
- 327 Slat Footboard 6/0 - 6/6**  
W79 D2 H22 (201 x 5 x 56cm)
- R42 Wooden Rails 5/0 - 6/6**  
W82 D3 H8 (208 x 8 x 20cm)
- SK1 Mattress Support System**



**912-400**  
**LEG NIGHTSTAND**  
W24 D18 H26 (61 x 46 x 66cm)  
1 Drawer, 1 Fixed Shelf, Pull Out Tray.  
Pages: 24/25, 26/27, 40

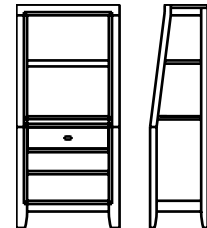

**912-402**  
**BOOKCASE NIGHTSTAND**  
W24 D14 H52 (61 x 36 x 132cm)  
1 Adjustable Shelf, 1 Drawer, 1 Shelf  
on Bottom.  
Pages: 28/29



**912-420**  
**NIGHTSTAND**  
W28 D18 H28 (71 x 46 x 71cm)  
2 Drawers, Open Compartment:  
W23 D17 H3 (58 x 43 x 8cm)  
Pages: 20/21, 40

*Please use the following when  
ordering frames and mirror supports:*

**912-M71**  
**TWO MIRROR SUPPORTS**

**912-095**  
**METAL FRAME FOR 4/6 OR 5/0  
HEADBOARDS ONLY**

**912-096**  
**METAL FRAME FOR 6/6  
HEADBOARD ONLY**

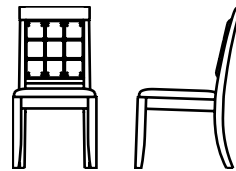

**912-622**  
**LEATHER SIDE CHAIR - KD**  
W20 D24 H39 (51 x 61 x 99cm)  
Seat H20 (51cm)  
Pages: 3, 4/5, 19, 44/45

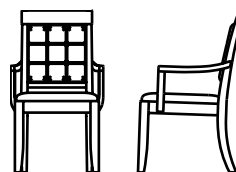

**912-623**  
**LEATHER ARM CHAIR - KD**  
W22 D24 H39 (56 x 61 x 99cm)  
Seat H20 (51cm)  
Arm H25 (64cm)  
Pages: 4/5, 19

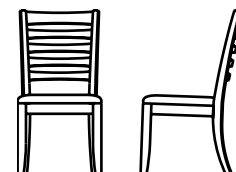

**912-636**  
**SPLAT SIDE CHAIR - KD**  
W20 D23 H39 (51 x 58 x 99cm)  
Seat H20 (51cm)  
Pages: 8/9, 19

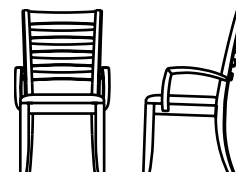

**912-637**  
**SPLAT ARM CHAIR - KD**  
W22 D23 H39 (56 x 58 x 99cm)  
Seat H20 (51cm)  
Arm H25 (64cm)  
Page: 19

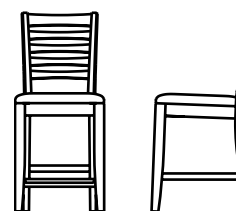

**912-690**  
**SPLAT BACK BAR STOOL - KD**  
W18 D19 H38 (46 x 48 x 97cm)  
Seat H25 (64cm)  
Pages: 14/15, 19

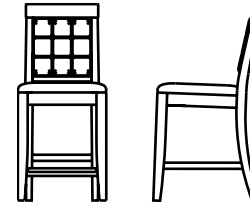

**912-691**  
**LEATHER BAR STOOL - KD**  
W18 D21 H40 (46 x 53 x 102cm)  
Seat H25 (64cm)  
Pages: 10/11, 19

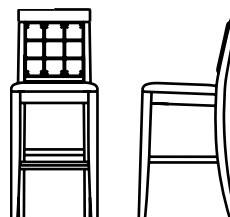

**912-692**  
**BAR HEIGHT STOOL - KD**  
W19 D21 H46 (48 x 53 x 117cm)  
Seat H30 (76cm)  
Pages: 16/17

Chairs noted as shipped KD require  
assembly.  
-622, -623, -636 & -637 packed 2 per  
carton. Service charge of \$10.00  
for recartoning will apply when one  
chair is ordered.  
-690, -691 & -692 packed 1 per carton.  
COM ORDERS NOT ACCEPTED.

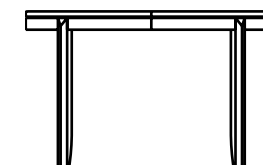

**912-701**  
**ROUND LEG TABLE - RTA**  
L48 W48 H30 (123 x 123 x 76cm)  
(1) 16" (40cm) Leaf  
Extends Table to 64" (163cm)  
Pages: 3, 8/9

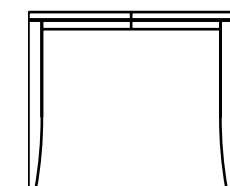

**912-705**  
**GATHERING TABLE - RTA**  
L60 W42 H36 (152 x 107 x 91cm)  
(1) 18" (46cm) Leaf  
Extends Table to 60" (152cm)  
Pages: 10/11

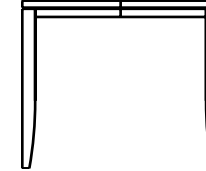

**912-706**  
**COUNTER HEIGHT PUB TABLE - RTA**  
W42 D42 H36 (107 x 107 x 91cm)  
1-20" (51cm) Leaf,  
Extends to 62" (157cm).  
Pages: 14/15

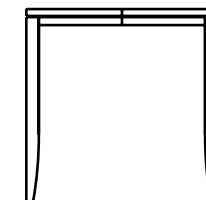

**912-707**  
**BAR TABLE - RTA**  
W42 D42 H42 (107 x 107 x 107cm)  
1-20" (51cm) Leaf,  
Extends to 62" (157cm).  
Pages: 16/17



**912-760**  
**LEG TABLE - RTA**  
L64 W44 H30 (163 x 112 x 76cm)  
(1) 16" (40cm) Leaf  
Extends Table to 80" (203cm)  
Pages: 4/5

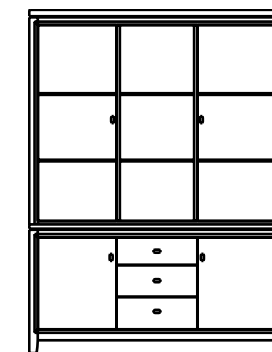

**912-830R CHINA COMPLETE**  
W60 D19 H80 (152 x 48 x 203cm)  
*Consists of:*  
**-831 China Deck**  
W60 D19 H50 (152 x 48 x 127cm)  
2 Doors, 6 Adjustable Glass Shelves,  
3 Can Light System, Touch Lighting.

**-830\* China Base**  
W60 D19 H30 (152 x 48 x 76cm)  
2 Doors, 3 Drawers, 1 Adjustable Shelf  
Behind each door, Silver Tray.  
Pages: 4/5, 7

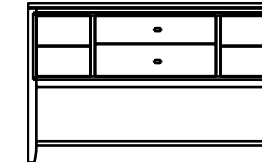

**912-850**  
**SIDEBOARD/CREDENZA**  
W60 D18 H38 (152 x 46 x 97cm)  
2 Glass Shelves, 2 Drawers,  
Silver Tray.  
Pages: 6, 8/9

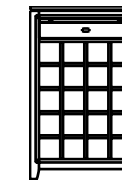

**912-890**  
**SERVER**  
W25 D14 H39 (64 x 36 x 99cm)  
Wine Storage, 1 Drawer,  
1 Pullout Shelf, Silver Tray.  
Pages: 3, 10/11, 12/13, 14/15

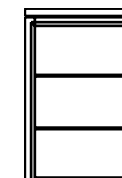

**912-891**  
**HUTCH**  
W25 D14 H35 (64 x 36 x 89cm)  
2 Adjustable Glass Shelves,  
Can Light, Touch Lighting.  
Fits on 890 Server.  
Pages: 3, 10/11, 12/13, 14/15



**912-580**  
**WALL UNIT**  
W22 D20 H65  
(56 x 51 x 165cm)  
2 Doors w/ 1 Adjustable Shelf,  
Center Upright w/ 2 Adjustable  
Shelves, Fixed shelf, 1 Open  
Compartment in Top.  
Pages: 32/33, 44/45

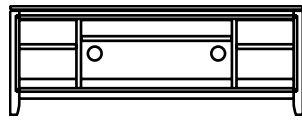

**912-581**  
**64" ENTERTAINMENT CENTER**  
 W64 D20 H23 (163 x 51 x 58cm)  
 1 Adjustable Shelf in each Compartment,  
 3 Open Compartments:  
 Inside W26 H12 (66 x 30cm)  
 Outside:W9 H12 (23 x 30cm)

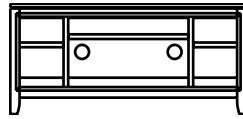

**912-585**  
**ENTERTAINMENT CENTER**  
 W51 D22 H21 (130 x 56 x 53cm)  
 1 Adjustable Shelf in each Compartment,  
 3 Open Compartments:  
 Inside W26 H12 (66 x 30cm)  
 Outside:W9 H12 (23 x 30cm)  
 Pages: 32/33



**912-586**  
**STORAGE BRIDGE**  
 W96 D22 H13 (244 x 56 x 33cm)  
 5 Open Compartments.  
 Left & Right Outsides:  
 W19 H8 (48 x 20cm)  
 Left & Right 2nd from Center:  
 W11 H8 (28 x 20cm)  
 Center:  
 W25 H8 (64 x 20cm)  
 Use with (2) 580 Wall Units. Use with  
 585, 591 or 593 Entertainment.  
 Pages: 32/33, 44/45



**912-587**  
**STORAGE BRIDGE**  
 W109 D22 H13 (277 x 56 x 33cm)  
 5 Open Compartments.  
 Left & Right Outsides:  
 W20 H8 (51 x 20cm)  
 Left & Right 2nd from Center:  
 W15 H8 (38 x 20cm)  
 Center:  
 W33 H8 (84 x 20cm)  
 Use with (2) 580 Wall Units.  
 Use with 581, 592 or 594 Entertainment.



**912-588**  
**DESK - RTA**  
 W51 D24 H30 (130 x 61 x 76cm)  
 3 Drawers.  
 Pages: 44/45

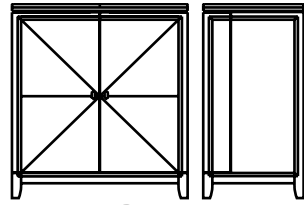

Closed

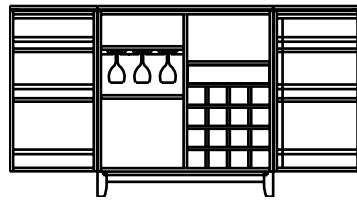

Open

**912-589**  
**FLIP TOP BAR**  
 W39 D22 H43 (99 x 56 x 109cm)  
 Black Laminate on Flip Tops, 2 Doors with  
 Bottle Storage, Wine Storage, 1 Drawer  
 on RSF, Stemware Holders, RSF Opening:  
 W18 D16 H10 (46 x 41 x 25cm),  
 LSF 2 Fixed Shelves,  
 Top Opening:  
 W18 D16 H8 (46 x 41 x 20cm),  
 Bottom Opening:  
 W18 D16 H15 (46 x 41 x 38cm).  
 Pages: 16/17, 18



**912-590**  
**ETAGERE PIER**  
 W23 D18 H67 (58 x 46 x 170cm)  
 1 Fixed Shelf, 2 Adjustable Shelves,  
 Top Opening:  
 W19 D21 H42 (48 x 53 x 107cm),  
 Bottom Opening:  
 W19 D21 H16 (48 x 53 x 41cm).  
 Pages: 34/35

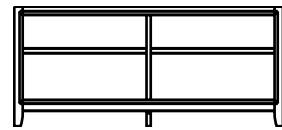

**912-591**  
**OPEN ENTERTAINMENT**  
**CONSOLE 50"**  
 W50 D18 H25 (127 x 46 x 64cm)  
 1 Fixed Shelf,  
 Top Opening:  
 W46 D16 H7 (117 x 41 x 18cm),  
 Bottom Opening:  
 W46 D16 H10 (117 x 41 x 25cm).  
 Pages: 34/35

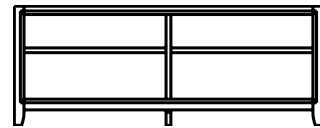

**912-592**  
**OPEN ENTERTAINMENT**  
**CONSOLE 64"**  
 W64 D18 H25 (163 x 46 x 64cm)  
 1 Fixed Shelf,  
 Top Opening:  
 W59 D16 H7 (150 x 41 x 18cm),  
 Bottom Opening:  
 W59 D16 H10 (150 x 41 x 25cm).

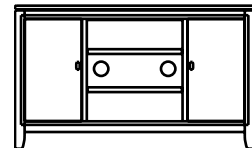

**912-593**  
**ENTERTAINMENT UNIT 51"**  
 W51 D22 H30 (51 x 61 x 99cm)  
 2 Doors, with 1 Adjustable Shelf Behind  
 Each.  
 Opening:  
 W12 D18 H21 (51 x 61 x 99cm)  
 2 Adjustable Shelves in Center,  
 Center Opening:  
 W20 D18 H21 (51 x 61 x 99cm)

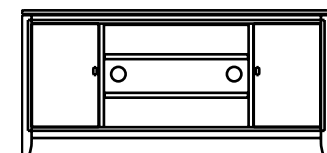

**912-594**  
**ENTERTAINMENT UNIT 64"**  
 W64 D22 H30 (163 x 61 x 99cm)  
 2 Doors with 1 Adjustable Shelf Behind  
 Each.  
 Opening:  
 W14 D18 H21 (36 x 61 x 99cm),  
 2 Adjustable Shelves in Center  
 Opening:  
 W29 D18 H21 (74 x 61 x 99cm).

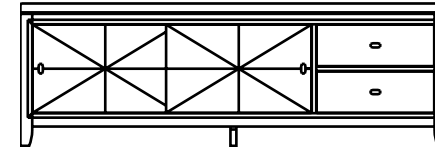

**912-595**  
**ENTERTAINMENT UNIT 72"**  
 W72 D20 H24 (183 x 51 x 61cm)  
 2 Drawers RSF, 2 Sliding Doors with 1  
 Adjustable Shelf Behind Each,  
 Opening:  
 W23 D17 H15 (58 x 43 x 38cm).  
 Pages: 42/43

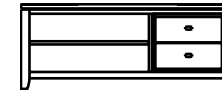

**912-910**  
**COCKTAIL TABLE**  
 W50 D30 H20 (120 x 76 x 51cm)  
 2 Drawers, 2 Fixed Shelves:  
 Each Opening:  
 W28 D30 H7 (71 x 76 x 18cm)  
 Pages: 36/37

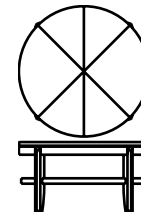

**912-913**  
**ROUND COCKTAIL TABLE - RTA**  
 Dia.36 H19 (91 x 48cm)  
 1 Fixed Shelf,  
 Opening: Dia.34 H6 (86 x 15cm).  
 Pages: 38, 42/43

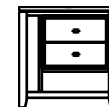

**912-915**  
**END TABLE**  
 W25 D28 H26 (64 x 71 x 66cm)  
 2 Drawers, 1 Open Compartment  
 on Bottom:  
 W17 D27 H5 (43 x 69 x 13cm)  
 Magazine opening on left:  
 W3 D27 H19 (8 x 69 x 48cm)  
 Pages: 36/37, 40

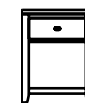

**912-916**  
**END TABLE - RTA**  
 W20 D22 H26 (51 x 61 x 66cm)  
 1 Drawer, 1 Fixed Shelf,  
 Opening:  
 W16 D22 H13 (41 x 61 x 33cm)  
 Pages: 38, 42/43

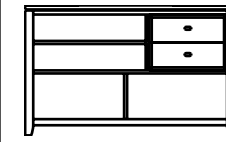

**912-925**  
**SOFA TABLE**  
 W52 D19 H32 (132 x 48 x 81cm)  
 2 Drawers, 4 Open Compartments.  
 Top Open Compartments:  
 W30 D19 H6 (76 x 48 x 15cm)  
 Bottom Open Compartments:  
 W23 D19 H11 (58 x 48 x 28cm)  
 Page: 36

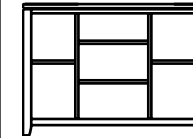

**912-926**  
**BOOKCASE CONSOLE**  
 W44 D14 H32 (112 x 36 x 81cm)  
 4 Adjustable Shelves,  
 Top Outside:  
 W11 D13 H11 (28 x 33 x 28cm),  
 Center Top:  
 W17 D13 H7 (43 x 33 x 99cm),  
 Bottom Outside:  
 W11 D13 H13 (28 x 33 x 33cm),  
 Center Bottom Two:  
 W17 D13 H9 (43 x 33 x 23cm)  
 Page: 39



**912-938**  
**SERVING CART**  
 W25 D20 H36 (64 x 51 x 91cm)  
 2 Fixed Shelves w/Gallery Rail, Castered.  
 Page: 42

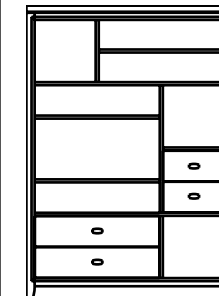

**912-939**  
**ETAGERE**  
 W52 D18 H73 (132 x 46 x 185cm)  
 4 Drawers, 7 Open Compartments,  
 2 Adjustable Shelves on LSF above  
 Drawers, Finished Back.  
 Pages: 40/41

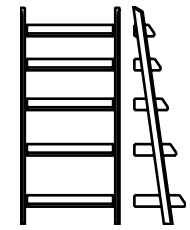

**912-940**  
**WALL STORAGE - RTA**  
 W35 D19 H76 (89 x 48 x 193cm)  
 5 Shelves.  
 Page: 42

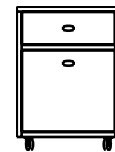

**912-941**  
**FILE CADDY**  
 W16 D22 H22 (41 x 56 x 56cm)  
 2 Drawers, File Storage in Bottom  
 Drawer, Casters.  
 Pages: 44/45