

0
11/2/90 *mm* (D)

DOE/ER-0457T

Standard NIM Instrumentation System

U.S. NIM COMMITTEE

May 1990

**DO NOT MICROFILM
COVER**

U.S. Department of Energy
Office of Energy Research
Office of Health and Environmental Research

DISTRIBUTION OF THIS DOCUMENT IS UNLIMITED

DISCLAIMER

This report was prepared as an account of work sponsored by an agency of the United States Government. Neither the United States Government nor any agency Thereof, nor any of their employees, makes any warranty, express or implied, or assumes any legal liability or responsibility for the accuracy, completeness, or usefulness of any information, apparatus, product, or process disclosed, or represents that its use would not infringe privately owned rights. Reference herein to any specific commercial product, process, or service by trade name, trademark, manufacturer, or otherwise does not necessarily constitute or imply its endorsement, recommendation, or favoring by the United States Government or any agency thereof. The views and opinions of authors expressed herein do not necessarily state or reflect those of the United States Government or any agency thereof.

DISCLAIMER

Portions of this document may be illegible in electronic image products. Images are produced from the best available original document.

Available from the National Technical Information Service, U.S. Department of Commerce,
Springfield, Virginia 22161

Price: Printed copy	A05
Microfiche	A01

Codes are used for pricing all publications. The code is determined by the number of pages in publication. Information pertaining to the pricing codes can be found in current issues of the following publications, which are generally available in most libraries: *Energy Research Abstracts (ERA)*; *Government Reports Announcements and Index (GRA and I)*; *Scientific and Technical Abstract Reports (STAR)*; and publication, NTIS-PR-360 available from NTIS at the above address.

Standard NIM Instrumentation System

U.S. NIM COMMITTEE

May 1990

This document is
PUBLICLY RELEASABLE

B Steel
Authorizing Official

Date: 3/22/06

U.S. Department of Energy
Office of Energy Research
Office of Health and Environmental Research
Washington, D.C. 20545

10/10/10

10/10/10

10/10/10

10/10/10

STANDARD NIM INSTRUMENT MODULES*

Abstract

NIM is a standard modular instrumentation system that is in wide use throughout the world. As the NIM system developed and accommodations were made to a dynamic instrumentation field and a rapidly advancing technology, additions, revisions and clarifications were made. These were incorporated into the standard in the form of addenda and errata. This standard is a revision of the NIM document, AEC Report TID-20893 (Rev 4) dated July 1974. It includes all the addenda and errata items that were previously issued as well as numerous additional items to make the standard current with modern technology and manufacturing practice.

Key Words

Instrumentation Standards

Instruments

NIM

Standards

Prepared by: U.S. NIM Committee*

***Work supported by U.S. Department of Energy**

NIM COMMITTEE MEMBERSHIP

National Institute of Standards and Technology	Louis Costrell (Chairman)	
Argonne National Laboratory	Frank R. Lenkszus	Stanley J. Rudnick
Atomic Energy of Canada Ltd	Eric Davey	
Brookhaven National Laboratory	John Gould	Seymour Rankowitz
	William P. Sims	
CEBAF (Continuous Electron Beam Accelerator Facility)	R. Roy Whitney	
CERN European Organization for Nuclear Research	Robert W. Dobinson	Henk Verweij
Department of Energy Environmental Measurement Laboratory	Norman Latner	Vincent C. Negro
Fermi National Accelerator Laboratory	Edward J. Barsotti	Thomas E. Droege
	Cordon Kerns	Kathleen J. Turner
Illinois, University of	Robert W. Downing	
Lawrence Berkeley Laboratory	Frederick A. Kirsten	A. E. Larsh
	Stewart C. Loken	Dick A. Mack
	Lee J. Wagner	(Emeritus)
Lawrence Livermore National Laboratory	Robert C. Lucena	Dennis W. O'Brien
Los Alamos National Laboratory	Allan Gjovig	Frank Naivar
	Ronald O. Nelson	D. Hywell White
Michigan, University of	Carl Akerlof	
National Aeronautics & Space Administration	Donald E. Stilwell	James H. Trainor
Northwestern University	Bruno Gobbi	
Oak Ridge National Laboratory	John A. Biggerstaff	Nat W. Hill
	Gerald K. Schulze	
Stanford Linear Accelerator Center	David B. Gustavson	Dale Horelick
	Paul F. Kunz	Leo Paffrath
	Helmut V. Walz	
TRIUMF	W. Kenneth Dawson	John Cresswell
Yale University	Satish Dhawan	Charles E. L. Gingell

NIM COMMITTEE ORGANIZATION

NIM EXECUTIVE COMMITTEE FOR NIM

Louis Costrell	NIST (Chairman)
Dick A. Mack	
Stanley J. Rudnick	ANL
William P. Sims	BNL
Lee J. Wagner	LBL

NIM EXECUTIVE COMMITTEE, CAMAC

Louis Costrell	NIST (Chairman)
Edward J. Barsotti	Fermilab
John A. Biggerstaff	ORNL
Satish Dhawan	Yale
Frederick A. Kirsten	LBL
Dick A. Mack	
William P. Sims	BNL
Donald E. Stilwell	NASA/GSFC

NIM EXECUTIVE COMMITTEE, FASTBUS

Louis Costrell	NIST (Chairman)
Carl Akerlof	U. Michigan
Edward J. Barsotti	Fermilab
W. Kenneth Dawson	TRIUMF
David B. Gustavson	SLAC
Paul F. Kunz	SLAC
Stewart. C. Loken	LBL
William P. Sims	BNL
Lee J. Wagner	LBL
D. Hywel White	LANL

USERS' GUIDE WORKING GROUP

Frederick A. Kirsten	LBL (Chairman)
Edward J. Barsotti	Fermilab
Boris Bertolucci	SLAC
Louis Costrell	NIST
W. Kenneth Dawson	TRIUMF
David B. Gustavson	SLAC
Connie A. Logg	SLAC
Edward D. Platner	BNL
Phillip J. Ponting	CERN
Ruth Pordes	Fermilab
Gary A. Smith	BNL
Helmut V. Walz	SLAC

NIM DIGITAL BUS (NIM/488) WG

Frederick A. Kirsten	LBL (Chairman)
Alfonso Criscuolo	LANL
Dale Horelick	SLAC
Dennis W. O'Brien	LLNL
Richard A. Todd	ORNL

ARCHITECTURE & PROTOCOL WKG GRP

Edward J. Barsotti	Fermilab (Chairman)
Robert W. Downing	U.IL (Vice-Chairman)
Boris Bertolucci	SLAC
John A. Biggerstaff	ORNL
A. William Booth	Fermilab
Louis Costrell	NIST
W. Kenneth Dawson	TRIUMF
Satish Dhawan	YALE
Robert W. Dobinson	CERN
David C. Doughty	CEBAF
Robert W. Downing	U. Illinois
Allan Gjovig	LANL
David B. Gustavson	SLAC
Dale Horelick	SLAC
Cordon Kerns	ANL
Michele Mur	CEN/Saclay
Ronald O. Nelson	LANL
Leo Paffrath	SLAC
Edward D. Platner	BNL
Phillip J. Ponting	CERN
Stanley J. Rudnick	ANL
Robert Skegg	TRIUMF
Gary A. Smith	BNL
Kathleen J. Turner	Fermilab
Helmut V. Walz	SLAC

MECHANICAL and

POWER SUPPLIES WORKING GROUP

Lee J. Wagner	LBL (Chairman)
Louis Costrell	NIST
Cordon Kerns	Fermilab
Dick A. Mack	
Stanley J. Rudnick	ANL
William P. Sims	BNL

SOFTWARE WORKING GROUP

David B. Gustavson	SLAC (Chairman)
Ruth Pordes	Fermilab (Vice-Chairman)
Jeffrey A. Appel	Fermilab
Timothy Berners-Lee	CERN
W. Kenneth Dawson	TRIUMF
Satish Dhawan	YALE
Robert W. Dobinson	TRIUMF
Thomas Kozlowski	LANL
Frank B. Lenkszus	ANL
Connie A. Logg	SLAC
Ronald O. Nelson	LANL
E. M. (Peggie) Rimmer	CERN
R. Roy Whitney	CEBAF

NIM COMMITTEE ORGANIZATION (Continued)

**Editors NIM System Standard:
(This document)**

**Louis Costrell
Frederick A. Kirsten
William P. Sims
Lee J. Wagner**

Technical Editor, FASTBUS Standard:

W. Kenneth Dawson

**Technical Editors,
FASTBUS Standard Routines:**

**Ruth Pordes
W. Kenneth Dawson**

Project Manager:

Louis Costrell

European (ESONE) Liaison:

Phillip J. Ponting

ABBREVIATED TABLE OF CONTENTS

Section	Page
Abstract	iii
NIM Committee Membership.....	iv
NIM Committee Organization.....	v
Abbreviated Table of Contents	vii
Contents	viii
1. Foreword	1
2. What's In a Name	1
3. Introduction	1
4. Glossary	4
5. NIM Module	6
6. NIM Bin	10
7. NIM Power Supply	12
8. Other Power Supplies.....	16
9. Documentation	17
X. Index	X-1
Appendix	
A. ECL (Emitter Coupled Logic)	
Front Panel Interconnections	A-1
(Detailed contents on page A-1)	
B. Standard NIM Digital Bus (NIM/488)	B-1
(Detailed contents on page B-2)	

CONTENTS

Section	Page
Abstract	iii
NIM Committee Membership	iv
NIM Committee Organization	v
Abbreviated Table of Contents	vii
Contents	viii
1. Foreword	1
2. What's In a Name.....	1
3. Introduction.....	1
3.1 Historical Development	1
3.2 Revisions	2
3.3 Interpretation of This Document	4
4. Glossary.....	4
4.1 Module Definitions	4
4.2 Bin Definitions	4
4.3 Connector Definitions	4
4.4 Power Supply Definitions	5
4.5 Organizations, Acronyms, Systems	5
5. NIM Module	6
5.1 General	6
5.2 Ventilation	6
5.3 Module Connectors and Connector Hoods	6
5.4 Module Connector Pin Assignments.....	6
5.5 Grounds	7
5.6 Coaxial Connectors	7
5.6.1 Signal Connectors	7
5.6.2 High-Voltage Connectors.....	7
5.6.3 Mounting of Signal and High Voltage Connectors	7
5.7 ECL (Emitter Coupled Logic) Front Panel Interconnections.....	7
5.8 Digital Bus	7
5.9 Logic and Analog Signals	8
5.9.1 Logic Levels for Transmission of Digital Data down to dc (Preferred Practice, except for NIM/488 Bus)....	8
5.9.2 Logic Signal Requirements	8
5.9.3 Fast Logic Levels and Characteristics (Preferred Practice).....	8
5.9.4 Analog Signals	9

Section	Page
5.10 Decoupling, Noise Generation, Noise Immunity	9
5.11 Power Requirements for NIM Modules	9
5.11.1 Standard Voltages.....	9
5.11.2 Marking of Power Requirements	9
5.12 Quality Shielding (Optional).....	10
5.13 Jig Alignment of Module Connectors.....	10
6. NIM Bin	10
6.1 General.....	10
6.2 Ventilation	11
6.3 Bin Connectors and Connector Hoods	11
6.4 Bin Wiring	11
6.4.1 Bin Power Connector	12
6.4.2 Ground Connections	12
6.5 Bus Signal Restrictions.....	12
6.6 Bin Power.....	12
6.7 Jig Alignment of Bin Connectors	12
7. NIM Power Supply	12
7.1 Ratings	13
7.1.1 Input	13
7.1.2 Output	13
7.2 Operational and Performance Characteristics.....	13
7.2.1 Voltage Adjustment	13
7.2.2 Regulation and Stability	13
7.2.3 Recovery Time.....	14
7.2.4 Output Impedance	14
7.2.5 Temperature	14
7.2.6 Temperature Coefficient	14
7.2.7 Noise and Ripple	14
7.2.8 Remote Sense	14
7.3 Protection	14
7.3.1 Fault and Overload Protection	14
7.3.2 Thermal Protection	15
7.4 Physical Characteristics.....	15
7.4.1 Dimensions.....	15
7.4.2 Shielding	15
7.4.3 Input Leads, Plug and Receptacle	15
7.4.4 Output Power Connector	16
7.4.5 Finish	16
7.4.6 Quality	16

Section	Page
8. Other Power Supplies.....	16
8.1 NIM Special Purpose Power Supply	16
8.2 NIM Modular Power Supply	16
8.3 NIM Special Purpose Modular Power Supply	17
8.4 Early Power Supplies	17
9. Documentation	17

APPENDIXES

A.	ECL (Emitter Coupled Logic) Front Panel Interconnections	A-1 (Detailed Contents on Page A-1)
B.	Standard NIM Digital Bus (NIM/488)	B-1 (Detailed Contents on Page B-2)

Figures	Page	
1	Typical NIM System Modules, Bin and Power Supply	3
2	NIM Module	19
3a	Connector Assemblies	20
3b	Connector Assembly Notes.....	21
4a	Module and Bin Connector Details	22
4b	Module and Bin Connector Dimensions and Notes	23
5	Bin and Module Connector Hoods	24
6	Bin and Module Connector Pin Assignments	25
7a	Bin, Front View.....	26
7b	Bin, Rear View	27
7c	Bin, Side and Top Views	28
7d	Bin Dimensions	29
8a	Power Supply Connection and Bin Wiring	30
8b	Power Supply Connection and Bin Wiring Notes	31
9	Power Supply Outline	32
10	Power Connectors	33
11a	Module Connector Jig, Sheet 1	34
11b	Module Connector Jig, Sheet 2	35
12a	Bin Connector Jig, Sheet 1	36
12b	Bin Connector Jig, Sheet 2	37
13	Module and Bin Connector Installation Tools	38
14	Module Rail Jig	39

NIM STANDARD INSTRUMENTATION SYSTEM

Adopted by NIM Committee of the
U.S. Department of Energy

1. FOREWORD

This document defines the NIM instrumentation system consisting of standard modular instruments, the bins in which they are housed, and associated power supplies, as shown in Figure 1. It is a revision of and supersedes U.S. Atomic Energy Commission Report TID-20893 (Rev 4) dated July 1974. This document is primarily an updating of the standard, incorporating the revisions that have been issued as Addenda and Errata and taking into consideration current practice and advances in the technology.¹

2. WHAT'S IN A NAME

Initially NIM was an acronym for Nuclear Instrument Modules. However, as the use of NIM instruments spread beyond the nuclear field, but with the NIM identification too well established to abandon, the acronym was then considered to stand for National Instrumentation Methods. That was not an appropriate name since the manufacture and use of NIM instruments spread rapidly throughout the world and NIM became truly international. Attempts to fit suitable words to the NIM initials were in vain and failure was conceded. Thus the designation NIM now stands by itself for both the system and the responsible committee. So the response to the frequent query "What does NIM stand for?" is - "It stands for NIM."

3. INTRODUCTION

3.1. Historical Development

In December 1963 the National Bureau of Standards, in a report to the U.S. Atomic Energy Commission, urged:

"..... that a module be developed by the National Laboratories with the intent that the module will become standard in all of the National Laboratories and will be duplicated by many manufacturers."

¹To keep advised of NIM developments, interested parties should request that they be placed on the NIM mailing list. Such requests, as well as any inquiries, comments or suggestions, should be addressed to Louis Costrell, Chairman, NIM Committee, Center for Radiation Research, National Institute of Standards and Technology, Gaithersburg, Maryland 20899, U.S.A.

Other contacts for information include L.J. Wagner, Lawrence Berkeley Laboratory, One Cyclotron Road, Berkeley, CA 94720, U.S.A.; W.P. Sims, Brookhaven National Laboratory, Upton, NY 11973, U.S.A.; P.J. Ponting, CERN, EP Division, 1211 Geneva 23, Switzerland.

Based on that recommendation, the Division of Biology and Medicine of the U.S. Atomic Energy Commission convened a meeting of representatives of the AEC National Laboratories on February 26, 1964 to determine the interest of the laboratories in such a development.² At the meeting it was decided that a standard module system should be produced and the NIM Committee (AEC Committee on Nuclear Instrument Modules) was established and was assigned the responsibility for this task.

The NIM Committee, consisting of representatives of all of the AEC National Laboratories and other major laboratories, held its initial meeting on March 17, 1964 and held additional meetings in April and May during which all the major decisions were made. The objective was to produce a standard module design such that modules would be physically and electrically interchangeable.

In July 1964 the specifications for the NIM system were published. Implementation was rapid with many laboratories having NIM systems in operation before the end of 1964. The first commercial NIM instruments were produced in November 1964 and in 1965 a wide variety of NIM instruments became commercially available.

3.2. Revisions

As the NIM system developed and accommodations were made to a dynamic instrumentation field and a rapidly advancing technology, additions, revisions and clarifications were made. These were disseminated in the form of addenda and errata and were incorporated into the standard in revisions dated January 1966, January 1968, December 1969 and July 1974. Subsequent addenda and errata have been incorporated into this standard as have additional items.

The Standard NIM Digital Bus adopted by the NIM Committee was published by the U.S. Department of Energy as Report DOE/ER-0173 dated August 1983. The bus utilizes the digital interface of ANSI/IEEE Std 488.1 with the codes and formats of ANSI/IEEE Std 488.2. Since Std 488.2 has been modified by the IEEE, it has been necessary to make corresponding minor modifications to the NIM Digital Bus specifications while maintaining maximum compatibility with the earlier standard. The revised NIM Digital Bus standard (NIM/488) has been incorporated into this document as Appendix B and supersedes DOE/ER-0173.

² Organizing Committee: F. S. Goulding, LBL; R. J. Berte, AEC; C. J. Borkowski, ORNL; D. B. Brown, Hanford; M. E. Cassidy, AEC/HASL; L. Costrell, NBS; R. J. Darneal, AEC; R. T. Graveson, AEC/HASL; R. Hiebert, LASL; W. A. Higinbotham, BNL; R. C. Kaifer, LLL; N. A. Lindsay, LASL; A. E. Larsh, LBL; D. A. Mack, LBL; C. Sewell, LLL; M. G. Strauss, ANL; H. R. Wasson, AEC. (AEC now DOE, HASL now EML, LASL now LANL, LLL now LLNL, NBS now NIST)

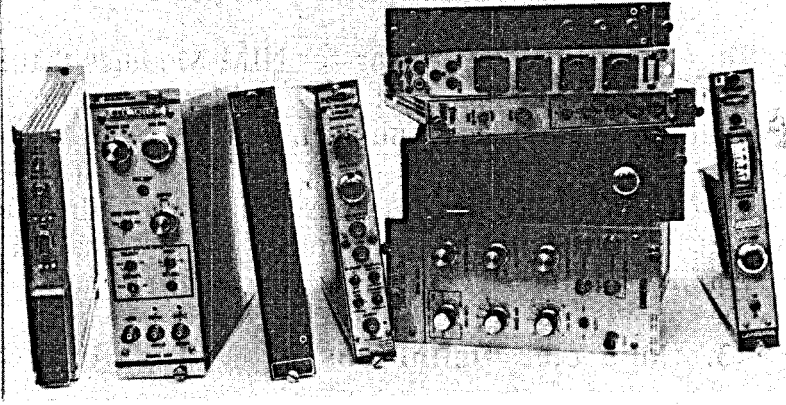
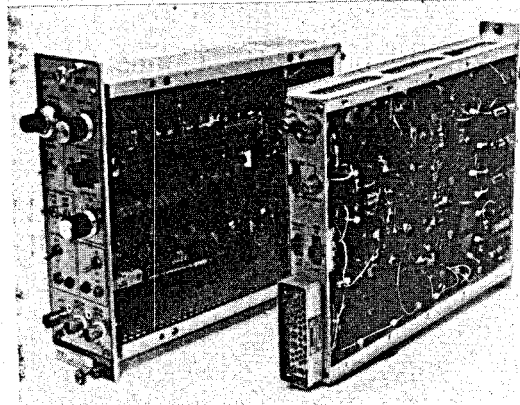
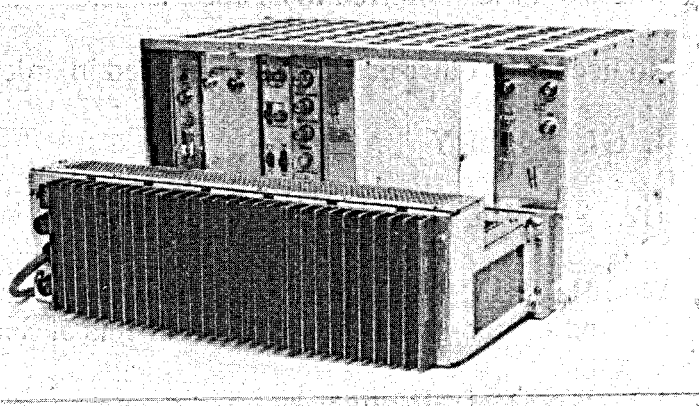
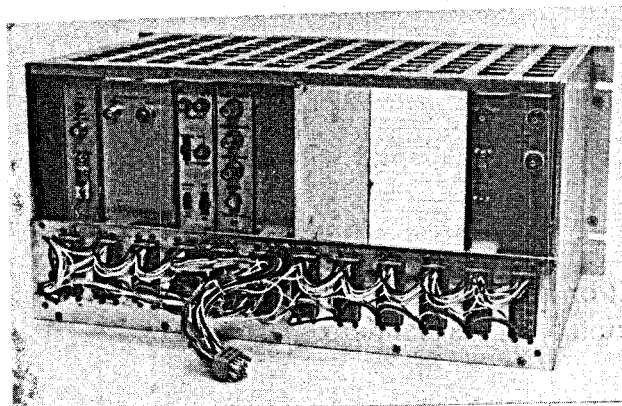
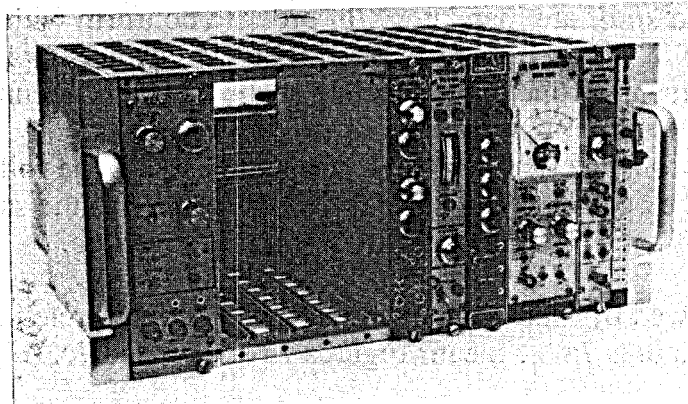

Figure 1

Typical NIM System Modules, Bin and Power Supply

3.3. Interpretation of This Document

Clauses using the word *shall* are mandatory. In order to conform with the specifications of this standard for a NIM Module, a NIM Bin, or a NIM Power Supply, they *shall* meet the mandatory requirements of the corresponding sections of this document.

Preferred Practice means that the item thus designated should be followed unless there are sound reasons to the contrary. The word *Recommended* has the same meaning. The word *should* is used for *Recommended* or *Preferred Practice*.

A figure number followed by more than one letter *shall* be interpreted as in the following example: Example - Figures 7a,b,c means Figures 7a and 7b and 7c. (Figures 2 through 13 begin on page 19.)

117 volts ac as used in this document indicates the typical voltage used in the USA and other countries, referred to as nominal 120 volts ac.

No license or other permission is needed in order to use this standard.

4. GLOSSARY

4.1. Module Definitions

Module (NIM Module). A modular instrument or unit that can be mounted in a NIM Bin and that conforms to the requirements of Section 5 of this standard.

4.2. Bin Definitions

Bin (NIM Bin). A housing for NIM Modules that includes 12 bussed Bin Connectors for mating with connectors on NIM Modules to provide power at the Modules and that conforms to all of the requirements of Section 6.

NIM Compatible Bin. A housing in which NIM Modules can be mounted and operated in accordance with the requirements of this standard but that does not conform to the full requirements for a NIM Bin as defined in Section 6.

4.3. Connector Definitions

Module Connector (NIM Module Connector). The connector at the rear of a NIM Module that mates with a NIM Bin Connector to provide power and other connections to the Module and that conforms to the requirements of Section 5.3.

Bin Connector (NIM Bin Connector). The connector at the rear of a NIM Bin that mates with the NIM Module Connector to provide power and access for other purposes to the Module and conforms to the requirements of Section 6.3. Twelve NIM Bin Connectors are bussed at the rear of a NIM Bin.

Reserved Pin. A Connector pin for future assignment by the Committee or withheld from use to avoid difficulties, possibly because of previous usage. Reserved pins are not to be used unless and until Committee assignment is made.

Pin (Connector Pin). The term pin is used to refer to either a connector pin or socket contact.

4.4. Power Supply Definitions

NIM Power Supply. A power supply that mounts at the rear of a NIM Bin to provide power at all the NIM Standard Voltages (plus and minus 6, 12, and 24 volts dc and 117 volts ac) to the bus at the rear of the NIM Bin and that meets all of the requirements of Section 7 of this standard.

NIM Special Purpose Power Supply. A power supply that can be used with NIM Modules that do not require all of the NIM Standard Voltages (plus and minus 6, 12 and 24 volts dc and 117 volts ac). The operational and performance requirements of Section 7.2 of this standard apply for those voltages that are provided.

NIM Modular Power Supply. A power supply built in the form of a NIM Module that plugs into a NIM Bin, meets the operational and performance requirements (Section 7.2) for a NIM Power Supply, and provides all the NIM Standard Voltages to the Bin Busses.

NIM Special Purpose Modular Power Supply. Same as a NIM Modular Power Supply except that it does not provide all of the NIM Standard Voltages.

4.5. Organizations, Acronyms, Systems

ANSI. American National Standards Institute, Inc.

CAMAC. A standardized modular instrumentation and digital system as defined in ANSI/IEEE Std 583 (often treated as an acronym for "Computer Automated Measurement and Control").

DOE. U.S. Department of Energy. (The former U.S. Atomic Energy Commission (AEC) has been integrated into the Department of Energy.)

ESONE. A multi-national committee representing European nuclear laboratories. It produced the initial CAMAC specification and collaborated with the NIM Committee in the maintenance and extension of CAMAC.

EURATOM. European Atomic Energy Agency

FASTBUS. A standardized high-speed modular data acquisition and control system developed by the NIM Committee, with the collaboration of the ESONE Committee, and defined in ANSI/IEEE Std 960.

IEC. International Electrotechnical Commission

IEEE. Institute of Electrical and Electronics Engineers, Inc.

NIM. (1) The standardized modular instrumentation system defined in this document.

(2) A committee sponsored by the U.S. Department of Energy and associated with the U.S. National Institute of Standards and Technology. Its membership consists of representatives of the U.S. National Laboratories and of other major laboratories and universities. The NIM Committee produced the NIM instrumentation specifications, developed the FASTBUS system with the collaboration of the ESONE Committee, and collaborated with ESONE in the maintenance and extension of CAMAC. It has responsibility for the NIM and FASTBUS systems and for the U.S. involvement with CAMAC.

5. NIM MODULE

5.1. General

A NIM Module *shall* conform to Figure 2. It has a nominal 8-3/4" (222 mm) panel height³ and a basic width such that a NIM Bin will accommodate 12 single-width NIM Modules or any combination of single- and multiple-width Modules with a total of 12 or less unit widths.

5.2. Ventilation

A Module *shall* permit vertical air flow past the components therein and, for that purpose, *shall* provide an open area (reasonably distributed) of not less than 10% of the total horizontal projection of the Module. Holes of less than 7/64 inch (2.8 mm) diameter are not considered in determining the area provided. (See also Section 6.2.)

5.3. Module Connectors and Connector Hoods

Module Connectors in accordance with Figures 3a,b and 4a,b and Module Connector Hoods in accordance with Figure 5 *shall* be mounted on the Modules as shown in Figure 2. The hoods serve to protect the Module Connector pins and, when mated with the optional Bin Connector hoods (Section 5.12), electrical shielding is enhanced (see Section 6.3).

5.4. Module Connector Pin Assignments

The Module Connector pin assignments *shall* be as in Figure 6.

³A limited number of modules with nominal 5-1/4 inch (133) panel height have been constructed. Their dimensions are as in Figure 2 except that the panel and module heights, and the height of the corresponding bin, are reduced by 3.500 inches (88.9 mm).

5.5. Grounds

Pin 34 of the Module Connector is the return ground for all dc supplies and pin 42 is the "High Quality Ground" return intended as the zero potential reference. High Quality Ground current load for any Module *shall not* exceed 1 mA for constant loads nor 100 microamperes for pulses or varying loads. Care should be taken to minimize capacitive coupling of the High Quality Ground to the local ground. (See also 6.5.)

Where precise reference levels are required they should be developed within the Module, and Module designers should consider the use of the High Quality Ground (pin 42) for reference purpose with due consideration for the current restrictions.

5.6. Coaxial Connectors

5.6.1. Signal Connectors. Signal connectors *shall* be either:

- (a) The 50 ohm BNC type in accordance with American National Standards Institute (ANSI) Standard N544, "Signal Connectors for Nuclear Instruments", also defined in International Electrotechnical Commission (IEC) Publication 313, "Coaxial Cable Connectors used in Nuclear Instrumentation"; or
- (b) Type 50CM in accordance with Section 4.2.5 of ANSI/IEEE Std 583-1982, "Modular Instrumentation and Digital Interface System (CAMAC)". (Commercial designations include LEMO and Kings K-loc).

5.6.2. High-Voltage Connectors. Connectors for high voltage applications up to 5 kV *shall* be the "Safe High Voltage Connectors" (commonly referred to as Type SHV) in accordance with ANSI Standard N42.4, "High Voltage Connectors for Nuclear Instruments", also defined as Type B Connector in IEC Publication 498, "High-voltage coaxial connectors used in nuclear instrumentation". These high-voltage connectors are of the "safe" type in that the pin and socket contacts are securely recessed in the connector so as to minimize the possibility of electrical shock when the connectors are handled with rated voltage applied.

5.6.3. Mounting of Signal and High Voltage Connectors. Signal and high-voltage connectors may be mounted on the front and rear of the Modules except that they *shall not* be mounted on the bottom 3.00" (76.2 mm) of the rear of the Modules.

5.7. ECL (Emitter Coupled Logic) Front Panel Interconnections

Front panel ECL (Emitter Coupled Logic) differential interconnections should be in accordance with Appendix A.

5.8. Digital Bus

The preferred digital bus for NIM instruments is the Standard NIM Digital Bus (NIM/488) defined in Appendix B. Logic levels on this bus *shall* conform to the Electrical Specification section of ANSI/IEEE Std 488.1-1987.

5.9. Logic and Analog Signals

5.9.1. Logic Levels for Transmission of Digital Data (Preferred Practice, except for NIM/488 bus of Appendix B)

	Nominal Signal Level	Output (shall Deliver)	Input (shall Respond To)
Logic 1	+4 V	+4.0 V Min	+3.0 V Min
Logic 0	0 V	+1.0 V Max	+1.5 V Max

Voltages listed include noise.

"*shall Deliver*" means *shall* deliver to any load impedance of 1000 ohms or greater.

"*shall Respond*" means *shall* respond fully within specifications.

To avoid damage to circuitry, no positive signal (logic level) voltage *shall* exceed 12 volts and no negative signal voltage *shall* exceed 2 volts.

5.9.2. Logic Signal Requirements. Reset and slow gate signals, including those on pins 35 and 36 (when used), *shall* conform to the levels specified in Section 5.9.1. In addition, the rise and fall times of signals on all busses *shall* be limited so as not to produce excessive cross-talk. Fast signals that can cause cross-talk problems *shall not* be applied to these busses but may be routed to or from the Modules by external cables.

5.9.3. Fast Logic Levels and Characteristics (Preferred Practice)

	Output Driver Current (mA) Into 50 Ohms	Receiver Input Voltage Response (Notes 1 & 2)
Logic 1	-14 to -18	-0.6 max. to -1.8 min.
Logic 0	-1.0 to +1.0	-0.2 min. to +1.0 max.

Notes: (1) Receiver response to input voltages more positive than +1.0 V or more negative than -1.8 V is not specified.

(2) "Response" means *shall* respond fully within specifications to any voltage within this range. Circuit designers are alerted to the overdrive required in many receiver circuits to assure "full specification performance", and the need therefore to set the receiver trigger threshold accordingly.

5.9.4. Analog Signals

For microsecond analog signals the preferred open-circuit output range is 0 to +10 volts.

For fast (submicrosecond) signals the preferred amplitude ranges are 0 to -1 volt and 0 to -5 volts into a 50 ohm load.

5.10. Decoupling, Noise Generation, Noise Immunity

Since the Modules receive their power from common power supplies and power distribution busses, the Module designer should provide adequate decoupling. Modules *shall* operate within their rated performance specifications when transients of up to ± 220 mV (measured across a 50 ohm resistive load) are present on any or all of the power distribution busses. Transients produced on any bus by an individual Module should not exceed ± 20 mV. (220 mV would be the maximum noise one Module would encounter if all other Modules in the Bin put 20 mV noise in phase on the bus.)

5.11. Power Requirements for NIM Modules

NIM Modules *shall* operate within specifications when provided with power from power supplies with operational and performance characteristics in accordance with Section 7.2 and with the voltages at the Module Connectors over the ranges listed below:

6.00 V	$\pm 3.0\%$
12.00 V	$\pm 1.0\%$
24.00 V	$\pm 0.7\%$

5.11.1. Standard Voltages. DC voltages of plus and minus 6.00, 12.00 and 24.00 are standard, as is also 117 volts ac. They are provided to the the Modules through the Module Connectors that mate with the Bin Connectors (Sections 6.3 through 6.6). In some special instances ac busses in the Bin may be disconnected by the user or the ac power requirement may be an appreciable fraction of the permissible Bin drain. In such cases the ac, where required in specific Modules, may alternatively be brought to the Modules through the rear of the Module. However, the bottom 3.00 inches (76.2 mm) of the rear of the Module is not available for such use. Note that 6 volt power is not necessarily available on busses in some early NIM Bins.

5.11.2. Marking of Power Requirements. On the front panel of each Module *shall* be listed all voltages used and the currents drawn by the Module.

Example:	+24 V	30 mA
	-24 V	30 mA
	+12 V	90 mA
	- 6 V	85 mA
	117 V ac	0.5 A

5.12. Quality Shielding (Optional)

Under conditions of high electrical ambient noise it is necessary to pay special attention to shielding. Individual users may, at their discretion, specify adherence to "quality shielding" requirements such as those listed below:

- (a) The Modules *shall* be constructed of high conductance material, such as suitably plated steel, and all joints between various parts of the Module *shall* be high conductance such that the resistance between any two parts of the shielding does not exceed 0.01 ohm.
- (b) The maximum ventilating hole size *shall* be 5/32 inch (4.0 mm). Note minimum ventilating hole size specified in Sec. 5.2.
- (c) Integrity of shielding between Modules *shall* be provided by interleaved hoods surrounding both the Module and Bin Connectors (Sections 5.3 and 6.3 and Figure 5) and by shielding the volume behind the Bin Connectors. All power and signal cables that cross through this shielded volume *shall* do so through suitable feed-through filters or shield grounding clamps.

5.13. Jig Alignment of Module Connectors

In order to meet the dimensional specifications for the Module assembly and assure proper mating of the Module and Bin Connectors, it is necessary to jig align the Module Connectors with respect to the bottom runner. A typical jig is shown in Figures 11a,b. Other jig designs may be more suited to particular Module designs. Figure 13 shows typical tools for installing the connector guide pins and sockets.

Comment: Jig alignment in accordance with the preceding is the most satisfactory. However, users who occasionally install Module Connectors but do not have jigs available can use an aligned Bin for that purpose. The connector should be installed in the Module with the guide pins and guide sockets "finger tight." The Module is then inserted into the Bin, thus lightly forcing the Module Connector block and its guides into proper position. The Module is then withdrawn and the guides tightened.

6. NIM BIN

6.1. General

NIM Bins *shall* conform to Figures 7a,b,c,d. They *shall* mount in standard EIA or IEC 19 inch racks and *shall* accommodate NIM Modules in accordance with Section 5 of this standard. Each Bin *shall* include 12 sets of guides and 12 Bin Connectors so as to accommodate up to 12 single-width Modules or any combination of single-width and/or multiple-width Modules with a total of 12 or less unit widths. The Bins *shall* provide power to the Modules through bussed Bin Connectors that mate with the Module Connectors.

6.2. Ventilation

Ample air flow through Bins and power supplies is essential to provide adequate cooling for both single Bin and stacked Bin systems. This may necessitate the use of fans, spacers, deflectors, or similar devices. (See also Section 5.2.)

6.3. Bin Connectors and Connector Hoods

Twelve Bin Connectors in accordance with Figures 3a,b and 4a,b *shall* be mounted on the front surface of the rear of the Bin to mate with Module Connectors of NIM Modules that are inserted into the Bins. The Bin Connectors are designated PG1B through PG12B to correspond to their location in the Bin, with PG1B being the rightmost Connector when the Bin is viewed from the front, PG2B the next Connector, etc. Connections to all pins in the Bin Connector blocks *shall* be such as to permit the pins to "float" mechanically. Pins not bussed or otherwise used need not be supplied. The use of Bin Connector hoods in accordance with Figure 5 (see Section 5.12) is optional. Where Bin Connector hoods are not installed a shim of 0.031 inch (0.79 mm) *shall* be installed between the Bin Connector and the front surface of the Connector mounting plate, or other suitable measures taken, so as to properly position the mating face of the Bin Connector. (The term pin or connector pin is used in this standard to refer to either a connector pin contact or a connector socket contact.)

6.4. Bin Wiring

Bin wiring *shall* be as in Figures 8a,b with pin assignments and other requirements as in Figure 6. All Bin Connector pins designated as follows *shall* be bussed to all 12 Bin Connectors, PG1B through PG12B:

Pin No.	Function
10	+6 V
11	-6 V
16	+12 V
17	-12 V
28	+24 V
29	-24 V
34	Power Return Ground
33	117 V ac, hot
41	117 V ac, neutral
42	High Quality Ground

Power *shall* be distributed to pins 10, 11, 16, 17, 28, 29, and 34 of Bin Connectors PG1B through PG12B by means of (1) bus wires, or (2) laminated busses, or (3) individual feeders.

The resistance (end to end) of the ground return bus (#34 pins) *shall not* exceed 1.4 milliohms. A maximum resistance of 3.5 milliohms is recommended for busses for pins 10, 11, 16, 17, 28, and 29, but in no case *shall* the resistance exceed 8.5 milliohms. Busses *shall* be continuous. The resistance of the leads from the busses to the Bin Connectors PG1B-PG12B *shall not* exceed 1.0 milliohm.

Where individual feeders are used, branching from the voltage sense points to the individual Bin Connectors PG1B through PG12B, it is recommended that the resistance of these feeder leads be not more than 5.0 milliohms, but in no case *shall* the resistance exceed 8.0 milliohms.

6.4.1. Bin Power Connector. The Bin Power Connector, PG13, in accordance with Figure 10, *shall* be connected to the Bin busses in accordance with Figures 8a,b for mating with PG14 (Section 7.4.4) to provide power to the Bin busses.

6.4.2. Ground Connections. Connections between the High Quality Ground Bus (pin 42), the Power Return Ground Bus (pin 34) and the chassis *shall* be made near the Ground Guide Pin of Bin Connector PG1B. The Chassis Ground is normally connected to the building ground. (See also Section 5.5.)

6.5. Bus Signal Restrictions

Implementation of and restrictions regarding the ground busses are discussed in Section 5.5. Restrictions regarding signals on the Reset bus (pin 35) and on the Gate bus (pin 36) are given in Section 5.9.2.

6.6. Bin Power

Power at the standard voltages of plus and minus 6.00, 12.00 and 24.00 dc as well as 117 volts ac *shall* be provided at the Bin busses as assigned in Section 6.4 and Figure 6.

6.7. Jig Alignment of Bin Connectors

In order to meet the dimensional specifications for the Bin assembly and assure proper mating of the Bin and Module Connectors, it is necessary to jig align the Bin Connectors with respect to the bottom of the runner guide. A typical jig is shown in Figures 12a,b. Other jig designs may be more suited to particular Bin designs. Figure 13 shows typical tools for securing the connector guide pins and guide sockets.

7. NIM POWER SUPPLY

This is the specification for the standard NIM Power Supply to be mounted on the rear of a NIM Bin to provide power for NIM Modules installed in the Bin. The supply *shall* conform to Section 7 and Figures 8a,b and 9. The documentation requirements of Section 9 *shall* apply.

7.1. Ratings

7.1.1. Input. The input voltage range *shall* be the nominal line voltage +10% to -12%, at nominal line frequency ± 3 Hz. (In the U.S. the nominal line voltage is 117 V and the nominal line frequency is 60 Hz.)

7.1.2. Output. The supply *shall* provide six simultaneous dc outputs with at least the following current ratings and with the following performance characteristics:

Voltage	Amperes	Regulation (See 7.2.2)	Short Term Stability (See 7.2.2)	Long Term Stability (See 7.2.2)	Noise and Ripple (See 7.2.7)
+6	0-to-5	± 0.1	$\pm 0.6\%$	0.5%	10mV
-6	0-to-5	± 0.1	$\pm 0.6\%$	0.5%	10mV
+12	0-to-2	$\pm 0.05\%$	$\pm 0.3\%$	0.5%	3mV
-12	0-to-2	$\pm 0.05\%$	$\pm 0.3\%$	0.5%	3mV
+24	0-to-1	$\pm 0.05\%$	$\pm 0.3\%$	0.5%	3mV
-24	0-to-1	$\pm 0.05\%$	$\pm 0.3\%$	0.5%	3mV

Note: Total band is the sum of the plus and minus values; e.g., band for $\pm 0.05\%$ is 0.1%.

In addition, the supply *shall* be capable of providing a minimum of 0.500 amperes at 117 volts ac to the Bin bus.

Output currents *shall* also be available to loads connected between any positive output and any negative output, equal to the capability of the lesser current rated supply.

7.2. Operational and Performance Characteristics

7.2.1. Voltage Adjustment. The output voltages *shall* be adjustable over a minimum range of $\pm 2\%$ by means of a screwdriver adjustment that is readily accessible while the power supply is in place and operating. The voltage outputs *shall* be settable to within $\pm 0.1\%$ of the specified values.

7.2.2 Regulation and Stability.

Regulation -- The output voltages *shall* vary by not more than the amounts specified in 7.1.2 over the combined range of zero to full load, and input voltages over the specified input range. Measurements *shall* be made within a one minute interval.

Short Term Stability -- After a 60-minute warm-up, during any 24-hour interval the voltages *shall* vary from the nominal values by not more than the amounts specified in 7.1.2. at constant ambient temperature for combined load and input line variations over their specified ranges.

Long Term Stability -- After a 60-minute warm-up, during any 6-month interval the voltages *shall* vary from the nominal values by not more than the amounts specified in 7.1.2. at any constant ambient temperature, input line voltage, and load within their specified ranges.

7.2.3. Recovery Time. The 12 and 24 volt outputs *shall* recover to within $\pm 0.1\%$ and the 6 volt outputs to within $\pm 1\%$ of the steady-state values within 100 microseconds following any change in input voltage over the specified input voltage range or between any change in load current between 10% and 100% of the specified output current range.

7.2.4. Output Impedance. The output impedance *shall not* exceed 0.15 ohm for the 6 volt supplies or 0.30 ohm for the 12 and 24 volt supplies. The impedance measurements *shall* be made at frequencies up to 100 KHz.

7.2.5. Temperature. The ambient temperature range is from 0°C to 50°C without derating. Operation to 60°C *shall* be possible with a current derating not to exceed $3\%/^{\circ}\text{C}$ for temperatures above 50°C .

The ambient temperature *shall* be measured at a location where it is not appreciably affected by the temperature of the power supply.

7.2.6. Temperature Coefficient. The output voltage coefficients for changes in ambient temperature between 0°C and 60°C *shall not* exceed $0.02\%/^{\circ}\text{C}$.

7.2.7 Noise and Ripple The combined noise and ripple *shall not* exceed the amounts specified in 7.1.2 These are peak-to-peak values as observed on an oscilloscope with a pass band from dc to 50 MHz.

7.2.8. Remote Sense. Remote sensing *shall* be available for all of the dc outputs through appropriate connections at the power supply connector that interfaces with the Bin bus as in Figures 8a,b. Proper operation of the 6 volt supplies within specifications *shall not* require connection of remote sense leads to the Bin busses.

7.3. Protection

7.3.1 Fault and Overload Protection. The input of the supply *shall* be protected with circuit breakers and/or fuses of appropriate rating (see Figures 8a,b). They *shall* be readily accessible while the supply is in place and operating.

The output of the supply *shall* be short-circuit protected by means of an electronic circuit. The current limiting threshold *shall* be set at least 0.2 amperes above the specified output currents. A continuous short-circuit *shall not* damage the supply or blow a fuse.

Fuses *shall not* be used in the neutral line. A circuit breaker may be used in the neutral line only if ganged to a circuit breaker of no greater trip rating in the hot line.

The outputs *shall* be protected by limiting circuits such that under no conditions will the outputs exceed 125% of their nominal values. Operation of the overvoltage protection *shall not* damage the power supply.

In no case *shall* a failure of any supply cause an increase in voltage of any other supply by more than 20%.

7.3.2. Thermal Protection. Two thermal protection circuits as described below *shall* be provided and wired as shown in Figures 8a,b:

(1) A thermal warning switch that *shall* close when the safe temperature within the supply has risen to within 20°C of a safe operating value.

(2) A thermal cutout switch that *shall* disable the supply when the temperature within the supply exceeds a safe operating value. The preferred implementation is a latching thermal cutout switch that requires manual resetting.

The maximum safe operating temperature, as measured at the thermal switch, *shall* be specified on the circuit diagram and in the instruction book.

7.4. Physical Characteristics

7.4.1. Dimensions. The dimensions of the power supply *shall* be in accordance with Figure 9. No part of the power supply (including screws, studs and other projections, but excluding the line cord and the output connector PG14) *shall* extend beyond the dimensions shown in Figure 9 or into the shielded recess.

7.4.2. Shielding. The entire supply *shall* be enclosed with an integral electrostatic shield. All components *shall* be contained within this shield. Portions of the shield may be screwed together with screws spaced no more than 3 inches (76 mm) apart. Heat sink fins may be employed as part of the shield. The shield may be perforated with holes up to 0.156 inch (4.0 mm) diameter to provide additional cooling. No part of the shield *shall* have a resistance greater than .010 ohm to any other part of the shield.

The power transformer *shall* be constructed with an electrostatic shield connected to the core.

7.4.3. Input Leads, Plug and Receptacle. For nominal 117 volts ac. use, power shall be provided to the supply as in Figures 8a,b via one of the following:

- A recessed two blade plug with ground pin, NEMA 5-15P, mounted at the rear of the supply together with a 5 foot (1.5 meter) power cord with NEMA 5-15 plug and receptacle (preferred method), or

- a 5 foot (1.5 meter) power cord entering the rear of the supply, and with a NEMA 5-15P plug at the other end, or
- as required in the country of use.

Plugs and receptacles for other than nominal 117 volts ac use are not specified.

7.4.4. Output Power Connector. Power connector PG14 for connecting the power supply output to the Bin busses *shall* be as in Figures 3a,b and 10 and wired in accordance with Figures 8a,b. Low resistance contacts in accordance with Note 6 of Figure 3b *shall* be used for the 6 volt and ground return contacts. PG14 *shall* be affixed to the supply by a suitable metal bracket having the orientation shown in Figure 9.

7.4.5. Finish. The finish *shall* be plated with a suitable material that will assure good electrical contact throughout the expected life of the power supply and that, where necessary, is passivated against atmospheric corrosion or against electrolysis when in contact with copper or other common finishes.

7.4.6. Quality. Because of the limited volume available and high operational reliability required, only the highest quality components should be employed. All semiconductor components should be constructed of hermetically sealed units. Components *shall not* be used beyond their design ratings. The supply *shall* be designed for a life expectancy of at least 10 years.

8. OTHER POWER SUPPLIES

Other power supplies used with NIM Bins and Modules include the types described below.

8.1. NIM Special Purpose Power Supply.

This type power supply is a power supply used with some NIM Modules that do not require all of the NIM Standard voltages (plus and minus 6, 12 and 24 volts dc and 117 volts ac). It *shall* meet the operational and performance requirements (Section 7.2) of a NIM Power Supply for the voltages that are provided. The documentation requirements of Section 9 *shall* also apply.

8.2. NIM Modular Power Supply

This type power supply *shall* be built in the form of a NIM Module (Figure 2) that plugs into NIM a Bin and *shall* provide all of the NIM Standard voltages (plus and minus 6, 12 and 24 volts dc and 117 volts ac). The outputs *shall* connect to the NIM Module Connector that mates with the corresponding Bin Connector, thus connecting to the Bin busses that distribute power to the Modules. It *shall* meet the operational and

performance requirements (Section 7.2) of a NIM Power Supply and the additional requirements given below. The documentation requirements of Section 9 *shall* also apply.

(a) **Input** - Input *shall* be in accordance with 7.1.1 and 7.4.3.

(b) **Output** - The power supply *shall* provide the NIM standard voltages (plus and minus 6, 12 and 24 volts dc and 117 volts ac) to the Module Connector pins in accordance with the pin assignment of Figure 6. The output leads *shall* be electrically floating; no internal ground connections *shall* be made in the power supply.

Full output currents *shall* be available through jacks that *shall* be mounted on the front panel of the power supply. Also mounted on the front panel *shall* be a pilot light powered by the output of the power supply.

(c) **Temperature Rise** - The temperature rise above ambient should not exceed 20°C on the front and sides or 40°C on the exposed rear panel of the Module.

(d) **Stray Flux** - Stray magnetic flux *shall not* exceed 10 gauss, peak.

(e) **Dimensions** - Dimensions *shall* be in accordance with Figure 2.

8.3. NIM Special Purpose Modular Power Supply.

This power supply *shall* meet all the requirements for a NIM Modular Power Supply as defined in Section 8.2 except that it need not provide all of the NIM Standard Voltages.

8.4. EARLY POWER SUPPLIES

Early NIM power supplies did not include 6 volt power. Some of these 12/24 volt power supplies had provision for interconnecting with 6 volt supplies to route 6 volt power to the Bin busses.

9. DOCUMENTATION

Two copies of an instruction book, including the schematic circuit diagram showing component values, *shall* be provided with each power supply.

All semiconductor components *shall* be designated by EIA type numbers or in nomenclature that is commonly used by semiconductor device manufacturers or *shall* be directly replaceable by the same. Where special types are used, the schematic diagram or the instruction book *shall* recommend and identify a semiconductor device manufacturer's equivalent that will provide satisfactory performance.

**DO NOT MICROFILM
THIS PAGE**

WIDTH UNITS	Y (INCHES)	Y (MILLIMETERS)	D (INCHES)	D (MILLIMETERS)
	NOMINAL	NOMINAL		NOMINAL
1	1.350	34.29	1.320	33.53
2	2.704	68.68	2.674	67.92
3	4.058	103.07	4.028	102.31
4	5.412	137.46	5.382	136.70
5	6.766	171.86	6.736	171.09
6	8.120	206.25	8.090	205.49
7	9.474	240.64	9.444	239.88
8	10.828	275.03	10.798	274.27
9	12.182	309.42	12.152	308.66
10	13.536	343.81	13.506	343.05
11	14.890	378.21	14.860	377.44
12	16.244	412.60	16.214	411.84

◆ TOLERANCE +0.000 inch
-0.010 inch
◆◆ TOLERANCE +0.00 mm
-0.25 mm

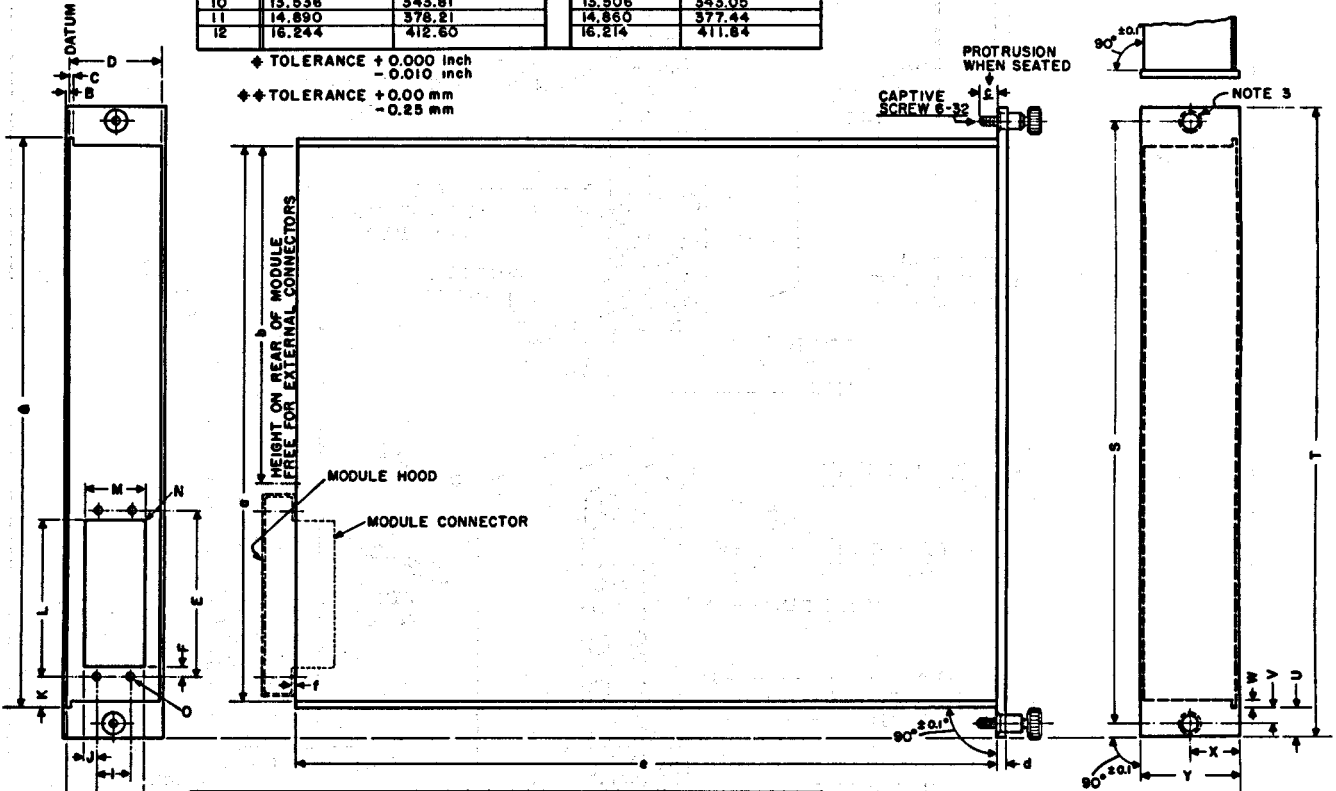

REF.	INCHES		MILLIMETERS		REMARKS
	NOMINAL	TOLERANCE	NOMINAL	TOLERANCE	
A	7.873	+0.000, -0.010	199.97	+0.00, -0.25	
B	0.015	±0.005	0.38	±0.13	
C	0.064	±0.005	1.63	±0.13	
D					SEE TABLE
E	2.281	±0.005	57.94	±0.13	
F	0.128	±0.005	3.25	±0.13	
G	0.629	±0.005	15.98	±0.13	
H	0.430	±0.010	10.92	±0.25	
I	0.468	±0.010	11.89	±0.25	
J	0.181	±0.005	4.09	±0.13	
K	0.461	±0.010	11.71	±0.25	
L	2.153	±0.005	54.69	±0.13	
M	0.790	±0.005	20.07	±0.13	
N	0.015		0.38		TYPICAL RADIUS
O	0.130	±0.005	3.30	±0.13	DIAMETER, 4 HOLES
P	0.461	±0.005	11.71	±0.13	
R	0.629	±0.005	15.98	±0.13	
S	2.290	±0.010	58.07	±0.25	
T	2.714	+0.000, -0.010	69.34	+0.00, -0.25	
U	0.421	±0.010	10.69	±0.25	
V	0.211	±0.010	5.36	±0.25	
W	0.128	±0.005	3.20	±0.13	
X	0.678	±0.005	17.18	±0.13	
Y					SEE TABLE
a	7.621	+0.000, -0.015	193.87	+0.00, -0.38	
b	4.645	±0.005	117.98	±0.13	
c	0.25	±0.06	6.35	±1.52	
d	0.125	±0.010	3.18	±0.25	
e	2.674	+0.000, -0.010	67.92	+0.00, -0.25	
f	0.031	±0.003	0.79	±0.08	SEE MODULE HOOD DRG

NOTES:

1. THE MILLIMETER DIMENSIONS ARE DERIVED FROM THE ORIGINAL INCH DIMENSIONS.
2. DIMENSIONS GIVEN ARE FOR THE OUTSIDE OF THE MODULE. METAL THICKNESS MUST BE INCLUDED WITHIN THESE DIMENSIONS. DIMENSIONS ARE ABSOLUTE AND INCLUDE PROJECTIONS SUCH AS SCREW HEADS, ETC.
3. FOR TYPICAL CAPTIVE SCREW DRILL 0.257 +/-0.005 INCH (6.53 +/-0.13 mm) AND COUNTER-SINK 82°, 0.020 +/-0.005 INCH (0.51 +/-0.13 mm) DEEP ON REAR OF THE PANEL. TWO HOLES MINIMUM.

Figure 2. NIM Module
19

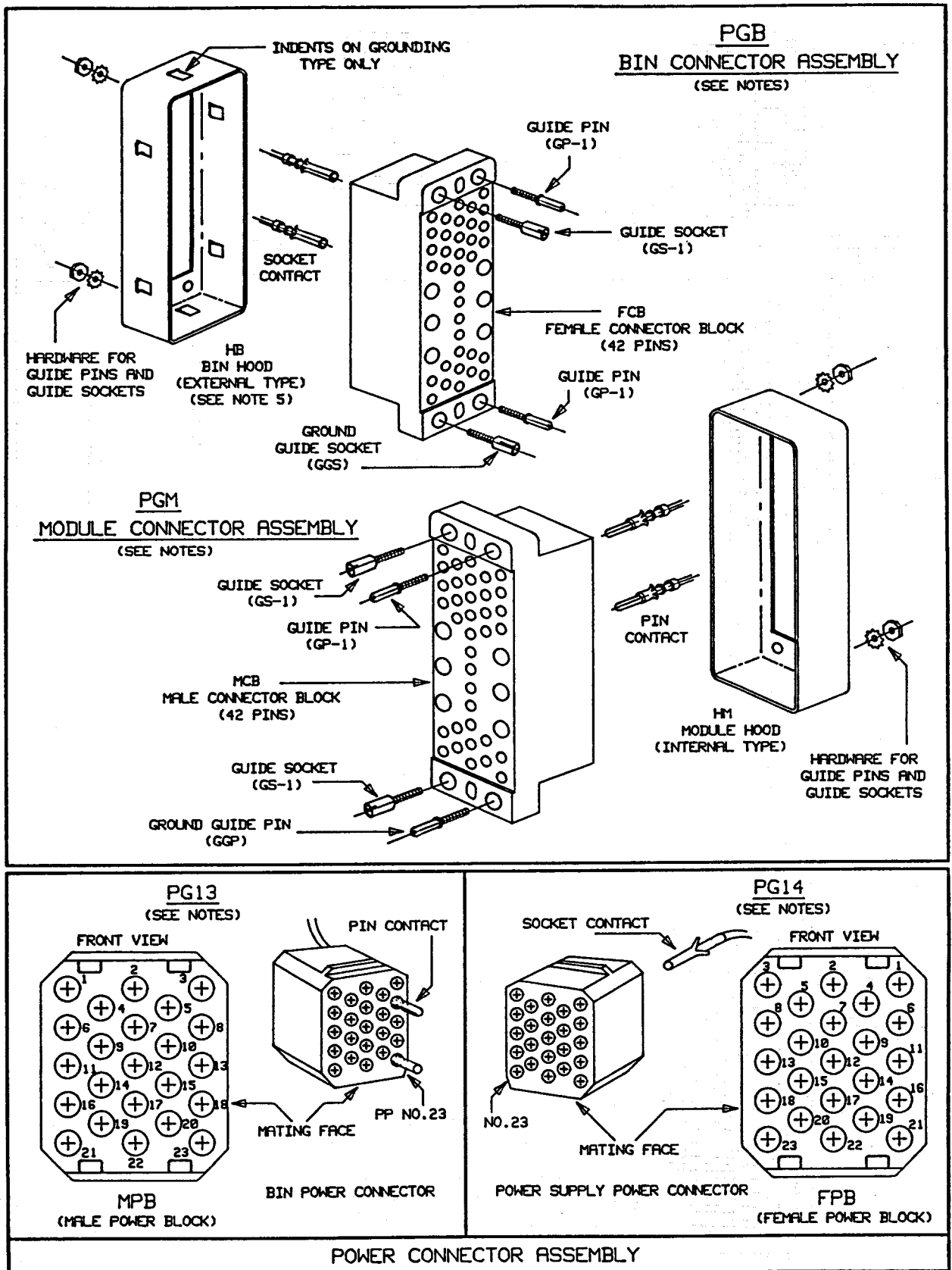

Figure 3a. Connector Assemblies

NOTES:

- PGB AND PGM CONSIST OF THE FOLLOWING, ASSEMBLED AS INDICATED ON THIS DRAWING. ON SOME DRAWINGS PGB CONNECTOR ASSEMBLIES ARE IDENTIFIED AS PG1B THRU PG12B TO INDICATE LOCATION IN BIN AS PER NOTE 2 OF FIG.8b. A SIMILAR NOTATION IS OCCASIONALLY USED FOR PGM TO IDENTIFY MODULE POSITION IN BIN.

PGB

1 EACH FEMALE CONNECTOR BLOCK (FCB)
 1 EACH GROUND GUIDE SOCKET (GGS)
 1 EACH GUIDE SOCKET (GS-1)
 2 EACH GUIDE PIN (GP-1)
 SOCKET CONTACTS AS REQUIRED

PGM

1 EACH MALE CONNECTOR BLOCK (MCB)
 1 EACH GROUND GUIDE PIN (GGP)
 2 EACH GUIDE SOCKET (GS-1)
 1 EACH GUIDE PIN (GP-1)
 PIN CONTACTS AS REQUIRED

PGB AND PGM CONNECTOR ASSEMBLY COMPONENTS

NIM IDENTIFICATION	AMP ASSEMBLY (SEE NOTE 8)		WINCHESTER ASSEMBLY (SEE NOTE 8)	
	PART NO.	REMARKS	PART NO.	REMARKS
FCB FEMALE BLOCK FOR (PGB)	202516-3	BLUE (DAP)	111-20854	GRAY (DAP)
" (ACCEPTABLE ALTERNATE)	202516-1	BLACK (PHENOLIC)	111-20854-T43	BLACK (PHENOLIC)
MCB MALE BLOCK FOR (PGM)	204186-5	GREEN (DAP)	111-20853-1	GRAY (DAP)
" (ACCEPTABLE ALTERNATE)	204186-1	BLACK (PHENOLIC)	111-20853-1-T43	BLACK (PHENOLIC)
GP-1 GUIDE PIN	200833-2	STAINLESS STEEL	111-20855	GOLD PLATED
GS-1 GUIDE SOCKET	203964-5	STAINLESS STEEL	111-20856-1	GOLD PLATED
GGP GROUND PIN	202514-1	GOLD PLATED	111-20855	GOLD PLATED
GGS GROUND GUIDE SOCKET	202512-1	GOLD PLATED	111-20858	GOLD PLATED
HM MODULE CONNECTOR HOOD	202394-2	ZINC PLATED STEEL	111-20851-1	CADIUM PLATED
HB BIN CONNECTOR HOOD OR	202579-5	GROUNDING ZINC P.S.		
HB BIN CONNECTOR HOOD	201390-5	NON-GNDG. ZINC P.S.	111-20852-1	NON-GNDG. CAD.PL
CONTACTS	TYPE II LONG (SEE NOTE 3) TYPE III+ LONG (SEE NOTE 4)		(SEE NOTE 7)	

- PG-13 AND PG-14 CONSIST OF THE FOLLOWING, ASSEMBLED AS INDICATED ON FIG. 3a.

PG-13

1 EACH MALE POWER BLOCK (MPB)
 1 EACH POLARIZING PIN (PP)
 PIN CONTACTS AS REQUIRED

PG-14

1 EACH FEMALE POWER BLOCK (FPB)
 SOCKET CONTACTS AS REQUIRED

PG-13 AND PG-14 CONNECTOR ASSEMBLY COMPONENTS

NIM IDENTIFICATION	AMP ASSEMBLY (SEE NOTE 8)		WINCHESTER ASSEMBLY (SEE NOTE 8)	
	PART NO.	REMARKS	PART NO.	REMARKS
MPB MALE POWER BLOCK FOR (PG-13)	202650-2	BLUE (DAP)	111-20859	GRAY (DAP)
" (ACCEPTABLE ALTERNATE)	202650-1	BLACK (PHENOLIC)	111-20859-T43	BLACK (PHENOLIC)
FPB FEMALE POWER BLOCK FOR (PG-14)	202651-2	BLUE (DAP)	111-20860	GRAY (DAP)
" (ACCEPTABLE ALTERNATE)	202651-1	BLACK (PHENOLIC)	111-20860-T43	BLACK (PHENOLIC)
PP POLARIZING PIN FOR (PG-13)	202888-1	NAT. NYLON		
CONTACTS	TYPE II LONG (SEE NOTE 3) TYPE III+ LONG (SEE NOTE 4)		(SEE NOTE 7)	

- AMP TYPE II CONTACTS (#16, .062" DIAMETER) 202507-1 AND 202508-1 ACCOMMODATE ONE #16 OR ONE #18 OR TWO #20 OR TWO #22 AWG WIRES WITH INSULATION GRIP (TOOL NO.90136-1). 202725-1 AND 202726-1 ACCOMMODATE TWO #18 OR ONE #14 AWG WIRES WITHOUT INSULATION GRIP (TOOL NO. 45098). 201578-1 AND 201580-1 ACCOMMODATE ONE #20 OR ONE #22 AWG WIRE WITH INSULATION GIRP (TOOL NO. 45099). THESE ARE TYPICAL CONTACTS ONLY AND OTHER CONTACTS HAVE SIMILAR CAPABILITIES. (SEE NOTE 8)
- AMP TYPE III AND CONTACTS (#16, .062" DIAMETER) A WIDE VARIETY OF TYPE III+ CONTACTS (SUCH AS PIN 66098-1 AND SOCKET 66100-1 AND MANY OTHERS) ARE AVAILABLE. (SEE NOTE 8)
- BIN CONNECTOR HOOD IS OPTIONAL. 0.031" (0.8MM) SPACER IS REQUIRED WHEN HOOD IS NOT USED.
- LOW RESISTANCE CONTACTS FOR HIGH CURRENT APPLICATIONS.
AMP TYPE II (#16, .062" DIAMETER) (SEE NOTE 3 AND NOTE 8)
- WINCHESTER CONTACTS (#16, .062" DIAMETER) (SEE NOTE 8)
(ALL CONTACTS LISTED BELOW USE WINCHESTER CRIMP TOOL #107-0970)

WIRES ACCOMMODATED	WINCHESTER PIN #	WINCHESTER SOCKET #	LOCATOR TO BE USED WITH CRIMP TOOL (WINCHESTER NO.)	NOTES
1-#14 OR 2-#18 OR 2-#20 AWG	100 - 7113P	-	107 - 0977 (BLUE)	WITHOUT INSULATION SUPPORT
1-#16 OR 1-#18 OR 1-#20 OR 2-#22 AWG	100 - 7116P	100 - 7113S	107 - 0982 (WHITE)	WITH INSULATION SUPPORT
1-#20 OR 1-#22 OR 1-#24 AWG	-	100 - 7116S	107 - 0977 (BLUE)	WITH INSULATION SUPPORT
	100 - 7120P	-	107 - 0982 (WHITE)	WITH INSULATION SUPPORT
	-	100 - 7120S	107 - 0776 (RED)	WITH INSULATION SUPPORT
	-	-	107 - 0985 (BLACK)	WITH INSULATION SUPPORT

- THE MANUFACTURERS OF THE COMPONENTS LISTED HEREON (FIG. 3b) HAVE ADVISED THAT THESE COMPONENTS ARE IN ACCORDANCE WITH FIG. 4a AND FIG 10. DIALYL PHTHALATE (DAP) CONNECTOR BLOCKS WERE ORIGINALLY SPECIFIED, PHENOLIC BLOCKS ARE NOW ACCEPTABLE.

Figure 3b. Connector Assembly Notes

REF	INCHES		MILLIMETERS	
	MIN.	MAX.	MIN.	MAX.
A	2.573	2.613	65.35	66.37
B	2.277	2.293	57.83	58.24
C	1.265	1.275	32.13	32.39
D	0.975	0.985	24.77	25.02
E	0.685	0.695	17.40	17.65
F	0.141	—	3.58	—
G	—	1.995	—	50.67
H	0.130	0.140	3.30	3.56
I	0.265	0.275	6.73	6.99
J	0.229	0.239	5.82	6.07
K	0.463	0.473	11.76	12.01
L	0.265	0.275	6.73	6.99
M	0.535	0.545	13.59	13.84
N	0.370	0.380	9.40	9.65
O	—	0.750	—	19.05
P	—	0.760	—	19.30
R	0.062	—	1.57	—
S	2.027	2.037	51.49	51.74
T	1.946	1.956	49.43	49.68
U	1.865	1.875	47.37	47.63
V	1.784	1.794	45.31	45.57
W	1.703	1.713	43.26	43.51
X	1.622	1.632	41.20	41.45
Y	1.541	1.551	39.14	39.40
Z	1.460	1.470	37.08	37.34
AA	1.379	1.389	35.03	35.28
BB	1.217	1.227	30.91	31.17
CC	1.055	1.065	26.80	27.05
DD	0.893	0.903	22.68	22.94
EE	0.731	0.741	18.57	18.82
FF	0.569	0.579	14.45	14.71
GG	0.488	0.498	12.40	12.65
HH	0.407	0.417	10.34	10.59
II	0.326	0.336	8.28	8.53
JJ	0.245	0.255	6.22	6.48
KK	0.151	0.161	3.84	4.09
LL	0.211	0.221	5.36	5.61
MM	0.427	0.437	10.85	11.10
NN	0.115	0.125	2.92	3.18
OO	0.300	0.320	7.62	8.13
PP	0.191	0.195	4.85	4.95
a	0.115	0.125	2.92	3.18
b	—	0.570	—	14.48
c	0.368	0.382	9.35	9.70
d	0.255	0.265	6.48	6.73
e	0.190	0.215	4.83	5.46
f	0.135	0.155	3.43	3.94
g	0.213	0.223	5.41	5.66
h	0.065	—	1.65	—
i	0.010	—	0.25	—
j	0.375	—	9.53	—
l	0.165	0.195	4.19	4.95
m	0.061	0.063	1.55	1.60
n	0.250	0.310	6.35	7.87
r	0.380	0.410	9.65	10.41
s	0.455	0.470	11.56	11.94
t	0.138	0.144	3.51	3.66
u	0.198	0.208	5.03	5.28
v	0.150	0.185	3.81	4.70
w	0.430	0.450	10.92	11.43
x	0.027	0.037	0.69	0.94
y	0.123	0.131	3.12	3.33
z	0.400	0.410	10.16	10.41
aa	0.175	0.185	4.45	4.70

NOTES:

1. THE MILLIMETER DIMENSIONS ARE DERIVED FROM THE ORIGINAL INCH DIMENSIONS.
2. THE PIN-SOCKET CONTACT RESISTANCE SHALL NOT EXCEED THREE MILLIOHMS WHEN CONTACT PIN EXTENDS 0.130 INCH (3.30 mm) BEYOND THE REFERENCE SURFACE OF THE BIN CONNECTOR BLOCK NOR SHALL IT EXCEED THREE MILLIOHMS FOR ANY PROTRUSION GREATER THAN 0.130 INCH (3.30 mm) BEYOND THE REFERENCE SURFACE OF THE BIN CONNECTOR BLOCK. PIN-SOCKET CONTACT RESISTANCE SHALL BE MEASURED AT ONE AMPERE.
3. NOTE 3 DELETED.
4. DEPTH OF HOLE IN GUIDE SOCKET AND GROUND GUIDE SOCKET SHALL BE ADEQUATE TO ACCOMMODATE GUIDE PINS WITH MAXIMUM PERMISSIBLE PROTRUSION WHEN REFERENCE FACES OF BIN AND MODULE BLOCKS ARE FULLY MATED.
5. SLOT 0.031 +/-0.005 INCH (0.79 +/-0.13 mm) WIDE, 0.050 +/-0.005 INCH (1.3 +/-0.13 mm) DEEP.
6. SLOT 0.032 +/-0.005 INCH (0.82 +/-0.13 mm) WIDE, 0.060 +/-0.005 INCH (1.5 +/-0.13 mm) DEEP.
7. 0.115 +/-0.005 INCH (2.92 +/-0.13 mm) ENTRANCE I.D. MUST ACCOMMODATE GROUND GUIDE PIN AND MUST EXERT SPRING PRESSURE ON GROUND GUIDE PIN WHEN MATED.

Figure 4b. Module and Bin Connector Dimensions and Notes

Figure 5. Bin and Module Connector Hoods
24

REF	INCHES		MILLIMETERS	
	MIN.	MAX.	MIN.	MAX.
a	0.380	—	9.65	—
b	0.229	0.239	5.82	6.07
c	0.463	0.473	11.76	12.01
d	0.470	0.480	11.94	12.19
e	0.945	0.955	24.00	24.26
f	*	*	*	*
g	2.150	2.160	54.61	54.86
h	2.276	2.286	57.81	58.06
i	2.529	2.539	64.24	64.49
j	2.782	2.792	70.67	70.92
k	0.120	0.130	3.05	3.30
l	0.248	0.258	6.30	6.55
m	0.11	0.14	2.8	3.6
n	0.128	—	3.25	—
o	—	0.077	—	1.96
p	0.028	0.034	0.71	0.86
r	0.672	0.702	17.07	17.83
s	0.995	1.005	25.27	25.53
t	0.495	0.505	12.57	12.83
u	—	0.15	—	3.8
v	2.839	2.849	72.11	72.36
w	2.557	2.567	64.95	65.20
x	0.277	0.287	7.04	7.29
y	0.40	0.60	10.	15.

* f. IS REFERENCE DIMENSION 2.030 INCH (51.56 mm)

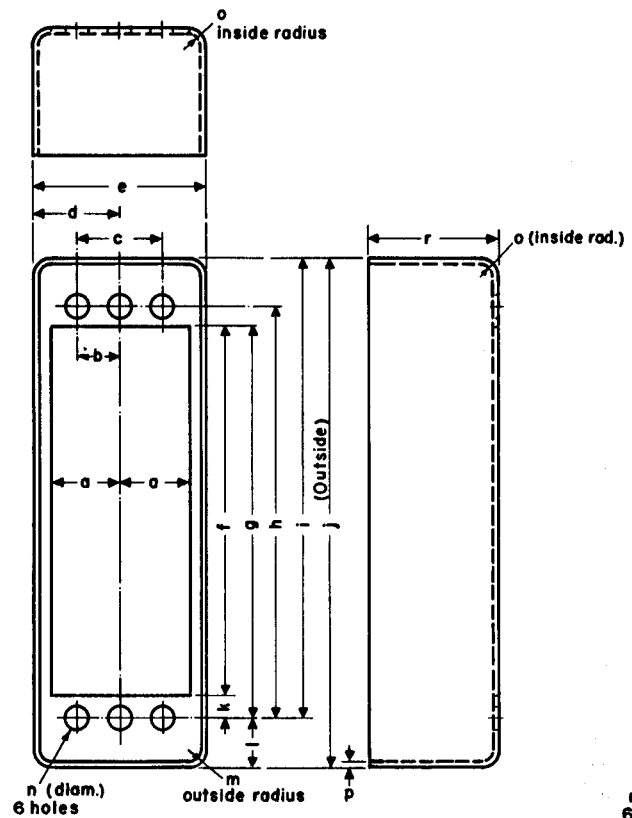

MODULE HOOD

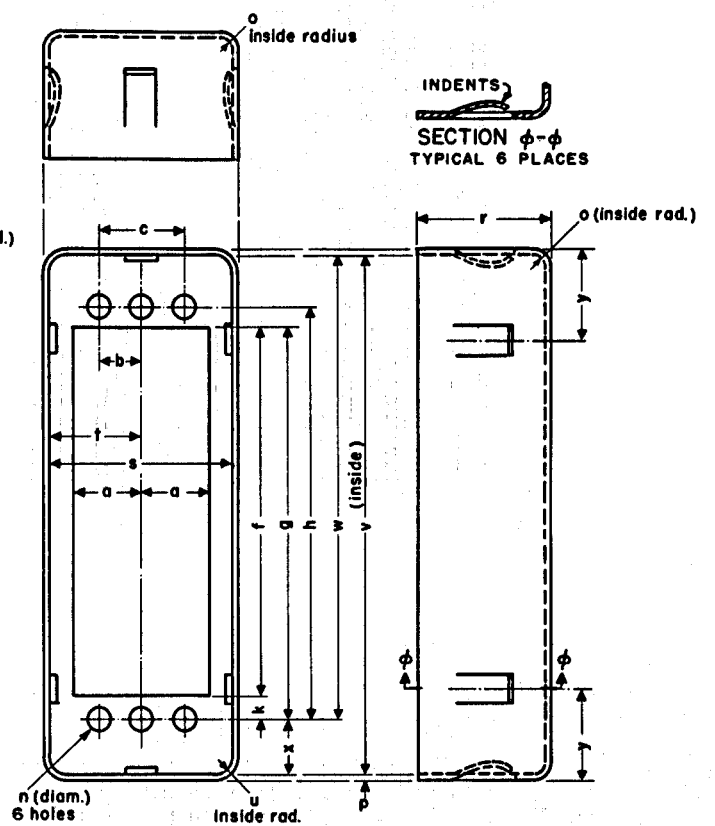

OPTIONAL BIN HOOD (GROUNDING TYPE)
(INDENTS OMITTED ON NONE GROUNDING TYPE)

- NOTES: -
1. THE MILLIMETER DIMENSIONS ARE DERIVED FROM THE ORIGINAL INCH DIMENSIONS.
 2. INDENTS ON GROUNDING TYPE BIN HOOD SHALL EXERT PRESSURE AGAINST MODULE HOOD TO ASSURE ELECTRICAL RESISTANCE OF NOT OVER 0.001 OHM BETWEEN THE HOODS. HOOD MATERIAL SHALL BE SUCH AS TO MAINTAIN ELECTRICAL RESISTANCE OF NOT OVER 0.001 OHM. (FOR EXAMPLE CADMIUM PLATED STEEL). THE FORCE NECESSARY TO INSERT MODULE HOOD INTO GROUNDING TYPE BIN HOOD SHALL NOT EXCEED 3 POUNDS WITH VERTICAL AND HORIZONTAL MISALIGNMENTS OF UP TO 0.015 INCH (0.38 mm).

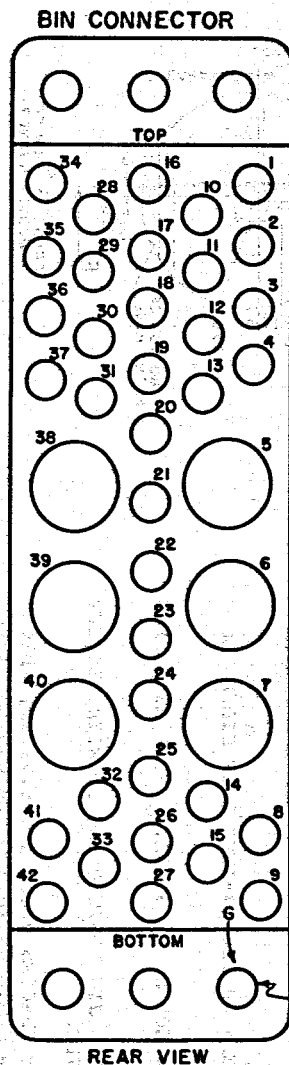

PIN	FUNCTION
1	RESERVED
2	RESERVED
3	SPARE
4	RESERVED
5	
6	
7	
8	+200 VOLTS D.C.
9	SPARE
10	+6 VOLTS
11	-6 VOLTS
12	RESERVED
13	SPARE
14	SPARE
15	RESERVED
16	+12 VOLTS
17	-12 VOLTS
18	SPARE
19	RESERVED
20	SPARE
21	SPARE
22	RESERVED
23	RESERVED
24	RESERVED
25	RESERVED
26	SPARE
27	SPARE
28	+24 VOLTS
29	-24 VOLTS
30	SPARE
31	SPARE
32	SPARE
33	117 VOLTS A.C. (HOT)
34	POWER RETURN GND
35	RESET
36	GATE
37	SPARE
38	
39	
40	
41	117 VOLTS A.C. (NEUTRAL)
42	HIGH QUALITY GND
G	GROUND GUIDE PIN

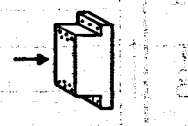
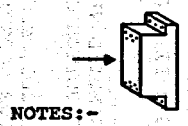
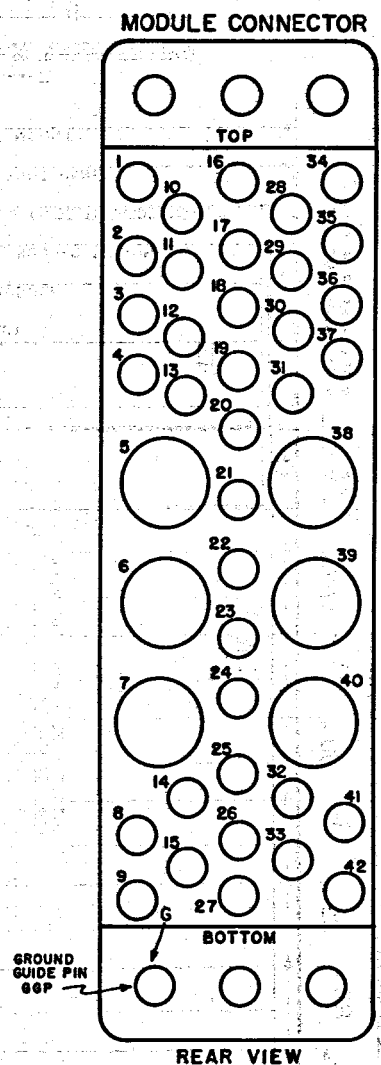

NOTES:-

- RESERVED PINS ARE FOR FUTURE ASSIGNMENT BY THE COMMITTEE AND SHALL NOT BE USED UNTIL SUCH ASSIGNMENTS ARE MADE.
- GP-1 = GUIDE PIN GGP = GROUND GUIDE PIN
GS-1 = GUIDE SOCKET GGS = GROUND GUIDE SOCKET
- THE POWER RETURN GROUND (BIN PIN 34) IS THE RETURN BUS FOR ALL dc SUPPLIES. THE HIGH QUALITY GROUND (BIN PIN 42) IS INTENDED AS ZERO POTENTIAL REFERENCE. HIGH QUALITY GROUND CURRENT LOAD BY ANY MODULE SHOULD BE LIMITED TO 1 MA. ALSO, PULSES OR VARYING LOADS SHOULD BE LIMITED TO NO MORE THAN 100 MICROAMPERES. CARE SHOULD BE TAKEN NOT TO CAPACITIVELY COUPLE HIGH QUALITY GROUND TO THE LOCAL GROUND. ANY CAPACITIVE COUPLING TO LOCAL GROUND SHOULD BE ISOLATED BY A RESISTANCE OF AT LEAST 1000 OHMS. THE CHASSIS GROUND IS NORMALLY CONNECTED TO THE BUILDING GROUND. CONNECTIONS BETWEEN THE HIGH QUALITY GROUND BUS (BIN PIN 42), THE POWER RETURN GROUND BUS (BIN PIN 34), AND THE CHASSIS ARE MADE AT THE GROUND GUIDE PIN OF PG1B.
- SIGNALS ON PINS 35 AND 36 SHALL UTILIZE THE "LOGIC LEVELS FOR TRANSMISSION OF DIGITAL DATA DOWN TO DC" OF THE NIM SPECIFICATIONS. A LOGIC "1" GATES ON AND RESETS.

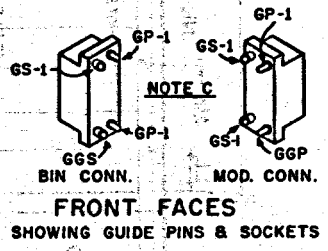
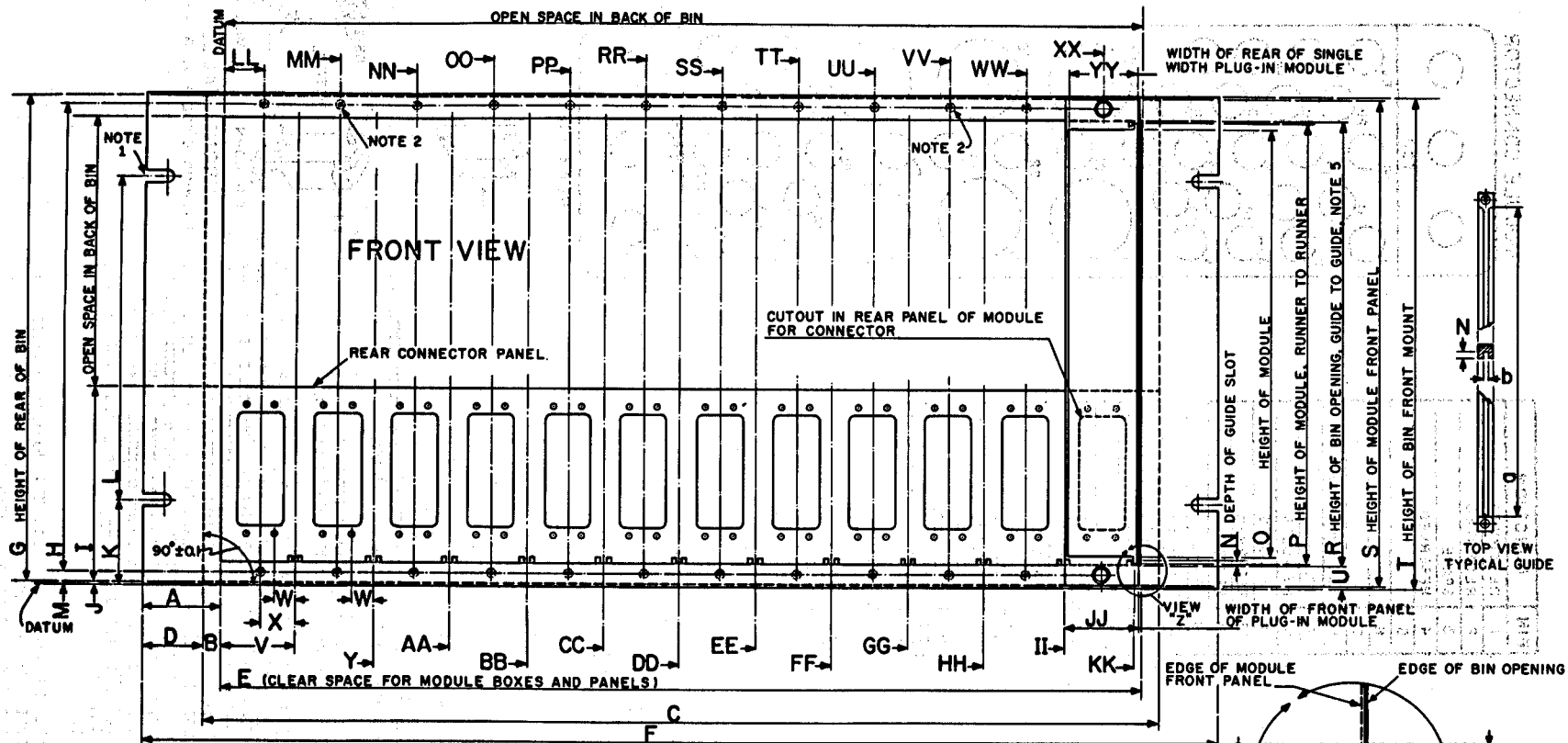

Figure 6. Bin and Module Connector Pin Assignments

Figure 7a. Bin, Front View



Notes:

1. OPEN OR CLOSED SLOTS IN ACCORDANCE WITH EIA OR IEC 19-INCH RACK STANDARDS (SEE SECTION 6.1 OF NIM STANDARD).
2. DRILL AND TAP FOR #6-32, CLASS 2 FIT, (24 HOLES) IF STEEL. DRILL AND PRESS THREADED INSERT IF ALUMINUM.
3. EACH POWER CONNECTOR TO BE ASSEMBLED WITH A JIG POSITIONING IT WITH RESPECT TO THE CENTER LINE OF ADJACENT BOTTOM GUIDE.
4. WHEN NOT USING BIN CONNECTOR HOODS, MOUNT SPACERS 0.031 IN (0.79 mm) THICK BETWEEN CONNECTORS AND CONNECTOR MOUNTING PLATE OR TAKE OTHER CONSTRUCTION MEASURES TO PROPERLY POSITION MATING FACE OF BIN CONNECTOR (SEE SECTION 6.3 OF NIM STANDARD).
5. R IS MEASURED BETWEEN INNER SLIDING SURFACES OF UPPER AND LOWER GUIDES.

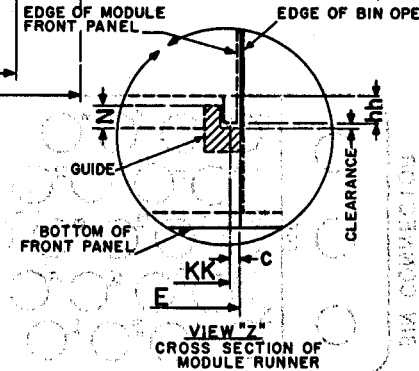
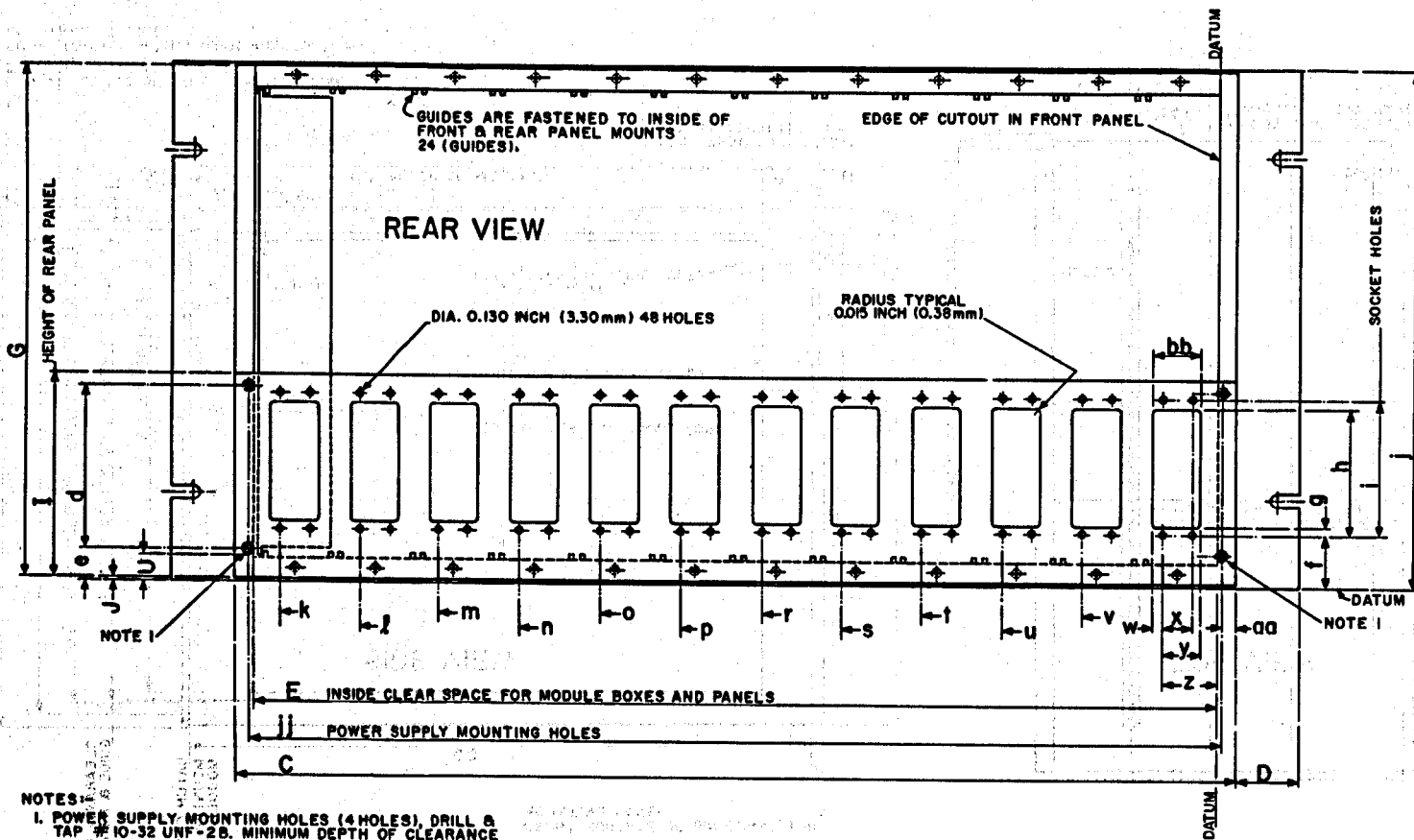

Figure 7b. Bin, Rear View
27



NOTES:

1. POWER SUPPLY MOUNTING HOLES (4 HOLES), DRILL & TAP #10-32 UNF-2B. MINIMUM DEPTH OF CLEARANCE HOLES BEHIND POWER SUPPLY MOUNTING HOLES TO BE .500 INCH (12.70 mm).
2. SEE NOTES 3 & 4 ON FRONT VIEW FIGURE REGARDING MOUNTING OF CONNECTORS.

Figure 7c. Bin, Side and Top Views
28

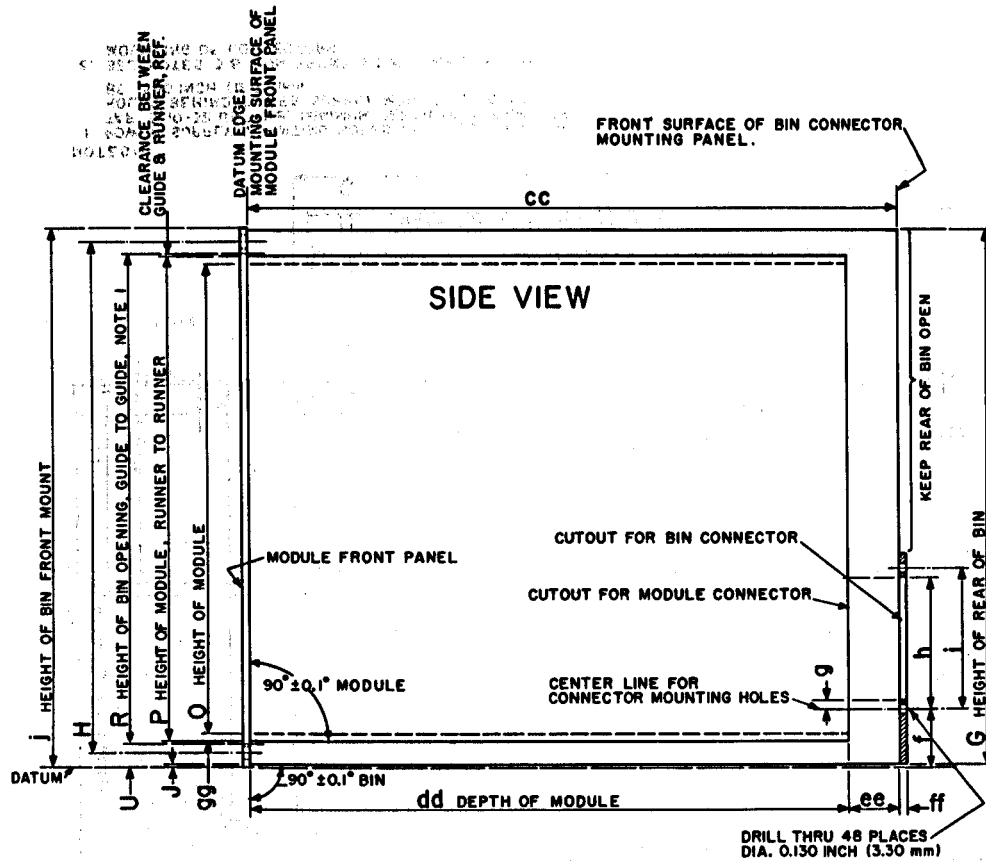

NOTES:-

1. R IS MEASURED BETWEEN INNER SLIDING SURFACES OF UPPER AND LOWER GUIDES.
2. GUIDE TO FALL WITHIN 0.005 INCH (0.13 mm) OF STRAIGHT LINE.

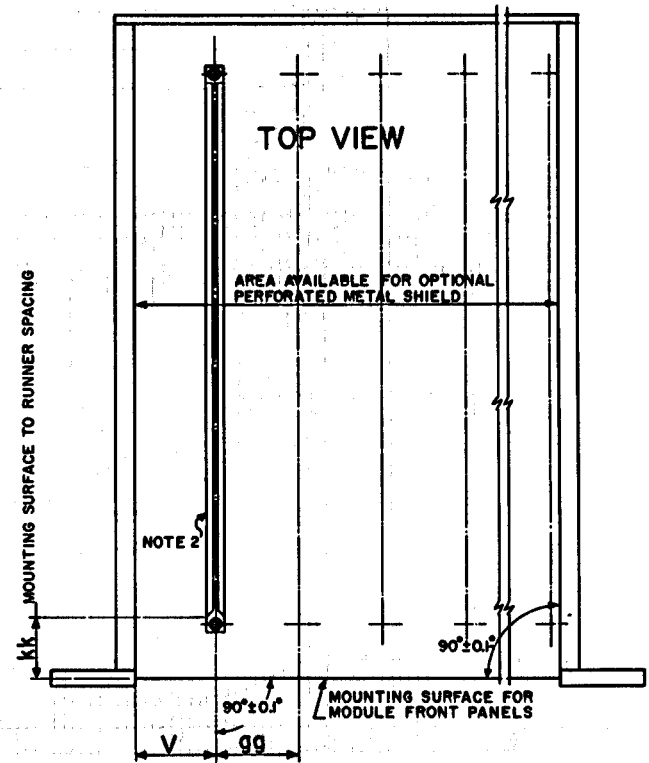

REF	Inches		Millimeters		REF	Inches		Millimeters	
	Min	Max	Min	Max		Min	Max	Min	Max
A	Note 7		Note 7		RR	7.449	7.459	189.20	189.45
B	"	8	"	8	SS	8.803	8.813	223.60	223.85
C	"	9	"	9	TT	10.157	10.167	257.99	260.24
D	"	9	"	9	UU	11.511	11.521	292.38	292.63
E	16.265	16.275	413.13	413.38	VV	12.865	12.875	326.77	327.02
F	18.970	19.030	481.84	483.36	WW	14.219	14.229	361.16	361.41
G	8.653	8.683	219.79	220.55	XX	15.573	15.583	395.55	395.80
H	8.300	8.280	210.32	210.82	YY	1.310	1.320	33.28	33.53
I	3.447	3.477	87.55	88.31	a	8.674Min, Note 10		220.32Min, Nt10	
J	0.018	0.028	0.46	0.71	b	0.079	0.089	2.00	2.26
K	1.474	1.494	37.44	37.94	c	(0.062 Ref)		(1.57 Ref)	
L	5.740	5.760	145.80	146.30	d	2.742	2.762	68.65	70.15
M	0.207	0.227	5.26	5.76	e	0.519	0.539	13.19	13.69
N	0.099	0.109	2.51	2.77	f	0.870	0.890	22.10	22.60
O	7.606	7.621	193.19	193.57	g	0.123	0.133	3.12	3.38
P	7.863	7.873	199.72	199.97	h	2.148	2.158	54.56	54.82
R	7.903	7.928	200.74	201.38	i	2.276	2.286	57.81	58.07
S	8.704	8.714	221.09	221.34	j	8.719	8.729	221.46	221.71
T	8.719	8.729	221.46	221.71	k	15.807	15.817	401.50	401.75
U	0.394	0.414	10.01	10.51	l	14.453	14.463	367.11	367.36
V	1.309	1.319	33.25	33.50	m	13.099	13.109	332.71	332.96
W	(0.396 Ref)		(10.06 Ref)		n	11.745	11.755	298.32	298.57
X	(0.630 Ref)		(16.00 Ref)		o	10.391	10.401	263.92	264.17
Y	2.663	2.673	67.64	67.89	p	9.037	9.047	229.54	229.79
AA	4.017	4.027	102.03	102.28	r	7.683	7.693	195.15	195.40
BB	5.371	5.381	136.42	136.67	s	6.329	6.339	160.76	161.01
CC	6.725	6.735	170.82	171.07	t	4.975	4.985	126.37	126.62
DD	8.079	8.089	205.21	205.46	u	3.621	3.631	91.97	92.22
EE	9.433	9.443	239.60	239.85	v	2.267	2.277	57.58	57.83
FF	10.787	10.797	273.99	274.24	w	0.156	0.166	3.96	4.22
GG	12.141	12.151	308.38	308.63	x	0.463	0.473	11.76	12.02
HH	13.495	13.505	342.77	343.02	y	0.624	0.634	15.85	16.11
II	14.849	14.859	377.16	377.41	z	0.913	0.923	23.19	23.44
JJ	1.340	1.350	34.04	34.29	aa	0.224	0.244	5.69	6.19
KK	16.203	16.213	411.56	411.81	bb	(0.790 Ref)		(20.07 Ref)	
LL	0.679	0.689	17.23	17.48	cc	10.500	10.515	266.70	267.08
MM	2.033	2.043	51.64	51.89	dd	9.664	9.674	245.47	245.72
NN	3.387	3.397	86.03	86.28	ee	(0.826 Ref)		(20.98 Ref)	
OO	4.741	4.751	120.42	120.67	ff	(0.125 Min)		(3.18 Min)	
PP	6.095	6.105	154.81	156.06	gg	(1.354 Ref)		(34.39 Ref)	
					hh	0.121	0.131	3.07	3.33
					jj	16.407	16.422	416.74	417.12
					kk	(1.000 Max)		(25.40 Max)	

Notes: (Notes 1-5 on Figs. 7a,b,c)

- Dimensions are absolute and include projections such as screw heads, etc. Angles zero degrees, 30 minutes unless otherwise specified.
- 1.080 in (27.43 mm) minimum if Module is offset; 1.368±0.010 in (34.75 ±0.25 mm) if Module space is centrally located.
- Chosen on basis of value of A.
- Dimensions C and D unspecified. However, bin shall mount in rack in accordance with Section 6.1 of NIM Standard. Room for optical mounting of slides is advantageous.
- Guiding portion of guide shall be at least 8.674 in (220.32 mm) long and shall be straight vertically and horizontally to within 0.005 in (0.13 mm) over total length. Guide entrance shall be tapered.

Figure 7d. Bin Dimensions

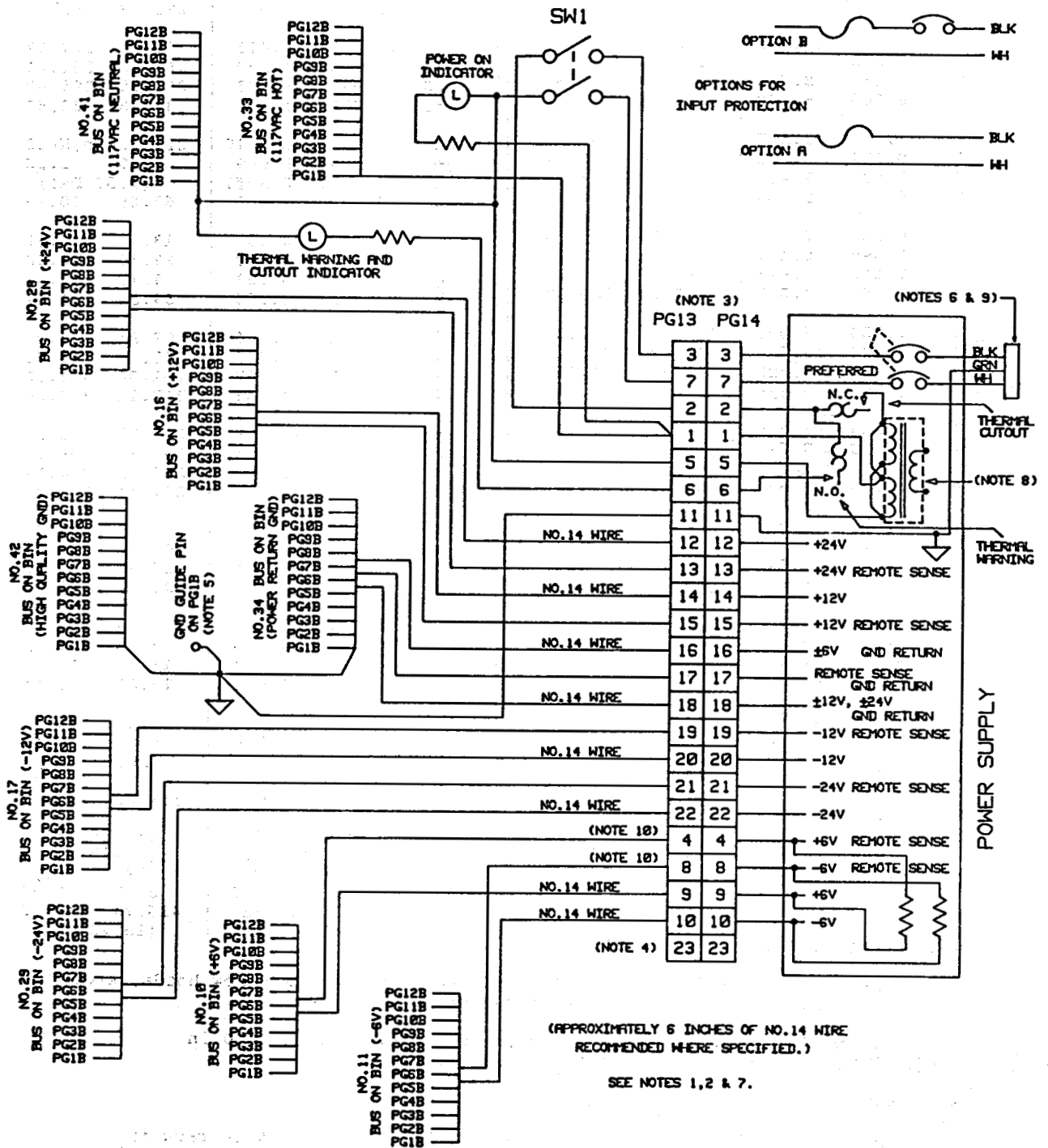
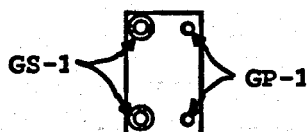

Figure 8a. Power Supply Connections and Bin Wiring

NOTES:

1. ALL WIRING BETWEEN PG13 AND PG1B THROUGH PG12B SHALL BE INCLUDED AS SHOWN.
2. THE BIN CONNECTORS, PGB, ARE DESIGNATED PG1B THROUGH PG12B TO INDICATE LOCATION IN BIN. PG1B IS ON RIGHT WHEN BIN IS VIEWED FROM FRONT, PG2B IS NEXT, ETC.
3. POWER CONNECTORS SHALL BE AS DEFINED IN THE FIGURE, "MODULE, BIN, AND POWER CONNECTORS".
4. POLARIZING PIN "PP" IS TO BE LOCATED IN POSITION 23 OF PG13.
5. CONNECTIONS BETWEEN THE HIGH QUALITY GROUND BUS (BUS PIN 42), POWER RETURN GROUND BUS (BUS PIN 34), CHASSIS GROUND (PIN 11 OF POWER SUPPLY CONNECTOR), AND CHASSIS ARE MADE NEAR THE GROUND GUIDE PIN OF PG1B.
6. A.C. PLUG FOR 117V A.C. SHALL BE NEMA 5-15P TWO POLE PLUG WITH U GROUND. POWER SHALL ENTER THE POWER SUPPLY VIA A CHASSIS-MOUNTED TWO POLE MALE RECEPTACLE WITH GROUNDING PIN, OR DIRECTLY THROUGH POWER CORD. PLUGS AND RECEPTACLES FOR 230V A.C. POWER ARE NOT SPECIFIED. ALTERNATIVELY, THE A.C. PLUGS AND RECEPTACLES SHALL BE AS REQUIRED IN THE COUNTRY IN WHICH THE POWER SUPPLY IS USED.
7. STANDARD POLARIZATION OF PG1B THROUGH PG12B (BY MEANS OF GUIDE PINS AND SOCKETS) IS AS SHOWN BELOW. ANY BIN WIRING OTHER THAN STANDARD SHALL INCLUDE CONNECTOR POLARIZATIONS THAT PREVENT MATING WITH STANDARD MODULES.



VIEWED FROM FRONT OF BIN

8. FOR 230V MAINS, CONNECTIONS SHOULD BE AS SHOWN AT RIGHT.

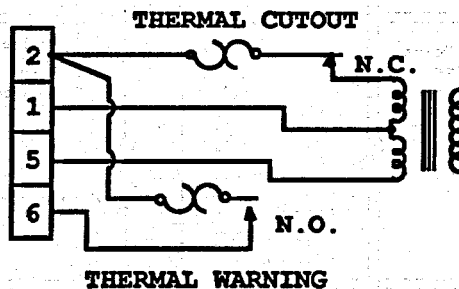

9. BINS MANUFACTURED BEFORE 1980 MAY NOT HAVE WIRING BETWEEN 6V BUSES AND PINS 4 AND 8 OF PG13.

Figure 8b. Power Supply Connection and Bin Wiring Notes

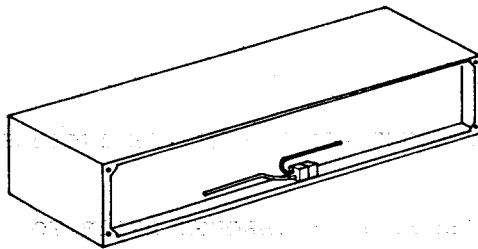

NOTES:

1. The front surface shall not have a flatness deviation greater than ± 0.015 inch per foot (± 1.3 mm per meter).
2. Dimensions are absolute and include projections, such as screw heads, etc.
3. Connector is PG14 of Figures 8a and 3a and shall be mounted to the power supply by means of a suitable bracket.

DIMENSION	ENGLISH UNITS		METRIC UNITS	
	Inches	Tolerance	mm	Tolerance
A	1	0	25.4	0.0
B	0.891	0	22.6	0.0
C	2.392	0.01	60.8	0.3
D	0.188	0.01	4.8	0.3
E	0.115	0.025	2.9	0.6
F	0.115	0.025	2.9	0.6
G	0.073	0	1.9	0
H	2.752	0.01	69.9	0.3
J	0.219	0.015	5.6	0.4
K	0.531	0.015	13.5	0.4
L	0.468	0.015	11.9	0.4
M	8.413	0.5	213.7	12.7
N	0.73	0	18.5	0.0
P	16.825	0.015	427.4	0.4
Q	0.5	0	12.7	0.0
R	0.531	0.015	13.5	0.4
S	3.438	0	87.3	0.0
T	18.407	0.015	466.7	0.4
U	15.263	0.015	413.1	0.4
V	16.763	REF.	400.4	REF.
W	4.5	0	114.3	0.0
X	4.55	0	115.6	0.0

* Indicates that this tolerance is unspecified
REF. indicates that the dimension is for reference only

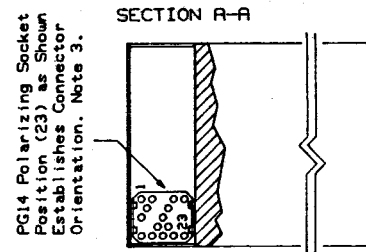
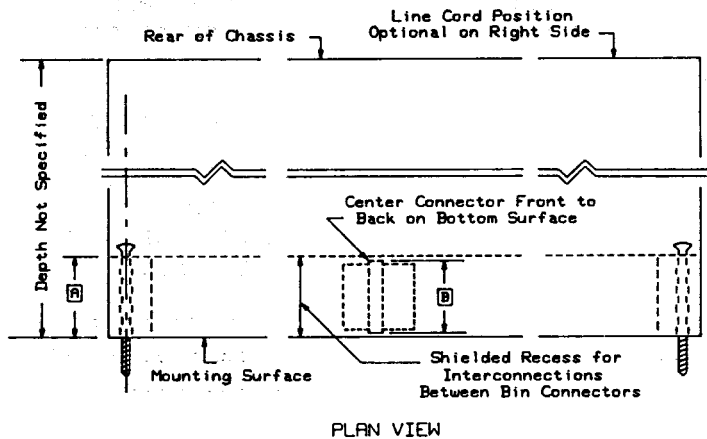

Beyond the Dimension **W**, the Power Supply Chassis May Extend Upward to the Maximum Height Given as Dimension **X**.

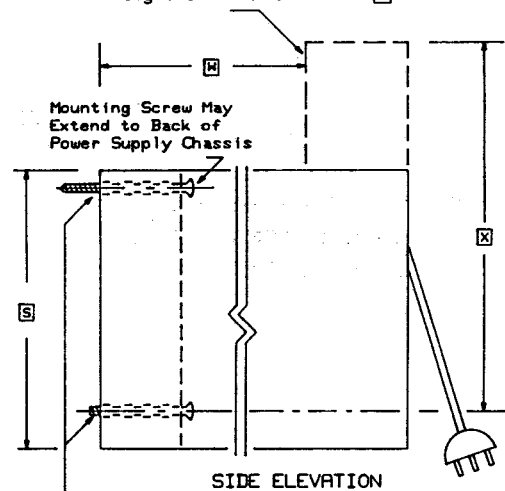
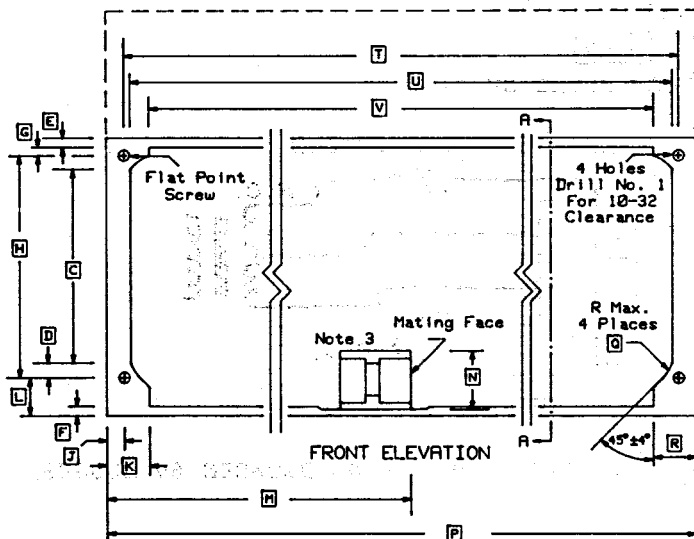

No. 10-32 UNF-2B Captive Screw (4 Places).
3 Screws (With Pilot Point) Extending 0.375" \pm 0.030"
(9.5mm \pm 0.8mm) Past Edge of Chassis, 1 Screw with
Flat End Extending 0.125" (3mm) Past Edge of Chassis.

Figure 9. Power Supply Outline

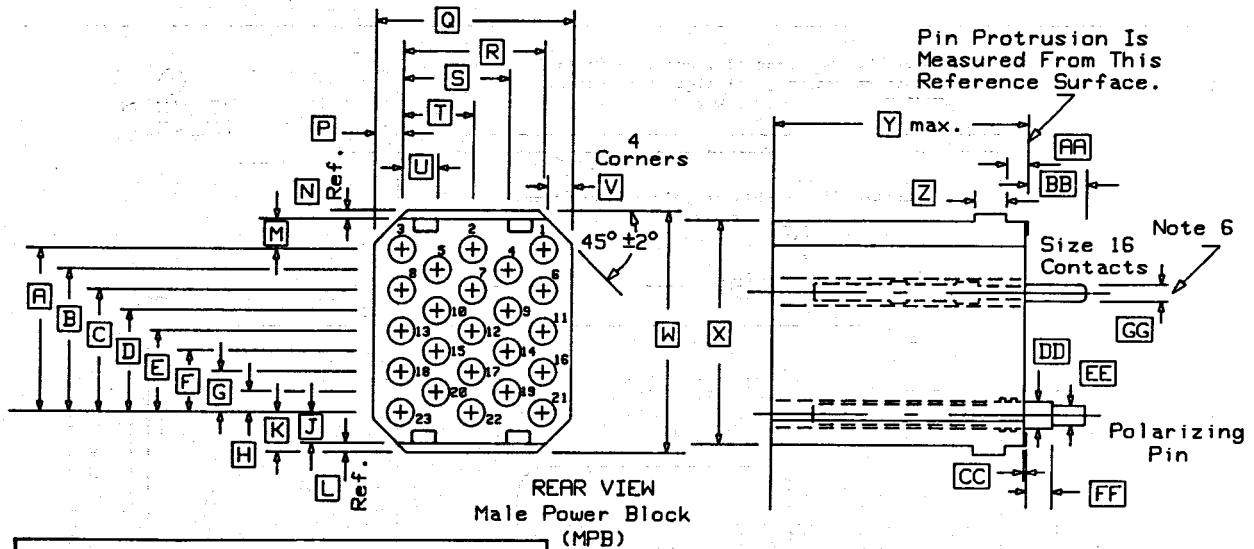

DIMENSION	ENGLISH UNITS		METRIC UNITS	
	Inches	Tolerance [1]	mm	Tolerance [1]
A	0.6	+	15.2	+
B	0.525		13.3	
C	0.45		11.4	
D	0.375		9.5	
E	0.3		7.6	
F	0.225		5.7	
G	0.15		3.8	
H	0.075		1.9	
I	0.113		2.9	
J	0.145		3.7	
K	0.032	REF.	0.8	REF.
L	0.113		2.9	
M	0.032	REF.	0.8	REF.
N	0.102		2.6	
O	0.726		18.4	
P	0.52		13.2	
Q	0.39		9.9	
R	0.26		6.6	
S	0.13		3.3	
T	0.09	0.01	2.3	0.3
U	0.888		22.6	
V	0.825		21.0	
W	0.93	0	23.6	0.0
X	0.116	0.002	2.9	0.1
Y	0.074	0.006	1.9	0.2
Z	0.22	0.12	5.6	3.0
AA	0.004	0.004	0.1	0.1
BB	0.125	0.004	3.2	0.1
CC	0.11		2.8	
DD	0.1	0.07	2.5	1.8
EE	0.062	0.001	1.6	0.0
FF	0.004	0.004	0.1	0.1
GG	0.48	0.004	12.2	0.1
HH	0.93	0	23.6	0.0
II	0.116	0.002	2.9	0.1
JJ	0.13	0	3.3	0.0
KK	0.825		21.0	
LL	0.888		22.6	
MM	0.15		3.8	
NN				
PP				
QQ				

[1] Tolerances are ±0.05° (0.1mm) unless otherwise specified.
 * indicates that this tolerance is unspecified
 REF. indicates that the dimension is for reference only

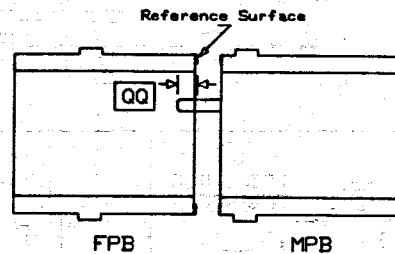
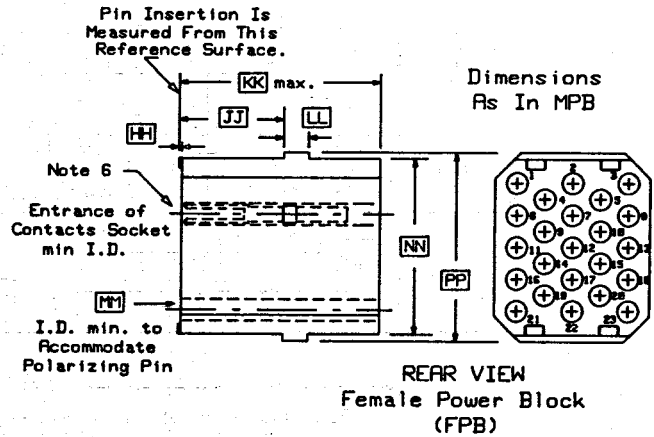

The Pin-Socket Contact Resistance Shall Not Exceed 3.0 Milliohms When the Contact Pin Extends [QQ] Beyond the Reference Surface of the Connector Block FPB, Nor Shall It Exceed 3.0 Milliohms for Any Insertion Greater Than [QQ] Beyond the Reference Surface of the Connector Block FPB (See Figure Above). Pin-Socket Contact Resistance Shall Be Measured At 1 Ampere. For Low Resistance Contacts for High Current Applications the Pin-Socket Contact Resistance Shall Not Exceed 1.5 Milliohms Under the Above Conditions.

Figure 10. Power Connectors

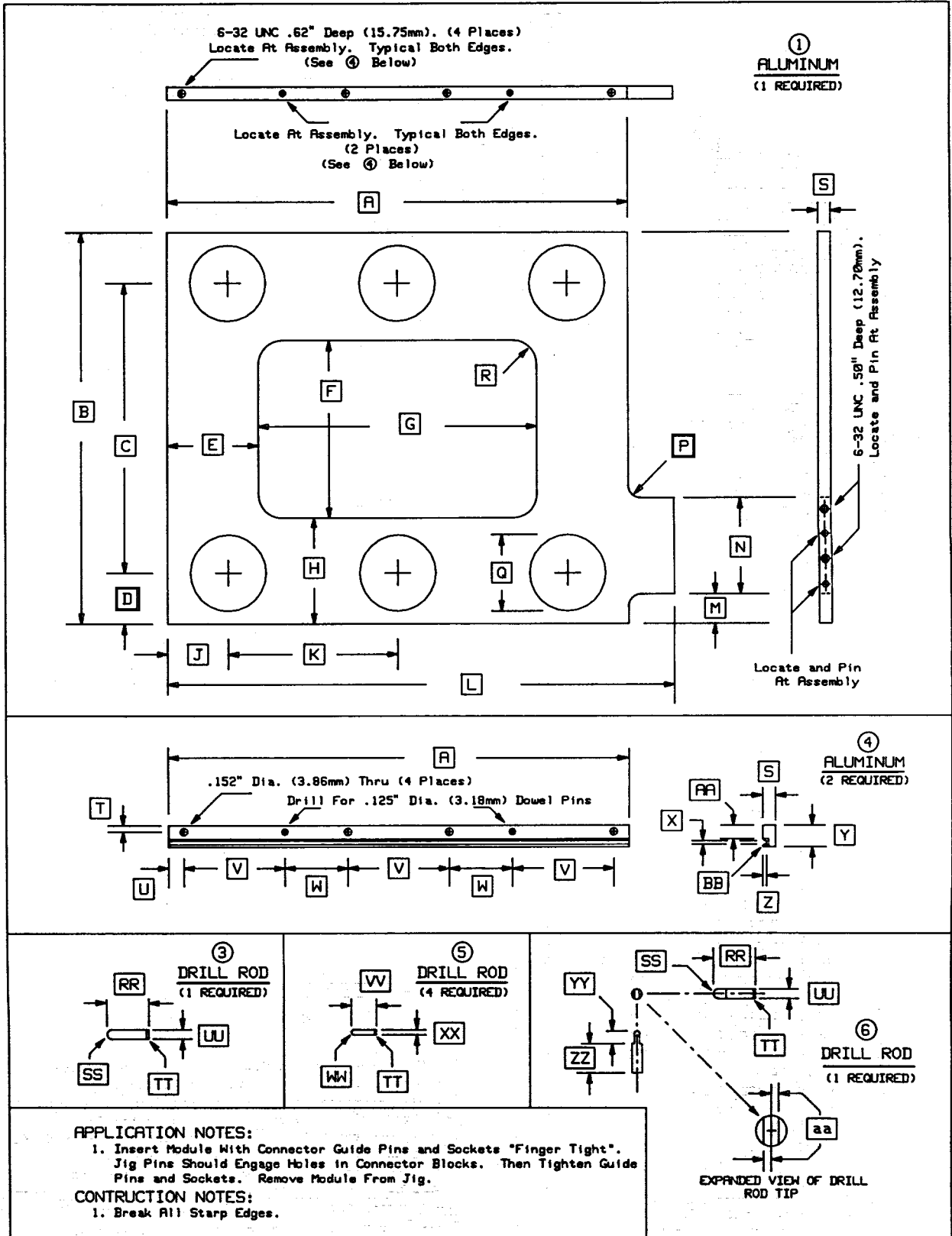
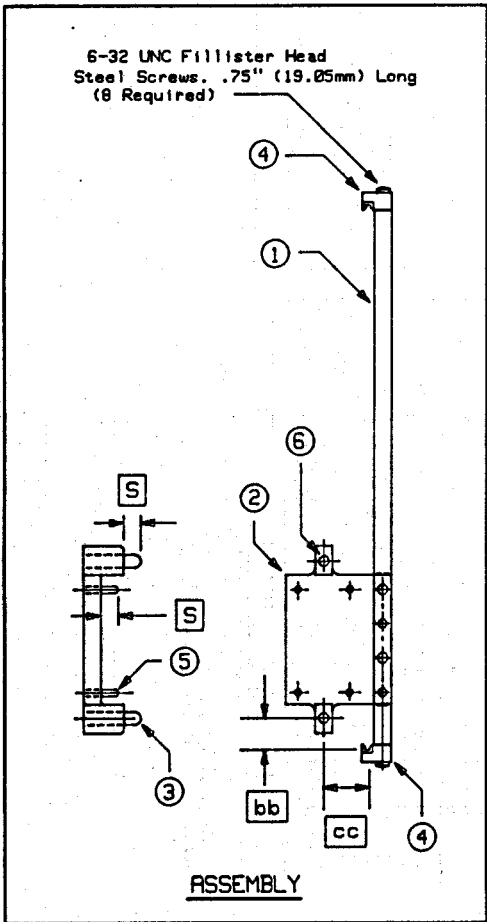
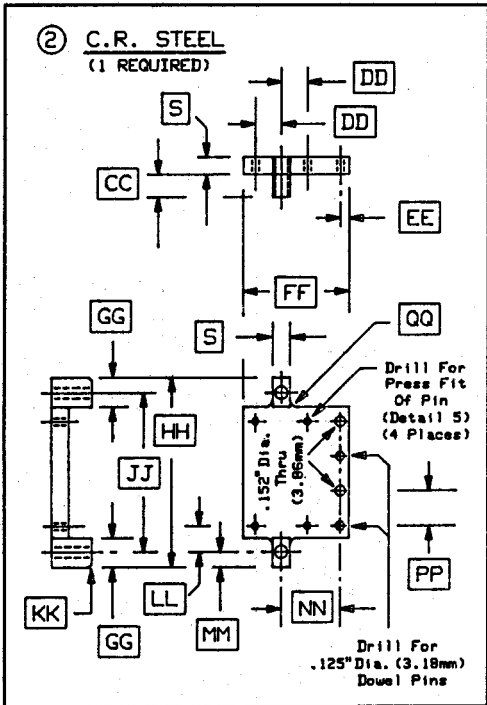

Figure 11a. Module Connector Jig, Sheet 1



DIMENSION	ENGLISH UNITS		METRIC UNITS	
	Inches	Tolerance [1]	mm	Tolerance [1],[2]
A	9.10		231.1	
B	7.732	0.001 0.001	196.39	0.03 0.03
C	5.73		145.5	
D	1.00		25.4	
E	1.80		45.7	
F	3.50		88.9	
G	5.50		139.7	
H	2.10		53.3	
J	1.18		30.0	
K	3.37	TYP. TYP.	85.6	TYP. TYP.
L	10.00		254.0	
M	0.58		14.7	
N	1.91		48.5	
P	[3] 0.25	TYP. TYP.	6.4	TYP. TYP.
Q	1.50	TYP. TYP.	38.1	TYP. TYP.
R	[3] 1.00	0.00 *	25.4	0.0 *
S	0.25		6.4	
T	0.125	0.005 0.005	3.2	0.1 0.1
U	.30		30.0	
V	2.00		50.8	
W	1.25		31.8	
X	0.071	0.003 0.00	1.8	0.1 0.0
Y	0.43		10.9	0.0 *
Z	0.075	0.001 0.001	1.91	0.03 0.03
AA	0.308	0.005 0.005	7.8	0.1 0.1
BB	[4] 0.04		1.0	
CC	0.330	0.005 0.005	8.4	0.1 0.1
DD	0.338	0.001 0.001	8.59	0.03 0.03
EE	0.125	0.005 0.005	3.2	0.1 0.1
FF	1.53		38.9	
GG	0.420	0.005 0.005	10.7	0.1 0.1
HH	2.720	0.000 0.002	69.09	0.00 0.05
JJ	2.281	0.001 0.001	57.94	0.03 0.03
KK	[5] 0.04		1.0	
LL	0.37		9.4	
MM	0.219	0.005 0.005	5.6	0.1 0.1
NN	0.851	0.005 0.005	21.6	0.1 0.1
PP	0.50	TYP. TYP.	12.7	
QQ	[3] 0.10	TYP. TYP.	2.5	TYP. TYP.
RR	0.83		21.1	
SS	[3] 0.093	0.005 0.005	2.4	0.1 0.1
TT	[5] 0.04		1.0	
UU	[6] 0.1875	0.001 0.001	4.76	0.03 0.03
VV	0.50		12.7	
WW	[3] 0.05		1.3	
XX	[6] 0.100	0.001 0.001	2.54	0.03 0.03
YY	0.25		6.4	
ZZ	0.58		14.7	
aa	0.050	0.000 0.005	1.3	0.0 0.1
bb	0.481	0.001 0.001	11.71	0.03 0.03
cc	0.668	0.001 0.001	16.97	0.03 0.03

- [1] Tolerances are $\pm 0.01"$ (0.3mm) unless otherwise specified.
- [2] Metric dimensions are derived from the English dimensions.
- [3] Radius
- [4] 45° chamfer, both ends around grooves
- [5] 45° chamfer
- [6] Diameter
- * Indicates that this tolerance is unspecified.
- TYP Indicates that this dimension typifies others that may not be shown on the drawing.

Figure 11b. Module Connector Jig, Sheet 2

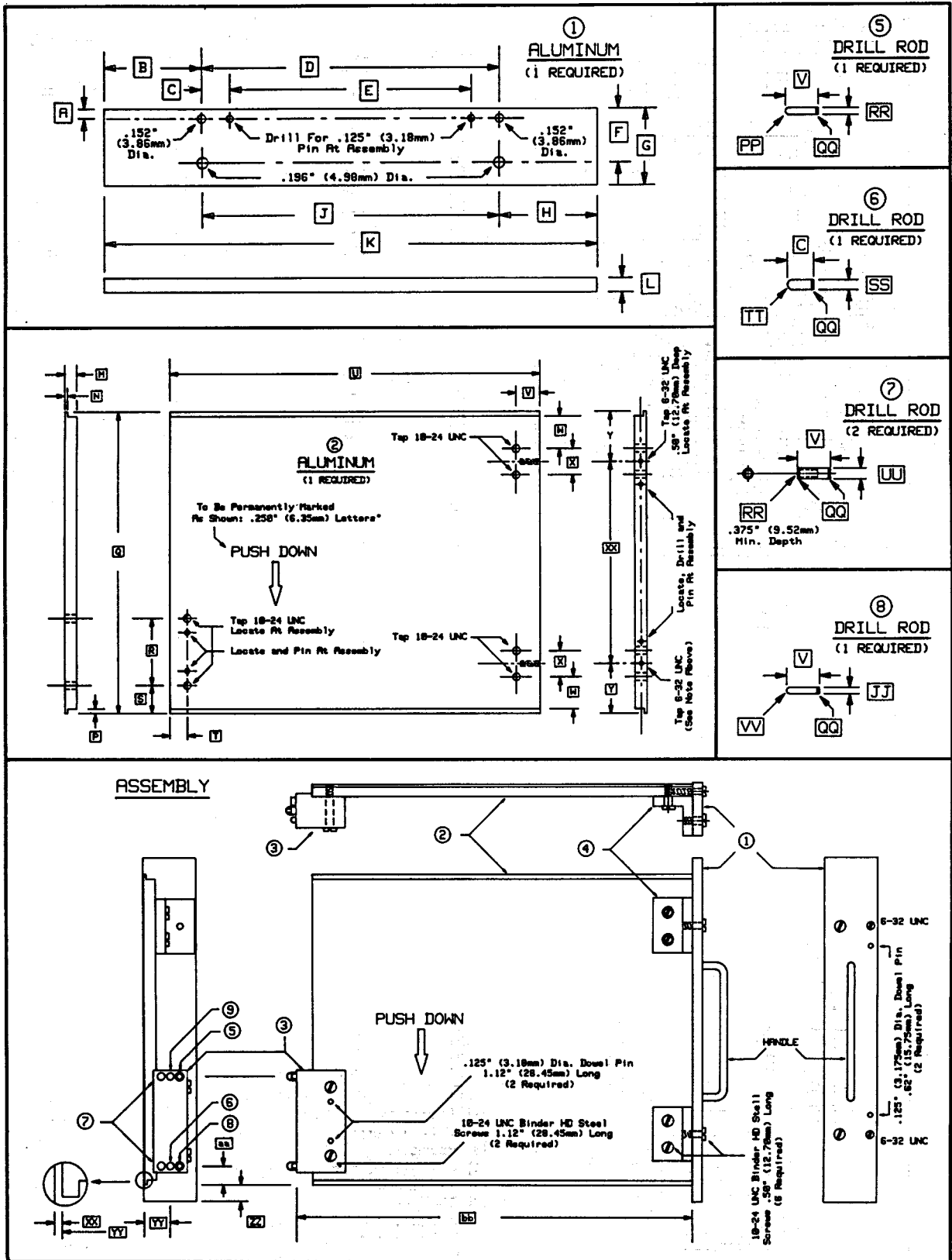
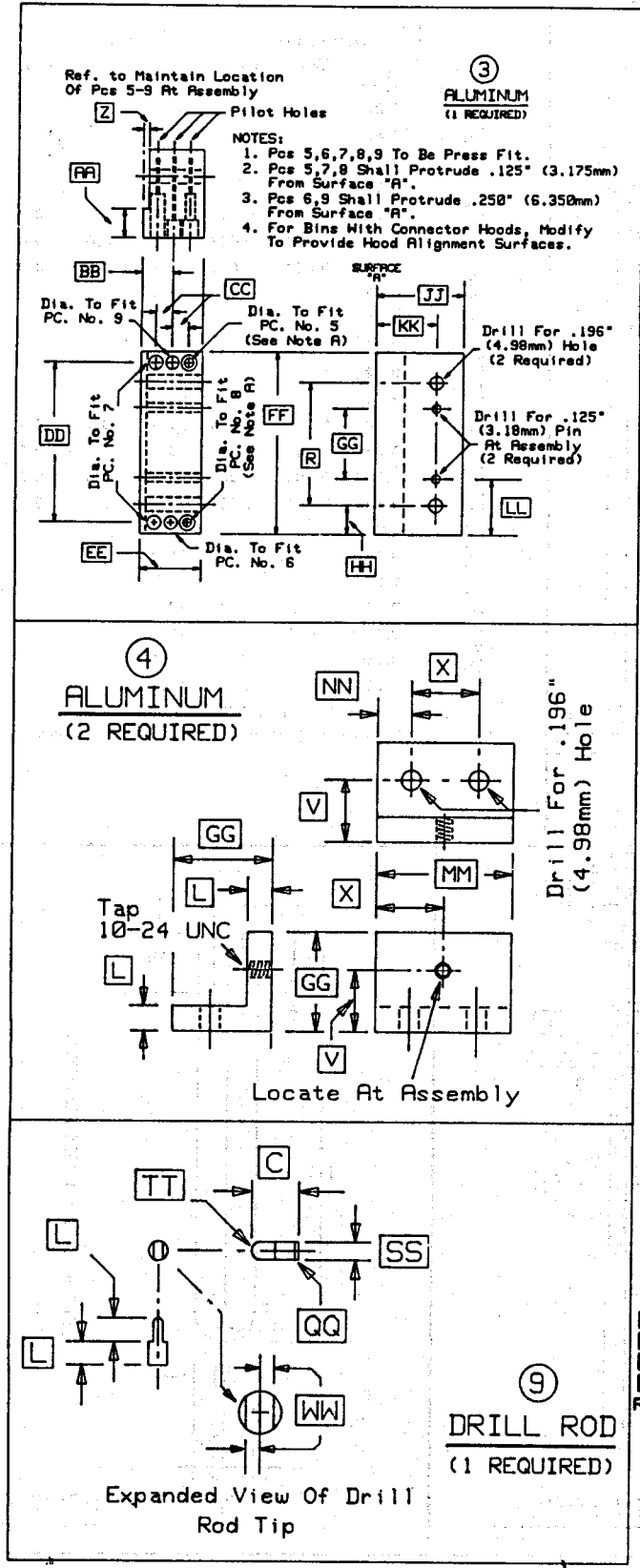

Figure 12a. Bin Connector Jig, Sheet 1



DIMENSION	ENGLISH UNITS		METRIC UNITS		
	Inches	Tolerance [1]	mm	Tolerance [1],[2]	
A	0.17		4.3		
B	1.72		43.69		
C	0.50		12.7		
D	5.27		133.9		
E	4.27		108.5		
F	0.95		24.1		
G	1.350	0.002	34.3	0.1	0.0
H	1.73		43.9		
J	5.25		133.4		
K	8.714	0.00	221.3	0.0	0.3
L	0.25		6.4		
M	0.31		7.9		
N	0.070	0.001	1.8	0.0	0.0
P	0.120	0.001	3.0	0.0	0.0
Q	7.874	0.001	200.0	0.0	0.0
R	1.75	REF	44.5	REF	REF
S	0.74	REF	18.8	REF	REF
T	0.453	REF	11.5	REF	REF
U	9.674	0.005	245.7	0.1	0.1
V	0.62	REF	15.7	REF	REF
W	0.84	REF	21.3	REF	REF
X	0.68	REF	17.3	REF	REF
Y	1.30	REF	33.0	REF	REF
Z	0.083	REF	2.11	REF	REF
AA	0.414	REF	10.5	REF	REF
BB	0.437	0.005	11.1	0.1	0.1
CC	0.234	0.002	5.9	0.1	0.1
DD	2.251	0.001	57.18	0.03	0.03
EE	0.87		22.1		
FF	2.60		66.0		
GG	1.00		25.4		
HH	0.42		10.67		
JJ	1.25		31.75		
KK	0.87		22.1		
LL	0.80		20.3		
MM	1.37		34.8		
NN	0.54		13.7		
PP [3]	0.067		1.7		
QQ [4]	0.04		1.0		
RR	0.134	0.001	3.4	0.0	0.0
SS	1.875	0.001	47.6	0.0	0.0
TT [3]	0.09		2.3		
UU	0.204	0.001	5.18	0.03	0.03
VV [3]	0.06		1.5		
WW	0.10		2.5		
XX	5.27	REF	REF		

[1] Tolerances are ±0.01" (0.3mm) unless otherwise specified.
 [2] Metric dimensions are derived from the English dimensions.
 [3] Radius
 [4] 45° chamfer
 REF Indicates that the dimension is for reference only.
 * Indicates that this tolerance is unspecified.

Note A: (For piece 3),
 Counterbore 0.225" (5.7mm) Dia. X 0.250" (6.4mm) deep.

Figure 12b. Bin Connector Jig, Sheet 2

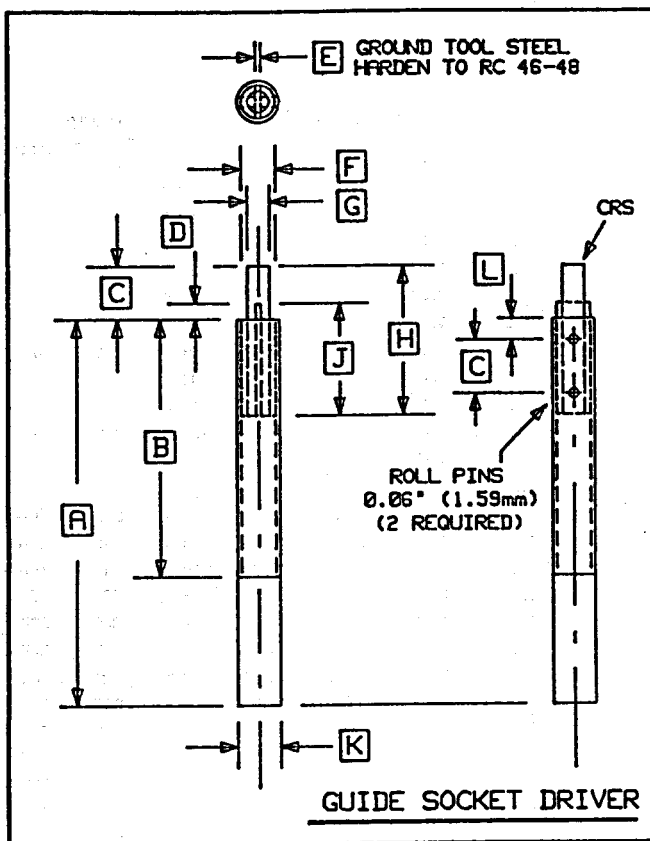

DIMENSION	ENGLISH UNITS		METRIC UNITS		
	Inches	Tolerance [1]	mm	Tol. [1],[2]	
A	2.25		57.2		
B	1.50		38.10		
C	0.31		7.9		
D	0.09		2.3		
E	0.031	0.001	0.8	0.0	0.0
F	0.203	0.001	5.2	0.0	0.0
G	0.130	0.001	3.3	0.0	0.0
H	0.88		22.4		
I	0.66		16.8		
J	0.25		6.4		
K	0.12		3.0		
L	2.75		69.9		
M	1.125	0.005	28.6	0.1	0.1
N	0.026	0.00	0.7	0.0	0.0
O	0.098	0.001	2.5	0.0	0.0
P	0.135	0.001	3.4	0.0	0.0
Q	0.38		9.7		
R	0.44		11.2		
S	0.38		9.7		
T	3.50		88.9		
U	0.75		19.1		
V	0.25		6.4		
W	0.50		12.7		

[1] Tolerances are ±0.01" (0.3mm) unless specified.
 [2] Metric dim's are derived from English dimensions.

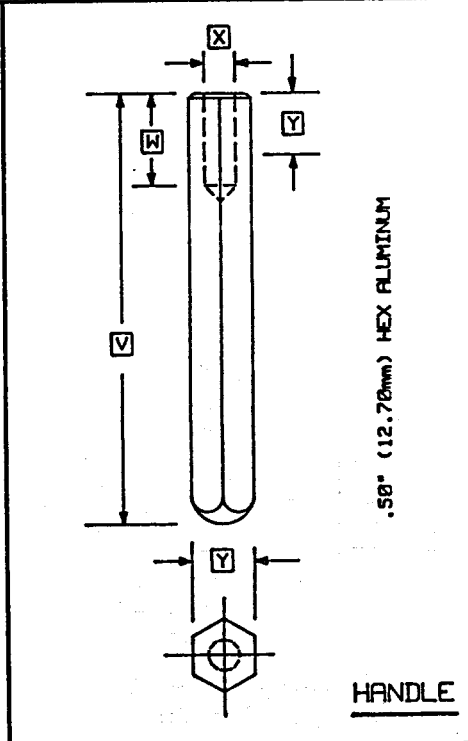
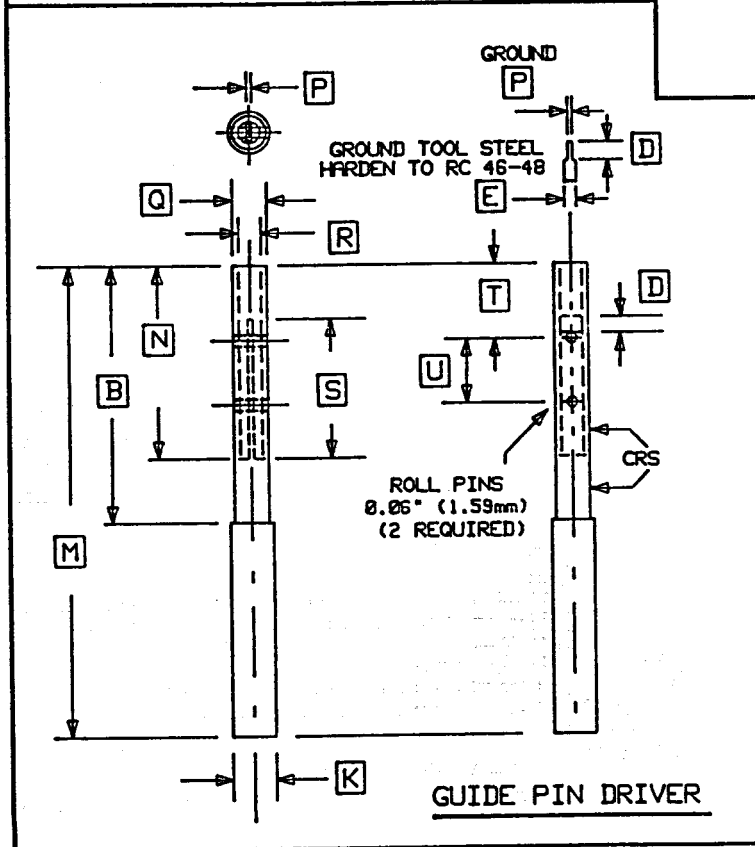
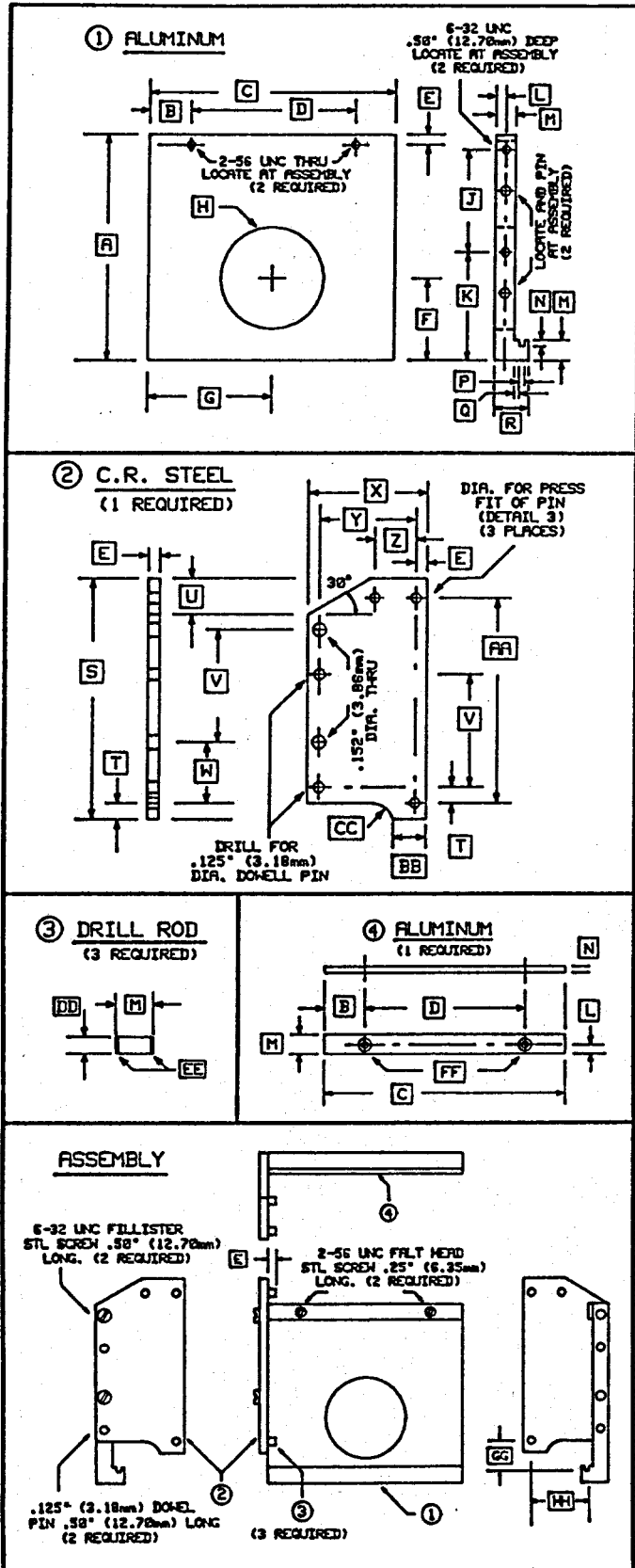

Figure 13. Module and Bin Connector Installation Tools



DIMENSION	ENGLISH UNITS		METRIC UNITS		
	Inches	Tolerance [1]	mm	Toler-	[1],[2]
A	2.75		69.9		
B	0.50		12.70		
C	3.00		76.2		
D	2.00		50.8		
E	0.125		3.2		
F	1.00		25.4		
G	1.50		38.1		
H	[3] 1.25		31.8		
J	1.25	REF REF	31.8	REF	REF
K	1.32	REF REF	33.5	REF	REF
L	0.12	REF REF	3.0	REF	REF
M	0.25		6.4		
N	0.075	0.005 0.005	1.9	0.1	0.1
P	0.070	0.005 0.005	1.8	0.1	0.1
Q	0.059	0.005 0.005	1.5	0.1	0.1
R	0.43		10.9		
S	2.68		68.1		
T	0.18		4.6		
U	0.40		10.2		
V	1.25		31.8		
W	0.68		17.3		
X	1.336	0.005 0.005	33.9	0.1	0.1
Y	1.086	0.005 0.005	27.6	0.1	0.1
Z	0.486	0.001 0.001	12.34	0.03	0.03
AA	2.281	0.001 0.001	57.9	0.0	0.0
BB	0.37		9.4		
CC	[4] 0.25		6.4		
DD	0.118	0.001 0.00	3.00	0.03	0.00
EE	[5] 0.03		0.8		
FF	[6]				
GG	0.461	0.001 0.001	11.7	0.03	0.03
HH	0.902	0.001 0.001	22.91	0.03	0.03

- [1] Tolerances are ±.01" (0.3mm) unless specified.
 - [2] Metric dimensions are derived from English dimensions.
 - [3] Diameter
 - [4] Radius
 - [5] 45° Chamfer
 - [6] .089" (2.3mm) Dia. hole, CS'K 0.82" (21mm) X 0.5" (13mm) deep.
- REF indicates that the dimension is for reference only.

Figure 14. Module Rail Jig

APPENDIX A

ECL (EMITTER COUPLED LOGIC) FRONT PANEL INTERCONNECTIONS

CONTENTS

Section	Page
A. General	A-1
A.1 Signal Amplitude and Levels.....	A-1
A.2 Cables.....	A-1
A.3 Connectors	A-1
A.4 Connector Signal Assignments	A-2
A.5 Connector Location on Module	A-2
A.6 Drivers, Receivers and Terminators.....	A-2
A.7 Cable Terminators.....	A-2
A.8 State of Receiver Output.....	A-3
A.9 Index	A-3

A. GENERAL

This specification for front panel interconnection is based on the recommendations of the major ECL logic manufacturers for communication between different parts of a system. They advise use of differential line driving and receiving for high noise immunity and cancellation of ground potential differences.

A.1. Signal Amplitude and Levels

Signals *shall* be ECL 10K or 10KH compatible with differential pairs with nominal -0.9 V level on one line and nominal -1.7 V level on the other line (for ECL positive logic a -0.9 V level is a logic "1" and a -1.7 V level is a logic "0").

A.2. Cables

Interconnections *shall* be made with single or multiple pair cables of nominal 70 ohms impedance when driven differentially.

A.3. Connectors

Connectors *shall* be of the IDC (Insulation Displacement Connector) type or equivalent with a 0.100 x 0.100 inch (2.54 x 2.54 mm) grid. The pin contact connector or header assembly *shall* be on the Module and the socket contact connector or receptacle assembly (cable connector assembly) *shall* be on the cable. The pin contact assembly connector on the Module *shall* have square pins with cross-section of .025 x .025 inch (0.635 x 0.635 mm) and length of 0.244 .020 inch (6.20 ±0.50 mm). For single twisted pair interconnections the cable connector assembly *shall* have a thickness of not more than 0.100 inch (2.54 mm).

The connector assembly should preferably be keyed as in MIL-C-83503(1984), "General Specification for Connector, Electrical, Flat Cable, and Printed Wiring Boards, Nonenvironmental", or color coded, and should have a locking mechanism.

A.4. Connector Signal Assignments

For keyed connector assemblies, the high true signals *shall* be on the keyed side and the low true signals on the opposite side. For color coded connector assemblies the high true signals *shall* be on the dark colored side and the low true signals on the light colored side. The header assembly on the Module *shall* have the high true signal(s) on its left hand pin(s) and the low true signal(s) on its right hand pin(s) as seen when facing the front panel.

A.5. Connector Location on Module

The connector location on the Module *shall* be such that the mating cable connector does not extend beyond the edges of the front panel.

A.6. Drivers, Receivers, and Terminators

The output drivers *shall* be of the voltage output type (such as 10116, 10216, 10101, 10105, etc) and *shall* deliver a nominal differential voltage swing of 1.6 V peak-to-peak (0.8 V with changing polarity) into the 70 ohm load (cable).

The driver *shall* have pull-down resistors of such value as to permit a current that provides a full voltage swing, as specified above, into the cable's impedance.

A.7. Cable Terminators

The cable terminators *shall* be on the receiver side and *shall* terminate the cable in its characteristic impedance.

Note: The value of the pull-down resistor R_p may be calculated from the relationship:

$$R_p = 3.65R_t / (0.8 + 0.002R_t)$$

where R_t is the value of the terminating resistance and R_p is attached to -5.2 V. Two mA is assumed to flow from the low state side of the driver to keep the driver biased in the "on" state.

It is recommended that the cable terminators be made symmetrical with respect to ground by, for example, connecting a 36 ohm resistor from each input to the receiver reference voltage V_{bb} as specified for 10K ECL. In order to limit common mode currents to V_{bb} a resistor of approximately 100 ohms should be inserted between V_{bb} and the junction of the two 36 ohm resistors.

A.8. State of Receiver Output

The receiver output *shall* be in a defined state when the cable is not connected. The defined state of the receiver output may be produced by offsetting one input by not less than 70 mV.

A.9. Index

Cables	A.2
Cable Terminators.....	A.7
Connector(s).....	A.3
Connector location.....	A.5
Connector signal assignments	A.4
Drivers.....	A.6
Signal amplitude.....	A.1
Signal levels.....	A.1
Receiver(s).....	A.6
Receiver output state	A.8
Terminators.....	A.6, A.7

APPENDIX B
STANDARD NIM DIGITAL BUS (NIM/488)

ABSTRACT

This appendix defines a standard digital data bus for NIM instruments as defined in the NIM specifications. It utilizes the Standard Interface for Programmable Instrumentation of ANSI/IEEE Std 488.1-1987 (Ref. 1) and the Codes, Formats, Protocols, and Common Commands of ANSI/IEEE Std 488.2-1987 (Ref. 2) of the Institute of Electrical and Electronics Engineers (IEEE) and the American National Standards Institute (ANSI), together with additional requirements and recommendations in this document to maximize compatibility of NIM instruments utilizing the bus.

The first version of the NIM Digital Bus (NIM/GPIB) as issued as U.S. Department of Energy Report DOE-0173 in August 1983. Since then the 488 standards have been revised and reissued. This revision of the NIM/488 standard has been updated to conform with the revised 488 standards.

NIM/488 WORKING GROUP

Frederick A. Kirsten (LBL), Chairman
Alfonso Criscuolo, LANL
Dennis W. O'Brien, LLNL
Richard A. Todd, ORNL
Dale Horelick, SLAC

CONTENTS

Section	Page
B. General.....	B-3
B.1. Scope	B-3
B.2. Object.....	B-3
B.3. Introduction.....	B-3
B.4. Interpretations and Definitions	B-3
B.5. ANSI/IEEE Std 488.1-1987 Requirements.....	B-4
B.6. ANSI/IEEE Std 488.2-1987 Requirements.....	B-4
B.7. Additional Requirements and Recommendations	B-4
B.7.1. Mechanical Features	B-4
B.7.1.1. Connector Location	B-4
B.7.1.2. Connector Orientation	B-5
B.7.1.3. Cables	B-5
B.7.2. Codes and Formats.....	B-5
B.7.2.1. Message Separators and Terminators.....	B-5
B.7.2.1.1. Data Separator.....	B-5
B.7.2.1.2. Message Unit Separators	B-5
B.7.2.1.3. Message Terminators.....	B-6
B.7.2.2. Header Type	B-6
B.7.2.3. Program Message Format.....	B-6
B.7.2.4. Numeric Data Type	B-7
B.7.2.4.1. Data Sheets	B-7
B.7.2.5. Block Data in Response Messages.....	B-7
B.7.2.6. Serial Poll Status Byte Format.....	B-7
B.7.3. Operational Requirements and Recommendations	B-10
B.7.3.1. Talker Response to Interface Message	B-10
B.7.3.2. Real-Time Triggering	B-10
B.7.3.3. Response to Syntax Errors in Program Messages	B-10
B.7.3.4. Mnemonic Codes.....	B-10
B.7.3.4.1. Device Commands.....	B-13
B.7.3.4.2. Interpretation of Received Device Commands	B-14
B.7.3.4.3. Messages in Response to a Device Command	B-14
B.8. References	B-14
B.9. Index	B-15
Figure B.7.2.6 Example of Implementation of the Serial Poll Feature in a NIM/488 Bus Module	B-8
Table B.7.2.6 Serial Poll Status Byte Bit Assignments.....	B-9
Table B.7.3.4 Mnemonic Codes.....	B-11

STANDARD NIM DIGITAL BUS (NIM/488 BUS)

B. GENERAL

This appendix defines the standard NIM Digital Bus (NIM/488).

B.1. Scope

This standard is applicable to NIM Modules as defined in the NIM standard.

B.2. Object

The objective of this standard is to define a data-busing technique that is optimized for the class of applications for which NIM modules are typically utilized. This standard will be of use to both designers and users of NIM equipment.

B.3. Introduction

The NIM Specification was originally formulated before the use of computers and programmable controllers became commonplace in small data acquisition systems. Therefore, it did not address the transmission of digital byte-oriented or word-oriented information to or from NIM Modules. It is now often necessary to have the capability to interface individual NIM Modules to a controller. Such capability is provided by this standard, utilizing the Digital Interface for Programmable Instrumentation of ANSI/IEEE Std 488.1-1987 (Reference 1) together with the Codes, Formats, Protocols and Common Commands of ANSI/IEEE Std 488.2-1987 (Reference 2) and additional requirements and recommendations as included herein.

It is expected that this standard will be used to specify the means by which individual NIM modules are interfaced to programmable controllers. However, certain features, particularly the recommended mnemonics, may be usefully employed where groups of NIM Modules are collectively interfaced through a common NIM/488 bus port, or with modules or system components other than NIM, where these are used in conjunction with NIM systems.

B.4. Interpretations and Definitions

In order to comply with this standard, a NIM Module or equipment *shall* satisfy the mandatory requirements in this standard. For the purpose of this standard, such modules and equipment are designated and referred to as NIM/488 Modules or equipment. The term NIM/488 is also used as a modifier for various functions, operations, etc., encompassed by this standard.

Clauses herein using the word *shall* are mandatory.

Reference to the "NIM Standard" or NIM Specifications" means to the document of which this specification for the NIM/488 Digital Bus is an Appendix .

Definitions of preferred practice (to be followed unless there are sound reasons to the contrary) include the word *should*.

Examples of permitted practice generally include the word *may* and leave freedom of choice to the designer or user.

NIM modules and equipment are defined as modules and equipment that comply with the requirements of the NIM Standard.

In this standard, the use of terms particular to the NIM/488 bus are as defined or used in ANSI/IEEE Std 488.1-1987 or ANSI/IEEE Std 488.2-1987.

Unless otherwise noted, the term "message" is used in this standard to mean "device-dependent message" as that term is defined in Section 1.4.1 of ANSI/IEEE Std 488.1-1987.

B.5. ANSI/IEEE Std 488.1-1987 Requirements

A NIM/488 bus module *shall* comply with the requirements of ANSI/IEEE Std 488.1-1987.

B.6. ANSI/IEEE Std 488.2-1987 Requirements

The codes and format conventions used by, or recognized by, a NIM/488 module for information transfer via the NIM/488 bus *shall* comply with the provisions of ANSI/IEEE Std 488.2-1987. However, under this standard, a NIM/488 Module is not permitted to use certain alternate methods of implementing some of the functions and procedures described in ANSI/IEEE Std 488.2-1987.

B.7. Additional Requirements and Recommendations

This section includes requirements and recommendations for NIM/488 Modules and equipment in addition to those of the NIM Standard and of ANSI/IEEE Std 488.1-1987 and ANSI/IEEE Std 488.2-1987. It also includes interpretations or limitations of provisions of ANSI/IEEE Std 488.1-1987 and ANSI/IEEE Std 488.2-1987.

B.7.1. Mechanical Features

B.7.1.1. Connector Location. The NIM/488 bus receptacle-type connector (Section 4 of ANSI/IEEE Std 488.1-1987) *shall* be mounted on the rear panel of the NIM Module within the area indicated in Figure 2 of the NIM specification as "free for external connectors". It should be mounted as low as practicable within this space.

B.7.1.2. Connector Orientation. The NIM/488 bus connector *shall* be mounted in a vertical orientation, with pin 1 in the upper left-hand corner when viewed from the rear of the Module. (Because of space limitations in the NIM Bin, the preferred orientation described in ANSI/IEEE Std 488.1-1987 is not suitable.)

B.7.1.3. Cables. Because of the restricted space in the rear of a NIM Bin, it may be advantageous to use short cables (i.e., of length 0.5 meter or less) for interconnecting Modules within the Bin, the cables being constructed from highly flexible cable, such as shielded ribbon cable. For longer runs, cables fully meeting the specifications of Section 3.7 and the recommendations of Appendix J of ANSI/IEEE Std 488.1-1987 may be necessary to attain secure data transfers. Examples of longer cable runs include those used to interconnect a NIM Bin and a controller or those used to interconnect two or more NIM Bins.

B.7.2. Codes and Formats

This section describes codes and formats that are required or recommended to be used by NIM/488 Modules in formulating or interpreting messages carried on the NIM/488 bus.

Certain codes and format conventions are specified here with the intent of achieving two goals:

- (a) To minimize the effort required to generate programs (software) for the controllers used with NIM systems interconnected by the NIM/488 bus;
- (b) To enhance the interchangeability of NIM/488 modules that fulfill similar functions.

B.7.2.1. Message Separators and Terminators. For NIM/488 purposes, certain of the options for Data Separators, Message Unit Separators, and Message Terminators specified in ANSI/IEEE Std 488.2-1987, Sections 7 and 8 are selected.

B.7.2.1.1. Data Separator. (ANSI/IEEE Std 488.2-1987, Sections 7.4.2 and 8.4.2). Data Separators are used to separate sequential data elements from one another.

NIM/488 Data Separators *shall* be the ASCII-encoded comma (.). Thus NIM/488 talkers *shall* transmit an ASCII-encoded comma as a Data Separator and NIM/488 listeners *shall* interpret an ASCII-encoded comma as a Data Separator.

Note that the NIM/488 Data Separator for Program Messages is an option selected from those of ANSI/IEEE Std 488.2-1987 Section 7.4.2.2. NIM/488 equipment *shall not* use the <white space> option described in that section.

B.7.2.1.2. Message Unit Separators. (ANSI/IEEE Std 488.2-1987, Sections 7.4.1 and 8.4.1). Message Unit Separators are used to separate sequential Program Message Units from one another.

NIM/488 Message Unit Separators *shall* be the ASCII-encoded semicolon (;). NIM/488 talkers *shall* transmit an ASCII-encoded semicolon as a Message Unit Separator. NIM/488 listeners *shall* interpret an ASCII-encoded semicolon as a Message Unit Separator.

Note that the NIM/488 Program Message Unit Separator is an option selected from those in ANSI/IEEE Std 488.2-1987 Section 4.1.1.2. NIM/488 equipment *shall not* use the <white space> option described in that section.

The previous version of this standard permitted the use of NL (Newline) as a Message Unit Separator. This is no longer permitted by ANSI/IEEE Std 488.2-1987 or by this revised standard.

The SP (space) character *shall not* be used as a non-terminating separator. Note however, that a space character may be used in accordance with Section 7.4.3 of ANSI/IEEE Std 488.2-1987.

B.7.2.1.3. Message Terminators. A NIM/488 talker *shall* transmit a message terminator at the end of a message, or series of contiguous message units, when a talking transaction has been completed. Following transmission of a message terminator, a talker *shall not* talk further until it has been further commanded by the system controller (ANSI/IEEE Std 488.2-1987, Section 6.4.3). Receipt of a message terminator *shall* alert the listener that the message exchange is complete and appropriate action in response to the preceding message unit(s) *shall* be completed.

A NIM/488 Message Terminator *shall* be the ASCII-encoded data byte NL (10 decimal) transmitted simultaneously with the END remote message (ANSI/IEEE Std 488.2-1987, Sections 7.5.2 and 8.5.2). NIM/488 talkers *shall* transmit NL with EOI asserted as the terminating separator. NIM/488 listeners *shall* interpret the single byte NL with EOI asserted as the terminating separator. To accommodate bus devices of earlier design, NIM/488 listeners should also accept CR followed by LF with EOI asserted as a message terminator.

(The END remote message consists of the EOI signal line being true and the ATN signal line being false while the data byte is being transmitted.) Note that the NIM/488 definition of a Program Message Terminator is a selected case of the options given in ANSI/IEEE Std 488.2-1987, Section 7.5.2.

B.7.2.2. Header Type. (Ref. ANSI/IEEE Std 488.2-1987, Sec. 7.6.1 and 7.2.2, Header Type 7.6.2). Header fields transmitted by NIM/488 equipment *shall* be the <simple command program header> or <simple query program header> of Sections 7.6.1 and 7.6.2 of ANSI/IEEE Std 488.2-1987. These header fields consist of at least one alphabetic character which may be followed by a succession of alphanumeric or underscore () characters.

B.7.2.3. Program Message Format. (Ref. ANSI/IEEE Std 488.2-1987, Section 7.3). Program messages transmitted by NIM/488 equipment *shall* have the syntax shown

in Figures 7-1 through 7-6 of ANSI/IEEE Std 488.2-1987, Section 7.3. (Note the restrictions on headers and separators in B.7.2.1 and B.7.2.2, above.)

B.7.2.4. Numeric Data Type. (Ref. ANSI/IEEE Std 488.2-1987, Sec. 8.7). Unless transmitted as block data (Section B.7.2.5 below), numerical data transmitted from or to NIM/488 equipment *shall* be in ASCII-encoded decimal form and *shall* be formatted in one of the format types NR1, NR2 or NR3 in the referenced section. The NR1 format is used to convey signed or unsigned integer values. NR2 is used to convey signed or unsigned explicit point values (in which the decimal point is included). The NR3 format is used to convey values in floating point (mantissa and exponent) notation. (Note that numeric fields may have imbedded SP (space) characters, but the fields *shall* be separated by separators.

B.7.2.4.1. Data Sheets. For a particular transaction, a NIM/488 Module will typically be designed to transmit or receive numeric values in only one of three numeric data types--implicit point, explicit point, or floating point (with exponent). The particular numeric data type used for each transaction should be clearly indicated on the data sheet for the Module.

B.7.2.5. Block Data in Response Messages. (Ref. ANSI/IEEE Std 488.2-1987, Section 8.7.9). When block data is sent in binary code to or from a NIM/488 Module, then the <DEFINITE LENGTH ARBITRARY BLOCK RESPONSE DATA> format specified in Section 8.7.9 of ANSI/IEEE Std 488.2-1987 *shall* be used.

The number of the <8-bit data field> bytes in such a block should have a default limit of not greater than 4096.

Note: The previous version of this document specified a binary block data field format using the Identifier B as described in ANSI/IEEE Std 728-1982, Section 4.3.2.3.1. This has now been updated to conform with the revised format specification in ANSI/IEEE Std 488.2, Section 8.7.9. In particular, the requirement for the Identifier B has been deleted, and the requirement for a single-byte checksum has been deleted.

B.7.2.6. Serial Poll Status Byte Format. (Ref. ANSI/IEEE Std 488.2-1987, Sec. 11). NIM/488 Modules *shall* have the serial poll capability. In response to the serial poll interface message, the NIM/488 Module *shall* return a status byte (the RQS and STB messages in ANSI/IEEE Std 488.1-1987) having the bit definitions as shown in Table B.7.2.6. It is not required that all bits of the serial poll status byte be implemented in a particular NIM/488 Module. However, if a particular bit is implemented, then it *shall* have the definition shown in the table. The definitions of bits DIO5 and DIO4 in Table B.7.2.6 are based on ANSI/IEEE Std 488-1982.

Upon sending the serial poll status byte, the following bits *shall* be reset to the logic 0 state: Requesting service (DIO7) and Abnormal (DIO6). In addition, the following bits that would be active if the Abnormal (DIO6) bit were in the logic 1 state *shall* also be reset to the logic 0 state: Module alarm (DIO4); Transmission error (DIO3); Execution

error (DIO2); and Syntax error (DIO1). None of the bits listed in this paragraph *shall* return to the logic 1 state except in response to a new local message.

A logic 1 state of any of the following bits *shall* result in setting the Abnormal bit (DIO6) to the logic 1 state: Module alarm (DIO4); Transmission error (DIO3); Execution error (DIO2); and Syntax error (DIO1).

A NIM/488 module may also include the capability to return the serial poll status byte and/or other status bytes as 'secondary status' in response to a program message.

An example of the implementation of the serial poll feature is given in Figure B.7.2.6.

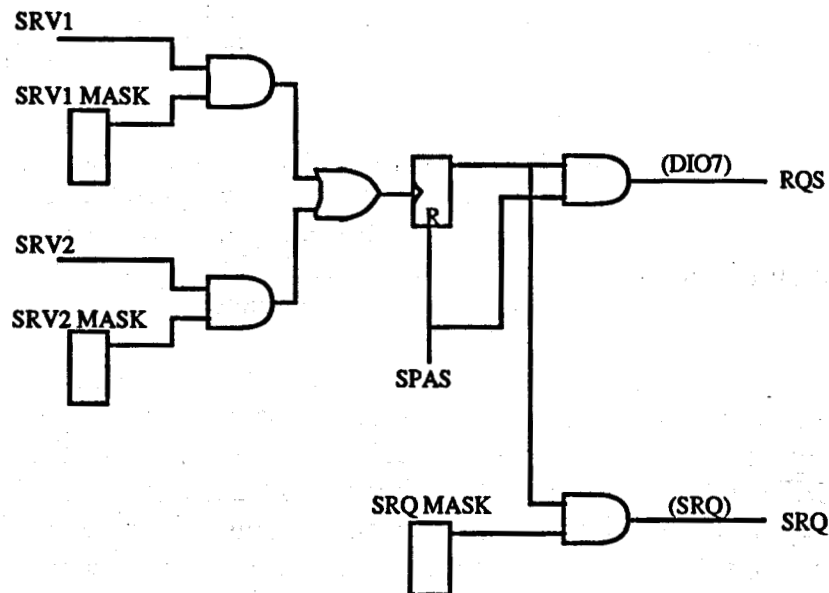

Figure B.7.2.6

Example of Implementation of the Serial Poll Feature in a NIM/488 Module

TABLE B.7.2.6

SERIAL POLL STATUS BYTE BIT ASSIGNMENTS

Bit transmitted on line	Definition for Bit = 1 unless noted (Note 1)	Remarks
DIO8	-	Designer's choice
DIO7	Requesting service	The RQS message
DIO6	Abnormal	Error condition, e.g.
DIO5	Ready or Done	See Note 2

If Abnormal (Bit sent on DIO6 = 1):

DIO4	Module alarm	Alarm not associated directly with NIM/488 bus
DIO3	Transmission error	Checksum error with block data, e.g.
DIO2	Execution error	Unable to execute command in previous program message.
DIO1	Syntax error	Unable to interpret NIM/488 bus message with this Module's listen address.

If Normal (Bit sent on DIO6 = 0):

DIO4		Designer's choice
DIO3		"
DIO2		"
DIO1		"

- Notes:**
1. Unless otherwise noted, the definition for the bit=0 is the logical negation of the definition for the bit=1.
 2. At the designer's option, 'Ready or Done' may mean, for example, that the Module has completed the execution of a previously received program message instruction and that the Module is therefore 'Not Busy'. It may imply that the data associated with the previous program message instruction is now ready.

B.7.3. Operational Requirements and Recommendations

B.7.3.1. Talker Response to Interface Message. When a NIM/488 Module enters the Talk state in response to an interface message, it *shall* transmit the data bytes that represent the response to the associated device-dependent message as soon as it is able to do so.

If a NIM/488 Module is unable to respond promptly to an interface message that causes it to enter the Talk state, it *shall* send a (null) program message consisting of a Header byte (Section B.7.2.2 above) followed by a NIM/488 Message Terminator (Section B.7.2.1.3 above) as soon as the interface message has been interpreted. In this situation, the setting of the RQS bit in the status byte and the sending of the SRQ message is optional. This definition of response is based on ANSI/IEEE Std 488-1978.

B.7.3.2. Real-Time Triggering. Under certain conditions, the triggering or synchronization of processes that can be effected via the NIM/488 bus may be useful. However, designers should be aware of the timing performance limitations that are concomitant with this feature. If the limitations are not significant for a particular design, then commands using the ENAB TRIG and DISA TRIG mnemonics (See Section B.7.3.4 below), together with the GET remote message may be useful.

Where these limitations are significant, triggering by means of external synchronizing signals independent of the NIM/488 bus may be necessary. Commands using the ENAB TRIG and DISA TRIG mnemonics may also be used to enable and disable such external signals.

B.7.3.3. Response to Syntax Errors in Program Messages. (Ref. ANSI/IEEE Std 488.2-1987, Section 6.5.4) When a NIM/488 module is unable to interpret a program message because of a syntax error, it *shall not* perform any action in response to the command contained in the program message and it *shall* set the Abnormal (DIO6) and Syntax error (DIO1) bits in the status byte (Section B.7.2.6 above) to the logic 1 state.

If the module contains the SR function, it should additionally set the DIO7 bit in the status byte to 1 and should send the SRQ message if SRQ is enabled. This definition of response is based on ANSI/IEEE Std 488-1978.

B.7.3.4. Mnemonic Codes. Device commands contained in program messages addressed to NIM/488 equipment are conveyed by means of mnemonic codes. Such mnemonic codes are transmitted in the header field of a program message. Messages transmitted in response to device commands may also use these mnemonic codes.

NIM/488 equipment *shall* transmit and interpret the mnemonic codes for device commands and for responses to device commands in accordance with Table B.7.3.4. Whenever a mnemonic code listed in Table B.7.3.4 is designed into NIM/488 equipment, it *shall* be used in a manner consistent with the definition given in the table. Mnemonic codes other than those listed in the table should be designed into NIM/488 equipment only

when none of the codes listed in the table convey the semantic meaning required in the particular design.

Each mnemonic code listed in Table B.7.3.4 has from one to four mandatory characters, which are printed in upper-case. The mandatory characters are unique to the particular mnemonic and *shall* be included whenever the mnemonic is used. For some mnemonics listed in Table B.7.3.4, additional characters are printed in lower case and are, for clarity, enclosed in parentheses. (The parentheses are not part of the mnemonic.) The transmission of these additional characters is optional. They are often included to make the codes more readable for the user.

In transmitting or receiving these mnemonic codes, the upper-case and lower-case versions of any character *shall* be considered equivalent (see examples below).

TABLE B.7.3.4 MNEMONIC CODES
(See notes at end of table)

VERB	COMMON INTERPRETATION		
-----	-----		
DISA(ble)	inhibit	turn off	lock
EXPA(nd) *			
ENAB(le)	turn on	arm	activate
INIT(ialize)	zero	clear	delete
LEAR(n)			
MOVE	transfer		
PAUS(e)	wait	delay	suspend
PRIN(t)			
READ			
SELE(ct)			
SET	adjust	change	
SHOW	display		
SLEW			
STAR(t)	execute	acquire	
STEP	advance	pulse	
STOP	abort		
TEST			
VERI(fy)			
WRIT(e)	load enter		

(continued)

TABLE B.7.3.4 (Con't)

NOUNS

ADC	HV	RATE
ALAR(m)	INPU(t)	REFE(rence)
ALL	LIMI(t)	REGI(ster)
ATTE(nuation)	LLDI(scriminator)	REMO(te)
BASE *	LOCA(tion)	RESE(t)
BIAS(-level)	LREF(erence)	RISE(-time)
BLRE(store)	MARK(er) *	ROI
BURS(t)	MASK	SHAP(ing-time-constant)
CHAN(nel)	MAST(er)	SHUT(down)
CONS(tant)	MESS(age)	SLAV(e)
CONT(rol)	MODE	SPEC(trum)
COOR(dinate)	MOTO(r)	STAN(dard)
COUN(t(er)(s))	NEXT	STAT(us)
COUP(ling)	NOCH(annels)	STRO(be)
CURS(or) *	OFFS(et)	SWEE(p) *
DATA	OVER(flow) *	SYNC(hronization)
DATE	OUTP(ut)	TASK
DAY	PAGE *	TEMP(erature)
DECA(y)	PANE(l)	THET(a)
DELA(y)	PASS	THRE(shold)
DISC(riminator)	PEAK	TIME
DISP(lay)	PEDE(stal)	TRIG(ger)
DIST(ance)	PERI(od)	TRUE
DWEL(l)	PHI	ULDI(scriminator)
ENER(gy)	PKTI(me)	VERS(ion)
FACT(or)	POLA(rity)	VOLT(age)
GAIN	PROB(e)	WALK
GATE	PULS(e(r))	WIDT(h)
GROU(p)	PZAD(just)	ZERO
HEIG(ht)	RANG(e)	

A

B

C

.

.

X

Y

Z

(Arbitrary use, i.e., register definitions)

(Cartesian coordinates or directions. Use PHI and THETA for cylindrical and spherical coordinates.)

(Continued)

TABLE B.7.3.4 (Cont'd)

MODIFIERS

ABSO(lute)	AC	ALPH(a
ANTI(coincent)	ASSY(metrical)	AUTO(matic)
BIPO(lar)	CLOS(ed)	COIN(cident)
CFRA(ction)	DC	DELA(yed)
DIFF(erentiate)	DIGI(tal)	DOWN *
EXTE(rnal)	FAST	FISS(ion)
HIGH	INTG(rate)	INTR(nal)
LEAD(ing-edge)	LEFT	LIVE
LOW	MINU(tes)	NEGA(tive)
NORM(al)	OFF	ON
OPEN	POLA(arity)	POSI(tive)
PRES(et)	PROM(pt)	PZER(o)
REAL	REJE(ct)	RELA(tive)
RIGH(t) *	SCND(ary)	SECO(nds)
SRTR(eject)	STOR(e)	SYMM(etrical)
TERT(iary)	THRE(shold)	TOTA(l)
UNIP(olar)	WIND(ow)	UP *

Note 1: Mnemonics related to displays are indicated by an asterisk (*).

Note 2: Use of additional characters shown in parentheses is optional.

Note 3: Upper case and lower case characters are equivalent.

B.7.3.4.1. Device Commands. Each device command transmitted by a NIM/488 talker *shall* include at least the mnemonic code for a VERB, may optionally include the code for a NOUN and, if a NOUN is used, may optionally include the code for a MODIFIER of the noun. The VERB, NOUN and MODIFIER are separated by '_'' (underline) characters, since spaces are not allowed within an HR3 header. Each command *shall* be transmitted in the syntax:

VERB[_NOUN[_MODIFIER]][_DATA][_DATA]....[_DATA];

where brackets ([]) are used to enclose optional fields.

Examples of device commands are:

1. SET_COUPLING DC
2. set_HV 4000
3. Start_Count

More than one device command can be transmitted in a given program message by using appropriate message unit separators.

B.7.3.4.2. Interpretation of Received Device Commands. NIM/488 equipment receiving device commands *shall* interpret upper-case and lower-case characters as equivalent. In interpreting a received mnemonic, the equipment *shall* ignore all characters after the mandatory characters until either an underline '_' mnemonic separator or a space ' ' header separator is received.

B.7.3.4.3. Messages in Response to a Device Command. The response transmitted by a NIM/488 talker in response to a received device command may use mnemonic codes. If mnemonic codes are used, they *shall* be transmitted using the following syntax:

NOUN[_MODIFIER][DATA][,DATA][,DATA].....[,DATA]

Examples of such responses are:

1. COUNT 2004623
2. Time_true 3.6E+03
3. trigger_OFF

B.8. References

1. "IEEE Standard Digital Interface for Programmable Instrumentation", ANSI/IEEE Std 488.1-1987, The Institute of Electrical and Electronics Engineers, 345 East 47 Street, New York, NY 10017.
2. "Code and Format Conventions for Use with ANSI/IEEE Std 488.1-1987", ANSI/IEEE Std 488.2-1987, The Institute of Electrical and Electronics Engineers, 345 East 47 Street, New York, NY 10017.

B.9. INDEX

ANSI/IEEE Std 488.1 Requirements	B.5.
ANSI/IEEE Std 488.2 Requirements	B.6.
Block Data in Response Messages	B.7.2.5.
Cables	B.7.1.3.
Codes and Formats	B.7.2.
Connector Location	B.7.1.1.
Connector Orientation	B.7.1.2.
Data Separator	B.7.2.1.1.
Data Sheets	B.7.2.4.1.
Definitions	B.4.
Device Commands	B.7.3.4.1., B.7.3.4.2., B.7.3.4.3.
Errors	B.7.3.3.
Header Type	B.7.2.2.
Interpretations	B.4.
Introduction	B.3.
Mechanical Features	B.7.1.
Message Format	B.7.2.3.
Message, Interface	B.7.3.1.
Message, Response	B.7.2.5., B.7.3.1.
Message Separators	B.7.2.1.
Message Terminators	B.7.2.1., B.7.2.1.3.
Message Unit Separators	B.7.2.1.2.
Mnemonic Codes	B.7.3.4., Table B.7.3.4
Numeric Data Type.....	B.7.2.4.
Object	B.2.
Operational Requirements and Recommendations	B.7.3.
Program Message Format	B.7.2.3.
Real-Time Triggering	B.7.3.2.
References	B.8.
Response to Syntax Errors in Program Messages	B.7.3.3.
Response Messages	B.7.2.5., B.7.3.1.
Scope	B.1.
Serial Poll Implementation Example	Figure B.7.2.6
Serial Poll Status Byte Bit Assignments	Table B.7.2.6
Serial Poll Status Byte Format	B.7.2.6.
Syntax Errors in Program Messages	B.7.3.3.
Talker Response to Interface Messages	B.7.3.1.
Triggering	B.7.3.2.

**DO NOT MICROFILM
THIS PAGE**

Acronyms	4.5
Analog Signals	5.9.4
ANSI 4.5	
Bin(s)	4.2, 6, 6.1, Figures 7a,b,c,d
Bin Connector(s)	4.3, 6.3, Figures 3a,b, Figures 4a,b
Bin Connector Hoods	6.3, Figure 5
Bin Connector Jig Alignment	6.7, Figures 12a,b
Bin Connector Pin Assignments	6.4, Figures 6, 8a,b
Bin Definitions	4.2
Bin Ground Connections	6.4.2
Bin Power	6.6
Bin Power Connector(s)	6.4.1
Bin Ventilation	6.2
Bin Wiring	6.4, Figures 8a,b
Bus Signal Restrictions	6.5
CAMAC	4.5
Circuit Breakers	7.3.1
Committee, NIM	3.1
Committee, Organizing	3.1
Connector(s), Bin	See Bin Connectors
Connector(s), Bin Power	See Bin Power Connectors
Connector(s), Coaxial	5.6
Connector(s) Definitions	4.3
Connector(s), High Voltage	5.6.2
Connectors, High Voltage, Mounting of	5.6.3
Connector Hoods	5.3, 6.3
Connector(s), Module	See Module Connectors
Connector(s), Signal, Mounting of	5.6.1, 5.6.3
Connector Hoods	5.3, 6.3
Circuit Breakers	7.3
Decoupling	5.10
Digital Bus	5.8 (Detailed Index in Section B.9)
Digital Bus Index	B.9
Documentation	9
DOE	4.5
ECL Front Panel Interconnections	5.7 (Detailed index in A.9)
ECL Index	A.9
ESONE	4.5
EURATOM	4.5
FASTBUS	4.5
Foreword	1
Fuses	7.3.1

Index (continued)

Glossary	4
Grounds	5.5, 6.4.2
Historical Development	3.1
IEC	4.5
IEEE	4.5
Information	1
Interpretation of document	3.3
Introduction	3
Logic Signal(s)	5.9
Fast	5.9.3
Levels	5.9.1, 5.9.3
Requirements	5.9.2
Mailing List	1
Modules	4.1, 5, Figure 2
Module Connector(s)	5.3, Figures 3a,b, Figures 4a,b
Module Connector Hoods	5.3, Figure 5
Module Connector Jig Alignment	5.13, Figures 11a,b
Module Connector Pin Assignments	5.4, Figure 6
Module Ventilation	5.2
NIM	2, 4.5
NIM Digital Bus (NIM/488 Bus)	See Digital Bus
NIM Bin(s)	See Bin(s)
Connectors for	See Connectors
Connector Hoods	See Connector Hoods
NIM Power Supply	4.4, (See also Power Supply, NIM)
NIM Module(s)	See Module(s)
Connectors for	See Connectors
Connector Hoods	See Connector Hoods
Noise Generation	5.10
Noise Immunity	5.10
Organizations	4.5
Power, Bin	6.6
Power Requirements for Modules	5.11
Power Requirements, Marking of	5.11.2

Index (continued)

Power Supply, NIM	7, Figure 9
Circuit Breakers	7.3.1
Connection	6.4, Figures 8a,b
Fuses	7.3.1
Input	7.1.1
Operational and Performance Characteristics	7.2
Output.....	7.1.2
Ratings	7.1
Physical Characteristics	7.4
Protection	7.3, 7.3.1, 7.3.2
Power Supply Definitions	4.4
Power Supplies, Early.....	8.4
Power Supply, NIM Modular	8.2
Power Supplies, Other	8
Power Supply, NIM Special Purpose	8.1
Revisions	3.2
Shielding, Quality	5.12
Signals	5.9
Ventilation	5.2, 6.2
Voltages, Standard	5.11.1