

~~SECRET~~



REPLY TO
ATTENTION OF

DEPARTMENT OF THE ARMY

UNITED STATES ARMY TANK-AUTOMOTIVE COMMAND
WARREN, MICHIGAN 48397-5000

AMCP EO-CCV-X

SPECIAL ARMOR
SECURITY CLASSIFICATION GUIDE

ISSUED BY: Program Executive Officer,
Close Combat Vehicles
Warren, MI 48397-5000

APPROVED BY: WS Flynn
WILLIAM S. FLYNN
Major General, USA
Commander
US Army Tank-Automotive Command
Warren, MI 48397-5000

EFFECTIVE DATE: 16 FEB 1988

SUPERSESSION: None

ACTION OFFICER: Milford S. Gilliam, AUTOVON 786-5453
Commercial (313) 574-5453 - Secure 04606 AUTOVON 786-6731
Commercial (313) 574-6731

DISTRIBUTION: US Government and its contractors who are authorized access to this program only. This guide is not available from the Defense Technical Information Center (DTIC), but may be obtained from the issuing agency.

CLASSIFIED BY: Cdr, USATACOM
DECLASSIFY ON: OADR

~~SECRET~~

UNCLASSIFIED

NATIONAL SECURITY INFORMATION

THIS DOCUMENT CONTAINS CLASSIFIED INFORMATION AFFECTING THE NATIONAL DEFENSE OF THE UNITED STATES WITHIN THE MEANING OF THE ESPIONAGE LAWS. U.S. CODE, TITLE 18, SECTION 793, 794 AND 798. THE LAW PROHIBITS ITS TRANSMISSION OR REVEALING ITS CONTENTS IN ANY MANNER TO ANY UNAUTHORIZED PERSON: THE LAW ALSO PROHIBITS ITS USE IN ANY MANNER PREJUDICIAL TO THE SAFETY AND INTEREST OF THE UNITED STATES, OR FOR THE BENEFIT OF ANY FOREIGN GOVERNMENT TO THE DETRIMENT OF THE UNITED STATES.

UNCLASSIFIED

UNCLASSIFIED

TABLE OF CONTENTS

	<u>PAGE</u>
SECTION 1 - GENERAL INFORMATION.....	1
References (U).....	1
Background (U).....	1
Purpose (U).....	1
Authority (U).....	1
Application (U).....	1
Questions and Recommendations (U).....	1
Public Release (U).....	1
Definitions (U).....	2
Foreign Government Information and Foreign Military Sales (FMS) (U).....	2
Distribution (U).....	2
Declassification (U).....	2
SECTION 2 - SPECIAL ARMOR SECURITY CLASSIFICATION GUIDANCE..	3
Annex A (Notes) (U).....	A-1
Annex B (Definitions) (U).....	B-1
Annex C (Security Procedures (U).....	C-1
Annex D (Special Armor Locations (S).....	D-1

UNCLASSIFIED

SECTION 1 - GENERAL INFORMATION (U)

1. (U) References:

a. (U) HQDA letter 70-82-1, 26 May 1982, subject: Special Access Program for Special Armor (U) expired.

b. (U) Security Classification Guide for Abrams (U) Tank System issued by Program Executive Officer, Close Combat Vehicles.

2. (U) Background.

3. (U) Purpose. To provide instructions and guidelines on the Security Classification of information and material pertaining to Special Armor. This guide will also be utilized in preparation of Department of Defense Contract Security Classification Specification, DD Form 254, to contractors performing on the program. This guide will be reviewed for accuracy and currency on the biennial basis.

4. (U) Authority. This guide is issued under the authority of the AR 380-5. It constitutes authority and may be cited as basis for classification, regrading or declassification of information concerning the Abrams Tank System. Unless otherwise noted, information or material identified as classified in this guide is classified by authority of approving official identified on the title page, IAW paragraph 2-400C, AR 380-5, an Original Classification Authority (OCA).

5. (U) Application. Changes in classification required by this guide will be made immediately. This guide will also be used in the biennial review of DD Form 254 currently in the possession of contractors.

6. (U) Questions and Recommendations. Questions concerning the content and interpretation of this guide should be directed to the issuing activity. If the security classifications imposed by this guide are considered impracticable, documented and justified, recommendations should be made through appropriate channels to the issuing activity. If current conditions, progress made in this effort, scientific or technological developments, advances in the state of art, or other factors indicate a need for change, similar recommendations should be made. Pending a final decision, the information will be protected at either the current level or the recommended level, whichever is higher. All users of this guide are encouraged to assist in improving its currency and accuracy. Overclassification or incorrect classification should be brought to the attention of the issuing authority.

7. (U) Public Release. The fact that this guide shows certain details of information to be unclassified does not allow automatic public release of them. Proposed public disclosures of unclassified information regarding the Abrams Tank System shall be processed through appropriate publication approval channels. Within the Department of the Army, procedures specified in AR 360-5 will be followed.

UNCLASSIFIED

UNCLASSIFIED

Defense contractors will comply with DoD 5220.22-M and other contractual requirements. For those agencies under the cognizance of the US Army Materiel Command, all information concerning the Program Executive Officer, Close Combat Vehicles will be forwarded for public clearance to Commander, US Army Tank-Automotive Command, ATTN: AMSTA-CT, Warren, MI 48397-5000, in accordance with AR 360-5, paragraph 9-2. Material submitted for clearance through the US Army Materiel Command will be forwarded to the Commander, HQ AMC (AMCPA), 5001 Eisenhower Avenue, Alexandria, VA 22333-0001 prior to public release.

8. (U) Definitions. See Annex B.

9. (U) Foreign Government Information and Foreign Military Sales (FMS). Should foreign government information be obtained in connection with this program, it will be marked and protected in accordance with AR 380-5 or DoD 5220.22-M. Foreign Military Sales: This program is subject to the Foreign Military Sales Program.

10. (U) Distribution. Distribution of this guide is limited to those individuals with an appropriate security clearance and a verified need-to-know. It will not be provided to the Defense Technical Information Center (DTIC) but is available from the issuing authority.

11. (U) Declassification. Information in this guide will be declassified upon Originating Agency's Determination (OADR).

UNCLASSIFIED

SECRET

SECTION 2 - SPECIAL ARMOR SECURITY CLASSIFICATION GUIDANCE

<u>Information Revealing</u>	<u>Classification</u>	<u>Declassification/ or Review</u>	<u>Notes</u>
12. (U) A compilation of material used in the production of Special Armor while in the production process.	S	OADR	5
13. (U) Manufacturing technology in the production process.	S	OADR	5
14. (U) Fabrication or manufacturing production process designs, drawings and blueprints in general.	S	OADR	6
15. (U) Fabrication or manufacturing production process designs, drawings and blueprints depicting the specific M1 tank recipe.	S	OADR	3
16. (U) Special Armor scrap resulting from the production process that discloses the composition and configuration of the Special Armor.	S	OADR	3
17. (U) Breached and exposed interiors of special armor.	S	OADR	2
18. (U) Illustration showing external dimensions of the armor package.	U		7
19. (U) Materials in storage.	U		
20. (U) Materials being transported into and out of the secure manufacturing area.	U		7
21. (U) Scrap materials that do not disclose the configuration or composition of the Special Armor.	U		1 & 7

SECRET

SECRET

SECTION 2 SPECIAL ARMOR SECURITY CLASSIFICATION GUIDANCE (Cont'd)

<u>Information Revealing</u>	<u>Classification</u>	<u>Declassification or Review</u>	<u>Notes</u>
22. (U) Range targets that reveal composition and configuration of Special Armor.	S	OADR	4
23. (U) Ballistic data on Special Armor.	S	OADR	5
24. (U) Ballistic data on laboratory development of Special Armor.	S	OADR	5
25. (U) Thickness, material obliquity and location of one or more conventional armor plates.	C	OADR	5
26. (U) Mechanisms and counter-measures (knowledge of the basic and scientific principles and warhead techniques effective against Special Armor.	S	OADR	4
27. (U) Terminal ballistic performance of Special Armor.	S	OADR	4
28. (U) The ability or inability of Special Armor to defeat an armament threat wherein the specification of the threat are given, i.e., size of the penetrator, warhead, velocity, etc..	S	OADR	4
29. (U) Statistical data that measures Special Armor performance	S	OADR	4
30. (U) Performance comparison of Special Armor with conventional or non-conventional armor (foreign or domestic)	S	OADR	5

SECRET

SECRET

SECTION 2 SPECIAL ARMOR SECURITY CLASSIFICATION GUIDANCE (Cont'd)

<u>Information Revealing</u>	<u>Classification</u>	<u>Declassification or Review</u>	<u>Notes</u>
31. (U) Knowledge that a specific type munition has been or will be designed as a countermeasure to Special Armor.	S	OADR	4
32. (U) Knowledge that a specific type munition can or cannot defeat Special Armor.	S	OADR	4
33. (U) A flash radiograph which depicts any Special Armor design information or any other type of exploitation.	S	OADR	5
34. (U) Vulnerability data (global and local) to include protection levels for Special Armor to include large caliber threats.	S	OADR	4
35. (U) Specific locations of Special Armor on the Abrams Tank System (less Special Armor skirts and gunshield)	C	OADR	2 & 9
36. (U) Description of the fundamental configuration of Special Armor	S	OADR	3

SECRET

ANNEX A
NOTES

CONFIDENTIAL

ANNEX- A

NOTES

1. (U) Scrap materials that disclose the configuration and composition of Special Armor will be disposed of in accordance with established procedures at the Lima Army Tank Plant (LATP), Lima, Ohio.
2. (U) If Special Armor, including skirts and gunshields, is breached and the interior is exposed, a properly cleared (SECRET) responsible individual will immediately cover the exposed area from view and initiate action to repair the breach by welding or will evacuate the exposed armor to a maintenance facility where repairs can be made. (Refer to Security Classification Guide for the Abrams Tank System for repair/ replacement procedures).
3. (U) Information will be declassified on Originating Agency's Determination Required (OADR).
4. (U) The classification will be the higher classification of the threat projectile or the range target.
5. (C) "Individual designs, drawings, or blueprints, or compilation of same, used for a specific process or purpose, after a competent technical authority determines that they do not reveal design information covered by the Special Armor Program (former GREEN GRAPE Special Access Program), may be classified at the CONFIDENTIAL level. Any assembly or blueprint, etc. that contains sufficient definition of Special Armor (formerly GREEN GRAPE) or its countermeasures will be classified as a minimum at the SECRET level in accordance with this guide. "
6. (U) Example: Engineering Change Proposal (ECP) documents with individual drawings pertaining to Special Armor components.
7. (U) The fact that materials utilized in the manufacture of Special Armor are being stored at the plant and is being transported into and out of the manufacturing area is UNCLASSIFIED as long as the details of construction and compilation of the list of materials used in the package are not revealed.
8. (U) Unless classified performance information is disclosed.
9. (U) Even though the locations of Special Armor skirts and gunshields installed on the tank are UNCLASSIFIED, those locations will not be included in unclassified briefings.

CONFIDENTIAL

ANNEX B
DEFINITIONS

SECRET

ANNEX - B

DEFINITIONS

1. (U) Armor - A protective covering designed to protect against ballistic penetration, especially as used on combat vehicles.
2. (U) Armored Combat Fighting Vehicles - Wheeled or tracked vehicles with an armor hull or body.
3. (U) Armor Ballistic Test - A test made from any combination or armor materials and designs which will be ballistically impacted or tested in some manner.
4. (U) Assembly - A group of two or more physically connected parts.
5. (U) Conventional Armor - A rolled, wrought or forged homogenous monolithic ballistic structure, which may consist of either ferrous or non-ferrous material.
6. (U) Exposure - That which can be seen.
7. (U) Flash Radiograph - A shadowgraph on film, or print that is produced by x-radiation.
8. (U) Homogenous Armor - Steel armor which has been manufactured and heat treated so that it possesses, as nearly as possible, the same chemical constituents, and physical and mechanical properties, throughout.
9. (U) Non-conventional Armor - An armor, or armor design, other than rolled, cast, wrought or forged homogenous monolithic armor (conventional armor).
10. (U) Outline - A line bounding the limits (envelope) of a special armor.
11. (U) Plate - A single sheet of armor material.
12. (U) Program - Planned procurement of a specific quantity of vehicles or major components for any single fiscal year or number of fiscal years.
13. (S) Special Armor - Special Armor referred to in this document consists of the specific tri-plate installed in the first generation Abrams tank and its associated threat mechanisms. Special Armor by this definition does not apply to future armor development such as that within the M1A1 Abrams tank.

SECRET

ANNEX C
SECURITY PROCEDURES

UNCLASSIFIED

SECURITY PROCEDURES

ANNEX - C

1. (U) Standard Security Procedures: In addition to the special security procedures outlined in this document, standard security procedures for the handling of classified information as outlined in appropriate Department of the Army or Industrial Security Regulation apply.
2. (U) The compromise or possible compromise of classified information shall be handled by DoD activities in accordance with Chapter VI, AR 380-5/DoD 5200.1R. Contractors shall handle in accordance with para 7, DoD 5220.22.M. Contractors will not comply with para 7b(1), DoD 5220.22M.
3. (U) Despite vigilance and attention to security requirements, minor security violations may occur. Lack of preparation regarding proper action to be taken in the event of a compromise can create even more serious problems. The first person who learns of a potential compromise will do all she/he can do to prevent the situation from worsening and will immediately notify their Security Manager (SM). The Security Manager will make an initial assessment of the seriousness of the compromise based upon the facts immediately available. This information will be reported to the Program Security Manager (PSM) by the most expeditious secure means available. Timeliness of reporting is more important than a complete report. The Security Manager must quickly arrive at the conclusion that the violation is either (1) critical, (2) serious, (3) procedural. These terms are defined as:
 - (a) (U) Critical - Program information has been compromised and there appears to be no certain way to limit the dissemination of that data (e.g., a research and development periodical is about to be published or has published an article which correctly defines the program data).
 - (b) (U) Serious - Program information has been compromised and containment of dissemination of this data, although difficult, appears to be possible (e.g., an electrical message containing the program data has been sent through GENSER channels and not the SSO system, and an unknown number of people have had potential access to the message).
 - (c) (U) Procedural - Program information has been incorrectly protected, but it appears that no compromise of the data has taken place (e.g., a program document has been incorrectly handled when being sent through US postal channels, but has arrived at the correct address, and is in the custody of a properly cleared person).
4. (U) Upon receipt of a report concerning a serious or critical compromise, the SM will immediately begin an investigation. The report of investigation will be submitted to the Commander, USATACOM within 15 days after the conclusion of the investigation and will report the effect of the compromise and recommended remedial actions.

UNCLASSIFIED

SECRET

ANNEX D

SPECIFIC LOCATIONS OF SPECIAL ARMOR ON THE ABRAMS TANK

SECRET

CONFIDENTIAL

ARMOR LOCATIONS



SPECIAL ARMOR



CONVENTIONAL ARMOR

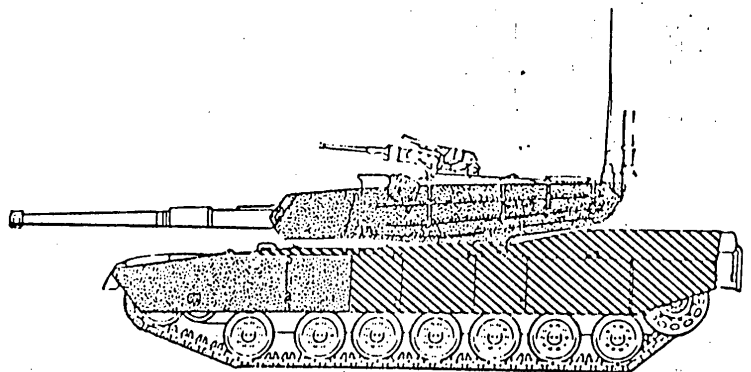
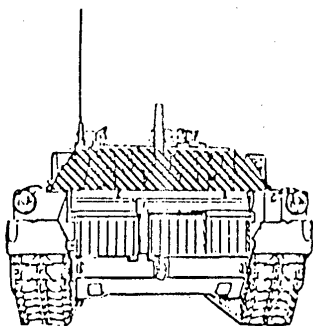
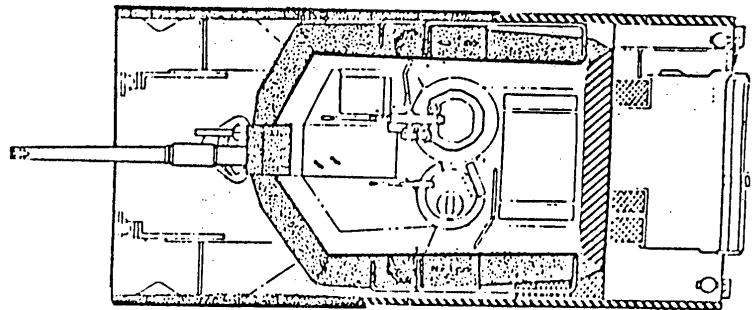
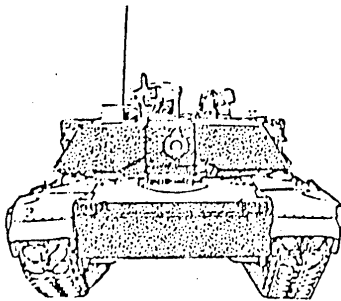

CONFIDENTIAL

SECRET

HULL SIDE SPECIAL ARMOR

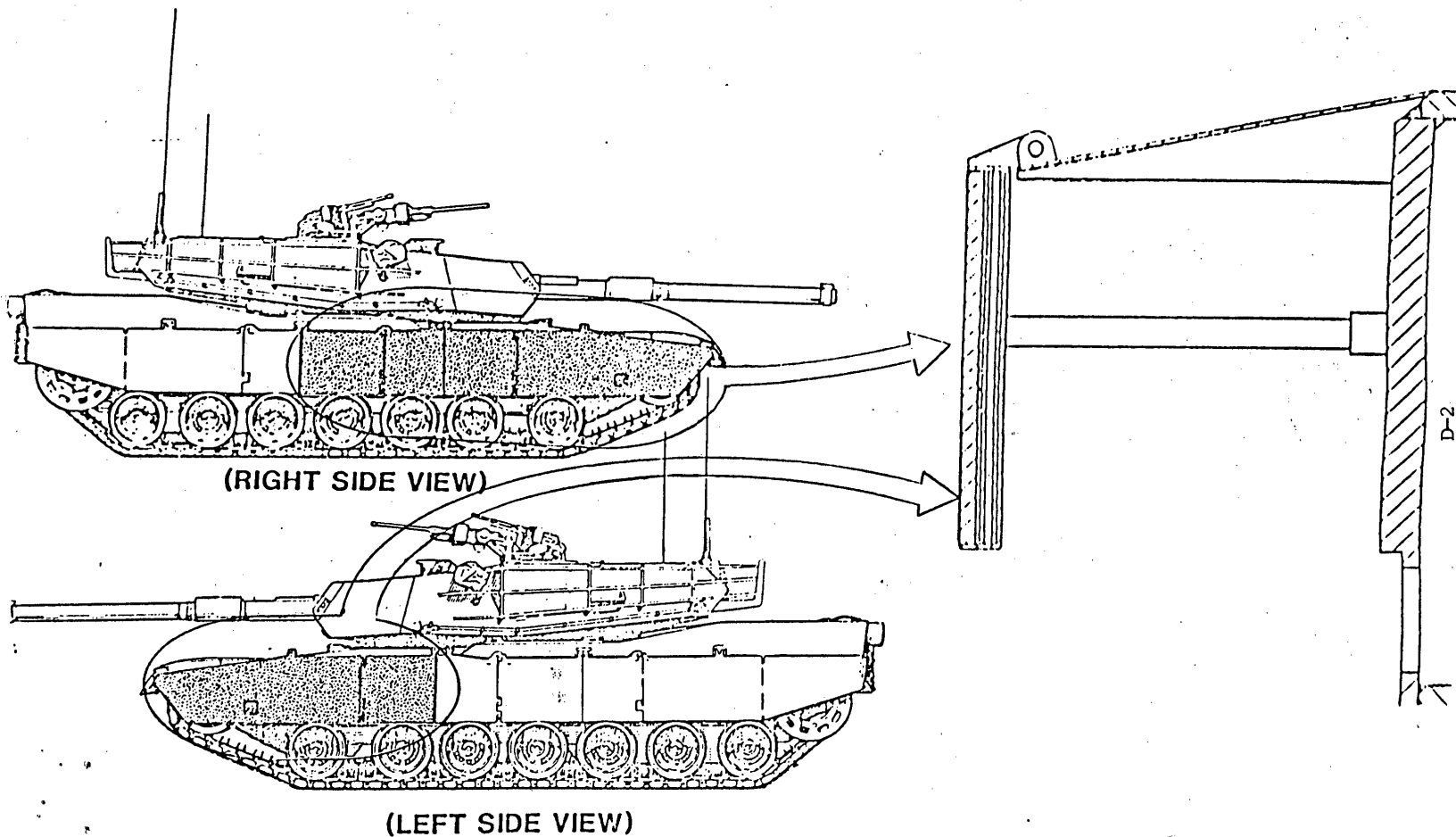

SECRET

SECRET

TURRET BUSTLE SIDE SPECIAL ARMOR

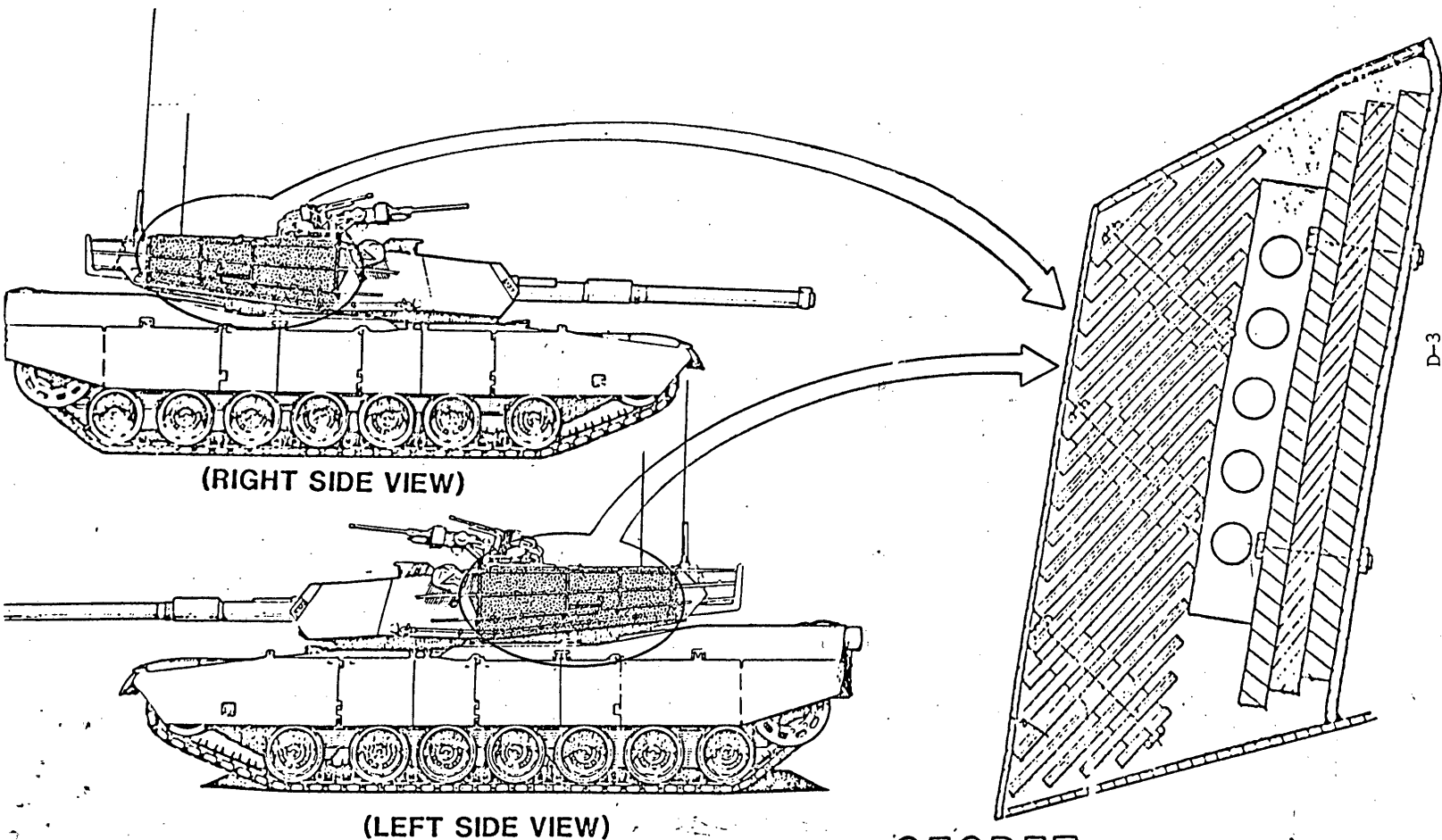

SECRET

SECRET

GUN SHIELD SPECIAL ARMOR

TURRET STRUCTURE

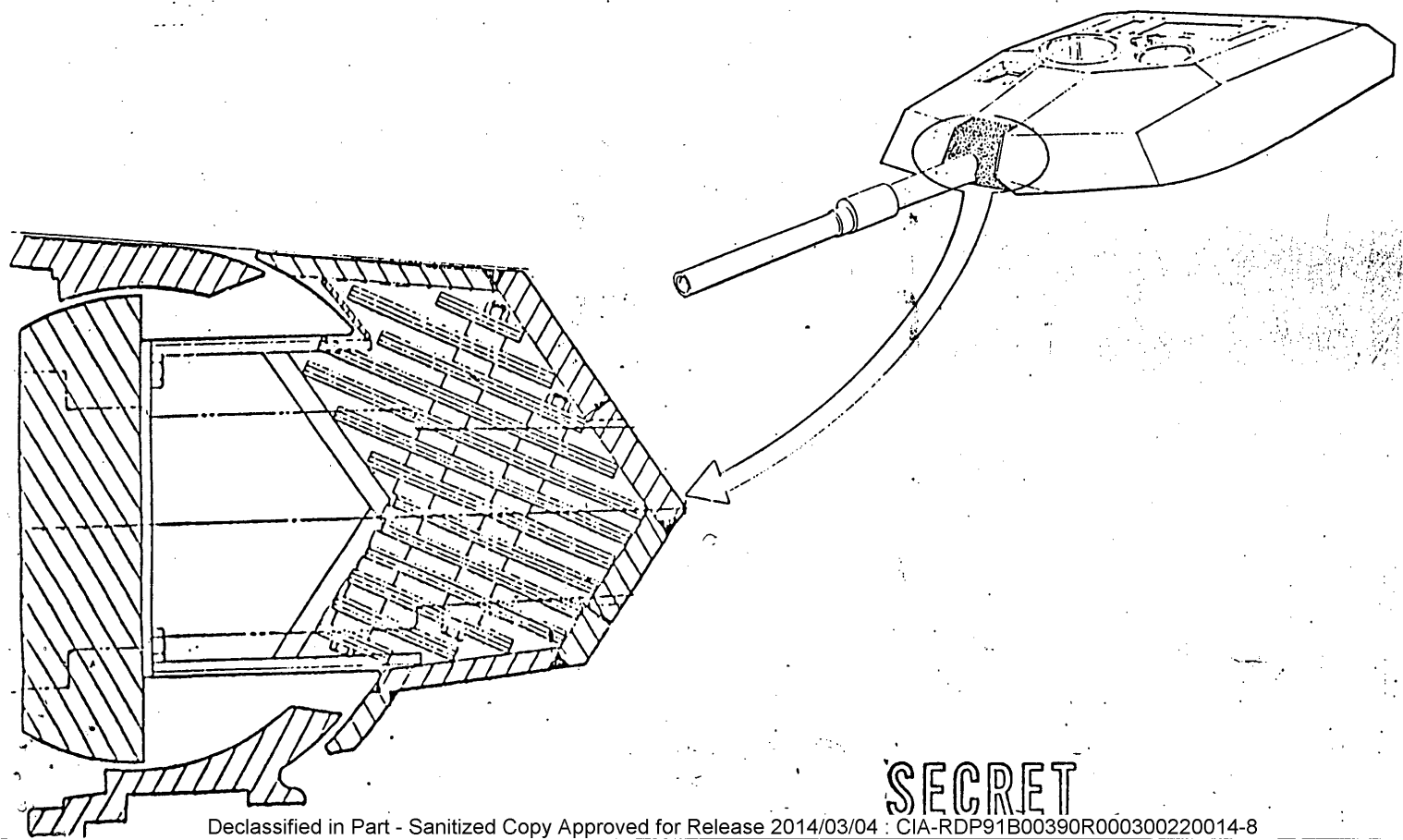

D-4

SECRET

SECRET

HULL FRONT SPECIAL ARMOR

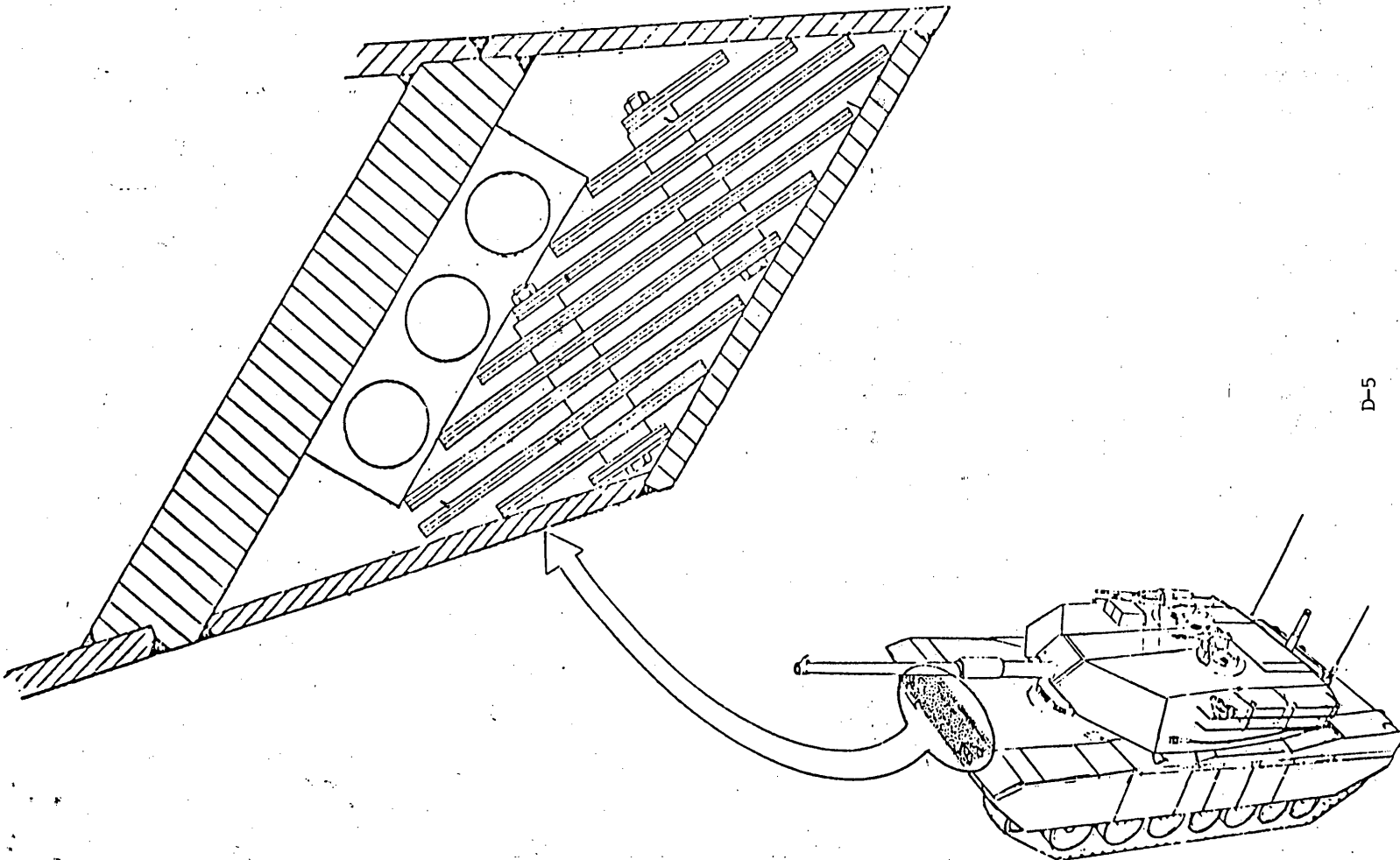

D-5

SECRET

UNCLASSIFIED

THIS PAGE INTENTIONALLY LEFT BLANK

UNCLASSIFIED

STAT

Declassified in Part - Sanitized Copy Approved for Release 2014/03/04 : CIA-RDP91B00390R000300220014-8

Page Denied

Declassified in Part - Sanitized Copy Approved for Release 2014/03/04 : CIA-RDP91B00390R000300220014-8