

concerto barocco

thresholds 28
essays in honor of Henry A. Millon

Editorial Policy

Thresholds is published biannually in January and June by the Department of Architecture at the Massachusetts Institute of Technology.

Opinions in *Thresholds* are those of the authors alone, and do not necessarily represent the views of the editors or the Department of Architecture.

No part of *Thresholds* may be photocopied or distributed without written authorization.

Thresholds is funded primarily by the Department of Architecture at MIT. This issue was made possible by a publication grant from the Graham Foundation for Advanced Studies in the Fine Arts as well as by support from the following at MIT: the Department of Architecture, the Dean of the Office of the Arts, the Dean of Humanities, the Dean of the School of Architecture and Planning, and the friends and alumni of the History, Theory, and Criticism Section. Individuals donating \$100 or more will be recognized as patrons.

Correspondence

Thresholds
Massachusetts Institute of Technology
Department of Architecture
Room 7-337
77 Massachusetts Avenue
Cambridge, MA
thresh@mit.edu

Printing

Copyright Winter 2005
Massachusetts Institute of Technology
ISSN: 1091-711X

Printed by Kirkwood Printing,
Wilmington, MA. Digitally Published
using Adobe InDesign CS.

Acknowledgements

Thanks to Lucia Allais, Zeynep Celik, Jennifer Ferng, Lauren Kroiz, Deborah Kully, John Lopez, Michael Osman, Sarah Rogers, Katherine Wheeler and Mechtild Widrich for their tireless support (technical and otherwise). And to Janna Israel for finding what could not be found.

Special thanks to the the administrative expertise and the endless patience of Melissa Bachman, Anne Deveau, Annette Horne-Williams and Anne Simunovic without whom this publication would not be possible.

We are very grateful for the ongoing support and assistance of Minerva Tirado and Jack Valleli.

And, finally a very special thanks to the faculty of HTC, especially Stanford Anderson, Mark Jarzombek, Erika Naginski and, of course, Henry Millon for making this issue a reality.

Pilaster Play

MARK JARZOMBEK

In 1492, when Bramante designed his extension of Santa Maria delle Grazie, he also designed the pier that linked his work with the preexisting medieval nave. It was an unprecedented piece of architectural wizardry composed entirely of panel-like pilasters standing shoulder to shoulder with no trace of the pier onto which they are applied. To move around the pier is to notice that one pilaster has neither base nor capital, that one has a sort of capital composed of layers of molding strips but no base, that one has both a capital and a base, and that one is in essence upside down with the molding strips at its base (Fig. 1, Pl. 5).

It is difficult to properly assess this piece of architecture. In truth, it could easily be dismissed as mere marginalia were it not for the fact that the pilaster as a design problem was so obviously intriguing to Bramante—much more so than to Brunelleschi whose use of the pilaster was decidedly more conservative. At Santa Maria delle Grazie, the pilasters cannot possibly be read as quasi-structural. They are instead the surfacing theme of the entire building.¹ And even where Bramante is at his most classical, as in the Tempietto di San Pietro in Montorio, at the level of the drum he offers a row of panel-like pilasters without capitals (Fig. 2). I use the word “panel-like” to emphasize the dual semantic role that this architectural element fulfills, as pilaster and as frame, in other words, as something solid albeit thin, and as something almost immaterial, a mere frame against the wall.

At Santa Maria presso San Satiro, in the Capella della Pietà, Bramante plays even more ingeniously with the panel pilaster theme (Fig. 3).² The geometry of the octagonal chapel is defined by splayed panel pilasters, the idea for which came from Brunelleschi's octagonal oculus of the dome of Santa Maria del Fiore, the splayed pilasters there being most probably the first such example in the history of architecture (Fig. 4). Bramante, however, destroys the residual structural reading of Brunelleschi's pilasters, which are of the Corinthian order, not only by using panel pilasters, but also by integrating their surfaces into the overall ornamental strategy of the interior. To make things more complicated, at the upper ambulatory level, the piers separating the two arches are pilaster-corbels hybrids that support stubby panel pilasters. These likewise read as support brackets for the entablature above. When all these features are taken together, it is clear that Bramante deliberately sought to blur the identities of frames, pilasters, dados, and brackets and yet still work within the principles of the classical system.

It would be wrong to argue that Bramante was engaged here in a self-conscious play on the architectural elements of classical language even though there is something nonetheless “at play,” so to speak, in his architecture. What he discovered was that pilasters can be embedded in traditional notions of a columnar order—living up to the expectations of proportion and scale—while at the same time existing at the margins of the permissible. In other words, although some pilasters must serve their columnar masters, others can exist in a more fluid state of definition.

The piers that define the octagon of the Cathedral of Pavia (begun 1488 and designed, scholars agree, with considerable input from Bramante) are another example of this phenomenon (Fig. 5). Here, the architect surfaced the

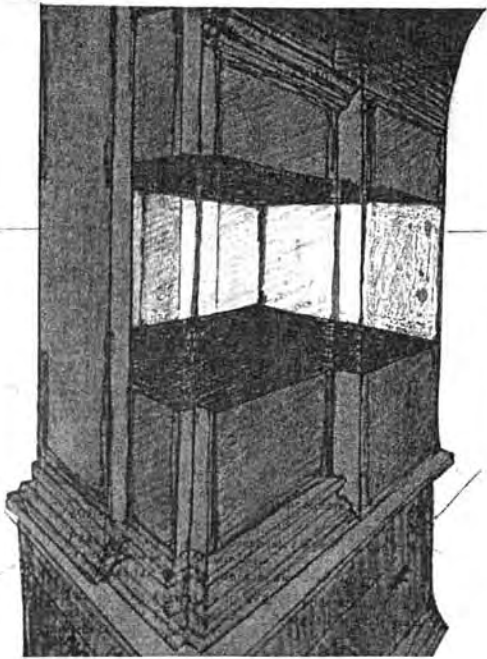

Figure 1. Sketch of a detail from Santa Maria delle Grazie, Milan (1466-1490, partially rebuilt by Bramante, 1492-99). (Author).

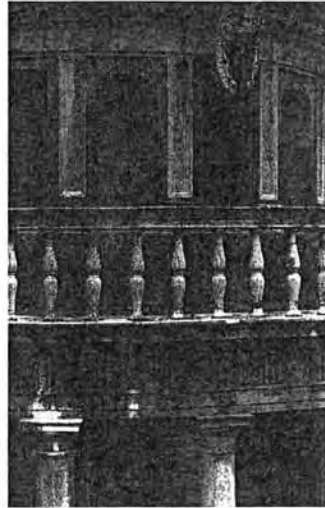

Figure 2. Bramante, Upper level of the Tempietto of San Pietro in Montorio, Rome (1499-1502).

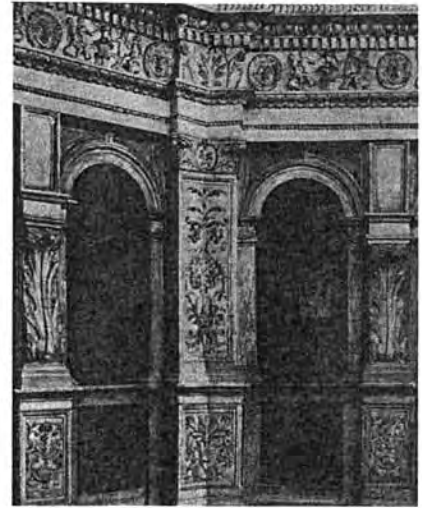

Figure 3. Bramante, False ambulatory level of the Capella della Pietà, Santa Maria presso San Satiro, (finished c. 1483).

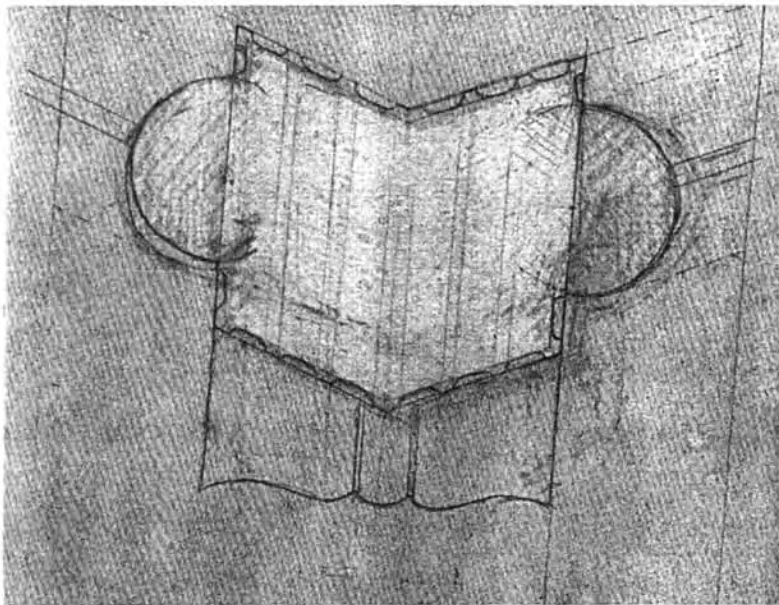

Figure 4. Sketch of a detail from Brunelleschi's Lantern of Santa Maria del'Fiore (completed 1472). (Author).

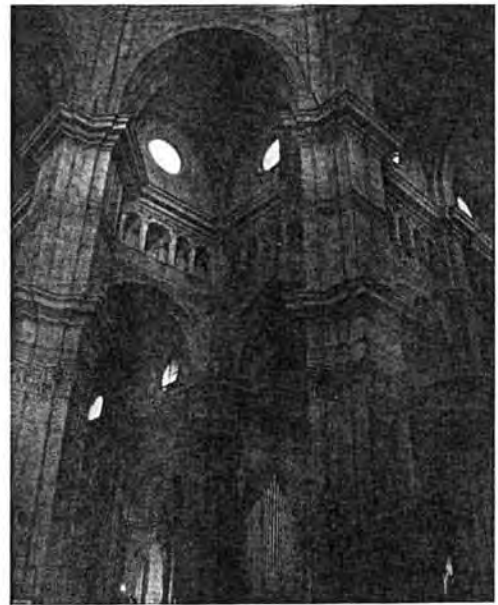

Figure 5. Interior, Cathedral of Pavia (begun 1488).

entire mass with panel pilasters, with the splayed central pilaster as the only element that runs the entire height into the drum. But the most remarkable part of the design is the upper register, which is divided into two equal zones consisting of pilasters, again without capitals, separated by an entablature band that seems to have slid down from the cornice above it. The lower pilaster bundle thus serves as a type of socle for the upper one while the upper one serves as a “bracket” for the entablature.

The background to this is certainly more medieval than classical. The principle of a splayed pilaster, for example, has its ancestry in the piers in the Baptistery of Pisa, the oculus piers of the Baptistery of Piacenza or those visible on the exterior of the choir of Santi Giovanni e Paolo in Venice (Fig. 6). Where the pilaster stubs at the attic level are concerned, their principal classical precedents are to be found at the Arch of Constantine and the Arch of Septimus Severus (Fig. 7). Yet the relationship of pilaster stub above and the principal order below was never particularly complex in the architecture of ancient Rome, and was certainly nothing like the pilasters from the Baptistery of Pisa (Fig. 8). There, pilasters without capitals are embedded in the surface decoration of the wall and define a type of mezzanine zone above the level of the primary order. These pilasters lead to pilaster clusters at the ambulatory level, which, in turn, support pilaster stubs underneath the string molding at the base of the dome. Of similar importance is the pilaster sequence on the façade of San Francesco in Prato or that on the exterior of the lantern of the Pistoia Baptistery, where pilaster stubs link the top of the columns with the entablature (Fig. 9).

It is not accidental that, on the subject of pilasters, the classical revival of the Renaissance integrated itself with the classical survival of the Middle Ages, given that the triphorim, the ambulatory, and the attic space were such important elements of the medieval spatial thinking. Stub pilasters, panel pilasters and wall panels, like those at San Miniato, helped to solve the problem of an integrated elevation in the northern Italian architectural tradition. Though Brunelleschi disdained the pilaster stub and the aesthetic of paneling in his architecture, Bramante and other architects obviously preserved these devices, thus allowing for more complex spatial structures than were possible in the Brunelleschian model. The screen between the apse and ambulatory of Antonio di Marco Gambello's San Zaccaria in Venice, begun in 1458, shows this particularly well, as does Antonio da Sangallo the Younger's design for the façade of San Pietro, which included a whole row of attenuated pilaster stubs (Fig. 10). Jacopo Sansovino's funerary monument for Ascanio Sforza in Santa Maria del Popolo in Rome (1505) also contains many such features. At his Loggetta of San Marco, Sansovino used pilaster stubs to orchestrate an entire attic-frieze zone that was completed in 1540—six years before Michelangelo began his work on San Pietro, where the theme was developed even further. Giuliano da Sangallo also maintained the tradition at Santa Maria delle Carceri, commissioned in 1485, where his pilasters are set against the darker hued stone of the frame-paneling, a device that Michelangelo was to develop at the Conservator's Palace in Rome (Fig. 11). Finally, one must not forget Giulio Romano's often ignored Palazzo Cicciporci (1521), where flat panel pilasters mark off the rhythm of the bays at the *piano nobile* and, on the floor above, narrow framed panels floating on the surface of the wall are meant to double as “pilasters.”

Michelangelo, more than any other architect of the time, brilliantly extended the slippages between “ambulatory” zone panels, socles, pilasters, dados and brackets that marked advanced architectural thinking of the time. The final stages of the façade for San Lorenzo (1516-20), for example, show a quasi mezzanine zone between with the bays marked off by pilaster stubs (Fig. 12). Though often explained away as a necessary staging for the sculptural ornamentation of the façade, the solution, as remarkable as it is awkward, derived directly from Antonio da

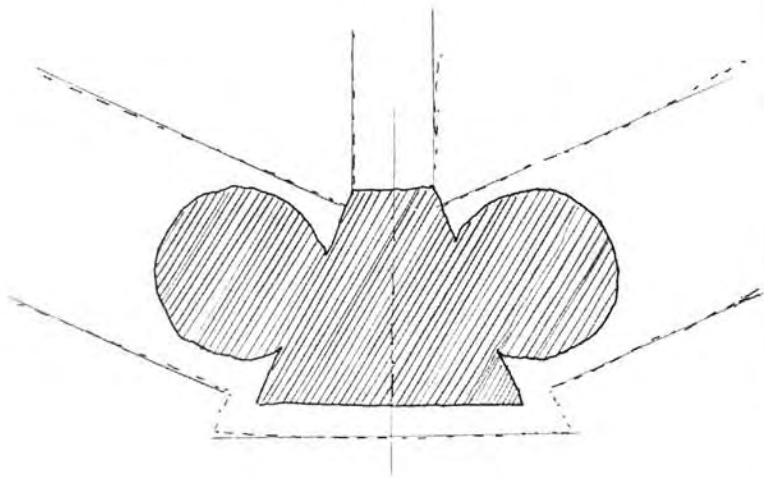

Figure 6. Sketch of the pier of the Lantern of Piacenza Baptistery.
(Author)



Figure 7. Arch of Septimius Severus, Rome (203 CE).

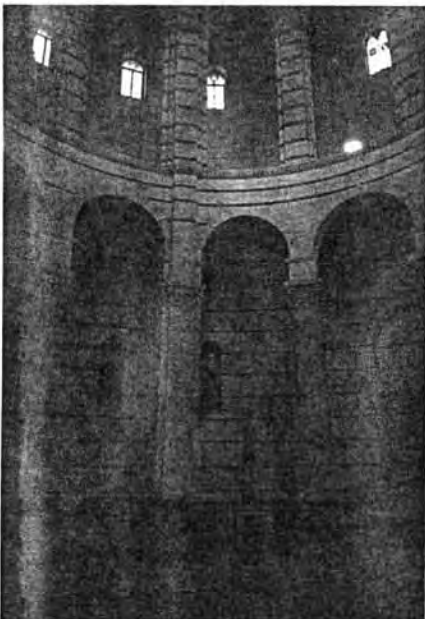

Figure 8. Interior of the Baptistery of Pisa, (1063-1390s).



Figure 9. Exterior of the Lantern from the Pistoia Baptistery, (finished 1359).

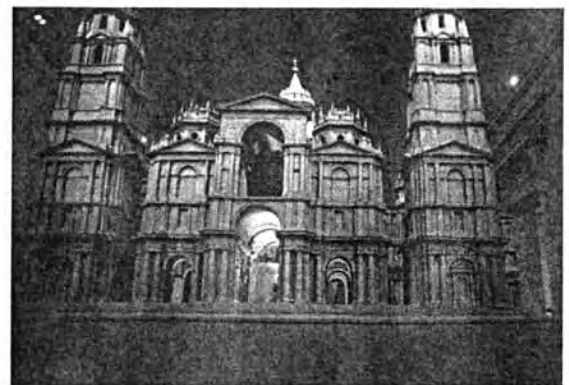

Figure 10. Antonio da Sangallo the Younger, Model of San Pietro (1548).



Figure 11. Giuliano da Sangallo, Santa Maria delle Carceri, Prato (begun 1485).

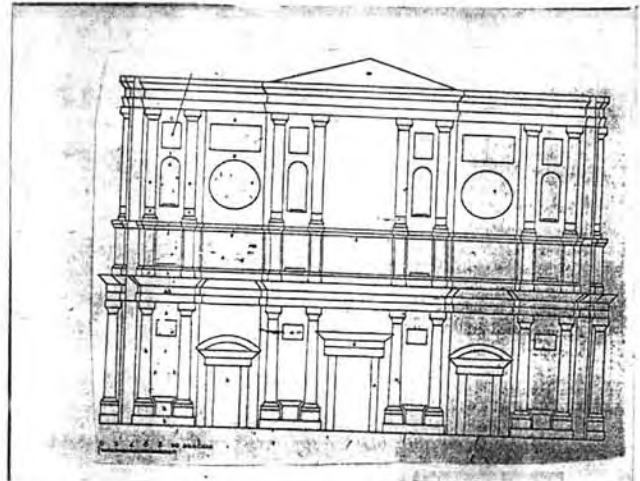

Figure 12. Façade project for San Lorenzo, Florence (1516-20).

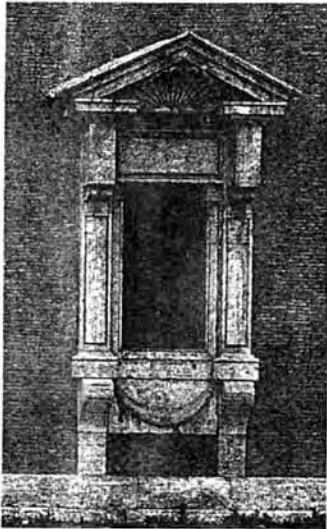

Figure 13. Right-hand window of Porta Pia.

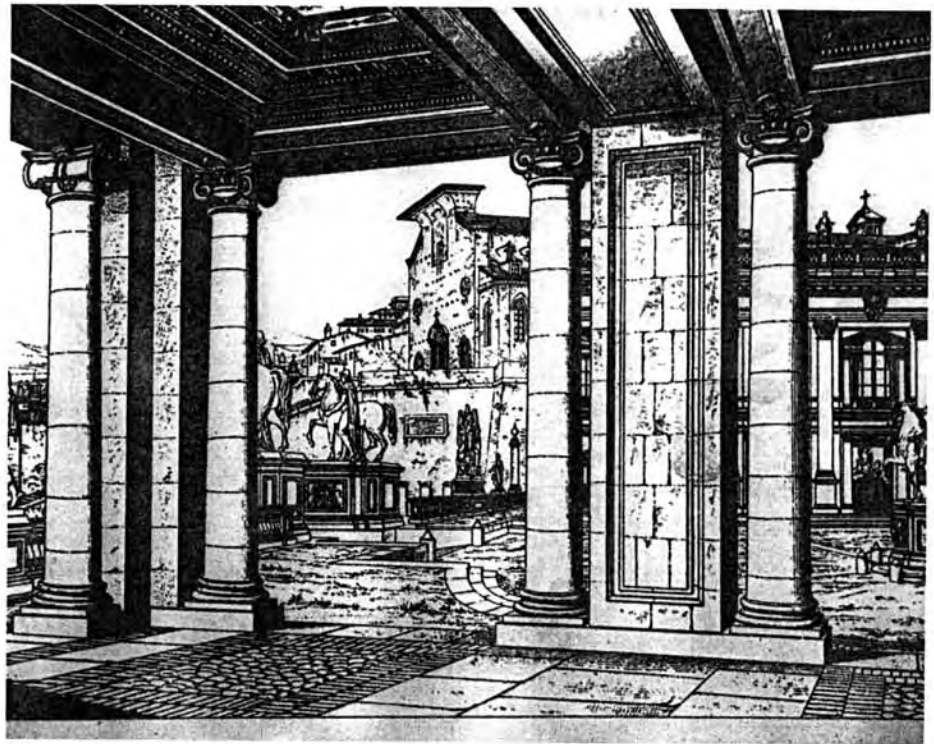

Figure 14. Drawing of Michelangelo's Colonnade of Conservator's Palace, Rome (designed ca. 1540) in Paul Latrouilly, *Édifices de Rome moderne* (Paris: Bance, 1860), pl. 353.

Sangallo the Younger's design for the façade of San Pietro, which Michelangelo purportedly otherwise disliked but here pushed to the limits of classical protocol. The breaking apart of the upper and lower halves of the façade was rarely ever used subsequently.

Michelangelo would explore the amorphous nature of architectural semantics throughout his architectural career, becoming particularly attracted to the design of doors and windows where the play on the theme of pilaster, panel and framing could be exercised without disturbing the more official requirements imposed by the architecture of grand orders. Particularly brilliant is a window design for the Porta Pia (1562), which is based on his obvious study of the courtyard of Bramante's Palazzina di Innocenzo VIII (Fig. 13). A broken pediment rests on corbel-pilaster hybrids that, in turn, sit on small tight-fisted corbels serving as capitals for a pilaster-like element. The base at the bottom, sitting on the broad shoulders of a scroll, can be read as the base either for the whole or for the rear most layer. On the interior, and framing the window opening itself, is a remarkable U-shaped pilaster with no base yet with two square blocks serving as "capitals" that hold the central block with its raised central panel.

In studying Michelangelo's designs, one might at first be inclined to agree with those scholars who point to their ostensibly sculptural character.³ Giulio Carlo Argan, for example, claims that Michelangelo's architecture, like his sculpture, possesses an "architectonic" based on "the not-finished."⁴ But those arguments imply that it was Michelangelo's sculptural talent—in combination, perhaps, with a psychological predilection to avoid "firm opposition" as Argan has phrased it—that motivated him to experiment with architectural form.⁵ Be that as it may, we have to be careful not to demote what Michelangelo learned from Bramante, Giuliano da Sangallo and Sansovino. Nor should one obfuscate the clarity and precision needed to create a successful play of the architectural semantic. And finally one should note that Michelangelo was able to solve the Sangallo problem that beset him in his design for the façade of San Lorenzo by creating a distinction between primary and secondary pilaster usages; the former followed the rules of proportion whereas the latter, though reserved for features like windows and attic storeys, was actually, for Michelangelo, the greater design problem. This is seen at the Conservator's Palace (designed around 1540) where the main façade, though not without its pilastric ambiguities, contrasts markedly with the back wall of the colonnade. There one finds wide panel pilasters that seem to be neither fully structural nor fully pilastric (Fig. 14).

Among the later masters of pilastric virtuosity was Francesco Borromini. Let me turn to the pier to the left of the entrance of the Oratory dei Fillipini (1637-52). Here, Borromini experimented with a range of pilaster types, the most important being the splayed pilaster (Fig. 15, Pl. 6). He also used pilaster voids that hold both real and invisible columns. One has to imagine the presence of non-structural elements. The interior of the pier is also open to interpretation as to what is or is not "pilaster" and what is and is not "column." Guarino Guarini maintained the thrust of Borromini's ideas in his façade for Santa Maria Annunziata in Messina, which sports splayed pilasters, panels, pilaster stubs, pilaster-walls, dados and frames (Fig. 16).

The pilaster's resistance to theoretical transcription clearly fascinated these architects, and it is for this reason that one should resist downplaying the unusual place of the panel pilaster in Renaissance design by relegating it to the Doric or "Tuscan" order when it is clearly something else. One should also not describe as Mannerist interrogations of the panel pilaster by Michelangelo and Borromini, given that the tradition of fusing panel, pilaster, wall and surface stretched back to the late medieval period and continued well into the seventeenth century. It was a tradition that understood the nature of architectural excess as a place where the architect could provoke more than just speculation on order and proportion by thinking about the complex superficiality, as it were, of the

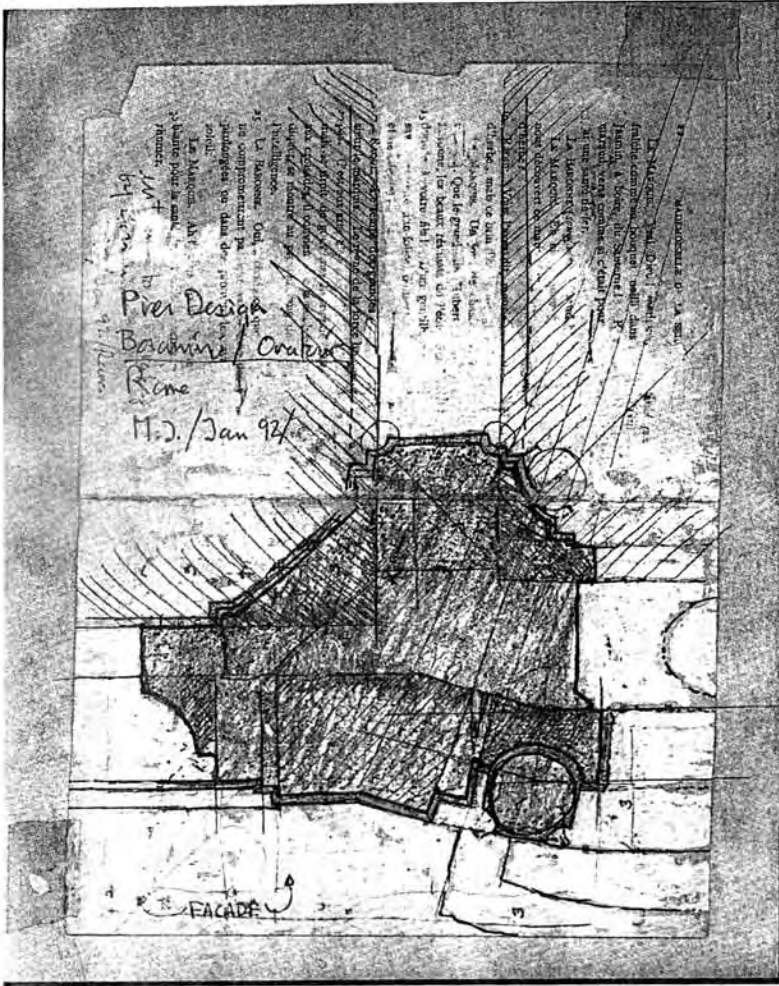

Figure 15. Sketch of Francesco Borromini's Oratory dei Fillipini, Rome (1637-52). (Author).

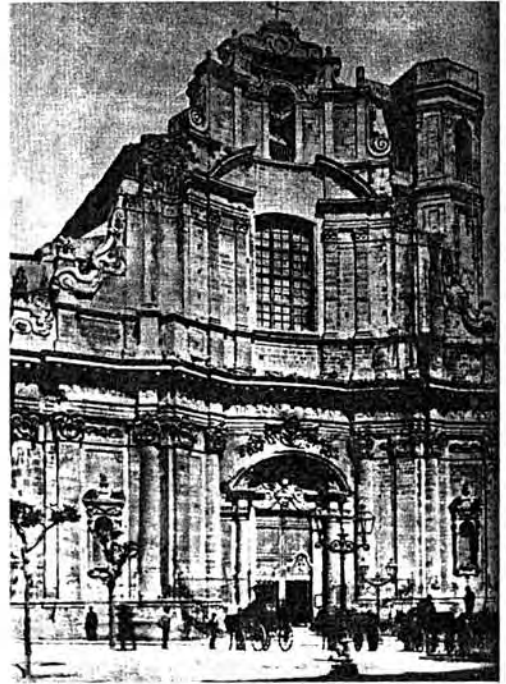

Figure 16. Guarino Guarini, Façade of Santa Maria Annunziata, Messina (ca. 1660).

architectural mass.

Eventually the search for an ambiguous yet fruitful relationship between surface and mass gave way to the more ephemeral ornamentations of the Rococo and then to the more rigorous ideals of Neoclassicism. The former moved architecture toward the cinematic and the latter, toward the horizon of functionalist modernity. Borromini's architecture stands at the threshold of that split and thus prompts tantalizing questions about the materiality of architecture squeezed between outside and inside forces. But it was Bramante who first opened up that space of inquiry, taking his lead from the Middle Ages, extending it into an aesthetic that Michelangelo and others could use as grounding for further elaboration. That the problem emerged in interstitial spaces, mezzanines, attic zones and secondary areas of architectural design was the reason for its survival, growth, and ultimate demise.

1. Cesare Cesariano, in his 1521 edition of Vitruvius, used the term "Attic" pilaster to describe that particular order. I prefer to use the term panel pilaster in order to avoid seeing these elements as conditioned by the principles of the orders.
2. Most scholars agree that Bramante was the principal designer. The sculptural ornamentation was executed by Agostino de Fondutis.
3. See James Ackerman, *The Architecture of Michelangelo* (London: A. Zwemmer, 1961), 68, and Robert S. Liebert, *Michelangelo, A Psychoanalytic Study of His Life and Images* (New Haven: Yale University Press, 1983), 212.
4. Giulio Carlo Argan and Bruno Contardi, *Michelangelo Architect*, trans. Marion L. Grayson (London: Thames and Hudson, 1993), 29.
5. *Ibid.*