

UNCLASSIFIED

AD NUMBER

AD378365

CLASSIFICATION CHANGES

TO: unclassified

FROM: confidential

LIMITATION CHANGES

TO:  
Approved for public release, distribution unlimited

FROM:  
Distribution: Further dissemination only as directed by Federal Aviation Administration, Office of Supersonic Transport Development, Washington, DC, 20553, Sep 1966, or higher DoD authority.

AUTHORITY

FAA ltr, 10 Oct 1972; FAA ltr, 10 Oct 1972

THIS PAGE IS UNCLASSIFIED

# **SECURITY**

---

# **MARKING**

**The classified or limited status of this report applies to each page, unless otherwise marked.**

**Separate page printouts MUST be marked accordingly.**

---

**THIS DOCUMENT CONTAINS INFORMATION AFFECTING THE NATIONAL DEFENSE OF THE UNITED STATES WITHIN THE MEANING OF THE ESPIONAGE LAWS, TITLE 18, U.S.C. SECTIONS 793 AND 794. THE TRANSMISSION OR THE REVELATION OF ITS CONTENTS, IN ANY MANNER TO AN UNAUTHORIZED PERSON IS PROHIBITED BY LAW.**

**NOTICE: When government or other drawings, specifications or other data are used for any purpose other than in connection with a definitely related government procurement operation, the U. S. Government thereby incurs no responsibility, nor any obligation whatsoever; and the fact that the Government may have formulated, furnished, or in any way supplied the said drawings, specifications, or other data is not to be regarded by implication or otherwise as in any manner licensing the holder or any other person or corporation, or conveying any rights or permission to manufacture, use or sell any patented invention that may in any way be related thereto.**

AD No. 378365

DDC FILE COPY

L

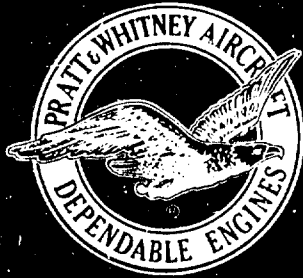

**Pratt & Whitney Aircraft**  
FLORIDA RESEARCH AND DEVELOPMENT CENTER

U  
A®

### NOTICES

When Government drawings, specifications, or other data are used for any purpose other than in connection with a definitely related Government procurement operation, the United States Government thereby incurs no responsibility nor any obligation whatsoever; and the fact that the Government may have formulated, furnished, or in any way supplied the said drawings, specifications, or other data, is not to be regarded by implication or otherwise as in any manner licensing the holder or any other person or corporation, or conveying any rights or permission to manufacture, use, or sell any patented invention that may in any way be related thereto.

All distribution of this document is controlled. In addition to security requirements which apply to this document and must be met, it may be further distributed by the holder only with specific prior approval of:

Director of Supersonic Transport Development  
Federal Aviation Agency  
Washington, D. C. 20553

The distribution of this report is limited because it contains technology identifiable with items excluded from export by the Department of State (U. S. Export Control Act of 1949, as amended).

(14) PWA-FP-66-100-Vc-3D

**CONFIDENTIAL**

PWA FP 66-100

SEPTEMBER 1966

~~C28-6C 2360~~

ACCESSION NO.	
EXPIRE DATE	
CLASSIFICATION	
STANDARD AERIALITY INDEX	
DATE	
SERIAL	

15

(6)

**ENGINE PROPOSAL  
FOR PHASE III OF THE  
SUPERSONIC TRANSPORT DEVELOPMENT PROGRAM**

**VOLUME III  
TECHNICAL / ENGINE.**

REPORT D. ✓

**INSTALLATION AND INLET  
SYSTEM COMPATIBILITY (U).**

D D C  
RECEIVED  
JAN 20 1967  
SECURITY  
A

(11) Sep 66

(12) 110p.

(15) FA-55-66-8

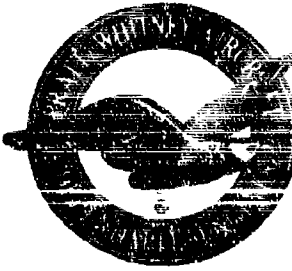

(COMPETITIVE DATA)

PREPARED FOR  
FEDERAL AVIATION AGENCY  
OFFICE OF SUPERSONIC TRANSPORT DEVELOPMENT  
WASHINGTON, D. C.

**YOU ARE HEREBY NOTIFIED THAT**  
THE BOEING COMPANY CONSIDERS ALL INFORMATION DESIGNATED BOEING - COMPETITIVE DATA IN THIS DOCUMENT TO BE OF A PROPRIETARY NATURE. THEREFORE, THE RECEIVER OF SUCH INFORMATION IS REQUESTED TO TREAT IT ACCORDINGLY AND NOT TRANSMIT, REVEAL OR DISCLOSE IT OR ANY PART THEREOF TO COMPETING COMPANIES OR ORGANIZATIONS OF BOEING WITHOUT THE SPECIFIC APPROVAL OF THE BOEING T38 CHIEF ENGINEER.

THE INFORMATION AND DESIGN DESIGNATED AS LOCKHEED - COMPETITIVE DATA IS CONSIDERED BY LOCKHEED AIRCRAFT COMPANY TO BE ORIGINATED BY AND TO BE THE PROPERTY OF LOCKHEED. LOCKHEED RESERVES ALL PATENT, PROPRIETARY, DESIGN, MANUFACTURING, REPRODUCTION, USE AND SALES RIGHTS THEREIN, AND TO ANY ARTICLE DISCLOSED THEREIN, EXCEPT TO THE EXTENT RIGHTS ARE EXPRESSLY GRANTED TO OTHERS. THE FOREGOING DOES NOT APPLY TO LOCKHEED VENDOR PROPRIETARY RIGHTS.

THIS DOCUMENT CONTAINS INFORMATION AFFECTING THE NATIONAL DEFENSE OF THE UNITED STATES WITHIN THE MEANING OF THE ESPIONAGE LAWS, TITLE 18 U. S. C., SECTIONS 793 AND 794. ITS TRANSMISSION OR THE REVELATION OF ITS CONTENTS IN ANY MANNER TO AN UNAUTHORIZED PERSON IS PROHIBITED BY LAW.

FAA SECURITY CONTROL  
NO. 67216

**Pratt & Whitney Aircraft** DIVISION OF UNITED AIRCRAFT CORPORATION  
FLORIDA RESEARCH AND DEVELOPMENT CENTER

(401355) mk

DECLASSIFIED AFTER 12 YEARS. DOD DIR. 5300.10

**CONFIDENTIAL**

CONTENTS:

SECTION		PAGE
I	A INSTALLATION COMPATIBILITY	D I - 1
	A. Scope and Objectives	D I - 1
	B. Description of Complete JTF17 Engine/Airframe Interface Boundary	D I - 1
	C. Installation Configuration and Supporting Design Details	D I - 38
	D. Secondary Airflow System Definition and Requirements	D I - 42
	E. Engine Mockup Plan	D I - 44
	F. Engine Installation Handbook	D I - 47
II	A INLET SYSTEM COMPATIBILITY	D II - 1
	A. Objectives and Introduction	D II - 1
	B. Airframe/Engine Compatibility Agreement	D II - 1
	C. Engine Inlet Compatibility Test Plan	D II - 2
	D. Analytical Simulation	D II - 12
	E. Distortion Prediction Development	D II - 37
III	A EXHAUST SYSTEM COMPATIBILITY	D III - 1
	A. Introduction	D III - 1
	B. Installation Effects	D III - 1

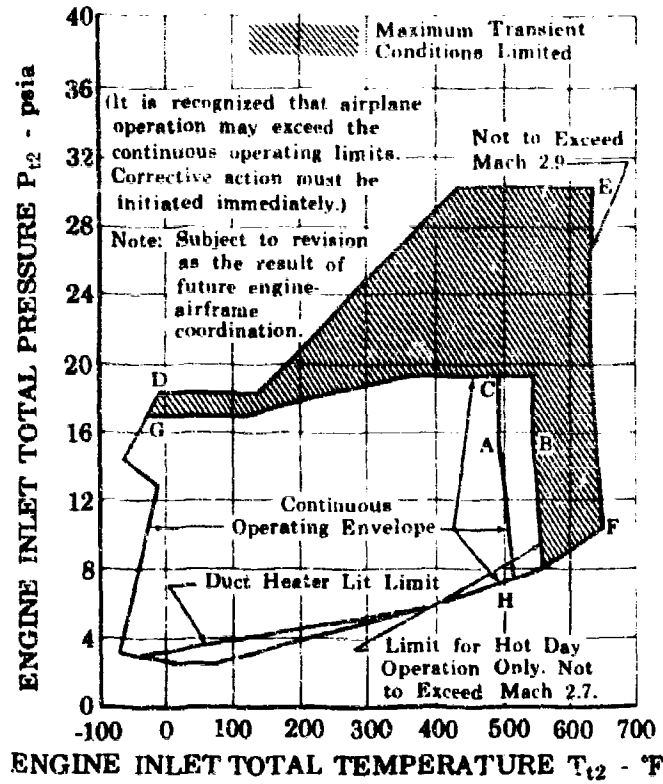

Figure 3. Engine Operating Envelope - Lockheed

FD 17609

BI

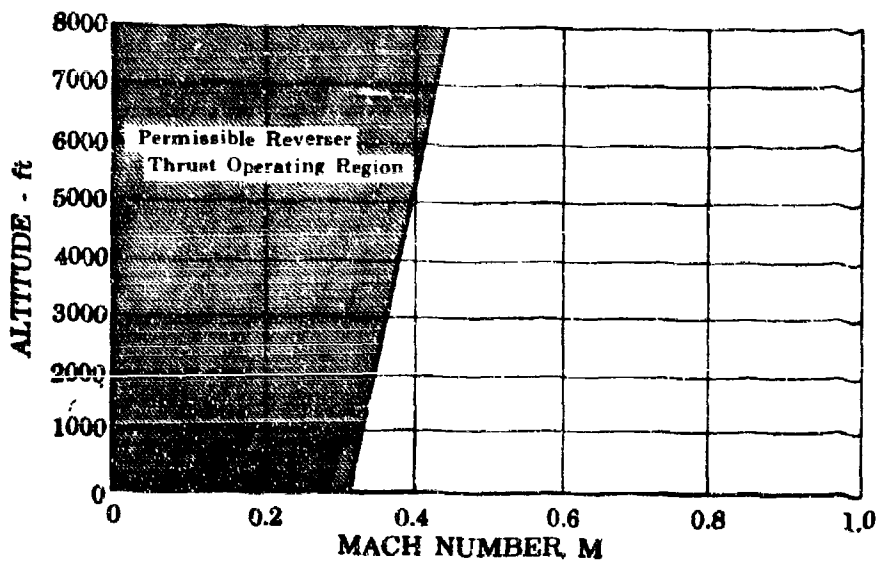

Figure 4. JTF17 Reverser Thrust Operation - Boeing

FD 16332

BI

**Pratt & Whitney Aircraft**

PWA FP 66-100

Volume III

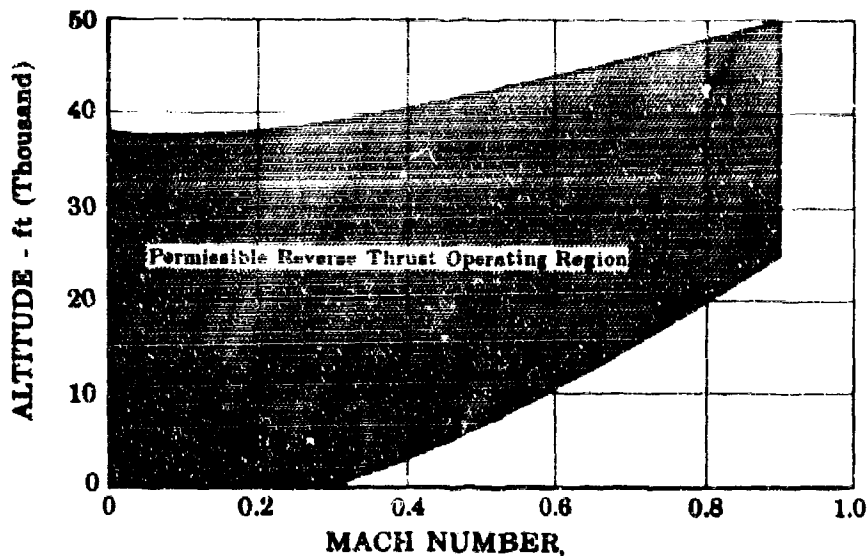

Figure 5. JTF17 Reverser Thrust Operation -  
Lockheed

FD 16331  
BI

Time percentages established were applied to the engine life objectives to obtain the requirements given below. Points indicated for various limiting conditions refer to figures 2 and 3.

For major cases, 50,000-hour life:

1. 30,000 mission cycles
2. 50,000 engine acceleration cycles - idle to SLTO
3. 21,000 hours at cruise (Point A)
4. 1000 hours at SLTO (M = 0-0.3)
5. 1500 hours at maximum compressor inlet temperature and pressure (Point C)
6. 750 hours at envelope limit (Line GCAH)
7. 50 hours at maximum transient point (Line DEF)
8. 4250 hours at hot day cruise (Point B)
9. 1000 hours at maximum reverse thrust

For disks, 20,000-hour disk life:

1. 12,000 mission cycles
2. 20,000 engine acceleration cycles - idle to SLTO
3. 8500 hours at cruise (Point A)
4. 400 hours at SLTO (M = 0-0.3)
5. 600 hours at maximum compressor inlet temperature and pressure (Point C)



**CONFIDENTIAL**

**Pratt & Whitney Aircraft**

PWA FP 66-100

Volume III

leakage connect points that permit optimum engine maintenance and foolproof assembly. The tubes are designed for easy maintenance and inexpensive fabrication and with adequate support to keep resonant frequencies well above engine operating frequencies.

Specific objectives and requirements are:

1. Each tube is designed for its specific application, i.e., function and environment, with a usable life that is consistent with 50,000 hours aircraft life and with 10,000 hours engine TBO without major repair.
2. Stresses associated with differential expansion and contraction of various parts of the engine during steady-state and transient operation must be kept within acceptable limits through proper routing and support arrangements.
3. Tubes are routed to ensure a nominal clearance envelope of 0.500 inch between engine components and other tubes. A clearance of 1.000 inch nominal is maintained adjacent to airframe structure.
4. Fuel and oil supply lines must function satisfactorily in ambient temperatures from  $-65^{\circ}\text{F}$  to  $700^{\circ}\text{F}$  and fluid temperature to  $400^{\circ}\text{F}$  maximum.
5. Air lines, including breather and signal lines, and fluid lines that are drained during part of the flight envelope must withstand ambient temperatures of  $1050^{\circ}\text{F}$  maximum.

### 3. Design Approach

#### a. Detailed Description

##### (1) Tubing

Experience gained from the design of the high Mach number and high performance J58 engine is being directly applied to the JTF17 engine. Development engine time in excess of 22,000 hours has been accumulated on tubing of the type used on the JTF17. Tubing systems for the JTF17 engine are designed using refined tube computer programs which were developed in conjunction with the J58 engine project. Two major tube computer programs are utilized. These are: (1) the tube stress program, and (2) the tube clearance program.

The procedure outlined in figure 3 demonstrates the approach used to design engine tubing systems. Each tubing system is analyzed to determine optimum tube size, wall thickness and tentative routes.

Pump inlet line sizes are designed with a fluid velocity of 10 to 16 ft/sec to prevent cavitation or erosion. Tube sizes for the duct heater fuel system are derived from a maximum allowable fill time requirement with resulting velocities and pressure drops in the system compatible with a pressure requirement at the nozzles. Other systems are

BII I-3

**CONFIDENTIAL**

**CONFIDENTIAL**

designed to permit minimum tube sizes within allowable pressure loss requirements and minimum expansion loop length.

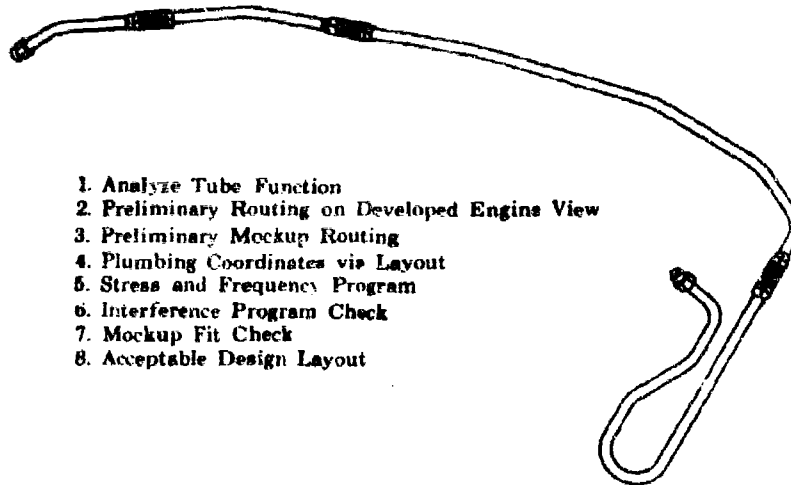

Figure 3. P&WA Tube Design Process

FD 17001  
BII

Tube wall thicknesses that have been established for the JTF17 engine are as follows:

Tube Size (Outside Dia, in.)	Maximum Operating Pressure, psi	Basic Wall Thickness, in.
Up to 2.500	Under 1000	0.035
Up to 0.438	Over 1000	0.035
0.500 to 0.688	Over 1000	0.049
0.750 to 1.500	Over 1000	0.065

Tubing routes are checked on engine mockups to provide a visual 3-dimensional aid for final route selection. Removal of components, ease of engine maintenance with respect to inspection parts, access panels and ports are considered during this phase of tubing design.

Tube OD wall thicknesses, coordinates, end points, bracket locations and final thermal calculations are input into a tubing computer program which computes stresses along the tube length, relative thermal movements at sliding bracket locations, and resonant frequencies between support points. The tube is redesigned and recomputed, in an iterative process, until the design requirements of stresses and frequencies are met. The maximum combined hoop, tension and bending design stress is limited to 22,000 psi, providing ample stress margin for tolerances and fatigue stresses for the material used. Tubing resonant frequencies are kept above 180 cycles per second, which is 20% above high rotor frequency.

**CONFIDENTIAL**

leakage connect points that permit optimum engine maintenance and foolproof assembly. The tubes are designed for easy maintenance and inexpensive fabrication and with adequate support to keep resonant frequencies well above engine operating frequencies.

Specific objectives and requirements are:

1. Each tube is designed for its specific application, i.e., function and environment, with a usable life that is consistent with 50,000 hours aircraft life and with 10,000 hours engine TBO without major repair.
2. Stresses associated with differential expansion and contraction of various parts of the engine during steady-state and transient operation must be kept within acceptable limits through proper routing and support arrangements.
3. Tubes are routed to ensure a nominal clearance envelope of 0.500 inch between engine components and other tubes. A clearance of 1.000 inch nominal is maintained adjacent to airframe structure.
4. Fuel and oil supply lines must function satisfactorily in ambient temperatures from  $-65^{\circ}\text{F}$  to  $700^{\circ}\text{F}$  and fluid temperature to  $400^{\circ}\text{F}$  maximum.
5. Air lines, including breather and signal lines, and fluid lines that are drained during part of the flight envelope must withstand ambient temperatures of  $1050^{\circ}\text{F}$  maximum.

### 3. Design Approach

#### a. Detailed Description

##### (1) Tubing

Experience gained from the design of the high Mach number and high performance J58 engine is being directly applied to the JTF17 engine. Development engine time in excess of 22,000 hours has been accumulated on tubing of the type used on the JTF17. Tubing systems for the JTF17 engine are designed using refined tube computer programs which were developed in conjunction with the J58 engine project. Two major tube computer programs are utilized. These are: (1) the tube stress program, and (2) the tube clearance program.

The procedure outlined in figure 3 demonstrates the approach used to design engine tubing systems. Each tubing system is analyzed to determine optimum tube size, wall thickness and tentative routes.

Pump inlet line sizes are designed with a fluid velocity of 10 to 16 ft/sec to prevent cavitation or erosion. Tube sizes for the duct heater fuel system are derived from a maximum allowable fill time requirement with resulting velocities and pressure drops in the system compatible with a pressure requirement at the nozzles. Other systems are

designed to permit minimum tube sizes within allowable pressure loss requirements and minimum expansion loop length.

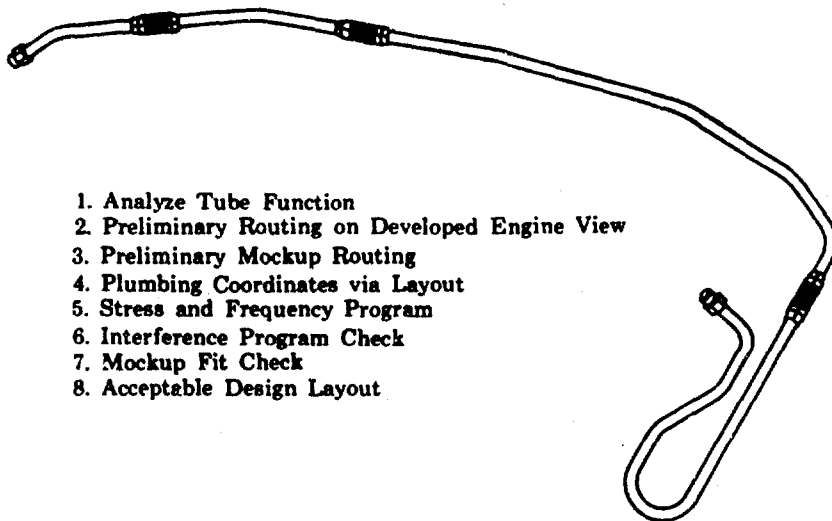

Figure 3. P&WA Tube Design Process

FD 17001  
BII

Tube wall thicknesses that have been established for the JTF17 engine are as follows:

Tube Size (Outside Dia, in.)	Maximum Operating Pressure, psi	Basic Wall Thickness, in.
Up to 2.500	Under 1000	0.035
Up to 0.438	Over 1000	0.035
0.500 to 0.688	Over 1000	0.049
0.750 to 1.500	Over 1000	0.065

Tubing routes are checked on engine mockups to provide a visual 3-dimensional aid for final route selection. Removal of components, ease of engine maintenance with respect to inspection parts, access panels and ports are considered during this phase of tubing design.

Tube OD wall thicknesses, coordinates, end points, bracket locations and final thermal calculations are input into a tubing computer program which computes stresses along the tube length, relative thermal movements at sliding bracket locations, and resonant frequencies between support points. The tube is redesigned and recomputed, in an iterative process, until the design requirements of stresses and frequencies are met. The maximum combined hoop, tension and bending design stress is limited to 22,000 psi, providing ample stress margin for tolerances and fatigue stresses for the material used. Tubing resonant frequencies are kept above 180 cycles per second, which is 20% above high rotor frequency.

BOEING COMPETITIVE DATA

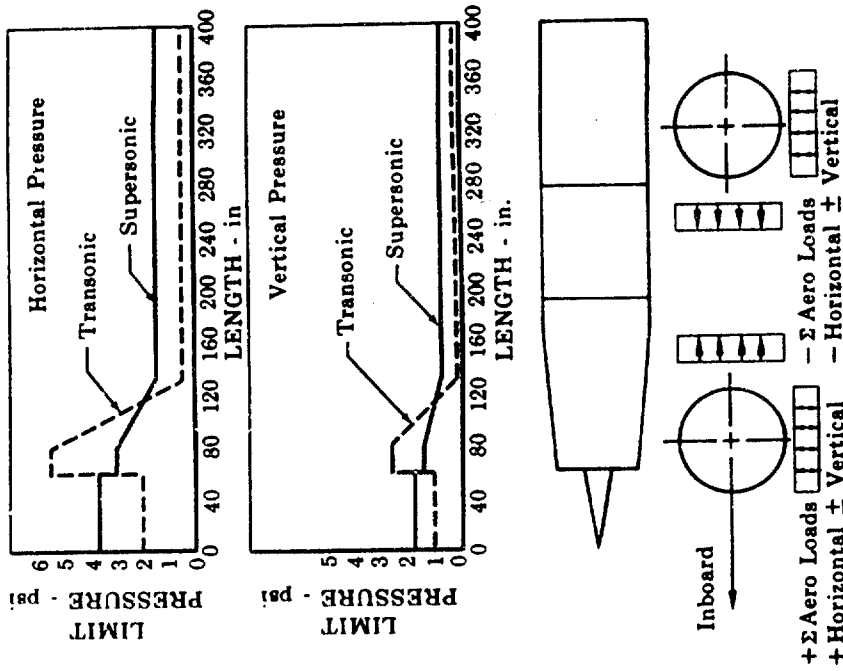

Figure 7. Aerodynamic Loads on Engine Pod (Boeing)

FD 16287  
IIA

BOEING COMPETITIVE DATA

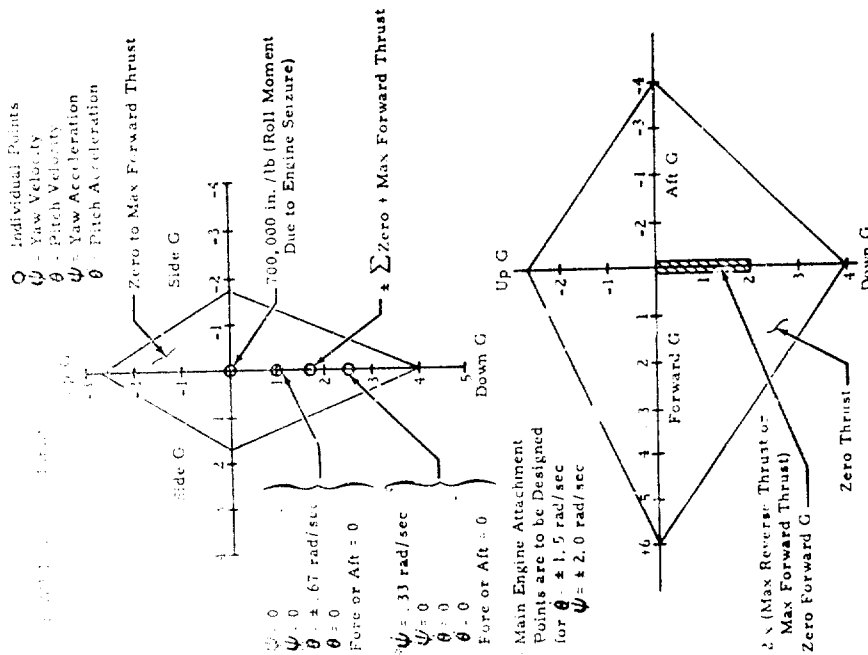

Figure 6. JTF17 Maneuver Load Diagram - Boeing Installation

BIIA-7

**CONFIDENTIAL**

**LOCKHEED COMPETITIVE DATA**

Note: All Loads Are Limit

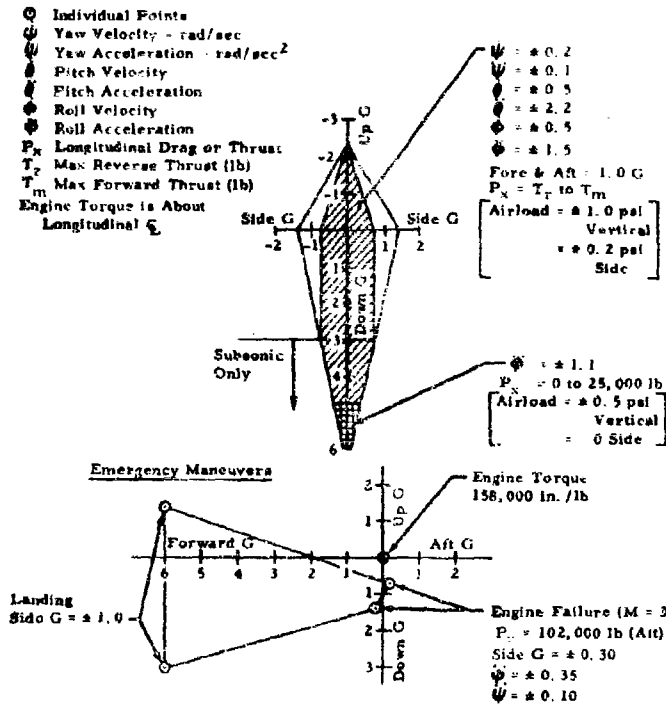

Figure 8. JTF17 Maneuver Load Diagram - Lockheed Installation

FD 16285  
IIA

Rotor integrity is assured by application of the following rotor tiebolt or axial retention criteria:

1. The moment imposed by loss of 10% of the blades of any one stage shall not stress the tiebolts more than the 0.2% yield strength of the material.
2. The strain energy produced from loss of 10% of the blades of any one stage must be within the strain energy absorption capability of the tiebolts.
3. In addition, the tiebolts must prevent flange separation during normal operation at the extreme conditions of maneuver and flight envelope.

Energy absorptive techniques are used to prevent gross rotor failures. Generally, this technique is to utilize energy by deformation or rubbing friction on less critical or smaller mass parts to prevent the sudden release of large masses of energy. This criteria is applied to rotor-stator axial spacing.

The minimum parts life requirements shown below are established on the basis of the general engine parts life requirements described in Section I (Introduction to Report B).

Fan disks	20,000 hours
Blade lock rings	20,000 hours
Fan rotor blades	10,000 hours
Rotor tiebolts	10,000 hours

BIIA-8

**CONFIDENTIAL**

Prior to the use of fans, the criteria employed to ensure containment equated the potential energy absorption capacity of the case to the kinetic energy of the blades released. While this method yielded generally acceptable results for high compressors and turbines (figures 25 and 26), tests revealed that the energy absorption was not sufficient for the larger diameter fans. The blade impact was determined to produce intense local compressive stresses that caused a portion of the case to be sheared before the energy could be absorbed.

A technique has been developed to provide a type of containment analysis that employs the shape of the failed blade and the dynamic shear strength of a localized section of the engine case. This method has provided consistent results in tests using actual blades and engine cases. From many tests, a factor has evolved that relates the actual blade velocity at impact to the total velocity of the same weight blade required to shear the case. Experience defines this factor. (See figure 27.)

In the JTF17, shear criteria has been used to size the fan case. The shear criteria was also used for the compressor and turbine sections as well as the energy criteria. Table 8 shows the actual containment factors, shear and energy, provided in the engine.

Containment Capability of cases is judged by a "containment factor," that is empirically obtained from test.

This containment factor (CF) relates case energy absorption potential (PE) to blade kinetic energy (KE)

$$CF = \frac{PE \text{ (Of all cases surrounding stage)}}{KE \text{ (All Blades Instage)}}$$

For unshrouded blades CF = 0.20

Shrouded blades CF = 0.12

(each as turbine stage)

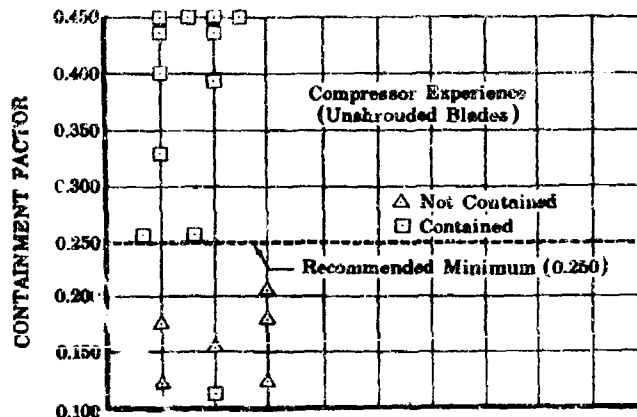

Figure 25. Containment Experience

FD 16232  
IIA





Table 8. JTF17 Blade Containment

Stage	Shear Criteria (See figure 27.)		Energy Criteria (See figure 25.)	
	Factor	Allowable Min	Factor	Allowable Min
First (Fan)	0.68	0.68	11.3	8.6
Second (Fan)	0.68	0.68	12.6	8.6
Third (Compressor)	0.914	0.68	0.25	0.25
Fourth (Compressor)	1.204	0.68	0.263	0.25
Fifth (Compressor)	0.957	0.68	0.322	0.25
Sixth (Compressor)	0.934	0.68	0.264	0.25
Seventh (Compressor)	1.315	0.68	0.379	0.25
Eighth (Compressor)	1.333	0.68	0.475	0.25
First (Turbine)	0.890	0.68	0.250	0.250
Second (Turbine)	0.755	0.68	0.120	0.120
Third (Turbine)	0.702	0.68	0.120	0.120

A containment failure involves an impulsive load of infinitely short duration that results in an extremely high strain rate (approximately 100,000,000 times greater than standard tensile test strain rates). High strain research indicates that the true energy absorption and shear capability of a material varies with strain rate, generally increasing substantially with increased strain rate.

Material dynamic shear factors have been obtained by Pratt & Whitney Aircraft through ballistic testing of materials at velocities related to blade impact and subsequently verified by whirl it testing with actual blades and cases. Figure 28 shows the relationship of dynamic shear factor to static tensile for a variety of materials.

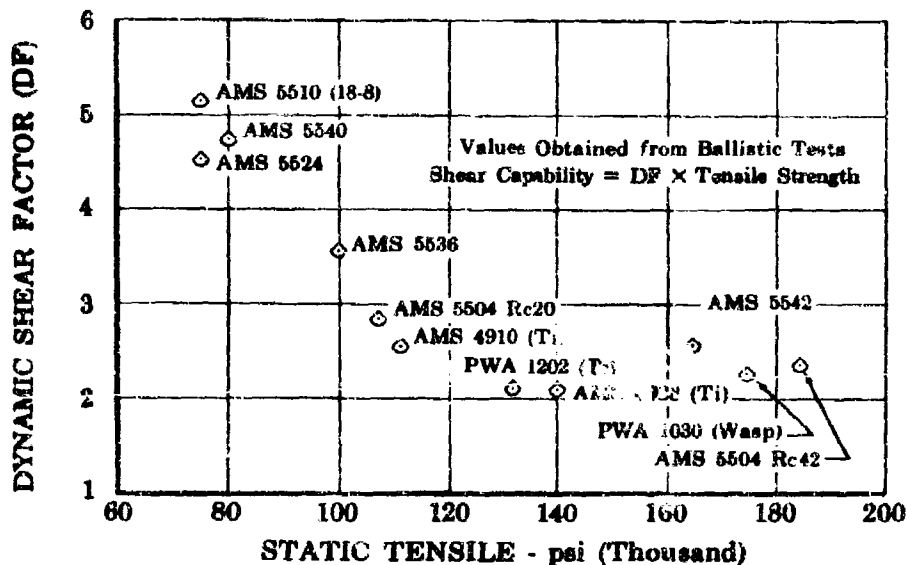

Figure 28. Dynamic Shear Factor vs Static Tensile Strength

FD 16279

IIA

## Pratt & Whitney Aircraft

PWA FP 66-100

Volume III

### (6) Intermediate Case

The intermediate case, which is the section between the fan and the compressor, is the support for the No. 1 and No. 2 bearings and also the major support for the gas generator.

The intermediate case is designed to carry the radial and thrust loads of the No. 1 and No. 2 bearings, thrust load, shear torsional load of the gas generator, and the main engine maneuver loads. In addition to these loads, the intermediate case must withstand the unbalance forces caused by blade loss and supplement the 2nd-stage fan OD liner in providing blade containment.

The basic structure of the intermediate case is a titanium weldment utilizing AMS 4966 (A-110) forgings and AMS 4910 (A-110) sheet. Butt welded joints will be used on all attachments by welding to integral, machined, contoured standups in the wall forgings. (See figure 29.) This construction has the decided advantage of having all welds loaded in simple tension or compression. Areas with combined bending stresses will occur in parent material away from the welds and heat-affected zone.

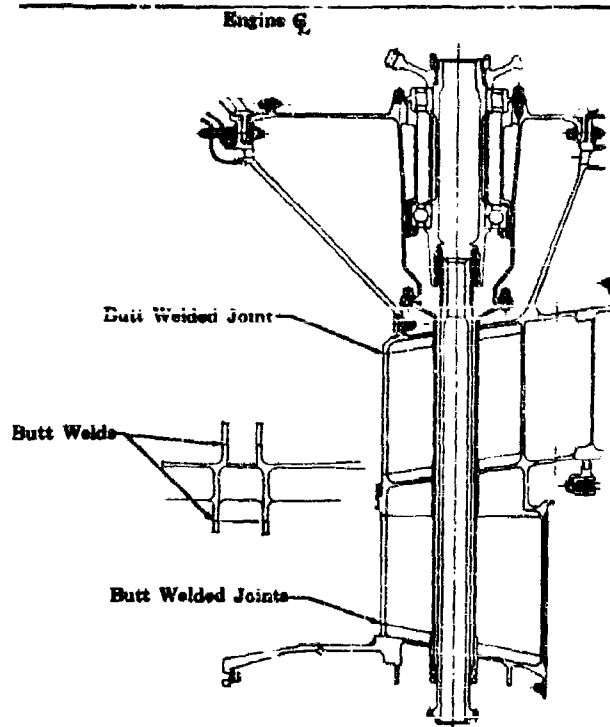

Figure 29. Intermediate Case Basic Structure

FD 17666

YIA

The struts are fabricated from a combination of sheet stock and forgings and are butt welded to airfoil contoured platforms that are an integral part of the wall rings.

Vane to shroud cracking experienced in service on the JT3D inlet case has led to the standup foot butt weld design. Cases such as the JT3D

**(g) LCF Design Approach**

Initial studies considered using engine 3rd stage (compressor 1st stage) air as a source for disk cooling. The temperature level was ideal for rapid disk metal temperature response but the pressure level was too low for the required flow. Subsequent studies led to the selection of 4th stage air. This source, in conjunction with antivortex tubes to compensate for radial inward flow pressure drop, resulted in acceptable bore air temperature and pressure levels.

The next step was to design a flow system in which the bore cooling air would contact all disks and yet be separated from higher temperature compressor discharge air. This was accomplished by incorporating a bore tube that returns the cooling air to the front of the high compressor where it is discharged through the intermediate case to the fan cavity.

The final cooling air flow path, which resulted in a disk thermal environment that satisfied LCF requirements, is shown in figure 63.

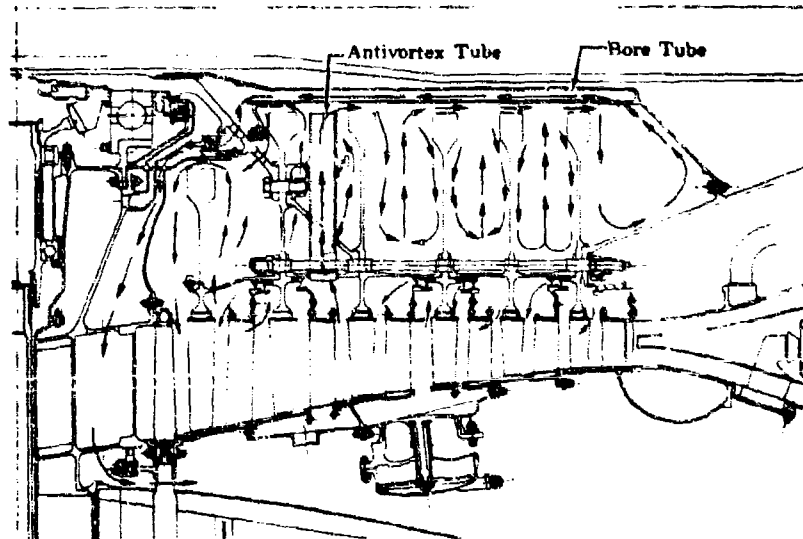

Figure 63. Compressor Disk Cooling System

FD 16417

IIA

To evaluate disk transient thermal response, a detailed analysis was performed on the most severe conditions of a typical aircraft mission cycle. This analysis was performed by creating a mathematical model of the entire rotor and programming all pertinent parameters on a digital computer. The computer program, in essence, simulated the total in-flight rotor environment.

To assure that optimum weight had been realized, the disks were first analyzed on a stress-limited basis. This means that the disk configuration was determined first from the standpoint of a noncyclic stress criterion such as yield, burst, and creep. This disk configuration was then adjusted to account for the specific number of dynamic and thermal cycles.

BIIA-75

Several supporting studies were conducted in conjunction with the main effort to obtain the basic cooling air flow path. One of these studies involved optimization of the bore cooling air flow rate. Results of this study are shown in figure 64. The curve shows that increasing the flow beyond 0.6% of gas generator flow offered little advantage in decreasing disk temperature gradient.

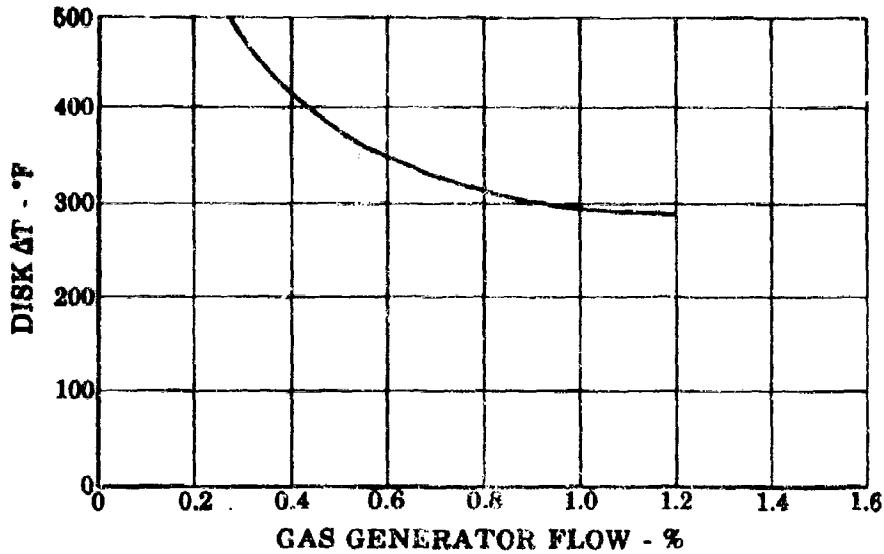

Figure 64. Disk Temperature vs Gas Flow

FD 17416

IIA

The substantiation of the need for a design using cold-bore cooling air is illustrated in figure 65. This curve showed the relative weight required to obtain cyclic life with a hot-bore and cold-bore configuration. The hot bore configuration is that used in the initial experimental engine.

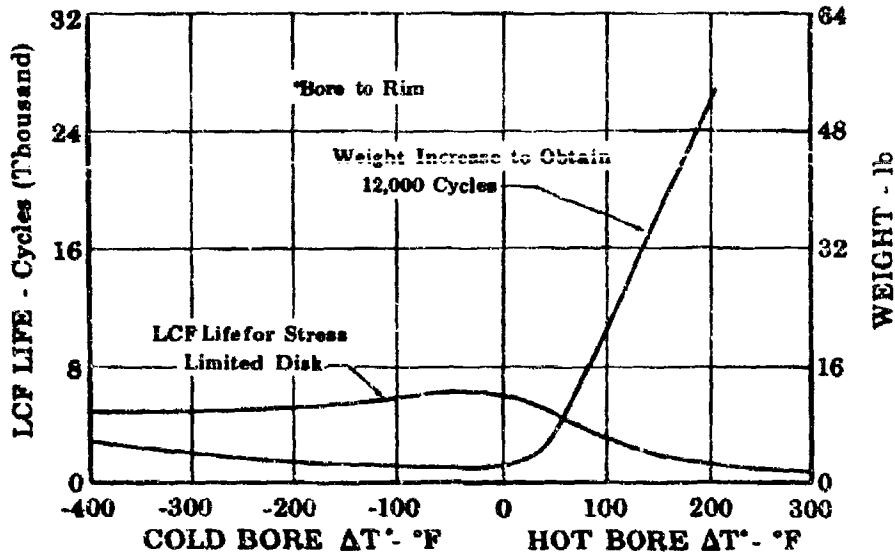

Figure 65. Cold Bore vs Hot Bore LCF Life and Weight Trends

FD 16359

IIA

BIIA-76

Fuel is metered to the duct heater as a function of power lever position and  $T_{t2}$  as shown on figure 3. Power lever translates a 3D cam and  $T_{t2}$  rotates the cam, the output of which is the desired duct heater fuel flow burner pressure ratio. This ratio is multiplied by burner pressure resulting in a signal proportional to fuel flow being generated.

The duct heater incorporates two zones of fuel injection. Within the unitized control, each zone is provided with a fuel shutoff valve and a manifold rapid fill system. This latter system reduces by a significant amount the time required for augmentor transients by providing a high rate of fuel flow from the gas generator boost pump during the fill period. Each zone is also provided with separate fuel pressure signals for operating the fuel manifold dump valves.

When the power lever is advanced beyond the maximum nonaugmentation flat to the minimum duct augmentation flat, a sequencing valve in the unitized fuel control initiates the following events: (1) the Zone I manifold dump valve closes, (2) the Zone I rapid-fill valve opens, (3) the Zone I shutoff valve opens, (4) the duct exhaust nozzle resets parallelly open, and (5) the duct igniters are energized. Fuel is delivered to the Zone I fuel manifold at a high flow rate until a pressure signal indicates the manifold is full. The rapid-fill valve closes, the igniters are turned off, and the duct exhaust nozzle reset is removed.

Further power lever advancement increases duct fuel-air ratio and duct nozzle area on a coordinated schedule to hold the total engine airflow constant.

If the power lever is moved to the Zone II range, the Zone II fuel manifold dump valve is closed, the Zone II shutoff valve is opened, and the Zone II rapid-fill valve is opened to fill the Zone II fuel manifold. A constant fuel-air ratio is held during the Zone II rapid-fill transient. Pressure increasing in the Zone II manifold provides a signal resulting in closing of the rapid-fill valve and simultaneous routing of metered fuel to the Zone II manifold. Total duct fuel flow is divided between Zone I and Zone II by the fuel nozzle flow characteristics. Zone II fuel ignites spontaneously when the fuel enters the burner. Continued power lever advancement causes increased duct heater fuel flow, increased engine thrust, and increased duct nozzle area to maintain constant engine airflow. Maximum duct augmentation is scheduled by power lever position. Fuel flow for quick filling of both the Zone I and Zone II fuel manifolds is supplied from interstage pressure of the gas generator fuel pump. The duct heater fuel flow schedule is shown in figure 8.

The total corrected engine airflow is controlled as a function of  $T_{t2}$  to the schedule defined in the engine specification. The airflow control is achieved by actuating the variable duct exhaust nozzle. In the cruise range the nominal airflow schedule may be manually adjusted by the flight crew between maximum and minimum limits to obtain optimum inlet performance. The total corrected airflow schedule, the maximum and minimum limits, and the nominal schedule coordinated with Boeing are shown in figure 11 of paragraph B of this section, while those coordinated with Lockheed are shown in figure 10 of paragraph B of this section.

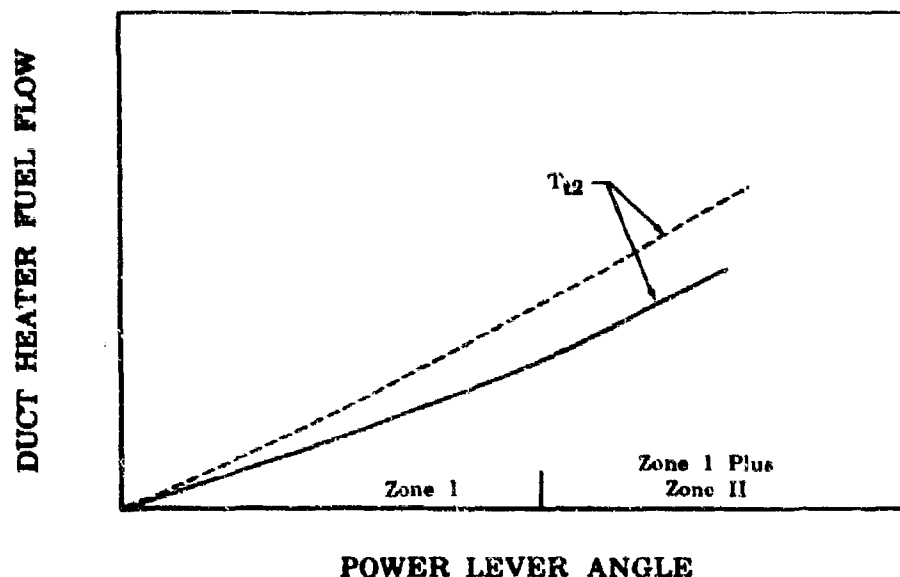

Figure 8. Duct Heater Fuel Flow Schedule

FD 16453

BIII

Total engine airflow is the sum of gas generator airflow and duct airflow. Gas generator airflow is determined by sensing high rotor speed and engine inlet temperature. Knowing this airflow permits determining the duct airflow required to obtain the desired total engine airflow. Therefore, desired duct airflow parameter will be scheduled as a function of high rotor speed and engine inlet temperature, as shown on figure 4.

The duct corrected airflow is measured using the duct pressure ratio parameter, which is the difference between fan discharge total pressure and fan discharge static pressure divided by fan discharge total pressure,  $(P_{t3} - P_{s3}) / P_{t3}$ . This same parameter is utilized in supersonic aircraft air induction controls. The unitized control will schedule the duct pressure ratio necessary to obtain the desired duct airflow. The actual duct pressure ratio will be determined by the control and compared with the scheduled pressure ratio. The difference between the pressure ratios initiates corrective action through a proportional plus integral servo and a power boost servo to reposition the duct exhaust nozzle as required in a closed loop basis to obtain the desired duct airflow.

#### c. Separately Mounted Components

The unitized fuel and area control system includes the following separately mounted components:

1. Turbopump controller, which regulates air supplied to the duct heater fuel pump by modulating a butterfly valve located in the pump air inlet supply.
2. Two engine inlet temperature sensors which sense temperature with a gas-filled tube. The resultant gas pressure is transduced into a fluid pressure and in turn sensed by the control for use as engine inlet temperature bias.

**Pratt & Whitney Aircraft**

PWA FP 66-100

Volume III

to close and opens the respective fuel manifold dump valves. Cooling fuel flow will also be reestablished through the duct heater fuel system components. In this event, the power lever must be retarded to the nonaugmented flat power lever position, or less, and then moved to an augmentation position before duct heater operation can be reinitiated.

In the event an inflight engine shutdown is performed, the engine may be restarted by placing ignition selector switches on the "on" position, the power lever at idle position and moving the shutoff lever to the "on" position. The gas generator ignition selector switches should be placed in the "off" position after engine restart is accomplished. Normal engine control by power lever modulation may then be resumed.

**Table 1. Sample Cruise Thrust Setting Tables**

<b>Subsonic:</b>		<b>36,150 Ft.</b>	<b>M = 0.9</b>
<b>Gross Wt.</b>  <b>480,000</b>	<b>OAT - °F</b>	<b>-70</b>	<b>-52</b>
	<b>EPR/EGT</b>	<b>2.26/1370</b>	<b>2.26/1450</b>
	<b>N<sub>2</sub>/N<sub>1</sub></b>	<b>94.7/97.2</b>	<b>96.5/100.0</b>
	<b>WFT</b>	<b>10600</b>	<b>10900</b>
	<b>AJD/DH</b>	<b>3.6/Not Lit</b>	<b>3.6/Not Lit</b>
	<b>RAT/TAS</b>	<b>-7/516</b>	<b>+14/528</b>
<b>360,000</b>	<b>EPR/EGT</b>	<b>1.91/1105</b>	<b>1.91/1180</b>
	<b>N<sub>2</sub>/N<sub>1</sub></b>	<b>89.6/92.7</b>	<b>91.5/94.7</b>
	<b>WFT</b>	<b>7800</b>	<b>8000</b>
	<b>AJD/DH</b>	<b>4.3/Not Lit</b>	<b>4.3/Not Lit</b>
	<b>RAT/TAS</b>	<b>-7/516</b>	<b>+14/528</b>
<b>Supersonic:</b>		<b>65,000 Ft.</b>	<b>M = 2.7</b>
<b>Gross Wt.</b>  <b>500,000</b>	<b>OAT °F</b>	<b>-70</b>	<b>-52</b>
	<b>EPR/EGT</b>	<b>0.743/1425</b>	<b>0.701/1425</b>
	<b>N<sub>2</sub>/N<sub>1</sub></b>	<b>100.0/86.2</b>	<b>100.4/86.5</b>
	<b>WFT</b>	<b>26000</b>	<b>27200</b>
	<b>AJD/DH</b>	<b>6.4/Lit</b>	<b>7.0/Lit</b>
	<b>RAT/TAS</b>	<b>494/1548</b>	<b>537/1584</b>
<b>370,000</b>	<b>EPR/EGT</b>	<b>0.743/1425</b>	<b>0.701/1425</b>
	<b>N<sub>2</sub>/N<sub>1</sub></b>	<b>100.0/86.2</b>	<b>100.4/86.5</b>
	<b>WFT</b>	<b>19100</b>	<b>20200</b>
	<b>AJD/DH</b>	<b>5.6/Lit</b>	<b>6.2/Lit</b>
	<b>RAT/TAS</b>	<b>494/1548</b>	<b>537/1584</b>
<b>Symbol</b>	<b>Description</b>	<b>Units</b>	
<b>OAT</b>	<b>Outside Air Temperature</b>	<b>°F</b>	
<b>EPR</b>	<b>Engine Pressure Ratio (Pt7/Pt2)</b>	<b>None</b>	
<b>EGT</b>	<b>Turbine Discharge Total Temperature</b>	<b>°F</b>	
<b>N<sub>2</sub>/N<sub>1</sub></b>	<b>High Rotor RPM/Low Rotor RPM</b>	<b>%</b>	
<b>WFT</b>	<b>Total Fuel Flow</b>	<b>PPH</b>	
<b>AJD</b>	<b>Duct Nozzle Jet Area</b>	<b>Ft<sup>2</sup></b>	
<b>DH</b>	<b>Duct Heater</b>	<b>Lit/Not Lit</b>	
<b>RAT</b>	<b>Ram Air Temperature (Tt2)</b>	<b>°F</b>	
<b>TAS</b>	<b>True Airspeed</b>	<b>Knots</b>	

26.0 TURBINE COOLING SYSTEM - The turbine cooling system is a self-contained, fixed orifice and self-regulating system which does not require an airframe supplied input.

26.1 Turbine Temperature Measurement System - The engine shall be equipped with thermocouples for use in conjunction with the airframe temperature indicating system. The thermocouples shall permit consistent measurement of exhaust gas temperature. The system design shall be such that it is possible to service check individual temperature probes for continuity.

27.0 CUSTOMER REQUIREMENTS

27.1 Drive Power Extraction - The maximum allowable continuous horsepower extraction and overload horsepower extraction at the power takeoff pad for all operating conditions as a function of high pressure compressor rotor speed is as specified in the form of torques and speed ratios on the Installation Drawing.

27.1.1 Dynamic Loading - The dynamic loading limit of the drive pad is specified on the Installation Drawing.

27.1.2 Power Takeoff Shaft Speed - Power takeoff shaft speed ratio is specified on the Installation Drawing.

27.1.3 Shear Section - The shear section requirements are specified on the Installation Drawing.

27.1.4 Mounting Pad and Power Takeoff (PTO) Shaft Loads - The mounting pad and PTO shaft load specifications are shown on the Installation Drawing.

27.1.5 Hydraulic Pump Drive Pads - Hydraulic pump pads shall be provided as shown on the Installation Drawing.

27.2 Compressor Bleed Air

27.2.1 Quality - The air at the engine bleed ports shall not contain quantities of engine generated noxious, toxic or irritating substances above the maximum threshold limit values of the substances shown below:

Substances	Parts per Million (Volume)
Carbon dioxide	5000.0
Carbon monoxide	50.0
Carbon tetrachloride	50.0
Decaborane	0.05
Diborane	0.1
Pentaborane	0.01
Ethyl alcohol (ethanol)	1000.0



**Pratt & Whitney Aircraft**  
Specification No. 2710

Substances (continued)	Parts per Million (Volume)
Fluorine	0.1
Fuels, aviation	250.0
Hydrogen peroxide	1.0
Methyl alcohol (methanol)	200.0
Methyl bromide	20.0
Monochlorobromomethane	40.0
Nitrogen dioxide	5.0
Oil breakdown products (aldehydes, acrolein, etc.)	1.0
Ozone	0.1
Unsym-dimethyl hydrazine	0.5

The air shall contain a total of not more than 5 milligrams per cubic meter of submicron particles.

Dirt or other foreign particle concentration in the bleed air after expansion to atmospheric pressure shall not exceed that of the air at the engine inlet on a per unit volume basis. If a demonstration is required P&WA will demonstrate on a normally functioning engine on a P&WA plant test stand that the above requirements are met within the accuracy of the testing technique available to P&WA at the time of the demonstration. However, it must be recognized that there may be occasional instances in service operation when the bleed air is contaminated.

27.2.1.1 Seals and Oil Lines - Accessory seals, bearing seals, and oil lines shall be designed so that a single failure (except for engine bearing failure) can not result in bleed air contamination. P&WA shall submit a failure analysis to the airframe manufacturer to demonstrate how the design meets this requirement.

27.2.2 Quantity - The engine shall provide for high pressure compressor air extraction, for aircraft use, as indicated:

- a. Within the operating envelope of the engine, high compressor air will be available in quantities not to exceed 5% of gas generator airflow from idle to a thrust corresponding to a turbine exhaust gas temperature 80°F (44.4°C) less than that corresponding to maximum cruise.
- b. Within the operating envelope of the engine, high compressor air will be available in quantities not to exceed 3% of gas generator airflow from a thrust corresponding to a turbine exhaust gas temperature 80°F (44.4°C) less than that corresponding to maximum cruise, to takeoff thrust.

The number, location and connection flange details of the bleed ports are defined on the Installation Drawing. Changes of compressor air extraction must not exceed 1% per second. For high pressure compressor air extraction, within the limits specified, the pressure and temperature at the engine bleed ports shall be as provided by curve No. S-84, sheet 1. The effects upon engine performance when bleeding air from the engine shall be as provided by curve No. S-84, sheet 1.

26.0 TURBINE COOLING SYSTEM - The turbine cooling system is a self-contained, fixed orifice and self-regulating system which does not require an airframe supplied input.

26.1 Turbine Temperature Measurement System - The engine shall be equipped with thermocouples for use in conjunction with the airframe temperature indicating system. The thermocouples shall permit consistent measurement of exhaust gas temperature. The system design shall be such that it is possible to service check individual temperature probes for continuity.

27.0 CUSTOMER REQUIREMENTS

27.1 Drive Power Extraction - The maximum allowable continuous horsepower extraction and overload horsepower extraction at the power takeoff pad for all operating conditions as a function of high pressure compressor rotor speed is as specified in the form of torques and speed ratios on the Installation Drawing.

27.1.1 Dynamic Loading - The dynamic loading limit of the drive pad is specified on the Installation Drawing.

27.1.2 Power Takeoff Shaft Speed - Power takeoff shaft speed ratio is specified on the Installation Drawing.

27.1.3 Shear Section - The shear section requirements are specified on the Installation Drawing.

27.1.4 Mounting Pad and Power Takeoff (PTO) Shaft Loads - The mounting pad and PTO shaft load specifications are shown on the Installation Drawing.

27.1.5 Hydraulic Pump Drive Pads - Hydraulic pump pads shall be provided as shown on the Installation Drawing.

27.2 Compressor Bleed Air

27.2.1 Quality - The air at the engine bleed ports shall not contain quantities of engine generated noxious, toxic or irritating substances above the maximum threshold limit values of the substances shown below:

Substances	Parts per Million (Volume)
Carbon dioxide	5000.0
Carbon monoxide	50.0
Carbon tetrachloride	50.0
Decaborane	0.05
Diborane	0.1
Pentaborane	0.01
Ethyl alcohol (ethanol)	1000.0

**Pratt & Whitney Aircraft**  
Specification No. 2710

Substances (continued)	Parts per Million (Volume)
Fluorine	0.1
Fuels, aviation	250.0
Hydrogen peroxide	1.0
Methyl alcohol (methanol)	200.0
Methyl bromide	20.0
Monochlorobromomethane	40.0
Nitrogen dioxide	5.0
Oil breakdown products (aldehydes, acrolein, etc.)	1.0
Ozone	0.1
Unsym-dimethyl hydrazine	0.5

The air shall contain a total of not more than 5 milligrams per cubic meter of submicron particles.

Dirt or other foreign particle concentration in the bleed air after expansion to atmospheric pressure shall not exceed that of the air at the engine inlet on a per unit volume basis. If a demonstration is required P&WA will demonstrate on a normally functioning engine on a P&WA plant test stand that the above requirements are met within the accuracy of the testing technique available to P&WA at the time of the demonstration. However, it must be recognized that there may be occasional instances in service operation when the bleed air is contaminated.

27.2.1.1 Seals and Oil Lines - Accessory seals, bearing seals, and oil lines shall be designed so that a single failure (except for engine bearing failure) can not result in bleed air contamination. P&WA shall submit a failure analysis to the airframe manufacturer to demonstrate how the design meets this requirement.

27.2.2 Quantity - The engine shall provide for high pressure compressor air extraction, for aircraft use, as indicated:

- a. Within the operating envelope of the engine, high compressor air will be available in quantities not to exceed 5% of gas generator airflow from idle to a thrust corresponding to a turbine exhaust gas temperature 80°F (44.4°C) less than that corresponding to maximum cruise.
- b. Within the operating envelope of the engine, high compressor air will be available in quantities not to exceed 3% of gas generator airflow from a thrust corresponding to a turbine exhaust gas temperature 80°F (44.4°C) less than that corresponding to maximum cruise, to takeoff thrust.

The number, location and connection flange details of the bleed ports are defined on the Installation Drawing. Changes of compressor air extraction must not exceed 1% per second. For high pressure compressor air extraction, within the limits specified, the pressure and temperature at the engine bleed ports shall be as provided by curve No. S-84, sheet 1. The effects upon engine performance when bleeding air from the engine shall be as provided by curve No. S-84, sheet 1.

**CONFIDENTIAL**

**Pratt & Whitney Aircraft**  
PWA FP 66-100  
Volume I

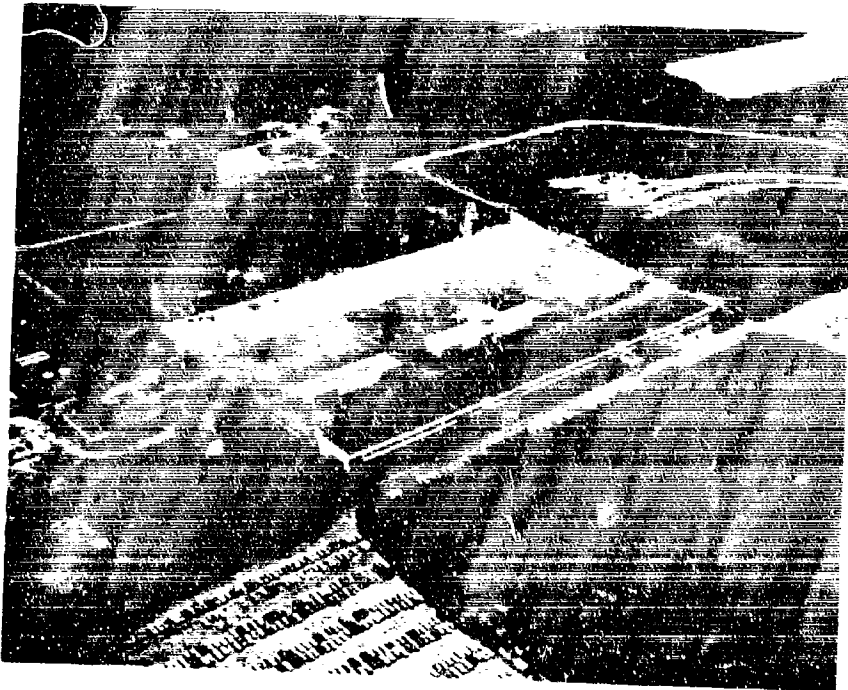

Figure 4. Florida Research and Development  
Center Manufacturing and Office  
Building

FE 13329

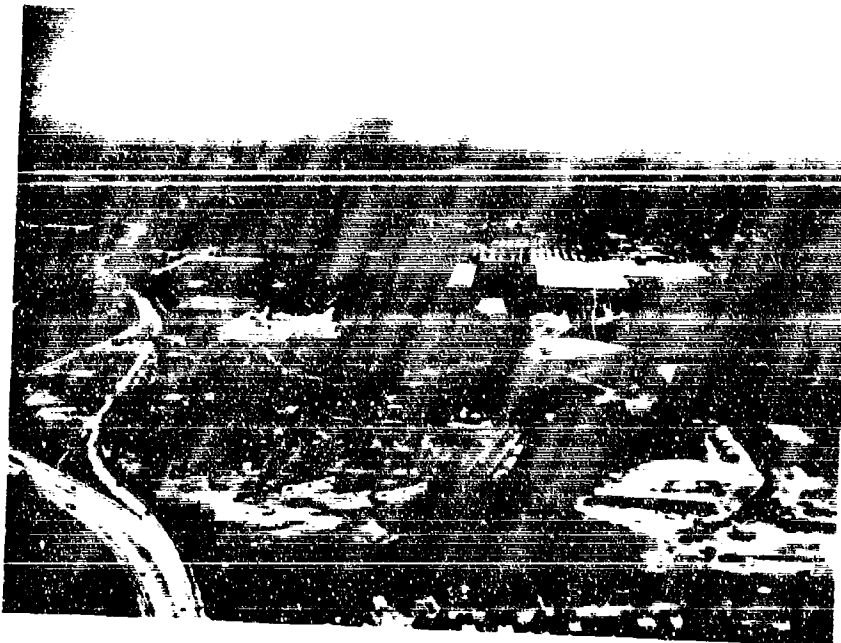

Figure 5. East Hartford Plant

Z 24989

**CONFIDENTIAL**

**CONFIDENTIAL**

The estimated cost of the JTF17 development program proposed to meet the SST objectives for engine life and reliability is \$325 million from the end of Phase II-C through engine certification in December 1971; a continued development program is planned after certification to improve the engine in service. The estimated costs for the various phases of the SST program are summarized below:

Assumed Time Frame	Program Phase	Estimated Cost
July 1965 through December 1966	Phase II-C (demonstrator)	\$ 50 Million
January 1967 through September 15, 1970	Phase III (FTS development, 20 prototype engines, and support for 100 hours of aircraft flying)	290 Million
September 15, 1969 through May 15, 1974	Phase IV (Engine certifi- cation, plus continued development and flight test support through air- craft certification)	252 Million
May 15, 1974 through May 1979	Phase V (Continued engine development)	180 Million

The estimated unit engine cost established in accordance with the FAA's instructions is \$1.21 million, for the engines to be delivered during Phase V.

The Mach 3+ flight time obtained with J58-powered aircraft each day now exceeds the total Mach 3.0 flight time obtained by all other aircraft to date. As this supersonic experience continues to accumulate in the years before the flight of the first supersonic transport, the Florida Research and Development Center engineering team will continue to apply to the JTF17 the hard lessons learned from the J58 program. In commercial service, other Pratt & Whitney Aircraft engines have demonstrated a maintenance cost per lb thrust per hour one-half that of competitive engines, and unmatched rate of TBO growth, and the lowest premature-removal rate in the industry. The same development philosophy that made this record possible will be applied to the SST propulsion task. This extensive and continuing high Mach number experience, combined with extensive and continuing commercial turbine engine experience, provides a singular understanding of the SST propulsion problems; an understanding which in the final analysis will result in the most economical engine.

**CONFIDENTIAL**

**5. Engine Weight**

The weights of the JTF17A-21 production engines are defined in the Engine Model Specifications as 9910 pounds and 9860 pounds for the Boeing and Lockheed models, respectively. Prototype engine weights are 3% higher. Pratt & Whitney Aircraft has developed a system of weight prediction and control that was applied to the JTF17 engine design during Phase II. Each component part was carefully estimated and controlled. The accuracy of this estimating system is confirmed by the fact that the actual weight of the first test engine proved to be 50 pounds less than the weight estimated for the engine. The extensive weight control program developed during Phase II will be continued through Phase III.

**6. Noise Attenuation**

Phase II-C tests and analyses indicate that the following FAA noise attenuation objectives can be met:

- 1. 1500 feet from centerline of runway 116 PNdb
- 2. 3 statute miles from start of takeoff roll 105 PNdb
- 3. 1 statute mile from runway on approach 109 PNdb

Current levels of unsuppressed and suppressed engine noise for Condition 1 are shown in figure 15. The potential for suppression devices to reduce the level of the predominant jet noise is also indicated.

Figure 16 shows noise levels for Condition 2 at the 3 mile point for the thrust levels the airframe manufacturers anticipate. The suppression devices, current and potential, include acoustic treatment of the duct heater diffuser to absorb fan generated noise, and reverser-suppressor attenuation to reduce the jet noise. A further reduction in total engine noise at thrust cutback after takeoff may be obtained through the use of duct heating beyond the thrust cutback point. By means of this procedure, the required thrust level will be attained at a lower fan rotor speed. Engine noise reductions of 5 PNdb may be obtained using this technique.

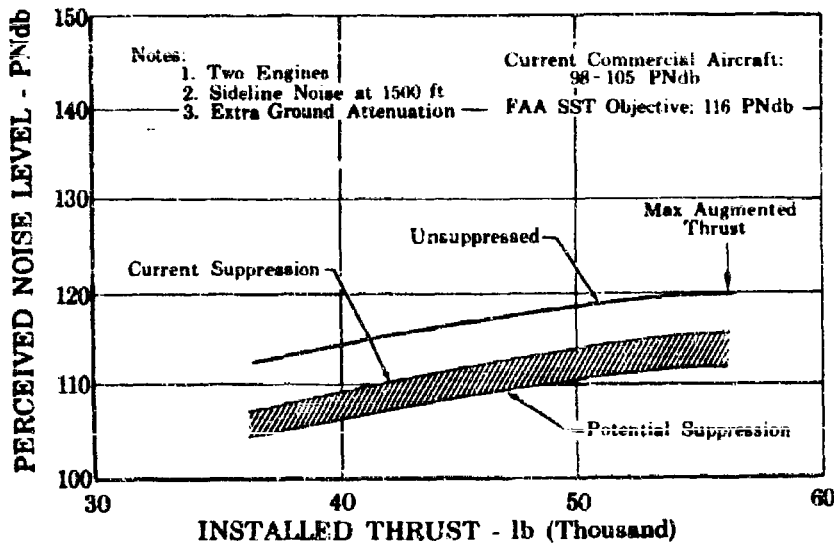

Figure 15. Predicted Turbofan Airport Noise Levels FD 16948

Figure 17 shows predicted noise level for Condition 3, the 1 mile approach condition, where acoustic damping and optimum blade-vane spacing reduce fan noise.

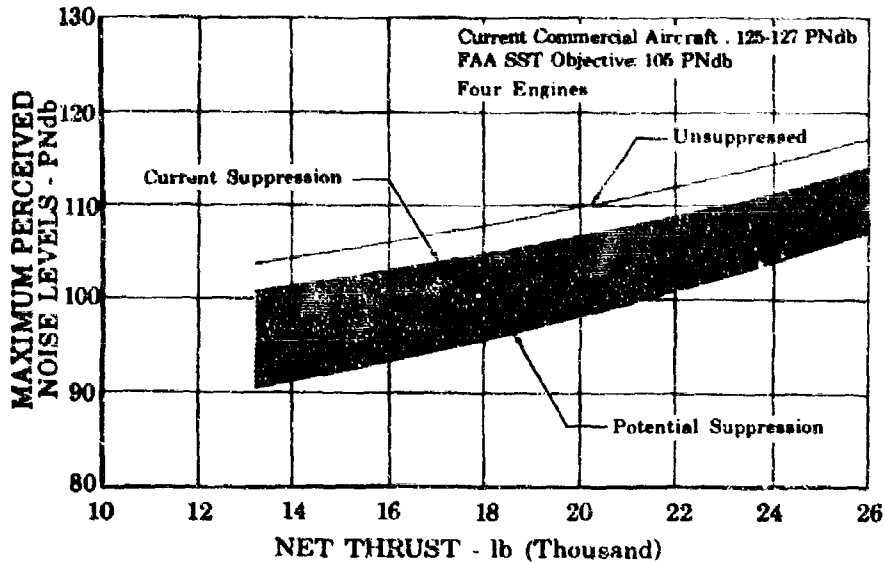

Figure 16. Predicted Turbofan Noise Levels at Thrust Cutback After Takeoff FD 16949

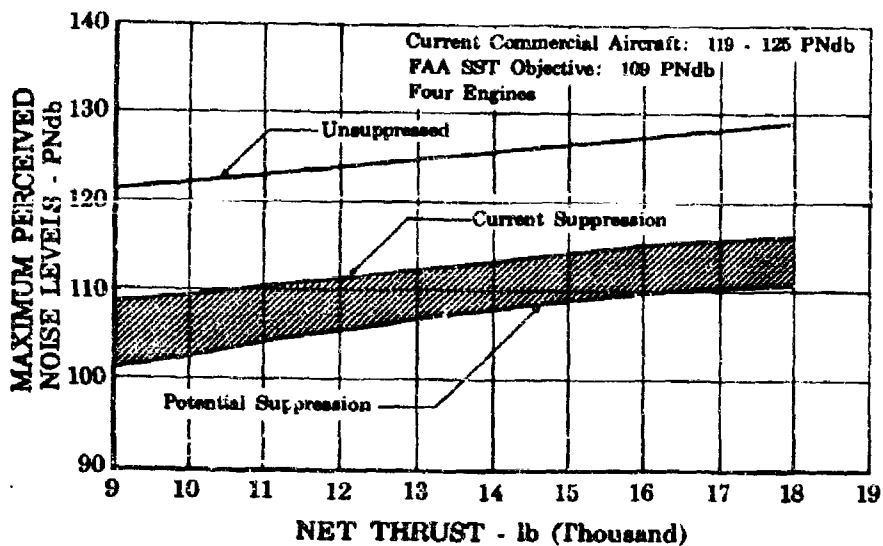

Figure 17. Predicted Turbofan Noise Levels at Approach Conditions FD 16950

SECTION I  
INSTALLATION COMPATIBILITY

A. SCOPE AND OBJECTIVES

This section describes the design approaches and design requirements used to define all interface boundaries between the Boeing B-2707 airplane and the Lockheed L-2000 airplane and the JTF17 engine. By virtue of the Phase II-C coordination effort, the section further delineates the high degree of airplane/engine compatibility achieved in the areas of engine mounts, accessory drives, external plumbing, air bleed systems, secondary airflow systems, instrumentation, and engine mockups.

Continuing coordination with the airframe manufacturer, airlines, and the FAA during Phases III, IV, and V will ensure that engine compatibility is maintained as the engine is developed and the airplane design is refined during the prototype and flight test programs. The plan and procedures for achieving this continued compatibility are described in Volume V, Report C, Configuration Management.

A set of the engine installation drawings, which are actually part of the engine model specifications, has been incorporated in this section for ready reference. As such, the drawings represent the engine coordinated configuration as approved by each of the airframe manufacturers.

B. DESCRIPTION OF COMPLETE JTF17 ENGINE/AIRFRAME INTERFACE BOUNDARY

All engine/airframe interface boundaries, including dimensions and load limitations for the interface, are shown on the Installation Drawing, figure 1 for the Boeing B-2707 and figure 2 for the Lockheed L-2000.

The symbols (X, AD, AE, etc.) which correspond to locating symbols used on the Installation Drawing for cross-reference are listed alphabetically in the nomenclature columns of Sheet 1 of the Installation Drawing and after each paragraph heading in this section and provide the location of each item by coordinate zones.

The prototype engine is currently identical to the production engine at the engine/airframe interface boundaries. During Phase III, required changes to the prototype engine will be coordinated with the airframe manufacturer and the FAA as shown in the configuration management plan. The interfaces are described below.

1. Mounting and Installation Attachment Systems

a. Engine Inlet (X)

A circular flange is located 5.30 inches ahead of the engine front mount ring to mate with the airframe inlet duct. Connection and mating to the airframe inlet for Lockheed is by a V-band clamp to the engine flange. The engine inlet case also provides for a Lockheed-supplied inlet





18 17 16 15 14 13

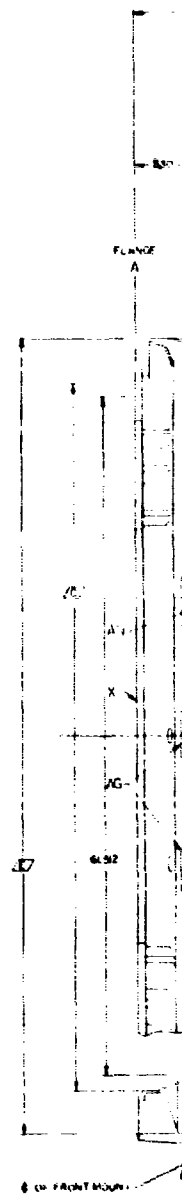
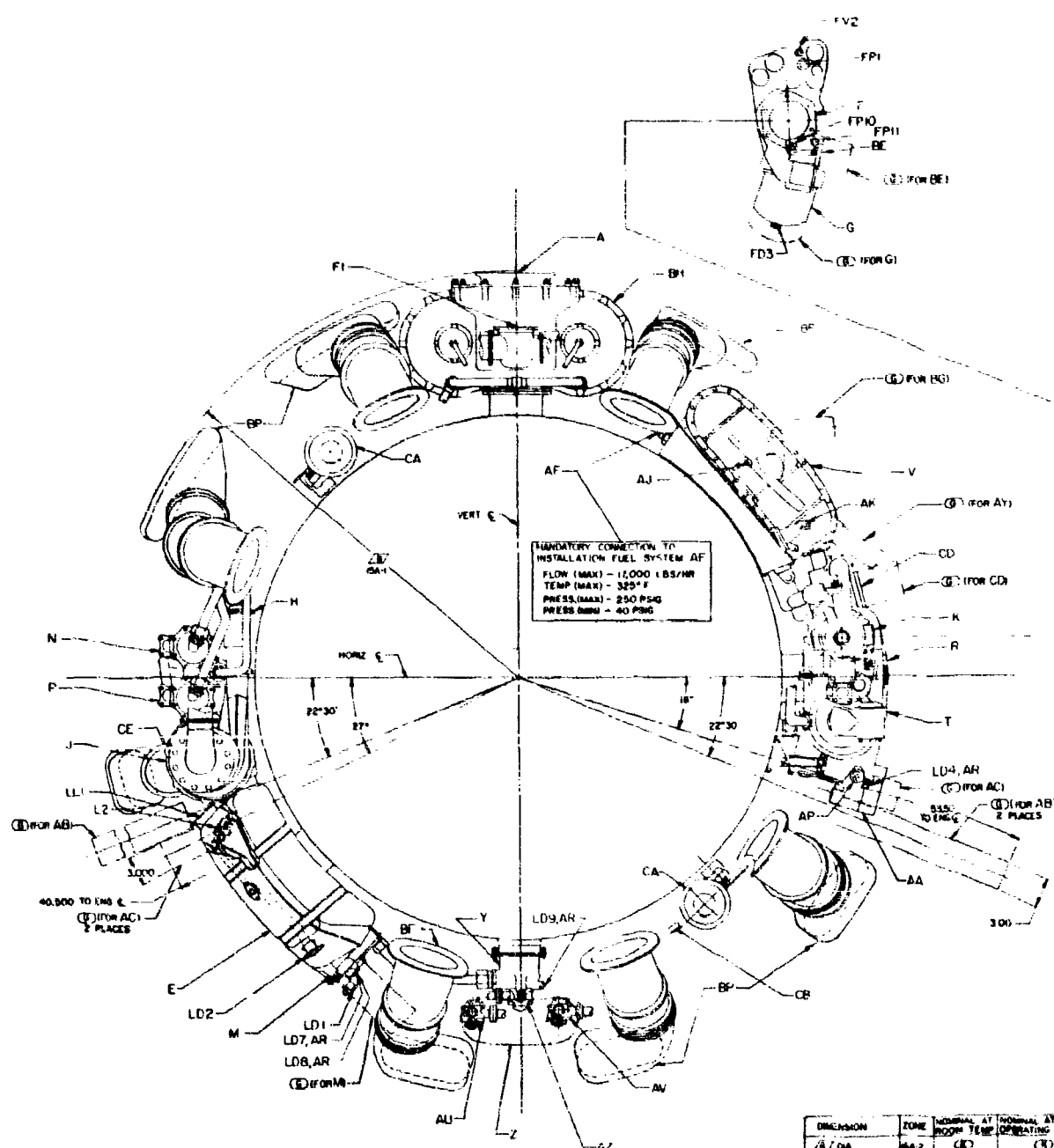

- 1. MASS VALVE
- 2. NOZZLE
- 3. ELECTRICAL
- 4. ELECTRICAL
- 5. ELECTRICAL
- 6. ELECTRICAL
- 7. ELECTRICAL
- 8. ELECTRICAL
- 9. ELECTRICAL
- 10. ELECTRICAL
- 11. ELECTRICAL
- 12. ELECTRICAL
- 13. ELECTRICAL
- 14. ELECTRICAL
- 15. ELECTRICAL
- 16. ELECTRICAL
- 17. ELECTRICAL
- 18. ELECTRICAL

DIMENSION	ZONE	NOMINAL AT ROOM TEMP	NOMINAL AT OPERATING TEMP	MAX TEMP	ENG WILL EXCEED AT ROOM TEMP	EXCESS AT ROOM TEMP	NO. OF LAG REQUIRED
Ø 7 DIA	BA-2	Ø 7.00	Ø 7.00	Ø 7.00	Ø 7.00	Ø 7.00	LARGEST CASE
Ø 7 DIA AT INLET CASE	FD-1	Ø 6.80	Ø 6.80	Ø 6.80	Ø 6.80	Ø 6.80	Ø 6.80
Ø 7 DIA AT PHOTO MOUNT POS 2	RY-3	Ø 7.00	Ø 7.00	Ø 7.00	Ø 7.00	Ø 7.00	Ø 7.00
Ø 7 DIA AT PHOTO MOUNT POS 4	RY-3	Ø 7.00	Ø 7.00	Ø 7.00	Ø 7.00	Ø 7.00	Ø 7.00
Ø 7 DIA	4C-1	Ø 6.80	Ø 6.80	Ø 6.80	Ø 6.80	Ø 6.80	Ø 6.80
Ø 7 DIA	4C-1	Ø 6.80	Ø 6.80	Ø 6.80	Ø 6.80	Ø 6.80	Ø 6.80
Ø 7 DIA	4C-1	Ø 6.80	Ø 6.80	Ø 6.80	Ø 6.80	Ø 6.80	Ø 6.80
Ø 7 DIA	4C-1	Ø 6.80	Ø 6.80	Ø 6.80	Ø 6.80	Ø 6.80	Ø 6.80

2129601





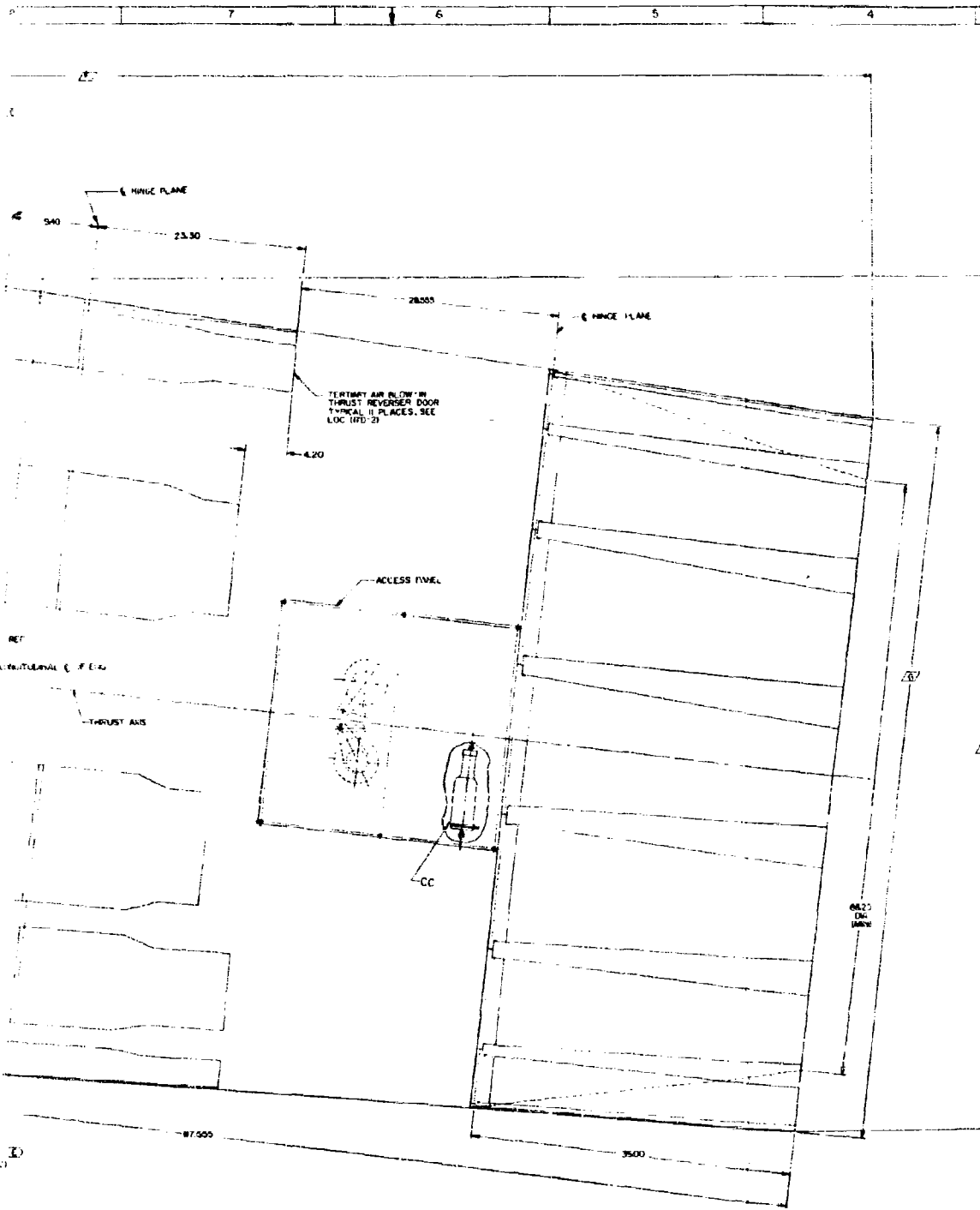

- ① - TORQUE REQUIREMENTS FOR ALL THREADED CONNECTIONS TO BE IN ACCORDANCE WITH 7-TORQUE P/W 888 STANARDS
- ② - W INDICATES DETAILS TO BE COORDINATED
- ③ - ATTACHMENT TO ACCESSORY DRIVE PADS TO BE COORDINATED & APPROVED BY P/W 8A
- ④ - ALL DIM ON DRIVES WHICH COMPLY WITH AND STD REQUIREMENTS ARE GIVEN AS AND STD DIM ALL OTHER DIM DO NOT MEET AND STD REQUIREMENTS ARE GIVEN AS CAL
- ⑤ - ALL CONNECTIONS INDICATED BY (H) MUST BE VENTED TO AMBIENT PRESSURE
- ⑥ - SUPPLEMENTARY LUG LIST UNAVAILABLE UNDER REQUESTS 228081 ALLOWABLE MOUNT & MANEUVER LOADS
- ⑦ - 228081 ELECTRICAL INSTALLATION CONNECTION DIAGRAM FUEL SUPPLY SYSTEM MUST BE COORDINATED WITH P/W 8A
- ⑧ - YELLOW COLORED PROVIDED FOR ITEMS INDICATED BY CLOSURES COLORED YELLOW MUST BE REMOVED & REWORKED CONNECTIONS MADE BEFORE ENG. OPERATION
- ⑨ - ALL OVERBOARD THE CONNECTION BOWSES INDICATED BY (D) ARE MISSING THE REDUCED 228081 AND 228081 THE RESULT NOT BE LIMITED BY LESS THAN ACCOMMODATING FITTING & TURNING SPECIFIED IN MS33466 IN MS5569
- ⑩ - THESE CONNECTIONS DRAIN ACCESSORY DRIVE PAD ELEMENTS WHICH MAY CONTAIN BURN NECESSARY FLUIDS IN ENG FUEL DRAINS MUST EMPTY SEPARATE FROM DR DRAINS
- ⑪ - ITEMS INDICATED BY (E) MUST EMPTY SEPARATELY OTHER DRAINS MAY BE MANIFOLDED BUT RESULTANT FLOW AREA MUST BE EQUIVALENT TO OR GREATER THAN THE AREA OF ALL DRAIN LINES ATTACHED
- ⑫ - (E) MIN SPACE FOR REMOVAL
- ⑬ - (C) SPACE AVAILABLE FOR ACCESSORIES
- ⑭ - ACCESSORY CONNECTIONS LESS THAN 20 MUST BE COORDINATED WITH P/W 8A
- ⑮ - SPACE REQD FOR REMOVAL OF ITEMS INDICATED BY (F) DETAILS FOR THE POS OF FEATURES SHOWN ARE & LABEL CONTAINING SUCH FEATURES UNLESS OTHERWISE SHOWN
- ⑯ - DIMENSIONS IN GENERAL ARE IN PROPORTION TO ROOM
- ⑰ - DIM INDICATED BY (G) ARE NOW AT ROOM TEMP
- ⑱ - DIM INDICATED BY (H) ARE NOW AT MAX OPERATING
- ⑲ - DIM INDICATED BY (I) ARE NOW AT MIN OPERATING
- ⑳ - ALL DIM ARE AT ROOM TEMP UNLESS OTHERWISE SHOWN

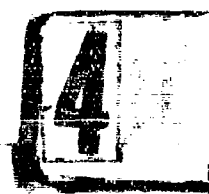

Pratt & Whitney Aircraft  
PWA FP 66-100  
Volume III

REV	NO	DATE	DESCRIPTION
1	1		REVISED
2	1		REVISED

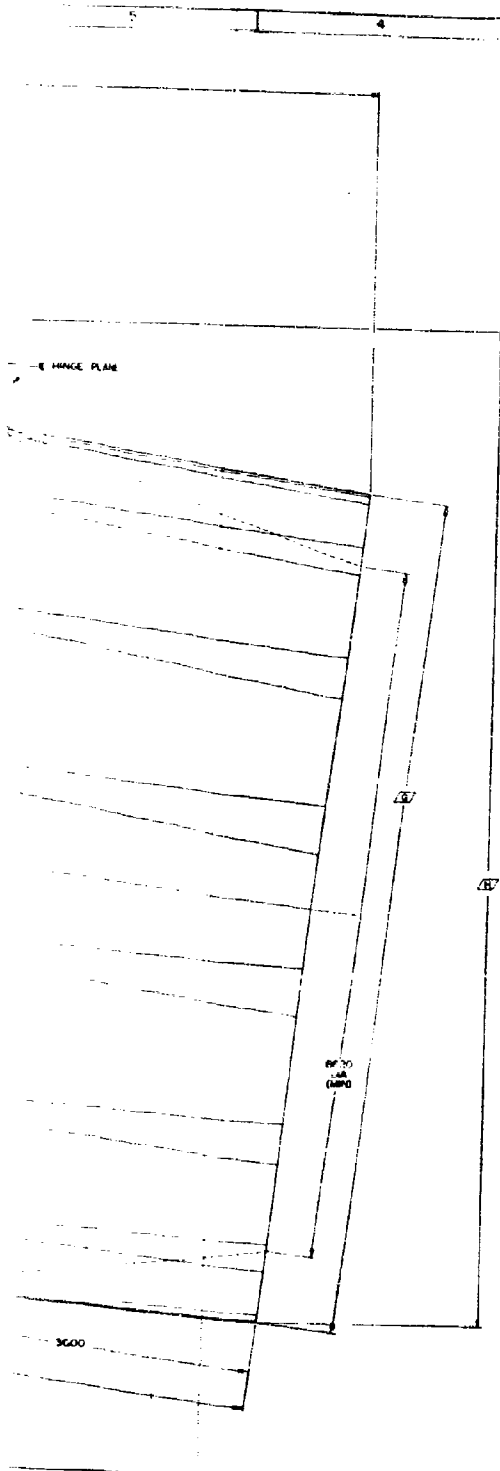

- ② - TORQUE REQUIREMENTS FOR ALL THREADED CONNECTIONS TO BE IN ACCORDANCE WITH APPROVED PIPING STANDARDS
- ③ - (X) INDICATES DETAILS TO BE COORDINATED
- ④ - ATTACHMENT TO ACCESSORY DRIVE PADS TO BE COORDINATED WITH PIPING BY PWA
- ⑤ - ALL LOW-LIFT DRIVES WHICH COMPLY WITH AND STD. REQUIREMENTS ARE GIVEN AS AND STD. DIM. ALL OTHER DIM. WHICH DO NOT MEET AND STD. REQUIREMENTS ARE GIVEN AS CALCULATED
- ⑥ - ALL CONNECTIONS INDICATED BY (H) MUST BE DESIGNED TO RESIST PRESSURE
- ⑦ - SUPPLEMENTARY TAG LIST (UNAVAILABLE UPON REQUEST)
- ⑧ - (20809) ALLOWABLE MOUNT & MANEUVER LOADS
- ⑨ - (212803) ELECTRICAL INSTALLATION CONNECTION DIAGRAM
- ⑩ - FUEL SUPPLY SYSTEM MUST BE COORDINATED WITH PWA
- ⑪ - YELLOW CLOSURE PROVIDED FOR ITEMS INDICATED BY (Z)
- ⑫ - CLOSURES COLORED YELLOW MUST BE REMOVED BEFORE CONNECTIONS MADE BEFORE ENG. OPERATION
- ⑬ - ALL (C) (PERFORATED) AND (CP) CONNECTION BOOSSES INDICATED BY (C) OR (CP) MUST BE PROVIDED (3) (3) ON AND (3) (3) TYPE FITTINGS MUST NOT BE RESTRICTED BY LESS THAN ACCOMMODATING FITTINGS & TUBING SPECIFIED IN MESSAGE B
- ⑭ - THESE CONNECTIONS DRAIN ACCESSORY DRIVE PAD COMPARTMENTS WHICH MAY CONTAIN BOTH ACCESSORY FLUID & ENG. OIL. FUEL DRAINS MUST EMPTY SEPARATE FROM OIL DRAINS IN ITEMS INDICATED BY (Z) MUST EMPTY SEPARATELY. OTHER DRAINS MAY BE MANIFOLDED BUT THE RESULTANT FLOW AREA MUST BE EQUIVALENT TO OR GREATER THAN THE AREA OF ALL DRAIN LINES ATTACHED
- ⑮ - (F) MIN. SPACE FOR REMOVAL
- ⑯ - (C) SPACE AVAILABLE FOR ACCESSORIES
- ⑰ - ACCESSORY CLEARANCES LESS THAN 25 MM (1 IN) COORDINATED WITH PWA
- ⑱ - SPACE REQ'D FOR REMOVAL OF ITEMS INDICATED BY (C)
- ⑲ - (C) SPACE FOR TAGS FOR UP FEATURES SHOWN AND (C) UP FEATURES CONTAINING SUCH FEATURES UNLESS OTHERWISE SHOWN
- ⑳ - EXPANSIONS IN GENERAL ARE IN PROPORTION TO ROOM TEMP DIM
- ㉑ - DIM. INDICATED BY (R) ARE NOM. AT ROOM TEMP
- ㉒ - DIM. INDICATED BY (S) ARE NOM. AT MAX. OPERATING TEMP
- ㉓ - ALL DIM. ARE NOM. UNLESS OTHERWISE SHOWN
- ㉔ - ALL DIM. ARE AT ROOM TEMP UNLESS OTHERWISE SHOWN

2129601  
SHEET 1

AUG 8, 1966

INDEX FOR INSTALLATION DIMS  
2129601 ENGINE INSTALLATION  
SHEET 1 - LIFT VIEW  
SHEET 2 - RH VIEW  
SHEET 3 - ADDITIONAL INFORMATION  
SHEET 4 - FLANGES & BOLT

2129601  
PWA

PRELIMINARY  
SUBJECT  
TO CHANGE

PRATT & WHITNEY AIRCRAFT  
CONTROLLED

NOTE: FOR ALL PERFORMING ORGANIZATION THIS DRAWING IS UNCLASSIFIED AND ALL INFORMATION CONTAINED HEREIN IS UNCLASSIFIED EXCEPT WHERE SHOWN OTHERWISE. DATE OF DECLASSIFICATION IS INDEFINITE.

DATE: 11-15-88 BY: 77445

CLASSIFICATION: UNCLASSIFIED

ENGINE INSTALLATION  
(JTF71A-218 PRODUCTION)

2129601

5

2129601  
DI





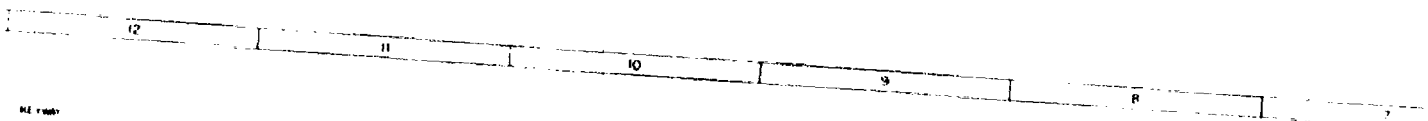

KEYWAY  
 BC  
 THIS CONNECTOR ACCOMMODATES  
 ANY CONNECTOR THAT MATES  
 WITH MS3100-148 2P

REVERSE POSITION TRANSDUCER CONNECTOR  
 SUBMITTAL OF DIM. DESIGNATION  
 SCALE NONE

KEYWAY  
 THIS CONNECTOR ACCOMMODATES  
 ANY CONNECTOR THAT MATES  
 WITH MS3003-45 2P

DUCT HEATER NOZZLE POSITION TRANSDUCER CONNECTOR  
 SCHEMATIC OF DIM. DESIGNATION  
 SCALE NONE

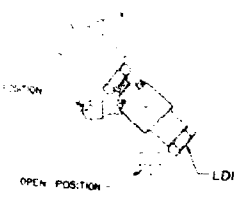

OPEN POSITION

DEL TANK DRAWING LDI  
 SCALE: NONE

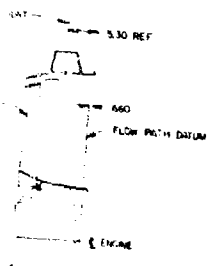

VIEW

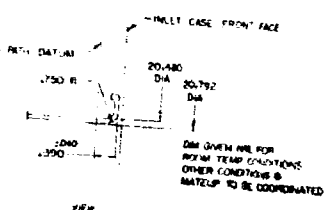

DIM. GIVEN ARE FOR  
 ROOM TEMP. CONDITIONS  
 OTHER CONDITIONS &  
 MATELUP TO BE COORDINATED

VIEW  
 SCALE: 1/1

INLET CENTERBODY FLOWPATH



ENGINE BEND POINT



Section D Detail

2129601 7

3





RIGHT SIDE VIEW:

NOTE:  
SPACE INSIDE THIS ENVELOPE RESERVED  
FOR ENGINE. ANY USE OF THIS AREA FOR  
APPURTENANCE EQUIPMENT SHALL BE PERMITTED  
ONLY AFTER SPECIFIC COORDINATION WITH P&WB.

2250 DA

ENGINE MOUNTS  
SHW AREA E

34.375  
REL  
TO EDGE E

VIEW OF FRONT MOUNT AE  
SCALE: NONE

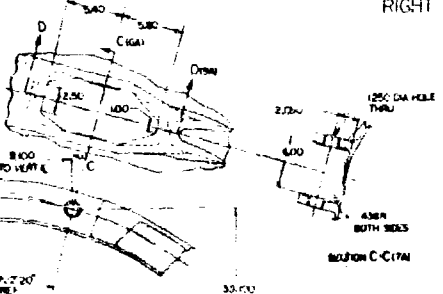

- ① - MIN SPACE FOR REMOVAL
- ② - INDICATES DETAILS TO BE COORDINATED
- ③ - DIMS INDICATED BY (3) ARE W/H AT MAX OPERATING TEMP
- ④ - DIMS INDICATED BY (4) ARE W/H AT MIN TEMP
- ⑤ - DIMS FOR THIS VIEW'S FEATURES SHOWN ARE CENTERLINES OF CASE CONTAINING SUCH FEATURES
- ⑥ - UNLESS OTHERWISE SPECIFIED
- ⑦ - ALL DIM SHOWN ARE NOM UNLESS OTHERWISE SHOWN

NO. 1 - 100% INSPECTION  
NO. 2 - 100% INSPECTION  
NO. 3 - 100% INSPECTION  
NO. 4 - 100% INSPECTION  
NO. 5 - 100% INSPECTION  
NO. 6 - 100% INSPECTION  
NO. 7 - 100% INSPECTION  
NO. 8 - 100% INSPECTION  
NO. 9 - 100% INSPECTION  
NO. 10 - 100% INSPECTION

FRONT C

NO.	DATE	BY	CHKD	APP'D

Pratt & Whitney Aircraft

PWA FP 66-100

Volume III

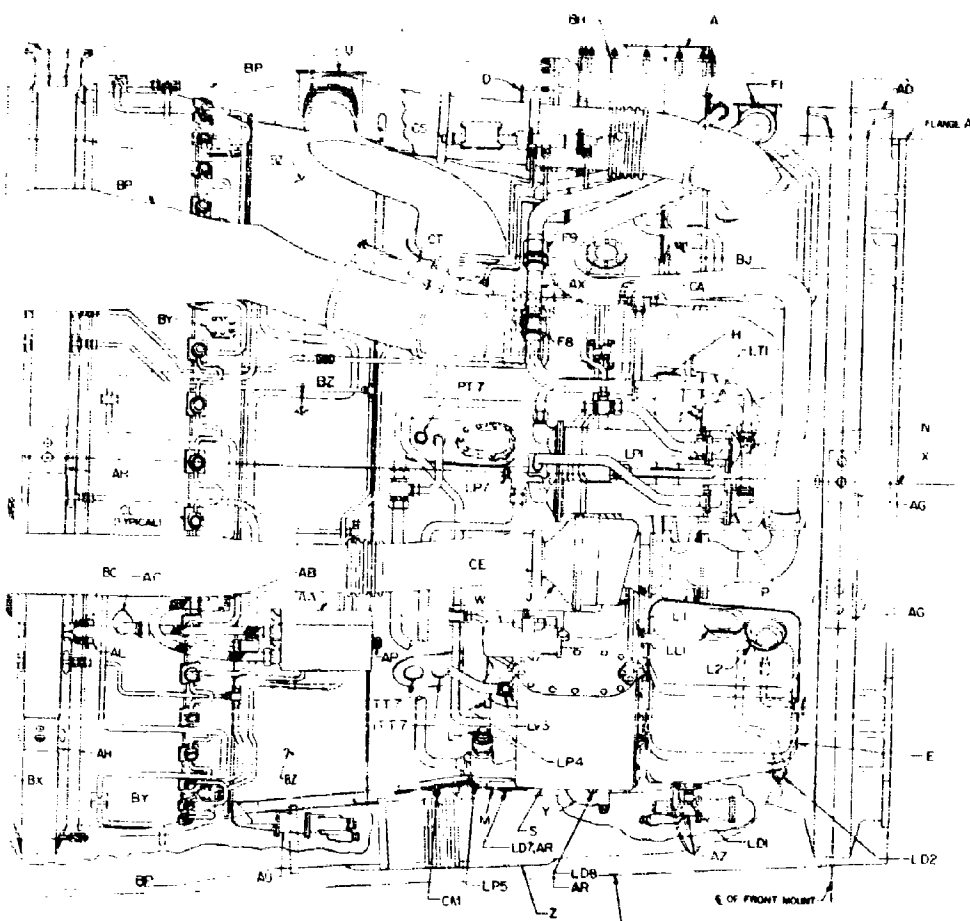

RIGHT SIDE VIEW.

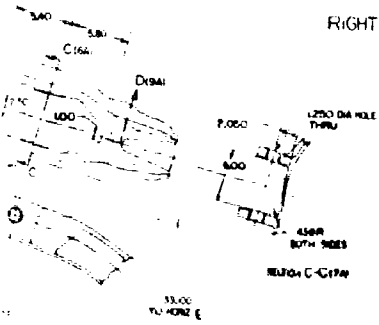

- ① - MIN SPACE FOR REMOVAL
- ② - INDICATES DETAILS TO BE COORDINATED
- ③ - DIM INDICATED BY ③ ARE NOM AT MAX OPERATING TEMP
- ④ - DIM INDICATED BY ④ ARE NOM AT ROOM TEMP
- ⑤ - DIMENSIONS FROM TRUE SURF OF FEATURES SHOWN ARE UNLESS OTHERWISE SPECIFIED
- ⑥ - ALL DIM SHOWN ARE NOM UNLESS OTHERWISE SHOWN

AUG 8, 1966

2129601  
SHEET 2

5

INDEX FOR INSTALLATION ENG  
ENGINE ENGINE INSTALLATION  
SHEET 1 - LEFT SIDE VIEW  
SHEET 2 - RIGHT SIDE VIEW  
SHEET 3 - AIRFRAME INFORMATION  
SHEET 4 - FLANGES & MOUNT

PRELIMINARY  
SUBJECT  
TO CHANGE

PRATT & WHITNEY AIRCRAFT  
CONTROLLED

NOTED TO ALL PERSONNEL REGARDING THIS DRAWING  
This drawing is the property of Pratt & Whitney Aircraft and is not to be distributed outside the organization without the written consent of the organization. It is to be used only for the purpose for which it was prepared and is not to be used for any other purpose without the written consent of the organization. All drawings are subject to change without notice and without obligation of notice.

DATE	7/27/66	BY	77 DA
REVISION		DATE	
APPROVED		DATE	
DESIGNED		DATE	
CHECKED		DATE	
ENGINE INSTALLATION (UT/TA 2B PRODUCTION)			
77645		2129601	

2129601  
DI

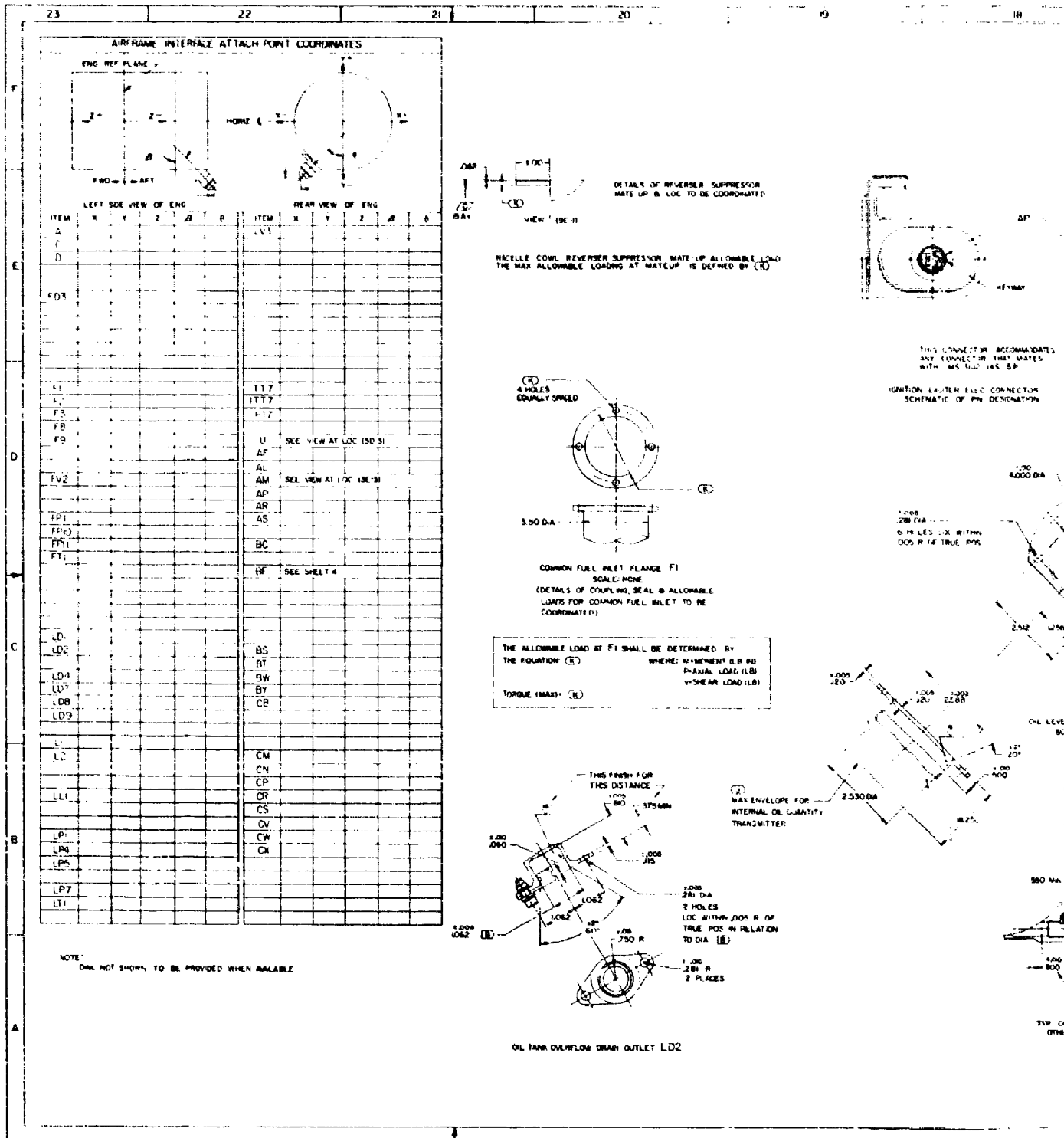



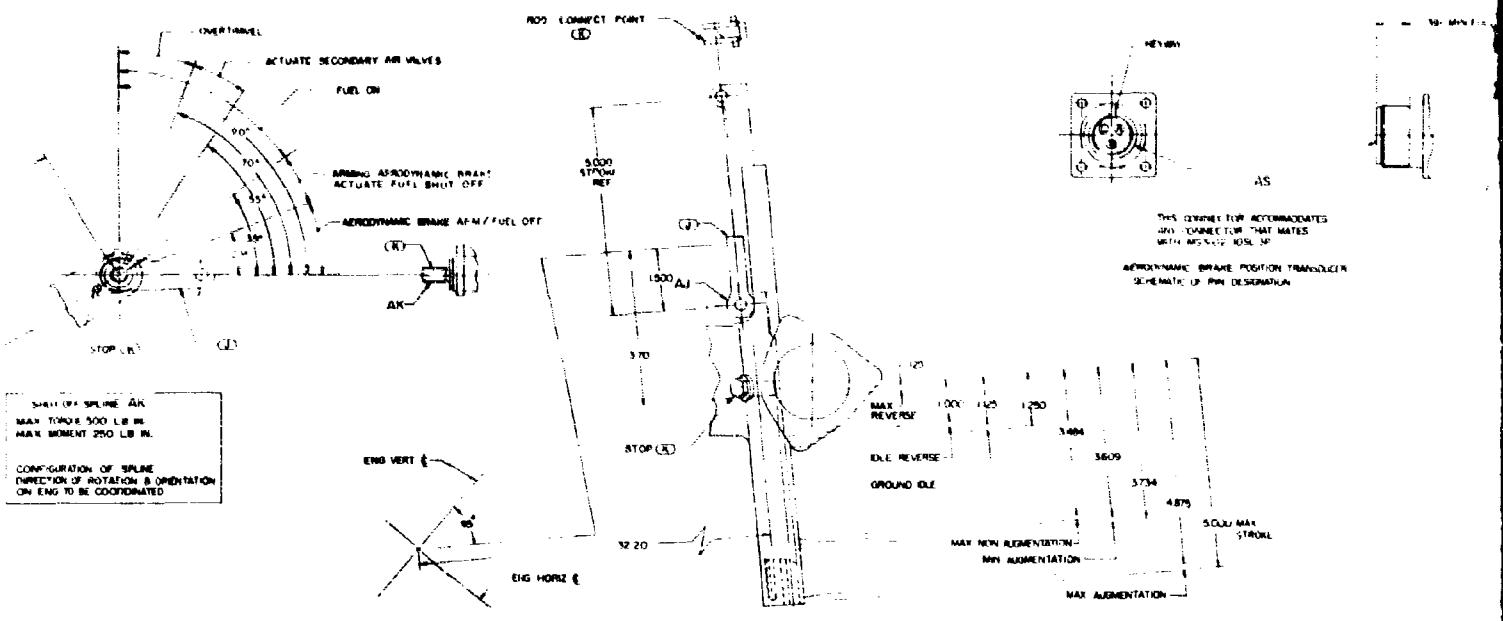

SHAFT OF SPLINE AX  
MAX TORQUE 500 LB IN  
MAX MOMENT 250 LB IN  
CONFIGURATION OF SPLINE  
DIRECTION OF ROTATION & ORIENTATION  
ON ENG TO BE COORDINATED

POWER ROD AJ  
MAX PUSH WILL EXCEED LB  
(AGAINST STOP)  
CONFIGURATION OF ATTACHMENTS  
DIRECTION OF POWER STROKE  
TO BE COORDINATED

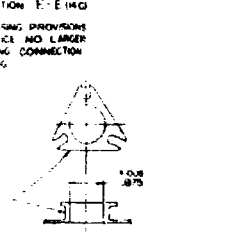
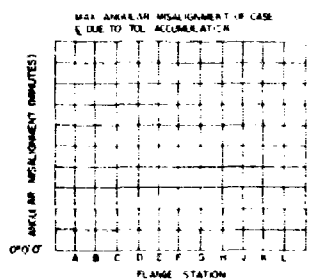
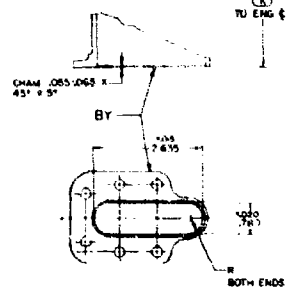
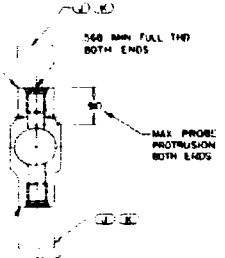

DETAILS OF COMPRESSOR INSPECTION PORT  
COMPRESSOR INSPECTION PORT

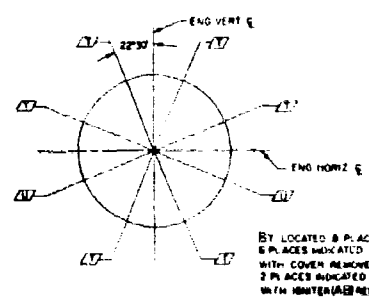

FROM SUPPLIER INSPECTION PORT  
SCHEMATIC VIEW (VIEWING PROVIDED)  
& PORTS EQUALLY SPACED  
SCALE: NONE

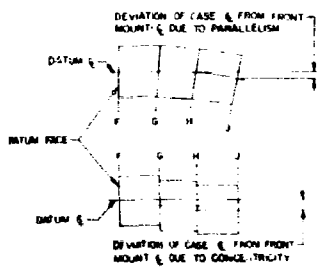

2128601

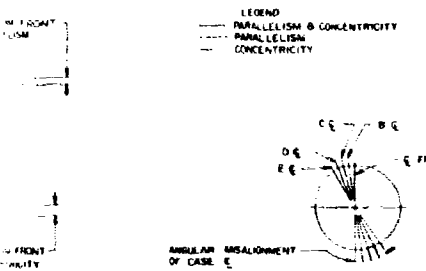
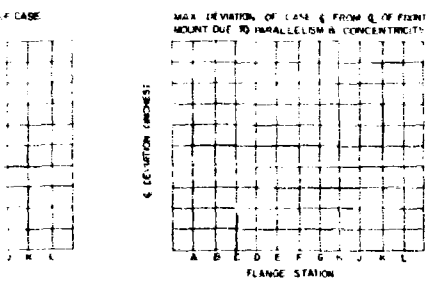
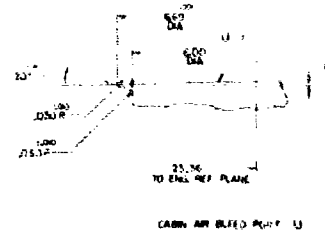
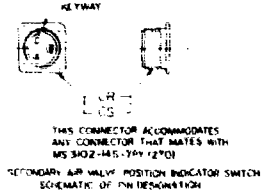
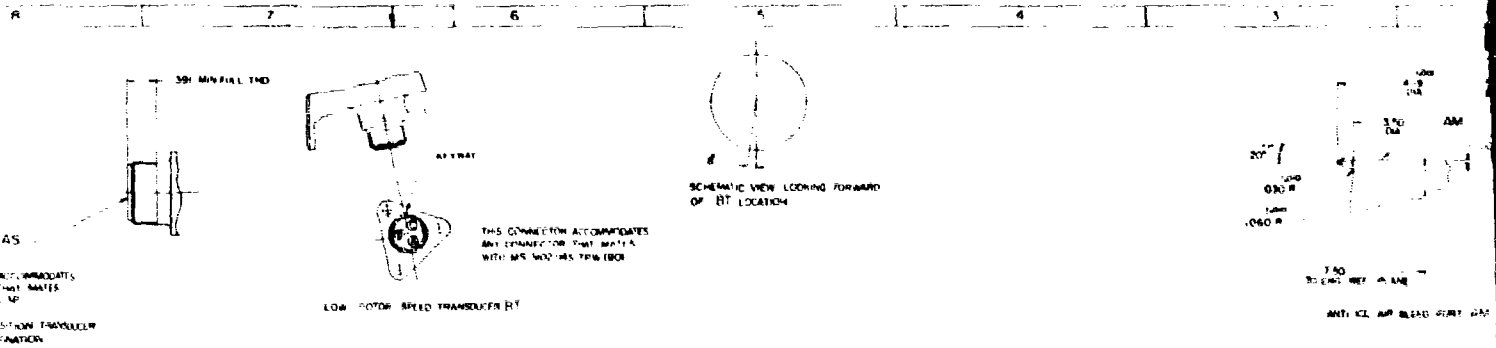

<p>MAX. ALLOWABLE LOADS FOR AIR BLEED PORTS</p> <ul style="list-style-type: none"> <li>T = TENSION APPLIED TO BLEED PORT FIT</li> <li>M = AXIAL MOMENT APPLIED AT END OF FIT</li> <li>M<sub>C</sub> = CIRCUMFERENTIAL MOMENT APPLIED AT END OF FIT</li> <li>S<sub>1</sub> = APPLIED TENSILE LOAD AT BLEED PORT END IN AXIAL DIRECTION</li> <li>P = APPLIED TENSION LOAD</li> </ul> <p>(THESE ARE TO BE USED AS POSITIVE VALUES)</p>	
<p>LOADS</p> <ul style="list-style-type: none"> <li>M (L)</li> <li>M<sub>C</sub> (L)</li> <li>V (L)</li> <li>P (L)</li> <li>T (L)</li> </ul>	<p>CABIN AIR BLEED PORT</p>
<p>LOADS</p> <ul style="list-style-type: none"> <li>M (R)</li> <li>M<sub>C</sub> (R)</li> <li>V (R)</li> <li>P (R)</li> <li>T (R)</li> </ul>	<p>ANT. ICE AIR BLEED PORT</p>

- ① - UNLESS OTHERWISE SPECIFIED, ALL CLEARANCES LESS THAN .015 MUST BE COORDINATED WITH PRIMA
- ② - MIN. SPACE FOR REMOVAL
- ③ - INDICATES DETAILS TO BE COORDINATED
- ④ - DIMENSION FROM FACE OF FEATURES SHOWN
- ⑤ - DIMENSIONS OF CASE CONTAINING SUCH FEATURES UNLESS OTHERWISE SHOWN
- ⑥ - ALL DIM. SHOWN ARE MIN. UNLESS OTHERWISE SHOWN

**Pratt & Whitney Aircraft**  
**PWA FP 56-100**  
**Volume III**

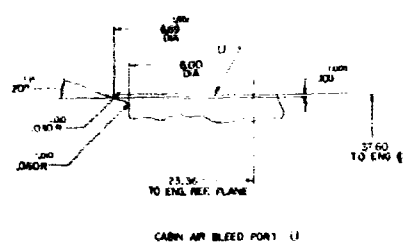
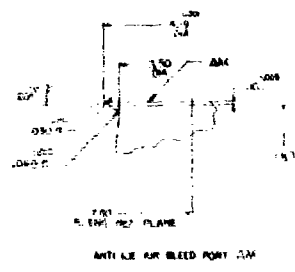
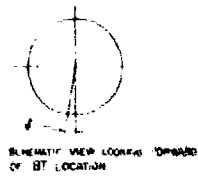

**MAX. ALLOWABLE LOADS FOR AIR BLEED PORTS**

- T = TORQUE APPLIED TO BLEED PORT FLS
- M = AXIAL MOMENT APPLIED AT FLS +12V
- M<sub>C</sub> = CIRCUMFERENTIAL MOMENT APPLIED AT FLS -12V
- S<sub>1</sub>, S<sub>2</sub> = APPLIED SHEAR LOADS AT BLEED PORT FLS IN TRIAL & VELOCITY DIRECTIONS RESPECTIVELY
- P = APPLIED TENSION LOAD

(THESE ARE TO BE USED AS POSITIVE VALUES)

**LOADS**

- M (K.I)
- M<sub>C</sub> (K.I)
- S<sub>1</sub> (K.I)
- S<sub>2</sub> (K.I)
- T (K.I)



**LOADS**

- M (K.I)
- M<sub>C</sub> (K.I)
- S<sub>1</sub> (K.I)
- S<sub>2</sub> (K.I)
- T (K.I)

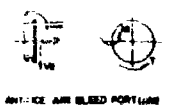

- ① SPACE AVAILABLE FOR ACCESSORIES
- ② ACCESSORY CLEARANCES LESS THAN 25 MUST BE COORDINATED WITH PRM
- ③ MIN. SPACE FOR REMOVAL
- ④ INDICATES DETAILS TO BE COORDINATED
- ⑤ DIMENSIONS FOR TOLERANCE ZONE OF FEATURES SHOWN
- ⑥ THE CENTERLINES OF CASE CONTAINING BLEACH MEASUREMENTS UNLESS OTHERWISE SHOWN
- ⑦ ALL DIM. SHOWN ARE NOM. UNLESS OTHERWISE SHOWN

2129601  
 SHEET 3

AUG 8, 1966

INDEX FOR INSTALLATION AND  
 ENGINE INSTALLATION  
 SHEET 1 - LH SIDE VIEW  
 SHEET 2 - RH SIDE VIEW  
 SHEET 3 - ACCESSORY CLEARANCES  
 SHEET 4 - PLANES & BUTT

PRELIMINARY  
 SUBJECT  
 TO CHANGE

PRATT & WHITNEY AIRCRAFT  
 CONTROLLED #

NOTICE TO ALL PERSONS PREPARING THIS DRAWING

THIS DRAWING IS THE PROPERTY OF PRATT & WHITNEY AIRCRAFT COMPANY AND IS LOANED TO YOU FOR YOUR INFORMATION ONLY. IT IS NOT TO BE REPRODUCED OR TRANSMITTED IN ANY FORM OR BY ANY MEANS, ELECTRONIC OR MECHANICAL, INCLUDING PHOTOCOPYING, RECORDING, OR BY ANY INFORMATION STORAGE AND RETRIEVAL SYSTEM, WITHOUT THE WRITTEN PERMISSION OF PRATT & WHITNEY AIRCRAFT COMPANY.

DATE	BY	APPROVED BY
11/12/66	J. J. [unclear]	[unclear]
<b>ENGINE INSTALLATION</b>		
(LITTON 21R PRODUCTION)		
PRATT & WHITNEY AIRCRAFT COMPANY	77945	2129601

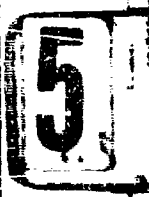

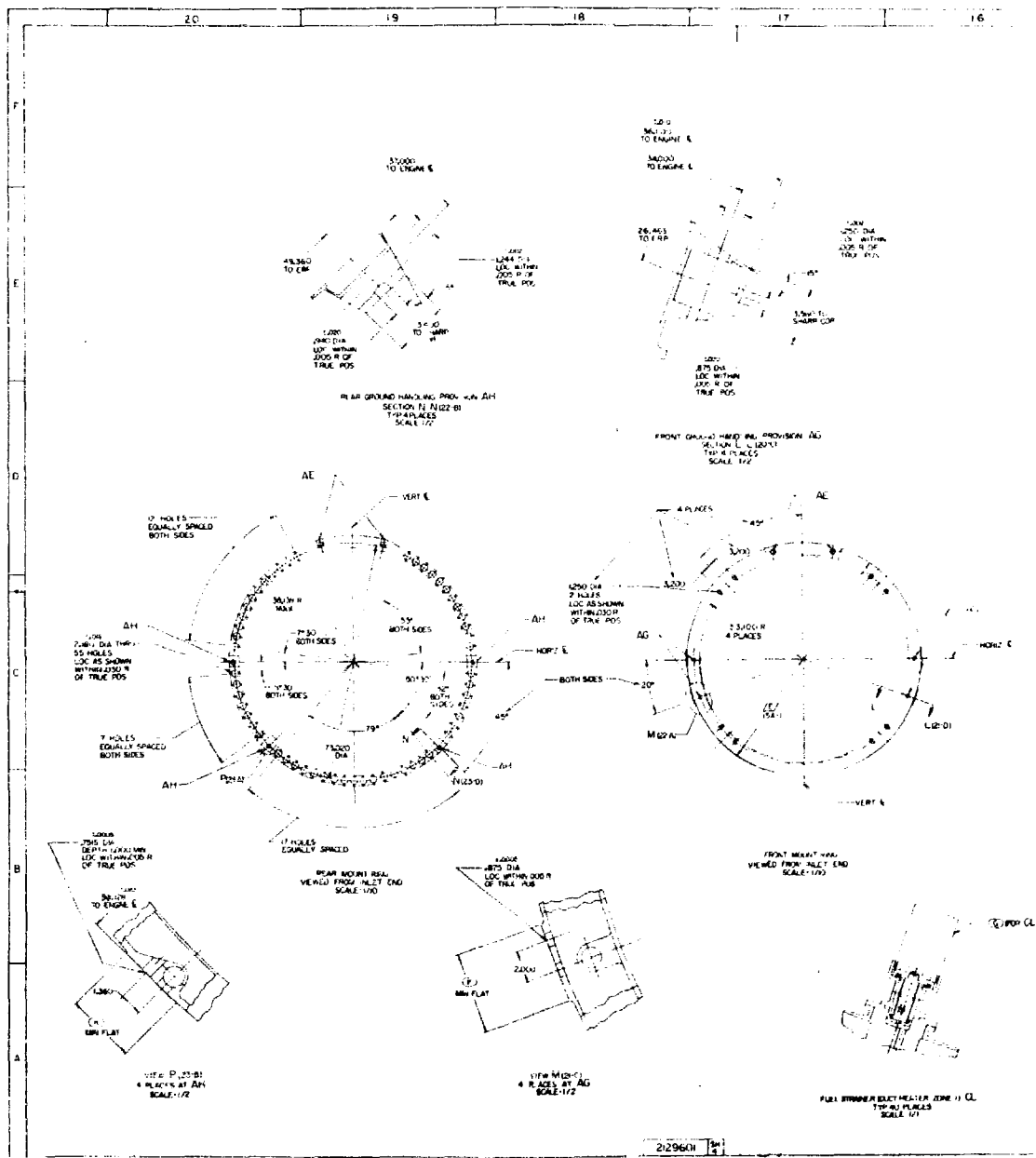

Figure 1. Engine Installation (Boeing)  
Sheet 4 of 4



16

15

14

13

12

11

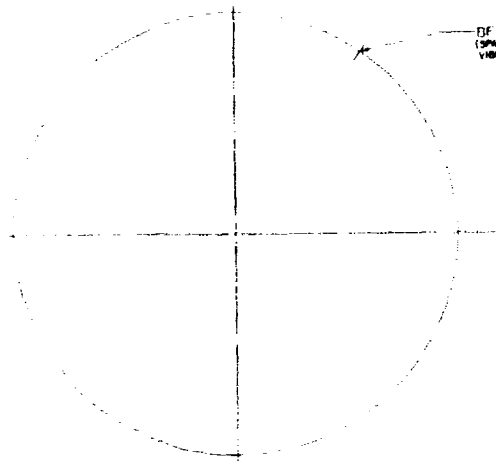

FLANGE G  
VIEWED FROM INLET END

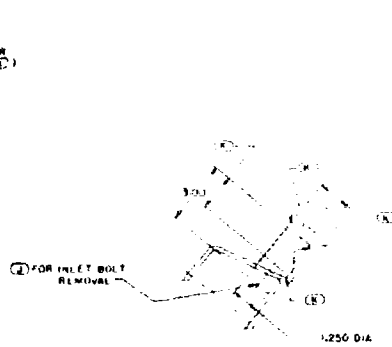

SECTION J-J (H-E)  
TYP 8 PLACES  
SCALE 1/2



VIEW H-I (G-L)  
TYP 4 PLACES  
SCALE 1/2

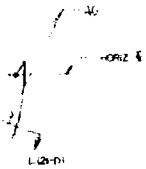

FOR CL

UNIT LOADS FOR INLET FLANGE A

P-AXIAL LOAD	50000 LBS
WINDER SHEAR LOAD	20000 LBS
VERTICAL SHEAR LOAD	13,300 LBS
HORIZ BENDING MOMENT	2260000 IN LBS
VERTICAL BENDING MOMENT	307,000 IN LBS

THESE LOADS REPRESENT THE LIMIT LOADS TO BE DISTRIBUTED TO FLANGE A ATTACHMENTS AND DO NOT OCCUR SIMULTANEOUSLY.

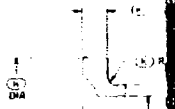

FOR CL

FLANGE A

ENTER ZONE H CL  
PLACES

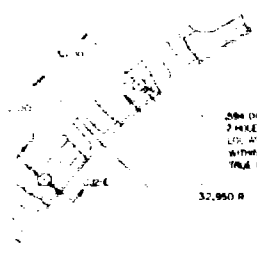
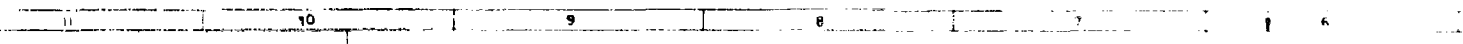

Ø 38 DIA  
2 HOLES  
LOC. AS SHOWN  
WITHIN .030 OF  
TRUE POS  
32.950 R

VIEW FROM INLET  
TYP 4 PLACES  
SCALE 1/2

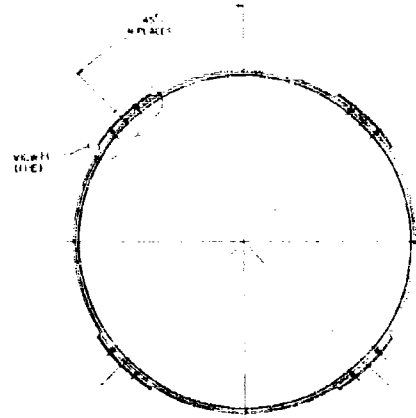

FLANGE A  
VIEWED FROM INLET END

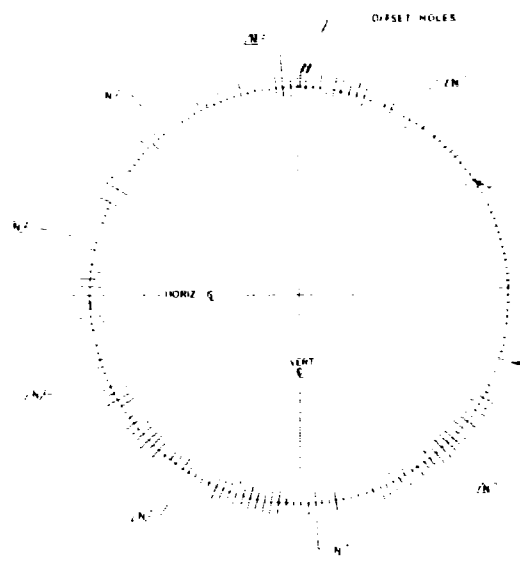

FLANGE C  
VIEWED FROM INLET END

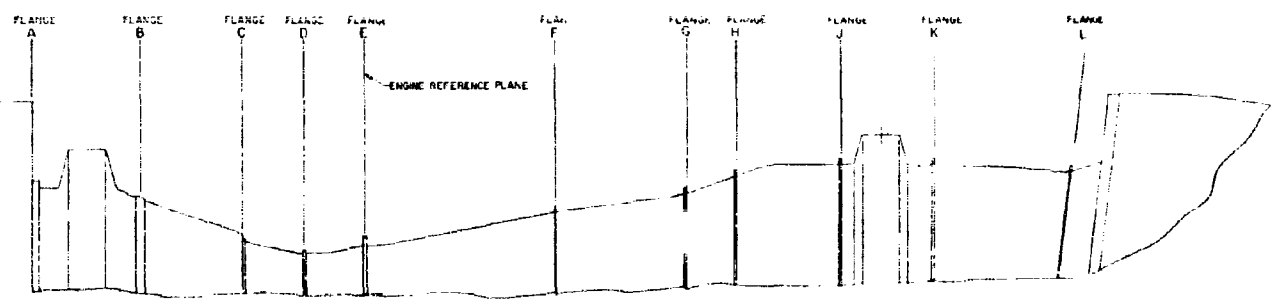
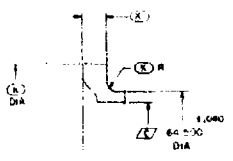

212960 1/2

3



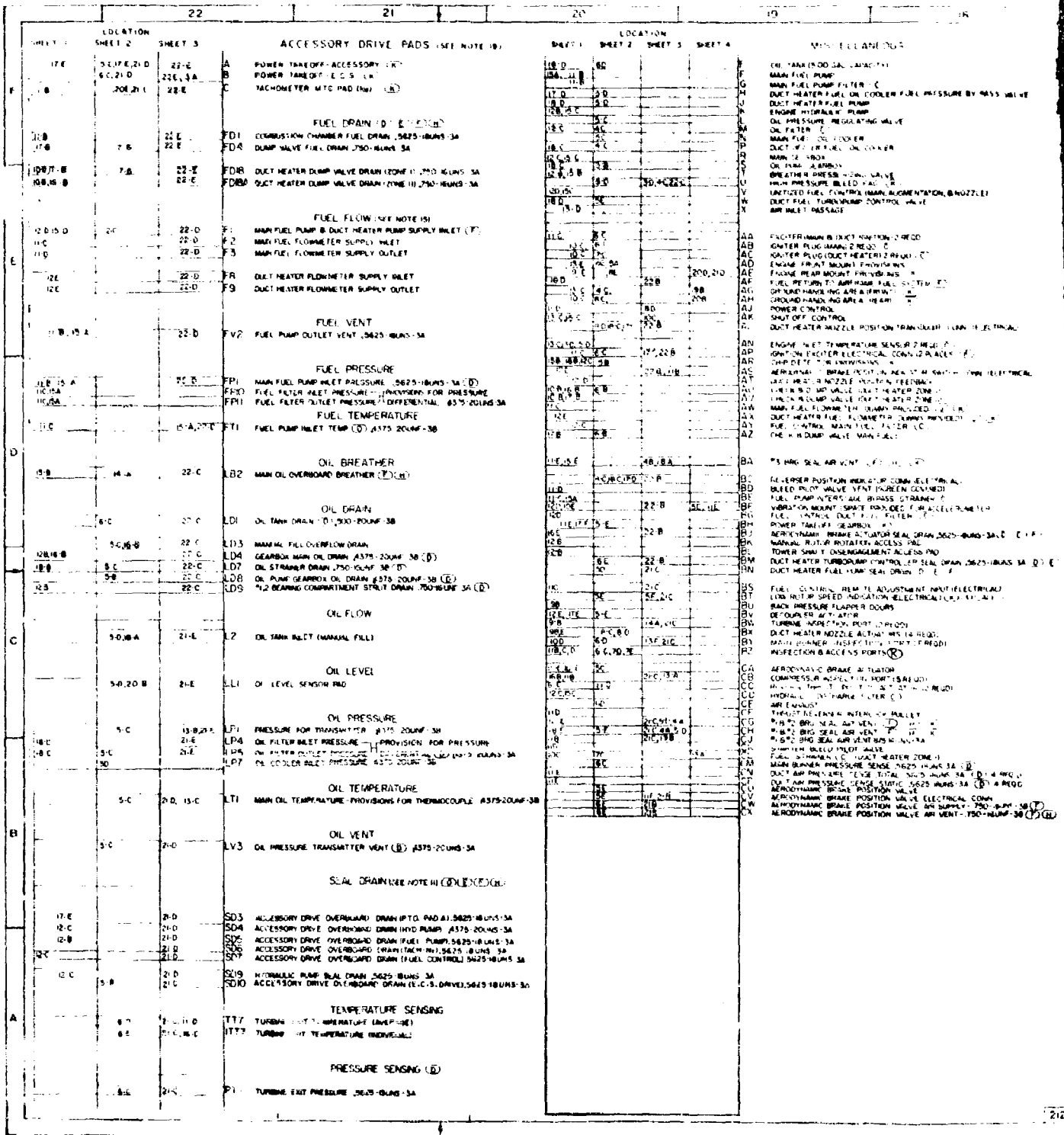

Figure 2. Engine Installation (Lockheed)  
Sheet 1 of 4



PRESSURE BY-PASS VALVE

NO. 8 NOZZLES

100 AMP ELECTRICAL

SWITCH 100 AMP ELECTRICAL

100 AMP ELECTRICAL

100 AMP ELECTRICAL

100 AMP ELECTRICAL

100 AMP ELECTRICAL

100 AMP ELECTRICAL

100 AMP ELECTRICAL

100 AMP ELECTRICAL

100 AMP ELECTRICAL

100 AMP ELECTRICAL

100 AMP ELECTRICAL

100 AMP ELECTRICAL

100 AMP ELECTRICAL

100 AMP ELECTRICAL

100 AMP ELECTRICAL

100 AMP ELECTRICAL

DISCOUPLER ACTUATOR (BV) (E)  
DISCOUPLING TO BE ELECTRICAL  
BYPASS  
RECOUPLING TO BE MANUAL

ALTERNATE POSITION  
ROTATED 180°

- BM MAY BE PLACED IN ALTERNATE POSITION (EXCEPT):
1. REMOVING BOLTS AT 180°
  2. DISCONNECTING TUBING
  3. INITIATING GEARBOX ABOUT 1/2 OF INNER SHAFT WITHOUT UNSEATING 1/8" DIA. (7)
  4. REPLACE BOLTS & TUBING

LIMIT LOAD FOR ALTERNATE POSITION  
MOMENT IN PLANE CONTAINING ENG. AXES  
MAXIMUM PERpendicular TO ENG. AXES  
MAXIMUM PERpendicular TO ENG. AXES  
MAXIMUM PERpendicular TO ENG. AXES  
MAXIMUM PERpendicular TO ENG. AXES

MANDATORY CONNECTION TO INSTALLATION FUEL SYSTEM-AP  
FLOW (MAX) - 17,000 LBS/HR  
TEMP (MAX) - 325°F  
PRESS (MAX) - 240 PSIG  
PRESS (MIN) - 40 PSIG

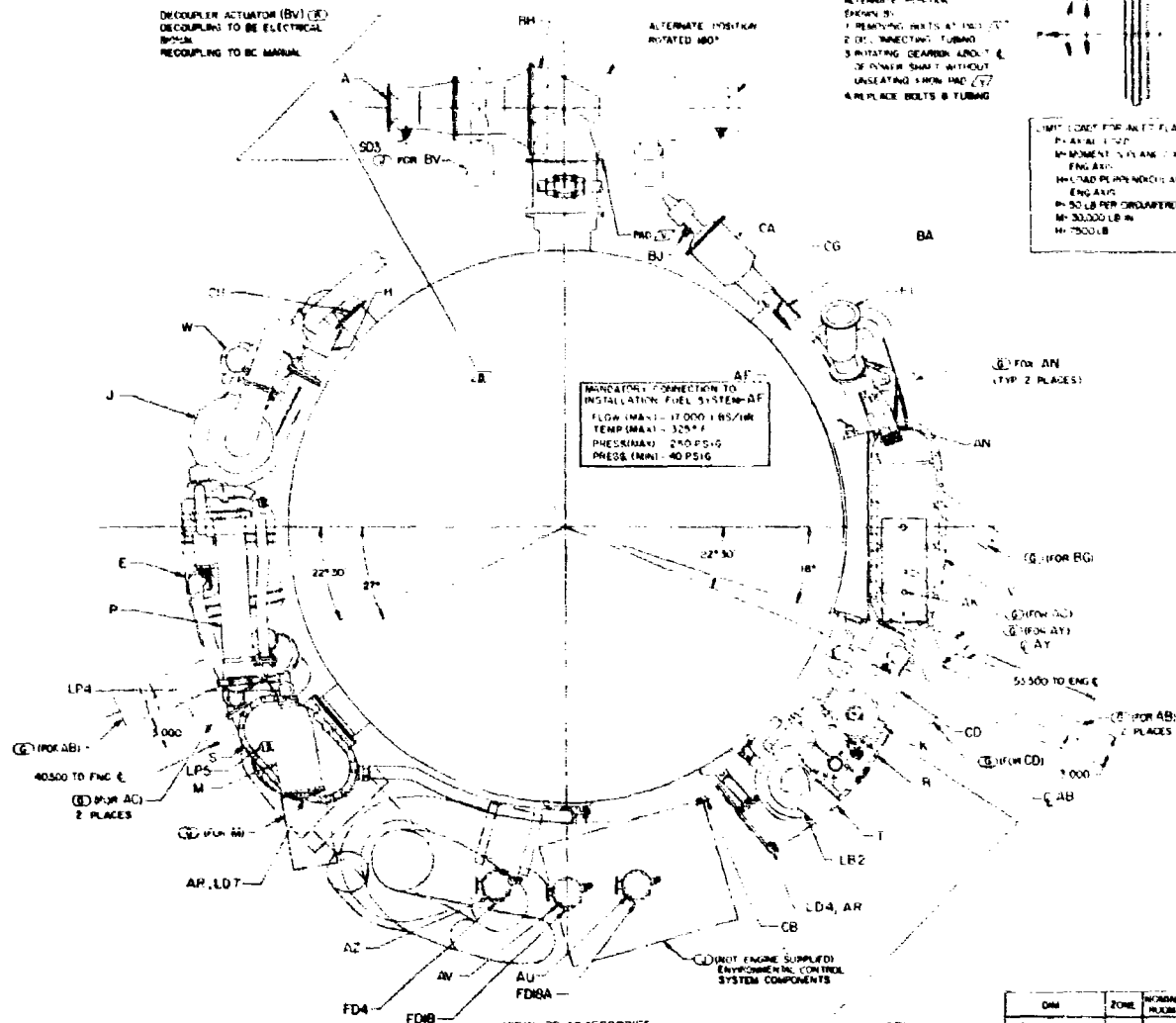

VIEW OF ACCESSORIES  
VIEWED FROM INLET END

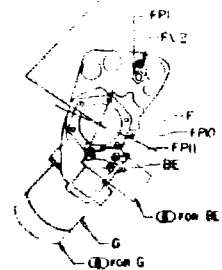

DIM	ZONE	NORMAL AT 10000 TEMP	NORMAL AT MAX OPERATING TEMP
A7 DIA	B2 2	76.647	77.00
Ø DIA AT PROJECTION	H D	47.382	(K)
Ø DIA AT INLET CASE	13 D	64.512	64.676
Ø DIA	14 D	83.000	(K)
Ø DIA AT FRONT MOUNTING	13 C	66.50	69.464
Ø LENGTH	9 F	217.076	(K)
Ø DIA	4 D	61.000	60.52
Ø HEIGHT	1 C	82.240	(K)

212B01

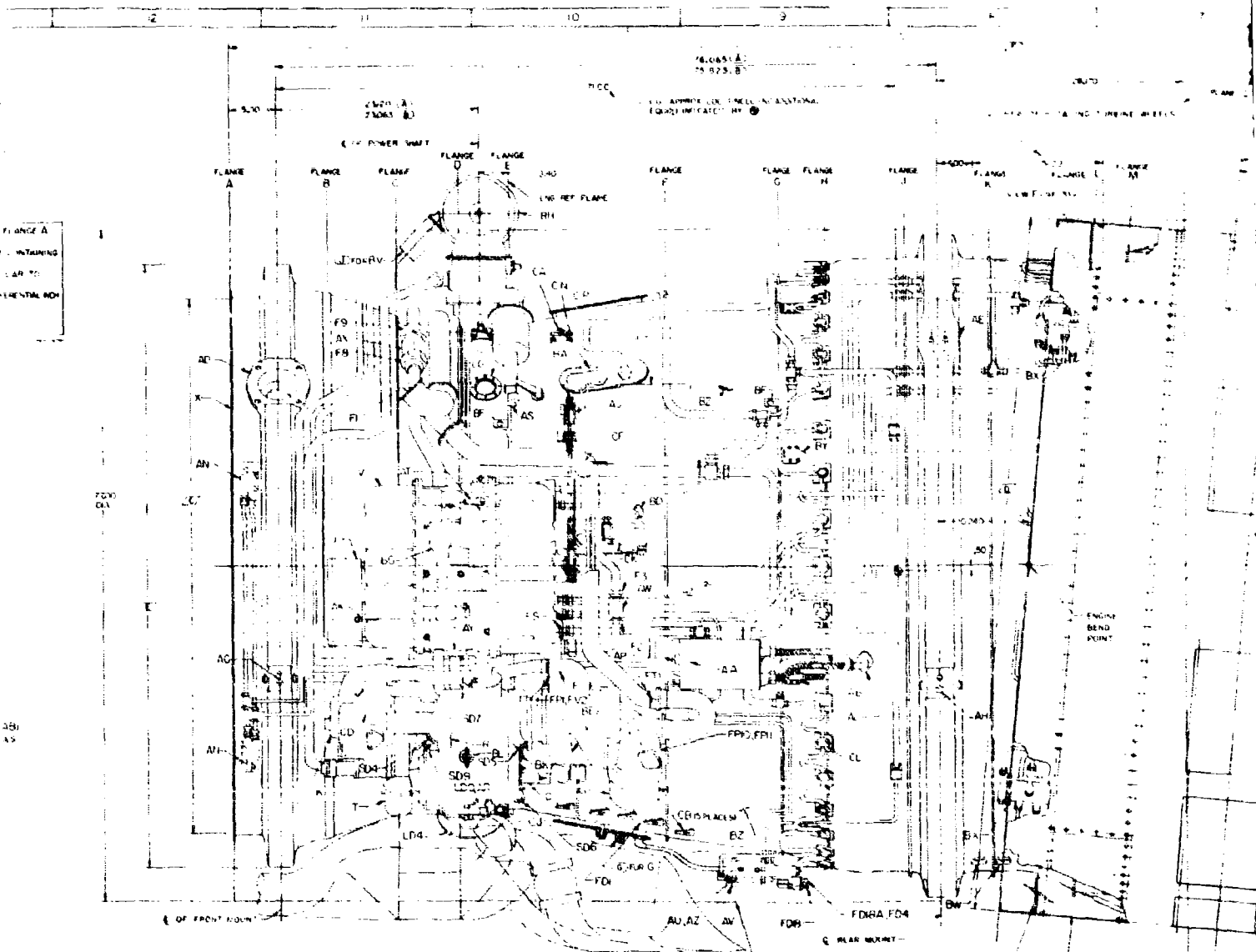

MAX. DIM. AT NOMINAL TEMP.	NOMINAL AT MAX. OPERATING TEMP.	ENV. DIM. AT 100°F. (38°C.)	DESCRIPTIONS
18,660	17,777	(S)	DIA. OF LARGEST CIRCLE CONC. WITH THE ANY INCLUDES LOCAL PROJECTIONS MEASURING AROUND FULL CIRCUMFERENCE OF ENG. INCLUDING P.T.O. BEAMOR & REVERSE SUPPRESSOR
42,392	41,392	(A)	LARGEST LOCAL RADIAL PROJECTION FROM C OF ENG.
61,512	61,476	(B)	INLET CASE FLOWPATH DIA.
86,200	86,164	(C)	P.T.O. DIA. CENTRIC WITH NOZZLE AXIS AT AIRFRAME MATEUP
85,320	85,284	(N)	BASIC RING DIA. EXCLUDING ATTACHMENT
72,056	71,920	(L)	LARGEST AXIAL LENGTH OF ENG.
83,000	80,320	(E)	DIA. OF ENG. WITH FUELSYSTEMS
94,948	94,812	(R)	MAX. OVERALL HEIGHT NORMAL TO LONGITUDINAL C OF ENGINE

2128101 1/1

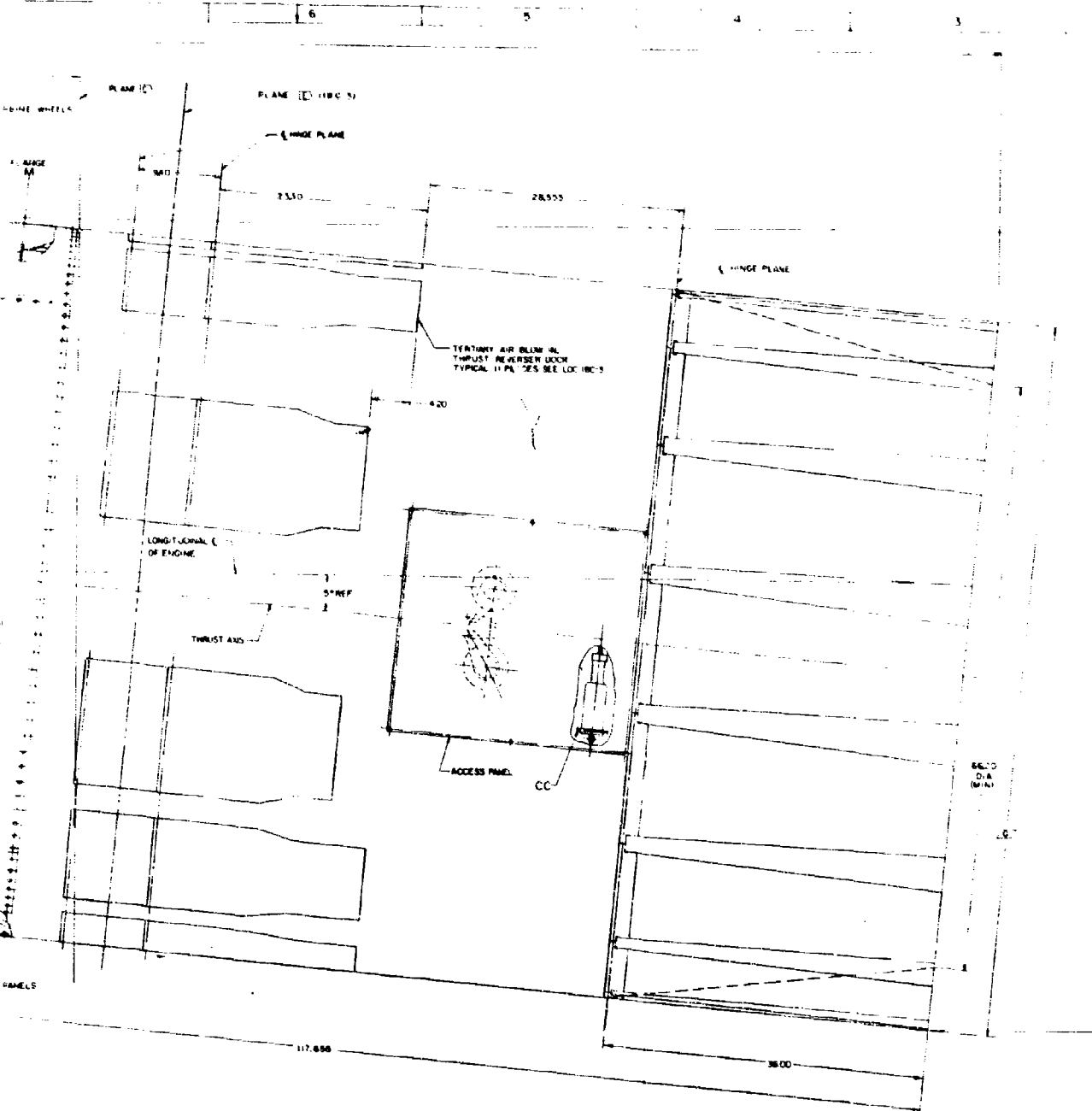

- 1. ENGINE ASSEMBLY TO BE ASSEMBLED WITH ALL APPROPRIATE DIMENSIONS AND TOLERANCES SHOWN ON DRAWING.
- 2. DIMENSIONS NOT SHOWN GIVEN AS INDICATED BY DIMENSION LINES.
- 3. SUPPLEMENTARY DIMENSIONS ALLOWABLE IN INSTALLATION.
- 4. FUEL SUPPLY SYSTEM WITH PRATT & WHITNEY COOPER'S COOPER'S COOPER'S COOPER'S COOPER'S YELLOW COLORED FUEL ALL OVERBOARD FUEL ACCESS PANELS MUST BE INSTALLED IN ACCORDANCE WITH THESE DIMENSIONS WHICH MAY CERTAINLY BE INDICATED BY DIMENSIONS SEPARATELY OTHER DIMENSIONS MUST BE OF ALL DIMENSIONS AND COORDINATED WITH THE SPACE REQUIRED FOR THE CENTERLINE OF THE UNLESS OTHERWISE INDICATED BY DIMENSIONS AND ALL DIMENSIONS ARE IN INCHES.

INDEX FOR INSTALLATION  
 ENGINE ASSEMBLY  
 SHEET 117.656  
 SHEET 117.656  
 SHEET 117.656  
 SHEET 117.656

NO.	DESCRIPTION	DATE

**Pratt & Whitney Aircraft**  
**PWA FP 66-100**  
**Volume III**

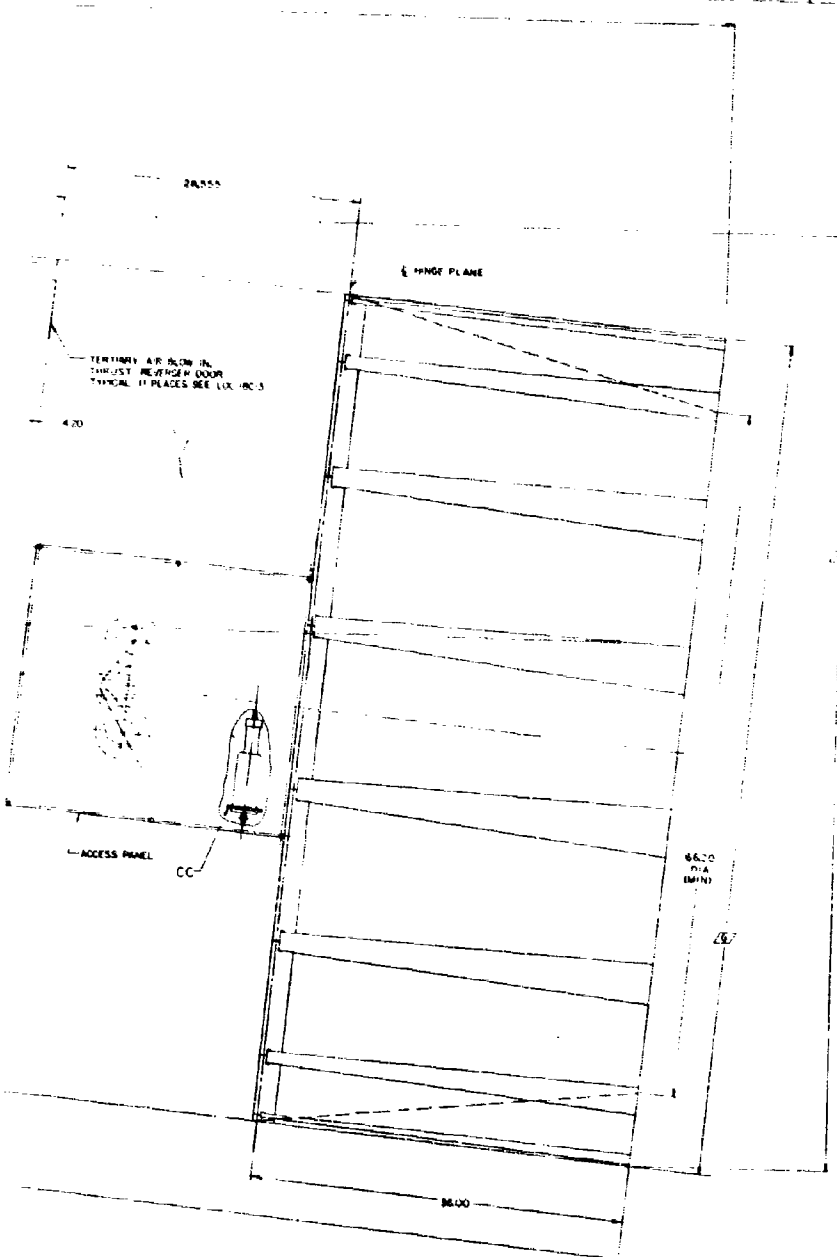

- 1. THESE REQUIREMENTS FOR ALL UNLUBRICATED ENGINE PARTS TO BE IN COMPLIANCE WITH APPROVED FEDERAL STANDARDS (LUBRICATED ENGINE PARTS TO BE IN COMPLIANCE WITH APPROVED MILITARY SPECIFICATIONS) TO BE COORDINATED WITH AND APPROVED BY PRATT & WHITNEY AIRCRAFT.
- 2. ALL DRAWINGS WHEN TYPED WITH THESE STANDARDS REQUIREMENTS ARE TO BE APPROVED BY PRATT & WHITNEY AIRCRAFT WHICH DO NOT MEET ANY STANDARD REQUIREMENTS ARE GIVEN AS CALLED OUT.
- 3. ALL DIMENSIONS UNLESS OTHERWISE SPECIFIED IN THE DRAWING SHALL BE IN INCHES AND DECIMALS THEREOF.
- 4. SUPPLEMENTARY DIMENSIONS UNLESS OTHERWISE SPECIFIED SHALL BE IN MILLIMETERS AND DECIMALS THEREOF.
- 5. 28000 ALLOWABLE FLIGHT SHIPPING AND HANDLING WEIGHT.
- 6. ELECTRICAL INSTALLATION CODE FOR THE MAIN FUEL SUPPLY SYSTEM MUST BE COORDINATED WITH PRATT & WHITNEY AIRCRAFT.
- 7. COLORED YELLOW MARKS BE REMOVED AND PROPER DIMENSIONS MADE BEFORE ENGINE INSTALLATION.
- 8. YELLOW CLOSURE PROVISIONS ARE INDICATED BY (Y) ALL OVERBOARD THROAT DOWN BUSES INDICATED BY (O) AND DOWN LINE DOWN BUSES INDICATED BY (D) ALL DIMENSIONS IN DRAWING TO BE INDICATED BY (D) ALL DIMENSIONS IN DRAWING TO BE INDICATED BY (D) UNLESS OTHERWISE SPECIFIED.
- 9. THESE DRAWINGS ACCESSORY DRIVE AND COMPARTMENTS WHICH MAY CONTAIN BOTH ACCESSORY FLUID AND ELECTRICAL FUEL DRAINS MUST BE SEPARATE FROM OIL DRAINS AND ITEMS INDICATED BY (O) UNLESS OTHERWISE SPECIFIED.
- 10. SEPARATELY OTHER DRAINS MAY BE INDICATED BY THE RESULTING AREA MUST BE EQUIVALENT TO OR GREATER THAN THE AREA OF ALL DRAINS ATTACHED.
- 11. SPACE AVAILABLE FOR ACCESSORIES.
- 12. ACCESSORY CLEARANCES LESS THAN 1/2 INCH MUST BE COORDINATED WITH PRATT & WHITNEY AIRCRAFT.
- 13. (R) DIMENSIONS FOR REMOVAL.
- 14. SPACE REQUIRED FOR REMOVAL OF ITEM INDICATED BY (R) DIMENSIONS FOR TRUE POS OF FEATURES SHOWN ARE CENTERLINES OF CASE EXCEPT WHERE FEATURES UNLESS OTHERWISE SHOWN.
- 15. DIMENSIONS IN GENERAL ARE IN INDICATION TO ROOM TEMP DIM.
- 16. DIMENSIONS INDICATED BY (R) ARE NOMINAL AT ROOM TEMP.
- 17. DIMENSIONS INDICATED BY (S) ARE NOMINAL AT MAX OPERATING TEMP.
- 18. ALL DIMENSIONS ARE NOMINAL UNLESS OTHERWISE SHOWN.
- 19. ALL DIMENSIONS ARE AT ROOM TEMP UNLESS OTHERWISE SHOWN.

APR 1966

MODE FOR INSTALLATION ONLY  
 ENGINE ENGINE INSTALLATION  
 SHEET 14 SIDE VIEW  
 SHEET 15 SIDE VIEW  
 SHEETS ADDITIONAL INFORMATION  
 SHEETS PLANS & DRAWINGS A  
 SHEET 14-15

DATE MINUTE  
 SUBJECT  
 TO CHANGE

PRATT & WHITNEY AIRCRAFT  
 CONTROLLED

NOTICE TO ALL PERSONS RECEIVING THIS DRAWING

THIS DRAWING IS THE PROPERTY OF PRATT & WHITNEY AIRCRAFT AND IS LOANED TO YOU FOR YOUR INFORMATION ONLY. IT IS NOT TO BE REPRODUCED OR TRANSMITTED IN ANY FORM OR BY ANY MEANS, ELECTRONIC OR MECHANICAL, INCLUDING PHOTOCOPYING, RECORDING, OR BY ANY INFORMATION STORAGE AND RETRIEVAL SYSTEM, WITHOUT THE WRITTEN PERMISSION OF PRATT & WHITNEY AIRCRAFT.

PROJECT NO.	77445	DATE	2-28-66
ENGINE INSTALLATION			
PRODUCTION			
ISSUED BY			
CHECKED BY			



2128101  
 DI









NOTE  
 SPACE UNDER THIS LINE IS RESERVED FOR ENGINE  
 SERIAL NO. THIS SPACE IS FOR AIR NAME EQUIPMENT  
 SERIAL NO. IDENTIFIED ONLY AFTER SPECIFIC  
 LICENSING WITH PWSW/WH/PTW/PA/WH

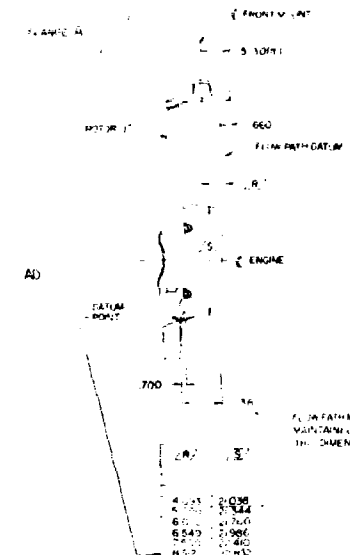
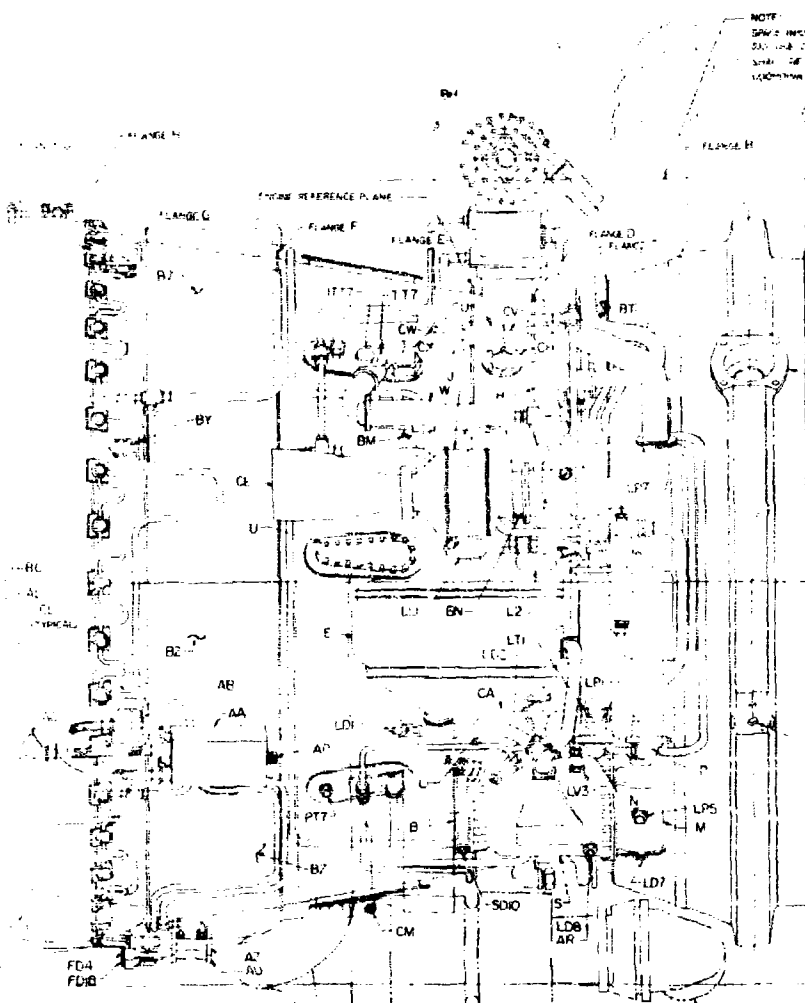

DIMENSIONS ARE IN INCHES  
 DIMENSIONS IN PARENTHESES ARE  
 METRIC EQUIVALENTS  
 MATERIAL TO BE COORDINATED  
 SHEET 1 OF 4 BY PWSW/WH/PTW/PA/WH

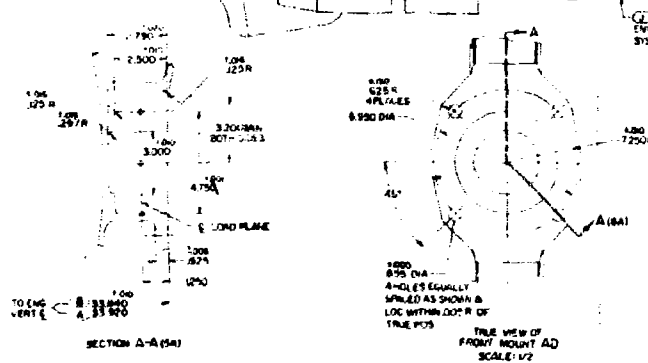
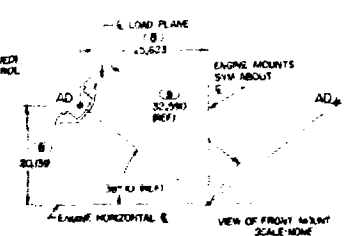

INDEX FOR INSTALLATION  
 SHEET 1 OF 4 ENGINE INSTALLATION  
 SHEET 2 OF 4 MAIN BODY VIEW  
 SHEET 3 INTERNAL INFORMATION  
 SHEET 4 FLANGE 1 ONLY AT 11.8  
 PART 34174  
 REV. 11-69

- ① SPACE AVAILABLE FOR ACCESSORIES
- ② ACCESSORY CLEARANCES LESS THAN 1/2 INCH MUST BE COORDINATED WITH PWSW/WH/PTW/PA/WH
- ③ 1/2 INCH SPACE FOR REMOVAL
- ④ INDICATES DETAILS TO BE COORDINATED
- ⑤ DIM INDICATED BY (B) ARE NOMINAL AT MAX OPERATING TEMP
- ⑥ DIM INDICATED BY (C) ARE NOMINAL AT ROOM TEMP
- ⑦ DATUMS FOR TRUE POS OF FEATURES SHOWN ARE CENTERLINES OF CASE CONTAINING SUCH FEATURES UNLESS OTHERWISE SPECIFIED
- ⑧ ALL DIA SHOWN ARE NOMINAL UNLESS OTHERWISE SPECIFIED

REVISED TO ALL PREVIOUS EDITIONS	
REV. NO.	DESCRIPTION
1	INITIAL
2	INITIAL
3	INITIAL
4	INITIAL
5	INITIAL
6	INITIAL
7	INITIAL
8	INITIAL
9	INITIAL
10	INITIAL
11	INITIAL
12	INITIAL
13	INITIAL
14	INITIAL
15	INITIAL
16	INITIAL
17	INITIAL
18	INITIAL
19	INITIAL
20	INITIAL
21	INITIAL
22	INITIAL
23	INITIAL
24	INITIAL
25	INITIAL
26	INITIAL
27	INITIAL
28	INITIAL
29	INITIAL
30	INITIAL
31	INITIAL
32	INITIAL
33	INITIAL
34	INITIAL
35	INITIAL
36	INITIAL
37	INITIAL
38	INITIAL
39	INITIAL
40	INITIAL
41	INITIAL
42	INITIAL
43	INITIAL
44	INITIAL
45	INITIAL
46	INITIAL
47	INITIAL
48	INITIAL
49	INITIAL
50	INITIAL
51	INITIAL
52	INITIAL
53	INITIAL
54	INITIAL
55	INITIAL
56	INITIAL
57	INITIAL
58	INITIAL
59	INITIAL
60	INITIAL
61	INITIAL
62	INITIAL
63	INITIAL
64	INITIAL
65	INITIAL
66	INITIAL
67	INITIAL
68	INITIAL
69	INITIAL
70	INITIAL
71	INITIAL
72	INITIAL
73	INITIAL
74	INITIAL
75	INITIAL
76	INITIAL
77	INITIAL
78	INITIAL
79	INITIAL
80	INITIAL
81	INITIAL
82	INITIAL
83	INITIAL
84	INITIAL
85	INITIAL
86	INITIAL
87	INITIAL
88	INITIAL
89	INITIAL
90	INITIAL
91	INITIAL
92	INITIAL
93	INITIAL
94	INITIAL
95	INITIAL
96	INITIAL
97	INITIAL
98	INITIAL
99	INITIAL
100	INITIAL

# Pratt & Whitney Aircraft

PWA FP 66-100

Volume III

NOTE:  
SPACE INSIDE THIS ENVELOPE RESERVED FOR ENGINE  
ANY USE OF THIS AREA FOR AIRFRAME EQUIPMENT  
SHALL BE PERMITTED ONLY AFTER SPECIFIC  
COORDINATION WITH PWA/FA/PCOM SPE SHE11

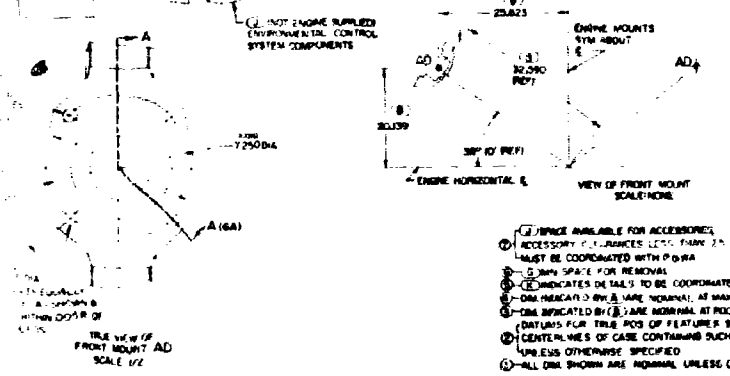
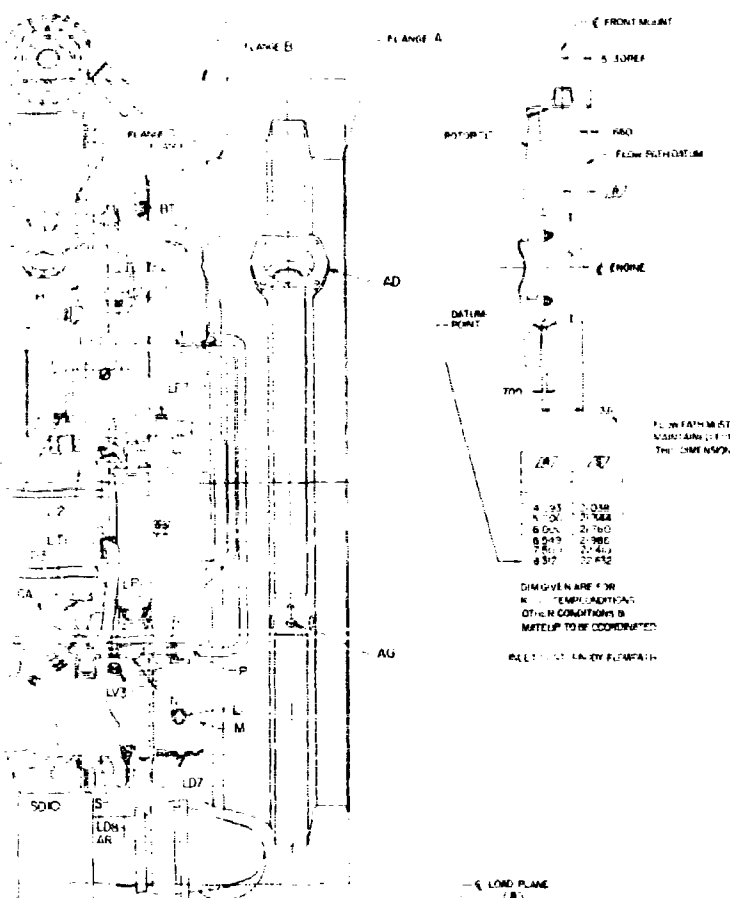

AUGUST 9, 1966

2128101 SHEET 2

PRELIMINARY SUBJECT TO CHANGE

PRATT & WHITNEY AIRCRAFT CONTROL LTD

NOTE TO ALL PERSONS RECEIVING THIS DRAWING

ENGINE INSTALLATION SHEET 1 OF 100 VEH SHEET 2 OF 100 VEH SHEET 3 OF 100 VEH SHEET 4 OF 100 VEH SHEET 5 OF 100 VEH SHEET 6 OF 100 VEH SHEET 7 OF 100 VEH SHEET 8 OF 100 VEH SHEET 9 OF 100 VEH SHEET 10 OF 100 VEH SHEET 11 OF 100 VEH SHEET 12 OF 100 VEH SHEET 13 OF 100 VEH SHEET 14 OF 100 VEH SHEET 15 OF 100 VEH SHEET 16 OF 100 VEH SHEET 17 OF 100 VEH SHEET 18 OF 100 VEH SHEET 19 OF 100 VEH SHEET 20 OF 100 VEH SHEET 21 OF 100 VEH SHEET 22 OF 100 VEH SHEET 23 OF 100 VEH SHEET 24 OF 100 VEH SHEET 25 OF 100 VEH SHEET 26 OF 100 VEH SHEET 27 OF 100 VEH SHEET 28 OF 100 VEH SHEET 29 OF 100 VEH SHEET 30 OF 100 VEH SHEET 31 OF 100 VEH SHEET 32 OF 100 VEH SHEET 33 OF 100 VEH SHEET 34 OF 100 VEH SHEET 35 OF 100 VEH SHEET 36 OF 100 VEH SHEET 37 OF 100 VEH SHEET 38 OF 100 VEH SHEET 39 OF 100 VEH SHEET 40 OF 100 VEH SHEET 41 OF 100 VEH SHEET 42 OF 100 VEH SHEET 43 OF 100 VEH SHEET 44 OF 100 VEH SHEET 45 OF 100 VEH SHEET 46 OF 100 VEH SHEET 47 OF 100 VEH SHEET 48 OF 100 VEH SHEET 49 OF 100 VEH SHEET 50 OF 100 VEH SHEET 51 OF 100 VEH SHEET 52 OF 100 VEH SHEET 53 OF 100 VEH SHEET 54 OF 100 VEH SHEET 55 OF 100 VEH SHEET 56 OF 100 VEH SHEET 57 OF 100 VEH SHEET 58 OF 100 VEH SHEET 59 OF 100 VEH SHEET 60 OF 100 VEH SHEET 61 OF 100 VEH SHEET 62 OF 100 VEH SHEET 63 OF 100 VEH SHEET 64 OF 100 VEH SHEET 65 OF 100 VEH SHEET 66 OF 100 VEH SHEET 67 OF 100 VEH SHEET 68 OF 100 VEH SHEET 69 OF 100 VEH SHEET 70 OF 100 VEH SHEET 71 OF 100 VEH SHEET 72 OF 100 VEH SHEET 73 OF 100 VEH SHEET 74 OF 100 VEH SHEET 75 OF 100 VEH SHEET 76 OF 100 VEH SHEET 77 OF 100 VEH SHEET 78 OF 100 VEH SHEET 79 OF 100 VEH SHEET 80 OF 100 VEH SHEET 81 OF 100 VEH SHEET 82 OF 100 VEH SHEET 83 OF 100 VEH SHEET 84 OF 100 VEH SHEET 85 OF 100 VEH SHEET 86 OF 100 VEH SHEET 87 OF 100 VEH SHEET 88 OF 100 VEH SHEET 89 OF 100 VEH SHEET 90 OF 100 VEH SHEET 91 OF 100 VEH SHEET 92 OF 100 VEH SHEET 93 OF 100 VEH SHEET 94 OF 100 VEH SHEET 95 OF 100 VEH SHEET 96 OF 100 VEH SHEET 97 OF 100 VEH SHEET 98 OF 100 VEH SHEET 99 OF 100 VEH SHEET 100 OF 100 VEH	ENGINE INSTALLATION (LIT-7A-21 PRODUCTION)
FA 55-66-8	7745
2128101	

2128101  
DI

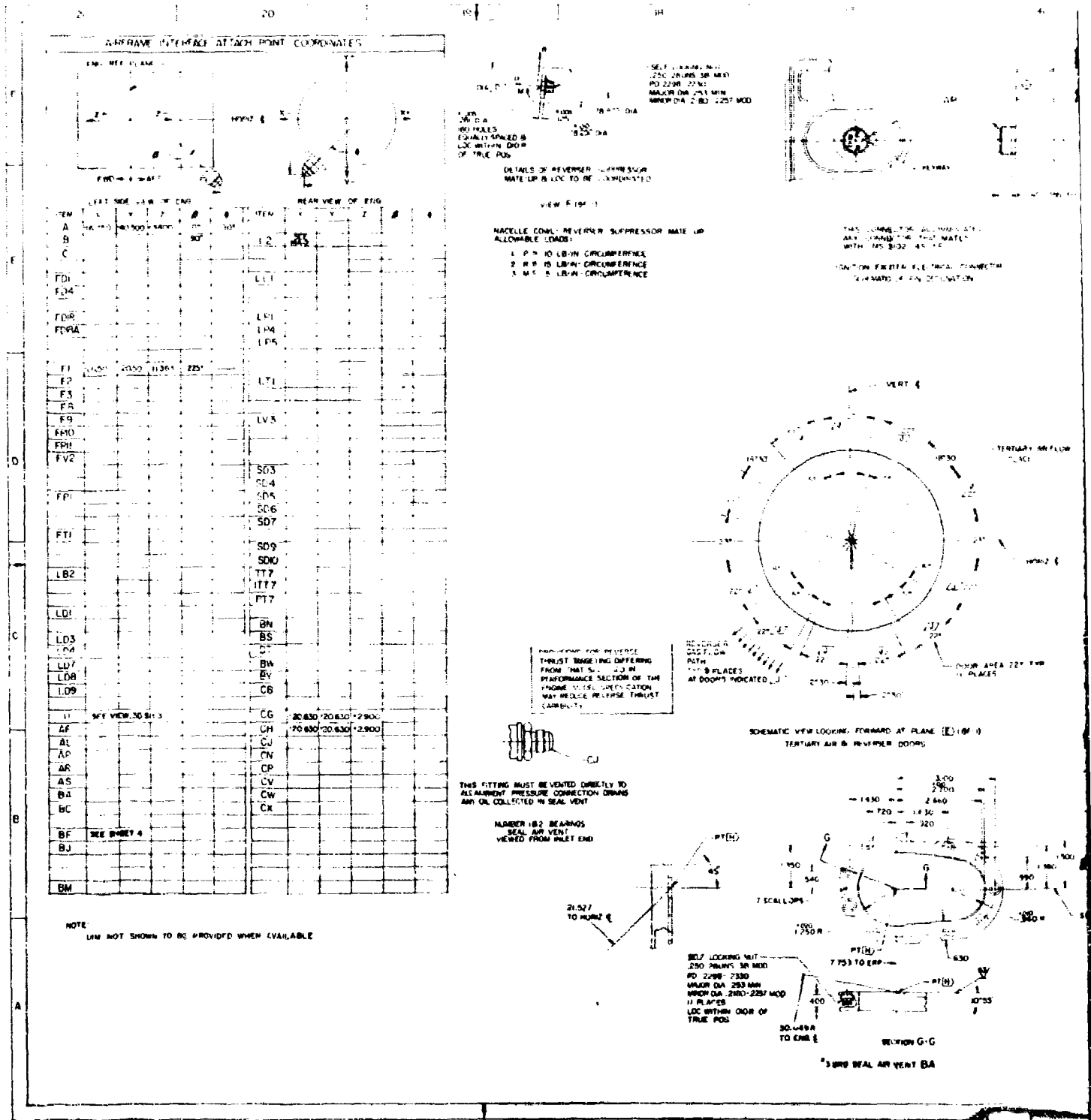
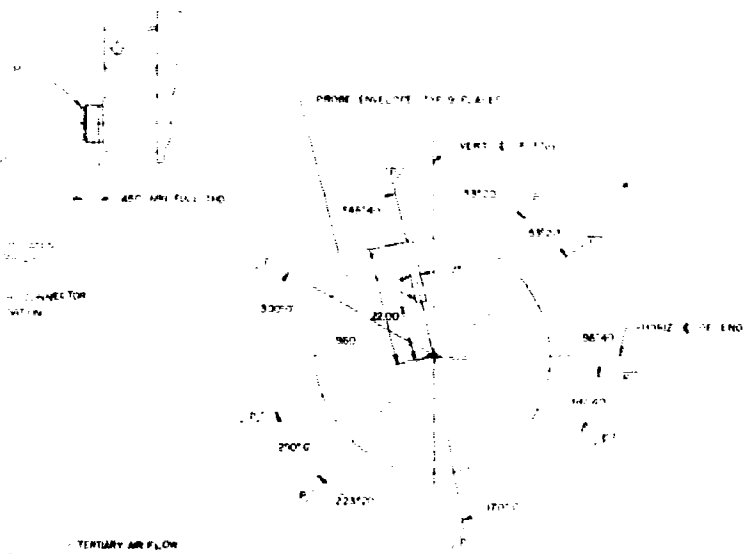

Figure 2. Engine Installation (Lockheed)  
Sheet 3 of 4





SCHEMATIC VIEW LOOKING FORWARD AT FLANGE OF TURBINE EXHAUST TEMPERATURE SENSING FRAMES AT LOC INDICATED BY 227

BY LOCATED 8 PLACES  
6 PLACES INDICATED BY 227 WITH COVER REMOVED  
2 PLACES INDICATED BY 227 WITH COVER (AB) REMOVED

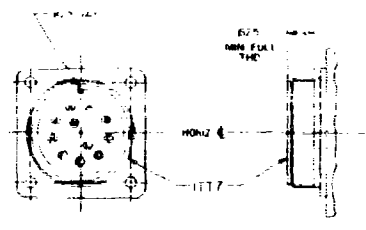
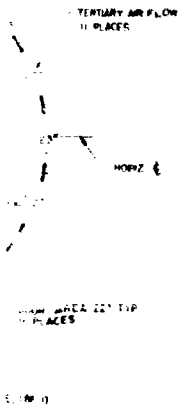

TURBINE INLET TEMPERATURE SCHEMATIC OF PIN DESIGNATION SCALE: 2:1

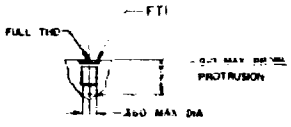

FUEL INLET TEMP FTI

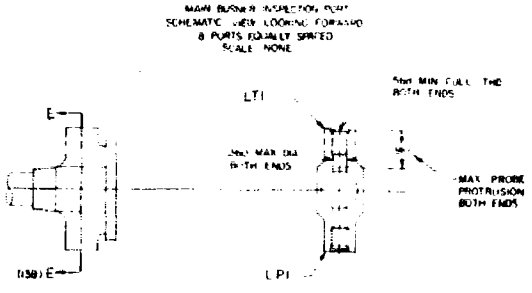

MAIN BLOWER INSPECTION PORT SCHEMATIC VIEW LOOKING FORWARD 8 PORTS EQUALLY SPACED SCALE: NONE

- SECTION E E01481
- 1. TRANSMITTER MUST CONTAIN AN O-RING NO LARGER THAN OAD DIA AT ATTACHMENT TO ENG CONNECTION
  - 2. MAX OPERATING OIL PRESSURE 40 PSIG
  - 3. MAX OIL TEMPERATURE 300° F
  - 4. PROVISIONS FOR DIRECT ATTACHMENT OF TRANSMITTER TO ENG MUST BE COORDINATED

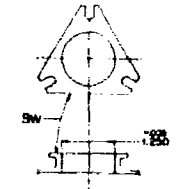

DETAILS OF TURBINE INSPECTION PORT & LOC (E)

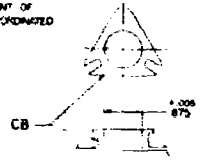

DETAILS OF COMPRESSOR INSPECTION PORTS & LOC (E)

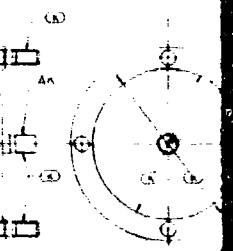
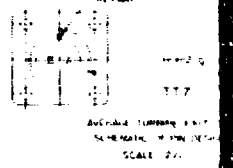
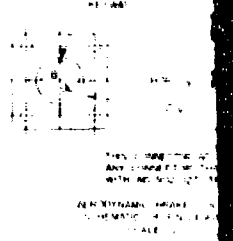

THIS SCHEMATIC IS DRAWN WITH 68° TO AERODYNAMIC DRAWING SCHEMATIC OF

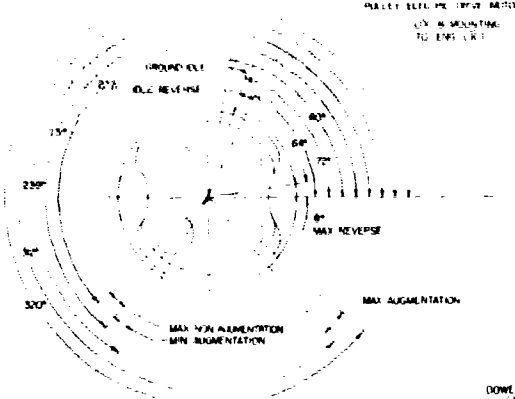
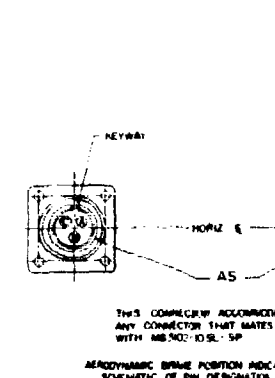
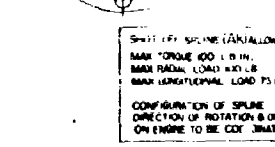
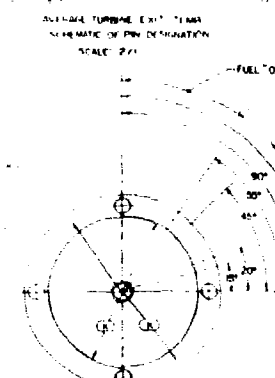
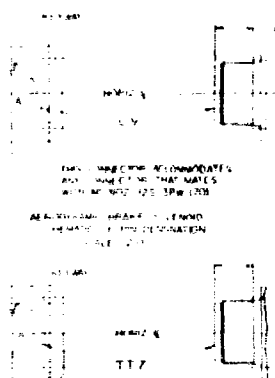

POWER SPLIT (A) ALLOWABLE LOADS  
 MAX RADIAL LOAD 400 LB  
 MAX LONGITUDINAL LOAD 75 LB  
 CONFIGURATION OF SPLINE, DIRECTION OF ROTATION & ORIENTATION TO BE CONSIDERED  
 (A) VARYING SPLINE TO DELIVER MAX TORQUE OF 400 LB-IN  
 POWER SPLITTING DEVICE MUST BE CAPABLE OF REVERSING INTERLOCK SYSTEM WITH MIN TORQUE OF 300 LB-IN

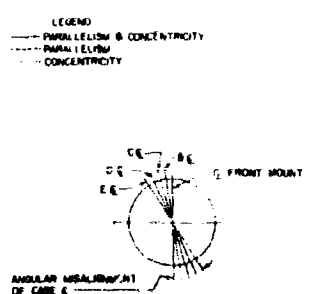
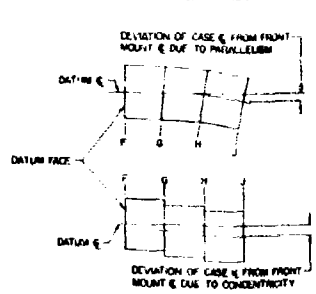
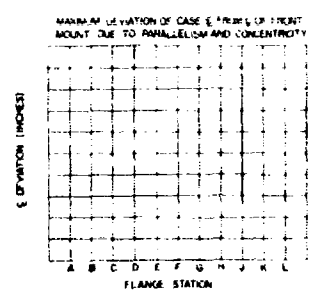
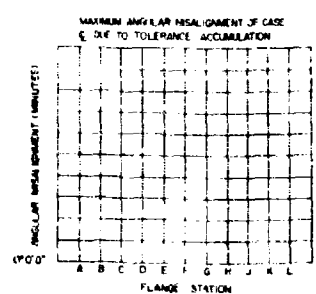

THIS CONNECTOR ACCOMMODATES ANY CONNECTOR THAT MATES WITH MS NO: 125 SP (28)

OR MOTOR SPEED FROM 1500 RPM

376 HUBS ARE MOUNTED TO THE END OF 6 PLACES EQUALLY SPACED A LOC WITHIN DOSE OF TRUE PCS

LAB SEAL AIR VENT CONNECTION SCALE 1:1 (ROTATED)

MAX TORQUE  
 M = 513 LB-IN  
 M<sub>2</sub> = 343 LB-IN  
 M<sub>3</sub> = 172 LB-IN  
 P = 172 LB-IN  
 T = 343 LB-IN

LOADS  
 M = 453 LB-IN  
 M<sub>2</sub> = 272 LB-IN  
 M<sub>3</sub> = 136 LB-IN  
 P = 136 LB-IN  
 T = 272 LB-IN

LOADS  
 M = 70 LB-IN  
 M<sub>2</sub> = 226 LB-IN  
 M<sub>3</sub> = 279 LB-IN  
 P = 279 LB-IN  
 T = 456 LB-IN



**Pratt & Whitney Aircraft**  
**PWA FP 66-100**  
**Volume III**

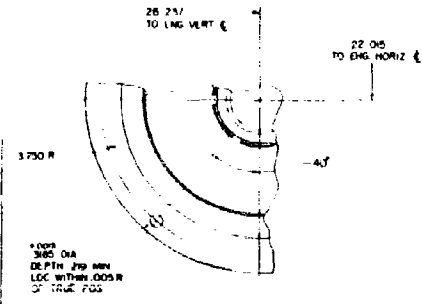
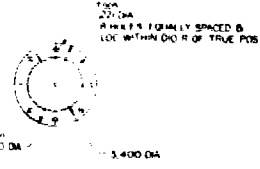
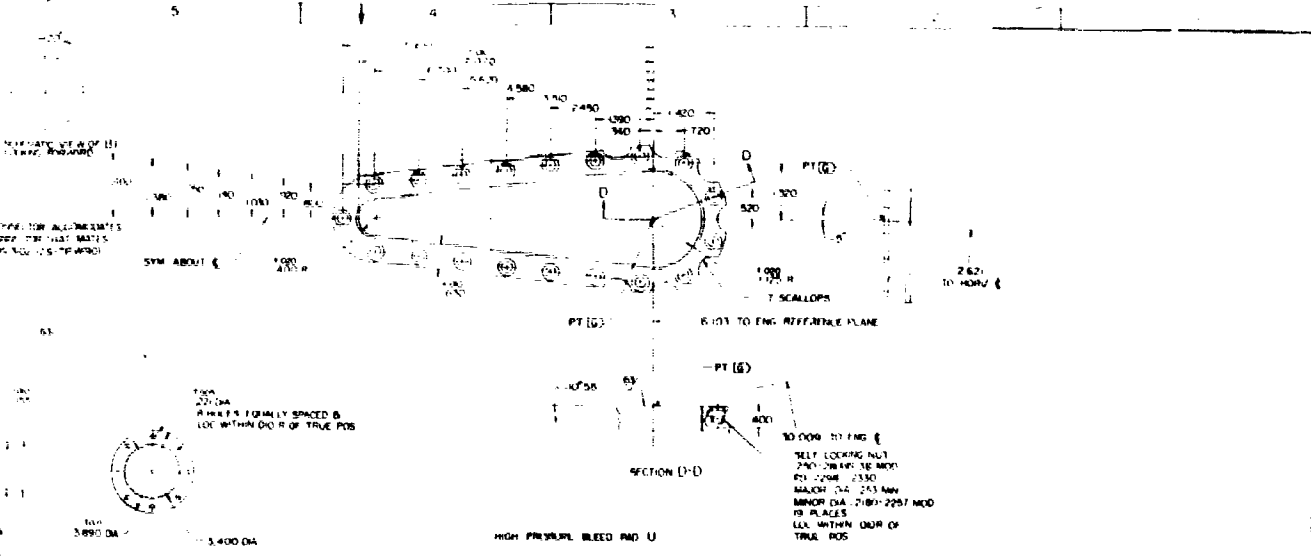

MAXIMUM ALLOWABLE LOADS FOR AIR BLEED PORTS

T TORQUE APPLIED TO BLEED PORT FLANGE  
 M AXIAL MOMENT APPLIED AT FLANGE +12.5V  
 MR CIRCULAR MOMENT APPLIED AT FLANGE +12.5V  
 V1, V2 AIR RES. SHEAR LOADS AT BLEED PORT FLANGES IN AXIAL AND VERTICAL DIRECTIONS RESPECTIVELY  
 P APPLIED TENSION LOAD  
 (THESE ARE TO BE USED AS POSITIVE VALUES)

LOADS	
M	513 LBF
MR	890 LBF
V1	343 LB
V2	172 LB
P	1.1 LB
T	330 LBF

CABIN AIR BLEED PORT (U)

LOADS	
M	893 LBF
MR	272 LBF
V1	570 LB
V2	285 LB
P	285 LB
T	547 LBF

#3 BRG VENT AIR PORT (SA)

LOADS	
M	70 LBF
MR	228 LBF
V1	273 LB
V2	345 LB
P	273 LB
T	928 LBF

#1 & 2 VENT AIR PORT (CBICH)

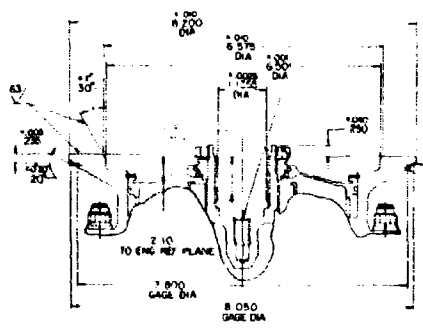

POWER TAKE OFF AND B  
 PER #5020 EXCEPT AS NOTED

SPEC. DIM.  
 NO. OF TEETH 24  
 DP 20/30  
 PRESSURE ANGLE 30°  
 EFFECTIVE CHORD 1.9942  
 LEADIN (L)  
 BASE DIA 1.08826  
 PD 1.200  
 FORM DIA 1.273  
 ROCT DIA 1.2881308  
 FILLET R .000 MIN

375 24 LWF 38 MOD  
 MAX DIA 3340 3413 MOD  
 MIN FULL THD .625

1.000 R  
 125 R

AUGUST 8, 1966

THIS DRAWING IS THE PROPERTY OF PRATT & WHITNEY AIRCRAFT COMPANY  
 IT IS TO BE USED ONLY FOR THE PURPOSES SPECIFIED IN THE ORDER  
 ANY REPRODUCTION OR USE OF THIS DRAWING WITHOUT THE WRITTEN PERMISSION OF PRATT & WHITNEY AIRCRAFT COMPANY IS STRICTLY PROHIBITED  
 THIS DRAWING IS THE PROPERTY OF PRATT & WHITNEY AIRCRAFT COMPANY

CONTROLLED  
 ENGINE INSTALLATION  
 (J717A) IN PRODUCTION  
 77443  
 2128101

4

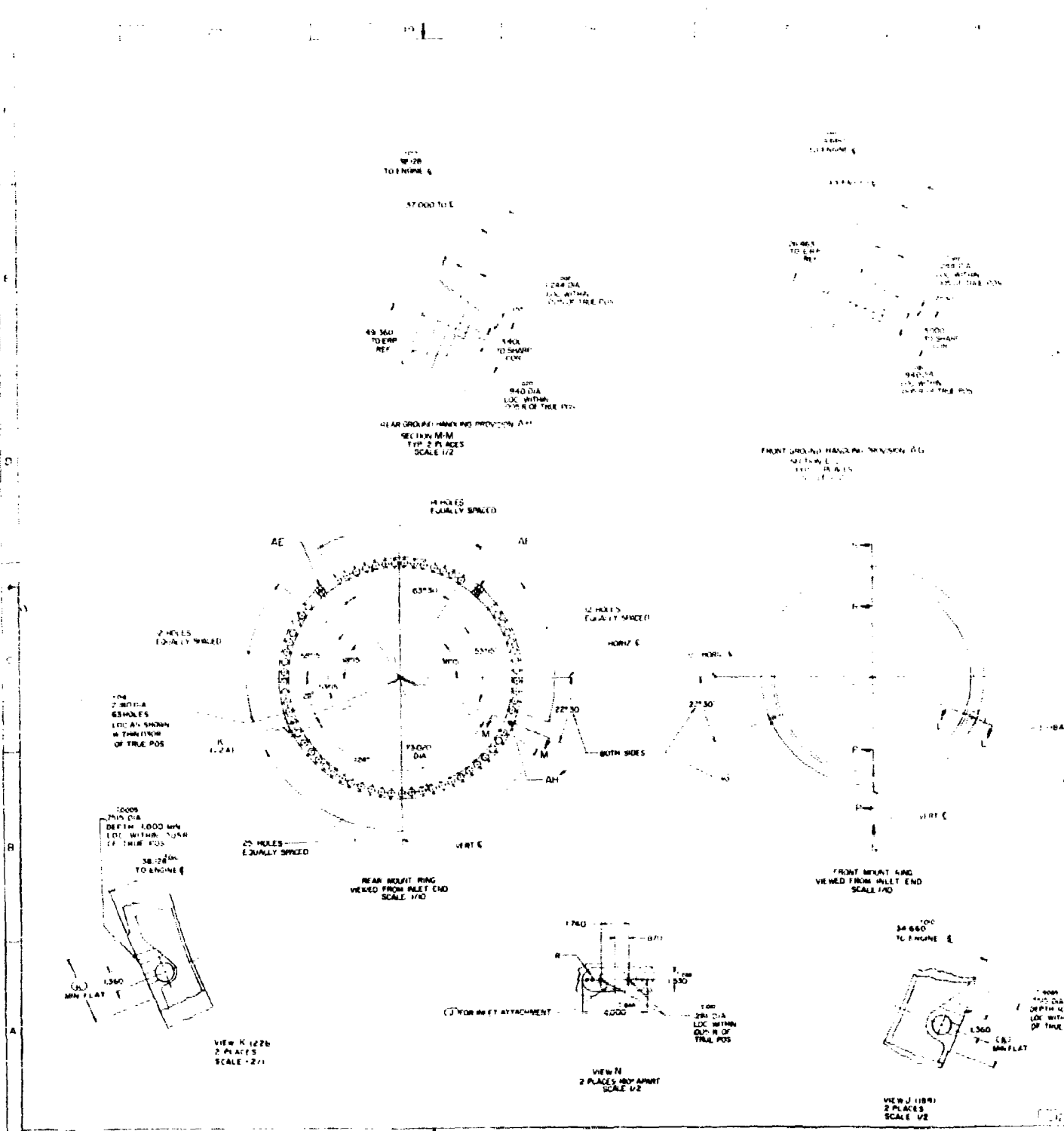
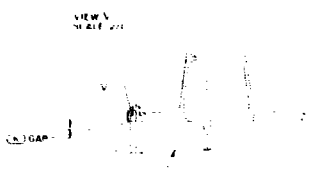
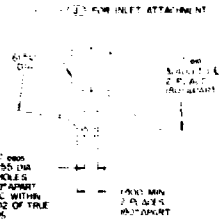

Figure 2. Engine Installation (Lockheed)  
Sheet 4 of 4





SECTION R  
SCALE 1/2



SECTION T  
SCALE 1/2

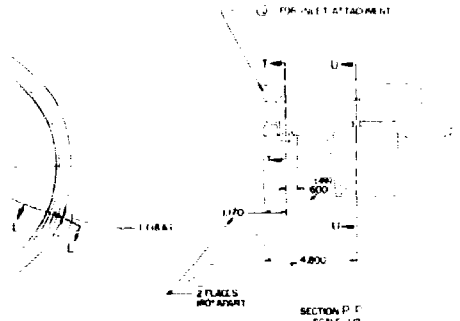

SECTION P  
SCALE 1/2

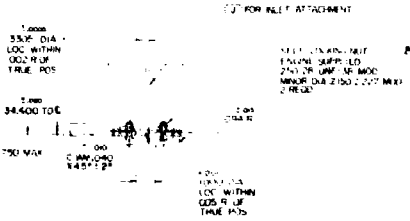

SECTION U-U  
SCALE 1/2



SECTION V-V  
SCALE 1/2



FUEL STRAINER (FUEL HEATER ZONE II) CL  
SCALE 1/2

2128101

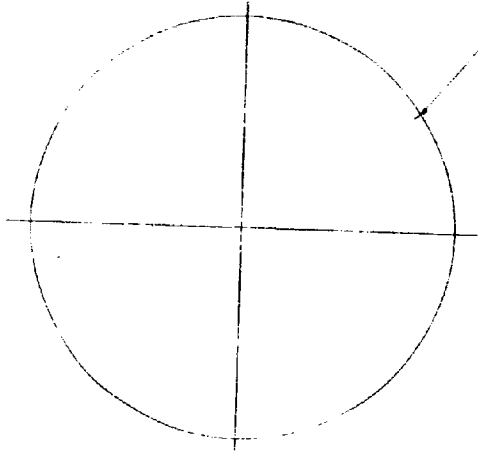

FLANGE C  
VIEWED FROM INLET END

BF  
(SPACE PROVIDED FOR  
VIBRATION PICK-UP (D))

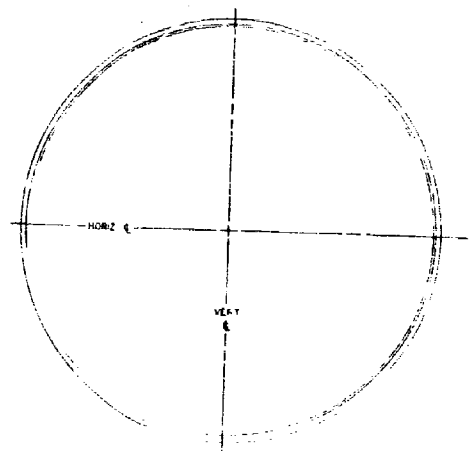

FLANGE A  
VIEWED FROM INLET END

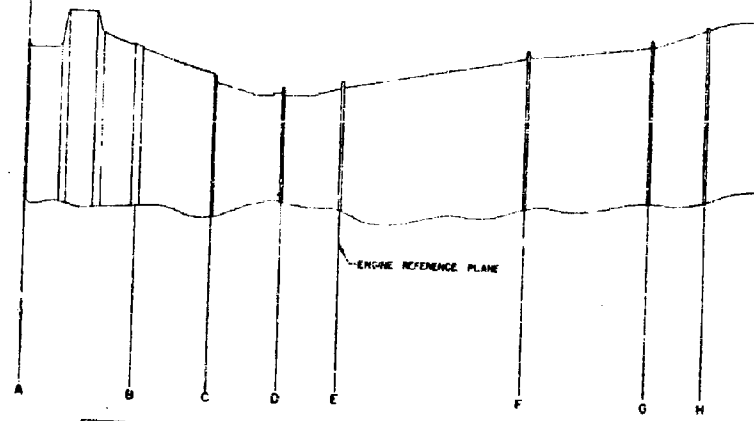
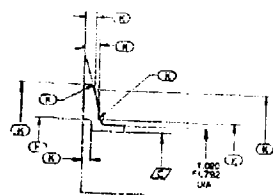
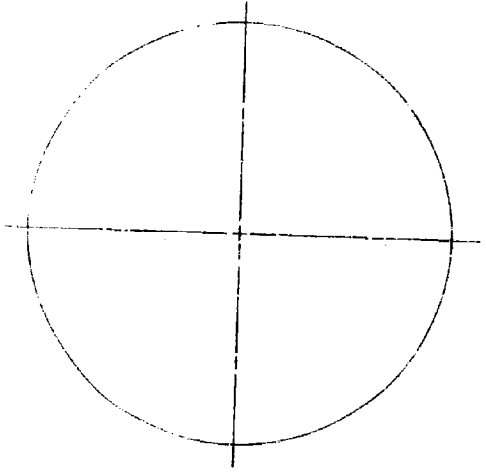

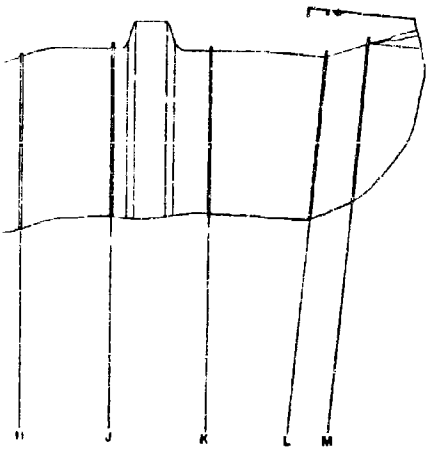
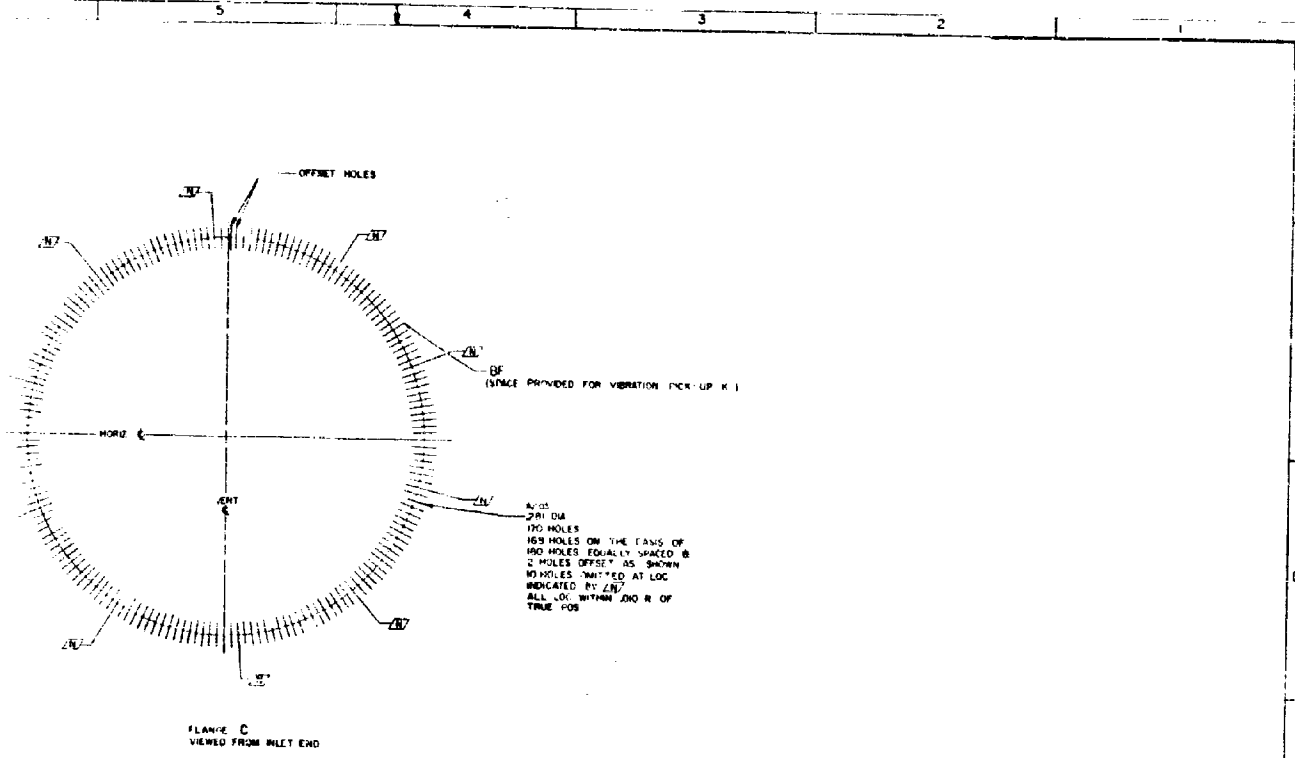

- ① - (X) INDICATES DETAILS TO BE COORDINATED WHERE IT IS DEEMED THAT PWA WILL NOT SUPPLY THE ENTIRE BRIT, BUT PROVISIONS MUST BE MADE FOR THE CUSTOMER TO ATTACH HIS PART TO THE BRIT. ONE OF THE FOLLOWING ALTERNATIVES MAY BE USED:
  - (a) A STUD BRIT MAY BE PROVIDED (DIMENSIONS OF A SIMILAR ADAPTER TO WHICH THE CUSTOMER MAY ATTACH HIS BRIT TO THE ADDED PARTS MAY BE PROVIDED, SUCH AS STUDS TO WHICH THE CUSTOMER PART MAY BE ASSEMBLED) PROVISIONS MAY BE MADE ON EXISTING PWA BRIT TO ENABLE THE CUSTOMER TO ATTACH HIS PART
  - (b) WHEN THE CUSTOMER BRIT REQUIREMENTS ARE PROVIDED, PWA WILL PERFORM A FIELD SURVEY, SHOWING ALL THE BRITS, WHEN APPROVED, THE INSTALLATION UWS WILL SHOW ALL THE BRITS PROVIDED FOR CUSTOMER USE, INCLUDING DIMENSIONING OF CERTAIN FEATURES
  - (c) SUCH AS HOLE LOCATIONS, SIZES, THREAD CALCULATIONS, ALLOWABLE LOAD AT CLAMPS, ETC.
  - (d) PWA DOES NOT PERMIT THE CUSTOMER TO REMOVE OR LOOSEN ENG BOLTS IN ORDER TO INSTALL BRITS OR OTHER HARDWARE PARTS. THE CUSTOMER SHALL BE PROVIDED WITH THE ENTIRE BRIT REGULAR WITH SUFFICIENT PROVISIONS FOR ATTACHING HIS PARTS WITHOUT DISTURBING THE BOLTED END ASSY.
  - (e) ALL ORG SHOWN ARE NONWELD, UNLESS OTHERWISE SPECIFIED
  - (f) ATTACHMENT FOR INSTALLATION BRITS
  - (g) DRAWING FOR TRUE POS OF FEATURES SHOWN ARE CENTERLINES OF CASE UNLESS OTHERWISE INDICATED
  - (h) UNLESS OTHERWISE INDICATED
  - (i) ASSEMBLE THESE BRITS WITH BEAD TOWARD REAR
  - (j) END END
  - (k) THESE BRITS ASSEMBLED ON REAR OF FLANGE

INDEX FOR INSTALLATION ENG  
 TYPICAL ENGINE INSTALLATION  
 SHEET 1 IN SIDE VIEW  
 SHEET 2 IN SIDE VIEW  
 SHEET 3 ADDITIONAL INFORMATION  
 SHEET 4 FLANGES, BRITS, & HOLES VIEW

2128101  
 SHEET 4

4

AUGUST 6, 1960

2128101  
 100-1

PRELIMINARY  
 SUBJECT  
 TO CHANGE

PRATT & WHITNEY AIRCRAFT  
 BRIT CONTROL

THIS DRAWING IS THE PROPERTY OF PRATT & WHITNEY AIRCRAFT. IT IS TO BE USED ONLY FOR THE PURPOSES SPECIFIED HEREIN. IT IS NOT TO BE REPRODUCED OR TRANSMITTED IN ANY FORM OR BY ANY MEANS, ELECTRONIC OR MECHANICAL, INCLUDING PHOTOCOPYING, RECORDING, OR BY ANY INFORMATION STORAGE AND RETRIEVAL SYSTEM, WITHOUT THE WRITTEN PERMISSION OF PRATT & WHITNEY AIRCRAFT.

DATE	BY	CHKD BY	APPROVED BY
10/15/60	J. W. M. / J. W. M.	J. W. M.	J. W. M.
ENGINE INSTALLATION			
PRATT & WHITNEY AIRCRAFT			
PRATT & WHITNEY AIRCRAFT	PRATT & WHITNEY AIRCRAFT	PRATT & WHITNEY AIRCRAFT	PRATT & WHITNEY AIRCRAFT
77440	2128101		

## Pratt & Whitney Aircraft

PWA FP 66-100

Volume III

duct strut extension or flow splitter to extend into and be attached to the engine inlet case. The provisions were requested to be compatible with the Lockheed airplane inlet system and consistent with Lockheed's experience. Engine development testing is required to confirm the merits of such a configuration and that such a system will not adversely affect compressor blade stress levels.

The connection to the Boeing inlet duct is accomplished with four pair of 2 bolt attaching points. While this design provides the maintenance feature specifically requested by Boeing, it will require a stiffer inlet case front flange to minimize leakage problems.

Matching the airframe inlet centerbody with the engine inlet case front bearing hub is required to provide a smooth airflow path to the engine compressor, although no mechanical connection is required.

### b. Front Mount (AD)

The front mount ring incorporates two mounting points located in the upper left and right quadrants of the engine. The systems are described in greater detail in paragraph C of this section. The design loads and method of loading are shown in the Loads Drawing, figure 3 for the Boeing B-2707 and figure 4 for the Lockheed L-2000. The engine mount structure, the materials selected, and the design practices used have been derived from years of experience with many successful commercial engine programs and Pratt & Whitney Aircraft's knowledge of high Mach number environment obtained through the J58 program.

### c. Rear Mount (AE)

The rear mount ring incorporates two mounting lugs located in the upper right and left quadrants of the engine. The design loads and method of loading are described in the Loads Drawing. The details of the systems are described further in paragraph C of this section.

### d. Reverser-Suppressor Shroud

The forward face on the nacelle mating flange of the reverser-suppressor consists of a bolt flange for attachment of the airframe nacelle cowl seal. It is located (behind the rear mount ring) approximately 18 inches for Boeing and 10 inches for Lockheed. The specific configuration of the flange was coordinated with the airframe manufacturers. The mating dimensional requirements and load limitations for the flange are given on the Installation Drawing. The specific requirements and description of the reverser-suppressor as requested by the airframe manufacturers are described further in paragraph C of this section.

**FLIGHT FRONT MOUNT DATA**  
 SCHEMATIC REAR VIEW OF FRONT MOUNT  
 DIRECTION OF LOADS POSITIVE AS SHOWN, NEGATIVE IN OPPOSITE DIRECTION

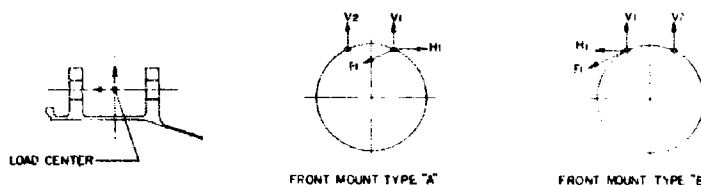

DEFINITIONS FOR EACH MOUNT TYPE:  
 F1=AXIAL LOAD ACTING AS SHOWN ON FRONT MOUNT ATTACHMENT  
 H1=HORIZONTAL LOAD ACTING AS SHOWN ON FRONT MOUNT ATTACHMENT  
 V1=VERTICAL LOAD ACTING AS SHOWN ON FRONT MOUNT ATTACHMENT

LOADS BASED ON THE FOLLOWING CONDITIONS:  
 1. LOADS (H1, F1, V1, H2, V2) ACTING ON FRONT MOUNT MUST BE APPLIED UNIFORMLY ON SURFACES AS SHOWN WITH LOAD CENTER LOCATED AT A RADIAL DISTANCE FROM ENGINE C.G. OF 34.320±0.050 R

THE ALLOWABLE LIMIT LOADS FOR EACH FRONT MOUNT ATTACHMENT SATISFY ALL VALUES GIVEN BELOW. THESE LOADS REPRESENT THE MAXIMUM LOADS AT EACH LOCATION AND DO NOT OCCUR SIMULTANEOUSLY

- 1. V1: 91,000 LBS
- 2. H1: 114,000 LBS
- 3. F1: 41,000
- 4. V2: 122,000 LBS

**SHIPPING & GROUND HANDLING FRONT MOUNT DATA**  
 SCHEMATIC REAR VIEW OF FRONT MOUNT WITH DIRECTION OF LOADS POSITIVE AS SHOWN  
 NEGATIVE IN OPPOSITE DIRECTION. AXIAL LOADS ARE POSITIVE TO REAR

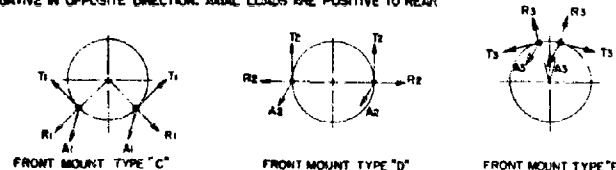

DEFINITIONS FOR EACH MOUNT TYPE:  
 T1=TANGENTIAL LOAD ACTING ON FRONT MOUNT GROUND HANDLING ATTACHMENT  
 T2=TANGENTIAL LOAD ACTING ON FRONT MOUNT GROUND HANDLING ATTACHMENT  
 A1=AXIAL LOAD ACTING ON FRONT MOUNT GROUND HANDLING ATTACHMENT WITH NO OVERTURNING MOMENT  
 R1=RADIAL GROUND HANDLING & SHIPPING LOAD ACTING ON EITHER FRONT FLIGHT ATTACHMENT  
 T3=TANGENTIAL GROUND HANDLING & SHIPPING LOAD ACTING ON EITHER FRONT FLIGHT ATTACHMENT  
 A3=AXIAL GROUND HANDLING & SHIPPING LOAD ACTING ON EITHER FRONT FLIGHT ATTACHMENT APPLIED WITH NO OVERTURNING MOMENT

THE GROUND HANDLING & SHIPPING ALLOWABLE LIMIT LOADS FOR FRONT MOUNT ATTACHMENT MUST SATISFY ALL VALUES GIVEN BELOW. THESE LOADS REPRESENT THE MAXIMUM LOADS AT EACH LOCATION AND DO NOT OCCUR SIMULTANEOUSLY

- |                  |                  |                  |
|------------------|------------------|------------------|
| 1. T1: 4,140 (K) | 4. R1: 6,140 (K) | 7. T3: 7,140 (K) |
| 2. T2: 5,140 (K) | 5. T2: 8,140 (K) | 8. T3: 8,140 (K) |
| 3. A1: 3,140 (K) | 6. A2: 6,140 (K) | 9. A3: 5,140 (K) |

**FLIGHT REAR MOUNT**  
 SCHEMATIC REAR VIEW OF  
 DIRECTION OF LOADS POSITIVE AS SHOWN



DEFINITIONS FOR EACH MOUNT TYPE:  
 LINKAGES (SUPPLIED BY CUSTOMER) TO MAIN STRUCTURE MUST HAVE ADEQUATE ALLOWABLE STRESS AS SHOWN ON INSTALLATION DRAWING  
 A4=AXIAL LOAD ACTING AS SHOWN ON INSTALLATION DRAWING  
 APPLIED AT C.G. OF MOUNT HOLE AT ENGINE CENTER OF GRAVITY  
 H2=TANGENTIAL LOAD ACTING ON REAR MOUNT ATTACHMENT  
 V2=VERTICAL LOAD ACTING ON REAR MOUNT ATTACHMENT

THE ALLOWABLE LIMIT LOADS FOR REAR MOUNT ATTACHMENT MUST SATISFY ALL VALUES GIVEN BELOW. THESE LOADS REPRESENT THE MAXIMUM LOADS AT EACH LOCATION AND DO NOT OCCUR SIMULTANEOUSLY

- 1. V2: 66,500 LBS
- 2. H2: 22,500 LBS

**SHIPPING & GROUND HANDLING REAR MOUNT DATA**  
 SCHEMATIC REAR VIEW OF REAR MOUNT WITH DIRECTION OF LOADS POSITIVE AS SHOWN  
 NEGATIVE IN OPPOSITE DIRECTION. AXIAL LOADS ARE POSITIVE TO REAR



DEFINITIONS FOR EACH MOUNT TYPE:  
 A4=AXIAL LOAD ACTING ON EITHER FRONT OR REAR MOUNT ATTACHMENT  
 T4=TANGENTIAL LOAD ACTING ON EITHER FRONT OR REAR MOUNT ATTACHMENT  
 R4=AXIAL GROUND HANDLING & SHIPPING LOAD ACTING ON EITHER FRONT OR REAR MOUNT ATTACHMENT APPLIED AT C.G. OF HOLE TO BE TAKEN BY SINGLE FLANGE  
 T5=TANGENTIAL GROUND HANDLING & SHIPPING LOAD ACTING ON EITHER FRONT OR REAR MOUNT ATTACHMENT (BOTH FLANGES)  
 R5=AXIAL GROUND HANDLING & SHIPPING LOAD ACTING ON EITHER FRONT OR REAR MOUNT ATTACHMENT (BOTH FLANGES)  
 THE GROUND HANDLING & SHIPPING ALLOWABLE LIMIT LOADS FOR FRONT MOUNT ATTACHMENT MUST SATISFY ALL VALUES GIVEN BELOW. THESE LOADS REPRESENT THE MAXIMUM LOADS AT EACH LOCATION AND DO NOT OCCUR SIMULTANEOUSLY

- |                  |                  |
|------------------|------------------|
| 1. T4: 4,140 (K) | 4. R4: 6,140 (K) |
| 2. T5: 5,140 (K) | 5. T5: 8,140 (K) |
| 3. R4: 3,140 (K) | 6. R4: 6,140 (K) |

(K) VALUES TO BE CHECKED

Figure 3. Load Installation, Allowable Flight

**FLIGHT REAR MOUNT DATA**  
 SCHEMATIC REAR VIEW OF REAR MOUNT  
 DIRECTION OF LOADS POSITIVE AS SHOWN, NEGATIVE IN OPPOSITE DIRECTION



DEFINITIONS FOR EACH MOUNT TYPE:  
 LINKAGES SUPPLIED BY CUSTOMER TO HAVE ATTACHMENT LOCATED AT R(1,2)  
 LINKAGE MUST HAVE ADEQUATE ALLOWANCE FOR ENGINE THERMAL EXPANSIONS  
 AS SHOWN ON INSTALLATION DRAWING  
 Aa=AXIAL LOAD ACTING AS SHOWN ON REAR MOUNT ATTACHMENT  
 APPLIED AT E OF MOUNT HOLE AT ENGINE MOUNT RING  
 H2=TANGENTIAL LOAD ACTING ON REAR MOUNT LINKAGE ATTACHMENT  
 V2=VERTICAL LOAD ACTING ON REAR MOUNT LINKAGE ATTACHMENT

THE ALLOWABLE LIMIT LOADS FOR REAR MOUNT ATTACHMENT MUST SATISFY  
 ALL VALUES GIVEN BELOW THESE LOADS REPRESENT THE MAXIMUM  
 LOADS AT EACH LOCATION AND DO NOT OCCUR SIMULTANEOUSLY  
 1.1a11 66,500 LBS 2.1a11 22,500 LBS 3.1a11 (C)

**SHIPPING & GROUND HANDLING REAR MOUNT DATA**  
 SCHEMATIC REAR VIEW OF REAR MOUNT WITH DIRECTION OF LOADS POSITIVE AS SHOWN  
 NEGATIVE IN OPPOSITE DIRECTION AXIAL LOADS ARE POSITIVE TO THE REAR

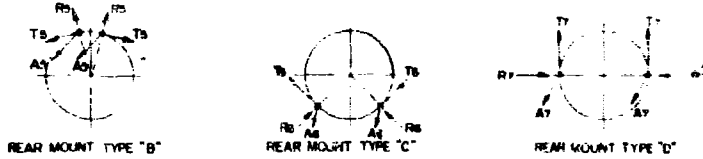

DEFINITIONS FOR EACH MOUNT TYPE:  
 Aa=AXIAL LOAD ACTING ON EITHER REAR MOUNT GROUND HANDLING  
 T2=TANGENTIAL LOAD ACTING ON EITHER REAR MOUNT GROUND HANDLING ATTACHMENT  
 R2=AXIAL LOAD ACTING ON EITHER REAR MOUNT GROUND HANDLING ATTACHMENT  
 As=AXIAL GROUND HANDLING & SHIPPING LOAD ACTING ON EITHER REAR FLIGHT  
 ATTACHMENT APPLIED AT E OF HOLE WITH NO OVERTURNING MOMENT (LOAD  
 TO BE TAKEN BY SINGLE FLANGE)  
 Ts=TANGENTIAL GROUND HANDLING & SHIPPING LOAD ACTING ON EITHER REAR  
 FLIGHT ATTACHMENT (BOTH FLANGES)  
 Rb=RADIAL GROUND HANDLING & SHIPPING LOAD ACTING ON EITHER REAR  
 FLIGHT ATTACHMENT (BOTH FLANGES)

THE GROUND HANDLING & SHIPPING ALLOWABLE LIMIT LOADS FOR REAR MOUNT  
 ATTACHMENT MUST SATISFY ALL EQUATIONS GIVEN BELOW THESE LOADS  
 REPRESENT THE MAXIMUM LOADS AT EACH LOCATION AND DO NOT OCCUR  
 SIMULTANEOUSLY

- |             |             |             |
|-------------|-------------|-------------|
| 1.1a11 (C)  | 4.1a11 (C)  | 7.1a11 (C)  |
| 2.11a11 (C) | 5.11a11 (C) | 8.11a11 (C) |
| 3.1a11 (C)  | 6.1a11 (C)  | 9.11a11 (C) |

(C) VALUES TO BE COORDINATED

2128091

AUGUST 8, 1966

2128091

PRELIMINARY  
 SUBJECT  
 TO CHANGE  
 PRATT & WHITNEY AIRCRAFT  
 CONTROLLED

NOTE TO ALL PERSONS RECEIVING THIS DRAWING

THIS DRAWING IS THE PROPERTY OF PRATT & WHITNEY AIRCRAFT COMPANY. IT IS TO BE USED ONLY FOR THE PURPOSES AUTHORIZED BY THE COMPANY. IT IS NOT TO BE REPRODUCED OR TRANSMITTED IN ANY FORM OR BY ANY MEANS, ELECTRONIC OR MECHANICAL, INCLUDING PHOTOCOPYING, RECORDING, OR BY ANY INFORMATION STORAGE AND RETRIEVAL SYSTEM, WITHOUT THE WRITTEN PERMISSION OF PRATT & WHITNEY AIRCRAFT COMPANY.

PRATT & WHITNEY AIRCRAFT COMPANY	Pratt & Whitney Aircraft	Division of	Pratt & Whitney Aircraft
2128091	2128091	LOAD INSTALLATION	ALLOWABLE FLIGHT, SHIPPING & GROUND HANDLING (AT F17A-218 PRODUCTION)
PRATT & WHITNEY AIRCRAFT COMPANY	FA-35-GE-8	DATE DESIGNED	7/14/65
PRATT & WHITNEY AIRCRAFT	2128091	DESIGNED BY	2128091
		SCALE (NONE)	





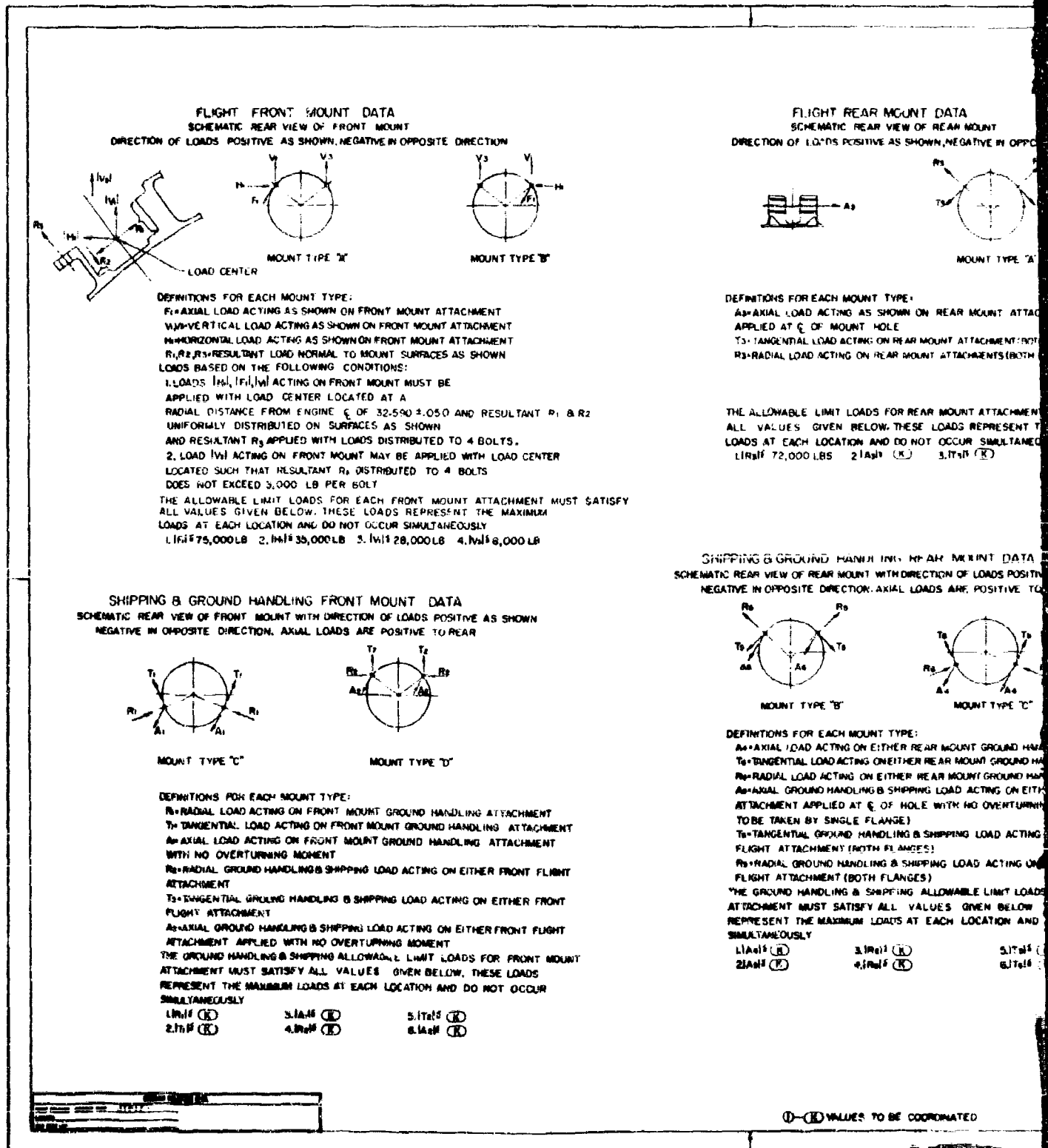
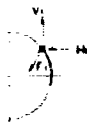

Figure 4. Load Installation, Allowable Flight

## FLIGHT REAR MOUNT DATA

## SCHEMATIC REAR VIEW OF REAR MOUNT

DIRECTION OF LOADS POSITIVE AS SHOWN, NEGATIVE IN OPPOSITE DIRECTION



TYPE "B"

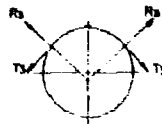
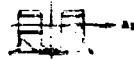

MOUNT TYPE "A"

## DEFINITIONS FOR EACH MOUNT TYPE:

- A<sub>2</sub>-AXIAL LOAD ACTING AS SHOWN ON REAR MOUNT ATTACHMENT  
 APPLIED AT  $\bar{c}$  OF MOUNT HOLE  
 T<sub>2</sub>-TANGENTIAL LOAD ACTING ON REAR MOUNT ATTACHMENT (BOTH FLANGES)  
 R<sub>2</sub>-RADIAL LOAD ACTING ON REAR MOUNT ATTACHMENTS (BOTH FLANGES)

THE ALLOWABLE LIMIT LOADS FOR REAR MOUNT ATTACHMENT MUST SATISFY  
 ALL VALUES GIVEN BELOW. THESE LOADS REPRESENT THE MAXIMUM  
 LOADS AT EACH LOCATION AND DO NOT OCCUR SIMULTANEOUSLY  
 LIMITS: 72,000 LBS 2.1A<sub>2</sub> (K) 3.1T<sub>2</sub> (K)

MOUNT TYPE "B" & R<sub>2</sub>

MOUNT TYPE "A"

MOUNT TYPE "B" MUST SATISFY  
MAXIMUM

MOUNT TYPE "A"

MOUNT TYPE "B"

SHIPPING & GROUND HANDLING REAR MOUNT DATA  
 SCHEMATIC REAR VIEW OF REAR MOUNT WITH DIRECTION OF LOADS POSITIVE AS SHOWN,  
 NEGATIVE IN OPPOSITE DIRECTION. AXIAL LOADS ARE POSITIVE TO THE REAR



MOUNT TYPE "B"



MOUNT TYPE "C"

## DEFINITIONS FOR EACH MOUNT TYPE:

- A<sub>4</sub>-AXIAL LOAD ACTING ON EITHER REAR MOUNT GROUND HANDLING ATTACHMENT  
 T<sub>4</sub>-TANGENTIAL LOAD ACTING ON EITHER REAR MOUNT GROUND HANDLING ATTACHMENT  
 R<sub>4</sub>-RADIAL LOAD ACTING ON EITHER REAR MOUNT GROUND HANDLING ATTACHMENT  
 A<sub>6</sub>-AXIAL GROUND HANDLING & SHIPPING LOAD ACTING ON EITHER REAR FLIGHT  
 ATTACHMENT APPLIED AT  $\bar{c}$  OF HOLE WITH NO OVERTURNING MOMENT (LOAD  
 TO BE TAKEN BY SINGLE FLANGE)  
 T<sub>6</sub>-TANGENTIAL GROUND HANDLING & SHIPPING LOAD ACTING ON EITHER REAR  
 FLIGHT ATTACHMENT (BOTH FLANGES)  
 R<sub>6</sub>-RADIAL GROUND HANDLING & SHIPPING LOAD ACTING ON EITHER REAR  
 FLIGHT ATTACHMENT (BOTH FLANGES)

THE GROUND HANDLING & SHIPPING ALLOWABLE LIMIT LOADS FOR REAR MOUNT  
 ATTACHMENT MUST SATISFY ALL VALUES GIVEN BELOW. THESE LOADS  
 REPRESENT THE MAXIMUM LOADS AT EACH LOCATION AND DO NOT OCCUR  
 SIMULTANEOUSLY

1.1A<sub>4</sub> (K) 3.1R<sub>4</sub> (K) 5.1T<sub>4</sub> (K)  
 2.1A<sub>6</sub> (K) 4.1R<sub>6</sub> (K) 6.1T<sub>6</sub> (K)

MOUNT TYPE "B"

MOUNT TYPE "C"

MOUNT TYPE "B"

MOUNT TYPE "C"

MOUNT TYPE "B"

MOUNT TYPE "C"

MOUNT TYPE "B"

MOUNT TYPE "C"

MOUNT TYPE "B"

MOUNT TYPE "C"

MOUNT TYPE "B"

MOUNT TYPE "C"

①-(K) VALUES TO BE COORDINATED

2128090

AUG 8, 1966

2128090

PRELIMINARY  
 SUBJECT  
 TO CHANGE  
 PRATT & WHITNEY AIRCRAFT  
 CONTROLLED DRAWING

NOTICE TO ALL PERSONS RECEIVING THIS DRAWING:  
 THIS DRAWING IS THE PROPERTY OF PRATT & WHITNEY AIRCRAFT COMPANY. IT IS TO BE USED ONLY FOR THE PURPOSES AUTHORIZED BY THE COMPANY. IT IS TO BE KEPT IN A SAFE PLACE AND NOT TO BE LOANED, REPRODUCED, COPIED, OR IN ANY MANNER DISSEMINATED TO ANY OTHER PERSON OR ORGANIZATION WITHOUT THE WRITTEN PERMISSION OF THE COMPANY. THE COMPANY ASSUMES NO LIABILITY FOR LOSS OF OR DAMAGE TO THIS DRAWING. THE COMPANY WILL NOT BE RESPONSIBLE FOR ANY LOSS OF OR DAMAGE TO THIS DRAWING. THE COMPANY WILL NOT BE RESPONSIBLE FOR ANY LOSS OF OR DAMAGE TO THIS DRAWING.

DATE	REVISED	BY	REASON
10-15-66	1	J. C. S. / J. S. W.	LOAD INSTALLATION - ALLOWABLE FLIGHT, SHIPPING & GROUND HANDLING (17717A-21L PRODUCTION)
APPROVED UNDER CONTROL PA-50-65-5	DATE PAID 77945	REV F	2128090
PREPARED UNDER CONTROL	SCALE NONE	DRAWN BY	CHECKED BY

## 2. Accessory Drive System

### a. Power Takeoffs (A) (B)

The power takeoff (PTO) gearbox and drive pad connection provided for driving airframe accessories and for starting the engine is located at the top of the engine. The drive pad connection can be oriented in the direction required to match the location of the airframe supplied drive shafts as coordinated to meet the airframe manufacturer requirements. The Boeing connection is on the top of the gearbox. The PTO for Lockheed can be ground installed for either a left- or right-side connection.

For Lockheed only, an additional power takeoff-environmental control system drive pad (B) is located on the lower right side of the engine for driving the airplane environmental control system air compressor.

Drive attachment requirements and horsepower extraction, torque, and moment limitations are tabulated on the Installation Drawing.

The J58 high Mach number experience for power takeoff gearbox design, gear trains, and lubrication has been used extensively in the design of the power takeoff gearbox drives and accessory drives.

### b. Accessory Drives (R)(S)

For Boeing only, two additional accessory drive pads are provided on the engine power takeoff gearbox for direct mounting of two airplane system hydraulic pumps. The location, configuration, and horsepower extraction requirements for the design of the gearbox were coordinated with Boeing. Drive pad requirements; spline definition; and horsepower, torque, and moment limitations are tabulated on the Installation Drawing.

### c. Power Takeoff Decoupler Actuation (BV)

An electrically-actuated power takeoff drive shaft decoupler is provided to permit in-flight or ground decoupling of the airplane remote gearbox drive system. The system permits decoupling in the event of an airplane accessory failure so that the engine can continue in operation. Only ground recoupling with a static engine is possible. The electrical connection description is located in figure 5. This provision is currently shown only on the Lockheed engine.

## 3. Fuel System

### a. Fuel Inlet (F1)

A common fuel inlet to the main and duct heater fuel pumps is provided on the upper right side of the engine for Boeing and on the left side for Lockheed. The Boeing inlet flange connection is of the bolted flange type with a conical metal seal. Lockheed requested and coordinated a special Marman Clamp, Conoseal type flange for their requirements with sealing configuration to be established.

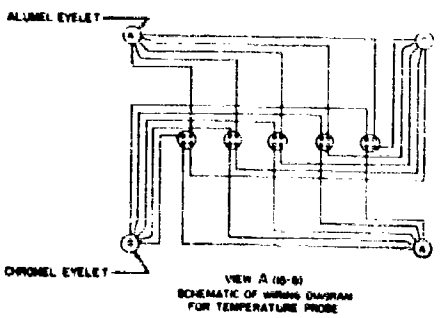
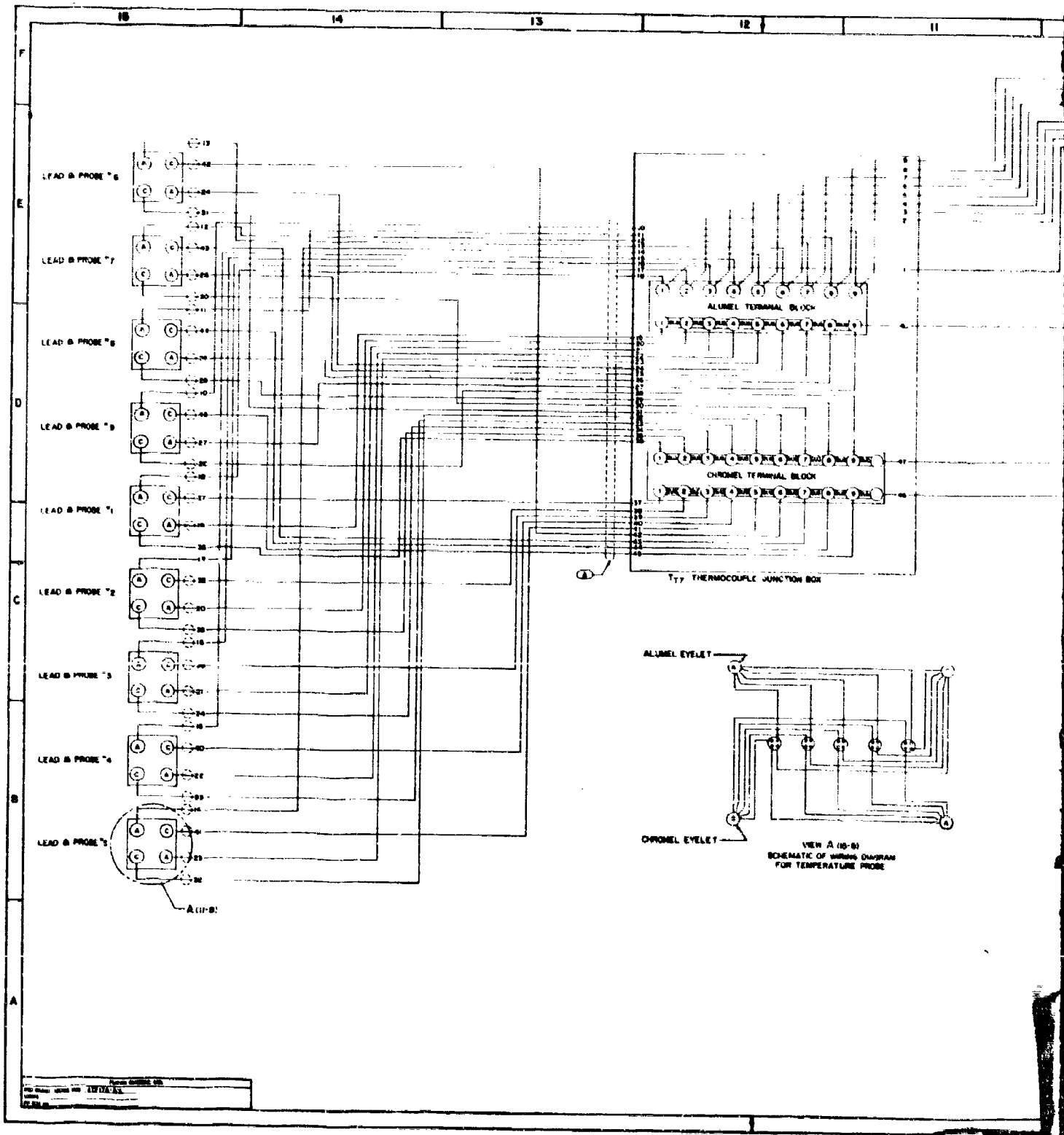

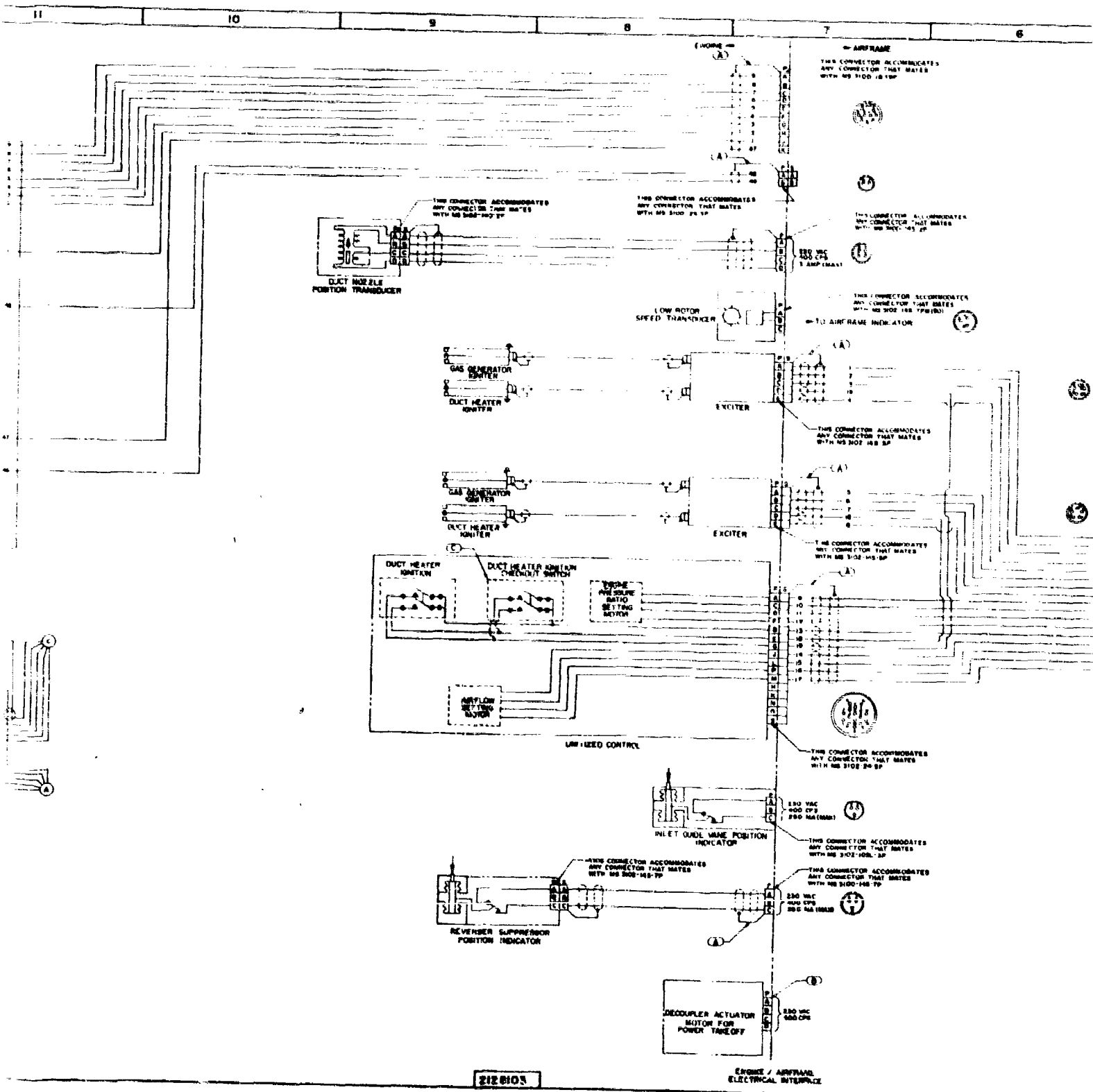

2121013

ENGINE / AIRFRAME ELECTRICAL INTERFACE

**Pratt & Whitney Aircraft**

PWA FP 66-100

Volume III

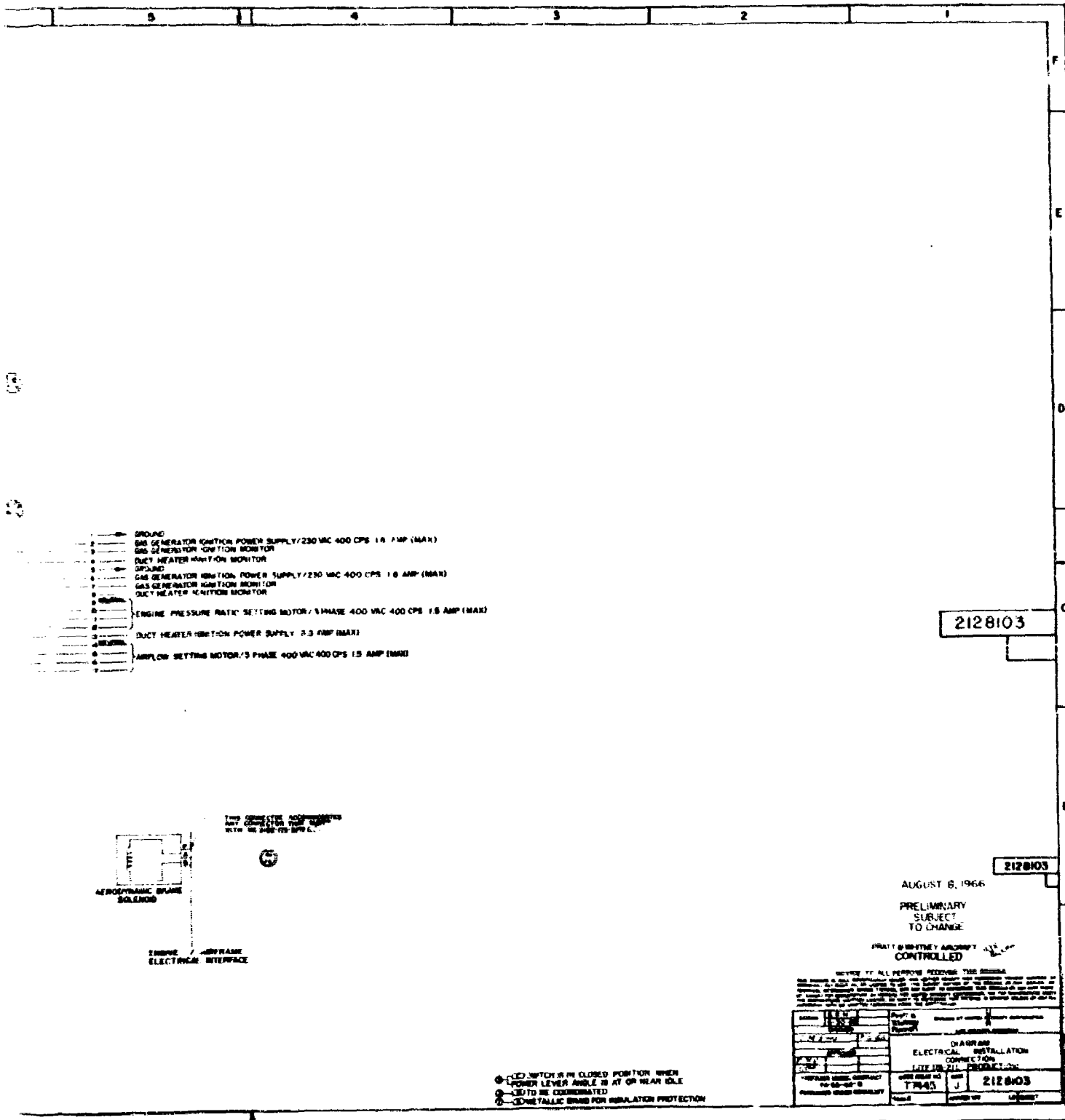

- 1 → GROUND
- 2 → GAS GENERATOR IGNITION POWER SUPPLY / 230 VAC 400 CPS 1.5 AMP (MAX)
- 3 → GAS GENERATOR IGNITION MONITOR
- 4 → DUCT HEATER IGNITION MONITOR
- 5 → GROUND
- 6 → GAS GENERATOR IGNITION POWER SUPPLY / 230 VAC 400 CPS 1.5 AMP (MAX)
- 7 → GAS GENERATOR IGNITION MONITOR
- 8 → DUCT HEATER IGNITION MONITOR
- 9 → GROUND
- 10 → ENGINE PRESSURE RATIO SETTING MOTOR / 3 PHASE 400 VAC 400 CPS 1.5 AMP (MAX)
- 11 → GROUND
- 12 → DUCT HEATER IGNITION POWER SUPPLY 3.3 AMP (MAX)
- 13 → GROUND
- 14 → AIRFLOW SETTING MOTOR / 3 PHASE 400 VAC 400 CPS 1.5 AMP (MAX)

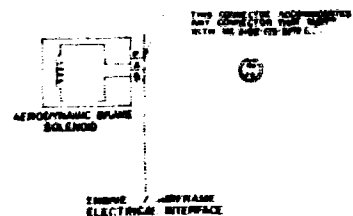

2128103

2128103

AUGUST 8, 1966

PRELIMINARY  
SUBJECT  
TO CHANGE

PRATT & WHITNEY AIRCRAFT  
CONTROLLED

NOTICE TO ALL PERSONS RECEIVING THIS DRAWING: THIS DRAWING IS THE PROPERTY OF PRATT & WHITNEY AIRCRAFT. IT IS TO BE USED ONLY FOR THE PURPOSES AND IN THE MANNER SPECIFIED HEREIN. IT IS NOT TO BE REPRODUCED, COPIED, OR TRANSMITTED IN ANY FORM OR BY ANY MEANS, ELECTRONIC OR MECHANICAL, INCLUDING PHOTOCOPYING, RECORDING, OR BY ANY INFORMATION STORAGE AND RETRIEVAL SYSTEM, WITHOUT THE WRITTEN PERMISSION OF PRATT & WHITNEY AIRCRAFT.

DATE	REV	BY	CHKD	APP'D
10/1/66	1	J	J	J
DRAWING NO.		2128103		
REV. NO.		1		
REV. DATE		10/1/66		
REV. BY		J		
REV. CHKD		J		
REV. APP'D		J		

- ① - LED SWITCH IN THE CLOSED POSITION WHEN POWER LEVER ANGLE IS AT OR NEAR IDLE
- ② - LED TO BE COORDINATED
- ③ - CONDUCTIVE BRIMS FOR INSULATION PROTECTION

2128103

DI



## Pratt & Whitney Aircraft

PWA FP 66-100

Volume III

The additional inlet lines for a common fuel inlet connection are provided as optional equipment as requested by and coordinated with the airframe manufacturers.

### b. Fuel Return to Airframe (AF)

Fuel is returned to the airplane from the engine fuel control during engine windmilling operation or when the fuel inlet temperature is high enough so that the added oil and accessory cooling load of the fuel system results in reaching the fuel system temperature limit. Details of the fuel control system are given in Volume III, Report B. Provisions are made to permit a minimum fuel flow in the return line at all operating conditions to cool the fuel return line and prevent the formation of coke.

### c. Fuel Pump Outlet Vent (FV2)

For fuel pump venting, a threaded connection with seal provisions is located at the fuel pump discharge boss. Venting of the fuel pump will expedite the pump recovery following component replacement or in the event the airplane fuel tank to engine line inadvertently becomes air locked.

### d. Fuel Drains

Fuel drains are located at the low point of each of the following fuel system components to allow fuel drainage overboard for safety and cleanliness:

1. Combustion chamber - gas generator
2. Fuel manifold drain valves - gas generator, duct heater Zone I and II.

All drain points have threaded connections with seal provisions and have been sized for engine shutdown fuel drain flows. For Lockheed these fuel drain locations (FD1, FD4, FD18, FD18A) are shown on the installation drawing and the expected drain quantities have been coordinated. For Boeing the fuel drains are connected to an engine supplied drain tank.

### e. Engine Fuel Power Control (AJ)

The engine fuel control and fuel system concept and functions are described in Volume III, Report B. Only the interface requirements are considered in this section. The rapid removal unitized control concept incorporates a universal type coupling between the control shaft and an engine mounted drive. For the Lockheed installation, the fuel control thrust settings are accomplished by an airframe-supplied electrical drive. The drive is located aft of the unitized fuel control on the left side of the engine and is connected to the control through a splined shaft and pulley system. Fuel control settings and allowable installation loads for the drive attachment to the shaft are shown on the Installation Drawing.

## Pratt & Whitney Aircraft

PWA F/ 36-100

Volume III

A different power control system was coordinated for the Boeing installation. Boeing required a mechanically actuated fuel control rack-and-pinion shaft with a maximum of 5 inches of stroke travel. The attachment is adjacent to the unitized fuel control on the upper left side of the engine. The attachment requirements and load limitations are on the Installation Drawing.

### f. Engine Fuel Shutoff Control (AK)

A detail description of the configuration and functions of the fuel shutoff control are presented in Volume III, Report B.

The fuel control shutoff system for the Lockheed installation consists of an airframe-supplied electrical drive system mounted directly on the front face of the fuel control.

An engine mounted shutoff control splined shaft located on the forward side of the unitized fuel control has been provided for Boeing. Mechanical actuation has been coordinated with Boeing for the fuel shutoff control.

### 4. Oil System

#### a. Oil Breather (LB2)

The breather pressurizing valve mounted on the engine main gearbox provides pressurizing and venting of the engine oil system. Pressurization of a fixed absolute and delta pressure is controlled by an aneroid valve system and a relief valve. For Lockheed, overboard breather venting from the deoiler is accomplished through the breather pressurizing valve by connecting to a four-stud flange with a metal seal. Allowable loads are shown on the Installation Drawing. For Boeing, overboard breather venting is accomplished by an engine supplied vent pipe to the reverser-suppressor cowl.

#### b. Oil Tank Inlet (L2)

The oil tank fill port is located on the upper portion of the oil tank on the right side of the engine. A dipstick is attached to the cap as a means for determining the oil level.

A separate remote oil filling system connection with seal provisions is provided on the aft side of the oil tank as requested by Boeing.

#### c. Oil Tank Overflow

For Boeing, oil tank overflow connections for the manual and remote fill (LD2) systems have been provided at the bottom of the tank. The manual fill drain system is routed to an engine supplied drain tank, while the remote fill drain connection is made by a two-bolt flange with an "O" ring. For Lockheed, an oil tank overflow connection for the manual fill (LD3) system has been provided at the bottom of the tank as a two-bolt flange with an "O" ring seal. Use of the overflow provisions with overboard drains will ensure that engine oil does not drip on the engine or nacelle.



d. Oil Drains (LD1)

A manual drain valve is provided at the lowest point of the oil tank to permit oil tank draining. A threaded connection is provided on the valve to permit the attachment of an overboard drain line.

Threaded plugs are located at low points of each of the following components to provide means for draining engine oil for maintenance purposes:

1. Main gearbox
2. Oil pump strainer
3. Oil pump gearbox
4. No. 1 and 2 bearing and seal compartment sump.

All connector sizes and locations have been coordinated with the airframe manufacturers and are shown on the Installation Drawing.

e. Seal Drains

Overboard seal drain provisions at the seal cavities of each of the following components are provided to facilitate seal drainage overboard for engine safety, maintenance, and cleanliness:

1. Unitized fuel control drive
2. Main fuel pump accessory drive
3. Hydraulic pump and hydraulic pump accessory drive pad
4. Duct heater fuel pump
5. Duct heater pump controller
6. Aerodynamic brake actuator
7. Secondary air valve actuators (Boeing only)
8. Environmental control system power takeoff (Lockheed only)
9. Tachometer generator accessory drive
10. P.T.O. accessory drive
11. Hydraulic pump PTO pads (Boeing only).

The attachment requirements for Lockheed have been coordinated and are shown on the Installation Drawing. For Boeing these drains are connected to an engine supplied drain tank.

f. No. 1, 2, and 3 Bearing Seal Vents (CG) (CH) (CJ) (BA)

Venting of the bearing compartment labyrinth back-up seals to ambient is required as an added measure of protection to ensure that engine oil leakage cannot get into the air passages and contaminate the bleed air and to ensure that surrounding hot air does not enter the compartment and auto-ignite or coke the oil. For Boeing this is achieved by providing an engine supplied overboard vent line from the separate vents to the reverser-suppressor cowl. For Lockheed, circular bolt flange overboard connections (CG, CH) are provided for the No. 1 and 2 bearing seal vents on each side of the top centerline of the engine and a threaded connection (CJ) is provided on the bottom. A common bolt flange is provided for the No. 3 bearing seal vent (BA) on the left side of the top centerline. The No. 4 bearing compartment vents through the exhaust nozzle; no airframe connection is required.

## Pratt & Whitney Aircraft

PWA FP 66-100

Volume III

Allowable loads for these connections are shown on the Installation Drawing for Lockheed only.

### 5. Electrical Systems

#### a. Ignition Exciter (AA)

Two ignition system exciter boxes located on the lower left and lower right sides of the engine are provided as voltage boosters for the engine electrical igniters. Engine-supplied individual leads connect the boxes to the main and duct heater combustion chamber igniters. This system provides a redundant dual ignition system for both primary engine and duct heater igniters. The ignition system power requirements and the exciter box and igniter locations were coordinated with the airframe manufacturers. Several changes in the location of the system were required to satisfy the maintainability requirements. Electrical connectors are located on each exciter. Descriptions of the connectors can be found on the Electrical Installation Diagram, figure 5 for the Lockheed L-2000 and figure 6 for the Boeing B-2707.

#### b. Control System Remote Adjustment Input (BS)

Means to electrically adjust the primary fuel flow as an engine pressure ratio adjustment and the fan nozzle area as an airflow adjustment are included on the engine. An electrical connector is located on the fuel control for the remote adjustment signals. The above system and optional variations to provide manual or automatic remote adjustment are described in detail in Volume III, Report B, Section III. An electrical connector description is located on the Electrical Installation Diagram.

The automatic remote adjustment system will be available as optional equipment for either an engine-mounted or airplane-mounted electronic computer. In either case, additional electrical connections, which are not shown on the Installation Drawing, are required. The remote adjustment system is further described in Volume III, Report B, Section III.

### 6. Air Bleed and Vent Systems

#### a. High Pressure Air Bleed Ports (U)(AM)

Air bleed ports for cabin or air pressurization systems are located on the engine diffuser case in positions specified by the airframe manufacturers.

A bolt flange type connection, located on the engine case just above the right horizontal centerline was coordinated with Lockheed to provide bleed air for the aircraft cabin air-pressurization compressor (environmental control system).

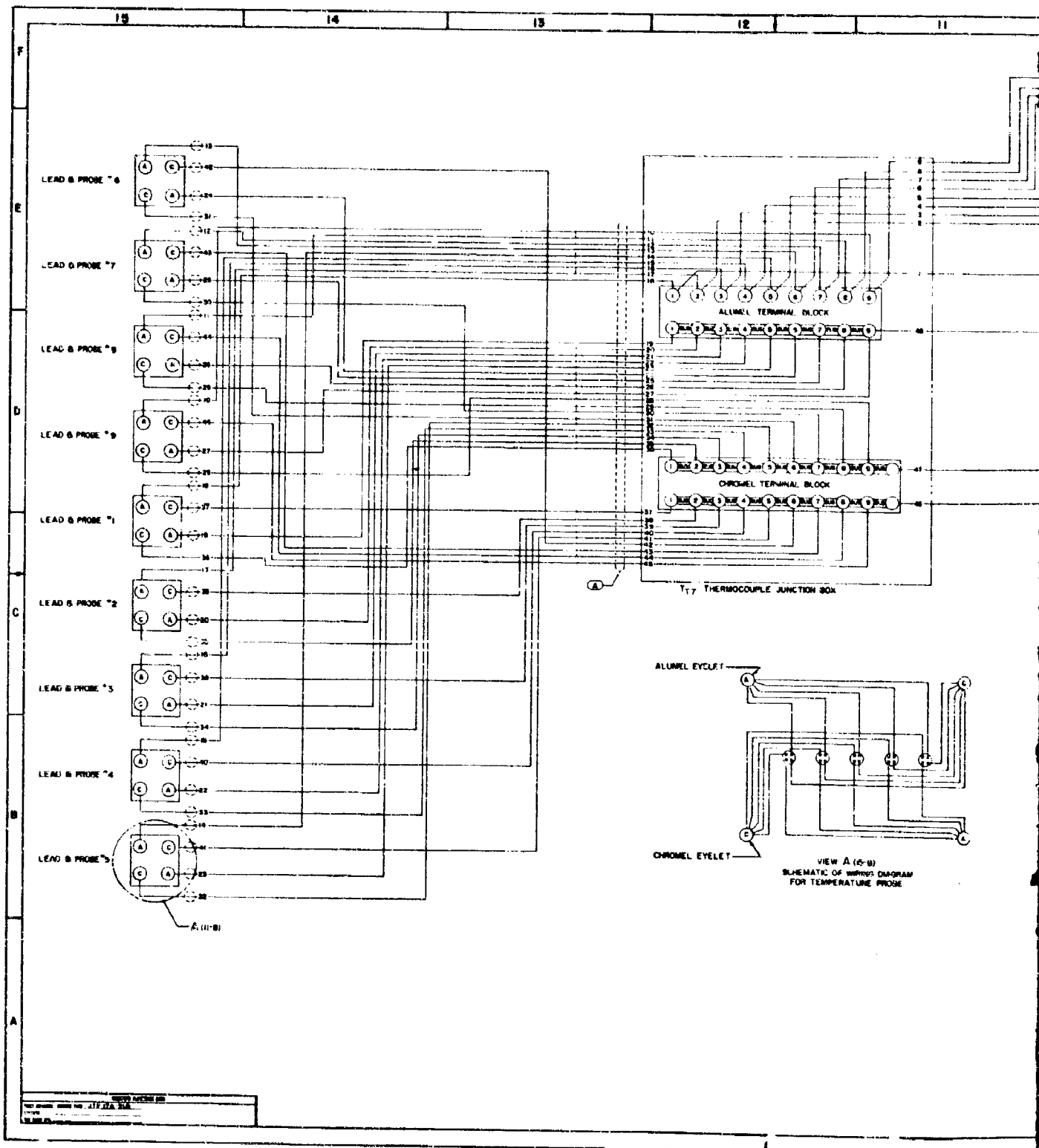
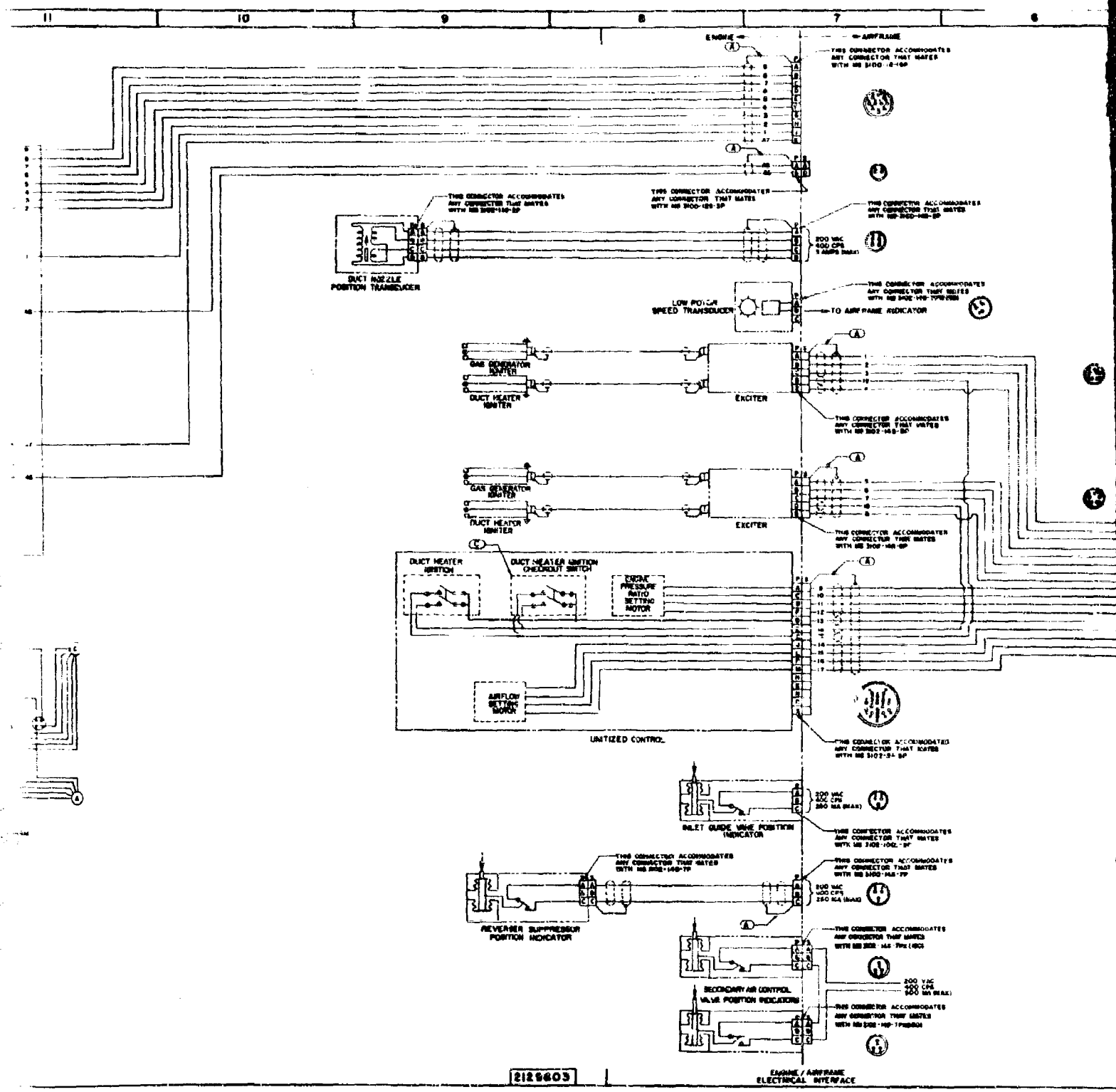

Figure 6. Diagram, Electrical Installation Connection (Boeing)



2128603

ENGINE / AIRFRAME  
ELECTRICAL INTERFACE

12



The Boeing installation requires an additional bleed air duct to manifold the engine bleed pads in the upper quadrants into a single large circular bolt flange at the top of the engine. The flange, as in the case of the power takeoff drive pad, faces up to directly accommodate the aircraft-mounted air conditioning system. A separate, smaller connection (AM) is located on top of the engine to provide high pressure bleed air for the airplane anti-icing system. In all cases, the coordinated provisions meet the bleed pressure load, installation vibration load, and environmental design requirements.

b. Bleed Pilot Valve Ambient Vent (BD)

The engine starting bleed system requires an ambient pressure sense to properly schedule the start bleed system. This is accomplished by a screen protected port on the bleed pilot valve located on the left side of engine. No airframe attachment is required.

c. Duct Heater Fuel Pump Exhaust (CE)

A duct is provided on the aft side of the duct heater turbo fuel pump for exhausting the pump turbine, which is driven by engine bleed air. For the Boeing installation, a discharge duct to the secondary air system bulkhead will be provided. For the Lockheed installation, a short diffusing duct is attached to the pump exhaust.

d. Secondary Air Flow Control

The installed engine secondary airflow systems differ markedly for the Boeing and Lockheed concepts.

Lockheed requires no secondary airflow control on the engine since control is accomplished by the airframe inlet system and is essentially a flow-through system. Boeing has a requirement for an unpressurized nacelle. Six secondary air flow ducts which are routed from the engine inlet to a bulkhead at the forward end of the reverser-suppressor are provided for Boeing installation. All six ducts have a check valve located at the aft bulkhead to prevent backflow during reverse thrust and airplane take-off. Four of the six ducts contain hydraulically operated valves to control the secondary air flow requirements for reverser-suppressor performance and cooling flow during cruise. Valve position indicator switches are provided. The electrical connector descriptions for the switches are located on the Electrical Installation Diagram.

e. Aerodynamic Brake Position Valve (CX)

The aerodynamic brake position valve requires an ambient pressure vent. This is accomplished by a screen protected part and is shown on the Installation Drawing.

7. Instrumentation and Instrumentation Provisions

a. Fuel Flowmeter Provisions (AW) (AX)

**Pratt & Whitney Aircraft**

PWA FP 66-100

Volume III

Provisions for fuel flowmeters to measure main engine and duct heater fuel flows are included in both the main fuel and the duct heater fuel supply lines as shown on the Installation Drawings.

b. Main Fuel Pump Inlet Pressure (FP-1)

Instrumentation provisions for sensing fuel pump inlet pressure are provided on the engine. Definitions of the connections are shown on the Installation Drawing.

c. Fuel Inlet Temperature (FT1)

Instrumentation provisions for sensing fuel inlet temperature are included on the engine. Definitions of the connections are shown on the Installation Drawing.

d. Fuel Filter Inlet and Outlet Pressures (FP10) (FP11)

Instrumentation provisions for sensing fuel pump filter inlet pressure and outlet pressure, or a delta pressure, are included on the engine. Definitions of the connections are shown on the Installation Drawing.

e. Oil Level Sensing (LL-1)

Oil level or oil quantity indicating instrumentation provisions are included on the engine. The oil tank flange connection and the internal sensor envelope are depicted on the Installation Drawing.

f. Oil Pressure and Temperature (LP1) (LT1)

Instrumentation provisions with a threaded connection having seal provisions are included in the main oil pressure line from the cooler to engine for sensing oil pressure. An identical connection for instrumentation provisions for sensing oil temperature is also provided. Provisions for direct engine mounting of a pressure transmitter will be incorporated if required. The above provisions are shown on the Installation Drawing.

g. Oil Pressure Transmitter Vent (LV3)

A threaded connection with seal is provided on the oil pump gearbox for venting the engine oil system pressure transmitter.

h. Oil Filter Inlet and Outlet Pressure (LP4) (LP5)

Instrumentation provisions for sensing oil pressure to and from the filter, or a delta pressure, are included on the engine and are shown on the Installation Drawing.

i. Turbine Exit Temperature (TT7) (ITT7) (Average and Individual)

An averaging and individual exhaust gas temperature measurement system is provided on the engine. The airframe electrical connection is located above the right horizontal engine centerline for Lockheed and on the lower

right side for Boeing. These locations were coordinated to provide connections for both the aircraft turbine exit temperature cockpit indicating system and for maintenance checking of the nine individual probes. A description of the system is provided on the Electrical Installation Diagram.

j. Turbine Exit Pressure (PT7)

Turbine exit or exhaust gas pressure instrumentation is provided on the engine. The coordinated airframe threaded connection for cockpit indication is located on the right side below the horizontal centerline for Lockheed and above the horizontal centerline for Boeing.

k. Duct Heater Nozzle Position Feedback (AL)

A linear variable differential transformer to indicate duct heater nozzle position is provided on the engine. The electrical connection is located on the right side of the engine ahead of the rear mount ring. A description of the connector is provided on the Electrical Installation Diagram.

l. Reverser Position Indicator (BC)

An indication of reverser ejector nozzle clamshell position is obtained from a limit switch located on the right side of the engine ahead of the rear mount ring. A description of the electrical connection is provided on the Electrical Installation Diagram.

m. Low Rotor Speed Transducer (BT)

A transducer is provided on the engine to indicate the low rotor speed by sensing 2nd-stage fan blade rotation. The location and the description of the connection are provided on the Electrical Installation Diagram.

n. Aerodynamic Brake Position (AS)

An aerodynamic brake position indication is supplied by a switch actuated by the aerodynamic brake actuator arm. This provides an indication of the inlet guide vanes in the start and cruise position. An indication for brake-on position is not considered necessary since rotor speed is affected significantly when the brake is on. A description of the connector is shown on the Electrical Installation Diagram.

o. Vibration Pickup (BF)

Vibration pickup mounting brackets are provided on the engine cases as depicted on the Installation Drawing.

p. In-flight Power-Setting Systems Provision

The use of engine pressure ratio as the basic power-setting parameter has proved successful on both turbojet and turbofan engines with fixed jet nozzle areas. By adding the measurement of total fuel flow to en-



## Pratt & Whitney Aircraft

PWA FP 66-100

Volume III

engine pressure ratio, slightly better thrust setting accuracy is achieved for a duct-burning turbofan engine. The use of turbine exit total pressure provisions, inlet total pressures, and total engine fuel flow measurements provides the required engine parameters for an in-flight power setting system. Such a modified engine pressure ratio system satisfies the requirement for a simple accurate method of setting engine thrust. The details of such a system are described in Volume III, Report A.

### C. INSTALLATION CONFIGURATION AND SUPPORTING DESIGN DETAILS

#### 1. Installation Configuration and Design for Airframe Compatibility

The engine mount points are primarily designed to effectively react the engine thrust and weight to the airplane wing or other primary structure. This necessitates locating the mount points in the upper quadrants. One of the front mount points reacts the total thrust load and a proportionate amount of the vertical and side load. The other front mount carries a proportionate amount of the vertical load. The rear mount attachment points provide for airframe-supplied links to allow for axial thermal growth of the engine. The rear mounts also carry the greater part of the engine vertical and side load. Further information about the engine mount system design may be found in Volume III, Report B, Section II, paragraph H.

The resulting engine-coordinated mounting points and the required airframe mount structure necessitates positioning the major engine controls, components, and accessory drives to the lower side areas of the engine for the Lockheed installation and on either side of the horizontal centerline for the Boeing installation. For the Boeing airplane, the component positioning must be compatible with the Boeing requirement for secondary airflow ducts. The secondary airflow is required for reverser-suppressor cooling and ejector nozzle performance. The ducted system permits designing a nonpressurized nacelle. The Lockheed engine configuration and component arrangement are greatly affected by the requirement to mount an engine-driven airframe environmental control system air compressor and heat exchanger on the bottom of the engine.

The power takeoff gearbox and drive pad and the locations differ between the Boeing and Lockheed installations. The Lockheed power takeoff is positioned at the top of engine to drive the airframe remote gearbox-mounted accessories. This gearbox has the added capability of being engine-mounted for either a right or left side airplane installation. An additional power takeoff-environmental control system drive pad is provided on the lower right side of the engine for the bottom-mounted environmental control system air compressor. For the Boeing airplane, the engine power takeoff gearbox and drive pad incorporate two additional hydraulic pump accessory drive pads for the airframe inlet control system. The gearbox is located at the top of the engine with the power takeoff pad facing upward.

The high pressure air bleed ports and manifold are located near the top of the engine for Boeing to facilitate direct routing of the air duct and vents into the airplane. The Lockheed installation requires only a single bleed air port located in the lower right side of the engine to

facilitate direct routing of the air duct to the bottom-mounted engine driven air compressor. All the bearing compartment labyrinth seal vents are located in the upper quadrants of the engine for ease of installation.

A common fuel inlet and manifold to the main and duct heater fuel pumps is provided near the top of the engine to facilitate connection to the airplane fuel manifold as requested by the airframe manufacturers. The locations differ slightly as a result of airplane differences.

The engine reverser-suppressor consists of the following major external components and assemblies: Reverser-suppressor to nacelle shroud, reverser doors, tertiary air blow-in doors, main structure, and aerodynamically-actuated variable nozzle flaps. The nozzle is canted down 5 degrees for Lockheed and 6 degrees for Boeing. The canting is required for airplane performance and installation compatibility. The forward face of the reverser-suppressor provides a flange for bolted attachment to the nacelle outer contour air seal at the engine-to-airframe boundary. Thrust reversing is provided by two hydraulically actuated semicircular reversing clamshells. Backflow of the reversed exhaust gases during reversing operations is prevented by a series of air balanced flapper doors which close because of exhaust gas pressure. The doors are located around the engine nozzle near the reverser-suppressor front face. Secondary airflow for reverser-suppressor performance and cooling is obtained from the airframe air inlet system. This secondary-air flows along the outside of the engine and through the flapper doors to the ejector nozzle for the Lockheed installation. For Boeing, the secondary air flows through six ducts.

The thrust reverser doors are configured and positioned to provide the required reversing gas flow targeting that has been coordinated with the airframe manufacturers. The door locations are a function of the design of the airplane wing and engine installation.

## 2. Installation Configuration and Design for Maintainability and Servicing

Borecope inspection ports have been spaced circumferentially around the engine diffuser case clear of the engine components and plumbing to permit inspection of the main burner, fuel nozzles, nozzle guide vanes, and burner swirl guides. The compressor borecope inspection ports are positioned along the bottom of the engine in a clear area that allows viewing of all compressor blade stages. The turbine inspection borecope ports are positioned at two locations on the rear mount ring case to allow viewing all turbine blade stages. The turbine 3rd-stage can be inspected from the exhaust end of the engine. Provisions to rotate the high compressor during borecope inspection have been incorporated into the main gearbox. All of these functions can be accomplished with the engine installed, if permitted by the nacelle design.

Components of the engine have been packaged or positioned to provide access to all inspection and servicing points on the engine. Specifically, the packaging allows access to the eight large access panels located circumferentially around the engine. The access panels permit inspection of the main burner fuel supply plumbing, compressor bleed valve plumbing and compressor air bleed plumbing, replacement of the primary gas generator

## Pratt & Whitney Aircraft

PWA FP 66-100

### Volume III

fuel nozzles, and removal of the compressor bleed valves. The engine has been designed so major plumbing is not routed over these panels. The reverser-suppressor design incorporates access panels for inspection of hydraulic actuators, plumbing, and reverser mechanism and for minor adjustments and parts replacement. Adjustments of the reversing and tertiary blow-in door system are provided to allow complete interchangeability of parts, thus not requiring replacement with matched parts or sets of parts. The clamshell hubs and bearings are easily removed and inspected after removal of the outside access panel and inside cover-plate. The complete reverser-suppressor assembly and nozzle can be installed or removed from the airplane without requiring other disassembly or rigging adjustment.

The engine oil system has been designed to utilize threaded type chip detector plugs. These are accessible at strategic locations to provide early warning of failure or excessive wear of bearing or power train areas of the engine.

All oil scavenge pumps are provided with inlet screens for protection against foreign objects in the oil sumps.

Lines and tubing on the outside of the engine are provided with sufficient mechanical connectors to permit easy removal of components and hot section inspection. All lines that cross Flange "G", which is the separation flange for a hot section inspection, have an additional connection permitting removal of short lines.

Fuel and exhaust nozzle area control management functions have been packaged on the left side of the engine in a single unitized control which can be removed by removing nine bolts and disconnecting the electrical and pneumatic connections. All fluid lines are connected to the pedestal base behind the unitized control so that disassembly and assembly of these lines is not required. The fuel controls linkages are designed so that removal of the fuel control will not disturb the airframe fuel control actuation system.

Fluid filters which are provided in the components of the fuel and hydraulic system are positioned so removal can be accomplished easily without the prior removal of other engine components.

All components weighing 45 pounds or more are provided with lifting eyes or other lifting provisions to facilitate ground handling for field installation or replacement.

Space for ground handling at the front and rear mount rings has been coordinated with the airframe contractors and is specified on the Installation Drawing. Ground handling fixtures for transportation or engine installation and removal from aircraft may be attached to the engine in these areas as desired by the airframe manufacturers.

Further detailed information about engine configuration to facilitate servicing and maintenance may be found in Volume IV, Report F, Section I; Volume IV, Report D, Section III; Volume V, Report C; and Volume III, Report B, Section II. Further maintenance and inspection information may be found in Volume III, Report B, Section II, paragraph H.

**CONFIDENTIAL**

**Pratt & Whitney Aircraft**  
PWA FP 66-100  
Volume III

### 3. Installation Configuration and Design for Safety Considerations

Engine-mounted components, lines, and fittings have been positioned to be within the envelope defined by the front and rear mount rings as far as possible with the constraints of the airplane requirements and physical space. This provides engine structural protection to the fluid-filled components and plumbing. Similarly, all fluid-filled components, except for the overboard drain valves, have been positioned away from the bottom of the engine for improved installation safety. For the Boeing installation a fuel drainage collector tank is provided on the bottom of the engine. Overboard drains from fuel components of the engine will be plumbed to this central collection tank and thus keep the airport ramp areas free of fuel. While the airplane is parked, no fuel will drain overboard. The collection tank will be emptied by aspiration through an internal ejector during engine operation.

All fluid-carrying lines have been designed for maximum safety by the use of lines with integral ferrules at all connections. Integral ferrules are incorporated by forging and subsequent machining of the tubing ends to form the ferrule, thus eliminating the need for brazed connector ends. All line connections are threaded connectors using a standard 37-degree cone end and a nickel seal. Use of this type of connection is based upon a record of excellent reliability in flight at Mach 3+ with the J58 engine. All engine and engine-to-airframe interface boundary connections through 1.25-inch diameter are of this type. Above 1.25-inch diameter size, connections are bolted flanges using the Haskell design "K" seal. The K-seal has proved superior for sealing during thermal shock tests and from J58 experience in these sizes. All engine connections are the types described, except where other types are specifically requested by the airframe manufacturers. No brazed connections are used because of the lack of reliable inspection methods. All lines and brackets have been designed for thermal deflection, internal pressures, manufacturing misalignment, and vibratory and maneuver loads. Tube and bracket stresses resulting from these loads are maintained at a safe margin below the material yield strength at all operating temperatures to achieve the best low cycle fatigue life. Line bracket spans are checked to assure that the line and bracket natural frequencies are outside the engine rotor speed range. Details of the design of lines, fittings, and brackets are given in Volume III, Report B.

All engine and engine-to-airframe interface boundaries for lines and electrical connections that are in close proximity to each other have been sized or designed to prevent improper connection to the engine or airframe.

The reverser-suppressor reversing actuation system has been designed so that if a hydraulic system failure should occur, the aerodynamic forces acting on the clamshell segments will automatically move them to the subsonic cruise position so that no reversing will result and forward thrust is available. The aerodynamically-actuated tertiary blow-in doors and the reverser-doors have been provided with an interconnecting lockout mechanism so that reversing cannot take place while the tertiary blow-in doors are in the closed (supersonic) position.

DI-41

**CONFIDENTIAL**

**CONFIDENTIAL**

As optional equipment, an automatic restart system switch is available. This engine-mounted switch senses a drop in compressor discharge pressure and automatically closes the ignition circuit for main burner relight. The system is not currently shown on the Installation Drawing but is shown in Volume III, Report B, Section III.

All filter housings in the main fuel and oil supply systems have pressure sensing provisions at the inlet and outlet of the filter to permit measurement of filter  $\Delta P$  as an indication of filter element clogging.

Provisions for chip detectors in engine oil system are covered above.

#### D. SECONDARY AIRFLOW SYSTEM DEFINITION AND REQUIREMENTS

##### 1. Description

The purpose of the secondary air system is to provide airflow for reverser-suppressor performance and for cooling of the reverser-suppressor shroud and ejector trailing edge flaps. In addition to these functions, the system is used to bypass air from the airplane inlet, commensurate with engine and airframe supersonic inlet requirements.

The Lockheed and Boeing airplanes use distinctly different secondary airflow systems as a result of different inlet and nacelle system concepts. The differences have little effect on the basic engine, but a significant effect on the installation configuration.

The Lockheed airframe system is shown schematically in figure 7. Secondary air enters the engine nacelle cavity through airframe-supplied inlet control valves in the plane of the engine air inlet. This also provides a means for shutting off the air and isolating the engine area in the unlikely event of a nacelle fire. The system utilizes the full nacelle annulus as a flow path, resulting in a pressurized nacelle cavity and therefore sealed from ambient static pressure. An engine flapper valve system is incorporated into the secondary air flow path at a reverser-suppressor bulkhead just behind the engine rear mount. The purpose of the valve system is to isolate the upstream environment from hot gases during reversing.

The Boeing airframe utilizes a ducted secondary airflow system shown schematically in figure 8. The system incorporates six ducts extending from an annular manifold aft of the engine front mount ring to the bulkhead at the forward end of the reverser-suppressor. The airflow is bled from the boundary layer in the engine gas path and flows in the ducts to an engine nacelle cavity just forward of the reverser-suppressor. Check valves are incorporated in each of the ducts at the aft bulkhead to prevent the reverse flow of hot gases during reverse thrust operation. Four of the ducts incorporate hydraulically-actuated valves to throttle secondary flow as required for performance and cooling. Two of these valves are scheduled by the engine control system to close at about Mach 2.0 to match the inlet and engine performance requirements. At cruise the option of manually closing the other two valves is avail-

DI-42

**CONFIDENTIAL**

(This Page is Unclassified)

**CONFIDENTIAL**

**Pratt & Whitney Aircraft**

PWA FP 66-100

Volume III

able if the engine is being operated at low cruise powers. Since the secondary flow is contained in ducts, the nacelle annulus will be maintained at or near altitude ambient pressure.

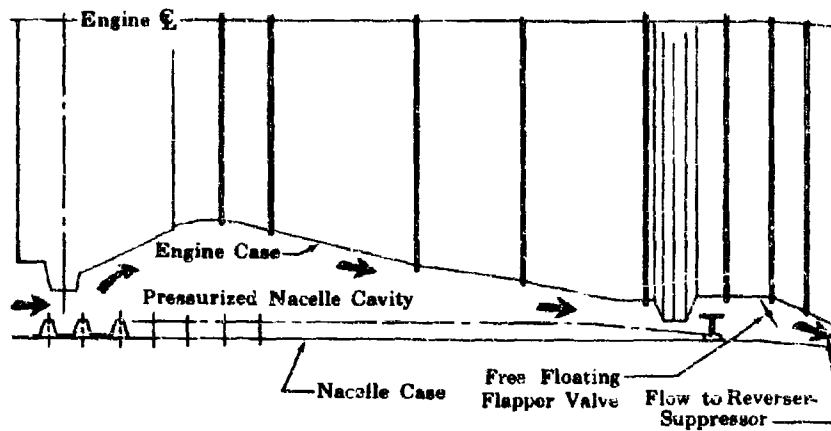

Figure 7. Lockneed Secondary Air Flow System

FD 17035

DI

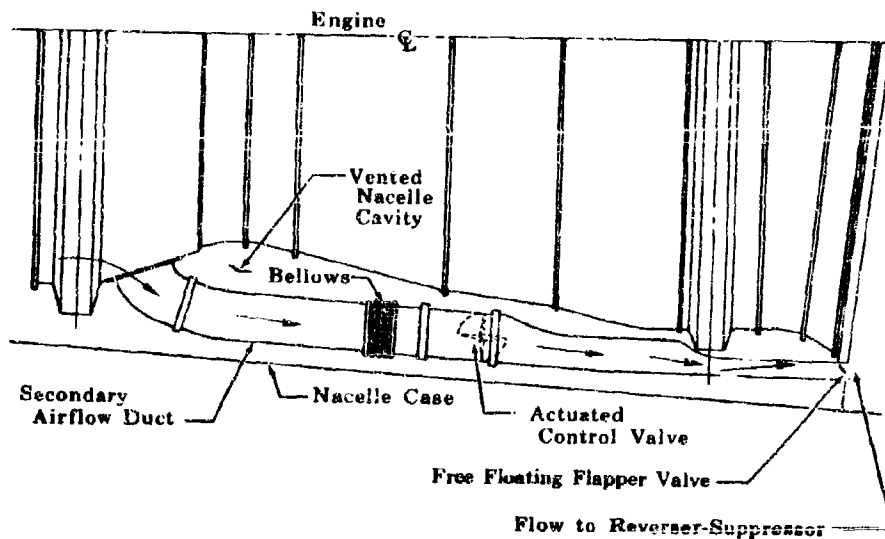

Figure 8. Boeing Secondary Air Flow System

FD 17034

DI

DI-43

**CONFIDENTIAL**

(This Page is Unclassified)

**CONFIDENTIAL**

## 2. Design Objectives

Within the framework of system design and airframe coordination, the design objectives of the secondary airflow systems were:

1. To provide secondary air to the aft section of the nacelle cavity compatible with the ejector nozzle performance and reverser-suppressor cooling requirements.
2. To bypass air from the engine inlet at a flow rate compatible with engine/airframe supersonic inlet requirements.

## 3. Design Requirements

A minimum of 2% corrected flow is required at all operating conditions when the reverser-suppressor tertiary doors are closed.

The airframe requirements relative to the airflow and inlet compatibility are being coordinated on a continuing basis with both airframe manufacturers.

## 4. Design Criteria

Consideration was given to the following factors:

1. Minimize all resistance to flow in the nacelle cavity and in the bypass ducts
2. Design the secondary airflow inlet geometry to have a minimum effect on engine inlet requirements

## 5. Design Approach

Balanced secondary flow requirements for the engine and the airplane inlet systems were determined by the same general method used for the J58 engine YF-12A and SR-71 bypass system flow requirements. Flow parameter characteristics of each system were determined using component blockage, net effective flow areas, and compressibility relationships. After the flow characteristics of the system had been established, the balanced flow was determined using the airframe-supplied inlet pressure and the ejector inlet pressure for various flight conditions.

## E. ENGINE MOCKUP PLAN

### 1. Scope and Objectives

This plan describes the methods and planning used to fabricate, provide, and maintain up-to-date full-scale engine mockups throughout the JTF17 program. The program provides the airframe manufacturer and Engineering Design with the most useful and complete mockups possible and with a clear conception of the engine external configuration. These mockups are primarily used to ensure engine installation compatibility and will aid in achieving practical solutions of general configuration details covering installation, accessibility, serviceability, and maintainability throughout the design and development of the engine. The plan further states the accomplishments achieved during Phase II-C in providing full-scale engine mockups to both airframe manufacturers.

**CONFIDENTIAL**

## 2. Organization

The engine mockup parts list is established under the direction of the Manager, JTF17 Development. A Development Project Engineer is responsible for coordination between the Product Support Group, who contact the airframe manufacturer, and the Design Installation Group and for ensuring that the mockup configuration is in accordance with the airframe manufacturer's requirements as well as the engine design requirements. These will be reviewed by the Chief of Configuration Managements. The Product Support, Installation and Field Engineering Groups are responsible for the coordination of installation requirements between the airframe manufacturer and Project Engineering. The JTF17 Engine Design Group is responsible for the engine design and drawings necessary to manufacture and maintain the engine mockup.

The Product Support Group is responsible for the construction and maintenance of the mockup engines, including the processing of material necessary for updating, used at the airframe manufacturers facilities.

## 3. Description

Engine mockups which are discussed in the following paragraphs can be described by the following class definitions:

1. Class I Envelope Engine Mockup - This class of mockup represents the overall size and approximate contour of a new engine model and is intended only to facilitate early installation studies.
2. Class II Preliminary Engine Mockup - This class of mockup is considered satisfactory for preliminary design work and is provided early in the design program, prior to the establishment of the complete engine design. The parts are fabricated to layouts, and inspection is limited to verification of the principal dimensions. Construction materials are usually fiberglass with metal flanges for engine cases, wood with metal inserts for accessories, and steel tubing for plumbing. This type engine mockup can be updated and maintained to the latest design configuration.
3. Class III Installation Design Engine - This class of mockup is intended to be used as an installation fixture for final installation design work and is an exact representation of the external details of the released engine design. All parts are manufactured to released engineering drawings and are inspected for conformance to the manufacturing tolerances specified on the drawings. Construction materials are metal and fiberglass.

## 4. Requirements

Experience has shown that full-scale engine mockups, because of their three-dimensional nature, play a very important role in the initial establishment of engine component clearances, plumbing routing, and for subsequent checks of the engine in the airframe.



## **Pratt & Whitney Aircraft**

**PWA FP 66-100**

**Volume III**

During the Phase II-C program, one full-scale engine mockup was delivered to each airframe manufacturer; each mockup represented the JTF17 specifically designed for the respective aircraft. At the same time, two other engine mockups have been maintained and used as in-house engineering design mockups. Each incorporates the major features of the basis engine and the differing airframe configuration.

During Phase III, a Class II engine mockup will be maintained at Pratt & Whitney Aircraft and continuously updated to incorporate the latest design changes. Concurrently, a duplicate set of parts will be fabricated and forwarded to the airframe manufacturer for incorporation into and updating of their Class II engine mockup.

The Boeing Company has requested one and possibly three additional Class II engine mockups of the Boeing JTF17 engine configuration for delivery early in Phase III. Approximately two years later, Boeing has a requirement for two Class III engine mockups representing a firm configuration for the prototype engine. Lockheed has requested an updated Class II engine mockup in 1967 and two Class III engine mockups for delivery in 1968 representing a firm configuration for the JTF17 prototype engine.

The updated Class II and the Class III Pratt & Whitney Aircraft mockups will be used as design tools for coordinating all proposed changes with the airframe manufacturer and for visualizing the Installation Drawing changes. These engine mockups will be manufactured as required and delivered in accordance with the schedule.

Throughout the SST engine program, emphasis will be placed on maintainability and accessibility features of the engine, the engineering mockups will aid in identifying such areas. Some of the features which will be emphasized are:

1. Quick disconnect features for components
2. Clearly identified service check points such as filters, chip detectors, pressure and temperature check points, and oil tank servicing points.
3. Inspection provisions such as borescope, access plugs, and access covers.

### **5. Mockup Changes and Review**

Should the airframe manufacturer's review of the Class III engine mockup indicate a need for configurational changes, field survey layouts will be prepared for airframe manufacturer review and approval. This procedure is described in detail in Volume V, Report C. If the change affects the engine mockup, parts will be made, checked out on the Engineering Design engine mockup, and sent to the airframe manufacturer for installation on the engine mockup. When the revision is satisfactory, and the field survey approved, the engineering change will be processed and incorporated into the Assembly Parts List Complete.

The engine mockup maintained for Pratt & Whitney Aircraft Engineering Design will be available for inspection or Mockup Review after completion. Tentative suggested schedule dates are shown on figure 9. On notification

by the FAA, Pratt & Whitney Aircraft will provide the facilities, services, personnel, and material for an engineering inspection of this JTF17 engine mockup, following the general procedures for Mockup Review in ANA Bulletin 406a.

6. Background and Facilities

Pratt & Whitney Aircraft has accumulated over 200 man-years of experience in building jet engine mockups for both military and commercial programs. The Installation Engineering Mockup Group and FRDC Engineering Design have provided mockups in recent years for aircraft programs such as the C-141, F-111, B-52, 707, 727, DC8, SR-71, F-12, and the Jetstar. Photographs of typical mockups are provided in figures 10 through 15. The experience of the Connecticut and FRDC personnel, the 11,300 sq. ft of mockup design, manufacturing, and assembly facilities in Connecticut and the 6,400 sq ft of mockup and assembly area at FRDC are available for the SST program.

F. ENGINE INSTALLATION HANDBOOK

The Installation Handbook will be provided as a separate enclosure.

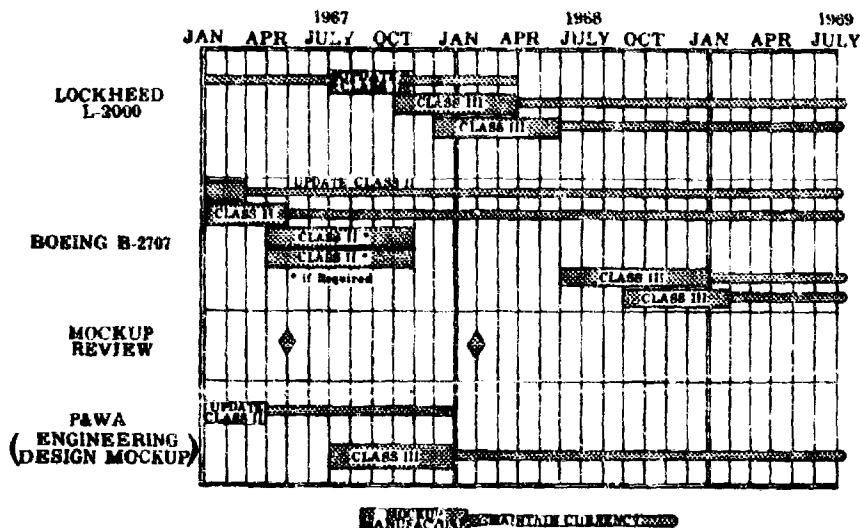

Figure 9. JTF17A-21 Mockup Schedule

FD 17641  
DI

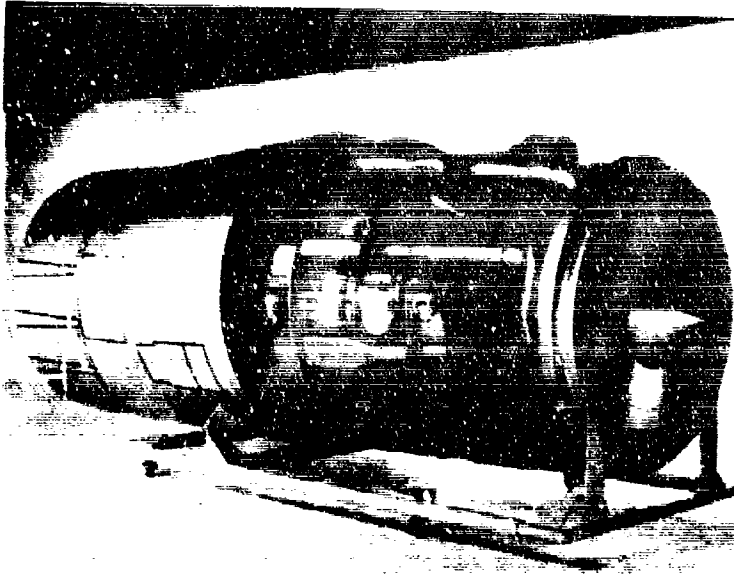

Figure 10. JTF17A-21B Mockup, 3/4 Right  
Front View

FE 60737  
DI



Figure 11. JTF17A-21L Mockup Delivered to  
Lockheed, 3/4 Right Front View

FE 56829

**CONFIDENTIAL**

Pratt & Whitney Aircraft  
PWA FP 66-100  
Volume III



Figure 12. JTF17 Mockup, Typical Closeup  
Showing Main Fuel Control, Main  
Gearbox, Main Fuel Pump, and  
Engine Hydraulic Pump

FE 60414  
DI

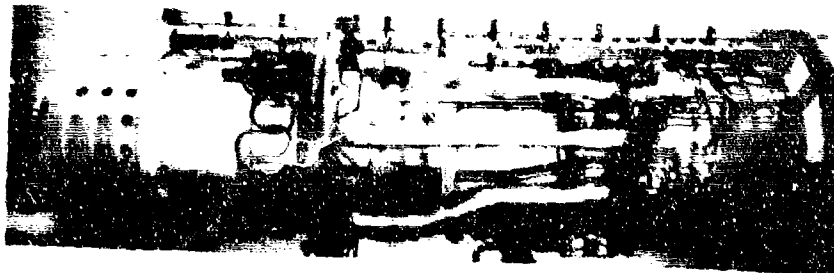

Figure 13. JT11D-20 Mockup (J58), Right Side  
View

FE 48692  
DI

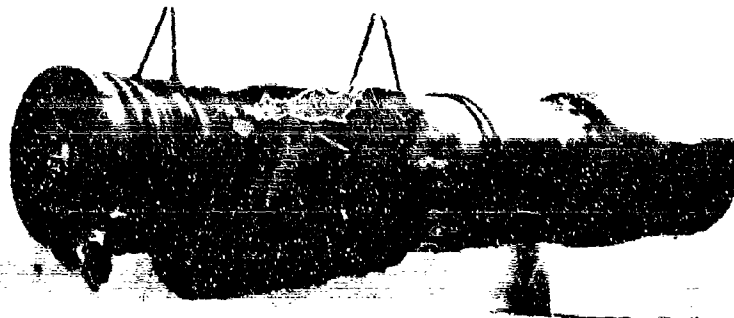

Figure 14. TF30P-1 Installation Design Engine,  
3/4 Left Front View

H-39671  
DI

DI-49

**CONFIDENTIAL**

**CONFIDENTIAL**

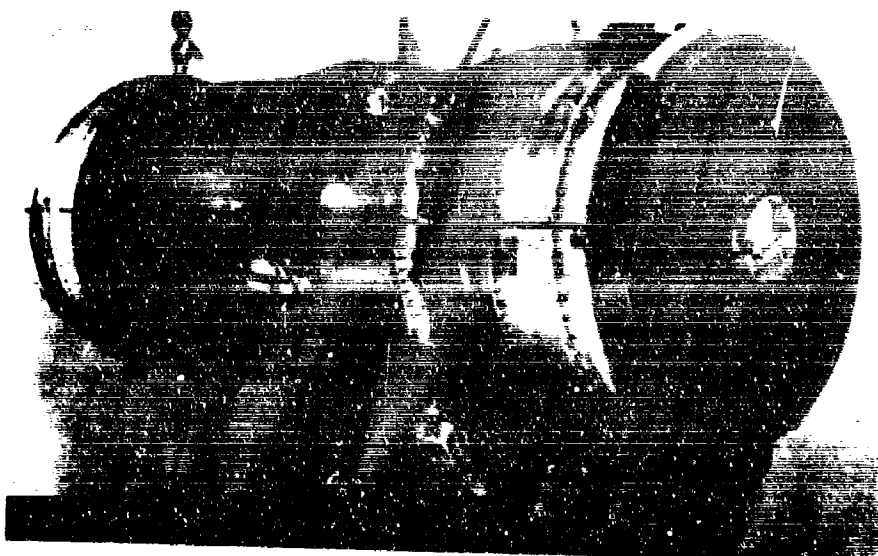

Figure 15. JT8D Installation Design Engine

H-52089  
DI

DI-50

**CONFIDENTIAL**  
(This Page is Unclassified)

SECTION II  
INLET SYSTEM COMPATIBILITY

A. OBJECTIVES AND INTRODUCTION

The development of a compatible high performance engine/inlet system is a primary requisite for initiation of supersonic transport flight testing. In order to accomplish this development within the allowed time schedule, P&WA and the airframe manufacturer will pursue, from the earliest possible date, a vigorous, coordinated program consisting of analytical studies, rig and model tests, and full-scale inlet and engine tests. As shown in the following sections of this report, analytical studies relating to determination of inlet and engine steady state requirements, dynamic compatibility, and distortion compatibility are already underway.

P&WA has over eight years experience in development of engines designed to operate at flight speeds equal to or greater than those planned for the SST. For example, the J58 engine has accumulated more flight time at and above Mach 2.7 than all other engines in the free world combined. The knowledge acquired as a result of this extensive experience has been incorporated into the design and development plans for the JTF17.

Our experience has shown that it is necessary to integrate the engine and airframe inlet duct at the earliest possible date. Therefore, to avoid the possibility of delays in the flight program and the complete engine-nacelle test program at AEDC, initial compatibility tests will be accomplished early in the engine development program on compressor component rigs and development engines. In view of the rapid modifications that are desirable in the early development cycle (and long lead times on experimental parts) the most efficient way to accomplish this testing is in the manufacturer's test facility. Thus, a large portion of the inlet/engine compatibility testing will be run in the extensive P&WA sea level and altitude engine and rig test facilities in preparation for the scheduled complete engine-nacelle tests at AEDC.

B. AIRFRAME/ENGINE COMPATIBILITY AGREEMENT

The Engine Inlet Compatibility Test Program has been coordinated with the airframe manufacturer and included in the following documents:

1. Boeing:  
"Coordinated Inlet/Engine Test Plan" Commercial Supersonic Transport Program Report D6A10007-2  
Engine/Airframe Technical Agreement Number D6A10199-1 P&WA
- 2) Lockheed:  
L-2000 Airframe/Engine Compatibility Agreement Exhibit A  
P&WA Interface Control Document  
Lockheed Phase III Proposal Volume IIE, Section 6  
AEDC Inlet/Engine Test Plan

**Pratt & Whitney Aircraft**

PWA FP 66-100

Volume III

**C. ENGINE INLET COMPATIBILITY TEST PLAN**

The compatibility of the engine and inlet will be tested in logical, sequential steps leading to the prototype flight test. Significant test milestones are shown in Table 1 and the tests are more fully described in the following paragraphs.

**1. Program Integration of Fan/Compressor Rig Testing**

Steady-state evaluation of simulated inlet total pressure distortion during fan rig tests provides early indications of engine distortion tolerance and engine/inlet compatibility. Concurrent full-scale engine testing will incorporate the fan/compressor configurations developed during this test phase that exhibit major improvements in distortion attenuation. Full use will be made of analytical simulation techniques to complement the testing phase, and improved techniques used as they are validated. Also, test data will be used as it is obtained to update the analytical simulation program. The testing and analytic processes necessary to attain distortion compatibility are inter-related and neither can proceed rapidly without the other.

Information obtained from distortion testing with the fan will be utilized to obtain representative duct burner and high compressor inlet profiles for additional component tests. The importance of fan/compressor distortion testing is emphasized for two reasons: first, this is the earliest and most economical means of evaluating distortion compatibility problems and second, this testing provides data which is essential for the engine test phase.

**Table 1. Engine Inlet Compatibility Testing Proposed Milestones**

- |    |   |            |
|----|---|------------|
| 1. | 0.6 Scale Fan Rig - Distortion generators will be used to simulate patterns obtained from airframe manufacturer testing of model inlet.   | Feb. 1967  |
| 2. | Rematched Engine - Testing with distortion generators will be done to evaluate distortion attenuating influence of high compressor. The data will be compared to fan rig distortion test data.  | May 1967   |
| 3. | 0.6 Scale Fan Rig - The fan rig will be tested at Willgoos Laboratory with the subsonic diffuser portion of the airframe inlet. These tests will evaluate the subsonic diffuser performance with static pressure gradients imposed by the fan.  | July 1967  |
| 4. | 0.6 Scale Fan Rig - Variable vane simulation of high compressor. Test with required back pressures to reproduce circumferential variation of flow determined from the rematched engine. Corroboration of this data when compared to the rematched engine distortion data will allow development of fan to continue on isolated test basis. Data will also be compared with analytical calculations of distortion effects for corroboration. | July 1967  |
| 5. | 0.6 Scale Fan Rig - Willgoos Laboratory testing with the subsonic diffuser portion of the airframe inlet. The July testing will be repeated to evaluate any changes indicated by the earlier test series.   | Sept. 1967 |

Table I. Engine Inlet Compatibility Testing Proposed Milestones  
(Continued)

- |     |  |            |
|-----|--|------------|
| 6.  | Full Scale Fan - Testing to be done at FRDC altitude facility with variable vane simulation of high compressor. Distortion generators will be used to simulate patterns obtained from airframe manufacturers testing.  | Jan. 1968  |
| 7.  | JTF17 - Engine will be tested with distortion generators to simulate patterns obtained by airframe manufacturers testing. Steady state and transient performance will be evaluated.  | Nov. 1967  |
| 8.  | JTF17 - Engine will be tested with the subsonic diffuser, flight configuration bleeds, and their controls. Data will be taken at cruise to check performance and preview dynamic compatibility before AEDC testing. Sea level static testing will be done to evaluate performance and distortion effects with a full inlet on the engine. Starting schedules will be optimized. The inlet will be operated in a near choked condition for fan noise attenuation studies. | Aug. 1968  |
| 9.  | JTF17 - AEDC Test Facility - A ground test engine with the supersonic inlet will be tested. Configuration will be a complete engine nacelle system to simulate the free stream inlet.  | Sept. 1968 |
| 10. | Flight Tests - Propulsion system performance and engine/inlet compatibility will be evaluated during the initial 100 hour flight test program. Flight tests are scheduled to begin as follows:   |            |

Boeing	1st Prototype	December 1969
	2nd Prototype	February 1970
Lockheed	1st Prototype	March 1970
	2nd Prototype	June 1970

2. Inlet Distortion Generator Tests

The early compatibility tests will consist of compressor component tests with simulated steady state distortion generated by distortion screens (figure 1). Since the distortion will vary both in magnitude and pattern as a function of flight Mach number, several representative distortion generating screens must be available. This also means that the simulation screen should be readily changed as a function of rotor speed and thus development of a remotely variable distortion generator will be undertaken. During these tests the presence of bleed ports and obstructions in the vicinity of the compressor inlet will be simulated as they can have an appreciable effect on the velocity distribution. Also important is the duplication of the static pressure field. This will be accomplished by constructing the inlet section of the test facility to conform with the geometry of the inlet diffuser. Of particular importance is the section within approximately one diameter of the fan face including simulation of bleed flows. Coupling the fan to the inlet diffuser will modify the inlet distortion, but this effect is expected to be of second order importance.



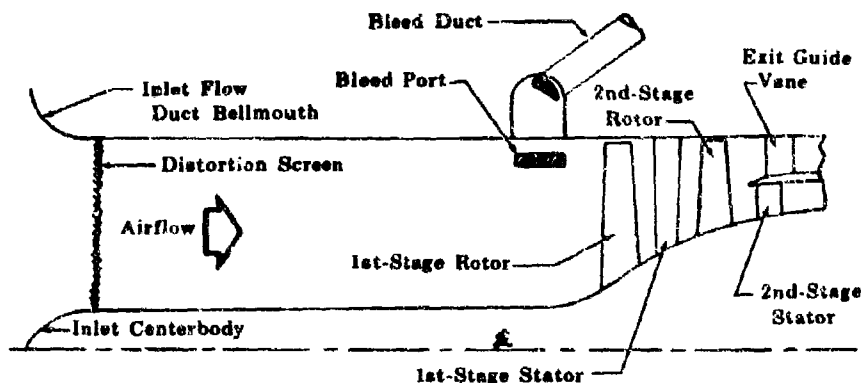

Figure 1. Fan Compressor Distortion Screen  
Test Rig

FD 16680  
DII

In supersonic aircraft, such as the YF-12, F-111 and Mirage IIIF, the surge tolerance is related more to the maximum instantaneous distortion produced by the inlet than it is to the time-averaged distortion. If the distortion pattern that exists just prior to an in-flight surge is recorded, it can be reproduced statically by distortion screens. When this is done, a test engine which is run with these screens will surge at the same operating conditions that accompanied the in-flight surge.

It is imperative that the instrumentation used in the development of inlet-engine compatibility possess high response capability. Experience has shown that inlet flow perturbations exhibiting time-variant characteristics that change in a period less than 0.01 seconds are not uncommon in supersonic propulsion systems. Such non-steady distortion finds its source in flow perturbations generated both externally and internally with respect to the inlet. Distortion generated externally to the inlet, and subsequently ingested, may be caused by gusts, landing gear, or other aircraft wakes. Internally generated distortion may be caused by fluctuations in inlet shock position, boundary layer separation from the subsonic diffuser walls, instability in the inlet control system, and other related causes.

Figure 2 shows a time history of inlet pressure stability for an engine stall that occurred during high altitude inlet-engine development testing at Mach 2-plus. The inlet pressure fluctuation that generated this engine stall was delineated by high-response instrumentation. During earlier tests time averaged distortion measurements failed to indicate the cause of surge. When high-response instrumentation was incorporated, a sharp increase in distortion was observed to precede surges resulting from distortion.

Inasmuch as the instantaneous extremes of inlet distortion are of significant interest in the development of a compatible inlet-engine system, the test inlet instrumentation should have response times on the order of one millisecond.

**CONFIDENTIAL**

**Pratt & Whitney Aircraft**  
PWA FP 66-100  
Volume III

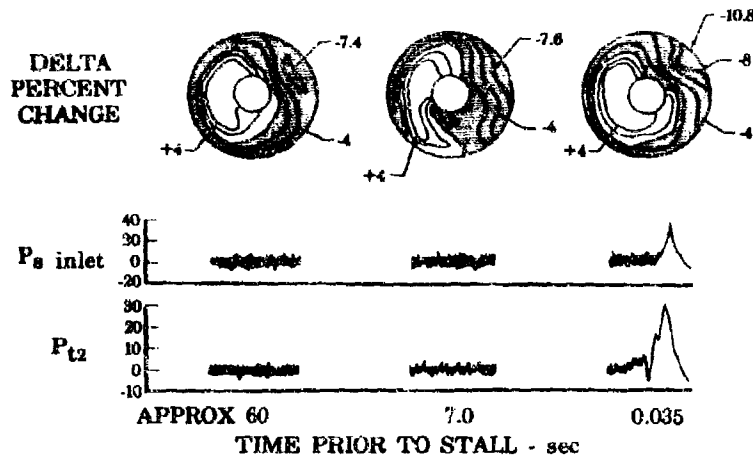

Figure 2. Time History Stability of Inlet Pressure Stability for an Engine Stall

FD 17643  
DII

### 3. High Compressor Simulation Tests

The necessity to simulate the high compressor during fan distortion testing is supported by analysis and testing. This work has shown that the high compressor has a stabilizing influence on the performance of the fan while operating in a distorted flow field. This beneficial influence of the compressor is the result of the characteristic of the front stages of the compressor wherein the stability of the flow increases as the corrected speed approaches 100%. Because the corrected speed of the high compressor remains above 80% at all conditions between takeoff and cruise, the airflow at a given  $N_2/\sqrt{\theta T_3}$  is nearly constant. This effect induces a stable flow at the back end of the fan which, in turn, reduces the effect of inlet distortion. The reason is that the fan root velocity and flow are maintained by the pumping effect of the compressor, even though the total pressure is low.

It should be noted that high compressor effects on fan flow do not alter the total pressure field at the fan face. Rather, the high compressor exerts a substantial influence on the fan root static pressure zone whose flow is destined for the high compressor by depressing the static pressure field in those regions corresponding to low total pressure zones in the fan flow exiting into the high compressor. The net result of approximating the static pressure field strength to that of the total pressure field is the tendency to maintain a constant velocity throughout the flow field, despite the presence of non-uniform total pressure gradients. A uniform velocity flow field is beneficial to fan performance in that design levels of blade loading are not exceeded because low-velocity-induced rotor blade stall is avoided. This characteristic is discussed in detail in Report A, Section IIIA - Fan/Compressor Performance.

A circumferentially-variable back pressure capability will be incorporated in the engine annulus portion of the fan rig discharge and will simulate the above characteristic of the high compressor by diverting high

DII-5

**CONFIDENTIAL**

**CONFIDENTIAL**

energy air flow into those engine flow zones of low energy. The degree and circumferential extent of back-pressuring will be initially predicted, and later modified as required when testing of the rematched engine rig is initiated for quantitative determination of high compressor-fan interaction effects. Figure 3 shows a representation of this apparatus. The individual groups of flow controllers are independently positioned at the exit of each duct partition such that the proper circumferential distribution of the engine flow Mach number is attained within each segment of the engine duct.

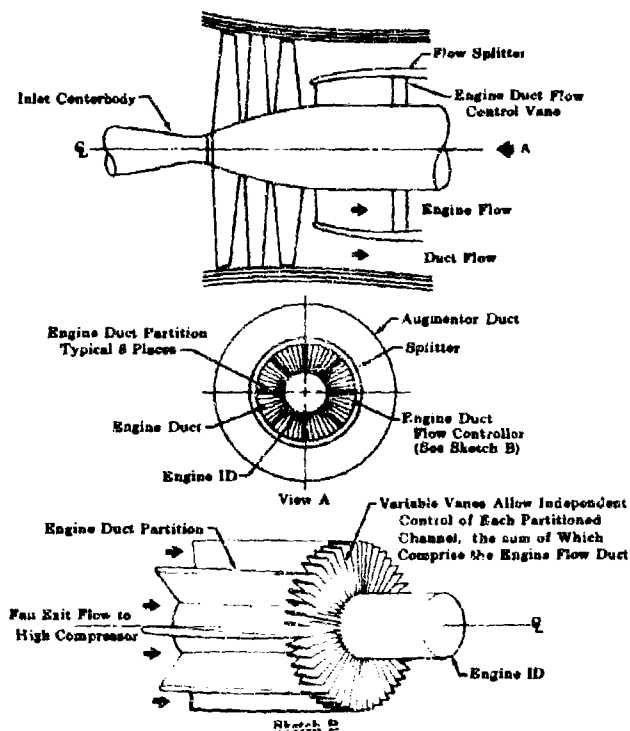

Figure 3. Inlet Test Rig Schematic

FD 16779  
DII

#### 4. 0.6 Scale Fan Rig Tests

Initial fan component testing will be accomplished using a 0.6 scale fan rig with distortion screens that duplicate the total pressure inlet distortion of the airframe manufacturer's inlet. In order to attain a more realistic and meaningful test, the fan rig will include circumferentially variable, back-pressure apparatus described in the preceding paragraph. Without the flow controllers in the engine duct, distortion testing of the 0.6 scale fan rig is useful, but in matching the predicted annular distribution of compressor air flow the stabilizing effects of the high compressor presence are simulated.

The majority of testing to refine the analytical simulation program used for the prediction of distortion effects will be done using this rig. Distortion screen testing intended to support and/or modify analytic

DII-6

**CONFIDENTIAL**

**CONFIDENTIAL**

**Pratt & Whitney Aircraft**  
PWA FP 66-100  
Volume III

theories will not be limited to usage of airframe inlet patterns, but will also incorporate distortion screen-generated perturbations aimed at the clear delineation of specific effects and their related causes. This testing is necessary to supply the calibration constants that will be progressively incorporated in the analytic prediction theory.

#### 5. Rematched Engine Tests

Early in the program, distortion screen testing using a modified engine will be accomplished. This engine will be modified by means of rematching to allow operation near its surge line at wheelspeeds corresponding to cruise operation. The method employed to induce fan surge will consist of progressively back-pressuring the augmentor duct, driving the fan into surge. Closure of the augmentor nozzle provides this back-pressure capability (A description of this engine is presented in Volume III, Report E, Section III).

The test objectives of this rematched engine are to determine the significance of high compressor interactions with the fan. These test results will be correlated with 0.6 scale fan rig distortion data, both with and without the latter's engine duct flow controllers. Necessary adjustments to the 0.6 scale fan rig flow controllers will be made on the basis of rematched engine test results, allowing further usage of the less expensive fan rig.

#### 6. 0.6 Scale Boilerplate Subsonic Diffuser and Fan Rig Tests

An additional step in inlet-engine component compatibility testing makes use of a "boilerplate" subsonic diffuser as supplied by the airframe contractor in conjunction with the 0.6 scale fan rig. This unit will be constructed such as to duplicate the inlet subsonic diffuser. A properly-positioned normal shock and preceding oblique shock will be produced at the entrance to the subsonic diffuser. The influence of the bleeds, and to a degree, the shock-boundary layer interactions will provide a partial simulation of inlet dynamics. The 0.6 scale fan rig used with the boilerplate inlet will permit an evaluation of the subsonic diffuser performance under more realistic operating conditions than were possible during inlet model tests.

#### 7. Full-Scale Fan Rig Tests

Following the 0.6 scale rig program will be full-scale fan distortion testing with engine duct flow controllers. Those fan configurations that show sufficient gains in distortion tolerance can be directly transferred to the concurrent complete engine program for further tests. As previously noted, the duplication of high-compressor interactions with the fan by use of a fan rig with controlled engine duct flow should provide accurate simulation of the engine fan characteristics.

Periodic cross checks will be made between results of this rig and the engine tests.

DII-7

**CONFIDENTIAL**

**CONFIDENTIAL**

8. Complete Engine Tests (Ref. Vol. III, Report E)

As a logical extension of the rig and modified engine test work described in the preceding section, the development of a compatible inlet-engine combination will be pursued through full-scale testing. Total duplication of the operating environment can be accomplished only by actual flight test. However, very early in the development cycle, rigorous experimental and analytical investigation can be conducted such as to include the great majority of in-flight variables. These tests will lead up to the full-scale simulated flight Mach number inlet engine compatibility test program that is planned for the AEDC facilities at Tullahoma, Tennessee and continue into the 100-hour prototype flight test program.

The primary objectives of full-scale engine testing include:

- Correlation of results with rig distortion testing.
- Evaluation of engine transient response in the presence of distortion.
- Evaluation of the effects of distortion on:
  - Steady-state engine performance
  - Turbine inlet temperature profiles
  - Duct heater operation
  - Altitude relight
- Checks on the validity of the analytical simulation programs and updating as required.
- Establishment of inlet and engine control systems compatibility.
- Correction of gross inlet-engine problems before proceeding with the AEDC test plan.

a. Testing with Distortion Screens

The airframe manufacturer will supply to P&WA the inlet distortion profiles obtained during the airframe inlet model test program. These profiles will depict both the time averaged distortion and the maximum instantaneous distortion recorded for each of the Mach numbers and attitudes investigated. Distortion generators will be used to reproduce these patterns during engine test so that ultimately the engine fan will accommodate the distortion pattern of the actual airframe inlet.

Experience in developing engines to operate in harmony with supersonic inlets has demonstrated that blockage screens installed one or two engine diameters ahead of the engine face in a properly constructed short duct can be used successfully to subject an engine or compressor rig to the distorted pressure field produced by an actual aircraft inlet. If, in the actual inlet duct, any bypass bleed doors, bends, etc., exist within the above-mentioned distance from the engine face, they will be duplicated in the test stand representation.

It is not sufficient to consider only the overall time-average distortion. As was indicated in the preceding section, the distortion pattern produced by an inlet ahead of an engine can be expected to vary with time. Experience has shown that if the distortion pattern that exists just prior

**CONFIDENTIAL**

**CONFIDENTIAL**

**Pratt & Whitney Aircraft**

PWA FP 66-100

Volume III

to a surge is recorded, and reproduced by the above mentioned distortion screens, the test engine will surge at the same operating conditions that accompanied the surge.

As discussed in Report A, the fan and compressor development will be directed toward attenuating the distortion profile. First stage turbine vane leading edge thermocouples will be installed to measure the effect of distortion on the turbine inlet temperature pattern.

The program will begin with testing in the P&WA sea level test stands. The initial tests will be designed to permit a comparison of the engine's takeoff performance obtained with a conventional bellmouth to that which results from running with the distortion screens described above. The engine/inlet characteristics will be evaluated at all engine conditions to demonstrate the ability to tolerate the distortion levels associated with landing approach, and after takeoff, with the thrust cut-back for community noise abatement. A demonstration of the JTF17's ability to function without performance loss or surge during these critical phases of operation will help ensure the development of an airplane that is both safe and quiet.

Following the sea level test, the distortion program will be shifted to the P&WA altitude test facilities. The program to be run in this facility will permit a detailed determination of the effects of inlet distortion on overall engine performance, required control schedules, duct heater efficiency, lighting limits, augmentor-blow-out limits, windmill relight characteristics, and turbine inlet temperature patterns.

In the event the distortion levels from the aircraft inlet model tests exceed the limits presented in the engine model specification, the test program will be aimed toward an evaluation of the effects of this distortion. Modifications will be proposed either to improve the distortion patterns supplied by the airframe manufacturer or to accommodate the inlet distortion in the engine. These modifications will be evaluated in a coordinated program with the airframe manufacturer. This will ensure the development of a propulsion package that provides optimum performance and stability in a minimum amount of time and with minimum cost.

The simulated altitude program will consist primarily of steady state calibrations plus normal augmentor transients. This will provide not only a demonstration of satisfactory engine performance but will verify the JTF17 insensitivity to reasonable inlet distortion during augmentor lights, throttle excursions with the augmentor lit and augmentor shut-off transients.

b. Testing with Simulated Inlet

(1) Boilerplate Subsonic Diffuser Tests

To more nearly simulate in-flight inlet dynamics, a boilerplate facsimile of the subsonic diffuser portion of the inlet duct (schematically illustrated in figure 4) will be installed ahead of the engine in the P&WA altitude test facility. This facsimile will be designed to produce a representation of the last oblique shock and the terminal normal shock associated with the actual inlet. The duct representation

DII-9

**CONFIDENTIAL**

**CONFIDENTIAL**

will include the inlet boundary layer bleed and bypass systems and their associated controls. The program to be run with this configuration will be primarily directed toward an assessment of the effects of inlet and engine dynamics on propulsion system compatibility. The test objectives will include an evaluation of the effects of terminal shock location, turbulence, and bypass flow variations.

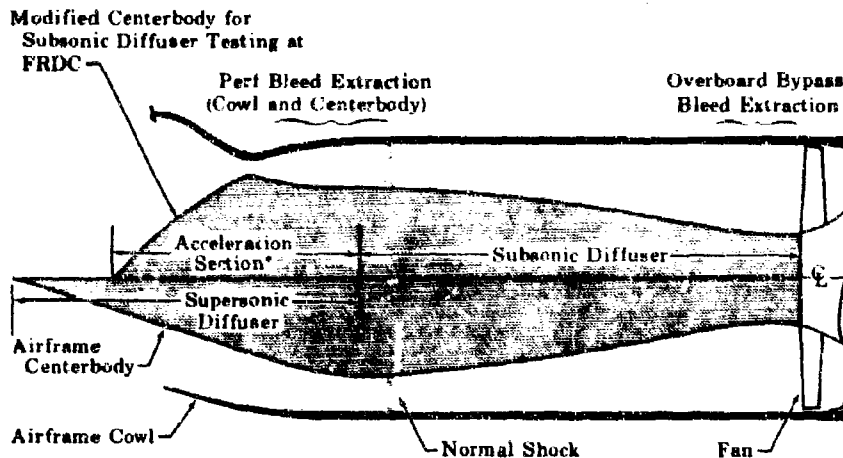

Figure 4. Inlet Duct Subsonic Diffuser  
Schematic

FD 17647  
DII

Within the limits imposed by the facility, tests will be conducted to determine the inlet duct response to engine transients and engine response to the inlet. These will include normal duct heater lights and shutoffs, engine acceleration and deliberately provoked airflow excursions beyond the normal tolerance limits.

In addition to evaluating the effects of engine transients as described above, the program will also include an investigation of the effects of bypass bleed valve excursions, variations in boundary layer bleed extraction, etc.

Artificially induced flow disturbances will be used to permit an evaluation of the sensitivity of the propulsion system to inlet boundary layer separation.

#### (2) Boilerplate Full Inlet Duct Tests

A boilerplate representation of the full inlet duct will be tested for compatibility on a JTF17 engine on a P&WA sea level test stand. These tests will be designed to investigate the effect of distortion on transient operating characteristics of the engine. This will be accomplished by subjecting the engine to a series of increasing rates of acceleration and deceleration.

DII-10

**CONFIDENTIAL**

**CONFIDENTIAL**

**Pratt & Whitney Aircraft**

PWA FP 66-100

Volume III

A proper evaluation of the effects of distortion on engine transient characteristics cannot be limited solely to gas generator transients but will include augmentor transients and an investigation of the effects of inlet pressure loss on starting characteristics. This phase of the test program will verify the engine's tolerance to distortion during typical duct heater light and shutoff transients. In addition to providing high efficiency and good stability during steady state operation, the augmentor and control systems are specifically designed to avoid fan surge during transients. A series of starting tests will also be conducted to define the optimum fuel control schedule with realistic inlet duct loss and distortion.

An important part of the noise abatement plan is the use of a choked or near-choked inlet duct to reduce forward propagated rotor noise during landing approach. A series of tests will be run in the P&WA sea level test facility to ensure freedom from any problems during this mode of operation.

#### 9. Instrumentation

The instrumentation needed for inlet-engine compatibility is divided into two categories, static instrumentation for quasi-steady engine operation and dynamic instrumentation for time variant processes that require a high degree of definition. Both types of instrumentation are useful in the isolation of component interaction effects, these effects being obtained by comparison of the component performance within the system to individual test performance. In addition to the instrumentation required to determine overall engine performance, special instrumentation will be installed to permit evaluation of the effects of distortion on turbine inlet temperature profiles, duct heater discharge temperature and pressure profiles, duct heater efficiency, etc. Dynamic instrumentation with response times of less than one millisecond will allow accurate definition of transients during the control compatibility and distortion testing.

#### 10. Compatibility Tests in AEDC Facilities

The test program described above will lead up to compatibility tests of the complete propulsion package that are scheduled to be run in the AEDC propulsion wind tunnel in Tullahoma, Tennessee. The details of this program are covered in the engine-inlet compatibility test plans that have been coordinated between Pratt & Whitney Aircraft and the two airframe manufacturers. The Pratt & Whitney Aircraft test program is designed to reduce the number of problems that may be encountered during the complete propulsion package compatibility evaluation at AEDC. The time spent in the 16 foot wind tunnel at Tullahoma may then be devoted exclusively to evaluation of those facets of the propulsion system compatibility investigation that can only be handled with realistic external flow.

#### 11. Flight Tests

The ultimate test of the engine/airframe compatibility will begin with the 100-hour flight test of the prototype supersonic transport. The

DII-11

**CONFIDENTIAL**



**CONFIDENTIAL**

propulsion system performance will be monitored by instrumentation and recording devices. Engine/inlet compatibility and performance and the operation of inlet and engine control systems will be evaluated in various steady state and transient flight conditions throughout the flight envelope. In addition, extreme and abnormal flight conditions will be simulated in flight. Pratt & Whitney Aircraft will prepare a propulsion system flight test program in coordination with the airframe manufacturer and will provide full support for the flight tests throughout the program.

#### 12. Cross-Check with Analytical Simulation

Throughout the test program described above, a continuous cross-check between engine test results and the analytical simulations described in the following section will be maintained. This will permit updating of the various simulation system gains and time constants and will ensure that the desired stability and performance requirements are met. Furthermore, this effort will permit an incorporation of the effects of inlet distortion and representation of certain failure modes into the simulations.

#### D. ANALYTICAL SIMULATION

##### 1. Introduction

Engine/inlet compatibility over the entire range of operation is important to the design and development of a supersonic propulsion system. The interactions between the engine and inlet are so many and complex that it would be hopeless to develop the system with a seat-of-the-pants, cut-and-try approach. Computer methods have been developed that allow dynamic simulation of inlet, engine and control systems. Use of these simulations permits the choice of proper control modes in the design stage rather than after flight test. Simulations continue to be valuable diagnostic tools throughout the development and flight test program, when measured component performance can be substituted for the originally estimated values in the computer. Dynamic simulation is thus particularly useful in simulating flight test problems and exploring various means of solution through control system changes and adjustments prior to actual flight testing of such changes.

Pratt & Whitney Aircraft has made extensive use of dynamic simulation to design and improve its engines. For example, during the design and development of the RL10, liquid hydrogen fueled rocket engine, dynamic simulations of the system required approximately 13,700 computer hours. Solutions to pump stall and control instability problems were found that were then confirmed by hardware tests, leading to a record of 48 engines flight tested without a failure. Similarly, for the J58 high Mach number turbojet engine, dynamic simulations of the engine/inlet system conducted in cooperation with the airframe manufacturer early in the program, involving 8430 computer hours, led to inlet control and engine control modifications before expensive hardware was committed. As a result, compatibility between the engine control system and the inlet control has presented no serious problems in the J58 installations.

**CONFIDENTIAL**

**CONFIDENTIAL**

**Pratt & Whitney Aircraft**  
PWA FP 66-100  
Volume III

Following this precedent, dynamic simulations of the JTF17 engine and control systems with the airframe inlet have been prepared and studied for approximately 2900 hours to aid the design and development of these systems. As rig and engine test data become available they will be used to verify the simulation and contribute to further improvement of performance. During Phase III and the remainder of Phase II, gains and time constants of the engine and control system will be continuously updated as required. (Refer to Report BIIIC and D and Report EI and II for complete discussion of engine and control test plans.)

## 2. Analytical Technique and Simulation

### a. Technique

The objective of a dynamic simulation dictates the analytical technique. Engine/inlet compatibility simulation techniques range from the use of several simple test signal type simulations to IBM 360 computer simulations. These simulations compliment each other. Simple simulations provide rapid parametric analysis of quasi steady state operation. Complex simulations provide detailed analysis of large scale engine/inlet transients.

The dynamic analysis of the JTF17 engine/inlet propulsion system requires both simple and complex simulations. Simple simulations have been programmed on digital and analog computers. A complex detailed simulation has been programmed on the IBM 360 digital computer. These programs have been closely coordinated with both airframe manufacturers to ensure the integrity of both the steady state and dynamic characteristics of the engine/inlet simulations.

As shown in Figure 5, typical engine operation at a given flight condition consists of a constant airflow regime and a non-constant airflow regime. Aircraft operation, except for descent, is expected to be in the duct heater lit constant airflow regime. A complex highly detailed simulation is used for the study of transients involving large variations in airflow, flight condition, and for failure analysis.

### b. Simulation

#### (1) Digital

Digital Computers are utilized for dynamic simulations by including the proper differential equations necessary for rotor inertia, mass storage, and control dynamics. Transients are calculated by computer cycling through the simulation for finite time increments. This time increment is selected to be compatible with the simulation dynamic characteristics. To illustrate, a simple first order lag is programed as follows:

In Laplace Notation

$$\frac{\text{Output}}{\text{Input}} = \frac{1}{\gamma s + 1}$$

Schematically: (See figure 6).

The calculation can be unstable if the time increment for calculation is not compatible with the time constant of the system.

DII-13

**CONFIDENTIAL**

**CONFIDENTIAL**

The desired result is shown in figure 7.

The above plot demonstrates a stability criterion necessary in digital programming of dynamic simulations. The time increment used in the calculation should be equal to or less than the smallest time constant in the system. The exact solution is approached by decreasing the size of the time increment.

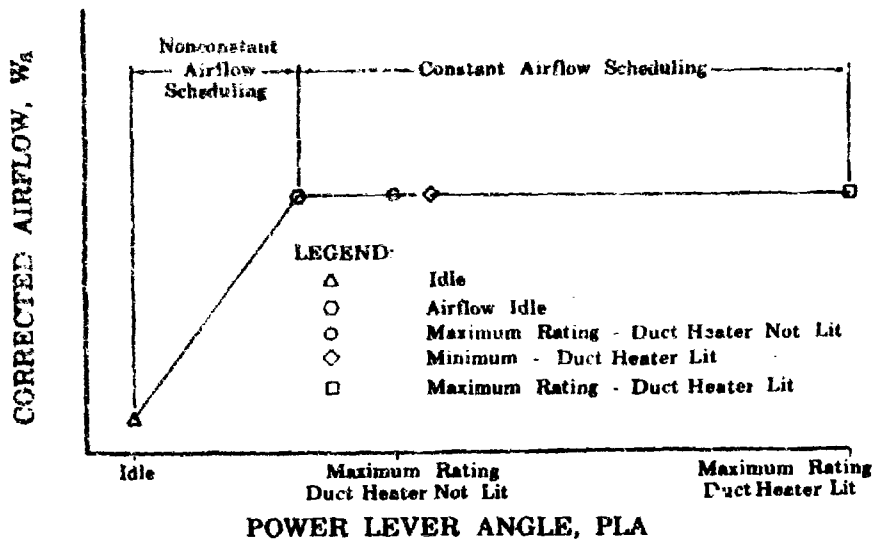

Figure 5. Typical Engine Operation

FD 16695  
 DII

S - Laplace Operator

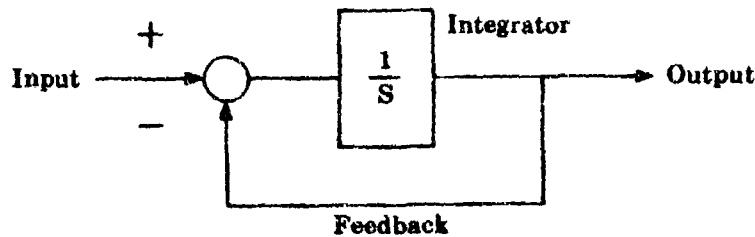

Figure 6. Schematic Representation of a Simple First Order Lag

FD 16691  
 DII

**CONFIDENTIAL**

The Desired Result is:

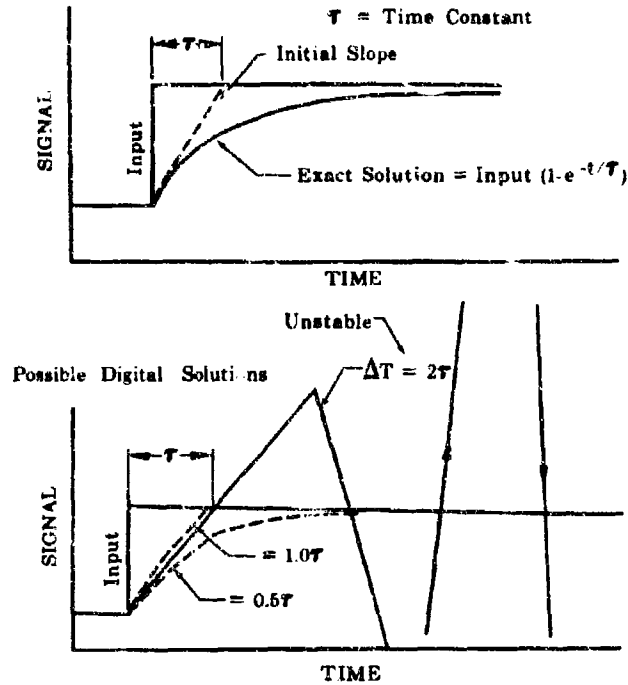

Figure 7. Stability Criterion for Digital Programming of Dynamic Simulations FD 16692  
DII

(a) IBM 1620 Simulations

Simple inlet simulations received from both airframe manufacturers have been programmed for checkout and study on the IBM 1620 computer. Figure 8 is a block diagram and a schematic of the Boeing Aircraft inlet simulation. Figure 9 represents the duct dynamics and bypass control system of the Lockheed Aircraft inlet simulation. The use of these simulations is discussed in paragraph 3, Analytical Studies. These simulations represent early estimates of the dynamics of the two inlets. The response and dynamics of both inlets are being improved through continued airframe development and test. Revisions to all computer simulations will be incorporated as they become available.

(b) IBM 360 Simulations

(1) Engine/Inlet Dynamic Simulations

A complex, highly detailed engine and control simulation has been prepared for study on an IBM 360 type digital computer. An interface deck has been written to enable coupling of the engine/control deck with an inlet simulation. The program can operate with or without an inlet simulation. This engine/control simulation has been sent to the airframe manufacturers for their engine/inlet compatibility studies. The simulation

**CONFIDENTIAL**

is very versatile. All power lever transients from idle to maximum duct heat are available. The simulation operates at all flight conditions within the flight envelope. Flight condition and/or ambient condition can be changed as a function of time. Failure modes such as windmilling and blowout are available.

Engine/inlet transients are simulated by computer cycling beginning at the aircraft inlet and progressing through the engine control and engine component calculations to the exhaust system. Figure 10 is a simplified block diagram that depicts the flow of information that occurs in the engine/inlet system. Figures 11 through 14 show detailed block diagrams of the engine control as programmed for this simulation. Inlet simulations from the Boeing Company and Lockheed California Company have been programmed for JTF17 engine/inlet compatibility studies with the JTF17 engine and control. (See figures 8 and 9.) These simulations represent early estimates of the two inlets and are dynamically identical to the simulations discussed above.

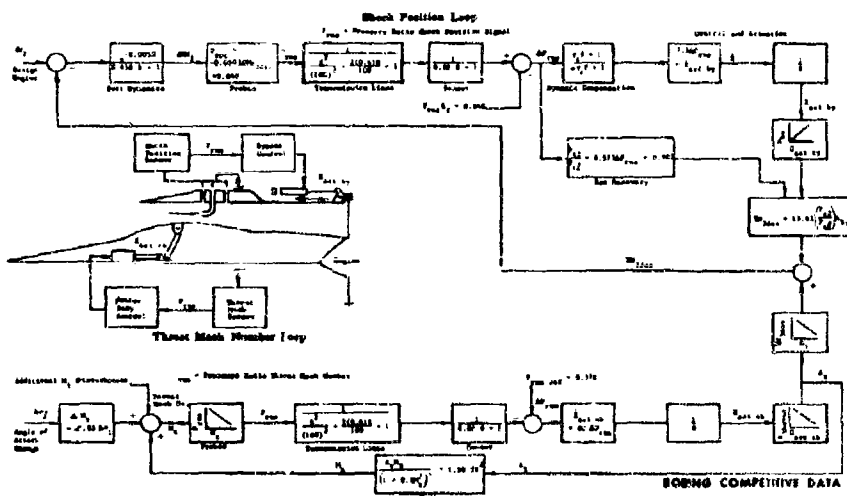

Figure 8. Boeing Simplified Inlet Block Diagram and Schematic

FD 16700  
DII

**CONFIDENTIAL**

**CONFIDENTIAL**

**Pratt & Whitney Aircraft**  
PWA FP 66-100  
Volume III

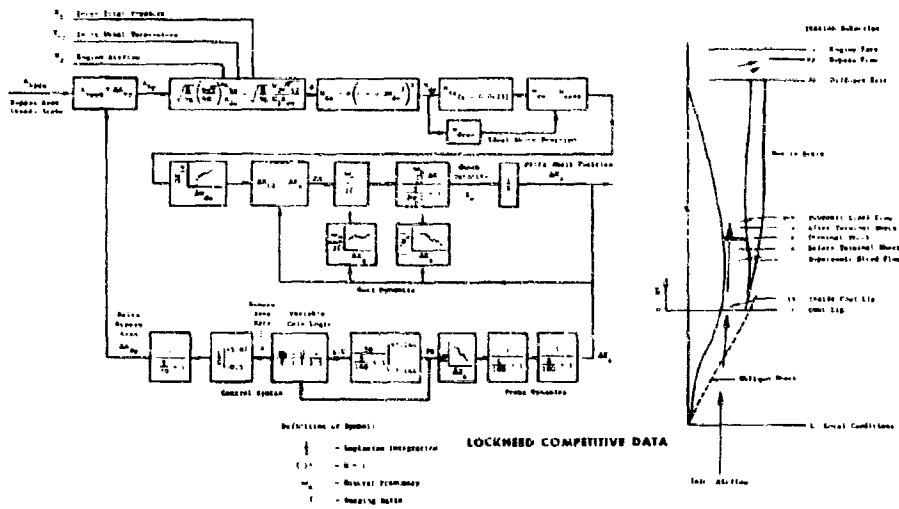

Figure 9. Lockheed Inlet Duct Dynamics and Control System

FD 16701  
DII

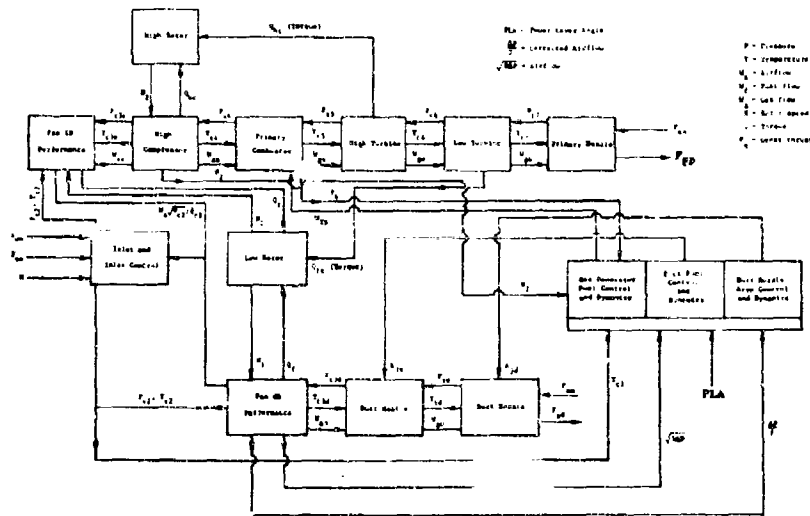

Figure 10. Digital Dynamic Simulation, Inlet/Engine Control

FD 16702  
DII

**CONFIDENTIAL**

**CONFIDENTIAL**

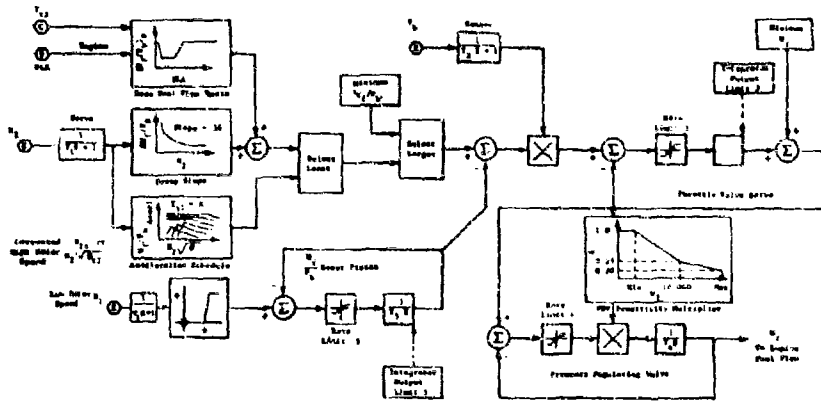

Figure 11. Gas Generator Control Function Diagram

FD 14758A  
DII

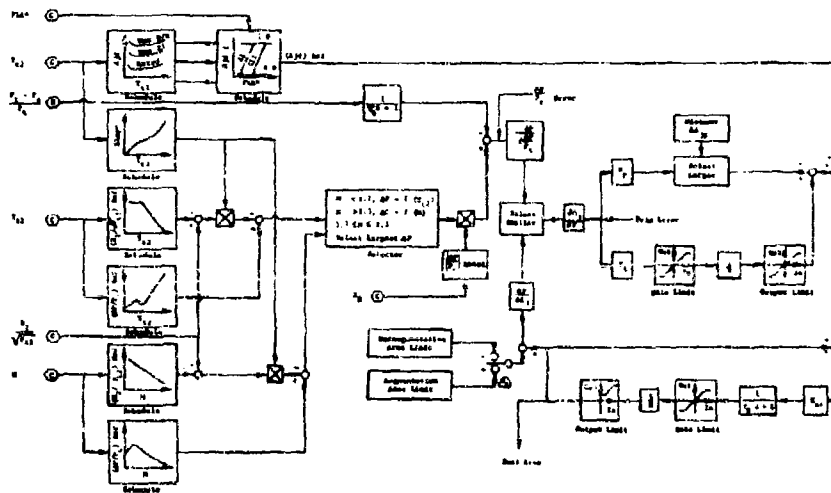

Figure 12. Exhaust Nozzle Area Control Function Diagram

FD 16777

DII-16

**CONFIDENTIAL**

**CONFIDENTIAL**

**Pratt & Whitney Aircraft**

PWA FP 66-100

Volume III

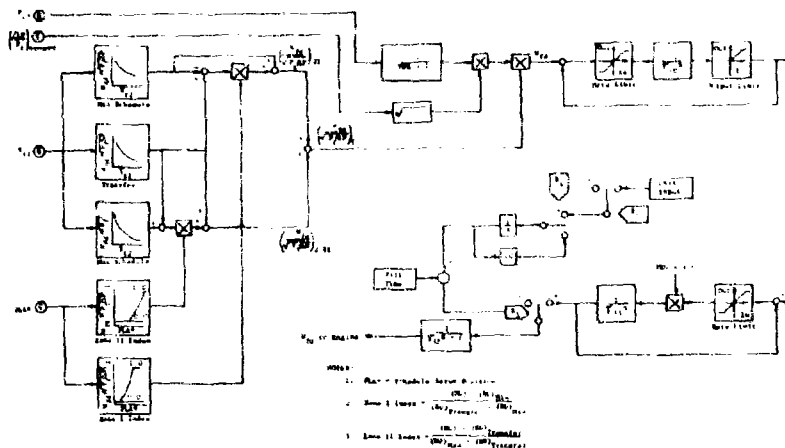

Figure 13. Augmentation Fuel Flow Control Function Diagram

FD 16748

DII

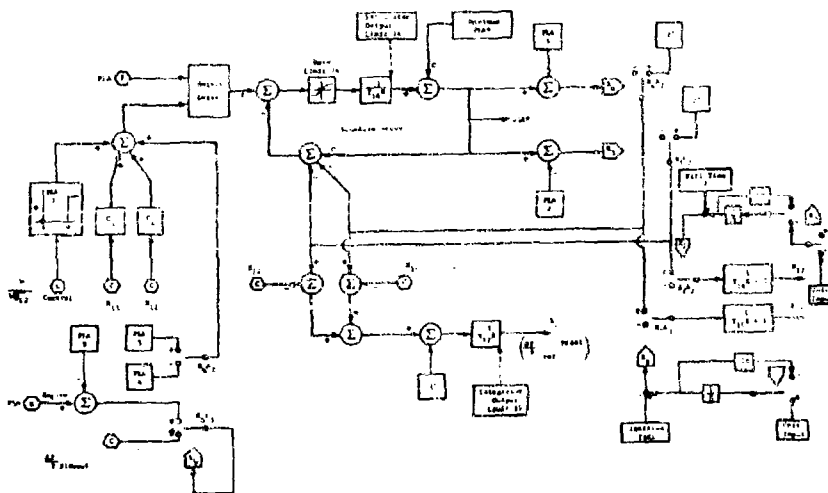

Figure 14 Schedule Servo and Ancillary Valves

FD 14770

DII

DII-19

**CONFIDENTIAL**



**CONFIDENTIAL**

## (2) Stability Analysis

An IBM 360 calculation routine is used for stability estimates. To analyze system stability a mathematical model of the dynamic properties of the system is constructed in the form of a block diagram. Each block in the diagram contains a mathematical expression (in Laplace notation) which represents the dynamic characteristics of a system component. The blocks are connected by lines representing the flow of interaction between components. The blocks are combined in a manner similar to combination of series and parallel electric components until the system is represented by one mathematical expression in one block with one input and one output. This single block transforms the input into the output and is called the system transfer function. The transfer function facilitates the frequency response analysis of system stability. Using the transfer function, the system output in response to a sinusoidal input can be determined. The magnitude and phase of the output wave relative to the input wave are calculated for a wide range of input frequencies. This output/input relationship is compared with established, mathematically derived criteria for divergence and limit cycle instability to determine if a system will be stable.

The IBM 360 calculation routine performs the following functions: (1) makes the detailed algebraic computations of reducing the block diagram to transfer function form, (2) calculates the magnitude and phase of the output relative to the input, for a given frequency input, (3) automatically plots frequency response results in any of several formats, (4) and in addition calculates parameters of interest including gain and phase margins and error coefficients.

## (2) Analog Simulations

The analog computer is used to study inlet/engine compatibility and dynamic response when simple simulations can be used (cruise mode of operation is an example). The inherent desirable characteristic of an analog computer is that it simulates the primary system in a continuous manner as opposed to the discrete time interval simulation of a digital computer. This provides excellent response characteristics. As an example, consider the first order lag described above for programming on a digital computer. The analog computer gives the exact solution as shown in figure 7.

Simple engine/control simulations have been generated and have been sent to the airframe manufacturers for their engine/inlet compatibility studies. Figure 15 illustrates a simple engine/control simulation suitable for power lever transients from maximum rated duct heater not lit to maximum thrust duct heater lit at all inlet started flight conditions. Figure 16 illustrates a similar dynamic simulation for part power engine/inlet compatibility studies at the supersonic cruise flight condition. Figure 17 is a schematic of a simple engine/inlet system used for analog studies. These simulations permit rapid assessment of current and proposed engine/inlet operation.

**CONFIDENTIAL**

**CONFIDENTIAL**

**Pratt & Whitney Aircraft**  
PWA FP 66-100  
Volume III

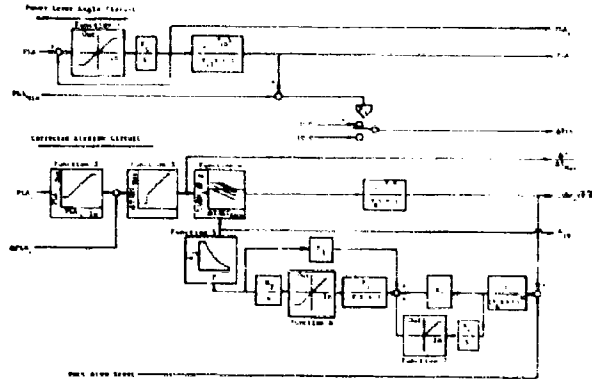

Figure 15. Engine/Control Simulation for Power Lever Transients FD 15581  
DII

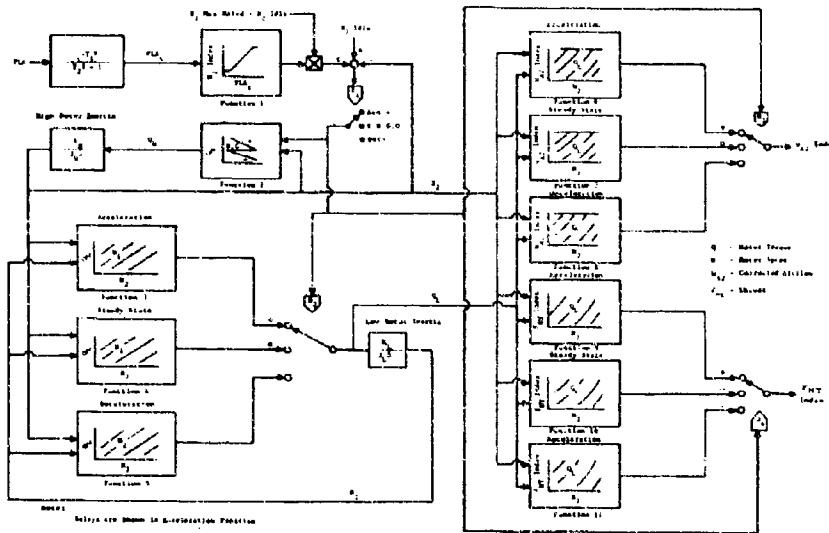

Figure 16. Engine/Control Simulation for Part Power Engine/Inlet Compatibility FD 15582  
DII

**CONFIDENTIAL**

**CONFIDENTIAL**

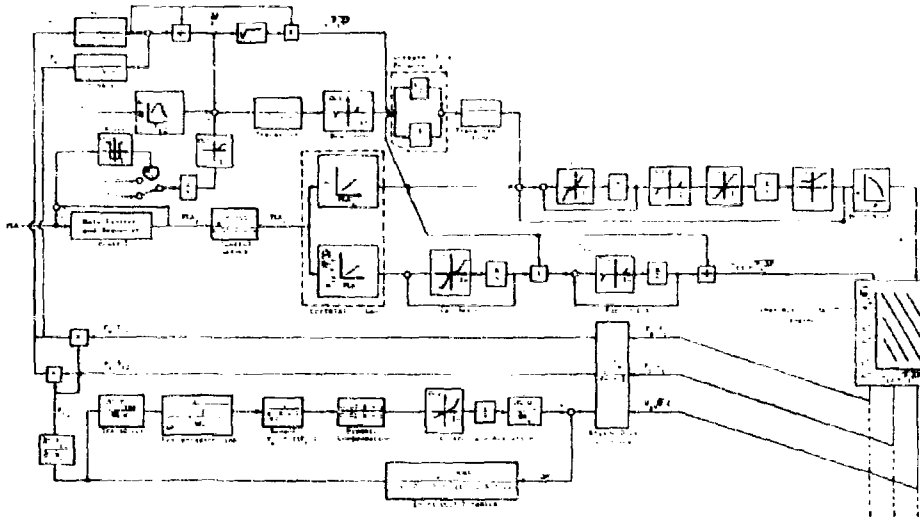

Figure 17. Engine/Inlet System for Analog Studies

FD 16703  
DII

### 3. Analytical Studies

#### a. Response and Stability

The excellent engine control frequency response characteristics and scheduling tolerances that exist over the entire JTF17 operation envelope further improve engine/inlet compatibility. Using the extensive experience gained by the J58 and other supersonic engine control programs, the JTF17 control, Report B-III, provides excellent scheduling tolerances and stability margins with closed loop vernier control. High frequency response characteristics are provided with open loop basic control.

This combination of basic control and vernier control, used by earlier supersonic engine controls and now further improved by the JTF17 control, decreases the level of engine induced disturbances upon the inlet.

Figure 18 illustrates the JTF17 control concept used to combine the advantages of both basic control and vernier control. JTF17 turbine temperature control is similar to the J58 control. The best features of the J58 and other supersonic engine control systems are incorporated in the JTF17 control. Figure 19 is a simple analytical model of the JTF17 control concept. A relatively slow highly accurate closed loop vernier control is used to adjust a high response reliable open loop basic control. Exceptional control accuracy, response, and reliability are the result.

Engine response and stability is further improved by JTF17 control gain schedules that are similar to J58 gain schedules. These schedules provide overall gain compensation. Gain compensation maintains the same overall duct area control sensitivity. JTF17 control gain schedules

**CONFIDENTIAL**

**CONFIDENTIAL**

**Pratt & Whitney Aircraft**  
 PWA FP 66-100  
 Volume III

achieve this objective by varying control gain inversely with duct heater gain. Gain compensation improves engine/inlet compatibility by maintaining JTF17 response and stability without deviation from nominal design levels.

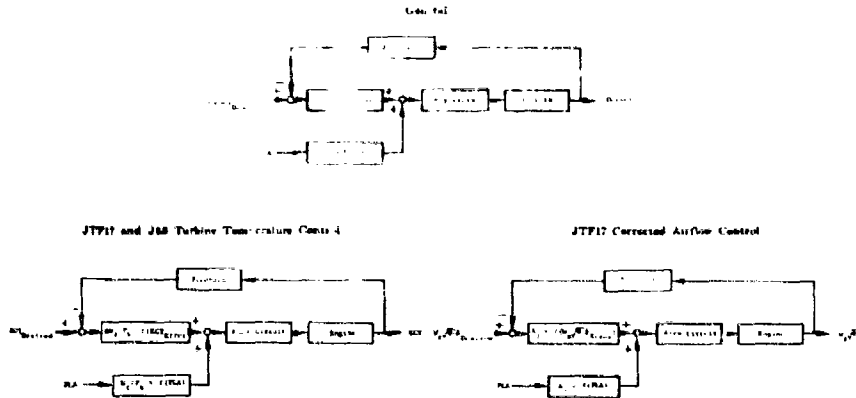

Figure 18. JTF17 Control Concept

FD 16704  
 DII

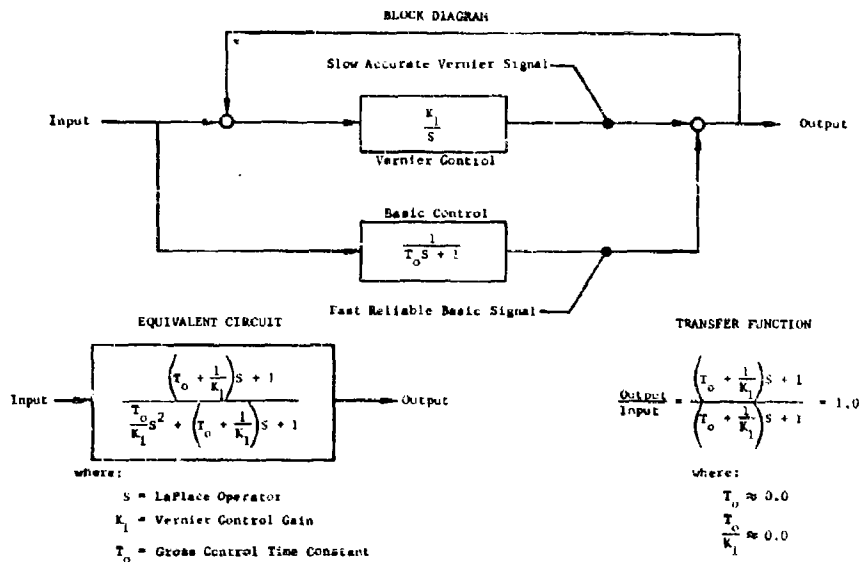

Figure 19. JTF17 Control Concept Analytical Model

FD 16705  
 DII

**CONFIDENTIAL**

**CONFIDENTIAL**

b. Downstream Transient Feedback Effects

Studies have been made to minimize downstream transient effects on the fan surge margin and inlet shock position. Protection is provided against adverse engine/inlet interaction due to duct heater light or rapid power lever movement.

One method of minimizing these effects is to minimize the fuel/air ratio required for ignition of the duct heater. During Phase II-C the minimum duct heater fuel/air ratio has been reduced from 0.008 to 0.002. This reduction came about when the duct heater configuration was changed from an aerodynamic flame holder type to a ram induction type. The ram induction configuration is characterized by very soft, smooth ignition at fuel/air ratios of 0.002 or less. Figures 20 and 21 are traces of data taken from oscillograph records of Zone I ignition at a 0.002 fuel/air ratio setting in the full-scale annular duct heater rig at conditions of pressure, temperature, and airflow corresponding to sea level static and cruise respectively. The pressure pip for the cruise light was 3.6% of the absolute pressure level and for the sea level light was 3% of the absolute level. These pressure increases were measured at the duct heater station. These pressure pulses will attenuate before reaching the fan discharge station. (See Engine Performance, Duct Heater, Sections III-A, III-B, III-C, and III-D for a complete description of the duct heater development.) Figures 22 and 23 show calculations from the digital simulation for duct heater light at sea level static and cruise with light-off fuel/air ratio of 0.002. Figures 24 and 25 are simulation traces of a 0.008 fuel/air ratio light-off with a ram induction duct heater at sea level static and at cruise. As shown by the traces, a reduction of light-off fuel/air ratio reduces the effect on surge margin and the airflow error signal. This low ignition fuel/air ratio also significantly reduces the thrust discontinuity at light-off.

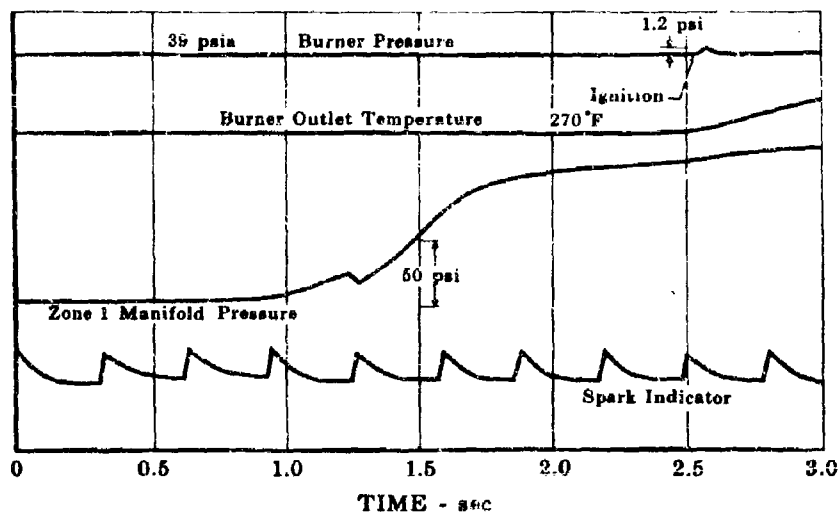

Figure 20. Sea Level Takeoff F/A 0.002 Full Scale Annular Duct Heater Rig

FD 16696  
D11

D11-24

**CONFIDENTIAL**

**CONFIDENTIAL**

Pratt & Whitney Aircraft  
PWA FP 66-100  
Volume III

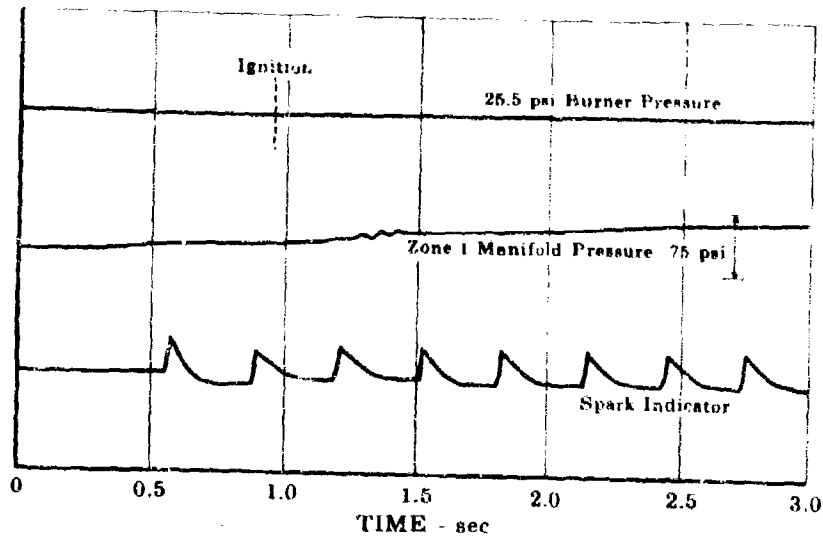

Figure 21. Full Scale Annular Duct Heater  
Rig Cruise Ignition (65K)

FD 16697  
DII

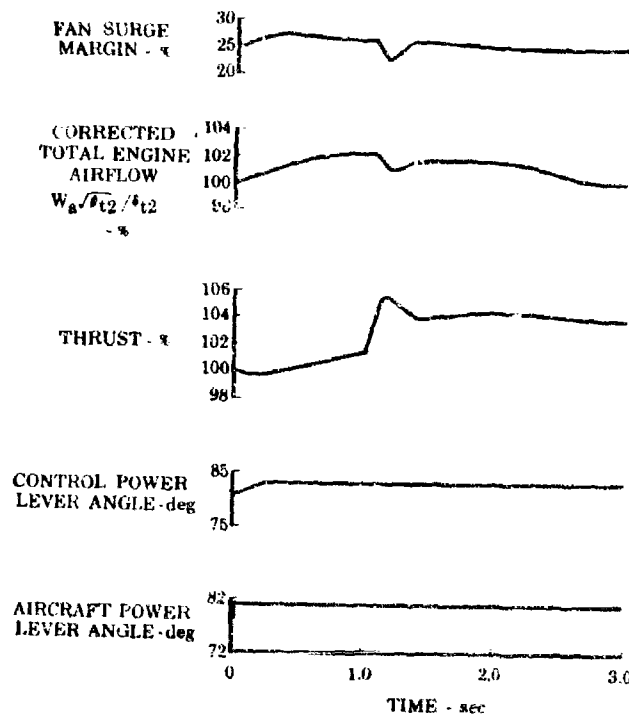

Figure 22. Maximum Nonaugmented to Minimum  
Augmentation Current Duct Fuel/Air  
Ratio

FD 16706  
DII

DII-25

**CONFIDENTIAL**

**CONFIDENTIAL**

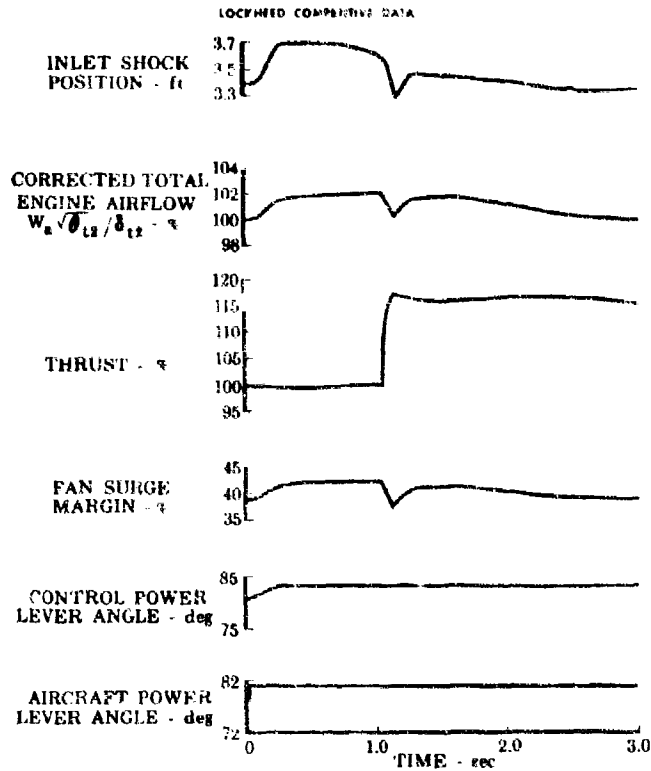

Figure 23. JTF17 Cruise Maximum Nonaugmented FD 16714  
to Minimum Augmentation Current Duct DII  
Fuel/Air Ratio

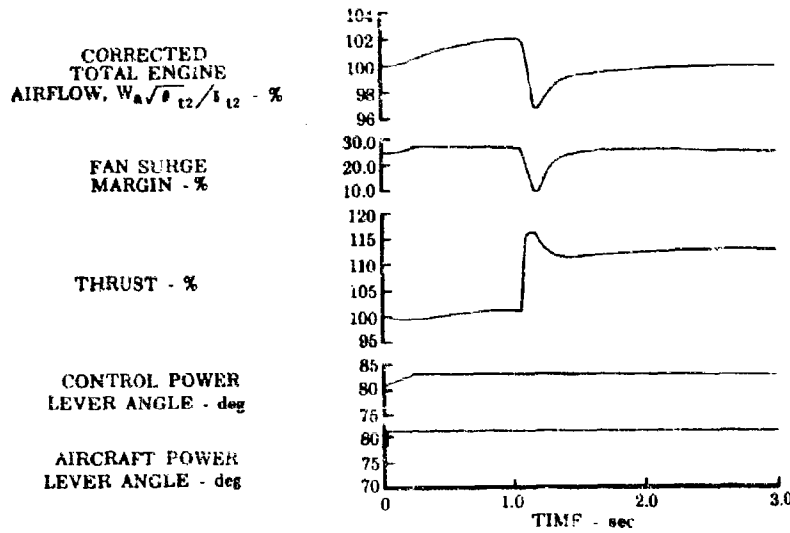

Figure 24. JTF17 Sea Level Static Phase II-B FD 16713  
Minimum Duct Heater Lightoff DII  
(F/A = 0.008)

**CONFIDENTIAL**

**CONFIDENTIAL**

Pratt & Whitney Aircraft

PWA FP 66-100

Volume III

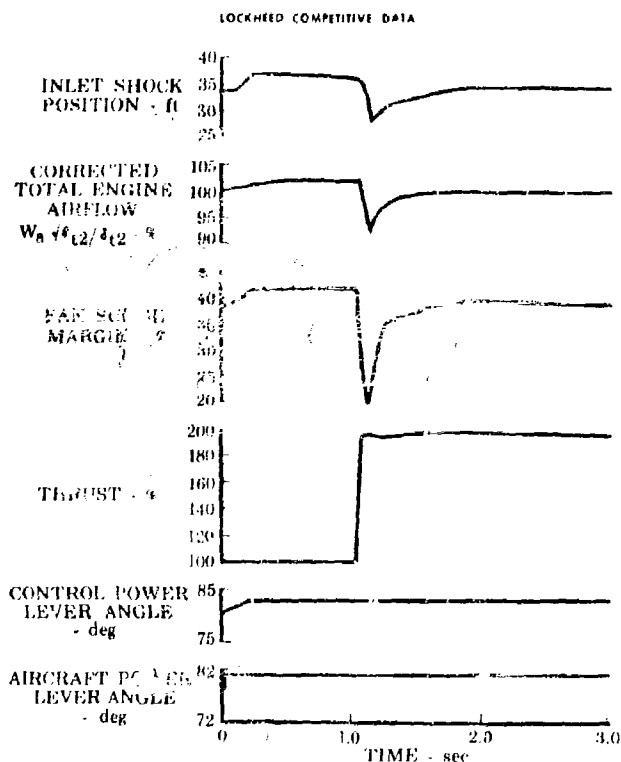

Figure 25. JTF17 Cruise Phase II-B Minimum Duct Heater Lightoff (F/A = 0.008) PD 16715 DII

Another method of minimizing the pressure ratio and airflow variation is to correlate duct nozzle area and fuel flow. Ideally, or with perfect correlation, there would be no effect on fan pressure ratio or airflow due to power changes in the duct heating mode. Figure 26 illustrates two correlation schemes, the TF30 and the JTF17. In the TF30 scheme, only one zone of the five separate burning zones is shown. Power lever angle schedules gross duct nozzle area which then schedules duct fuel flow with the correlation cam. A proportional plus integral controller makes vernier adjustments to the system. The correlation cam scheme for the JTF17 is an improvement over these earlier configurations. The nozzle area feedback scheduling of fuel has been eliminated. Duct nozzle area and fuel flow are scheduled directly with power lever angle and nozzle area is adjusted by a proportional plus integral controller to eliminate any airflow errors. Since perfect correlation is not possible with any real system, further steps are necessary to insure protection.

The JTF17 control definition provides nonlinear control characteristics that maintain inlet margin and fan surge margin equal to or greater than steady state margins. Figure 27 illustrates typical nonlinear gain and response circuits. Scheduling increased inlet bypass door area and increased duct nozzle area increases inlet unstart margin and fan surge margin. Figures 28 and 29 show the desired inlet and engine control action during transients. If a limit cycle of either duct fuel or area

DII-27

**CONFIDENTIAL**



occurs, the fan surge margin is increased due to nonlinear duct heater gain and response characteristics. A nonlinear gain is used with the duct corrected airflow error signal such that increases in duct airflow occur rapidly and decreases in duct airflow occur slowly. A similar nonlinear gain is used with the duct area slide valve. A nonlinear response is used with the duct heater fuel circuit such that increases in duct fuel occur slowly and decreases in duct fuel occur rapidly. The control further improves engine and inlet transient margins by resetting duct corrected airflow upon initiation of duct heating. Figure 30 illustrates the desired effect of duct nozzle area reset during power lever angle modulation in the duct heating mode. Transient surge margins are maintained greater than steady state surge margins. Figure 31 is a digital simulation trace of a power lever angle transient from maximum nonaugmented to maximum duct heat at cruise with neither inlet nor duct area reset. Figure 32 shows the same transient with duct area reset. Inlet unstart margin and fan surge margin are maintained at safe margins during the transient.

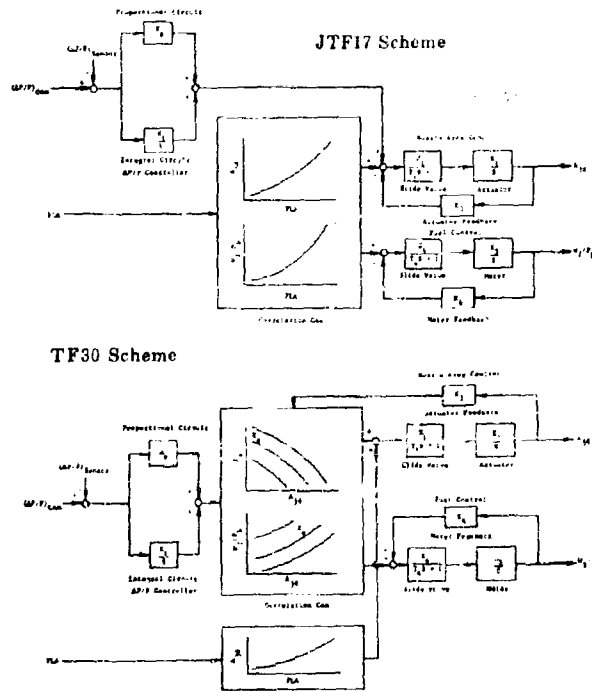

Figure 26. Duct Heater Control

FD 15698  
 DII

**CONFIDENTIAL**

Pratt & Whitney Aircraft  
PWA FP 66-100  
Volume III

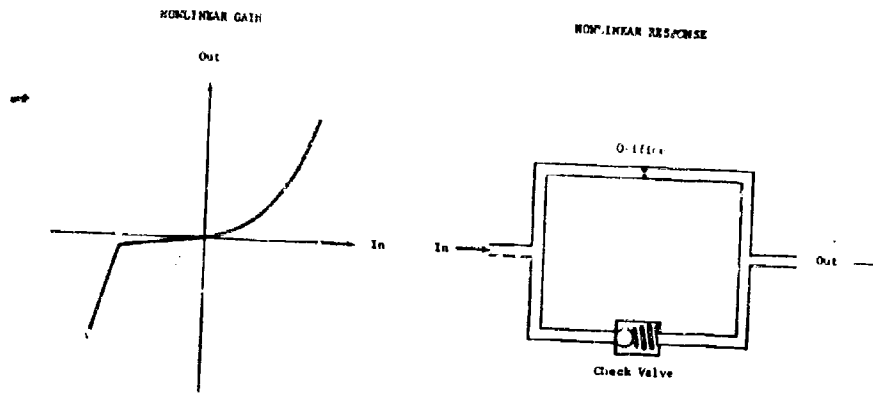

Figure 27. Typical Nonlinear Circuits

FD 15547  
DII

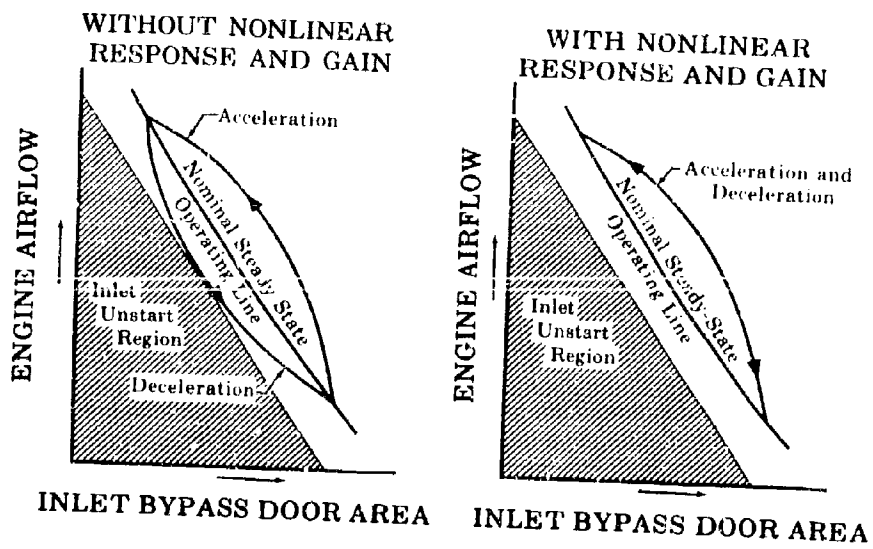

Figure 28. Inlet Control Action

FD 15545B  
DII

DII-29

**CONFIDENTIAL**

**CONFIDENTIAL**

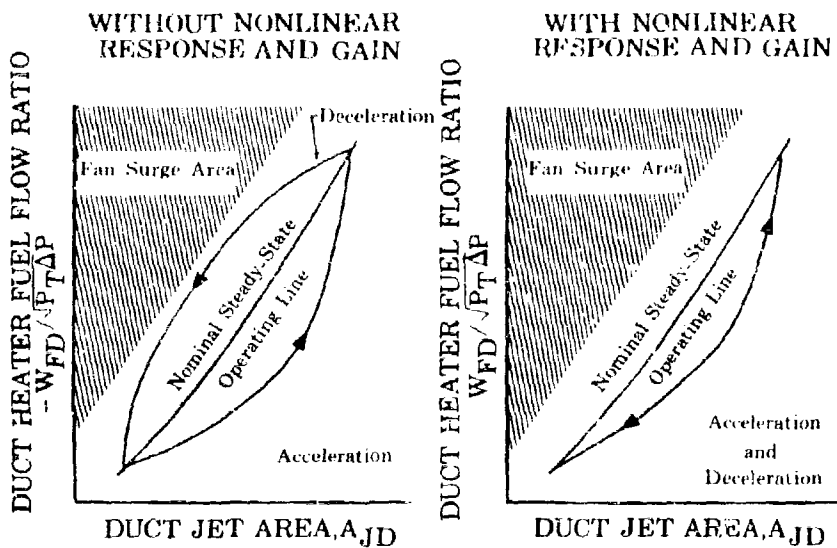

Figure 29. Duct Control Action

FD 15546  
 DII

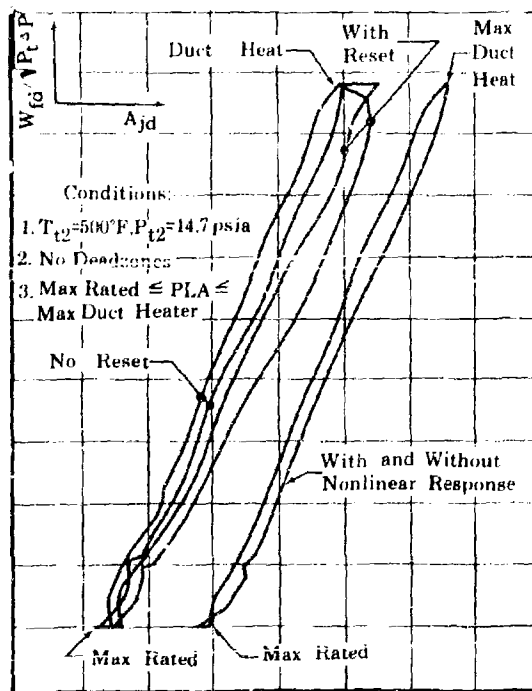

Figure 30. Analog Simulation Trace

FD 16740  
 DII

**CONFIDENTIAL**

CONFIDENTIAL

Pratt & Whitney Aircraft

PWA FP 66-100

Volume III

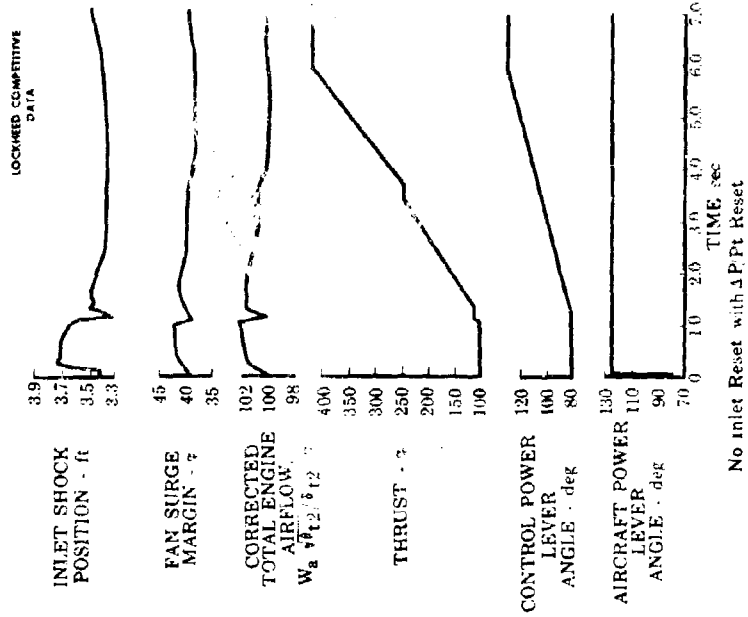

Figure 31. JTF17 Maximum Nonaugmented to Maximum Augmentation DII

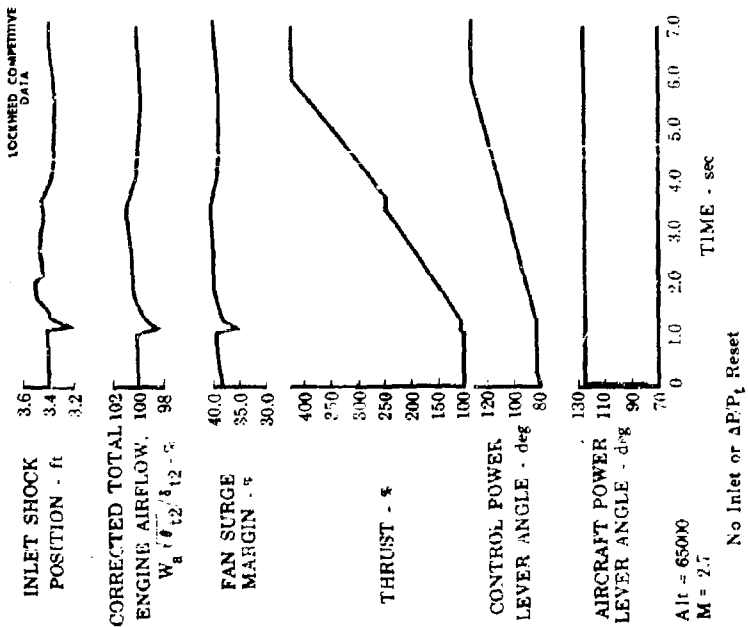

Figure 32. JTF17 Maximum Nonaugmented FD 16717 to Maximum Augmentation DII

CONFIDENTIAL

**CONFIDENTIAL**

Studies by the Lockheed and Boeing Companies show that inlet reset is not necessary and none is provided. A disadvantage inherent with inlet reset is the increase in distortion that accompanies supercritical inlet operation. If the inlet can be designed to operate safely without reset, this would, of course, eliminate the transient increase in distortion due to reset.

Figure 33 is a trace obtained from an early Lockheed inlet simulation with a severe ramp in engine airflow demand. The inlet simulation did not disgorge the shock and handled the airflow transient very well. Figure 34 is a simulation trace of a power lever transient from maximum rated to idle at cruise. Safe inlet unstart margins are maintained for this large transient in airflow.

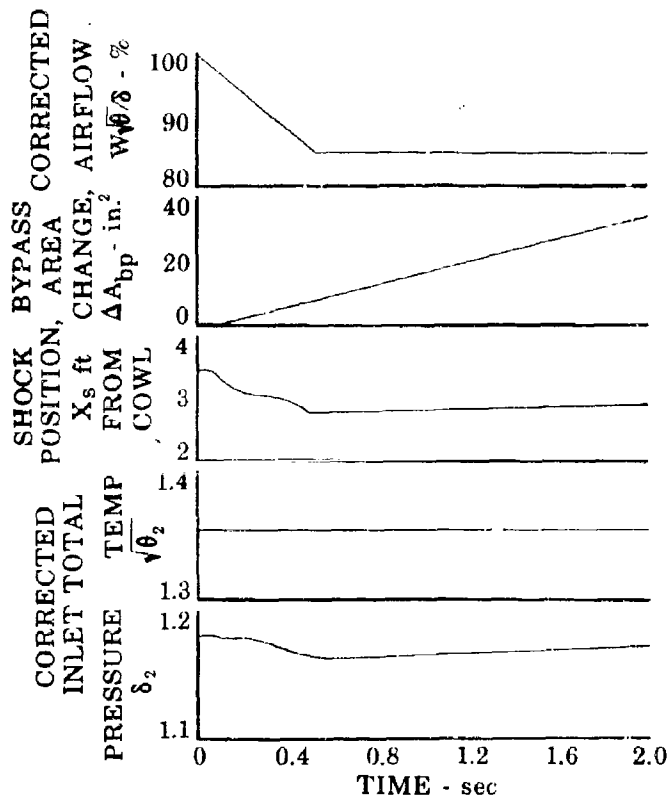

Figure 33. Inlet Response to Change in Corrected Flow F1 16745

**CONFIDENTIAL**

**CONFIDENTIAL**

Pratt & Whitney Aircraft

PWA FP 66-100

Volume III

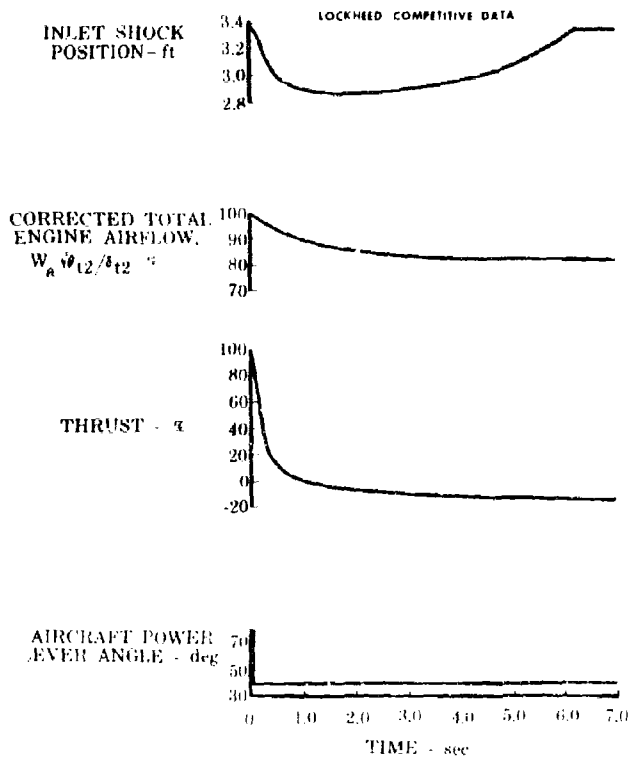

Figure 34. JTF17 Cruise Maximum Nonaugmented to Idle FD 16718  
DII

By means of duct fuel-area correlation and nonlinear response and gain, the JTF17 control achieves tolerance to scheduling and dynamic mismatch.

Further tolerance is achieved by controlling the slow velocity of the power lever angle input servo for the duct heating mode. This has an overall effect of slowing down all power lever transients above maximum rated. The effect can be seen by comparing power lever angle, PLA, to control servo position power lever angle, PLAC. The slow rate limit in the control tolerates a large amount of mismatch in the correlation cam and circuit dynamics. Figure 35 illustrates this tolerance on a maximum rated-maximum duct heat-maximum rated transient. Three analog computer simulation traces are shown: a base case, a +10% duct fuel flow error case, and a case with duct nozzle area rate decreased to a fourth of the base case value. The system tolerated both cases of large mismatch and maintained safe margins.

c. Pressure, Temperature, Airflow Transient Effects

The engine/inlet system is relatively insensitive to large airflow disturbances. Figure 34 shows data, calculated with the digital simulation of a power lever angle transient from maximum rated to idle at cruise. This is a normal transient, that is, one that should occur at least once

**CONFIDENTIAL**

on every flight. The system compensated for the large decrease in engine airflow without disorging the shock from the inlet. Figure 36 shows the tolerance of the system to another abnormal airflow transient, in-flight shutdown at cruise. The engine/inlet system retained the shock for this severe airflow transient.



Figure 35. Control Dynamic Mismatch Effects FD 16746  
DII

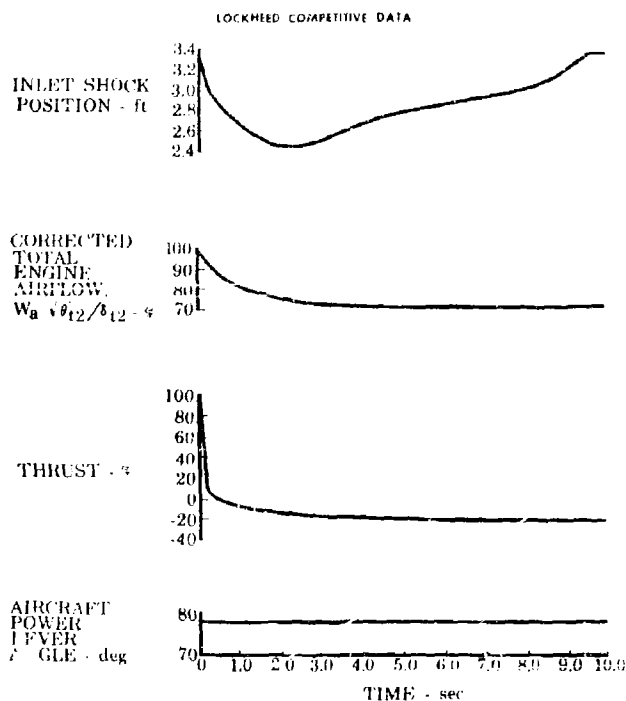

Figure 36. JTF17 Cruise Maximum Nonaugmented Fuel Shutoff Valve Turned Off - Engine Windmills FD 16719  
DII

DII-34

**CONFIDENTIAL**

**Pratt & Whitney Aircraft**

PWA FP 66-100

Volume 111

The most severe pressure transient the engine will feel occurs if the inlet shock discharges. The dynamics of the unstarted inlet are not available but an estimate of the total pressure variation of the engine face during unstart and restart has been made. Figure 37 shows the effects of this pressure perturbation on the engine. The sequence of events is as follows: (1) the inlet total pressure is ramped down and decreases the corrected airflow, (2) the duct nozzle area opens to correct the negative airflow error, (3) duct nozzle area modulates to correct the airflow error. At the beginning of this transient the engine feels a momentary high over-temperature and decrease of surge margin on the fan and high compressor. This is a normal occurrence on a high Mach number engine during an inlet unstart. Past experience on the J58 engine has shown that this momentary transient has no adverse effect on the integrity of the engine. The transient occurs too quickly for the hardware to feel significant over-temperature; see plot of the turbine leading edge temperature, figure 37. A possible source of trouble is the minimum fuel flow limit. If this limit is set too high, serious engine over-temperature might occur with the low unstarted recovery. The JTF17 fuel flow limit offers safe operation with an unstarted inlet at cruise altitudes at Mach 2.7.

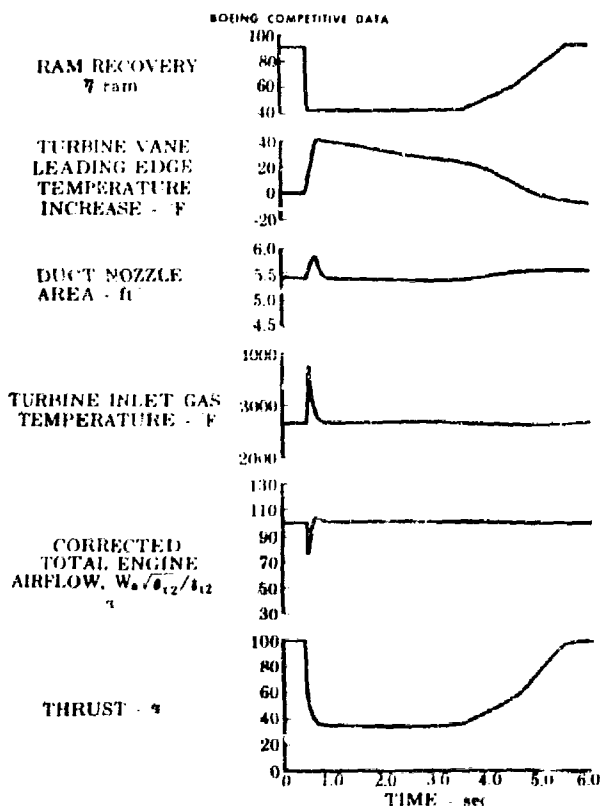

Figure 37. JTF17 Cruise Inlet Unstart and Restart

FD 16720  
DII

DII-35

**CONFIDENTIAL**



**CONFIDENTIAL**

#### 4. Phase III - Analytical Simulation Test Plan

A closely coordinated effort will be maintained with the airframe manufacturer to make maximum use of all available data affecting the compatibility of the engine and inlet with respect to both steady state and transient operation. Analog and digital simulations of both inlet and engine systems will be employed. Revised inlet steady state and dynamic characteristics as obtained from the airframe manufacturer will be included in the computer program as provided.

The analog and digital simulations will be updated as additional performance characteristics become available. Modifications to these simulations will be made to effect satisfactory solutions. Off design variations studies will be conducted to further refine engine/inlet compatibility estimates. These revised and updated simulations will provide the necessary information for the more specific and detailed studies required by the development program.

Transient engine/inlet operation studies will continue with increased emphasis toward physical control hardware. Engine and rig test data will be used to insure the validity of the simulations. This will be a closely coordinated effort by both the engine and the airframe manufacturers. As new inlet model test data is obtained, the inlet simulation will be revised to include significant changes in dynamics or concept. Engine test program data will be used to check the validity of the engine simulation gains and time constants. See Report E-I and II for a complete discussion of the engine test plans. The engine control test plan, (see Report B-III-C), will provide data to check the control simulation. Refer to table 1 for proposed milestone time chart of inlet/engine compatibility testing. The computer simulation can then be used concurrently during the test programs to ensure that desired stability and performance requirements are met. This will begin a continuing cycle of test, refinement of simulation, analytical studies and further tests until a configuration suitable for the AEDC compatibility test is evolved. The program will evaluate phenomena such as the effect of variable gains, deadband, random noise, interaction between control components for the effects on the overall system.

The dynamic simulation is being enlarged to include inlet flow distortion effects and certain failure mode effects on the system. An imposed inlet flow distortion will always tend to degrade the flow stability and performance characteristics of fans and multi-stage axial flow compressors. Methods for exact analytical solutions for the processes by which a distorted flow affects the stability and performance characteristics are being studied. Until these methods are perfected, the effects of flow distortion determined from rig test results will be programmed into a simulation. This simulation can be used to determine safe system operating limits, performance trade factors, and general tolerance to distortion over a broad range of system operating conditions.

**CONFIDENTIAL**

E. DISTORTION PREDICTION DEVELOPMENT

1. Empirical Distortion Factors

Empirical distortion correlation factors have been previously used to predict inlet distortion tolerance. Their popularity is due to their relative simplicity rather than to their complete effectiveness. Since they are founded upon test data they have the inherent capability of producing reasonable predictions of distortion tolerance for conditions that are close to the correlated data. However, when differences in the distortion pattern occur or changes in the compressor (sometimes quite small) are made, these correlations are usually inadequate. As an example, a partial listing of the effectiveness of one typical distortion factor is shown in table 3. Figure 39 presents a number of presently used similar statistical distortion factors. As an example of the unreliability of presently used statistical correlation methods to predict distortion effects, figure 38 presents the application of these distortion factors to the data shown on the performance maps of two very similar compressors with both undistorted and distorted inlets.

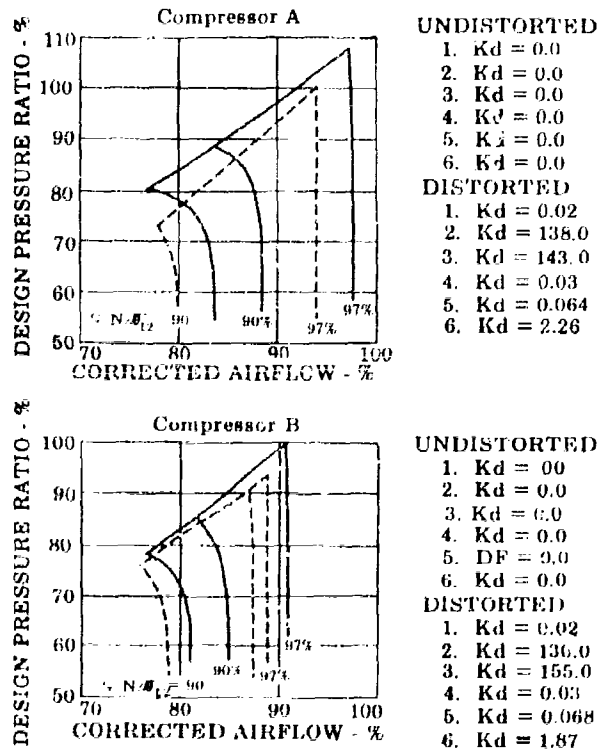

Figure 38. Effect of a Specific Distortion On Two Compressors

FD 16682

DII

Although the difference between these two multistage compressors was only an alteration of the inlet guide vane camber, a substantial increase in the surge line deterioration due to distortion is evident for the "A" configuration. Other changes within the compressor or to the flow path, adding stages to the front of the compressor, changing hub-tip ratio, etc., would similarly negate the confidence in a completely empirically derived distortion factor.

**CONFIDENTIAL**

Table 3. Pratt & Whitney Aircraft Experience with  $K_d$

Engine	Type	Aircraft	Experience
J57	Jet	F4D	$K_d$ correlated well
J57	Jet	F101	$K_d$ correlated well
J57	Jet	F100	$K_d$ correlated well
J57	Jet	F102	$K_d$ correlated well
J75	Jet	F105	$K_d$ correlated well
J60	Jet	Jet Star	$K_d$ not able to handle the vorticity encountered
TF33	Fan-Jet	B52-11	$K_d$ did not correlate well. Correlation was improved by weighting the fan portion of the flow less heavily.
JT8D	Fan-Jet	727	$K_d$ did not correlate well
TF30	Fan-Jet	F111	$K_d$ did not correlate well

$$\begin{aligned}
 (1) \quad K_d &= \left[ \frac{P_{t2 \text{ avg}} - P_{t2 \text{ min avg}}}{P_{t2 \text{ avg}}} \right] \\
 (2) \quad K_d &= \left[ \frac{P_{t2 \text{ avg}} - P_{t2 \text{ min avg}}}{P_{t2 \text{ avg}}} \right]^{0.2} \left[ \theta - \right]^{0.2} \left[ \frac{W\sqrt{\theta/\delta}}{W\sqrt{\theta/\delta}_{\text{design}}} \right]^{10^{2.4}} \\
 (3) \quad K_d &= \left[ \frac{P_{t2 \text{ avg}} - P_{t2 \text{ min avg}}}{P_{t2 \text{ avg}}} \right] \left[ \theta - \right] \left[ \frac{(\theta + )N_{\text{ref}}}{(360)N} \right]^{10^2} \\
 (4) \quad K_d &= \left[ \frac{P_{t2 \text{ avg}} - P_{t2 \text{ min avg}}}{P_{t2 \text{ avg}}} \right] \left[ \theta - \right] \left[ \frac{(\theta - ) + (\theta + )}{324} \right]^{10^{-2}} \\
 (5) \quad K_d &= \left[ \frac{P_{t2 \text{ max}} - P_{t2 \text{ min}}}{P_{t2 \text{ avg}}} \right] \sqrt{\frac{A_{\text{equivalent}}}{A_{\text{total}}}} \\
 (6) \quad K_d &= \sum_1^m \left[ \frac{P_{t2 \text{ avg}} - P_{t2 \text{ min}}}{P_{t2 \text{ avg}}} \right] \left[ \theta - \right] \left[ C_{RM} \right] \\
 &\quad \sum_1^m C_{t_{lm}}
 \end{aligned}$$

Figure 39. Statistical Distortion Factors

UGS 1502B  
DII

**CONFIDENTIAL**

**CONFIDENTIAL**

**Pratt & Whitney Aircraft**

PWA FP 66-100

Volume III

## 2. Considerations for Analysis of Distorted Flow

Two factors make synthesis of an analytical prediction system difficult. Most obvious is that axial symmetry can no longer be assumed. This requires that the conservation and momentum equations be satisfied with an additional degree of freedom and recognizes that circumferential as well as radial gradients will exist in all variables, such as flow rate, pressure, etc. Less obvious is the fact that the rotor flow cannot be made steady by selection of a frame of reference rotating with the rotor. This is apparent when one considers the changing angle of attack, Mach number, etc. as "seen" by a rotor as it passes through the regions of differing inlet distortion. These two considerations; the (a) non-axisymmetric and (b) non-steady, nature of the flow within the compressor undergoing inlet distortion, are the reasons which have prevented the relatively rigorous analysis used for non-distorted flow from being extended to include distortion. Lack of such a model has consequently forced reliance upon the frequently inadequate techniques of empirical correlation. Several ways of improving these analytical tools are being investigated at P&WA. The most promising of these methods will be described in the paragraph 6, "Analytical Prediction of Distorted Compressor Performance."

## 3. Undistorted Inlet Compressor Information

One very useful tool in the analysis and prediction of distorted compressor performance is a library of undistorted compressor performance data, collated for efficient access. In this area, P&WA has conducted over 100,000 compressor cascade tests, the pertinent data for which are contained in digital computer "memory" for automatic inclusion in digital computations of the flow through a multistage axial flow compressor. Similar information from both P&WA single stage and multistage compressors is available for comparative purposes.

## 4. Analytical Prediction of Distorted Compressor Performance

Since the existing analytical compressor design calculations are valid for axisymmetric flows they are completely capable of accounting for the effects of the radial component of the distortion. By then approximating the combined circumferential and radial distortions generally encountered with a number of sectors, within which only radial distortion is present (figure 40) the present methods may be readily extended. The number of sectors used in this approximation is dependent upon the severity of the circumferential distortion and the accuracy desired. Inherent in this portion of the procedure is the assumption that the blading, in passing from sector-to-sector, can instantaneously adapt to the new environment. Within these assumptions, a complete definition of the internal, non-axisymmetric, flow field is made to satisfy a given set of boundary conditions. From the results of these computations the lift that any blade element will be required to generate in order to remain in equilibrium with the flow field is given (figure 41). Since the circulation (lift) about the blade cannot instantaneously be altered to maintain this equilibrium to the non-steady conditions, it becomes necessary to determine the extent of the departure from apparent equilibrium that is actually

**CONFIDENTIAL**

experienced. To accomplish this, the cyclic lift distribution is approximated with discrete increments. At the occurrence of each of these increments a vortex is shed by the lifting surface and "washed" downstream with the flow as depicted in figure 42. At any instant in time the lift on the blade element is determined through integration of the effect of all of these vortexes on the circulation about the lifting line (or blade). In this fashion, the transient response (figure 43) of the various blade elements is calculated and then included to satisfy the required boundary conditions as an iterative procedure, with the stage matching considerations already mentioned.

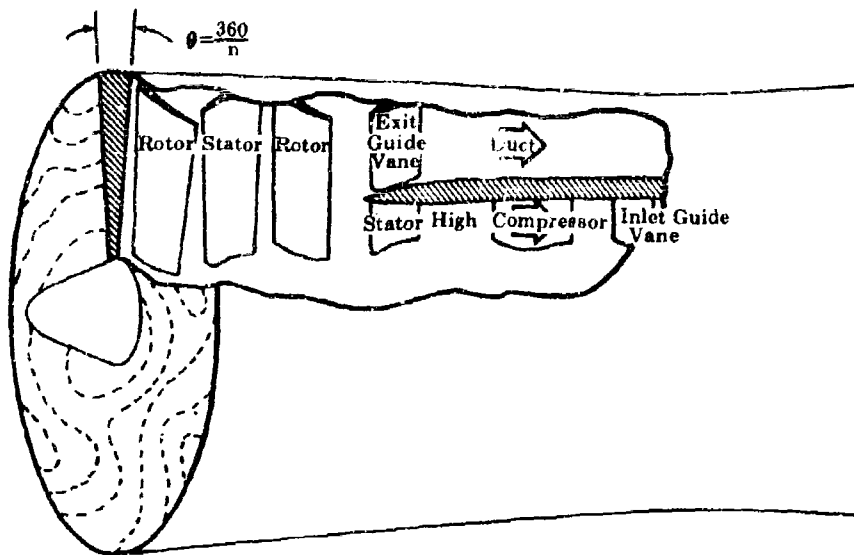

Figure 40. Exposed Sector

FD 16683  
 DII

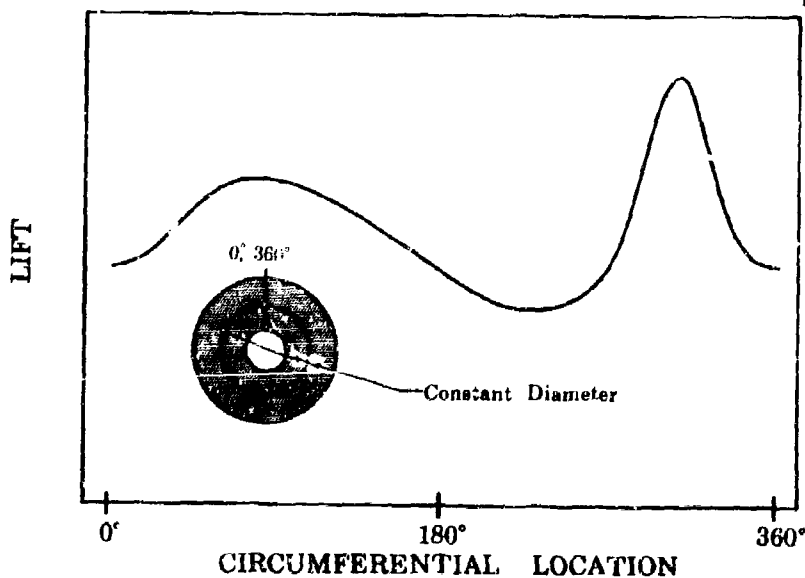

Figure 41. Equilibrium Circumferential Loading of Rotor Blades

FD 16684  
 DII

DII-40

**CONFIDENTIAL**

Pratt & Whitney Aircraft  
PWA FP 66-100  
Volume III

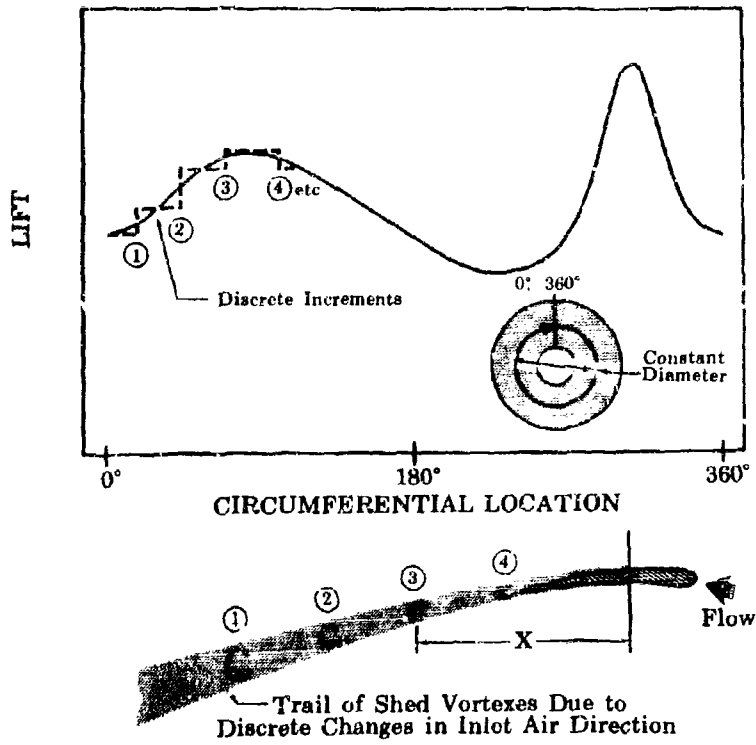

Figure 42. Transient Response Prediction Method

FD 16685  
DII

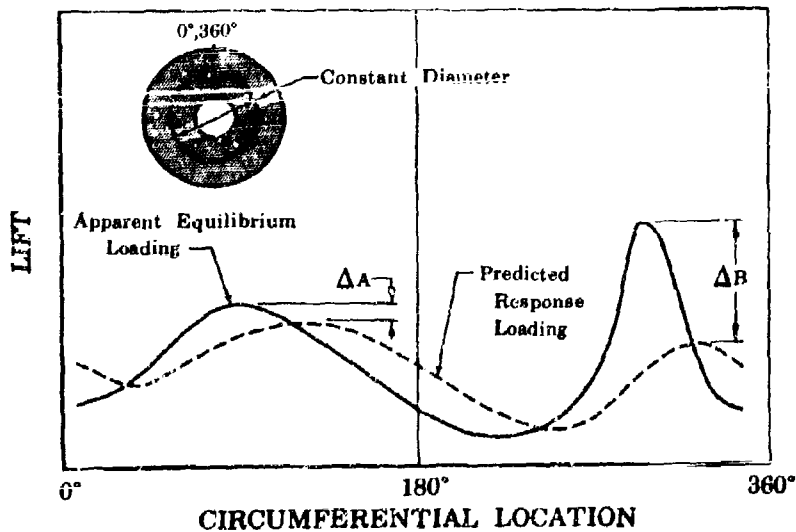

Figure 43. Predicted Rotor Blade Response

FD 16686  
DII

DII-41

**CONFIDENTIAL**

It may be noted in figure 43 that the response will be out of phase with the equilibrium loading and that the response to a severe but local region of distortion, seen as  $\Delta B$ , may be less than that to a relatively less severe but more extensive region, such as  $\Delta A$ . This effect together with those attributed to rotor speed and flow velocity are automatically included since they determine the position of the discrete shed vortices relative to the blade. Their importance is evidenced by the fact that many empirical prediction methods utilize weighting factors which are functions of the circumferential extent of the low pressure region, the rotor speed and flow rate.

Having completed the iteration, a complete description of the conditions occurring instantaneously throughout the compressor is available. It is now possible to evaluate these quasi-steady conditions using the extensive criteria already mentioned for evaluation of a non-distorted flow since the non-axisymmetric non-steady aspects of the flow are accounted for.

It is recognized that successful completion of such an ambitious undertaking is largely dependent upon a firm understanding of the effect of the distortion on the internal aerodynamics. The interstage data referred to previously will provide this necessary input as will similar data now being obtained on current P&WA engine compressors, both of the "fan" and jet types. The superiority of this "Blade Element Response" method is illustrated (figure 44) by comparing its comprehensiveness with that of six empirical correlations which have found widespread use. "Types of Distortion Factors" identified by numbers one through six on figure 44 correspond to similarly numbered  $K_D$  factors shown on figure 38.

EFFECT	TYPE OF DISTORTION FACTORS						BLADE RESPONSE ANALYSIS
	1	2	3	4	5	6	
DISTORTION AMPLITUDE: $P_{t2 \max}$ , $P_{t2 \min}$ relative to $P_{t2 \text{ avg}}$	●	●	●	●	●	●	●
CIRCUMFERENTIAL EXTENT: ( $\theta^-$ ), ( $\theta^+$ )	---	●	●	●	●	●	●
RADIAL DISTORTION: Distortion is weighed according to spanwise location.	---	---	---	---	---	●	●
DISTORTION TOPOLOGY: Accounts for size, location and relative level of engine face distortion as expressed in terms of $P_{t2}$ , velocity, incidence angle, etc.	---	---	---	---	●	---	●
STACK REMATCHING: Operating point/operating line changes to accommodate distortion.	---	---	---	---	---	---	●
DISTORTION ATTENUATION: Degree of reduction in distortion level characteristic of rotor blade(s). A spanwise function.	---	---	---	---	---	---	●
BLADE LOADING: Determination of blade pressure rise relative to maximum pressure rise possible.	---	---	---	---	---	---	●
APPLICATION TO NEW DESIGN: Prediction system allows present stage matching to accommodate distortion.	---	---	---	---	---	---	●
COMPRESSOR - INLET INTERACTION: Internal/external perturbation effects of distortion on assembled components that comprise integrated propulsion system.	---	---	---	---	---	---	●

Figure 44. Aerodynamic Distortion Considerations FD 16637  
DII

**CONFIDENTIAL**

**Pratt & Whitney Aircraft**

PWA FP 66-100

Volume III

## 5. Distortion Limits Based on Blade Element Characteristics

As discussed in the preceding paragraphs, the techniques used in the prediction of blade element response to distortion were used as a guide to establish criteria to define distortion limits for inlet-engine compatibility. Use of this general approach will be coordinated with the airframe manufacturers and would take the place of the presently used method which treats inlet-engine distortion compatibility on the basis of correlation of  $(P_{t2} \text{ Max} - P_{t2} \text{ Min})(P_{t2} \text{ Avg})^{-1}$  data. Although the method presented herein is an initial step toward a more sophisticated technique, it does have immediate merit in that it is based on more fundamental factors than is the above referenced method of defining a distortion limit. The advantage of referencing the distortion limits to blade element performance is that a more realistic distortion limit, dependent upon the distribution and extent of the distortion is attained. It is recognized that absolute levels of both performance limits and surge limits will be set as a result of Phase III testing and analysis.

The blade element performance shown in figure 45 represents that of a typical first stage blade. This blade characteristic is independent of engine configuration and is equally representative of turbojet first stage blades as of turbo-fan blades. It can be seen that the rotor blade root by virtue of its lower pressure rise reserve, would be less tolerant of low pressure regions of distortion than are the mid-span and tip. Conversely, high pressure distortion regions at the root, leading to higher than average flow, a characteristic of some early SST inlet distortion data, are favorably handled with relatively small pressure ratio losses. A distortion limit based on blade element performance would account for this. Response of a fixed point on the blading as it passes through the distortion also needs to be considered, the response increasing as a function of dwell time in a given low or high pressure zone. The circumferential extent of pressure zones characterized as low or high with respect to an annular average, as well as the variations in total pressure within the particular zone under consideration, will determine the degree of rotor blade response to the inlet velocity of that zone. Rotor speed effects must also be considered, as the performance of the blade elements varies significantly with both angular velocity and inlet mass flow.

## 6. Blade Element Distortion Limit Analysis Procedure

Airframe inlet distortion is of an unsteady nature, in many instances varying in a time period during which the rotor makes considerably less than one revolution. However, in many cases the response of the rotating blades is sufficient to almost fully react to a time variant inlet distortion as if it were a steady process.

Therefore, in order to provide adequate definition of the airframe inlet distortion, total pressure pickups should be located at the inlet-engine interface on 10 to 12 circumferentially equi-distant rakes, each rake containing 5 to 6 pickups which are placed at centers of equal annular areas. The time required for a given blade to pass from one of these rake stations to another is approximately one millisecond, so that the total pressure instrumentation should have a response time on the order of 1/500 to 1/1000 sec. The total of these equal annular areas

DII-43

**CONFIDENTIAL**



**CONFIDENTIAL**

comprises the inlet annulus. It should be recognized that complete definition of the inlet flow field exceeds practical limitations. However, instrumentation possessing the characteristics noted above serves reasonably well, dividing the engine-inlet interface into 5 or 6 annuli of equal areas, the circumferential pressure distribution of each annulus being provided every  $30^\circ$  or  $36^\circ$ , dependent upon the number of rakes that are utilized. Specific requirements for the instrumentation used to define distortion must be established mutually by the engine and airframe manufacturers. Should instrumentation having a slower response be used for the purpose of defining engine face distortion, then compatible distortion limits will be negotiated in an effort to compensate for the inaccuracies introduced by poorer response pickups.

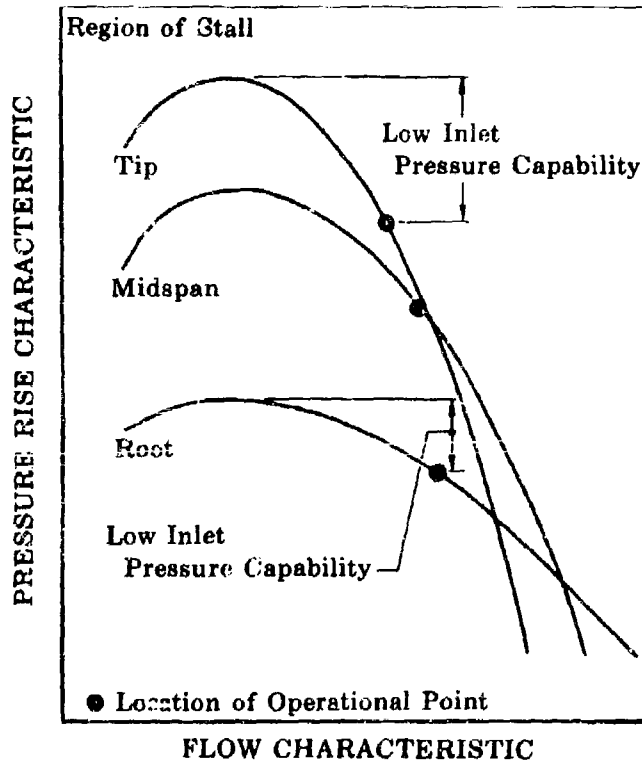

Figure 45. Blade Element Performance

FD 16688  
DII

**CONFIDENTIAL**

**CONFIDENTIAL**

**Pratt & Whitney Aircraft**

PWA FP 66-100

Volume III

The terms used in the "Blade Element" distortion limits method are listed below:

- P<sub>t2</sub> avg = Average area weighted engine inlet total pressure
- P<sub>t2</sub> max = Maximum engine inlet total pressure measured using recommended instrumentation.
- P<sub>t2</sub> min = Minimum engine inlet total pressure measured by recommended instrumentation.
- P<sub>t2</sub> rad = Average area weighted inlet total pressure for given annulus
- N<sub>1</sub> = Angular velocity of fan rotor, rpm
- θ<sub>t2</sub> =  $T_{t2} \text{ avg } R/518.7$
- C = Circumferential distortion factor that accounts for zones of distortion in which blade response is complete. This factor may be considered to be representative of a square wave distortion pattern of long period.
- θ<sub>1</sub> = That angle, at a constant radius, subtending the zone in which the total pressure deviation from average reaches a limiting value; a maximum in the case of high pressure, or a minimum for the case of low pressure (see figure 46) deg.
- θ<sub>2</sub> = That angle, at a constant radius, subtended by the beginning of a low or high pressure zone and the pressure level that is 90% of the difference between max or min P<sub>t2</sub> and P<sub>t2</sub> rad occurring at θ<sub>1</sub>, deg. (See figure 46)
- θ<sub>3</sub> = That angle, at a constant radius, subtended by the terminus of θ<sub>1</sub> and the intercept of the response pressure level  $P_{t2} \text{ rad} - Z (P_{t2} \text{ rad} - P_{t2} \text{ min or } P_{t2} \text{ max})$  with the pressure zone boundary following θ<sub>1</sub>, deg. (See figure 46)
- θ<sub>4</sub> = The angle, at a constant radius, between the occurrence of the minimum (or maximum) pressure and a value of 90% of the difference between P<sub>t2</sub> rad and that pressure, leaving a low or high pressure zone. (See figure 46)

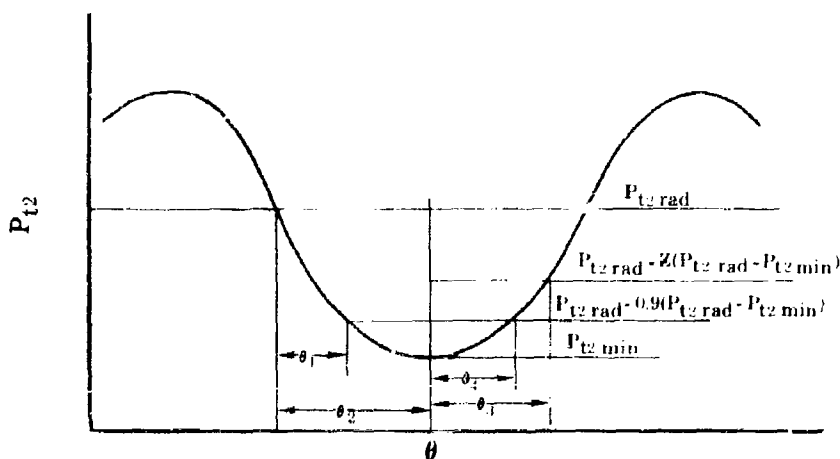

Figure 46. Constant Radius Circumferential Inlet Distortion

FD 17803  
DII

DII-45

**CONFIDENTIAL**

**CONFIDENTIAL**

These angles are used to define the significant circumferential extent of a distortion pattern and to indicate its wave form as illustrated below. It may be noted by referring to figure 46 that when  $\theta_1 = \theta_2 = 0$  and  $\theta_4 = \theta_3$  the distortion pattern in question has a square wave form. Conversely, when  $\theta_1 = \theta_2 \neq 0$  and  $\theta_4$  is very small, the circumferential pattern under investigation is sharply cusped.

- Z = That factor which depicts the degree to which a blade elements respond to the pressure perturbation ( $P_{t2 \text{ rad}} - P_{t2 \text{ min}}$  or  $P_{t2 \text{ max}}$ ) as it rotates through the arc  $\theta_1$ .

An inlet distortion pattern, representing the total pressure field at an instant of time as measured with the previously described instrumentation, is analyzed in two parts to determine its effect on the engine:  
1) Radial and, 2) circumferential.

The radial component of the distortion is examined by determining the area average total pressure for each concentric annulus ( $P_{t2 \text{ rad}}$ ) and comparing the resultant radial distribution (normalized by  $P_{t2 \text{ avg}}$ ) with the limits specified in figure 47 and figure 48. Operation within the band bounded by the curves of figure 47 will produce a negligible effect on engine performance. Operation within the band bounded by the curve of figure 48 will not so adversely affect engine operation as to precipitate engine stall or flameout.

A radial total pressure gradient or distortion is the normal inlet condition anticipated for all fan/compressor stages. This occurs because each stage provides the succeeding stage with a non-uniform profile. Since this condition is usual and anticipated, it is included in the design procedures. The first stage design must include the radial distortion provided by the inlet and differs from the design of succeeding stages only in that the inlet distortion is usually poorly defined during the early phases of engine development. As compatibility testing of the inlet provides a better definition of the expected radial distortion it may become necessary to modify the design of the fan stages to be tolerant to a different radial pattern than was originally planned for. This flexibility is a part of the anticipated development program during which compatibility is achieved by early modification of both inlet and engine. For this reason the curves depicted in figure 47 and figure 48 must be considered as schematics, representative of trends and concepts but subject to significant alteration during compatibility development.

The circumferential component of the distortion requires more complex limitations because it is necessary to account for not only the radial differences in blade attenuation but also the transient response of a blade element as it rotates through the non-uniform flow field. The limiting levels of circumferential distortion for each annulus are expressed by the ratio of the maximum and the minimum total pressure within the annulus to the mean annulus total pressure. These limiting values are expressed in the following equations:

DII-46

**CONFIDENTIAL**

**Equations Defining Allowable Circumferential Distortion**

$$\frac{P_{t2 \text{ max}}}{P_{t2 \text{ rad } <}} = 1 + CxRzMxY$$

$$\frac{P_{t2 \text{ min}}}{P_{t2 \text{ rad } >}} = 1 - CxRzMxY$$

The quantities C, R, M, and Y are factors relating to the circumferential "shape" of the pressure profile and the transient response of the blading and will have values defined by theoretical studies and compatibility testing during Phase III. These tests will also provide the boundary condition data needed for the previously described "Blade Element Response" method of analytically predicting distortion effects.

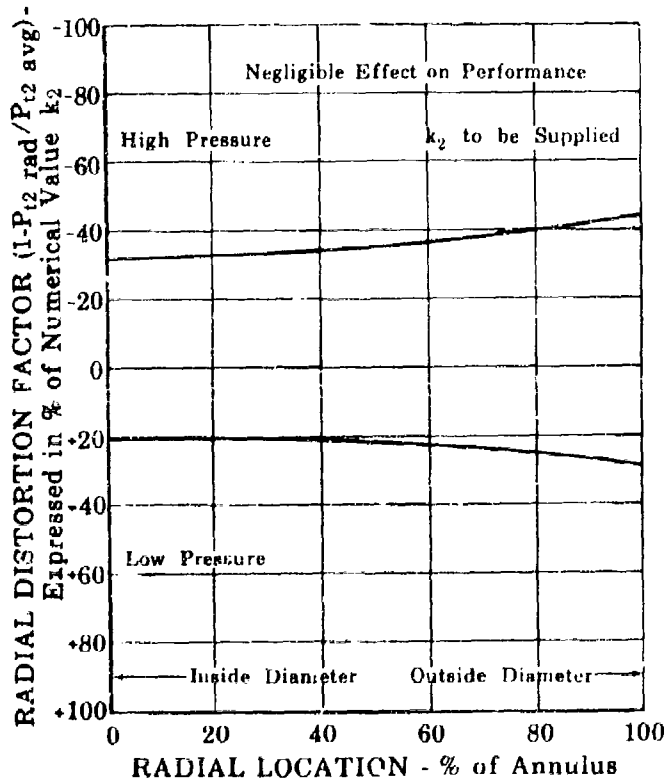

Figure 47. Estimated Limiting Value of Radial Component of Inlet Total Pressure Distortion - Negligible Effect on Performance

FD 17820  
 DII

**CONFIDENTIAL**

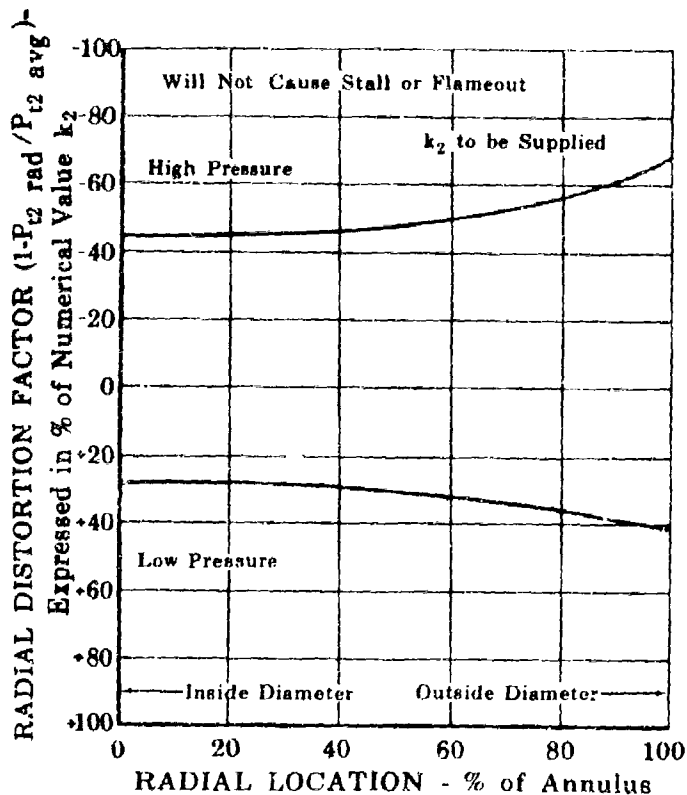

Figure 48. Estimated Limiting Value of Radial Component of Inlet Total Pressure Distortion - Will Not Cause Stall or Flameout FD 17821  
DTT

The maximum circumferential distortion allowable when the complete response is attained by the blading is accounted for by the quantity C (figure 49 and figure 50) dependent upon the rotor corrected speed and the spanwise location of the annulus under consideration. Since complete response is not the general case, the modifiers R, M, and Y are provided to account for less than complete response due to the circumferential distortion gradient and the dwell or residence time of the blade elements within the high or low pressure zones. These modifiers are set equal to unity for the case of complete response and increase accordingly with decreasing levels of response.

The response to the pressure deviation (min or max pressure) from the average (P<sub>t2 rad</sub>) is estimated by the factor Z of figure 51a a function of the angle  $\theta_1$  between P<sub>t2 rad</sub> and the minimum (or maximum) pressure and the angle,  $\theta_2$ , required to attain 90% of the difference between P<sub>t2 min</sub> or P<sub>t2 max</sub> and P<sub>t2 rad</sub>. Because of its bivariate dependence, the quantity Z accounts for the element response to the minimum (or maximum) pressure based on the rapidity ( $\theta_1$ ) with which it is reached and the

**CONFIDENTIAL**

**CONFIDENTIAL**

**Pratt & Whitney Aircraft**

PWA FP 66-100

Volume III

"shape" of the leading pressure gradient ( $\theta_2$  and  $\theta_1$ ). The response, Z, is used to define the portion of the low (or high) pressure region of primary interest through the angle,  $\theta_3$ , terminating (figure 46) when the pressure returns to  $P_{t2 \text{ rad}} - Z(P_{t2 \text{ rad}} - P_{t2 \text{ min}} \text{ or } P_{t2 \text{ max}})$ .

The response, R, (figure 51b) is then determined by the total angular displacement ( $\theta_1 + \theta_3$ ) of the significant portion of the low (or high) pressure zone. The modifier, M, given in figure 51c, is a function of Z and  $\theta_3$ . This factor accounts for both the initial response (Z) and the dwell, or residence time, of the blade within the significant portion of the low (or high) pressure zone. The dwell time ( $\theta_3$ ) becomes less significant as the response to the leading portion of the zone (Z) approaches 1.0 denoting complete response.

Finally, the factor Y, figure 51d, is determined from the ratio of  $\theta_4$  to  $\theta_3$ . This factor approximately accounts for profile shape within the dwell region.

The maximum and minimum pressures allowable in each annulus are calculated through substitution of the above determined factors in the "Equations Defining Allowable Circumferential Distortion." Operation within these limits when the value of C is determined by the curve of figure 49 will not effect engine performance. If the curve of figure 50 is used to define the quantity C, the resultant allowable circumferential distortion will not cause surge or flameout. A linear interpolation shall be used to determine the value of the quantity C between the ID and OD.

Separation of the distortion into radial and circumferential components provide a logical distinction because of their steady and non-steady character, respectively. However, their combined effect on the fan/compressor aerodynamics is, in the final analysis, the significant aspect. For this reason, the foregoing discussion is of a general nature and trade-offs may be made between radial and circumferential allowances to provide adaptation to the distortion pattern produced by a specific inlet. As in the case of the radial distortion allowance, the circumferential limits may be changed by modification of the fan/compressor if this measure is indicated during compatibility testing. Since modifications to increase the engine distortion tolerance sometimes lead to a performance decrement, carefully coordinated analysis between airframe and engine manufacturer is mandatory.

While the above improved method of defining distortion limits includes factors which are considerably more pertinent than does the former  $(P_{t \text{ max}} - P_{t \text{ min}})$  definition it must be recognized that no simple method,

$$P_{t \text{ avg}}$$

such as described, can provide a universally applicable system. Consequently, special cases involving unusual distortion patterns may be considered individually by more rigorous and detailed analysis by coordination with the airframe manufacturer.

DII-49

**CONFIDENTIAL**

**CONFIDENTIAL**

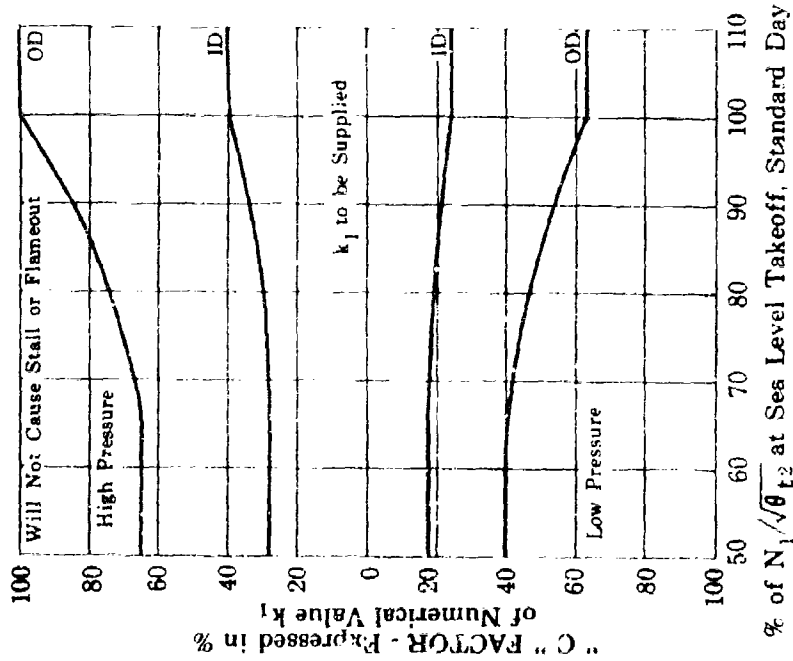

Figure 50.

Estimated Limiting Criteria for  
 Circumferential Component of Inlet  
 Total Pressure - Will Not Cause  
 Stall or Flameout  
 FD 17823  
 DII

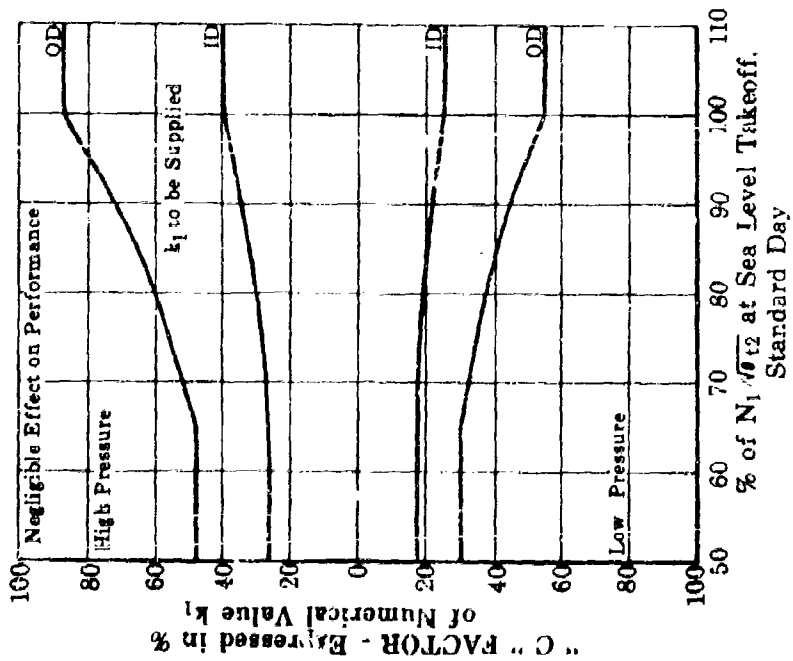

Figure 49.

Estimated Limiting Criteria for  
 Circumferential Component of Inlet  
 Total Pressure - Negligible Effect  
 on Performance  
 FD 17822  
 DII

**CONFIDENTIAL**

CONFIDENTIAL

Pratt & Whitney Aircraft  
PWA FP 66-100  
Volume III

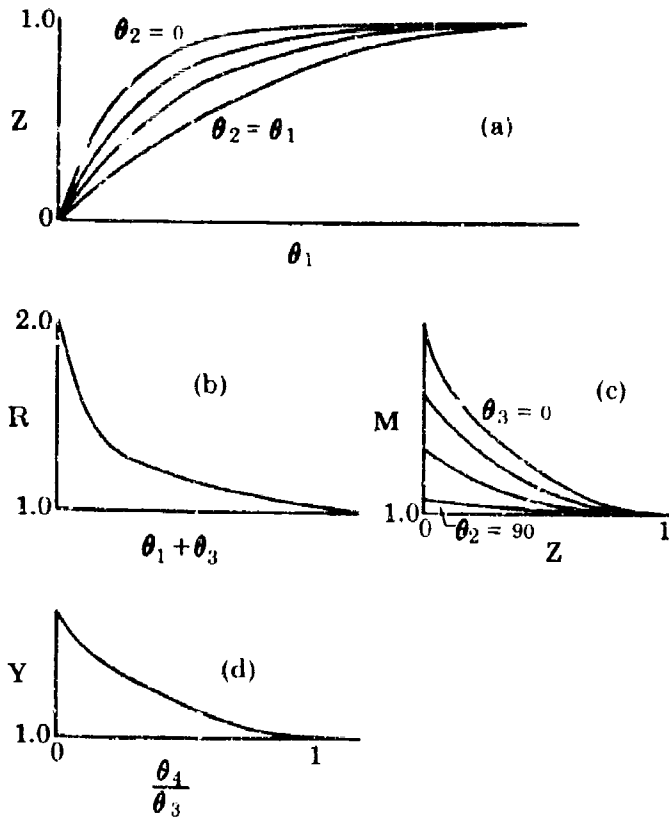

Figure 51. Slope and Response Factors to be Used in Intermixing "Blade Element" Distortion Limits FD 17804 DII

DII-51

CONFIDENTIAL



**CONFIDENTIAL**

**Pratt & Whitney Aircraft**

PWA FP 66-100

Volume III

SECTION III  
EXHAUST SYSTEM COMPATIBILITY

A. INTRODUCTION

The design of the engine exhaust system and its installation in the airframe must be analyzed and tested to optimize the performance and insure the compatibility of the airframe/engine combination. The inlet and exhaust system compatibility are both important to the performance of a supersonic transport. Pratt & Whitney Aircraft and the airframe manufacturer will execute a coordinated program of analytical studies, design and testing to develop a compatible, high-performance exhaust system. Already in Phase II, extensive work has been done toward this objective. The results of this work, which have been fully coordinated with the airframe contractors, are discussed in the following paragraphs. A more complete explanation, including such interactions as the routing of secondary air and the effect of tertiary air doors-open operation, is given in Volume III, Report A, Section III E.

B. INSTALLATION EFFECTS

The selection of the exhaust nozzle configuration for the JTF17 engine was based upon trade-off studies involving three different nozzle configurations. Although not the only criterion, the sensitivity of the nozzle to installation effects was an overriding factor in the evaluation of candidate nozzles. Such trade-off studies rely heavily on experience of service aircraft for evaluation criteria, and the initial evaluation was made utilizing the excellent service experience of the blow-in-door ejector in the YF12 aircraft. When data became available from the less favorable F-111 installation, these trade-off studies were repeated to assure data from the less favorable installation received proper consideration.

Three configurations, the plug nozzle, the long variable flap nozzle and the blow-in-door ejector were included in the study. Detail results of these studies can be made available upon request; however, in summary the plug nozzle was rated very low because of its relatively high sensitivity to performance loss from flow field variations, and its unsuitability to incorporation of sound suppressor devices. The blow-in-door ejector and long variable flap nozzle were rated about equal for performance loss due to installation effects during the initial evaluation and again during the reevaluation. The final choice of the blow-in-door ejector was then made on the basis of its overall performance, as a result of better sealing, less complexity and weight, and better noise attenuation characteristics. A complete description of the ejector and its design features is presented in Volume III, Report B Engine Design, Section II.

To achieve the performance and weight advantages of the blow-in-door nozzle, care must be taken in its installation to account for variations of the aircraft local flow field. Model tests, summarized in figure 1, have shown that tertiary door-open nozzle performance is dependent upon providing the required quantity of tertiary flow regardless of the amount of door blockage. Performance is directly related to tertiary flow quantity as indicated in figure 1, and adverse local flow fields are compensated by increasing tertiary door area. An exhaust system placed rel-

DJII-1

**CONFIDENTIAL**

(This Page is Unclassified)

**CONFIDENTIAL**

ative to the aircraft such that it operates in a uniform flow field with minimum deviation from free stream conditions will exhibit little or no installation effect. Both airframe manufacturers are aware of this, and have provided wing-mounted installations that should produce minimum deviations of the nozzle local flow fields from free-stream conditions.

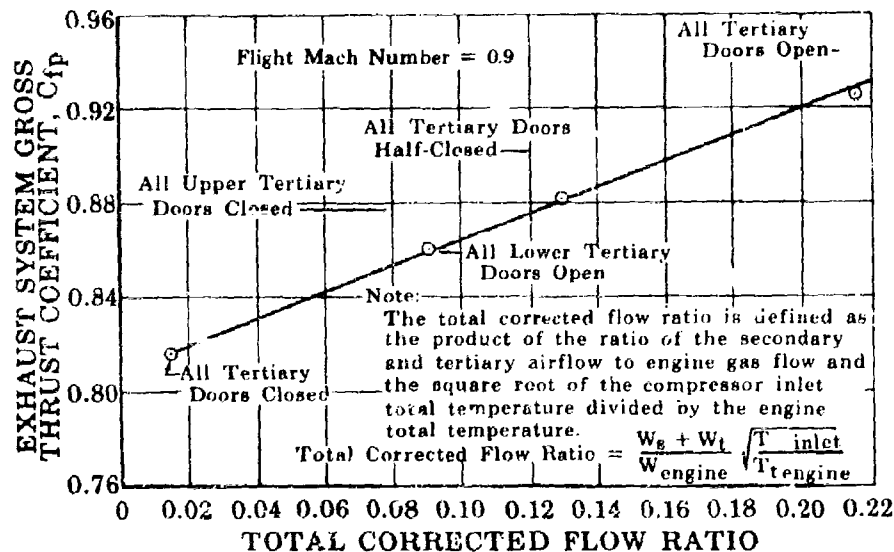

Figure 1. Variation of Exhaust System Performance with Total Corrected Flow Ratio (M = 0.9)

FD 17124  
DIII

The JTF17 exhaust system is being designed to compensate for variations in local flow conditions when they occur, thereby minimizing installation effects. The local flow field approaching the exhaust nozzle may vary from isolated test conditions due to the effect of the wing and adjacent bodies, overboard bleed flows upstream of the nozzle, and differences in model and full-scale boundary layers. The difference between free-stream Mach number and the local Mach number around the nozzle can affect nozzle performance by changing the tertiary air inlet conditions and the external pressure drags. High local Mach numbers, and consequently low local static pressure fields, may also cause the pressure-actuated tertiary doors to close prematurely and thereby produce overexpansion losses in the nozzle. The local pressure field can also affect the position of the trailing edge flaps which can produce overexpansion losses in the nozzle if the flaps float to a larger exit area. A variation of boundary layer height between the installed and isolated test conditions will also affect the tertiary flow and internal performance. The isolated transonic wind tunnel investigations of the JTF17 exhaust system are conducted in a free stream flow field with 4-inch diameter models. The models are mounted on a shaft approximately 6 feet long that protrudes from a streamlined strut located just ahead of the test section. Calculations indicate that the relative boundary layer heights between the isolated scale model tests and the actual aircraft (approximately 11 inches full scale) are similar. In

DIII-2

**CONFIDENTIAL**

**CONFIDENTIAL**

**Pratt & Whitney Aircraft**

PWA FP 66-100

Volume III

the absence of large quantities of overboard bleed and large variations in boundary layers, installation effects are primarily a function of the local Mach numbers produced by the aircraft. Experience has shown that differences in nozzle performance occur in the transonic flight region where the tertiary doors are open and the trailing edge flaps are closed. At cruise Mach numbers, nozzle performance is not affected by the aircraft flow field.

1. Previous Experience

Installation effects have been thoroughly investigated in the Pratt & Whitney Aircraft J58 engine installation in the YF12 aircraft. Wing-nacelle model test programs and full scale flight investigations have been conducted in conjunction with the airframe manufacturer. Results of these programs show that installation effects are predictable and that the exhaust system can be designed to minimize these effects in the transonic flight range, as shown in figure 2.

J58 experience has shown that an approximation of installation effects for a wing mounted nacelle can be made by testing isolated scale models at the local Mach number of the aircraft flow field. For example, a simulation of the conditions at a flight Mach number of 1.05 could be made by testing at approximately Mach 1.2. This type of test would simulate both the lower pressure air entering the tertiary doors as well as the increment in boattail pressure drag caused by the aircraft flow field. This test would not, however, show the effect of low pressures caused by the boattail on aircraft surfaces. A similar investigation has been carried out for the JTF17 exhaust system installation in the L-1011 aircraft, as discussed in the next paragraph.

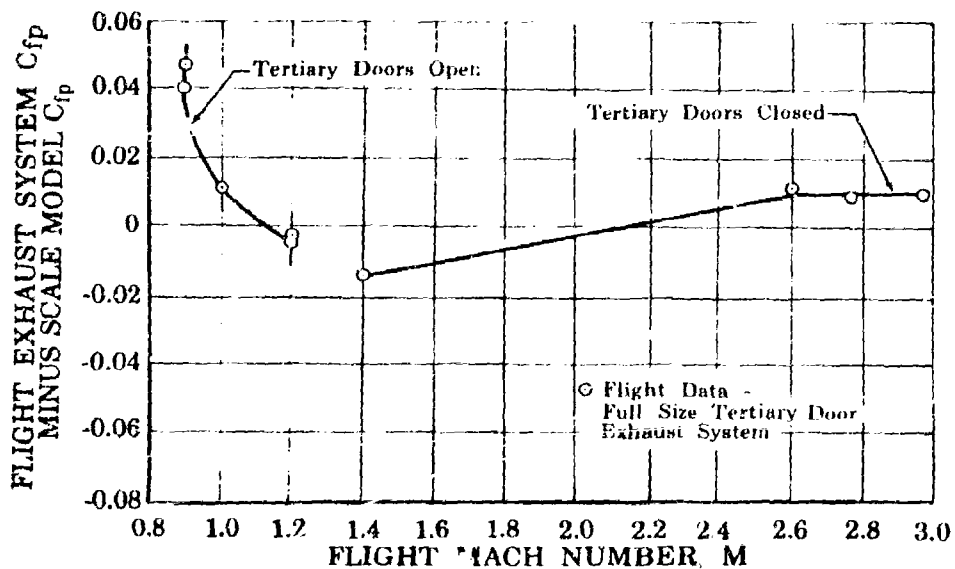

Figure 2. Performance Comparison of Flight and Scale Model Exhaust Systems FD 17100 DIII

DIII-3

**CONFIDENTIAL**

2. JTF17 Exhaust System Installation Effects

Chordwise static pressure distributions have been measured for the inboard and outboard nacelles on the Lockheed wing. Average local Mach numbers in the vicinity of the tertiary doors have been calculated from these data and a comparison is shown in the following table:

Freestream Mach Number	0.9	1.3
Average Local Mach Number	0.92	1.31

Figures 3 and 4 indicate the estimated performance increments as a function of local Mach numbers for the JTF17 nozzle during transonic acceleration and subsonic cruise respectively. No appreciable installation effect is estimated from either figure with the maximum  $\Delta C_{f_{p_{inst}}}$  of 0.004 occurring during subsonic cruise operation. During operation at acceleration conditions, exhaust system throat areas and pressure ratios are larger than for subsonic part power and installation effects will be less than at part power conditions.

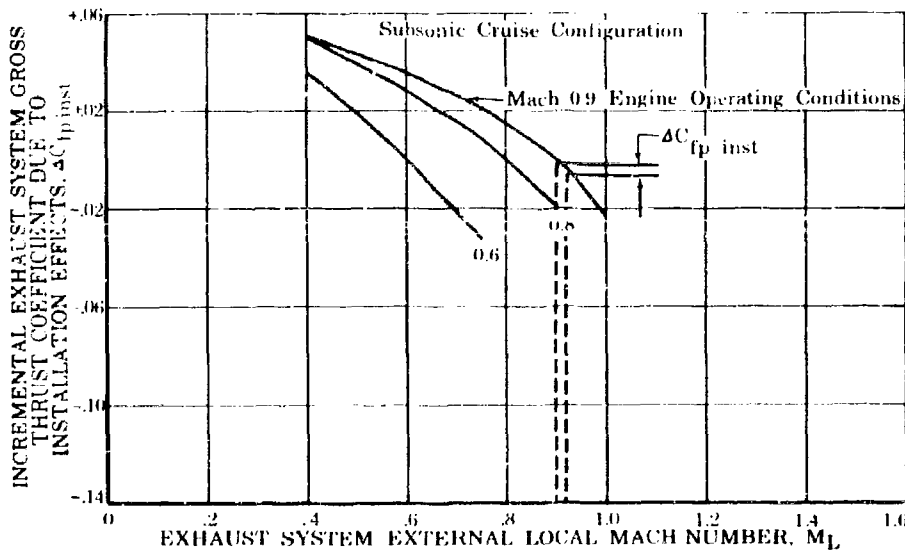

Figure 3. Estimated JTF17 Exhaust System Installation Effects, Lockheed Installation, Subsonic Cruise Configuration

FD 17125  
DIII

CONFIDENTIAL

Pratt & Whitney Aircraft

PWA FP 66-100

Volume III

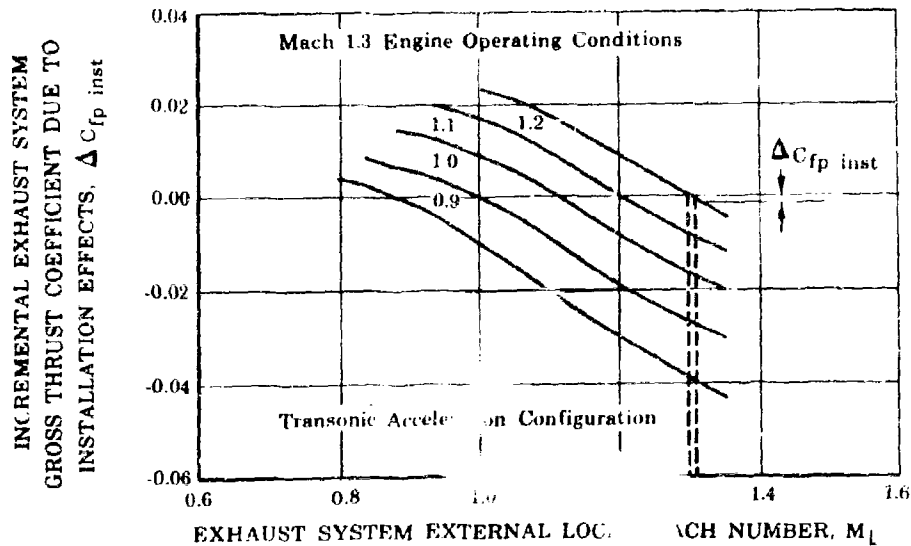

Figure 4. Estimated JTF17 Exhaust System Installation Effects, Lockheed Installation, Transonic Acceleration Configuration

FD 17126  
DIII

### 3. JTF17 Installation Tests

During Phase II-C the L-2000 propulsion installation details were supplied by Lockheed, and the first of a series of tests with a JTF17 exhaust system wind tunnel model representing the Lockheed installation were conducted in the United Aircraft Research Laboratories main wind tunnel to investigate installation effects on exhaust nozzle performance. The complete test series to be continued into Phase III will investigate the effects of the basic aircraft installation, angle of attack, exhaust system trailing edge flaps, eleven deflection angle, and exhaust system axial location.

The initial tests established the effects of the L-2000 installation on the performance of the JTF17 exhaust system during subsonic part power operation and investigated the wing and exhaust system local flow field pressure and Mach number distributions.

The 1/20th scale installation model consists of a metric flowing nacelle with the JTF17 exhaust system and a non-metric half wing of cropped-delta plan form with an open channel dummy nacelle as shown in figure 5. The metric flowing nacelle consists of a 4-inch outside diameter shaft which extends 7 feet downstream of the trailing edge of a streamlined fairing. The upstream end of the shaft is attached to a three-flow force balance and the exhaust system is attached to the downstream end.

The non-metric half wing consists of a cropped-delta plan form with a modified double wedge section and a 10 degree tip droop. A half wing model is representative of the installation since a splitter plate

DIII-5

CONFIDENTIAL

**CONFIDENTIAL**

at the wing root divides the flow field and the flowing nacelle is located several nacelle diameters away from the centerline. An open channel dummy nacelle simulates the inboard propulsion package. Replaceable elevons are available to simulate various trim positions but were not tested during this initial test program. The flowing nacelle shaft was set at a negative incidence of 2 degrees relative to the wing chord. The installed tests were conducted at angles of attack of 2 degrees and 5 degrees. The wing was mounted on edge in the test section on a wing root plate and two support struts. The test instrumentation consisted of the following:

1. A three-flow balance to record exhaust system gross thrust coefficients.
2. Three static pressure pipes located three feet from the upper wing surface, three feet from the lower wing surface, and three inches off the wing tip.
3. Tunnel wall static pressure plates are mounted on the upper wing surface side of the tunnel and on the lower wing surface side of the tunnel.
4. A tunnel spanning static and total pressure "T" rake. Readings from this rake were taken just upstream of the plane of the ejector tertiary doors.
5. The lower surface of the wing was instrumented with 35 static pressure taps and the upper surface with 18 taps.
6. The exhaust nozzle had four static taps circumferentially spaced just ahead of the tertiary doors.
7. Two one-inch high boundary layer mice were mounted on the nacelle just ahead of the tertiary doors above and below the wing.



Figure 5. Exhaust System Installation Model  
Tests - Lockheed Configuration

FD 16905  
DIII

DIII-o

**CONFIDENTIAL**

(This Page is Unclassified)

Preliminary results of these tests are shown in figure 6. The curves show the variation of isolated and installed nozzle performance with flight Mach number for Mach 0.9 engine operating conditions. The JTF17 exhaust system installed performance is approximately 1/2% lower than isolated model performance; however, the installed model performance meets the subsonic cruise performance goal. Angle of attack has little effect on the installed performance. The excellent agreement between the theoretical and test results indicates that installation effects for the JTF17 exhaust system are predictable and the nozzle design can be modified when necessary to minimize these effects.

The initial test program was limited to subsonic Mach number because of wind tunnel limitations. Wind tunnel flow field investigations conducted with both Boeing and Lockheed wings (no exhaust nozzles) indicated that satisfactory flow fields could be established for subsonic Mach numbers only. However, a wind tunnel modification incorporating a perforated wall test section to permit transonic Mach number testing is planned early in Phase III.

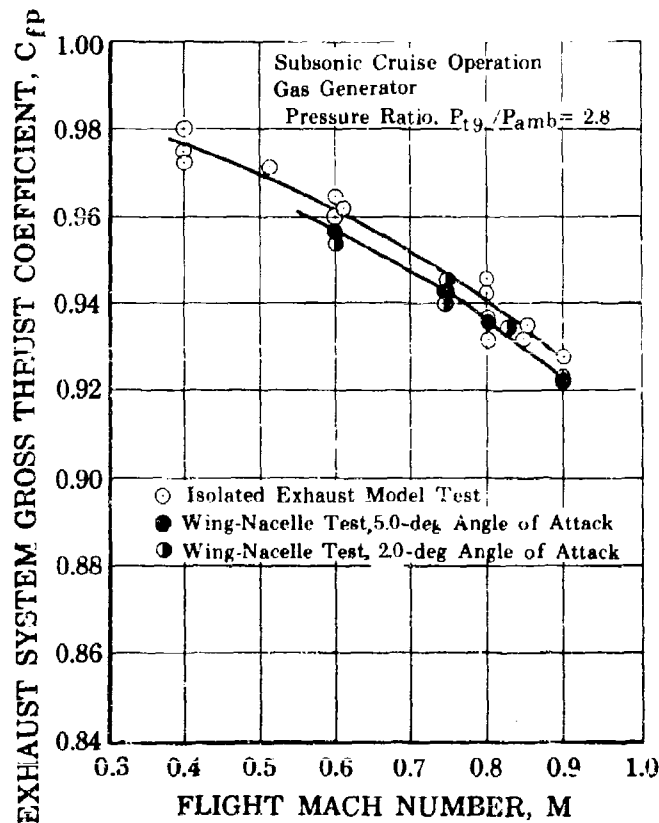

Figure 6. JTF17 Exhaust System Wing - Nacelle Test, Lockheed Installation, Subsonic Cruise Operation

FD 17127  
DIII