

O

AR-009-889

DSTO-GD-0109

T

The Response of Surface
Ships to Underwater Explosions

Warren D. Reid

S

R

19970624 097

APPROVED FOR PUBLIC RELEASE

Approved for public release
Distribution Unlimited

© Commonwealth of Australia

DEFENCE SCIENCE AND TECHNOLOGY ORGANISATION

THE UNITED STATES NATIONAL
TECHNICAL INFORMATION SERVICE
IS AUTHORIZED TO
REPRODUCE AND SELL THIS REPORT

The Response of Surface Ships to Underwater Explosions

Warren D. Reid

**Ship Structures and Materials Division
Aeronautical and Maritime Research Laboratory**

DSTO-GD-0109

ABSTRACT

This report is a summary of technical information gathered by the author during an attachment to the Underwater Explosions Research Department (UERD) of the Naval Surface Warfare Center (NSWC) Carderock Division from April 1993 to July 1994.

The report covers aspects of UERD's work in the area of: ship shock trials, response of surface ships to underwater explosions, computer modelling of surface ship responses and other technical information culled from the general literature.

RELEASE LIMITATION

Approved for public release

D E P A R T M E N T O F D E F E N C E

DEFENCE SCIENCE AND TECHNOLOGY ORGANISATION

Published by

*DSTO Aeronautical and Maritime Research Laboratory
PO Box 4331
Melbourne Victoria 3001*

Telephone: (03) 9626 8111

Fax: (03) 9626 8999

© Commonwealth of Australia 1996

AR No. AR-009-889

September 1996

APPROVED FOR PUBLIC RELEASE

The Response of Surface Ships to Underwater Explosions

Executive Summary

An underwater explosion detonated nearby a ship or submarine, can in many situations, be devastating to the combat readiness of the vessel. Damage to a vessel may occur in the form of dished hull plating or more serious holing of the hull. However some damage may not be obvious and could occur as a result of shock-wave loading of equipment and systems aboard the vessel. Equipment damage may incapacitate a vessel.

Much research effort has been expended in the study of underwater shock, especially during the period after World War II, where it became obvious that many navy vessels could be disabled easily by a non-contact underwater explosion. Thus a concerted effort, initially by the British and American Navies was made to try and make equipment and systems more resistant to underwater shock. This was achieved through laboratory shock testing of equipment prior to its installation aboard vessels. Thus a series of specifications and standards were born which ensured that equipment basically survived the rigours of combat.

However, there are so many variables involved in the shock loading process that it often proved extremely difficult to shock harden an item of equipment to just survive its required combat requirements. This often resulted in equipment that was over designed and extremely expensive, due to the number of testing iterations required by a shock standard. Even then it was (and still is) necessary to subject the ship to a shock trial to ensure that the equipment, as it was installed on the ship, will survive shock loading (as opposed to the laboratory installation).

"First of Class" ship shock trials tend to be fairly expensive and nowadays environmental concerns are making open-water shock trials extremely difficult to perform. With the advances in computer modelling capabilities, it is now possible to model the response of a vessel to an underwater explosion and identify potential problems or failures associated with this response. This has the potential to save much money and, although a vessel may have to go through a shock test programme, the number of tests and size of explosive charges may be reduced.

The increasing use of Commercial-Off-The-Shelf (COTS) equipment aboard naval vessels also has the potential to save defence dollars. The ultimate aim will be to have "unhardened" equipment isolated from the shock loading through flexibly mounted rafts. Again, modelling will play an important part in the assessment process and will enable raft designs to be optimised.

This report provides a brief review of the response of surface vessels to underwater shock loadings, with emphasis placed upon the author's interpretation of the

evaluation processes used by the Underwater Explosions Research Department of the Naval Surface Warfare Center of Portsmouth Virginia, USA.

Acknowledgments:

The author would like to thank the personnel of the Underwater Explosions Research Department (UERD), Carderock Division of the Naval Surface Warfare Center, Virginia, USA, especially Mike Riley and those of the Applied Mechanics Branch (Code 601) for their help in the preparation of this report.

Contents

1. CHARACTERISTICS OF UNDERWATER EXPLOSIONS	1
1.1 Sequence of events	1
1.2 The shock-wave.....	1
1.3 The gas bubble	2
1.4 Energy balance	4
1.5 Similitude equations.....	5
2. HULL DAMAGE AND RESPONSE TO UNDERWATER EXPLOSIONS	6
2.1 Shock factors.....	6
2.2 Shock damage.....	7
2.3 Bubble pulse damage.....	10
2.4 Bubble collapse damage.....	10
2.5 Surface cut-off and bulk cavitation damage.....	11
3. EQUIPMENT, MACHINERY AND PLATFORM RESPONSE AND DAMAGE...12	
3.1 Motions throughout a vessel	12
3.2 Equipment damage due to motion	16
3.3 Materials effects	18
4. MEASUREMENT AND ANALYSIS OF SHOCK MOTIONS	
(SHOCK SPECTRA)	19
4.1 Response versus time behaviour	19
4.2 Shock spectra	20
4.2.1 Linear plots	20
4.2.2 Tri-axial plots.....	21
5. SIMULATION OF SHIP-SHOCK ENVIRONMENTS	24
5.1 Shock testing standards.....	24
5.2 Shock machines.....	24
5.2.1 Light Weight Shock Machine (LWSM).....	24
5.2.2 Medium Weight Shock Machine (MWSM).....	25
5.2.3 Floating Shock Platform (FSP)	27
6. MODELLING RESPONSES TO UNDERWATER SHOCK.....27	
6.1 Hull plating and hull mounted component response.	27
6.2 Peak translational velocity.....	28
6.2.1 PTV of surface ships: Method 1 [10]	28
6.2.2 Surface Ships: Method 2 [10].....	29
6.3 Taylor flat plate theory	31
6.4 Hull plate damage.....	33
6.5 G-Shock	34
6.6 DDAM.....	36
6.7 UERDTOOLS	36
6.8 Hopkinson Scaling	36
7. SUMMARY	36
8. REFERENCES	37

1. Characteristics of underwater explosions

The following discussion in this section is by way of brief introduction only. For further information on the dynamics of underwater explosions, references such as Cole [1] should be consulted.

1.1 Sequence of events

On detonation of an explosive underwater, a superheated, highly compressed gas bubble is formed, along with a shock-wave in the surrounding water. The exponentially decaying shock-wave propagates as a spherical pressure wave and is originally much faster than the speed of sound. The propagation velocity drops to the speed of sound in water. As this is taking place, the gas bubble begins to expand in size whilst the pressure in the bubble reduces. Because of inertial effects in this expansion process, the bubble overshoots the gas equilibrium condition (hydrostatic pressure > gas bubble pressure). After reaching a maximum radius with a minimum pressure, the bubble contracts again to a minimum radius at a maximum pressure, although the pressure is not as high as the initial detonation. This cycle may occur a number of times with pressure pulses (which are not shock-waves) being emitted at each bubble minimum. The peak pressure of the first bubble pulse can be approximately 10 - 15 % of the shock-wave peak pressure and during this pulsation process the bubble migrates upwards due to the influence of gravity (at a greater rate when the bubble radius is a minimum).

1.2 The shock-wave

The shock-wave consists of an almost instantaneous rise in pressure to a peak pressure, followed by an exponential decay in pressure down to the hydrostatic pressure. Initially the velocity of the shock-wave is proportional to the peak pressure (up to 68.95 MPa). However as discussed above, the wave quickly settles down to a velocity of approximately 1525 m/s. The peak pressure and the decay constant depends upon the size of the explosive charge and the stand off distance from this charge at which the pressure is measured.

For planar waves and TNT explosive equivalents:

$$P_0 = 52.4 \cdot (W^{1/3} / R)^{1.18}$$

where P_0 is the pressure in MPa, W is the weight of TNT in kilograms, and R is the stand-off in metres.

The pressure change with time follows an exponential decay and is given by:

$$P = 52.4 \cdot (W^{1/3} / R)^{1.18} \cdot (e^{-(t-t_0)/\theta})$$

where t_0 is the initial time at which the shock wave arrives at the distance R ,

t = the time elapsed since the shock-wave arrived at the distance R , and

$$\theta = 0.084 \cdot W^{1/3} \cdot (W^{1/3} / R)^{-0.23}$$

where θ is the decay time in seconds (the time it takes for the pressure to decay to $1/e$)

The impulse, I , or rate of change of pressure of a shock-wave is defined as the time integral of pressure or,

$$I(t) = \int_0^t P(t) dt$$

The shock-wave energy flux density is a measure of the work done on a surface, or the energy behind the shock front per unit area. It is defined as the time integral of

$$P \cdot u \quad , \quad \text{or} \quad 1/\rho c \cdot \int_0^t P^2(t) dt$$

where P is Pressure and u is the water particle velocity immediately behind the shock front, ρ is the density of water and c is the speed of sound in water.

As the shock-wave passes a fixed location and subjects the water to a transient pressure, the liquid is simultaneously subjected to a flow with a velocity in the direction of the wave. This velocity is related to the transient pressure by

$$P(t) = \rho \cdot c \cdot u(t) \quad (\text{for plane waves only})$$

If the shock-wave is spherical then the amplitude of the wave decreases inversely with distance from the detonation point, due to the greater area over which the disturbance spreads. However in most applications of shock-wave theory the shock-wave can essentially be considered to be planar.

1.3 The gas bubble

The gas bubble generated by the explosion is almost spherical during its initial stage of expansion and contraction. The maximum bubble radius and the time taken to reach the first bubble-radius minimum can be calculated. Both vary with the size of the explosive charge and the depth at which the explosion occurs. For TNT charges these parameters can be calculated from:

$$R_{\max} = 3.50 \cdot (W^{1/3} / Z_0)^{1/3}$$

$$T = 2.11 \cdot (W^{1/3} / Z_0^{5/6})$$

where R_{\max} is the maximum bubble radius in metres and $Z_0 = D + 9.8$ is the total static pressure at the location of the explosive, D is the explosion depth in metres, W is the equivalent mass of TNT explosive in kg and T is the time to maximum radius in seconds.

The peak pressure of the bubble which is achieved during its first minimum is approximately 10 to 15 % of the shock-wave peak pressure and can be reduced by large migrations of the bubble towards the water surface. However the pressure pulse that the bubble produces can result in localised loading effects on a ship hull. Also, large bubbles often lose their symmetry and can collapse in upon themselves thus forming a toroid shaped bubble and a column of rapidly moving water. The combination of the water jet and bubble pulse can produce extensive damage in hull structures of ships (see section 2).

Figure 1 shows the shock-wave and pressure pulses emitted from a bubble with time.

As the gas bubble expands during its oscillation it displaces water around it. As the bubble contracts to a minimum the water rushes in to surround the volume vacated by the contracting bubble. It is during this minimum stage that the bubble migrates upwards at its maximum rate. First instincts would suggest that this is incorrect as the buoyancy of the bubble is at its greatest when the bubble is at its maximum size. However when the bubble is large, inertial forces brought on by the surrounding water dominate, cancelling out the buoyancy effect to a large extent. When the bubble is at its minimum, the inertial forces are also at a minimum and thus the buoyancy of the bubble causes it to rise at its maximum rate [2].

The vertical migration, m , which is defined as the distance from the location of the explosive to the location of the first minimum is experimentally known as:

$$m = (12.2 / (d + 9.8)) \cdot W^{1/2}$$

where d is the initial depth of the explosive and W is the equivalent explosive weight of TNT in kg. The migration from the first minimum to the second minimum is usually about half that of the initial integration. Figure 1 is a schematic of this behaviour [2].

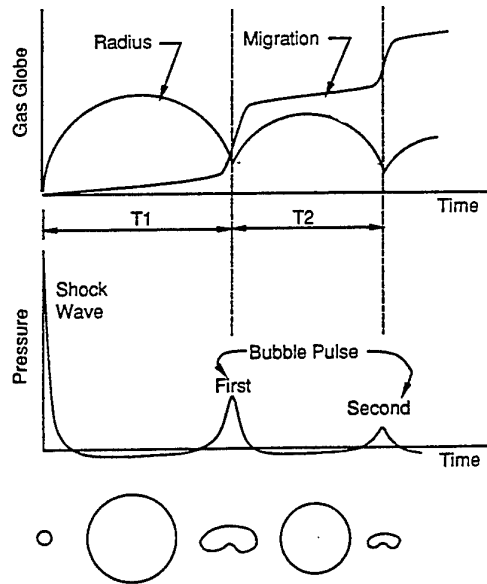

Figure 1. Bubble migration behaviour versus bubble expansion [2].

Depending on the initial depth of the explosion the bubble may migrate close to the water surface during its oscillation stage. If the bubble gets close enough to the surface, then the characteristic plumes of water that occur just after the shock-wave cavitates the surface (spray dome) can be seen. Each of the plumes matches an outward expansion of the bubble which causes water to be displaced radially outward. If the first bubble expansion does not break through the water surface, then the first plume appears to be broad and low. The bubble then goes through another oscillation phase, thus migrating closer to the surface. If the bubble is going to breach the water surface it is usually during the second or third oscillation maximums, as after these the energy has dissipated quite dramatically. When the bubble does breach the surface the water plume is usually thinner and higher and blackened due to the venting of the explosion gases that contain a large amount of carbon rich products.

1.4 Energy balance

In terms of the total energy released by an underwater explosion, approximately 53% goes into the shock-wave and 47% into the pulsation of the gas bubble. Of the shock-wave energy, 20% is lost during early propagation whilst the remaining 33% is available as damaging energy. In the bubble pulsation 13% of the explosion energy is radiated during the first bubble expansion/contraction period. 17% is lost as a

pressure pulse at the first bubble minimum and the remaining energy (17%) is usually left in the second pulsation.

The vicinity of the sea bed and water surface can affect the behaviour of the explosion. When a shock-wave reaches the surface it usually results in a broad, shallow, white spray dome being produced. This is due to the reflected tension wave at the surface which imparts an upward velocity to the water particles. Since water can sustain very little tension it cavitates. If the explosion is close to the surface then the bubble breaks the surface and no bubble oscillation will take place. Reflection of the shock-wave off the ocean floor can also occur (as a compression wave) and can cause additional damage to ships, especially in shallow waters. Reflection factors of up to 1.4 are used to approximate the increase in energy capable of loading or even damaging a vessel's hull.

1.5 Similitude equations

The equations discussed in the previous section apply to TNT charges only. When different explosives are used the input constants vary according to Table 1.

Table 1. Coefficients for Similitude Equations.

	Coefficient	HBX-1 ref [3]	TNT ref [3]	PENT ref [3]	NUCLEAR ref [7]
Shock-wave	K1	53.51	52.12	56.21	1.06E4
Pressure	A1	1.144	1.18	1.194	1.13
Decay	K2	0.092	0.092	0.086	3.627
Constant	A2	-0.247	-0.185	-0.257	-0.22
Impulse	K3	7.263	6.52	6.518	4.5E4
	A3	0.856	0.98	0.903	0.91
Energy Flux	K4	106.8	94.34	103.11	1.15E7
Density	A4	2.039	2.155	2.094	2.04
Bubble Period	K5	2.302	2.064	2.098	249.1
Bubble Radius	K6	3.775	3.383	3.439	400.5

The constants referred to in Table 1 are to be used in the following equations:

$$\text{Pressure} = (K1 \cdot (W^{1/3} / R)^{A1}) \cdot e^{(t-t_0)/\theta} \quad (\text{MPa})$$

$$\text{Peak Pressure} = K1 \cdot (W^{1/3} / R)^{A1} \quad (\text{MPa})$$

$$\text{Decay Constant} = K2 \cdot W^{1/3} \cdot (W^{1/3} / R)^{A2} \quad (\text{ms})$$

$$\text{Impulse} = K3 \cdot W^{1/3} \cdot (W^{1/3} / R)^{A3} \quad (\text{MPa-sec})$$

$$\text{Energy Flux Density} = K4 \cdot W^{1/3} \cdot (W^{1/3} / R)^{A4} \quad (\text{m-kPa})$$

$$\text{Bubble Period} = K5 \cdot W^{1/3} / ((D+9.8)^{5/6}) \quad (\text{sec})$$

$$\text{Bubble Radius} = K6 \cdot W^{1/3} / ((D+9.8)^{1/3}) \quad (\text{m})$$

where W = charge weight (kg)

R = Slant Stand-off (m)

D = Charge Depth (m)

2. Hull damage and response to underwater explosions

2.1 Shock factors

The most widely used parameter for describing shock severity is the shock factor value. This value is a shock input severity parameter which is a function of charge weight and charge distance (or stand-off from the ship). When this value is measured to any portion of the ship hull plating it is more commonly referred to as the Hull Shock Factor (HSF). The HSF represents the available energy that a shock-wave contains which may do work in damaging hull plating on the ship. It has been found that:

$$\text{HSF} = (W)^n / D$$

where W is the mass of explosive in TNT equivalence
 D is the stand off distance from the charge to the target

The value of n actually varies slightly under experimental conditions. However, this value is considered to be classified information, therefore in order to keep this report unclassified, the value of n will not be discussed further.

When the charge position is measured relative to the ship's keel and the angle of incidence of the shock-wave with respect to the ship is also taken into account the calculated value is referred to as the Keel Shock Factor (KSF or Q). In this situation the above equation must also be multiplied by:

$$(\sin \theta + 1)/2$$

where θ is the angle between a horizontal line and a line drawn from the charge to the ship's keel.

Therefore when the charge is situated directly underneath the vessel, θ is large and $KSF = HSF$. If on the other hand θ becomes small the $(\sin \theta + 1)/2$ term approaches 0.5. Testing experience and theory have shown that the KSF is approximately proportional to the vertical velocity imparted to the ship when it behaves as a rigid-body.

2.2 Shock damage

Shock damage to the hull area of a vessel can vary quite dramatically, depending upon the charge size, orientation and proximity to the hull. If the charge is located directly or almost directly underneath and/or close by to a vessel (figure 2, scenario B) then there could be a contribution to the damage arising from the bubble collapse onto the ship's hull and also due to whipping damage caused by the bubble pulses. These two damage mechanisms will be discussed in sections 2(iv) and 2(iii) respectively.

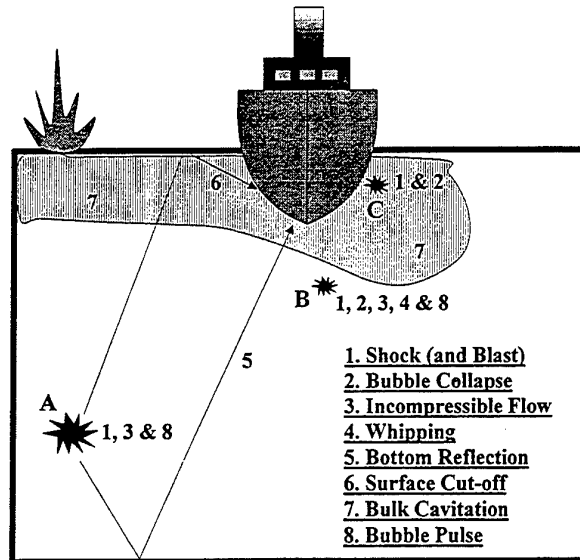

Figure 2. Likely loading functions on a surface ship from three different underwater explosion scenarios; A, B, C.

An explosive charge detonating in contact with or in very close proximity to the ship's hull (metallic) will also generally tear a large hole given that the hull thickness is not too great and that the charge is of a sufficient size (figure 2, scenario C). The bulkheads close to the point of attack will also often rupture due to direct exposure to the shock-wave, or to deformation caused in the bulkhead by hull deformation. Fragmentation of the shell of the explosive charge may also cause severe damage to equipment in the immediate vicinity. Although the damage may quite often be severe it usually does not extend far into the ship nor in the fore-and-aft direction.

As the stand-off increases, the point at which the hull just ruptures is reached. Past this point the hull is still water tight but heavily deformed with the level of deformation decreasing as the stand-off continues. Eventually a point is reached where only elastic hull deformation occurs. Some methods for calculating hull plate deflections are covered in section 6.

At large stand-off distances (figure 2 scenario A), the shock-wave front is essentially planar and the ship is more or less loaded as a whole rather than in localised areas as with a smaller charge close in to the hull. However different portions of the ship will respond at different velocities depending upon the mass per unit area. Most ship shock trials are performed at large stand-off distances for this reason.

When a shock-wave arrives at a ship's hull, the pressure loading on the plating shows an almost instantaneous rise to a peak pressure followed by an exponential decay period. If the plating is relatively light it responds by accelerating until a point is reached where the plating moves faster than the water adjacent to the plating can respond. Because water cannot sustain tension a localised cavitation region is produced and the maximum velocity which the hull has picked up is the kick-off velocity. At some later stage the cavitation envelope adjacent to the hull closes and the plate is reloaded again but usually not at the previous loading level. However it is not uncommon for further deformation to take place due to cavitation closure. A typical deflection/time loading plot for ship hull plating is shown in figure 3.

The incompressible water flow from the expanding gas bubble, can also contribute to hull plating damage. The water flow that develops ahead of the expanding gas bubble is capable of quite high loading pressures due to its momentum and acts for a longer period of time than the shock-wave. It is therefore capable of inflicting substantial localised hull plating damage. It is possible under certain circumstances that approximately 60% or more of the energy involved in plastic deformation damage comes from the early bubble expansion and only 40% or less from the shock-wave [4].

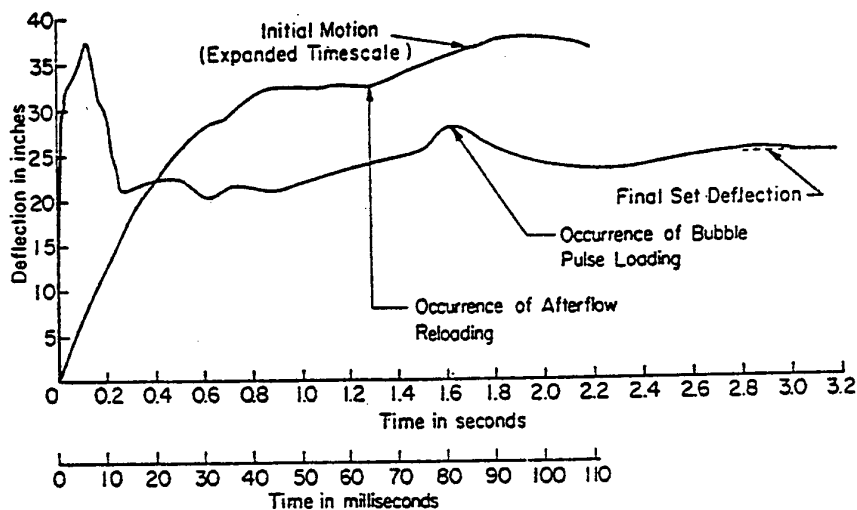

Figure 3. Loading phase on hull plating during an underwater explosion event. [4]

2.3 Bubble pulse damage

Following the detonation of the explosive, the gas bubble volume changes due to the oscillations of the bubble (section 1). As the bubble decreases in size it reaches a minimum volume at which point the pressure is at a maximum. Due to the rapidly changing pressure in the gas bubble a pressure pulse is emitted. The first pressure pulse emitted at the first bubble minimum has about 17% of the initial explosive energy which means that the bubble pulse usually does not do any damage. However depending upon the bubble pulse loading phase it may or may not contribute to the shock damage. In certain circumstances shock mount bottoming of equipment may occur because of the bubble pulse, due to the equipment response being out of phase with its base motion.

Because the bubble-pulse loading occurs at a later stage than the shock-wave loading, it may also be directed against a different portion of the ship. The gas bubble migrates upwards at the greatest rate when it is at its smallest and if the ship is in the path of the bubble, the pressure pulse may occur quite close to the hull. This may cause the hull to be holed or deformation or rupture at the bulkhead restraints.

If the frequency of the shock and bubble pulses matches the natural frequency of oscillation of the ship's hull girder then the severe bending moment on the ship girder can result in whipping damage. In severe situations the elastic limit of the ship or submarine's keel may be surpassed resulting in severe structural damage. This damage mechanism is potentially more dangerous for surface ships than submarines due to the lack of resistance to bulk movement that would normally be provided by the water surrounding a submarine.

2.4 Bubble collapse damage

Another damage mechanism which follows on closely to that of bubble-pulse loading is bubble collapse. If the oscillating gas bubble is close enough to a rigid body surface such as a submarine or ship hull then the pressure differential created as the bubble decreases in volume (caused by resistance to water flow close to the hull) will result in the bubble collapsing onto the hull and producing a high speed water jet, which in some instances is capable of holing the hull. Much research is currently being performed to model the collapse and formation of the water jet, using hydrocodes and finite element models. Water jet velocities following collapse have been recorded in the 130 - 170 m/s range [5].

2.5 Surface cut-off and bulk cavitation damage

Surface cut-off occurs when a plane compressive wave hits a free surface, is then reflected off that surface as a tensile wave, and then interacts with (cancels out) the compressive wave so as to produce a slightly negative pressure. For ships and submarines near the surface it means that the shock-wave pressure loading (which is decreasing in an exponential fashion after the initial loading phase) on the hull may suddenly drop to the ambient pressure. This may be significant if another reloading occurs (eg. due to bubble pulse) and the hull is moving down towards the water surface.

The phenomenon of bulk cavitation occurs when a shock-wave is reflected off a free surface such as the air/water interface. The compression shock-wave reflects off the free water surface as a tensile wave and since water can only sustain a very small level of tension it begins to cavitate. The cavitated region forms a bulk cavitation envelope which has an upper and lower boundary and extends in a radial direction away from the centre of the explosive burst position (figure 4). The extent and duration of the cavitated region that forms can be generated from equations in which the negative pressure distribution with time is determined [6].

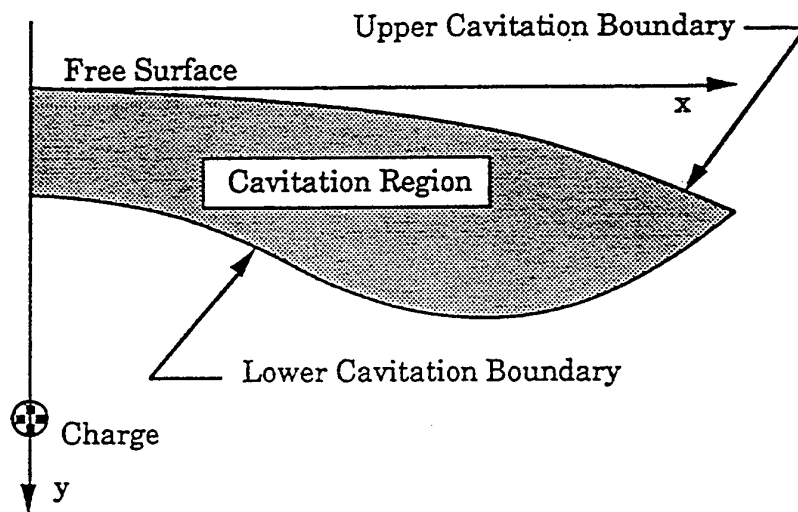

Figure 4. Bulk cavitated region formed by underwater explosion [2].

Eventually the bulk cavitated region closes (like a zipper) and the water layer above the cavitated region closes down onto the lower layer causing a water hammer (effect) which sends out a pressure wave (cavitation pulse). If the point of closure of the cavitation region lies close to the hull of a ship or submarine then reloading may occur. In certain circumstances this may result in higher recorded strains, than the original pressure pulse resulting from the detonation of the charge.

3. Equipment, machinery and platform response and damage

3.1 Motions throughout a vessel

The response of a vessel to an underwater shock-wave depends upon whether that vessel is a surface ship or a submarine. Surface ships will primarily move in an upward direction (a small amount of athwartships and fore and aft movement will also occur) no matter where the charge is located (assuming it is below the centre of gravity of the ship). Submarines will respond by moving in the direction that the shock-wave is travelling.

As the shock-wave strikes a ship hull, part of its energy is transmitted to the hull which is then transmitted to the bulkheads and deck structures throughout the ship as a relative velocity translation. In the stiff regions of the ship such as bulkheads, the velocity is transmitted extremely well with little attenuation along the bulkhead up into the top deck levels of the ship (figure 5). The velocities in the sections and decks between bulkheads usually varies somewhat (+- 20 to 30 %) from that seen in the bulkheads.

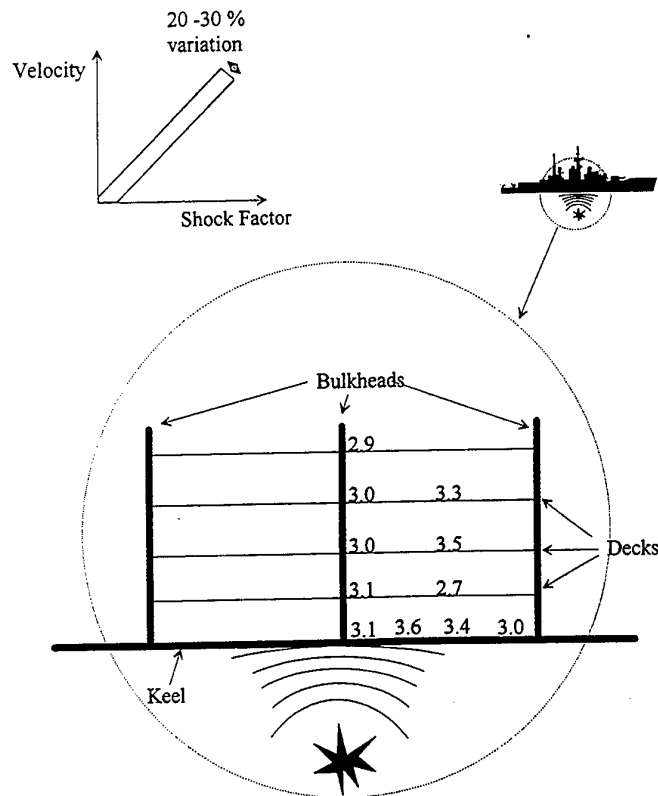

Figure 5. Schematic representation of velocity (m/s) distribution and variation throughout a ship when subjected to a shock loading.

Accelerations however can usually vary quite dramatically in any part of the ship (figure 6). At the keel an accelerometer will accurately reflect the acceleration of the ship to the shock-wave, however it will also record the localised high frequency response of the ship structure in this particular region. For this reason velocity meters are often used in locations throughout the ship where the rigid body response is required. If acceleration data is required then the velocity data is integrated, alternatively, the velocity data can be differentiated to produce displacement data. The integrated acceleration data that is produced does not contain the high frequency components that would be recorded by an accelerometer, however velocity meters can only be used to record the initial acceleration portion of the shock loading and the upward deceleration of the ship that follows.

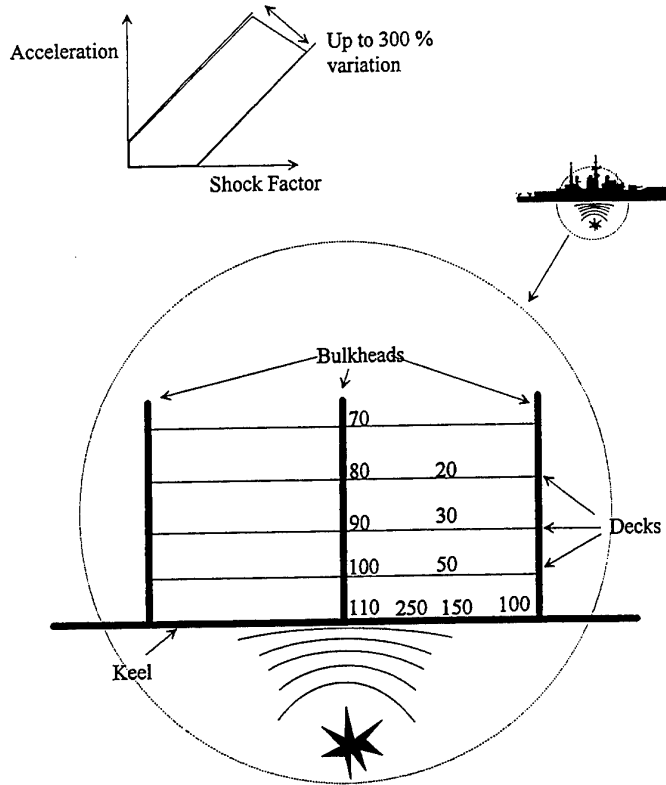

Figure 6. Schematic representation of acceleration (g) distribution and variation throughout a ship when subjected to a shock loading.

The accelerations recorded at a bulkhead throughout the various levels of a ship will tend to decrease as measurements are taken higher up in a ship's structure. The reason for this lies in the fact that the bulkhead is not a totally stiff structure and therefore will not instantaneously transmit these accelerations over the height of the bulkhead (thus resulting in a gradual decrease in the acceleration recorded at increasing bulkhead height). Velocities will be fairly constant at various points in the bulkhead because the elastic energy that can reduce an acceleration response due to non steady-state motion will eventually reflect a similar velocity motion at a remote portion of the bulkhead.

Away from the bulkhead the accelerations may vary quite dramatically, especially on flexible beams and decks. The acceleration response of these regions will be a function of the mass and stiffness of the region. This is why accelerometers are usually only used to record the response of localised regions and specific equipment away from the keel of the ship. Accelerometers have been used near the keel and on bulkheads, however the information usually requires extensive filtering and experience to determine the actual response in this region.

There is a correlation between the Keel Shock Factor (or shock level that the ship is subjected to) and the velocity and acceleration response of a ship. Figures 5 and 6 show

typical responses. The important point to note is that the spread of results is very much smaller for the velocity results compared with those of the acceleration results for the reasons discussed above.

The Peak Translational Velocity (PTV) of a ship represents the overall peak velocity that a section or whole of a ship attains as a rigid body rather than the localised, high frequency, velocity responses usually seen in individual components of a structural section. The PTV will generally be directly proportional to the KSF or the energy flux density of the shock-wave that reaches the ship hull.

Generally speaking, a plot of the PTV versus the explosive charge weight with conditions giving the same keel shock factor, shows a linear behaviour [7]. However if the explosive charge weight is extended to both very small and very large charges, the relationship becomes non-linear and more like that shown in figure 7. The reason for this behaviour is that at large stand-off distances, with large explosive charges, the reflected shock-wave that rebounds off the water surface tends to reduce the effect of the original shock-wave that emanated from the explosive charge. At distances close-in to a vessel and at smaller explosive weights the shock-wave tends to cause more localised responses at the vessels hull due to the sphericity of the wave as it strikes the hull. In both cases the PTV response of the vessel is reduced. There is a large amount of information available for responses caused by large explosive charges at large stand-off distances, however very little appears to be available for smaller charges used close-in to a target.

Combat scenarios for Royal Australian Navy vessels are more likely to involve small charges in relatively close proximity to a vessels hull. Therefore future experimental and modelling work in the underwater shock area should be directed towards this type of scenario.

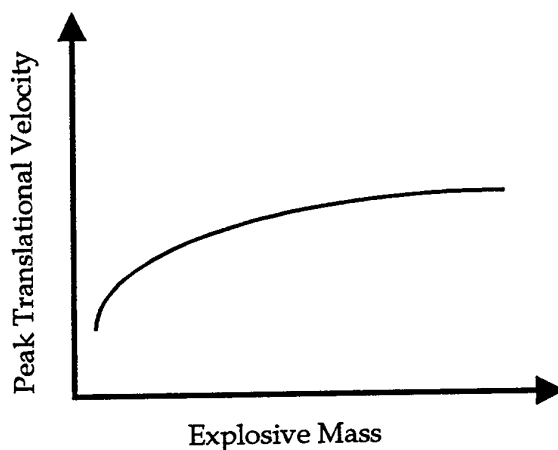

Figure 7. Schematic plot of Peak Translational Velocity v Explosive charge weight, for a constant Keel Shock Factor (Q) over very large charge weight ranges.

The computer code G-shock (see section 6), can be used to generally predict the PTV response of ships in the higher explosive weight/large stand-off regime, however it begins to be less accurate when smaller explosive weights are used (eg. < 250 kg). Taylor Flat Plate theory (see section 6), will however give a fairly accurate response of the localised hull response to a shock-wave. It works particularly well with items such as hull penetrations and when equipment items are mounted to hull frames. For close-in explosions it predicts the localised response of the hull where-as at large distances and large charges it begins to approximate the PTV predicted by G-shock. However the G-shock response prediction never actually matches or surpasses that of the Taylor Flat Plate Theory prediction. This is because the localised response will always be greater than that of the ship as a whole. Taylor Flat Plate Theory and G-Shock are covered in greater detail in section 6.

3.2 Equipment damage due to motion

The damage to an item of equipment (caused by its response to a shock loading) is basically caused by either an acceleration or displacement. However the potential for damage (based upon the input motion to the ship) is best shown by the velocity response of the sections of a ship where the equipment is located. In terms of the velocity response of equipment that is highly likely to produce damage, most unhardened items¹ and computing and sensitive electronic equipment often fail at quite low velocity levels. Analog equipment (eg radio transmitters etc), switchboards, pumps, motors, generators etc usually fail at a slightly higher velocities. Velocity levels which produce failure of this equipment is considered to be classified and these levels will therefore not be discussed further.

It has been found that equipment damage is proportional to inelastic relative displacement [7]. There are three distinctive regions in which shock induced damage of equipment may be classified with respect to a series of time history curves (Figure 8).

¹ Items that have not been designed or modified specifically to survive a shock test.

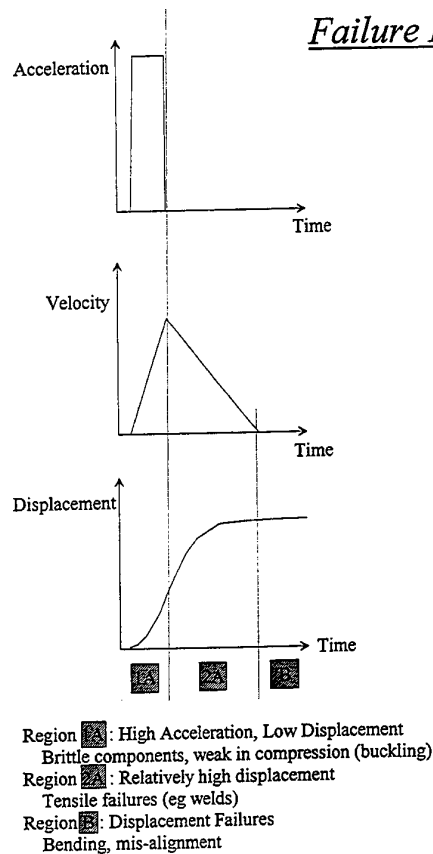

Figure 8. Time-history response regions relating to shock induced damage of equipment.

The region where failures are most likely to occur is region 1A. This is where the accelerations are high but the displacements are relatively small. This region is also characterised by an area of positive acceleration. Materials or components that are likely to fail are those of a brittle nature, are weak in compression or are susceptible to buckling failures. Shear failures are also common especially where heavy objects are bolted to one another and a relative shearing movement is involved. Cast objects often fail in this region along with other failures due to "brinelling" or the localised impact and plastic deformation of two hard objects.

Region 2A is where the acceleration due to the shock impulse is removed, thus resulting in a deceleration and a decreasing velocity. Displacements are quite high in this region and the types of failures usually relate to tensile failures such as in welds. Region B is where the velocity input to the motion has ceased and the object fails due to its momentum causing excessive displacement as it enters a plastic regime where bending failures are common. Equipment damage may also occur from high displacements due to impact with other equipment.

A shock spectral plot (section 4(ii)) can be divided up into regions where displacement (at low frequencies) failures are likely to be common, or where acceleration related (at high frequencies) failures are likely. An indication of the regime where the failure is likely to occur will best be given by the relative velocity. Larger shock impulses will result in greater velocities. The use of shock factors in assessing the severity of an

explosion must be used with care. For instance, a small charge close to a hull may give the same Keel Shock Factor as a large charge further away, however the large charge will have a longer impulse time which may result in more damage to heavier items of equipment. The smaller charge on the other hand, will result in an increased peak pressure of the shock-wave when it strikes the vessel's hull and this is more likely to produce greater accelerations than the larger charge especially in lighter items of equipment. The smaller charge is also more likely to produce whipping damage due to the greater bending moment placed upon the vessel's hull girder. This occurs because the more spherical shock-wave of the smaller charge produces a greater lead time in loading the fore and aft ends of the vessel compared to midships.

Displacement damage usually results in misalignment or may be caused by impact with another item of equipment. Potential for this damage mechanism to occur is usually best measured by a relative displacement meter, however the result can be inferred by differentiating velocity (or double differentiating acceleration results) results with careful analysis to allow for the drift in the zero datum that may have occurred. The next section (Measurement and Analysis of Shock Motions) on shock spectra shows how the potential for shock damage to equipment can be determined based upon a specific input motion and the mass and stiffness of the foundation of that item.

The G-SHOCK computer program is one means by which the potential motions of the bulkhead regions of a ship may be determined based upon various factors such as the mass, draft and buoyancy for each frame section of the ship. In order to determine how items of equipment mounted on flexible foundations will behave, it is necessary to use some form of finite element analysis such as NASTRAN or DYNA/USA to analyse its response to these input motions. Simulation of ship board motions is further discussed in section 6.

3.3 Materials effects

The materials from which a deck or structural portion of a ship is made will also have a large effect upon the response motions and therefore the damage potential to equipment. Traditional construction materials such as steel and aluminium behave according to their stiffness. A relatively stiff material such as steel will tend to transmit more of the high frequency component of a shock loading response and also provide less damping throughout the structure. Composite materials such as Glass Reinforced Plastic (GRP) are being introduced into ship structural sections for reasons of lightness of weight and therefore increased ship performance. However from a shock loading point of view, there is potential for equipment damage if these materials are used, for instance in deck structures. The main reason for this lies in the fact that GRP has a stiffness approximately 1/10 that of steel and any shock input motion to the deck could result in excessive displacement of the deck structure with resulting damage to equipment. The natural frequency of the deck structure could play an important part

in the damage potential and careful design consideration may be necessary to prevent this excessive displacement through the use of supports, bracing etc. However on the positive side, the good natural damping characteristics of this material will attenuate the shock loading response in the upper portions of the ships structure.

4. Measurement and analysis of shock motions (shock spectra)

4.1 Response versus time behaviour

A number of measurements may be taken during a ship shock trial, machine or floating platform test. The response versus time behaviour of the component or platform is usually derived from a displacement, velocity or acceleration gauge. This information provides valuable data on the likely mean and maximum displacements, velocities and accelerations that a component is likely to be subjected to. A typical velocity versus time plot measured at the keel of a Floating Shock Platform is shown in figure 9.

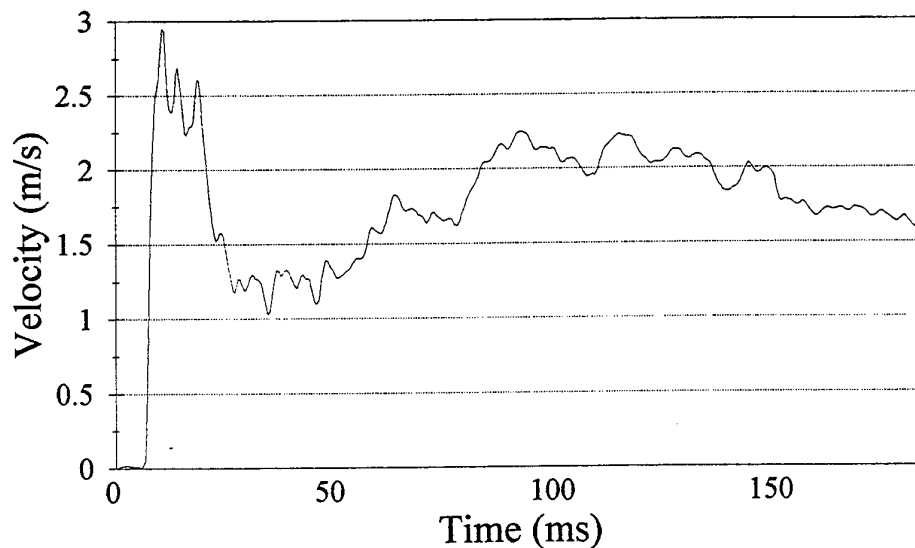

Figure 9. Velocity versus time response recorded on the inner bottom of a Floating Shock Platform after a shock-wave strikes the hull.

4.2 Shock spectra

4.2.1 Linear plots

Valuable data may also be obtained if a frequency shock spectrum is produced. This is performed by converting the amplitude versus time plot of the transient into a peak amplitude versus frequency spectrum. The most convenient way of doing this is to analyse the amplitude versus time response to determine how a number of components (mass-spring systems) mounted on a base (where the transient response was recorded) would behave if each of these components had different frequency responses. Theoretically the components have zero mass and by determining the response at a number of frequencies a shock spectrum is produced. Heiber & Tustin [8] give a definition of the shock response spectrum as:

"a plot of the peak responses of a large number of single-degree-of-freedom systems, of differing natural frequencies, to a specific input transient. Unless otherwise specified, the systems are undamped (although 5% damping is now becoming a standard for ships). Some authors specify that the systems are also mass-less, which is merely to emphasise that the systems do not load the input, as they are imaginary."

The Shock Response Spectrum method was first devised by Biot in the 1930's to enable him to determine the resistance of buildings to earthquakes. He proposed that, rather than be concerned with the shape of input shock pulses, we should describe the response of systems to those pulses. Modern day computers have made the calculation of the response of each single-degree-of-freedom (SDOF) system relatively quick (a matter of seconds on a PC).

A shock response spectrum generated at various damping rates is shown in figure 10. A number of factors can be determined from these plots. The dominant-system frequency response of a component can be determined for a particular frequency or range of frequencies. In this case there is a significant resonant frequency response at around 200 Hz. Therefore systems designers can allow for this in the planning stages and alter the characteristics of a particular system to avoid this region. It also gives the designer a concise indication of the maximum dynamic loads of a system. Therefore maximum accelerations and displacements can be determined for a system and related back to the likely stresses in a system (ie. from finite element analysis) and design changes made before production.

Apart from an absolute acceleration spectrum, pseudo-velocity and absolute or relative displacement spectra can also be derived. When a damping rate of 0% is assumed and velocity and displacement response are derived, these responses are defined as pseudo responses. This is because, even though pseudo-velocity/displacement values have units of m/s, they do not exactly reflect the behaviour of the system. All systems have

some form of internal damping (albeit very small in some cases) which would not allow the system to attain the response levels indicated.

A shock spectral plot also allows the designer to visualise the effect of design changes in the stiffness of the mounting media. Different mounting fixtures have different damping factors or compliances and a shock spectrum can be produced for different rates of damping. From this information the effects of different mounting arrangements and brackets can be determined. The residual response signals (ie. the response of the component after the shock input has ceased) can also be used to help in the analysis of the fatigue properties of the component.

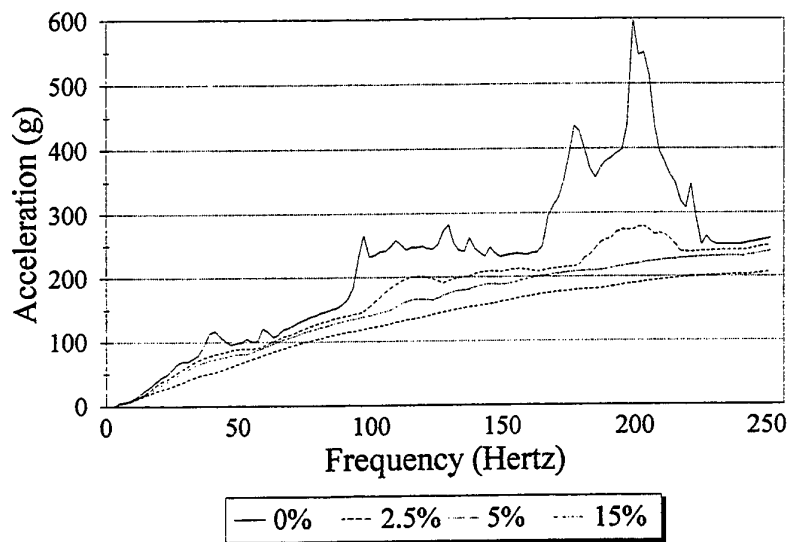

Figure 10. Comparison of various damping rates on an acceleration shock response spectra.

4.2.2 Tri-axial plots

By plotting all three responses (acceleration, velocity, displacement) on a tri-axial plot, some valuable information can be obtained on the likely response of a system. A tri-axial plot of a shock spectrum from the Medium Weight Shock Machine (MWSM - section 5(ii)) is shown in figure 11. The plot shows the acceleration, velocity and displacement response of a system as one plot. The velocity is usually plotted on the vertical axis whilst the displacement is plotted as a 45 degree positive slope and the acceleration as a 45 degree negative slope. Frequency is plotted on the horizontal axis.

The UERDTOOLS software [16] allows a tri-axial plot to be generated from linear plots, however the ASCII file used to generate the plot must contain pseudo-velocity and frequency values. The software generally operates using imperial units, although

it does allow for conversion to metric equivalents, however tri-axial shock spectra plots can only be generated in imperial units.

The damage potential of a shock pulse on an item of equipment increases as the relative displacement increases, or as the acceleration of the equipment increases. The magnitude of the responses shown on the shock spectral curve provides a measure of the damage potential from a shock pulse as a function of frequency.

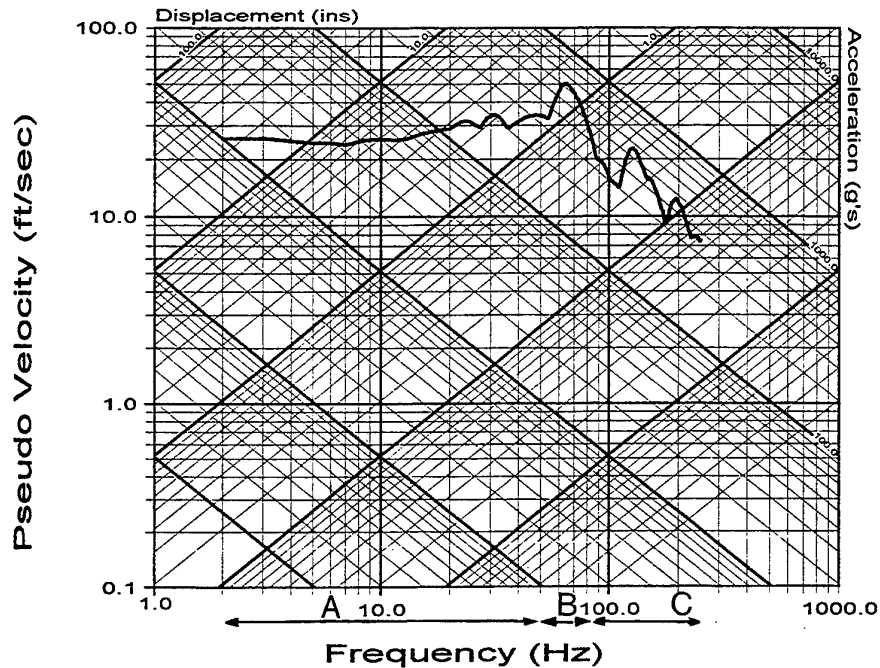

Figure 11. Tri-axial shock spectra plot from an input motion recorded on the MWSM (0% damping). Sections A, B and C refer to sections of the spectrum that can be correlated with equipment motion responses (see below).

There are a number of regions in a triaxial plot from which the different responses of a system can be identified. For example, in figure 11, the first region, designated as A, lies in the low frequency region between about 2 and 50 Hz. This region shows a nominally constant velocity of 25 to 40 feet/sec (7.6 to 12.2 m/s) which corresponds to a frequency region over which the shock input motion can be considered to be an impulsive velocity change. This is equivalent to the velocity of the centre of gravity of the MWSM table as it moves between the stops. At very low frequencies the shock spectrum can become asymptotic to the maximum displacement shown in the shock motion (not shown in figure 11). This typically occurs on the Light Weight Shock Machine (LWSM - section 5(ii)) or when light loads are used on the MWSM. At some intermediate frequency (region B, 50 to 80 Hz), peaks in the shock spectral curves indicate sustained frequencies of the shock motions.

As the frequencies of the shock spectral values become higher (as in Region C), the single-degree-of-freedom systems become very stiff and they will therefore eventually behave as a rigid body. At high frequencies the acceleration shock spectral values will therefore be asymptotic to the maximum value of acceleration existent in the shock motion. This would be true if the responding spring/mass system had very little mass. In reality this is not necessarily so and the "troughs" of this portion of the plot are usually more representative of the behaviour of these systems.

In figure 11 the likely maximum acceleration of systems in region C is about 400 g. However equipment that is very light may accelerate at 800 to 1000 g. Sustained vibrations or resonant responses are generated between 50 to 80 Hz in Region B and could cause responses up to 2000 g for a light-weight undamped system. The maximum displacement amplitude in this region is about 3 inches (75 mm, the distance the MWSM anvil table top travels before it hits the stop).

If a shock isolator was applied to limit the transmission of the shock-wave to 100 g then the natural frequency of the mounted equipment would have to be less than about 15 Hz and one would have to provide a clearance of 4 inches (101 mm) for equipment with frequencies above 10 Hz. If only 3 inches (75 mm) clearance was available then the natural frequency would have to be limited to above 25 Hz.

An idealised shock response spectrum will contain constant displacement, velocity and acceleration responses over different frequency ranges. The frequency change points, where each of the responses change, can be simply calculated. To determine the frequency change point for absolute acceleration (g) to pseudo-velocity (m), this is given by:

$$f_u = (a_0/v_0) 9.8 / (2\pi.f)$$

where π is pi, f_u is the upper frequency change point, a_0 is the constant acceleration, v_0 is the constant velocity and $9.8 \text{ m/s}^2 = 1 \text{ g}$

Alternatively to find the lower frequency change point, f_L :

$$f_L = (v_0/d_0) 2\pi.f / 1000$$

where d_0 is the constant displacement.

5. Simulation of ship-shock environments

5.1 Shock testing standards

The aim of shock testing equipment is to produce the same damage to the test equipment as it would also receive in a service environment. If an item of equipment passes a test to a US based standard, then it may be placed at any location on the ship with sufficient confidence that it will survive the service environment. The ship-board shock test procedure of MIL-S-901D is used by the US Navy. MIL-S-901D specifies that depending upon the mass of an item of equipment, a specific shock test machine is to be used along with a particular mounting arrangement and an operating procedure. There are three shock test machines specified by MIL-S-901D. If the weight of the equipment to be tested is less than 250 pounds (113 kg) then the Light Weight Shock Machine is to be used; if between 250 and 6000 pounds (113 to 2721 kg) then the Medium Weight Shock Machine is to be used; and if between 6000 and 30,000 or 40,000 pounds (2721 to 13605 or 18140 kg) then variants of the Floating Shock Platform (FSP) are to be used. Items too heavy or large for these shock machines must rely on calculations by some method of dynamic analysis.

The performance required of the equipment being tested is a function of the importance of the equipment to the effective operation of the ship. MIL-S-901D specifies that shipboard equipment usually falls into one of two categories: Grade A items are those which are essential to the safety and continued combat capability of the ship whilst Grade B items are those whose operation is not essential to the safety and combat capability of the ship but which could become a hazard to personnel, to Grade A items, or to the ship as a whole as a result of exposure to shock.

5.2 Shock machines

5.2.1 Light Weight Shock Machine (LWSM)

The first LWSM was assembled in Britain in 1939, whilst updated and modified versions were produced in the US in 1940. In its current form the LWSM (figure 12) conforms with the MIL-S-901D shock testing standard and consists of a welded framework of standard steel structural sections and two hammers; one swinging in a vertical arc and the other dropping vertically. An electric hoist raises either of the hammers so that they can drop onto an anvil plate on its side edge or back face. Each hammer weighs 400 pounds (181 kg) and can be raised to a vertical height of 5 feet (1524 mm) above its impact position for a maximum energy input capability of 2000 ft.lb (2712 Joules). In all there are 3 anvil operating positions and the test schedule requires that the item be tested at hammer heights of 1, 3 and 5 foot (300, 900 and 1500 mm) hammer heights.

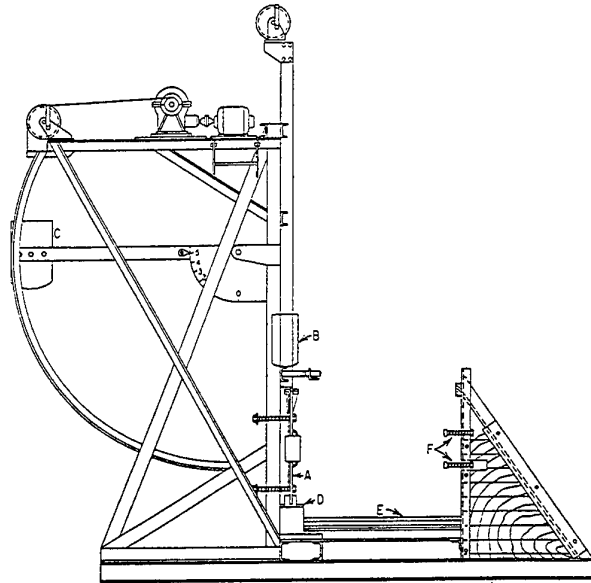

Figure 12. Light-Weight Shock Machine [9].

The tests are performed in any order at increasing hammer heights until the item fails through structural collapse or inadequate performance or all 9 tests are passed. Unfortunately the LWSM does deform plastically during use which means that the shock characteristics will also change. Therefore there is also a requirement to inspect the LWSM regularly to repair cracked welds and replace the impact pads when they become sufficiently deformed.

5.2.2 Medium Weight Shock Machine (MWSM)

The first Navy High-Impact Shock Machine for Medium Weight Equipment was installed at the former Naval Engineering Experiment Station (now NSWC Carderock Division Annapolis Detachment) in 1943. The current version of the MWSM allows equipment in the range 250 to 7400 pounds (113 to 3357 kg) to be tested. The basic design of the MWSM (figure 13) consists of an anvil table struck from below by a swinging hammer. The hammer weighs 3000 pound (1361kg) and swings through an arc of up to 270 degrees whereupon it strikes a 4500 pound anvil table. The anvil table is restrained by 12, 2" diameter bolts which allow a table free motion of either 3" or 1.5" (75 or 38 mm) before it is sharply stopped and allowed to fall back onto the machine foundation.

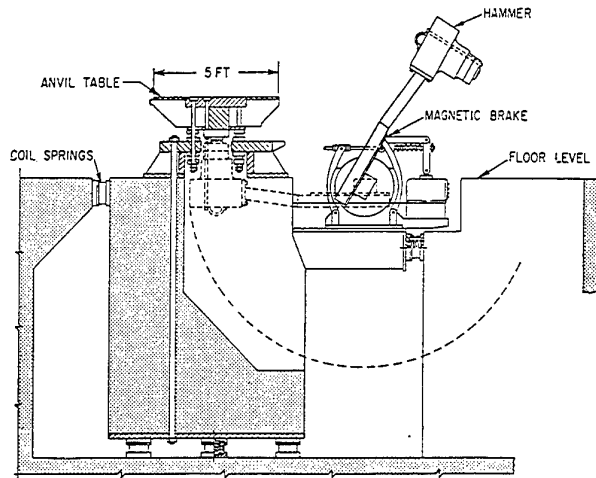

Figure 13. Medium Weight Shock Machine [9].

The medium-weight shock test is based entirely upon anvil-table velocity which is about 7 ft/sec (2.1 m/s) for a 250 pound (113 kg) load and a 5 foot (1.5 m) drop height. For a 4500 pound mass on the anvil table the velocity decreases to about 6 ft/sec (1.8 m/s). The majority of the energy dissipation in the MWSM is elastic in nature which therefore makes the MWSM much more predictable than the LWSM. The operating variables are the energy input to the equipment/anvil system and the free travel of the anvil table. A total of 6 blows are made on the anvil; 2 at a low drop height with a 3" (75 mm) table travel, 2 at a higher hammer height with a 3" (75 mm) table travel and 2 at the higher height with a 1.5" (38 mm) table travel. Each group of blows also includes one at an inclined mounting.

The MWSM is much easier to mathematically model than the LWSM because of the smaller number of variables involved and also because the energy response of the system is essentially elastic in nature. The whole system can essentially be treated as a mass-spring-mass system which is excited by imparting a sudden velocity to the mass representing the anvil-table. The anvil-table itself oscillates with a natural frequency of around 65 Hz after being hit and this motion may nullify or augment the motion experienced by an item of equipment, depending upon the stage of the motion at which it occurs. If the load mass has its maximum velocity away from the anvil at the time, the load velocity change may be greater than that caused by the original hammer impact (up to 2 times). The initial anvil-table velocity varies from 3.4 ft/s (1.04 m/s) for

a drop height of 0.75 ft (0.23 m), to 10.3 ft/s (3.14 m/s) for the maximum drop of 5.5 ft (1.68 m) and follows a linear behaviour. The initial velocity is essentially independent of load when the load is mounted on the channels (analogous to the similar velocities seen high up in a ships bulkhead - section 3) When the anvil-table hits the stops, it rebounds downward with a velocity dependent upon the original striking velocity of the hammer and the fundamental oscillation of the table.

Accelerations imparted to the anvil table by the hammer also follow a linear behaviour and range from 220 g (0.75 ft drop height) to 580 g (5.5 ft drop height).

5.2.3 Floating Shock Platform (FSP)

The FSP was designed in 1959 to handle all up loads of 30,000 pounds (13607 kg) (40,000 pounds or 18140 kg when the centre of gravity is low). The FSP consists of an open steel barge to which equipment is bolted or welded (including the equipment foundation). The equipment is installed, as it would be aboard the ship and therefore the test hopefully approaches actual service conditions.

Rather than a mechanically induced shock loading, an explosive charge detonated underwater is used to load the FSP. The explosive charge weight is 60 pounds (27 kg) and is detonated at a depth of 24 feet (7.31m) at various horizontal stand-off distances of 60(18.2), 40(12.2), 30(9.1), 25(7.6) and 20(6.1) feet (metres) to the near side of the FSP. The shock motion of the FSP is considerably different from that of the LWSM and MWSM. This is due to a number of reasons based upon the predominantly vertical motion of the FSP when the shock-wave hits it and that the rigid-body displacements are not limited by travel stops. Also the FSP is so large that other motions are induced due to its flexible structure which produces variations in the velocity/acceleration response depending upon where the measurement is taken on the FSP. The largest displacement occurs in the vertical; direction, reaching a maximum of 16.5" (420 mm) at 300 ms after the arrival of the shock-wave. This translates to a peak body velocity of 7.2 ft/sec (2.19 m/s). Much smaller displacement components in the athwartships direction and some rotational components are also observed.

6. Modelling responses to underwater shock.

6.1 Hull plating and hull mounted component response.

When a shock-wave hits the plating structure of a ship a proportion of the energy carried by the shock-wave is transferred to the plate, whilst the remaining portion is reflected. The portion transferred to the plate depends upon a number of factors such as angle of incidence of the incoming shock-wave with respect to the plate and whether the plate is water backed or not. The energy transferred to the plate varies approximately with $\cos \theta$ (angle of incidence). However if the plate is water or fluid

backed then the plate may remain undamaged by the shock-wave. This is due to the fact that the majority of the shock-wave is transmitted through the plate and into the fluid. This situation may occur in various tanks on-board which share the outer hull as one of the compartment walls. If the tank is full this may prove to be disastrous for the inner tank wall as this will then react to the shock-wave. The ideal situation for low shock damage exists when the tanks are just under full, where the shock-wave can be dissipated at a free surface and there is a large fluid bulk to absorb any reflected waves. The following theories relate to the determination of the response of air-backed plates to incident shock-waves.

6.2 Peak translational velocity

The peak translational velocity (PTV) of a surface ship or submarine is the overall maximum velocity imparted to it by a shock-wave. For surface ships the PTV can be determined from basic fluid mechanics and formulae such as Taylor Flat Plate Theory which is discussed in the next section.

6.2.1 PTV of surface ships: Method 1 [10]

The kick-off velocity of a ship (or the peak upward velocity that the ship as a rigid body achieves as a direct result of an underwater shock loading) is a function of the vertical fluid-particle velocity:

$$U_c(z) \approx (P_0 / \rho C) e^{(-z/CT)}$$

where U_c is the vertical fluid particle velocity,

P_0 is the peak pressure,

z is the depth at cut-off time,

θ is the decay constant

ρ is the density of water

$C = c \cdot ((D^2 + h^2)^{0.5}) / 2D$,

c is the acoustic velocity of sound in water,

D is the charge depth,

h is the horizontal stand off,

If the cut-off time is taken as the time it takes for bulk cavitation to begin at a depth equal to the draft of the ship then the kick-off velocity of the ship will be given by:

$$U_k \approx (P_0 T_0 / \rho d) (1 - e^{-t/\theta})$$

where U_k is the kick-off velocity of the ship
 d is the draft of the ship
 t is the time period that the shock-wave acts upon the hull before cut-off
 θ is the decay constant.

This method does not however take into account the hydrostatic or atmospheric pressure at the draft depth of the ship, thus giving slightly higher results than the following method.

6.2.2 Surface Ships: Method 2 [10]

This method relies on the fact that the kick-off velocity is a function of the kick-off velocities from the compressive shock-wave (u_1) and the rarefaction wave (u_2) that is reflected at the air/water interface. ie.

$$U_k = u_1 \sin \phi + u_2 \sin \phi_r$$

where U_k is the ship kick-off velocity
 ϕ is the slant angle along the horizontal between the charge and the target.
 ϕ_r is the slant angle along the horizontal between the charge and the target after reflection at the air/water interface.

The mass of a surface ship is identical to the water displaced and therefore the water particles through this volume may be calculated. If the charge is at a depth D and the ship has a draft d , and R and R_r are the incident and reflected slant ranges to the target respectively then:

$$U_k = u_1(D-d)/R + u_2(D+d)/R_r$$

$$R = (h^2 + (D-d/2)^2)^{0.5}$$

$$R_r = (h^2 + (D+d/2)^2)^{0.5}$$

where h is the horizontal distance from the charge to target.

$d/2$ has been taken as the centre of (buoyancy) gravity of the ship. The following calculations may be used to obtain the response at any position along the draft of the ship. Therefore at the maximum ship draft, U_k will be a minimum and at the minimum ship draft U_k will be a maximum. It has been found that the mid-draft position gives a reasonably accurate response of the overall ship PTV.

The cavitation cut-off time is given by the time taken for the shock-wave to traverse the extra distance along the reflected shock-wave path ie.

$$t_c = (R - R_r)/C$$

where c is the acoustic velocity of water $\cong 1525$ m/sec.

Now
$$U_k = (P_1/\rho c) \sin\phi + (P_1+P_a+\rho d)/(\rho c) \sin\phi_r$$

where $u_1 = P_1/(\rho c)$ and $u_2 = (P_1+P_a+\rho d)/(\rho c)$
and P_a is the atmospheric pressure, and ρd is the pressure at the mean draft due to hydrostatic pressure

P_1 may simply be calculated from

$$K1*((W^{1/3})/R)^{A1} \cdot e^{(t-t_0)/\theta}$$

where W is the weight of the charge in pounds, θ is the decay time (secs) and $K1$ and $A1$ are explosive constants, see section 1(v).

Submarines [10]:

The PTV of a submerged cylinder or submarine will be given by the PTV of the equivalent mass of fluid moved by the shock-wave. This will however depend upon whether the submarine is neutrally buoyant.

For a step pulse wave (ie. a long duration wave such as that given by a nuclear explosion) the velocity V_e attained over the envelopment time of the shock-wave is given by:

$$V_e = V_0(M_d + M_a)/(M_s + M_a)$$

where M_d is the displaced mass of water by the submarine
 M_s is the structural mass (or dry mass) of the submarine
 M_a is the entrained mass of water around the sub, which must also be moved
 V_0 is the incident-wave fluid-particle velocity = $P/\rho C$

For an infinite cylindrical shell, ($t_e = 2a/c$),
where t_e is the envelopment time.

$$M_d = \pi\rho a^2, M_a = \pi\rho a^2, M_s = 2\pi\rho a h$$

For a spherical shell, ($t_e = 2a/c$)

$$M_d = (4/3)\pi\rho a^3, M_a = (2/3)\pi\rho a^3, M_s = 4\pi\rho a^2 h$$

If the shock-wave is a step-exponential wave, such as that found with conventional explosive charges, then the velocity varies up to a maximum and then back to zero. In this situation it is easier to calculate the distance which the submarine moves over the impulse time. Therefore:

$$X_e = X_0(M_d + M_a)/(M_s + M_a)$$

where X_e is the distance over which the hull moves due to the incident shock-wave
 X_0 is the incident-wave fluid-particle displacement = $(P/\rho c)\theta$

An average translational velocity can be obtained from X_0/θ

The response of the submarine will depend upon the buoyancy of the sub and how the non-hull mass in the sub is mounted to the hull. If the sub has neutral buoyancy then

$$V_e = V_0, \text{ as } M_d = M_s$$

If the non-hull mass within the sub is rafted then M_s approaches or = 0, and

$$V_e = 2V_0$$

although when this mass begins to move there will be an oscillation in the velocity as the mass is accelerated.

Submarines with stiffly mounted internal equipment (natural periods much less than t_e) respond as neutrally buoyant bodies: those with softly mounted internal equipment (natural periods much greater than t_e) initially respond as positively buoyant bodies and then oscillate as they translate.

6.3 Taylor flat plate theory

The theory was evolved by the same G.I. Taylor [11] who performed many studies upon the fragmentation behaviour of metals in contact with explosives. The theory allows for a quick and reasonably accurate estimation of the velocity of an air-backed flat plate after being struck by an incident shock-wave underwater. This allows typical kick-off velocities to be determined for items that are hull mounted. The theory has been proven in the past to be good in giving quick answers compared to much slower and computer intensive Finite Element Methods. Experimental versus predicted results usually show a +/- 20% deviation with the Taylor theory most likely to over predict at lower velocities and under predict at higher velocities (figure 14).

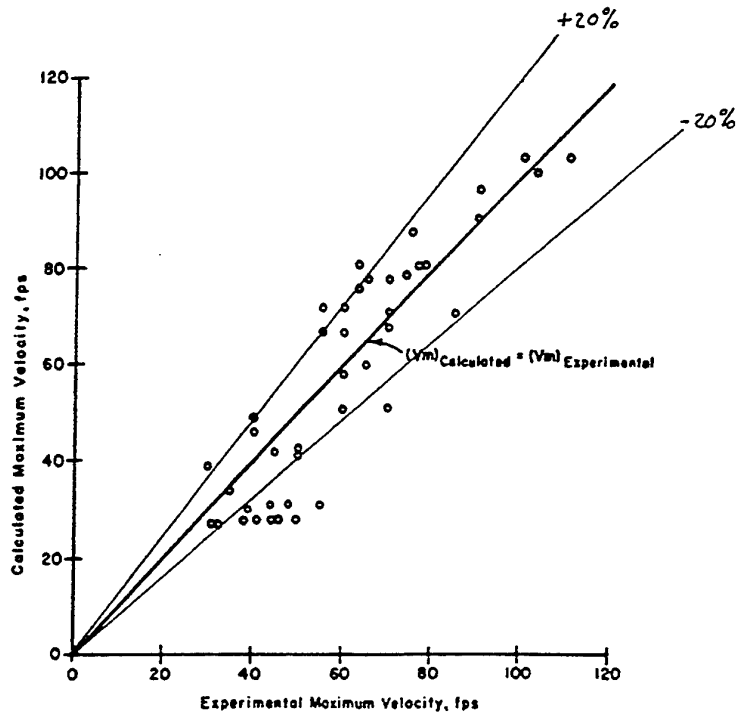

Figure 14. Variation in predicted results from Taylor Flat Plate theory with experimental results.

The maximum kick-off velocity of the hull is given by :-

$$V_{max} = (2 \cdot P_{max} \cdot \theta) / (m_p \cdot (1-\beta)) \cdot [\exp(-\beta \cdot t_0 / \theta) - \exp(-t_0 / \theta)]$$

and $\beta = \rho \cdot c \cdot \theta / m_p$

where P_0 is the Initial peak pressure of the incident shock-wave as it hits the ship hull,

ρ is the density of water (= 1000 kg/m³)

c is the velocity of sound in water (1525 m/s)

t_0 is the time taken for the shock wave to reach the plate

β is a dimensionless quantity made up of :

m_p = the mass of the plate per unit area.

θ = the decay constant of the shock-wave pressure.

The time to reach the maximum velocity after the shock-wave hits the hull (Note: this is also the time to localised cavitation) is given by :

$$t_{max} = \theta \cdot (\ln \beta) / (\beta - 1)$$

For 12 mm steel plate, velocities of > 30 m/s are not uncommon, compared with only 3 m/s for the whole ship. The discrepancy arises because of the lack of ship board mass behind the steel plate compared to the much greater mass of the ship.

Taylor Flat Plate Theory may also be applied generally to determine the approximate, overall maximum-hull-velocity response to an underwater explosion. This involves using the overall mass of the ship and the wet-hull surface area to generate a velocity estimate.

6.4 Hull plate damage

The amount of hull plate damage that is produced can be determined via an energy balance of the kinetic energy that is transferred to the plate by the shock-wave and the work required to deform the plate and therefore produce a deflection in the plate [12].

The kinetic energy of the plate at the kick-off velocity is given by

$$0.5 m_p \cdot v_0^2$$

where v_0 is the kick-off velocity and m_p is the mass of the plate per unit area.

The work of plastic deformation is taken as the extensional energy required to produce an observed contour. In this particular case elastic energy is neglected and the material is assumed to flow under a constant yield stress. For a parabolic shaped contour in which the stresses in all directions are considered equal and the plate deflection considered large compared with the plate thickness, the energy W , absorbed by a rectangular plate with sides $2a$ and $2b$ is

$$W = 64/45 (a/b + b/a) \sigma_y h d^2$$

where σ_y is the yield stress of the material
 h is the plate thickness
 d is the deflection at the centre of the plate.

The effect of cavitation pressure on the outside of the plate and the static air pressure on the inside should also be taken into account to obtain good correlation with experimental results. Thus

$$W_{\Delta p} = 16/9 \cdot a.b. \Delta p. d$$

where Δp is the atmospheric pressure differential pushing on the outside of the plate, (usually about 96 kPa)

Therefore if d is the unknown then

$$0.5 m v_0^2 = 64/45 (a/b + b/a) \sigma_y h d^2 + (16/9) \cdot a.b. \Delta p. d$$

The minimum panel deflection occurs when $a = b$, and d is directly proportional to the kick-off velocity of the plate. However increasing the hull plating weight does not necessarily decrease the plate deflection to the same extent. eg increasing plating weight 10x only decreases the plate deflection by 4x

6.5 G-Shock

As discussed in section 3, G-Shock is a finite element computer program used to calculate the early time shock response of a surface ship hull girder to an underwater explosion. A finite element beam model of the hull girder is dynamically loaded with a series of shock impulses (fig 15). These impulses are implemented with successive applications of the "Spar-Buoy" model. Dynamic equations of motion are directly integrated and nodal displacements, velocities, accelerations and forces are output at various intervals to an output file.

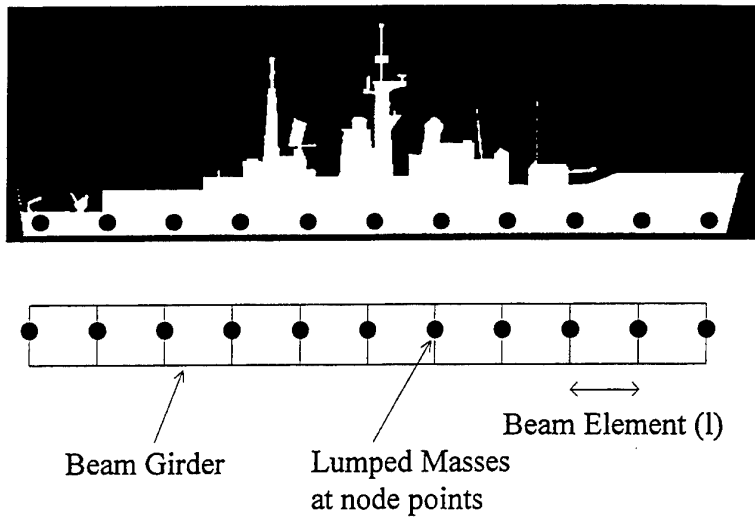

Figure 15. Schematic of beam element model used in G-Shock.

The principle of G-shock is based upon the Spar Buoy model developed by John Gordon formerly of UERD [13]. The Spar Buoy model is based upon a number of assumptions:

1. Assumption one is that the shock-wave impulse at the keel of the ship is equal to the vertical momentum of the ship (conservation of momentum).

2. The structural interaction of various cross-sections of the ship is accounted for through shear transfer.
3. The angle of obliquity that the shock-wave makes with the hull is accounted for by dividing the speed of sound in water by the cosine of the angle of the direction of travel of the shock-wave with respect to the vertical.
4. The ship is launched upward with a velocity determined by the Spar Buoy model.

The model first derives the motion of water particles in the free field ie.

$$\rho \dot{X} = \rho \int^Y U dY - P_a t,$$

where $U = U(Y)$ which is the water particle kick-off velocity at depth Y below the water surface, ρ is the density of water and P_a is the pressure at the hull.

Without proceeding through the whole derivation which is covered in the report by Costanzo [14], the theory basically equates the momentum of a water column to an equivalent water column mass of the ship (based upon the average draft of the ship). The kick-off velocity of the ship is equivalent to the velocity of the ship just as cavitation begins in the water adjacent to the ships hull. The effects of gravity are also taken into account in determining the actual kick-off velocity.

In G-Shock, the output file that generates the results based upon the Spar-Buoy model lists the acceleration, velocity and displacement of the various node points throughout the ships' length. G-Shock is often used in conjunction with the MSWHIP code to produce an overall assessment of the response to an underwater shock. This is achieved by simply adding the individual responses from the two response output files together to produce an overall acceleration, velocity, displacement response.

The input file for G-Shock involves a number of sections:

- (a) Material Parameters such as the Flexural Modulus of Elasticity and the Shear Modulus of Elasticity.
- (b) Elemental input parameters such as cross-sectional area, cross-sectional moment of inertia and the fraction of the cross-sectional area that participates in shear.
- (c) Nodal input parameters such as the lumped mass, draft, beam at waterline, buoyancy mass ratio.
- (d) Attack geometry parameters
- (e) Explosive constants
- (f) Underwater explosion load parameters
- (g) Time parameters
- (h) Response output requests.

6.6 DDAM

The Dynamic Design Analysis Method (DDAM) is a basic procedure to mathematically model an item of equipment or structure as a system of masses and springs, and to apply normal mode theory to solve for member stresses [15]. The dynamic characteristics of a model are estimated, in terms of vibration mode shapes and frequencies, and applies pre-determined static forces to each mode shape using specified shock design values.

6.7 UERDTOOLS

UERDTOOLS [16] is a general purpose computer program for analysing shock input motions. The program enables shock spectra to be generated on both linear and tri-axial plots and various other routines to be performed including; interpolation and filtering of data, curve fitting, differentiation, integration and running similitude equation and the G-shock programs.

6.8 Hopkinson Scaling

The whole aim of scaling is to determine how parameters will change so as to allow an experiment for instance to be performed on a smaller scale without the associated costs of a full scale test. Hopkinson scaling is a means by which this can be done and aims to produce a dimensionless quantity which can be easily scaled for different experiments. eg Prandtl's number, Reynold's number. By determining how the units of each individual quantity varies with the four basic functions ie. Force, length, energy and time then the scaling factor of each quantity can be determined.

7. Summary

US shock testing concentrates on large conventional explosions and nuclear blasts. However, this is not particularly relevant to Australia, where combat scenarios would typically involve much smaller explosive charges in coastal environments, against generally smaller vessels. It is very difficult to obtain information on ship and submarine response to small explosive charges. It is suggested that research on ship and submarine shock response by DSTO should therefore concentrate on this combination of smaller vessels and explosive charges. This would serve as a useful source of information to exchange with the US under existing and future defence agreements.

Deficiencies in the MIL-S-901D shock testing procedure are also apparent, although this procedure has stood the test of time. With emphasis shifting more toward commercially available equipment (COTS equipment), shock testing procedures will have to accommodate equipment mounted on large shock isolation rafts.

Other significant areas of shock research in which much work needs to be done is in the area of structural response due to the effects of different materials of construction in naval vessels. A number of GRP vessels are under construction or in service around the world and very little information exists on the response or behaviour of these vessels under shock loading conditions.

8. References

1. Cole R.H., "Underwater Explosions", Princeton, USA 1948.
2. Shin Y.S., 'Overview of Underwater Shock and DDAM', Short Course presented at 64th Shock and Vibration Symposium, Fort Walton Beach Florida, October 1993.
3. Private communication with personnel of Naval Surface Warfare Centre, Underwater Explosions Research Division, Virginia, USA, August 1993.
4. Keil A.H. "The Response of Ships to Underwater Explosions" Department of the Navy, David Taylor Model Basin Structural Mechanics Laboratory Research and Development Report 1576., November 1961.
5. Plesset M.S. and Chapman R.B., "Collapse of an initially spherical cavity in the neighbourhood of a solid boundary.", Journal of Fluid Mechanics (1971), vol 47, part 2, pp283 - 290.
6. Costanzo F and Gordon J. "A Procedure to Calculate the Axisymmetric Bulk Cavitation Boundaries and Closure Parameters." David Taylor Research Center, Ship Structures and Protection Department, Underwater Explosions Research Division, Bethesda Maryland. Report SSPD-89-177-78 August 1989.
7. Riley M.R, Private discussions with M.R. Riley, Underwater Explosions Research Department, Naval Surface Warfare Center, Carderock Division, Virginia USA. January 1994
8. Heiber G.M. and Tustin W., "Understanding and Measuring the Shock Response Spectrum - Part 1", Sound and Vibration Journal, March, 1974.
9. Clements E.W., "Shipboard Shock and Navy Devices for its Simulation", NRL Report 7396, July 1972.

10. Geers T.L., DeRuntz J. and Shin Y. "Response of Marine Structures to Underwater Explosions" Course presented at Newport News Shipyard, Virginia, February 1994.
11. Batchelor G.K., "The Scientific Papers of Sir Geoffrey Ingram Taylor", Volume 3, Cambridge 1963.
12. Hollyer R.S., "Direct Shock-Wave Damage to Merchant Ships from Noncontact Underwater Explosions", Paper presented to Hampton Roads Section SNAME, April 1959.
13. Private communication with personnel of Naval Surface Warfare Centre, Underwater Explosions Research Division, Virginia, USA, November 1993.
14. Private communication with personnel of Naval Surface Warfare Centre, Underwater Explosions Research Division, Virginia, USA, April 1994.
15. Shin Y., "Response of Marine Structures to Underwater Explosions: Dynamic Design Analysis Method", Course presented at Newport News Shipyard, Virginia, February 1994.
16. "UERDTOOLS", Underwater Shock Analysis Computer Program, P. A. Mantz, Underwater Explosions Research Department, Naval Surface Warfare Center, Carderock Division, 1994, USA.

DISTRIBUTION LIST

The Response of Surface Ships to Underwater Explosions

Warren D. Reid

AUSTRALIA

DEFENCE ORGANISATION

S&T Program

Chief Defence Scientist	} shared copy
FAS Science Policy	
AS Science Industry and External Relations	
AS Science Corporate Management	
Counsellor Defence Science, London (Doc Data Sheet)	
Counsellor Defence Science, Washington (Doc Data Sheet)	
Scientific Adviser to Thailand MRDC (Doc Data Sheet)	
Senior Defence Scientific Adviser/Scientific Adviser Policy and Command (shared copy)	
Navy Scientific Adviser	
Scientific Adviser - Army (Doc Data Sheet and distribution list only)	
Air Force Scientific Adviser	
Director Trials	

Aeronautical and Maritime Research Laboratory

Director
Chief, Ship Structures and Materials Division
J.C. Ritter
N.M. Burman
D.S. Saunders
W. Reid

Electronics and Surveillance Research Laboratory

Director

DSTO Library

Library Fishermens Bend
Library Maribyrnong
Library DSTOS (2 copies)
Library, MOD, Pyrmont (Doc Data sheet only)
Australian Archives

Forces Executive

Director General Force Development (Sea)
Director General Force Development (Land) (Doc Data Sheet only)
Director General Force Development (Air) (Doc Data Sheet only)

Navy

SO (Science), Director of Naval Warfare, Maritime Headquarters Annex, Garden Island,
NSW 2000 (Doc Data Sheet only)
Underwater Explosions Research Dept, Naval Surface Warfare Center, Carderoch Divison
Mr Michael Riley Code 601
1445 Crossways Blvd, Chesapeake VA 23320-2843 USA (2 copies)
John Colquhoun, DECCNA, CPI-5-Bay 5, Canberra ACT 2600

Army

ABCA Office, G-1-34, Russell Offices, Canberra (4 copies)

S&I Program

Defence Intelligence Organisation
Library, Defence Signals Directorate (Doc Data Sheet only)

B&M Program (libraries)

OIC TRS, Defence Central Library
Officer in Charge, Document Exchange Centre (DEC), 1 copy
*US Defence Technical Information Centre, 2 copies
*UK Defence Research Information Centre, 2 copies
*Canada Defence Scientific Information Service, 1 copy
*NZ Defence Information Centre, 1 copy
National Library of Australia, 1 copy

UNIVERSITIES AND COLLEGES

Australian Defence Force Academy
Library
Head of Aerospace and Mechanical Engineering
Deakin University, Serials Section (M list), Deakin University Library, Geelong, 3217
Senior Librarian, Hargrave Library, Monash University
Librarian, Flinders University

OTHER ORGANISATIONS

NASA (Canberra)
AGPS

OUTSIDE AUSTRALIA**ABSTRACTING AND INFORMATION ORGANISATIONS**

INSPEC: Acquisitions Section Institution of Electrical Engineers
Library, Chemical Abstracts Reference Service
Engineering Societies Library, US
American Society for Metals
Documents Librarian, The Center for Research Libraries, US

INFORMATION EXCHANGE AGREEMENT PARTNERS

Acquisitions Unit, Science Reference and Information Service, UK
Library - Exchange Desk, National Institute of Standards and Technology, US

SPARES (10 copies)

Total number of copies: 59

DEFENCE SCIENCE AND TECHNOLOGY ORGANISATION DOCUMENT CONTROL DATA				1. PRIVACY MARKING/CAVEAT (OF DOCUMENT)	
2. TITLE The Response of Surface Ships to Underwater Explosions			3. SECURITY CLASSIFICATION (FOR UNCLASSIFIED REPORTS THAT ARE LIMITED RELEASE USE (L) NEXT TO DOCUMENT CLASSIFICATION) Document (U) Title (U) Abstract (U)		
4. AUTHOR(S) Warren D. Reid			5. CORPORATE AUTHOR Aeronautical and Maritime Research Laboratory PO Box 4331 Melbourne Vic 3001		
6a. DSTO NUMBER DSTO-GD-0109		6b. AR NUMBER AR-009-889	6c. TYPE OF REPORT General Document		7. DOCUMENT DATE September 1996
8. FILE NUMBER 510/207/0506	9. TASK NUMBER NAV 96/074	10. TASK SPONSOR NAVY	11. NO. OF PAGES 38		12. NO. OF REFERENCES 16
13. DOWNGRADING/DELIMITING INSTRUCTIONS None			14. RELEASE AUTHORITY Chief, Ship Structures and Materials Division		
15. SECONDARY RELEASE STATEMENT OF THIS DOCUMENT <i>Approved for public release</i> OVERSEAS ENQUIRIES OUTSIDE STATED LIMITATIONS SHOULD BE REFERRED THROUGH DOCUMENT EXCHANGE CENTRE, DIS NETWORK OFFICE, DEPT OF DEFENCE, CAMPBELL PARK OFFICES, CANBERRA ACT 2600					
16. DELIBERATE ANNOUNCEMENT No limitations					
17. CASUAL ANNOUNCEMENT Yes					
18. DEFTTEST DESCRIPTORS Underwater explosions, shockwave, ship, NSWC, velocity response, shock machine, shock response spectra, cavitation					
19. ABSTRACT This report is a summary of technical information gathered by the author during an attachment to the Underwater Explosions Research Department (UERD) of the Naval Surface Warfare Center (NSWC) Carderock Division from April 1993 to July 1994. The report covers aspects of UERD's work in the area of: ship shock trials, response of surface ships to underwater explosions, computer modelling of surface ship responses and other technical information culled from the general literature.					