



The Hundred Years War (Part II)

Different Vistas

*Edited by L.J. Andrew Villalon
and Donald J. Kagay*

BRILL

The Hundred Years War
(Part II)

History of Warfare

Editor

Kelly DeVries

Loyola College

Founding editors

Theresa Vann

Paul Chevedden

VOLUME 51

The Hundred Years War (Part II)

Different Vistas

Edited by

L.J. Andrew Villalon and Donald J. Kagay



BRILL

LEIDEN • BOSTON
2008

Cover illustration: "Bataille entre Romains et Carthaginois (-203 ou -202)", Français 268, fol. 423. With kind permission of the Bibliothèque nationale de France. Illustration suggested by Clifford J. Rogers.

This book is printed on acid-free paper.

Library of Congress Cataloging-in-Publication Data

The Hundred Years War (part II) : different vistas / edited by L. J. Andrew Villalon and Donald J. Kagay.

p. cm.— (History of warfare ; v. 51)

Includes bibliographical references and index.

ISBN 978-90-04-16821-3 (hardback : alk. paper) 1. Hundred Years' War, 1339-1453. 2. France—History, Military—1328-1589. 3. Great Britain—History, Military—1066-1485. 4. France—Foreign relations—Great Britain. 5. Great Britain—Foreign relations—France. 6. Military art and science—Europe—History. I. Villalon, L. J. Andrew. II. Kagay, Donald J. III. Title. IV. Series.

DC96.H88 2008

944'.025—dc22

2008022006

ISSN 1385-7827

ISBN 978 90 04 16821 3

Copyright 2008 by Koninklijke Brill NV, Leiden, The Netherlands.
Koninklijke Brill NV incorporates the imprints Brill, Hotei Publishing,
IDC Publishers, Martinus Nijhoff Publishers and VSP.

Brill has made all reasonable efforts to trace all rights holders to any copyrighted material used in this work. In cases where these efforts have not been successful the publisher welcomes communications from copyrights holders, so that the appropriate acknowledgements can be made in future editions, and to settle other permission matters.

All rights reserved. No part of this publication may be reproduced, translated, stored in a retrieval system, or transmitted in any form or by any means, electronic, mechanical, photocopying, recording or otherwise, without prior written permission from the publisher.

Authorization to photocopy items for internal or personal use is granted by Koninklijke Brill NV provided that the appropriate fees are paid directly to The Copyright Clearance Center, 222 Rosewood Drive, Suite 910, Danvers, MA 01923, USA.
Fees are subject to change.

In Piam Memoriam
Dr. Dana Sample
Recte Vixit et Fortiter Obiit

CONTENTS

List of Illustrations	xi
List of Maps	xiii
List of Contributors	xv
Acknowledgments	xxi
Abbreviations	xxiii
Introduction	xxv

PART ONE

BROADER HORIZONS OF THE HUNDRED YEARS WAR

The Hundred Years Wars: Not One But Many	3
<i>Kelly DeVries</i>	

PART TWO

AGINCOURT AND ITS AFTERMATH

The Battle of Agincourt	37
<i>Clifford J. Rogers</i>	
Grief and Memory After the Battle of Agincourt	133
<i>Megan Cassidy-Welch</i>	

PART THREE

THE IBERIAN FACE OF THE HUNDRED YEARS WAR

“Cut Off Their Heads, or I’ll Cut Off Yours”: Castilian Strategy and Tactics in the War of the Two Pedros and the Supporting Evidence from Murcia	153
<i>L. J. Andrew Villalon</i>	

- The Defense of the Crown of Aragon during the War of
the Two Pedros (1356–1366) 185
Donald J. Kagay

PART FOUR

THE TECHNICAL ASPECTS OF ARCHERY
IN THE HUNDRED YEARS WAR

- The English Longbow: A Revolution in Technology? 213
David Whetham
- The Longbow-Crossbow Shootout at Crécy (1346): Has the
“Rate of Fire Commonplace” Been Overrated? 233
Russell Mitchell

PART FIVE

MILITARY PARTICIPANTS IN THE
HUNDRED YEARS WAR

- Philip VI’s Mortal Enemy: Robert of Artois and the
Beginning of the Hundred Years War 261
Dana L. Sample
- The Combat of the Thirty against Thirty: An Example of
Medieval Chivalry? 285
Steven Muhlberger
- John Hawkwood: Florentine Hero and Faithful
Englishman 295
William P. Caferro
- The Afterlife of a Hero: Bertrand du Guesclin Imagined 329
Richard Vernier

PART SIX

FISCAL, LITERARY, AND PSYCHOLOGICAL ASPECTS
OF THE HUNDRED YEARS WAR

Purveyance and Peasants at the Beginning of the Hundred Years War: Maddicott Reexamined	345
<i>Ilana Krug</i>	
The Good, the Bad, and the Ugly: Visions of Burgundy, France, and England in the <i>Oeuvres</i> of Georges Chastellain	367
<i>L. B. Ross</i>	
Mental Incapacity and the Financing of War in Medieval England	387
<i>Wendy J. Turner</i>	
Appendices	
Appendix One: The Hundred Years War and Genealogical Charts	403
Appendix Two: Genealogies	424
Popes	425
European Rulers and Nobility	426
Kings of England	426
Kings of Scotland	426
Kings of France	427
French Noble Houses	427
Low Countries	428
Holy Roman Emperors	429
Duchy of Milan	430
German Noble Houses	431
Spanish Rulers	431
Castile	431
Crown of Aragon	431
Navarre	432
Portugal	432

Muslim Rulers 433
 Naşrid Dynasty of Granada 433
 Ottoman Turks 434
Byzantine Rulers 434
 Paleologi 434
Appendix Three: Battles, Campaigns, Treaties 435
Bibliography 439
Index 467

LIST OF ILLUSTRATIONS

Rogers

- Figure 1: Proposed arrangement of English men-at-arms and archers at Agincourt. In this arrangement, all of the bowmen are on the far flanks of the English men-at-arms (as indicated by Waurin) 131
- Figure 2: Proposed arrangement of English men-at-arms and archers at Agincourt. In this arrangement, there are small wedges of archers between the wedges (as suggested by the *Gesta*) 131
- Figure 3: Proposed arrangement of English men-at-arms and archers at Agincourt. In this arrangement, the three battles of English men-at-arms each have large wings of archers (another interpretation of *Gesta*'s description) 132
- Figure 4: An example of how the stakes could be staggered to allow for footmen to side-step through the offsets, while the palings would still present effectively a solid fence to enemy horsemen 132

Mitchell

- Figure 1: Visualization in three dimensions of the space occupied by the Genoese, with the "effective target area" for the English longbowman shown in grey 252
- Figure 2: Formation Depth as a Gauge to Missile Fire. An arrow falling at 45-degrees must be within height "a" in order to fall into the Genoese formation 252
- Figure 3: Even though there is empty space inside the Genoese formation, both the crossbowman's legs and the ground between them tend to be shielded by the body of the man in front 253
- Figure 4: Target area without *pavise*, with least favorable use of *pavise*, and with more favorable use of *pavise*, with an

identical distribution of incoming arrows. The darker the arrow, the more likely a meaningful hit 253

Figure 5: A crossbowman bending his bow with a belt-claw, and then aiming his Crossbow (From Viollet-le-Duc) 254

Figure 6: Different forms of crossbow bolts. 1, 2, 3, 4, 5, 6, 7 are military bolts; 6, bolt with tow soaked in oil for firing at ships and wooden structures; 7, Bolt for a Slur Bow; 8, Bolt for Killing Deer; 9, 10, Bolts for Killing Large Birds; 11, 12, Bolts for Killing Game Birds. The Latter did not have Metal Heads, and were Blunt, so as not to Damage the Game 254

Figure 7: Crossbow with its bow bent by the windlass and its bow-string secured over the fingers of the nut 255

Figure 8: A military crossbow being bent by a goat’s-foot lever 256

Figure 9: Primitive crossbow without a stirrup 257

Figure 10: A store of crossbow bolts, shafts, and heads. The crossbowman is aiming at a target to the left of the picture (from a catalogue of the arsenal of Emperor Maximilian I (1459–1619) 257

LIST OF MAPS

Map 1: France in 1328	xxx
Map 2: French Territory Ceded to England after the Treaty of Brétigny 1360	xxxix
Map 3: England and France in the later Hundred Years War	xxxix
Map 4: Low Countries in the Later Middle Ages	33
Map 5: Northern England and Scotland	34
Map 6: Battle of Agincourt	130
Map 7: Zones of the War of the Two Pedros	183
Map 8: Northern Castile	184
Map 9: Medieval Crown of Aragon	209
Map 10: Counties of Catalonia	210
Map 11: Northern Italy	327

LIST OF CONTRIBUTORS

WILLIAM CAFERRO is associate professor of medieval history at Vanderbilt University, with specialties in economic and social history. He received his Ph.D. from Yale University in 1992 and has held prestigious research fellowships from the Institute for Advanced Studies in Princeton and from Villa i Tatti in Florence. Caferro is the author of *Mercenary Bands and the Decline of Siena* (Baltimore, 1998) and co-author of *The Spinelli of Florence: Fortunes of a Renaissance Merchant Family* (University Park, Penn., 2001). His latest book is entitled *John Hawkwood: An English Mercenary in Fourteenth Century Italy* (Baltimore, 2006).

MEGAN CASSIDY-WELCH is a lecturer in medieval European history at the University of Melbourne, Australia. She is a graduate of the University of Melbourne and the University of London. Her Ph.D. dissertation focused on Cistercian practices and understandings of space, and was published as *Monastic Spaces and their Meanings: Thirteenth-Century English Cistercian Monasteries* (Turnholt, Belgium, 2001). Forthcoming publications include *Frightful Abodes of Misery: A Cultural History of the Medieval Prison, Practices of Gender in Late-Medieval and Early-Modern Europe*, and a number of articles on memory, space, and power in the central and later Middle Ages. Her current research concerns social displacement and the aftermath of the Hundred Years War in medieval France. Professor Cassidy-Welch is past president of the Australian and New Zealand Association of Medieval and Early Modern Studies (ANZAMEMS) and is a medieval area editor for H-France.

KELLY DEVRIES holds a Ph.D. in Medieval Studies from the Centre for Medieval Studies at the University of Toronto and is currently Professor of History at Loyola College in Maryland. DeVries is the author of six books, including *Medieval Military Technology* (Peterborough, Ont., 1992); *Infantry Warfare in the Early Fourteenth Century: Discipline, Tactics, and Technology* (Woodbridge, Suffolk, 1996); *The Norwegian Invasion of England in 1066* (Woodbridge, Suffolk, 1999); *Joan of Arc: A Military History* (Stroud, 1999); *A Cumulative Bibliography of Medieval Military History and Technology* (Woodbridge, Suffolk, 2002); and *Guns and Men in Medieval Europe, 1200–1500: Studies in Military History and Technology* (Aldershire,

Hampshire, 2002). DeVries's seventh book, co-written with Robert D. Smith is entitled *A History of Gunpowder Weaponry in the Middle Ages: The Artillery of the Valois Dukes of Burgundy, 1363–1477* (Woodbridge, 2005). DeVries has also edited *The Battle of the Golden Spurs*, an English translation of J. F. Verbruggen's *De slag der guldensporen: Bijdrage tot de geschiedenis van Vlaanderens vrijheidsoorlog, 1297–1305* (Woodbridge, 2002). Currently, he is co-editor of *The Journal of Medieval Military History* and serves as series editor for the military history series published by Brill Academic Publishing.

DONALD KAGAY is an expert in medieval legal and military history, with a specialty in the medieval Crown of Aragon. He received his Ph.D. at Fordham University, under Dr. Joseph O'Callahan. His scholarship includes the publication of three books, eight essay collections, and twenty-six refereed articles. In 1994, the University of Pennsylvania published his most significant scholarly contribution, a translation of a major medieval law code under the title *The Usages of Barcelona: The Fundamental Law of Catalonia*. This book has also been published electronically in the *Library of Iberian Resources Online*. libro@uca.edu. Kagay's second book, *The Customs of Catalonia between Lords and Vassals of Pere Albert, Barcelona Canon: A Practical Guide to Feudal Relations in Medieval Spain*, was published by the Arizona Center for Medieval and Renaissance Studies in 2002. His third book (a collection of thirteen earlier articles), *War, Government, and Society in the Medieval Crown of Aragon* was published in 2007 by Ashgate as part of its Variorum series. He is co-founder of two scholarly organizations—The *Texas Medieval Association (TEMA)* and *De Re Militari* (the latter dedicated to the study of warfare in the Middle Ages).

ILANA KRUG received her Ph.D. in Medieval Studies from the University of Toronto in 2006, and is currently a Visiting Assistant Professor at York College of Pennsylvania, where she teaches European history. Her research focuses on the effects of natural disasters, war, and wartime demands on the peasantry in late medieval England, with an eye towards the peasant reaction manifest in literature and legal documents. Her recent article, "Wartime, Corruption, and Complaints of the English Peasantry," recently appeared in *Noble Ideals and Bloody Realities: Warfare in the Middle Ages*, ed. Niall Christie and Maya Yazigi (Leiden, 2006). She is presently working on a book on military supply and purveyance in medieval England.

RUSSELL MITCHELL is an independent scholar specializing in historical problems associated with archery in the Middle Ages. He has received MAs in history at the University of Texas at Arlington and the Central European University. He is currently an instructor in history with the Dallas County (Texas) Community College District.

STEVEN MUHLBERGER is Professor of History at Nipissing University in New York State. His most recent books, *Jousts and Tournaments: Charny and the Rules for Chivalric Sport in Fourteenth-Century France* and *Deeds of Arms: Formal Combats in the Late-Fourteenth Century*, concern the ideology and practice of chivalry during the first half of the Hundred Years War. Professor Muhlberger's current research involves careful analysis of Geoffroi de Charny's *Questions* on the law of arms to determine what they show about noble identity in late medieval France.

CLIFFORD J. ROGERS is an associate professor at the United States Military Academy, where he teaches both medieval and military history. The author of *War Cruel and Sharp: English Strategy under Edward III, 1327–1360* (Woodbridge, Suffolk, 2000), Rogers is also the editor or co-editor of: *The Military Revolution Debate* (Boulder, Colo., 1994), *The Wars of Edward III: Sources and Interpretations* (Woodbridge, Suffolk, 1999), and *Civilians in the Path of War* (Lincoln, Neb., 2002). He has also published numerous articles on aspects of warfare in the Middle Ages. His writings have been awarded the Royal Historical Society Alexander Prize, the Society for Military History Moncado Prize, and *De Re Militari's* 2003 Verbruggen Prize. Rogers has held both Fulbright and Olin fellowships and is currently a co-editor of *The Journal of Medieval Military History*. His scholarly edition and translation of *The St. Omer Chronicle* is nearing completion.

L. B. ROSS graduated in spring, 2005 with a Ph.D. in medieval history from the University of New Mexico, where she still works as full-time computer analyst and part-time faculty in the University of New Mexico History Department. She has specialized in Burgundian studies, and has given talks on this topic at Arizona State University and Western Michigan University. Her first article "Beyond Eating: Political and Personal Significance of the *entremets* at the Banquets of the Burgundian Court" has appeared in the volume *At the Table* (Turnholt, Belgium, 2007). She is in the process of completing her first book *Unkind to*

Each Other: Interpersonal Behavior in the Historical Writing of Fifteenth-Century Burgundy, France, and England, based on the works of Georges Chastellain and other fifteenth-century historians.

DANA SAMPLE was an associate professor of history at the University of Virginia's College at Wise. She obtained a masters degree in history from Old Dominion University and later received both an M.A. and Ph.D. in medieval history from the City University of New York. After teaching at Hampton University, she moved to the University of Virginia's College, located in Wise, Virginia, where she gained a well-earned reputation as a teacher, winning the Harrison Award for Outstanding Teaching. Although she taught a number of medieval courses, including one on Byzantium and Islam, her research centered around the late-medieval history of England and France. Professor Sample produced as her thesis an edition of the documents dealing with the dispute over the county of Artois. She delivered several papers and published articles on Robert of Artois, one of which appeared in 2006 in *Shell Games: Studies in Scams, Frauds, and Deceits (1300–1650)* (Toronto, 2004). Professor Sample died of cancer in March, 2007, while this volume was in its final preparation.

WENDY TURNER earned a Ph.D. in 2000 at UCLA. She is currently an Associate Professor of history at Augusta State University in Georgia. Author of several recent articles on the intersection of law and medicine in medieval English society, Turner has just completed a manuscript on "The Care and Custody of the Mentally Incompetent in Late Medieval English Law."

RICHARD VERNIER received a Ph.D. in Romance Languages and Literatures from the University of California at Berkeley. He is currently Professor Emeritus at Wayne State University, having also taught at San Diego State College and the University of Washington. His publications include *Yves Bonnefoy ou les mots comme le ciel* (Paris, 1986), as well as numerous articles in *The French Review*, *Sub-Stance*, *World Literature Today*, *L'esprit critiqueur*, etc. He is also the author of poems entitled *Le Feu parmi les arbres* (Paris, 1981), and an autobiographical narrative entitled *La Patience* (Solaire, 1986). Although much of his academic work has been largely devoted to the explorations of modern French poetry and poetics, Vernier has maintained his early interest in medieval studies, as exemplified by some of his most recent works including the

translation from Catalan of *The Dream of Bernat Metge* (Ashgate, 2002) and a biography of a leading medieval military figure, *The Flower of Chivalry: Bertrand du Guesclin and the Hundred Years War* (Woodbridge, Suffolk, 2003). He is currently completing a biography of Gaston III Phoebus, Count of Foix (1331–1391).

L. J. ANDREW VILLALON received his Ph.D. in history from Yale University in 1984 and is a professor emeritus at the University of Cincinnati and a senior lecturer at the University of Texas. Villalon, who specializes in late medieval and early modern European history, has delivered numerous conference papers and his articles have appeared in both collections and scholarly journals including the *Sixteenth Century Journal*, the *Catholic Historical Review*, *Mediterranean Studies*, and the *Proceedings of the Ohio Academy of History*. He has co-edited four other volumes of medieval essays—*The Final Argument: The Imprint of Violence on Society in Medieval and Early Modern Europe* (Woodbridge, Suffolk 1998), *The Circle of War in the Middle Ages: Essays on Medieval Military and Naval History* (Woodbridge, Suffolk, 1999), *Crusaders, Condottieri, and Cannon: Medieval Warfare in Societies around the Mediterranean* (Leiden, 2002), and *The Hundred Year War: A Wider Focus* (Woodbridge, Suffolk). Currently, he is working on studies dealing with the canonization of San Diego and the life of Sir Hugh Calveley, while he and co-editor Donald Kagay are preparing a joint monograph dealing with the War of the Two Pedros (1356–1366). In addition to his major field, Villalon has published articles on automotive history and the history of World War I. He has received several grants for study in Spain, including a Fulbright, two awards from the American Association of University Professors for defending academic freedom, and in 2001, he was presented the Professional-Scholarly Activity Award for the University College at the University of Cincinnati.

DAVID WHETHAM took a degree in Philosophy at the London School of Economics, and then went on to earn a Masters Degree in War Studies at King's College, London. After time spent traveling around the Great Lakes region of Africa, he returned to King's College to complete a PhD in War Studies. Whetham spent time working as a researcher for BBC History, and then joined the Organization for Security and Co-operation in Europe [OSCE] in Kosovo, supporting the 2001 and 2002 elections. His main research interests are focused on the ethical dimensions of warfare and the development of the laws of war, but he also retains a keen interest in medieval warfare.

ACKNOWLEDGMENTS

Once again, the editors wish to thank people whose efforts have helped bring this volume into print. First of all, we must express our appreciation to the members of the staff of Brill for their efforts in moving this book from conception to production. In particular, we wish to acknowledge the work of Julian Deahl, Marcella Mulder, and Gera van Bedaf who have been of great assistance to the editors. We also owe an on-going debt to the editor of Brill's military history series, Kelly DeVries. Once again, we must thank an anonymous reader whose insightful comments helped shape the final product. And as always, we wish to thank the contributors who have worked with us from the start in a highly collegial fashion, accepting with good grace and humor the critique of both the editors and the reader. We thank you for your patience and hope that the present volume will seem an adequate reward.

It is our sad duty to report the death of Dana Sample who was the first to contribute an article to this volume. The editors offer their heartfelt condolence to her family and dedicate this volume to her memory.

ABBREVIATIONS

Cafèrro

AG	Archivio Gonzaga
ASF	Archivio di Stato di Firenze
ASL	Archivio di Stato di Lucca
ASM	Archivio di Stato di Milano
ASMa	Archivio di Stato di Mantua
ASPer	Archivio di Stato di Perugia
ASS	Archivio di Stato di Siena
ASVe	Archivio di Stato di Venezia
ASV	Archivio Vaticano
BLF	Biblioteca Medicea Laurenziana de Firenze
PRO	Public Record Office

Kagay

ACA	Arxiu de la Corona d'Aragó
CAVC	<i>Cortes de los antiguos reinos de Aragón y de Valencia y principado de Cataluña</i> , ed. Fidel Fita y Colomé and Bienvenido Oliver y Estreller. 27 vols. Madrid, 1896–1922.
CDACA	<i>Colección de documentos inéditos del archivo general de la corona de Aragón</i> , ed. Próspero de Bofarull y Moscaró <i>et al.</i> , 41 vols. Barcelona, 1847–1910.
XV CHCA	<i>XV Congrés d'història de la corona d'Aragó</i> (El poder real en la Corona de Aragón Siglos XIV–XVI). 5 vols. Zaragoza, 1993.
CHJZ	<i>Cuadernos de Historia “Jerónimo Zurita”</i>
CSJP	<i>The Chronicle of San Juan de la Peña: A Fourteenth-Century Official History of the Crown of Aragon</i> . Translated by Lynn H. Nelson. Philadelphia, 1991.
DHC	<i>Documents Historichs Catalans del segle XIV: Colecció de cartas familiars correspenents als regnats de Pere de Punyalet y Johan I</i> . Edited by Josep Coroleu. Barcelona, 1889.
LF	<i>Libre dels fets del rei en Jaume</i> , ed. Jordi Bruguera. 2 vols. Barcelona, 1991.

Krug

CPR

Calendar of Patent Rolls. 27 vols. London, 1894–1916.

PRO

Public Record Office

Rogers

CAR

Chronique d'Arthur de Richemont

CS

The Battle of Agincourt: Sources and Interpretations. Edited and translated by Anne Curry. Woodbridge, Suffolk, 2000.

EHR

English Historical Review

MWF

Monstrelet/Waurin/LeFevre

Sample

AN

Archives Nationales

BNF

Bibliothèque Nationale de France

Turner

CFR

Calendar of the Fine Rolls. Public Record Office. 22 vols. London, 1911–1962.

CIM

Calendar of Inquisitions Miscellani [Chancery]. *Henry III–Henry V*. Public Record Office. 7 vols. London, 1916–1968.

CIPM

Calendar of Inquisitions Post Mortem and other Analogous Documents Preserved in the Public Record Office, Public Record Office. 20 vols. London, 1904–1970.

CPR

Calendar of the Patent Rolls, 1216–1509. Public Record Office. 52 vols. London, 1891–1901.

PRO

Public Record Office

Villalon

BAE

Biblioteca de Autores Españoles

CRC

Crónicas de los Reyes de Castilla

INTRODUCTION

This second volume dedicated to studies on the Hundred Years War continues the dual focus of the first.¹ To begin with, it too stresses the editors' belief that the Hundred Years War encompassed far more than an Anglo-French conflict to decide who would rule France, that in fact, it also influenced or was influenced by events and conflicts occurring throughout western Europe and that it is only logical to view these as part and parcel of that larger war that dominated the later Middle Ages. As was the case with the earlier volume, volume two has also tried to include revisionist articles that take a fresh look at even such well-studied topics as the battles of Crécy (1346) and Agincourt (1415).

The first part, "Broader Horizons of the Hundred Years War," contains a single article, "The Hundred Years Wars: Not One War But Many" by Kelly DeVries, that establishes the volume's overall point of view. DeVries briefly surveys the military history of this period, looking at the interrelated series of conflicts that occurred throughout Western Europe, while showing how they were inextricably linked to the Anglo-French struggle and, in many cases, to one another. Starting with Scotland, his essay supplies a gazeteer of military and political activity occurring in the Holy Roman Empire, the Iberian kingdoms of Castile, Navarre, Portugal, and the Crown of Aragon, the Low Countries, and Burgundy, stressing that most of the wars were really part of the one larger conflict. From the perspective of a historian highly conversant with the literature of the period, DeVries also suggests fruitful directions in which future scholarship on the Hundred Years War might proceed.

The second part, "Agincourt and its Aftermath," focuses in on the conflict's best known and best-documented battle, later immortalized in William Shakespeare's *Henry V*. By closely analyzing not only the contemporary chronicles, but also the most recent archaeological and technological evidence, Clifford Rogers has produced in his article "The Battle of Agincourt" what is arguably the most thorough and

¹ *The Hundred Years War: A Wider Focus*, ed. L. J. Andrew Villalon and Donald J. Kagay (Leiden, 2005).

sophisticated treatment to date, one that any future scholarship on this encounter will have to address. Among the topics on which Rogers sheds new light are the formation and tactics employed by both side, the probable numbers involved, the actual effect of the English arrow rain, the penetrative power of the longbow, and the explanation for the magnitude of French defeat despite an overwhelming numerical superiority. Included with Rogers's essay are several detailed appendices further exploring technical matters raised in the text.

A second article in this section, "Grief and Memory after the Battle of Agincourt" by Megan Cassidy-Welch deals with the psychological toll the battle exacted on survivors and their families, in particular those who had been on the losing side. For the French, public and private grief was deeply felt and emotionally expressed not only by veterans and families mourning their dead, but also by a society crushed by defeat. It was memorialized in private funeral ceremonies and in state-sponsored rites and writings aimed at keeping alive the memory of those who lost their lives at Agincourt. Among the reactions closely examined are those of chroniclers, including the foremost female writer of the period, Christine de Pizan.

In Part Three of this volume, "The Iberian Face of the Hundred Years War," a pair of papers focuses on a theatre of conflict far from central stage, but one which would on several occasions in the second half of the fourteenth century greatly influence the war's course. In the mid-1360s, during a hiatus in the fighting north of the Pyrenees that followed the Treaty of Brétigny (1360), the Hundred Years War spilled across the mountains into Iberia where it merged with a decade-long struggle, the War of the Two Pedro's (1356–1366), being fought primarily between Castile and the Crown of Aragon, but also involving to a lesser extent the other Iberian kingdoms of Granada, Portugal, and Navarre. Essays by Andrew Villalon and Donald Kagay explore from opposite sides this regional conflict which touched off two invasions of Castile (1366 and 1367) by English, French, Gascon, and Breton forces, invasions that brought into play many leading figures from the larger struggle, including the Black Prince and the future constable, Beltran duGuesclin. In "Cut Off Their Head's or I'll Cut Off Yours: Castilian Strategy and Tactics in the War of the Two Pedros and the Supporting Evidence from Murcia," Villalon treats the lengthy assault on his eastern neighbor launched by the Castilian monarch, Pedro I "the Cruel" (1350–1366/69); in particular, highlighting the counterproductivity of Pedro's "strategy of terror" and stressing the importance of

surviving evidence from the archives at Murcia. By contrast, Kagay has produced an article, “The Defense of the Crown of Aragon during the War of the Two Pedros (1356–1366),” based on extensive research in Barcelona’s Archivo de la Corona de Aragón, which closely examines the complex array of defensive actions employed by Pedro’s Aragonese opponent, Pere III (aka Pedro IV) (1337–1387) in his attempt to counter Castilian aggression. Ultimately, the events in Spain set the stage for a significant intervention by both France and England (1366–1367) that in turn did much to bring about a renewal of fullscale warfare between the two countries in 1369.

What would any collection on the Hundred Years War be without some treatment of the most effective missile weapons of the Middle Ages: the English longbow and the crossbow employed by most continental armies? Part Four, “The Technical Aspects of Archery in the Hundred Years War” serves this purpose.

In “The English Longbow: A Revolution in Technology?” David Whetham supplies a fine summary of the evolution of the English longbow, indicating that what was new to the central and later Middle Ages was not the weapon itself, but the way in which the weapon was used in battle. Long, powerful bows had actually been in use for centuries by various cultures; on the other hand, massed and coordinated volleys had begun to emerge as a potent force on the field of battle only toward the end of the thirteenth century. It was this tactical use of the weapon that led to the great English victories of the Hundred Years War, in turn giving rise to myths extolling the longbow’s newness and invincibility.

The second article, “The Longbow-Crossbow Shootout at Crécy (1346): Has the ‘Rate of Fire Commonplace’ Been Overrated?” by Russell Mitchell, takes a fresh look at the alleged matchup between the two weapons that occurred during the initial stages of the battle of Crécy (1346). Rather than reaffirming the conventional wisdom that this confrontation reflected the absolute technological superiority of the former over the latter, Mitchell argues that Crécy was not really a meaningful test of two weapons systems going head-to-head with one another. Instead, the highly-professional Genoese crossbowmen fighting in the service of France, realizing that they had been thrown into the *mêlée* almost as an afterthought and without a crucial piece of their equipment (the *pavises* that would have helped shield them from the rain of English arrows) hastily fired a volley or two, then withdrew from the field before any real exchange with the enemy could develop.

According to Mitchell, it was this precipitate withdrawal that probably spurred the French king to accuse his Genoese mercenaries of treason and order his horsemen to ride them down. Mitchell further argues that had the French waited for arrival of the crossbowmen's baggage containing their *pavises* and only then committed to battle the potent weapons system they represented, the story of Crécy might have been very different.

Part Five—"Military Participants in the Hundred Years War"—examines three significant figures to come out of the conflict and a famous exercise in chivalry uncharacteristic of the bloody struggle. In "Philip VI's Mortal Enemy: Robert of Artois and the Beginning of the Hundred Years War," Dana Sample reevaluates the role of Robert, Count of Artois, in inciting the conflict, reaffirming to an extent the view of contemporary chroniclers that attribute to this slippery figure a greater role than most modern historians concede to him.

Steven Muhlberger's essay, "The Combat of the Thirty against Thirty: An Example of Medieval Chivalry?" examines a famous chivalric episode of the year 1350 that pitted thirty Franco-Breton knights against a like number of Englishmen and their allies. Muhlberger shows that just how chivalric this event truly was depends largely on what sources the historian credits: the principal chroniclers of the event, Jean le Bel and Jean Froissart, paint the combat in far more knightly colors than does a highly partisan Breton poet who saw the English as evil and rejoiced at their defeat.

In "John Hawkwood: Florentine Hero and Faithful Englishman," William Caferro continues his examination of the career of the English adventurer begun in the first volume of this collection. Here, Caferro shows that the conversion of this refugee from the Hundred Years War into a Florentine hero has been overstated throughout the centuries; that, in fact, his conversion suited the propagandistic needs of Florence and his national loyalties may have remained far more English than earlier historians ever imagined.

Richard Vernier's "The Afterlife of a Hero: Bertrand du Guesclin Imagined" traces how one of the two great French heroes of the Hundred Years War, Constable Bertrand du Guesclin, has been viewed over succeeding centuries and how his image has changed to meet the needs of subsequent generations. Vernier also compares du Guesclin's afterlife to that of Joan of Arc, the premier French hero of the conflict.

The final part, "Fiscal, Literary and Psychological Aspects of the Hundred Years War," contains three articles. In "Purveyance and

Peasants at the Beginning of the Hundred Years War: Maddicott Reexamined,” Ilana Krug focuses on the system of purveyance through use of which the English monarchy secured at favorable prices foodstuffs for its armies serving on the continent. Krug argues that the primary authority on purveyance, H. R. Maddicott, overstates the negative effect the system had on the English peasantry.

Lia Ross examines the works of a leading French literary figure of the later fourteenth century in her article, “The Good, the Bad, and the Ugly: Visions of Burgundy, France, and England in the Oeuvres of Georges Chastellain.” In the opening sections of his chronicle that have survived, Chastellain, who is writing for the most part after the conflict has ended, supplies a retrospective view of the Hundred Years War. Although Chastellain primarily served the duke of Burgundy, Philip the Good (1419–1467), who had in the early years of his reign sided with England against France, the chronicle is in general pro-French and vitriolically anti-English. As a result, the author takes pains to explain and excuse his master’s anti-French stance. Ross points out that despite his antipathy toward England, Chastellain paints a surprising mixed portrait of France’s major adversary, Henry V (1414–1422), depicting him as a talented political and military leader.

The final essay in the collection, “Mental Incapacity and the Financing of War in Medieval England” by Wendy Turner, explores connections between the treatment of madness and the financing of war in medieval England. Having surveyed how the horrors of combat and captivity could unhinge the minds of men who had experienced them, Turner then shows how the crown benefitted financially from a system that afforded it considerable control over the mentally incompetent and how, in turn, this freed up funds for the war effort.

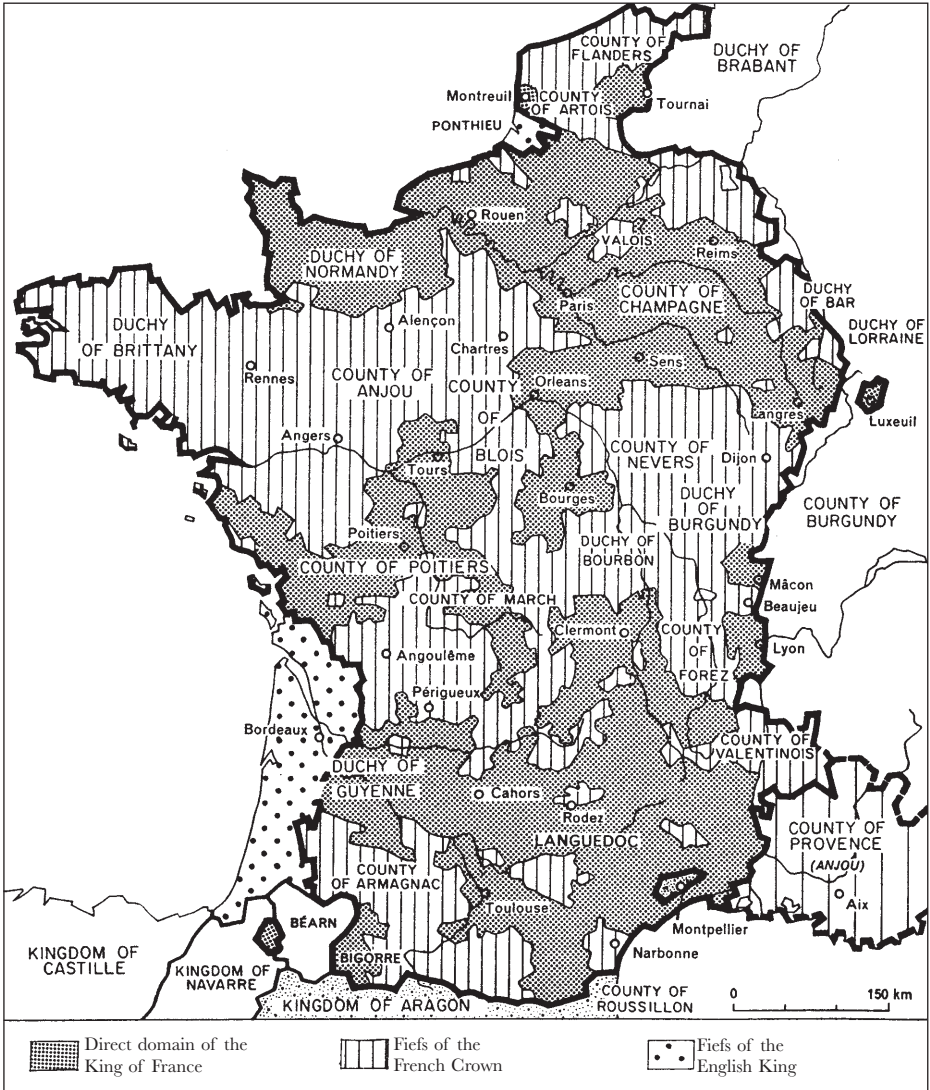

Map 1: France in 1328.



Map 2: French Territory Ceded to England after the Treaty of Brétigny 1360.



Map 3: England and France in the later Hundred Years War.

PART ONE

BROADER HORIZONS OF THE
HUNDRED YEARS WAR

THE HUNDRED YEARS WARS: NOT ONE BUT MANY

Kelly DeVries
Loyola College

When the English King Edward III (1327–1377) launched his major invasions of France in 1339 and again in 1340, it was ostensibly to recover his crown as king of France, a crown which had been legalistically “stolen” from him in 1328 when, despite being the closest heir to the dead king, Charles IV (1322–1328), he was declared ineligible to receive it because this royal descent was gained through a woman. The throne instead was given to a cousin, Philip of Valois, who was then crowned as King Philip VI of France (1328–1350). This action is recognized by most historians as the first blow struck in what would become known as “The Hundred Years War.” The initial military action taken by Edward would lead in 1339 to a geographically-extensive, but ultimately-impotent campaign fought across the northern French counties of Cambrai, Vermandois, and Thiérarche. There followed in 1340 a major English naval victory at Sluys, counterbalanced by the unsuccessful siege of Tournai.

The idea that two nations could fight a war lasting more than a century, as France and England did in the last two centuries of the Middle Ages, seems to most modern military historians to be the very definition of the words “medieval warfare.” And yet, in defining the Hundred Years War in this manner, these same historians have misconstrued the conflict by narrow-mindedly focusing upon the fighting between those two kingdoms. They have all too often ignored or at least downplayed as an integral part of the conflict the fact that each of these major combatants was also conducting military activity against third parties and that these parties engaged in conflict between themselves without direct French or English involvement.

In fact, the Hundred Years War was not fought only during the period 1337–1453, the most commonly given dates, nor was it fought only by England and France. Its origins can be traced at least to the late-thirteenth century with the establishment of the “Auld Alliance” between Scotland and France (1295–1296) followed by William

Wallace's rebellion of 1297–1298. Its roots also extend back to the early-fourteenth century revolt of the townspeople of the county of Flanders (1302) against their French overlords. Nor is the date usually given for its conclusion—1453—all that precise. Some of the issues involved in the Hundred Years War were not solved until 1477, when Charles the Bold (1467–1477), last Valois duke of Burgundy, died on the field of Nancy, thus ending the Swiss-Burgundian-German-Lorraine Wars; or even 1485, when the defeat and death of King Richard III of England (1483–1485) at the battle of Bosworth Field, terminated the Wars of Roses (1455–1485). Most importantly, other conflicts were fought along the way which directly involved not only France and England but also the Low Countries, Burgundy, Switzerland, the Holy Roman Empire, the various Spanish Kingdoms, Portugal, and Scotland.¹

As with most historical periodizations, the concept of a Hundred Years War is a relatively modern one, constructed by relatively modern historians. The earliest reference to the term as used to define warfare in Western Europe during the fourteenth and fifteenth centuries does not enter the literature until 1823. It appeared first in France and was later accepted in England.² The actual dating of the conflict to 1337–1453—a period that obviously exceeds a hundred years—would not appear until even later. At any rate, it is an odd selection of dates, since the French and English had long been at war and had already fought one another several times during the fourteenth century.³ Nor would 1453 put an end to Anglo-French fighting. Edward IV

¹ Some might even suggest that the conflict lasted into the Italian Wars begun in 1494. While the confidence given to the French by their victories in the fourteenth and fifteenth centuries certainly encouraged the Italian campaign of Charles VIII (1483–1498), I can find no direct link historically between what I call the Hundred Years Wars and his punitive march against Naples. If someone can make that link, however, I would welcome it as it would further validate my thesis.

² Anne Curry, *The Hundred Years War* (Houndmills, 2003), 5–27, contains perhaps the most complete historiography on the struggle.

³ Curry, *Hundred Years War*, 1. The rationale for using 1337 as the beginning of the war, despite having no actual fighting between the two sides, lies in the fact that in that year the French king, Philip VI, “officially” confiscated Edward III’s lands in France. These lands were primarily Gascony and Ponthieu, as Normandy, Anjou, Maine, Touraine, and Poitou had been surrendered to the French king, Louis IX (1226–1270), by the English king, Henry III (1216–1272), in the treaty of Paris in 1259. The lands lost in 1259 would become an issue for the English during the Hundred Years War, but the confiscation of Gascony and Ponthieu was never completed by Philip VI due to Edward’s willingness to fight over the issue.

(1461–1483) launched a campaign into France in 1475⁴ and Henry VIII (1509–1547) did the same in 1512–1513.⁵ Calais, a city captured in 1347 as one of the earliest English victories, in fact did not return to French possession until 1553.⁶

But then, as we have noted, the “Hundred Years War” is a modern construct. No contemporary writer saw anything special in the dates modern historians use to bracket this conflict. The first combat recorded by Jean Froissart, regarded by many as “the historian of the Hundred Years War,” is not between England and France but between England and Scotland.⁷ This is followed by an account of the fighting between France and Flanders, when the Flemish revolted against French rule, fighting that was ended by the battle of Cassel in 1328. Then Froissart’s chronicle swings back to warfare between England and Scotland. Although the chronicler discusses Philip VI’s inheritance of the French throne—an inheritance he believed should have gone to Edward III as nephew of the deceased Charles IV—he clearly interprets the other

⁴ See J. R. Lander, “The Hundred Years War and Edward IV’s 1475 Campaign in France,” in *Tudor Men and Institutions: Studies in English Law and Government*, ed. A. J. Slavin (Baton Rouge, La., 1972), 70–100.

⁵ See C. G. Cruickshank’s two studies: *Army Royal: Henry VIII’s Invasion of France, 1513* (Oxford, 1969) and *The English Occupation of Tournai, 1513–1519* (Oxford, 1971).

⁶ Two older studies may still be the best on the English occupation of Calais: Georges Daumet, *Calais sous la domination Anglaise* (Arras, 1902) and F. Lennel, *Calais sous la domination Anglaise*, vol. 2 of *Histoire de Calais*, 2 vols (Calais, 1908–1910).

⁷ There were two Froissart editing projects undertaken in the middle of the nineteenth century. The first, by Baron Joseph-Marie-Bruno-Constantin Kervyn de Lettenhove was published in its entirety and with many significant added texts to provide context for the chronicle of Froissart. *Oeuvres de Froissart*, ed. Kervyn de Lettenhove, 29 vols. (Brussels, 1867–1877). The second was begun by Siméon Luce under the patronage of the Société de l’Histoire de France, but was incomplete at his death. Volumes continued to be appear over the next century—fifteen in total—but to date the edition has not been completed. *Chroniques*, ed. Siméon Luce et al., 15 vols., Société de l’Histoire de France (Paris, 1869–1975). Recent editions have been made by George T. Diller, drawn from single manuscripts. *Chroniques: Dernière rédaction du premier livre. Édition du manuscrit de Rome Reg. lat. 869*, ed. George T. Diller (Geneva, 1972) and *Chroniques: Livre I. Le manuscrit d’Amiens. Bibliothèque municipale n-A 486*, ed. George T. Diller, 5 vols. (Geneva, 1991–1998). There are also compilations of several manuscripts by Diller, Peter F. Ainsworth, and Alberto Varvaro: *Chroniques: Livres I et II*, ed. Peter F. Ainsworth and George T. Diller (Paris, 2001) and *Chroniques: Livres III et IV*, ed. Peter F. Ainsworth and Alberto Varvaro (Paris, 2004). Almost all the English translations of Froissart are abridged to highlight English warfare, and in particularly the Anglo-French conflict. Consequently, they do not provide an accurate view of Froissart’s historical scope. Take, for example, the most accessible of these translations, made by Geoffrey Breerton, *Chronicles* (Harmondsworth, 1968).

conflicts he has mentioned as a significant and inter-related part of the history of warfare in Western Europe during the fourteenth century.

Jean Froissart was born in Valenciennes, in the southern Low Countries, so perhaps it was natural for him to take an interest in military affairs of regions other than England and France, especially after his return to the European continent following the deaths of his patron, the queen of England, Philippa of Hainaut, in 1369 and her husband, Edward III, in 1377. Froissart ends his chronicle in 1400 at a time of peace between France and England. At this point in his narrative, as well as in his life, he is far more concerned with other events of the period than any future Anglo-French warfare: the deposition of Richard II (1377–1399) by Henry IV (1399–1413) in 1399 and the Flemish rebellion of Flanders against France in 1379–1385. The chronicle could not have predicted the turn events would take when Henry V of England (1413–1422) would renew the conflict by launching a new and successful invasion of France. After all, the last English campaign against the French reported by Froissart had been that of the bishop of Norwich, who, in 1383, under the guise of a “Crusade” against the followers of the Avignon pope, Clement VII (1378–1394), had led his army on a filibustering expedition through Flanders, where he fought mainly against Flemings, who supported the same pope that he did, the Roman pontiff, Urban VI (1378–1389). This unfortunate military adventure ended with the bishop’s ignoble defeat at the siege of Ypres.⁸ (Interestingly, Froissart’s derisive tone in reporting this action is echoed by modern historians describing the same event).⁹ For all intents and purposes, it appeared that England’s effort on the continent had collapsed and probably ended ignominiously. An angry English government, stung by humiliation, put Norwich and most of the military leaders of the campaign on trial for their failure.

The fact that chronicles of the period saw no special significance in the dates modern historians use to bracket the conflict is also illustrated by another major example: Jehan (or Jean) de Waurin. Like Froissart,

⁸ Froissart, *Chroniques*, ed. Luce, IX:95–137, contains the account of the bishop of Norwich’s Crusade.

⁹ The most complete modern account of Henry Despenser’s campaign in 1383 is George M. Wrong, *The Crusade of 1383 Known as That of the Bishop of Norwich* (London, 1892). But, see also Norman Housley, “The Bishop of Norwich’s Crusade, May 1383,” *History Today* 33 (1983): 15–20, and Kelly DeVries, “The Reasons for the Bishop of Norwich’s Attack on Flanders in 1383,” in *Fourteenth Century England III*, ed. W. M. Ormrod (Woodbridge, Suffolk, 2004), 155–65.

Waurin, is always associated with the Hundred Years War, as indeed he should be. After all, he was born in Artois near the end of the fourteenth century, fought in the battles of Agincourt (1415) and Verneuil (1424), and was an official of the court of Philip the Good (1419–1467) in Burgundy, serving as ambassador to various places, including Rome. His chronicle, assigned the title *Récueil des croniques et anchiennes istories de la Grant Bretagne* by its nineteenth-century editors, William and Edward Hardy, is one of the most widely used sources for Anglo-French warfare from 1399 to 1453.¹⁰ But a large part of Waurin's narrative discusses the history, especially of military events, that took place from 1453 to 1471, when the work ends. (Its author is thought to have died sometime around 1474). In chronicling this later period, he writes extensively on the War of the Public Weal, fought primarily between the French king, Louis XI (1461–1483) and Duke Charles the Bold of Burgundy; the Liégeois Revolt against Burgundy; the Wars of the Roses; and, even farther afield, the Ottoman advances in the eastern Mediterranean. Indeed, in his accounts of the year 1453, Waurin shows as much if not more interest in the siege and fall of Constantinople as he does in the battle of Castillon and the fall of Bordeaux.¹¹

The treatment of the fourteenth and fifteenth centuries by these two major chroniclers should suggest to modern historians a new paradigm for considering the Hundred Years War. Instead of simply viewing it in its traditional Anglo-French context, the conflict should be seen as a larger (and longer) series of interrelated wars throughout Western Europe during the last two centuries of the Middle Ages. This larger struggle helped set the stage—politically, economically, and, of course, militarily—for much that would follow: the rise of the centralized early modern state, the growth of Spanish and Holy Roman Imperial power, the Italian wars, the exploration and exploitation of the Americas, and the emergence of the “Swiss way of war.” Viewing events in this manner also helps explain the homogeneity of late medieval/early

¹⁰ Jehan de Waurin, *Récueil des croniques et anchiennes istories de la Grant Bretagne*, ed. W. and E. L. C. P. Hardy, 5 vols., Rolls Series (London, 1864–1991). Despite its age, this edition has not been updated. The Hardys also attempted a translation of the chronicle from medieval French to English—also for the Rolls Series—but only completed the first three volumes (London, 1864–1891). This, like the translations of Froissart, often leads to a focus on the fighting between England and France, again skewing the author's own interests and biases.

¹¹ *Ibid.*, V:244–51 (battle of Castillon and fall of Bordeaux); V:251–61 (fall of Constantinople).

modern military strategy, tactics, and technology—a broad based phenomenon that some historians have erroneously named the “Military Revolution.” But that goes beyond the scope of this article. Here, we shall simply outline how other European lands—Scotland, the Holy Roman Empire, the Iberian kingdoms, the various Low Countries, and Burgundy—affected and were affected by the so-called Hundred Years War, before, during, and after the traditional chronology. To accomplish this, the article will first list the events occurring in these many lands that influenced the French and English struggle and then discuss briefly how this influence was felt.

*Scotland*¹²

- 1295–1296 The Auld Alliance between France and Scotland is established, first in Paris in 1295 and then the following year in Dumfermline.¹³
- 1297–98 William Wallace leads the Scottish armies against England in the First War of Independence, winning at the battle of Stirling Bridge in 1297, but losing at the battle of Falkirk in 1298.¹⁴
- 1300 Edward I (1272–1307) captures Caverlock Castle in southwest Scotland.
- 1301 The English king launches his campaigns in Scotland, his sixth campaign against the Scots.
- 1303 He conducts his seventh campaign into that kingdom.
- 1304 The Scots submit to Edward I at St. Andrews.

¹² Ranald Nicholson’s *Scotland: The Later Middle Ages* (New York, 1974) is an excellent study of this period of Scottish history, and because of Nicholson’s own interests—as seen in *Edward III and the Scots: The Formative Years of a Military Career, 1327–1335* (Oxford, 1965)—his treatment of the Scottish War of Independence, as it is now known, is detailed and complete. However, even Nicholson does not follow Scottish soldiers fighting in France. See also James Campbell’s very general essay, “England, Scotland and the Hundred Years War in the Fourteenth Century,” in *Europe in the Late Middle Ages*, ed. J. R. Hale, J. R. L. Highfield and B. Smalley (Evanston, Ill., 1965), 184–216.

¹³ For an introduction to the Auld Alliance see Elizabeth Bonner, “Scotland’s ‘Auld Alliance’ with France, 1295–1560,” *History* 84 (1999): 5–30.

¹⁴ The number of books on William Wallace seem to multiply yearly. My favorite is Chris Brown, *William Wallace: The True Story of Braveheart* (Stroud, 2005). The best study of the two battles of Wallace is Pete Armstrong, *Stirling Bridge and Falkirk, 1297–98: William Wallace’s Rebellion* (London, 2003). For a more general history of the period see Fiona Watson, *Under the Hammer: Edward I and Scotland, 1286–1307* (East Linton, 1998), which should be consulted not only for Edward’s conflict with Wallace but for all of the Anglo-Scottish wars to 1307. See also Michael Prestwich’s outstanding biography of Edward I: *Edward I* (London and New Haven, 1988) for all of Edward’s wars.

- 1305 William Wallace is executed at Smithfield, near London.
- 1306 Robert Bruce, earl of Carrick and lord of Annandale, assassinates (or arranges the assassination of) John III Comyn, guardian of Scotland, at Greyfriars Church in Dumfries, then crowns himself king of Scotland (1306–1329), but loses to the English later in the year at the battles of Methven and Dalry.¹⁵
- 1307 To prove his resolve to the Scots, Edward I holds a parliament at Carlisle which begins yet another campaign into Scotland, but Robert Bruce defeats the English armies at the battle of Loudon Hill.¹⁶ The English king dies and, his heir, Edward II (1307–1327) cannot sustain the Scottish campaign.¹⁷
- 1308 Under Robert Bruce's direction, Scottish forces raid northern England. Such raids will continue throughout Bruce's life. (He will die in 1329).
- 1311 Edward II fails miserably in his campaign against Scotland.
- 1313 The Scottish army drives English forces out of Perth and begins the siege of Carlisle.
- 1314 Edward Bruce, Robert's brother, besieges Stirling Castle, provoking Edward II to fight and lose the battle of Bannockburn.¹⁸ As a result of this loss, the English are driven from Scotland.
- 1315 Edward Bruce campaigns in Ireland, defeating an Anglo-Norman army at the battle of Connor.¹⁹
- 1317 Edward Bruce is defeated in several engagements in Ireland, forcing his brother, the king, to travel there.

¹⁵ The standard biography of Robert Bruce is G. W. S. Barrow, *Robert Bruce and the Community of the Realm of Scotland* (London, 1965) which has recently been released in a fourth edition (Edinburgh, 2006). Quite good also, and better on Bruce's military career in my opinion, is Chris Brown, *Robert Bruce: A Life Chronicled* (Stroud, 2004). Colm McNamee, *The Wars of the Bruces: Scotland, England, and Ireland, 1306–1328* (East Linton, 1997) specifically focuses on the military history between Scotland and England during the Bruce's generalship, as does the slightly older A. A. M. Duncan, "The War of the Scots, 1306–23," *Transactions of the Royal Historical Society*, 6th ser., 2 (1992): 125–51.

¹⁶ On the battle of Loudon Hill see Kelly DeVries, *Infantry Warfare in the Early Fourteenth Century: Discipline, Tactics, and Technology* (Woodbridge, Suffolk, 1996), 49–57.

¹⁷ A good general history of Edward II's military problems remains Michael Prestwich, *The Three Edwards: War and State in England, 1272–1377* (London, 1981).

¹⁸ More may be written about Bannockburn than perhaps any battle in history. W. M. Mackenzie's *The Battle of Bannockburn: A Study in Mediaeval Warfare* (Glasgow, 1913) and John E. Morris' *Bannockburn* (Cambridge, 1914) are the places to start any study of the battle—especially as they disagree quite a bit. Of the numerous more recent works my favorite is Pete Armstrong, *Bannockburn 1314: Robert Bruce's Great Victory* (London, 2002), although much may change if the battlefield is ever correctly identified by archaeology. For a concise account of the battle, see DeVries, *Infantry Warfare*, 66–85.

¹⁹ Séan Duffy's *Robert the Bruce's Irish Wars: The Invasions of Ireland, 1306–1329* (Stroud, 2002) covers the subject nicely.

- 1319 Edward II besieges Berwick-upon-Tweed, but raises the siege after the Scottish general, Sir James Douglas, defeats an English army raised by Archbishop Melton of York at the battle of Myton.
- 1320 In a letter (later known as the declaration of Arbroath) written to Pope John XXII (1316–1334) at Avignon, Robert Bruce and fifty-one other nobles and magnates declare Scotland to be an independent and sovereign state. The pope does not ratify the declaration, but neither does he condemn it.²⁰
- 1322 Another of Edward II's campaigns into Scotland fails. Robert Bruce's raids into Yorkshire are much more successful, including his defeat of an English army led by the earl of Richmond.
- 1323 Edward II executes Andrew of Harclay, earl of Carlisle, for negotiating a treaty with Robert Bruce, but later that year arrives at a truce with the Scottish king.²¹
- 1327 Edward II is deposed by his wife, Isabelle, and her lover, Roger Mortimer, who become regents for his son, the newly-crowned king, Edward III. Mortimer's army is crushed by Robert Bruce in the Weardale campaign.²²
- 1328 Following the deposition of his father, Edward III signs the treaty of Edinburgh-Northampton which recognizes Robert Bruce as king of a sovereign Scotland. This is done so that Edward might pursue his inheritance claims as king of France.²³
- 1329 Robert Bruce dies and is succeeded as king by his son, David II Bruce (1329–1371).²⁴
- 1332 At the battle of Dupplin Moor,²⁵ Edward Balliol, leading an army of "disinherited" Scottish nobles, defeats a Scottish army led by the earl of Mar, guardian of Scotland and regent for David II. Balliol declares himself king but is soon defeated by the earl of Moray, John Randolph, at the battle of Annan. He is then forced to flee to England.

²⁰ See Edward J. Cowan, "For Freedom Alone": *The Declaration of Arbroath, 1320* (East Linton, 2002).

²¹ M. H. Keen, "Treason Trials Under the Law of Arms," *Transactions of the Royal Historical Society*, 5th ser., 12 (1962): 85–103.

²² The significance of Mortimer's disastrous Weardale campaign has been pointed out by many historians. See especially A. E. Prince, "The Importance of the Campaign of 1327," *English Historical Review* [*EHR*] 50 (1935): 299–302 and Randal Nicholson, "The Last Campaign of Robert Bruce," *EHR* 77 (1962): 233–46.

²³ Edward III's wars with Scotland are covered nicely in Nicholson's *Edward III and the Scots* cited above.

²⁴ For a biography on David II, see Michael Penman, *David II, 1329–71* (East Linton, 2004).

²⁵ For the Anglo-Scottish wars that follow (until 1363), see Chris Brown, *The Second Scottish Wars of Independence, 1332–1363* (Stroud, 2002). On the battle of Dupplin Moor, see Nicholson, *Edward III and the Scots*, 57–92 and DeVries, *Infantry Warfare*, 112–20.

- 1333 Having laid siege to Berwick Castle, Edward III then defeats a Scottish army at the battle of Halidon Hill. Berwick falls the next day.²⁶
- 1334 For his own safety, David II travels to France. Edward Balliol is recrowned king, recognizing Edward III as his overlord and ceding to him Berwick and eight shires of southern Scotland. A Scottish rebellion ultimately forces him to again flee to England.
- 1335 Edward III campaigns in Scotland, placing Edward Balliol back on the throne. Once again Balliol's kingship fails.
- 1336 Edward III returns yet again to Scotland and campaigns in the Highlands. Edward Balliol is put back on the throne. Edward III uses the Scottish-French alliance as a means of raising taxes for war against France.
- 1339 While Edward III is campaigning in northern France, the Scots again force Edward Balliol to flee to England.
- 1341 David II returns to Scotland from France; his supporters force all remaining English from Edinburgh.
- 1342 Edward III campaigns unsuccessfully in southern Scotland. The Scots recapture Roxburgh Castle and drive the English out of the kingdom.
- 1346 While Edward III besieges Calais, David II invades England where he is defeated, wounded, and captured at the battle of Neville's Cross by the forces of Henry Percy, Ralph Neville, and William la Zouche, Archbishop of York.²⁷ For the next eleven years David is imprisoned in England.²⁸
- 1355 The Scots recapture Berwick.
- 1356 Edward III again takes Berwick, and Edward Balliol, still titularly the king of Scotland, abdicates his throne to the English sovereign.
- 1371 David II dies without a direct heir. As a result, his nephew, Robert II, "the Steward," (1371–1390) is made king.
- 1384 A Scottish army besieges and destroys Lochmaben Castle, then begins raiding Cumberland.²⁹
- 1385 The Scots, supported financially by France, raid Northumberland. Richard II sacks Edinburgh in retaliation.

²⁶ Nicholson, *Edward III and the Scots*, 123–62 and DeVries, *Infantry Warfare*, 120–28. On the siege of Berwick itself, see Ranald Nicholson, "The Siege of Berwick, 1333," *Scottish Historical Review* 40 (1961): 19–42.

²⁷ The articles collected in *The Battle of Neville's Cross, 1346*, ed. David Rollason and Michael Prestwich (Stamford, 1998) are for the most part excellent. See also DeVries, *Infantry Warfare*, 176–87 and C. J. Rogers, "The Scottish Invasion of 1346," *Northern History* 34 (1998): 51–69.

²⁸ E. W. M. Balfour-Melville, *Edward III and David II* (London, 1954) has been updated in parts by A. A. M. Duncan, "Honi soit qui mal y pense: David II and Edward III, 1346–52," *Scottish Historical Review* 67 (1988): 113–41.

²⁹ On the Anglo-Scottish Wars from 1369 to 1403, see Alastair J. Macdonald, *Border Bloodshed: Scotland, England and France at War, 1369–1403* (East Linton, 2000).

- 1388 James, the earl of Douglas, defeats Henry Percy, “Hotspur,” at the battle of Otterburn but is killed in the process. The defeat is demoralizing for the English, but little else results from it.³⁰
- 1390 Robert III Stuart (1390–1424) succeeds his father as king of Scotland.
- 1400 Henry IV invades Scotland but is forced to return to England by the Welsh rebellion led by Owain Glyn Dŵr.³¹
- 1402 Henry Percy, earl of Northumberland, and his son, Hotspur, defeat Archibald Douglas’ Scottish army at the battle of Homildon Hill. Included among the Scottish troops is a unit of French cavalry.³²
- 1406 James I Stuart (1424–1437) succeeds his father, Robert III, as king of Scotland, while still a prisoner of the English who had captured him earlier in the year as he was traveling to France. During his captivity, many Scottish nobles and soldiers were lured to France to fight the English there.³³
- 1421 Scottish soldiers assist the French in gaining victory over the English at the battle of Baugé.
- 1424 James I returns from England after signing the treaty of Durham which establishes peace with the English. Archibald, earl of Douglas, and John Stuart, earl of Buchan, are killed at the battle of Verneuil.³⁴

³⁰ On the battle of Otterburn, see the many articles in *War and Border Societies in the Middle Ages*, ed. Anthony Goodman and Anthony Tuck (London, 1992).

³¹ A. L. Brown, “The English Campaign in Scotland, 1400,” in *British Government and Administration: Studies Presented to S. Chrimes*, ed. H. Hearder and H. R. Loyn (Cardiff, 1974), 40–54 and Ian Arthurson, “The King’s Voyage into Scotland: The War that Never Was,” in *England in the Fifteenth Century: Proceedings from the 1986 Harlaxton Symposium*, ed. D. Williams (Woodbridge, 1987), 1–22.

³² Despite their victory here, the Percies were in rebellion against Henry IV, which culminated in the defeat of Hotspur and Owain Glyn Dŵr at the battle of Shrewsbury the next year. See J. M. W. Bean, “Henry IV and the Percies,” *History* 44 (1959): 212–27.

³³ Surprisingly, there has been little work done on the Scottish armies and soldiers that fought in France during the Hundred Years War. That much more can be done is hinted at in Annie I. Dunlop, *Scots Abroad in the Fifteenth Century* (London, 1942). See also Amicie de Villaret, *Campagnes des Anglais dans l’Orléanais, la Beauce Chartrain et le Gatinais (1421–1428): L’armée sous Warwick et Suffolk au siège de Montargis. Campagnes de Jeanne d’Arc sur la Loire postérieures au siège d’Orléans* (Orléans, 1893); and Bernard Chevalier, “Les écossais dans les armées de Charles VII jusqu’à la bataille de Verneuil,” in *Jeanne d’Arc: Une époque, un rayonnement* (Paris, 1982), 85–94.

³⁴ Michael K. Jones, “The Battle of Verneuil (17 August 1424): Towards a History of Courage,” *War in History* 9 (2002): 375–411, is now the authority on this battle, but see also J. Augis, “La bataille de Verneuil (jeudi 17 août 1424) vue de Châteaudun,” *Bulletin de la société Dunoise* 16 (1932–35): 116–21; M. Harbinson, “Verneuil—The Events of 17 August 1424: an Examination of the Sources and the Account of Thomas Basin,” *The Hobilar* 30 (1998): 18–22; and M. A. Simpson, “The Campaign of Verneuil,” *EHR* 49 (1934): 93–100.

- 1428 Sir John Stewart of Darnley, constable of Scotland, is killed at the battle of the Herrings.³⁵
- 1436 James I besieges Roxburgh Castle, but fails to capture it.³⁶
- 1437 James I is assassinated by Sir Robert Graham at the Friars Preachers Monastery in Perth and is succeeded by his son, James II (1437–1460).
- 1440 A feud between James II and the Douglas family begins with the execution of William, earl of Douglas. The feud, which essentially creates a Scottish civil war, continues through James II's reign and into that of James III (1460–1488).
- 1448 Scotland attempts to wage war against England.
- 1452 James II murders William, earl of Douglas, at Stirling Castle.
- 1460 James II captures Roxburgh Castle, but is killed during his inspection of his artillery when a cannon accidentally explodes. He is succeeded by his son, James III, who is still a child.
- 1461 Henry VI (1422–1461) is forced to flee to Scotland after his defeat at the battle of Towton by his cousin, Edward IV. Out of gratitude for Scottish support, Henry cedes Berwick to Scotland.
- 1468 After being tried as a traitor, Robert, lord Boyd, who had been one of the regents of James III, flees to England. His brother, Alexander, is executed for treason.

The Anglo-Scottish chronology makes clear several ways in which Scotland both influenced and entered into the Hundred Years War. The first has been observed by some historians: that by their military activity on the northern borders of England, the Scots kept Edward III from embarking on the conflict before 1337. As early as 1328, the citizens of Bruges tried to offer the English king their allegiance if he would assist them in their rebellion against the French. Initially, he promised to do so, but was then forced to renege, much to the rebels' detriment as they could not militarily sustain their revolt without England's aid after suffering defeat at the battle of Cassel (1328). Clifford J. Rogers makes a good point about Edward's growing confidence in his own tactical abilities after the battle of Halidon Hill in 1333.³⁷ On the other hand, the fact that it took the English king another half-dozen years to actually make it to the continent suggests that he was still not

³⁵ Kelly DeVries, *Joan of Arc: A Military Leader* (Stroud, 1999), 65–68.

³⁶ The Anglo-Scottish Warfare of the fifteenth century is very poorly researched. About the only good secondary source is Nicholson's *Scotland: The Later Middle Ages*.

³⁷ This point is made by Rogers in both "Edward III and the Dialectics of Strategy, 1327–1360," *Transactions of the Royal Historical Society*, 6th ser., 4 (1994): 83–102 and *War Cruel and Sharp: English Strategy under Edward III, 1327–1360* (Woodbridge, 2000).

confident enough strategically to leave his border open to yet another potential Scottish attack.

The Anglo-Scottish chronology raises another issue here that has been somewhat ignored by Hundred Years War historians who are so tightly stuck on a 1337–1453 chronology. The financial resources that were needed for Edward to fight a war in France were significant; in fact, his failure to receive sufficient funds from Parliament is given by Rogers and Jonathan Sumption as the reason for the English failure to capture Tournai in 1340.³⁸ Yet the fact that these funds had been drained off consistently since the very beginning of the Scottish War of Independence in 1297 has been largely forgotten. What were the further financial repercussions of continued threats to England by the Scots throughout the fourteenth century? And how did the need to respond to these threats militarily impinge on the English war effort in France? In fact, at various times during the period, the Scots received French funding. On the other hand, England relied only on what its own economy could provide. Although both the wool trade with Flanders remained fairly constant throughout Edward's reign, the Flemish rebellions of 1337–1345 and 1379–1385 and the Brabantese War of Succession of 1355–1357 did disrupt that trade to some extent, no doubt affecting English financing of the war. (The extent of such disruption has yet to be explored by historians.)

Another obvious connection between Scotland and the Hundred Years War has received even less commentary by military historians. The Scottish threat to northern England had virtually disappeared by Henry V's reign, which may have had something to do with that king's interest in renewing an English military effort in France. Instead, Scottish warriors appear to have shifted their fight against the English to France. Chroniclers note the Scottish presence at such battles as Baugé (1421), Verneuil (1424), and the Herrings (1429), as well as in the army that served with Joan of Arc at Orléans and along the Loire River. This interesting shift in military theaters may have had something to do with

³⁸ Rogers, *War Cruel and Sharp*, 199–216 and Jonathan Sumption, *The Hundred Years War: Trial by Battle* (Philadelphia, 1991), 338–70. Neither details what forms of financing there were, why such financing was solely in the hands of Parliament, why Edward had not arranged his financing more completely before he left England, why England was paying for the siege alone when Flemish, Brabantese, Hainauter, and German allied forces were also involved, probably in greater numbers than the English, and, finally, why if his war financing was such a hardship in 1340, it was well in hand by 1341 when Edward was prepared to make yet another assault on the continent.

the instability of the Scottish throne. On the other hand, the presence in France of so many Scottish leaders whose families had fought against England over the decades may simply signify a desire on their part to take their fight to the English, wherever possible.

*Holy Roman Empire*³⁹

- 1337 Holy Roman Emperor Ludwig IV of Bavaria (1314–1347) (of the House of Wittelsbach) makes an alliance with Edward III.⁴⁰
- 1338 Ludwig names Edward III as imperial vicar west of the Rhine River.
- 1340 The Holy Roman Emperor sends troops to participate on Edward's side at the siege of Tournai.
- 1341 Ludwig abandons his English alliance and allies himself with Philip VI.
- 1346 Charles IV (of the House of Luxemburg) (1347–1378) is elected king of Germany by barons opposed to Ludwig IV's rule.⁴¹ Nine years later, he will be declared Holy Roman Emperor.
- 1378 Charles IV signs a peace treaty with Charles V of France (1364–1380) in Paris. To seal the friendship, he names the dauphin, later Charles VI (1380–1422), imperial vicar over the kingdom of Arles.
- 1416 Emperor Sigismund (1410–1437) travels to Paris in a vain attempt to make peace between England and France.⁴²
- 1473 Charles the Bold, Duke of Burgundy, meets with Emperor Frederick III (of the House of Habsburg) (1440–1493) at Trier in an effort to be crowned "king of Burgundy."⁴³ Frederick refuses to accommodate the Burgundian duke.
- 1474 With the support of King Louis XI of France, the Swiss Confederation achieves its independence from Austria. The confederation forms the Union of Constance with Strasbourg, Schlestadt, Colmar, Basel, and

³⁹ This is an area of historical neglect that is badly in need of a scholarly study.

⁴⁰ There is only one study of any significance here—and it is very dated—despite its importance to the early stages of the Hundred Years War: H. S. Offler, "England and Germany at the Beginning of the Hundred Years' War," *EHR* 54 (1939): 608–31.

⁴¹ John the Blind's bravery at Crécy is still memorialized on the battlefield by a monument, parts of which are centuries old. For a brief and very nationalistic biography of John, see Walther Rose, "König Johann der Blinde von Böhmen und die Schlacht bei Crécy (1346)," *Zeitschrift für historisches Waffenkunde* 7 (1915–17): 37–60. Sadly none of the biographies of Charles IV detail his interactions with the French or the English during the Hundred Years War.

⁴² Unfortunately Sigismund's biographies also do not discuss his activity with France or England during the Hundred Years War.

⁴³ The sources for Charles the Bold's life will be indicated below.

- Austria as a defensive pact against Charles the Bold, who initiates the siege of Neuss.⁴⁴
- 1475 The armies of Frederick III, the Union of Constance, and other German entities raise the siege.
- 1476 The Swiss defeat the Burgundians at the battles of Grandson and Murten.⁴⁵
- 1477 The Swiss defeat the Burgundians at Nancy and there Charles the Bold is killed.

While the connection of the Holy Roman Empire to the Hundred Years War is less noteworthy than that of Scotland, there are several things that do stand out. Most notably, there is the active participation of Holy Roman Emperor, Ludwig IV, at the outset of the conflict, although little scholarly emphasis has been placed on this outside of H.S. Offler's article.⁴⁶ Nor has the failure of Ludwig's alliance with Edward III received much attention, despite the loss by the English king of what could have been an invaluable and wealthy ally, and despite the fact that this failure seems to have been one of the principal justifications used by German barons for overthrowing Ludwig. The fact that the Germans replaced Ludwig with Charles IV (1347–1378), whose father, John the Blind, duke of Luxemburg and king of Bohemia (1310–1346), had lost his life so famously fighting on the French side against Edward at the battle of Crécy (1346) suggests German interest in what was happening in the Hundred Years War. The fact that the imperial chronology produced in this article has only a few entries primarily reflects the limited research that has to date been devoted to this aspect of the conflict, a clear call for more work in the future.

⁴⁴ The most complete discussion of the siege of Neuss are found in the articles in *Neuss, Burgund und das Reich* (Neuss, 1975), especially Joseph Lange's "Pulchra Nussia: Die Belagerung der Stadt Neuss, 1474/75," 9–190. But see also Robert Douglas Smith and Kelly DeVries, *The Artillery of the Dukes of Burgundy, 1363–1477* (Woodbridge, 2005), 174–84; Charles Brusten, "Charles le Téméraire et la campagne de Neuss, 1474–75," *Publications du centre européen d'études burgundo-médiévales* 13 (1971): 67–73; and Jean-Marie Cauchies, "Charles le Hardi à Neuss (1474/75): Folie militaire ou contrainte politique," *Publication du centre européen d'études bourguignonnes (XIV^e–XVI^e siècles)* 36 (1996): 105–15.

⁴⁵ On the battle of Grandson, see especially the articles in *Grandson 1476: Essai d'approche d'une action militaire du XV^e siècle*, ed. Daniel Reichel (Lausanne, 1976) and Smith and DeVries, *Artillery*, 188–92. For the battle of Murten, see the articles in *Die Murtenschlacht: Ein Schweizer Ereignis in Europas Geschichte zwischen Mittelalter und Neuzeit, 1476–1976* (Fribourg, 1976); P. E. de Vallière, P. E., *Morat: Le siège et la bataille, 1476* (Lausanne, 1926); and Smith and DeVries, *Artillery*, 191–97.

⁴⁶ Cited above.

*Iberia*⁴⁷

- 1312–1350 Reign of Alfonso XI of Castile (1312–1350), Europe’s highest ranking victim of the Black Death. During the latter part of the reign, both France and England vie for a Castilian alliance. While not joining either side outright, Alfonso generally leans toward France.
- 1329 Joanna (Joan) II, the daughter of King Louis X (1314–1316) is crowned queen of Navarre (1328–1349) by her cousin, King Philip VI. Her relationship to Louis makes her the closest possible heir to the French throne after the death of Charles IV in 1328; however, according to Salic Law, she is ineligible to inherit the crown and is passed over for a second time.
- 1336 Pere III (also called Pedro IV) “the Ceremonious” (1336–1387) becomes king of Aragon and rules until 1387.⁴⁸
- 1349 The son of Joanna II, Charles II “the Bad,” (1349–1387) is crowned King of Navarre.⁴⁹
- 1350 Pedro I “the Cruel” (1350–1366/69) begins his reign as king of Castile.⁵⁰ An English fleet, led by the constable of France, Charles de la Cerda, serving Edward III and his son, Edward, the Black Prince (d. 1376), defeats a Castilian fleet at the battle of Winchelsea (also known as the battle of Les Espagnols sur Mer).
- 1354 Charles II of Navarre kills Charles de la Cerda, and then allies himself with the Black Prince through the treaty of Mantes.

⁴⁷ P. E. Russell’s *The English Intervention in Spain and Portugal in the Time of Edward III and Richard II* (Oxford, 1955) is one of the seminal works of history, although it is becoming dated in parts. However, because it is so good there has been little further work done on the subject. A very dated look at the Castilian-French relationship is Georges Daumet, *Étude sur l’alliance de la France et de la Castille au XIV^e et XV^e siècle* (Paris, 1898), but it is all we have except perhaps for Emilio Mitre Fernández, “Castilla ante la Guerra de los Cien Años: actividad militar y diplomática de los orígenes de conflicto al fin de las grandes treguas (c. 1340–c. 1415),” in *XXXI Semana de Estudios Medievales, Estella, 18 a 22 de julio de 2004* (Pamplona, 2005), 199–236.

⁴⁸ On some of Pedro’s interactions with France, see Joaquín Miret y Sans, “Négociations de Pierre IV d’Aragon avec la cour de France (1366–1367),” *Revue hispanique* 13 (1905): 76–135 and Antonio Gutiérrez de Velasco, “Pierre IV et Bertrand Duguesclin,” *Les cahiers de l’Prose*, n.s. 17.2 (Apr–Jun 1970): 57–66.

⁴⁹ For a biography of Charles of Navarre, see André Plaisse, *Charles dit le Mauvais, comte d’Evreux, roi de Navarre, capitaine de Paris* (Evreux, 1972).

⁵⁰ A nice introduction to the military history of Pedro I of Castile is L. J. Andrew Villalon, “Pedro the Cruel: Portrait of a Royal Failure,” in *Medieval Iberia: Essays on the History and Literature of Medieval Spain*, ed. Donald J. Kagay and Joseph T. Snow (New York, 1997), 201–16. For a biography of the Castilian king, see Clara Elstow, *Pedro the Cruel of Castile, 1350–1369* (Leiden, 1995).

- 1356–1366 War of the Two Pedros is fought between Aragon and Castile.⁵¹
- 1358 Charles of Navarre leads a French army in the suppression of the *Jacquerie* revolt.⁵²
- 1364 Bertrand du Guesclin leads a French army to victory over the Navarrese led by an English general, Jean de Grailly, captal de Buch, at the battle of Cocherel.⁵³
- 1365 Charles V of France and Charles II of Navarre make peace. Bertrand du Guesclin is asked by the French king to hire Free Companies to fight with Enrique II Trastámara (1366/69–1379) in an attempt to seize the Castilian throne from his half-brother, Pedro I.
- 1366 Enrique de Trastámara gains the kingship of Castile.
- 1367 At the battle of Nájera (April 3), an army supporting Pedro I, led by the Black Prince defeats the forces serving Enrique II led by Bertrand du Guesclin.⁵⁴ As a result, Pedro is restored to the throne.
- 1369 Enrique defeats Pedro at the battle of Montiel, executes him, and rules as king of Castile, despite continuing opposition from Pedro's die-hard supporters and Castile's neighbors.
- 1372 John of Gaunt, son of Edward III and son-in-law of Pedro the Cruel, claims Castile. Enrique II forces Fernando I of Portugal (1367–1383) to break his alliance with John of Gaunt. Castilian naval forces lent by Enrique to France join the French fleet in

⁵¹ On the War of the Two Pedros, see the recent article by Donald J. Kagay, "The Defense of the Crown of Aragon during the War of the Two Pedros (1356–1366)," *Journal of Military History* 71 (2007): 11–34.

⁵² The best study for military historians on the *Jacquerie* is David M. Bessen, "The *Jacquerie*: Class War or Co-opted Rebellion?" *Journal of Medieval History* 11 (1985): 43–59, but see also Raymond Cazelles, "The *Jacquerie*," in *The English Rising of 1381*, ed. R. H. Hilton and T. H. Aston (Cambridge, 1984), 74–83 and the old standard, Siméon Luce, *Histoire de Jacquerie* (Paris, 1894).

⁵³ See Kenneth A. Fowler, *Medieval Mercenaries*, vol. 1: *The Great Companies* (Oxford, 2001), 86–117, 155–223; Fowler, "L'emploi des mercenaires par les pouvoirs Ibériques et l'intervention militaire Anglaise en Espagne (vers 1361–vers 1379)," in *Realidad e imágenes del poder: España a fines de la edad media*, ed. Adeline Rucquoi (Valladolid, 1988), 23–55; L. J. Andrew Villalon, "'Seeking Castles in Spain': Sir Hugh Calveley and the Free Companies' Intervention in Iberian Warfare (1366–1369)," in *Crusaders, Condottieri, and Cannon: Medieval Warfare in Societies around the Mediterranean*, ed. L. J. Andrew Villalon, and Donald J. Kagay (Leiden, 2003), 305–28; and Edouard Perroy, "France, England, and Navarre from 1359 to 1364," *Bulletin of the Institute of Historical Research* 13 (1935/36): 151–60 for this and some of the following events.

⁵⁴ This is one of the most under-researched of any major battle that took place during the Hundred Years War despite the presence of the Black Prince and Bertrand du Guesclin. The best study is L. J. Andrew Villalon, "Spanish Involvement in the Hundred Years War and the Battle of Nájera," in *Hundred Years War: A Wider Focus*, ed. L. J. Andrew Villalon and Donald J. Kagay (Leiden, 2005), 3–74, but see also Fernando Castillo Cárceres, "Analysis de una batalla: Nájera 1367," *Cuadernos de historia de Espana* 73 (1991): 107–46.

- defeating the English off the port of La Rochelle. This results in the re-establishment of a significant French naval presence in the Bay of Biscay.⁵⁵
- 1373 Fernando of Portugal and John of Gaunt again form an alliance against Enrique II, but the short, unsuccessful war that follows ends in the establishment of peace between Portugal and Castile.
- 1377 Castilian corsairs raid the southern coast of England.⁵⁶
- 1378 England makes peace with Charles of Navarre in order to attack Castile.
- 1379 Enrique II dies and is succeeded by his son, Juan I (1379–1390), as king of Castile. John of Gaunt once again claims the Castilian throne.
- 1380 The English defeat a Franco-Castilian fleet off the coast of Kinsale, Ireland.
- 1382 By marrying Beatrice of Portugal, Juan I forges an alliance with her father, King Fernando, causing the English to evacuate the kingdom.
- 1383 Fernando dies and the Castilian king claims the throne of Portugal through his wife. However, this is not accepted by the Portuguese and Juan is forced to march his army into Portugal.⁵⁷
- 1384 The Portuguese defeat Juan at the battle of Atoleiros. The Castilian king begins a siege of Lisbon but has to raise it within a few weeks after plague decimates his besieging troops.
- 1385 João I (1385–1433), the illegitimate son of Pedro I of Portugal (1357–1367) and Grand-Master of the Order of Aviz, is crowned the king by the Portuguese *cortes*. He is supported by John of Gaunt who sends English longbowmen to fight with the Portuguese in their stunning defeat of the Castilians at the battle of Aljubarrota.⁵⁸
- 1386 The treaty of Windsor is signed between England and Portugal, culminating in the wedding of Philippa of Lancaster, John of Gaunt's daughter, to João the following year. John of Gaunt uses the occasion to launch an attack on Castile.

⁵⁵ James Sherborne, "The Battle of La Rochelle and the War at Sea, 1372–5," *Bulletin of the Institute of Historical Research* 42 (1969): 17–29; José María Blanco Nuñez, "Las armadas de Castilla y Aragón durante la Guerra de los Cien Años," in *XXII Kongreß der Internationalen Kommission für Militärgeschichte Acta 22: Von Crécy bis Mohács Kriegswesen im späten Mittelalter (1346–1526)* (Vienna, 1997), 269–80.

⁵⁶ C. F. Richmond, "The War at Sea," in *The Hundred Years War*, ed. Kenneth Fowler (London, 1971), 102–7; Michael Hughes, "The Fourteenth-Century French Raids on Hampshire and the Isle of Wright," in *Arms, Armies and Fortifications in the Hundred Years War*, ed. Anne Curry and Michael Hughes (Woodbridge, Suffolk, 1999), 121–44.

⁵⁷ Carlos Bessa, "Le Portugal 1383–1385: crise, art militaire et consolidation de l'indépendance," in *XXII Kongreß*, 28–50, only just introduces the subject.

⁵⁸ While a good military study of the battle of Aljubarrota in English has yet to be written, the battlefield has been excavated and a short summary of the findings is in Afonso Do Paço, "The Battle of Aljubarrota," *Antiquity* 37 (1963): 264–69. A Portuguese treatment of the battle is João Gouveia Montiero, *A Batalha Real. Aljubarrota—1385*, 2nd ed. (Lisbon, 2003). On the aftermath, see Thomas M. Izbicki, "The Punishment of Pride: Castilian Reactions to the Battle of Aljubarrota," in *Medieval Iberia*, 217–28.

- 1387 Charles III (1387–1425) succeeds Charles II as king of Navarre, and Joan (Juan) I (1387–1395) succeeds Pere III as king of Aragon.
- 1390 Enrique III (1390–1406), who in 1388 had married Katherine of Lancaster, John of Gaunt’s daughter, succeeds his father, Juan, as king of Castile.
- 1410 The death of Marti (Martin) I, king of Aragon (1395–1410), without direct heirs initiates a two-year interregnum. Ferran (Fernando) I “the Just” (1412–1416), a member of the Castilian ruling house of Trastámara, is crowned king of Aragon in 1412.
- 1458 Richard Neville, earl of Warwick, defeats a Castilian fleet in the English Channel.
- 1472 Although Joan II, king of Aragon and Navarre, (1458–1479) and Louis XI of France cooperate in suppressing a Catalan revolt in Perpignan, once it is settled they fight against each other over possession of the region.⁵⁹
- 1475 The Aragonese-French war ends when Louis captures Perpignan, Roussillon, and Cerdagne.

While German and Scottish troops actually served in the Low Countries and France during the Hundred Years War, it was primarily the other way round in the case of Iberia. Here, French, English, and Bretons brought the Hundred Years War into the Peninsula through their massive intervention. On opposite sides of the intervention stood two of the conflict’s dominant figures: Bertrand DuGuesclin led the Franco-Bretons supporting the usurper, Enrique II, while Edward, the Black Prince, commanded the army that restored Pedro I to the throne. Apparently, it was during his 1367 campaign in northern Spain fought on behalf of Pedro, that the prince contracted the illness that eventually killed him. This would put his young son, Richard II, on the throne of England in his stead, leading to what many historians regard as the principal reason for the English military setbacks at the end of the fourteenth century. Of equal interest to French historians has been the participation on the other side—that supporting Enrique de Trastámara—of the future constable of France, Du Guesclin, the man whom many historians see as the architect of French victory at the next stage of the Hundred Years War (1369–1380). Although the Black Prince achieved a crushing victory at the battle of Nájera (1367), as in many other English battlefield successes this did not lead to victory in the larger conflict. In reality, the victory at Nájera decided

⁵⁹ The standard work remains Joseph Calmette, *Louis XI, Jean II et la révolution catalane* (Toulouse, 1903).

nothing. Within months, the Black Prince, estranged from his ally, Pedro I, evacuated the peninsula. At the same time, Enrique returned from France at the head of a rebuilt army and eighteen months later won at Montiel (1369) what would turn out to be the decisive battle of the civil war. Here, he captured and executed Pedro I, thereby securing his place on the Castilian throne.

No historian suggests that John of Gaunt was anywhere near as great a military leader as his elder brother, the Black Prince. However, his assistance to the Portuguese against the Castilians during the 1380s is almost always viewed as a military victory. For their part, Portuguese historians have suggested that their English counterparts overstate the role of the longbow at the battle of Aljubarrota in 1385. Whatever the case, there can be no doubt that this period of Iberian conflict and its influence on the Hundred Years War requires much more investigation than has been undertaken to date. English historians sidestep, if not completely ignore, the fact that John of Gaunt's success in Iberia may have less to do with his military skills than his ability to produce marriageable daughters, two of whom—Philippa and Katherine—became spouses of peninsular monarchs.

Outside of Nájera and Aljubarrota, the role of the Navarrese in that conflict remains largely unexplored. Neither Joanna II nor her son, Charles “the Bad,” has received an adequate biography—Plaisse's treatment of Charles notwithstanding.⁶⁰ Hence, the fascinating figures have not received the historical attention they deserve, despite their connections to almost everything that happened in France during the lead-up to and the first few decades of the Hundred Years War. Finally, what were all those Castilian ships doing fighting against the English fleet during these centuries? Can we call this naval warfare on a state level or was it simply piracy on a more private level?

⁶⁰ I find Plaisse's biography, *Charles dit le Mauvais* (cited above) to be fraught with more popular than scholarly writing, although it is certainly the place where a good scholarly biographer needs to start his study.

*The Low Countries*⁶¹

- 1302 The county of Flanders, led by the town of Bruges, rebels against France. The Flemish victory at the battle of Courtrai prompts Pope Boniface VIII (1296–1303) to issue the bull *Unam sanctam*.⁶²
- 1304 The French victory at the battle of Mons-en-Pévèle essentially ends the Flemish rebellion.⁶³
- 1312 Robert of Béthune, count of Flanders, reluctantly concedes the castellanies of Lille, Douai, and Béthune to King Philip IV “the Fair” of France (1285–1314) as part of the treaty of Athis-sur-Orge.
- 1314 Philip IV campaigns briefly in Flanders; although initially quite successful, he suspends his campaign when threatened by a tax revolt from towns in France.
- 1315 Louis X, who had succeeded to the throne of France in 1314, fails to conquer anything during his Flemish campaign.
- 1320 Robert of Béthune failed in his attempt to win back Lille in 1319 and this forces his submission to Philip V (1316–1322) in Paris.

⁶¹ An excellent work on the Low Countries during the fourteenth and fifteenth centuries is Wim Blockmans and Walter Prevenier, *The Promised Lands: The Low Countries Under Burgundian Rule, 1369–1530*, ed. Edward Peters, trans. Elizabeth Fackelman (Philadelphia, 1999). Before this period about the only solid book is F. Quicke, *Les Pays-Bas à la veille de la période Bourguignonne, 1356–1384: Contribution à l'histoire politique et diplomatique de l'Europe occidentale dans la seconde moitié du XIV^e siècle* (Brussels, 1947). As with many other subjects in this article, there is a need for a history of the Low Countries' urban revolts during the fourteenth and fifteenth centuries. For an introduction, see Kelly DeVries, “The Rebellions of the Southern Low Countries' Towns during the Fourteenth and Fifteenth Centuries,” in *Power and the City in the Netherlandic World*, ed. Wayne Te Brake and Wim Kibler (Leiden, 2006), 27–44 and Jan Dumolyn and Jelle Haemers, “Patterns of Urban Rebellion in Medieval Flanders,” *Journal of Medieval History* 31 (2005): 369–93.

⁶² There are numerous studies on the battle of Courtrai, especially with the recent seven-hundredth anniversary of the battle. The best is still J. F. Verbruggen, *The Battle of the Golden Spurs: Courtrai, 11 July 1302*, ed. Kelly DeVries, trans. David Richard Ferguson (Woodbridge, 2002). However, scholars should also consult Philippe Despriet, *Kortrijk 1302: Keerpunt in de Frans-Vlaamse oorlog, 1297–1305* (Courtrai, 2002); J. F. Verbruggen and Rolf Falt, *1302 opstand in Vlaanderen* (Tiel, 2002); and the articles in *Omtrent 1302*, ed. Paul Trio, Dirk Heirbaut, and Dirk van den Auweele (Leuven, 2002). A concise account is in DeVries, *Infantry Warfare*, 9–22. Frantz Funck-Brentano, *Philippe le Bel et Flandre: Les origines de la guerre de cent ans* (Paris, 1896) certainly saw the connection between these events and the Hundred Years War, but few have followed his lead.

⁶³ J. F. Verbruggen, *Vlaanderen na de Guldensporenslag* (Bruges, 1991) is one of the very few works on the Flemish rebellion after the battle of Courtrai. It is badly in need of translation. On the battles of Arques (1303) and Mons-en-Pévèle (1304) see DeVries, *Infantry Warfare*, 23–48. And on the Treaty of Athis-sur-Orge see Randall Lesaffer, “*Cedant arma togae*. De vrede van Athis-sur-Orge (1305),” in *Omtrent 1302*, ed. Paul Trio, Dirk Heirbaut, and Dirk van den Auweele (Leuven, 2002): 161–81.

- 1323 A rebellion of burghers and peasants breaks out in Flanders.⁶⁴
- 1327 Edward III begins putting together a coalition with Flanders but does not fulfill his end of the agreement.⁶⁵
- 1328 The battle of Cassel is won by newly-crowned French king, Philip VI, ending the Flemish revolt.⁶⁶
- 1337 Edward III sends an embassy to meet with Low Countries' princes, using England's control of the wool trade to gain the adherence of most of them to his leadership. When the count of Flanders, Louis I of Nevers (1322–1346), refuses to join the others, an action that results in a wool embargo, Jacob van Artevelde leads an uprising of Ghentenaars which causes the count to flee to France.⁶⁷
- 1338 Edward III travels to Antwerp and meets with Low Countries' leaders.
- 1340 In Ghent, Edward III proclaims himself king of France. He later returns to Flanders, winning the naval battle of Sluys, but fails in his efforts to besiege Tournai and returns to England.⁶⁸
- 1345 Jacob van Artevelde is killed in Ghent by a dissatisfied faction of townspeople.
- 1346 Liégeois burghers defeat their newly-appointed prince-bishop, Englebert de la Marck, at the battle of Vottem.⁶⁹ He is restored to rule after granting concessions to the rebels.
- 1349 Named count three years earlier, Louis II of Male (1346–1384), now retakes the county of Flanders.
- 1355 At the death of Jan III (1313–1355), his eldest daughter, Joanna, and the count of Flanders, Louis of Male, Jan's son-in-law by his second

⁶⁴ On the Flemish rebellion of 1323–1328 the best works are William H. TeBrake, *A Plague of Insurrection: Popular Politics and Peasant Revolt in Flanders, 1323–1328* (Philadelphia, 1993) and J. Sabbe, *Vlaanderen in opstand, 1323–1328: Nikolaas Zannekin, Zeger Janszone en Willem de Deken* (Bruges, 1992), although both are rather slight on military history.

⁶⁵ A historical work on par with Russell's, *The English Intervention in Spain and Portugal in the Time of Edward III and Richard II* is Henry Stephen Lucas, *The Low Countries and the Hundred Years' War, 1326–1347* (Ann Arbor, 1929), although some updating work on the period has been done by Low Countries' scholars.

⁶⁶ See DeVries, *Infantry Warfare*, 100–11 and the articles in *Nikolaas Zannekin en de slag bij Kassel, 1328–1978: Bijdrage tot de studie van de 14de eeuw en de landelijke geschiedenis van de Westhoek* (Diksmuide, 1978).

⁶⁷ David Nicholas', *The Van Arteveldes of Ghent: The Varieties of Vendetta and the Hero in History* (Ithaca, 1988) has become the standard history of Jacob van Artevelde, but I still like Hans Van Werveke, *Jacques van Artevelde* (Brussels, 1943) and Patricia Carson, *James van Artevelde: The Man from Ghent* (Ghent, 1980).

⁶⁸ On the battle of Sluys see Kelly DeVries, "God, Leadership, Flemings, and Archery: Contemporary Perceptions of Victory and Defeat at the Battle of Sluys, 1340," *American Neptune* 55 (1995): 223–42. And on the siege of Tournai, see Kelly DeVries, "Contemporary Views of Edward III's Failure at the Siege of Tournai, 1340," *Nottingham Medieval Studies* 39 (1995): 70–105 and Clifford S. Rogers, "An Unknown News Bulletin from the Siege of Tournai in 1340," *War in History* 5 (1998): 358–66.

⁶⁹ On the battle of Vottem, see DeVries, *Infantry Warfare*, 150–54.

- daughter, Margaret, fight over succession to the duchy of Brabant. The war will end in Joanna's favor in 1357.⁷⁰
- 1379 Flemish burghers, led by Ghentenaar, Philip van Artevelde (son of Jacob), revolt against their count, Louis of Male.⁷¹
- 1382 The town of Ghent gains victory over Bruges at the battle of Bevershoutsveld,⁷² but later in the year at the battle of Rosebeke the Flemish rebels are defeated—and Philip van Artevelde is killed—by a French army led by King Charles VI and Duke Philip the Bold of Burgundy (1364–1404).
- 1383 Henry Despenser, Bishop of Norwich, launches a disastrous “Crusade” into Flanders; he is ultimately defeated at the siege of Ypres.⁷³
- 1384 Philip the Bold succeeds as count of Flanders at the death of his father-in-law, Louis of Male.⁷⁴
- 1385 Ghent surrenders to Philip the Bold, ending the Flemish rebellion.⁷⁵
- 1390 Jean of Bavaria, brother-in-law of Duke Jean the Fearless of Burgundy (1404–1419), is made prince-bishop of Liège.
- 1402 The Liégeois rebel against Jean of Bavaria.

⁷⁰ On this war and others participated in by the Brabantese during the last half of the fourteenth century, see Serge Boffa, *Warfare in Medieval Brabant, 1356–1406* (Woodbridge, 2004) and idem, “The Duchy of Brabant Caught Between France and England: Geopolitics and Diplomacy during the First Half of the Hundred Years War,” in *Hundred Years War*, 211–40. For the inheritance conflict, see F. Blockmans, “De erfstrijd tussen Vlaanderen en Brabant in 1356,” *Bijdragen en mededelingen betreffende de geschiedenis van Nederland* 69 (1953): 11–16.

⁷¹ On the 1379–1385 Flemish rebellion, see R. Demuyne, “De gentsch oorlog (1379–1385): Oorzaken en karakter,” *Handelingen van de maatschappij voor geschiedenis en oudheid te Gent*, n.s. 5 (1951): 305–18; M. Vandermaesen and M. Ryckaert, “De Genste opstand (1379–1385),” in *De witte Kaproenen: De Gentse opstand en de geschiedenis van de Brugse Leie*, ed. Maurice Vandermaesen, Marc Ryckaert, and Maurits Coornaert. (Ghent, 1979), 7–31; David Nicholas, “The Scheldt Trade and the ‘Ghent War’ of 1379–85,” *Bulletin de la commission royale d’histoire de Belgique* 144 (1978): 189–359; and Smith and DeVries, *Artillery*, 60–70. For Philip van Artevelde’s role in the 1379–1385 Flemish rebellion, see Nicholas, *The Van Arteveldes of Ghent*.

⁷² Kelly DeVries, “The Forgotten Battle of Bevershoutsveld, 3 May 1382: Technological Innovation and Military Significance,” in *Armies, Chivalry and Warfare in Medieval Britain and France: Proceedings of the 1995 Harlaxton Symposium*, ed. Matthew Strickland (Stamford, 1998), 289–302. The battle of Rosebeke must also be revisited, with Friedrich Mohr’s German dissertation, *Die Schlacht bei Rosebeke am 27. November 1382: Ein Beitrag zur mittelalterlichen Kriegsgeschichte* (Berlin, 1906) being the only lengthy study.

⁷³ The bishop of Norwich’s Crusade is badly in need of a new study. Until then, see George M. Wrong, *The Crusade of 1383 Known as That of the Bishop of Norwich* (London, 1892) and Kelly DeVries, “The Reasons for the Bishop of Norwich’s Attack on Flanders in 1383,” in *Fourteenth Century England* 3, 155–65.

⁷⁴ The best biography of Philip the Bold remains Richard Vaughan, *Philip the Bold: The Formation of the Burgundian State* (London, 1962).

⁷⁵ Recounting numerous Ghentenaar rebellions against the Burgundians, see Marc Boone, *Gent en de Bourgondische hertogen, 1385–1453: Een sociaal-politieke studie van een staatsvormingsproces* (Brussels, 1990).

- 1406 Antoine, son of Philip the Bold, inherits the duchy of Brabant (1406–1415) from his aunt, Joanna.
- 1408 Jean the Fearless raises the siege of Maastricht by Liégeois rebels and then defeats their remaining forces at the battle of Othée.⁷⁶
- 1425 Humphrey, duke of Gloucester and uncle to King Henry VI of England, through his wife, Jacqueline of Bavaria, claims the counties of Hainaut and Holland. When she refuses to recognize his claims, Humphrey tries for three years to take them by force.⁷⁷
- 1436 At Countess Jacqueline's death, Hainaut and Holland become the possessions of Philip the Good, duke of Burgundy. The Brugeois begin a two-year rebellion against Burgundy.⁷⁸
- 1449 Ghent rebels against Philip.⁷⁹
- 1453 Philip defeats the Ghentenaars and other Flemings at the battle of Gavere.⁸⁰
- 1455 The revolt of Utrecht, Guelders, and Deventer leads to an invasion by Philip the Good.
- 1465 The Liégeois revolt against Philip's son, the future duke of Burgundy, Charles the Bold.⁸¹
- 1466 Charles besieges Dinant, severely punishing the citizens after the town falls.⁸²
- 1467 Liège surrenders for the first time to the Burgundians.
- 1468 The Liégeois are defeated by the Burgundians at the battle of Brusthem.⁸³

⁷⁶ See Kelly DeVries, "John the Fearless' Way of War," in *Reputation and Representation in Fifteenth Century Europe*, ed. Douglas L. Biggs, Sharon D. Michalove, and A. Compton Reeves (Leiden, 2004), 39–55. On the battle of Othée, in particular, see Hubert Carrier, "Si vera est fama: Le retentissement de la bataille d'Othée dans la culture historique au XV^e siècle," *Revue historique* 305 (2001): 639–70; Yves Charlier, "La bataille d'Othée et sa place dans l'histoire de la principauté de Liège," *Bulletin de l'Institut archéologique liégeois* 97 (1985): 138–278; and the dated Erich Wille, *Die Schlacht von Othée, 23 septembre 1408* (Berlin, 1908). On the sieges of Maastricht, see G. D. Franquinet, "Les sièges de Maastricht en 1407 et 1408, avec annexes," *Annales de la société historique et archéologique à Maestricht* 1 (1854–55): 205–37.

⁷⁷ Smith and DeVries, *Artillery*, 94–98.

⁷⁸ J. Dumolyn's *De Brugse opstand van 1436–1438* (Courtrai-Heule, 1997) is the only history of this revolt, but this work is far more interested in its social than its military history.

⁷⁹ On this rebellion, see Jelle Haemers, *De Gentse opstand (1449–1453). De strijd tussen rivaliserende netwerken om het stedelijke kapitaal* (Kortrijk-Heule, 2004).

⁸⁰ Smith and DeVries, *Artillery*, 132–34. On the battle of Gavere see V. Fris, "La bataille de Gavre," *Bulletin de la société d'histoire et d'archéologie de Gand* 18 (1910): 185–233 and Luc de Vos, "La bataille de Gavere le 23 juillet 1453. La victoire de l'organisation," in *Kongreß*, 145–57.

⁸¹ For the revolt of Liège against Burgundy in 1465–1470 see the articles in *Liège et Bourgogne: Actes du colloque tenu à Liège les 28, 29 et 30 octobre 1968* (Liege, 1972) and Smith and DeVries, *Artillery*, 146–65.

⁸² Smith and DeVries, *Artillery*, 152–56.

⁸³ *Ibid.*, 158–61.

- 1470 Charles defeats and sacks Liège, thus ending the Liégeois revolt.
 1473 Charles captures the duchy of Guelders.⁸⁴

The work of Belgian historians is simply not read by English and French scholars, even that part of it written in English or French—which in fact is the majority. Some of this may be the fault of Belgian historians who delight in pointing out that the southern Low Countries was not only the wealthiest, but also the most rebellious region in late medieval Europe. But most of this neglect derives from a simple ignorance of English and French historians concerning the true influence of the Low Countries in the Hundred Years War. The interaction of Edward III with various Low Countries princes has been largely neglected. Nor has there been much interest shown in the Burgundian acquisition of these principalities, until virtually the whole of the Low Countries had fallen to that duchy.⁸⁵ This neglect has given rise to some odd conclusions: that the failure at Tournai was solely one of non-funding by the English Parliament; that Edward III lingered in Crécy because he had visited Ponthieu when he was a young boy; that the bishop of Norwich simply decided to fight his Crusade against the supporters of the pope; and so forth. And what is one supposed to make of Humphrey of Gloucester's relationship to and war against his wife, Jacqueline of Bavaria, countess of Hainaut and Holland, with so little work done on it from the English side?

Then there is the role of the numerous urban rebellions that were waged in the southern Low Countries during the fourteenth and fifteenth centuries. The fact that there were many rebellions is well understood, but the problems they led to in the Hundred Years War have been inadequately examined. All too often, the political, military, and economic problems that faced those fighting the Hundred Years War, including not only France and England but also Burgundy, are not linked with these rebellions in the Low Countries. Nor has the rivalry of the various Low Countries principalities, or even of the towns within those principalities, been given due consideration by military historians. Yet, as one reads about the competition between the Brugeois and

⁸⁴ *Ibid.*, 170–73.

⁸⁵ Despite the importance placed on these acquisitions by English historian Richard Vaughan in his important studies.

Ghentenaars at the siege of Calais in 1436,⁸⁶ it is hard to over-estimate the importance of these regional rivalries.

*Burgundy*⁸⁷

- 1318 With the marriage of his daughter, Jeanne III, to duke Eudes IV of Burgundy (1295–1349), King Philip V of France makes peace with the Burgundians.
- 1330 The duke of Burgundy gains the counties of Burgundy and Artois when Jeanne III inherits them from her mother.
- 1349 Philip of Rouvres succeeds his grandfather, Eudes IV, as duke of Burgundy (1349–1361).
- 1361 At the death of the childless Philip of Rouvres, King Jean II of France (1350–1364) gains the duchy of Burgundy.
- 1362 At the battle of Brignais in Burgundy, the Free Companies defeat the French army.
- 1363 Philip the Bold is made the first Valois duke of Burgundy by his father, Jean II.⁸⁸
- 1369 Philip marries Margaret, the daughter of Louis of Male, count of Flanders.
- 1380 With his brothers, Louis I of Anjou and Jean, duke of Berry, Philip serves as co-regent for Charles VI (until 1388).
- 1392 When Charles VI exhibits signs of mental instability, Philip is again named regent with his brother, Jean of Berry, (until 1402 when the regency is transferred to Louis of Orléans).
- 1396 Jean the Fearless leads a crusader army to destruction at the battle of Nicopolis.⁸⁹

⁸⁶ I have investigated this more fully in “Calculating Profits and Losses during the Hundred Years War,” in *Money, Markets and Trade in Late Medieval Europe: Essays in Honour of John H. A. Munro*, ed. Lawrin Armstrong, Ivana Elbl, and Martin M. Elbl (Leiden, 2007), 187–209.

⁸⁷ Valois Burgundy is the subject of a number of good recent books. The best books to start with are: Richard Vaughan, *Valois Burgundy* (London, 1975) and Bertrand Schnerb, *L'état Bourguignon, 1363–1477* (Paris, 1999). (The Vaughan biographies will be cited separately below.) On the military history of the Burgundian dukes see Smith and DeVries, *Artillery*.

⁸⁸ Richard Vaughan, *Philip the Bold: The Formation of the Burgundian State* (London, 1962).

⁸⁹ Aziz Suryal Atiya, *The Crusade of Nicopolis* (London, 1934) is the standard history of this conflict, but a better military history is David Nicolle, *Nicopolis, 1396: The Last Crusade* (London, 1999).

- 1404 Jean the Fearless succeeds his father, Philip, as duke of Burgundy (1404–1419).⁹⁰ As he begins to dispute the regency of Louis of Orléans, the Burgundian-Armagnac civil war breaks out.
- 1405 Jean gains Paris and takes control of the throne.
- 1407 Louis of Orléans is assassinated in Paris by Jean who confesses to the murder but rationalizes it as a “tyrannicide.”⁹¹
- 1409 Jean is absolved of Louis of Orléans’ assassination by the treaty of Chartres; however, fighting between the Burgundian and Armagnac factions does not cease.
- 1411 The Burgundians defeat the Armagnacs at the battle of Saint-Cloud.
- 1412 King Henry IV of England forms an alliance with the Armagnacs by the treaty of Bourges, but this is nullified later in the year by the treaty of Auxerre temporarily making peace between the Burgundians and the Armagnacs.
- 1413 Jean is exiled from Paris during the Cabochien riots.⁹² The Armagnacs resume control over the French kingdom.
- 1414 Henry V forms an alliance with the Burgundian duke.⁹³ As a result, the Armagnacs drag Charles VI along on their campaign into Burgundian lands.
- 1415 With the treaty of Arras, Jean makes peace with the Armagnacs, but does not fight alongside them at the battle of Agincourt, even though his brothers, Duke Antoine of Brabant and Count Philip II of Nevers join the French army.
- 1416 Duke Jean meets with Henry V at Calais before the king’s return to England to raise money for further campaigning in France.
- 1418 Paris falls to Jean.

⁹⁰ See Richard Vaughan, *John the Fearless: The Growth of Burgundian Power* (London, 1966) and Bertrand Schnerb, *Jean sans Peur: Le prince meurtrier* (Paris, 2005). Many believe that Vaughan’s biography of John the Fearless is his weakest work on the four Valois dukes of Burgundy. Schnerb’s biography is a superb study and should be consulted first for military history.

⁹¹ On the French civil war between Burgundians and Armagnacs, see J. d’Avout, *La querelle des Armagnacs et des Bourguignons* (Paris, 1943). This is still of value, but has largely been supplanted by Bertrand Schnerb, *Les Armagnacs et les Bourguignons: La maudite guerre* (Paris, 1988).

⁹² There is no modern study of this important event, although A. Coville’s *Les cabochiens et l’ordonnance de 1413* (Paris, 1888) must still be considered.

⁹³ Leonard V. D. Owen, *The Connection Between England and Burgundy During the First Half of the Fifteenth Century* (Oxford, 1909) is one of the few studies that goes into the relationship of Burgundy and England between the Burgundian-Armagnac civil war and the Congress of Arras.

- 1419 Jean is assassinated on Montereau Bridge by associates of the dauphin, later Charles VII (1422–1461).⁹⁴ Jean's son, Philip the Good, inherits the duchy of Burgundy and immediately allies with Henry V.⁹⁵
- 1420 Burgundian troops participate in the capture of Montereau, Allibaudières, Sens, and Melun.
- 1421 Philip captures Saint-Riquier and Abbeville, and wins the battle of Mons-en-Vimeu.
- 1423 English and Burgundian forces defeat the French at the sieges of Le Crotoy and Landrecies and the battle of Cravant.
- 1430 The Burgundians besiege Compiègne, capturing Joan of Arc but failing to take the town.⁹⁶ Joan is sold to the English and subsequently tried and burned at Rouen.
- 1432 Philip the Good fails in the siege of Lagny-sur-Marne.
- 1433 The Burgundians capture Coursent, Mussy l'Eveque, Fortepice, Avalon, Saint-Valery-sur-Somme, and Haplincourt.
- 1434 Philip captures Belleville.
- 1435 At the congress of Arras, the Burgundians renounce the English alliance, but do not actually side with the French.⁹⁷
- 1436 Philip besieges English-held Calais but must raise the siege after only a few days.⁹⁸
- 1437 Philip purchases the duchy of Luxembourg after the death of Emperor Sigismund threatened to lead to war.
- 1456 The dauphin, later Louis XI, flees to Burgundy for safety during a conflict with his father, Charles VII.⁹⁹
- 1465 The War of the Public Weal is fought primarily between Charles the Bold, son of Philip the Good, and Louis XI.¹⁰⁰ The battle of Montlhéry

⁹⁴ John's assassination is studied in P. Cockshaw, "L'assassinat du duc Jean de Bourgogne à Montereau: Études des sources," in *Les Pays-Bas bourguignons: Histoire et institutions. Mélanges André Uytendaele*, ed. J.-M. Duvosquel, J. Nazet, and A. Vanrie (Brussels, 1996), 145–62 and the excellent Bernard Guenée, *Un meurtre, une société: L'assassinat du duc d'Orléans, 23 Novembre 1407* (Paris, 1992).

⁹⁵ Philip the Good is the subject of a number of recent biographies, including Richard Vaughan, *Philip the Good: The Apogee of Burgundy* (London, 1970); Emmanuel Bourassin, *Philippe le Bon* (Paris, 1999); and Paul Bonenfant, *Philippe le Bon, sa politique, son action* (Paris and Brussels, 1996).

⁹⁶ Smith and DeVries, *Artillery*, 101–4.

⁹⁷ The seminal work on this Congress is Jocelyne Gledhill Dickinson, *The Congress of Arras, 1435: A Study in Medieval Diplomacy* (Oxford, 1955). Anglo-Burgundian relations after the Congress of Arras is well presented in Marie-Rose Thielmans, *Bourgogne et Angleterre: relations politiques et économiques entre les Pays-Bas Bourguignonnes et l'Angleterre, 1435–1467* (Brussels, 1966).

⁹⁸ See Monique Sommé, "L'armée Bourguignonne au siège de Calais de 1436," in *Guerre et société en France, en Angleterre et en Bourgogne XIV^e–XV^e siècle*, ed. P. Contamine et al. (Lille, 1991), 197–219 and Smith and DeVries, *Artillery*, 101–10.

⁹⁹ For the War of Public Weal and other military interactions of Louis XI and Charles the Bold, see Paul Murray Kendall, *Louis XI: "... the Universal Spider..."* (London, 1974) and Jacques Heers, *Louis XI* (Paris, 2003).

¹⁰⁰ A good recent study is Jean-Marie Cauchies, *Louis XI et Charles le Hardi: De Péronne à Nancy (1468–1477): le conflit* (Brussels, 1996).

- is nominally won by Charles who follows it up with a short bombardment of Paris.¹⁰¹
- 1467 Charles becomes duke of Burgundy.¹⁰²
- 1468 The new duke marries Margaret of York, sister of the English king, Edward IV (1461–1483). Louis XI appears at the side of Charles during the siege of Liège, although he had previously allied himself with the Liégeois rebels.¹⁰³
- 1470 Edward IV undergoes an exile in Burgundy for more than a year before returning to England to regain his throne from Henry VI.
- 1471 Louis XI invades Burgundian-held Picardy, capturing Saint-Quentin, Amiens, Corbie, Roye, and Montdidier.
- 1472 Charles of Burgundy fails in his attempt to recapture Amiens and Corbie, but succeeds at Nesle, Roye, and Montdidier. He then besieges Beauvais, but an impassioned defense of their town by the Beauvaisis keep it from falling to the Burgundians.¹⁰⁴
- 1474 Charles formalizes his alliance with Edward IV with the treaty of Picquigny. The Burgundians begin the siege of Neuss.
- 1475 Louis XI takes advantage of Charles's absence at Neuss to capture Montdidier, Roye, Corbie, Jonvelle, and Jussey, while also causing damage to Saint-Riquier, Hesdin, Doullens, Arras, Bavay, Avesnes, and Valenciennes. Charles ends these attacks by signing the treaty of Soleuvre with the French king. The Burgundians invade and conquer Lorraine.¹⁰⁵
- 1476 Charles loses the battles of Grandson and Murten.

¹⁰¹ On the Burgundian army during the War of the Public Weal, see Charles Brusten, *L'armée Bourguignonne de 1465 à 1468* (Brussels, 1954). On the battle of Monthéry and the subsequent bombardment of Paris see Smith and DeVries, *Artillery*, 142–49.

¹⁰² Recent biographies of Charles the Bold include Richard Vaughan, *Charles the Bold: The Last Valois Duke of Burgundy* (London, 1973); Klaus Schelle, *Charles le Téméraire: La Bourgogne entre les lys de France et l'aigle de l'Empire* (Fayard, 1979); Werner Paravicini, *Karl der Kühne: Das Ende des Hauses Burgund* (Göttingen, 1976); and Jean-Pierre Soisson, *Charles le Téméraire* (Paris, 1999); Henri Dubois, *Charles le Téméraire* (Paris, 2004).

¹⁰³ On the relationship between Charles and Edward see Mark Ballard, “Du sang de Lancestre, je suis extrait . . . : Did Charles the Bold Remain a Loyal Lancastrian?” in *L'Angleterre et les pays Bourguignons: Relations et comparaisons (XV^e–XVI^e siècles* (Neuchâtel, 1995), 83–90, and on the marriage between Charles and Margaret of York see Patricia Robins, “Le mariage de Marguerite d'York et de Charles le Téméraire en 1468,” *Handelingen van de koninklijke kring voor oudheidkunde, letteren en kunst van Mechelen* 95 (1991): 75–96.

¹⁰⁴ A popular account of this siege is Sylvie Binet, *Jeanne Hachette: l'héroïne de Beauvais* (Paris, 1995). See also Smith and DeVries, *Artillery*, 168–71.

¹⁰⁵ See Smith and DeVries, *Artillery*, 185–88.

1477 The Burgundian duke loses the battle of Nancy where he also loses his life.¹⁰⁶ Louis XI immediately marches into Picardy, Artois, and Burgundy.¹⁰⁷

Of all non-Anglo-French entities influencing the Hundred Years War, it is the duchy of Burgundy that has received the most interest. The role of the dukes in fighting on various sides during the conflict can be easily traced through the seminal work of Richard Vaughan. Nevertheless, errors persist. For example, upon occasion, historians still roll out the old “wives’ tale” of a deal being done between Guillaume de Flavy and the English at Compiègne, an arrangement that led to the capture of Joan of Arc,¹⁰⁸ despite the fact that it was the Burgundians, and not the English, besieging the city.¹⁰⁹ Historians have also routinely failed to emphasize that Philip the Good’s renunciation of his English alliance at the Congress of Arras (1435) did not lead to any meaningful alliance with France. When the Burgundians attempted to gain Calais failed in 1436, the duke in effect took his country out of the war, never again to fight on either side. The absence of any joint effort of France and Burgundy played a significant role in prolonging the war for several decades.

Finally, there has been a curious absence in any history of the Hundred Years War of a discussion about why France seemed content to simply end the war with England in 1453. Why did the French military leadership, who had so soundly defeated the English in Normandy in 1450 and in Gascony in 1453 not try to capitalize on this by undertaking their own attack on Calais or perhaps even on England itself? Their failure to do so seems especially odd considering that the English almost immediately fell into the Wars of the Roses, further draining

¹⁰⁶ See Pierre Frédéric, *La mort de Charles le Téméraire (5 janvier 1477)* (Paris, 1966); Pierre Gérard, *La bataille de Nancy, son importance européen* (Paris, 1976); and the articles in *Cinq-centième anniversaire de la bataille de Nancy (1477): Actes du Colloque organisé par l’institut de recherche régionale en sciences sociales, humaines et économiques de l’Université de Nancy II (Nancy, 22–24 septembre 1977)* (Nancy, 1979).

¹⁰⁷ On Louis’ military reaction to Charles the Bold’s death see André Leguai, “La conquête de la Bourgogne par Louis XI,” *Annales de Bourgogne* 49 (1977): 7–12.

¹⁰⁸ Most recently by Stephen W. Richey, *Joan of Arc: The Warrior Saint* (Westport, Conn., 2003).

¹⁰⁹ See DeVries, *Joan of Arc*, 167–81 and DeVries, “Calculating Profits and Losses.” In repeating this story Richey and others completely ignore Pierre Champion’s definitive study on the siege and Flavy’s defense of the town: *Guillaume de Flavy: Capitaine de Compiègne: Contribution à l’histoire de Jeanne d’Arc et à l’étude de la vie militaire et privée au XV^e siècle* (Paris, 1906).

their strength. After all, thirty year later, Henry Tudor would conquer the kingdom with relatively few troops, certainly a much smaller number than the French could have put into the field in the 1450s. But, on the other hand, this apparent oddity can be completely understood when one notes the fact that the Burgundian threat posed by Philip the Good and, later, Charles the Bold, was so evident in the two decades following the “traditional” end of the Hundred Years War that it would have been folly to leave that danger unmet while undertaking an invasion of England. This, no doubt, is why Edward IV sought an alliance between the Yorkists and the Burgundians with the marriage of his sister, Margaret, to Charles the Bold in 1468. One might wonder what Charles thought he was getting from the match, especially as Edward ended up staying with him for a year of exile only two years later. Even after Louis XI had won the War of the Public Weal, any treaty signed between France and Burgundy could not be trusted to maintain the peace. In short, after 1453 it was the Burgundian presence that let the English off the French hook. Later, in the 1470s, it would be the Swiss, Germans, and Lorrainers who would let the French off the Burgundian hook.

Conclusion

As this article has tried to suggest, a number of questions concerning the Hundred Years War remain unanswered. Many of these center around the involvement of “other” powers in the conflict and the influence that their involvement had on the course of the war. While it may be more exciting to time and again revisit great battle such as Crécy, Poitiers, and Agincourt, the major breakthroughs of future scholarship will probably come when scholars delve into less well-known aspects of the many phases and theaters of the conflict, including those that involved participants other than France and England. The geographical and chronological framework imposed by modern historians has tended to limit our understanding of this crucial late-medieval conflict. It is time for a change!

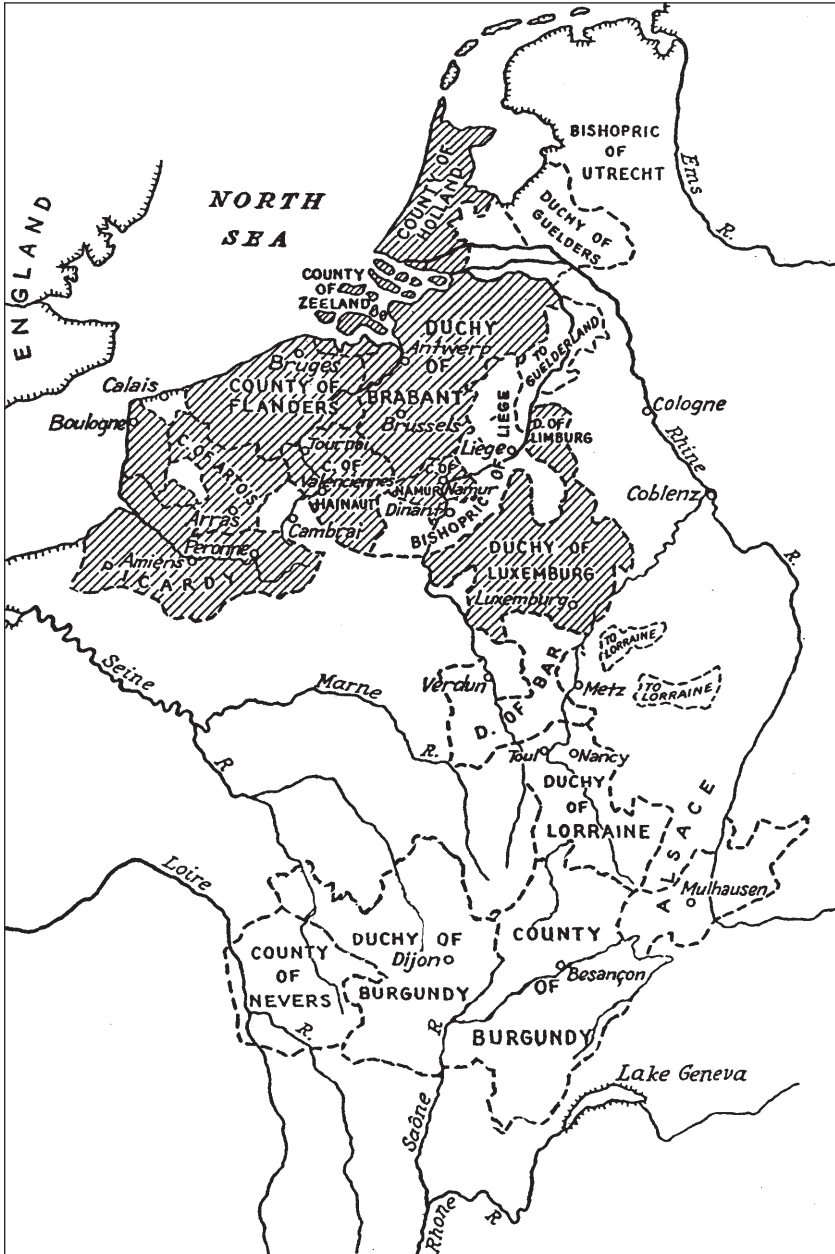

Map 4: Low Countries in the Later Middle Ages.

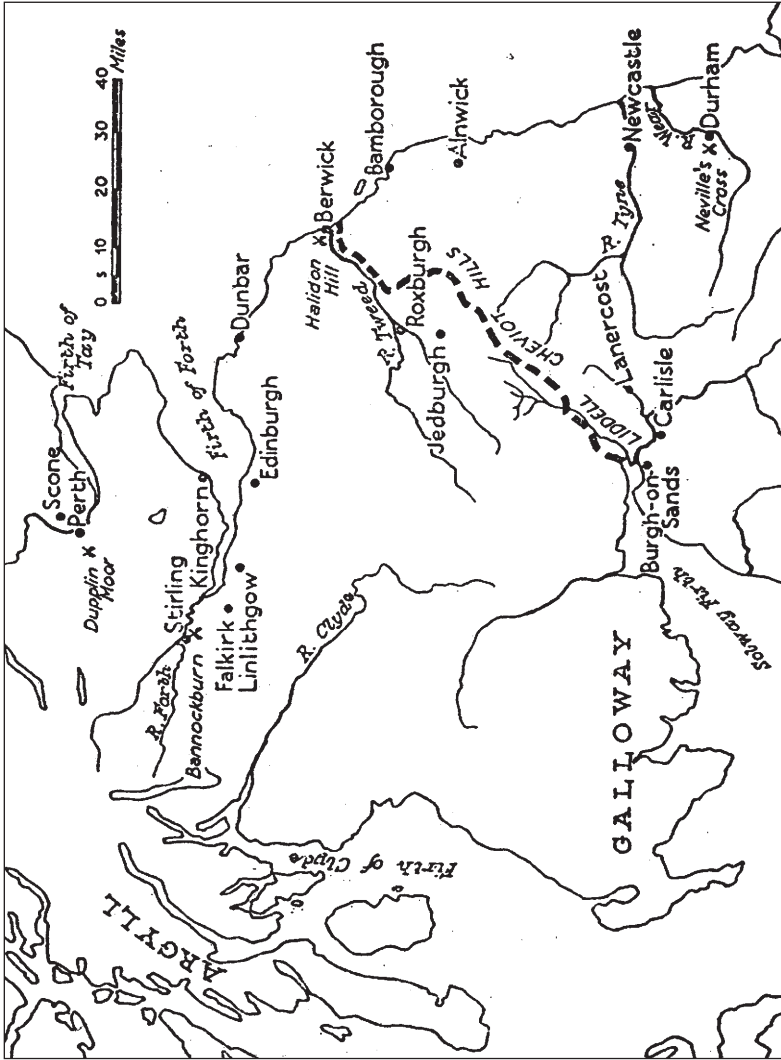

Map 5: Northern England and Scotland.

PART TWO

AGINCOURT AND ITS AFTERMATH

THE BATTLE OF AGINCOURT

Clifford J. Rogers
United States Military Academy¹

The smallest detail, taken from an actual incident in war, is more instructive to me, a soldier, than all the Thiers and Jominis in the world.

—Colonel Charles Jean-Jacques-Joseph Ardant du Picq

*Introduction*²

It may seem odd for a historian today to write an article on this topic. On the one hand, battle history is rather out of fashion; on the other hand, the one medieval battle that *has* received by far the most attention over the past few years is Agincourt, which has been the subject of three books since 2005. It might seem, therefore that there could hardly be much more worth saying on the subject. Battles, however, are important. The ability to win battles plays a major role in winning wars—even wars involving few or no general engagements, which were common in the Middle Ages³—and soldiers and rulers pay close

¹ My thanks to Anne Curry, Brent E. Hanner, Russ Mitchell, and Randall Moffett for discussions related to this article, and especially to Carroll Gillmor, Michael K. Jones, and Matthew Strickland, and an anonymous reader for their comments on drafts of this work. I must also express my gratitude to the Leverhulme Trust, as the final revisions of this article were undertaken with the support of a Leverhulme Visiting Professorship at Swansea University.

² In his 1979 *The Athenian Empire*, the distinguished historian of Ancient Greece, Russell Meiggs, included an index entry which read: “Probably, perhaps. *Passim*.” The reader should understand that the same caveat applies here. Nearly every paragraph of this article is the result of an “act of imagination” (to borrow a phrase from Kim Kagan, author of a recent book on the “face of battle” approach). I have, however, done my best to ensure that my crop of images and guesses has roots in the sources, and to signal with qualifiers the passages which required particularly high ratios of imagination to source testimony.

³ When no battle takes place, it is often because one opponent has realized that he is likely to lose an open fight, and chooses to avoid battle, even when doing so is very costly to his strategic objectives. In such circumstances, the *ability to win* a battle is a very important asset for the other side, even if the ability never is put to the test. Cf. Carl von Clausewitz, *On War*, ed. and trans. Michael Howard and Peter Paret (Princeton,

attention to them. Decisions about recruitment, training, and equipment are often strongly influenced (though not determined) by military leaders' understanding of what is needed to be able to stand up to an enemy in open battle. In turn, recruitment, training, and equipment are important to the study of a wide variety of historical topics, including governmental structures, political events, economic developments, and class identities. If we want to understand medieval warfare and its impact on society, then, we need to have some understanding of battle, and if we want to understand battle in general, we must understand particular battles with as much detail and as much analysis of cause-effect relationships as we can. Of all medieval battles, Agincourt may offer the best prospects for true understanding, since the contemporary and near-contemporary source materials for the combat itself, and for the armies which fought it, are exceptionally rich.

Agincourt has certainly been written about many times, including studies by some excellent historians. The eighty-five-year-old narrative of J. H. Wylie remains in some ways unsurpassed.⁴ John Keegan's treatment of Agincourt in his brilliant *The Face of Battle* has inspired many historians, myself included, with its very different, bottom-up approach.⁵ More recently, Jim Bradbury and Matthew Bennett have also provided well-done analyses of the action, benefitting from their broader knowledge of medieval military history and from the discovery and publication, in 1984, of a copy of the preliminary French battle plan drawn up in mid-October, 1415.⁶ Within just the past few years, Anne Curry has edited two entire volumes devoted to the subject and

1984), 1.2 (97–9) and 3.1 (181). Certainly soldiers for decades afterwards paid close attention to Agincourt; Constable Richemont, for example, would sometimes pause on journeys through Picardy to take young knights to the battlefield, to discuss the action while on the terrain, a sort of early “staff ride.” Guillaume Gruel, in *The Battle of Agincourt: Sources and Interpretations* [hereafter abbreviated *CS*], ed. and trans. Anne Curry (Woodbridge, Suffolk, 2000), 182. Since her translations are normally reliable, I have for the convenience of the reader generally cited the contemporary sources as they appear in Curry's sourcebook; where I cite the original instead, it usually because my translation of the passage in question would be a bit different, or because I want to quote the original language for the reader (e.g. where precise word-choice or phrasing is especially important or is somewhat ambiguous). Curry's collection also introduces the sources in terms of date of authorship, bias, etc.; the reader is referred to her work concerning those matters.

⁴ J. H. Wylie and W. T. Waugh, *The Reign of Henry the Fifth*, 3 vols. (Cambridge, 1914–1929).

⁵ John Keegan, *The Face of Battle* (New York, 1976).

⁶ Christopher Phillpotts, “The French Plan of Battle during the Agincourt Campaign,” *English Historical Review* [*EHR*] 99 (1984): 59–66.

authored another. Michael K. Jones and Juliet Barker have also recently provided us with well-received book-length studies of the subject, and there is a shorter but still significant study of the battle in Matthew Strickland and Robert Hardy's excellent book, *The Great Warbow*.⁷

And yet, despite all this scholarly activity, there is no fully satisfactory analytical narrative of the battle currently available. John Keegan's study was a suburb essay, but his conclusions can be challenged on many points. Many of the other modern treatments of the subject have covered the battle itself too briefly or have lacked scholarly footnotes or both. Curry, Jones, and Vale provide more detail and some *apparatus criticus*, but their notes are not full enough to fully guide the student through the rich source material and the complexities of the arguments over key points about the battle.

This would not be much of a problem if the answers to the main questions about the battle were generally agreed upon, but they are not. Philippe Contamine figures there were only around 9,000 French men-at-arms on the battlefield; Anne Curry thinks the French army was around 12,000 men in total, including around 8,000 men-at-arms; Keegan, Bennett, and Hibbert follow A. H. Burne in concluding there were 20,000–30,000 Frenchmen, “mainly” or “almost exclusively” men-at-arms.⁸ It makes a great difference to our understanding of the conflict which of these is correct. How big was the English army—16,000 men or 8–9,000? Was constable d'Albret in effective command of the French army, or was he unable to assert his authority over the royal dukes? Were there “wedges” of English archers positioned between their battalions of men-at-arms? Were the archers on the wings fortified behind a “fence”

⁷ Anne Curry, *Agincourt: A New History* (Stroud, UK, 2005); Michael K. Jones, *Agincourt 1415* (South Yorkshire, UK, 2006); Juliet Barker, *Agincourt: Henry V and the Battle that Made England* (London, 2005); Matthew Strickland and Robert Hardy, *The Great Warbow* (Stroud, UK, 2005). This article was completed in draft (except for Appendixes II and III) before the publication of any of these four last-mentioned studies, and is mostly independent of them. Where I have made any alteration to my argument in response to their works, that fact is indicated in the footnotes.

⁸ Philippe Contamine, “Crécy (1346) et Azincourt (1415): une comparaison,” in *Divers aspects du Moyen Âge en Occident, Actes du congrès tenu à Calais en Septembre 1974* (Calais, 1977), 35; Curry, *Agincourt*, 187; Alfred H. Burne, *The Agincourt War* (1956; reprint, Are, Hertfordshire, 1999), 80 (“mainly composed of men-at-arms”), 91–94; Bennett, *Agincourt*; 72; Hibbert, *Agincourt*, 99; Keegan, *Face of Battle*, 83 (“almost exclusively”); 87 (“a very large proportion”). Strickland and Hardy, *Great Warbow*, 325, says the army may have been as large as 24,000, including “perhaps as many as 14,000 men-at-arms,” but cites Burne to support that figure, and on p. 328 implies a significantly larger number of men-at-arms than 14,000.

of palings, or deployed amidst a “deep band” of scattered stakes? Were their arrows largely ineffectual against plate-armored men-at-arms, or highly lethal? Did the French dead pile up into tall mounds of corpses, or not? How, fundamentally, should we explain Henry’s victory against such overwhelming numerical odds? These questions, among others, remain open. Some of them are, certainly, points of detail, but one of the strengths of Keegan’s work was to highlight the importance of the details in explaining the broader picture.

My aim in this article is to revisit these questions, and to answer them in a fully “transparent” fashion, exposing to the reader both the precise sources and the underlying reasoning that lead me to prefer one conclusion to another.

Overview

Before proceeding, it will be useful to have in mind a general idea of the events of 1415. Recognizing that factional strife and the madness of Charles VI (1380–1422) had left France weak, the recently-crowned Henry V (1413–1422) had decided to pursue the rights he considered himself to have inherited from Edward III (1327–1377), namely either the territories and ransom owed in accordance with the treaty of Brétigny (1360) or even the French throne itself. He gathered what was for the fifteenth-century a very large army and took it across the Channel to besiege the town of Harfleur, probably a sign that from the first he envisioned a slow conquest up the Seine of the sort he would pursue in 1417–1419.⁹

Harfleur surrendered after a five-week siege on September 22, 1415. Although only about half his original field force remained fit and available for service, King Henry then chose to march for Calais. Most recent historians have concluded that this march was something of a propaganda ploy: that he intended to move through northern France so fast that there would be no danger of meeting a full-scale French army. By contrast, I have recently argued that he undertook this maneuver

⁹ His purpose here was *not* to seize a base of operations at the shortest possible distance from England; he already had that, in Calais. Cf. Keegan, *Face*, 80–81.

primarily because he hoped it would lure the French into attacking his army, giving him the opportunity for a decisive battlefield victory.¹⁰

In any case, when Henry found the Blanchetacque ford was blocked by the enemy, he turned south and marched up the Seine until he found a crossing point. By then a large French force was marching parallel to his right flank, and his army, thus prevented from foraging effectively, was growing hungry. Shortly after he crossed the Somme, he found the road to Calais blocked by another large French army which “closed the pass” between the villages of Agincourt and Tramecourt.¹¹

The next day, the English and French arrayed themselves for battle. All of Henry’s men, and the majority of the French, were on foot. Most or all of the English archers were positioned on the wings of their army, and opposite them the French stationed contingents of heavy cavalry on armored horses, who were intended to ride down the archers at the start of the combat. As a counter to this threat, the English archers implanted thick wooden stakes in the ground, with sharpened points projecting towards the breasts of their enemies’ mounts.

The English wanted to fight on the defensive, and the French did not want to oblige them, so for some hours neither side moved. Then, recognizing that his enemies could wait forever but he could not, Henry moved his line forward, within range of his longbowmen. After his men halted, reformed, and replanted the stakes, he ordered the archers to begin firing. The resulting flight of arrows convinced the French cavalry to charge over the muddy ground between the armies.¹² The horses were promptly pincushioned with arrows, and nearly all of them turned back, many completely out of control. Some of these careening horses crashed into the main French line of dismounted men-at-arms, which was then advancing, and cast it into disorder. After the French vanguard had come into contact with the English men-at-arms, and the second line had advanced to support it from the rear, the archers, many of whom were out of arrows in any case, advanced out of their defenses and made a hand-to-hand attack on the French flanks and rear, while the men-at-arms struggled front to front.

¹⁰ Clifford J. Rogers, “Henry V’s Strategy in 1415,” in *The Hundred Years War: A Wider Focus*, ed. L. J. Andrew Villalon and Donald J. Kagay (Leiden, 2005), 399–428.

¹¹ *Chronique de Ruisseauville*, in *Archives historiques et littéraires du nord de la France et du midi de la Belgique*, [ser. 1], 4 (1832): 138: *cloient le pas*.

¹² This depiction of the opening of the battle has recently been disputed, but I think it is correct. See Appendix III.

The French of the first and second lines, by this point too crammed together to fight effectively, were rapidly overwhelmed. The third line, still mounted, seemed to be preparing to join the fight when word came of an attack on the English baggage train. These twin threats led Henry to order that all prisoners be killed, and many were. Seeing this, the French drew off; the killing ended, and the battle was over.

The English Forces

Under his command at Agincourt, King Henry had about 5,000 archers and 1,000 men-at-arms.¹³ The latter were gentlemen, mostly esquires, wealthy enough to afford heavy plate armor and a well-trained war-stallion. Such men saw military service as a key element of their social *raison d'être*, and grew up learning weapons skills and absorbing a martial culture.¹⁴

By 1415, that was almost equally true of the common man in England, especially among the prosperous yeoman class from which most of Henry's archers were drawn. These soldiers were equipped much more lightly. For torso armor, they might have a mail haubergeon, a strong brigandine made with riveted metal plates between layers of leather or cloth, or a simple jack made of as many as twenty-three to

¹³ I here follow the statement of the *Gesta Henrici Quinti* [*Gesta*]; *CS*, 27 as a royal chaplain, its author was in an exceptionally good position to know the truth. For earlier translation of work, see *Gesta Henrici Quinti. The Deeds of Henry the Fifth*, trans. Frank Taylor and John S. Roskell (Oxford, 1975). Other sources vary widely; see the table in *CS*, 12. It is certainly not impossible that the figure of 7,000 to 8,000 favored by several good sources, including Walsingham and the *Chronique de Ruisseauville*, is correct; this might, however, include noncombatants, who would have included about 1,000 pages (one per man-at-arms—see Curry, in *CS*, 433) and some carters, priests, carpenters (important for crossing rivers), etc. Other sorts of camp-followers, such as sutlers and prostitutes, who would follow most armies in substantial numbers, seem in this case to have been kept to a minimum. For the size of the English army at the battle, see Appendix II.

¹⁴ Philippe Contamine, *Guerre, état et société à la fin du moyen âge. Etudes sur les armées des rois de France, 1337–1494* (Paris, 1972), 175. Contamine quotes Christine de Pizan, who, in the *Livre des faits et bonnes meurs du sage roy Charles V*, commenting on Vegetius' preference for peasants as soldiers, notes that *noblece de courage, desir d'onneur, paour du contraire fait plus en fait d'armes que ne fait peine et long travail de corps, lesquelles condicions sont plus communement es nobles que es populaires* (nobility of courage, desire for honor, and fear of the opposite, which are found more commonly among the nobles than the general populace, are more valuable in deeds of arms than are bodies hardened by long labor). Cf. also Philippe Contamine, *War in the Middle Ages*, trans. Michael C. Jones (Oxford, 1987), 156.

thirty layers of quilted fabric and leather or waxed cloth, which offered significant protection at relatively low cost¹⁵—or they might have no protection at all. Many also had light helmets of metal (*cuir-bouilli*), or iron-framed osier. Few had armor for their arms or legs.¹⁶ In hand-to-hand combat, they employed a variety of weapons: swords, axes, hatchets, and lead-tipped mauls.¹⁷

But of course their principal arm was the famous English longbow. The great length of this yew self-bow made it possible to draw long arrows (the longer the draw, the more energy stored), and the bows were so thick and stiff that they often had draw-weights of well over 100 pounds, and sometimes (it seems) as much as 180 pounds.¹⁸ Not only were these weapons astoundingly accurate in the hands of a skilled archer—under Henry VIII, a statute set 220 yards as the *minimum* allowable distance for target-shooting—they were also extremely powerful.¹⁹ Longbowmen, like men-at-arms, had to be trained from youth, developing “bodies stronger than other people’s,” and “hands

¹⁵ As early as 1369, English archers in Florentine service were to have a *panziere* (probably in this context a haubergeon, but possibly a breastplate), helmet and mail gauntlets. A 1440 English indenture specified that archers should have “good jakkis of defence [and] salades.” Contamine, *Guerre*, 279; idem, *War*, 129–30; also *A Parisian Journal, 1405–1449*, trans. Janet Shirley (Oxford, 1968), 58. For English archers in 1417 protected only by small iron helmets and “scruffy purpoints made of old bedding,” see Pierre Cochon, *Chronique normande*, ed. C. de Robillard de Beurepaire (Rouen: Société de l’histoire de Normandie, 1870), 277.

¹⁶ Waurin, in *CS*, 160.

¹⁷ The French thought that the English had provided themselves with these mallets mainly for the purpose of driving in stakes, but while they may have been used for that, that was not why they were acquired in the first place, since the stakes were only picked up in mid-march as an improvisation. Matthew Strickland, drawing on a sixteenth-century source, suggests these may have been five-foot spiked weapons similar to Flemish *goedendags*. Strickland and Hardy, *Great Warbow*, 337.

¹⁸ Mary Rose bows ranged from 130-lb to 180-lb draw weight. Analysis of one of the few extant medieval longbow war-arrows (the Westminster arrow) suggests it was designed for a bow with 130–147 lb draw weight. Robert Hardy, “The Longbow,” in *Arms, Armies, and Fortifications in the Hundred Years War*, ed. Anne Curry and Michael Hughes (Woodbridge, Suffolk, 1999), 172–73; Strickland and Hardy, *Great Warbow*, 1–20, especially 17. P. Pratt, “The Arrow,” in Robert Hardy, *Longbow: A Social and Military History* (Cambridge, 1976), 203. Editors’ note: For more on longbow technology, see David Whetham, “The English Longbow: A Revolution in Technology?,” and Russell Mitchell, “The Longbow-Crossbow Shootout at Crécy (1346): Has the ‘Rate of Fire Commonplace’ Been Overrated?” both of which appear in this volume.

¹⁹ For the figure of 220 yards, see Francis Grose, *Military Antiquities Respecting a History of the English Army* (London, 1801), 135. For 380 yards, see Gerry Embleton and John Howe, *The Medieval Soldier. 15th Century Campaign Life Recreated in Colour Photographs* (London, 1994), 66.

and arms of iron.”²⁰ A 150-pound bow could drive a heavy 60-gram arrow 320 yards, and a light target arrow 350.²¹ A broadhead arrow, of the sort that might be used against horses, would break through mail with ease, while a narrow-pointed “bodkin” shaft could be lethal even through plate armor.²²

²⁰ From youth: “men never shoot well, unless they be brought up to it”: Bishop Latimer, quoted in Strickland and Hardy, *Great Warbow*, 30; de Pizan, *Book of Deeds of Arms*, 33, and Oxford, Ms. Bodleian 824, f. 27v. For strength of bodies and arms, see Dominic Mancini’s report of the archers in the Yorkist army in 1483. Dominic Mancini, *The Usurpation of Richard the Third*, trans. C. A. J. Armstrong (1969; reprint, London, 1989), 99.

²¹ According to the calculations of Pratt, “Arrow,” 203. The same author figures that a 100-lb bow could fire arrows of 24, 40 and 60 grams to a range of 300, 255, and 230 yards, respectively. These last two figures are good matches for the ranges achieved by Mark Stretton with even heavier arrows of 50 and 100 grams: respectively, 250 and 225 yards. <http://www.primitivearcher.com/articles/warbow.html>; note also Mark Stretton, “Medieval Arrow Heads. Practical Tests, Part 1,” *The Glade* 107 (2005): 23. Likewise, Simon Stanley can attain a range of 340 yards with a 42 gram arrow from a 145-pound bow. Roy King, “Rambling on the Longbow—The Other Archery,” *Instinctive Archer Magazine* (Spring 1996): 10–12 and online at <http://www.tradgang.com/ia/1996spring/p10.jpg>, [~p11.jpg](http://www.tradgang.com/ia/1996spring/p11.jpg), and [~p12.jpg](http://www.tradgang.com/ia/1996spring/p12.jpg); with similar results noted in Anna B. Crowley, “Appendix,” in Strickland and Hardy, *Great Warbow*, 409 (arrow 1), and Hardy, *Longbow*, 53 (a skilled archer using a 116-lb bow “in the presence of witnesses consistently shot arrows to 350 yards.” In the sixteenth century, Sir John Smythe stated that many archers could shoot 333 yards or more. *Certain Discourses Militarie* (London, 1590), 14v (margin).

²² Penetration of armor is testified to in the sources for Agincourt, both indirectly (all the killing and wounding implies it) and explicitly: Monstrelet, in *CS*, 160; the French “began to bow their heads so that the arrow fire would not penetrate the visors of their helmets”; *Gesta*, in *CS*, 36: “the missiles which by their very force pierced the sides and visors of their helmets” (and see also Elmham, in *CS*, 47). Froissart also bears witness that this was possible, describing how at the siege of Pontevedra in 1386 (when, as at the time of Agincourt, armor of steel rather than iron was commonly being made, though not universally in use) the bailiff of the town was struck by an English arrow *qui luy percha le bascinet et la teste aussi* (“which pierced his bascinet and his head also.”) Froissart, *Oeuvres*, 11:412. The same sorts of results are described against high-quality early-fifteenth-century plate armor in Walsingham’s narrative of Homildon Hill. When the earl of Douglas, “evidently placing trust in his armor and that of his companions, which for three years they had taken pains to improve . . . strove to rush the archers,” the bowmen “pierced entirely through these armored men [*armatos omnino penetrarent*], drilling through their helmets [*cassides terebrarent*] . . . and piercing through all their armor with ease [*et omnem armaturam levi negotio transverberarent*]. The earl of Douglas was pierced [*confossus est*] with five wounds, notwithstanding his extremely costly [*sumptuosissima*] armor.” Thomas Walsingham, *Historia Anglicana*, ed. H. T. Riley, 2 vols. (London, 1864), 2:251–52. My attention was drawn to this passage by Strickland and Hardy, *Great Warbow*, 263, 315. On the results and implications of modern tests for the question of the efficacy of the longbow vs. plate armor, see Appendix I. For “well-steeled” arrows already much earlier, see *Calendar of Patent Rolls, 1358–61*, 323, and Pratt, “Arrow,” 201. On the lethality of arrows vs. mail, see Clifford J. Rogers, “The Efficacy of the Medieval Longbow: A Reply to Kelly DeVries,” *War in History* 5

Most of the English bowmen were mounted archers—meaning that they had provided themselves with cheap riding horses, though they invariably fought on foot, attached to the retinues of the men-at-arms.²³ There were also, however, a significant number of foot archers, many of whom had been raised by commissions of array in the countryside. Some, and probably all, of the latter were organized in companies of 50, rather than 20 and 100, as had been the norm in Edward III's day.²⁴ A similar arrangement may have been made for the retinue archers, but probably not; there was not much need for it, since the archers do not seem ever to have acted in discrete tactical units, and for administrative purposes on the march they would have fallen under the authority of the men-at-arms to whom they were attached.

The English Formation

There are basically two reasonable ways of envisioning the English deployment at Agincourt. [See Appendix I, Figures 1 and 2] The difference between these two formations is a small one—consisting of the little wedges of archers which may or may not have been positioned between the three “battles” into which the English men-at-arms were

(1998): 233–42; Russell Mitchell, “Archery *versus* Mail: Experimental Archaeology and the Value of Historical Context,” *Journal of Medieval Military History* 4 (2006): 18–28. As reported in the last-cited article, after tests with Hungarian bows of under 70 pounds draw weight, used against a 16-gauge mild steel riveted mail shirt, the experimenters “were left wondering what possible use mail could have served against archery”: “two of the five hits penetrated through *both* sides of the mail shirt and its leather padding, and partially exited the back of the target” (emphasis added). In another similar set of tests, a bodkin arrow was loosed from a 75 lb yew longbow at 7 yards against a shirt of antique eastern mail (22 gauge, welded) hung over a burlap-wrapped pine box. The arrow penetrated the mail, penetrated the front board, carried on through the void, pierced the back board, and hit (but did not penetrate) the back of the hauberk. Saxton T. Pope, “A Study of Bows and Arrows,” *University of California Publications in American Archaeology and Ethnology* 13, no. 6 (1923): 369. Note also the confirming results of Stephen Grancsay, “Just how Good was Armor?,” *True* (April, 1954): 89, and Stretton (“Arrowheads, part 1,” photograph 12, with the accompanying text.), and Clive Bartlett and Gerry Embleton, “The Medieval Footsoldier, 1460–85: Body Protection and Campaign Service,” *Military Illustrated*, 12 (1988): 44.

²³ Curry in *CS*, 423. The proportion of horse archers after detachments for garrisoning Harfleur would doubtless have been substantially higher than the proportion of horse archers in the initial invasion force, since it would only be sensible to leave unmounted men in garrison and take riders for a mobile campaign.

²⁴ See *CS*, 422; note that the other contingents are mostly at or near multiples of 50.

divided. We can be fairly sure that if these wedges did exist, they were not large—i.e., the deployment was not something like that which appears in Figure 3—for the same basic reasons we may doubt whether they were present at all: the great majority of the sources speak only of two wings of archers, in front of and flanking the men-at-arms.²⁵ Moreover, the men-at-arms in the center were divided into three battles, but these three were so “nearly joined” that from the perspective of the French they seemed to be a single formation.²⁶ And, as Jim Bradbury

²⁵ Enguerran Monstrelet, Jean Waurin, and Jean Le Fèvre [MWF] in *CS*, 423; *Chronique anonyme du règne de Charles VI in La chronique d'Enguerran de Monstrelet: en deux livres avec pièces justificatives, 1400–1444*, ed. L. Douët-d'Arcq, 6 vols (Paris, 1857–62), 6:229: “The English [archers] were in two woodlets [*bosquès*; given as *basquès* by Curry] and the French main battle (*bataille*) was between them with the intention of meeting the main battle of the king of England which was higher up than [i.e. beyond] his archers”; Tito Livio Frulovisi, *Vita Henrici Quinti* in *CS*, 56, 59–60: “the king drew up three battles (*acies*) and two wings (*alas*) according to the custom of the English”; see also *Ibid.*, 59–60; *Brut* variation, in *CS*, 95: “the king arranged his main force (*battle*) and his wings”; Wauquelin’s contemporary translation of Edmond de Dynter, *Chronique des ducs de Brabant*, in *CS*, 173–74: “he put his archers, in excellent order, in front on the wings.” Note also Thomas Walsingham, *St. Albans Chronicle*, in *CS*, 52: Henry “made the archers go first from the right and also from the left.” Note also that the purpose of the French cavalry strike forces is given by the sources equally as either to attack the English archers or to attack the English wings, suggesting that the two are synonymous. Archers: Monk of St. Denis, *Histoire de Charles VI*, in *CS*, 106; Dynter, in *CS*, 173, 174; *Chronique de Ruisseauville*, in *CS*, 125; Walsingham, in *CS*, 52. Wings: Gruel, *Chronique*, in *CS*, 184 (and cf. Walsingham in *CS*, 52, and other sources that have the French cavalry stationed on the flanks). *MWF* assert that the French mounted men at arms were “ordered to make a wing to attack the English on the flank[s]” in order “to break the English shooters (*pour rompre le traict des Anglois*).” In *CS*, 156; Le Fèvre, *Chronique*, 248. For wings of archers, see Gruel, *Chronique*, in *CS*, 184.

²⁶ For the perception that the English were “nearly joined,” see Tito Livio, in *CS*, 59. For the claim that the English appeared to be a single battle formation: see *Gesta*, ed. Taylor and Roskell, 82 (*bellum unum*), 90. All this makes it impossible to accept the argument Robert Hardy has recently made in *The Great Warbow* (306–11) for a formation in which the three battles of men-at-arms are separated by bodies of archers with frontages comparable to their own. His case against the idea that the vast majority of the archers were deployed to the wings rests heavily on calculations of frontages that are marred by two problems. First, he figures the English men-at-arms would each have held a frontage of two yards, i.e. stood in open order. That is highly unlikely: cf. Clifford J. Rogers, *Soldiers’ Lives through History: The Middle Ages* (Westport, Conn., 2007), 162–64, and *idem*, “The Offensive/Defensive In Medieval Strategy,” in *From Crécy to Mohács: Warfare in the Late Middle Ages (1346–1526)*. *Acta of the XXIInd Colloquium of the International Commission of Military History* (Vienna, 1997), 159–60. Second, he seems to believe that the width of the English fighting line (i.e. the gap between the Agincourt and Tramecourt woodlines) was around 1000 yards, rather than 700 yards.

has strongly argued, the normal practice of the English throughout the late Middle Ages was to deploy all their archers in two wings.²⁷

All of this would lead me to follow Jim Bradbury and Matthew Bennett in simply throwing out the idea of the intermediate archer wedges, were it not for the fact that the one source which strongly indicates their existence happens to be one of the best, if not the best: the anonymous chaplain's *Gesta Henrici Quinti*. This text states that Henry "positioned 'wedges' [or 'troops'] of his archers in between each 'battle.'" ²⁸ Furthermore, the text describes the French men-at-arms of the vanguard as splitting into three columns when they came near to the English main line, possibly out of "fear of the missiles which by their very force pierced the sides and visors of their helmets."²⁹ As we shall see below, this would most naturally occur if there were indeed wedges of archers intermixed with Henry's men-at-arms. Finally, there is significant support for the proposition that most, but not all, of the archers at Agincourt were positioned on the wings in Monstrelet's description of the English deployment for Verneuil, which would naturally have emulated the successful arrangements of Agincourt. At Verneuil, says Monstrelet,

the archers were deployed in line in front [*ou front devant*—almost the same phrase he uses for their deployment at Agincourt], each one having a stake in front of him, sharpened and stuck in the ground. And *the largest*

²⁷ Bradbury, *Medieval Archer*, 88–158, the traditional understanding of Froissart's *herces* notwithstanding. For what it is worth, the earliest use of "herse" for a military formation that I know of in an English text (not counting Berners' translation of Froissart)—one not noted in the OED—is in Digges' *Stratiticos* where it seems to be used almost synonymously with "bataille" and "sleeve." Leonard and Thomas Digges, *An Arithmetical Warlike Treatise Named Stratiticos* (London, 1579), 106.

²⁸ *Gesta*, in *CS*, 34; the word *cuneus* literally means "wedge," but in Medieval Latin was often used simply to mean a body of troops; the *Gesta* uses the same word, for example, for bodies of French cavalry. (*Gesta*, trans. Taylor and Roskell, 80, 82); likewise in Hardyng's Latin chronicle [in *CS*, 84] and *Vita et Gesta Henrici Quinti*, in *CS*, 71. Walsingham uses it for "army." [*CS*, 51.] The translation of the *Gesta* seems to reinforce the depiction of archers stationed elsewhere than on the flanks when it describes the French cavalry charge as directed against "*those of our archers who were on both sides of our army.*" But the Latin could easily be read as "against our archers, on [or from] both sides of our army": *Gallorum equites ordinati a lateribus irrupciones fecerunt in sagittarios nostros ex utraque parte exercitus nostri.* *Gesta*, trans. Taylor and Roskell, 86.

²⁹ *Gesta*, in *CS*, 36. Again, this is consistent with what the text says later about three mounds of bodies. It is possible, though not probable, that the St. Denis chronicler had something like Figure 2 in mind when he said the archers surrounded the English like a crown; one could see Figure 2 as a crown in profile, with the wings and the two small wedges as the fleurons projecting from the circlet (the men-at-arms). See note 40.

forces of the archers were deployed alongside (*vers*) the two ends of the battle [of men-at-arms] in the fashion of wings.³⁰

Major treatments of the battle divide on this issue. Charles Oman, A. H. Burne, Christopher Hibbert, and John Keegan, like most earlier writers, accepted the *Gesta's* testimony, while the two most recent analyses, those of Jim Bradbury and Matthew Bennett, disagree, placing the archers only on the wings. It is impossible to say with certainty which is correct, but the main reasons for rejecting the intermediate wedges are really only strong arguments against fairly large wedges, and would not apply to small ones like those depicted in Figure 2. Hence, considering the strong testimony of the *Gesta* and preferring explicit positive statements to implied negatives, it seems to me most likely that there were two little troops of archers, deployed in wedges, between the battles of men-at-arms.

That, however, raises the question of why they were there. Similar arrangements have been proposed for the battle of Crécy based on the idea that if all the archers had been on the wings, they would not have been able to reach the center of the front with their arrows,³¹ but that would not have been a problem on the narrower field at Agincourt. It also seems likely that Henry would have expected these small troops of archers to form weak points in the line, rather than (as the event arguably showed) strong ones.³² So again, this calls for an explanation of their presence.

Certain largely unnoticed phrases in some of the sources, along with military common sense, suggest a possible though highly speculative answer. Many sources describe the English archers at Agincourt (and other battles) as deployed “in line in front.” A variety of sources make it very clear that [as depicted in Figures 1–3] the wings of archers were positioned forward of the men-at-arms, angled so as to provide

³⁰ Monstrelet, *Chronique*, 4:193: *Et furent mis les archers ou front devant, ayant chacun ung penchon [sic] devant eulx aguisé et fiché en terre. Et estoient les plus grans foucz (forces?) [sic] desdiz archers vers les deux bous de la bataille en manière de heles.* “Foucz” (literally “flocks [of sheep],” e.g. in Bibliothèque de l’Agglomération de St. Omer, Ms.707, f. 219.

³¹ Hardy, “Longbow,” in *Arms*, ed. Curry and Hughes, 174–180; the same logic, with less justification, is also applied to Agincourt.

³² If Henry had not presumed that men-at-arms could pose stronger resistance to the French advance than could his archers, why would he have put the heavy troops in the front line at all? Also, note the *Gesta's* description of the battles of men-at-arms as “the three places where the strong contingents guarding our standards were (*tribus locis ubi erat fortitudo et acies vexillorum nostrorum*).” *Gesta*, trans. Taylor and Roskell, 90–91; cf. 88.

interlocking fields of enfilading fire in front of the English position. The *au froncq devant* phrase is usually taken to mean just that.³³

However, the *Chronique de Ruisseauville* gives a fairly clear description of English archers acting as skirmishers, advancing out towards the French vanguard and firing on the run.³⁴ Also, the St. Denis chronicle describes Henry deploying his archers “surrounding” the men-at-arms “in the form of a crown, in order to hinder any sudden movements of the enemy” and mentions light-armed troops (i.e. archers) “who went in front of the battle [*aciem*], as customary.”³⁵ Thus, there may well have been some archers initially deployed in line directly in front of the English men-at-arms and possibly also in front of the arrayed wings of archers.³⁶

The value of archers acting as skirmishers directly in front of the French vanguard during its slow advance is easy to see. Once the French cavalry had left the scene, the bowmen could have positioned themselves just twenty or thirty yards in front of the advancing knights and esquires, fired a volley point-blank into the faces of the enemy’s leading rank, and then run back another twenty yards to repeat the process.³⁷ Under such circumstances, arrows could not fail to find a target and would have had an excellent chance to penetrate armor. Bowmen operating in this fashion would have been under some danger from “friendly fire” falling short, but would have faced little threat from

³³ Le Fèvre/Waurin, in *CS*, 159.

³⁴ *Chronique de Ruisseauville*, in *CS*, 125: “The English began to bray and to cry out and to shout three times whilst coming up against our men, the French. They came very quickly, the archers in front running without armour and with their breeches hanging down, always firing on the French, and our men of France advanced in fine fashion and without rushing.” The running advance “always firing on the French” would not refer only to advance of the English line into its second position, because that advance was *into* firing range. For an evocative sixteenth-century print showing, in the background, a cloud of Scottish and Irish archers dispersed for skirmishing in advance of a regular pike-and-shot formation, and some of them clearly running while drawing their bows, see Geoffrey Parker, *The Military Revolution: Military Innovation and the Rise of the West, 1500–1800* (Cambridge, 1988), 50.

³⁵ *Chronique d’un religieux de Saint Denis*, ed. L. Bellaguet, 6 vols. (Paris, 1844), 5:554–56: *Ad instar quoque corone duodecim milia sagittariorum quos habetis vos ambient, ad reprimendum hostiles motus subitos qui supervenire poterunt; levis armature viri de more aciem precedentes.*

³⁶ Matthew Bennett’s suggestion along these lines has been accepted by Strickland and Hardy (*Great Warbow*, 327–28).

³⁷ In the sixteenth century, skirmishing English archers sometimes came as close as “four or five pikes’ lengths” to fire against advancing French men-at-arms afoot. Blaise de Monluc, *Commentaires et Lettres de Blaise de Monluc, Maréchal de France* ed. Alphonse de Ruble, 5 vols. (Paris, 1864), 1:301. For English archers keeping up deadly fire while retreating, at Homildon Hill in 1402, see Strickland and Hardy, *Great Warbow*, 315.

the enemy footmen, who could not even try to reach them without breaking formation, and who could hardly have caught an unarmored archer with a twenty yard head-start anyway—even if they survived the concentrated sheets of arrow-fire that would doubtless have been directed at any individuals making the attempt.

Henry might well not have wanted to send men far out into the open ground between the opposing lines *before* the French cavalry had been dealt with, as such skirmishers would have been in great jeopardy from a mounted attack. However, he could have gained at least some of the same advantages simply by arraying a line of archers immediately in front of his men-at-arms, as depicted in one fifteenth-century manuscript illumination.³⁸ Once the dismounted element of the French army came even with the tips of the archer wings, skirmishing bowmen could come out to meet them with little fear of the French cavalry. These archers could have added direct fire to the enfilading fire of the archers on the flanks, and would have been especially effective as the French advanced, say, from 120 to 60 yards out from the English formation. At that latter point, the skirmishers could have run to staked-out wedge-shaped enclosures between the battles of men-at-arms, or over to the flanks; none would have had to go more than about 60 yards to reach his new position.³⁹ Some might also have been intended to move back into line behind the men-at-arms, to fire over their heads at deep targets (such as the French second line, or even, with steep indirect fire, at the back of the vanguard) and also to allow for some sort of response if the French were at any point able to break through the perilously thin line of English men-at-arms.⁴⁰ If some such plan had been in place, the natural thing to do once the French cavalry had been disposed of would have been for these front-line archers (along with some of the men from the wings) to run forward and act as skirmishers in the way already described. Such a deployment would utilize only 250 or so archers out of 5,000, so it would represent only a minor change to the basic picture of Figure 1.

³⁸ Bradbury, *Medieval Archer*, 102.

³⁹ I.e. the hypotenuse of a 40-yard by 40-yard triangle; 40 yards out because 60 (to the French)—20 (head\start); 40 yards across from the center to the edge of an 80-yard “battle.” If 80 archers (i.e. those originally stationed in front of the forty files to the left and right of the enclosure) formed into a wedge, it would have been 17 men wide at the base, nine deep at the apex.

⁴⁰ The French, according to *Gesta*, in *CS*, 35, deployed some of their crossbowmen behind their men-at-arms, from where they fired a single volley at the English. Digges, writing in the next century, recommends something along these lines. Note also Saint-Denis’ idea of the archers in a circle around the men-at-arms. See note 29.

In any case, we know that the English men-at-arms were deployed in a tight formation four men deep; they would therefore have occupied a rectangle about 250 yards long by 4 yards deep.⁴¹ When this is drawn *to scale* on a map of the battlefield (as is almost never done), it strongly highlights how thin the English line was, and how fragile it must have appeared to everyone on the field.

Many of the previously published maps and diagrams of the battle have been highly misleading in their depictions of the archers' formations. It is important to remember that the archers were five times as numerous as the men-at-arms, and probably occupied about ten times as much physical space, since they had to be deployed in greater depth in order to ply their bows. Yet their units are almost always shown as being no more than approximately twice the size of the formation containing the men-at-arms. Also, their wings were not in parallel with

⁴¹ The figure of four deep comes from Tito Livio, in *CS*, 59–60. For the typical depths of three or four ranks, see Clifford J. Rogers, *War Cruel and Sharp: English Strategy under Edward III, 1327–1360* (Woodbridge, Suffolk, 2000), 266–67. The English men-at-arms were using long lances like pikes, so they would have been deployed with very little space between ranks, allowing the lance-points of the rear rank to contribute to the defense of the front line. For the frontage, I have allowed each man-at-arms 3' (like a Roman legionnaire, according to Vegetius), rather than the mere 30" allowed to pikemen by Digges, since men-at-arms were more likely to use swords, axes, and other swinging weapons than were early modern pikemen. At 30" per man, the frontage would only be 208 yards. Digges, *Stratiotocos*, diagram following f. Aiiiv ("the Bataille in Portraiture"). Thirty-six inches per man is still quite a dense formation; Diego García de Palacio in 1583 allowed fully five feet of frontage per man for Spanish soldiers: *Diálogos Militares*, ed. Laura Manzano Baeno (Madrid, 2003), 226 (Libro 4, Pregunta III). My thanks to Enrique García Hernán for sending me a copy of that work. Such relatively loose formations were normal in the seventeenth century also. See David Parrott, "Strategy and Tactics in the Thirty Years' War: The 'Military Revolution'," in *The Military Revolution Debate*, ed. Clifford J. Rogers (Boulder, Colo., 1995), 231–32. For visual images of dense arrays of dismounted men-at-arms, see the illumination in Bradbury, *Medieval Archer*, 102; *Medieval Warfare*, ed. Maurice Keen (Oxford, 1999), 145; Hibbert, *Agincourt*, plates 17, 20; the cover of *Guerre et société en France, en Angleterre et en Bourgogne XIV^e–XV^e siècle*, ed. Philippe Contamine et al. (Lille, 1991); Michael Prestwich, *Armies and Warfare in the Middle Ages* (New Haven, Conn., 1996), 163. Note the French king holding a sword as if it were a spear-shaft, because there is no room to do more than jab. In the fifteenth century this became a commonly used technique, leading to the forging of swords with a non-edged *ricasso* forward of the hilt. See also the images reproduced in Contamine, *Guerre, état, et société*, plates 16 and 18 facing p. 659. Although very small, the image of the massed infantry formation visible top-center in the roughly contemporary illumination reproduced in Gutierre Diaz de Gamez, *The Unconquered Knight. A Chronicle of the Deeds of Don Pero Niño, Count of Buelna*, trans. J. Evans (London, 1928), facing 106, is also very evocative. As Matthew Strickland told me, a great deal of artistic license must be allowed in viewing these images. The point, however, is that the artists were clearly attempting to convey a sense of men in very tight array. What is more, I cannot recall ever having seen a fifteenth-century illumination of soldiers in array which would convey the impression of a relatively open formation of the sort indicated by García de Palacio.

the men-at-arms, but angled forward quite substantially, so that—as Geoffrey le Baker said of the similar formation at Crécy—“they did not impede the men-at-arms, nor did they attack the enemies head-on, but shot arrows like thunderbolts into their flanks.”⁴²

This angle, of course, means that the frontage occupied by the archers had to be significantly longer than if they had been in line with the men-at-arms; the greater the angle, the longer the hypotenuse. If we knew the angle, we could calculate the length, and vice-versa. It is gratifying to find that we come to precisely the same result approaching the problem from either direction. If we begin with the known number of archers, assume that each required a frontage of 3', and guess that they were deployed in seven ranks, we can calculate a frontage of 357 yards for each wing. On the other hand, one may start from the map—meaning the superb survey of the battlefield prepared by Sir John Woodford in 1818,⁴³ which has not heretofore been much used by any of the main studies of the engagement. If we assume that the archers would have initially been emplaced at an angle that would have enabled those on the right to use the road segment coming into Tramecourt from the south-west as a part of their defense, then again we reach nearly the exact same conclusion.⁴⁴ [See Map 6.]

⁴² Geoffrey le Baker, *Chronicon*, ed. E. M. Thompson (Oxford, 1889), 83–84. On the English formation at Crécy, see Rogers, *War Cruel and Sharp*, 42 (n. 92); probably also at Poitiers (see maps *Ibid.*, 274–75, drawn based on that assumption). For archaeological evidence of what this meant in the circumstances of the battle of Aljubarrota—where the archers seem to have been at about a 45-degree angle to the men-at-arms—see Afonso do Paço, “The Battle of Aljubarrota,” *Antiquity* 37 (1963): 267. Hence their ability to fire into the flanks of the advancing French center (*Gesta*, in *CS*, 36; Juvenal des Ursins, in *CS*, 130), and then later attack with hand weapons “striking from the right and the left” (Waurin in *CS*, 162) against the formations of dismounted men-at-arms “between” the wings of the archers (*Chronique anonyme* in *CS*, 115). Note also Elmham, *Liber Metricus* (ed. Cole), 122: *Quorum [the French] sunt latera nostris penetrata sagittis/Fronsque per armatos hostica trita fuit*. And the *Chronique anonyme* (ed. Douët-d'Arcq), 229: “The English began to fire on the French. The English [who were firing] were in two woodlets and the French main battle was *between them* [*estoit entredeux*] with the intention of meeting the main battle of the king of England.” (Emphasis added.)

⁴³ British Library, Add. Ms. 16368, map C; printed in *CS*, 362–63 (fig. 2).

⁴⁴ This would also be quite a good match for the angle apparently employed at Aljubarrota (and revealed by modern archaeology). See above note 42. A recent visit to the battlefield and discussion of the terrain there with Major Christian Teutsch and Cadets Joshua Dulaney, Tyler Martin, Brandon Schmidt, Alessandra Braun, Marie Hokenson, Ian Lenny, Karl Schoch, and Marc Triller made it clear that the archers could not have been positioned on the road itself, because it drops off from the level of the central battlefield in a way that would have made bowmen standing on it unable to see their targets. There is, however, high ground a short distance south of the road that would be perfectly suitable.

The Archers' Palisade

The various accounts of the battle make it clear that the English archers, after taking up their initial position and again after marching to within firing range of the French lines, formed some sort of defense using six-foot wooden stakes that they had been carrying with them for several days, for just such a purpose.⁴⁵ The stakes, sharp at both ends, and thick enough to be used as clubs,⁴⁶ were driven into the soft, wet soil, angled so that their points extended toward the French lines at the height of a horse's breast or belly, so that the animals would be impaled if they ran onto them. The stakes were rough-cut along the march,⁴⁷ and probably fire-hardened at the points.⁴⁸ It is likely that the men preparing them left the stubs of some projecting branches intact, as impact points for mallet-blows, so that the stakes could be driven in without the need to re-sharpen the points.⁴⁹ Or perhaps the stakes were simply thrust into the soft ground without hammering.

It is natural to envision these stakes set up like the palings of a stockade but slanting forward. The primary sources generally support that picture of the English defenses, though the *Gesta* makes it clear that some of the stakes were also positioned farther back among the archers, to pose a hazard to any horseman who might manage to leap over or push through the palings placed in "front of them in line abreast."⁵⁰ Waurin describes the stakes as being used to form a "hedge or fence (*une haye*) in front of the archers," clearly indicating a basically linear barrier defense.⁵¹ The early ballad, *The Battle of Agincourt*, describes the

⁴⁵ *Gesta*, in *CS*, 30.

⁴⁶ *Ibid.*, 36; *Brut*, in *CS*, 92.

⁴⁷ In later campaigns, standardized stakes were provided: in one case they are reported as 11' long; in another, as tipped with iron. Grose, *Military Antiquities*, 143; *Journal d'un bourgeois de Paris sous Charles VI et Charles VII, 1405-1449*, ed. Alexandre Tuetey (Paris, 1881), with preface and notes by André Mary (Paris, 1929), 231 which details the battle of the Herrings.

⁴⁸ Describing an episode of 1441, Waurin portrays some Englishmen as fortifying themselves with *peuchons aguisies a deux boutz et bruslez selon leur maniere acoustumee de faire*. Jean de Waurin, *Recueil des Croniques et anciennes istories de la Grant Bretagne, a present nomme Engleterre*, 5 vols. (London: 1864-1891), 3:330.

⁴⁹ Cf. Keegan, *Face*, 90.

⁵⁰ *Gesta* in *CS*, 30. This describes a preliminary order for their use, but the same source (*Ibid.*, 34) specifies that on the day of the battle the stakes were employed "as previously arranged."

⁵¹ Waurin, *Recueil*, 211: *avoit chascun archier Anglois ung peuchon aguisie a deux boutz, dont ilz faisoient une haye devant eulz et sen fortiffoient*. "Haie" in French is most often "hedge" or "hedgerow," but can also mean "fence," especially in a military context (Larousse

stakes as “before” the archers.⁵² Tito Livio Frulovisi describes the palings being set up “as a shield” against the French cavalry.⁵³

John Keegan, however, argues against this understanding of the employment of the stakes:

If they hammered their stakes to form a single row, it supposes them standing for some time on the wrong side of it with their backs to the enemy. Is it not more probable that each drove his in where he stood, so forming a kind of thicket, too dangerous for horses to penetrate but roomy enough for the defenders to move about within. . . . If the 5,000 archers, on the remaining 700 yards, planted their stakes side by side, they would have formed a fence at five-inch intervals. That obstacle would have been impenetrable to the French—but also to the English archers.⁵⁴

Keegan adds to this textual analysis in an asterisked footnote:

Indeed, they could not have got back *behind* it after they had driven their stakes in]; and *their* freedom of movement was, as we shall see, latterly an essential element in the winning of the battle. If we want to picture the formation the archers adopted, therefore, it would be most realistic to think of them standing a yard apart, in six or seven rows, with a yard between them, also disposed checkerboard fashion so that the men could see and shoot more easily over the heads of those in front: the whole forming a loose belt some twenty or thirty feet deep, with the stakes standing obliquely among them.⁵⁵

This use of deductive reasoning to test the words of the primary sources is typical of Keegan’s approach in *The Face of Battle*; the technique, which is essentially the old Delbrückian method of *Sachkritik*, can be a valid and important method of historical analysis. It is especially useful as a way of determining which of two conflicting primary sources of

has among the definitions: “MILIT. Fence [clôture]”; note also: “FIG. Line, row [de personnes].”) Furthermore “*se ranger en haie*” means for troops “to form line.”

⁵² *CS*, 296.

⁵³ Tito Livio in *CS*, 61. This clearly implies a barrier interposed between the archers and the enemy. The idea may have been borrowed from the Flemings, who at Beverhoutsveld in 1382 arrayed their *batailles* behind a line of wheelbarrow-like *ribaudiaux* which, along with small cannon, incorporated long iron spikes [*picos*] projecting forward. Jean Froissart, *Oeuvres*, ed. Kervyn de Lettenhove, 25 vols. (Brussels, 1870–77), 10:28–29. Likewise the Turks at Nicopolis had a barrier of stakes in front of their infantry. *Le livre des faits du bon messire Jehan le Maingre, dit Bouciquaut*, ed. Denis Lalande (Paris, 1985), 105.

⁵⁴ Keegan, *Face*, 90–91. Keegan’s calculations, incidentally, are not correct; the depth of a formation composed of 6–7 double ranks would be 12–14 yards, not 20–30 feet.

⁵⁵ *Ibid.*

comparable authority should be accepted. It can also, in some cases, be used to discard the testimony of a primary source even in the absence of another contradictory source. In those cases, however, the logical argument must be very strong. Even though his reasoning has often been accepted by later writers, Keegan's argument concerning the stakes at Agincourt does not meet that standard.

Again, Keegan's basic objection to the idea of a fence is that it would have been (in Matthew Bennett's words) "too inflexible a barrier": the men who put up the stakes would have been trapped on the wrong side of the palisade when they were done working, and, even if they managed to solve that problem, they would not have been able, later in the battle, to freely move out to attack the flanks of the French columns in the way they did. When carefully considered, however, this argument has no real validity. Even if there were any sources that specifically said there was no fence—and there are no such sources—Keegan's reasoning would still not be strong enough to justify preferring those sources to the ones that indicate the stakes were indeed mostly lined up in a sort of stockade in front of the archers' lines. His logic certainly fails to provide sufficient grounds to reach a conclusion that none of the primary sources really supports, and some, as we have already seen, tend to contradict. The archers could easily have solved the problem of creating a stockade that would still enable them to pass behind it after they had driven in their stakes. One way would be to stagger the line of stakes every few yards, or even every, say, 50 yards, up or back by a couple of feet. [See Figure 4.]

The bowmen would then easily be able to side-step behind the palisade after it was finished. In order to attack out of the enclosure later in the battle, the archers could have done the same thing in reverse. Or, for that matter, they could simply have stomped on the back of the stakes, pushed them down, and walked over them. The palings were not very solidly stuck into the muddy ground; one source has many of them falling of their own accord.⁵⁶ Like a nail lightly set in wood before

⁵⁶ Waurin, *Recueil*, 214: *Saveuses' men se ferirent dedens ces archiers Anglois quy avoient leurs peuchons fichies devant eulz, mais ilz ne tenoient gueres en la terre quy estoit si molle. Si passerent oultre hardiement ledit messire Guillaume.* It seems to me fairly clear that Waurin means the stakes rather than the horsemen when he says "they did not hold for long but were barely held in place [*tenoient*] in the ground, which was so soft," especially since the next phrase is "So the said messire Guillaume and his two companions pressed on boldly." This, certainly, is what Le Fèvre had in mind in his version of the passage: *mais la terre estoit se mole que lesdis peuchons cheoient.* Le Fèvre, *Chronique de Jean Le Fèvre*,

hammering, the stakes did not need to be all that firmly emplaced to be able to impale a horse, since if a charging mount hit one, its own momentum would ram one point deeper into the ground, while the other point drove into the animal's chest.⁵⁷

Furthermore, if, as Keegan thinks, each archer drove his stake in where he stood, and stood a yard apart from the man in the next file, there would be (allowing 4" for the thickness of the stake itself) about 5' 8" empty space between each pair in line, and about 46" empty space between each stake and the next one over-and-back⁵⁸—which a lance-armed horseman moving at a walk could certainly penetrate. Indeed, given that 40" frontage was considered sufficient in the sixteenth century for horsemen in formation, a 46" gap could perhaps have been slalomed through at a slow trot.⁵⁹ While such an arrangement might have been effective in preventing or ruining a charge at the gallop, it would certainly not have resulted in many of the French horses being halted in front of the stakes, as the *Gesta* describes happening.⁶⁰ Hence, we should envision at least half of the archers' stakes being planted along their front with a span of 6" or 9" between them, and another two or three stakes per yard of frontage planted in depth.⁶¹

255. Anne Curry, however, apparently interprets Waurin's pronoun differently: "But the ground was so soft that the stakes made their horses fall." *CS*, 161.

⁵⁷ The results of such collisions are described in the Bourgeois de Paris' account of the battle of the Herrings in 1429: *Journal d'un bourgeois de Paris*, 211–32; cf. also *Le livre . . . Bouciquaut*, 106, where the French cavalry at Nicopolis (1396) was able with difficulty to penetrate the Turkish stake barrier, though the stakes *entroient es panes des chevaux, et moult occirent et mahaignerent des hommes qui des chevaux cheoyent*.

⁵⁸ I.e. the hypotenuse of a triangle whose other sides were each three feet, minus a generous 4" for the thickness of the stake.

⁵⁹ At the battle of the Herrings in 1429, the charging Gascon and Lombard horsemen are reported to have twirled [*tournoierent*] their lances in front of them (presumably meaning that the points were swung in circles, not that the lances were spun like batons) in order to provide their mounts with some protection from arrows. *Journal d'un bourgeois*, 232. It would have been relatively simple to use the lance-tip to smack down fixed stakes in soft ground. In envisioning this, it is helpful to look at the depiction of the two lance-armed men-at-arms in the illumination on the dust-jacket of *CS*.

⁶⁰ *Gesta*, in *CS*, 35.

⁶¹ With six ranks on each 3' of frontage, that would be one stake on each 12" of frontage if only half the stakes were used for the "fence," and the other half used in depth. Allowing 3" for the diameter of the stake itself leaves 9" of empty space. If four stakes were set in each yard of frontage, there would be a six-inch space between each.

The French Army

With the exception of Philippe Contamine in 1977 and Anne Curry in 2005,⁶² recent writers on the battle have mostly accepted A. H. Burne's conclusion that the French army at Agincourt contained around 24,000 soldiers, "mostly" or "almost entirely" men-at-arms. The number is, as we shall see, a good one for a number of reasons, but as a total of combatants, not as a total of men-at-arms. It is surprising that so many scholars have been willing to accept the idea that such a large contingent of men-at-arms could have been gathered for the battle of Agincourt. In 1340, Philip VI (1328–1350) did manage to assemble something not too far short of that—22,500 men-at-arms—for the "Host of Bouvines,"⁶³ but at Crécy in 1346, he had no more than 12,000. Considering that the population of France had fallen by nearly half in the decades between 1348 and the battle of Agincourt, due in large part to successive outbreaks of the Black Death, it would seem reasonable to presume that the French at Agincourt would have been hard-pressed to match the figure of men-at-arms from 1346, much less surpass the total of 1340.

In fact, the combined evidence is quite strong that the French army was composed of about 10,000 men-at-arms, 10,000 *gros valets*, and perhaps 4,000 archers, crossbowmen, and other communal foot. This would make the ratio of French to English combatants 4 to 1, which is precisely the figure given by both the St. Denis chronicler and Thomas Basin. What is more, the *Chronique anonyme* says "better than four against one."⁶⁴

We can reach the figure of 10,000 men-at-arms from several directions. First of all, there are the direct statements. The *Chronique d'Arthur de Richemont* says the Frenchmen defeated at Agincourt amounted to

⁶² Contamine, "Crécy (1346) et Azincourt (1415)," 35. Michael K. Jones figures the French army at around 28,000, including around 15,000 men-at-arms. *Agincourt*, 97.

⁶³ This includes the garrisons of various strongholds in northern France. Contamine, *Guerre, état et société*, 70.

⁶⁴ For a four to one ratio, see Saint-Denis, in *CS*, 104; Basin, in *CS*, 189; *Chronique anonyme*, in *CS*, 115. This also more-or-less splits the difference between Waurin and LeFèvre, who in a rare disagreement give the ratio as (respectively) 6:1 and 3:1. In *CS*, 157. For what it is worth, the sixteenth-century manuscript of the chronicle of the London Franciscans, independently of any known earlier source, gives the strength of the French as 26,000 men. *Monumenta Franciscana*, ed. Richard Howlett, 2 vols. (London, 1882), 2:166.

“a good 10,000 men-at-arms.”⁶⁵ Berry Herald states that “In this company of French were 10,000 men-at-arms, most of whom were knights and esquires.”⁶⁶ The *Chronique Normande* mentions that the French had 10,000 men-at-arms pursuing the English, though this was before the arrival of the duke of Orléans. The chronicle of Ruisseauville appears to say that the French had an advantage of 10 to 1 in knights and gentlemen, which would again be 10,000 men-at-arms for the French.⁶⁷

The figure of 10,000 men-at-arms also squares with what other sources tell us about the component parts of the French array at Agincourt. The St. Denis chronicler and Jean Juvenal des Ursins both indicate there were 5,000 men-at-arms in the French vanguard, and Berry Herald agrees closely, breaking the number into 3,000 men-at-arms under the constable and marshal, 1,200 under the duke of Bourbon, and 600 of Orléans’ men, for a total of 4,800. The second line is reported as having been the same size as the vanguard.⁶⁸ It seems to have been composed of around 3,400 men-at-arms or somewhat more, with the remainder of the 5,000 being made up by the best-armored *gros valets* and other troops.⁶⁹ Another 1,000–1,400 men-at-arms were

⁶⁵ Guillaume Gruel, *Chronique d’Arthur de Richemont, connétable de France, duc de Bretagne (1393–1458)*, ed. A. Le Vasseur (Paris, 1890), 181: *furent noz gens desconfitz, et mors, et prins, et en fuyte, lesquels estoient bien dix mille hommes d’armes*. This is one of the few passages where Anne Curry’s translation is problematic; she has “fighting men” for *hommes d’armes*. In *CS*, 184.

⁶⁶ Berry Herald, in *CS*, 181.

⁶⁷ Dwynter in *CS*, 141: *che fu le plus grant pïet a voir que on veist onques, veut le noble chevalerie et gentilleche qui la estoit au regard des englés, car les franchois estoient bien X, contre un engles*. The text’s ratio clearly is meant to refer to men-at-arms alone, as the phrase “chevalerie et gentilleche . . . au regard des englés,” indicates, though taken in isolation the key phrase could be understood as the balance of forces overall, rather than in men-at-arms. Since the same chronicle later says the English had 8,000–9,000 men including the archers, if the 10:1 ratio meant for overall forces, that would make the French army 80,000–90,000 strong. Aside from being absurdly large, that would also not fit with the text’s statement that, although the French army was “entirely defeated, all killed or taken prisoner aside from a large number . . . who fled” (140), there were only around 6,000 dead and 2,200 prisoners (143–4). By contrast, when the author of the *Journal d’un bourgeois* wrote that the French outnumbered the English by half again, he likely was counting only the French men-at-arms (or only the French in the first two lines and the wings, excluding the third line and the bowmen), instead of all the English. In *CS*, 177.

⁶⁸ Waurin/Monstrelet in *CS*, 156.

⁶⁹ Jean Juvenal des Ursins, in *CS*, 132: “In the second there were 3,000 [knights and esquires], not counting the *gros valets*, the archers and crossbowmen.” Berry Herald, in *CS*, 181: Bar, 600; Nevers, 1,200, Eu, 300, Marley 400, Vaudémont, 300, Rocssy and Braine, 200, Brabant, very few, but the Hainaulter men-at-arms put themselves under his banner. This comes to a total of 3,000 plus the troops from Hainault and Brabant;

assigned to the wing cavalry forces,⁷⁰ which brings us to between 9,200 and 9,800 men-at-arms. In addition, there were some men-at-arms in the third line, though probably not more than a few hundred.⁷¹

at a guess, 3,400 men. The men-at-arms from Hainault were probably quite numerous, since the seneschal of Hainault had been requested to serve with 120 men-at-arms and 60 archers. What is more, according to the chronicles, “all the barons of Hainault” were there along with “all the flower of the chivalry.” (In *CS*, 132, 181, 187, 115; note also 110; for the seneschal’s summons, see Curry, *New History*, 142. Fourteenth-century treaties called for Hainault to provide forces of 500 to 1,000 men-at-arms. Henri Laurent, *Actes de documents anciens intéressant la Belgique conservés aux archives de l’état à Vienne, 1196–1356* (Brussels: Lamertin, 1933), no. 76; Rogers, *War Cruel and Sharp*, 133–34. If the line consisted of 312 files, composed of an even 11 ranks of men-at-arms, backed up by four or five of *gros valets*, that would take 3,432 men-at-arms.

⁷⁰ The Berry Herald, in *CS*, 181, gives a figure of 600 on each wing. Tito Livio, in *CS*, 60–61 posits a total of 1,000. According to Waurin/Lèvre (*CS*, 156), Vendôme commanded 600 men, while Mostrelet (*CS*, 156) places the number under Vendôme’s command at 1,600 and those under the admiral at 800 (*MWF*, in *CS*, 156, 161). The *Gesta* (*CS*, 34) states that there were “many hundreds on each flank of the vanguard. Gruel, *Chronique*, in *CS*, 184, indicates that many of these men were Lombards or Gascons, which is supported by the use of the latter in a similar role at the battle of the Herrings. *Journal d’un bourgeois de Paris*, 211–33.

⁷¹ For claim that there were some in the third line—“tout le surplus des gens de guerre” “all the rest of the men at arms,” see *MWF*, in *CS*, 156; Le Fèvre, *Chronique*, 248; Vale, *Agincourt*, 399 (n. 32). Monstrelet, supplemented by Waurin/Le Fèvre, in *CS*, 163; Fenin, in *CS*, 118. Berry Herald says the total French force of men-at-arms was 10,000, but the contingents he lists—which do not include the men of Hainault and Brabant or any men-at-arms in the third line—total 9,000. In *CS*, 181. In her new book, Anne Curry takes a very different approach to the question of the size of the French army, using as her starting point the document showing the French crown planned in August to raise a force of 6,000 men-at-arms and 3,000 bowmen. To that figure she adds estimates for the companies of men known to have been at the battle but not included in the original recruiting plan (or noted in the Somme battle plan). She reaches a conclusion not too far off mine: around 8,000 men-at-arms and 4,000 other troops, mostly *gens de trait*. Curry, *New History*, 181–87. A problem with her methodology that would account for her lower figure of men-at-arms is that she says quite arbitrarily (without a supporting citation) that the “additional numbers for soldiers brought by Orléans, Bourbon, Nevers, Brabant and others from the northern and eastern areas, who joined the army late in the day . . . cannot have numbered more than 2,500, to which we need to add about 500 or so who responded within Picardy to the second issue of the *semonce* of 20 September.” *Ibid.*, 186–87. But the companies of Orléans, Bourbon and Nevers alone, according to the very credible figures in Berry Herald, amounted to 3,000 men-at-arms; the duke of Bar and the count of Roucy and Braine, who were in the same category of late arrivals, together had 800 (Berry Herald, in *CS*, 181), for a total of 3,800, not 2,500. Also, we probably ought to allow a larger figure for the many small contingents arriving independently of the large companies. Local (and not-so-local) men-at-arms who could reach the battlefield individually had a strong impetus of honor to join the army since most of them expected to win an easy victory, which meant low risk and the possibility of substantial profit, as well as the priceless opportunity to tell their grandchildren they had been at the battle. Hence, when forbidden by his father to join the army, the nineteen-year-old count of Charolais (the future Duke Philip the Good) reportedly “took to his chamber in floods of tears,”

It was normal practice in the early fifteenth century for each man-at-arms to be accompanied by a lighter-armed combatant called a *gros valet* (as well as a noncombatant page), just as it was normal for an English man-at-arms to serve alongside three or more archers.⁷² The nature of this category of combatants has not been well understood—indeed, the principal authority on the late-medieval French army, Philippe Contamine, once wrote that “it is difficult to consider them as full-fledged combatants,” and Matthew Bennett agrees that they were “men not usually involved in the battle.”⁷³ A variety of evidence, however, leaves no doubt that the *gros valets* were fighting men, equipped and expected to participate in battle. The confusion may have arisen in part because of the modern meaning of *valet*, but in the thirteenth and early fourteenth centuries *valetus* was used to signify a heavy cavalryman, often with an armored horse, but of lesser status than a knight.⁷⁴

A properly equipped *valet* in 1351 was expected to have a respectable horse worth at least 20 *livres tournois* (l.t.) and a significant amount of body armor, including a haubergeon, a bascinet with camail, a gorgette,

while on the other hand “on all sides men were flooding in as if they were going to a festival of jousting or to a tournament.” (Le Fèvre/Waurin, in *CS*, 151, 169). Moreover, although Curry recognizes that “some [men-at-arms] would have been accompanied at their own expense by *gros valets*, military servants who had limited defensive and offensive equipment and who could be given some function in combat,” she does not seem to recognize quite how numerous they likely were, or to count them at all in her estimate of the total strength of the French army.

⁷² Contamine, *Guerre, état, et société*, 226.

⁷³ Contamine, “Crécy (1346) et Azincourt (1415),” 35: “*qu’il est difficile de considérer comme des combattants à part entière*” though the same author does admit elsewhere (*Guerre, état, et société*, 21) that they “in certain cases acted as true combatants.” Bennett, *Agincourt*, 64. Note also Curry’s translation of *varles* as “servants” in *CS*, 469 (though recognized as “soldiers” on 125).

⁷⁴ *Valetti* was used for esquires/sergeants with barded horses during the Welsh wars of Edward I. John E. Morris, *The Welsh Wars of Edward I* (Oxford, 1901), 52–3. This was still the case around 1300. Prestwich, *Armies*, 17. As late as 1333, the term was used for someone in status between a knight and a bourgeois (presumably an esquire or gentleman). *Foedera, conventiones, litterae et cuiuscumque generis. Acta publica inter reges Angliae et alios quosvis imperatores, reges, pontifices, principes, vel communitates*, ed. Thomas Rymer, 6 vols. (London, 1816–1869), 2:865. In *The ‘Templar of Tyre,’* written after 1314, the word “*valé*” is applied to noblemen not yet knights, but clearly combatants. *The ‘Templar of Tyre.’ Part III of the ‘Deeds of the Cypriots,’* trans. Paul Crawford (Aldershot, 2003), chaps. 328, 391, 393, 491. Well after Agincourt, in 1445, an English statute seems to use “*vadlet*” to designate the next class below esquires eligible for knighthood, i.e. by implication including esquires not eligible for knighthood. J. G. Edwards, “The Huntingdonshire Parliamentary Election of 1450” in *Essays in Medieval History Presented to Bertie Wilkinson*, ed. T. A. Sandquist and M. R. Powicke (Toronto, 1969), 386.

gauntlets, and plate forearm guards.⁷⁵ In 1422, for lances recruited in Lombardy, the armor such a warrior was expected to bring into battle was similar though a bit lighter: a small iron helmet (*capeline*), a haubergeon, and plate forearm guards.⁷⁶ Around the time of Agincourt, *valets* were sometimes included on French muster rolls.⁷⁷ In 1415, the word *valettus* was occasionally used in English records as a synonym for archer.⁷⁸ A few decades after Agincourt, *varlets* could be used as a synonym for the *coutilliers* in the *compagnies d'ordonnance*, and these were expected to be armored, well-armed combatants.⁷⁹ More decisively for this question of terminology, in the battle plans drawn up for the French army in 1415, the *gros valets* were given the same tactical role they had at Othée in 1408: in each case, they were to make mounted enveloping attacks, formed up behind a cutting edge of men-at-arms.⁸⁰ At Othée, in fact, the majority of the *combatans* killed in the fighting on the victorious side were *gros valets*.⁸¹ Earlier, at Westrozebeke in 1382,

⁷⁵ Contamine, *Guerre, état et société*, 20, 21 (n. 65), 659 (n. 19). The *autres combatans* who were to accompany the *glaiives* on a 1:1 basis according to a treaty of 1367 were likely *valets armés*. Philippe de Mézières, in 1396, also counted *gros valets* as combatants, and assumed each knight or esquire in his crusading order would have one or more. N. Jorga, *Philippe de Mézières, 1327–1405, et la croisade au XIV^{me} siècle*, Bibliothèque de l'école des chartes, fascicule 110 (Paris, 1896), 496.

⁷⁶ Contamine, *Guerre, état, et société*, 253 (n. 96).

⁷⁷ *Ibid.*, 226 (n. 106).

⁷⁸ Hitchin, "Bowmen," in *Agincourt 1415*, ed. Curry, 2, 37; note also Wylie and Waugh, *Reign*, 2:67 (n. 9), 3:184. Similarly, Juvenal des Ursins in *CS*, 132: Henry's forces included "4,000 *gros valets* armed with hauberks, great jacques and axes." Christine de Pizan is somewhat ambiguous as to the combatant status of the *gros valet*: *Et par deriere iceste [arrieregarde] sont les ver[l]es au cheval qui aident les autres se besoing est; et ilz sont bons; et les chevaulx de leurs maistres la tiennent. Livre de chevalrie*, Ms. Bodleian 824, f. 50.

⁷⁹ Jean Chartier, *Chronique de Charles VII*, ed. Auguste Vallet de Viriville, 3 vols. (Paris, 1858), 2:236: "lequel varlet estoit armé de sallade, jacquette, dague ou haubergeon, brigandine, hache ou guisarme." Moreover, several sources criticize the decision to send the *gros valets* to the rear, thus making room for the numerous men-at-arms. (Cochon, the *Chronique anonyme*, and *Chronique de Ruisseauville* in *CS*, 113, 115, 125). This indicates that sending the *gros valets* to the rear was not a normal practice. If it had been, there would have been no need to make special mention of the fact that it was being done at Agincourt or to criticize the decision as the sources do. Christine de Pizan is somewhat ambiguous as to the combatant status of the *gros valet*: "Et par deriere iceste [arrieregarde] sont les ver[l]es au cheval qui aident les autres se besoing est; et ilz sont bons; et les chevaulx de leurs maistres la tiennent." *Livre de chevalrie*, Ms. Bodleian 824, f. 50.

⁸⁰ Matthew Bennett, "The Development of Battle Tactics in the Hundred Years War," in *Arms*, 1–20, highlights the connections; Phillpotts, "Plan," 66; *La chronique d'Enguerran de Monstrelet: en deux livres avec pièces justificatives, 1400–1444*, ed. L. Douët-d'Arcq, 6 vols. (Paris, 1857–62), 1:355–66.

⁸¹ Monstrelet, *Chronique*, 1:355–66; esp. 359 ("combatans"), and 366 (5–600 killed, including seven named, another 100–120 *homes*, et le surplus *varlets*).

the French had incorporated 1,500 “*varlez* armed with jacks and axes” into their vanguard, along with 2,000 men-at-arms.⁸² Hence, these men should certainly be counted as combatants. When the sources for the Agincourt campaign comment that the *gros valets* were strong enough to have won the battle by themselves, it may be an exaggeration, but it is by no means wild hyperbole.⁸³

A good estimate for the number of *gros valets* is 10,000, one for each man-at-arms. As already noted, it seems that about 1,600 of them, probably men whose equipment made them nearly the equivalent of proper men-at-arms, were stationed in the second line. That would leave an additional 8,400, a very large and potentially formidable force, in the third line.⁸⁴

In addition to the men-at-arms and *gros valets*, the French army included a substantial number of archers and crossbowmen as well as other urban foot. The recruitment plan drawn up for this force had called for 3,000 missile troops to accompany 6,000 men-at-arms.⁸⁵ Some of the nobles who joined the army later would have also brought bowmen, and in addition there were contingents provided by the towns in the north-east. Amiens, for example, sent 30 crossbowmen and 20 shield-bearers (*pavisiers*), along with some cannon.⁸⁶ In total, the con-

⁸² *Chronique des règnes de Jean II et Charles V*, quoted in Contamine, *Guerre, état et société*, 226.

⁸³ *Chronique de Ruisseauville*, in *CS*, 126: “It is said that the *gros varlets* might have fought well against the English and all their power.” Pierre Cochon, *Chronique Normande*, ed. C. de Robillard de Beaurepaire (Rouen, 1870), 274, says the same.

⁸⁴ The fact that Le Fèvre describes the third line as made up of all the *gens de guerre* remaining after the formation of the wings and first two battles adds additional confirmation to what I said above concerning the combatant status of the *gros valets*. Le Fèvre, *Chronique*, 248.

⁸⁵ Curry, *New History*, 97.

⁸⁶ *CS*, 461–62. Senlis was requested to send troops; Tournai probably sent 50 crossbowmen and 25 *pavisiers*; St. Omer sent archers and crossbowmen. Contamine, *Guerre, état et société*, 216 (n. 54). According to the Saint-Denis chronicler (in *CS*, 102) the townsmen of Paris offered 6,000 fully equipped soldiers, demanding they should be in the first rank if it came to battle; but they were declined, since “we are already three times more numerous than the English.” Note also *Journal d’un Bourgeois*, in *CS*, 177: “Many *baillis* of France died too; they had brought the levies from their *baillages* and all were killed—such as the *bailli* of Vermandois, the *baillis* of Mâcon, of Sens, of Senlis, of Caen, of Meaux, all with their men.” The chronicler’s claim is borne out for Vermandois, Auxerre and Sens, Senlis, and Caen; Meaux is possible but questionable. In addition, the *baillis* of Amiens and probably Tournai were killed. The *bailli* of Mâcon, having died in service, was replaced on December 27, on the same day as the *baillis* of Evreux, Montargis, St.-Pierre-le-Moûtier and Touraine, which suggests that most or all of them were also killed at Agincourt, or died later from wounds. Hence,

tingents of common infantry likely amounted to around 4,000 men, or even significantly more.⁸⁷

French Deployment

The French vanguard and “main division” were arrayed in tight, dense formations of about sixteen ranks each.⁸⁸ The second line was stationed a bowshot behind the first.⁸⁹ Since each line, as we have seen, contained about 5,000 men, it would have extended around 312 yards: 25% longer than the frontage of English men-at-arms. Thus the French line would overlap the English by around 31 yards on either side, more than enough for an effective envelopment, provided the English archers were first cleared out of the way.⁹⁰

That end was to be accomplished by two wings of mounted men-at-arms which flanked the vanguard.⁹¹ These horsemen, like their

it is likely that at least ten royal *baillis* were killed or mortally wounded at Agincourt, quite a substantial fraction of that small group. See *Gallia regia*, ed. G. Dupont-Ferrier, 6 vols. (Paris, 1942–1960), nos. 551, 2525, 4238, 20780, 22954, 22413–4, 12416–7, 14544, 15658–9, 20497–8, 22140–1, 15116. In addition, the *bailli* of Boulogne was present, according to Juvenal des Ursins, in *CS*, 131.

⁸⁷ Saint-Denis, in *CS*, 106. A similar figure might be arrived at through calculation. Waurin and Monstrelet, in *CS*, 156 would have the French army contain 8,000 archers and 1,500 or 33,000 (depending on how the text is read) crossbowmen; but these chroniclers give inflated numbers for the French in general, e.g. 8,000 men-at-arms in the vanguard and in the main battle.

⁸⁸ Tito Livio, in *CS*, 59; Pseudo-Elmham, in *CS*, 71.

⁸⁹ 1460 legal document, in *CS*, 446–47.

⁹⁰ The French dismounted men-at-arms have most often been depicted by recent historians as stretching from woodland to woodland. The conclusion that these men were, on the contrary, deployed on only about half the front is supported, aside from the calculations above, by (1) the fact that the French cavalry was clearly on the front line, since it was hit by the provoking fire of the English archers; (2) the cavalry is described in the sources as on the wings, but never as in front of the dismounted men-at-arms; and (3) the English archers are described as first firing into the flanks of the French dismounted men-at-arms and then striking them from the left and right. On the other hand, however, note *Gesta*, in *CS*, 36: “And when the men-at-arms had from each side advanced towards one another over roughly the same distance, the flanks of both battle-lines, ours, that is, and the enemy’s, extended into the woodlands which were on both sides of the armies.”

⁹¹ One text could be taken as suggesting that they were, instead, in line with the rearguard. This, however, would not fit with the known fact that the English archers, after advancing into bow range of the French, hit the horsemen on the flank. The French second line was stationed about a bowshot behind the first (document in *CS*, 446–67), so even its position would have been out of range at the start of the battle. Cf. Vale, *Agincourt*, 267.

descendants in the eighteenth century, were likely drawn up almost stirrup to stirrup, in two lines each of two ranks. Twelve-hundred men formed up in that way would occupy about 333 yards of frontage, nearly filling the gaps on the flanks between the dismounted men-at-arms and the woods on either side.⁹²

It would have been normal practice for the French to have positioned their crossbowmen in front of the vanguard, to keep enemy archers at a distance and to open the combat. Perhaps remembering the fate of the Genoese at Crécy, however, the French leaders at Agincourt decided not to follow this tradition. The missile troops were probably stationed between the first and second main lines at the start of the battle, with orders to file off to the side as soon as the second line was ready to advance.⁹³

The third line, composed mainly of *gros valets*, was the most numerous of the three main divisions and occupied by far the greatest amount of physical space. It most likely stretched across the full width of the battlefield, if not along an even broader front north of the constricting woods.

French Tactical Plans

The renowned soldier, Marshal Boucicaut, took the lead role in drawing up a formal tactical plan for the French army around ten days before the engagement, after the junction of his own force with that commanded by constable d'Albret, the duke d'Alençon, and the count of Richemont. As one might expect from such an experienced officer, the plan was a very sensible one, and, indeed, had it been adhered to and implemented on suitable terrain, the French would almost certainly have won the battle.

Boucicaut's plan, which was discovered in the British Library in the early 1980s, envisions a rather complicated deployment. Some of the details remain unclear, due either to ambiguous phrasing or to

⁹² This allows 40" of frontage per horseman, as Digges called for in the mid-sixteenth century. *Stratoticos*, diagram following f. Aiiiv ("the Bataille in Portraiture"). For the figure of 600 on each wing, see Berry Herald, in *CS*, 181. As noted above, the sources generally agree that this figure is roughly correct.

⁹³ *Gesta*, in *CS*, 35.

the damaged condition of the manuscript, but the general concept is clear enough. [See Figure 4]. The document calls for the French army to be arranged into seven divisions if the English formed their men-at-arms into a single battle, eight if the English adopted a different plan. Either way, the French would have a main line composed of dismounted men-at-arms, split into a central “vanguard” under the constable and marshal, flanked by two smaller “wings of foot.” The crossbowmen and archers of the army were to form up in two divisions, one in front of each of these wings.⁹⁴ On the far left of the army and a bit to the rear, there was to be a powerful cavalry strike-force, with at least a thousand men-at-arms backed by half the army’s *gros valets*, mounted on the best horses of their masters. The master of crossbowmen (the next-ranking military officer in France after the constable and marshals) was to command this force. Another body of cavalry, presumably in the corresponding position on the right, would contain the other half of the *gros valets*, spearheaded by 200 men-at-arms. The men-at-arms commanded by Alençon, Eu, and all other lords not assigned elsewhere were to join the large French vanguard if the English men-at-arms formed into a single division; otherwise, these forces were to make up a separate division, probably intended to be positioned behind the vanguard.⁹⁵

The plan called for the battle to be opened by the main cavalry strike-force, which was intended to ride down and scatter the archers of Henry’s right wing. Simultaneously, the smaller cavalry force on the French right was to circle around the other wing of archers and hit the English baggage, and then the main line, from the rear.

⁹⁴ Phillpotts, “Plan,” 65.

⁹⁵ *Ibid.*: *sera une autre bataille aupres de celle-la* [the vanguard]. Phillpotts refers to this as a “main battle,” but “second battle” would probably be a better translation for “*autre bataille*,” given that it is only the division under d’Albret and Boucicaut which is described as “*une grosse bataille*.” On the other hand, the second line is described as the main battle in the document in *CS*, 446–47. The prepositional phrase *aupres de* has usually been interpreted as meaning “alongside,” but there are several considerations that, taken together, suggest otherwise. First, although it can mean “next to,” its more normal meaning is “near to.” Second, everywhere else in the document there is a strong emphasis on specifying which forces are to be on the left vs. on the right; it would be very odd for Boucicaut in this one case to fail to specify the relative positions of the two, unless that question was understood to have been answered by the description of the *grosse bataille* as being formed up *premierement, come avant garde*. (Phillpotts, “Plan,” 64.) Third, there is the fact that at Agincourt Alençon’s force was formed up as a second line behind Albret’s, rather than in line with it.

Between the time when this plan was drawn up and the immediate preparations for the engagement began, the size of the French army increased substantially, with the arrival of the contingents of the dukes of Orléans, Bourbon, and Bar, and a half-dozen counts.⁹⁶ The majority of the newcomers joined Alençon in forming the second line of men-at-arms. Some were also assigned to strengthen the right-wing cavalry, and possibly the left-wing strike-force as well. With so many men-at-arms available, it was decided to shift the relatively light-armored *gros valets* out of the flanking forces and into a third line, as we have seen.

There was one more major departure from the earlier deployment plan. The missile troops, who had been intended to form up in front of the wings of the main line, were pulled back, and apparently placed between the first and second lines.⁹⁷ The usual reason given for this change is that there was not enough room for them on the narrow battlefield selected,⁹⁸ but this does not really make sense. In Boucicaut's plan they were to be stationed directly *in front of* the "wings of foot."⁹⁹ Hence, they would not add to the breadth of the line, only to its depth, so the narrowness of the field at Agincourt would not be a reason to dispense with them. More likely, reflection on the battle of Crécy led the French leaders to conclude that the harm the crossbowmen might do in impeding the advance of the French men-at-arms would outweigh

⁹⁶ Probably not as much, however, as Phillpotts thinks. As noted above, at Agincourt the Constable and the Marshal's men in the center of the vanguard amounted to 3,000 men-at-arms; add this to the planned 1,200 men-at-arms of the two wings and we get at least 4,200 men-at-arms, suggesting an army of around 10,000–12,000 men (allowing for the *gros valets* and a substantial number of infantry)—i.e. nearly half the final total.

⁹⁷ *Gesta*, in *CS*, 35: "enemy crossbows which were at the back of the men-at-arms and on the flanks after a first but over-hasty volley by which they did injury to very few, withdrew for fear of our bows." This statement must mean the the crossbowmen were behind the first line, since the second line was a full bowshot further back. See document in *CS*, 446–67). For other sources that bear on this issue, see *MWF*, in *CS*, 156 (archers and crossbowmen attached to vanguard and second line), Dyster, in *CS*, 173 (archers and crossbowmen in the rear); *Chron. St. Denys* (ed. Bellaguet), 560 (supposed to be in front, but sent back [*referebant*] because their help was not needed), cf. *Chronique de Ruisseauville*, in *CS*, 125 (French bowmen were not employed).

⁹⁸ Phillpotts, "Plan," 64. This view is derived from the Waurin/Le Fèvre account: the French "had plenty of archers and crossbowmen, but nobody wanted to let them fire. The reason for this was that the site was so narrow that there was only enough room for the men-at-arms." A number of other sources agree that the field was not wide enough "to hold the whole force" of the French (Tito Livio, in *CS*, 60), and that the French nobles had little interest in the service of the crossbowmen (Saint-Denis, in *CS*, 106).

⁹⁹ *CS*, 468.

the limited good they could be expected to accomplish in a duel with the English archers, who outclassed them completely.¹⁰⁰

Given the tactical plan outlined by Boucicaut, the choice of the battlefield between Agincourt and Tramecourt is rather puzzling.¹⁰¹ Considering their vastly superior numbers and especially their overwhelming superiority in cavalry, the French clearly should have chosen a more open battlefield, where their horsemen could easily have enveloped the English line. With more operating room, they could also have reduced the depth and increased the breadth of their main line of dismounted men-at-arms, further facilitating enveloping attacks against the English. It did not take great prescience to recognize that formations as deep as the ones actually adopted at Agincourt would not make the most efficient use of the available soldiers.¹⁰² The fields just a few hundred yards north of the actual battlefield would have admirably suited a broad deployment, and made it basically impossible for the English to secure their flanks. That would have made a French victory virtually certain.

What, then, can explain the French choice of position? It seems that despite the offensive nature of the Boucicaut plan, by October 24, the Valois army's leadership had been half-way converted to the idea of a defensive tactical stance.¹⁰³ This is suggested both by the long pause

¹⁰⁰ *Gesta*, in *CS*, 35. The longbow had a much greater rate of fire than the stirrup-drawn crossbow, and even more so when compared to windlass crossbows; it was also far more accurate at long distance, and as late as 1481 considered to equal Italian crossbows (given the date, presumably steel-bowed) in range. Quoted in A. W. Boardman, *The Medieval Soldier in the Wars of the Roses* (Stroud, 1998), 136. It is likely that most of the crossbows at Agincourt, intended for field use, were still composite- rather than steel-bowed; note de Pizan, *Book of Deeds*, 109.

¹⁰¹ It clearly *was* a choice. After nearly coming into contact with the English army at Blangy the previous day, the French moved to the battlefield while out of contact with their enemies. While their choice of battlefield thus *may* practically have been limited to the immediate vicinity of Agincourt (though with their superior numbers and cavalry, they should have been able to break contact and take up a blocking position farther along if they had wanted to), but nothing could have prevented them from simply occupying the ground to the north of the Agincourt-Tramecourt pass, rather than the pass itself. Cf. Phillpotts, "Plan," 64.

¹⁰² For similar observations from the ancient world, see Xenophon, *Cyropaedia*, 6.22–3; Josephus, *Jewish War*, 3.10.2.

¹⁰³ I say "half-way" because, as will be developed below, their decision to leave much of their front line manned by horsemen is inconsistent with a defensive plan. Walsingham's chronicle makes the interesting implication that what tipped the balance for the French—i.e., what made them, in the event, leave the initiative to the English, despite having formed up in a manner better suited to the offense—could have been the unexpectedly bad condition of the intended fighting-ground between

the morning before the battle—the French did not initiate their attack until provoked by the English advance and initial volleys—and by the narrowness of the position, which could have been seen as favoring a defense. Furthermore, the strategic situation allowed for the French to push the burden of the tactical offensive onto the English. With the road to Calais blocked and his supplies desperately short, King Henry did not have the option of holding still or, realistically, of retreating. He had to move forward or starve, so if the French did not attack him, he would have to attack them.¹⁰⁴ Since the English tactical system was predicated on the defense, there was more than a little logic in wanting to force Henry's men to assume the offensive, especially considering that it was recognized at the time that in infantry combat the defending side always had a great advantage.¹⁰⁵

Thus, there was nothing fundamentally wrong with a plan to hold the Agincourt-Tramecourt gap and fight a primarily defensive battle. But if that was the intent of the French commanders, they should have made much more substantial changes to the deployment envisioned in the Boucicaut plan. The sensible thing to do would have been to post the most heavily armored men, on foot, from woodline to woodline, supplementing their defenses with pavises taken from the shield-bearers. The numerous French crossbowmen could have lined the woods to the left and right, to enfilade the English forces if they marched between them, or to harass the English bowmen if they tried to break up the

the two armies on the morning of the combat: “unsluggishly on the great morning did the French send the vanguard into the field.” Because of the muddiness of the place, however, the French did not wish to proceed far into the field. They waited to see what our men “intended to do.” The king realized the astuteness of the French in standing firm in one place so that they might not be exhausted by advancing on foot through the muddy field.” *CS*, 51–52. The French plans for deployment can hardly have been made any later than the preceding evening. Assuming that is correct, the field would have been in significantly better shape for a charge when the decision to retain an offensively-oriented formation was made than it was the following morning, both because it rained heavily all night (below, note 156) and because meanwhile “pages, servants and several others in exercising the horses had churned up the ground making it so soft that the horses could scarcely lift their hooves out of it.” (Waurin/LeFèvre, in *CS*, 147). As an instrument for turning dirt into mud, an equine's hoof would be hard to improve upon. One soldier noted concerning a muddy track in WWII: “a mule's spindly leg, digging deeply in with each step, was a sure way of making the quagmire almost bottomless.” John Ellis, *The Sharp End* (London, 1993), 25.

¹⁰⁴ Pseudo-Elmham in *CS*, 71–72; *Gesta*, in *CS*, 34; Walsingham, in *CS*, 51.

¹⁰⁵ In general, see Rogers, “Offensive, 158–71. At Agincourt, see note 107.

French main line with archery.¹⁰⁶ Such a formation could have absorbed all the archers' limited supply of arrows without being destroyed, and left plenty of additional mounted troops to swing around to the west of Agincourt, to the east of Tramecourt, or both, and attack the English from the rear.¹⁰⁷ The men-at-arms and *gros valets* designated for that role should have been positioned off to the left and right of Tramecourt and Agincourt, ready to storm along the roads east and west of the villages. But, as we have seen, the actual French deployment put the third line cavalry directly behind the first two lines, failed to make any real use of the crossbowmen, and left cavalry, rather than dismounted men-at-arms, occupying the majority of the space on the front line, which made a defensive battle impractical. As Clausewitz notes, cavalry is, inherently "totally incapable" of defensive fighting.¹⁰⁸

To sum up the import of the last several paragraphs, the decisions made by the French leaders even before the battle had begun go a long way toward explaining the outcome. Their choice of battlefield could have been a good one with a different formation; their deployment could have worked well on a different battlefield; but to array their forces in the way they did, on the ground they chose, was little short of idiotic.

Furthermore, the deployment chosen and the statements of the chroniclers make it clear that the mounted men-at-arms on the wings were intended to ride down the English archers. This was not very wise, as events showed, and as should have been predictable, given the results of the cavalry attacks at Crécy and Poitiers. It was especially unwise considering the much higher ratio of archers to cavalymen at Agincourt than at either of those earlier actions.¹⁰⁹ Even aside from

¹⁰⁶ The crossbowmen could also have been stationed in front of the main line, as was envisioned in the earlier plan, but since in the open they would likely have been out-shot by the longbowmen as at Crécy, this would probably not have been wise.

¹⁰⁷ The 10,000 French men-at-arms could have covered the 700 yards along the Agincourt-Tramecourt road in a deployment 10 deep, sent 1000 men-at-arms and 5,000 *gros valets* to turn *each* English flank, and had 1,050 men-at-arms and 4,000-odd infantry left over as a tactical reserve.

¹⁰⁸ Carl von Clausewitz, *On War*, ed. and trans. Michael Howard and Peter Paret (Princeton, N.J., 1984), 285.

¹⁰⁹ On the other hand, of course, the armor of 1415 was heavier than that of 1356—but not radically so, as substantial elements of plate armor were already in use at the earlier date, as was horse-barding. To be fair to the French, it should also be noted that the French right wing cavalry at Poitiers had been quite effective at resisting the English archers' direct fire early in that battle. But, again, there we had around 500 horsemen ranged against just 1,000 archers, rather than 2,500, and the

the question of the wisdom of a frontal attack against concentrated longbow fire, it is obvious that if a charge was planned, it should have been launched while the English were in motion (just before their most advanced forces came into range of the French horses), or at the latest while they were re-setting their stakes. That the French did not charge until after the English had re-emplaced their palisade may have been a fault of execution rather than intent: it appears that many of the horsemen were out of formation when the English unexpectedly began to move forward.¹¹⁰ There is, however, little excuse for that, under the circumstances.¹¹¹ All of this means that the tactical errors of the French leadership were a necessary, though not a sufficient, cause for the French defeat.

Archery vs. Cavalry

The French effort to ride down the English archers failed miserably. This fact was traditionally seen as just another example of the lethal effectiveness of the English longbow; however, in recent years, this traditional interpretation has come into question. In *The Face of Battle*, Keegan suggested that the initial arrow-strike must have been of limited effectiveness against the plate-armored French men-at-arms. According to Keegan, the fact that at least some of the horsemen reached the stakes constituted a “failure of the missile principle.”¹¹² This moderate skepticism was picked up and carried much further by Kelly DeVries,

archers had had to fire significantly up hill, which has a large effect on arrows’ power. On the last point, see Mark Stretton, “Medieval Arrowheads. Practical Tests, Part Two,” *The Glade* 108 (2005), 55. Stretton found that an arrow fired at a 100-yard range with a 52-ft elevation—a fairly good match for the circumstances at Poitiers, as it happens—had less hitting power than one striking a level target from 240 yards. Furthermore, at Poitiers the horsemen had benefited from use of large leather shields, which they apparently did not think to employ again at Agincourt. For Poitiers, see Rogers, *War Cruel and Sharp*, 371–84.

¹¹⁰ Berry Herald in *CS*, 181–82: Henry “found the French in poor array and in small number, because some had gone off to get warm, others to walk and feed their horses, not believing the English would be so bold as to attack them.”

¹¹¹ It is possible that part of the reason for these problems was the factionalism in the French army. The leaders of the cavalry forces were both prominent Burgundians, while the bulk of the army hailed from the Armagnac faction. There were personal enmities involved as well. Vale, *Agincourt*, 281–82.

¹¹² For Keegan, see Rogers, “Efficacy,” 241 (n. 44); note also Keegan, *Face*, 102 (“On the flanks, however, the French [dismounted men-at-arms] cannot yet [when the archers left their stakes] have suffered many casualties.”

who argued that at Agincourt and the other battles of the Hundred Years War,

the English archers... could not have caused the losses of life attributed to them by historians. In fact, there is little evidence that the longbowmen... did any more damage than the killing of a few horses and the wounding of even fewer men.¹¹³

In contrast to the position adopted by Keegan and even more forcefully by DeVries, the present article will argue that taking into account the full range of source material available for the battle of Agincourt leaves little or no doubt that the French horsemen were indeed routed by the highly-effective arrow-fire of the English archers. The following passages come from the principal chronicle accounts.

Because of the strength of the arrow fire and their fear of it, most of the other [horsemen] turned back... Those on horseback were so afraid of death that they put themselves into flight away from the enemy [*MWF*];¹¹⁴

French cavalry posted on the flanks made charges against those of our archers who were on both sides of our army. But soon, by God's will, they were forced to fall back under showers of arrows and to flee [*Gesta*];¹¹⁵

But at the first volley of arrows which the archers caused to rain down upon them they turned and fled [Monk of St. Denis];¹¹⁶

When they made their course against the archers, [they turned back] because of the arrow fire which their horses could no longer endure [*Chronique de Ruisseauville*];¹¹⁷

¹¹³ Kelly DeVries, *Medieval Military Technology* (Peterborough, Ontario, 1994), 38; see also idem, "Catapults are Not Atom Bombs: Towards a Redefinition of 'Effectiveness' in Premodern Military Technology," *War in History* 4 (1997): 454–70, and idem, *Infantry Warfare in the Early Fourteenth Century* (Woodbridge, Suffolk, 1996), 5–6, 127–28. I have already responded to the position held by DeVries in my article "Efficacy," 233–42, but primarily with reference to the fourteenth century. Here, I shall bring to bear the later battle of Agincourt. I should also note, lest thought to be beating a dead horse, that in our most recent communication on the subject Professor DeVries was not ready to concede defeat in this debate. Moreover, even those who accept the effectiveness of the longbow against armor in the mid-fourteenth century question its lethality versus men equipped with steel plate armor, which many men-at-arms would have possessed in 1415. See Appendix 1.

¹¹⁴ *MWF*, in *CS*, 161.

¹¹⁵ *Gesta*, in *CS*, 35.

¹¹⁶ Monk of St. Denis, in *CS*, 106; St. Denis in *CS*, 106. Note also Juvenal des Ursins, in *CS*, 130: "When the horses felt themselves pierced by arrows, they could no longer be controlled by their riders in the advance. The horses turned."

¹¹⁷ *Chronique de Ruisseauville* in *CS*, 125.

The archers simultaneously shot arrows against the advancing knights so that the leading horses were scattered in that great storm of hail [Walsingham].¹¹⁸

Although the best sources particularly emphasize the effect of the English archery on the (armored)¹¹⁹ French horses, other contemporary and near-contemporary sources indicate that their riders, too, suffered directly from the arrows:

[The archers' arrows] inflicted something of a massacre on them [Monk of St. Denis]¹²⁰

The English archers caused maximum damage to the French with their arrows, so that they could not get close enough to the English to engage them in hand-to-hand combat [Edmond de Dynter];¹²¹

Our archers shot no arrows off target; all caused death and brought to the ground both men and horses [*Brut*];¹²²

...wounding so many horses on which the French were mounted and men also, killing a good number, so that even before they came to hand to hand fighting, the French turned round [Thomas Basin].¹²³

Our archers shot full heartily/And made the Frenchmen fast to bleed;/ Their arrows went full good speed,/Our enemies therewith down they fell ["Battle of Agincourt"];¹²⁴

The order of the English would have been thrown into disorder by the French knights if the great part of the latter had not been killed

¹¹⁸ Walsingham, in *CS*, 52. Note also: "When the horses felt themselves pierced by arrows, they could no longer be controlled by their riders in the advance. The horses turned..." (Juvenal des Ursins, in *CS*, 130); "The shower of arrows fell upon [the horsemen] so thickly, that they were compelled to retreat" (*Chronique de Normandie*, in *CS*, 186); "When they experienced the arrow fire coming so thickly, they [were] put to flight" (Gruel, in *CS*, 184).

¹¹⁹ Walsingham, in *CS*, 52: "the mounted men ahead who were to overwhelm our archers by the barded breasts of their horses, and to trample them down under their hooves." In addition to plate peytrals and chamfrons, horses may well have had mail rather than merely cloth padding protecting their necks, backs, and rumps, as depicted in an illumination of 1415 reproduced in Hibbert, *Agincourt*, at plate 2. *Chron. St. Denys* (ed. Bellaguet), 560, says the men were "perfectly armored" [*ad unguem loricatedos*] and with the fastest mounts.

¹²⁰ *Chron. St. Denys* (ed. Bellaguet), 562: *ex eis modica strage facta*.

¹²¹ Dynter in *CS*, 173.

¹²² *Brut*, in *CS*, 92.

¹²³ Basin, in *CS*, 190.

¹²⁴ "Battle of Agincourt" in *CS*, 297.

or wounded with arrows and had been forced to retreat in terror [Tito Livio].¹²⁵

The effectiveness of the bowmen should not be surprising. The scanty evidence available suggests that most were using bows with draw strengths of 100 pounds or more. Many may have been drawing weapons in the 140–160 pound range, loosing long arrows easily capable of punching through sheet steel.¹²⁶ These powerful weapons were thus able to have a deadly impact on the first two lines of heavily-armored, dismounted, French men-at-arms, as well as routing the cavalry. Furthermore, the sheer volume of fire through which the horsemen had to pass meant they had little chance of success. It appears that the French were not ready for the English maneuver into bowshot range, and that many of the knights and esquires of the wing forces had left their formation to take their ease while awaiting the course of events. This poor discipline helps answer the otherwise puzzling question of why the cavalry failed to charge before the English re-built their palisade.¹²⁷ It is true that the French had good reason not to strike at the moment the English began to move; after all, the more of the muddy field the archers had to cross, and the less the French had to, the better.¹²⁸ The charge, however, should have been launched either while the archers were still in motion or, at the latest, the instant they began to replace their stakes. The horsemen would not have been able to hit the archers before the wooden hedge was set in place, but the moral impact of their charge would have been significantly greater. Furthermore, they

¹²⁵ Tito Livio in *CS*, 61. The sources cited in this and the previous three notes are not among our best sources for Agincourt, and a skeptic might dismiss their testimony on that basis, but at the least what they say should be treated seriously as evidence of what the capabilities of the longbow were generally understood to be in the fifteenth century. For one lone statement to the contrary, see Juvenal des Ursins (an even more problematic source), in *CS*, 130–1.

¹²⁶ See Appendix I.

¹²⁷ Berry Herald, in *CS*, 181–82: Henry “found the French in poor array and in small number, because some had gone off to get warm, others to walk and feed their horses, not believing the English would be so bold as to attack them.” Monstrelet/Le Fèvre/Waurin claim that the French “put themselves in order” in response to the English advance, and also note that when the time came for the cavalry charge, the wing forces were seriously below their intended strength. *MWF*, in *CS*, 160–61. The latter observation is confirmed by *Chronique de Ruisseauville*, in *CS*, 125. Some delay would have been difficult to avoid, but the English advance presumably took at least a quarter hour, so the French should have had time to react.

¹²⁸ As it was, it took “considerable effort” for the English to advance into bow-range. Elmham, in *CS*, 52.

might have avoided the first two or three volleys of arrows since the bowmen engaged in setting their stakes would have been too busy to fire. Even after the English loosed their initial provoking shots, French unreadiness led each wing to launch its charge at substantially less than the planned strength.¹²⁹

Even if a full five hundred horsemen on each flank had made the charge, however, they would have faced grim prospects. Because the archers' lines were slanted toward the French, the horsemen on the far flank would have been as much as 175 or more yards closer to their targets than those stationed adjacent to the dismounted forces. If Henry moved his outermost archers up to within 275 yards of the cavalry line, somewhat less than half his archers would have been able to participate in the provoking volley(s); however, that would have produced enough volume of fire to force the French to attack. A French cavalry regiment of 1788, on a good field, could have made a 275-yard charge in about 76 seconds; to cover 325 yards (our estimate for bow-range using flight arrows) would have taken some 90 seconds. But a fifteenth-century charge would have been quite a bit slower, with heavier horses, bearing their own and their riders' armor, not having had the benefit of drill, and probably never attempting more than a trot.¹³⁰ Factoring in all this, and assuming the deep, sucking mud at Agincourt would have added at least 50% to the time needed to cover the ground, an educated guess would be that the French horsemen at Agincourt would have taken two and half to three minutes under fire to reach the stake line. [See Appendix IV for the calculations.] If we assume that the archers averaged six shots per minute until the enemy reached a flat-trajectory range of 70 yards,¹³¹ then shot at the faster rate of one arrow per six

¹²⁹ *MWF*, in *CS*, 161. There are variations of the charge story. Monstrelet says that Brabant was supposed to have 800 men, "but there were only 120 of them to force a way through the English." LeFèvre/Waurin tell us that of 1000–1200, "when it came to the time to attack they could only find 800 men." They also allege that "Sir Guillaume de Saveuses, a very valiant knight, took the Agincourt side with about 300 lances." Waurin himself says that "when it came to the time to attack there were but 120 left of the band of Sir Clignet de Brabant "on the Tramecourt side." Jean Juvenal de Ursins, in *CS*, 133 claims that "when they wanted to find 400 horsemen whom they had ordered the day before to break the battle line of the English, they could find only 40." The *Chronique de Ruiseauville*, in *CS*, 125 reports that "without any doubt, only few came."

¹³⁰ See Appendix IV.

¹³¹ This is the target range for modern Olympic outdoor archery competition. Stretton's statement bear this out: using his strong bow and heavy arrows, it is between 60 and 80 yards that "elevation is introduced to hit the target." "Practical Tests, Part

seconds, that would allow for 17 arrows starting at 275 yards, or 20 at 325.¹³² Since the archers outnumbered the charging horsemen about 5 to 1, this would mean that many horsemen would have more than 100 arrows targeted at them during their charge.

Let us consider the horsemen closest to the archers, i.e. those with just 275 yards to cover. Each would be facing about five archers; allowing each of them 17 arrows would mean each man-at-arms would be the target of 85 arrows, by the simplest calculation. But that ignores the fact that after each volley¹³³ there would have been fewer and fewer targets for each flight, as horses were brought down or turned back.¹³⁴ Let us now, in order to simplify the analysis, assume that archers all along the line reserved their fire versus distant targets, and all only delivered the same 17 volleys, though as already noted many would have been able to do more. To take some very arbitrary numbers, for illustrative

2,” 56. The last 70 yards through the Agincourt mud would take roughly 30 seconds at a trot, including the 15% and 50% increases in required time vs. eighteenth-century standards employed in the calculations in Appendix IV.

¹³² The estimate of 6–10 arrows per minute is quite conservative; cf. Hardy, “Longbow,” 162: “a skilled longbowman can and no doubt could loose up to 20 aimed arrows” in a minute; also Roy King, “Rambling on the Longbow—The Other Archery,” *Instinctive Archer Magazine*, Spring 1996, pp. 10–12 (and online at <http://www.tradgang.com/ia/1996spring/p10.jpg>, [~p11.jpg](http://www.tradgang.com/ia/1996spring/p11.jpg), and [~p12.jpg](http://www.tradgang.com/ia/1996spring/p12.jpg)), at 11. The later publication posits a four-second draw-to-release for Simon Stanley’s long-range shots; and Mark Stretton, “Experimental Tests,” in Hugh D. H. Soar, *Secrets of the English War Bow* (Yardley, Penn., 2006), estimates about 5–6 seconds for this operation. Of course, a rate of 15–20 arrows per minute would result in running out of arrows very quickly. A range of 275 yards would be more realistic for military volleys. Though Smythe *Certain Discourses*, 14v (margin) claimed some archers could shoot to 400 yards, he thought it absurd to envision combat volleys even at 300.

¹³³ That the English were firing by volley is born out by most of the major chronicles. *tirer à la vollée* (Le Fèvre, *Chronique*, 254); “At the first volley [*densum tractum*]” (Saint-Denis, in *CS*, 106; ed. Bellaguet, 560); *tirer à la vollée* (Le Fèvre, *Chronique*, 254); “the archers simultaneously shot”; “volleys of arrows struck” (Walsingham, in *CS*, 52); “numerous volleys” (Pseudo Elmham, in *CS*, 72). The same conclusion is also implied by the statement that clouds of arrows “took more light from the sun than a black cloud would have done.” (See note 167). For earlier variations on the phrase “*archiers traoyent a la volée*,” see Chandos Herald, *Vie du Prince Noir*, ed. Diana Tyson (Tübingen, 1975), ll. 1189, 3227; Cuvelier, *La chanson de Bertrand du Guesclin*, ed. Jean-Claude Faucon (Toulouse, 1990), ll. 9390, 14899. Though the evidence is thin, it seems that, as with most coordinated actions on the battlefield, the English used command shouts (begun by a leader and returned by all) to make possible firing by volleys, see *The Black Book of the Admiralty*, ed. T. Twiss, vol. 1 (London, 1871), 1:454–55; *Chronique de Ruisseauville*, in *CS*, 125; Basin, in *CS*, 190; Le Fèvre, *Chronique*, 253; Bennett, “Development of Battle Tactics,” 19–20.

¹³⁴ Some of these would have been due to the indirect rather than direct effects of the arrows, e.g. when a horse in the second line tumbled over a horse brought down in the first line.

purposes, say that only one arrow in 400 at the initial range (275 yards) was effective in disabling or turning back a horse or rider; assume that the men-at-arms charged immediately after receiving just that one volley; say another 0.25% of arrows at 265, 255 and 245 yards did the same, 0.5% at 235, 225 and 205; 1% at 185, 165 and 145; 1.5% at 125, 105 and 85; and 2% at 65 and 45.¹³⁵ It must be remembered that the legally-mandated *minimum* range for target practice for English bowmen under Henry VIII, when archery had declined substantially, was 220 yards.¹³⁶ True, that was against a stationary target, but one where the intended strike zone was much smaller than a single horseman, not to mention the broad-side-of-a-barn-scale target of a whole formation of cavalry.¹³⁷ Given these assumptions, of 500 horsemen initially lined up,

¹³⁵ The increasing effectiveness of the arrows at each stage would be due to a number of factors. First, of course, the closer the range, the easier it is to hit any target. Second, this would be especially true of a moving target, since the longer the distance the higher the trajectory, and the greater the likelihood of arrows falling either short or long. Once the arrows were fired at a relatively flat arc, judging the distance incorrectly would be of lesser import: e.g. in the final flight, firing essentially straight out, there would be no need to adjust for range. Third, arrows lose kinetic energy to air resistance as they fly; in general, the shorter the range, the harder the hit and the greater the probability of penetrating armor and inflicting serious damage. (This is an oversimplification, however; for complicated reasons, there are some points at which an increase in range causes an *increase* in impact. See Stretton, "Practical Tests, Part 2," 55–56.) Fourth, these calculations include "losses" from men turning back out of fear as well as due to death or serious wounds. Fear can build cumulatively; a man might brave a hit or two at long range without suffering serious damage, then be turned back less by the physical impact of a third, stronger hit than by the prospect of a still more powerful fourth. Furthermore, one of the strongest antidotes to fear is the solidarity of comrades advancing in line; as the advancing line thinned out, each remaining rider would feel himself more and more a particular target, and perhaps sense that his own luck was running out. This is of course speculative, but not purely so: we do have primary sources which state clearly that many of the riders turned back because they were "afraid of death" (*MWF*, in *CS*, 161, 163 and Tito Livio, in *CS*, 62) along with the others who lost control of their injured mounts or who were themselves hit and wounded or killed. Note that volleys strike at varying intervals in *yardage* because of two factors: the acceleration of the charge, and the countervailing accelerated rate of fire assumed for close range direct fire shots.

¹³⁶ Grose, *Military Antiquities*, 135. An exception in the mandated range was made for those under 24 years of age.

¹³⁷ At least one manuscript of Christine de Pizan's *Livre des fais d'armes*, if its editor and translator are correct, says that English bowmen were able to hit a barge (presumably used as a way to practice shooting at a moving target) at 600 feet. If de Pizan means the "Paris foot" of 12.79 inches, that would be 213 English yards. Christine de Pizan, *The Book of Deeds of Arms and of Chivalry*, trans Sumner Willard, ed. Charity Cannon Willard (University Park, Penn., 1999), 33. However, in Bodleian Ms. 824, f. 27v it is claimed that they can place their arrow right where they want it at that range: "*de vi^c pies loings mettoient la bonne ou ilz traioient.*" Essentially the same claim is made in BN Ms.

6 would be disabled by the provoking volley, 19 more lost by 245 yards, 37 more by 205 yards; another 25 each at 185, 165 and 145 yards; 111 more by 85; and 50 at 65 and at 45 yards. That would mean, from the initial 500, 494 advancing, 475 continuing past 245 yards, 438 past 205, 363 past 145, 252 past 85, 202 past 65, and just 152 brave and lucky souls pressing on (and, some of them, accelerating to an all-out charge) past 45 yards.¹³⁸ Since each volley would be the same number of arrows directed at fewer and fewer horsemen, by the time these hypothetical 152 reached that point, they would each have, effectively, been targeted not by 75 arrows, but by over 100, including more than thirty loosed at 85 yards or less. And for the last 45 yards, because a man atop a *magnus equus* is much taller than a man afoot, even at close range one or two ranks of bowmen would still be able to fire over the heads of his comrades in the front rank.¹³⁹ Hence, even if we arbitrarily assume that only one half of the archers had the steadiness of nerve to fire effectively in the last seconds before the stallions reached the stakes, that would be an average of around seven more full-power, point-blank shafts sent winging out towards each final target.¹⁴⁰ At that range, a very large proportion of shots would hit their mark, and nearly every hit would be at close to a “normal” angle (i.e. perpendicular to the target), and therefore have a good chance of penetrating gorget, visor, breastplate, or chanfron.¹⁴¹

The men and horses who survived and persevered to reach the palisade—and more than a few apparently did so¹⁴²—must mostly have

603, as edited in Christine Moneera Laennec, “Christine *antypgrafe*: Authorship and self in the prose works of Christine de Pizan with an edition of BN Ms. 603, ‘Le Livre des Fais d’Armes et de Chevalerie,’” (Ph.D. dissertation, Yale University, 1988), 2:53. My thanks to Craig Taylor for directing me to this useful dissertation.

¹³⁸ These calculations are made using rounding; using decimal calculations would produce slightly different results. Cf. Monstrelet, in *CS*, 161.

¹³⁹ Or more if, as would be only sensible, the archers were arrayed with the shortest men up front and the tallest in the rear.

¹⁴⁰ Of 2500 archers, there must have been about 820 in the first two ranks, or 1230 in the first three. Figure the first three ranks fire at 25 yards and the first two at 5 yards. This would equal 1025 arrows for 152 targets or almost seven arrows per rider.

¹⁴¹ See notes 28, 149, and Appendix I. Note also that in this circumstance the forward momentum of the horse and rider would significantly increase the impact of the arrow.

¹⁴² *Gesta* in *CS*, 35–36: “they were forced to fall back under showers of arrows and to flee to their rearguard, save for . . . the many who were stopped by the stakes driven into the ground and prevented from fleeing very far by the stinging hail of missiles shot at both horses and riders in their flight.” Saint-Denis and *MWF*, however, give the impression that few riders progressed as far as the stakes.

been pincushioned with minor wounds.¹⁴³ If they slowed and halted as they approached the stakes, looking for a way through or hoping to sweep down the palings with a swinging lance, they would have faced yet another sheet of arrows.¹⁴⁴ Some riders might have pressed on at speed, hoping to jump the stakes. These were horsemen and steeds of the highest quality, and on solid ground, even with the weight of their armor, they might have been able to manage it. It would have been very tricky, however, for the long stirrups, high pommel and cantle, and rigid torso armor used by late-medieval men-at-arms all worked against a rider's ability to assume a good jumping position, leaning forward and with heels down.¹⁴⁵ In the thick, slippery mud of Agincourt, it would have taken a truly exceptional (or exceptionally rash) rider and mount even to attempt such a leap, and the result would almost certainly have been failure. The horse would have been impaled, his rider cast forward into the muck, where he would lie prostrate, breathless, and helpless amidst a crowd of enemies. The same fate would have met (and, according to Waurin, did meet) the few men-at-arms determined enough, and riding steeds mettlesome enough, to try simply smashing

¹⁴³ This was the case with Sir John Paston's nephew, Henry Fenyngley at the battle of St. Albans in 1455, who "fought manfully and was shot through the arms in three or four places." Boardman, *Medieval Soldier*, 167. It was physically quite possible to continue fighting after suffering several arrow wounds, provided the victim had sufficient determination and depending on where exactly the arrows hit. There is an interesting example from the siege of Pontevedra in 1397. According to his standard-bearer, Don Pero Niño fought there for two hours, though at the beginning of the combat he was wounded by an arrow which pierced his camail (not, as in the Evans translation, his gorget) and left the armor knitted to the nape of his neck, and again later by a crossbow-bolt which pierced through his nostrils. As his standard-bearer told the story, although the arrow wound "hindered him much in the movement of the upper part of his body," the knight "felt not his wound, or hardly at all" and he proceeded to fight harder than before. Gutierre Diaz de Gamez, *The Unconquered Knight. A Chronicle of the Deeds of Don Pero Niño, Count of Buelna*, trans. Joan Evans (New York, 1928), 37–38; Gutierre Diez de Games, *El Victorial. Crónica de don Pero Niño*, ed. Juan de Mata Carriazo (Madrid, 1940), 82–83. The same goes for horses as well: e.g. see *The Unconquered Knight*, 194–96. Similarly David II of Scotland was able to put up a hearty fight against his captors after the battle of Neville's Cross, despite having two arrow heads in his skull (Rogers, "Scottish Invasion," 65–66), and Henry V himself, while still Prince of Wales, was very severely wounded by an arrow in the face at Shrewsbury, but continued fighting until the battle was won. Stickland and Hardy, *Great Warbow*, 264, 284–85.

¹⁴⁴ Tito Livio, in *CS*, 61–62: "All the English fixed in the ground stakes as a shield for themselves so that the advancing cavalry of the enemy was forced to pull back from fear or else was fixed, wounded, and killed."

¹⁴⁵ I am deeply indebted to Carroll Gillmor for helping me understand this whole topic, though she would not necessarily agree with all of what is written here.

through the barrier.¹⁴⁶ Those who pulled up short of the stakes, and survived long enough to wheel and flee, were unlikely to make it far before being shot in the back. The brutal realities of the scene are terrible to contemplate.

Defeat of the French Vanguard: The Advance

Dramatic as it was, the bloody wrecking of the French cavalry still left the English a long way from victory. It was the subsequent combat with the vanguard (the principal force of dismounted men-at-arms) on which the outcome of the battle largely depended. That division contained the key leaders and the majority of the elite fighters of the Valois army. Because of the way the French had deployed their forces, the fate of their second line was determined by the struggle of the first. The relative lack of senior leaders and men-at-arms in the rearguard made that force unlikely to tip the balance of victory or defeat, though its fresh troopers could have been devastatingly effective in a pursuit role if the Lancastrian army had broken under the onslaught of the more heavily armed combatants.

It must be remembered here that the primary target of the men-at-arms in the French vanguard was the English men-at-arms, whom they outnumbered by at least five to one. These are, as Shakespeare said, “fearful odds” whom they outnumbered by at least five to one,¹⁴⁷ and could not have been overcome except by the combined action of many factors. The four most important elements in explaining this phase of the battle are: (1) the nature of the battlefield, (2) the disruption caused by the maddened horses of the wing cavalry, (3) the impact of English arrows, and (4) the fact that the dismounted French men-at-arms were moving forward, while the English were standing still.

Two key characteristics of the battlefield itself combined with the last-mentioned factor to set the stage for French disaster. First, as noted in the discussion of the French plan, the field was a narrow one, ideal for a weak army’s defense, but highly disadvantageous for an attacking

¹⁴⁶ Waurin, in *CS*, 161: “It was their misfortune that their horses fell amongst [*entre*] the stakes and fell to the ground amongst the archers who killed them immediately.”

¹⁴⁷ *Henry V*, Act 4, Scene III.

army superior in strength.¹⁴⁸ This meant that if the French wanted to use their full numbers, they had to arrange them in a dense and very deep formation, with probably sixteen ranks in the vanguard alone. Second, the open fields over which troops had to advance were recently plowed, absolutely sodden after a week of heavy rain capped by the heavy downpour that had continued throughout the preceding night, and further liquefied by the churning hooves of the many French horses which had been exercised on the ground.¹⁴⁹ As a result, the heavily-armored men-at-arms, weighted down by plate worn over long mail shirts,¹⁵⁰ found themselves sinking in the soft ground over their ankles.¹⁵¹

Medieval infantry forces on the advance tended to move slowly, “by the small step,” in order to keep their array in good order. Over a muddy field like that of Agincourt, it would probably have taken at least fifteen minutes to cover the approximately 450 yards necessary to reach the English men-at-arms.¹⁵² For the first three minutes or so the

¹⁴⁸ Waurin/Le Fèvre, in *CS*, 159: “the site was narrow and very advantageous for the English and the very opposite for the French.” Note also Tito Livio, in *CS*, 60; Pseudo-Elmham (following Tito Livio), in *CS*, 71; Gruel, in *CS*, 184.

¹⁴⁹ Jean Juvenal des Ursins, in *CS*, 133 (“in their path...[they] found the worked ground very soft because of the rain which had fallen that week, whereby they could not easily move forward”). See also *Chronique de Ruisseauville*, in *CS*, 124: “all night [before the battle] it never stopped raining.” *MWF*, in *CS*, 154, 159. According to the *Chron. St. Denys*, ed. Bellaguet, 558: “*prodigia inundacione pluviarum*” fell on fields recently recently sown with grain. *MWF* in *CS*, 161 for the exercising of the horses.

¹⁵⁰ See note 173.

¹⁵¹ *The Chron. Saint Denys*, ed. Bellaguet, 558, says the mud was “over their ankles” [*ultra cavillas pedum*]. Cochon, in *CS*, 113 says it was “at least a foot [deep].” *Chronique de Ruisseauville*, 139: “their feet sank very deeply into the earth [*entroient moult parfont de leurs piés en le terre*].” Jean Juvenal des Ursins, in *CS*, 130 (drawing on Saint-Denis), claims that the mud rose “right to the thick of their legs”—i.e. mid-calf—so that “they could scarcely move their legs and pull them out of the ground.” Cf. also Jean de Bueil, in *CS*, 358: “a field with mud right up to their knees.” *MWF* in *CS*, 159 claim “the horses could scarcely lift their hooves out of [the mud]...” The horses’ horseshoes would have been particularly difficult to pull out of the mud, as smooth metal in contact with mud creates a strong “suction” effect. This was illustrated well in the “Battlefield Detectives” television program on Agincourt, though it was misapplied there, since men-at-arms did not (unlike horses) have metal on the bottoms of their feet.

¹⁵² The ordinary parade-ground pace for the French infantry in 1750, with the benefit of cadence, was 40 yards/minute (60 paces of 24”); the regulations also allowed for a “small step” of just eight inches. Brent Nosworthy, *Anatomy of Victory: Battle Tactics, 1689–1783* (New York, 1990), 204. In the American Revolution, it was the same. For the exceptionally well-drilled army of Frederick the Great, the drill pace at the “ordinary step” was just over 52 yards/minute. William [sic] Balck, *Tactics*, trans. Walter Krueger, 2 vols. (Ft. Leavenworth, Kan., 1911–1914), 1:54. At Agincourt the French advanced “without rushing.” *Chronique de Ruisseauville*, in *CS*,

vanguard probably received very little fire, since the archers were busy warding off the cavalry attack. But even a few arrows—which at long range would have fallen nearly vertically—would have encouraged the men to keep their heads down, to protect their faces. The visor was generally among the thinnest pieces of a knight's armor, and even a penetration of just an inch or two could do severe damage there. Many fourteenth-century sources describe archers "blinding" large numbers of their enemies.¹⁵³ Those within the center of the formation, who were of course the vast majority of the total, could not have seen much anyway. Imagine the effect on such a densely-packed mass of nearly-blind¹⁵⁴ men when the out-of-control stallions driven back by arrow-fire crashed in among them, as the sources emphasize that some of them did.¹⁵⁵ This

125. I use the figure of 450 yards because the English *archers* were at longbow-range, and the men-at-arms were farther back. Keegan's estimates are very different; he figures the English could have advanced 700 yards to their second position in just ten minutes, and that the French dismounted men-at-arms would have taken only 3–4 minutes "at most" to close with their English counterparts (apparently figuring they had only "two or three hundred yards" to cross to do so.) *Face*, 90, 97, 95. Even if he is right, it would not make too much difference, since the archers could have easily fired all the arrows they had in the eight minutes it would have taken, even at that rapid clip.

¹⁵³ Monstrelet, in *CS*, 160: the French "began to bow their heads so that the arrow fire would not penetrate the visors of their helmets." See also note 28 and Appendix I. For arrow blinding the enemy, see *Chronicon de Lanercost, MCCI-MCCCXLVI*, ed. J. Stevenson (Edinburgh, 1839), 268, 274. David II suffered two serious arrow wounds in his skull at Neville's cross; Philip VI left the field of Crécy with an arrow in his jaw. Rogers, "Efficacy," 238. The earl of Douglas, despite his "extremely costly" armor, lost an eye at Homildon Hill in 1402. See *Liber Pluscardensis*, ed. F. J. H. Skene (Edinburgh, 1877), 344. The future Henry V was badly wounded by an arrow in the face at Shrewsbury. According to the report left by his surgeon, he was "struck by an arrow next to his nose, on the left side"; it "entered at an angle, and after the arrow shaft was extracted, the head of the aforesaid arrow remained in the furthestmost part of the bone of the skull for the depth of six inches." Strickland and Hardy, *Great Warbow*, 284–85. His son Henry VI and the duke of Buckingham were both wounded by arrows in the face at St. Albans in 1455—Buckingham three times. Boardman, *Medieval Soldier*, 167, 187. It should be remembered, also, that the effectiveness of the visor was reduced by the fact that, unlike other pieces of armor, it could not be backed by quilted cloth protection.

¹⁵⁴ Cf. Jean Juvenal des Ursins, in *CS*, 133, "Our men...lowered their heads and inclined them towards the ground. When the English saw them in this position, they advanced on them so that our men knew nothing until they hit them." Note also that, as Matthew Bennett points out (following Juvenal des Ursins) "the English stood with the low, winter sun behind them." *Agincourt*, 80.

¹⁵⁵ *MWF*, in *CS*, 161, modified slightly from Le Fèvre, *Chronique*, 255–56: "Because of the strength of the arrow fire and their fear of it, most of the others doubled back into the French vanguard, causing great disarray and breaking the line in many places, making them fall back onto the ground which had been newly sown. Their horses had

would have happened not just once, but probably in several waves, following the volleys of the archers against the cavalry. Each time, after each horse had pushed its way through or been brought down, the men who had been thrown to the ground or pushed aside, even if not trampled by the horses or by their own comrades, would have faced difficult decisions. They knew and accepted as an article of faith that it was of the utmost importance for them to maintain their formation. They would normally look to their banners to see where they should be,¹⁵⁶ but that would require looking up, perhaps raising their visors, and risking death from a descending arrow.¹⁵⁷ The banner-bearers in the areas of impact themselves had to decide: should they halt to allow the

been so wounded by the arrow shot of the English archers that they could not hold or control them. As a result the vanguard fell into disorder and countless numbers of men-at-arms began to fall." Gruel, in *CS*, 184: "there were a large number of horsemen on our side, Lombards as well as Gascons, who were supposed to make an attack against the English wings. When they experienced the arrow fire coming so thickly, they put to flight and broke the battle line of our men in such a way that they had great difficulty ever getting back into order." Cochon, in *CS*, 186: "the shower of arrows fell upon [the horsemen] so thickly, that they were compelled to retreat amongst their own people, by which they broke their vanguard." Note also Walshingham, in *CS*, 52: "The horses were pierced by iron; the riders, turning round by means of their bridles, rushing away, fell to the ground amongst their army." This episode does lend some credibility to the idea that the main French battles occupied a wider line than figured above, since if they had room to avoid the men, most of the retreating horses would have done so. My hypothesis is that most did indeed do just that. But if we assume—just as an illustration—that of 700 horses, 570 survived to retreat from in front of the archers, and that 95% of those 700 did move back through the empty space, that would still leave 25 animals blinded by blood from wounds crashing into the formations. Each one of these would have caused major disruption. Another point to consider in this regard is that a horseman near the inner flank of the first line who, for example, had a seriously wounded horse and wanted to turn back might turn his horse towards the middle of the field in order to get out of the way of the second line, i.e. into the empty space directly in front of the dismounted men-at-arms. Similarly, someone in the second line deciding to "drop out" of the charge might first head inwards in order to increase the range between himself and the archers (and make himself a less attractive target) before turning back. Once he had begun to retreat, if he wished to avoid his own men-at-arms he might then have to turn his horse back towards the archers, something he or his horse might be unwilling to do—perhaps thinking that his own comrades would get out of his way (or at worst bring down his horse), whereas a lone charge in the direction of the bowmen might prove suicidal.

¹⁵⁶ De Pizan, *Book of Chivalry*, 48, 65–66; Bodleian, Ms. 824, ff. 37, 49v: "*au regart de la baniere se gouverne l'ost; la principale baniere a la quelle est le regart de la bataille.*" Note also Le Baker, *Chronicon*, 149, where it is taken as exceptional that Maurice Berkeley (having broken formation to pursue a retreating foe) pays no attention to the banners in the air.

¹⁵⁷ Lifting their visors is something Le Fèvre and Waurin specifically say the French men-at-arms "dared not do." Le Fèvre, *Chronique*, 254: "*ne s'ozioient les Francois descouvrir.*"

restoration of order within their own unit, even though that might put their banner out of line with the others, not to mention increasing the amount of time they would be under fire before reaching the enemy? Or should they press on, hoping that order could be reestablished on the move—even though they knew that just *keeping* order on the move, much less regaining it once lost, was a difficult task?

Then, for another ten to fourteen minutes after the intermittent hammering by maddened warhorses had ended, the soldiers had to pass through a constant hail of arrows. It is likely that the bowmen loosed only a couple of shots a minute at long range, conserving their arrows for rapid fire at short range. Every thirty seconds or so, then, assuming the English were firing in volleys, as they almost certainly were,¹⁵⁸ there would have been a shout of command, the terrifying thrum of 5,000 bowstrings singing in unison, the rushing sound of feathered shafts flying up then falling down,¹⁵⁹ a sudden darkening of the light as the arrow-cloud obscured the sun,¹⁶⁰ a deafening clatter of steel on steel, like the heaviest imaginable hail against a tin roof, mingling with a chorus of curses and screams as some of the arrow-tips sank into flesh.¹⁶¹ At Neville's Cross in 1346, the Scots advancing through the arrow-storm were described as "advancing stooped over," like men leaning into a downpour.¹⁶² This description would doubtless have applied to the French at Agincourt: they marched with bowed heads, for they dared not, we are told, raise their visors or look up.¹⁶³ Each man's sensory

¹⁵⁸ See note 138.

¹⁵⁹ Keegan says the sound would not have gone before the arrows themselves, but arrows do not travel at supersonic velocity.

¹⁶⁰ "Raising horrible cries, they began to bend their bows with all their might and to let fly arrows into the enemy in such quantities that their density obscured the sky just like a cloud." (Basin, in *CS*, 190). They took more light from the sun than a black cloud would have done." *Pastorelet*, in *CS*, 352. See also Pseudo-Elmham, in *CS*, 72; Monk of St. Denis, in *CS*, 106.

¹⁶¹ Cf. Walsingham, in *CS*, 52.

¹⁶² *Chronicon de Lanercost*, 349: "*proni procedentes*." See also Keegan, *Face*, 41.

¹⁶³ Waurin and Le Fèvre, in *CS*, 160: "the French began to bow their heads... The English fired so vigorously that... the French did not dare uncover themselves or look up." Monstrelet, in *CS*, 160: "the French began to bow their heads so that the arrow fire would not penetrate the visors of their helmets." Likewise, at Neville's Cross, the Scots "were unable to lift their heads." *Historia Roffensis*, in Rogers and Buck, "Three New Accounts," 78–79; *French Chronicle of London*, ed. G. J. Aungier, *Camden Series*, XXVIII (London, 1844), 77. It is interesting to note Lord Chandos's much more recent observation that "Troops always, in my experience, unconsciously assume this crouching position [like men walking into a strong wind or rain] when advancing against heavy fire." Quoted in Keegan, *Face*, 248.

world would have been reduced to the sight of a narrow slice of mud sucking on the armored feet of the next rank forward, the smells of wet manured earth,¹⁶⁴ blood, and fear, and the rumbles of marching and muttering from his fellow soldiers, interspersed with the more frightening noises already mentioned, coming more and more frequently, and punctuated with ever-louder and more widespread cries of distress as the effectiveness of the arrows increased with diminishing range.

Even arrows that did not penetrate armor would have hit with all the bruising force of a blacksmith's hammer, potentially knocking a man off his feet or breaking bones.¹⁶⁵ With perhaps twenty arrows falling for each soldier in the vanguard, the average man was probably hit several times, with a mix of penetrating and non-penetrating shots.¹⁶⁶ Some men probably had arrows nail their hands or arms to their lances, as the *Scottichronicon* describes happening at Homildon Hill in 1402.¹⁶⁷ Those who were injured in foot or leg, or stunned by a blow to the back of the head, would have had to struggle to keep from falling; if they did go down, their comrades would have had little choice but to

¹⁶⁴ See footnote 163 above.

¹⁶⁵ This is like the arrows of the twelfth-century archer, Benkin, whose "shots stupefied and stunned, even if [due to the target's armor] they did not wound." Galbert of Bruges, *The Murder of Charles the Good*, trans. James B. Ross (New York, 1967), 165. Useful insight into this very important aspect of the battle can be found by reading the experiences of the reenactor Robert Reed ("Chef de Chambre") (Historic Interpreter, Higgins Armory Museum) posted at <http://forums.armourarchive.org/phpBB2/viewtopic.php?t=31091&sid=fa8aa65336e85831dc81530d9872a7853> <http://forums.armourarchive.org/t=31091> (25 May, 2005, 9:50 PM). We must bear in mind that a strong archer's heavy bodkin arrows would most likely have around double the kinetic energy and three times the momentum of the ones used in this experiment.

¹⁶⁶ In a period of ten minutes, the archers—who were equal in number to the soldiers of the French vanguard—could easily have shot three times that many arrows, if they had them, but they would have used some up firing on the cavalry and directed some towards the second line of the French. Most of them probably began the combat with two sheaves of 24 arrows each. At Poitiers, according to the *Eulogium historiarum*, some archers loosed over a hundred shafts before the battle was decided, however, Geoffrey le Baker indicates that in order to do this they had to recover arrows from the ground and from the bodies of "half-dead wretches" during a pause in the fighting. Le Baker, *Chronicon*, 150; *Eulogium historiarum*, ed. F. S. Haydon, 3 vols. (London, 1858–1863), 2:225.

¹⁶⁷ Quoted in Strickland and Hardy, *Great Warbow*, 263.

walk over them, which would have been intensely miserable for both the trampled and the trampers. Indeed, considering the depth of the mud, it could have meant death to anyone who fell face-forward. Of course, in a formation that started out as a dense one and, through a process of compression, had become packed even tighter, it would have been difficult to fall.¹⁶⁸ Doubtless in many cases the wounded were helped forward by their friends to the right and left—meaning in each instance three men focused on something other than fighting. If they tried to push their way to the rear, they would cause great disruption in the dense mass. If, on the other hand, they tried to hold their positions and move forward with the formation, all men in the files behind them would be blocked from any possibility of participating actively in the fighting. If those stacked up behind a wounded man halted until the neighboring files had cleared his position, so that he could fall out of formation and not be trampled, the disruption to the formation would again be substantial.

The result of all this would have been an intense adrenalin rush and a constant state of whole-body muscular tension for every soldier in the advance. Anyone who has participated in boxing or any other martial art knows how draining just a few minutes of that can be. Under these circumstances, marching across a muddy field encumbered by sixty to eighty pounds of arms and equipment—including a visored bascinet that made it difficult to draw the deep breaths necessary to sustain significant exertion—must have entailed an exhausting physical

¹⁶⁸ The situation would be similar to what Guy of Amiens says of Hastings, and the reports of Robert the Monk and Gilo of Paris (not independent testimonies, admittedly) concerning the battle of the Iron Bridge outside Antioch in the First Crusade. Guy of Amiens, *Carmen de Hastingae Proelio*, ed. Catharine Morton and Hope Muntz (Oxford, 1972), 27; William of Poitiers, *Gesta Guillelmi*, ed. and trans. R. H. C. Davis and Marjorie Chibnall (Oxford, 1998), 131: “so tightly packed that there was hardly room for the slain to fall”; 133: “the dead by falling seemed to move more than the living. It was not possible for the lightly wounded to escape, for they were crushed to death by the serried ranks of their companions.” *Robert the Monk’s History of the First Crusade*, trans. Carol Sweetenham (Aldershot, 2005), 132; *The Historia Vie Hierosolimitanae of Gilo of Paris*, ed. and trans. C. W. Grocock and J. E. Siberry (Oxford, 1997), 118–121, esp. 119: “The bold and the fearful perished together: one was prevented from fighting in the fray, the other was denied a sure [*fida*] escape... they were packed chest to chest and limb to limb. Only our men waged war: the Turks endured it. Parthian and Arab helplessly fell forward on the sword, and our men could not kill to the same extent as the close-packed host could die.” Note also to Lucan’s *Pharsalia*, IV.775–87.

effort.¹⁶⁹ Thus, when the two lines clashed and began to draw on their reserves of energy for the desperate business of hand-to-hand combat, the English were fresh, while the French were already “worn out,”¹⁷⁰ even “exhausted.”¹⁷¹

The men on or near the left and right edges of the mass (only a small minority) would have suffered far less from the physical compression and sensory isolation that beset those in the center. When wounded, for example, they could have fallen out of the ranks without being trampled, and they would have been able to see and understand what was happening in the battle to a somewhat greater extent, though even their degree of visibility would have been limited by the danger involved in looking up from the ground. This would have been small consolation, however, since seeing the rout of the cavalry was disheartening.¹⁷² Those on the edges would also have faced the dismaying sight of skirmishing archers who seem to have hovered around the French formation. These men fired point-blank shot after point-blank volley directly into the faces of men-at-arms with little fear of retaliation from enemies who were forbidden to break ranks. Any Frenchman who tried to charge these archers would have become a special target; and, in any case, such an individual, in his heavy armor, could hardly have succeeded in coming to grips with an agile Bowman twenty or thirty yards away.¹⁷³

¹⁶⁹ Fifty-seven pounds would be fairly typical for a full “white harness,” but the typical man-at-arms at Agincourt seems to have worn in addition to his plate armor a camail and a “very heavy” coat of mail, down to his knees, which would weigh at least twenty pounds, and probably closer to thirty. In respect to the weights, see Vale, *War and Chivalry*, 184–85; Claude Blair, *European Armour* (London, 1958), 192. For what was worn at Agincourt, see *MWF*, in *CS*, 159. Lefèvre, *Chronique*, 252 speaks of the “long coats of steel” (*cotte d’achiers longhes*). All the iconographic evidence indicates soldiers at Agincourt wore mail hauberts.

¹⁷⁰ Elmham, in *CS*, 47; similarly Pierre de Fenin, in *CS*, 118: “much worn down.”

¹⁷¹ Saint-Denis, in *CS*, 107 (ed. Bellaguet, 562: *nimio fatigati*); *Chronique anonyme*, in *CS*, 115: “exhausted and . . . so worn out they could scarcely move”; note also Waurin, in *CS*, 159. Had it not been for the power of the English archery, the French could have and almost certainly would have halted a moderate distance from the English line in order to recover breath and order—just as the English did during their advance (Le Fèvre, *Chronique*, 253)—but there is no sign in the sources that they did so.

¹⁷² *Chron. St. Denys* (ed. Bellaguet), 562.

¹⁷³ The archers would not have gotten much closer than that for a variety of reasons, the two most important of which being the need to ensure they could not be reached by a sudden charge, and the need to stand away from the zone in which the arced fire of the main forces was falling. For the latter reason, they would probably have stood farther away from the mass early in the advance, when there would have had to have been more margin of error for longer-range fire.

Throughout their advance, substantial numbers of the French were killed or wounded by the incoming clouds of arrows. “Many of the French fell, pierced with arrows, here fifty, there sixty,” writes one author.¹⁷⁴ Because of the direct fire just described, the soldiers on the perimeter would have been especially hard hit. The heaviest losses of all, however, would have come to the men on the flanks once they came into point-blank range of the palisade. By then the archers would have begun to focus their fire intensively on the men-at-arms whose approach threatened them personally—those on each flank of the advancing line.¹⁷⁵ Not only would this now be close-range fire, it would also be coming at them “from all sides.”¹⁷⁶ Because the English wings were angled forward and extended farther laterally than the French vanguard, as the latter advanced towards King Henry’s men-at-arms, it would have been entering into a sort of well of fire. As the French formation marched past them, the archers on the far extremities of the English line gained the ability to fire directly into the flanks and then the rear of their advancing enemy.¹⁷⁷ As at Cannae, the forward movement of the attacking force had carried it into the jaws of a double envelopment.

It is probably the intensity of fire against the flanks that explains a peculiar phenomenon noted by the Chaplain. When they came close to the English main line, the French, who up until then had maintained a solid line, seem to have divided into a sort of trident formation, with each of its three prongs pointed at the banner that marked the center of an English division.¹⁷⁸ Some modern historians have suggested that

¹⁷⁴ Walsingham, in *CS*, 52. Note also *Chron. St. Denys* (ed. Bellaguet), 560 (the archers’ arrows “gravely wounded many of the French”) and Dwyer, in *CS*, 173.

¹⁷⁵ This means that fewer than 45 men would have been the main target of several hundred short-range or direct-fire arrows during each volley fired in the last minute or two of their advance. Twelve or more such volleys would have left few Frenchmen standing.

¹⁷⁶ Walsingham, in *CS*, 52: “the cloud of arrows flew again from all directions.”

¹⁷⁷ *Gesta*, in *CS*, 36: “our archers notched their sharp-pointed arrows and loosed them into the enemy’s flanks.”

¹⁷⁸ *Gesta* (ed. Taylor & Roskell), 90–91. Keegan accepts that the French men-at-arms at this stage were lined up only opposite the English men-at-arms, which should have led him to doubt that they had initially been lined up “from woodline to woodline,” since that would then have required the men on the far flanks to come around 200 yards inward as they advanced—or even as much as 350 yards inward, if the width had really been around 1,000 yards as he figures. (By his map, it would be roughly 166 yards, but his map cannot be reconciled with his text, since it shows the French first and second lines with frontages of around 700 yards, equal to the entire English frontage; yet his text [*Face*, 91] has the English occupying 950 yards, and the French

this resulted from the French aristocrats sheering away from the archers out of disdain,¹⁷⁹ but if the knights and esquires of the vanguard had begun the battle with that attitude, it cannot have survived this long. While the sources do tell us that the French avoided the bowmen, they state explicitly that this was due not to contempt, but to fear. In the words of one French chronicler, “the English fired so vigorously that there were none who dared approach them”¹⁸⁰ due to the “continuous way in which they had rained down on our men a terrifying hail of arrow shot.”¹⁸¹

Apparently, the survivors of those parts of the French line that extended in front of the archers finally decided to break formation and push inward and forward toward the temptingly thin line of English men-at-arms, thereby escaping the pitiless rain of arrows. As a result, they crossed in front of their own main line. This would explain the left and right prongs of a trident. A similar channeling of French men-at-arms might have occurred in the center, if indeed there were small wedges of archers flanking the English king’s center division.

There are several alternative scenarios that might explain the “central prong” of the French trident. Once their formation had been broken by heavy casualties and losses in leadership (especially the banner-bearers), individual knights may have been pulled towards the center of the line either by clustering around their main banners, or by an eager effort to recover the day by personal heroism. From their perspective, it was only necessary to cut through at most three ranks of Englishmen in order to reach the enemy’s principal banners or even the person of King Henry. If their banners or sovereign went down, the English could

dismounted men-at-arms about the same [87, 88, 97, and cf. 91]). This is at least better than the scale on Hibbert’s map, which, doubtless due to a typesetting error, has the same frontages stretching about two miles. (*Agincourt*, before p. 101; cf. his text on p. 99). If we take the boundaries of the open fields as they appear on the Woodford survey, then measure the distance from west-east along the Agincourt-Tramecourt road using satellite imagery (on GoogleEarth, for example) for confirmation, we find that the linear frontage of the English position would be only 700 yards.

¹⁷⁹ Keegan, *Face*, 83; Hibbert, 110; cf. Bennett, *Agincourt*, 80.

¹⁸⁰ Le Fèvre/Waurin, in *CS*, 160. Likewise Dwyer, in *CS*, 173: “The English archers caused maximum damage to the French with their arrows, so that they could not get close enough to the English to engage them in hand-to-hand combat.” The latter “English” must still refer to the archers specifically, since of course the English men-at-arms *were* engaged hand-to-hand.

¹⁸¹ Saint-Denis, in *CS*, 107.

be expected to break, freeing the French vanguard from the noose that was strangling it.

Another alternative explanation would have the troops in the center being literally squeezed out of their formation, as inward pressure from the flanks (caused by the “push” of enfilading arrow-fire) compressed the mass of the Frenchmen until the soldiers in the center had to elbow and fight their way forward out of the crush, lest they be smothered to death. Indeed, any combination of these factors could have worked together to funnel survivors of the final phase of the advance into narrowing, wedge-like columns.

Defeat of the French Vanguard: The Contact

There must have been a tremendous surge of emotion in the belly of each front-line French soldier when he finally came up within a few yards of the English men-at-arms. He had persisted through a truly hellish experience, risen to the occasion, and shown himself and all the world that he did not lack courage. If he had the good fortune to be positioned near the center of one of the English battles, he would finally be freed from the need to endure arrow-strikes. All he had to do now was cut his way through the four ranks of enemies in front of him, and he would win victory and undying glory.

Many French men-at-arms would have looked forward to the prospect of hand-to-hand combat with a peer in any case; under these circumstances, the prospect of an even fight would have been intensely desirable.¹⁸² However, the typical French man-at-arms in the first rank faced a fight that was far from even. He was very likely seriously bruised and battered by arrow-strikes which had not penetrated his armor, and probably also suffering from one or more minor wounds from shafts that had reached flesh. He was physically exhausted by slogging through the mud under fire and by his efforts to resist the thrusts and eddies of crowd-pressure. His feet were still deep in the

¹⁸² Le Fèvre/Waurin, in *CS*, 169: “on all sides men were flooding in as if they were going to a festival of jousting, joust or to a tournament.” de Pizan, *Book of Deeds of Arms*, 33, 36; idem, *Livre des fais d’armes*, Oxford, Bodleian Ms. 824, ff. 26v–27: *qui en tel discipline [l’art et science d’armes] est bien enseigne paour de combatre n’a nulle, contre quelconque adversaire; ains lui est si que droit soulas et delit*. She also advises selecting as men-at-arms those who *se delicter en l’exercite d’armes* (f. 29v).

mud, whereas his opponent's were likely planted on the relatively solid unplowed ground of the Agincourt-Tramecourt wagon track.¹⁸³ If he had broken out of line to charge forward, he had the advantages of momentum and sufficient room to move, but he also suffered the tremendous disadvantage of being a single individual fighting a solid formation. While his own flanks were completely unguarded, the flanks of his opponent were secure.¹⁸⁴

The original plan drawn up by Marshal Boucicaut suggests that many of those stationed in the front ranks may have been armed with axes of various sorts, and some of the front-line troops may have taken the large shields known as *pavises* from the crossbowmen for extra protection.¹⁸⁵ The few who survived were relatively successful, some of them managing to penetrate the English line before being taken down.¹⁸⁶ But most of those originally in the front had probably been brought down by arrow fire earlier in the engagement and replaced by lancers who had cut their lances in half to make them stiffer and handier for close-quarter fighting, as French men-at-arms habitually did when anticipating combat on foot.¹⁸⁷

¹⁸³ This is not mentioned specifically in the sources, but it is likely for several reasons. First, it would be the obvious thing for Henry to do to halt his men-at-arms on that lone strip of solid footing. Second, it would help explain how the English were able to halt the first push of the French, despite the mass of the latter. Third, Tito Livio has contact occur when the English are "within twenty paces of the town of Agincourt." (In *CS*, 61.) Fourth, Tito Livio (in *CS*, 60), Pseudo-Elmham (in *CS*, 71), and Walsingham (in *CS*, 51) put the English within "two or three bowshots" or 1000 paces from the initial French position, reports that fit neatly with the length of the "tunnel" formed by the hedges of Agincourt and Tramecourt, implying that the French were at one end of it, and the English at the other. The *Gesta* states that the men-at-arms made contact when each side "had advanced towards one another over roughly the same distance," which would have them right about at the road. (In *CS*, 36).

¹⁸⁴ Note the comment of Jean de Bueil (whose father, uncles, and cousins were killed at Agincourt) that one reason for the French defeat was that "when it came to fighting, they made contact with very few men, a few at a time [*les ungs après les autres*]." *Le Jouvencel*, ed. Léon Lecestre, 2 vols (Paris, 1889), 2:63.

¹⁸⁵ For the evidence of front-line troops armed with axes, see Plan, in *CS*, 468, in the context of Elmham, in *CS*, 47. On the question of shields, see Waurin/Le Fèvre, in *CS*, 160: "The French began to bow their heads, especially *those who had no shield (pavaix)*, because of the English arrow fire." (Emphasis added.)

¹⁸⁶ Elmham, in *CS*, 47.

¹⁸⁷ *MWF*, in *CS*, 159, 161. For an illumination showing combat with these weapons, see Contamine, *Guerre, état, et société*, pl. 18 facing p. 658. According to Froissart, the French cut their lances down to five feet at Poitiers, Calais, and Auray, as did the Navarrese at Thorigny, and (exceptionally) the English at Nogent-sur-Seine. Froissart, *Oeuvres*, 5:243, 5:413, 7:46; 6:136; 6:164.

If there were two lone individuals in a field fighting, one with a 5' lance or any other short hand-weapon and the other with a full-length shaft, the odds would be all in favor of the former. He would, with any luck, be able to knock aside the point of his enemy's weapon and leap or jog forward to get "inside the guard" of the latter, where he would be past and therefore immune to his enemy's spear-point. Meanwhile, he could still effectively wield his own shorter weapon. But the dynamic was quite different when two formations clashed. At Agincourt, the leading French spearman, in order just to get within striking distance of his enemy, had to sidestep the thrusts of two enemy lance-tips, since the weapons of the second rank of Englishmen would have extended around six to seven feet in front of the first rank—i.e. farther than the available thrusting length of his own five-foot weapon.¹⁸⁸ Even then, he would still need to cope with the strikes of the spears from the third rank. This would buy the first Englishman the time he needed to draw a sword and dagger, letting him again fight on favorable terms.

Thus far we have been envisioning the attack of an individual French soldier who had broken formation and charged against the English line. Where that did not occur, and after a minute or two of combat even where it did, the full mass of the French line would have come up parallel to the English front. At this point, the Frenchmen would regain the advantage of comrades protecting their flanks. On the other hand, and more importantly, they would lose the ability to dodge backwards or to the side. In turn, that would reduce their ability to work their way past the lance-points in front of them, even if the French were simply in a close formation. But the French by this point were hardly in anything much like an ordered formation; they were more of an

¹⁸⁸ The allowance of 3' of depth for each rank is that given for sixteenth-century pikemen by Digges. Mainly from various iconographic evidence, I conservatively assume a lance of 10–11' and, for the first two ranks, the rear hand 1' up from the butt of the weapon, so that at full thrusting extension all but that one foot would be forward of the wielder's shoulder. A man in the third rank would likely use an overhand grip with his rear hand even with the butt. In 1397, the Irish reportedly used spears or lances four yards long. At that time these were considered (by a Spanish observer) exceptionally long, but by 1453, a length of 13.8 modern feet from point to rest—i.e. approaching 16' overall—was normal for a man-at-arms' lance. Antoine de la Sale, *Histoire et cronique du petit Jehan de Saintré* (Paris, 1830), clxiii. Note also Contamine, *Guerre, état, et société*, 302 (n. 147), 659. See also the illuminations in Nicholas Hooper and Matthew Bennett, *Cambridge Illustrated Atlas of Warfare: The Middle Ages* (Cambridge, 1996), 143. For shortened lances, in Contamine, *Guerre, état, société*, plates 2 and 18, and Cuvelier, *Chanson de Bertrand du Guesclin*, 109; and *Medieval Warfare*, ed. Keen, 145.

oppressively dense crowd, and moreover one driven forward by the pressure of the rear ranks' efforts to continue to advance.

As individual French men-at-arms, bleeding, exhausted, and crowded together, lost their separate combats and went down, the men of the next rank, advancing to take their places, would have to begin their own effort to push through the lance-hedge while standing on the highly unstable platform of their fallen comrades.¹⁸⁹ This would have been bad if the downed men had been killed, worse if they had only been wounded or stunned, and were struggling to save their own lives by getting back on their feet, or just by turning their faces out of the smothering mud. Those who went down, moreover, would often fall forward, since there was no room to fall in any other direction. A man might also die standing up, or be pushed back by a lance-thrust onto the person behind him. In that case, the men at the back would have had little choice but to push the corpse—or wounded comrade—forward, hoping to bring an enemy lance-point to the ground with it. Once even a few men had gone down on a given section of front, there might thus be a four- or six-foot wide band of bodies covering exactly the same ground that the next man up would have to cross, while dodging lance-points, before he could make his first effort to hit an opponent. Before long the blockage would be two or three bodies deep, in places, and even more treacherous.¹⁹⁰

Under such circumstances, a French soldier stepping up into the front rank could hardly have been blamed for concluding that his prospects were grim, that he had done all that could reasonably be asked of a man by getting this far, and that he would now be justified in trying to escape. But, unless he happened to be on or near the flank of the French formation, how could he?¹⁹¹ To the left or right, escape between gnashing jaws of spear-thrusts coming from both sides would be virtually impossible. He might try to shoulder his way back, but those behind

¹⁸⁹ Keegan, *Face*, 100–1, made this point very well, and it is a crucial one.

¹⁹⁰ The French would have had the best chance of success in their individual combats at the first phase of the contact, before they were so pressured from the rear, and before they had to walk over bodies to reach the English. Hence, at first contact they were able to push the English back nearly a lance-length. *Gesta*, trans. Taylor and Roskell, 88; Pierre de Fenin, in *CS*, 118. This fits with Tito Livio's observation that "Of the English, the duke of York, the earl of Suffolk and others numbering up to a hundred were killed *in the first fight*." In *CS*, 63 (emphasis added).

¹⁹¹ See, for example, Gilo of Paris's description of the battle of the Iron Bridge, in note 168.

would presumably not be eager to allow that, and were so densely packed that it would have been very difficult anyway.¹⁹² Furthermore, to make the attempt, he would have to turn his back on his opponent, with no real hope of being able to leap out of harm's way faster than a blow could come.

Those in the rear ranks, of course, had more flexibility in this regard, but as already noted, they would not have had a very good idea what was going on twenty, thirty or even forty feet in front of them. They were far enough back that they were doubtless still taking some plunging arrow fire from English archers confident that they could fire accurately enough not to drop shafts among their own men.¹⁹³ Consequently, those in the rear would have had a strong incentive to keep their heads down and visors in place. The noise of combat would also have been intense. Still, after a while even they must have understood that things were not going well up front. We can imagine cries of "Get back! Stop pushing! Make room!" or even "Retreat! Retreat!" By this point, some men must have succumbed to terror, or simply let pragmatism overcome fear of dishonor, and turned tail. The opportunity for such an escape would have been rather short-lived, however, for it would only have taken about ten to fifteen minutes before the second division arrived behind the first, closing off the possibility of escape for the vast majority of the army.¹⁹⁴

At this point, the only outlet for the pressure of the French advance would have been on the flanks. Doubtless some individuals and small groups did break away and try either to charge the archers or to flee to the rear. Those who attempted to come to grips with the bowmen stood little chance of success. Again, in an individual contest, an armored man-at-arms, even one exhausted by the stress of combat and the mud-march, would have the advantage over an archer, however "light on his feet" the latter might be—provided, that is, that the Frenchman

¹⁹² For another example, see Lucan, *Pharsalia*, IV.778–9: "*Ac, si quis metuens medium correpsit in agmen, / Vix impune suos inter convertitur enses*" (trans. Sir Edward Ridley: "did any shun the foe, / Seeking the inner safety of the ring, / He needs must perish by his comrades' swords").

¹⁹³ For archers firing from the flanks, i.e. with their arrows firing more or less parallel to the French line, it would not have been very challenging to keep their arrows within a few yards of left-right deflection.

¹⁹⁴ The second division started off a bowshot behind the first division. Document in *CS*, 446–67. It would have largely avoided the delays occasioned by the horses from the wing forces that struck the vanguard, but would also have been slowed more by the mud, which would have been even worse after the first division's passage.

was not handicapped by arrow-wounds suffered earlier.¹⁹⁵ However, at this point in the battle, it would not have been an individual man-at-arms facing an individual archer. Where the English center, composed of men-at-arms, met the wings of archers, the bowmen's formation would still have been intact and protected by the stake fence. While this barrier might not have provided a strong defense against dismounted men-at-arms, it would have slowed down any approach long enough to ensure that there was time for concentrated arrow fire to bring down a few targets. And there could hardly have been more than a few such targets at a time.¹⁹⁶

Those who fled for the rear would also have been tempting exercises for archery—or opportunities for bold bowmen to gain rich ransoms by running out after them.¹⁹⁷ A fugitive's best hope would have been to get away from the press and then hit the ground, in hopes that either his side would somehow win in the end, or at least that he would survive to be taken prisoner instead of being killed, once the battle was decided.

The Attack of the Second Line

By the time the French second line had closed up on the vanguard, Englishmen on the far flanks of their own line would have found themselves something like 200 yards *behind* the enemy's lines. If they

¹⁹⁵ John Barbour in the late fourteenth century wrote that “against armored men to fight / unarmored men have little might.” *The Bruce*, ed. W. W. Skeat (London, 1889), 309, modernized. Cf. Burne, *Agincourt War*, 38; Bennett, *Agincourt*, 80; also Saint-Denis, in *CS*, 107, which does give some credence to the archers' having an advantage from being lightly armed, though with the key additional clause “and their ranks were not too crowded.” For the ability of men-at-arms in fifteenth-century plate to retain a certain degree of agility, cf. Embleton and Howe, *Medieval Soldier*, 43 (including the photograph in the upper left).

¹⁹⁶ Even if the three right-flank files of the French line had somehow, miraculously, managed to coordinate a sudden right-face and charge, that would still be only around 96 men (or 48, before the second battle closed up), charging 2,500 archers, 192 (or 96) of them directly to their front—assuming that there had been no reinforcement of the archers at the critical juncture by the bowmen from the far flanks.

¹⁹⁷ Cf. Basin, in *CS*, 190 (perhaps referring to a later stage of the battle?): “It was a pitiful sight to see how, once their ranks had been broken, confusion spread amongst the French army, and how many of them tried to save their skins by fleeing. Ten Englishmen pursued a hundred Frenchmen, and one Englishman ten Frenchmen. When they were caught by the English they put up no resistance and put their sole hope in flight. Thus they let themselves be killed or led off as captives like a flock of sheep.”

stayed where they were, they would only be able to participate in the battle with long-range shots, which would have posed the risk of firing into their own men and would, in any case, have been of limited effectiveness. Some archers presumably continued to man the stake-line, guarding against the threat of an attack by the cavalry of the third French line, augmented by horsemen driven off in the initial charge.¹⁹⁸ On the other hand, we know that many of the archers, especially those who had run out of arrows, began to leave their enclosure in order to attack the French flank and rear, “wherever they saw breaks in the line.” This last phrase probably means that the disordered individuals fleeing the field provided the archers with their targets. In trying to kill or capture these fleeing Frenchmen, the English bowmen would naturally have begun to encircle the mass of the French men-at-arms. This encirclement would have encouraged further panic in the Valois ranks, while at the same time foreclosing the last avenues of escape. The *Gesta*, our best single source for the battle, writes that

so great was the undisciplined violence and pressure of the mass of men behind that the living fell on top of the dead, and others falling on top of the living were killed as well, with the result that... a great heap grew of the slain and of those lying crushed in between... which had risen above a man's height.¹⁹⁹

Piles of bodies the height of a man or of a spear are commonly referred to in ancient and medieval sources, almost always in the context of a battle where the losers had been subjected to a double envelopment followed by a full encirclement and the same kind of compression experienced at Agincourt. In describing the results of such a combat, the chroniclers or contemporary historians often remark that many died without striking a single blow, or that more were killed by crushing and suffocation than by wounds.²⁰⁰ In its allegorical description of Agincourt,

¹⁹⁸ Le Fèvre/Waurin, in *CS*, 162.

¹⁹⁹ *Gesta* in *CS*, 37; note also, on the same page: “we who had gained the victory came back through the masses, the mounds, and the heaps of the slain.” The author was an eyewitness to the size of the heap, which he clearly found very moving. One version of the *Brut* claims the heaps of dead were *two* spear's lengths high. *Brut*, in *CS*, 92.

²⁰⁰ This was particularly true at the battle of Dupplin Moor (1332), which was almost a preview of Agincourt, minus the cavalry charges and on a smaller scale. The English adopted the same sort of formation, with men-at-arms and spearmen four deep in the center and archers in forward-leaning wings; the Scottish vanguard had some initial success, then stalled under cross-fire until the main battle piled onto it from behind, leading to mass death by crushing and suffocation. There, ten different chronicles attest to the tall piles of dead. See Rogers, *War Cruel and Sharp*, 40–46. For other medieval

Le pastoralet describes the dead lying “one on top of the other, in piles, heaps,” adding “many . . . died lying among the dead without receiving a single blow.”²⁰¹ John Hardyng, who claimed to be an eyewitness, agrees that thousands of the French at Agincourt were “slain unsmitten,” “dead through press.”²⁰² Many other chronicles, French, English, and Scottish, support the basic accuracy of this statement. Thomas Elmham, Jean Juvenal des Ursins, the English *Brut*, Thomas Basin, and the *Liber Pluscardensis*, all describe the same phenomenon: how “the living were pushed towards death[;] the living went under the dead; the battle lines, sinking to the ground, piled up into heaps”;²⁰³ “the noble French fell one on top of the other [so that] many were suffocated”;²⁰⁴ “so thick, each on top of the other, that a great number of them were slain without making any stroke,”²⁰⁵ “and were suffocated in the crush”;²⁰⁶ “heap upon heap, extinguished by the thousands.”²⁰⁷

The count of Richemont was found alive after the battle pinned under two or three corpses, which would have been a pile three or four feet deep, or more if, as is likely, he was not at the very bottom of the stack.²⁰⁸ How many bodies would have to be piled on top of a man before he would suffocate to death “unsmitten”? Four or five, perhaps? That would produce a pile as high as a man.

In his account of the battle, John Keegan argued that the eyewitness testimony of the *Gesta* must be wrong on this point:

examples, see my “The Offensive/Defensive in Medieval Strategy,” 59. Another, not mentioned there but significant for its chronological proximity to Agincourt, is the 1408 battle of Othée, where the defeated Liégeois: *cheurent par milliers . . . l’un sur l’autre, en telle manière qu’ilz gisoient là par grans monceaux*. Monstrelet, *Chronique*, 1:364. Ancient examples include Caesar’s eyewitness account, when his legionnaires fought the Nervii (quoted note 212,) and Lucan’s *Pharsalia*, IV.786–87. Note also *Robert the Monk’s History of the First Crusade*, 132, and William of Poitiers, *Gesta Guillelmi*, 131.

²⁰¹ *Le Pastoralet*, in *CS*, 352.

²⁰² John Hardyng, *Chronicle*, in *CS*, 81–82.

²⁰³ Elmham, *Liber Metricus de Henrico Quinto*, in *Memorials of Henry the Fifth, King of England*, ed. C. A. Cole (London, 1858), 122; for the first two clauses I have used Curry’s translation (in *CS*, 47). I have altered her translation of the third, *acies fit cumulata ruens*, which she renders as “the battle lines piled in.”

²⁰⁴ Jean Juvenal des Ursins, in *CS*, 131.

²⁰⁵ *Brut*, in *CS*, 94.

²⁰⁶ Basin, in *CS*, 190.

²⁰⁷ *Liber Pluscardensis*, 351: *cumulus super cumulum extincti sunt per millia*.

²⁰⁸ Gruel, *Chronique*, in *CS*, 184. Orléans was likewise found alive buried under the slain. Le Fèvre/Waurin, in *CS*, 164.

Brief reflection will, moreover, demonstrate that the ‘heap higher than a man’ is a chronicler’s exaggeration. Human bodies, even when pushed about by bulldozers, do not, as one can observe if able to keep one’s eyes open during the film of the mass-burials at Belsen, pile into walls, but lie in shapeless sprawling hummocks . . . men falling to weapon-strokes in the front line, or tripping over those already down, will lie at most two or three deep. For the heaps to rise higher, they must be climbed by the next victims: and the ‘six-foot heaps’ of Agincourt could have been topped-out only if men on either side had been ready and able to duel together while balancing on the corpses of twenty or thirty others. The notion is ludicrous rather than grisly.²⁰⁹

There are, however, a number of flaws in Keegan’s reasoning, though it has been generally accepted by later writers.²¹⁰ First of all, for the mounds to rise five or six feet deep; it would not be necessary for *both* sides to climb up and fight, since the English had lances about twelve feet long. They could quite readily have stood on solid ground and picked off the French who were trying to clamber up over the bodies of their comrades in order to come to grips with their foes.²¹¹ Would the Frenchmen have done so? Under the circumstances described above, they might have had no choice.²¹²

Corpses being bull-dozed in a single direction and into a ditch may not form into tall mounds, but the men-at-arms in the center of the French mass would have suffered swelling tides of pressure from all directions. Picture the situation of a man-at-arms who started out in the sixth rank. The first three men in the file before him have gone down; the next two are stalled in front of him, fighting the English and trying not to trample the wounded men and corpses lying in between. At the same time, the rear is pressing him from behind. While he may realize that pushing forward will only hinder those in front of him, even men immediately behind him may not see this, having their eyes bent

²⁰⁹ Keegan, *Face*, 107.

²¹⁰ For example, Bennett, *Agincourt*, 80.

²¹¹ In fact what the *Gesta* says on this point is “our [English] men climbed up on those heaps, which had risen above a man’s height, and butchered their enemies down below with swords, axes, and other weapons.” *Gesta*, in *CS*, 37.

²¹² There is, moreover, precedent for their doing so. According to Caesar’s eyewitness account, when his legionnaires fought the Nervii: “As the first among them fell, the next ranks stepped up onto the fallen and fought from atop their bodies; when they too were cut down, and the corpses heaped up, those who were on top of them hurled their weapons at our men as if from a mound [or hill]” (*cum primi eorum cecidissent, proximi iacentibus insisterent atque ex eorum corporibus pugnarent, his deiectis et coacervatis cadaveribus qui superessent ut ex tumulo tela in nostros coicerent*). Caesar, *Bello gallica*, 2.27.3–4.

to the ground to avoid arrow-fall. The men six or seven ranks father back certainly do not appreciate his situation, and try to keep up the formation's forward momentum by adding their weight to its advance. He digs in his heels to resist the pressure, yells at the ones behind him to wait. But, with ears covered by bascinets, they cannot make out his visor-muffled words through the war cries, the crash of weapons, and the echoes of their own heavy breathing inside their helmets. He will find it very difficult to hold his position. He may be pushed forward, in which case he may well cause the men in front of him to stumble, or be distracted, or be unable to dodge an incoming blow. As a result, they may go down. In turn, he may tumble over them, and be slain, leaving the next in line to face a similar fate.

As an alternative, he may turn around, pushing back to stop the forward momentum of the formation, in hopes of saving himself and those in front of him. However, with several men pushing forward and only one pushing back, this would likely produce even worse results, as he would inevitably be pushed backwards into the front two ranks without being able to see them. If the next three men, in the ranks behind him, also face about to aid in resisting the forward pressure, then the bizarre situation might arise in which three ranks have fallen, two are fighting the English, four are pushing back towards the rear, and five are pushing forward from the back, leaving several crushed in the middle. Now imagine another fifteen ranks from the second line piling forward. It is not at all hard to imagine mass suffocation in the midst of "the press," a term often used in medieval (and ancient) sources to describe a battle.²¹³

Moreover, as we know from the accounts of the gas chambers at Auschwitz,²¹⁴ human beings deprived of breath may struggle up over other human beings, clawing and kicking their way towards what they hope will be breathable air, and the resulting mounds can be even more than six feet high.²¹⁵ Hence, despite Keegan's reservations, we should

²¹³ Jean le Bel uses the term in respect to Crécy. See *Chronique de Jean le Bel*, ed. Jules Viard and Eugène Déprez (Paris, 1904), 105 [re Crécy].

²¹⁴ *World at War*, Episode 20: "Genocide"; "Low-key Commemoration of Auschwitz in SA," *Mail and Guardian Online*, 26 Jan 2005, online at: <http://www.mg.co.za/article-direct.aspx?articleid=196222&area=%02f>; quotation from Miklos Nyiszli's journal, at http://www1.yadvashem.org/education/book_reviews/english/book-nyiszli.htm; William Shirer, *The Rise and Fall of the Third Reich* (New York, 1960), 970.

²¹⁵ There are also reports from the BBC of "piles of bodies nine-feet high [lining] both sides of the road" during the Rwandan genocide. See Tom Giles, "Media Failure

not dismiss the chroniclers' statements concerning the mounds of bodies. The situation was beyond grisly; it was horrific in the extreme. The contemporary commentator who described the battle as "the ugliest and most wretched event that had happened in France over the last 1,000 years" was not exaggerating.²¹⁶ Even without the crushing, suffocating effects of this compression, the French would almost certainly have been defeated, but the disaster would have been far less total than it was.²¹⁷

Killing of Prisoners

The death toll grew still further in the final act of the battle, when King Henry ordered the killing of the prisoners in response to an apparent dual threat from front and rear. The number who perished in this episode, however, was probably much smaller than the total of those who had been trampled and smothered to death in the midst of the press.

Modern writers have often left their readers with a somewhat misleading understanding of the moral and legal implications of Henry's order. The slaughter of the prisoners has been called an "outright atrocity" that "quite offended against the conventions of warfare" and "appalled contemporaries."²¹⁸ While it may have been an atrocity by

over Rwanda's Genocide," 7 April 2004, at <http://news.bbc.co.uk/2/hi/programmes/panorama/3599423.stm>. If the sources and the argument thus far presented do not suffice, it is possible to approach the problem from a different direction. It is fairly clear from the sources that well over 5,000 Frenchmen died at Agincourt, and that the vast majority of them were killed in front of the English men-at-arms. If just 3,875 men were killed on the 250-yard frontage of the English men-at-arms, that would be 31 men per two yards of frontage. If stacked in a pile of triangular cross-section, they would have formed a wall 10 bodies (20') wide at the base, with 8 in the next layer, 6 in the next, then 4, 2, and 1, reaching 5–6' high at the apex. The reality would of course not be so neat or regular, but *the total volume would not change*; presumably the mounds would be lower in places and higher in others—but probably more often higher than lower, because the dynamics of the situation would have made the base narrower, in general.

²¹⁶ Cochon, *Chronique normande*, in CS, 113.

²¹⁷ Even once the French were fully surrounded, if that had merely resulted in extension of the fighting zone to the full perimeter of their mass, that would not have been nearly as bad as what happened, because tight-packed though they might have been, men-at-arms would have been able to fight relatively effectively against archers, and without the "pushed towards death" factor. Keegan, *Face*, 101, 105.

²¹⁸ *Ibid.*, 80; Bennett, *Agincourt*, 82, 84.

modern laws of war, there is obviously little profit in applying the Geneva Convention to the actions of medieval kings. Even if Henry's contemporaries were appalled by the death of that many brave men, their emotion was generally one of sadness, not outrage. When one reads the full range of sources on the battle and on Henry's reign, it is very striking that there is virtually *no* criticism of this action.²¹⁹ Indeed, far from decrying the Lancastrian for this supposed misdeed, the primary texts, even the partisan French chronicles, generally hold him up as a model of a just and moral king.

To understand this episode, one must have some knowledge of its context. Throughout the Hundred Years War, English armies followed a strict policy of not taking prisoners while the combat remained undecided. At Crécy in 1346, this policy was still seen as unusual; its wisdom was questioned, but not its moral legitimacy.

The Germans who were on the side of the King of England came to him and said: "Sire, we wonder greatly that you permit the shedding of so much noble [blood]: for if you were to take them alive, you could thereby make great progress in your war, and would gain very great ransoms from them. And the King responded that they should not marvel at it, for thus it had been ordered, and thus it had to be."²²⁰

At Crécy, both sides fought under special red banners which signified *guerre mortelle*—war to the death—meaning that from a legal standpoint combatants had neither the right to expect mercy, nor any obligation to offer it. The same concept was embodied in an Anglo-Burgundian ordinance issued before the battle of Cravant in 1423, proclaiming that none should be permitted to seize captives until after the battle was clearly won, that any prisoners taken in violation of the order were to be put to death, and that the same fate was to be meted out to any captors who resisted the execution of their prisoners.²²¹

²¹⁹ It is worth noting that Edward III received little or no criticism for his even harder policy in 1333. The day *after* the battle of Halidon Hill, he had all the prisoners he could get hold of put to death, likely as an enforcement of a no-prisoners ordinance issued before the fighting began. Rogers, *War Cruel and Sharp*, 74.

²²⁰ *St. Omer Chronicle*, Ms.707 of the Bibliothèque de l'Agglomération de St. Omer, f. 218.

²²¹ For the use of red banners, see Maurice H. Keen, *The Laws of War in the Late Middle Ages* (London, 1965), 105. Monstrelet, *Chronique*, 4:160 deals with the battle of Cravant. The Swiss after Grandson made a similar ordinance. See Albert Lynn Winkler "The Swiss and War: The Impact of Society on the Swiss Military in the Fourteenth and Fifteenth Centuries" (Ph.D. Diss., Brigham Young University, 1982), 77, 204. There seems also to have been a similar ordinance made by the English-advised

The situation at Agincourt seems to have been much the same. “The English took no prisoners until victory was certain and apparent.”²²² From an English standpoint, this policy, as King Edward had said, was what “had to be.” Self-interest powerfully encouraged individual soldiers to take prisoners during the fighting (after all, a wealthy knight’s ransom would be a small fortune, and the ransom of a count or great baron would be a rather large one), but for them to do so was strongly against the interests of the army as a whole. Men-at-arms whose attention was focused on making captures were not focused on winning, and given the disparity of the sizes of the two armies, the English could not afford any distractions.²²³ Most importantly, for a man-at-arms to accept a prisoner’s surrender and bring him to safety in the rear would require disruption to the English formation, while an intact and orderly formation was the crucial element for English success.

At Agincourt, some French men-at-arms were taken prisoner before their army’s vanguard and second line were entirely defeated. It is likely, however, that these were mostly captured by the archers, either running down fugitives or collecting the disabled from the wreckage of the French cavalry’s charge on the wings. The complete defeat of the dismounted French men-at-arms took only a very short time, no more than about thirty minutes from the first contact of the French vanguard with the English center.²²⁴ As soon as this fighting was fully decided, the English men-at-arms too began to take numerous prisoners, many of whom were wounded and had to be pulled from under the mounds of the slain. This was permitted by the English leaders on the premise that the battle was effectively over. But when that presumption was thrown into question—when it again appeared that the battle was perhaps *not* yet decided—then the standing order mandating no quarter until after victory again came into force.

Both sides understood that this resulted from French efforts to restart a battle that appeared to be at its end.²²⁵ The renewed threat came

Portuguese before Aljubarrota (1385), or possibly in the interval between the defeat of the Franco-Castilian vanguard and the attack of the main body; see Froissart, *Oeuvres*, 11:179–80, 313.

²²² Tito Livio, in *CS*, 62.

²²³ Cf. Froissart, *Oeuvres*, 11:313.

²²⁴ *Chronique de Ruisseauville*, in *CS*, 125.

²²⁵ Juvenal des Ursins, in *CS*, 131: “After the defeat there came a rumour that the duke of Brittany was coming with a large company. As a result, the French rallied, which was a bad thing, for most of the English killed their prisoners.” Gruel, in *CS*,

from the third line of the Valois army. Although mostly composed of *gros valets*, it also contained a substantial number of men-at-arms, perhaps as many as 600,²²⁶ since the initial contingent of knights and esquires had been reinforced by troopers who had rallied from the cavalry's defeat. The danger posed by this as yet uncommitted force was very real. As noted earlier, some contemporaries believed that the forces not yet engaged would have been a match for the English even at the beginning of the battle. If the French third line had made a determined attack at this late stage, with the archers away from their stakes and mostly out of arrows, and the men-at-arms worn down by a hard fight, it would have stood an excellent chance of success. At the same time as these men-at-arms and *gros valets* were readying themselves to mount a new attack, the English baggage train was hit by raiders who inflicted considerable damage and carried off substantial plunder, including King Henry's crown and his sword of state.²²⁷

Threatened front and rear by fresh forces that still substantially outnumbered his own men, Henry might legally have been able to justify even breaking the normal laws of war based on the recognized principle of *necessitas non habet legem*.²²⁸ But the king's friends offered no such defense of his actions; they did not need to, since even his enemies made no accusations of wrongdoing that would require rebuttal. These two facts

187: "When the battle was over, the people of the king of Sicily came up, when the English feared that they should again be attacked, on which account proclamation was made that each man should put to death his prisoner, except the nobles, and for this cause many prisoners were put to death." Saint-Denis, in *CS*, 108: Henry mistakenly thought some were "intending to return to the charge and so ordered that all the prisoners should be killed. This order was executed quickly and the carnage lasted until he had realized and seen with his own eyes that all the men were thinking of flight rather than of continuing the conflict." *Chronique de Ruisseauville*, in *CS*, 125: "When the English king saw that [French attacks] were being launched, he had it proclaimed by sound of trumpet that anyone who had prisoners should kill them." Le Fèvre/Waurin, in *CS*, 163: many from the rearguard and those who had regrouped from the center "showed signs of wanting to fight, marching forward in battle order" under "standards and ensigns. . . . When the English saw them together in this fashion, it was ordered by the king of England that each man should kill his prisoner. . . ." *Chronicle of Peter Basset*, in *CS*, 88: "As Sire Guillaume de Tybouville, knight, lord of La Rivière Thibouville, rallied the enemy to the number of 20,000 men of war and more under a white banner to give a new battle, the victorious prince had cried throughout his host that every man kill his prisoner. And that was the reason so many nobles were killed." Similarly, *Brut* in *CS*, 92, 96.

²²⁶ Monstrelet, in *CS*, 163.

²²⁷ *Gesta* and *MWF*, in *CS*, 37, 162–63. For the plunder, see also Wylie, *Reign of Henry V*, 2:170–71, 89.

²²⁸ "Necessity knows no law."

show that in truth his action was not one that “quite offended against the conventions of warfare.” Rather, it was understood as a legitimate, if regrettable, response to a difficult situation. When responsibility was assigned, it was assigned not to Henry but to the men who created the situation, both those who rallied the third line for a renewed attack on the English²²⁹ and those who struck the English baggage.²³⁰

One reason why the Lancastrian king was spared criticism may have been that he sent a herald to warn the French of the consequences of renewing the battle before ordering the execution of the prisoners.²³¹ Also, he halted the killing as soon as the threat of a French attack evaporated.²³² The number of prisoners who perished at the hands of their captors was probably not all that great: in the hundreds, perhaps even the dozens, rather than the thousands. No source gives a specific tally of those slain in this phase, but it must be remembered that many hundreds of French prisoners survived to be put to ransom.²³³

Explaining the French Defeat

The English at Agincourt were so badly outnumbered, and in such a dangerous strategic position, that the magnitude of their victory and the French defeat can only be explained by layering a whole series of causal factors on top of one another. The French lost because of the fighting qualities of the English *and* the effectiveness of the longbow *and* the mud *and* their own errors. They chose the wrong battlefield; they chose the wrong deployment for that battlefield; they chose to shorten their men-at-arms’ lances to five feet; they advanced the second line prematurely; and they failed to make good use of either their crossbowmen or their third line. The most significant of these errors was the faulty deployment for battle, which was the root cause of the disordered state in which the French men-at-arms found themselves when they hit the English line. The wing cavalry forces were not strong enough to succeed, and the detritus of their defeat by the longbowmen broke up

²²⁹ Monstrelet, in *CS*, 164. Note also Jean Juvenal des Ursins, in *CS*, 131.

²³⁰ Fenin, in *CS*, 119.

²³¹ Tito Livio, in *CS*, 62.

²³² Saint-Denis, in *CS*, 108; note that this is a French source.

²³³ The Monk of St. Denis’ figure (in *CS*, 110) of 1400 knights and esquires ransomed is a fully credible one. Walsingham, in *CS*, 53 says only 700, but adds “it is said.”

the French array, a disruption from which the dismounted troops could not recover under the pressure of continued arrow fire.

Special emphasis must be placed on two of these factors to explain why the French defeat turned into such an utter disaster. At the beginning of the battle, the French enjoyed the initiative, possessed a covering line of cavalry, and had the benefit of the strategic situation. Consequently, had they arranged their forces more wisely, they might have launched an attack on the English, failed, and still have come out of the battle in good shape, perhaps even going on to gain some sort of victory in the campaign. However, because of their flawed deployment, their first line of dismounted troops advanced into the jaws of a double envelopment. At that point, their second line advanced prematurely in such a manner that it hindered the vanguard instead of keeping the English archers pinned down behind their stakes. This allowed the bowmen to encircle the French position, cutting off all avenues of escape. The consequent extreme compression of the French mass is the principal reason for the astoundingly high death rate suffered by their army. Of around 10,000 men-at-arms involved in the fighting, the *death* rate seems to have been at least 45%, and quite possibly 60%, roughly doubling or quadrupling the figures for Crécy and Poitiers.²³⁴

²³⁴ At Crécy, the French had lost around 1,600–2,000 men-at-arms out of a total of 8,000 (or possibly 12,000) men-at-arms killed, a figure that represented 13% to 25% of those engaged in the battle. At Poitiers, around 2,500 out of 10,000 to 14,000 men were killed (17% to 25%). According to the *Gesta*, French losses in gentlemen alone at Agincourt were 5,600–6,600. This fits very well with Monstrelét's statement (in *CS*, 170) that "according to an account kept," 5,800 men were buried on the battlefield, not counting many who were taken away by their friends, or who died of wounds after fleeing." The *Chronique de Ruisseauville* (in *CS*, 127) alleges that 1,200 or more men were thrown into each of five mass graves. Perceval de Cagny (in *CS*, 121) gives another closely matching estimate—five to six thousand men of war. These sources are different enough that they are clearly independent testimonies, and they include all three of the most reliable texts for this question, making their cumulative testimony exceptionally powerful. Note that they come from an Englishman, a Burgundian, and two Frenchmen, so there is no need to assume that they are driven by "patriotic hyperbole." (Cf. *CS*, 405; Curry, *New History*, 234.) Moreover, the very high proportion of the senior nobility present known to have died (three dukes and eight counts) lends credibility to these figures.

Not all contemporaries agreed. A second group of sources supplies a somewhat lower figure for the number of French dead. Pierre de Fenin (in *CS*, 118) says 3,000–4,000; Berry Herald (*CS*, 182) says 4,000 knights and esquires and 500–600 other men of war. By contrast, a third group of sources sets French losses at a higher figure: around 8,000 to 10,000 or more. Tito Livio, in *CS*, 63; Pseudo Elmhan, in *CS*, 74; Waurin, in *CS*, 168 (1,600 varlets and 8,400 or more men-at-arms of gentle birth, "according to the declaration of several heralds and other notable people worthy of belief"); Le Fèvre,

Although King Henry and his troops deserve credit for their stalwart performance, it remains true that the battle was far more lost by the French than it was won by the English.²³⁵ Writers of both the fifteenth and twentieth centuries have therefore sometimes attributed French defeat to the ill-discipline of the Valois soldiers and the apparent lack of a single commander for the French army.²³⁶ On the other hand, it seems that both of these explanations have been given more weight than they deserve.

Admittedly, the French experienced problems from their lack of military discipline, most notably in the absence of some men from their battle-stations when the English made their initial advance into bow-range. Some French soldiers did flee before the fighting was over, and this could be called a failure of discipline, but to do so runs the risk of tautological reasoning. Since the losing side always has fugitives, every defeated army could be said to have lost due to lack of discipline, however disciplined it may have been while the outcome was in question. But the very high death rate suffered by the French shows on the face of it that they cannot be criticized for abandoning the fight prematurely.²³⁷

A different sort of ill-discipline could be attributed to men-at-arms who broke from linear formation just before contact with the English

Chronique, 267–68, and in *CS*, 169 (an estimated 10,000 men, including 7,000–8,000 noblemen, *que moy mesmes vey, à mes yeulx* [“which I saw myself, with my own eyes”]); Cochon (in *CS*, 186) estimates 7,000–8,000 knights and esquires. Morosini (in *CS*, 194) claims there were 10,000 to 12,000 French fatalities.

Adam of Usk, uniquely, gives a high total overall, but a low one for nobles—123 great lords, 1,400 armigerous nobles (knights and esquires), and 7,000 commoners. Adam of Usk, *Chronicle*, trans. Chris Given-Wilson (Oxford, 1997), 257. Walsingham (*CS*, 53) says 3,069 knights and squires, plus a number of other soldiers not tallied by the heralds. What is probably a newsletter that circulated in England shortly after the battle says the French lost 4,000 knights and esquires. In *CS*, 264.

²³⁵ I would not say that Henry’s tactical leadership was a principal cause of the English victory; he competently applied an established doctrine, but in terms of command decisions and actions, he did nothing especially noteworthy. He does seem to have done very well in sustaining the morale of his troops (see Jones, *Agincourt*, on this subject). This was however due, in part, to his strategic rather than his tactical leadership: he had led his men into a desperate situation where flight was hopeless, making bravery almost assured. Cf. Sun Tzu, *Art of War*, XI.33, XI.30.

²³⁶ For the indiscipline of the Valois army, see Basin, in *CS*, 189. Note also Pierre de Fenin, in *CS*, 118; Saint-Denis, in *CS*, 105–6 and Saint-Denis, ed. Bellaguet, 564. For the lack of a unified command, see quotation from Bennett, in the text below, and note also Hibbert, *Agincourt*, 106; Strickland and Hardy, *Great Warbow*, 331; Vale, *Agincourt*, 261–64.

²³⁷ For another view, see Wylie, *Reign of Henry V*, 2:202–5.

line. However, their situation at the time was so horrible that one should hesitate to reproach them for breaking ranks. While their discipline may have been insufficient for the task at hand, that does not necessarily mean it was poor. Similarly, it is clearly true that the French were not sufficiently drilled or “disciplined” to maintain their formation in good order as they advanced to meet the English—but there is no reason to think that any other contemporary force, or for that matter a heavily-drilled corps of Napoleon’s *Grande Armée*, could have done much better, marching through the mud, the arrow fire, and the crashing impact of maddened horses.

Matthew Bennett has written that

on the fateful day itself, if one were to ask who commanded the French army, the answer must be no one. This, along with the evident, and contrasting, tactical competence and cohesion of the English, is the root cause of the French defeat.²³⁸

The truth, however, is that we do not know the answer to the question he poses. A case could be made that constable d’Albret and marshal Boucicaut shared command of the French army, and that constable d’Albret, as the highest-ranking military officer of the French crown, was, in fact, fully in command. As Christine de Pizan wrote just five years before Agincourt, it was the very essence of his office to be the “sovereign master,” “to whom is committed the principal responsibility for all [soldiers],” under the king himself. Moreover, in July of 1415, he had been appointed lieutenant of King Charles VI, precisely so that he would have all the authority he needed to direct the military effort against Henry V.²³⁹

Historians have sometimes suggested that the numerous dukes, counts, and other great lords of the French army refused to subordinate themselves to a mere military officer. It should be remembered, however, that d’Albret was himself a great magnate of the realm, whose lands and lordships made him at least the equivalent of a count, even though he did not hold that title. Thus, although his authority derived principally from his office, not his birth, no one could have accused him of attempting to assert that authority over men from a higher social

²³⁸ Bennett, *Agincourt*, 16.

²³⁹ Bodleian Ms 824, ff. 18r–v (*Book of Chivalry*, 23); Vale, *Agincourt*, 158.

class.²⁴⁰ What is more, even the highest nobles were quite capable of recognizing the importance of military expertise and were willing to allow veteran soldiers to exercise practical command. At Agincourt, for example, the young duke of Orléans, the highest-ranking nobleman in the army and the leader of a national faction, had his own personal troops “commanded on his behalf by the lord of Gaules.”²⁴¹ Waurin, who was in the French army, specifically states that the vanguard “was commanded by the constable”; the dukes of Orléans and Bourbon are merely mentioned as being “in his company.”²⁴²

Admittedly, there is some support for the other position in the chronicles. The *Geste des nobles françois* says that “All the lords wanted to be in the vanguard, against the opinion of the constable and the experienced knights.”²⁴³ Pierre de Fenin claims that the second and third lines failed to fight because all the leaders had crowded into the

²⁴⁰ His mother was a Bourbon; his wife, the lady of Sully and Craon, was a “princesse” and the widow of a grandson of Charles V; his heir would later hold two counties. Mas Latrie, *Trésor de chronologie*, cols. 1533, 1621. The dukes and perhaps the counts had a higher social rank or status, but the difference was between strata within a single class. Note Waurin’s phrasing: “the constable, the marshal, the admirals, and the other princes [et les autres princes].” *Recueil*, 2:213.

²⁴¹ Berry Herald, in *CS*, 181. Note also Waurin, in *CS*, 156; though cf. *Chronique anonyme*, in *CS*, 115.

²⁴² Waurin, *Recueil*, 2:206; cf. Le Fèvre, *Chronique*, 248 (“with him”); note also Montrelet, in *CS*, 156: “the constable and other wise men of the council of the king of France ordered three battles to be made...” It is true that, on the other hand, the *Chronique anonyme* (ed. Douët-d’Arcq), 6:228–9, states that *de l’armée de France estoit à ce jour le chief et souverain, le duc d’Orléans*. Since both Waurin and the *Chronique anonyme* are Burgundian-leaning, it is likely that the latter’s statement aims to blame the Armagnac faction for the defeat; however, since Waurin’s statement cuts against his presumptive bias, and because he was an eyewitness, his statement should be given much more weight.

In support of the contrary position, some historians have claimed that d’Albret and Boucicaut wanted to avoid fighting the English in open battle, but that they were “overruled” by the princes of the blood. (Strickland and Hardy, *Great Warbow*, 326; note also Allmand, *Henry V*, 90; Vale, *Agincourt*, 255.) There are problems with this story, however. First, it comes from the somewhat late and unreliable Jean Juvenal des Ursins (in *CS*, 130). Second, Juvenal des Ursins essentially acknowledges in his text that he is repeating hearsay evidence; he asserts only that “it was said that” d’Albret and Boucicaut wanted to avoid battle. Third, even very cautious professional soldiers should have seen the situation at Agincourt as meriting the risks of battle. Even if Juvenal des Ursins’ tale is true, however, it does not really show that d’Albret lacked effective tactical command authority over the dukes, since the constable had already been given a specific written order by the king himself, “signed with his own hand,” to give battle to the English army. Montrelet and Waurin, in *CS*, 150.

²⁴³ *Geste*, in *CS*, 111. Juvenal des Ursins (in *CS*, 132) says much the same: “all the lords wanted to be in the first battle, so that each would have as much honour as another, as they could not agree to do anything else.”

first line and “as a result there was no control or discipline among their men.”²⁴⁴ These, however, do not rank among our best sources. Moreover, Fenin’s testimony contains a manifest error, since the second line of the French unquestionably *did* fight. And while the *Geste* may be correct that all the lords *wanted* to be in the first line, if so, it would be a testament to the ability of the constable to exercise his authority even over great magnates, since in the event two dukes and six counts accepted stations in the second and third lines.²⁴⁵

On the other hand, all the principal military office-holders (the constable, marshal, master of crossbowmen, admirals, master of the king’s household, and the lieutenant of the Dauphin), were given leadership positions in the front-line forces.²⁴⁶ With the benefit of hindsight, it was probably a mistake not to leave one senior military professional, such as the marshal or the master of crossbowmen, to command the second line, but it is an understandable error and by no means one indicative of a lack of proper structure of authority in the army.²⁴⁷

In sum, both the fact and the scale of the French defeat at Agincourt are better explained by bad decisions made by individual human beings than by any other single factor. We know very little about how those decisions were made, so we cannot even make informed guesses about the extent to which deeper social and political problems in the French polity (such as class prejudices and factional divisions) influenced them. But in the end, it does not seem that any inherent weakness in the French army or state doomed the Valois forces to failure. Commanders’ decisions *do* matter in warfare, and it would be hard to find a better illustration of that fact than the battle of Agincourt. Moreover, the outcome of battle does influence the fate of nations and the lives of their populations. This too can readily be observed in the history of Western Europe during the decades following St. Crispin’s day of 1415.

²⁴⁴ Fenin in *CS*, 118. Note also Saint-Denis, in *CS*, 106; Vale, *Agincourt*, 266; Strickland and Hardy, *Great Warbow*, 331. The one portion of the battle array where many soldiers *were* separated from their leaders was the third line—the *gros valets* were separated from their men-at-arms and captains—and of course most of the men of the third line survived, so that their view of the battle might have had a somewhat disproportionate weighting in the general understanding of the battle that developed post facto.

²⁴⁵ Compare Vale, *Agincourt*, 264.

²⁴⁶ Le Fèvre, in *CS*, 156; Berry Herald, in *CS*, 181.

²⁴⁷ When I say a “proper” structure, I do not mean to suggest that the French army of Agincourt, or, for that matter, any medieval army, had the same ideas concerning military rank, authority, and chain-of-command as a modern force.

APPENDIX I

Arrows vs. Armor

The ability of longbow arrows to penetrate the plate armor of 1415 has been a subject of much debate. Recently, a study based on careful metallurgical analysis, some fairly sophisticated mathematical modeling, and some controlled testing has suggested that English archers would have been quite unable to defeat the steel plate armor in general use by the time of Agincourt, even at close range.²⁴⁸ On the other hand, as we have seen, most of the contemporary and near-contemporary sources indicate that the longbow arrows were highly effective against the French men-at-arms, dropping “here fifty, there sixty,” penetrating the sides and visors of helmets, inflicting many grave wounds, even going “through breastplate, hauberk, and bascinet” and causing many to retreat “out of fear of death.”²⁴⁹ The analysis of the battle above accepts the contemporary claims as basically accurate. In doing so,

²⁴⁸ “A knight in Milanese plate armour of the early fifteenth century... [would have] discarded most of his mail. The plates might be 2 mm thick and rounded in form. It would be made of medium-carbon steel (***) or better); it would often be hardened, but for this example an air-cooled steel only will be considered. An arrow would in effect be striking at 30 deg[rees] [due to the rounded form of the armor], and would need to deliver 230 J[oules] in order to defeat this armour (280 J if padding included).” A. R. Williams, *The Knight and the Blast Furnace: A History of Metallurgy of Armour in the Middle Ages and the Early Modern Period*, (Leiden, 2003), 947. On p. 946, however, he suggests that one should add not 50 J but 150 J “to allow for padding, and the need to disable an opponent,” suggesting the arrow would need to deliver 380 J. Even 280 J is double or more the impact energy of a heavy arrow from the strongest Mary-Rose style bows. Moreover, applying the factors Williams gives on p. 946 to account for different metallurgies, we can calculate that by his estimate normal north-European steel armor (low-carbon, low-slag; what he calls “***) quality) would still require 157 J, probably more than any longbow at Agincourt could have delivered, to defeat 2 mm plates at 30 degrees. Another 50 J would be required to penetrate the padding beneath, even if mail were not being worn under the blank harness. This is far more than any longbow can deliver. Note also Malcolm Vale, *War and Chivalry*, 113: “if armour was proof against the longbow by the end of the fourteenth century, its resistance to other missiles is not so easy to establish.” The best study of the archer’s ability to penetrate armor is Strickland and Hardy, *Great Warbow*, 274, 276–78.

²⁴⁹ Notes 22 and 174, above; *Gesta*, in *CS*, 36; and “The Battle of Agincourt,” in *CS*, 297.

this article discounts the most recent “scientific” analysis, and therefore demands some justification.

Early on in my study of Agincourt, I gathered a substantial amount of information about modern tests. This information convinced me that a longbow arrow could potentially kill a man right through a steel breastplate, at close range and at the right angle of impact, and that even at long range, a volley of arrows could cause a significant number of serious wounds, including some disabling ones, even against armored men-at-arms. After collecting more data and engaging in more analysis which reconfirmed those conclusions but added much more depth and complexity to them, I found that I had too much material to append to this already lengthy study. I therefore intend to treat the subject more fully in a separate publication. All that it is necessary to do here is to show that the claims made in the first sentence of this paragraph are reasonable ones.

The main factors that have to be taken into account to determine the effect of an arrow-strike are: initial kinetic energy of the arrow; range; angle of impact; thickness of armor struck; metallurgy of armor struck; and type of padding beneath the armor. If all the above are known, calculation can give us a good idea of how much penetration into flesh the arrow would be able to accomplish.

Each of the following six paragraphs addresses one of those six factors. Each properly deserves a page or so of explication, but for reasons already given, that degree of attention will not be provided here. Instead, I will limit myself to citing the key sources on which my conclusions are based. It should be understood, however, that these conclusions derive from a concatenation of estimates and guesses. Their seeming precision should not be mistaken for a claim of accuracy. On the other hand, I think the errors I have doubtless made should tend to cancel each other out. Even if I am off significantly, I am not so far wrong as to undercut the ultimate conclusion that the statements of contemporary sources on this matter cannot be dismissed as implausible.

The kinetic energy of the arrow is determined largely by the draw-strength and draw-length of the bow, and secondarily by the weight of the arrow. A variety of tests have shown that, for a long-bodkin arrow suited to the bow, a 70 lb longbow produced kinetic energy [ke] of 46–58 joules [J]. The initial ke grows in rough proportion with poundage, so that one set of tests found a 145 lb bow at 31” produced up to 103 J, while another found a bow of 150 lb drawn to 32” produced 111–146 J, and a third found a bow drawing 165 lb at 31.5” could

produce up to 138 joules. By interpolation, a bow of 100–110 lb might produce around 85 J.²⁵⁰

The effect of range on penetrative ability are calculated differently by different methods. The pattern appears not to be a simple decrease of energy with increasing distance. However, taking into account both calculated and experimental results, it would seem that a longbow arrow might retain 80% of its effective impact at 220 yards, or around 60% at 280–330 yards.²⁵¹

The impact energy that actually does useful work in penetrating armor and causing injury is proportional to the cosine of the angle of impact (relative to a “normal” or perpendicular hit), i.e. 90% at 20 degrees, 71% at 45 degrees, 50% at 60 degrees, etc.²⁵²

Astoundingly, few pieces of medieval armor have been measured for thickness, and there are in any case very few pieces from the time of Agincourt to be measured. The best data currently available indicates the following might be fairly typical: 3 mm for a bascinet top; 2 mm for a breastplate; 1.25–1.75 mm for visors, bascinet sides and backs, cuisses, backplates, and probably gauntlets, vambraces, greaves, etc., with the backplates of arm and leg harnesses usually at the lower end of that range.²⁵³ The resistance posed by a piece of armor is proportional to its thickness raised to the power of 1.6; e.g. increasing the thickness from 1.5 mm to 2 mm increases the energy needed to defeat the armor by 60%.²⁵⁴

²⁵⁰ The test conducted in Pratt are in Hardy, *Longbow*, 203 (table 4). See also Williams, *Knight*, 927 (n. 2); Gransay, “How Good,” 89 (58 J at 20’ with 68 lb bow); Stretton, “Tests 1,” 23; King, “Ramblings,” 11–12. However, note the anomalous result of (by calculation) 44.5 J from a 90-lb bow cited in Strickland and Hardy, *Great Warbow*, 278 (without, apparently, recognizing its oddity).

²⁵¹ Stretton, “Tests 2,” 55; Crowley in Strickland and Hardy, *Great Warbow*, 410–11 (tables 3–4).

²⁵² Williams, *Knight*, 929, 937–39.

²⁵³ Peter Jones, “The Target,” in Hardy, *Longbow*, 206–7; Williams, *Knight*, 913. While Williams, 917 is considering a breastplate of 1470, another passage found on page 916 suggests that somewhat thinner armor was worn back in 1415, especially since at that time mail was still often worn underneath. For a late-fourteenth century arm harness in the Oakeshott collection with a thickness of only about 1.0–1.22 mm, and other limb armor at around 1.2 mm, see the posts by “Kenwrec Wulfe” and by Randall Moffett (5/19/06) at <http://forums.armourarchive.org/phpBB2/viewtopic.php?t=59830>. For a 1455 Italian armor with a backplate *estimated* at 1–1.5 mm, see <http://forums.armourarchive.org/phpBB2/viewtopic.php?t=66725> (post by Per Lillelund, 11/19/06). Further studies of armor thickness are much needed.

²⁵⁴ Williams, *Knight*, 928–29, 936.

In 1415, a wide variety of metal was in use on the battlefield. The best Milanese armor available (probably only worn by a small minority at Agincourt) might be medium-carbon, hardened steel with a hardness of 275–375 on the Vickers scale. Good quality, up-to-date armor was likely to be of low-carbon, air-cooled steel, with a hardness of about 200–240. Much of the armor in use, however, and quite likely the majority of all pieces, was probably still of wrought iron or very-low (1% or less)-carbon steel, with a hardness of only 150–175 and a relatively high slag content. Compared to modern mild steel, (accepting A. R. Williams' calculation), these three classes of armor, which he calls ***, **, and *, would have about 110%, 75%, and 50% of the protective strength, respectively.²⁵⁵ Out of a sample of twelve surviving Italian armor pieces dating from c. 1395–1435 and 27 non-Italian pieces from 1380–1450, the breakdown between ***, ** and * metal was about 5 (13%), 13 (33%), and 21 (54%).²⁵⁶

Based on experiments by Saxton Pope, Steven Grancsay, and Russ Mitchell, it appears that 45 J would suffice to penetrate mail and light padding and inflict a lethal wound. Testing by Peter Jones shows that a long bodkin arrow with 55 joules of initial energy would penetrate 1.5 mm of modern mild steel sheet at a 45 degree impact.²⁵⁷

²⁵⁵ *Ibid.*, 934.

²⁵⁶ The divisions are debatable, but I have made them as follows. By page in Williams, *Knight*: *: 74, 169 (visor), 65 (sample SA3280), 171, 345 (visor), 346, 347, 351, 356, 746, 348, 352, 343, 353, 354, 349, 744, 358 (breastplate, sample 1), 358 (plate below breastplate), 359 (backplate), 359 (plate below backplate). **: 345 (skull), 350, 357, 745, 355, 743, 358 (forearm), 71, 72, 166–7, 169 (skull), 170, 172–3; ***: 73, 75–6, 165, 747, 359 (knee). The bascinet of Duke Ernst of Austria, dated c. 1400, would qualify as below-average ** metal. It has an average hardness for ** steel, but its very low carbon content, 0.1%, would give it significantly reduced fracture toughness vs. the 0.3% standard for ** steel. See Williams, 166–67, 608, 718, 933, and 941. The reader can reach his own conclusions about the proportion of men-at-arms at Agincourt likely to have had better armor, bearing in mind that probably only about one in forty were even of knightly status, and only one in perhaps 200 were bannerets. Contamine, *Guerre, état et société*, 227–28.

²⁵⁷ For figure on mail penetration, see note 22. For the energy needed to penetrate 1.5 mm plate, see Jones, “Target,” 206–8. Pope achieved similar results vs. steel plate (penetrating 1.59 mm soft steel plate and driving a half inch into the wood backing), with a direct hit by a 75 lb bow with a draw of 28”. “Study of Bows and Arrows,” 369. Using a 68-lb. bow and a rather light 2.5 oz. Bodkin arrow, Lou Stemmler was able to penetrate the metal of a seventeenth-century helmet. Grancsay, “how Good,” 89–90. Another set of tests found that it took 20 J to penetrate a 1.9 mm wrought iron plate, while 75 J were needed to make a 6 mm hole. Since a 1.9 mm wrought iron plate should have, using Williams' calculation methods, only about 66% of the protective strength of a 1.59 mm mild steel plate, it is difficult to reconcile these num-

How all these elements interact is complicated in the extreme. However, using the above, and taking 110 and 155 pound draw-weights, as “average” and “strong” for archers at Agincourt, we can reach the following conclusions:

To cause a gut wound through breastplate, mail and padding would take a strong archer vs. ** metal, but only an average (or slightly above average) archer vs. * metal, at very short range and with a direct hit. A strong archer could have done it to a man-at-arms with the latter class of armor even at long range. Against the rare knight wearing *** metal, it would have been almost impossible at any range.

Limbs and faces, covered by thinner plate and mostly not much else, were much more vulnerable. Even at 220 yards, an average archer could inflict a serious limb injury with a 20-degree hit vs. **, or with a 45-degree hit vs. * armor. A strong archer could do so, at that range, vs. ** at 45 degrees, or vs. *** with a direct hit.

The thickest part of any suit of armor was usually the top of the bascinet. Just to penetrate the top of an average bascinet (say, 3 mm) at 20 degrees would take around 97 J for **, or 62 J for * metal. Behind the steel would be a significant amount of padding. Hence, a very strong archer might be able to drive an arrowhead into, and perhaps even through, a skull after defeating a good-quality bascinet (but not an excellent-quality one), if only at short range and with a direct hit. However, against wrought iron armor, even an archer whose skills were only slightly above-average could do it at short range, and a strong archer could accomplish it at 220 yards.

bers. However, the tests by Jones and Pope and Grancsay involved actually shooting arrows, while these latter tests (by A. R. Williams) were done using a mechanical tester. Thus, the discrepancy suggests to me that the use of a mechanical tester does not produce valid results. That conclusion is reinforced for me by the fact that the tester also apparently indicated it would take 270 J for an edged weapon to defeat a “typical helmet of munition quality.” If we were to accept that conclusion, and also the same article’s claim that an axe blow could not typically deliver more than 130 J, we would have to conclude that no medieval soldier ever had his head split by an axe through his helmet. T. Phillip D. Blackburn, et al., “Head Protection in England before the First World War,” *Neurosurgery* 47 (2000): 1280–81. See also John Barbour, *The Bruce*, ed. and trans. A. A. M. Duncan (Edinburgh, 1997), 450–51.

APPENDIX II

The English Numbers

In giving the size of the English army at Agincourt as about 1,000 men-at-arms and 5,000 archers, I have followed the statements of the *Gesta*.²⁵⁸ Although this agrees with most modern historians of the campaign, Professor Anne Curry has recently argued that the size of the English army at Agincourt was substantially larger. Her basic method is as follows: she calculates the size of the army at embarkation for France based on indenture records, then deducts the number of soldiers known from the post-campaign pay-accounts to have perished during the siege of Harfleur (36), the number of men detached for the garrison of the town after its surrender (1,200), and the number of soldiers shown on the sick-lists to have been invalidated home before the start of the march to Calais (1,330). “Since the army that left England contained a minimum of 11,248 men and most likely nearer 12,000,” she concludes, “we can prove that Henry still had at least 8,680 soldiers with him on his march and at the battle.”²⁵⁹

The word “prove,” however, is much too strong to be used here, as her calculations rest on three unproven assumptions, two of which are downright doubtful. The first assumption is that those who indented to provide a given number of troops on average fully met their quotas; this is borne out by the cases where we can check the indentures against later muster records, and can be accepted. The second assumption is that the pay rolls fully and accurately reflect the number of men who died at Harfleur. This seems very unlikely.

First, we do not have a post-campaign account for every retinue. Second, Curry recognizes the fact that

Henry’s decision in March 1417 that those who died at the battle should none the less be paid for the rest of the quarter meant that there was no particular need to record English casualties in preparing the accounts.

²⁵⁸ *Gesta*, in *CS*, 27 (900 lances and 5,000 archers at the time of the war-council in Harfleur); 38 (not over 6,000 fighting men).

²⁵⁹ Curry, *New History*, 70–71, 113–14, 131, 187.

Thus... [none] of the surviving accounting materials can be relied upon as a guide to the numbers of the English army who died at the battle.²⁶⁰

But the same royal decision to which she refers also provides that those who died during the siege of Harfleur, or were permitted to leave the army, should receive pay for the full quarter. Hence, the fact that the vast majority of the retinues are not known to have suffered any deaths during the siege cannot be taken as conclusive evidence that all their personnel survived.²⁶¹ Indeed, there are strong reasons to conclude that the fifteen men-at-arms (including one earl) and twenty-one archers noted in the pay records as having died during the siege fall far short of making a complete list. Those death numbers would indicate a ratio of 1 man-at-arms to 1.4 archers. Since the overall ratio of men-at-arms to archers in the army was 1 to 4,²⁶² if these death records were complete it would indicate that the men-at-arms suffered a mortality rate 3.5 times as high as archers did. That seems highly unlikely, especially since among those whose military status is identified in the sick lists, there are 183 men-at-arms and 753 archers (a 1 to 4.11 ratio), and since men-at-arms' higher status and wages would have given them better access to fresh food, which is a crucial factor in surviving dysentery.²⁶³

Moreover, the narrative sources widely report that during the siege of Harfleur thousands of men were stricken with the bloody flux (dysentery), which "carried off far more of our men, both nobles and others, than had the sword."²⁶⁴ Considering that the number of men stricken with serious illness was probably in the thousands,²⁶⁵ the

²⁶⁰ Curry, in *CS*, 42.

²⁶¹ The known dead come from just 15 of around 250 retinues. Curry, *New History*, 114; Vale, *Agincourt*, 118.

²⁶² Curry, *New History*, 70.

²⁶³ Hence, for example, in the Earl of Arundel's retinue, while the ratio of troops was 1:3 and the ratio of sick was 1:3.5, the ratio of dead was 1:6.5. The mortality rate for men-at-arms was less than one-half the rate for the archers. Curry, *New History*, 114. Among a group of British troops in the West Indies, it was found that "mortality from diseases of the stomach and bowels among the officers was as 2 to 4 per cent, while that among the soldiers [who were issued salted provisions five days per week] was as 20.7, or a tenfold ratio." Alexander Wynter Blyth, *A Dictionary of Hygiene and Public Health* (London, 1876), 196.

²⁶⁴ *Gesta*, in *CS*, 27.

²⁶⁵ There were 1,330 known soldiers on the sick lists, plus an unknown number of dead. Curry's suggestion that the low death rate she describes could be the result of the less easily transmittable amoebic rather than bacterial dysentery (*New History*, 85) ignores the undoubted fact that the *infection* rate *was* quite high, as indicated by the sick lists.

expected death total from dysentery would be in the hundreds, not a few dozens. Among nineteenth-century soldiers who received hospital care for dysentery, death rates could be as low as 7–10%, but in difficult wartime conditions patient mortality rates of 20–25% were common.²⁶⁶ In the words of one nineteenth-century British medical expert (with reference to the Crimean War), dysentery can be “made fatal by lying on the ground, by the use of impure water, by dirt and damp, by privation, and by the substitution of salt pork, rum, and biscuits, for the fresh meat, vegetables, bread, fruit, ale, stout, or wine that officers and men . . . live on at home.”²⁶⁷ Under really bad conditions, as much as a third to a half of an army could quickly be laid low by dysentery and other diseases.²⁶⁸

The Burgundian chronicles say that 2,000 or more died of the flux at Harfleur; John Streeche makes it “many thousand”; another fifteenth century English chronicle says nearly 5,000 men perished.²⁶⁹

²⁶⁶ In the Russo-Turkish war of 1828 and the Sino-Japanese War of 1898, about 25% of dysentery patients died; the same was true at the Andersonville POW camp in the American Civil War. Philip E. S. Palmer, Maurice Merrick Reeder, et al., *Imaging of Tropical Diseases: With Epidemiological, Pathological and Clinical Correlation*, vol. 2 (N.P., 2001), 163. A Dutch force of around 2,500 men at the Cape of Good Hope in 1804–5 had 633 men attacked by dysentery or catarrhal fever, of whom 133 (21%) died. Mucor [Stephen Curtis Candler], *On the Causation and Prevention of Dysentery, Cholera, Diphtheria, etc.* (London, 1873), 17. Among American Regular Army troops in 1898, about one in four of those hospitalized for dysentery died (though only about one in four of those treated for dysentery were hospitalized, so that the over-all death rate of dysentery victims was only around 7%). *Annual Reports of the War Department for the Fiscal Year Ended 30 June 1899* (Washington, 1899), 654. Even in peacetime among a civilian population, the mortality rate for patients in one 1897 Japanese outbreak exceeded 20%. Swapan Kumar Niyogi, “Shigellosis,” *The Journal of Microbiology*, Vol. 43, no. 2 (April, 2005): 134.

²⁶⁷ *Seventeenth Annual Report of the Registrar-General of Births, Deaths, and Marriages in England* (London, 1856), 53.

²⁶⁸ Due principally to an outbreak of dysentery, nearly 1,500 out of somewhat more than 3,000 soldiers in Maracaybo, Columbia, reportedly died in just two months. Colonel Francis Hall, *Columbia, Its Present State, etc.* (London, 1824), 124. Also over a period of two months, between a third and a half of Schomberg’s army died at Dundalk Camp in 1689 (nearly 7,000 men). John M. Stapleton, Jr., “The Blue-Water Dimension of King William’s War: Amphibious Operations and Allied Strategy during the Nine Years’ War, 1688–1697,” in D. J. B. Trim and Mark Charles Fissel, *Amphibious Warfare 1000–1700: Commerce, State Formation and European Expansion* (Leiden, 2006), 329. Note also Maurice de Saxe, *My Reveries*, trans. T. R. Phillips, in *Roots of Strategy* (Harrisburg, Penn., 1985), 199; Rogers, *Soldiers’ Lives through History: The Middle Ages*, 112.

²⁶⁹ LeFèvre, *Chronique*, 226,230 (and including at least 500 knights and esquires). See also Waurin, *Recueil*, 2:183, 187. John Streeche, *The Chronicle of John Streeche for the Reign of Henry V (1414–1422)* ed. Frank Taylor, in *Bulletin of the John Rylands Library*, 16 (1932), 152. Chronicle in C. L. Kingsford, *English Historical Literature in the Fifteenth*

The latter figures are almost certainly too high; the number given by the Burgundians also would represent a surprisingly high death rate, but it is by no means outside the bounds of possibility. Consider that of fourteen English dukes, earls and bishops who were present at the siege of Harfleur, two died there, a third was invalidated home and died in England, and three more were also evacuated, thus equating to a mortality rate of 14% or 21% of the whole group (depending on whether one counts as a fatality one of the magnates who perished after being evacuated), and 50% of those known to have been seriously afflicted.²⁷⁰ Since Curry's figure of 36 dead out of 12,000 soldiers represents an overall death rate of just 0.3% (or just 2.7% of the number on the sick lists) it cannot be accepted as credible.

Professor Curry's third assumption, also problematic, is that her total of 1,330 soldiers given leave to return to England is a complete tally of those who departed the army before the start of the field campaign. While this number is much more credible than the figure of 36 dead, it is still likely to be substantially too low. Curry recognizes that the sick lists were instituted in response to worries over "desertion after the fall of Harfleur" and probably reflect records of those who took ship for home from the port, with the names being written down at embarkation.²⁷¹ She does not, however, make any allowance in her accounting for (1) those who went home before the system was put in place (which seems to have been only after the end of the siege),²⁷² (2) those listed on sick-rolls that no longer exist in the archives, (3) those who deserted the army and slipped away home without authorization,²⁷³ or (4) those who were too sick to serve at the time of Henry's departure from Harfleur, but who chose to remain in the town to recover rather than

Century, 285. Morosini, in *CS*, 193, quotes reports of 6,000 dead. Note also *Gesta*, in *CS*, 27; Tito Livio, in *CS*, 57; Pseudo-Elmham, in *CS.*, 65.

²⁷⁰ Curry, *New History*, 58, 85, 114. Similarly, in Sir Simon Felbrigg's retinue, of thirteen men-at-arms (including himself), one (7.7%) died at Harfleur, six were invalidated home, and six continued to Agincourt. Curry, in *CS*, 431. On the other hand, in the earl of Arundel's retinue, which started with 100 men-at-arms and 300 archers, the post-campaign account indicates that 2 of the former and 13 of the latter died during the siege; another 19 and 68 were on the sick lists. Curry, *New History*, 114. There are slightly different numbers given in Vale, *Agincourt*, 206. Hence we have about 25% of the retinue either dead or evacuated, with 15% of those severely ill dying, but only about 4% of the total strength.

²⁷¹ Curry, *New History*, 114.

²⁷² *Gesta*, in *CS*, 27; Vale, *Agincourt*, 203–4.

²⁷³ Captains commanding these men would have a significant incentive to cover up their desertion, since, if the absence were noted by the royal clerks, the deserters' pay would be deducted from the sum owed the captain.

braving a sea-voyage home.²⁷⁴ Since the magnitude of those factors cannot be estimated with any kind of precision, Curry's methodology cannot bring us to a satisfactory conclusion concerning the size of the army that marched for Calais. On the other hand, it does show that the English army cannot realistically have been as large as claimed by even the more conservative French chronicles which give the number of English archers alone at 10,000–16,000. Indeed, when rough allowance is made for a realistic estimate of the dead and for the four groups just noted as missing from her calculations, the documentary evidence she provides lends strong support to the conclusion that a historian would in any case draw from the chronicle sources: that the English army at Agincourt may have been as small as 6,000 men, or at most as large as around 8,000.²⁷⁵

If we cannot establish based on documentary sources just where within that range we should pin our best-guess estimate, that brings us back to the chronicles. The *Gesta* and two of its derivatives, Hardyng's prose account and Elmham's *Liber Metricus*, describe the field army as made up of 900–1,000 men-at-arms and 5,000 archers.²⁷⁶ Although LeFèvre and Waurin give an estimate for the strength of the archers that is clearly too large (10,000 at the battle), they agree precisely with the *Gesta* in numbering the men-at-arms at 900–1,000; this confirmation is particularly important because these are the only other eyewitness testimonies, and because the difference in the number of archers shows that their tally is in some measure independent.²⁷⁷ Among the other chronicles worthy of being taken into consideration, Thomas Walsingham and John Streeche give the army's total strength as 8,000 men; different versions of the *Brut* have 7,000 or 8,000 men; the *Chronique de Ruisseauville* has 8,000–9,000; and Hardyng's rhymed chronicle has 9,000.²⁷⁸ At first glance, this list might seem to favor an estimate of 8,000 men rather than 6,000, but further consideration indicates that

²⁷⁴ *Gesta*, in *CS*, 27, gives the impression that there was a substantial number of men in the last two groups.

²⁷⁵ Juliet Vale, using the same documents as Curry, and having read Curry's book, concludes that "contemporary administrative records support the chroniclers' assessment of [the army's] size as being in the region of six thousand fighting men." Vale, *Agincourt*, 206–7, 263.

²⁷⁶ See table in *CS*, 12, and Hardyng in *CS*, 83.

²⁷⁷ It is worth noting that LeFèvre qualifies his estimate of the archers, when he first gives it, by adding "as I have heard" ("*comme j'ay entendu*"), which he does not do with his figure for the men-at-arms. *Chronique*, 253–54.

²⁷⁸ See table in *CS*, 12.

the general rule of thumb that advises accepting the lowest credible figures for troop strengths, especially of medieval armies, should be held to in this case.

In deciding among these sources, we must ask of each author: what does he know, and what motive does he have to distort or slant his presentation? The latter question is particularly important when the author is not someone in a position to know the truth first-hand. Most chroniclers tried to be accurate in what they stated as fact. If they intentionally mislead, it is more often by omission than by falsehood. When they give inaccurate information it is usually due to error rather than intentional distortion. To be sure, a chronicler who did not have really solid information to rely on and had to choose from multiple conflicting reports and rumors might well pick from among them the story or claim that fit best with his biases, presumptions, or agenda.

The author of the *Gesta*, however, was one of Henry V's own chaplains during the campaign, and pretty clearly was given a royal commission to write the history of the operation after its conclusion. Thus, he would doubtless have been able to find out first-hand an accurate count of Henry's fighting strength at the battle, if the English government itself had that information. The same cannot be said for any other source. Did King Henry's clerks have muster records which gave the exact numbers of men-at-arms and archers at the battle? Indeed they did, and more. A year after the battle, Sir Robert Babthorpe, the king's comptroller (and an Agincourt veteran himself) presented to the Treasurer and Barons of the Exchequer a "Roll of the musters of various dukes, earls, barons, knights, squires, and other men with the names of their retinues which were with our lord the king at the battle of Agincourt...in which the names of each of the dukes, earls, barons, knights, squires and other men are noted one by one" or "in which the names of every man-at-arms and every archer are noted one by one."²⁷⁹

Without doubt, the chaplain had an agenda which could conceivably have caused him to understate the size of the English force in order to support his rhetorical scheme of presenting Agincourt as a victory given by God. But if we accept that the author of the *Gesta* actually knew the correct size of the army, then for him to lowball the figure

²⁷⁹ J. Hamilton Wylie, "Notes on the Agincourt Roll," *Transactions of the Royal Historical Society*, 3d ser., 5 (1911): 116. Unfortunately this roll has been lost.

in his text, he would have to actually lie—again, so far as we know, unlike any of the other authors. As a priest and as a historian, he would presumably have hesitated to do so. And even if he had been willing to sacrifice the truth to his agenda (something which should not be simply presumed), he would not need to do so, as the simple truth was quite glorious enough for Henry, and already a strong indication of divine favor. The sources are clear that most of the French were supremely confident in victory due to their overwhelming numbers. That is the key point for the chaplain's theme, and whether the English had 6,000 men, 7,000, or even 8,000, the point would still be valid. Hence, if King Henry's army had really been at the top end of that range rather than the bottom, there is little reason to doubt that the chaplain would have said as much. If he wanted to exaggerate the disparity between the two armies, he could easily have done so without having to lie by inflating the size of the French army, concerning which he would have heard diverse reports, without being able to be certain which was correct. This, in fact, is what he seems to have done—though, it should be noted, keeping his figure near the bottom of the range given by other chroniclers²⁸⁰—when he stated that the French amounted “by their own reckoning” to “more than sixty thousand who drew the sword.” The first-quoted phrase is worth emphasizing, because it quite possibly makes his overall statement not only honest but literally true, even though not ultimately accurate.²⁸¹

In short, the author of the *Gesta* was an eyewitness to the battle, and almost certainly knew the truth about the English numbers. Furthermore, he is generally very reliable in the other details he gives. Finally, he had no strong motive to falsify what he knew. As a result of these

²⁸⁰ See chart in *CS*, 12. All of the English chroniclers who do not give the same figure as the *Gesta* give even higher numbers, ranging up to 140,000 and 150,000. The only French chronicles that give overall numbers for the strength are the Burgundians are those of Monstrelet, Waurin and LeFèvre, who reckon the French army at 50,000 to 90,000. *MWF*, In *CS*, 145, 155, 157.

²⁸¹ By their own reckoning, the French numbered over 60,000, but that “reckoning” was not accurate. Considering the Burgundian chroniclers' figures just given in the last note, and considering that the the *Chronique de St.-Denis*, though it does not give a specific number for either army, says the French outnumbered the English by 4:1, and that the army of the latter comprised 12,000 archers and an unspecified number of men-at-arms, again implying a French total of somewhere around 56–60,000, it would not be at all surprising, however, if some of the high-ranking French prisoners to whom the chaplain had access did indeed estimate their own force at as much as 60,000 combatants.

factors, his testimony outweighs the statements of men like Walsingham and Streeche, who were in monasteries in England in 1415. Although we cannot be entirely certain that the English did not have 7–8,000 combatants at the battle, the balance of evidence supports the *Gesta's* smaller estimate.

APPENDIX III

The English Advance

In the description of the start of the battle, it was taken as fact that the English archers did re-set their stakes after advancing into bow range and before the French cavalry charged. This is the traditional understanding of the battle, but it has recently been challenged by Michael K. Jones, who argues it is “quite unbelievable” that the French would have failed to strike with their cavalry during the relatively long interval it would have taken for the English to shift their position over the muddy fields.²⁸² He also notes that the *Chronique anonyme* does state that the English had a major advantage in the battle because they “were fresh and unwearied as they had not moved from their advantageous position.” Moreover, he says, the author of the *Gesta* “makes no clear reference to a repositioning of the stake wall,” while the pseudo-Elmham specifically says the archers left the stakes “behind them in the field” when they advanced. Drawing on this and other evidence, Jones concludes that the opening of the battle was very different than has been generally understood. He thinks that the initial English advance involved only a short movement forward, twenty paces or so, with the archers leaving most of the stake-wall behind them. At that point, a group of archers who had advanced under cover to a concealed position within bow-range of the French began to loose their arrows, which, in combination with taunting behavior by the English troops, provoked the French into charging at the main English line. In response, the English quickly fell back to their initial position, so that the archers regained the shelter of the stakes, having successfully lured the French into a trap.²⁸³

This is an intriguing and original argument, and Jones offers a significant amount of evidence (in addition to the points noted in the last paragraph) to support his case. In the end, however, Jones’s revisionist view of this stage of the battle should not be accepted.

²⁸² Jones, *Agin-court*, 104.

²⁸³ *Ibid.*, 102–12, 148–49.

First of all, if the English had really employed such a clever gambit, and then demonstrated the exceptional discipline required to turn their backs on a cavalry charge and reform behind their defenses, surely at least one of the sources would have mentioned the fact. Second, it is not so surprising that the French would have failed to charge the English while the latter were advancing. The French were clearly surprised by the English maneuver and not ready to act.²⁸⁴ Moreover, from their perspective, the longer the English marched toward them, the better. The farther King Henry's men came, the more tired and disordered they would be. The French, at the same time, would have less of the muddy field to traverse before closing with the English.²⁸⁵ Consequently in addition to their lack of preparedness, they had good reason to hold back from charging while the English marched toward them. Third, the better sources, directly or by implication, support the traditional account of the English advance into bow-range.

Waurin and LeFèvre, who were eye-witnesses, describe the wings of English bowmen advancing deliberately across the fields until they came into extreme bow-range of the French line, at which point they began to fire, thereby provoking the French charge.²⁸⁶ The *Gesta*, likewise, says the French crossbowmen fired one volley just before the advance of the French main body began, and that this volley did inflict a few English injuries.²⁸⁷ Even the *Chronique anonyme*, a key text for Jones, opens its description of the battle with "The English began to fire on

²⁸⁴ *MWF*, in *CS*, 160: "When the French saw the English come before them [in their final advance], they put themselves into battle order each under their own banner, placing helmets on their head. They were urged by the constable and the other princes to confess their sins in true contrition and to fight well and boldly." Berry Herald, in *CS*, 181–82: Henry "found the French in poor array and in small number, because some had gone off to get warm, others to walk and feed their horses, not believing the English would be so bold as to attack them."

²⁸⁵ Walsingham, in *CS*, 51: "Because of the muddiness of the place... the French did not wish to proceed far into the field..., the king realized the astuteness of the French in standing firm in one place so that they might not be exhausted by advancing on foot through the muddy field."

²⁸⁶ LeFèvre, *Chronique*, 253–54: "When the English saw that the French would not approach them, they marched towards them... Then, the archers... began to shoot in volleys against the French, from as great a distance as their strength allowed them to shoot [*de aussi loing que ilz pouvoient tirer de leur puissance*].... Then the French, seeing the English come towards them, set themselves in order..."; Waurin, *Recueil*, 2:212: "Once the archers of England who, as I said, were on the wings, saw that they were close enough, they began to shoot against the French with great vi[g]or."

²⁸⁷ *Gesta*, in *CS*, 36.

the French.”²⁸⁸ Thus, when the French charged, the English obviously had come within bow-range of their line. Yet, when the armies formed up in the morning, four or five sources clearly indicate the English were separated from the French by at least two to three bowshots.²⁸⁹ Hence, the advance noted in many sources cannot have been, as Jones suggests, a matter of just a couple dozen yards; it must have been at least a full bow-shot (around 300 yards), and was probably at least 500 yards.

In support of his idea of a much shorter advance, Jones cites a passage from the Pseudo-Elmham, using Curry’s translation, which states that “when [the English] had approached towards the enemy’s ranks, to the distance of twenty paces, not far from Agincourt... the enemy now first stirring himself, proceeded to meet the English.”²⁹⁰

Jones takes this to mean that the English had advanced twenty paces from their *starting line*, but the Latin clearly implies that twenty paces is actually meant as the distance from some *end point*. In context, the first phrase should probably be translated as “when they had approached toward the enemy lines all the way up to within a short distance, 20 paces from Agincourt.”²⁹¹ In any case, the Pseudo-Elmham’s text has no real value on this point, since it is merely a slightly confused paraphrase of Tito Livio’s clearer statement: “when within twenty paces of the town of Agincourt they came to the French enemy.”²⁹² Either way, the overall meaning is close to the same: before meeting the French, the English advanced from their initial position at the southern end of the

²⁸⁸ *Chronique anonyme*, in *CS*, 115.

²⁸⁹ Tito Livio, in *CS*, 60: “two or three bow shots.” Pseudo-Elmham, in *CS*, 71 puts the number at three bow shots; Walsingham, in *CS*, 51 alleges 1000 paces; The Monk of St. Denis, in *CS*, 106 gives a figure of 2000 paces; and Capgrave, *Abbreviation of Chronicles*, in *CS*, 76, n. 39 estimates the distance as “less than a mile”. Note also *Gesta*, in *CS*, 33 (on the “far side” of the Tramecourt woods).

²⁹⁰ Pseudo-Elmham, in *CS*, 72.

²⁹¹ Pseudo-Elmham, *Vita et Gesta Henrici Quinti*, ed. Thomas Hearne (Oxford, 1726), 65: *Cumque usque ad distanciam viginti passuum non procul de Agincourt versus acies hosticas appropinquassent*. The “usque ad” [right up to, all the way as far as] does not fit with Jones’s reading of the text. An advance to within 20 paces of Agincourt makes perfect sense, while an advance to within 20 paces of the French line (which the Latin could also mean) does not, as it would not allow room for the French cavalry to charge, or for the French infantry to become exhausted in their advance; also, if the English had kept marching until they were just twenty paces from the French lines, that would have given the French bowmen the chance to fire more volleys more effectually.

²⁹² Tito Livio, in *CS*, 61.

pass to a new line “not far from Agincourt” or “twenty paces from Agincourt.” As discussed above in the main text of this article, that most likely means they advanced far enough for the men-at-arms to benefit from the “advantageous position” on the hard ground of the Agincourt-Tramecourt road, with the archers’ wings projecting further forward so that they were within bowshot of the French position at the “far side” of the pass.²⁹³

A final two pieces of evidence that support this general interpretation come from the *Gesta* and Thomas Walsingham. The former states that the men-at-arms made contact when each side “had advanced towards one another over roughly the same distance.”²⁹⁴ The latter describes the French launching their attack after they “saw that our men had crossed the field with considerable effort.”²⁹⁵ It is difficult to see how these can be reconciled with Jones’ version of events.²⁹⁶

On the other hand, it is true that, as Jones observes, the traditional understanding of the advance does contradict the *Chronique anonyme*’s statement that the English had the advantage in hand-to-hand combat because they were fresh and rested, not having moved from their initial advantageous position, whereas the French were exhausted from their trudge through the mud. Likewise, if the Pseudo-Elmham were correct that the English left behind their stakes in the advance, that would imply they did not move far beyond the stakes, since they were clearly (from a number of sources) behind them before the cavalry reached them. But neither of these sources can compare in authority with the accounts of the men who were actually present at the battle (the *Gesta*, Waurin, and LeFévre). The *Chronique anonyme*’s statement is most likely a somewhat confused version of a true and important observation: that the English men-at-arms fought on favorable ground (probably the hard earth of the Agincourt-Tramecourt road), and were calmly resting on the defensive,

²⁹³ *Gesta*, in *CS*, 33.

²⁹⁴ *Gesta*, in *CS*, 36.

²⁹⁵ Walsingham, in *CS*, 51, 52: “it was necessary for the English, if they wished to come to grips with the enemy, to traverse the middle ground on foot, burdened with their arms.”

²⁹⁶ Note also, for what it is worth, the *Great Chronicle of London*, in *CS*, 99: the English “went on foot in their whole array for an English mile” before the opposing lines made contact. See also the *Chronique de Ruisseauville*, in *CS*, 125; and Berry Herald, in *CS*, 181.

after having had time to recover their breaths, by the time the French reached them. As for the Pseudo-Elmham, again his text should not be given much weight in comparison to Tito Livio, who says specifically what other sources also imply: that the English made the advance to near Agincourt “each one with a great sharp stake.”²⁹⁷

²⁹⁷ Tito Livio, in *CS*, 61.

APPENDIX IV

The Duration of the Cavalry Charge

In *The Face of Battle*, John Keegan estimates that the charge of the French cavalry took about 50 seconds to cover “two or three hundred yards.” This is much too fast for 200 yards, and completely off the mark for 300, which is a more realistic estimate of bow-range.²⁹⁸

Keegan, moreover, seems not to take into account the fact that, due to the forward-leaning angle of the wings, the horsemen on the far flanks would have quite a bit less ground to cover than the men nearer the center—perhaps as much as 200 yards less. He also seems not to take into account that the cavalry had to charge over fields so sodden and churned that “horses could scarcely lift their hooves out of [the mud].”²⁹⁹

How long it would take for a line of cavalry to cross a given distance depends on a number of variables, mainly the amount of ground covered at different gaits (walk, trot, and, if used, canter, slow gallop and charge) and the speed which could be averaged at each gait without dissipating the cohesion of the formation. Different cavalry manuals of different nations in different eras have given different figures for each of these.

It seems safe to say that a late-medieval charge must normally have been rather slow and ponderous compared to a similar attack in the eighteenth-century. After all, medieval war horses were bigger and slower; many of them were armored (at least at Agincourt), and those not armored would have had to adjust their speed to those that were,

²⁹⁸ Keegan, *Face*, 95.

²⁹⁹ LeFèvre/Waurin in *CS*, 154. The recent “Battlefield Detectives” television show on Agincourt showed that the mud created by the heavy soil of Agincourt after a long period of rain would have created great suction against the lifting of a metal-bottomed shoe. The program implied that this was of great relevance to understanding the problems of the dismounted men-at-arms, which is somewhat off target since the bottoms of boots were not armored. Horseshoes, however, were smooth metal in contact with mud, and so the horses would indeed have found it hard going to pull their hooves up. In any case, the soil testing done in the show was valuable in demonstrating that the earth of Agincourt was capable of creating exceptionally gluey, sticky mud.

in order to maintain formation. In addition, the horses had to bear the weight of a heavily-armored rider and a very large, heavy saddle. Moreover, medieval forces were not standing units accustomed to regular drill, crucial for maintaining order at any kind of high speed. Thus, although later cavalry forces covered much of the distance of an attack at the gallop, Guibert in 1772 observed that “for a long time in France, it has been believed that cavalry cannot charge at the gallop in order.”³⁰⁰

Still, eighteenth-century tactics can give us a baseline to bracket fifteenth-century charges; the latter may well have been quite a bit slower, but can hardly have been any faster. According to the French cavalry regulations of 1788, the final all-out burst was to be made at a distance of about 40 yards, after 50 yards at a walk, 150 at a trot, and 80 at a gallop.³⁰¹ The same regulations give speeds of 100–110 yards/minute for the walk, 200–220 for the trot, and 340 for the gallop. These match fairly closely with 1924 British cavalry regulations, which also give a rate for the full gallop (the final charge) of 440 yards/minute.³⁰² The total for the 1788 charge is 320 yards; adding 5 yards to the trotting phase to equal estimated arrow-range of 325 yards, this works out to 90 seconds charging time. For a 275-yard charge from a standing start, assuming 50 yards at a walk, 105 at a trot, 80 at a gallop, and 40 at the charge, the time would be about 76 seconds. This, then, would be an absolute minimum estimate for the cavalry charge at Agincourt, *without* taking into account the mud.

To make a more accurate estimate, we should allow for the lesser speed of a heavier horse with a much heavier load. I know of no way to make such a calculation, other than a simple guess that the speed at each gait should be reduced by at least 15%, which would produce an estimate of about 88 seconds for 275 yards and 104 seconds for 325. If, however, we follow Guibert (who is supported by other sources)³⁰³

³⁰⁰ Quoted in Bvt. Commandant Édouard Desbrière, (chef de la section historique de l'état-major de l'armée) and Captain Maurice Sautai, *La Cavalerie de 1740 à 1789* (Paris, 1906), 60.

³⁰¹ Desbrière and Sautai, *Cavalerie* 110, counting a *toise* (6 French feet) as two yards. At the turn of the twentieth-century, Col. Maxime Pierre Joseph Cherfils, commander of the 7th dragoons, figured a gallop about the same way at 340 meters per minute. *Essai sur l'emploi de la cavalerie. Leçons vécues de la guerre de 1870* (Paris, 1898), 330.

³⁰² <http://users.tkk.fi/~vesanto/link.useful/gmlibrary/pace.html>. See also Balck, *Tactics*, 2:32, for rates from several countries.

³⁰³ In the seventeenth century, cavalry “would advance at a normal or even a slow trot; at the very fastest a quick trot.” Nosworthy, *Anatomy of Victory*, 122. Emperor

and assume that a fifteenth-century charge never accelerated past the trot (especially on soft ground), the figures become respectively 103 and 119 seconds.

These figures do not take into consideration the effect of the mud at Agincourt, which was so thick that “horses could scarcely lift their hooves out of it.”³⁰⁴ Again, I know of no way to account for this other than another educated guess. It would be not unrealistic to think that horsemen would take two or three times as long to traverse such difficult ground while maintaining formation. But even if we only add 50% to the time required—a very conservative estimate³⁰⁵—, that brings us up to two and a half minutes for 275 yards and three minutes for 325 yards. (Note that these calculations still do not factor in the likelihood that each charging horse would be further slowed by one or more arrow wounds over the course of its run.)

Maurice, in the sixth century, likewise called for cavalry in close order to charge “not too fast but at a trot, to avoid having the impetus of their charge break up their ranks before coming to blows with the enemy, which is a real risk.” Maurice, *Strategikon*, trans. George T. Dennis (Philadelphia, 1984), 38.

³⁰⁴ Waurin, in *CS*, 159.

³⁰⁵ Austrian drill regulations in the late nineteenth century called for movement of 225 m/minute at the trot, but observation of movement in the field, over mere “soft ground,” clocked the actual rate at only 150–160 m/minute, i.e. at one third less than normal. Balck, *Tactics*, 2:32–33. The same source notes that “the trot over soft ground imposes the same strain on the [horse’s] lungs as the gallop over hard, level ground.”

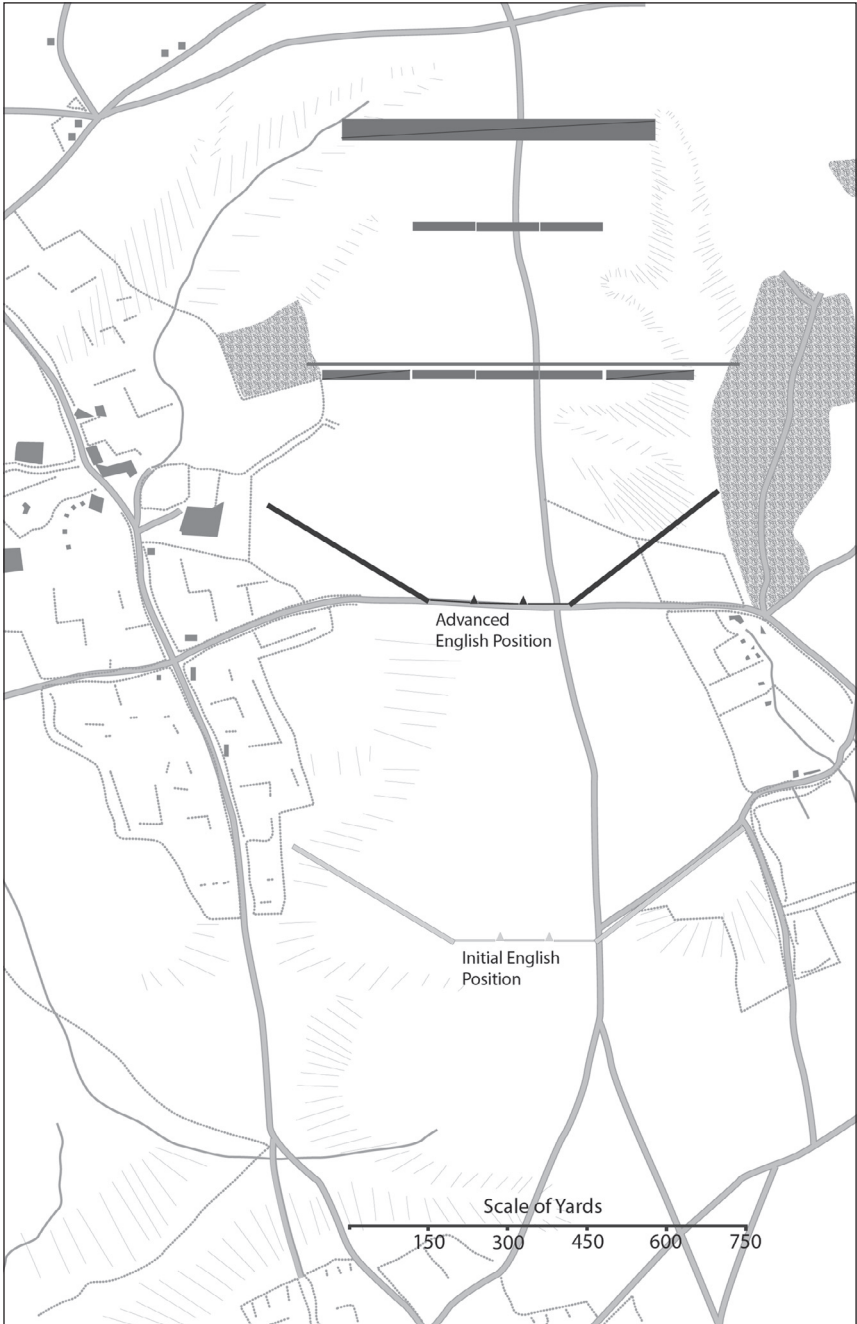

Map 6: Battle of Agincourt.

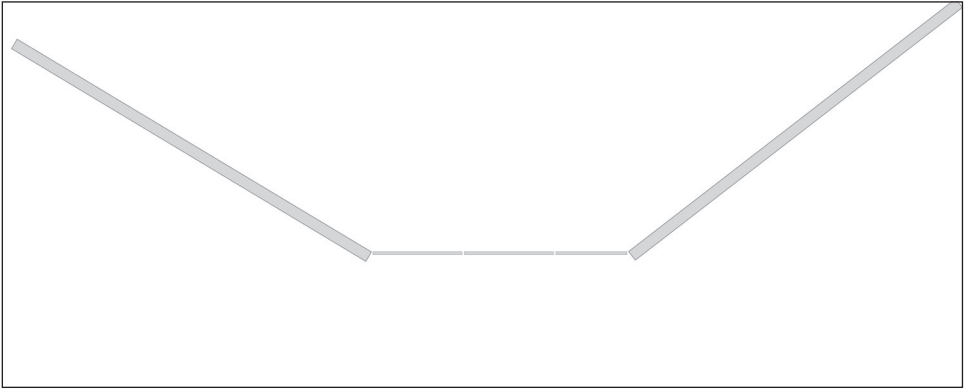

Figure 1: Proposed arrangement of English men-at-arms and archers at Agincourt. In this arrangement, all of the bowmen are on the far flanks of the English men-at-arms (as indicated by Waurin).

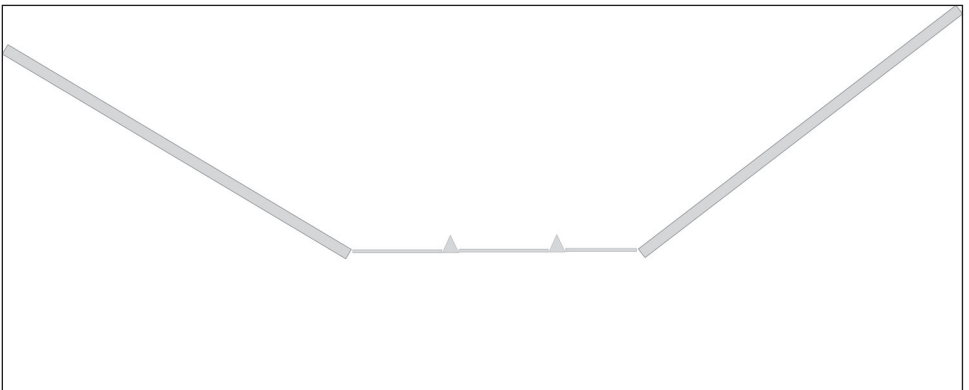

Figure 2: Proposed arrangement of English men-at-arms and archers at Agincourt. In this arrangement, there are small wedges of archers between the wedges (as suggested by the *Gesta*).

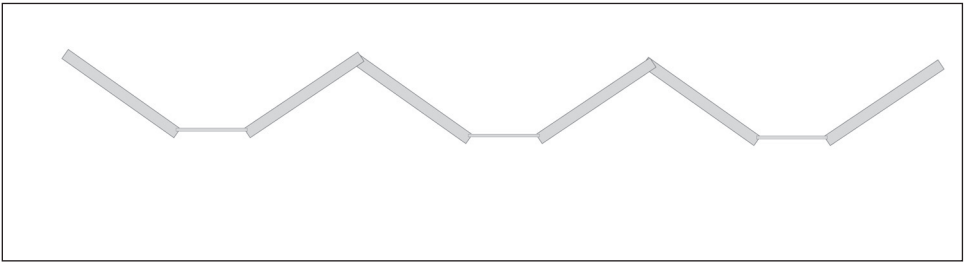

Figure 3: Proposed arrangement of English men-at-arms and archers at Agincourt. In this arrangement, the three battles of English men-at-arms each have large wings of archers (another interpretation of *Gesta's* description).

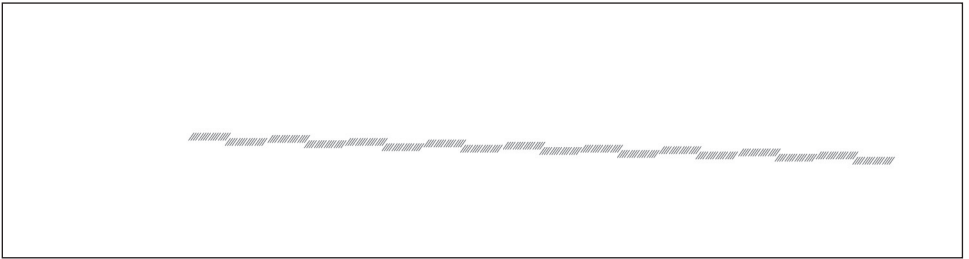

Figure 4: An example of how the stakes could be staggered to allow for footmen to side-step through the offsets, while the palings would still present effectively a solid fence to enemy horsemen.

GRIEF AND MEMORY AFTER THE BATTLE OF AGINCOURT

Megan Cassidy-Welch
University of Melbourne

... For this damned war has caused us so much misery...¹

great grief there was throughout the kingdom of France especially at the king's court for the loss at Agincourt.²

Who is the one who does not find sadness where it is common to everyone?³

Of the many general outcomes of military engagement during the Hundred Years War, emotional and psychological consequences remain generally unexplored. While this is partly a result of the paucity of source material dealing explicitly with the aftermath of military action and its sometimes intangible effects on civilian populations, it is also partly a result of the tendency of military historians to conceive of the effects of warfare in a conventionally socio-political sense. That is, consequences of war—especially on non-combatants—still tend to be measured in terms of economic loss, geographical displacement, the fracturing of social and political networks, agricultural and rural devastation, political change and so on.⁴ These are all important, indeed

¹ *Journal d'un bourgeois de Paris de 1405–1449*, ed. Colette Beaune (Paris, 1990), 150.

² *Recueil des Croniques et Anchiennes istories de la Grant Bretagne a present nomme Engleterre par Jehan de Waurin*, ed. W. L. Hardy and E. L. C. P. Hardy, 5 vols. (London, 1864–1891), 5:225 (bk 1).

³ *Oeuvres de Robert Blondel*, ed. A Héron, 2 vols. (Rouen, 1891–1893), 1:34.

⁴ For a few examples, see Robert Boutruche, *La crise d'une société: seigneurs et paysans du Bordelais pendant la Guerre de Cent Ans* (Paris, 1947); *Society at War: the Experience of England and France during the Hundred Years' War*, ed. C. T. Allmand, (1973; reprint, Woodbridge, Suffolk, 1998); Nicholas Wright, *Knights and Peasants: The Hundred Years War in the French Countryside* (Woodbridge, Suffolk, 1998); Anne Curry, "The Impact of War and Occupation on Urban Life in Normandy, 1417–1450," *French History* 1 (1987): 157–81. For recent historiography, which tends to focus on modern military history, see the debates surrounding the "new" military history in (*inter alia*) John Whiteclay Chambers II, "The 'new' military history: myth and reality," *The Journal of Military History* 55: 3 (July, 1991): 395–406; for similar questions in the German context, see *Was ist Militärgeschichte?* ed. Thomas Kühne and Benjamin Ziemann (Paderborn, 2000).

fundamental, effects, of course, and all at least hint at the sometimes terrible experiences of those who were forced to deal with the loss and displacement suffered by many during the fourteenth and fifteenth centuries. Yet questions remain to be asked about the way in which medieval people dealt with and responded to the violence of war and the trauma of loss. How did they articulate grief? What were the means by which war was remembered and the war dead commemorated during this period?

Much work has been completed on emotional and psychological consequences of modern warfare by historians of the Great War and the Second World War. Scholars such as Jay Winter, in his groundbreaking book, *Sites of Memory, Sites of Mourning*, have taken a cultural historical approach to the aftermath of violent conflict. They have interrogated the ways in which societies have attempted to talk about the grief that accompanies war, the processes of mourning which articulate loss, and the construction of collective memories about war and death.⁵ It is clear from such studies that attitudes towards death and grief must be historically contextualized. For Winter, the reflections of Sigmund Freud on mourning and melancholia provided an early-twentieth century context in which to consider other cultural manifestations of loss and bereavement.⁶ In the medieval context, Frederick Paxton has shown that by the ninth century, outward or public responses to death (whether deaths as result of combat or otherwise) had become strongly Christian, highly politicized, and ritually delineated.⁷ The eagerness of Carolingian rulers to assert control and homogeneity over funerary and mortuary practices led, in Paxton's words, to a "complex and coherent ritual process," which eventually pervaded not just the Frankish church, but medieval western Europe in general.⁸ Such rituals were not just associated with the practical interment of a corpse, but were also concerned to provide a clear framework in which appropriate lamentation could take place and in which the dead could be adequately

⁵ Jay Winter, *Sites of Memory, Sites of Mourning: The Great War in European Cultural History* (Cambridge, 1995).

⁶ See Sigmund Freud, "Mourning and Melancholia," in *Collected Papers*, trans. Joan Riviere, 5 vols. (London, 1950), 4:152–70. See also *European Memories of the Second World War*, ed. Helmut Peitsch, Charles Burdett, and Claire Gorrara (New York, 1999).

⁷ Frederick Paxton, *Christianizing Death: The Creation of a Ritual Process in Early Medieval Europe* (Ithaca, N.Y., 1990).

⁸ *Ibid.*, 209.

commemorated.⁹ Thus, the way in which grief is expressed, in which lamentation is practiced, and in which these emotional responses to death are used to shape collective memory about an event or events, must be anchored to the contexts in which they occur.

It is the purpose of this study to explore some manifestations of grief, mourning and remembrance during the Hundred Years War. It will focus on the experience of those affected by the catastrophic French defeat at Agincourt, a battle which took place amidst many manifestations of quotidian violence discussed by Nicholas Wright and others. Three main questions arise. First, how do the written texts articulate ideas of grief and mourning? Second, how do those texts incorporate grief and loss into their narratives? Third, how did grief and mourning help to shape individual and collective memory of Agincourt and its aftermath? In any attempt to answer these questions the sources must be approached with caution. This study will concentrate on the French chronicle and narrative material composed between the time of Agincourt and the mid-fifteenth century; it will also deal to a lesser extent with the literary (mainly poetic) material from the same period.

From the outset, it is crucial to remain aware of not just the various political persuasions of the authors, but more pertinently to remain aware of the narrative purposes of their historical accounts. Michel Pintoin, the “Religieux of St-Denis,” for example, may talk about the aftermath of Agincourt, but his moralizing propensity emerges out of a textual tradition quite distinct from a writer such as Christine de Pizan, whose *Epistre de la prison de vie humaine*, addresses ways of mourning for Christian women.¹⁰ This is not to say that the reader can always be certain of the intent or purpose of the writer of historical texts, nor is it to say that these texts have nothing in common. But it is important to recognize that the representation of death and loss and the memorialization of violence and grief must be considered in light of both the historical context and the specific historical narrative. Likewise, the writers of these narrative sources tended to be either clerical or aristocratic, and they often relied on one another for their information concerning events. Their representations of grief and bereavement should not be taken to indicate what the entire population was feeling, even if some

⁹ For more on the context of commemoration and the ritual process, see Patrick J. Geary, *Living with the Dead in the Middle Ages* (Ithaca, N.Y., 1994).

¹⁰ For the “Religieux of St Denis” and the historiographical milieu to which he was attached, see Gabrielle Spiegel, *The Chronicle Tradition of Saint Denis* (Leiden, 1978).

of these texts claim to do just that. These caveats taken into account, it is nonetheless possible to make inroads into the questions at hand.

I. *Grief and Mourning*

The initial news of the defeat at Agincourt was brought to Charles VI (1380–1422) at Rouen by a messenger. All chroniclers agree that these tidings were grievous. For Jehan de Waurin, the defeat was “piteous”; for Enguerrand de Monstrelet, this was the “saddest of days.” Sadness was expressed by Jean Le Fèvre,¹¹ author of the *Geste des nobles françois*¹² and by the “Religieux of St Denis”: “I don’t think that there has been a bigger disaster in France for the last fifty years or in my opinion one that has worse consequences” he wrote of this “sad outcome.”¹³ Consequences were also noted by Perceval de Cagny, writing in the late 1430s. For this writer, Agincourt was in hindsight “most wretched and a cause of great and unrecoverable damage for the king.”¹⁴ The king’s reaction ranged from “great sorrow,” according to Le Fèvre, to distress and anger, according to Waurin. There was general consternation, reported the *Religieux of St Denis*, and the king felt:

bitter sadness in thinking that the kingdom had been deprived of so many of its illustrious defenders and that revenues already diminished in order to pay the troops would be completely ruined by the ransoming of prisoners.¹⁵

Indeed, on hearing the news, “the king and dukes of Guienne and Berry were overcome by a tremendous sadness and fell into a state of profound dejection.”¹⁶

¹¹ *Chronique de Jean le Fevre, Seigneur de Saint-Remy*, ed. F. Morand, 2 vols. (Paris, 1876–1881), 1:268–69.

¹² *Chronique de la Pucelle ou Chronique de Cousinot*, ed. A. Vallet de Viriville (Geneva, 1976), 156–57.

¹³ *Chronique du Religieux de Saint-Denys contenant le règne de Charles VI de 1380 à 1422*, ed. and trans. M. Bellaguet; intro. Bernard Guenée, 6 vols in 3 (Paris, 1994), 3:580: *Non magis infortunium regnum pertulisse a quinquaginta annis citra profitoer, neque, iudicio meo, consequencie peioris*; and the *Religieux*, 573 refers to this *casus miserabilis*.

¹⁴ *Chronique de Perceval de Cagny*, ed. H. Moranville (Paris, 1902), 94–101 for the account of Agincourt.

¹⁵ *Chronique du Religieux de Saint-Denys*, 3:570.

¹⁶ *Ibid.*, 3:574.

The loss at Agincourt was almost immediately placed into historical perspective. For the “Religieux of St Denis,” the sadness of all men and women was at least in part due to the realization that their age had been dishonored in the eyes of posterity. A later writer, Thomas Basin, noted another of the defeat’s long-term consequences: “it destroyed a great part of those who could defend the kingdom from the enemy.” This, observed Basin, was a lasting cause of ruin and destruction to France.¹⁷

Personal losses were also strongly felt. *Les Mémoires de Pierre Fenin* tell us that the duke of Burgundy “was much distressed by the French loss when he was told of it, and particularly by the loss of his two brothers, duke Anthony of Brabant and the duke of Nevers.”¹⁸ According to the *Journal d’un bourgeois de Paris*, the duke of Burgundy was still very distressed by the death of his brothers and their retainers weeks after the battle.¹⁹ For others, Waurin observed that the duke’s murder several years after Agincourt had the effect of compounding the lingering distress of battle.²⁰

In some writers, expressions of grief and anger erupted simultaneously. The *Journal d’un bourgeois de Paris* is one of a number of texts chronicling the city’s rage. This was directed not only against those suspected of being traitors, but also at French impotence in the face of English advances; “no one did anything about it”, he wrote, “because . . . all the princes of blood royal had been taken prisoner by the English king at the battle of Agincourt.”²¹ By 1419, according to the *Journal*, there was nothing but “poverty, misery, . . . [and] grief” throughout northern France.

In short, grief was a manifestation of many different emotions, including loss, shame, absence, and distress. Such feelings surfaced not only in relation to the many deaths suffered at Agincourt, but were also expressed in relation to prisoners of war.²² Fifteen-hundred noblemen,

¹⁷ Thomas Basin, *Histoire de Charles VII*, in *The Battle of Agincourt: Sources and Interpretations*, ed. and trans. Anne Curry (Woodbridge, Suffolk, 2000), 186.

¹⁸ *Mémoires de Pierre de Fenin*, ed. E. Dupont (Paris, 1877), 58–67 for the account of the battle of Agincourt.

¹⁹ *Journal d’un bourgeois de Paris*, 96.

²⁰ *Jehan de Waurin*, 5:275 (bk 1).

²¹ *Journal d’un bourgeois de Paris*, 135.

²² For the emergence and treatment of madness among contemporary English prisoners, see Wendy J. Turner’s essay “Mental Incapacity and Financing War in Medieval England,” in this volume.

knights, and esquires were dragged from the battlefield as spoils of battle.²³ Almost all chronicles list the names of the most important of these men: Charles, duke of Orléans, who had been found alive under a pile of corpses on the battlefield; Boucicaut, marshal of France; Jean I, duke of Bourbon; Arthur III, duke of Brittany, Charles of Artois, count of Eu, and Louis of Bourbon, count of Vendôme. These prisoners numbered among the men who rode with the victorious King Henry V on his way to Calais the day after the battle of Agincourt. They were the men whose ransoms, as the victorious sovereign rather smugly told them, would finance his plans for further incursions into France and the ultimate capture of the French crown. The prisoners, once they reached London, were paraded through the streets as public evidence of the king's success. They were ordered to follow him through the cheering crowds, walking through Cheapside, where the conduits ran with wine. Along the route to Westminster, they were treated to maidens singing verses of congratulation and thanks for an English victory.²⁴

For French chroniclers, this was one of the most shameful aspects of the Agincourt defeat. The "Religieux of St Denis" laments that the nobility of France were taken prisoner and put to ransom "like a vile troop of slaves." "O eternal dishonor," Pintoin intoned, and "most galling to think [that] France [was] feeble and the laughing stock of other countries."²⁵ One biographer of Charles VII (1422–1461) blamed the nobles for their own predicament. "When they were caught by the English, they put up no resistance... They let themselves be... led off as captives like a flock of sheep."²⁶ Another author lectured the French army on the perils of ignoring history:

The annals of earlier reigns ought to have served as lesson for the lords of France... they even had an example from recent times in the person of the illustrious king of France, John, who for having attacked the English under similar circumstances had been defeated and taken prisoner [after the battle of Poitiers].²⁷

²³ For prisoners of war, see Christopher Given-Wilson and Françoise Beriac, "Edward III's Prisoners of War: The Battle of Poitiers and its Context," *English Historical Review* 116 (2001): 802–33.

²⁴ *Gesta Henrici Quinti*, ed. and trans. Frank Taylor and John S. Roskell (Oxford, 1975).

²⁵ *Chronique du Religieux de Saint-Denis*, 3:562.

²⁶ Basin, *Histoire*, in *Battle*, 186.

²⁷ *Ibid.*, chap. 9. For reactions to the battle of Poitiers (and some comparisons with Agincourt), see Françoise Autrand, "La Déconfiture. La Bataille de Poitiers (1356) à

Most vivid of all, the Norman writer, Pierre Cochon, described the imprisonment of the dukes and nobles as “the ugliest and most wretched event that had happened in France over the last 1000 years.”²⁸

Alain Chartier also discussed such shame in association with loss in the *Livre des quatre dames*. Chartier sought to explore the aftermath of Agincourt through the experiences of four fictional women, whose loves had respectively died, been captured, deserted or were missing in action.²⁹ Using the format of a courtly-love debate, he assumed aristocratic female voices to talk about an important form of trauma after Agincourt. To the woman whose lover died in battle, death is both honorable and cruel. There is no hope for her, and although she might find some consolation in the valorous nature of his death, she is the victim of a cruel fortune. For the woman whose lover has been taken as a prisoner of war, anxiety seems to become the principal emotion. She is continually fearful for her lover’s safety as fortune continues to wound him.³⁰ In her case, shame enters into the equation since the honor of her soldier has been compromised by his having been taken prisoner. The woman whose lover deserted the battlefield manifests grief over her own shame and dishonor having given her heart to someone who displayed such cowardice in the military arena. Her reaction mirrors actual historical accounts of Agincourt in which blame attaches to those who shirked their duties by either fighting weakly or not fighting at all.

Mourning, whether conducted in public or private, was a longer lasting process that followed initial, more spontaneous manifestations of sadness and grief. It could be expressed through the pragmatic task of burying the dead in appropriate ways or carrying out the appropriate funerary and commemorative rites. Women widowed after the battle engaged in personal displays of lamentation and loss. By contrast, the crown sponsored no “official” mourning after Agincourt; as a matter of fact, the only commemorative service for some of those who died

travers quelques textes français des XIV^e et XV^e siècles,” in *Guerre et société en France, en Angleterre et en Bourgogne XIV^e–XV^e siècle*, ed. Philippe Contamine, Charles Giry-Deloison and Maurice Keen (Lille, 1991), 93–121.

²⁸ Translated in *Battle of Agincourt*, 113.

²⁹ *The Poetical Works of Alain Chartier*, ed. J. C. Laidlaw (Cambridge, 1974), 198–304 for the text of *Le Livre des Quatre Dames*.

³⁰ *Livre des quatre dames*, 237 (l. 1300).

on the battlefield seems to have taken place at the University of Paris.³¹ Nonetheless, mourning, both formal and informal, was widespread throughout society.

II. *Interment*

While not all written accounts of Agincourt describe the burial of the dead, those passages which do range in length from a mere line or two to fairly elaborate descriptions of the fate of the corpses. Monstrelet, for example, describes the careful washing of the dead lords and dukes, and states that all the bodies which were recognizable were taken away by servants and friends “in order to be buried in their lords’ churches.”³² It is clear from his account that for some survivors, like Philip of Charolais, finding and claiming the bodies of their loved ones was of great importance. Because of “the great sadness in his heart, resulting from the deaths of his two uncles,” Philip ordered that their bodies be retrieved from the field and brought home.³³ Like some of the other sources, Monstrelet says that the bodies had been stripped by the English as well as local peasants, then left completely naked on the field. Those who were not claimed by servants, relatives, or friends, and those who died in local hospitals or houses as a result of their wounds were buried on the site of the battle. The later *Chronique de Normandie*, written in the 1460s, alleges that only the bodies of the nobility were carried “each to his own territory.”³⁴ If this source is to be believed, soldiers of lesser rank were, for the most part, left on the field.

According to Monstrelet, those in charge of burying the unclaimed dead marked out a square of twenty-five feet within which they dug three ditches, each as wide as two men. Here, some 5,800 of the dead were buried.³⁵ Monstrelet fails to mention a cross being erected over the top of their mass grave. Unlike the later *Chronique de Perceval de*

³¹ See Curry, *The Battle of Agincourt*, 332. For the University of Paris service, see *Chartularium Universitatis Parisiensis*, ed. H. Denifle and E. Chatelain, 4 vols. (Paris, 1889–1897), 4:308 (no. 2051).

³² *La Chronique d’Enguerran de Monstrelet*, ed. L. Douet-D’Arcq, 6 vols. (Paris, 1859), 3:122–24.

³³ *Ibid.*, 3:123.

³⁴ Curry, *Battle of Agincourt*, 187.

³⁵ The *Chronique de Ruisseauville* reports that 6000 men were buried in the mass graves. See Gérard Bacquet, *Azincourt* (Belgrade, 1977), 91–6, esp. 95.

Cagny, he tells of the graves being strewn with thorny branches to keep out the animals. According to sources like Pierre Fenin and Perceval de Cagny, Louis de Luxembourg, bishop of Théroutanne, blessed and consecrated the battlefield.

The *Chronique* also hints at some attempt to disguise the true and horrific nature of French losses. The narrative alleges that once Bishop Louis de Luxembourg, with the aid of the abbot of Blangy, blessed the ground, he ordered not three but five graves dug, each accommodating the bodies of approximately 1,200 men. They placed a great cross of wood above each grave. To help disguise the number of dead, the bishop then extracted an oath from those charged with burial detail that they would not tell just how many they had buried.³⁶

The “Religieux of St Denis” says that Henry V himself ordered a battlefield burial for the few English dead, after which he had his troops pay their last respects.

He also allowed the same respects to be paid to the French and agreed that the bishop of Théroutanne should bless the unhallowed place so that it might serve as a cemetery. He allowed this favor at the beseechings of the French princes of blood...trying to console them and encouraging them to resign themselves to this cruel blow of fortune.³⁷

According to Edmond de Dynter’s *Chronique des ducs de Brabant*, written in the 1440s, the English burned some of their dead in a barn while returning the bodies of noblemen to England. Dynter supports the allegations of the earlier chroniclers that the French were left naked on the field. The naked corpse of the duke of Brabant was found quite some distance away, wounded in the head and neck. Survivors of his contingent took the battered corpse home for burial. A full description of his funeral survives:

They took it [the body] to Saint-Pôl where they put it in a lead coffin with spices and aromatic herbs. On the vigil of All saints, the next Tuesday, the cortege went to Tournai where the bishop and chapter came out to meet it and accompanied it beyond the city with much lamenting. On Wednesday, November 1, the cortege came to Hal and rested for the night in the church of St Mary, where vigils and exequies were performed. On the next day, November 2, the corpse was taken to Brussels and put in the church of Saint-Goule, where exequies were celebrated. Then the three Estates assembled and accompanied the bier between Brussels

³⁶ *Chronique de Perceval de Cagny*, 94–101.

³⁷ *Chronique du Religieux de Saint-Denys*, 3:568–70.

and Hal. On November 3, it was taken to Fure where in the church of St John, after solemn requiem mass, the duke was buried alongside his first wife.³⁸

Such a procession mirrored the funerary rituals of other fifteenth-century men of high status. A manuscript illustration of the funeral of Charles VI in 1422,³⁹ provides a contemporary comparative example of another visible act of mourning. Here, an effigy of the king lies on the coffin, which is borne by members of the Parlement of Paris attired in red. Hooded mourners in black accompany the coffin as it leaves the private world of the castle and enters the public domain of the city. The famous funeral monument to Philippe Pot, the grand seneschal of Burgundy, depicts a similar fifteenth-century procession in sculptural form. Again, hooded mourners bear aloft the body of the dead man as the procession makes its way to the grave.⁴⁰

Funeral rites after Agincourt were also conducted for the corpse of the duke of Alençon, who was interred at the Abbey of St Martin. Jacques de Châtillon and sixteen others were buried in the church of Auchy-les-Moines.⁴¹ The sites of these burials were diverse, but were generally located in the eastern end of the church, some in the choir, others in the nave, and in the chapels. Some men were buried outside in the cemetery behind the choir. Interestingly, the list of the burials at Auchy-les-Moines reveals that none of the men were interred at the traditionally more “secular” western end of the church. Burial at the eastern end had frequently been reserved for ecclesiastics, those of high rank or significant patrons, while the western end of the church was considered to be the proper place for non-ecclesiastics and those

³⁸ *Chronique des ducs de Brabant par Edmond de Dyncer*, ed. P. D. X. De Ram, 6 vols (Brussels, 1854–1860), 3:304.

³⁹ Depicted in *Les Chroniques de Charles VII*, Paris, BN MS Fr. 2691, fol. 11 and reproduced in T. S. R. Boase, *Death in the Middle Ages: Mortality, Judgement and Remembrance* (London, 1972), 100, (plate 99).

⁴⁰ The monument is now in the Louvre, Paris (Richelieu wing, France, room 10). For more on this sculpture in the context of Burgundian art, see Patrick M. De-Winter, “Art from the Duchy of Burgundy,” *The Bulletin of the Cleveland Museum of Art* 74 (Dec. 1987): 406–49. For Burgundian funerary customs, see Malcolm Vale, “A Burgundian funeral ceremony: Olivier de la Marche and the obsequies of Adolf of Cleves, lord of Ravenstein,” *The English Historical Review* 111: 443 (Sept. 1996): 920–39.

⁴¹ See Bacquet, *Azincourt*, 83, citing Bibliothèque municipale de Besançon, coll. Chifflet, ms 64.

of lesser rank. By the fifteenth century, however, such distinctions had been eroded.⁴²

The eventual burial of the corpse in a location significant to the family of the dead man was not always possible. Constable d'Albret, for example, together with thirteen of his companions, ended up being buried in the church of Cordeliers du Vieil-Hesdin, far from his home in Lot-et-Garonne. Others were more fortunate. The duke of Bar was returned for burial to the family chapel, while Guillaume de Longueil's corpse was taken back to his city of Dieppe and buried there. The archbishop of Sens was appropriately buried in Sens cathedral with his nephew. The bodies of various nobles from Picardy, the Artois, and Flanders were returned to their home fiefs.⁴³

Some chroniclers relayed information on burials in the context of what is reported as general or widespread grief surrounding "this piteous and saddest of days."⁴⁴ In particular, some writers emphasized the familial disruption caused by the loss at Agincourt. Jean Juvenal des Ursins wrote that "in many places of this kingdom there were ladies . . . who had been widowed and poor orphans."⁴⁵ The *Religieux of St-Denis* painted a tragic picture of grieving widows and mothers:

It was a sight to bring tears to the eyes to see some of the women crying bitterly at the loss of their husbands, others inconsolable at the death of their children and closest relatives.⁴⁶

III. *Female Mourning*

That such mourning for the dead took place far from the battlefield is also clear from literary texts such as Christine de Pizan's *Epistre de la prison de vie humaine*. This text was written between 1416 and 1418 for Mary of Berry, duchess of Bourbon. The duchess had lost a son-in-law and three cousins at Agincourt. Her husband, the duke of Bourbon,

⁴² See inter alia Christopher Daniell, *Death and Burial in Medieval England, 1066–1550* (London, 1997); *The Place of the Dead in late medieval and early modern Europe*, ed. Bruce Gordon and Peter Marshall (Cambridge, 2000).

⁴³ Bacquet, *Azincourt*, 83–88.

⁴⁴ *La Chronique d'Enguerran de Monstrelet*, 3:124.

⁴⁵ Jean Juvenal des Ursins, *Histoire de Charles VI, roi de France* in *Choix des chroniques et mémoires sur l'Histoire de France*, ed. J. A. C. Buchon (Paris, 1843).

⁴⁶ *Chronique du Religieux de Saint-Denis*, 3:574.

and son, the count of Eu, had been taken to England as prisoners of war after the battle.⁴⁷ The *Epistre* takes the form of a fairly conventional consolation, and Christine's debt to Boethius is apparent throughout.⁴⁸ It may, however, be read not merely as a book of comfort, but also as a guide to appropriate ways of expressing grief and practicing mourning, especially for women.⁴⁹

As Leslie Abend Callahan has shown, excessive outpourings of grief were culturally rejected by the time Christine de Pizan wrote her *Epistre*.⁵⁰ Instead, noble women were encouraged to transcend what the "Religieux of St Denis" described as the wound of loss and to avoid protracted periods of grief and mourning. Those who died on the battlefield died with grace and valor, according to Christine. Such men should not be wept over, but celebrated. Christine also argued that death is inevitable and should not be feared or lamented, but simply accepted; the dead, she says, experience all the joys of the blessed, including the beatific vision. In Christine's opinion, eternal life will be much more rewarding than this life for those who deserve it, men like the noble warriors fallen at Agincourt. Her advice, then, is for women such as the duchess of Bourbon, to be thankful for the children they have left, and to realize that death is an escape from the mortality that must afflict us all.

It is worth noting that Christine's *Epitre* for Mary of Berry differs markedly from an earlier attempt to express her own grief over the death of her husband, in the ballade, *Dueil Angloisseux*. Here, Christine reveals the "immoderate fury" that accompanied her loss and insists at the conclusion of each of the four stanzas that she "can neither be cured nor die." There is no hint of the devout acceptance of death that

⁴⁷ *The Epistle of the Prison of Human Life*, ed. Josette A. Wisman (New York, 1984).

⁴⁸ Glynis M. Cropp, "Boèce et Christine de Pizan," *Le Moyen Age* 36:2 (1981): 387–417.

⁴⁹ For an interesting parallel consolation text composed after the battle of Poitiers, see Guillaume de Machaut's *Le confort d'un ami* in *Oeuvres de Guillaume de Machaut*, ed. E. Hoepffner, 3 vols. (Paris, 1908–1921), 3:1–141. For an account of English war widows in the mid-late fifteenth century, see Joel T. Rosenthal, "Other Victims: Peeresses as War Widows, 1450–1500" in *Upon my Husband's Death: Widows in the Literature and Histories of Medieval Europe*, ed. Louise Mirrer (Ann Arbor, Mich., 1992), 131–52; Arden, "Grief," 305–19.

⁵⁰ Leslie Abend Callahan, "The Widow's Tears: The Pedagogy of Grief in Medieval France and the Image of the Grieving Widow," in *Constructions of Widowhood and Virginity in the Middle Ages*, ed. Cindy Carlson and Angela Jane Weisl (New York, 1999), 245–63.

characterizes the later *Épître*. Indeed, Christine is more interested in the desolate feeling that such losses invoke. She is “full of tears, anguish and torment,” her body is wraithlike, and she is “bereft of joy.” She is full of foreboding “which dries up all hope,” “without hope of relief,” and wishful of death.⁵¹ Such language should be read as historically informed: Christine’s earlier outpouring of grief over the loss of her husband was no longer appropriate after Agincourt, when so many women were suffering similar losses, and when such loss had occurred in the wider context of a “national” political disaster.⁵²

Visual images of fifteenth-century widowhood formalize the ways in which women mourned. One fifteenth-century image of a widow depicts the woman already mourning and holding a book while her husband’s corpse is being washed and readied for enclosure in a coffin to the right of the scene.⁵³ The widow, who faces away from the body of her dead husband, rests her head on one hand in a gesture that suggests sadness. It also suggests that an appropriate response to death begins even before the corpse was interred. The widow wears robes and a head-dress; the book is presumably a devotional text of some sort, probably a bible. For this widow, mourning was something to be conducted in private, at least initially. The visual separation of the widow from the corpse of her husband reinforces the notion that he is already absent, already a memory.⁵⁴ Indeed, the act of mourning for widows like Christine de Pizan and the duchess of Bourbon was in part a memorial practice. For such women, and for others who articulated their grief in culturally-appropriate ways, mourning and memory were intimately related to making personal and public sense of grievous loss. The last part of this article will explore the importance of memorial practices in this context.

⁵¹ See Jacqueline Cerquiglini, *Cent ballades d’amant et de dame par Christine de Pizan* (Paris, 1982).

⁵² Callahan, “The Widow’s Tears.”

⁵³ Miniature from the Hours of Phillip the Good, Flemish, fifteenth century, Den Haag, Koninklijke Bibliotheek, Ms. 76, f. 2.

⁵⁴ There is of course a vast historiography on images of death in the Middle Ages. For some of the most influential in recent discussions, see Philippe Ariès, *L’homme devant la mort* (Paris, 1977); *Last Things: Death and the Apocalypse in the Middle Ages*, ed. Caroline Walker Bynum and Paul Freedman (Philadelphia, 2000); Patrick Geary, *Living With the Dead in the Middle Ages* (Ithaca, N.Y., 1994); Megan McLaughlin, *Consorting with Saints: Prayer for the Dead in Early Medieval France* (Ithaca, N.Y., 1994); Jean-Claude Schmitt, *Les revenants: les vivants et les morts dans la société médiévale* (Paris, 1994).

IV. *Memory*

One reaction to trauma, according to Freud, is for a victim to exert some control over what has happened either by repressing or reconstructing the memory of the traumatic event.⁵⁵ This theory has primarily been explored by medieval historians interested in the memorialization of violence. David Nirenberg, for instance, has shown how pogroms of 1096 became deeply embedded in a Jewish consciousness. This event is seen by many as a starting point of continual violence against Jews as well as a source of Jewish collective memories.⁵⁶ Central to the processes of remembering violence is the notion that the past needs to be accounted for, and that trauma, loss, and grief must be placed into both an individual and historical context.

The historicizing of memory may be expressed through the written word or through cultural practices such as funeral rituals, memorial services, and so on.⁵⁷ The memories themselves are not always shaped by the people who were present at an event. This was certainly true of post-Agincourt France, where individual and collective responses to the battle and attempts to fit the disaster into the wider context of French history are found in chronicles, other historical narratives, and books of advice and consolation. Remembrance soon passed from those who had actually participated in the battle, to those who personally suffered because of the loss (mothers, widows, families) and then to those who claimed possession of communal memories (historians, chroniclers, and other writers).

Almost immediately after the defeat, Agincourt began to enter the historical record. In their written texts, chroniclers and commentators adapted four major means of narrating and explaining the tragedy. Some treated the battle of Agincourt as a break in the otherwise glorious record of French history. One such author is Pierre Cochon who wrote in the early 1430s that the loss at Agincourt was the “ugliest and most wretched event that had happened in France over the last

⁵⁵ Sigmund Freud, “Mourning and Melancholia,” see note 6 above.

⁵⁶ David Nirenberg, “The Rhineland Massacres of the Jews in the First Crusade,” in *Medieval Concepts of the Past: Ritual, Memory, Historiography*, ed. Gerd Althoff, Johannes Fried and Patrick J. Geary (Washington D.C., 2002), esp. 303–9.

⁵⁷ Described by Pierre Nora as *lieux de mémoire*. See Pierre Nora, “Between Memory and History: Les lieux de mémoire,” *Representations*, special issue 26 (1989): 7–25.

thousand years.”⁵⁸ In a similar vein, Jean Juvenal des Ursins asserted that Agincourt was the most shameful event that had ever happened to the kingdom of France. The “Religieux of St Denis,” who also saw the loss as shameful, believed that France, in losing at Agincourt, had squandered the great historical legacy of such figures as Charlemagne and St. Louis, thus disrupting the narrative of glory that was French history. The “Religieux” tells us in no uncertain terms that “the memorable triumphs” of the past were the true stuff of history, while the dreadful events of the present simply constituted tragedy: “I would rather have buried in eternal oblivion events whose telling is more suited to the tragic muse than to history,” he wrote.⁵⁹

Second are those writers who portray the battle as God’s judgment on a sinful French people. Such a response to defeat was fairly common in the Middle Ages,⁶⁰ it had already been seen after the battle of Poitiers. In writing of Agincourt and its consequences, Jean Juvenal des Ursins in his *Loquar in tribulatione* places the French misfortune into the longer context of civil war and conflict with England. In an earlier text, Ursins also maintains that war, famine, and death are all part of God’s punishment for sin and the long train of French suffering should be understood in that light.⁶¹

Related to the concept of divine retribution is the notion of fortune. In *Le Quadrilogue invectif*, Alain Chartier uses the vicissitudes of fortune as a means of explaining the defeat:

For we may record in our hearts the cruelty of the unhappy battle of Agincourt, which we bought dear. And yet we lament the sorrowful fortune and bear upon us all that evil mischance out of which we cannot come save by diligent labour and wise suffering in chastising our perilous hastiness by the guarantee of restraint.⁶²

Chartier is informing his reader that Agincourt should be remembered for the lessons it teaches us about caution and the vagaries of fortune.

⁵⁸ *Chronique normande de Pierre Cochon*, ed. C. de Robillard de Beurepaire (Rouen, 1870), 273–76.

⁵⁹ *Chronique du Religieux de Saint-Denis*, 3:566.

⁶⁰ Kelly DeVries, “The Effect of Killing the Christian Prisoners at the Battle of Nicopolis,” in *Crusaders, Condottieri, and Cannon: Medieval Warfare in Societies Around the Mediterranean*, ed. Donald J. Kagay and L. J. Andrew Villalon (Leiden, 2003), 167–72.

⁶¹ *Écrits politiques de Jean Juvenal des Ursins*, ed. P. Lewis, 2 vols. (Paris, 1978–1985), 1:8.

⁶² Alain Chartier, *Le Quadrilogue Invectif*, ed. E. Droz (Paris, 1923), 31.

Third, there are writers who warn of what may happen if pride, sin, and other moral flaws are allowed to run free. An example of this approach is the *Bourgeois* of Paris, who blames the count of Armagnac for the loss at Agincourt and the subsequent privations experienced throughout northern France:

I do not think that anyone, not the most brilliant, could enumerate all the unhappy, appalling, monstrous, and damnable sins that have been committed since the disastrous and damnable appearance in France of Bernard, count of Armagnac.⁶³

According to the *Bourgeois*, Henry V would never have invaded “nor would so many good men have been killed on that dreadful day of Agincourt had it not been for the pride of this wretched name, Armagnac.”⁶⁴ While the *Bourgeois* is quite open about his own political affiliations, he also attempts to place the defeat into a larger moral context.

A similar emphasis may be found among writers who use the battle of Agincourt not just as a moral warning, but as an historical one. As Françoise Autrand has pointed out, the historical language of such warnings had already been articulated after the battle of Poitiers; what is more, later authors like Georges Chastellain would draw direct parallels between these two military disasters.⁶⁵ For the “Religieux of St Denis,” Agincourt represents an “eternal dishonor,” and a “disaster forever to be deplored!”⁶⁶ He tells us that he only includes the terrible tale of Agincourt in his historical writing for didactic purposes: in order that it might serve as something of a warning against future repetition of the mistakes that brought it about. Here, the “Religieux” reveals his assumption that history teaches lessons and that Agincourt (like Poitiers) should have shown the French the value of caution in fighting the English. All four of these approaches enshrine the battle as a significant albeit catastrophic event in the history of France.

Initial reactions of grief, anger, and mourning soon gave way in the written texts to a set of more politicized messages about the French monarchy, the war with England, and the fate of the kingdom. Such

⁶³ *Journal d'un bourgeois de Paris de 1405–1449*, 146.

⁶⁴ *Ibid.*

⁶⁵ See Autrand, “Déconfiture,” 108–9.

⁶⁶ *Chronique du Religieux de Saint-Denis*, 3:562.

historicizing propensities may well have been an attempt to generalize individual losses in a manner that would make sense of trauma. Rather like those “non-combatant moralists” of the First World War, such as Ezra Pound and T. S. Eliot,⁶⁷ writers after Agincourt attempted to relate the disaster of the battle and its aftermath to a larger historical and moral picture.

A good example of this is to be found in the collection of short texts entitled *L'Honneur de la couronne de France*, which contains a dialogue between the Spirit of France and Truth. Written sometime after the murder of John the Fearless, duke of Burgundy, in 1419, this work records the musings of France on the misfortune suffered during the English invasion of Normandy. The text talks about the reasons for this misfortune, and is quite explicit about the moral failings that contributed to continued French defeat. Readers hear of the general weakness of the French, their infighting, their lack of pious priests, their sad lack of valor and so on. The author also places these failings into a historical context, arguing that the nation has forgotten the heritage of its past and does not know how to triumph in the face of adversity as did its Merovingian kings. At the same time it excoriates the defeat, this work places the dead of Agincourt among heroes of the French past, men who exemplify a valiant death in battle.⁶⁸ By their valor, the dead of Agincourt provide some historical consolation for the dismal defeat.

It is also worth noting that the text portrays France as a mourning mother, recognizing the vagaries of fortune, soliciting help from Truth in order to defend herself against continual threats from her enemies.⁶⁹ For her part, Truth has some solutions to offer, ranging from the pragmatic (reorganization of the army, the dismissal of useless advisers, and the building up of fortifications around towns), to the moral (regulations enforcing religious observance and increased sumptuary laws). Throughout the text, memory is invoked as both consolation and as a way of learning the lessons of the past.

⁶⁷ Jay Winter writes eloquently of this literary genre in *Sites of Memory, Sites of Mourning*.

⁶⁸ *L'Honneur de la couronne de France: quatre libelles contre les anglais*, ed. N. Pons (Paris, 1990), 74 (ll. 603–5).

⁶⁹ *Ibid.*, 76 (ll. 635–39).

V. Conclusion

As the battle of Agincourt was incorporated into the historical consciousness of France, grief soon gave way to the lessons of war. The shock and sadness reported in many of the chronicles and other sources, together with the ritualized practices of mourning associated with remembrance of the dead were important manifestations of a collective reaction to defeat. Yet, as with other episodes of military trauma, the event also needed to be explained and absorbed into the longer narrative of French history. Ultimately, individual mourning for the dead ran its course. The war itself, of course, continued.

PART THREE

THE IBERIAN FACE OF
THE HUNDRED YEARS WAR

“CUT OFF THEIR HEADS, OR I’LL CUT OFF YOURS”:
CASTILIAN STRATEGY AND TACTICS IN THE WAR
OF THE TWO PEDROS AND THE SUPPORTING
EVIDENCE FROM MURCIA

L. J. Andrew Villalon
University of Texas, Austin

I. *Introduction*

“There was no Hundred Years War in Spain!” This (mistaken) opinion is shared by not-a-few Hispanists who study the Middle Ages.¹ In reality, the Hundred Years War did on various occasions spill over the Pyrenees and in at least one instance, had a significant impact on Spanish history. During the mid-1360s, the larger struggle merged with and decisively influenced a bloody Iberian episode known as the War of the Two Pedros, and led to a change of dynasties in the central Iberian state of Castile.

¹ This article combines material from two papers on the War of the Two Pedros, presented at the 35th and 39th International Congresses on Medieval Studies meeting at Western Michigan University (Kalamazoo, Michigan) in May, 2000 and May, 2004. I would like to thank the following archives, libraries, and individuals for the aid and/or comfort they extended to me during the process of researching and writing this essay: in the United States, the University of Cincinnati library system, in particular, the reference department, archives, interlibrary loan, and photoduplication services; in Spain, the Archivo Histórico Nacional and Real Academia de la Historia; and (in alphabetical order) Judith Daniels, Julian Deahl, Kelly DeVries, Dan Gottlieb, Janine Hartman, Donald Kagay, Mark Lause, Sally Moffitt, Paul Moran (both the elder and younger), Marcella Mulder, Norman Murdoch, Mark DuPuy, Clifford Rogers, Charles Seibert, Blasco Sobrinho, Ann Twinam, Theresa Vann, Thomas White, and the anonymous reader recruited by Brill. This article and the papers on which it is based were completed while I was still on the faculty at the University of Cincinnati. Despite a policy that did relatively little to encourage, promote, or reward research conducted by members of the two-year units operating under its aegis, I am nevertheless indebted to the university for its library facilities and for several grants that helped finance research in Spain on this and other projects. I am eternally grateful to members of UC’s Department of Romance Languages and Literatures, in particular the department head, Lowanne Jones, for the very kind welcome they afforded me during my last two years at the university. I must also thank Dean Karen Gould of the College of Arts and Sciences for facilitating my transfer into a department where I felt a true sense of belonging.

Not particularly well-known even among Spanish medievalists, the War of the Two Pedro's was fought between the kingdoms of Castile and Aragon during the ten years from 1356 to 1366.² The conflict, which centered around Castilian attempts to redraw the border at the expense of Aragon, was divided into two fairly equal periods by a short-lived peace signed at Terrar in 1361. Having enjoyed success throughout most of the struggle, by 1366, Castile had added considerable territory in the areas west of Zaragoza and south of Valencia,³ seizing places like Calatayud, Tarazona, and Alicante, as well as many smaller town and villages. Despite this, in a stunning, eleventh hour reversal, Aragon actually won the war, a victory due entirely to foreign intervention.

The intervention of 1366 that abruptly ended the War of the Two Pedros resulted directly from the course of the Hundred Years War north of the Pyrenees. With the signing of the treaties of Brétigny and Calais in 1361, that conflict had ground to a temporary halt, leaving thousand of soldiers on both sides unemployed. Many of these men subsequently banded together into the so-called Free Companies, terrorizing extensive regions of France, while living off the land. Late in 1365, both France and the papacy came to the aid of the beleaguered Aragonese and together, the three powers put up enough money to lure many of these battle-hardened veterans into the Iberian Peninsula, where they immediately shifted the military balance, invading Castile and forcing its monarch, Pedro I "the Cruel" (1350–1366/69), to flee, first into Portugal, then to the English territories in southern France. The invasion by the Free Companies set the stage for a Spanish participation in the Hundred Years War that would continue on and off for decades.

² The author's previous publications that touch on the conflict or its leading figures include: "Pedro the Cruel, Portrait of a Royal Failure," in *Medieval Iberia: Essays on the History and Literature of Medieval Spain*, Donald J. Kagay and Joseph Snow (New York, 1997), 201–16; "Seeking Castles in Spain: Sir Hugh Calveley and the Free Companies Intervention in Iberian Warfare (1366–1369)," in *Crusaders, Condotiervi, and Cannon: Medieval Warfare in Societies around the Mediterranean*, ed. L. J. Andrew Villalon and Donald J. Kagay (Leiden, 2003), 305–32; "The Battle of Nájera and the Hundred Years War in Spain," in *The Hundred Years War: A Wider Focus* [hereafter, *Hundred Years War*], ed. L. J. Andrew Villalon and Donald J. Kagay (Leiden, 2005), 3–74.

³ For a detailed treatment of war on the Valencian frontier based on extensive archival material, see María Teresa Ferrer i Mallol, "The Southern Valencian Frontier during the War of the Two Pedros," *Hundred Years War*, 75–115.

In the face of the invasion, Castilian garrisons promptly withdrew from Aragon, permitting the Aragonese to reoccupy at leisure all of their lost territory, rewarding those places that had most strenuously resisted capture and punishing those that had surrendered to the enemy with unseemly haste.⁴ At this point, the conflict simply petered out; no formal peace treaty was ever signed putting an official end to the war.

The present article will provide a brief account of the War of the Two Pedros, introduce the principal antagonists and explore the offensive strategy employed by the conflict’s perennial aggressor, Castile. It will also outline the source problem involved in studying the war and consider how surviving documentation from the city of Murcia somewhat alleviates that problem. Finally, we shall look at how the War of the Two Pedros influenced and, in turn, was influenced by the Hundred Years War of which it became, for all practical purposes, an extension.

Merely summarizing the conflict will necessitate some mention of Aragon and its monarch—“the other Pedro”—however, treatment of their role in the conflict will be kept to a minimum. The next article in this collection by co-editor Donald J. Kagay will closely examine that side of the war, using extensive source materials preserved in the Archivo de la Corona de Aragon.⁵

⁴ The most accurate contemporary narrative of how Aragon reclaimed its territories after the passage of the Free Companies appears in the chronicle of the Aragonese king, Pere III. See: Pere III, *Chronicle* [hereafter Pere, *Chronicle*] trans. by Mary Hillgarth; ed. J. N. Hillgarth 2 vols. (Toronto, 1980), 2:576–78. The medieval chronicler known only as the Chandos herald, whose epic poem is our best literary source of information for the life of the Black Prince, is almost certainly mistaken when he indicates that the companies freed all Aragonese lands occupied by Castile. Much of that captured territory lay far south of the companies line of march, in the kingdom of Valencia. These towns and cities were retaken only when Castile recalled its garrisons in order to oppose the invasion, leaving the Aragonese free to march back in. See: *Life of the Black Prince by the Herald of Sir John Chandos* [hereafter Chandos herald], ed. Mildred K. Pope and Eleanor C. Lodge (Oxford, 1910), 150. Another, somewhat freer English translation of the Chandos herald can be found in Richard Barber, *The Life and Campaigns of the Black Prince* (London, 1979), a new version of which has recently come out with Boydell and Brewer.

⁵ Located in Barcelona, the ACA (in Catalan, the Arxiu de la corona d’Aragó) is one of the foremost archives of Europe for the study of medieval history.

II. *Two Kings Named Pedro*

The two Pedros from whom the conflict takes its name were the contemporary monarchs of Castile and Aragon, each in his own right a remarkable figure. The more famous of the two was the Castilian king, Pedro I, who reigned from 1350 to 1369, and is best-known by his contrasting sobriquets as Pedro the Cruel or Pedro the Just—the choice depends largely upon how one views his sanguinary activities.⁶ His opponent, one of those rare medieval monarchs who helped write his own chronicle,⁷ was known in the realms he ruled by different names and numbers: In Aragon proper, he was Pedro IV (1336–1387), while farther to the east, in the principality of Catalonia, he was Pere III.⁸ (In order to avoid confusion, throughout this article, the regnal name Pedro will be reserved for the Castilian king while his Aragonese counterpart will be referred to as Pere.)

Pedro the Cruel occupies a niche in Spanish history which the English reserve for Richard III; and while there is no literary portrait of the man to rival Shakespeare's Richard, his fame as a blood-thirsty tyrant has endured. Born around 1334, he was the only surviving legitimate son of Alfonso XI (1311–1350), Europe's highest ranking victim of

⁶ The most widely-used edition of the Pedro's chronicle, the one cited in this article, is Pedro López de Ayala, *Crónica del Rey Don Pedro Primero* [hereafter Ayala, *Pedro*], in *Crónicas de los Reyes de Castilla [CRC]*, Biblioteca de Autores Españoles [BAE] 66 (Madrid, 1953), 393–614. For a more recent edition, see: *Crónica del rey don Pedro*, ed. Constance L. Wilkins and Heanon M. Wilkins (Madison, Wisc., 1985.) Two nineteenth century treatments of this controversial figure are Antonio Ferrer del Rio, *Examen histórico-crítico del reinado de Don Pedro de Castilla* (Madrid, 1851) and Prosper Mérimée, *Histoire de Don Pedro I^{er} Roi de Castille* (Paris, 1865). A highly useful book for the study of the reign, one that reprints a number of key documents, is J. B. Sitges, *Las Mujeres del Rey Don Pedro I de Castilla* (Madrid, 1910). In our own time, Clara Estow has contributed a fine full-length biography of the king entitled *Pedro the Cruel, 1350–1369* (Leiden, 1995). For my own assessment of Pedro and his highly impolitic policies, see Villalon, "Pedro the Cruel," 205–216.

⁷ For an analysis of Pere's participation in the writing of his own chronicle, see J. N. Hillgarth's superb introduction to the English translation. The introduction can be found in Pere, *Chronicle*, 1:1–65; pages 61–64 deal with Pere's personal role in the work's composition.

⁸ Hillgarth supplies readers of the chronicle with an excellent summary of the monarch's long reign. For a recent treatment of the policies of this devious monarch, see David Cohen's article, "Secular Pragmatism and Thinking about War in some Court Writings of Pere III el Cerimonios," in *Crusaders*, 19–53.

the Black Death.⁹ There are indications that this offspring of a loveless royal marriage experienced a troubled and even dangerous childhood, arising out of the king’s indifference to his mother, María of Portugal, and close attachment to the royal mistress, Leonor de Guzmán, who provided Pedro with a flock of half-siblings (three of whom he later murdered.)¹⁰

In 1350, at the age of sixteen, he came to power when plague killed Alfonso during the siege of Gibraltar. For the first half dozen years of the reign, the young monarch found himself dominated by competing aristocratic factions, after which he took firm control of the kingdom. Starting in 1356, the year in which his war with Aragon broke out, and continuing for the next decade, Pedro’s power reached its zenith. Throughout this period, his increasingly murderous purge of all internal opposition, real or imagined, alienated growing numbers of Castilian aristocrats. Those who escaped the king’s wrath rallied around his slightly older, but illegitimate half-brother, Enrique, count of Trastámara,¹¹ who eventually claimed the Castilian throne. In 1366, Enrique invaded Castile, backed not only by his indigenous following, but also by the free companies, whose services were bought and paid for by France, Aragon, and the papacy. The resulting civil war to which this invasion gave rise ended three years later in Pedro’s death below the castle of Montiel. At the time, the controversial monarch was only thirty-five years of age.

The other Pedro—Pere III of Catalonia (dubbed “the Ceremonious”)—was born in 1319, came to the throne in 1336, and died in 1387,

⁹ [anonymous] *Crónica del Rey Don Alfonso el Onceno* [hereafter *Crónica de Alfonso XI*] in CRC, vol. 2, BAE vol. 66 (Madrid, 1953). In its disappointingly short passage about the plague, Alfonso’s chronicle refers to the disease which descended on his army at Gibraltar as “the great dying” (*la mortandad grande*), a term Spanish writers would continue to use for several hundred years. The Aragonese historian of the sixteenth century, Jerónimo Zurita, who goes into somewhat greater detail concerning the epidemic, also refers to a “grande mortandad.” See: *Anales de la Corona de Aragón*, ed. Angel Canellas López, 9 vols. (Zaragoza, 1967–1985), 4:133, 158–59. Only later would Europeans call it “the Black Death.” Most modern works on fourteenth century plague concentrate their attention primarily on Italy and England, the two venues that produced the best sources. For some idea of its influence on Spain, see Philip Ziegler, *The Black Death* (New York, 1969), 113–16; Amada López de Meneses, *Documentos acerca de la peste negra en los dominios de la Corona de Aragón* (Zaragoza, 1956).

¹⁰ Ayala, *Pedro*, 481–83, 500.

¹¹ Pedro López de Ayala, *Crónica del Rey Don Enrique Segundo de Castilla* [Ayala, *Enrique II*] in CRC 2, BAE 68 (Madrid, 1953), 1–64. Enrique II would have dated his reign from his coronation in Burgos in 1366; most historians, however, would date its beginning to Pedro’s death three years later. It is there that Ayala begins his chronicle.

at the comparatively “ripe old age” of sixty-eight. Perhaps the best short summary of his reign was supplied by the great Aragonese historian, Jerónimo Zurita, who said of him that “[he] ruled for over fifty years and was always at war.”¹² During this half century, the king battled one opponent after another including his cousin, the king of Majorca; his nation’s great maritime rival, Genoa; his own rebellious subjects; and three successive monarchs of Castile, one of whom, Enrique II, had once been his leading ally in the War of the Two Pedros.

Although these conflicts gained for Aragon the kingdom of Majorca, tightened its hold on Sardinia, and preserved it from the depredations of Castile, the strain placed upon royal finances was severe. As a result, Pere increasingly fell back upon support from the principality of Catalonia and its great maritime city of Barcelona, the wealthiest of his realms and the only one which never rebelled against him. In turn, the king was forced to concede to his Catalan subjects ever greater rights of self-government, including a much strengthened *corts* with increased control over the raising and spending of revenues.¹³

Despite the enormous antagonism that grew up between the two Pedros, their family lives showed some remarkable parallels. Each had a troubled relationship with his royal father, due largely to the presence of the kings’ “other women” in whose shadow each man grew up. In Pedro’s case, that other woman was Leonor de Guzmán, one of the most notorious royal mistresses in Spanish history; in Pere’s, it was his father’s second wife, Queen Leonor de Castilla. Both future monarchs numbered among their deadliest enemies half-brothers sired by the two Leonors. Both became king at the age of sixteen, after which they moved as quickly as possible to rid themselves of their female nemeses: Pedro imprisoned the royal mistress and then countenanced (some say connived at) her murder; Pere simply drove his step-mother into exile. Finally, over the course of their reigns, both monarchs did away with one or more of those troublesome siblings.

¹² Quoted in Hillgarth’s introduction to Pere, *Chronicle*, 2:2.

¹³ For detailed treatment of the limitations that near-constant warfare placed on Pere’s control of finances, see Donald J. Kagay, “A Government Besieged by Conflict: The Parliament of Monzón (1362–1363) as Military Financier.” in *Hundred Years War*, 116–150.

III. *Background to Conflict*

In a masterpiece of understatement, one modern historian has said of the war that "the reasons for [it] are hard to determine."¹⁴ Pedro's ten-year conflict with Aragon ostensibly grew out of his anger at a relatively minor incident, an act of piracy on the part of an Aragonese nobleman named Francés de Parellós. Under royal orders to take an Aragonese flotilla north to the Bay of Biscay, where it might aid the French in their war with England, Perellós stopped over in the Castilian port of San Lúcar de Barrameda. Here he seized two vessels, claiming that they hailed from the Italian city of Piacenza, an ally of Aragon's perennial enemy, Genoa, and then refused to release them, even when an order came directly from Castile's monarch in the neighboring city of Seville. Instead, Perellós disposed of their cargos and hastily resumed his journey northward.¹⁵

Infuriated not only by the original act but by the blatant defiance of his orders, Pedro hurriedly put together a Castilian squadron and sent it off in the wake of the Aragonese. When these ships returned to Seville, having failed to overtake Parellós, the king redirected them to attack the Aragonese island of Ibiza in the Balearics, in itself a fairly extreme reaction to the seizure of two ships that were not even Castilian.¹⁶ Pedro cited this piece of nautical "free-lancing" on the part of the Aragonese noble as sufficient justification for launching his war.

Nevertheless, in the diplomatic exchanges that followed, the question of how to deal with Perellós's act of piracy retreated to relative insignificance as the Castilian king used the occasion to demand lands along the frontier, all of which had been Aragonese for more than half a century. To the extent that there was a rational motive behind the conflict, this was it; however, since the territorial issue was raised only after the conflict began, it appears at first glance more of a *post facto* rationale than a *bonafide* cause.

On the other hand, the question arises, did Pedro, having put down the internal disturbances that troubled his first few years, simply await a convenient *casus belli* in order to pursue a war of conquest against Aragon? While there is no direct evidence that he planned such a

¹⁴ Hillgarth's introduction to Pere, *Chronicle*, 1:32.

¹⁵ Ayala, *Pedro*, 474-75.

¹⁶ Ayala, *Pedro*, 475.

conflict before the Perellós incident, several things at least suggests that possibility. First, the war emerged from a radical reorientation of Castile's foreign policy that Pedro initiated following his succession. At the risk of wandering into the realm of psycho-history, this reorientation may have reflected the king's resentment of his father, Alfonso XI, forged in childhood and expressed in a renunciation of Alfonso's most cherished policies. During his reign, the new monarch abandoned the guiding principles of Alfonsine diplomacy—peace with Castile's Christian neighbors, a reinvigorated crusading effort against Muslim Granada, and a moderately pro-French stance in the Hundred Years War—substituting for them peace and alliance with the Moors, a brutal war against Christian Aragon, and a drift toward England that by the 1360s had produced a full-fledged military pact.

The first step in this reorientation of Castilian policy came almost immediately after the old king's burial, when Pedro made peace with Granada, thus cutting off the traditional avenue of his kingdom's expansion and opening the way for his "redirection" of its aggression. Then, in April, 1354, two years before the Aragonese war actually began, the king ordered a royal official in Murcia to strengthen and repair the fortress (*alcazar*) defending that city.¹⁷ While this military renovation may have been a perfectly innocent coincidence, given the geographical position of Murcia and in light of what happened later, it allows of another, more sinister interpretation. In a war directed eastward, Murcia would be on the frontline and therefore bear the brunt of Castile's military effort. Pedro's order to repair that city's fortifications may have signaled that as early as 1354, he contemplated the possibility of conflict with Aragon, aimed at overturning the 1304 treaty of Torrellas that had established a southern boundary between Valencia and Murcia.¹⁸ The fact that he soon began demanding the

¹⁷ The best-preserved *Castilian* documents dealing with the War of the Two Pedros that are currently known and available to historians are preserved in Murcian archives. They are printed in a two volume work composing part of the *Colección de Documentos para la Historia del Reino de Murcia* and are entitled *Documentos de Pedro I*, [hereafter *Documentos*] ed. Angel Luis Molina Molina, (Murcia, 1978). One of these documents—138 (doc. 76)—specifies use of one-third of the *tafureria* (a tax on gambling) for the purpose of strengthening the fortifications. In subsequent citations, a page number will be given first, followed by the number in the collection assigned to each document.

¹⁸ Determination of a southeastern border between Castile and Aragon had been made necessary by the enormous southward advance of both kingdoms during the thirteenth century. The panel of arbitrators appointed in 1304 had tried to execute a fair settlement, based on successes each kingdom had experienced in its conduct of the

surrender of frontier territory leads one to wonder if this was what he had in mind all along. If so, his seeming over-reaction to a relatively minor violation of Castilian sovereignty becomes explicable: it would have been Castile’s first strategic gambit—seizing a pretense for war that might shift the “war guilt” to Aragon. The gambit, if indeed that is what it was, failed: Aragon’s obvious willingness to make restitution and punish the offending official left the papacy and others in little doubt that blame for the conflict lay at Pedro’s door.

IV. *The War of the Two Pedros*

Following the attack on Ibiza, what had begun as a naval conflict shifted back to the mainland. Early in 1357, Pedro went to the front and established his headquarters at Molina, which eventually became another of the major staging points for Castilian forces invading Aragon. After personally leading several sorties into the neighboring kingdom,¹⁹ the king agreed to a fifteen-day truce, but in March, without warning and (if the Aragonese are to be believed) in violation of that same truce, his army suddenly fell upon the town of Tarazona, whose inhabitants were allowed to leave for Tudela de Navarra, four leagues away, with only what they could carry on their backs, after which the place was repopled with Castilians.²⁰ By April, 1357, Pedro was already operating in Aragon with a force estimated to number some 9,000 horse accompanied by an unspecified number of footsoldiers.²¹

These opening moves foreshadowed many of Castile’s longterm military policies. The war would be fought along much of the frontier, not just in territory that Pedro claimed during early negotiations. On almost all occasions, Pedro’s forces, with some aid from the other Iberian states, seized the offensive. Much of Castile’s military activity would take the form of raids aimed at devastating enemy territory. Known in Spanish as *cavalgadas*, they were comparable to the French *chevauchées*.²² There was also coastal raiding, directed primarily against

Reconquista. For text of treaty of Torrellas, see Josep-David Garrido i Valls, *La conquesta del sud Valencià i Múrcia per Jaume II* (Barcelona, 2002), 81–85 (doc. 3).

¹⁹ His first conquest was the castle of Bordalva. Ayala, *Pedro*, 477.

²⁰ Ayala, *Pedro*, 478.

²¹ *Ibid.*

²² The term *cavalgada* is used in *Documentos*, 169–70 (doc. 110). For description of the *chevauchée* and its effect, see Nicholas Wright, *Knights and Peasants: The Hundred Years*

the kingdom of Valencia and the neighboring Balearic Islands, but on rare occasions reaching as far north as Catalonia. The one characteristic form of military activity not yet visible in the opening weeks were siege operations, directed against Aragonese towns and castles near the frontier, stretching all the way from Alicante on the southeastern coast diagonally northward toward the region west of Zaragoza.

In addition to actual military efforts, several times during the war, Pedro agreed to a truce or even a full-blown treaty, only to turn around and violate the agreement. Perfidy of this sort helped him seize Tarazona in 1357 and Calatayud five years later. As towns and castles were taken, the Castilian king would often expel their Aragonese inhabitants and resettle them with Castilians.

Despite the rapid onset of hostilities in the war's opening weeks, for several years, fighting remained at a comparatively low level, while the two parties tried, through papally appointed intermediaries, to hammer out a diplomatic solution. Almost immediately, the papacy attempted to defuse the situation. In 1357, when word of the conflict reached Rome, Pope Innocent VI (1352–1362) dispatched Cardinal Guillen of Burgundy to mediate between the belligerents.²³ Upon arriving in Spain, the cardinal first arranged for a short truce (the one which Pedro violated by his attack on Tarazona); then, in May, he got both sides to accept a one-year pause in hostilities, hoping that during that period, he could hammer out a lasting peace.²⁴

The cardinal appears to have had considerable cooperation from the Aragonese monarch who did not want war. When Castile demanded that the Aragonese surrender the offending captain and confiscate the properties in their kingdom belonging to an exiled Castilian noble,²⁵ Pere III went a long way toward meeting the demands. He agreed to make full restitution for the seizure. He promised to punish Perellós severely, even to turn him over to Castile if a trial resulted in the death

War and the French Countryside (Woodbridge, Suffolk, 2000), 33–34; Matthew Strickland, *War and Chivalry: The Conduct and Perception of War in England and Normandy, 1066–1217* (Cambridge, 1996), 258–90.

²³ Ayala, *Pedro*, 477.

²⁴ Ayala, *Pedro*, 477–78.

²⁵ Ayala, *Pedro*, 474. Pedro Moñiz de Godoy, grand commander in the order of Calatrava, was an exile in Aragon. Pere had bestowed upon him the encomienda of Alcañiz, even though it was officially in the gift of the order's Grandmaster Padilla, one of the Castilian king's favorites. Pedro now ordered that Godoy be stripped of the property, the first indication that he intended to use the Perellós incident to address wider ranging issues.

sentence. And he committed himself to seizing the Castilian exile's property.²⁶ Pedro refused to compromise. When Pere did not accept Castilian demands outright, the king's emissary, acting on royal instructions, delivered what amounted to a declaration of war.²⁷

Thereafter, all peace-making efforts foundered in the face of Pedro's escalating demands and Aragon's unwillingness to meet them. At the beginning, the king had required only that the Aragonese surrender the offending captain and confiscate the exile's property. By 1359, however, he was demanding not only the surrender of Parellós, but also extensive territory along the southern frontier, and a war indemnity of 500,000 florins. Specifically, he required that the Aragonese surrender a number of towns, including the port city of Alicante, that had been awarded to Aragon by the 1304 treaty of Torrellas, in which a panel of arbitrators had established a boundary between the two kingdoms. Although Pere showed every indication of wanting peace, such demands far exceeded what he was willing to pay for it. And when it became clear that he would not accede to these terms, the conflict heated up.

From the beginning, a pattern of Castilian victory began to emerge. In the course of the decade, despite experiencing occasional setbacks (for example, losing the war's biggest land battle at Araviana in 1359), Castilian troops managed to overrun sizeable swaths of territory along the border. In spite of considerable efforts on the part of Pere III to mobilize the several kingdoms making up the Crown of Aragon, throughout most of this time, his forces seemed unable to do more than take back a few of the lost lands. In fact, Aragon's counter-offensive thrusts into Castile were largely the work not of the Aragonese, but of Pere's Castilian allies led by Enrique de Trastámara, and, for the most part, they accomplished little.

It was one such thrust that led to the battle of Araviana, among the few from which Aragon emerged triumphant. In September, 1359, Enrique, his younger brother, Tello, and several members of the Aragonese house of Luna entered Castile near the town of Almazan at the head of 800 horse. Near Araviana, the raiders routed a considerably larger Castilian force (1500 men), set in place to guard the borders

²⁶ Ayala, *Pedro*, 475. Pere agreed to reclaim the property, though he indicated that in fairness, he would compensate Godoy at his own expense.

²⁷ Ayala, *Pedro*. It is difficult for the historian not to be reminded of the Austrian ultimatum to Serbia in 1914, delivered by the only power actually seeking a war and not really meant to be accepted!

against just such an incursion.²⁸ Among those whose corpses littered the field were Juan Fernández de Henestrosa, overall commander of Castilian forces along the frontier and uncle to the king's mistress, María de Padilla, and Gómez Suarez de Figueroa, grand master-designate of the order of Santiago.

Ultimately, the conflict appears to have had a "brutalizing" effect upon both monarchs. They became increasingly ruthless not only toward individuals whom they regarded as having betrayed the war effort or given comfort to the enemy, but even toward those who had failed to show sufficient zeal in its pursuit. The executions and assassinations which won the Castilian Pedro his famous sobriquet can mostly be traced to the war years: the spectacular murder of his half-brother, Fadrique, in 1358, on grounds of having had treasonable intercourse with the enemy;²⁹ the sudden execution of his principal adviser, Gutier Fernández de Toledo in 1360 for the same reason; the imprisonment and death in 1364 of the *justicia mayor*, Juan Alfonso de Benavides, whose crime had been to surrender Segorbe back to the Aragonese when Pedro failed to relieve its starving garrison.³⁰ These and many other deaths trace directly to the war. On the other side, in 1363, Pere countenanced the death his eldest half-brother, Fernando (Ferran), for trying to take the Castilian

²⁸ Ayala, *Pedro*, 499.

²⁹ Ayala, *Pedro*, 481–83. The relationship between Pedro and his half-brother, Fadrique (Enrique of Trastámara's twin), was complex. During the opening years of the reign, Fadrique had been a leader of the aristocratic opposition; however, in 1356, he deserted his former allies, including his brother, and made his peace with the king—or so he thought. In May, 1358, he entered Seville in triumph, having just retaken the town of Jumilla in Murcia from the Aragonese. Suspecting nothing, he accepted Pedro's invitation to dine in the alcazar. Once there behind locked doors, he and his lone companion, Sancho Ruiz de Villegas, were chased through the buildings by Pedro's guards and eventually bludgeoned to death. Pedro himself may have assisted in the killing of Fadrique; and if Ayala is to be believed, he then calmly ordered dinner to be served in the same room with the corpse.

³⁰ Ayala, *Pedro*, 536. In 1364, an Aragonese army, bent on recapturing Segorbe, laid siege to the town. After a long defense, and with supplies fast running out, Benavides met with the besiegers and agreed that if Pedro failed to send a relief force within a specified time, he would surrender. However, in return for this commitment, the Aragonese permitted the justiciary to return to Castile to discover if any such relief would be forthcoming. Pedro, although he no intention of helping the beleaguered garrison, condemned his justiciary for even daring to negotiate with the enemy, however desperate the circumstances. Instead of permitting the nobleman to return to his post to carry on as best he could, the king tossed him into prison where shortly afterwards he died.

exiles out of the war.³¹ Not long thereafter, he judicially murdered his longtime adviser, Bernat de Cabrera, due largely to the latter’s doubts about the wisdom of continuing the fight.

This increasing brutality is reflected in a document dating to late June, 1364, sent by the Castilian king to his frontline city of Murcia. When a force of Moorish light cavalry supplied by Pedro’s Granadan ally arrived there with instructions to cross the frontier and wreak devastation (the Spanish verb is *talar*) on a region around the enemy town of Orihuela, the king commanded his Murcian subjects:

Go with them . . . and do such a good job devastating Orihuela that there is nothing left to destroy; and wage the cruelest war you can, cutting off the heads of everyone you capture, so that there will be no man of Aragon taken who is not immediately killed.³²

Pedro made it very plain that those who failed to follow these blood-thirsty instructions would earn more than his displeasure: “be assured that if you do not do this, your heads will be sent to me!”³³

Despite the vicious nature of the struggle, for the most part, it displayed a singular lack of noteworthy battles. On occasions when the two sides met in the field, one or the other usually backed away at the last moment. What is more, those few encounters that did take place were neither very large nor in any way decisive. For example, in the war’s largest encounter, fought at Araviana in 1359, a force of only some 800 Aragonese and Castilian exiles took on about 1500 Castilians. Although the Aragonese won, killing several of the Castilian leaders and seizing several others, this clash did little or nothing to influence the course of the war.³⁴

What was true on land was also true on the water. In 1359, shortly after the collapse of negotiations, Pedro launched the most ambitious undertaking of the entire conflict, personally leading a raid along the Aragonese coast with a fleet of 128 ships, including contingents

³¹ Ayala, *Pedro*, 528–29.

³² *Documentos*, 162–63 (doc. 100). Since this document has provided the title of the present article, its precise wording in Spanish has been included herein: *yd con ellos . . . e talad muy bien Orihuela que non finque cosa della por talar e fazer la as cruel guerra que pudieredes, a quantos omes tomeredes cortalles las cabeças que non finque ome de Aragon que sea tomado que non sea luego muerto.*

³³ *Documentos*, 163: *sed ciertos que si lo asi non fizieredes que a los vuestros cabeças me tornaria por ello.*

³⁴ Ayala, *Pedro*, 499.

supplied by Portugal and Granada. He threatened Barcelona, besieged Ibiza, sacked Alicante, and challenged a fleet commanded by the royal favorite, Admiral of Aragon, Bernat de Cabrera. Having decided that Venice was aiding the enemy, Pedro also seized a Venetian ship and made an unsuccessful attempt to cut off the Flanders galleys on their way back into the Mediterranean.³⁵ Nevertheless, even this spectacular expedition failed to produce a battle. Although the two fleets came within several leagues of one another off the island of Ibiza, the smaller Aragonese flotilla merely shadowed the Castilians who eventually sailed off to aid a Castilian army besieging Alicante. Surprisingly, the only time that forces loyal to the two Pedros would meet on a major battlefield was at Nájera on April 3, 1367—more than a year after the war had ended!³⁶

V. *The Source Problem*

Historians attempting to write a balanced account of the War of the Two Pedros face a key difficulty: Surviving sources are, to borrow a popular term from military parlance, highly “asymmetrical.” In other words, there is nowhere near as much from the Castilian side as there is from the Aragonese, an imbalance readily explained, but hard to address.

By the mid-fourteenth century, the Aragonese had long since begun to operate that superb system of royal archives which endows the region with one of the finest collections of medieval state documents in Europe. Barcelona’s Archivo de la Corona de Aragon contains numerous “files” (*legajos*) and registers (*registros*) replete with material on the conflict.³⁷ The case for Castile is very different. One leading scholar of this period has accused Pedro’s successor, Enrique II, of having tried to “cull” from both public and private archives any documentation that might have cast the reign of his hated enemy in a better light.³⁸

³⁵ Ayala, *Pedro*, 498–99.

³⁶ See my article “The Battle of Nájera,” in *The Hundred Years War*, 3–74.

³⁷ For materials in Archivo concerning the Castilian war, see Federico Udina Martorell, *Guía del Archivo de la Corona de Aragon* (Madrid, 1986), 192–94.

³⁸ P. E. Russell, *The English Intervention in Spain and Portugal in the Time of Edward III and Richard II* (Oxford, 1955), 17–18, esp. n. 1.

However, even without such conscious censorship, Castilian sources for the mid-fourteenth century would still have been very thin, due to the sorry state of document preservation in that kingdom. In contrast to the Aragonese, the Castilians would not establish a central repository for decades to come. Royal documents continued to travel with a peripatetic court, necessitating a periodic "lightening of the load," either by destruction or abandonment of those no longer considered worth carrying. Despite several fifteenth century attempts, it was not until the early sixteenth century that an Archivo General was finally set up in the ancient castle of Simancas and the preservation of Castilian royal documents began on a regular basis.³⁹

In the absence of sources comparable to those for Aragon, historians of fourteenth century Castile have little choice but to rely far more heavily upon a chronicle account left by one of the principal figures of the age, Pedro López de Ayala, whose *currículum vitae* encompasses not only historian, but also military commander, diplomat, and high government official.⁴⁰

³⁹ Ibid., vii–viii; Sitges, *Mujeres*, 8. For more background on Castile's oldest archive, see: Francisco Javier Alvarez Pinedo and Jose Luis Rodríguez de Diego, *Los Archivos Españoles: Simancas* (Madrid, 1993), 16.

⁴⁰ The first biographical treatment of López de Ayala appears in Fernán Pérez de Guzmán's *Generaciones y Semblanzas*, an early fifteenth century work in which the author provided sketches of his contemporaries. Guzmán states that the Ayala family had branched off from the older line of Haro. See: Pérez de Guzmán, *Generaciones y Semblanzas*, ed. J. Domínguez Bodona (Madrid, 1965), 37–39. For an English translation, see Fernán Pérez de Guzmán, *Pen Portraits of Illustrious Castilians*, trans. Marie Gillette and Loretta Zehngut (Washington, D.C., 2003), 20–21. For a modern, full-length account of Ayala's life and work, see Michel Garcia, *Obra y personalidad del Canciller Ayala* (Madrid, 1983). This work appends several of the contemporary sources that supply our information concerning the chronicler. Despite providing useful material on his political career, an earlier biography in Spanish by Luis Suárez Fernández, *El Chanciller Ayala y su Tiempo* (Vitoria, 1962) is seriously flawed. English readers should consult Helen Nader, *The Mendoza Family in the Spanish Renaissance 1350–1550* (Rutgers, 1979). Nader's third chapter, entitled "Pedro López de Ayala and the Formation of Mendoza Attitudes," provides a fine capsule biography of the great chronicler, a penetrating analysis of his chronicle of Pedro I, and valuable bibliography. See also: Clara Estow's recent article, "Royal Madness in the Crónica del Rey Don Pedro," *Mediterranean Studies*, 6 (1996): 13–28. Estow has recently completed a new biography of Ayala that should appear in the near future.

VI. *Pedro López de Ayala*

Born in the Basque country in 1332,⁴¹ Pedro López de Ayala entered Castile's royal household as a page early in Pedro's reign⁴² and for many years, supported the king loyally in both his war against Aragon and the struggle with his illegitimate half-brother, Enrique de Trastámara. Then, in the pivotal year of 1366, the house of Ayala joined much of the kingdom in transferring its allegiance to the pretender. During the three year civil war that followed, the future chronicler helped his new master overthrow his old one. In 1367, he was captured fighting in the hard-pressed center at the battle of Nájera,⁴³ but after several months in captivity, won his release and rejoined Enrique for the war's closing campaigns.⁴⁴

Thereafter, for three decades, Ayala continued to serve successive members of the new Trastámaran dynasty.⁴⁵ In 1382, during a diplomatic mission to France, he witnessed the battle of Roosebeke; and in 1385, he was again captured, this time at the battle of Aljubarrota that ended Castile's ill-starred invasion of Portugal.⁴⁶ In 1398, he capped his career with a brief stint as lord chancellor, afterwards retiring into a Geronymite monastery in the Basque country where he died in 1407.

Despite busy years of public service, Ayala found time in later life to write a chronicle for each king he had served, the last of which remained unfinished at his death.⁴⁷ The most ambitious—and most controversial—was the one dealing with Pedro. Internal evidence suggests that the author was working on it during the mid-1380s, nearly

⁴¹ The chronicler's father, Fernán Pérez de Ayala, first mentioned in the chronicle in relation to the events of 1351, is characterized as a *natural* of the Basque province of Vizcaya. Ayala, *Pedro*, 416. Pérez de Guzmán, *Generaciones*, 37.

⁴² Ayala, *Pedro*, 431. The first reference to the author contained within the chronicle appears with events from the year 1353, the fourth year of Pedro's reign, at which time, according to the author, he was a *doncel* or royal page.

⁴³ For recent analyses of this, the most underrated great battle of the fourteenth century, see my articles: "Seeking Castles in Spain," in *Crusades*, 321–23 and "Spanish Involvement," in *Hundred Years War*, 3–74.

⁴⁴ Ayala, *Pedro*, 579.

⁴⁵ Ayala served the first three Trastámarans—Enrique II (1369–1379), Juan I (1379–1390), and Enrique III (1390–1407)—and wrote their chronicles.

⁴⁶ Pérez de Guzmán, *Generaciones*, 38; *Pen Portraits*, 20.

⁴⁷ The two not previously cited are: Pedro López de Ayala, *Crónica del Rey Don Juan Primero de Castilla e de Leon*, and *Crónica del Rey Don Enrique Tercero del Castilla e de Leon*, in *CRC 2*, *BAE* 68 (Madrid, 1953), 65–159 and 161–257.

two decades after the events had transpired.⁴⁸ Unfortunately, Ayala’s desertion from Pedro to Enrique has led many historians over the centuries to charge his chronicle with bias and misrepresentation. What is more, the paucity of Castilian documentation from the period either supporting or contradicting Ayala, makes it decidedly difficult to gauge his accuracy. Yet the *Crónica de Pedro I* is critical to any understanding of the last great medieval clash between Castile and Aragon, especially from the Castilian side.

VII. *The Murcian Documents*

Fortunately, a small, but significant cache of Castilian war documents has survived in the archives of the city of Murcia, supplying a critical supplement to Ayala’s chronicle. Thanks to the Academia de Alfonso el Sabio, these have been published in a two-volume set containing what their principal editor, Angel Luis Molina Molina, represents as a complete collection.⁴⁹ It is by no means *all* that one would desire. The regular cartularies containing royal letters from 1354 to 1367 have disappeared from the Archivo Municipal; and a disproportionate number of the letters that do survive date to a two-year period—from 1364 through 1365—due to the fortunate survival of one *Libro de Actas Capitulares*. Nevertheless, working from what still does exist, as well as things printed by earlier scholars that have since disappeared, Molina has managed to compile 102 relevant items.⁵⁰ To understand Castile’s day-to-day conduct of the war, these documents are crucial. They supply at least some idea of the wide-ranging demands that must have been made on any front-line city, of which, Murcia was only one. Other such

⁴⁸ Estow, who has studied Pedro’s reign extensively, places composition of his chronicle in 1384. Internal evidence from the chronicle strongly suggests that Helen Nader is wrong when she states “after [Ayala’s] last visit to Avignon in 1396, he wrote chronicles of the reigns of the four kings he had served” unless she means that during the closing years of his life, he put finishing touches on works started earlier. Estow, “Royal Madness,” 16 (n. 11); Nader, *Mendoza Family* 61.

⁴⁹ Any monograph on the War of the Two Pedros will require combing other municipal archives, especially in border regions where fighting took place, to see if any similar documents have missed the attention of historians. Unfortunately, the likelihood of this being the case seems slight.

⁵⁰ *Documentos*, vii–viii. Along with Ayala, the Murcian documents supply the principal basis for this article.

towns mentioned in Ayala's chronicle include Molina, Alfaro, Gomara, Agreda, and Logroño.⁵¹

Their significance is multiplied when the historian makes several fully-warranted assumptions about them. Clearly, they represent only a fraction of the total war-related correspondence between Murcia and the king. The war lasted for a decade; all of our letters date to just two years. What is more, all of them come from a single *Libro de Actas*; the major repository—the collection of cartularies containing royal letters—is no longer extant. We can also safely assume that other major staging points for the war effort all carried on a similar correspondence with the king none of which is known to have survived. Each of these frontline places contained royal garrisons and from several of them, expeditions against Aragon were launched. In short, the Murcian documents we still have must be just the tip of the iceberg.

Obviously, the king called on the city to supply troops. Letters mention both cavalry (*omes de caballo*)⁵² and footsoldiers (*peones*).⁵³ The numbers being called up ranged from ten horsemen being sent to reinforce the garrison at Cartagena against a possible enemy landing⁵⁴ to a force of 100 horsemen and 200 foot, charged with escorting the bishop of Cartagena and a royal party traveling through the war zone.⁵⁵ These troops were not infrequently moved about from one place to another; for example, Murcia received a royal order to dispatch ten horsemen to Cartagena early in July, 1364. Several weeks later, the king sent a second letter, this one ordering that these ten men be withdrawn and that Murcia send in their place ten horsemen and twenty foot to the castle at Alicante.⁵⁶ The following January, Pedro commanded the city to double that contingent.⁵⁷

⁵¹ Ayala, despite a fairly close involvement with Murcia, mentions other places along the frontier at least as prominently, in particular, Molina. Among the Murcian documents are several that mention Ayala and his role in the conflict. For example, in January, 1365, Pedro sent his recently-appointed *frontero* to Murcia whose inhabitants were instructed to supply his cavalry and infantry with whatever they would need to carry out their task. The king commanded that Ayala be obeyed “as if he were my very body.” See: *Documentos*, 179–80 (doc. 121); 182–83 (doc. 125); 185–86 (doc. 128).

⁵² Alternatively, *hombres de caballo*. See: *Documentos*, 161 (doc. 98); 163–64 (doc. 101); 165 (doc. 103); 167 (doc. 106); 172 (doc. 113).

⁵³ *Documentos*, 181 (doc. 123).

⁵⁴ *Documentos*, 163–64 (doc. 101).

⁵⁵ *Documentos*, 172 (doc. 113).

⁵⁶ *Documentos*, 165 (doc. 103).

⁵⁷ *Documentos*, 181 (doc. 123).

Footsoldiers are most frequently referred to in the documents as "*ballesteros*," a word that usually signifies archers or crossbowmen.⁵⁸ In particular, the documents repeatedly allude to a force called the *ballesteros de la nomina* who seem to have been a regular militia maintained by the city.⁵⁹ During the early 1360s, members served at such sieges as Alicante, Callosa, and Elche.⁶⁰ In December, 1364, Pedro ordered that every year these men be replaced by others, thereby allowing them to look after their civilian interests.⁶¹

Although Murcia is an inland city, there was even one occasion when it was called upon to provide men for the fleet. From his siege camp at Orihuela, Pedro sent a letter commanding 85 men to help work the galleys "since some in their crews were sick or had deserted (*son ydos*)."⁶²

The letters leave no doubt that Murcian levies were paid for their services, six maravedis daily for a horseman, one or two for a *ballestero*. Whether this compensation came from the king or the city or some combination of both is less clear. At the same time, many of these troops were expected to provide some or all of their own equipment. While besieging Elche in December, 1364, the king reminded the city of military clauses in his father's 1348 *Ordenamiento of Alcalá*, calling on Castilians to supply horses and arms in accordance with their means, as specified in the statute. Mentioned specifically were sword blades (*fojas*), helmets (*baçinetes*), and shields (*adargas*). Higher-ranking troops were expected to absorb even higher costs. In January, 1365, Pedro commanded that any inhabitant who possessed 10,000 maravedis would have to maintain a war horse worth a thousand, as well as appropriate

⁵⁸ While this is the principal translation of the term, it is not the exclusive one. A *ballestero de maza*, of the sort Pedro several times used to do his dirty work, was a mace bearer; a *ballestero de corte* was a royal porter; and the word *ballestero* alone could refer to an armorer as well as an archer. For letters referring to *ballesteros*, see: *Documentos*, 158 (doc. 94); 158–59 (doc. 95); 159–60 (doc. 96); 160 (doc. 97); 165 (doc. 103); 166–67 (doc. 105); 173 (doc. 113); 175 (doc. 116); 176–77 (doc. 117); 180 (doc. 122); 181–82 (doc. 124); 185–86 (doc. 128).

⁵⁹ *Documentos*, 160 (doc. 97). For such urban contingents of archers and crossbowmen, see James F. Powers, *A Society Organized for War: The Iberian Municipal Militias in the Central Middle Ages, 1000–1284* (Berkeley, 1984), 131–32.

⁶⁰ *Documentos*, 159–60 (doc. 96); 185–86 (doc. 128).

⁶¹ *Documentos*, 176–77 (doc. 117).

⁶² *Documentos*, 194–95 (doc. 140).

arms and armor.⁶³ At the daily wage of six maravedis paid a horseman, it would take quite a while to recoup this expenditure.⁶⁴

At least equal in number are letters dealing with Murcia's logistical responsibilities. First and foremost, these included the billeting of troops on their way into Aragon. All were to be housed at the city's expense, including Muslim forces lent by the ruler of Granada. In June, 1364, Pedro warned the city council of the imminent arrival of 600 Moorish light cavalry who were to be provided with free lodging and reasonably-priced necessities.⁶⁵ In August, he ordered the council to provide lodging for one Miguel Jiménez and the twenty horsemen with him.⁶⁶ And in April of the following year, the city received orders to accommodate another force of Moorish cavalry. This time, the council was cautioned to see that no violence was directed at these non-Christian allies,⁶⁷ clearly implying that the earlier group to come through had not been so fortunate.

The city also had to supply war materiel, foodstuffs, transportation, and, of course, pay its taxes. When Pedro's tax collectors came into the region in October, 1364, and again a year later, the Murcians were required to house them and supply both an escort to protect them and animals to transport what they collected.⁶⁸ The king ordered a royal official in the city to send 60 *cahices* (18½ bushels) of his grain to the castle of Polop and charged Murcia with supplying the mules necessary for its transportation.⁶⁹ From the siege camp at Elche, he ordered the Murcians to send him 60 oxen with their drovers and an escort in order to transport war engines and other heavy materiel.⁷⁰ After the siege, the city had to supply both the escort and mules necessary to transport back to Seville royal loot in the form of 61 Moorish captives taken during raids into Valencia.⁷¹

⁶³ *Documentos*, 182–83 (doc. 125).

⁶⁴ *Documentos*, 163–64 (doc. 101), 165 (doc. 103).

⁶⁵ *Documentos*, 162–63 (doc. 100).

⁶⁶ *Documentos*, 167–68 (doc. 107).

⁶⁷ *Documentos*, 187–88 (doc. 132).

⁶⁸ *Documentos*, 155–56 (doc. 91); 171–72 (doc. 112).

⁶⁹ *Documentos*, 157 (doc. 93).

⁷⁰ *Documentos*, 172–73 (doc. 114). For the use of such siege machines in medieval Iberia, see Paul E. Chevedden, "The Artillery of King James I the Conqueror," in *Iberia and the Mediterranean World of the Middle Ages*, ed. P. Chevedden, D. Kagay, P. Padilla, and L. Simon, 2 vols., (Leiden, 1995–1996), 47–94.

⁷¹ *Documentos*, 178–79 (doc. 119).

In July, 1364, Pedro notified Murcia that he had dispatched two Granadan brothers to repair royal war engines (*ingenios bélicos*) in Cartagena, the cost of which, including the engineers' salaries, was to be absorbed by the city.⁷² In September, he ordered the city to pay the cost of bringing four of its older siege engines into good repair and building a new trebuchet (*trabuco* or *trabuque*).⁷³ Not only did he send his own royal engineer to take charge, he also gave permission to recruit as many carpenters as needed from neighboring places.⁷⁴ Not all such undertakings were on a similar scale. When the castellan of Relleo began work on his castle, the king only required Murcia to supply him with a blacksmith and pay the man three *maravedis* a day.⁷⁵

Not infrequently, correspondence spelling out the city's contribution was generated when a military commander complained of its non-performance. As early as October, 1359, Pedro's general at the siege of Jumilla informed the king that towns around Murcia were refusing to make supplies available for purchase. Pedro immediately commanded that they do so.⁷⁶ After receiving similar complaints from the governor (*alcaide*) of the castle of Callosa, he ordered Murcia to provide the men and animals needed to keep that place supplied.⁷⁷ When the *alcaide* holding Alicante complained that the Murcians would not transport the supplies he had bought to feed his garrison, the king lectured the city fathers. It would not do to have to evacuate Alicante for lack of provisions nor would it be proper to weaken the garrison by sending its men to transport the food. Consequently, the Murcians would have to transport and protect the supplies whenever called upon to do so.⁷⁸

The king used the royal power of taxation to help the city meet its military commitments. When the city council complained that it did not have enough money to undertake work on siege artillery, Pedro graciously allowed it to charge the people of Murcia a further *alcabala*

⁷² *Documentos*, 2:164 (doc. 102). The senior engineer, identified as Mahomet, would receive five *maravedis* daily; his brother, Ali, three.

⁷³ For the importance and spread of this weapon, see Paul Chevedden, Zvi Shiller, Samuel R. Gilbert, and Donald J. Kagay, "The Traction Trebuchet: A Triumph of Four Civilizations," *Viator* 31 (2000): 433–86.

⁷⁴ *Documentos*, 168 (doc. 108), 169 (doc. 109).

⁷⁵ *Documentos*, 184–5 (doc. 127), 185–86 (doc. 128).

⁷⁶ *Documentos*, 153 (doc. 88).

⁷⁷ *Documentos*, 181–82 (doc. 124).

⁷⁸ *Documentos*, 156–57, 190–91 (docs. 94, 135).

or sales tax.⁷⁹ And when the council wrote to the king complaining that certain categories of the population did not wish to pay for the common defense, Pedro responded immediately. Priests, their concubines (*mancebas*) and illegitimate children, hidalgos, and officers of the mint (*monederos*) were commanded to contribute their fair share to the construction of walls, bridges, and guard houses.⁸⁰

VIII. *Castile's Strategy of Terror*

The Murcian documents confirm that in his pursuit of victory, Pedro I used both carrot and stick, though more of the latter than the former. In May, 1361, he awarded Murcia the right to add to its heraldic device of five crowns a sixth to symbolize its service in the recent war. The royal letter thanked the city's inhabitants "for the entry you made into the lands of Aragon and the many other signal services you have performed since the commencement of this struggle."⁸¹ Two months later, Pedro enhanced the city's crest still further, this time adding lions and castles, the heraldic symbols of Castile.⁸² A more tangible concession came in June, 1364, when, in answer to a Murcian petition, Pedro ordered all captured enemy sites along the frontier to return property confiscated from its inhabitants since the conflict's outbreak.⁸³ At the same time, there is some indication that the king made efforts to win over places seized from the Aragonese. Another royal letter, dated October 4, 1357, conceded to conquered Jumilla the status of a royal town and conferred upon its inhabitants the municipal code (*fuero*) enjoyed by the people of Murcia.⁸⁴

Despite such concessions, in Pedro's dealings with both friends and enemies, use of the the stick tended to prevail. Thus, a central point that comes through clearly in Ayala's chronicle is borne out by the Murcian documents: the monarch employed terror as a major military strategy, an external terror directed against the enemy and an internal

⁷⁹ For the proliferation of the *alcabala* during the reigns of Alfonso XI and Pedro I, see Miguel Angel Ladero Quesada, *Fiscalidad y poder real en Castilla (1252-1369)* (Madrid, 1993), 179-90.

⁸⁰ *Documentos*, 191-92 (doc. 136).

⁸¹ *Documentos*, 154 (doc. 89).

⁸² *Documentos*, 154-55 (doc. 90).

⁸³ *Documentos*, 161-62 (doc. 99).

⁸⁴ *Documentos*, 152-53 (doc. 87).

one aimed at inspiring his own followers to greater efforts in behalf of the war. While evidence indicates that the royal proclivity to use terror in governing his realm predates the conflict with Aragon, there can be no doubt that as that conflict intensified, so too did the terror.

Just how this would impact the Aragonese, especially as the war became increasingly bitter, can be seen in royal directives "to wage the cruelest war you can" and "do such a good job devastating that there is nothing left to destroy." At the same time, however, the monarch's brutality was not infrequently directed at his own followers. Severe punishments were meted out, not just for treason or disobedience, but for failure, even when that failure was largely the fault of the crown; as for example, when it failed to provide adequate supplies or relieve a besieged garrison. Terror, directed at both enemies and supporters, constituted a significant Castilian strategy in the War of the Two Pedros.

This fact is aptly illustrated by some of the wording one finds in royal documents of the period. There is a standard medieval formula used by Spanish kings when addressing commands to their subjects: "*so pena de mi merced*" which is roughly translated by the English equivalent "on pain of my displeasure." In other words, failure to carry out the command will result in royal displeasure. Not surprisingly, Pedro's documents are replete with this warning, accompanied by the not-uncommon clarifier, "*de los cuerpos e de los que auedes*," signifying that such royal displeasure would affect both the body and the worldly goods of the person who earned it.

On the other hand, quite a number of the Murcian documents carry an alternative formula that is not all that common: the king tells the inhabitants of the city that if they fail him, "Let your heads be returned to me as a result" (*que los vuestros cabeças me tornaria por ello*). This royal imprecation, worthy of the Red Queen in *Alice in Wonderland*, was no laughing matter to the many who fell victim to Pedro's ire, men such as the king's half-brother, Fadrique, and his close advisers, Toledo and Benavides!⁸⁵

One of these men, whom Ayala treats in considerable detail, provides the prototypical example: Gutier Ferrández de Toledo.⁸⁶ From the beginning of the reign and throughout most of its first decade, Toledo

⁸⁵ The following royal instructions contain some variant on this warning: *Documentos*, 157 (doc. 93); 162–63 (doc. 100); 165 (doc. 103); 175 (doc. 116).

⁸⁶ For references to this figure see, for example: Ayala, *Pedro*, 501–2, 504, 507.

was a member of the king's inner circle. When Pedro, upon coming to power, reorganized his household, he appointed this nobleman chief of the royal bodyguard (*guarda mayor del rey*). In that capacity, Gutier Ferrández was given command of the forces sent to deal with Alfonso's illegitimate sons and other partisans of Leonor de Guzmán, most of whom had fled to fortified strongpoints in the south. After having brought the important city of Algeçiras back under royal control, he escorted Doña Leonor to her final imprisonment in Talavera (though he appears to have had nothing to do with her subsequent murder).

In 1353, due to his close association with a disgraced royal adviser, Toledo's rising political star experienced a momentary eclipse; by the following year, however, he was back in the king's good graces, having stood by Pedro at a time with a majority of the realm's great nobles joined a short-lived confederation trying to seize control of the kingdom. At the meeting held between the two parties in the town of Tejadillo, it was Toledo who spoke for the crown.

For the next half dozen years, Gutier Ferrández served Pedro in numerous capacities, and, at one time or another, filled the posts of *alcalde mayor* of Toledo and royal *repostero mayor*.⁸⁷ He fought in the Aragonese war, commanded a garrison in the frontier fortress of Molina, and, for a time, had overall charge of defending Castile's eastern border. He also played a major role in ongoing diplomatic conversations with Aragon (conversations that would ultimately lead to his downfall).

None of these proofs of loyalty earned Toledo the benefit of the doubt or even a face-to-face meeting when Pedro (on not very good evidence) came to suspect him of dealing with the enemy. Ordered to participate in a new round of peace talks, he joined his fellow negotiators near the frontier, only to learn that they had instructions to seize and execute him.⁸⁸ Before cutting off his head and (as per instructions)

⁸⁷ To be appointed *repostero mayor* (literally "lord high butler") usually signaled noble rank and a close connection to the king.

⁸⁸ In 1360, Toledo led a Castilian delegation to Tudela, a town in Navarre, in order to conduct peace talks with Aragon. When the negotiations reached an impasse, he appears to have opened private talks with the Aragonese infante, Fernando. According to Ayala, he did this in an attempt to bribe Fernando into coming back over to Pedro's side. For many years, Fernando had lived in exile in Castile where he served first his uncle, Alfonso XI, and later his cousin, Pedro. However, in the mid-1350's he had participated in the aristocratic league which had tried unsuccessfully to seize control of the realm; and, as a result, had been forced to flee. Eventually, the infante had entered the service of his own half-brother, Pedro the Ceremonious. Apparently, Pedro saw the whole affair differently; from that moment, he began to suspect Toledo

sending it back to Pedro,⁸⁹ they did permit the condemned man to write one final letter to the king, in which Toledo reaffirmed his loyalty and warned the monarch against continuing the policy of terror.

My Lord, I, Gutier Ferrández... kiss your hands and take leave of you. I now journey before an even greater lord than yourself... Since the day you were born, my father, my brothers, and I have all served you loyally... [Nevertheless] you have ordered me killed... Now, at the moment of death, I give you my final counsel—if you do not put aside the dagger, if you do not stop committing such murders, then you shall lose your realm and place your person in the greatest jeopardy.⁹⁰

This prescient advice fell on deaf ears; the royal terror to which Pedro’s followers were subjected continued unabated. Ultimately, it would have a significant effect, though not the one Pedro envisaged. Instead of being encouraged to ever-increasing diligence in the prosecution of the war, during the 1360s, the Castilian aristocracy rose up against their king with a degree of class unity and grim determination rarely if ever equaled in its history. It was Pedro’s behavior, of a sort that today might be called paranoid, that drove the nobility into opposition and gave rise to their unrelenting efforts to get rid of him.⁹¹ Even in the Middle Ages, the traditional sanction of monarchy—“that divinity which doth hedge a king”—could not always preserve monarchs from the consequences of their extreme actions. Loyalty could not easily survive in a realm where the ruler punished with death not only obdurate opponents, but also faithful supporters; where failure, even after heroic efforts, might well occasion imprisonment or execution; where royal promises meant little; and where men or women suffered for the activities of their relatives.

of dealing with the enemy. Despite the nobleman’s long record of loyal service, he was given no opportunity to explain his actions or to defend himself. Ayala, *Pedro*, 501–2, 504, 507.

⁸⁹ Ayala, *Pedro*, 507, 508. On several occasions, Pedro demanded that he be sent the head of his victim.

⁹⁰ Ayala, *Pedro*, 507.

⁹¹ The nineteenth century French romantic writer, Prosper Mérimée, whose lengthy biography of the king is, in general, quite favorable to him, sums up his behavior toward the aristocracy in terms which indeed argue paranoia:

Don Pedro could never hear of the defection of one of his Ricos Hombres without imagining that the whole of his nobility were conspiring against him. His fury then conjured up enemies everywhere; he struck at random; now at a traitor, now at a faithful vassal. Not to be feared, seemed to him the greatest of reproaches; a few heads must fall in self-justification.

In such a climate, those who failed Pedro, even when the failure was not their fault, often adopted as the wisest course desertion to the other side; in other words, Castilians who fought without success, not wishing to face the king's wrath, went over to his brother, Enrique. As a result, a following that numbered at most several hundred when the war began, had within a decade grown into the thousands.

Not surprisingly, the Aragonese took full advantage of this situation. At the start of hostilities, Pere enlisted Enrique de Trastámara and his followers in the fight against the common enemy and throughout the conflict, with the sole exception of a few months of peace following the treaty of Terrar,⁹² Aragon supplied sanctuary to the growing number of Castilian exiles, providing them with financial support and a base from which to operate. Ultimately, it would be Castilians, often under Enrique's personal leadership, who would launch the most significant incursions into their homeland. At the battle of Araviana in 1359, which proved to be Aragon's most noteworthy victory, Castilians made up a large percentage of the victorious force.⁹³

An incident late in the war supplies a telling example of the counter-productivity of Pedro's policy of internal terror. In 1364, after a siege of many months, the Castilian garrison in Monviedro was reduced to eating its horses, mules and whatever rats had not already deserted the place. Although surrender was inevitable, the terms were honorable, permitting survivors to keep their arms and go where they would. As they marched out of the town, Enrique, who had been present at the siege fighting for Aragon, stood by the side of the road and reminded his countrymen that having lost the town, they could not expect a very pleasant homecoming. Forced to conclude that their recent enemy was right, most joined him on the spot.⁹⁴

⁹² Ayala, *Pedro*, 511. One clause in the treaty called upon Pere to expel the Castilian exiles and deny them the use of Aragonese territory for continued fighting, a clause that he honored. However, as soon as hostilities broke out anew, the monarch recalled his Castilian allies from southern France.

⁹³ Ayala, *Pedro*, 499.

⁹⁴ Ayala, *Pedro*, 535–36.

IX. *The Granadan Alliance*

Interestingly, while driving ever greater numbers of his own subjects into the enemy camp, Pedro worked hard to involve the remaining Iberian kingdoms on his side. In this, he enjoyed considerable success; at one time or another, Portugal, Navarre, and Granada all contributed to the Castilian war effort. For example, the great naval expedition of 1359 contained Portuguese and Granadan contingents.⁹⁵

The Granadan alliance, in particular, loomed large in Pedro's strategic thinking, a fact fully demonstrated by events early in the 1360s.⁹⁶ As Castile prepared for its annual attack on Aragon, a palace coup deposed Pedro's ally, Muḥammad V (1354–1359; 1362–1391), and replaced him with a new king referred to in Ayala's chronicle as Bermejo, who showed every sign of shifting sides.⁹⁷ As a result, for the first and only time in the war, the Castilian monarch felt compelled to negotiate seriously with the Aragonese. The result was the treaty of Terrar which proved decidedly unfavorable to Castile, committing Pedro to surrender most of his territorial gains in return for little more than an Aragonese commitment to expel Castilian exiles.

Furious at this turn of events, the Castilian monarch now unleashed his army against Granada. In conjunction with Muḥammad V's supporters,⁹⁸ Pedro's troops cut a wide swath through Moorish territory, forcing the enemy to sue for peace. Having allowed Bermejo to journey to Seville, Pedro had him treacherously seized and murdered.⁹⁹ Muḥammad V regained the throne and immediately reaffirmed his alliance with Castile, after which Pedro, assured of renewed Granadan

⁹⁵ Ayala, *Pedro*, 494. The king of Granada contributed three galleys.

⁹⁶ For a detailed analysis of the role Granada played in shaping the Hundred Years War, see Clara Estow, "War and Peace in Medieval Iberia: Castilian-Granadan Relations in the Mid-Fourteenth Century." *Hundred Years War*, 151–73.

⁹⁷ Ayala, *Pedro*, 510–11. For the palace coup that deposed Muḥammad V and installed Ismā'īl II, see L. P. Harvey, *Islamic Spain, 1250 to 1500* (Chicago, 1992), 206–10.

⁹⁸ Ayala, *Pedro*, 517. Among the foreigner filibusters said to have entered Castile for the campaign were the Count of Armagnac, the Aragonese noble, Pedro de Xérica, and the English knight, Sir Hugh Calveley, two of whom, the count and Calveley, would continue during the 1360s to play an important role in Iberian events.

⁹⁹ Ayala, *Pedro*, 518–19. Pedro justified this conduct on the grounds that he had never given a formal safe conduct; and besides, the victims were rebels against legitimate authority, with whom (like heretics) faith need not be kept.

support, violated the recent peace and launched his successful sneak attack on Calatayud.

X. *A Major Failure in Pedro's Strategic Thinking*

There was one critical strategy that Pedro failed to follow, one that might have saved him: in 1365, upon learning that the free companies were about to enter the war against him, he made no attempt to buy them off. Such an expedient had become standard operating procedure for those dealing with this serious threat, especially since the battle of Brignais in 1361, when the companies had mauled a French army sent out to subdue them, killing several prominent members of the royal family.¹⁰⁰

According to Ayala, an opportunity had presented itself.¹⁰¹ Early in 1366, as the free companies were gathering in Barcelona, a delegation of Pyrenean nobles led by the Seigneur d'Albret, arrived in Burgos where they informed Pedro that many in the companies, who were either related to them or allied to the English or both, might be convinced, with the proper "persuasion," to abandon the expedition or even to change sides. If the king desired, these nobles would undertake the necessary negotiations. Either through parsimony (as Ayala suggests) or a failure to assess the seriousness of the situation, Pedro rejected this offer. While there is no guarantee that such a preemptive strike would have saved him, others, including the papacy, had enjoyed good luck with this strategy.

XI. *Epilogue*

Rather than face the threat posed by the free companies, Pedro I fled southward, first to Seville, then into neighboring Portugal. His flight triggered a mass defection of his Castilian subjects to his half-brother,

¹⁰⁰ Jean Froissart, *Chronicles of England, France, and Spain and the Adjoining Countries from the Latter Part of the Reign of Edward II to the Coronation of Henry IV*, trans. Thomas Johnes, 2 vols. (London, 1857), 1:296–97.

¹⁰¹ Ayala, *Pedro*, 537.

Enrique de Trastámara, who mounted the throne as Enrique II. While this effectively ended the War of the Two Pedros between Castile and Aragon, fighting continued in a new form, a three-year civil war for the crown of Castile.

In the opening chapter of this new conflict, the deposed king took ship for the English territories in southern France, where he appealed to his ally, England, in the person Edward, “the Black Prince,” who was serving his father, Edward III (1327–77) as governor of Guienne. Having agreed to help Pedro, the prince mounted an expedition and in spring, 1367, entered Castile by way of Navarre. On April 3, Edward’s army won a crushing victory at Nájera, one of the great battles of the fourteenth century. Despite this, Enrique escaped and, with the aid of the French crown, rebuilt his shattered forces. Meanwhile, Pedro, through his battlefield brutality and failure to pay what he had promised, alienated the English, who evacuated the peninsula in autumn, just as Enrique was returning for a second try. The civil war then dragged on for eighteen months until, May, 1369, when Enrique and Bertrand DuGuesclin, on loan from France, routed Pedro’s army near the castle of Montiel. Shortly afterwards, while trying to escape, the king was captured and in a dramatic confrontation stabbed to death by his half-brother, Enrique.

In that same year, the Hundred Years War once again heated up. During this new round of conflict, one that France would dominate, French aid to the victorious Castilian pretender paid great dividends. Enrique de Trastámara, now Enrique II, actively participated on the side of France, in particular at sea. The first Trastamaran monarch lent his fleet to fight alongside the French navy in a sea war that witnessed a decisive encounter off La Rochelle (1372) and that established for the first time in decades a formidable French naval presence on the Bay of Biscay, one that was capable of challenging the English and their lifeline to the territories in southern France. This, in turn, contributed significantly to the success that France enjoyed during the last decade of Charles V’s reign.¹⁰² The alliance between France and Castile, cemented at this time, endured for the better part of a century.

¹⁰² See appendix I in this volume.

In a strictly Iberian context, the War of the Two Pedros became the last medieval attempt to alter the boundary between Castile and Aragon. In this respect, it achieved nothing. The borders were essentially the same at the end of the conflict as they had been at the beginning. A century later, in 1469, they were still the same when the crowns were united by the marriage of the Catholic Monarchs, Ferdinand of Aragon (1479–1516) and Isabel of Castile (1474–1504).

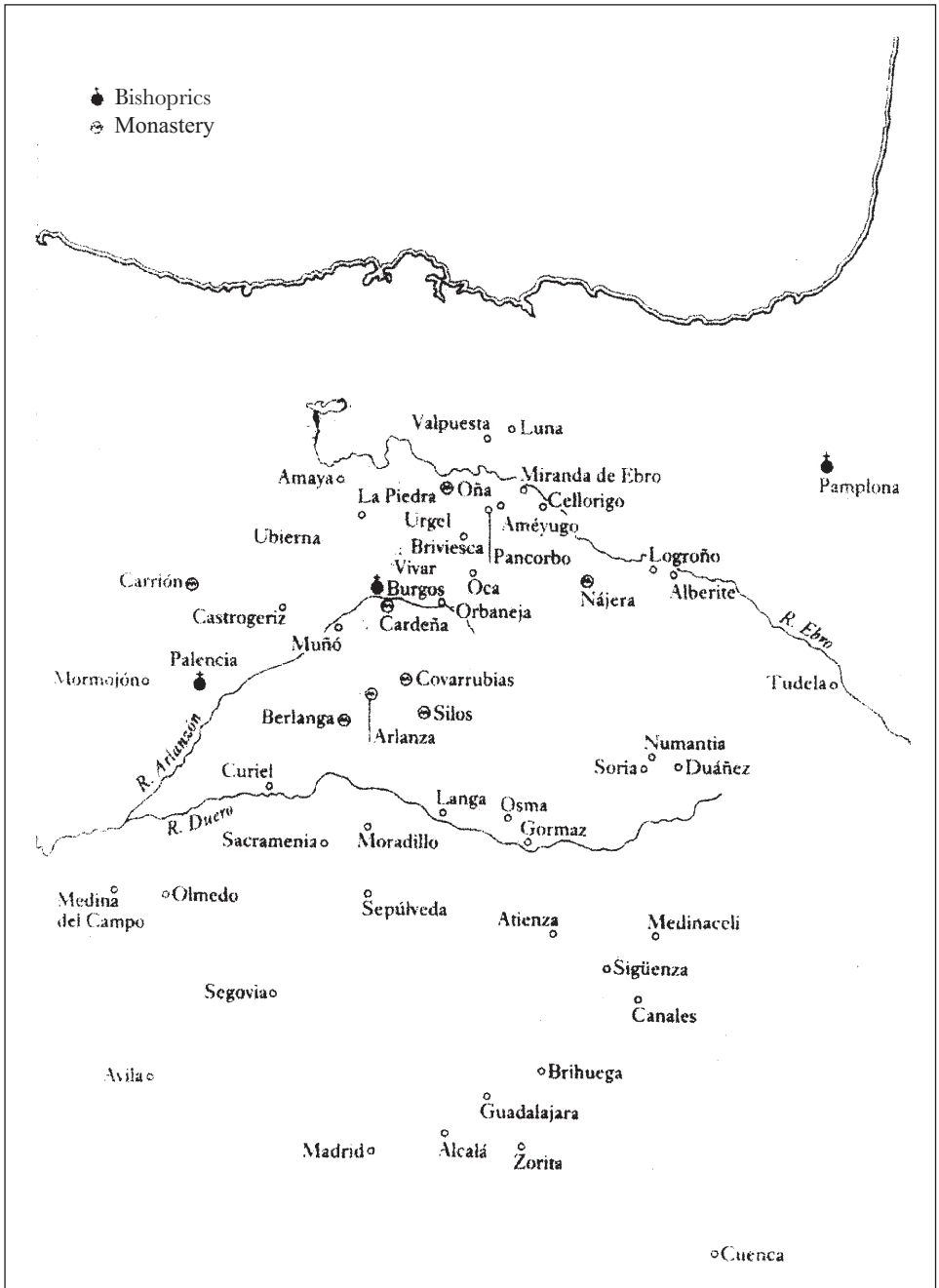

Map 8: Northern Castile.

THE DEFENSE OF THE CROWN OF ARAGON
DURING THE WAR OF THE TWO PEDROS (1356–1366)¹

Donald J. Kagay
Albany State University

For many in the modern world, the study of strategy in the Hundred Years War (a conflict which took well over a century to unfold) is unthinkable if not downright ludicrous. It is the purpose of this paper to explore the military, administrative, and psychological underpinning of the complicated structure of defense that emerged during the War of the Two Pedros, a bitter border conflict of the mid-fourteenth century between Castile and the Crown of Aragon. In this struggle which consumed an entire decade (1356–1366), the centuries-old lessons of border fighting were used as two evenly-matched opponents dueled across frontiers that could change hands with lightning speed. The Castilian monarch, Pedro I “the Cruel” (1350–1366/69), showed himself a master of offensive warfare whose persistence and cunning should by all accounts have brought under his control broad swaths of Aragon and Valencia.² The Aragonese sovereign, Pere III “the Ceremonious” (1336–1387), was a mediocre soldier who seldom tested his courage in the “region of warfare and peril” that was the frontier.³ He was, however, a shrewd planner and administrator who saw that his very survival as a ruler depended on a willingness to exercise flexibility in conducting traditional border war while, at the same time, casting around for new and often innovative means of defense.

¹ An earlier version of this paper appeared in the *Journal of Military History* 71 (2007): 11–33.

² For Pedro I, see Clara Estow, *Pedro the Cruel of Castile, 1350–1369* (Leiden, 1995); L. J. Andrew Villalon, “Pedro the Cruel: Portrait of a Royal Failure,” in *Medieval Iberia: Essays on the History and Literature of Medieval Spain*, ed. Donald J. Kagay and Joseph T. Snow (New York, 1997), 201–16.

³ Robert I. Burns, S.J., “The Significance of the Frontier in the Middle Ages,” in *Medieval Frontier Societies*, ed. Robert Bartlett and Angus MacKay (Oxford, 1996), 322.

I

To understand the defensive methods Pere III utilized to save his crown against the incessant military pressure of his Castilian adversary, one must review, in general terms, the mundane and theoretical lessons of strategic defense as they emerged over the centuries and then compare them specifically to the way of war during the greatest conflict of the fourteenth century.

Theoretical discussions of the defensive stances mounted by military forces of all sizes has a long provenance in Western Europe. Late antique military writers, such as Vegetius and the Byzantine Emperor, Maurice, put a considerable amount of information at the disposal of commanders attempting to defend their positions from enemy attack or to bolster their own assault troops with rear-line “defenders.”⁴ In the Renaissance, Machiavelli, reflecting the accepted military knowledge of the Middle Ages, characterized good commanders as those who do not attack unless “compelled to do so by absolute necessity.”⁵ Guicciardini and other Italian historians of this period praised more than one contemporary military leader “for waging war more with his mind than with his sword [while] . . . holding off the mighty and unconquerable legions of foreign peoples rather than challenging them to battle.”⁶

While updating the battlefield truisms of the preceding millennium, the greatest military expert of the nineteenth century, Carl von Clausewitz, continued to stress that “it is easier to hold ground than to take it” and “war serves the purpose of the defense more than that of the aggressor.”⁷ He repeatedly emphasized the importance of fortresses as not only refuges for weak or exhausted troops, but also as staging points for offensive operations.⁸ Within such strongholds, defenders could keep much greater forces at bay with a much smaller outlay in men and

⁴ Vegetius, *Epitome of Military Science*, trans. N. P. Milner (Liverpool, 1996), 120–26 (IV:1–6); Maurice’s *Strategikon: Handbook of Byzantine Military Strategy*, trans. George T. Dennis (Philadelphia, 1984), 15, 118 (I:3; XI:2).

⁵ Niccolò Machiavelli, *The Art of War*, trans. Ellis Farnsworth (1965; reprint, New York, 1999), 203–4 (VII:21).

⁶ Hans Delbrück, *The Dawn of Modern Warfare*, vol. 4 of *History of the Art of War*, trans. Walter J. Renfroe, Jr, 5 vols. (1985; reprint, Lincoln, Neb., 1990), 4:110.

⁷ Carl von Clausewitz, *On War*, ed. and trans. Michael Howard and Peter Paret (Princeton, 1984), 358, 370 (6:1,5); idem, *Principles of War*, trans. Hans W. Gatzke (1942; reprint, Mineola, N.Y., 2003), 53–55.

⁸ Clausewitz, *On War*, 393–99 (10:1–11); Paul Hill and Julie Wileman, *Landscapes of War: The Archaeology of Aggression and Defense* (Charleston, S.C., 2002), 106–7.

matériel. They were, as von Clausewitz pointed out, “an actual shield against enemy attack.”⁹ B. H. Liddell-Hart followed this line in the twentieth century by advising commanders to stand fast until the attackers “beat themselves.”¹⁰ The great, Second World War commander, Dwight Eisenhower, though a proponent of offensive warfare, clearly recognized the advantage gained from “carefully-prepared defenses.”¹¹ Even on the asymmetrical battlefield of the twenty-first century, defenders, according to Edward Luttwak, possess the initial advantage, even if they lack the emotional charge from being on the offensive.¹²

In the shadow of such theory, the practicalities of war in all eras seem much less certain, but are perhaps more interesting. In southern England, northern France, and the Low Countries, all regions that played a role in the Hundred Years War, manpower was originally associated with military institutions of the twelfth and thirteenth centuries: the feudal array and national host (*levée en masse*).¹³ As wars grew longer and more frequent in the late-thirteenth century, more select units recruited by local captains replaced this badly-coordinated, general militia. These more efficient contingents, signing indentures which specified the duration and location of their service, received a daily wage from extraordinary subsidies voted by the national parliament or regional estates.¹⁴

While modern military theorists occasionally view campaigns of the Hundred Years War—and indeed all medieval warfare—as contests dominated by forces “inimical to military art,”¹⁵ such campaigns were fought according to offensive and defensive theories developed and tested through long usage. Because of the over-all scarcity of fodder

⁹ Clausewitz, *On War*, 397 (10:7).

¹⁰ B. H. Liddell Hart, *Strategy* (New York, 1954), 328.

¹¹ Dwight D. Eisenhower, *Crusade in Europe* (Garden City, N.Y., 1948), 350, 450.

¹² Edward N. Luttwak, *Strategy: The Logic of War and Peace* (Cambridge, Mass., 1995), 58–59.

¹³ *Society at War: The Experience of England and France during the Hundred Years War*, ed. C. T. Allmand (New York, 1973), 48; Michael Powicke, *Military Obligation in Medieval England* (1962; reprint, Oxford, 1996), 1–47; Barnaby C. Keeney, “Military Service and the Development of Nationalism in England, 1272–1327,” *Speculum* 22 (1947): 538–42.

¹⁴ *Society at War*, 50–55; Powicke, *Military Obligation*, 48–117; Keeney, “Military Service,” 546–49; Philippe Contamine, *War in the Middle Ages*, trans. Michael Jones (1980; reprint, Oxford, 1990), 127–29; John France, *Western Warfare in the Age of the Crusades, 1000–1300* (Ithaca, N.Y., 1999), 130–34; Andrew Ayton, “English Armies in the Fourteenth Century,” in *Arms, Armies and Fortifications in the Hundred Years War*, ed. Anne Curry and Michael Hughes (Woodbridge, Suffolk, 1999), 25–26; Peter Coss, *The Knight in Medieval England 1000–1400* (Stroud, 1996), 102–7.

¹⁵ Liddell Hart, *Strategy*, 75.

and the short duration of optimum campaigning seasons, attackers focused much of their energies on the raiding expedition (*chevauchée*) that provided plunder and other supplies for forces which spread “damage [and] destruction” (*dampnum; demolicio*) through a wide swath of enemy territory.¹⁶ Even if they never got down to the serious and costly business of besieging a castle which, as Pierre Dubois warned, “can hardly be taken within a year,” attackers gained important advantages from the *chevauchée*, despite the growing clerical and lay disapproval of the tactic in the later decades of the Hundred Years War.¹⁷

Though always risking personal or national dishonor by not immediately taking the field to expel an invasion, defenders normally avoided battle and preferred to out-wait their adversaries. This Fabian strategy consisted of guarding the strong points of the frontiers, demolishing indefensible fortifications, and effecting a scorched-earth policy along the enemy’s line of march.¹⁸ Even if a pitched battle ultimately resulted from an enemy invasion, a truly defensive outlook prevailed among most military leaders who generally adhered to the long-held view that attacking first in a battle could quickly result in ignominious defeat. Commonly-accepted military wisdom counseled battlefield commanders to keep their formations intact until the enemy initiated action.¹⁹ Though defense in all its aspects required a commander to have steady nerves and exercise a solid discipline over his troops, it

¹⁶ Clifford J. Rogers, “The Offensive/Defensive in Medieval Strategy,” in *From Crécy to Mohács: Warfare in the Late Middle Ages (1346–1526)*. *Acta of the XXIInd Colloquium of the International Commission of Military History* (Vienna, 1997), 162–63, idem, “By Fire and Sword: *Bellum Hostile* and the ‘Civilians’ in the Hundred Years War,” in *Civilians in the Path of War*, ed. Mark Grimsley and Clifford J. Rogers (Lincoln, Neb., 2002), 54; Yuval Noah Harari, “Strategy and Supply in Fourteenth-Century Western European Invasion Campaigns,” *The Journal of Military History* 64 (2000): 300–1, 310, 333; H. J. Hewitt, *The Organization of War under Edward III 1338–1362* (New York, 1966), 100, 105, 112–3, 117.

¹⁷ Philippe de Mézières, *Letter to Richard II: A Plea Made in 1395 for Peace between England and France*, trans. G. W. Coopland (Liverpool, 1975), 51; Rogers, “Offensive,” 164–66; Harari, “Strategy,” 301; Hewitt, *Organization*, 132–34; W. R. Jones, “The English Church and Royal Propaganda during the Hundred Years War,” *Journal of British Studies* 19 (1979): 18–30.

¹⁸ Rogers, “Offensive,” 163; Contamine, *War*, 209, 220; Harari, “Strategy,” 310; Charles Oman, *A History of the Art of War in the Middle Ages*, 2 vols. (1924; reprint, Mechanicsburg, Penn., 1998), 2:108.

¹⁹ Rogers, “Offensive,” 159–60, 167; idem, “The Age of the Hundred Years War,” in *Medieval Warfare: A History*, ed. Maurice Keen (Oxford, 1999), 146. This defensive axiom was drawn largely from Vegetius’s advice on battlefield tactics. Vegetius, *Epitome*, trans. Milner, 73–77, 83–86 (III:6,9).

became a viable and well-honored blueprint for military success in the many landscapes of the Hundred Years War. Most of the campaigns of this expansive conflict thus followed the same safe course of defense: “pillaging, . . . sieges [and, only occasionally] battles.”²⁰

The “art of war” practiced in the Iberian Peninsula, though honed initially against Spanish Islam, contained all the theoretical and practical elements of northern European battlefields of the high Middle Ages. The Castilian king, Alfonso X (1252–1282) and his nephew, the marcher lord, Juan Manuel (1282–1339), produced important treatises and translations on the waging of war. Though both men had first-hand experience in border combat against Muslim and Christian adversaries, they colored many of their discussions with a patina derived from such earlier writers as Vegetius and Isidore.²¹ In the *Siete Partidas*, Alfonso *el Sabio* discussed warfare in all its aspects. In his treatment of generalship, strategy, the maintenance of troops in the field, and the holding of castles, the king gives a fairly accurate view of how war was conducted in his day.²² In the *Libro de los Estados* (1330), the *Libro de los Castigos* (1330), and the *Libro del Conde Lucanor* (1335), Juan Manuel, though a scholar well-acquainted with the record of ancient war, spoke of combat from the point-of-view of an experienced campaigner. From his often quite diffuse writings, the prince emerges as a cautious warrior who equated the full staffing and supply of castles with the proper protection of a person’s patrimony.²³ In the transport of troops across open country in either offensive or defensive mode, he counseled a thorough reconnoitering by outriders and immediate communication between the various units of the marching army through the use of trumpets and other signals.²⁴ While Juan Manuel advised extreme caution especially when passing through Muslim territory or in responding to enemy raids (*cabalcadas, algaras*), he rarely advocated unleashing “war, most cruel” (*lo mas crua guerra*) except in desperate situations.²⁵

²⁰ Contamine, *War*, 219.

²¹ Nancy Joe Dyer, “Alfonsine Historiography: The Literary Narrative,” in *Emperor of Culture: Alfonso X the Learned of Castile and his Thirteenth-Century Renaissance*, ed. Robert I. Burns, S. J. (Philadelphia, 1990), 146; José María Castro y Calvo, *El arte de gobernar en las obras de Don Juan Manuel* (Barcelona, 1945), 321–420.

²² *Las Siete Partidas*, trans. Samuel Parsons Scott, ed. Robert I. Burns, S. J., 5 vols. (Philadelphia, 2001) 2:439–61 (Part. II, Tit. xxiii, laws, i–xxx).

²³ Castro y Calvo, *Arte*, 188.

²⁴ *Ibid.*, 190–91.

²⁵ *Ibid.*, 189; James Powers, “Army, Castilian, Catalan, Muslim, Portuguese,” in *Medieval Iberia, An Encyclopedia*, ed. E. Michael Gerli (New York, 2003), 112.

The clearest picture of Iberian warfare in the century before the Hundred Years War, however, comes not from such juridical or literary works, but rather from an autobiographical record of the military “good works” (*bones obres*) of the great Aragonese king, Jaume I “the Conqueror” (1213–1276).²⁶ Holding himself to a high standard of chivalric valor and unflinching service to “god and His mother,” Jaume led massive armies (by medieval standards) against the small Muslim states of Majorca, Valencia, Jativa, and Murcia.²⁷ His triumphs came less from the “winner-take-all” outcome of the great battle than from an interconnected series of sieges, each of which led to the uncontested surrender of many other fortresses in the vicinity.²⁸ In all these campaigns, Jaume proved himself a talented military administrator²⁹ and an innovator in the use of artillery.³⁰ His guile as a commander was only matched by his thorough preparation in advance of campaigns.³¹

After sixteen years of reshaping the boundaries of eastern Spain, however, Jaume was forced to defend what he had conquered. To put down major Muslim and Christian insurrections in the last three decades of his reign,³² the Aragonese king relied on small levies of horse and

²⁶ *The Book of Deeds of James I of Aragon: A Translation of the Medieval Catalan Llibre dels Fets* [BD], trans. Damian Smith and Helena Buffery (Aldershot, Hampshire, 2003) 71 (chap. 48); Robert I. Burns, S.J., “The Spiritual Life of James the Conqueror, King of Arago-Catalonia, 1208–1276. Portrait and Self-Portrait,” *The Catholic Historical Review* 72 (1976):8; Donald J. Kagay, “The Line between Memoir and History: James I of Aragon and the *Llibre del Feys*,” in *War, Government, and Society in the Medieval Crown of Aragon* (Aldershot, Hampshire, 2007), study XII, 173–74.

²⁷ The largest of these expeditions, those against the Balearics and Valencia, features armies of between 15,000 and 20,000 men. The expeditions against Jativa and Murcia had fewer than 5,000 men. *LF*, 2:266, 304 (chaps. 346, 406); Alvaro Santmaria, “La expansion político-militar de la Corona de Aragón bajo la dirección de Jaime I: Baleares,” in *Jaime I y su época X Congreso de Historia de la Corona de Aragon* [XCHCA] (Zaragoza, 1979), *Ponencias*, 122–23; Antonio Ubieta, Arteta, “La reconquista de Valencia y Murcia,” in *XCHCA, Ponencias*, 157–65.

²⁸ For instance after Jaume took Morella and Peñíscola in 1233, the surrounding castles and villages of Chivert, Cervera, Polpis, Castellon de Burriana, Borriol, Avinroma, Alcalaten, and Villa Hamez quickly surrendered. *BD*, 172–77 (chaps. 182–90); F. Darwin Swift, *The Life and Times of James the First the Conqueror* (Oxford, 1894), 58.

²⁹ Donald J. Kagay, “Army Administration, and the Realm of the Thirteenth-Century Crown of Aragon,” in *Iberia and the Mediterranean World of the Middle Ages: Essays in Honor of Robert I. Burns, S. J.*, ed. P. E. Chevedden, D. J. Kagay, P. G. Padilla, and L. Simon, 2 vols. (Leiden, 1996), 2:96–115.

³⁰ Paul E. Chevedden, “The Artillery of King James I the Conqueror,” in *Iberia and the Mediterranean World*, 2:47–94; Burns, “Spiritual Life,” 33.

³¹ *BD*, 64, 178 (chaps. 43, 193); Burns, “Spiritual Life,” 23–24.

³² For the Al-Azrak revolt of 1246 and the revolt of the Andalusian Muslims in 1276 as well as baronial uprising of the same period, see *BD*, 271–79, 375–78 (chaps. 361–72, 555–60), Robert I. Burns, S. J. and Paul E. Chevedden, *Negotiating Cultures:*

foot commanded by aristocratic, clerical, and urban captains. Royal and parliamentary funds went toward the repair and provisioning of castles that dominated endangered areas as well as for the payment of their garrisons. Unlike the era of his great conquests, Jaume's last years focused on the defense of frontiers; in these campaigns, victory was defined not by territory gained, but by that retained.³³

Because this small-scale warfare waged over vast tracts of borderland became the principal form of military operation in Iberia for the next two centuries, the administration of fortresses became a prime concern of the sovereign and the men whom he appointed to maintain them. Castle tenure, which was minutely discussed in the *Siete Partidas* and in the *Costum d'Espanya* (a set of fortress norms accepted in both Castile and in the Crown of Aragon by the early fourteenth century), established extremely high standards for castellans and the garrisons they commanded. No matter how long a castle commander held out against the hardships of an enemy siege, his surrender, even when justified by great suffering, branded him as a traitor whose inconsiderate actions caused the symbolic "death of his lord."³⁴ The high stakes of such fortress defense led one widely-experienced castellan, the chronicler, Ramón Muntaner (1265–1336), to conclude that "one of the greatest dangers in the world is to hold a castle for a lord."³⁵ Unfortunately, for many castellans serving the Aragonese crown in the great Castilian war of the mid-fourteenth century, defense of castles in the sparsely-populated, highly-porous borderlands of Aragon and Valencia proved no easy matter. In the course of the war, many fortresses were overrun by enemy raiders serving a sovereign declared to be thoroughly evil by his Aragonese rival. Loss of these places to such an iniquitous figure could all-too-readily open the unsuccessful castellan to charges of malfeasance and treason.

Bilingual Surrender Treaties in Muslim-Christian Spain (Leiden, 1999), 103–8; Donald J. Kagay, "Structures of Baronial Dissent and Revolt under James I (1213–1276)," in *War, Government, and Society*, VII, 63–64.

³³ Jaume's defensive point-of-view is clearly expressed in 1264 when the king attempted to convince his Catalan and Aragonese parliaments to fund an expedition against the rebellious Muslims of his son-in-law, Alfonso X, before their bad influence spread to his own Moorish population. *BD*, 286–88 (chaps. 381–82).

³⁴ *Siete Partidas*, 2:384 (Part. II, tit. xviii, law vi); Maria Teresa Ferrer i Mallol, "La tiença a costum d'Espanya en els castells de la fronters meridional valenciana (Segle XIV)," *Miscellania de Textos Medievals* 4 (1988): 5–6.

³⁵ *The Chronicle of Muntaner*, trans. Lady Henrietta Goodenough, 2 vols. (1921; reprint, Nendeln, Liechtenstein, 1967), 2:453 (chap. 188).

II

Though similar in some important ways, for example in language and culture,³⁶ Castile and the Crown of Aragon had a long and troubled relationship. Because of the manifold marriage connections between the Aragonese and Castilian ruling houses, much of the unrest between them started as familial disagreements only to escalate later into international incidents. The most significant of these incidents centered on the *infantes de la Cerda*, Castilian princes who were manipulated by successive Aragonese monarchs of the late-thirteenth century, all of whom were related to the *infantes*.³⁷ Such a diplomatic strategy, that involved using disgruntled family members on the other side of the border, was a risky one for both states. It often spawned political turbulence and produced “over-mighty subjects” who regularly sought sanctuary by crossing the border and taking up residence in the court of their sovereign’s principal adversary.³⁸

³⁶ For development and relationship of the principal languages of the region (Castilian, Aragonese, and Catalan), see Lynn Williams, “Language,” in *The Companion to Hispanic Studies*, ed. Catherine Davies (London, 2002), 15–19; Bill Richardson, *Spanish Studies: An Introduction* (London, 2001), 66–70; Joan Martí i Castell, *Els orígens de la llengua catalana* (Barcelona, 2001), 45–46; Vicente García de Diego, *El dialecto aragonés* (Zaragoza, 1916). For the early development and maturity of both Catalan and Castilian/Aragonese, see Teofilo Ruiz, *From Heaven to Earth: The Reordering of Castilian Society, 1150–1350* (Princeton, N.J., 2004), 29–30.

³⁷ The *infantes de la Cerda*, Alfonso and Fernando, were sons of the Castilian crown prince, Fernando de la Cerda. With his death in 1275, the royal claims of his sons were frustrated by their uncle, Sancho IV (1284–1296), and were sponsored by the Aragonese kings, Pere II (1276–1285) and Alfons II (1285–1291). For the *infantes de la Cerda*, see Eloy Benito Ruano, “El problema sucesorio de la corona de Castilla a la muerte de don Fernando de la Cerda,” in *VII centenario del Infante Don Fernando de la Cerda. Jornadas de Estudio Ciudad Real, abril 1975* (Madrid, 1976), 217–25; M. T. Ferrer i Mallol, “Causes i antecedents de la guerra dels dos Peres,” *Boletín de la Sociedad Castellonense de Cultura*, 43 (1987): 446–50.

³⁸ Since the last decades of the thirteenth century, the Castilian and Aragonese baronies had stood foursquare against what they perceived as the centralization of royal law and government. To stop this hated development, they formed political and military organizations—*uniones* in Aragon and *hermandades* in Castile. Leaders of these bodies, such as Prince Ferran, half-brother of Pere III, and Enrique de Trastámara, half-brother of Pedro I, moved across the Aragonese-Castilian border when in danger. In this way, unrest in one realm was spread to the other. For baronial organizations, see Joseph F. O’Callaghan, “Kings and Lord in Conflict in Late-Thirteenth Century,” in *Iberia and the Mediterranean World*, 2:117–38; Kagay, “Structures,” 1 (1989): 61–85; idem, “Rebellion on Trial: The Aragonese *Unión* and its Uneasy Connection to Royal Law, 1265–1301,” in *Law, Government, and Society*, study VI, 30–43.

Aside from such dynastic maneuvering, the principal focus of dispute between Castile and the Crown of Aragon was land. By the treaty of Almizra (1244), the two reconquest powers laid out boundaries over Muslim territory they had not yet conquered. Nevertheless, the actual conquest of these lands frequently brought with it bitter disputes between the conquerors.³⁹ The center of this internecine conflict was Murcia, the region that lay due south of the Crown of Aragon's southernmost realm, Valencia. The great Aragonese king, Jaume I, had effectively won the region in 1265–1266 and had then bestowed it on his Castilian son-in-law, Alfonso X. On the other hand, many of the residents of the Crown of Aragon continued to regard Murcia as their land.⁴⁰ At the end of the thirteenth century, political pressure to reclaim the Murcian territories influenced another Aragonese ruler, Jaume II (1291–1327) to mount a war of aggression against Castile.⁴¹ It is hardly surprising, then, that when the War of the Two Pedros commenced some fifty years later, Murcia, a symbol of the troubled relationship between the two largest Iberian states, was one of its principal combat zones.

III

When the enduring conflict descended onto the Crown of Aragon in the fall of 1356,⁴² territory which had long been a peaceful backwater

³⁹ *Documentos de Jaime I de Aragon*, ed. Ambrosio Huici Miranda and Maria Desamparados Cabanes Pecourt, 5 vols. (Valencia, 1976–1988), 3:176–77 (doc. 380); Miguel Angel Ladero Quesada, “Sobre la evolución de las fronteras medievales hispánicas (Siglos XI a XIV),” in *Identidad y representación de la frontera en la España medieval (siglos XI–XIV)*, ed. Carlos de Ayala Martínez, Pascal Buresi, and Philippe Jossierand (Madrid, 2001), 28–29; Juan Manuel del Estal, “Alicante en la política territorial de los dos Jaimes de Aragon,” in *XCHCA, Comunicaciones, 1–2*, 70; Derek W. Lomax, *The Reconquest of Spain* (London, 1978), 162.

⁴⁰ J. Torres Fontes, *La reconquista de Murcia en 1266 por Jaime I de Aragon* (Murcia, 1987); Josep-David Garrido i Valls, *Jaume I i el regne de Múrcia* (Barcelona, 1997).

⁴¹ María Teresa Ferrer i Mallol, “Notes sobre la conquest del Múrcia per Jaume II (1296–1304),” in *Homenaje de la memòria del Prof. Emilio Sáez. Aplec de estudis dels seus deixebles i col·laboradors* (Barcelona, 1989), 27–44; Josep-David Garrido i Valls, *La conquesta del sud Valencià i Múrcia per Jaume II* (Barcelona, 2002).

⁴² The war commenced in late summer of 1356 when Francesç Perrellós, a Catalan privateer, captured two Italian merchantmen at Cadiz. The ships were under the protection of Genoa and their ally, Castile; therefore, Pedro I viewed the attack as a clear provocation. He demanded restitution from Perrellós's overlord, Pere III, and when it was not immediately forthcoming, he broke feudal ties with Pere III which served as

once more stood at the forefront of national defense. The principal theaters of the war—on the Aragonese frontier opposite Cuenca and on the southern border of Valencia opposite Murcia—though far apart were strikingly similar in geography. Covered with treeless steppes which supported only sparse stands of heather, this landscape has been called by one observer “the bleakest and most inhospitable land in the whole of Spain.”⁴³ Because of the harsh nature of the terrain which provided very little fodder for animals, the Castilians often relied on lightning raids that depended on surprise to overwhelm an entire district. Since both theaters of the war contained narrow bands of fertile territory in the midst of vast swaths of wasteland, the bitterest fighting swirled around such Aragonese and Valencian “oases” as Calatayud, Teruel, Elche, Orihuela, and Alicante. By their intermittent but intense raids, the Castilians forced the Aragonese and Valencians to adopt an increasingly complex defensive policy, in some respects reminiscent of the policy pursued by the realms of Christian Iberia in their long struggle with Islam.⁴⁴

On the Christian side of these much-embattled borders, defenders had learned by experience the Vegetian lessons discussed in the *Siete Partidas*. In this great thirteenth-century master work, Alfonso X counseled constant surveillance to offset enemy surprise attacks and warned against abandoning the tactical advantage of fortified positions.⁴⁵ This was to be accomplished by the manipulation of national and feudal allegiance. According to law, when dangers to the widely-scattered borderlands constituted a serious enough emergency, the ruler in the Crown of Aragon could call out all able-bodied men of military age and use

a declaration of war. Pere III of Catalonia (Pedro IV of Aragon), *Chronicle* [Pere III], trans. Mary Hillgarth, ed. J. N. Hillgarth, 2 vols. (Toronto, 1980), 2:498–503 (VI:3–4); *Arxiu de la Corona d'Aragó* [ACA], Cancilleria real, R. 1379, ff. 12v–15v.

⁴³ Naval Intelligence Division, *Spain and Portugal*, 3 vols. (London, 1941), 1:108. For general view of the campaigning regions, see Richard Ford, *A Hand-Book for Travelers in Spain and Readers at Home*, ed. Ian Robertson (Carbondale, Ill., 1966), 2:606–8, 3:1302–4, 1319–20; idem, *Gatherings from Spain*, ed. Ian Robertson (1846; reprint, London, 2000), 10–11; Karl Baedeker, *Spain and Portugal: Handbook for Travelers* (London, 1913), 160, 167; W. B. Fisher and H. Bowen-Jones, *Spain: An Introductory Geography* (New York, 1966), 47.

⁴⁴ Josiah Cox Russell, *Medieval Regions and their Cities* (Newton Abbot, 1972), 168–69; Fisher and Bowen, *Spain*, 156; Naval Intelligence Division, *Spain and Portugal*, 3:109–10, 590–91.

⁴⁵ *Siete Partidas*, 2:443,450–51, 457 (II:vii, xvii, xxv).

them in any way he saw fit to repel the invaders.⁴⁶ On the other hand, since the Crown of Aragon was composed of independent realms with little to bind them except the same sovereign, such national defense schemes that viewed all of eastern Spain as a single unit often proved unworkable and exceedingly unpopular.⁴⁷ If the external danger did not last long, sovereigns were sometimes better advised to individually instruct their major vassals to see to the defense of the land they held in fief from the Crown.⁴⁸ This policy was reinforced by the construction of strategically-important castles along the frontiers which were garrisoned by these vassals.⁴⁹

A line of heavily fortified cities and towns bolstered the regime of castle defense along the Aragonese and Valencian borders. In many cases, these urban centers were the core of a hundred or more “hamlets” (*aldeas*) of various sizes and states of military readiness.⁵⁰ The crown’s manipulation of urban manpower proved even more adaptable and cost effective than the use of the nobility. In exchange for generous settlement charters (*carta de población*) and “letters of protection” (*cartas de protección*), settlers in these urban outposts constituted militias whose prime duty it was to patrol and defend the borderland where they lived.⁵¹

⁴⁶ *The Customs of Catalonia between Lords and Vassals by the Barcelona Canon, Pere Albert: A Practical Guide to Castle Feudalism in Medieval Spain*, trans. Donald J. Kagay (Tempe, Ariz., 2002), 36–42 (arts. 37–39); Tomás Mieres, *Apparatus super constitutionibus curiarum generalium Cataloniae* (Barcelona, 1621), ff. 27v, 163v.

⁴⁷ Johannes de Socarrats, *Tractatum Petri Alberti canonici barchinonensis de consuetudines Cataloniae inter dominos et vassallos ac nonnullis aliis que commemorationes Petri Alberti apellantur* (Barcelona, 1551) 373 (law 39). For the Crown of Aragon, see Joan Reglà, *Introducció a la història de la Corona d’Aragó* (Palma, 1973); T. N. Bisson, *The Medieval Crown of Aragon: A Short History* (Oxford, 1986); Donald J. Kagay, “The Institutional Blue Print of a Crusader Land: The Case of the Medieval Crown of Aragon,” *Journal of the Georgia Association of Historians* 24 (2003): 25–60.

⁴⁸ Arxiu de la corona d’Aragó [ACA], Cancillería real, R. 1379, ff. 149–50; R. 1382, ff. 184v–85; 186–89, 198v–99; R. 1384, ff. 5v–6; Joaquim Miret i Sans, *Itinerari de Jaume “el Conqueridor”* (Barcelona, 1917), 376; Kagay, “Structures,” 64.

⁴⁹ Bonifacio Palacios Martín, “La frontera de Aragón con Castilla en la época de Jaime I,” in *Jaime I y su época (X Congrés d’història de la corona d’Aragó) [XCHCA]*, 3 vols. (Zaragoza, 1975), *Comunicaciones 1–2*, 490–95; Antonio Gutiérrez y Velasco, “Las fortalezas aragonesas ante la gran ofensiva castellana en la guerra de los Dos Pedros,” *Cuadernos de Historia Jerónimo Zurita [CHJZ]* (12–13 (1961): 7–39.

⁵⁰ Palacios Martín, “Frontera,” 487–88; Donald J. Kagay, “Two Towns Where there was Once One: The Aldea in Medieval Aragon,” *Journal of the Rocky Mountain Medieval and Renaissance Association* 14 (1993): 33–43.

⁵¹ Palacios Martín, “Frontera,” 488; James F. Powers, *A Society Organized for War: The Iberian Municipal Militias in the Central Middle Ages, 1000–1284* (Berkeley, 1988), 136–37, 140, 143; idem, “Two Warrior-Kings and Their Municipal Militias: The Townsman-Soldier in Law and Life,” in *The Worlds of Alfonso the Learned and James the*

IV

Starting with his accession to the throne in 1336, Pere III found his borderlands to be hot spots of conflict and dissension. Here, he faced not only Castilian hostility, but also a homegrown opposition, centering on the Valencian *Unión* and one of its leaders, his over-mighty half-brother, Ferran.⁵² Even though the king defeated unionist forces at the battle of Epila in 1348 and at least officially put an end to the institution, its residual influence along the southern frontiers remained strong as did that of his half-brother.⁵³

Although Pere had survived of this turbulent period along his southern and western borders, his Castilian adversary's first attack against southern Valencia launched in September, 1356, initially took him by surprise. Nevertheless, he rallied to make use of his earlier experience to mount a moderately-successful defense.⁵⁴ Though letting it be known that he intended "to personally go to the frontier... [inflicting] such damage... [as he could] on the king of Castile,... his lands, and people," Pere soon thought better of this dangerous reaction.⁵⁵ Spending the last months of 1356 in Perpignan and Barcelona, all of them far removed from the actual fighting,⁵⁶ the king attempted to secure

Conqueror: Intellect and Force in the Middle Ages, ed. Robert I. Burns, S. J. (Princeton, N.J., 1985), 95–129; Manuel González Jiménez, "Frontier and Settlement in the Kingdom of Castile (1085–1350)," in *Medieval Frontier Societies*, ed. Robert Bartlett and Angus MacKay (Oxford, 1996), 67–68.

⁵² Pere III, 2:433–35 (IV:45); Vicente Boix y Ricarte, *Crónica de la Provincia de Valencia*, 3 vols. (Madrid, 1867), 3:56. For Prince Ferran, see María Teresa Ferrer i Mallol, "The Southern Valencian Frontier during the War of the Two Pedros," in *The Hundred Years War: A Wider Focus*, ed. L. J. Andrew Villalon and Donald J. Kagay (Leiden, 2005), 80–81, 106–7; idem, "Causes," 452–60.

⁵³ For the battle of Epila in the summer of 1348, see J. Lee Shneidman, *The Rise of the Aragonese-Catalan Empire 1200–1350*, 2 vols. (New York, 1970), 2:500–2; Manuel Dualede Serrano, "Tres episodios de la lucha entre 'Pere el de Punyaleit' y la Unión aragonesa, relatados por el monarca a su tío Pedro, conde de Ribagorza," *Estudios de la Edad Media de Aragón 2* (1946): 350–51. For the Ferran's later career leading to his murder in 1363, see Donald J. Kagay, "The Captaincy System in the Late-Medieval Crown of Aragon: An Administrative Scaffolding of Defense and Imperialism," *Studies in Medieval and Renaissance History*, forthcoming.

⁵⁴ ACA, Cancillería real, R. 1148, f. 24v; *Epistolari de Pere III*, ed. Ramon Gubern, 1 vol. to date (Barcelona, 1955), 129–34 (doc. 129–34); Zurita, *Anales*, 4:309 (IX:vi); María Teresa Ferrer i Mallol, "La frontera valenciana durant la guerra amb Castella," in *Pere el Cerimoniós i la seva època*, ed. Teresa Ferrer i Mallol (Barcelona, 1989), 250–51.

⁵⁵ ACA, Cancillería real, R. 1380, f. 23.

⁵⁶ ACA, Cancillería real, R. 1148, ff. 104v, 124v; R. 1380, ff. 3v, 34v–35, 41r–v, 79v. Pere's court was in Perpignan from late August to late September. He moved through

his Aragonese and Valencian frontiers with the use of small feudal contingents, led by others. The subordinates to whom he entrusted command were either great nobles or trusted members of the royal family.⁵⁷ Eventually, in a desperate effort to keep fresh troops serving along his exposed borders, Pere even called in the help of distant vassals from beyond the Pyrenees.⁵⁸

Pere's war effort was quickly hampered by a lack of supplies in the "lunar-type, God-forsaken red-clay nothingness" he had to defend.⁵⁹ The very scale of this borderland soon stretched to the breaking point the king's capabilities for raising money and forces.⁶⁰ The Aragonese sovereign also found himself unable to control his forces stationed along the border, which regularly raided into Castilian territory against official written orders.⁶¹ These same contingents, however, proved unable to block effectively Castilian raids that were coming in the opposite direction. During the War of the Two Pedros, both sides practiced a locally-based and extremely disordered form of warfare, not unlike "the skulking way of war" seventeenth-century native Americans practised against English colonists.⁶² The inability to defend against such attacks deepened the fear of people living along the borders and undermined confidence in Pere's efforts to mount an effective defense of his realms.

Figueras down to Barcelona where he arrived in early October. He remained in the Catalan capital until late November when he took a short trip to Calatayud on the Aragonese frontier.

⁵⁷ Zurita, *Anales*, 4:300–1 (IX:iii). For Aragon, these captains were Lope de Luna, Pedro Fernández de Ixar, Jordan Perez de Urries, Miguel Pérez Zapata, Juan López de Sesse, Miguel de Gurrea, Lope de Gurrea. For Valencia, the principal leaders were Pere's cousin, Count Alfonso of Denia, and the great noble and administrator, Pedro de Xérica.

⁵⁸ *Ibid.*, 4:314–5 (IX:vii). For the important Pyrenean noble houses of Foix and Castellbó, see Santiago Sobrequés, *Els barons de Catalunya* (1957; reprint, Barcelona, 1980), 95–105, 200–6; Alan Friedlander, "House of Foix," in *Medieval Iberia*, 337–38.

⁵⁹ Shneidman, *Rise*, 2:500.

⁶⁰ Zurita, *Anales*, 4:301 (IX:iii). Zurita said of Valencia, "this kingdom lacks supplies and neither friends nor enemies can be maintained there."

⁶¹ *Ibid.*, 4:302 (IX:iii).

⁶² *Ibid.*, 4:321–22 (IX:ix); Patrick M. Malone, *The Skulking Way of War: Technology and Tactics among the New England Indians* (New York, 2000), 6–24. For similar episodes of border war in Scotland and Britain of the high and later Middle Ages, see John Aberth, *From the Brink of the Apocalypse: Confronting Famine, War, Plague, and Death in the Later Middle Ages* (New York, 2001), 36–43; Richard Lomas, *North-East England in the Middle Ages* (Edinburgh, 1992), 48–49; Colm McNamee, *The Wars of the Bruces: Scotland, England, and Ireland, 1306–1328* (East Lothian, Scot., 1997), 20–33; Matthew Strickland, *War and Chivalry: The Conduct and Perception of War in England and Normandy, 1066–1217* (Cambridge, 1996), 258–329.

As the fall of 1356 slipped into the winter of 1357, Pere's hope for a short and isolated conflict was dashed when Pedro I seized the important Aragonese border town of Tarazona in mid-February.⁶³

The destructive potential of the conflict soon dawned on Pope Innocent VI (1352–1362) who sent a legate to Spain to help bring hostilities to a rapid end.⁶⁴ Nevertheless, Pere grudgingly prepared for a widening war by establishing “national defense forces” in Catalonia, a region that had not yet suffered Castilian attack. Relying on *Princeps namque*, an article of the *Usatges of Barcelona* which mandated national defense whenever Catalonia suffered enemy invasion, the beleaguered Aragonese sovereign attempted to define the Castilian war as a Catalan national emergency before it had truly become one.⁶⁵ This ploy initially proved unsuccessful,⁶⁶ but in 1359, when Pedro sailed up the Catalan coast with a large Castilian-Portuguese fleet, hoping to force a landing near Barcelona, Pere used *Princeps namque* to good effect in calling out urban contingents whose mere presence stymied a Castilian invasion.⁶⁷

When Pere attempted to transform this emergency measure into an integral part of his defense of the entire Crown of Aragon, diverting Catalan troops summoned under *Princeps namque* into Aragonese or Valencian campaigns, he met with bitter resistance from the Catalans who looked on these actions as a cynical ploy by their ruler to bring Catalan forces into foreign campaigns.⁶⁸ This “nationalistic” opposition to his defense plans so frustrated Pere that on one occasion he begged all of his people, no matter from what realm, to engage in a single

⁶³ Zurita, *Anales*, 4:324–26 (IX:x); Antonio Guitiérrez de Velasco, “La conquista de Tarazona en la guerra de los Dos Pedros (Año 1357),” *CHJZ*, 10–11 (1960): 83–89.

⁶⁴ Pere III, 2:515–7 (VI:14–16); ACA, Cartas reales, Pedro IV, no. 5746; Zurita, *Anales*, 4:328–332 (X:xi); Guitiérrez de Velasco, “Conquista,” 89–92; Ferrer i Mallol, *Frontera*, 252–4.

⁶⁵ *Usatges*, trans. Kagay, 80, (art. 64); *Customs of Catalonia*, 38–39 (art. 38); Kagay, “National Defense,” 68–74.

⁶⁶ Ramon d'Abadal i de Vinyals, *Pere le cerimoniós i els inicis de la decadència política de Catalunya* (Barcelona, 1972), 268.

⁶⁷ ACA, Cancillería real, R. 1382, ff. 28v, 89v–90; Pere III, 2:522–23 (VI:22) Stephen P. Bensch, *Barcelona and its Rulers, 1096–1291* (Cambridge, 1995), 217–18; Kagay, “National Defense,” 74–75.

⁶⁸ ACA, Cancillería real, R. 1382, 201v–202 [new numbering]. The differences between Pere's various realms concerning general defense are most apparent in the great “parliament” (*parlamentum*) of Monzón in 1362–1363. For these national divisions, see *Colección de documentos inéditos del archivo general de la corona de Aragón [CDACA]*, ed. Próspero Bofarull y Moscaró, 41 vols. (Barcelona, 1847–1910), 48:60–65; *Parlements*, 25; Cawsey, *Kingship*, 137; Donald J. Kagay, “A Government Besieged by Conflict: The Parliament of Monzón (1362–1363) as Military Financier,” in *Hundred Years War*, 126–29.

campaign to defeat the Castilian enemy. Despite his flights of frustrated hyperbole, the king soon realized that *Princeps namque* was an inefficient and expensive way to put troops on his embattled frontiers.⁶⁹ Although the king would utilize the national defense clause eleven times during the Castilian war, he seldom invoked it against Pedro, but instead used it to deal with the mercenaries or “free companies,” who after the treaty of Brétigny (1360) crossed the Pyrenees in search of employment.⁷⁰

Casting about for a better, more unified defense strategy, Pere convoked “parliaments,”—general assemblies of all his realms—“to put in order” the Castilian conflict which for a number of reason had grown “badly organized.”⁷¹ In these meetings, the various estates (great and lesser nobility, clergy, and townsmen) agreed to support the royal war effort against Castile for up to two years.⁷² Pere also used the opportunity of the large assemblies to cajole both ecclesiastical and urban individuals and groups to provide troops and supplies for short tours of duty on endangered frontiers.⁷³

On paper, Pere’s defensive response to intermittent Castilian attacks between 1357 and 1362 seemed eminently logical. He subdivided the affected fronts among captains (*capitaniae*, *frontalers*) who normally commanded up to 100 horsemen and 150 garrison troops. The king stated that the appointment of these “strong men” in places where he could not be present was only fitting for royal “honor and the usefulness of

⁶⁹ Sánchez Martínez, “Convocatoria,” 98–102.

⁷⁰ ACA, Cancillería real, R. 1382, ff. 104r–v; R. 1383, f. 58; R. 1384, ff. 4v–5; R. 1519, ff. 1–73v; Pere III, 2:532–33 (VI:30); Kagay, “National Defense,” 95–96. For “free companies” in Spain, see Kenneth Fowler, *The Great Companies*, vol. 1 of *Medieval Mercenaries* (Oxford, 2001), 155–222. For treaty of Brétigny, see John Le Patourel, “The Treaty of Brétigny, 1360,” *Transactions of the Royal Historical Society* [5th ser.] 10 (1960): 19–39.

⁷¹ ACA, Cancillería real, R. 1380, f. 115; R. 1382, ff. 51v–52. See Section VI below.

⁷² ACA, Cancillería real, R. 1382, f. 52v, 81r–v; Donald J. Kagay, “The Emergence of ‘Parliament’ in the Thirteenth-Century Crown of Aragon: A View from the Gallery,” in *On the Social Origins of Medieval Institutions: Essays in Honor of Joseph F. O’Callaghan*, ed. Donald J. Kagay and Theresa M. Vann (Leiden, 1998), 222–24; Luis González Antón, *Las Cortes de Aragón* (Zaragoza, 1978), 30–34; Esteban Sarasa Sánchez, *Las Cortes de Aragón en la Edad Media* (Zaragoza, 1979), 30–32; Antonio Marongiu, *Medieval Parliaments: A Comparative Study* (London, 1968), 65–76.

⁷³ ACA, Cancillería real, R. 1380, f. 4; R. 1382, ff. 96r–v, 137v–138; R. 1383, ff. 174v–175, 176r–v, 218, 235v–236.

the republic.”⁷⁴ These captains were issued detailed orders for the sector in which they operated during a period of up to three months.⁷⁵

The frontier captains seldom acted as completely independent agents, but were instead forced to work with a small group of royal counselors and officials who relayed the king’s latest plans to the front and saw to funding and logistical matters. Through these trusted intermediaries, Pere attempted to fine-tune his defense by determining who would be recruited,⁷⁶ how these troops would be moved between fronts,⁷⁷ and what means could be utilized to avoid the duplication of their tours of duty.⁷⁸ The royal officials also gathered intelligence from paid Jewish, Muslim, and Christian spies, many of whom lived in towns and villages on either side of the frontier.⁷⁹

The final component of this fluctuating defense picture was Pere’s increasing reliance on cities and towns throughout his realms. As his customary military funding dried up, he had to transform his urban subjects living along the affected frontiers into unpaid defenders. Despite the steadily increasing royal tax burdens the Castilian war imposed on them, townsmen now had to assume the sole responsibility for repairing their own fortifications, in order to avoid the “vengeance, confusion, and damage” Pedro the Cruel was sure to inflict on them.⁸⁰ At times, however, they seemed to have even more to fear from their own sovereign who, while giving little support for the garrisoning of urban fortifications, repeatedly warned that the surrender of these fortresses was tantamount to treason.⁸¹

⁷⁴ ACA, Cancillería real, R. 1381, ff. 41v–42, 48v, 49v, 183v; R. 1383, f. 173; Donald J. Kagay, “A Shattered Circle: Eastern Spanish Fortifications and their Repair during the Calamitous Fourteenth Century,” *Journal of Medieval Military History* 2 (2004): 130.

⁷⁵ ACA, Cancillería real, R. 1382, ff. 132r–v, 174r–v.

⁷⁶ ACA, Cancillería real, R. 1382, ff. 137v–138; R. 1384, f. 3. Pere insisted that the frontier troops be “capable and suitable” and warned his officials about recruiting “the old, powerless, and poor.”

⁷⁷ ACA, Cancillería real, R. 1383, ff. 50r–v.

⁷⁸ ACA, Cancillería real, R. 1383, f. 243.

⁷⁹ ACA, Cancillería real, R. 1382, ff. 51v, 107; Powers, *Society*, 152–53.

⁸⁰ ACA, Cancillería real, R. 1183, f. 203; R. 1383, ff. 46, 80v, 115r–v, 123; R. 1384, f. 24v; *Documents Historichs Catalans del segle XIV: Colecció de cartas familiars corresponents als regnats de Pere de Punyaleu y Johan I [DHC]* ed. Josep Coroleu (Barcelona, 1889), 16; Kagay, “Shattered Circle,” 125.

⁸¹ ACA, Cancillería real, R. 1154, f. 55v; R. 1381, f. 83v; R. 1382, ff. 133v–134v; *Epistolari*, 167–68 (doc. 25); Kagay, “Shattered Circle,” 132; Ferrer i Mallol, “Tinença,” 66 (doc. 24). For treason in medieval Crown of Aragon, see Donald J. Kagay, “The

Due to their very location, the Aragonese and Valencian frontier towns and villages were caught between two contesting, national forces. While Pere wanted to control these areas of borderland, he seldom had the money to do so. Although grudgingly forced to recognize limited urban autonomy in the war zone, he spent a great deal of his time in trying (often illogically) to reassert his authority over his warrior-townsmen. Trying to encourage their service, Pere waived their debts for up to four months after returning from the frontier.⁸² Despite this commonsense measure, the king (in almost the same breath) ruled against the urban desire to wrest profit from the throes of border warfare by outlawing tolls on soldiers moving up to the front. He also took steps against the inevitable black market that sprang up in every urban site, no matter how tiny.⁸³ Pere's attempted control over the fluctuations of the wartime economy even extended to clerics who would suffer royal displeasure if they engaged in supply hoarding or profiteering.⁸⁴ In truth, the Castilian war had become a fiscal maw which the Aragonese king could never hope to fill. On one occasion, Pere, with grim determination, declared his intention to defeat Pedro even if every Christian, Muslim, and Jew under his rule was forced into bankruptcy in the process.⁸⁵

V

For most of the long conflict, Aragon's monarch stood squarely on the defensive, attempting often unsuccessfully to turn back attacks by his far more offensive-minded opponent. In the last several years of the war, however, this began to change. In 1364 and again in 1365, Pere took the offensive more often, always loudly declaring his intention to

Treason of Center and Periphery: The Uncertain Contest of Government and Individual in the Medieval Crown of Aragon," *Mediterranean Studies* 14 (2004): 17–35; idem, "Defending the Western and Southern Frontiers in the War of the Two Pedros: An Experiment in Nation-Building," *Journal of the Georgia Association of Historians* 23 (2002): 89.

⁸² ACA, Cancillería real, R. 1383, ff. 244r–v.

⁸³ ACA, Cancillería real, R. 1382, ff. 131r–v, 133r–v; R. 1383, f. 195.

⁸⁴ ACA, Cancillería real, R. 1380 f. 90.

⁸⁵ ACA, Cancillería real, R. 1381, f. 53v; Kagay, "Shattered Circle," 130.

vindicate his reputation on the battlefield.⁸⁶ By contrast, his opponent increasingly sought to defend what he had already won rather than further expand his winnings at the price of battle. Pedro I refused to be lured into a winner-take-all duel, even if in failing to do battle his reputation as a warrior suffered.

Pere's predecessors as far back as Jaume I looked on Castile's borderland opposite Aragon and Valencia as a zone that could be easily overrun by a sudden, large scale, sudden raid since few of the towns located there were protected by either "wall or moat."⁸⁷ Although Pere was fully familiar with the thinking of these earlier kings, and in particular that of his illustrious great-great grandfather, Jaume I, it took him a long time to move toward an offensive way of war. In the opening stages of the conflict, however, the Aragonese sovereign utterly failed to adapt a strategy of rapid response to Castilian attacks, fearing that given the nature of the territory, even small forays by his own troops into the bleak borderland would quickly deplete the region's limited resources.⁸⁸ Eventually, however, he developed some rapid response measures to such Castilian probing for soft spots.

This regular cadence of shock and counter-shock throughout the Aragonese-Castilian war was broken occasionally by episodes of particularly brutal fighting on either side of the border. In the spring of 1360, Castilian expatriates commanded by Enrique de Trastámara's brother, Sancho, raided into Castile, ambushing a force led by King Pedro. In the *melée*, the invaders massacred over two-hundred of the enemy, including the master of Calatrava. Though this victory was supposedly brought about "by the help and justice of a mediating God," Pere did not always find his border fortunes so favored.⁸⁹ In the late summer of 1362, Pedro led a massive army of over 40,000 men against the Aragonese border town of Calatayud. After delivering "heavy blows" against the town's partially-upgraded defenses with the

⁸⁶ Luttwak, *Strategy*, 47 asserts that a leader's reputation can be vindicated by managing a successful defense, but this often led him to continue this string of defensive successes and even go on the offensive—sometimes quite unwisely.

⁸⁷ *LF*, 2:142–43 (chap. 147); *Book of Deeds*, trans. Smith and Buffery, 150–51; Kagay, "Shattered Circle," 124.

⁸⁸ ACA, Cancillería real, R. 1148, f. 104v; *Epistolari*, 1:125 (doc. 17). For utilization of landscape by military commanders, see Hill and Wileman, *Landscapes of War*, 137–41.

⁸⁹ ACA, Cancillería real, R. 1383, ff. 179v, 180.

36 engines he had brought to the siege,⁹⁰ the Castilian ruler unleashed his shock troops (many of them Muslim) on the battered outpost, an action that ended with the slaughter of most of the garrison troops and urban defenders.⁹¹

Each of these violent eruptions seemed to push Pere closer to an offensive strategy against Castile and away from the caution that generally marked his character. On several occasions, he uncharacteristically gave notice that he was “making a B-line” (*via directa*) to the front and all his subjects had to give their support or be responsible for his disastrous defeat.⁹² Pere, however, seldom fulfilled his bombastic intentions of seeking out his archenemy for a final decision on the battlefield and fell back on the relatively safe tactic of the *chevauchée*. Although he unleashed large raids on Castilian borderlands in 1358 and 1359, the Aragonese king was unable to stay in enemy territory long enough to besiege strong points “because of the lack of victuals.”⁹³ For several years afterwards, Pere was content to allow bands of up to a hundred horsemen to conduct random “forays” (*entradas*) into Castilian territory near Aragon.⁹⁴ Though by spring, 1362, Pere was announcing his intention of leading a “great invasion” to relieve Calatayud and then devastate Castilian territory, he never carried out either project because of “the great expenses and costs” such efforts would involve.⁹⁵

Even with his military expenses somewhat stabilized by the declared support of his parliaments, Pere proved so touchy about mounting war debts that he routinely began dismissing his salaried troops even when peace talks were only in a nascent stage.⁹⁶ Nevertheless, despite increasing fiscal pressure on the Aragonese crown, the last years of the war witnessed Pere’s growing determination to goad Pedro into a pitched battle. When Pedro launched a major offensive against the Valencian capital in December, 1363, Pere, raised an army of some 1,700 horsemen, and the following April led them on a forced march

⁹⁰ ACA, Cartas reales, Pedro IV, caja 52, no. 6241; Zurita, *Anales*, 4:439–441 (IX:xli); Kagay, “Shattered Circle,” 132. For traction artillery in late-medieval Iberia, see Daniel Ensenyat Pujol, *La reintegració de la Corona de Mallorca a la corona d’Aragó (1343–1349)*, 2 vols. (Mallorca, 1997), 1:64, 92, 349; Antoni Ignasi Alomari i Canyelles, *L’armament i la defensa a la Mallorca medieval* (Palma, 1995), 79–80.

⁹¹ Zurita, *Anales*, 4:442 (IX:xli).

⁹² ACA, Cancillería real, R. 1379, f. 177v; R. 1380, f. 171v; R. 1382, f. 85v.

⁹³ Pere III, 2:521 (VI:21); Zurita, *Anales*, 4:327, 366 (IX:x,xx).

⁹⁴ ACA, Cancillería real, R. 1382, ff. 83, 131, 136v.

⁹⁵ ACA, Cancillería real, R. 1382, f. 174; R. 1383, ff. 179v, 245r–v.

⁹⁶ Pere III, 2:532 (VI:30).

through northern Valencia to relieve the city. Although, the Castilian force outmanned the Aragonese army and could have blocked its access to Valencia, the Castilian king now chose to avoid conflict.⁹⁷ He again proved reluctant to fight in August, 1364, when Pere took a small force from Valencia to relieve the beleaguered outpost of Orihuela.⁹⁸ With Orihuela secure for the moment, Pere moved north to Zaragoza where he gathered strength to launch yet another successful attack in April, 1365, against Castilian forces in the Valencian city of Murviedro.⁹⁹ While Pere's offensive campaigns of 1364–1365 temporarily threw Pedro off balance in southern Valencia, they did not defeat him. This would be accomplished only through a combination of diplomacy, civil war, and foreign invasion. Pere's expeditions of this era are important, however, for gaining some understanding of his development as a military leader. After so many years as the manager of a diffuse defense, the Aragonese king finally came to demonstrate some competence as an offensive commander, able to instill confidence in his troops.

In the march to Valencia in 1364, the king (admittedly by his own account) displayed "a very bold and manly spirit" that, by its very intensity, "put out the eyes of his enemies."¹⁰⁰ This self-portrayal as a valorous captain is scarcely congruent with his earlier history of brutal vindictiveness against enemies, real or imagined.¹⁰¹ Whether he really intended to trust his life to martial fate or was merely playing a role which "pertained to his honor,"¹⁰² the Aragonese king did display qualities of command consistent with his knack for political and military survival. He was an excellent quartermaster who normally kept his

⁹⁷ Ibid., 2:548 (VI:40); Ayala, 142 (15:iii). Pere numbered the Aragonese force at 1,722 knights and the Castilian army at 6,000. Ayala claimed that the two armies totaled over 3,000 knights and the Castilian force had thrown over 2,500 "light cavalry" (*jinetes*) against the Valencian capital.

⁹⁸ Pere III, 2:564 (VI:52); Ayala, 143 (15:vii). Pere estimated his force at 1,000 knights; Ayala claimed Pedro had up to 3,000 knights and 1,000 *jinetes* in this action.

⁹⁹ Ayala, 145 (16:ii); Zurita, *Anales*, 4:533–34 (IX:xi); Ferrer i Mallol, "Frontera," 309–313.

¹⁰⁰ Pere III, 2:560 (VI:49); Zurita, *Anales*, 4:503–4 (IX:liv).

¹⁰¹ For examples of this vindictiveness against Bernat Cabrera, the Aragonese and Valencian *Unión*, Jaume III of Majorca, and Prince Ferran, see "Kagay, "Treasons," 53; Jaime Caruana Gómez de Barreda, "Dos relaciones inéditas sobre sucesos de la Unión," *Estudios de la Edad Media de Aragón* 3 (1947–1948): 486–87, 496; Martínez Ferrando, *Tràgica Història*, 210–13; Ferrer i Mallol, "Frontera," 285–87.

¹⁰² Pere III, 2:564 (VI:52).

troops fed even as he led them across great stretches of “waste and desert” or through Castilian-held territory.¹⁰³ He did this not only by living off the land, but also by using supply ships.¹⁰⁴ Pere also proved an adaptable field commander, leading his men to the attack or managing a retreat while maintaining “good order.” He often deployed his men as irregulars who fought “like *almogàvers*,” a charge Pedro hurled against the Aragonese army in an attempt to impugn the professionalism of its royal commander.¹⁰⁵

As Pere’s public-relations image changed from cautious defender to brave (even rashly brave) attacker, he increasingly described Pedro, the once-fearsome raider, as an insecure commander who would not militarily engage even when he possessed the numerical or tactical advantage. In Ibiza (1359),¹⁰⁶ along the Aragonese frontier (1361),¹⁰⁷ and in the territory bounded by Murviedro, Grau, and Valencia (1363–1365),¹⁰⁸ Pere drew up his troops “in ordered battalions” to await combat with his Castilian adversary who then went to some lengths to avoid it.¹⁰⁹ Pedro I’s actions could be consistent with the outlook of many medieval commanders who operated under the Vegetian principle that a pitched battle should be avoided “because it involved too many risks and its result was final.”¹¹⁰ On the other hand, many Iberian observers, including the sixteenth-century Aragonese chronicler, Jerónimo Zurita, concluded that “there could be no possible excuse” given by the Castilian king to

¹⁰³ Ibid., 2:562 (VI:50).

¹⁰⁴ Ayala, 142 (15:iii). For Jaume I’s use of sea transport, see Kagay, “Army Mobilization,” 108–9.

¹⁰⁵ Pere III, 2:552–53 (VI:44). The *almogàvers* were border fighters Jaume I and Pere II had used in wars against Valencia (1276–1277), the Barbary coast (1280), and Sicily (1283). These irregulars lived off the land, wore no armor, and carried few weapons but a “stout blade.” See Desclot, *Chronicle*, 28–29 (chap. 7); Bisson, *Medieval Crown*, 93.

¹⁰⁶ Ayala, 106 (10:xvi); Pere III, 2:525–26 (VI:25).

¹⁰⁷ Ayala, 121 (12:i); Pere 2:530 (VI:29).

¹⁰⁸ Ayala, 141–42 (15:ii); Pere III, 2:538, 550, 553 (VI:35, 41, 44); Zurita, *Anales*, 4:505 (IX:lv).

¹⁰⁹ Zurita, *Anales*, 4:505 (IX:lv). For battle formations in the Hundred Years War, see Jim Bradbury, *The Medieval Archer*, (New York, 1985), 120–33; Michael Prestwich, *Armies and Warfare in the Middle Ages: The English Experience* (New Haven, Conn., 1996), 318–23; Kelly DeVries, *Infantry Warfare in the Early Fourteenth Century* (Woodbridge, 1996), 194–95.

¹¹⁰ Vegetius, *Epitome*, 116 (chap. 26); Helen Nicholson, *Medieval Warfare*, (New York, 2004), 113, 135.

explain his cowardly shirking of battle.¹¹¹ Whichever the case, Pedro, fearing that his Aragonese rival would engage in both broad-based invasions and unpredictable border raids, began to learn some of the defensive lessons Pere had internalized in the last decade.¹¹²

Pere took every possible opportunity to speculate on the reasons for his adversary's actions, and each of these explanations served a propaganda campaign of the Aragonese king that purified his own motives, overlooked his own failures, and vilified all things Castilian. From Pere's official point-of-view, Pedro was afflicted by increasingly-debilitating twinges of conscience over the "unjust war" he had long fought. He was therefore unwilling to trust his fate to "God, the judge of battles."¹¹³ According to Pere's propagandistic assertions, Pedro had shunned the good advise of his own advisers to go into battle against the clearly inferior Aragonese contingents precisely because he had no trust that his own troops would die for him when the crucial battle commenced.¹¹⁴ In fact, the ready defection of Castilian nobles to the Aragonese side that occurred throughout the conflict bore out some of Pedro's suspicions.¹¹⁵ In the end, Pere, the secular pragmatist, declared victory over his "principal adversary," even with no battlefield triumph to point to. Though the great Castilian victory at Nájera (1367)¹¹⁶ temporarily undermined the Aragonese king's slant on recent history, Pedro's shameful end at Montiel (1369)¹¹⁷ ultimately vindicated Pere's successful defense of his lands against the cruel king of Castile.

¹¹¹ Zurita, *Anales*, 4:503 (IX:liv).

¹¹² For Pedro's military aims and strategies in the war with Aragon, see L. J. Andrew Villalon, "The Strategy and Tactics of Castile in the War of the Two Pedros," in this volume.

¹¹³ Pere III, 2:526, 553 (VI:26, 44).

¹¹⁴ *Ibid.*, 2:530, 550, 565–67 (VI:29, 41, 52); Ayala, 106 (10:xvi). Pere provides his version of this Castilian indecision by "recreating" some of the advice given Pedro when battle seemed imminent and then the Castilian king in typical fashion responded that he could trust no one in his own army. Ayala, too, discusses the confidence Pedro's advisers exuded when it looked as if the last battle with Pere loomed and then portrays their sense of betrayal at Pedro's refusal to fight.

¹¹⁵ Ayala, 145 (16:ii).

¹¹⁶ L. J. Andrew Villalon, "Spanish Involvement in the Hundred Years War and the Battle of Nájera," in *Hundred Years War*, 3–74.

¹¹⁷ Ayala, 196–97 (IV:8).

VI

After a decade of almost-constant border war, Pere had somehow survived. The Aragonese monarch had learned military lessons from the Castilian conflict and showed his determination never again to suffer the humiliating defeats Pedro had early on inflicted on his frontiers. At the end of the conflict, Pere clearly fell back to a position more in keeping with his careful and secretive nature. After losing vast tracts of his kingdoms only to regain them basically by default, he again became a proponent of the defensive stance. Following the lessons he had learned from the war, Pere expanded castle building and repair along the Valencian and Aragonese frontiers even after his former ally, Enrique de Trastámara, had become Castilian king in 1366.¹¹⁸ As he told a parliament in 1370, “it is no less virtuous to retain and conserve that which was gained than to make new conquests.”¹¹⁹ Gone is the rhetoric of “nationalistic” heroism vindicated on the battlefield that had characterized the closing years of the war. In its place stands Pere’s fluent banter of self-and regnal-preservation.¹²⁰

In order to endure and win the long conflict with Castile, the Aragonese king had been forced to relinquish some of his sovereignty to parliaments and town councils, simply to get troops recruited, deployed, and paid. During the War of the Two Pedros, governmental institutions in the Crown of Aragon, originally set up by royal lawyers fell at least temporarily under the control of legal professionals employed by the parliaments and the towns.¹²¹ During this temporary loss of royal “control” (*potestas*),¹²² the Crown of Aragon suffered the birth pangs of identical twins: the “military state” and the “fiscal state.”¹²³ It is

¹¹⁸ ACA, Cancillería real, R. 783, f. 19; R. 1272, f. 84; R. 2093, ff. 157v–58; R. 2343, f. 36; J. M. Madurell y Marimon, “Pere el Cerimoniós i les obres públiques,” *Analecta Sacra Tarraconensia* 11 (1936): 385 (doc. 8); *Documenta selecta mutuas Arago-Cathalaunice et ecclesiae relationes illustrantia*, ed. Johannes Vincke (Barcelona, 1936), 508–9 (doc. 661); Julio Valderon Baroque, *Enrique II de Castilla: La guerra civil y la consolidación del régimen (1366–1371)* (Valladolid, 1966), 234–43.

¹¹⁹ Ramon d’Abadal, *Pere el cerimoniós i els inicis de la decadència política de Catalunya* (Barcelona, 1972), 188–89; Cawsey, *Kingship*, 133.

¹²⁰ David A. Cohen, “Secular Pragmatism and Thinking about War in Some Court Writings of Pere III *el Cerimoniós*,” in *Crusaders*, 22.

¹²¹ Burns, “Significance,” 324–25.

¹²² *Usatges*, trans. Kagay, 13; *Customs of Catalonia*, 3–5 (arts. 3–5).

¹²³ Norman Housley, “European Warfare, c. 1200–1320,” in *Medieval Warfare*, ed. Keen, 134–35; d’Abadal, *Pere*, 269–70.

ironic, then, that Pere's ten years war in defense of the lands he had inherited and Pedro's ravenous attacks to wrest many of these territories away from his Aragonese rival unleashed energies on both sides of the frontier that would eventually propel both Castile and the component parts of the Crown of Aragon along political trajectories toward the hybrid national polity that is modern Spain.¹²⁴

¹²⁴ Kagay, "Defending," 89; Angel Smith and Clare Mar-Molinero, "The Myths and Realities of Nation-Building in the Iberian Peninsula," in *Nationalism and the Nation in the Iberian Peninsula: Competing and Conflicting Identities*, ed. Clare Mar-Molinero and Angel Smith (Oxford, 1996), 5–8, 12–17; Carlos Blanco Aguinaga, "Sobre las nacionalidades de España, el estado de las autonomías y los estudios hispanística," in *Las Nacionalidades del estado español: una problemática cultural*, ed. Cristina Dupláa and Gwendolyn Barnes (Minneapolis, 1986), 15–32; Christopher Allmand, "New Weapons, New Tactics," in *The Cambridge History of Warfare*, ed. Geoffrey Parker (Cambridge, 2005), 96–98.



Map 9: Medieval Crown of Aragon.



Map 10: Counties of Catalonia.

PART FOUR

THE TECHNICAL ASPECTS OF ARCHERY
IN THE HUNDRED YEARS WAR

THE ENGLISH LONGBOW: A REVOLUTION IN TECHNOLOGY?

David Whetham
King's College, London

Introduction

A new and deadly weapon, mastered by the Welsh and then harnessed in the interests of the English crown, burst into European history at the end of the thirteenth century, revolutionizing warfare and ultimately destroying chivalry as it was known. From the society that borrowed it, the weapon has taken its name: the English longbow. The old system of mounted knight and charger was no match for the “medieval machine gun” as it has been dubbed on many history web sites. This period of medieval military history is usually portrayed as a classic example of technological determinism with a new technology driving social change. Is this, however, an accurate portrayal? Is this truly a case of old technology being replaced by new, part of the inevitable march of history, or is it really a half-told and partially-misunderstood episode that actually challenges technological determinism as a major explanatory theory in medieval history?

This article will seek to examine the facts behind myths that have grown up concerning the medieval longbow. It will provide a brief survey of the arguments and debates that surround this evocative weapon, the way it was used, and how effective it proved to be. We will begin by looking at what exactly a longbow is, demonstrating that this fundamental question is not as straightforward as some might think. We shall then consider the weapon's history and its evolution over a considerable length of time, exceeding the traditional boundaries of the Middle Ages. The other components of the “longbow system” will also be examined, including not only the all-important arrow, but also the most critical part of the weapon system—the archer himself. The effectiveness of the whole system will then be considered, with reference to both modern ballistic tests and historical case studies to see if the weapon really was as effective in the medieval period as many have claimed. Before concluding, the paper will look at the particular social

conditions that contributed to the weapon's popularity throughout the British Isles.

Definition of the Longbow

Bows are basically made either totally of wood or of some combination of wood and other materials. These other composite materials range from horn and sinew used in earlier bows to the efficient man-made plastics and fibres of today. Historically, in Western Europe where the supply of wood was never an issue, the simple wooden bow made from a single piece of timber was, until very recently, far more common than the complicated composite bow. Therefore, it is on the wooden longbow as it existed in medieval Europe that this article will concentrate.

Not until the records of the later Middle Ages did it become common to distinguish between different types of bows. In fact, when one examines the subject methodically, it immediately becomes clear that the distinction between a "normal" bow and a "long" bow is in many ways an artificial one. Both longer and shorter bows can employ the same basic materials to form what is essentially a giant spring. As this flexible spring is drawn back, potential energy is stored in the elastically-deformed bowstave. When the string is suddenly released, much of this potential energy is converted into the kinetic energy of the arrow being propelled toward its target. Although there are many types of wood suitable for making bow staves, yew has long been recognised as one of the best.¹ The cream-coloured sapwood of the yew better resists tension and so is placed on the back side of the bow, farthest from the string and nearest to the target. The dark honey-coloured heartwood of the yew resists compression; consequently, it is perfect for being placed at the belly of the bow, closest to the string. As a result, it will be compressed as the string is drawn back. Working in tandem, the two different qualities of the same piece of wood provide the natural spring required for the bow's power.

The simplest distinction between a "normal" and a "long" bow lies, not surprisingly in its length. The longbow is of sufficient length for the bow string to be pulled to the ear rather than to the chest. When combined with the archer's sideways stance, this greater pull distance

¹ E. G. Heath, *A History of Target Archery* (New York, 1973), 18.

permits greater force to be exerted upon the arrow, a force that translates into greater range and penetration. Unfortunately, this definition is not alone adequate; after all “one man’s longbow is another man’s short bow.”²

For the purposes of this article, the British Long-Bow Society’s criteria of a length of at least 5’ 6” will be taken as a defining characteristic of the longbow. The Society adds an additional qualification: the cross section of the bowstave on a true longbow must resemble a ‘D’ shape. In the Middle Ages, an advantage of this narrow ‘D’ section centered on the bow’s manufacture: more staves could be produced from the same amount of quality yew wood and this was an important consideration when producing weapons on a large scale for military campaigns.³ Although flat bows (i.e. those with a flat cross-section) can clearly be “long” bows in respect to length, the absence of the D-shaped cross-section distinguishes them from those that were employed in the wars of the medieval period. Such flat bows are still considered to be in a slightly different category from true longbows.⁴

Early Use of the Bow

Precisely when the first bow made its appearance in the human arsenal remains a matter of considerable debate. It is clear from evidence found in burial sites that the weapon was in use around the Mediterranean by the late-Palaeolithic (12,000 to 10,000 B.C.).⁵ Cave paintings show its use against animals as well as other men. The advantages of the new

² Jim Bradbury, *The Medieval Archer* (Woodbridge, Suffolk, 1985), 73.

³ Archaeologists at the Mary Rose museum in Portsmouth have determined that the 137 whole longbows recovered from the ship were produced from the same baulk of yew. See <http://www.maryrose.org/ship/bows1.htm>.

⁴ According to the 2002 rule book of the British Long-Bow Society, to qualify as a longbow, a bow must be not less than 60” between nocks for arrows less than 27”, and not less than 66” for longer arrows (medieval war arrows would have been at least 27” long and probably averaged over 30”—see below). The depth of the limb section should also be no less than 5/8 of the width at any point. See Hilary Greenland, *The Traditional Archer’s Handbook: A Practical Guide* (Bristol, 2001), 112.

⁵ Arthur Ferrill, *The Origins of War: From the Stone Age to Alexander the Great* (London, 1988), 16ff. For more information on the origin of the bow, see Gad Ransing, *The Bow: Some Notes on Its Origin and Development* (Lund, 1967). Hardy notes the extreme age of some of the arrow heads found around the Mediterranean, some of which may date to as much as 50,000 years old. Robert Hardy, *Longbow: A Social and Military History* (London, 1995), 12.

weapon were obvious. The range of even a primitive bow was at least double that of any weapon that man might throw with his arm alone. It was an easy weapon to construct, and the individual using it could carry far more arrows than spears. When acting together, a group of archers could lay down a barrage of arrows; Neolithic paintings from the Spanish Levant depict archers drawn up in lines so as to maximize their effect on the target. A human burial site along the Nile River in ancient Nubia, dating to between 12,000 and 4,500 B.C., has revealed that about 40% of the burials contain small flake arrow heads. Here, excavators found one young adult female whose body was riddled with 21 chipped stone artifacts—almost certainly arrowheads. As Arther Ferrill has pointed out in this regard, “overkill may be a modern concept, but it was an ancient practice.”⁶

Due to the materials used in a bow’s construction and their obvious tendency to decay over time, actual examples of the weapon can be extremely hard to find. Fortunately, several sites in Switzerland and Germany have together provided more than 20 late Stone Age bows made from yew or their fragments. One of these may originally have been well over 80” in length.⁷ Sophisticated flat bows, showing the beginnings of a ‘D’ section were found at Holmegaard in Denmark. These date from the Mesolithic-Neolithic Transition period⁸ and were made from elm grown in the shade, a wood which, according to Robert Hardy, is the next best for bow production after yew.⁹ Another bow found at this same site dates to approximately 2,800 B.C. and is halfway between a true longbow and a flat bow. Slightly younger are six yew longbows from Germany and Holland that date from between 2,400 and 1,550 B.C.¹⁰

The earliest English bow thus far uncovered comes from Meare Heath in Somerset. Originally over six feet long, it was a flat bow made of yew, with a convex back and an uncurved belly, dating to between 2,800 and 2,570 B.C. Slightly later in date, also from Somerset, a bow that today’s experts would characterize as a high stacked yew longbow exhibits a

⁶ Ferrill, *Origins*, 23. The sling, which may have been nearly as effective as the very early bow, was certainly being used by 7000 B.C.

⁷ Hardy, *Longbow*, 17ff.

⁸ *The Traditional Bowyers’ Bible*, ed. J. Hamm, 3 vols. (Azle, Texas, 1992–91), 2:91. See also C. J. Becker, “En 8000 aarig stenalderboplads I Holmegaards mose,” *Fra Nationalmuseets Arbejdsmark 1945*, 65ff.

⁹ Hardy, *Longbow*, 17ff.

¹⁰ *Ibid.*

flat back with rounded sides and belly.¹¹ This weapon is remarkably similar to those used in the later Middle Ages. A recent excavation at Amesbury near Stonehenge unearthed the grave of a man dating to around 2,300 B.C., whose trappings included many flint arrowheads and a slate wrist guard of the sort used to protect an archer's forearm against the recoil of a large bow.¹²

Taken together, this early evidence for the use not only of bows but of "longbows" demonstrates with some certainty that the "new and devastating weapon" employed by the armies of Edward I (1272–1307) had actually been known in the British Isles for some 4,000 years before the king's Welsh wars and had been popular elsewhere long before that.

English and Scandinavian Bows of the Middle Ages

Although archaeological evidence is sparse at best and reliable recorded history is almost entirely absent, it is hard to believe that the people of Celtic and later Roman Britain, a land teeming with game and suitable timber, would have done without such an effective weapon.¹³ Following the Roman period, Britain was gradually settled by successive waves of Anglo-Saxon migrants. These newcomers may have brought their own bows with them, although, here too, evidence is hard to come by. Part of the confusion over Anglo-Saxon use of archery arises from the fact that the same Anglo-Saxon word may be used to describe both an arrow and a throwing spear. This has led some historians to assert that the bow must have been introduced as a by-product of the Norman Conquest since it can be proved that the Normans possessed these weapons and employed them on the battlefield. On the other hand, there are accounts that point toward archery use in Britain before the Norman Conquest. For example, in 633, Offrid, son of Edwin, king of

¹¹ Hilary Greenland, "Meare Heath Enigma," *Instinctive Archer Magazine* (Winter 1999).

¹² *Wessex Archaeology*, www.wessexarch.co.uk/projects/amesbury/archer_burial.html (accessed June 8, 2003). Leather wrist guards were also found onboard the *Mary Rose* and would have served the same function nearly 4 millennia later. See www.maryrose.org/ship/bows2.htm.

¹³ It is very difficult to disagree with Robert Hardy's argument that the bow had always been the weapon of the common man. Hardy, *Longbow*, 29f.

Northumbria, was killed by an arrow when fighting against the Welsh and Mercians.¹⁴

Presumptive evidence for the presence of bows can also be drawn from the cultivation of hemp in the British Isles. Until fairly recently, scholars assumed that hemp did not make its appearance in Britain until a fairly late date; however, soil samples unearthed near Thetford now suggest that hemp has been grown there from as early as 1000 B.C. and that it was successfully cultivated from early Saxon times to the sixteenth century.¹⁵ Although hemp, a highly versatile plant, can be used for everything from clothing to rope manufacture, it is also an excellent material for making bow strings. While its use in this capacity cannot be demonstrated by archaeological evidence, it seems highly likely that some of the hemp found its way into British bow strings.

As early as the third century, Scandinavia provides physical evidence for the extensive use of bows that exploited the properties of heartwood and sapwood. Of 36 found on the fourth-century Nydam ship, all were taller than the men who would have used them. Written evidence of Viking archery remains somewhat anecdotal; nevertheless, it is clear that the Vikings had a healthy level of respect for the weapon, at least as an instrument for hunting.¹⁶ Whether or not they used it extensively in battle is harder to determine. When the people of Scandinavia began to spread over Europe starting late in the eighth century, they brought the bow with them into regions that they raided or settled like the British Isles. Laws survive that regulate the number of bows and arrows to be provided by the peasantry for Viking warriors. Later Norwegian statutes specify the weapons that free men were required to bring into battle include not only spears, swords or battle axes but also bows and arrows. One Swedish law uses the word “bow” to mean the fighting man who wielded it.¹⁷

The *Saga of Olaf Trygvason* tells how its hero Olaf had with him a mighty archer called Einar Tambeskjelve. As Einar started to get

¹⁴ Hardy, *Longbow*, 30.

¹⁵ H. Godwin, “The Ancient Cultivation of Hemp,” *Antiquity* 41 (March 1967): 42–49.

¹⁶ Interestingly, noted medievalist Lynn White points out that in old Irish there are two words for bow: one is for a short bow, and its root is Celtic; the other is for a longbow, and its root is Norse. See Robert E. Kaiser, “The Medieval English Longbow: Characteristics and Origins,” *Journal of the Society of Archer-Antiquaries* 23 (1980): 20–29.

¹⁷ Hardy, *Longbow*, 28ff.

dangerously close to hitting his enemy's head with his arrows, that individual instructed his own excellent Finnish archer to "shoot me that giant." The Finn shot an arrow into the centre of Einar's bow just as he was drawing it back. As a result, the bow shattered in his hand with a mighty crack. Upon hearing the noise, King Olaf asked, "what broke then?" Einar replied, "Norway, my king, from your grasp."¹⁸ Admittedly, one must be careful when using such sources written well after the events they depict; however, the significance of the bow in this saga can hardly be denied.

After more than a century of contact with the region of western France, the Vikings settled in Normandy by the start of the ninth century. Meanwhile, Danish kings ruled the north of Britain from the city of York between 876 and 954, after which England and Denmark were united into a single kingdom under Danish rule from 1013 to 1035. The high levels of cultural exchange that took place between Scandinavia and its new outposts in northwestern Europe probably encouraged the use of bows in both places.

From Hastings to Edward I

The *Abingdon Chronicle* provides us with clear evidence of Welsh archery eleven years before Hastings when Ralph, earl of Hereford, was ambushed by Welsh bowmen who shot so accurately and strongly that "the English people fled [from the Welsh], before ever a spear had been thrown."¹⁹ The *Anglo-Saxon Chronicle* records that, in England at that time, archery was used for the killing of game but was not much utilized in battle.²⁰ This suggests some expertise in archery even if the archers were unlikely to form part of the regular fighting force in pre-conquest England.

¹⁸ Snorri Sturluson, 'King Olaf Trygvason's Saga, *Heimskringla: A History of the Norse Kings*, trans. Samuel Laing (London, 1907), 118. Text taken from Berkeley Digital Medieval and Classical Library: <http://sunsite.berkeley.edu/OMACL/Heimskringla/trygvason3.html>. The poet Sturluson claimed to have simply written down old stories that old and wise men believed to be true. The saga was written about 1225.

¹⁹ Hardy, *Longbow*, 31ff. See also Florence of Worcester, *Chronicon*, ed. B. Thorpe, 2 vols. (London, 1848–1849), 1:213.

²⁰ Hardy, *Longbow*, 32.

To the extent they were used, archers almost certainly would have been drawn from the *fyrð*, the military levy of Anglo-Saxon England.²¹ Although it seems certain that there were Saxon archers present at Hastings (1066), they were badly outnumbered by their Norman counterparts. Of 29 archers represented on the Bayeux Tapestry, only one is a Saxon and while this may represent artistic convention, it may also reflect reality.²² On the other hand, the appearance of only a single Saxon archer may signify the absence of archery from the local *fyrð* fighting at Hastings, rather than its absence from the entire Saxon army. Clearly, the Tapestry, like the *Saga of Olaf*, must be treated with caution when employed as a source for the use of bows. Careful examination does suggest that it pictures bows of different length, some of which display at least one characteristic of the longbow; i.e., its length in proportion to the height of its user.²³

Many histories now jump straight to Edward I's campaigns at the end of the thirteenth century, or perhaps even to the English victory at Crécy (1346), helping foster the false impression that the Normans introduced the bow and that it then lay quietly until harnessed in the service of the state by later Plantagenet monarchs, under whom it developed into a new and powerful weapon shaking the very foundations of the European social order. In reality, there is an intervening history that is too often ignored. While the crossbow was gaining ground throughout continental Europe, archery with the bow, both long and short, remained popular not only in Britain, but elsewhere.²⁴ Throughout their lands, both in England and on the Continent, the Normans continued to use the weapon. William the Conqueror's son, Henry I (1100–1135), issued an edict that if any man, while practicing with bow and arrow, accidentally killed another, he should not be indicted for murder or manslaughter. (This edict followed the death of his own brother, William II Rufus (1087–1100), under dubious circumstances,

²¹ Michael Powicke, *Military Obligation in Medieval England: A Study in Liberty and Duty* (1962; reprint, Oxford, 1996), 1–25.

²² Bradbury, *The Medieval Archer*, 34.

²³ An example of this need for caution is the fact that the arrows appear on the wrong side of the bowstave, probably explained by the embroiderer sewing the more important shape of the bow first. See Bradbury, *The Medieval Archer*, 36ff.

²⁴ For example, Galbert of Bruges describes a “fiery young” mercenary archer called Benkin at the siege of a castle in Flanders in 1127 who was “expert and swift in shooting arrows” Galbert of Bruges, *The Murder of Charles the Good*, ed. and trans. James Bruce Ross (Toronto, 1991), 165.

shot with an arrow while hunting with Henry in the New Forest.)²⁵ King Stephen (1135–1154) employed archers as well as slingers at the siege of Exeter in 1136; two years later, a large body of English bowmen routed the Scots near Northallerton in Yorkshire.²⁶ Gerald of Wales recorded an event that took place at the siege of Abergavenny Castle in 1182; according to Gerald, archers besieging the castle fired with such force that they penetrated an oak door nearly a hand thick. Gerald also tells of a knight who was shot by an arrow that pierced his iron thigh armor, the lower part of his leather tunic, and his saddle, eventually killing the horse he was sitting on!

The bows [the Welsh] use are not made of horn, nor of sapwood, nor yet of yew. The Welsh carve their bows out of the dwarf elm trees in the forest. They are nothing much to look at, not even rubbed smooth, but left in a rough and unpolished state. Still, they are firm and strong. You could not [only] shoot far with them; but [also] they are powerful enough to inflict serious wounds in a close fight.²⁷

It is interesting that Gerald makes the clear distinction between the longbow and composite bows, suggesting that both were known in late-twelfth century England and Wales. The statement also contains an implicit recognition on the part of contemporaries that yew was the finest material for bow-making. Although the crossbow had found its way into England, it never became as popular as the bow.²⁸ By 1242, the Assize of Arms could name archers as the second most important class of soldiers after the mounted knight.²⁹

²⁵ Bradbury, *The Medieval Archer*, 7.

²⁶ Michael Prestwich, *Armies and Warfare in the Middle Ages: The English Experience* (New Haven, Conn., and London, 1996), 120.

²⁷ Gerald of Wales, *Journey Through Wales and The Description of Wales*, trans. Lewis Thorpe (Harmondsworth, 1978), 112ff. I have added the corrections to the translation of *non tantum ad eminentia missilia mittenda, sed etiam ad graves cominus ictus percutiendo tolerandos* which changes the emphasis significantly. See; idem, *Opera* (London, 1861–1891), 6:52ff.; Hardy, *Longbow*, 37.

²⁸ Philippe Contamine, *War in the Middle Ages*, trans. Michael Jones (Paris, 1984), 247.

²⁹ Kelly DeVries, *Medieval Military Technology* (Peterborough, Ontario, 1992), 37.

The Archer

Perhaps the most important part of the weapon system is the man behind the bow. To become a good archer, specific muscles need to be developed—not a thing easily done. For a long time, the true power of the medieval longbow was underestimated, since it was being measured by modern standards of archery. Even the most scientific of tests, conducted according to what a present-day archer might accomplish do not do the weapon justice. In the late 1970s, experts were still contending that the upper draw weight of a medieval longbow would probably not have much exceeded 100 lb pull (45 kg), and that the average draw weight would have been substantially less.³⁰ Scholars were therefore somewhat surprised by the discovery of Tudor-period bows on board the flagship of Henry VIII (1509–1547), the *Mary Rose*, raised in Portsmouth Harbor in 1982. These have an average length of 78” (198 cm) and it has been estimated that their pull weights would have ranged between 100 and 180 lbs (45 and 81 kg)!³¹ In short, rather than 100 lb being an upper limit as was once thought, the *average* pull of these bows would have been about 150 lbs (68 kg).

The size of *Mary Rose* bows has greatly changed the way in which scholars view the medieval longbow and how it must have been used. It is reasonable to assume that the weapons carried on Henry VIII’s warship in 1545 would have been comparable to those employed a century earlier, at the height of their popularity during the Hundred Years War. One Tudor author, Sir John Smythe, actually claimed that war bows had once been of an even a greater length than they were in his time: “Warre Bowes being of the wood of Yewgh, were longer than now they use them.”³² It would be interesting to know, assuming that Smythe’s claim is true, if the longer bows of an earlier day would have had even greater pull weights than those found on the *Mary Rose*.

³⁰ Kaiser cites Count M. Mildmay Stayner, Recorder of the British Long-Bow Society who suggested medieval bows drew between 90 and 110 lbs, and W. F. Paterson, Chairman of the Society of Archer-Antiquaries, who suggested an absolute maximum of only 80 to 90 lbs. See Kaiser, “Medieval English Longbow.” As late as 1985, Bradbury was suggesting that 50 lbs or less could well have been the typical pull weight of the medieval long bow. See Bradbury, *Medieval Archer*, 148.

³¹ Details of the scientific experiments that were carried out to determine these figures is excellently set out by Prof. P. L. Pratt in Hardy, *Longbow*, 209–17. The full inventory can be found online at: http://www.maryrose.org/mary_rose_archive.html.

³² Sir John Smythe, *Certain Discourses* (London, 1590), 19.

The skeletons of two men found within the doomed ship have been identified by one of the world's leading maritime archaeologists as archers thanks to the presence of physical deformities caused by regular practice with a large bow. One of these men had a thickened left fore-arm characteristic of bowyers; and both had spinal deformations from the pressure of repeatedly drawing a bow with the body twisted sideways. These deformities were present despite the fact that both men were still only in their twenties.³³

While it may appear strange that medieval people would be capable of pulling such immense weights—weights that until very recently were thought impossible, it was the technique that made it possible. An archer could not draw a war bow and hold back the string while carefully sighting his target. Even if it were physically possible (which it is not), the enormous tension of a bow held at full draw would have been greatly detrimental to the weapon. Watching experienced modern archers attempt to shoot bows of only around 100 lbs (45 kg), it is clear that even these must be drawn and loosed in a single fluid motion, one that requires the entire body to be “thrown into it.”³⁴ It is this fluid technique rather than simple brute force that made possible the firing of heavy, English war bows in use during the later Middle Ages.

The level of practice required for effective use of the long bow was extremely high and such skills must have quickly atrophied in the absence of practice.³⁵ It is highly doubtful that the majority of modern enthusiasts would be willing or even able to put themselves through the type of training regime that could inflict the physical deformities similar to those discovered on the *Mary Rose* archers.

Even for a man in peak physical condition, firing a heavy war bow would have quickly taken its toll. While he initially might have been able to loose as many as ten or twelve arrows per minute, this number would have quickly declined to five or fewer as fatigue set in from the enormous exertion such activity required. Clearly though, if faced with

³³ Margaret Rule, *The Mary Rose* (London, 1983), 184–86.

³⁴ I am grateful to bowyer Hilary Greenland and blacksmith Hector Cole for a most interesting day's shoot in January 2004 where many of these ideas were discussed and put into practice.

³⁵ In an otherwise informative work, Barber claims that the longbow was a comparatively easy weapon to employ compared with the “very high degree of training” required for the use of a crossbow. Clearly this argument is untenable given the data presented in the argument above. See Richard Barber, *The Knight and Chivalry* (Woodbridge, Suffolk, 1995), 233.

successive waves of attackers over a length of time, there would have been opportunity to recover in between volley sessions.

The Arrow

Attention must now turn to the projectile. Roger Ascham, tutor to Edward VI (1547–1553) and Elizabeth I (1558–1603), wrote a famous treatise on archery called *Toxophilus*. Although archery was being phased out in Europe by the sixteenth century, information from the *Toxophilus* remains pertinent to the study of medieval archery. Ascham noted that the medieval arrow consisted of three component parts: the stele (shaft), the fletching (feathers), and the arrowhead.

Ascham lists fourteen different woods that were used at that time for the stele of the arrow, including birch, oak, and ash. It was the latter material that he considered to be most suitable for war arrows since it was “both swifter and hevier, is more fit for sheaafe arrows [those used in war].”³⁶ Although the majority of the 3,500 arrows found on the *Mary Rose* were made from poplar, shafts of ash, beech, and hazel were also present.³⁷

The length of arrows used in the Middle Ages is open to some question since there are no surviving examples. However, the large number of arrows recovered from the *Mary Rose* allows an accurate estimate as to their size and shape. The distribution of lengths demonstrated two peaks, one of 29.5” (75 cm) and the other at 31.5” (80 cm) with the longer arrows being more prevalent. These would have corresponded to a 28” (71 cm) and a 30” (76 cm) draw respectively to allow room for the arrow head to remain in front of the bow. This has implications for the size of the bow that must have shot them.

Flexibility of the shaft would have been of vital concern due to what is known as “the archer’s paradox.” An arrow fired from any bow, short or long, has to travel around the bow stave. While the bowstring returns to the center of the bow, the arrow must go past the considerably thicker bowstave to continue on to the target. At first, the force of inertia causes the arrow to buckle somewhat, as the bow pushes the

³⁶ Roger Ascham, *Toxophilus, The Schole of Shootinghe*, 2nd Book (1545; reprint, New York, 1969), 12–14.

³⁷ See *Mary Rose* web site: <http://www.maryrose.org/ship/bows2.htm>.

arrow head to one side. As a result, the arrow shaft begins to vibrate. At this point, the arrow must have the correct spine (flexibility) in order to straighten out in flight as quickly as possible.³⁸

The arrow's fletching causes it to spin as the air passes differently over the rough and the smooth side of the feather. Different types of arrows had different lengths of fletching. Larger fletchings will help the arrow straighten in flight, thereby increasing its accuracy and helping to correct any deviation caused by the archer's paradox.

On the other hand, by providing less resistance, smaller fletchings will allow the arrow to travel faster. The pinion or flight feathers were to be preferred for this role. Consistent with current practice, the cock feather (the feather placed at right angles to the notch into which the string was fitted) was colored differently from the other two feathers. This color coding: made it easier for the archer to fit his arrow to the bowstring "surelye it standeth with good reaso[n] to have the cocke fether black or greye, as it were to gyue a man warning to noche right."³⁹ Because they make the arrow spin in a certain direction, it is essential that all three feathers are from the same wing of the bird; mixing left and right pinion feathers will simply not have the desired effect. The level of expertise required to consistently produce quality arrows must have been considerable as even a tiny variation in the position or angle of the fletchings can have an enormous impact on the accuracy of the projectile.

One indication of just how finely balanced the different elements of the arrow really are comes from tests carried out in October, 2003, at the Bashforth Impact Laboratory at Cranfield University, part of the Royal Military College of Science. Tiny pieces of foil were glued to some arrows to improve their radar cross section. The difference in the accuracy between arrows left un-doctored and those that had the tiny additions was significant. At 220 yards (200 meters), archers brought in for the tests had been consistently hitting within 5 meters of the target. However, this was reduced to an average error in accuracy of 2 meters using the "radar friendly" arrows, even though the naked eye cannot detect any appreciable difference in the arrow's aerodynamics.⁴⁰

³⁸ For an excellent explanation of this effect, see Greenland, *Archer's Handbook*, 2–3; Hardy, *Longbow*, 212.

³⁹ Ascham, *Toxophilus*, 12,15–17.

⁴⁰ I am very grateful to Ian Horsfall, Steve Champion and Celia Watson for sharing this and other data used below with me.

The head of a medieval war arrow could come in a variety of different shapes, from the leaf shaped, broadhead arrow through to the infamous bodkin. It is impossible to know for certain whether medieval arrow heads were attached with some kind of glue or merely prised down onto close-fitting shafts.⁴¹ By contrast, modern arrows tend to be attached by some type of adhesive.

Barbed heads are more effective against game as they help ensure that the arrow remains in the target longer, thus causing the animal to collapse through blood loss even if the initial wound is not lethal. By contrast, broadheaded arrows would be more effective against non- or lightly-armored human targets. The long, thin bodkin was probably reserved for war use and had a number of advantages over the barbed arrow. Bodkins were designed with a diamond cross section giving four, steel sharpened cutting edges for greater penetration of any armour worn by the target. The smaller cross section of the bodkin enabled it to fly straighter over longer distances than a broadhead arrow, since there is less resistance from side winds to affect its flight. Finally, the bodkin could be manufactured in a third of the time. This fitted it for the type of mass production necessary to supply an English army in the midst of a campaign.⁴²

The String

Medieval bow strings were made from hemp or linen, both of which were easily available and have excellent shooting characteristics. The best quality hemp produces a fine, forgiving string. Although possessing natural water resistance, the string would also have been waxed for additional protection.⁴³ Bowstrings, like the bows and arrows themselves,

⁴¹ Chemical analysis undertaken in 2006 by Paul Bourke at Cranfield University on a fourteenth-century arrowhead uncovered in the Forest of Dean uncovered traces of an animal-based glue in the socket. While it would be unwarranted to generalize from this single find, this is still an exciting discovery and does support the idea that at least some medieval arrow heads were attached with some kind of adhesive.

⁴² Mark Stretton, "Medieval Arrow Heads," *The Glade*, 102 (Winter 2003/4): 33. As noted above, the narrow 'D' cross section of the medieval longbow aided its mass production too. There were over 400,000 arrows recorded stored in the Tower of London in 1356. See Peter N. Jones, "The Metallography and Relative Effectiveness of Arrowheads and Armor during the Middle Ages," *Materials Characterization* 29 (Sept., 1992): 112.

⁴³ Greenland, *Archer's Handbook*, 50.

have a tendency to deteriorate over time. Therefore, it is hardly surprising that no medieval strings survive. What is more, none have survived from the *Mary Rose*. However, from the size of the nock on the arrows that did survive on the ship, we can deduce that the strings could have been no wider than 1/8 of an inch (3.2 mm). This is comparable to the thickness of many modern strings. A thicker string would actually have slowed down the arrow; a strong, thin string is best although its manufacture requires a high level of expertise.⁴⁴

Effectiveness

This is the area that has received the most attention in the ongoing debate about the medieval longbow. Folklore as well as some of the more credulous histories tell a tale of how clever English yeomen armed with their new and devastating weapon repeatedly overcame the French nobility on the battlefields of the Hundred Years War. Captive of their Gallic arrogance, the French could not embrace the new military technology and refused to learn from their mistakes.⁴⁵ Recently, a growing number of historians have challenged this interpretation, questioning just how decisive the longbow really was. Some of these sceptics have rightly pointed out that armor improved throughout the Middle Ages. At Agincourt in 1415, men-at-arms were dressed in sheets of steel, deliberately designed to deflect arrow heads. Describing the effect of the initial English volley in this battle, John Keegan remarks: “these arrows cannot...given their terminal velocity and angle of impact, have done a great deal of harm.”⁴⁶

Tests done at the Royal Armaments Research and Development Establishment by Peter N. Jones appear to bear out this assumption.

⁴⁴ The best hemp strings in the world today are made in Japan and utilise a jealously guarded recipe for a protective resin.

⁴⁵ Matthew Bennett brings out these national stereotypes well and also the way that the most influential historians, Sir Charles Oman and Lt. Col. A. H. Burne, were convinced of the superiority of English firepower through the ages. See Matthew Bennett, “The Development of Battle Tactics in the Hundred Years War,” in *Arms, Armies and Fortifications in the Hundred Years War*, ed. Anne Curry and Michael Hughes (London, 1994), 1–20.

⁴⁶ John Keegan, *The Face of Battle* (London, 1993), 94–98. Keegan does accept that the moral effect of the volleys would have been significant and also that at closer ranges, some arrows would have found weak spots or may even have penetrated the armour itself.

Here, arrows with long needle-point bodkin heads, shot from a 70 lb (31.75 kg) bow could not penetrate 3 mm plate armor at a range of 33 ft (10 m). While there was limited penetration of 2 mm armor, this diminished substantially when the angle of the strike became more oblique. Arrow heads exhibited considerable penetration of 1 mm armor until a firing angle of 40° was reached, at which point penetration also declined.⁴⁷

On the basis of this and other similar experiments, scientists have determined that, while the longbow might well prove effective against un-armored or mail-armored targets, it was far less effective against plate armor of the fifteenth century. Only a lucky, head-on hit at fairly close range had any chance of penetrating the chest plate; and while other relatively less well-protected parts of the body might fall victim to an oblique strike, such a wound would not be overly severe.

In his quest for a redefinition of “effectiveness” in premodern military technology, Kelly DeVries uses this and other evidence to challenge the view that the longbow was some kind of invincible new weapon.⁴⁸ While this author sympathizes with the broader argument that DeVries employs and agree on a number of points, there are problems with this particular evidence that have come to light through recent tests and these problems need to be addressed.

As demonstrated above, the average pull of a medieval war bow would probably have been twice as powerful as the 70 lb bow used in Peter Jones’s experiment. Tests done at the Bashforth Laboratory in October 2003, showed that the 70 lb bow had a launch velocity of between 108 and 117 feet/sec. (33 and 35.6 meters/sec.), while a bow of approximately 150 lb (68 kg) had a launch velocity of 170 feet/sec. (52 meters/sec.). Using this heavier bow, a 2.6 ounce (74 g) arrow shot in the air at an angle of 43° landed at 240 yards (220 m) with a terminal velocity of 154 feet/sec. (47 meters/sec.).⁴⁹ There is clearly a significant difference in the performance of these two bows. The heavy bow exhibits at least 50% greater velocity at 240 yards than its lighter counterpart does at only five. As a result, to produce

⁴⁷ Jones, *Effectiveness of Arrowheads*, 115–16.

⁴⁸ Kelly DeVries, “Catapults Are Not Atomic Bombs: Towards a Redefinition of ‘Effectiveness’ in Premodern Military Technology,” *War in History* 4, no. 4 (1997): 454–70.

⁴⁹ As Ian Horsfall points out, what most people forget is that unlike the relatively flat trajectory of a bullet, an arrow will lose some velocity as it goes up, but will then gain kinetic energy on the way back down.

valid information concerning the performance of a medieval longbow, those conducting the tests must revisit the issue, making use of weapons with a comparable draw weight. Further tests completed at the UK Defence Academy in August, 2005, with a 140 lb (64 kg) longbow and correspondingly heavier arrows confirm this view. While there was still difficulty in penetrating the thicker 3 and 2 mm metal plates, the arrows could easily penetrate 1 mm plates of good quality wrought iron to a depth of 80 mm (3.1"), even at an oblique angle of 60°.

Mark Stretton, the archer from the 2005 Defence Academy tests, has also completed a number of other tests employing a 144 lb bow against different types of armor and the results have been enlightening. Stretton found that riveted steel chainmail provided little or no protection against any of the arrowheads, from crescent-shaped through to heavy bodkin, when they were shot from this heavy bow. Chainmail was very effective at preventing penetration by edged weapons such as swords, but it was not going to provide security against archery.

Next, Stretton tested a quality brigandine armor. This was constructed of a leather jerkin with overlapping metal plates riveted on, covered in velvet. It was lighter than chainmail and was significantly more flexible than plate. In contrast to chain, it appears to have been a very effective form of protection against archery, perhaps explaining its popularity amongst archers and many other types of soldier in the Wars of the Roses (1455–1485). The heavy bodkin arrowhead had the most success, managing to cut through the metal plates to the leather underneath, but the ingenious manufacture of the armor meant that the power was absorbed to some extent as the armour enveloped the head: "although the impact would certainly knock you off your feet you would probably still be alive."

For all-round protection on a medieval battlefield, those who could afford it increasingly utilized plate armor. It effectively acted as a shell which prevented cutting or crushing blows from causing internal injuries. It was developed and refined over time to also provide a better defence against archery although this was not its primary function. Most armor surfaces were angled to provide a slanting target and greatly reinforced by additional plates of metal.

Taking these developments in armor manufacture into account, a glaring weakness in the Bashford Laboratory test becomes apparent. Peter Jones assumed that archers of the fifteenth century were still using the long needle-pointed bodkin. However, with the steady improvement of armor, the bodkin tip would also have been refined. By the late

Middle Ages, there were actually several different varieties of bodkin head in use. Just as the fletching of an arrow shaft could make a huge difference in its effectiveness, the type of bodkin placed on its tip would also have a bearing on the arrow's performance. For example, the very long thin bodkin used in the Jones experiments, known as a Type 7,⁵⁰ may have been effective against lighter armor. However, against plate, the spire-like point began to roll up like a scroll, diminishing the energy at the point of impact. This would result in the arrow either bouncing off the armor or, at most, "lightly grazing" the target⁵¹ By contrast, shorter bodkins (Type 10, for example) will avoid this problem. Because the tip of the arrow does not deform in the same manner, it will "keep on cutting as the shaft keeps on driving."⁵²

Slow motion photography reveals that once this type of arrow strikes its target a shockwave passes up and down the shaft very rapidly. The shockwave combined with the arrow's spin produces a hammer-drill effect. Once the tip has done its job of punching through the plate, friction is reduced enabling the arrowhead to pass through to its socket. Since the arrow shaft has a smaller diameter than the head, the rest of the arrow continues on into the target until it encounters another obstacle.⁵³ In short, due to the improvements medieval arrow makers made in their product, arrows tipped with an appropriate bodkin fired from a heavier bow would probably have maintained their effectiveness up to a range of 200 yards.

Nevertheless, it is also important to recognise some of the longbow's limitations in this regard. While the medieval longbow was an extremely powerful weapon, it was not necessarily a highly accurate one. A war bow could not be held at full draw while a target was being selected. With the single fluid motion of draw and loose required by the weapon, pin point accuracy would be unobtainable. On the other hand, the degree of accuracy was considerably less important than the actual volume of arrows "dropped" into the "kill box." Even at long range, arrows from the heavy bow shot into the "kill box" could still have had a devastating impact.

⁵⁰ See the Museum of London Arrow Collection Catalogue for the various arrow types.

⁵¹ Stretton, *Medieval Arrow Heads*, 33.

⁵² *Ibid.*

⁵³ Mike Loades, *Archery: Its History and Forms*, Running Wolf Productions, 16mm, 1995. Brief footage of this effect can be also be seen on: "The Longbow: Wood Against Steel," *Decisive Weapons* BBC2 (Originally aired October 16, 1996).

According to Clifford Rogers, it would take a heavily-armored man about two minutes to cross 200 yards on foot. In that time, the archer could loose a significant number of arrows. Given the rate of fire of a medieval longbowman (8 to 15 arrow per minute), if there were 5000 archers at Agincourt, something approaching 1000 arrows a second could be fired at the advancing French formation. Any mount riding through this target area would have been peppered with arrows, some of which would probably have hit vulnerable areas unprotected by heavy armor. What is more, death could result from a single arrow not deflected or stopped by the armor worn by men-at-arm. The psychological effect of arrows clanging off one's head and shoulders must have been significant, causing hesitation and disrupting the cohesion of an attack. This would have been exacerbated by seeing men in front or at the side stumbling and falling after being unfortunate enough to suffer a penetrating hit.⁵⁴ In short, there was no need to actually target individuals; the volume of archery would have achieved the desired effect of breaking up entire formations.

Clearly, the tactical use of "volume archery" would have been tempered by logistical realities. The supply of arrows was not going to last long if archers engaged the enemy at extreme range every time the English line was attacked. In addition, wooden bows do not last forever. They have only a certain number of shots in them. Over the course of their limited lifetime, they will also suffer a gradual loss in performance. The bow string also has a finite lifespan: modern archers are advised to change their traditional hemp or linen strings after 1,000 shots. One can imagine just how quickly this number would be reached by people using their heavy bows on a daily basis.⁵⁵ Some hemp or linen strings would undoubtedly have broken on the field of battle, but while spare strings would have been easy enough for each man to carry, the same cannot be said of arrows or spare bows.

This leads one to wonder if there was a medieval equivalent of the "powder monkeys" of a later era—children running around warships to keep the guns supplied with that crucial ingredient. Undoubtedly, spare parts for the archer were an essential part of the medieval English war

⁵⁴ Clifford J. Rogers, "The Efficacy of the English Longbow: A Reply to Kelly DeVries," *War In History* 5, no. 2 (April, 1998): 235; idem, "The Battle of Agincourt" in this volume.

⁵⁵ Greenland, *Archer's Handbook*, 50.

machine. Logistical considerations aside, simply creating this enormous volume of arrows would have proven a very difficult task.

The Longbow in Battle

The “volume of arrows” landing in the same target area is critically important for understanding the true effectiveness of the medieval longbow. Edward I did not introduce a new weapon to the English army following his subjugation of the Welsh. Instead, the English developed an appreciation for what this *old* weapon could do when employed in significant numbers.⁵⁶ This appreciation was probably brought about by the English experience in fighting against the Welsh. Terrain and guerrilla tactics of their enemy meant that traditional heavy cavalry was relatively ineffective, necessitating the use of light infantry. Edward recruited increasing numbers of archers from Nottinghamshire and Derbyshire, as well as large contingents of already-subjugated Welshmen. Systematic training now began based around an existing core of good archers.

Edward I learned lessons in the Welsh wars that he carried with him first to Scotland, then to the Continent. It was *massed* archery, not the individual archer, that made for a new tactical system. When employed in large numbers, and supported by knights and men-at-arms arrayed on foot, the English archer was devastating.⁵⁷

What was true against the Scots at Falkirk (1298), Dupplin Moor (1332), and Halidon Hill (1333) proved equally true against the French in the great battles of the first phases of the Hundred Years War: Crécy (1346), Poitiers (1356), and Nájera (1367). As late as Agincourt in 1415, and despite the lesson learned by the enemy at earlier battles, the longbow still played a critical role in English victory and would continue to do so until new military technology and organization along with incipient nationalism re-fashioned a French war effort which ultimately dismantled the English war machine.

⁵⁶ Hans Delbruck, *History of the Art of War*, trans. Walter J. Renfro, Jr., 6 vols. (Westport, Connecticut, 1982), 3:387.

⁵⁷ Bradbury, *The Medieval Archer*, 90.

THE LONGBOW-CROSSBOW SHOOTOUT AT CRÉCY (1346): HAS THE “RATE OF FIRE COMMONPLACE” BEEN OVERRATED?

Russell Mitchell
Dallas County Community College

Then the Genoways again the second time made another leap and a fell cry, and stept forward a little, and the Englishmen removed not one foot: thirdly, again they leapt and cried, and went forth till they came within shot; then they shot fiercely with their crossbows. Then the English archers stept forth one pace and let fly their arrows so wholly [together] and so thick, that it seemed snow. When the Genoways felt the arrows piercing through heads, arms and breasts, many of them cast down their crossbows and did cut their strings and returned discomfited. When the French king saw them fly away, he said: “Slay these rascals, for they shall let and trouble us without reason.” Then ye should have seen the men of arms dash in among them and killed a great number of them: and ever still the Englishmen shot whereas they saw thickest press.¹

With these words, the foremost chronicler of the fourteenth century, Sir John Froissart, helped establish one of the enduring commonplaces of medieval military history—the supposed “matchup” of Crécy (1346) featuring the longbow and the crossbow. In this first great land battle of the Hundred Years War (1337–1453), the crossbow is said to lose because of its opponent’s superior range and rate of fire.

The commonplace is restated in leading works of the present day; for example, in *War, Cruel and Sharp: English Strategy under Edward III 1327–1360*, Clifford Rogers posits an explanation for the crossbowmen’s defeat highly reminiscent of Froissart:

[The crossbowmen] began to fire at the English, but quickly discovered that they were completely outmatched by the English longbowmen, who could fire farther and faster with deadly effect. The situation was made *doubly worse* (emphasis added) by the fact that their large shields, or *pavises*,

¹ Jean Froissart. *The Chronicles of Froissart*, trans. John Bouchier, Lord Berner, ed. G. C. McCaulay. (New York, 1910), 26–28 (chap. 1). Cited from online edition available at: <http://www.fordham.edu/halsall/source/froissart-full.html>.

which they normally used to give them cover in the field, were still in the rear, in the baggage.²

Note that in Rogers' description, the lack of *pavises* is mentioned only as an aggravating factor in a situation already assumed to be overwhelmingly unfavorable to the Genoese, because of the widely-known difference in rate of fire between the self bow and the crossbow.

The "Rate of Fire Commonplace" in Scholarly Literature

Rogers is by no means alone in his assessment. The "rate of fire commonplace" as *the* explanation for the fourteenth century victory of the longbow over its competitor pervades much of the literature. Matthew Bennett describes Genoese losses at Crécy as a combination of both inferior numbers and inferior rate of fire.³ Edouard Perroy notes the "very rapid fire" of the "Welsh archers."⁴ J. F. Verbruggen stresses the difference in rate of fire when discussing the role of the two weapons in England,⁵ as does Philippe Contamine.⁶ Jonathan Sumption unreservedly engages in technological determinism in his assessment of the longbow's superiority at the earlier battle of Sluys (1340):

... the longbow once again proved to be greatly superior to the crossbow used by the French and their Italian auxiliaries. It was more accurate. It had a longer range. Above all it could be fired at a very rapid rate...⁷

In his *La Guerre de Cent Ans*, Jean Favier notes that while the crossbow is accurate and can "work wonders" in sieges, it suffers from a three-to-one disadvantage in rate of fire compared to what he characterizes as the less accurate, and less powerful longbow.⁸ By contrast, Ferdinand Lot

² Clifford J. Rogers, *War, Cruel and Sharp: English Strategy under Edward III 1327–1360* (Woodbridge, Suffolk, 2000), 267.

³ Matthew Bennett, "The Development of Battle Tactics in the Hundred Years' War," in *Arms, Armor and Fortifications in the Hundred Years' War*, ed. Anne Curry (Woodbridge, 1994), 10.

⁴ Edouard Perroy, *The Hundred Years War* (Bloomington, Ind., 1962), 119.

⁵ J. F. Verbruggen, *The Art of Warfare in Western Europe during the Middle Ages: From the Eighth Century to 1340* (Woodbridge, 1997), 118–9.

⁶ Philippe Contamine, *War in the Middle Ages*, trans. Michael Jones (Oxford, 1984), 72.

⁷ Jonathan Sumption, *The Hundred Years War I: Trial by Battle* (Philadelphia, 1990), 326.

⁸ Jean Favier, *La Guerre de Cent Ans* (Paris, 1980), 87–88.

places the rate of fire differential at as much as 5 or 6-to-1.⁹ Andrew Ayton describes the crossbow's enduring dominance in continental Europe *despite* its rate of fire disadvantage.¹⁰ Thus, a historian like Alfred Burne places himself in a distinct minority when he ignores this difference.¹¹

On the other hand, the rate of fire advantage exhibited by the longbow may not have been as decisive a factor at Crécy as it is usually given credit for being. It has, nevertheless, created a haze of mythology around the weapon that lingers outside of specialists' circles to this day and that clouds what is known about the actual events occurring on the battlefield.

The Chronicle Accounts

As is so often the case with medieval sources, the chronicles that supply our principal narratives of the battle of Crécy disagree on various points, including their depiction of just what was involved in the opening contest between longbows and crossbows. Matteo Villani seems primarily interested in how the English archers killed French men-at-arms and horses.¹² Giovanni Villani cites the rate of fire difference (placing it at 3-to-1), but adds a fact which, if true, would have greatly aided the longbowmen, to wit that during the exchange, the English archers enjoyed considerable cover.¹³ The *Storie Pistoresi* notes that the English archers cruelly struck down the French, and that the Genoese crossbowmen were all killed in the battle.¹⁴ Jean de Venette's account alleges that the weather ruined the crossbowmen's weapons, and that the Genoese attempted to excuse themselves for their poor performance

⁹ Ferdinand Lot, *L'Art Militaire et Les Armées au Moyen Age en Europe et Dans Le Proche Orient* (Paris, 1946), 314-5.

¹⁰ Andrew Ayton, "Arms, Armour, and Horses," in *Medieval Warfare: A History*, ed. Maurice Keen (Oxford, 1999), 205.

¹¹ Alfred Burne, *The Crécy War: A Military History of the Hundred Years' War from 1337 to the Peace of Bretigny, 1360* (London, 1955), 173.

¹² Matteo Villani, *Cronica: con la continuazione di Filippo Villani* (Parma, 1995), 46 (I,xxiv, 33-36). *L'Inghilese Fermi al loro carreaggio coll'ordine dato a li arcieri, senza perdere i colpi, delle loro saette fedivano i cavalla de' Franceschi e' cavaliere.*

¹³ Giovanni Villani, *Cronica*, XII/LXVII in *Cronisti del Trecento*, ed. Roberto Palmarocchi (Milan, 1935), 396-97.

¹⁴ *Storie Pistoresi*, ed. S. Lapi in *Rerum Italicorum Scriptores*, ed. L. A. Muratori (Citta de Castello, 1927), vol. 11 pt. 5: 222-23.

when subsequently attacked by the French.¹⁵ Jean le Bel simply states that the English archers put the Genoese to flight.¹⁶ While the chroniclers' descriptions make it clear that the Genoese were defeated, which of the fine details they provide can be trusted?

In "Crécy and the Chroniclers," Andrew Ayton has devoted considerable effort to pointing out the difficulties inherent in assessing the chroniclers' reliability, while equally warning against the pitfalls of uncritically borrowing details set forth in different chronicles, then putting them together in order to form a coherent battle narrative.¹⁷

Reassessing Battlefield Realities

Rather than argue over which of the chronicle accounts are likely to be the most reliable, this article will adopt a different approach, one that involves reassessing certain conditions on the ground that faced the men fighting at Crécy. It is a reassessment which is based in large part on extensive research into the use of medieval bows, much of it of a "hands-on" variety. Such research has helped make possible a better understanding of what bowmen on each side must have seen and experienced during the opening stages of the battle. Combined with a "face value only" reading of the narrative sources, this may lead to a more nuanced explanation for the victory of one missile weapon over the other than that provided by the perennial "rate of fire commonplace." In this way, it is hoped that arguments over source reliability can be put aside in favor of something that will develop its explanatory momentum based upon the battlefield realities faced by the warriors at Crécy.

A decision to reassess such realities is by no means an unprecedented approach. Sir Philip Preston, for example, has amply demonstrated just how such a rethinking of the basics may enhance our understanding of the chronicle sources and perhaps clear up apparent disputes between

¹⁵ Jean de Venette, *The Chronicle of Jean de Venette*, ed. Austin P. Evans (New York, 1953), 43.

¹⁶ Jehan Le Bel, *Chronique de Jean Le Bel: publiée pour la Société de l'histoire de France*, ed. Jules Viard and Eugène Déprez (Paris, 1905), 102–3 (chap. LXXII).

¹⁷ Andrew Ayton and Philip Preston, "Crécy and the Chroniclers" in *The Battle of Crécy, 1346*, ed. Andrew Ayton and Philip Preston (Woodbridge, Suffolk, 2005), 288.

them.¹⁸ His careful analysis of the topography at Crécy and his observation that under battlefield conditions there is no simple east-west transit across the Vallée des Clercs, offers the possibility of harmonizing several of the sources that appear to disagree. For example, assuming that the traditional assessment of where the English deployed holds without drastic revision,¹⁹ then the French units forced to enter from either the north or south ends of the Vallée des Clercs would have been entering the battlefield at an angle to the English position.

Preston's observation allows the possibility of significant refinements to the battle narrative. An entry from the south of the Genoese and the cavalry placed at their rear combined with a (later) main French thrust around from the north end of the valley would explain a number of issues, not the least of which was how the French king, Philip VI (1328–1350), was unable to get close enough to the English lines to enter battle personally, yet was still able to obtain a sufficiently close view that he could judge the performance of the Genoese crossbowmen, something that would be a geometric impossibility had the king been forced to look up slope along a kilometer's length of crowded valley floor to watch the opening action. Similarly, it would help to explain the French chroniclers' focus on English archery, as their knights and men-at-arms would have been forced to endure a horse-killing "gauntlet," with not a few of their mounts presenting broadside to the English archers, prior to their coming into conflict with the Black Prince's battle.²⁰

Under these circumstances, it is perfectly reasonable to posit that English archers might have been protected by ridges, hedges, and wagons at the same time that English men-at-arms, standing farther along the English front line, were able to fight on a relatively clear field against an enemy reaching them in poor array. With such a wealth of possible refinements deriving from a single topographical observation, does it not make sense to re-examine the primary assumption underlying the question "how dominant was the longbow at Crécy?"

¹⁸ Philip Preston, "The Traditional Battlefield of Crécy," in *Battle of Crécy*, 109–38.

¹⁹ An English deployment *across* the Vallée des Clercs in any fashion would have been extremely unlikely, if only because the short width of the valley would have allowed the Genoese to "cap the T" on the English formation while simultaneously using the eastern ridgeline as partial concealment. This is not plausible given our knowledge of how events transpired at Crécy.

²⁰ Ayton, "Crécy and the Chroniclers," 290, 317.

The Situation Facing the Bowmen at Crécy

Let the reader rest assured that this paper will take no issue with the basic fact that the Genoese were badly overmatched at Crécy. They were outnumbered and (if an anachronism be permitted) out-gunned.

For the purposes of this paper, we will accept the upper end numbers of roughly 7,500 English archers.²¹ The numbers for the Genoese are more problematic: at best they seem to put the crossbowmen on a relatively even footing; at worst, they suggest an English numerical advantage of perhaps 3 to 1.²² Whichever the case may be, the circumstances under which the Genoese had to fight put them under at a severe—even fatal—disadvantage. For purposes of this analysis and to demonstrate just how hopeless the situation was for the Genoese whatever their numbers, we will accept the upper-end figure of 6,000 crossbowmen. Just how much more uneven the contest would have been had their numbers been even fewer, we shall leave to the reader to intuit.

Give a force of 6,000 Genoese, what precisely would have been the size of the target at which English archers would have been discharging their shafts? Ayton and Preston, in “Topography and Archery,”²³ note that the Vallée des Clercs is frequently no wider than two hundred meters across. With most of their gear remaining in the baggage train, and without the benefit of shield-bearers to support them in hand-to-hand combat, it is highly unlikely that the crossbowmen would have extended their line to the absolute edges of the valley, but would instead have maintained some clearance on either side. At the same time, according to the *Chronicle of St. Omer*, they did not crowd together, but made use of the entire space available to them.²⁴

Each crossbowman would have required roughly a square yard in order to move freely with his weapon and equipment, and to aim in whatever direction was required. Therefore, if the Genoese did indeed number 6,000, then the widest reasonable formation becomes roughly 30 ranks of 200 men each. This would have presented a front-rank target to the longbowmen of six feet by six hundred feet for direct

²¹ Andrew Ayton, “The English Army at Crécy,” in *Battle of Crécy*, 189.

²² Bertrand Schnerb, “Vassals, Allies, and Mercenaries: The French Army before and after 1346,” in *Battle of Crécy*, 265–72.

²³ Ayton and Preston, “Topography,” 367.

²⁴ Cited in Rogers, *War*, 265: *tous les champs en estoient couvers*.

fire: or, in other words, the approximate height of a man and his helm multiplied by the width of the formation. While this alone would have been a substantial target for English longbowmen, it almost certainly understates the reality, given the fact that much or all of their fire was arcing rather than direct.

The case for arcing fire is based on several factors. Since the English enjoyed only a mild elevation advantage from the gently sloping terrain, such fire would have been far more effective, especially at longer range; to fire farther, an archer must aim higher. Arcing fire could hit even the rear ranks of crossbowmen that would otherwise have been partially obscured to direct fire by the ranks in front of them standing higher up the slope.²⁵ In addition to these practical realities, several of the source descriptions support the same conclusion. The “snow” metaphor in the passage from Froissart with which this essay begins strongly suggests that English archery at Crécy involved long-range arcing fire. So too does the chronicle of Giovanni Villani where the arrows are described as appearing like a cloud in the air.²⁶

Let us assume that the English adopted a 45 degree plunging fire and that the Genoese formation advanced across a mild slope of approximately 2 degrees, both reasonable assumptions given what we know about arcing fire and the field at Crécy. Under those circumstances, hitting the Genoese formation from 150 yards, the probable distance at which the exchange took place, is the equivalent of hitting a paper target 90 feet tall by 600 feet wide.²⁷

In other words, it would be akin to hitting a 54,000 ft² target from a maximum range of only 200 yards, a target augmented at the rear by a crowd of closely-packed horsemen. Such a target is much bigger than the proverbial “broad side of a barn.” A more accurate comparison of the Genoese formation would be to the *broad side of a city block!* It would have been almost impossible for an archer with even an hour’s practice to have failed to get his arrow roughly where it needed to go in order to do some good. (See Figures 1 and 2.)

²⁵ This concealment of the back ranks would hold true under any circumstances in which the defender did not have a drastic height advantage, as for example, when shooting down from a tower or wall.

²⁶ In Giovanni Villani, *Nuova Cronica*, Book XIII, chapter LXVII, arrows are described in the following words: *che pareva inn aria uno nuolo*. An edited text of this work is available online at <http://bepi949.altervista.org/biblio4/T3LIBRO13c.html>.

²⁷ Archers who would have felt comfortable shooting with direct fire should still have had little to no trouble getting their shafts into the formation.

The figure of 150 yards for the range at which the exchange probably took place is conjectural; however, it is conjecture based on both a knowledge of longbow technology and certain information provided by Froissart. The extreme range for longbows used at Crécy would probably have been about 180–200 yards. For his part, Froissart indicates that the English continued firing upon the Genoese *as they fled the field*, something which could not have been done had the longbowmen originally let fly at their maximum range.

Shooting Fish in a Barrel

Although there would have been “empty” space within the Genoese formation where arrows could fall to the ground without hitting anyone, much of the “vertical” empty space would tend to be obscured from the viewpoint of an arrow coming in at about 45 degrees, which, upon missing one man would tend to strike the man behind him. Obviously, the higher the angle at which the arrow was fired, the easier a time it would have falling through the formation without hitting anything. True “plunging fire” coming in at an angle of 70–90 degrees would have been much more likely to strike the ground between two crossbowmen than arrows landing at the assumed 45 degree angle. This fact added to the shorter range that could have been achieved with a 70–90 degree arc makes it highly unlikely that English archers would have used such an exaggerated elevation when discharging their shafts. Froissart’s description of arrows striking the torso, face, and arms may well be an accurate reflection of the wounds being sustained by the Genoese: at a 45 degree the lower bodies of the crossbowmen were generally obscured from the trajectory of the incoming missile. (See Figure 3.)

The degree to which the “horizontal” empty space—that which separates two men standing in the same rank—will let an arrow fall harmlessly to earth will depend largely upon the degree of “dress within the ranks”—in other words, whether the Genoese were assembled in rows with each man standing behind the man in front or in a “checkerboard” arrangement or simply without any internal order at all. Taking into account the professionalism of the crossbowmen involved, a complete absence of order within the formation seems unlikely; however, the question of just what order did exist is not really answerable on

the basis of our sources. A “checkerboard” arrangement might have provided additional freedom of motion in order to aim, but even this is not enough to strongly prefer one formation over the other. What is more, a “checkerboard” arrangement lends itself less neatly to Froissart’s description of wounds since more of the individual crossbowman’s legs would be available for the arrows to strike. To summarize, although the amount of “horizontal” empty space in the Genoese formation might have been somewhat greater than vertical empty space, one cannot tell for certain without knowing whether the crossbowmen stood in regular rank and file or branched out into a checkerboard.

In addition, we are still somewhat in the dark regarding how the English archers were drawn up. As a result, we do not know to what degree their fire was primarily perpendicular to the target area or how much of it came in at an angle from the sides. In the latter case, the vast majority of the “horizontal” empty space would vanish, for the same reason as the amount of “vertical” miss space is so low. Were we to change our initial assumption and posit that each crossbowman needed only 2.5 lateral feet in order to function, the Genoese formation would not be quite so deep. On the other hand, such an assumption would create a formation with almost no “horizontal” empty space at all.

What is worse, from the standpoint of the crossbowman in the missile duel, is that English archers were able to focus solely upon their Genoese counterparts. By contrast, since the archers appear to have been interspersed among English men-at-arms, shots fired by the Genoese would have been distributed across the entirety of the English formations. As a consequence, the Genoese would have faced a significantly greater rate of attrition than the longbowman. This becomes even more the case if either Jean de Venette’s description of rain-soaked crossbow strings²⁸ or Villani’s assertion that the archers had some cover are correct.²⁹

In short, there is very little chance that longbow shafts would simply miss their targets; the longer the exchange lasted, the fewer crossbowmen would be left standing.

²⁸ Ayton, “Crécy and the Chroniclers,” 289, n. 10. Newhall is correct in stating that the strings would stretch, not contract, as de Venette suggests.

²⁹ Villani, *Nuova Cronica*, bk. XIII, chap. LXVII.

Longbows used at Crécy and their Rate of Fire

If the roughly 42 g “Abbey arrow” referred to by archery expert, Robert Hardy, was representative of those produced for this campaign, it strongly suggests that the bows’ draw weight would have been not much greater than 70–80 pounds resulting in a maximal range not greatly exceeding 200 yards, somewhat less when using any sort of military shaft. Hardy’s assertion to the contrary notwithstanding, it is highly unlikely that an arrow exceeding 40 g could be fired by a 130-pound bow at full draw (28–30 in.): the “archer’s paradox” stresses would rip it to flinders. And in fact, Hardy’s assertion is directly contradicted by his own technical appendix.³⁰ At any rate, only the professional foresters and retinue archers fighting at Crécy would have had the time and practice necessary to develop specific musculature required to pull this much heavier bow.

In regard to the rate of fire: it is generally understood that a longbowman was capable of firing ten to twelve shots per minute, although perhaps only half as many when aiming carefully at individual figures. At Crécy, it is unlikely that the majority of the archers were engaged in careful aiming at the distance the exchange took place, if for no other reason than it was a waste of time given the nature of the target. A highly practiced archer could certainly fire at individual figures within the target mass, but to make such a shot, he would have to use his own equipment (arrows as well as bows), tailored to his strength. This is, in fact, a serious issue for long-range accuracy with the self bow. Unlike a crossbow, the ability to load and shoot such a weapon is not an all-or-nothing proposal. One man may pull a 100-lb self bow with ease. The next may be able to pull it, but only with considerable effort, while a third may be forced to “tune” the bow to a lower weight, or failing to do so, pull it to only half or three-quarter or its full draw. For close-range shooting at man-sized figures, this may make little or no difference in terms of accuracy, but for long-range shooting it is critical.³¹

³⁰ Robert Hardy, *Longbow: A Social and Military History* (London, 1993), 212, 216, 227 (technical appendix 2). Hardy’s arrow weight table corresponds with general knowledge of wooden-shaft spine weights. One cannot reasonably conflate performance of bows recovered from the Mary Rose shipwreck with equipment used two centuries earlier at Crécy without making some tortured assumptions.

³¹ For example, in backyard practice, I routinely shoot my “strength” bow, which is a 128-lb composite recurve, with an accuracy comparable to a similar bow of 78

From fourteenth-century sources, we know that arrows, and in some cases even the bows, were supplied from a central source and then divided amongst the archers. If one accepts figures for longbow draw weights that start around 80 pounds, then the arrows are likely to have been overbuilt relative to the pull of the less-experienced archer, so as to prevent them from ripping themselves apart in flight due to the stresses of archer's paradox. (One notes, hopefully without risking a debate on "realism" in medieval artwork, that one of the manuscript illuminations for Froissart's account of Crécy depicts three longbowmen, not one of whom has his bow pulled back to a "full draw."³²) Any arrow that is not correctly matched to the strength of one's draw will suffer horizontal displacement in flight, thus lessening its effectiveness against individual targets. The problem would not arise if archers were directing their shafts at the larger "formation target."

While foresters and other elite archers may have used a higher percentage of their own arrows, even they were likely to have made some use of common stores, if only because of the bulk involved in marching while carrying large numbers of arrows. At the same time, run-of-the-mill archers who drew most heavily from those stores would wind up with arrows whose spine weights were poorly matched to the pull weight of their bows. These were precisely the bowmen least likely to be able to compensate for the discrepancy, if, indeed, they were even aware of it.

The rate of fire for the English longbowmen, if precise aiming was not required, rises dramatically.³³ While nobody would mistake me for Robin Hood, the archery-related experiments I have been deeply involved with in the past four years probably place me on par with a "proficient but inexpert" archer in Edward III's forces. When shooting for speed into a generalized target, the sort presented by the Genoese

pounds (at my weight limit), even though the weight of the "strength bow" limits me to no more two thirds of its full draw.

³² Bibliothèque Nationale, Paris, Ms. Fr. 2642, f. 159v. There are, admittedly, a number of ways in which this could be explained away, one of which is that this does not occur consistently in illuminations of the period. For comparable illustrations of crossbowmen in siege warfare, see Pamela Porter, *Medieval Warfare in Manuscripts* (Toronto, 2000), 37, 44, 50–51.

³³ Ayton and Preston's "controlled volleys" ("Topography," 370) are an interesting attempt to explain the encounter, and no less conjectural than some of my own suppositions, but still problematic. While compatible with Villani's "cloud" of arrows, their suggestion is made at the price of discounting almost the entirety of Froissart's account of the encounter.

formation, I shoot at a consistent 16–17 shots per minute, a rate of fire limited directly by my ability to fit the nock of the arrow to the string. One of the easiest ways of telling how much a traditional archer has practiced is not via his shooting, which may reflect a number of unnoticed and therefore uncorrected faults, but the degree to which the archer has to pay attention in order to nock an arrow.³⁴ Having seen more practiced archers literally double (and in one case, triple!) that rate of fire, it seems reasonable to take my admittedly anecdotal shot speed as a benchmark. At this rate of firing, in the first thirty seconds, 7,500 archers could put a total of sixty thousand shafts into the air, into a target area that would be all but impossible to miss.

It is no wonder, then, that the “rate of fire” argument captures such attention. The argument has a serious problem, however: it works too well. If, in one of the classic examples of shooting fish in a barrel, nine out of every ten shafts did nothing but hit the ground inside the Genoese formation (a very unlikely scenario for reasons already specified), that would still leave enough shafts to put every single crossbowman out of combat before the French knights had a chance to receive Philip’s order to attack the Genoese, let alone to actually engage them. Robert Hardy suggests that 15 “reasonably-aimed” shots a minute would be more than sufficient to accomplish the task.³⁵ An extremely conservative 12 shot-per-minute average would still result in the English putting 45,000 shafts into the air in the first thirty seconds of combat.

The stream of English arrows would probably not have been evenly distributed throughout the Genoese formation: while many archers would shoot at the crossbowmen closest to them, others would tend to fire into the center of the target area in order to improve their chances of obtaining a hit. The result of all this would be a marked “clumping” of arrow fire within the Genoese formation. Nevertheless, the very number of arrows would tend to blanket, even if unevenly, the entire force of crossbowmen. Unless one entertains a radically low assessment of the skill of the English longbowmen, within at most two minutes, there should not have been enough crossbowmen left

³⁴ As opposed to archers using modern compound bows, which operate much more like a crossbow than a traditional self-bow.

³⁵ Hardy, *Longbow*, 68.

on the field for the French men-at-arms to attack or to shoot at these mounted attackers.³⁶

The rate of fire argument is compelling, because in the abstract it is so obviously, overwhelmingly correct: English archers could lay down a killing field of fire that Genoese crossbows could not match, turning a relatively small area of the field into a virtual pin cushion. But is this what really happened? Or must other factors be taken into consideration in explaining the Genoese retreat?

Whither the Pavises?

While the “rate of fire” argument rests solidly upon narrative evidence, so too does something else: it is clear that the Genoese were not allowed to wait until their full equipment, including *pavises* and presumably extra bowstrings, had arrived at the scene of battle. This fact should lead historians to ask the critical question, “would it have made much of a difference if the Genoese had possessed their *pavises* during the battle?” In the statement quoted at the beginning of this article, Clifford Rogers seems to indicate that the absence of *pavises* was merely an aggravating factor in the crossbowmen’s defeat, that their real problem lay in the English rate of fire. It is with this view that one may take issue.

In fact, the arrival of the *pavises* and the rest of their equipment would almost certainly have had a significant impact on the opening stages of the battle. For one thing, had the insertion of the Genoese into the fight awaited the arrival of their baggage, the battle of Crécy would not have opened as a contest between troops who were reasonably well-rested and those who were already tired out from hours of marching. Also, unless one seriously posits that professional crossbowmen would go on campaign without a supply of spare strings, one must assume that the arrival of baggage would have rendered any effect the weather may have had on the crossbows a non-issue.³⁷

³⁶ Without any means of creating an ordered front, any relatively small groups of surviving crossbowmen would have been trampled flat from the sheer mass of impact.

³⁷ If, in fact, crossbow strings were so sensitive that any lingering dampness on the battlefield might have reduced their effectiveness, it is unlikely that one they would have been used so extensively the troops of the Teutonic Order, during their operations in north-central Europe, in conditions which were vastly more humid.

The fact that crossbowmen were accustomed to fighting on an open field from behind the protection accorded by *pavises* may help account for Froissart's strange assertion that before they let fly, the Genoese took a short leap forward accompanied by a yell. Though in the chronicle this maneuver seems almost quaint, it may have been part of a ritual, meant to be accompanied by thousands of heavy wooden shields crashing to the ground in unison. While in the absence of the *pavises*, it might seem almost comical, their presence could render it intimidating.

We cannot calculate the Genoese rate of fire, since we don't know whether they trained to shoot individually, or as teams with dedicated shooters and loaders. Nor do we know whether soldiers deployed *pavises* individually or gathered themselves behind a row (or rows) of these shields as was the common practice in fifteenth-century Central Europe. In either case, the presence of these shields would have afforded shooters considerable protection of the sort they entirely lacked at the actual battle.

Under these altered circumstances, just what sort of a target would the English have been shooting at? Since one can assume that faced with a rain of incoming arrows the Genoese would cling tightly to their shields, the addition of this bulky piece of equipment might not mandate that much of an increase in the overall size of their formation. So assuming that the Genoese were smart enough to stay behind their *pavises*, the "individual *pavise*" scenario would result in a total target area of roughly the same size or perhaps even slightly smaller since rather than standing upright, the front row of crossbowmen might have crouched down slightly behind their *pavises*. But while the overall target available to the English would remain just about equal, the real question becomes, how much damage could shafts fired into that target area be expected to inflict upon crossbowmen huddled behind their *pavises*?

Here, the answer is simple: damage inflicted by English arrows would be much, much less—despite the longbow's vaunted rate of fire advantage! Figure 4 shows the maximum possible target area available to English arrows, both with and without the presence of *pavises*. In their presence, arcing fire would have two clear advantages over direct fire. First, it would permit English archers to hit "behind the shield" into the crossbowman's upper body. Nevertheless, part of the target area that could be struck this way—the upper lungs and subclavian arteries—would be completely unavailable to direct fire due to protection afforded by the *pavise*. Either such hit would be immediately incapacitating.

Secondly, arcing fire could also be directed against the entire formation rather than just those crossbowmen completely visible to the archer.

On the other hand, whether the fire was direct or arcing, the *pavise* would provide hard cover, which in combination with the kettle-helm worn by individual crossbowmen might obscure as much as 90% of each individual so shielded. In a formation where the presence of *pavises* protects so much of the soldier's body, the issue of just how much protection the helmet might afford takes on increased importance. The degree to which the kettle helm would protect a crossbowman's face, neck, and/or shoulders from arcing fire is a direct function of the angle with which the individual shaft hit the formation. Nevertheless, whatever the angle, one must remember that a kettle helm is a fairly stout piece of equipment.³⁸ Archery tests conducted upon a sallet, a not dissimilar piece of head armor, have demonstrated that penetration could occur, but would be by far the exception, rather than the rule.³⁹ While such a hit would undoubtedly produce a battering effect that might slow the crossbowman's shooting or even knock him out, it would rarely kill or permanently disable him. What is more, it is safe to surmise that a shaft hitting *on the rear* of the man's helm would rarely accomplish more than just grazing the wearer's shoulder or back or perhaps simply skittering off harmlessly.⁴⁰ An arrow that did pass just behind a crossbowman's shoulder would be likely, depending on how the crossbowmen lined up within the formation, to either strike the ground or the *pavise* of the crossbowman behind him.

The situation regarding "horizontal space" is much the same. Here, target areas that could have produced any meaningful effect are also greatly reduced by the presence of *pavises*. Flank or angled shooting might improve the odds of hitting behind the shield, but not all that

³⁸ Interestingly, Froissart describes arrows piercing the crossbowmen's heads. Having marched six leagues under circumstances making an ambush exceedingly unlikely, is it possible that a number of Genoese had left their kettle helms with their *pavises*?

³⁹ In Budapest during earlier experiments, the kindness of a local historical re-enactor allowed us the serendipitous chance to fire upon a replica of a fifteenth-century German harness. The harness' sallet defeated all but one shot, the bodkin head of which penetrated cleanly through a weak point at the temple with enough energy to create what would have been an immediately fatal wound.

⁴⁰ For reasons already stated, I believe that such an angle would be roughly 45 degrees, but this need not be the case. The more direct the fire, the more the front ranks will obscure those behind them; whereas plunging fire down from a very high angle will be increasingly likely to strike into *pavises* or the ground.

dramatically if the Genoese were well trained in the use of their *pavises*. In addition, extensive shooting from the flanks would presuppose the “archers on the wings” theory of the English formation, which is not generally accepted.

By the simple expedient of turning around into a deep crouch while reloading, or else taking advantage of the *pavises*’ three-dimensional design to stack them one on top of the other, the target area would almost completely vanish except at the moment when the crossbowman was actually firing. English archers’ would have had only two remaining options: first, to attempt direct fire at a face-sized target that was continuously appearing and then disappearing behind a *pavise*—with a three-to-four-second flight-time delay built into the process;⁴¹ secondly, to attempt, if range allowed, “true” plunging fire at 60–80 degrees in the air, in hopes that the shaft would come down directly onto the man behind the *pavise*.⁴² Both options would present a formidable challenge for even the best archers in the English ranks, not to mention their less talented comrades.

At this point, one can reasonably argue that the presence of the *pavise* would render the rate of fire almost irrelevant, in turn, shifting the contest to one of accuracy. This is ground upon which the crossbow is generally as dominant as the longbow is when it comes to rate of fire. If Villani is correct when he describes the English archers as having cover among the wagons, then, in the presence of *pavises*, the opening phase at Crécy might have resembled an artificial siege with archers on both sides firing from behind concealment. This is, of course, the natural and preferred terrain of professional crossbowmen. If Villani is wrong about the English having cover, then what we would have is a recipe for slaughter, but his time within the English ranks—a slaughter that might have forced the English king to abandon the advantages of the his carefully-picked position.

Given what we know of the maulings regularly inflicted on the Ottomans by a combination of heavy cavalry and *pavise*-equipped crossbowmen during the late-fifteenth century, one can say that Philip

⁴¹ Medieval “whack-a-mole,” anyone?

⁴² Even if the weather is absolutely calm, a high-arcing shot is inherently difficult. At the same time, even if one could follow the progress of a single shaft in the midst of the “arrow blizzard,” the *pavises* themselves would thoroughly obstruct the view of the archer. They would make it impossible for the archer to see where his arrow landed in order to “range” the crossbowman, a problem that grows more acute if the crossbowman were on sloping terrain.

VI's battle plan was essentially sound. Had the king been able to avert a rush to battle, taking time to deploy his crossbowmen as they were meant to be deployed, the early stages of the Hundred Years' War might have turned on a very different axis.

The Basis for a New Battle Narrative

“What ifs” make for interesting conjecture, but do not constitute history. Philip VI did *not* adhere to his original plan, but instead committed the Genoese crossbowmen to battle both exhausted and ill-equipped. Instead of pursuing the “what if,” let us ask a fundamentally different question: “What are the chances that the Genoese crossbowmen, being professional—even elite—soldiers, were not perfectly aware of the ramifications of Philip VI's order that they enter the battle virtually unprepared?”⁴³

Worn out and lacking at least one essential piece of their equipment, their major protection on the field of battle, there was no way that the Genoese could have survived a true missile duel with Edward III's greater number of longbowmen. While the entire historiography of the battle of Crécy revolves around the notion that the Genoese were completely outmatched, that is at best only partially correct. In a world that preferred individual deeds of arms performed by men-at-arms, this valuable fighting force was more or less thrown away *and they knew it*. Effectively ordered to commit suicide by Philip VI, they put in the minimum possible performance at long range, then immediately attempted to quit the field. At this point, they were attacked by the French who saw through their departure. They were wiped out by a combination of *unanswered* archery fire, attacks from mounted French men-at-arms and dismounted sergeants, as well as the horrific effects of trampling and suffocation from overcrowding.

Considered in this light, subsequent events make better sense. Philip VI and the French chivalry did not attack the Genoese out of any fit of adolescent pique. Their anger at the crossbowmen becomes quite understandable when instead of standing and fighting, they withdrew

⁴³ Ayton and Preston, “Topography,” 369. The authors consider this momentarily, but fail to give it any weight in comparison to the standard technologically-abstracted argument.

as quickly as they could. From a French point of view, this was obvious evidence of cowardice, if not treason.⁴⁴

What happened, though tragic, was based upon reasonable conclusions by all parties involved. The Genoese concluded that they were being sacrificed to no purpose and so they withdrew. The French, particularly those unfamiliar with the crossbowmen's plight, saw that withdrawal as cowardice or even disloyalty. Nor can one really blame the Genoese for turning their weapons on the French when the latter attacked them.

What ensued was a tactical disaster, albeit one that need not have occurred had a potent weapons system available to the French not been criminally misused. French men-at-arms were eventually able to engage the English formations, but in very poor order. Horses either foundered on piles of bodies or else were maddened by archery fire, some of it launched by those last, hapless crossbowmen. The French made valiant but piecemeal attacks upon dense English formations ensconced in prepared positions, positions that stood on higher ground and were supported by point-blank missile fire into the attackers flanks.⁴⁵ Welsh skirmishers finished off the wounded and greatly added to the overall confusion. Finally, and in spite of the pleadings of their king, what remained of the French withdrew, realizing that they were in a tactically hopeless situation.

The chronicles of the two sides present conflicting views of the battle. The English, in stark contrast to the French, gave relatively little credit to their longbowmen for the victory. The principal credit was to be given to the Black Prince and the members of his retinue, for bearing the brunt of a disorganized, but valiant assault for hours on end. While having the longbowmen had been a definite advantage, it was the contemporary English view that these troops could not have salvaged the battle had the Black Prince's retinue broken.

⁴⁴ This is supported as well by Villani: *I cavaliere francesci e lloro sergenti veggendoli fuggire, credetono gli avessono traditi, ellino medesimi gli uccidieno.*

⁴⁵ Geoffrey Le Baker, *Chronicon*, ed. E. M. Thompson (Oxford, 1889), 83–84, quoted in Rogers, *War*, 266. Note that this sort of firing would also be much slower, as targets of opportunity were picked for carefully-aimed shots. It is reasonable, therefore, that the longbowmen were running out of ammunition by the end of the battle, rather than having completely exhausted their supplies within the first few minutes of shooting, given both the advance of friendly troops into the kill zone, and the fact that *the sun set during the battle.*

By contrast, French chroniclers emphasize to a much greater extent than their English counterparts, the importance of English archery. After all, while the longbowmen did not win the battle single-handedly, there could be no minimizing the horror they inflicted on their adversaries. Much of the disorder in French ranks could be traced to the archers' activities. Horses and men fell before their shafts. And the cream of French society laying dead in heaps without ever having had a chance to come to blows with an enemy a tantalizingly short distance away. The fact that some French horsemen were able to force a path at all through this midden of wounded and dying should be regarded as an achievement worthy of some admiration in and of itself. For while one might pick one's way through or over dying footmen, one cannot, after all, ride or walk over a dying horse, let alone hundreds of them, as they thrash and roll about on the ground.⁴⁶

According to Bertrand Schnerb, Crécy was a defeat from which the French leadership was unable to learn.⁴⁷ On the other hand, a detailed consideration of exactly what happened at Crécy seems to place the lion's share of blame on Philip VI's shoulders, and much less upon the French army in general. Had the king withheld his crossbowmen until such time as they were prepared to fight—and fight effectively—Crécy would almost certainly not have become the military disaster it did.

If this revisionist reconstruction of what took place in the first phases of the battle is correct, it provides some grounds for rehabilitating the French. In fact, following Crécy, they recognized both the power of the longbow and its ramifications in battle, as well as their own mistakes during the conflict: *par hastivité et desarroy furent les Français desconfiz* (by hastiness and disorder were the French defeated).⁴⁸

⁴⁶ Villani, *Nuova Cronica*, bk. XIII, chap. LXVII: *ch'ellino medesimi s'affollarono l'uno sopra l'altro al modo che divenne loro a Coltrai co' Fiaminghi, e specialmente gl'impediro I Genovesi morti, che n'era coperta la terra della prima rotta battaglia, e' cavalla afollati morti e caduti, che tutto il campo n'era coperto, e fediti delle bombarde e saette, che non v'ebbe cavallo di Francesci, che non fosse fedito, e innumerabili morti.*

⁴⁷ Schnerb, "Vassals," 272.

⁴⁸ *Chronique des quatre premiers Valois (1329–1393)*, ed. Siméon Luce (Paris, 1862), 16; Ayton, "Crécy and the Chroniclers," 289.

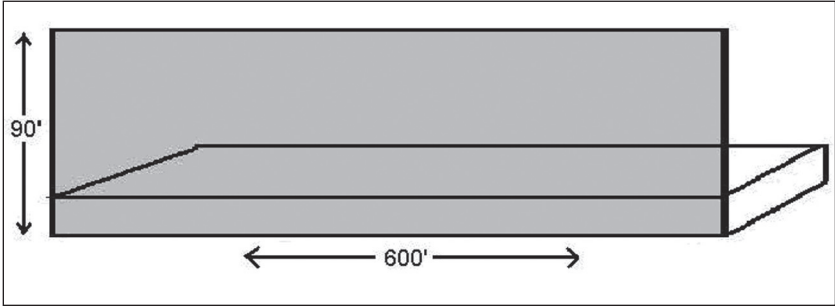

Figure 1: Visualization in three dimensions of the space occupied by the Genoese, with the “effective target area” for the English longbowman shown in grey.

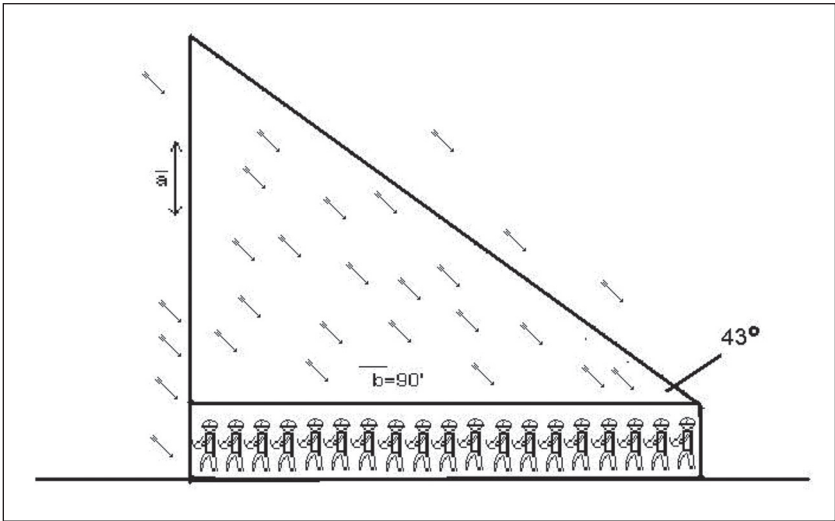

Figure 2: Formation Depth as a Gauge to Missile Fire. An arrow falling at 45-degrees must be within height “a” in order to fall into the Genoese formation.

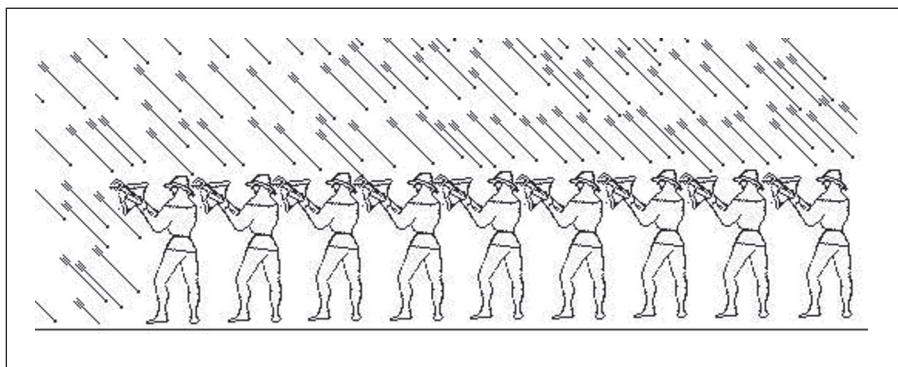

Figure 3: Even though there is empty space inside the Genoese formation, both the crossbowman's legs and the ground between them tend to be shielded by the body of the man in front.

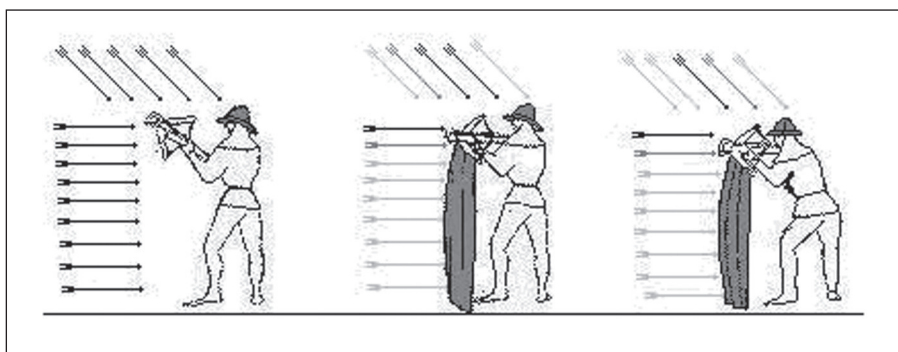

Figure 4: Target area without *pavis*, with least favorable use of *pavis*, and with more favorable use of *pavis*, with an identical distribution of incoming arrows. The darker the arrow, the more likely a meaningful hit.



Figure 5: A crossbowman bending his bow with a belt-claw, and then aiming his Crossbow (From Viollet-le-Duc).

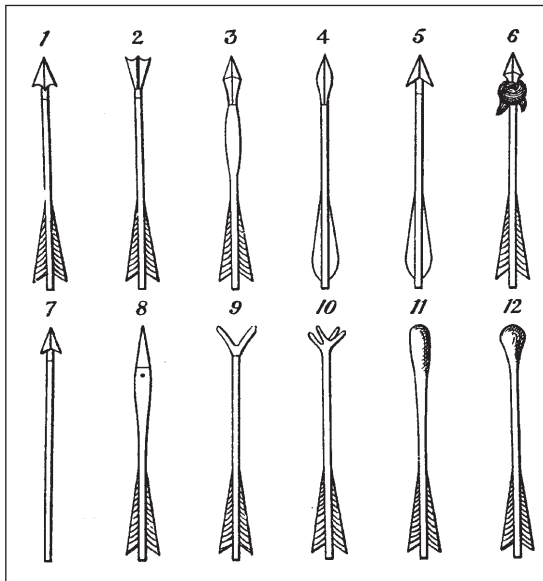

Figure 6: Different forms of crossbow bolts. 1, 2, 3, 4, 5, 6, 7 are military bolts; 6, bolt with tow soaked in oil for firing at ships and wooden structures; 7, Bolt for a Slur Bow; 8, Bolt for Killing Deer; 9, 10, Bolts for Killing Large Birds; 11, 12, Bolts for Killing Game Birds. The Latter did not have Metal Heads, and were Blunt, so as not to Damage the Game.

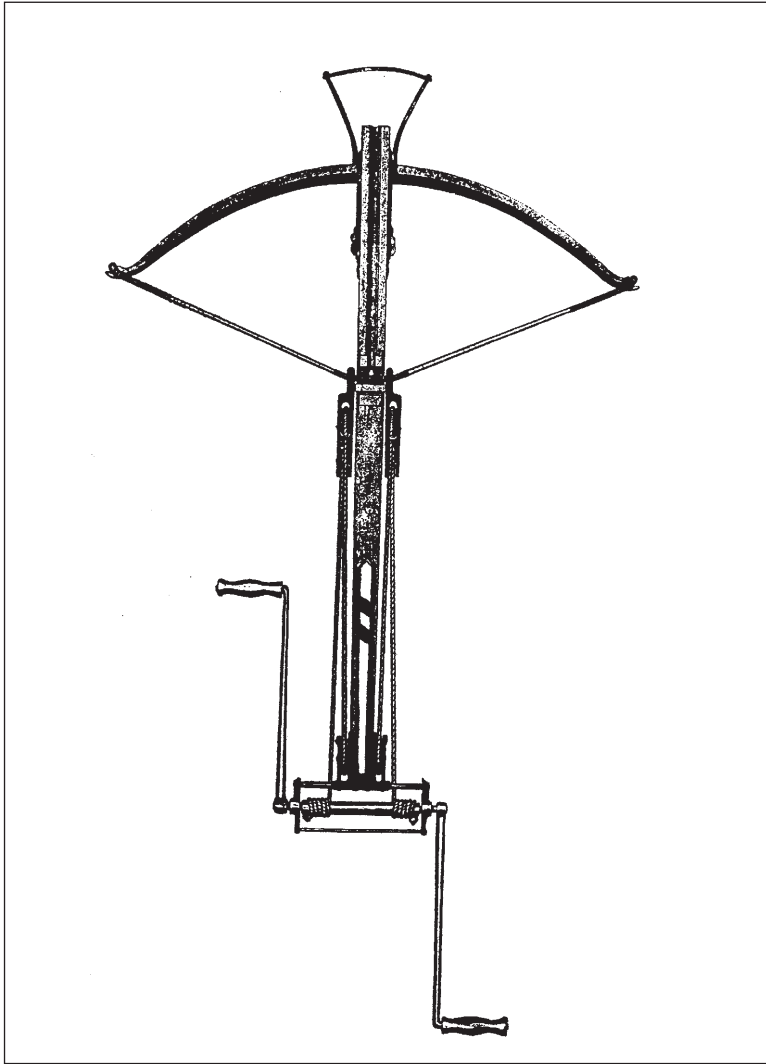

Figure 7: Crossbow with its bow bent by the windlass and its bow-string secured over the fingers of the nut.

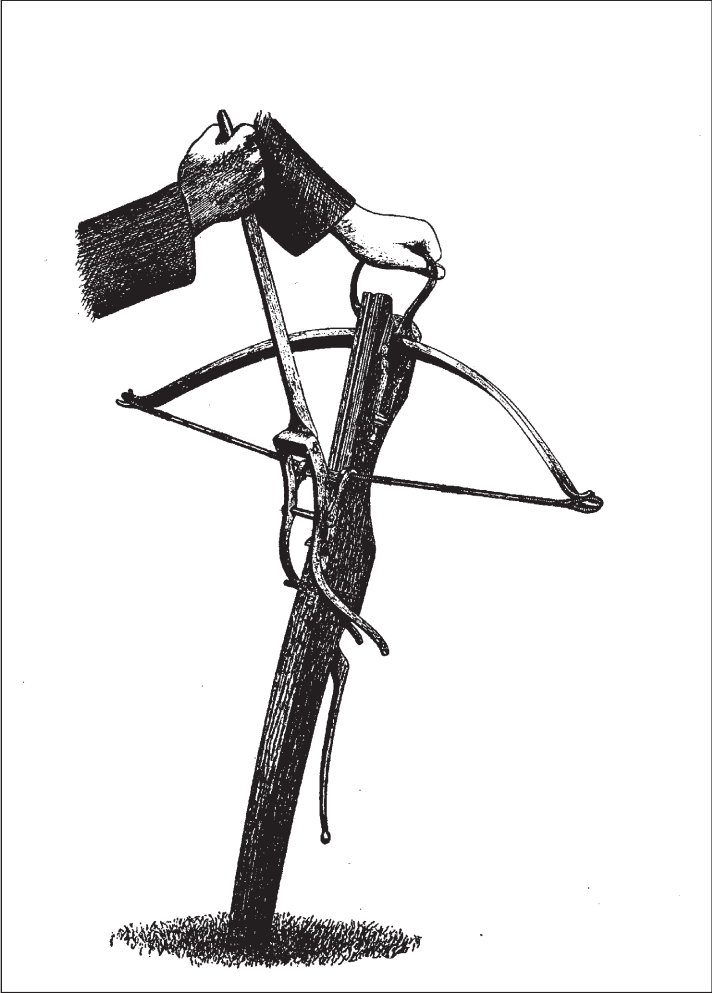

Figure 8: A military crossbow being bent by a goat's-foot lever.

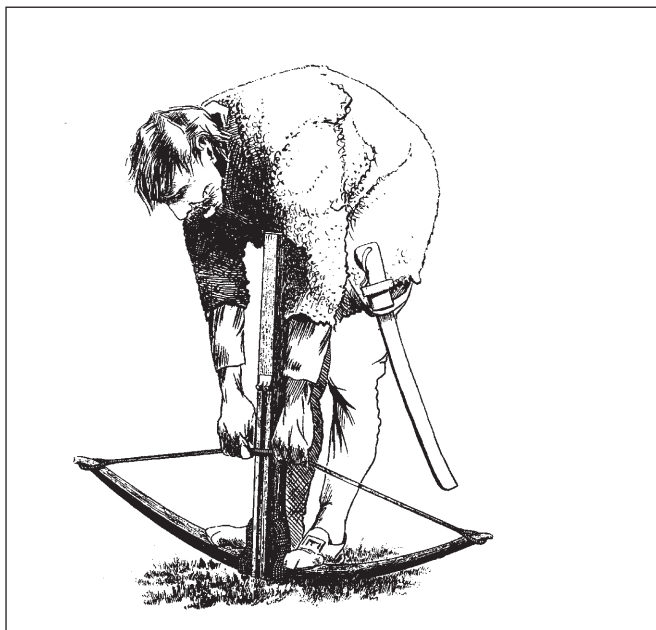

Figure 9: Primitive crossbow without a stirrup.

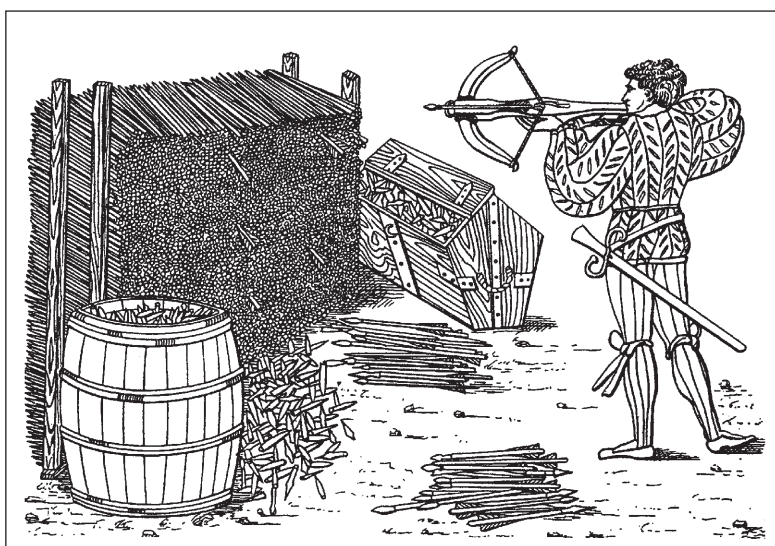

Figure 10: A store of crossbow bolts, shafts, and heads. The crossbowman is aiming at a target to the left of the picture (from a catalogue of the arsenal of Emperor Maximilian I (1459–1619).

PART FIVE

MILITARY PARTICIPANTS IN
THE HUNDRED YEARS WAR

PHILIP VI'S MORTAL ENEMY: ROBERT OF ARTOIS AND THE BEGINNING OF THE HUNDRED YEARS WAR

Dana L. Sample†
The University of Virginia's College at Wise

Sometime around 1346, an anonymous poet wrote *Les vœux du héron* (*The Vows of the Heron*), a French vowing poem about the beginning of the Hundred Years War. Robert of Artois presents a heron, the symbol of cowardice, to Edward III (1327–1377) to goad him into going to war with Robert's great enemy, King Philip VI of France (1328–1350). Edward and several other English nobles vow on the heron to wage war on Philip so the English king can claim his right to the French throne.¹ Although few scholars have put much faith in the historical accuracy of the poem, its interpretation may need some revision. The actual vowing ceremony probably never took place, but the animosity between King Philip and Robert of Artois, a peer of France and an over-mighty subject, was both real and persistent.

In a letter dated March 7, 1337, Philip proclaimed his vassal to be a mortal enemy for having committed "certain crimes" and for having conspired against "us and our royal majesty." The king warned any of his liegemen who helped or provided refuge to Robert that they would suffer the confiscation of their lands and, perhaps, even execution. He also ordered the contents of the letter published throughout his realm and the letter itself to be affixed to the door of his palace in Paris.²

Two months later, Philip proved as good as his word when he announced the confiscation of Gascony from its duke, Edward III of England, who was harboring the exiled Robert at the English court

¹ The modern edition of this poem is *The Vows of the Heron (Les Vœux du Héron): A Middle French Vowing Poem*, ed. John L. Grigsby and Norris L. Lacy, Garland Library of Medieval Literature, Series A, vol. 86 (New York, 1992).

² Paris, Archives Nationales (AN), JJ 20, ff. 194v–195v. The original of this letter has not survived but it was transcribed in registers containing copies of documents pertaining to the case of Robert of Artois. Citations from these documents will come from the register designated as AN, JJ 20, which was analyzed and edited in Dana L. Sample, "The Case of Robert of Artois (1309–1337)," (Ph.D. diss., City University of New York, 1996).

and providing him with an income. Philip accused Edward of being a rebellious and disobedient vassal for, among other things, allowing Robert of Artois safe refuge in his kingdom. Afterwards, he wrote to the seneschal of Périgord that he had confiscated Gascony “for the security of our kingdom.”³

I

Most historians consider the seizure of Gascony in May, 1337, as the start of the Hundred Years War, and they have long recognized that Robert of Artois’s association with Edward III influenced the French decision. Few, however, have accorded much importance to the viewpoint of French contemporaries, that Robert was, in the words of P. S. Lewis, “the evil genius who urged Edward III to war in the 1330s.”⁴ Documentary evidence suggests, however, that Philip’s relationship with the nobleman may have played a considerably larger role in the outbreak of war than is usually thought.

Robert was not simply a convenient *casus belli* in 1337; the king and his officials had begun to pursue him long before that year, as court transcripts, royal letters, papal missives, diplomatic correspondence, and chronicles amply demonstrate. Such materials, especially those relating to Robert’s infamous and unsuccessful claim to the county of Artois, have been largely ignored in examining the outbreak of the Hundred Years War. These same documents show that King Philip had at least three good reasons to designate Robert as his “mortal enemy”: (1) Robert was convicted of two serious crimes, forgery and subornation of perjury, resulting from his scandalous lawsuit to claim the county of Artois; (2) Robert threatened to kill Philip, his family, and other French magnates after he lost the suit; and (3) Robert acted against Philip’s interests in the Low Countries and England. All of these actions embittered the French king against his vassal and later made him a perfect scapegoat in the war of propaganda. In short, the crown endured a long and troublesome connection with Robert of Artois that needs to be reconsidered as an important factor in the failure of Anglo-French diplomacy during the 1330s.

³ This letter is reproduced in *Oeuvres de Froissart*, ed. Joseph-Marie-Bruno-Constantin Kervyn de Lettenhove, 28 vols. (1867–77; reprint, Osnabrück, 1967), 18:33–37.

⁴ P. S. Lewis, *Later Medieval France: The Polity* (New York, 1968), 40.

II

For the most part, historians of the twentieth century have failed to re-assess Robert's role in bringing about the Hundred Years War. Following the trends of modern historical writing, many have explained the outbreak as the result of long-term problems between England and France, such as the feudal and jurisdictional status of Gascony, the conflicts over Scotland, and the disputed succession to the French throne, to name just three. The impact of a single individual comes far down on this list, if, in fact, it appears at all. Edouard Perroy, for example, briefly explains Robert's claim to Artois, then erroneously attributes his presence in England to an accusation that he had poisoned his aunt Mahaut, the countess of Artois. In the end, Perroy admits that Robert may have influenced the English claim to the French throne, but argues that the English king did not really need outside pressuring in order to undertake that action.⁵

Other historians have blamed Edward, rather than Robert of Artois, for the breach with Philip. Both John le Patourel and Malcolm Vale argue that the English king had broken his feudal contract by refusing to hand over the refugee.⁶ Eugène Déprez, who based his work on English diplomatic sources, interprets the nobleman's role in the limited context of the confiscation of Gascony.⁷

A few scholars of the Hundred Years War have considered Robert's influence in somewhat greater detail. For example, Henry Lucas, in his study of the Low Countries, writes of Robert's history after the flight from France, arguing that he had helped his English ally gather supporters on the continent. Lucas cites a few documents demonstrating Philip's growing antagonism, but does not analyze them in any detail.⁸ Jonathan Sumption's massive tome on the early years of the Hundred Years War also treats Robert of Artois more fully;

⁵ Edouard Perroy, *The Hundred Years War* (Bloomington, 1959), 93.

⁶ John le Patourel, "The Origins of the War," in *The Hundred Years War*, ed. Kenneth Fowler (London, 1971), 28–29; and Malcolm Vale, *The Origins of the Hundred Years War* (Oxford, 1996), 259. See also J. R. Maddicott, "The Origins of the Hundred Years War," in *England in Europe: 1066–1453*, ed. Nigel Saul (New York, 1994), 142–43; Anne Curry, *The Hundred Years War* (New York, 1993), 52–53; and Christopher Allmand, *The Hundred Years War: England and France at War c. 1300–c. 1450* (Cambridge, 1988), 11.

⁷ Eugène Déprez, *Les préliminaires de la guerre de cent ans: la papauté, la France et l'Angleterre (1328–1342)* (Paris, 1902), 135–36, 165, 224–25.

⁸ Henry Lucas, *The Low Countries and the Hundred Years War, 1326–1347* (Ann Arbor, Michigan, 1929), 176–216.

nevertheless, like the majority of historians, Sumption largely discounts the contemporary opinion that Artois “started” the war. Instead, he theorizes that Philip VI simply used Robert as his justification for going to war, hoping to gain support from many French nobles, who were also Robert’s foes. According to this view, the French king acted more from calculation than from outrage over Robert’s treason.⁹

Only a relatively small minority of historical opinion has placed Robert of Artois anywhere near center stage. According to Michael Jones, there is very little evidence supporting the contention that Edward himself insisted on claiming the French throne. Therefore, “contemporary opinion that it was Robert of Artois who persuaded Edward of his rights may need to be taken more seriously than is customary.”¹⁰

III

In his own mind, Robert of Artois had good cause for betraying Philip VI. To understand their enmity fully and to appreciate why it became so all-consuming, one must go back to the younger years of both men, for the king had not always considered the nobleman his “mortal enemy.” In fact, the opposite is true. For many years, Philip and his father Charles, count of Valois, had openly supported Robert’s pretensions as the count of Artois against those of his aunt, the countess Mahaut.

The issue of conflicting claims to the county of Artois was aired for the first time in 1309 when Philip IV “the Fair” (1285–1314) considered in the presence of a large and distinguished group of nobles and councilors arguments put forward by both Countess Mahaut and Robert of Artois. On this occasion, he came down on the side of the countess. Nearly a decade later, in May, 1318, a new king, Philip V (1316–1322), revisited the question, again ruling in favor of his mother-in-law, Mahaut, insisting at the same time that peace be maintained between the two parties. In order to promote such a peace, Philip V required a number of Robert’s supporters to sign and seal a letter promising to

⁹ Jonathan Sumption, *Trial by Battle*, vol. 1 of *The Hundred Years War*, 2 vols. to date (Philadelphia, 1991), 170–73.

¹⁰ M. C. E. Jones, “Relations with France, 1337–9,” in *England and Her Neighbours, 1066–1453*, ed. M. C. E. Jones and M. Vale (London, 1989), 251. See also Curry, *Hundred Years War*, 52–53.

restrain both parties from overturning the king's decision.¹¹ Among the prominent nobles who supported Robert and the royal decree were the count of Valois and his son, Philip (the future Philip VI). The amicable relationship between Robert and the house of Valois was solidified in that same year when Robert married the count's daughter, Jeanne of Valois, half-sister of the future king.

Ten years later, Robert championed Philip of Valois's claim to the throne when the last Capetian, Charles IV (1322–1328), died without sons. According to later tradition represented by the Flemish chroniclers, Jean le Bel and Jean Froissart, Robert had strongly supported Philip and had been rewarded with a prominent position in the new king's government. As Froissart put it, Robert became one of the most influential men in Philip VI's council.¹²

Whatever one's judgment on the reliability of Jean le Bel or Froissart, other evidence supports their stories. According to the more reliable chronicler of Saint-Denis, Robert was an important participant in Philip's campaign against the Flemish, culminating in the French victory at the battle of Cassel.¹³ In the early months of his reign, the king granted Robert the sizeable income of 3000 *livres tournois* [hereafter abbreviated l.t.] from the treasury. Even more indicative of royal favor was the fact that in January, 1329, the king made Robert's county of Beaumont-le-Roger a peerage, bestowing on him and his heirs the title of peer of France.¹⁴ This gave Robert a status equal to his aunt, the countess of Artois.

Further confirmation of the extent to which the crown favored Robert can be seen in respect to his dispute over Artois. For the first time in the twenty years that the nobleman had been seeking a positive resolution to his claim on the county, the odds rested with him rather than his aunt. He lost little time trying to press his advantage. The king

¹¹ The other seals belonged to Louis, count of Evreux; Charles, count of La Marche (the future Charles IV); and Louis, count of Clermont. The letter was copied several times, although the original seems to have disappeared; see, for example, AN, JJ 20, fol. 90v.

¹² Jean le Bel, *Chronique de Jean le Bel*, ed. Jules Viard and Eugène Déprez, (Paris, 1904), 95–96; and Froissart, *Œuvres de Froissart*, 2:215–16, 297–98.

¹³ *Les grandes chroniques de France*, ed. Jules Viard, (Paris, 1937), 85.

¹⁴ *Registres du Trésor des Chartes, inventaire analytique*, vol. 3: *Règne de Philippe de Valois*, ed. Aline Vallée, part 1, nos. 91 and 2208. For more on the early relationship between Philip VI and Robert of Artois, see Raymond Cazelles, *La société politique et la crise de la royauté sous Philippe de Valois* (Paris, 1958), 76–81.

agreed to re-open the case after Robert informed him that long hidden letters proving his claim had been discovered. Although he had not yet been able to produce the letters, he nevertheless persuaded his royal brother-in-law to set up a commission to interview witnesses both in Paris and Arras concerning their existence. In his letter of June 7, 1329, Philip appointed the eight commissioners and ordered them to begin an inquiry.¹⁵ They established to their satisfaction that letters did exist, even if they had not been found; consequently, in December, 1329, the king formally granted Robert permission to pursue his lawsuit.¹⁶

The new hearing was the beginning of the end for their friendship. By December, 1330, Robert had obtained the letters, which he presented to the king and his court. Philip, proclaiming himself annoyed at the fraud that had been perpetuated on his brother-in-law, ordered the letters read aloud in open court.¹⁷ The triumph, however, was short-lived. The duke and duchess of Burgundy, who at that time also claimed Artois, insisted that the letters be examined; as a result, they were quickly proven to be forgeries.¹⁸ Witnesses who had testified in 1329 as to their existence were branded as perjurers and those who had not already fled the realm were detained. Some of these prisoners now confessed that Robert had known all along that the letters were fabrications; in fact, he himself had perpetrated the scam. At first, Philip gave his brother-in-law every opportunity to defend himself, but when, despite being subpoenaed four different times, Robert refused to appear before a gathering of his peers to answer criminal charges, the king's attitude hardened.

Criminal activity on the part of any great noble would have been a cause for concern. Philip, however, seemed to take Robert's betrayal particularly hard. Michaelmas, 1331, the date on which Robert failed to appear in court, marks the beginning of Philip's ongoing attempt to capture him. For the next six months, royal prosecutors continued to summon the king's brother-in-law three more times, sending the *baillis* of Troyes, Meaux, and Anjou, along with several royal councilors to

¹⁵ AN, JJ 20, fols. 4v–5.

¹⁶ AN, JJ 20, fols. 40r–v.

¹⁷ AN, JJ 20, fol. 93.

¹⁸ Mahaut of Artois had died in November, 1329. Her daughter Jeanne, the widow of Philip V, inherited the county, but she died unexpectedly in January, 1330. Their daughter, also Jeanne, who was married to Eudes, the duke of Burgundy, became the new countess of Artois and performed homage for it to Philip in August, 1330, while Robert of Artois was still preparing his case.

bring in the fugitive. Although they traversed Robert's lands and sought him at his known haunts, he was nowhere to be found.¹⁹ In April, 1332, the court convicted Robert *in absentia* and sentenced him to banishment and the confiscation of his estates.²⁰ By that time, however, he had fled France and was hiding out in Brabant, where he remained most of the time until his escape to England sometime between 1334 and 1336.

IV

The case of Robert of Artois is one of the best-documented trials in medieval French history. Philip VI himself ordered the compilation of registers containing copies of relevant materials. Records generated by the case as well as related court actions were carefully preserved. Two registers, probably finished in 1337, and several shorter or incomplete record books survive today. One of the longest of these, deposited in the Bibliothèque Nationale de France, contains over ninety documents, prefaced by two illuminations picturing the king presiding over an assembly of nobles and prelates.²¹ Another long manuscript, almost an exact copy of the Bibliothèque Nationale register, but without accompanying decoration, resides in the Archives Nationales in Paris, housed with other judicial registers of the Capetian and Valois kings.²² Two partial manuscripts were bound with the Archives Nationales register. Another incomplete copy also survives in the Bibliothèque Nationale.²³ The somewhat unusual organization of the documents details the downfall of Robert of Artois, culminating with the letter issued by Philip VI proclaiming his former friend to be his mortal enemy.

Most registers compiled by the royal notaries of the late Capetians and the early Valois periods do not serve as narratives. Notaries registered royal acts, often by order of the king. Very important acts were registered in several places: in Parlement, in the Chamber of Accounts,

¹⁹ The reports of the *baillis* and councilors are copied in AN, JJ 20, fols. 97–102, 103v–108v, 111–121v.

²⁰ The order of banishment and confiscation is transcribed in AN, JJ 20, fols. 124–126v.

²¹ Paris, Bibliothèque Nationale de France [BNF], Ms. fr. 18437.

²² AN, JJ 20.

²³ AN, JJ 20² and AN, JJ 20³; BNF, ms. fr. 4774.

in the Châtelet, and in the chancery.²⁴ Sometimes duplicate copies of registers were made, but not always. By contrast, those involving the downfall of Robert of Artois were repeatedly copied until they reached eight or more in number. The royal archives (the *Trésor des chartes*) possessed three copies including the two that have survived. The Louvre held two of the registers; two or possibly three copies were deposited in the Chamber of Accounts; and one may have been placed in the archives of the Parlement of Paris.²⁵ Even though only two have survived, the large number originally compiled implies an importance not accorded to other records.

Typical registers contain many different kinds of acts from a specific period of time (grants, letters of remission, confirmations, etc.) often organized to coincide with the terms of the French chancellors. The registers dealing with Robert, however, do not conform to these standards. They are far more than just compilations of documents. They contain the testimony from the 1329 inquiry, the later confessions of the forgers and perjurers, proceedings from the trials of these individuals, and other related items. Read as a whole, they help to justify the king's punishment of his brother-in-law and to explain why he was so highly offended by Robert's presence in England. The confessions of participants in the scheme clearly point to Robert himself as the mastermind; and surely he stood the most to gain if it proved successful. Anyone who reads through the evidence would have a hard time escaping the conclusion that the nobleman had really committed these crimes.

V

Even more troubling, however, was what happened after Robert was convicted and sentenced. Philip became aware that outside of France,

²⁴ Octave Morel, *La grande chancellerie royale et l'expédition des lettres royaux de l'avènement de Philippe de Valois à la fin du XIV^e siècle (1328–1400)* (Paris, 1900), 321–23.

²⁵ Gérard de Montaigu, guardian of the royal archives from 1370 to 1391, recorded on the parchment cover of the register now designated as AN, JJ 20 that the archives possessed three copies. For the Louvre copies, see Léopold Delisle, *Le cabinet des manuscrits de la Bibliothèque Impériale*, vol. 3 (Paris, 1881), 160 (nos. 999–1000); for the copies in the Chamber of Accounts, see Antoine Lancelot, "Mémoires pour servir à l'histoire de Robert d'Artois," *Mémoires de l'Académie des Inscriptions et Belles-Lettres* 10 (1736): 602, and Charles-Victor Langlois, *Registres perdus des archives de la Chambre des comptes de Paris* (Paris, 1916), 168; and see also Elizabeth A. R. Brown and Richard Famiglietti, *The Lit de Justice: Semantics, Ceremonial and the Parlement of Paris, 1300–1600* (Sigmaringen, 1993), 109–13.

his enemy had been actively working behind the scenes against the royal interests. Details of this activity are also preserved in the registers.

Robert had even earlier shown himself to be a master of intrigue. In 1315, he took over leadership of a revolt in Artois against the government of his aunt, Mahaut. The next year the future Philip V (at that time, the regent of France) sent an army against the rebels, resulting in Robert's imprisonment for several months at the Châtelet, then at the abbey of Saint-Germain-des Près.²⁶ During the reign of the next king, Charles IV, Robert involved himself with the English queen Isabelle, wife of Edward II (1307–1327), who came to France to negotiate peace between her brother, the king, and her husband after several years of Anglo-French conflict in Gascony. For his part, Robert had joined in these hostilities under the leadership of his father-in-law, Charles of Valois. During Isabelle's sojourn in France, she became involved with English exiles, discontented with the tyrannical rule of her husband. At this time, she entered into an adulterous relationship with Roger Mortimer, with whom she planned to invade England and overthrow Edward. Robert also entered into this conspiracy, providing aid and counsel to Isabelle. Even the English king knew of Robert's participation in his wife's plotting; he sent a letter to the French nobleman, urging him to advise Isabelle and their son to return to England quickly.²⁷

It was not Robert's early predisposition for intrigue, however, that would permanently alienate him from the French court; on the contrary, he reached the height of his power later on, during the first years of Philip VI's reign. Interestingly enough, his rise came at the expense of the new English king, Edward III, the young son of Isabelle, who had his own strong claim to the French throne.

Nevertheless, following the collapse of his suit over the county of Artois, he began plotting against the French king in a manner that destroyed any remnants of his friendship with Philip. The Artois registers provide a detailed overview of Robert's machinations. Probably the most intriguing evidence comes from two depositions extracted from a friar, Henri Sagebren, and a priest, Jean Aimery, both from Brabant, who

²⁶ See Lancelot, *Mémoires*, 576–80.

²⁷ *Calendar of Close Rolls, Edward II: 1323–27* (1895; reprint, London, 1971), 580–82; see also Roy Martin Haines, *King Edward II: Edward of Carnarfon, His Life, His Reign, and its Aftermath, 1284–1330* (Montreal, 2003), 168–73; for Isabelle's stay in France, see Sophia Menache, "Isabelle of France, Queen of England—a Reconsideration," *Journal of Medieval History* 10 (1984): 107–24; and Paul Doherty, *Isabella and the Strange Death of Edward II* (New York, 2003), 81–90.

were arrested in France early in 1334, having been accused of spying on Robert's behalf. Their sworn statements, given before the bishop of Paris and other magnates, proved to the king that his brother-in-law was conspiring against him in the Low Countries, even hiring assassins to kill people considered to be enemies. The list included the duke of Burgundy, Philip's chancellor Pierre Forget, and the count of Bar.²⁸

Robert went so far as to threaten the life of the French king. According to Friar Sagebren, the nobleman had declared that he had many friends in Paris, men who would stand by him if he killed Philip.²⁹ Sagebren recounted a bizarre story that further reveals Robert's intense antagonism toward his royal brother-in-law. Allegedly, Robert had shown the friar a waxen figure in the image of a young man, the fourteenth-century equivalent of a "voodoo doll," magically enchanted to harm the king's eldest son, Prince John. Robert said that he wanted another such idol to represent the queen, that "she-devil," as he described her. "If she were dead and her son dead, I would have my land from the king."³⁰

Philip took these threats toward himself and his family seriously, spending months and considerable manpower chasing Robert throughout neighboring territories, forcing the fugitive to move from place to place to avoid being captured. Philip seemed particularly concerned that his "mortal enemy" might form alliances with powerful princes both within France and outside, as a number of sources from the early 1330s demonstrate. Just one month after Robert's banishment in 1332, Philip moved aggressively to neutralize such potential alliances by creating his own. Three letters dating to May of that same year, sealed by the archbishop of Cologne, the count of Guelders, and the margrave of Juliers, confirmed an agreement with the French king to fight against Robert of Artois, the duke of Brabant, and "all others who might support the said Robert."³¹

Nor could Philip ignore the possibility that Robert still had supporters at home. Historians have argued that the conflict between the king and his vassal had divided the French magnates into two camps. Philip ultimately prevailed, for in this unequal contest, the royal

²⁸ AN, JJ 20, fol.181v.

²⁹ AN, JJ 20, fol. 183.

³⁰ AN, JJ 20, fols. 179v–187v. The anonymous chronicler of Paris may have heard these depositions; see *Chronique parisienne anonyme de 1316 à 1339*, ed. A. Hellot, *Mémoires de la Société de l'Histoire de Paris et de l'Île de France*, vol. 11 (Paris, 1885), 157–60.

³¹ AN, J 522, nos. 5, 6, and 7; see also Cazelles, *Société politique*, 83–84.

“party,” including the duke of Burgundy and the count of Flanders, was stronger than the coalition of nobles, such as the duke of Brittany, who supported Robert.³²

Still, as Marie-Thérèse Caron has stated, Robert saw himself in the role of kingmaker, and considered himself equally capable of unmaking a king.³³ Philip, perhaps aware of this belief as well, elicited an oath from Jeanne of Evreux, widow of Charles IV and Robert's niece, requiring her to swear that she would not help or support her uncle who had plotted the deaths of the royal family. Jeanne's brother, Charles of Evreux, the count of Etampes, and Philip's own brother, Charles of Valois, count of Alençon, swore similar oaths several months later.³⁴ All three of these individuals were related to Robert of Artois either through blood or marriage. Jeanne and Charles of Evreux were the children of his sister, Marguerite; the count of Alençon, like Philip VI himself, was Robert's brother-in-law.

In addition, Philip had to monitor Robert's contacts in the nearby duchy of Brabant, especially with Duke John III (1312–1353) who was Robert's nephew by marriage, and John II, count of Namur, who was the son of Robert's sister Marie. Philip's concerns were justified; both men harbored the fugitive for months at a time. This was attested to in the statements by Henri Sagebren and Jean Aimery. Philip alternated between intimidating and cajoling both the duke of Brabant and the count of Namur into relinquishing their “guest,” offering, in return, his daughter, Princess Marie, in marriage to the duke's son, John. This marriage took place in September, 1332, but while Robert did leave the duke's capital of Brussels, he remained in the region for at least another year-and-a-half.

Other evidence contained in the registers suggests that during this period, Robert may also have traveled briefly to the south. According to a fiscal requisition submitted to the Chamber of Accounts, a royal sergeant was assigned the task of pursuing Robert into Provence and Lombardy.³⁵ Despite Philip's considerable efforts to recover the man he had earlier banished, Robert eluded capture long enough to escape to England.

³² Marie-Thérèse Caron, *Noblesse et pouvoir royal en France* (Paris, 1994), 92–93; and see also Cazelles, *Société politique*, 81–86.

³³ Caron, *Noblesse*, 92–93.

³⁴ The oaths are copied in AN, JJ 20, fols. 188–189v.

³⁵ Cazelles, *Société politique*, 102.

VI

It might be argued that Philip VI possessed the requisite resources to arrest Robert, had he really desired to do so. Taking that position would imply that king did not, in fact, feel as threatened as he made out to be the case. On the other hand, his issuance of letters establishing alliances with imperial princes, his insistence that Robert's relatives and friends in France swear not to help the fugitive, and his carrot-and-stick approach toward Robert's kin in Brabant contradict any such interpretation. What is more, Philip's actions indicate that he was truly tracking his adversary. It was royal officials who arrested both Henri Sagebren and Jean Aimery on charges of spying for Robert. In turn, these captives gave valuable information regarding the nobleman's whereabouts and his murderous intentions toward the king. Further evidence that Philip was hot on Robert's trail comes from the reports of contemporary chroniclers. The chronicler of Saint-Denis explained, for example, that the king encouraged the duke of Brabant to expel Robert.³⁶ While another French chronicle, the *Manuel d'histoire de Philippe VI*, stated that "the king took great pains to apprehend him," forcing Robert to take pains not to be apprehended.³⁷

Chroniclers from the Low Countries also commented on the chase. Both Jean le Bel and Jean Froissart devoted substantial space in their chronicles to Robert of Artois's career. The more reliable of the two is probably Jean le Bel, whose patron was the famous knight, John of Hainault, who, like Robert of Artois, became a close friend of Edward III. Le Bel, in particular, reported on the conflict between the two adversaries in considerable detail. He wrote that Philip contacted both the duke of Brabant and the count of Namur, threatening to wage war against them if they gave extensive aid and comfort to his "mortal enemy." According to Jean Le Bel, the king hated Robert so much and chased him so incessantly through France, Flanders, Brabant, Germany, and Liège that the fugitive had no choice but to escape to England disguised as a merchant.³⁸

Froissart puts it even more vividly. According to his chronicle, Robert told the duke of Brabant that Philip was pursuing him from country to

³⁶ *Les grandes chroniques*, 128.

³⁷ Clifford J. Rogers, "A Continuation of the *Manuel d'histoire de Philippe VI* for the Years 1328–39," *English Historical Review* 114 (1999): 1260.

³⁸ Jean le Bel, *Chronique*, 98, 107.

country, to the point that he did not know where to turn next. Once in England, Robert had informed Edward III of the French king's refusal to allow anyone, including the count of Hainault, the duke of Brabant, and the count of Namur, to give him refuge.³⁹ A very similar portrayal of this period appears in the chronicle of the Bourgeois of Valenciennes.⁴⁰ The reports of these chroniclers coupled with the other existing documentary evidence, strongly suggest that Philip VI was serious in his attempts to find and arrest Robert, even though all of his efforts turned out to be in vain.

VII

In fact, Philip did not need Robert of Artois to stir up difficulties with Edward III; trouble enough already existed between the two kings, dating from before the beginning of Philip's reign when English representatives argued for Edward III's right to the French throne after the death of Charles IV. Hostilities would almost certainly have broken out without any interference by the fugitive nobleman. The French king had been directing bellicose threats toward Edward for years. In 1334, for example, Philip refused to continue negotiations over Gascony while Edward's conflicts with Scotland persisted. Although no war broke out this time, the next two years saw a continuing deterioration in the relationship between the two rulers. Matters reached a point where Pope Benedict XII (1334–1342) abandoned a proposed crusade in March 1336, because Philip and Edward could not arrive at any amicable agreement. Instead, the French king moved his crusading fleet from Marseilles to Normandy, a rather pointed hint that he might invade England and send troops to Scotland.

What historians often ignore or under-emphasize is the fact that during this same two-year period (1334–1336) Robert of Artois disappeared from the continent, only to resurface in England. As a result, Philip's increasing bellicosity found a new focus, one that, unlike his interference in Anglo-Scottish affairs, he could more easily justify. The circumstances surrounding Robert's flight and its exact date have

³⁹ Froissart, *Oeuvres*, 2:300–5.

⁴⁰ *Récits d'un bourgeois de Valenciennes*, ed. Kervyn de Lettenhove (1877; reprint, Geneva, 1979), 156–57.

remained obscure. The most often-repeated story comes from Jean le Bel. The chronicler reported that Robert traveled to England secretly, disguised as a merchant, and then went straight to Edward III, who took pity on the fugitive, sympathizing with his plight.⁴¹ Unfortunately, Jean le Bel failed to provide any date for this meeting, a failure shared by most other contemporary chroniclers who reported Robert's presence in England.

A few, however, did offer dates, albeit sometimes incorrectly. Froissart placed the fugitive in England at the time that Edward III's queen, Philippa of Hainault, was pregnant with their eldest son, the future Black Prince. He, however, had been born in June, 1330, long before Robert had been convicted of his crimes and banished from France.⁴² Another chronicler, Richard Lescot, a monk of Saint-Denis, stated that by 1336 Robert had already crossed over to England, a statement which stands a much greater likelihood of being true.⁴³ However, without any corroborating evidence, the chronicle is not much help in determining just when Robert's flight occurred. And, in fact, documentary evidence of the sort that might solve the issue is lacking. None of the materials compiled for the Artois registers throws light on the mystery nor do any other documents provide a date.

Some later historians have reached the conclusion, on largely non-existent grounds, that Robert first arrived in England in the early months of 1334. The eighteenth-century scholar, Antoine Lancelot, in refuting Froissart's story, stated that Robert had to have gone to England after the siege of Berwick, which took place in the spring of that year. However, he gives no reason for his assertion.⁴⁴ Modern historians have accepted this unsupported assumption, which could lead one to argue, as Sumption has, that although Philip must have known where Robert was hiding, he did not raise the issue for nearly two years.⁴⁵ This, in turn, would imply that the French king was not overly concerned about Robert's whereabouts, even if the count was hiding in England, and chose to complain only after he had already decided to go to war for other reasons.

⁴¹ Jean le Bel, *Chronique*, 107–8.

⁴² Froissart, *Oeuvres*, 2:303.

⁴³ Richard Lescot, *Chronique de Richard Lescot religieux de Saint-Denis (1328–1344) suivie de la continuation de cette chronique*, ed. Jean Lemoine, Société de l'histoire de France (Paris, 1896), 42.

⁴⁴ Lancelot, *Mémoires*, 635–36.

⁴⁵ Sumption, *Trial by Battle*, 171.

On the other hand, this interpretation would be undercut if either of the following cases could be demonstrated. First, Robert did indeed cross into England earlier than 1336, but Philip did not find out until later. Second, Robert remained on the continent, hiding out among his friends and supporters in the Low Countries or elsewhere, not making his way to England until sometime in 1336. The first possibility has no documentary evidence to support it, either French or English. The second may be more likely, given certain documents issued by the French, English, and papal chanceries in 1336. The earliest reference to Robert in any of these records dates from October 3 of that year, when Edward III repaid 500 marks to John de Pulteney, a citizen of London, who had lent this same sum to Robert to finance his campaign in Scotland.⁴⁶ The first certain indication that Philip knew of Robert's presence in England is a letter of December 26, 1336, sent to the seneschal of Gascony, demanding that Edward return his wayward vassal to France. In the letter, the French king explained that messengers he had recently sent to England had returned with news that "[Edward] had with him in his company Robert of Artois..., about which he [Philip] was greatly astonished."⁴⁷

Actually, the French king probably knew that Robert was in England somewhat earlier than the December letter since the pope certainly did. Benedict XII was well-aware of the feud between the two men. His relationship with Philip was problematic at best, but in this matter, at least, the pope agreed decisively with the king. Benedict may have found out about Robert's presence in England as early as the summer of 1336, when English ambassadors visited Avignon to discuss "questions and dissensions between the two kings." Benedict explained all this in a letter to Philip dated November, 1336.⁴⁸ At the same time, he wrote to the English ruler informing him that "the king of France cannot treat with him while he entertains and takes counsel with Robert of Artois, a capital enemy and conspirator against the life of that king and his eldest son." The pope warned Edward that he was jeopardizing his reputation by associating with a malcontent and would-be assassin and advised him

⁴⁶ *Calendar of Patent Rolls, Edward III: 1334-1338* (1893; reprint, Leichtenstein, 1972), 322.

⁴⁷ Déprez, *Préliminaires*, 414-15.

⁴⁸ *Calendar of Entries in the Papal Registers Relating to Great Britain and Ireland*, vol. 2: A.D. 1305-1342, ed. W. H. Bliss (London, 1895), 561.

to expel Robert immediately. Benedict evidently assumed that Edward was ignorant of the danger that Robert of Artois posed. The pope sent his envoy, Philip de Cambarlhaco, archdeacon of Ghent, to England to provide “private and trustworthy information,” intelligence that probably came from Philip himself.⁴⁹ Writing to his nuncio, Cardinal Bertrand, in June, 1339, the pontiff requested that he learn whatever he could about Robert and report his findings to Avignon.⁵⁰

The papal reactions to Philip’s problem are informative. As a man of God, Benedict desired peace and actively mediated between Philip and Edward.⁵¹ However, his efforts at negotiation were hampered in part by the assumption that he, as a French pope residing in Avignon, was little more than a puppet of the French king.⁵² Whatever the case may be, his letters concerning the fugitive nobleman clearly indicate that on this issue he sided with Philip over Edward. The involvement of the pope also demonstrates yet again, how seriously Philip considered the threat posed by his former vassal. It was enough of a concern to call for papal intercession.

VIII

Philip never stopped thinking about Robert of Artois, even though he may not have known the fugitive’s whereabouts during these years. It was a busy time for the French king, full of many other concerns that could easily have distracted him from the chase. In 1334, Philip mediated a dispute between the duke of Brabant and the count of Flanders. He gave refuge to the exiled Scottish king, David Bruce, and his queen. In the following year, the king had a grave crisis on his hands: his eldest son John, duke of Normandy, became seriously ill nearly to the point of death in June. When the prince finally recovered, he and his father made pilgrimages to several religious shrines out of gratitude. During all this time, negotiations with England continued and the two feuding kings were being pressured to undertake a joint crusade to the Holy Land.

⁴⁹ *Papal Registers*, 561–62.

⁵⁰ *Ibid.*, 574.

⁵¹ Benedict’s mediation is discussed in Helen Jenkins, *Papal Efforts for Peace under Benedict XII, 1334–1342* (Philadelphia, 1933).

⁵² *Ibid.*, 16–17.

Despite this, Robert never seemed far from Philip's mind. The author of the *Grandes chroniques* reported that in 1334, the king arrested his sister, Jeanne, Robert's wife, along with their children, imprisoning her in the castle of Chinon and the children in the Château-Gaillard, because he suspected her of conspiring with her husband.⁵³ Philip's actions seem unduly harsh. While his sister, Jeanne, may indeed have plotted with her husband, unlike other participants in Robert's scheme, she was convicted and punished without the benefit of trial. The king's nephews and niece, the oldest of whom was barely a teenager, certainly could not have been guilty. The implication seems clear: Philip wanted his vassal in custody, but since this proved impossible, he settled for the next best thing, Robert's family. Perhaps the king also thought that the fugitive would return to France on his own if he learned of the mistreatment of his wife and children. This, however, did not happen.

Philip also continued his vendetta against Robert in a different fashion. In 1335, he initiated legal proceedings against some of the witnesses who had perjured themselves in the 1329 inquiry. In a letter dated February 17, 1335, he instructed the *parlement* of Paris to prosecute the false witnesses, proclaiming that "such great falsehoods and misdeeds and the persons who committed them and helped and consented to do them, should not remain without due punishment."⁵⁴ In all, nine individuals were tried during the spring of 1335, most of whom were fined and pilloried for their crimes. One was banished from France, as Robert had been, but the worst punishment was reserved for the lone woman in this group: burning at the stake. Her execution on June 3, 1335, was such a significant event that twenty-four of the king's councilors were present as witnesses.⁵⁵ The time and effort spent to try and punish this group, most of whom had already been imprisoned for several years, illustrates yet again Philip's refusal to put the Artois case behind him.

Given these circumstances, the king's public response to the news that his vassal had sought sanctuary in England makes far more sense. The scandalous court case and troubled relationship with the French king, combined with the refuge found at Edward's court to make the

⁵³ *Les grandes chroniques*, 142; for the report about the Château-Gaillard, see *Chronique des quatre premiers Valois (1327–1393)*, ed. Simeon Luce (1862; reprint, New York: Johnson Reprint Corporation), 2.

⁵⁴ AN, JJ 20, fol. 137v.

⁵⁵ AN, JJ 20, fols. 155v–156.

fugitive an easy target for French propaganda seeking to justify the outbreak of a war. The monk of Saint-Denis did not hesitate to attribute to Robert of Artois the escalation of hostilities between the two kings. He alleged that Philip and Edward had failed to reach an agreement over disputed territories in Aquitaine because of Robert's interference. According to the monk, it was he [Robert] who had counseled Edward to invade France.⁵⁶ Another chronicler, the author of the *Manuel d'histoire* claimed that the English king intended not only to invade, but also to rule France as its king, a course counseled by the traitor who had "taught the English all these tricks."⁵⁷

As semi-official historians of the monarchy, they may well have been expressing the king's own opinion. Pope Benedict XII may have been referring to Robert's influence when writing to Edward III in March, 1341, after the English king had publicly claimed the throne of France. Here, the pontiff stated that Edward "appears to be led by perverse counsels, and needs to have sounder ones put before him."⁵⁸ In the accounts of the contemporary French historians, Robert instigated the war for his own nefarious purposes, no doubt resulting from the failure of the now infamous court case, an event these same chroniclers treated in scurrilous detail.⁵⁹

French writers go on to describe Robert's unsuccessful career as an English general during the early campaigns of the Hundred Years War. The *Grandes chroniques*, for one, described his defeat at Saint-Omer in 1340 at the hands of the duke of Burgundy and the count of Armagnac. This work adds a telling detail: the French king himself wanted to be present when the duke engaged his mortal enemy in battle.⁶⁰ What better way to underscore Robert's treachery against France, and, at the same time, to undermine his reputation, than to highlight his failures as a military leader? Accounts of Robert's final campaign in Brittany, in 1341, also appear in the official histories. "In Brittany," wrote Richard Lescot,

⁵⁶ *Les grandes chroniques*, 157, 160; Lescot, 42, 44–45.

⁵⁷ *Manuel d'histoire*, 1262–63.

⁵⁸ *Papal Registers*, 579.

⁵⁹ See, for example, *Les grandes chroniques*, 108–11, 123–26, 129–31; Richard Lescot, 15, 24–27, 29; and *Manuel d'histoire*, 1260–61.

⁶⁰ *Les grandes chroniques*, 188–97; a much shorter account of the defeat at Saint-Omer can be found in Richard Lescot, 52.

Robert of Artois, by whom and because of whom many evils befell the kingdom of France, died and was carried to England, where he had not been born, to be buried.⁶¹

IX

By contrast, it should be noted that chronicles from the Low Countries and from England portray Robert of Artois rather differently than those from France. Flemish chroniclers tended to sympathize with the fugitive and express understanding of his decision to take up with Edward III. The most prominent of these writers, Jean le Bel and Jean Froissart, had prolonged contact with the English court and were thus predisposed to look favorably on Robert's relationship with the English king. Jean le Bel, in particular, consistently depicts Philip VI in a negative manner, blaming him, and not his vassal, for all French suffering during the early period of the Hundred Years War.⁶² Yet, even though Jean le Bel wrote about the fugitive in positive terms, he reiterated one aspect of the conventional wisdom found in French chronicles: that Robert became one of Edward's closest advisors, counseling him to fight for his right to the French throne.⁶³

Jean Froissart also cast Robert of Artois in a generally favorable light, though the fugitive appears far more frequently in Froissart's chronicle and comes across as a more complex character. In fact, he echoed some of the themes raised by French writers and used extensively in pro-French propaganda. The author began by explaining that Robert had been very powerful in France at the time of Philip's ascent to the throne. This power, however, had disappeared when the French king banished him from the kingdom for committing forgery. According to Froissart, Robert had stayed in Brabant while trying to elude Philip's men, eventually escaping to England and finding shelter in Edward's court. The chronicler also asserted that Robert found Edward in Scotland, where he told the king of his troubles. Subsequently, Robert encouraged Edward to abandon his Scottish campaigns and pursue a more noble cause—his claim on the throne of France. The chronicler

⁶¹ Richard Lescot, *Chronique*, 59.

⁶² See Diana B. Tyson, "Jean le Bel: Portrait of a Chronicler," *Journal of Medieval History* 12 (1986): 321–22.

⁶³ Jean le Bel, *Chronique*, 53.

has Robert explaining to the English monarch that, whereas Philip was only a cousin to the last Capetian king, Edward was his nephew.⁶⁴

Froissart's depiction of the relationship between Edward III and Robert of Artois has been of special interest to some later scholars. According to George Diller, Froissart portrayed Robert as a manipulative man bent on revenge against his own king and country. In this scenario, he becomes the anti-chivalric hero.⁶⁵ Peter Ainsworth contends that Froissart represented Robert as an instigator of the Hundred Years War because he wanted to explore the moral issues surrounding the French peer's decision to betray Philip and support Edward.⁶⁶

By contrast, contemporary English chronicles treat the issue quite differently. Many of them never mention Robert of Artois at all. When they do, it is usually in the context of one of the early battles of the Hundred Years War. For example, the *French Chronicle of London* lists Robert of Artois as a participant in the 1340 siege of Tournai.⁶⁷ While several English chronicles explain why Robert was in England, they do not link his presence at court with the outbreak of war. The Lanercost chronicle includes Robert in a list of Edward's allies, referring to him as

the Count of Artois-Arras, whom the King of France expelled from his country and of whose lands he had taken possession, [who] was in England at that time [1337] under the protection of the king, who treated him courteously in all respects.⁶⁸

Geoffrey Baker added a few more details in his chronicle: in 1340, Edward III traveled to Flanders, bringing Robert with him. According to Baker, the Frenchman had lived for a long time in England at the king's expense. He had escaped from France to ask for help "against the tyrant of the French" (*contra tyrannum Francorum*), who had confiscated

⁶⁴ Froissart, *Œuvres*, 2:298, 300–303, 305, 313.

⁶⁵ George T. Diller, "Robert d'Artois et l'historicité des *Chroniques* de Froissart," *Le Moyen Âge* 86 (1980): 225–27.

⁶⁶ Peter Ainsworth, *Jean Froissart and the Fabric of History: Truth, Myth, and Fiction in the Chroniques* (Oxford, 1990), 287.

⁶⁷ *Croniques de London depuis l'an 44 Hen. III jusqu'à l'an 17 Edw. III*, ed. George James Augier, Camden Society (1844; reprint, New York, 1968), 78.

⁶⁸ This quote appears in an excerpt of the Lanercost chronicle entitled "Edward III builds up an alliance against the king of France, 1337," in *English Historical Documents*, vol. 4:1327–1485, ed. David C. Douglas (New York, 1950–1959), 61–62.

his lands in Artois and Brabant.⁶⁹ These rather gossipy tidbits notwithstanding, one would not expect the contemporary English chroniclers to pay the same attention to Robert that the French chroniclers had. After all, Robert was Philip's scapegoat, not Edward's.

X

Given Philip's preoccupation with his disloyal vassal, is it still reasonable to argue, as Norris Lacy has, that *The Vows of the Heron* merely "offers a fascinating example of the metamorphosis of history into fiction?"⁷⁰ Even if the actual events in the poem never took place—a view currently held by most historians and literary critics—could *The Vows of the Heron* actually illustrate a different kind of truth? Perhaps this poem represents a type of war propaganda common in the 1340s and 1350s as described recently by John Aberth. Propagandists offered up enemies, characterized them as being destructive of national interests, and demonized them.⁷¹ Robert of Artois seems to supply a good example of this.

In his case, the propaganda may have been close to the truth, at least to the truth as Philip saw it. Robert had openly flouted royal authority. He had made threats against the king and his family. He was in England at the court of a man who had been sparring with the French monarchy for years. Is it any wonder that Philip would have assumed Robert was up to no good? He had already proven himself to be of questionable character, the type of unscrupulous and vengeful person who might very well wish to goad Edward into war.

The author of *The Vows of the Heron* was well-aware of these issues and Robert's earlier history:

He had been banished from the noble country of France,
Exiled from the land of fair King Philip,
And he dared not stay in the land this side of the sea,

⁶⁹ Geoffrey Baker, *Galfridi Le Baker de Swinbroke, Chronicon Angliae Temporibus Edwardi II et Edwardi III*, ed. J. A. Giles, Publication of the Caxton Society, vol. 7 (1847; reprint, New York, 1967), 145.

⁷⁰ Norris Lacy, "Warmongering in Verse: *Les Voeux du Héron*," in *Inscribing the Hundred Years' War in French and English Cultures*, ed. Denise N. Baker (Albany, New York, 2000), 18.

⁷¹ John Aberth, *From the Brink of the Apocalypse: Confronting Famine, War, Plague, and Death in the Later Middle Ages* (New York, 2000), 62, 70.

In Hainaut or Brabant or all of the Cambrésis
Or in Flanders or Namur or in the Auvergne.⁷²

In the poem, Robert catches a heron, “the most cowardly bird,” has it cooked, and presents it during a feast

to the most cowardly one
Who lives or has ever lived: that is Edward Louis
Disinherited of the noble land of France.⁷³

Robert then challenges Edward to fight for his rightful inheritance, and all of those present at the feast, including the king, swear on the heron to do just that, to “set the country ablaze.”⁷⁴

The poet displays his knowledge of Robert’s reputation as well. Following Edward’s vow on the heron, Robert proclaims himself happy now that he has exacted revenge on his pursuer, while at the same time bemoaning his own downfall:

When he [Philip VI] was established as regent of France
I was part of his privy council, I tell you.
Unfailingly I gave him loyal counsel,
And I have been badly rewarded for it.⁷⁵

Throughout the poem, Robert’s desire for revenge manifests itself. He prods the other guests at the feast, such as the earls of Salisbury and Derby, to echo the king’s vow. After one such oath Robert says,

I would welcome such a war.
The time will yet come, and God has ordained it,
When my children will be released from prison
And I will be able to harm those who have so grieved me.⁷⁶

At times, the anonymous poet appears to sympathize with the exiled nobleman, leading the poem’s nineteenth-century editor, Thomas Wright, to argue that he was a supporter of Artois.⁷⁷ On the other hand, the poet makes a provocative comparison between Robert and

⁷² *Vows of the Heron*, ll. 34–38.

⁷³ *Ibid.*, ll. 81–83.

⁷⁴ *Ibid.*, l. 100.

⁷⁵ *Ibid.*, ll. 135–38.

⁷⁶ *Ibid.*, ll. 280–83.

⁷⁷ *Political Poems and Songs Relating to English History Composed during the Period from the Accession of Edward III to that of Richard III*, ed. Thomas Wright, Rolls Series, no. 14 (London, 1859), 1.

John of Hainault, who had also attended the feast. Although John vows on the heron, he adds a standard feudal exception:

But if the king of France
 Wanted to summon me back
 To France, from which I know I am banished,
 By God the omnipotent, I would leave Edward
 So honorably that no one, great or small,
 Could accuse me of behaving improperly
 Or of harming him with any traitorous act.⁷⁸

John's portrayal as a loyal vassal to both kings, and his disinclination to shame himself by resorting to treachery, contrasts greatly with Robert of Artois, who gleefully embraces his own "traitorous act" against Philip VI.

A recent interpretation by Patricia DeMarco suggests that *The Vows of the Heron* satirizes and criticizes Robert of Artois's desire for vengeance.⁷⁹ It is also possible that the poet may have been trying to raise a propagandistic point based on Robert's well-known character and career. No evidence indicates that the poem was written expressly for Philip VI or for that matter, for Edward III; nevertheless, the French king would have appreciated its treatment of Robert far more than his English counterpart might.

Even if pure propaganda, the story behind Robert of Artois and *The Vows of the Heron*, finds an echo in later generations in both literature and historical writing. John Barbour, in his late fourteenth-century poem *The Bruce*, compares the young and wayward James Douglas to "Robert the good count of Artois . . . for pretending to behave badly . . . [when it was] of great use to him."⁸⁰ A fifteenth-century French chronicle, the *Chronographia regum francorum*, passes off as history a shortened version of the poem:

Robert of Artois left the city [London] to hunt birds with his falcon; when he captured a bird, which was said to be a heron, he returned to London and presented the same bird to King Edward, who was sitting at the dinner table, saying that he was offering the most timid of all birds to the least brave king in the world. "For," he said, "lacking all bravery,

⁷⁸ *Vows of the Heron*, ll. 389–93.

⁷⁹ Patricia DeMarco, "Inscribing the Body with Meaning: Chivalric Culture and the Norms of Violence in *The Vows of the Heron*," in *Inscribing the Hundred Years' War*, 27–53.

⁸⁰ John Barbour, *The Bruce*, ed. A. A. Duncan (Edinburgh, 1997), 62–63.

you are not daring enough to go after the kingdom of France which belongs to you by right.”⁸¹

The late sixteenth-century English play, *The Reign of King Edward the Third* (now attributed to Shakespeare) begins with a scene between Edward and Robert in which the latter discusses with the former his French lineage and claim to the French throne, thereby inspiring him to take up arms.⁸²

XI

While most historians writing of the Hundred Years War have tended to reject the interpretation of the villainous Robert of Artois portrayed in such works, the historical record amply demonstrates that the propaganda against him has considerable foundation in reality. Robert did not become the focus of blame in France for no reason. He committed serious crimes and instead of answering the charges against him, he left the kingdom and took up with Philip’s enemies. The French king tried in vain to capture Robert and went to considerable lengths to punish anyone who might help him pursue his fraudulent claim on Artois. For his part, Robert proved himself capable of creating trouble for his liege lord long before the outbreak of war in 1337. As a result of all this, the French king must have felt himself justified in proclaiming Robert his “mortal enemy” and using that nobleman’s presence in England as the legal reason for confiscating Gascony. If one looks at these events from Philip’s point of view, the author of *The Vows of the Heron* may have been right to stress Robert of Artois’s role in the outbreak of the Hundred Years War.

⁸¹ This excerpt from the chronicle is printed in Grigsby and Lacy, *The Vows of the Heron*.

⁸² *The Reign of King Edward the Third*, act 1, sc. 1, lines 1–50.

THE COMBAT OF THE THIRTY AGAINST THIRTY: AN EXAMPLE OF MEDIEVAL CHIVALRY?

Steven Muhlberger
Nipissing University

On March 16, 1351, one of the most picturesque combats of the fourteenth century took place in a Breton field near a tree that came to be known as “the Halfway Oak.” That oak was halfway between the French-held castle of Josselin and the English stronghold of Ploermel, and in its presence the commanders of those garrisons met in accordance with an earlier agreement.¹

They had sworn that each would bring a company of thirty, and those companies would fight on foot without “reinforcement or help,”² without “cheating or fraud”³ of any sort, to the finish *a outrance*.⁴ This did not necessarily mean “to the death,” but rather until one side was victorious, and the warriors on the other were either dead, disabled, or captured—as in any serious battle. A key part of the agreement was that no one would take advantage of the ultimate expedient of the defeated warrior: none of them, no matter how things went, would run away. In fact, no one did. After a hard-fought contest, the French (or, rather Breton) garrison, led by Sir Jean de Beaumanoir, a Breton knight of some local importance, overcame a motley force of English, Germans, and even a few pro-English Bretons, killing several, including their leader, a man alternately referred to as Bamborough or Brandenburg, who may have been either English or German.⁵

¹ All translations into English are mine, or in the case of Froissart, adapted from Thomas Johnes’s nineteenth-century translation.

² *Chronique de Jean le Bel*, ed. Jules Viard and Eugène Déprez. 2 vols. (Paris, 1906), 2:195.

³ H. R. Brush, ed., “La Bataille de trente Anglois et de trente Bretons,” *Modern Philology*, 9 (1911–2): 511–44; 10 (1912–3): 82–136. The original of the quoted phrase is on p. 89.

⁴ “*A outrance*” is often interpreted in modern times as meaning “with sharp weapons;” my reading of fourteenth-century texts is that the phrase indicated the extremities to which an unregulated fight might go. More regulated combats—festive jousts and even individual challenges—might end long before they reached “extremities.”

⁵ The most recent detailed discussion is in my *Deeds of Arms: Formal combats in the late fourteenth century* (Highland Village, Texas, 2005), 76–120. See also Jonathon Sumption,

This formal combat—formal in the sense that time, place, numbers, and the specification of what constituted victory were arranged in advance and adhered to—caught the imagination of contemporary observers, even though it was by no means the only or even the first such challenge. Such writers as Jean le Bel, who was perhaps the earliest chronicler to write about the Combat, or Jean Froissart, who later adapted and elaborated on Le Bel’s account, saw it as a pure example of chivalry: LeBel characterized it as “a most marvelous deed of arms that should never be forgotten,”⁶—a contest of Rolands and Oliviers.⁷ Froissart echoed this assessment. The two chroniclers lauded the participants as heroes because they took their vocation as warriors with unflinching seriousness, even though most of these men were at the time obscure figures scrabbling at the margins of respectability. In the grubby Breton war, where plundering the weak and avoiding confrontation with the strong was normal behavior for combatants, these men embodied a more honorable type of conflict, one involving men at arms against men at arms, equal numbers against equal numbers, and no retreat. They showed themselves as good as their word. They had said they would fight to the end, and they did.

Because contemporaries—at least some of them⁸—found the Combat of the Thirty against Thirty so admirable, and because it continued to be commented on by writers in later generations, it is an excellent way to access attitudes toward war, courage, and chivalry. What does the combat tell us about how the men who took part in such challenges actually behaved?⁹

We have a pretty fair idea of how chivalrous gentlemen were supposed to act when they challenged their king’s enemies to a fight. Although they were duty bound to oppose one another in war, and although even an arranged fight could lead to death or horrific injury, such matters

The Hundred Years War: II: Trial by Fire (Philadelphia, 1999), 25–35 for the political and strategic context. For a recent account of one highly visible combatant on the English side, see L. J. Andrew Villalon, “‘Seeking Castles in Spain’: Sir Hugh Calveley and the Free Companies’ Intervention in Iberian Warfare (1366–1369),” in *Crusaders, Condottieri, and Cannon: Medieval Warfare in Societies around the Mediterranean*, ed. L. J. Andrew Villalon and Donald J. Kagay (Leiden, 2003), 305–328.

⁶ *Chronique de Jean le Bel*, 2:194.

⁷ *Ibid.*, 2:196.

⁸ Froissart does mention that “some people regarded it . . . as the product of presumption and rashness;” Jean Froissart, *Oeuvres* [KL], ed. Kervyn de Lettenhove, 25 vols. (Brussels, 1867–1877), 5:295.

⁹ This is one of the many questions about the Combat raised in my book, *Deeds of Arms*.

were supposed to be entered into with the greatest courtesy. When in 1390, the young Thomas Mowbray, earl of Nottingham and earl marshal of England, wrote to the lord of Coucy in an attempt to engage the Frenchman in a challenge with lances, swords, daggers, and axes, he posed the challenge as a request for a favor, from a much younger man to one whom all knew to be superior in reputation and honor.¹⁰ Froissart's account of the famous formal deed of arms between Sir Renaud de Roze and John Holland, earl of Huntingdon, shows Roze sending a letter to the earl "begging" for the opportunity to fight. It was a compliment, said the herald who delivered the request, telling John Holland that Renaud "salutes you by me, and you will be pleased to read this letter." And indeed Holland was: he told the herald, "Friend, you are welcome; for you have brought me what pleases me much," and said to his father-in-law, John of Gaunt, leader of the English army, "I love nothing better than fighting, and the knight entreats me to indulge him."¹¹

If the initiation of a challenge between national enemies was supposed to be courteous, the conclusion was supposed to be equally even-tempered. When Roze and Holland were done, says Froissart, John of Gaunt entertained Roze, his friends, and his retainers at dinner, and there was much pleasant chat.¹² A few years later, the great joust at St. Inglevert, a hard-hitting contest between English and French partisans where weapons of war were exclusively used, became almost as famous for the sumptuous feasts and celebrations put on by the three French knights who hosted the event, as it was for the tremendous success those same Frenchmen achieved in the lists.¹³ Says Froissart, the English had come to St. Inglevert in response to a most courteous invitation, and in hopes of finding the French to be "good companions."¹⁴ And if we believe Froissart and other writers as well, the English were not disappointed.

Conversely, other examples in the chronicles show knights who could not meet the standards of courtesy and good fellowship necessary, even between enemies. A hostile Portuguese version of the Roze-Holland challenge shows Holland losing his cool: Upon being struck by Roze,

¹⁰ Ibid., 14:398–99.

¹¹ Ibid., 12:116–7.

¹² Ibid., 12:123–24.

¹³ *Jouistes de Saint-Inglebert, 1389–1390. Poème contemporaine*, ed. J. Pichon in *Partie inédite des chroniques de Sainte-Denis* (Paris, 1864), 77–78.

¹⁴ KL, 14:106.

Sir John was caught and took a straight and heavy fall from the saddle; but he leapt up shouting so fiercely that he looked for all the world as if he would be at daggers drawn with the Frenchman if given the opportunity.¹⁵

The Monk of St. Denis' account of St. Inglevert shows an Englishman, Robert de Rochefort, claiming intemperately that he had been cheated of an opportunity to fight. He was given the opportunity to meet the French champion, Boucicaut, and was humiliated by him, a comeuppance that even the English cheered, because they disapproved of Rochefort's discourteous behavior.¹⁶

The standard set by chroniclers for champions on such occasions involved positive courtesy and the avoidance of bragging and insult; hot deeds but cool words. The accounts we have briefly looked at, and many others, show that in a formal deed of arms *how* the thing was done was often as important as who won. Indeed, it is an important characteristic of fourteenth century deeds that both sides in a challenge could come out of it looking good. There might not be a "winner." The best but not the only example of this is the jousting at St. Inglevert as reported by Froissart. Although his account cannot be taken as literally true, it surely strove for a certain degree of verisimilitude, and it shows that unambiguous victory was rare: the three French champions faced forty-six opponents, and unhorsed only eight.¹⁷

How does the Combat of the Thirty against Thirty, or the contemporary accounts of it that survive, measure up against this standard? It is the argument of this paper that although the Combat has often, from the time of Jean le Bel, been presented as something conducted in accordance with a courteous chivalry, this was not the universal view. Although not wishing to debunk the idealizing accounts of Le Bel and his follower, Froissart, it is necessary to point out that there is an alternate account, written by an anonymous Breton poet, which shows

¹⁵ Fernão Lopes, *The English in Portugal 1367–87: Extracts from the Chronicles of Dom Fernando and Dom João*, ed. and trans. Derek W. Lomax and R. J. Oakley (Warminster, 1988), 277.

¹⁶ *Chronique du Religieux de Saint-Denys*, ed. M. Bellaguet. 6 vols. (Paris, 1839–1852), 1:680. Whether this incident actually happened is hard to say. Froissart's account of St. Inglevert also reports how an English partisan offended chivalric manners and was taught a lesson by a Frenchman, but the identities and other details are entirely different; *Deeds of Arms*, 212–3.

¹⁷ Steven Muhlberger, "The Tournament at St. Inglevert—An Analysis of the Action," <http://www.nipissingu.ca/departement/history/muhlberger/froissart/analysis.htm>.

a different ideal of chivalry at work, or at the very least, a different and saltier standard of public behavior.

Before looking at this alternative account, consider how Jean le Bel and Froissart show the Combat to be a courteous occasion.¹⁸ First, and very importantly, the original challenge between the French Breton captain, Beaumanoir, and the English/German, Bamborough or Brandenburg, is presented as an exchange of courtesies: Beaumanoir asked his rival, in classic style, “whether he had any companion, or perhaps two or three, who wished to joust with steel lances against three, for the love of the ladies.” And if Brandenburg rejects the proposal as too mild, and presents his own counterproposal, he does so politely: “If you like,” he says, “you will choose twenty or thirty of your companions . . . and I will choose as many.”¹⁹ There is no personal animus about any of it.

Second, the emphasis in Le Bel and Froissart is far more on *how* the deed was done, and not on who won. The willingness of all concerned to agree to rules and actually observe them, to fight their best and not to run when injured or in danger of capture are the focus—and both sides are shown as equally worthy in that respect.

Finally, as in the case of the Roye-Holland challenge, or the warlike joust at St. Inglevert, the Le Bel and Froissart accounts insulate the featured deed of arms from politics, tactics, or strategy. The Combat of the Thirty against Thirty, they show us, was not about winning the war in Brittany, but about testing the quality of individual warriors.

As a result, these two well-known accounts of the Combat show us a timeless example of chivalry, offered as an inspiration to all good men-at-arms, with little or no partisan content.

But even in the 1350s, another tale was already making the rounds, one that is preserved in a poem called *The Battle of the Thirty English and the Thirty Bretons*.²⁰

It is quite unlike Le Bel’s or Froissart’s account. The latter two writers were quite distant from the incident, Le Bel in space, Froissart in both time and space. They could afford to look at it as a specific instance

¹⁸ *Chronique de Jean le Bel*, 2:194–97; KL, 5:289–95.

¹⁹ *Chronique de Jean le Bel*, 2:195.

²⁰ Edited by Brush (note 2); an English verse translation by William Harrison Ainsworth was published, with extensive notes, in *Bentley’s Miscellany* 45 (1859): 5–10, 445–459. The translation without the notes is currently available on the World Wide Web at <http://www.nipissingu.ca/departement/history/MUHLBERGER/CHRONIQUE/texts/ainswort.htm>. The Ainsworth translation is based on Crapelet’s 1827 edition and translation into modern French.

illustrating a general principle. But the poet was a Breton, writing for the hometown crowd. Where Le Bel knew only the names of the captains, and scrambled those, the Breton poet named all the combatants on both sides, and paraded his knowledge of the local heroes: the knights of Brittany and the flower of Breton squires.²¹ The Combat of the Thirty against Thirty, in this telling, was not a test of chivalry in which both sides might look good; it was, instead, a battle between English plunderers and oppressors, and those loyal and worthy Bretons who defended their people (and, if only incidentally, the kingdom of France).

As the Breton poet begins his story, he shows Beaumanoir challenging his English counterpart not for the fun of it, not as a test of chivalry, and not out of boredom. He does it as protector of the little people of Brittany, whom Brandeburg and his garrison have been abusing:

Knights of England, you do great evil,
To torment the poor people, who sow the grain
And provide the meat and wine they raise . . .
Those who have endured so much should have peace
From now on.²²

The English commander responds uncompromisingly:

Beaumanoir, be silent, there is nothing to discuss . . .
Edward will be crowned King of France,
The English have the mastery,
Despite the French and all their allies.²³

Two features of this interchange are salient. First, unlike the Le Bel version, the rivalry between the two men and their companies is firmly situated in a context of serious political and military rivalry. Second, there is no moral equality between the men. Beaumanoir sees Brandeburg as an evil-doer; Brandeburg dismisses his accuser as contemptible. The challenge grows not out of chivalric brotherhood but out of hostility and personal animus.

As the story develops, there are more such barbed interchanges. The two captains repeatedly denigrate each other. No sooner has Brandeburg agreed to meet Beaumanoir, than the Franco-Breton tries to shame

²¹ *Ibid.*, 100.

²² *Ibid.*, 84.

²³ *Ibid.*

him by bringing up a similar incident where Brandenburg supposedly chickened out:

Do not do to me what you did to Pierre Angier...
 He chose a day for battle with you
 At the town of Ambissat. And I have heard said
 That he went to that place to acquit his oath
 With twenty-six spurred knights
 All accoutered in gold and steel.
 And Brandenburg, you defaulted. You did not dare to go.
 This deed we are discussing is a very great one.
 You should not mock it.²⁴

And some days later, when Brandenburg showed up at the Halfway Oak before Beaumanoir, the same word, default, was immediately on his lips:

In a loud voice he cries, "Beaumanoir, where are you?
 I believe you have defaulted,
 But if we had joined battle, you would have done nothing."²⁵

When Beaumanoir does arrive, Brandenburg first tries to wiggle out of his commitment—thus showing to a Breton audience his basic lack of worth—then returns to his normal boasting:

Brandenburg replied [to Beaumanoir] "I take all your power and lordship
 As less than a bud of garlic. For despite you, this day,
 I will have the mastery, and will conquer all Brittany and Normandy."
 Brandenburg says to the English, "My lords the Bretons are wrong,
 Lay on, strike, put them to death, make sure
 That none escapes me, neither weak nor strong."²⁶

And soon after he issues even a hotter defiance of a sort never seen in Froissart:

Surrender quickly, Beaumanoir, I will not kill you
 But I will make of you a present to my lady love.
 For I have promised to her and I do not lie to her
 That today I will lead you into her pleasure chamber.²⁷

²⁴ Ibid.

²⁵ Ibid., 96.

²⁶ Ibid., 100.

²⁷ Ibid., 104.

There speaks a presumptuous villain, one who will soon die himself. But other actors, notably the Bretons who are the heroes of the piece, are quite willing to match insult with insult. Beaumanoir meets the above sally with a much more civilized comeback, yet one that still held a sting:

We hear you well, me and my company
 If it please the King of Glory, and Saint Mary
 And the good St. Yves, in whom I have great faith,
 Throw the dice, don't hold back,
 The luck will fall on you, your life will be short.²⁸

His companion, Alain de Keranrais, speaking up for Beaumanoir on the same occasion, is much more forthright:

Brigand traitor, what are you thinking?
 You think you will silence a man of such courage?
 With my own body, I defy you today
 On his behalf. Now I will strike you with my sharp lance!"
 Alain Keranrais struck him that moment,
 In everybody's view, with his sharp steel lance,
 In the middle of the face and his point has pierced him
 To the brain.²⁹

Perhaps the most interesting aspect of the anonymous poetic account is how it centers on words. The poet shows us only a few blows with sword or spear in enough detail that we can visualize them; but he tells us at great length what those present said. Hot hostile words and hot deeds go together, indeed, the words act as precursors to and motivators of the deeds. Both sides use bold, provocative, and frightening language against their opponents; each resists the threats of the other with more words, not just counter-threats, but with verbal encouragement aimed at their companions-in-arms. But whether they are threats or encouragements, the messages have a common element. In a great and dangerous armed confrontation, the motivating ideas are simple. They are bad, we are good; we've got to stick together and beat them. The enemy must be reduced to shame and contempt. There is no room here for expressions of chivalric brotherhood: not when the two sides wind themselves up to face death, not while they are fighting and doing their best to keep their companions' courage up, not even at the end. The poet, speaking

²⁸ Ibid.

²⁹ Ibid., 104.

as a partisan (as indeed, he has throughout), gives only the slightest nod to the defeated English as he finishes his account

The English have lost their strength and power . . .
 Thomas Belifort [one of the most notable among the English]
 Has nothing left but his anger.³⁰

The anonymous poet shows us an arena dominated by anger, which is the expression of fear, and the antidote for it. The famous phrase aimed at a tiring Beaumanoir by one of his men is an expression of anger at a captain who seems to be letting down the side: "Drink your blood, Beaumanoir, your thirst will pass!" The remark induced anger, counteracting Beaumanoir's exhaustion "[the French commander] had such anger that his thirst passed."³¹ Even those who have never been in combat will find the anger and hot words very easy to believe, perhaps more believable than the courteous exchanges recorded by Le Bel or Froissart.

It will be tempting for some to say that the more courteous account is a typical chivalric-revival fraud.³² On the other hand, the poet's "more realistic" rendition is better seen not as an exposé of the chivalric authors, but as an explanation for their appeal, and for the appeal of the point of view that they typify. They upheld the view that the most admirable men-at-arms were not simply the most able and courageous warriors, but instead those who combined prowess with courtesy. Further, that courtesy and respect between noble men-at-arms is the glue that holds together noble society. This is not an idea that originated with Jean le Bel, Jean Froissart, or, for that matter, any other denizen of the fourteenth century. The strong appeal of a courteous warrior was perennial, and persisted because those who knew war and warriors realized how easily such men, especially the most effective, could break loose from all civilized restraint and make war even more horrible than it already was. Noble society required strong, brave men to defend it,

³⁰ Ibid., 112.

³¹ Ibid., 108.

³² Very critical evaluations late-fourteenth-century chivalry can be found in Kenneth McRobbie, "The Concept of Advancement in the Fourteenth Century in the *Chroniques* of Jean Froissart," *Canadian Journal of History* 6 (1971): 1–19; Nicholas Wright, *Knights and Peasants: The Hundred Years War in the French Countryside*. (Woodbridge, 1998). See an interesting recent analysis in Andrew Taylor, "Chivalric Conversation and Denial of Male Fear," in *Conflicted Identities and Multiple Masculinities: Men in the medieval west*, ed. Jacqueline Murray (New York, 1999), 169–88.

and to justify the privileges that nobles held as the brave defenders of the weak. Yet strong brave men without courtesy and restraint were a danger to noble solidarity and to all social order. Thus what we see in the contrasting accounts of this scuffle in Brittany are two contrasting but complementary attitudes: an appreciation of the brave and a fear of bravery unrestrained.

Returning to the question at hand: How did men act in such formal challenges as the Combat of the Thirty against Thirty? Probably not as well as some observers, including themselves in cooler moments, would have wished. Nevertheless, it seems unlikely that even the most savage army was unaffected by courteous expectations of the sort expressed in LeBel and Froissart. It was such men, after all, who would live or die, depending on what standard of chivalric behavior was observed. For that reason, among others, courteous restraint was also valued by the chivalric nobility. In the end, we can never be sure how often ferocity or courtesy won out. In all probability, we share that uncertainty with the warriors themselves. As they entered the field of battle or the more regulated field of honor, they never knew how they or their opponents would perform.

JOHN HAWKWOOD:
FLORENTINE HERO AND FAITHFUL ENGLISHMAN

William P. Caferro
Vanderbilt University

The Englishman John Hawkwood was fourteenth-century Italy's most famous and successful mercenary soldier. He began his career in France in the battles of the Hundred Years War and arrived on the peninsula with the famed White Company in 1361.¹ He passed the next thirty-three years on Italian soil, during which time he distinguished himself by his feats of arms. His successes included the brilliant tactical victory on behalf of Padua at Castagnaro in 1387 and the daring retreat from Milanese territory at the head of Florentine forces in 1391, which forestalled certain defeat. When Hawkwood died in 1394, Florence commemorated him with an elaborate funeral and commissioned a mural in his honor in the cathedral, later repainted (1436) by Paolo Uccello.

I

Uccello's portrait remains in the cathedral and is Hawkwood's most enduring legacy to the modern world. It has fixed for generations the connection between the Englishman and Florence, and has served as a starting point for scholarly studies. Hawkwood's first biographer, the eighteenth-century Italian scholar, D. M. Manni, cast the captain's life wholly in terms of his Florentine employment. Manni entitled his book *Commentario della vita del famoso capitano Giovanni Aguto Inglese, general condottiere d'armi fiorentini*, (my bold), laying the focus on Hawkwood's military service to that city. Manni's English contemporary, the antiquarian Richard Gough, presented Hawkwood in a similar

¹ See William P. Caferro, "The Fox and the Lion": The White Company and the Hundred Years in Italy," in *The Hundred Years War: A Wider Focus*, ed. L. J. Andrew Villalon and Donald J. Kagay (Leiden, 2005), 179–210; idem, *John Hawkwood: An English Mercenary in Fourteenth-Century Italy* (Baltimore, 2006).

manner. Although stating his intention to “reclaim” Hawkwood for his native land, Gough in fact followed closely Manni’s model, treating the captain’s career in terms of the Florentines, whom Hawkwood purportedly served “with irreproachable fidelity.”² Gough’s fellow Englishman, John Temple-Leader, established the link still further. He fashioned Hawkwood into an *inglese italianato*, who was “transformed” by his service into an adoptive Florentine. Temple-Leader carefully laid out the points of contact between the captain and the city: stressing Hawkwood’s receipt of a lifetime pension in 1375, his acquisition of local property in 1383, and citizenship in 1391. Although an amateur historian, Temple-Leader nevertheless made extensive use of Florentine documentary sources, assisted by Giuseppe Marcotti, who did the actual archival work. Their book, *Sir John Hawkwood*, was published both in Italian and English in the late nineteenth century and proved highly influential on both sides of the Atlantic.³

The image of a “Florentine Hawkwood” has since worked its way through the literature. The Italian scholars, F. Dini and A. Medin, making further use of the Florentine archives, elaborated on Hawkwood’s landed investments in the city and the lavish funeral given him by officials.⁴ The German writer, Fritz Gaupp, added rhetorical flourish, reading virtually every act of Hawkwood’s career in terms of Florence. In Gaupp’s rendering, Hawkwood’s relationship with the city was a species of love story. When he raided Florentine lands in 1375, it was “a brutal wooing” of the city, which culminated in a subsequent “marriage proposal.”⁵ The portrait found its way into numerous general works on mercenaries.⁶

² Domenico M. Manni, “Commentario della vita del famoso capitano Giovanni Aguto Inglese, General condottiere d’armi fiorentini,” in *Rerum Italicarum Scriptores*, supplementum II (Florence, 1777); Gough provided more information on Hawkwood’s English background, but much of it is inaccurate. Richard Gough, *Memoirs of Sir John Hawkwood* (London, 1776).

³ John Temple Leader and Giuseppe Marcotti, *Sir John Hawkwood* (London, 1889).

⁴ F. Dini, “La Rocchetta di Poggibonsi e Gio Acuto,” *Miscellanea storica della Valdelsa* 5 (1893): 13–31; A. Medin, “La morte di Giovanni Aguto,” *Archivio Storico Italiano* 17–18 (1886): 161–71.

⁵ Fritz Gaupp, “The Condottiere John Hawkwood,” *History* 23 (March, 1939): 311.

⁶ For recent restatement of the orthodoxy see Philippe Contamine, *War in the Middle Ages*, trans. Michael Jones (Oxford, 1984), 159; Denys Hay and John Law, *Italy in the Age of the Renaissance, 1380–1530* (London, 1989), 86–87.

But the notion of a “Florentinized” Hawkwood has always been problematic. For one thing, it derives from a suspect methodology that has focused almost solely on Florentine sources. In truth, Hawkwood played out his career throughout Italy, and worked for numerous employers besides Florence. For another thing, it stands at odds with the scholarly interpretation of Florentine military history, which has stressed the city’s deeply held mistrust of its mercenary captains and its preference for employing them only for short-term service. To allow for Hawkwood’s career, scholars have granted him special status; in the tradition of Gough, they have made him the one faithful, trustworthy, and “honest” mercenary, in a profession known for much the opposite. These were the qualities that commended Hawkwood to Florence, tied him to the Florentines, and served as the hallmark of his career. In terms of the broader history of the mercenary profession, Hawkwood is the exception that proves the rule.

This well-entrenched portrait needs revision. A spate of recent work on Hawkwood, after almost a century of neglect, has to some extent helped broaden our horizons, presenting a somewhat darker and more rounded vision of the man. In his work on medieval mercenaries, Kenneth Fowler has extended his research into numerous archives, both in Italy and England.⁷ Nevertheless, the preponderance of the new work is of a popular nature, and has followed the basic outlines set out by Temple-Leader.⁸ Although we have some additional information about the man, Hawkwood has nevertheless emerged more romanticized than ever.

The proper understanding of Hawkwood is one that does not equate him with any particular Italian state or moral virtue. The mercenary leader was neither a “Florentine” soldier, nor an honest or faithful man. What allegiance he possessed lay outside of Italy altogether, in his native England and with the English king, a connection he shared with other English mercenaries in Italy.⁹ Hawkwood’s most prominent personal characteristics were his duplicity and craftiness, traits well-known to

⁷ Kenneth Fowler, “Sir John Hawkwood and the English Condottieri in Trecento Italy,” *Renaissance Studies* 11 (1998): 131–48.

⁸ Duccio Balestracci has followed closely in this tradition of Gaupp and Temple-Leader, offering little that is new. Duccio Balestracci, *Le armi, i cavalli, le oro: Giovanni Acuto e I condottieri del Trecento* (Rome, 2003). Frances Stonor Saunders reiterates much of Temple-Leader, but treats Hawkwood in a much broader context. Frances Stonor Saunders, *Hawkwood, Diabolical Englishman* (London, 2004).

⁹ Saunders’s popular book places more emphasis on Hawkwood’s English nature. Saunders, *Hawkwood, Diabolical Englishman*, 120–121, 124–5, 149–150, 291–299.

contemporaries, embedded in his nickname “*acuto*” and reinforced by local comparisons of him to a “fox.” These characteristics were the keys to his success on the battlefield as well as his success in dealing with his employers. Hawkwood’s relationship with Florence throughout his career was one of give-and-take, characterized by profound tensions and dissimulation on both sides. His enduring positive image was largely the result of Florentine propaganda, constructed in the context of war with Milan and diplomacy with other states. The image arose at the end of his career, most notably after his death, when he was safely in his grave. Uccello’s portrait was the culmination of this stylized Hawkwood, a mercenary captain domesticated post-mortem.

II

To put Hawkwood’s career into proper perspective, it is necessary first to review its chronology. During the thirty-three years he passed in Italy, the Englishman worked for Florence for only twelve. He served Milan for the same number of years. His Milanese service, however, was more continuous; he spent six consecutive years serving Milan, but no more than five straight years with the Florentines. He also served the Pisans and the papacy for six years consecutively. Hawkwood did not begin his employment with Florence until he had been in Italy for sixteen years. Thus, his service to the city constituted a relatively small part of his overall career.

Hawkwood also forged close personal ties with both his Pisan and Milanese employers. He acted as a kind of bodyguard to the Pisan doge, Giovanni dell’Agnello, who largely owed his political ascendancy in 1364 to Hawkwood’s military support.¹⁰ The two men were tied by means of what one scholar has called a “secret pact,” reinforced by familial association. Agnello made Hawkwood the godfather of his son, Francesco, and gave the boy the incongruous middle name of “Aguto,” the mercenary’s Italian nickname.¹¹ Hawkwood’s connection with Pisa was sufficiently strong throughout the 1360s for at least one contem-

¹⁰ Natale Caturegli, *La Signoria di Giovanni dell’Agnolo* (Pisa, 1920), 97.

¹¹ Both the Lucchese chronicler Giovanni Sercambi and the anonymous Pisan chronicler make note of the name. The latter mistook it for the child’s first name. Giovanni Sercambi, “Le croniche Lucchese,” ed. Salvatore Bonsi, in *Fonti per la storia d’Italia*, 23 vols. (Rome, 1963), 1:132; “Chronica di Pisa,” ed. L. A. Muratori in *Rerum Italicarum Scriptores* (Milan, 1729), 15: col. 1047.

porary, the Holy Roman Emperor, Charles IV (1374–1378), to think that he was in fact a Pisan citizen, not an Englishman.¹² Hawkwood established similarly close ties to the Milanese tyrant, Bernabò Visconti. In 1377, he married Bernabò's illegitimate daughter, Donnina, with whom he remained until his death.

The full extent of his association with the two cities will never be fully known, owing to absence in both places of archival material. What we do know, however, is that Hawkwood never established such intimate arrangements with Florence. He served the city by means of impersonal contracts and never sought broader integration with the political elite or with Florentine society in general. Even in the last years of his life, possessed of estates outside the city walls and government grants of dowries for his daughters, Hawkwood did not marry the young women to Florentine citizens. Instead, he worked to his dying day to liquidate his Italian properties and return home to England.

For most of the first decades of his career in Italy Hawkwood served Pisa and Milan during a period when these two cities often opposed Florence. In 1363, during their war with Florence, the Pisans promoted him to his first full captaincy of an army. His initial offensive in the winter of that year was unsuccessful, as he drove his men too hard through snow and icy weather. But six months later, with the German mercenary captain, Hannekin Baumgarten, Hawkwood conducted a more successful campaign, leading Pisan forces to the walls of Florence.¹³ The action constituted the first tangible evidence of the Englishman's military skill and, according to the scholarly literature, the first indication of his moral character as an "honest" mercenary. With the Pisan army massed before the gates of Florence, Florentine officials bribed most of the leading captains, who then turned southward to plunder Sienese lands.¹⁴ Hawkwood, however, held firm, the only leading mercenary to do so.

This episode stands as the genesis of Hawkwood's modern-day reputation for fidelity. But like so much else about the captain, it has been taken entirely out of context by scholars. The dissolution of armies

¹² J. H. Böhmer, *Regest Imperii; Die Regeste des Kaiserreichs unter Kaiser Karl IV, 1346–1378* (Innsbruck; reprint, Hildesheim, 1968), 8:388. The letter was to Mantua and was dated May 14, 1368.

¹³ Filippo Villani, *Cronica di Matteo e Filippo Villani* (Florence, 1826), 5:257–76.

¹⁴ "Chronica di Pisa," col. 1045. The desertion of Hawkwood's army is described also by Villani and Donato Velluti. Villani, *Cronica*, 284; *La Cronica Domestica di Messer Donato Velluti*, ed. Isidoro del Lungo and Guglielmo Volpi (Florence, 1914), 237–38.

through bribery was a common occurrence. Historians traditionally place the blame on mercenaries and their inherently perfidious nature, but, in reality, such episodes depended greatly upon the actions of employers. Behind many acts of betrayal were late payments or non-payment—a persistent and too-often unacknowledged problem. There is evidence to suggest that this was in fact true in the above case. Pisa owed its captains substantial amounts of money and their contracts were coming due. According to the extant agreement between Florence and one of the deserting contingents, (led by the German, Albert Sterz), the band was owed 60,000 florins, an indication that it had not received wages for a long time.¹⁵ The debts Pisa owed its soldiers find confirmation in a letter by Andrew Belmont, another of the deserting captains. This missive reflects Belmont's bitterness about money owed him by Pisa. While Belmont was fuming over the non-payment of his men, Albert Sterz had already contemplated leaving Pisan service well before the attack on the walls of Florence.¹⁶ A letter in the Archivio Segreto Vaticano shows that Sterz had entered negotiations with the pope about leaving Italy and going East on a crusade. In other words, Hawkwood's army lacked unity from the very outset of its campaign.

It would be incorrect to assume that the same financial condition that alienated his comrades existed also for Hawkwood. As captain general of the overall army, and with close personal ties to the Pisan ruler, Agnello, he had very likely gained special financial consideration and higher priority with respect to payment of wages. There is in any case little prior evidence to suggest moral failing on the part of Albert Sterz. When he served the marquis of Montferrat in 1361, he explicitly rejected Milanese attempts to bribe him, an attitude that drew the praise of a Milanese chronicler.¹⁷ But unlike Hawkwood, Albert gained no posthumous reputation for honesty as a result of this episode.

Conversely, eight years after the events at the Florentine gates, Hawkwood deserted his employer in a manner similar to that of his comrades in 1364. While conducting a siege of the city of Pavia in 1372, he quit Milanese service and went over to their enemy, the pope.

¹⁵ Giuseppe Canestrini, "Documenti per servire della milizia italiana del secolo XIII al XVI," *Archivio Storico Italiano*. (s. 1), 15 (1851): 57–60.

¹⁶ Andrew Belmont's letter was addressed to the Florentine envoy Zenobio dell'Antella on September 4, Archivio di Stato di Firenze [ASF], Signori, Risponsive, 6, no. 9. See also n. 17.

¹⁷ Petri Azarii (Azario), "Liber Gestorum in Lombardia," ed. Francesco Cognasso in *Rerum Italicarum Scriptores* (Bologna, 1925–1939), vol. 16, pt. 4:161.

The standard story is that Hawkwood did so out of frustration with the rulers of Milan, who did not allow aggressive campaigning.¹⁸ On the other hand, letters in the Archivio Gonzaga in Mantua suggest a different explanation: the mercenary's contract was coming due and he attained better terms from the papacy.¹⁹

If contemporary Florentines were impressed by Hawkwood's behavior, there is no mention of it in the sources. Rather than embrace his moral rectitude, Florence worked diligently, and deviously, to rid itself of him. When possible, the Florentines sided with those who might defeat him in the field while attempting through diplomacy to encourage him to leave Italy altogether. For his part, Hawkwood rode against Florence, both at the head of free companies and in the joint service of Milan and Pisa, when in the winter of 1369, he inflicted a major defeat on the Florentine army at Cascina.

During these episodes, the condottieri's relationship with Florence can be reconstructed from diplomatic correspondence preserved in the Florentine state archives. This documentation consists of both ambassadorial reports and instructions from city officials to their envoys. Such sources show that Florence was preoccupied with Hawkwood, whom they saw as a great threat. The city's basic diplomatic strategy involved manipulation through flattery and deceit. In July, 1365, Florence sent Doffo di Giovanni dei Bardi and Simone Simonetti, to persuade the mercenary leader to leave Italy and go on the pope's proposed crusade. The two envoys were instructed to fashion their proposal as a courtesy extended to "a rare friend and son."²⁰ At the same time, they were to convince Hawkwood to accept the least possible sum of money for the journey by insisting that Florence was in dire financial straits. While Bardi and Simonetti were negotiating with the condottieri, Florence sent a "secret" dispatch to the pope and other Italian states, suggesting that they jointly purchase the services of a German mercenary company

¹⁸ "Annales Mediolanenses," *Rerum Italicarum Scriptores* 16 (1730): col. 750. See also Johannis de Mussis, "Chronicon Placentinum," in *Rerum Italicarum Scriptores*, ed. Ludovico Muratori, 16 (1730): col. 514.

¹⁹ The letters are incorrectly dated as 1373 by a later archivist, but they refer to the events of 1372. Archivio di Stato di Mantova [ASMa], Archivio Gonzaga [AG], Busta 1367 (12, 18, 20 September). Hawkwood's own letter on the matter is in Busta, 1321 (September 23, 1372).

²⁰ ASF, Signori-Carteggi, Missive i Cancelleria, 13, f. 50v.

which might “destroy” the English captain.²¹ According to this dispatch, with Hawkwood out of the way, the allies could then absorb the victorious Germans into their own armies, thus eliminating the problem of marauding mercenary bands.²² The plan did not succeed.

The language of “friendship” formed an essential component of Florence’s diplomatic correspondence with Hawkwood. Letters usually began by addressing him as “dearest friend.”²³ They frequently went on to laud such traits as his “nobility” (*nobilitas*) and “virtue” (*virtus*). The latter term must be treated with great care. It was used in a military context, and is best rendered into English as “prowess” or “courage.” It was not, as Temple-Leader understood it, a reference to a moral quality or, in that regard, an insight into Hawkwood’s broader relationship with Florence. The word was largely formulaic, as was its occasional partner, “faith” (*fides*). It was applied to virtually all military men in Florentine service. We see these same terms in letters to the German captains, Lutz von Landau and Konrad von Aichelberg, as well as to Hugh de Montfort, none of whom developed a special rapport with the city.²⁴

Florence’s diplomatic efforts with regard to Hawkwood had a strong English dimension to them. The city consistently used as its envoy Doffo dei Bardi, son of the founder of the great Bardi bank, a man with long years of experience in England. Himself a banker, Bardi was personally acquainted with King Edward III (1327–1377).²⁵ This added prestige and authority to his dealings with Hawkwood, which were almost certainly conducted in English. Florentine budgets of the *camera del commune* reveal that Florence handsomely paid an English-speaking knight, Walter Lesley to bribe English contingents surrounding its town

²¹ Temple-Leader and Marcotti, *Sir John Hawkwood*, 72; Eugene Cox, *The Green Count of Savoy* (Princeton, 1967), 274.

²² ASF, Signori-Carteggi, Missive i Cancelleria, 13, ff. 53v–54r. The Florentines also had an outstanding agreement with Sterz and the Germans. C. C. Bayley, *War and Society in Renaissance Florence* (Toronto, 1961), 36–37.

²³ ASF, Signori-carteggi, Missive i Cancelleria, 13, fol. 50v; Signori-carteggi, Missive i Cancelleria, 14, f. 41r; Signori-carteggi, Missive i Cancelleria, 15, ff. 2v, 3r, 7r, 8r, 9v, 16r, 19v, 31r, 36v; Dieci di balia, legazioni e commissarie, 1, f. 199r; Signori-carteggi, Missive i Cancelleria 22, ff. 71v, 149r, 149v, 160v, 161v, 162r, 170v.

²⁴ Biblioteca Riccardiana, Ms. 786, f. 68v; ASF, Signori-Carteggi, Missive i Cancelleria, 22, ff. 149r–v.

²⁵ Armando Saporì, *La crisi delle compagnie mercantili dei Bardi e dei Peruzzi* (Florence, 1926), 86; Edwin Hunt, *The Medieval Super Companies* (Oxford, 1994), 241.

walls in 1364.²⁶ Lesley had been a member of the Great Company, forerunner to the White Company, when it was at Avignon, just before it entered Italy. After this initial service, Lesley remained as envoy to the English mercenaries employed by Florence throughout the rest of the Pisan war. Doffo dei Bardi was eventually replaced as ambassador to Hawkwood by two other members of banking families with strong English ties: Simone di Ranieri Peruzzi and Spinello Alberti. In his *ricordanze*, Peruzzi clearly indicates that he was fluent in English.²⁷

Florence's strategy makes clear the obvious though oft-minimized fact that Hawkwood was, throughout his Italian sojourn, a displaced Englishman who strongly identified with his native land and language. The connection is apparent in the very first Italian contract (*condotta*), that bears Hawkwood's name—an instrument negotiated in 1361 between the White Company and the marquis of Monteferrat. It contains an explicit pledge of allegiance to the king of England. In it, Hawkwood and his fellow Englishmen refused to undertake any service that would oppose the interests of their own king.²⁸ The clause was repeated in all of Hawkwood's subsequent contracts, as well as those of his fellow Englishmen.²⁹ By contrast, mercenaries of other nationalities did not include such a pledge in their contracts.

The condottieri's allegiance to the English king constituted a central component of his career. It manifested itself even when he was at the head of purportedly "free" companies. In 1367, seeking to pressure Pope Urban V (1362–1370) with whom relations had become strained, Edward III instructed Hawkwood and the English mercenaries in Italy to support Milan, the pope's principal adversary. That he and his comrades complied is indicated in a letter by Benabò Visconti to Edward thanking the English king for his support.³⁰ This supplies our first direct evidence of a pattern that would become prominent in Hawkwood's later career: his choice of employers was often conditioned, at least in part, by English foreign policy. His full-time employment by Bernabò Visconti in 1368 corresponded with a marriage agreement between the

²⁶ Camera del comune, scrivano di camera uscita, 22, f. 13.

²⁷ Armando Saporì, *Il Libro di commercio dei Peruzzi* (Milan, 1934), 522.

²⁸ Francesco Cognasso, "Note e documenti sulla formazione dello stato visconteo," *Bollettino della Società Pavese di Storia Patria* 23 (Jan.–Dec. 1923): 160.

²⁹ ASF, Dieci di balia, deliberazioni, condotte e stanziamenti, 3, ff. 10r–12r; 31r–33r; 105r–6r.

³⁰ Edinburgh University Library, Sc2–305, f. 116v–7r. I thank the staff at the library for sending me a copy of the letter on CD ROM.

English crown and Milan, matching Edward III's son, Lionel, duke of Clarence, with Bernabò's niece, Violante.³¹

The strong connection between Hawkwood and England is apparent elsewhere. The great Flemish chronicler, Jean Froissart, claimed that when Hawkwood left Milanese service in 1372 and went over to the pope, it was on account of the presence in the papal army of Enguerand de Coucy who had married a daughter of Edward III.³² The composition of Hawkwood's armies reflected a preference for his own countrymen. A Florentine ambassadorial dispatch from 1369 quotes him as saying he had "more faith in his English soldiers than in others."³³ His forces often contained such countrymen as William Gold, William Boson, John Brice, and Richard Romsey, several of whom originally came to Italy with Hawkwood. There is also evidence of a connection between Hawkwood and men from his home county of Essex. Hawkwood's son-in-law, William Coggeshale, joined the condottieri's brigade as a teenager and rode with him for years, before returning to Essex, where he became quite prominent.

III

While the tight connection between Hawkwood and England continued in subsequent years, his attachment to Italy also grew deeper. By the late 1360s and early 1370s, he had acquired landed holdings, located mostly in lower Lombardy.³⁴ He owned property near Bologna and Parma, and perhaps gained possession at this time of the town of Gazzuolo on the Oglio River near Cremona, bordering lands that belonged to the lord of Mantua. According to his modern biographers, Hawkwood's relationship with Italy reached a key phase with his raid on Tuscany

³¹ Negotiations regarding the union were already underway in July 1366, and the deal was struck in middle of May 1367. Documents relating to this are in, *Repertorio Diplomatico Visconteo: Documenti dal 1263 al 1402*, ed. Elia Lattes, 2 vols. (Milan, 1918), 2:168; *Foedera, Conventiones, Litterae et cuiuscunque generis Acta Publica inter Reges Angliae et alios quovis Imperatores, Reges, Pontifices, Principes, vel Communitates*, ed. Thomas Rymer, 6 vols. 3:782–83, 797; Anthony Luttrell, "English Levantine Crusaders," *Renaissance Studies* 2 (1988): 151–53.

³² Jean Froissart, *Chronicles of England, France and Spain*, trans. J. Johnes, 2 vols. (London, 1868), 2:574.

³³ ASF, Signori-Carteggi, Missive i Cancelleria, 14, f. 38v.

³⁴ Archivio Segreto Vaticano [ASV], Reg Vat, 269, f. 178r; *Repertorio Diplomatico*, 166.

in the summer of 1375. It was this event which brought him into the Florentine orbit. This was the “brutal wooing” of the city that began a long and felicitous relationship. The critical link tying him to the city was a lifetime pension, followed two years later by full-time Florentine military service.

On the other hand, evidence for any lasting nexus between Hawkwood and Florence is slim. As he approached Tuscany in 1375, Simone di Ranieri Peruzzi depicted him as an angry captain, who spoke disparagingly of the region, in general, and of Florence, in particular. The mercenary leader mocked the city’s internal political discord, saying that “they don’t pull the same rope, but call one [Guelf] and the other Ghibelline.”³⁵ This statement—hardly a marriage proposal—suggests that Hawkwood had gained an understanding of the pervasive antagonisms that animated local Italian politics. He tried to take advantage of these antagonisms by bringing with his army exiles from Florence and other Tuscan cities, a strategy typically adopted by marauding bands and one designed to exert political pressure on places under attack, making them capitulate more quickly. Hawkwood knew the Florentine exile community well and had established close ties with the powerful exile, Giovanni d’Azzo degli Ubaldini, a rural lord, whose family controlled a northern access into Florentine territory.

The mercenary’s raid into Tuscany in 1375 lasted for three months, during which he extorted from Florence bribes worth 130,000 florins. This sum shocked Ambassador Peruzzi, who initially counseled the city to take up arms rather than pay. Ignoring this advice, Florentine authorities gave in to Hawkwood’s demands, in addition granting him a lifetime pension worth 1200 florins a year, which was exempt from taxation.³⁶

This pension has been the source of much confusion about Hawkwood’s relationship with Florence. On the one hand, it did establish a long-term tie between the captain and the city, one strengthened by the fact that Florence appears to have paid consistently and on-time.³⁷ On the other hand, the pension was nothing more than a form of tribute, and, at that, a fairly common one, often bestowed upon mercenary captains. Many of Hawkwood’s contemporaries had already received

³⁵ Archivio di Stato di Siena [ASS], Concistoro, 1786, #74.

³⁶ ASF, Capitoli i registri, f. 48r.

³⁷ Temple-Leader and Marcotti, *Sir John Hawkwood*, 92; Gaupp, *Condottieri*, 311; Saunders, *Hawkwood*, 176–79.

such grants. For example, in 1373, an obscure German contemporary, Robotus von Engestorp, had received a lifetime pension from Venice.³⁸ Hawkwood himself had previously extorted one from Queen Johanna I of Naples (1343–1382). In 1383, he gained another from the city of Lucca.³⁹ In fact, his connection to Lucca proved particularly strong: he would eventually acquire land in that city, gain citizenship, and conduct banking with local firms.⁴⁰ Nevertheless, scholars have not made a case for the condottieri becoming “an adoptive Lucchese.”

The incontrovertible result of Hawkwood’s raid in 1375—that which most mattered to the captain himself—was the great wealth that it produced. A letter in the Archivio Gonzaga reports Hawkwood as having now amassed savings of 100,000 ducats. The dispatch also indicates that, at the height of his financial fortunes, he contemplated returning home to England.⁴¹ The impulse is confirmed in a petition submitted to the English crown by Hawkwood’s representatives securing “pardon” for crimes committed while a free captain in France. The pardon was received in 1377 and provided Hawkwood an honorable means of returning home.⁴²

Despite the pull of his homeland, Italy was difficult to leave at this point. Hawkwood’s raid on Tuscany had initiated a war between the pope and Florence, which involved much of central Italy. The market in soldiers grew tight, and Hawkwood was at the height of his demand as a captain. The ambiguity of his intentions raised further the price of his service. As a result, he remained in Italy. He took up first with the papacy against Florence and its allies for which he and his brigade were purportedly paid 30,000 florins a month, a sum that contemporaries thought impossible for the pope to raise.⁴³ Two years later, he switched sides, receiving an even more lucrative offer, which required the financial participation of sixteen separate states. The contract of May, 1377, guaranteed Hawkwood a personal stipend of 3,200 florins

³⁸ Stephan Selzer, *Deutsche Söldner im Italien des Trecento* (Tübingen, 2001), 110.

³⁹ ASV, Reg Vat. 269, fols. 179v–180r.

⁴⁰ Archivio di Stato di Lucca [ASL], Consiglio Generale 8, p. 73 (March 17, 1382); *Calender of Close Rolls, Richard II, 1381–1385*, vol. 2 (London, 1920), 367; Holmes, “Florentine Merchants,” 201–202. For Lucchese activity as bankers in England, see Kaeuper, *Bankers to the Crown*, 9, 81–82; Hunt, *The Super-companies*, 58–59; De Roover, *Money, Banking and Credit*, 39; Meek, *Lucca*, 44, 200–2.

⁴¹ ASMa, AG, Busta 1367 (October 26, 1375).

⁴² *Calender of Patent Rolls, Edward III, 1374–1377*, vol. 16 (London, 1916), 435; For Hawkwood’s intentions, see Caferro, *John Hawkwood*, 175–95.

⁴³ ASF, Signori-Carteggi, Missive i Cancelleria, 15, f. 14v (October 16, 1375).

a month as well as payment for his brigade at the rate of 42 florins per month per lance, for the first two months.⁴⁴ The earnings represent a high point in the mercenary's career.

Hawkwood departed papal service just after his participation in February, 1377, in the sack of the city of Cesena. The sack was one of the most brutal acts of the century. Together with Breton mercenaries his men slaughtered unarmed locals at the direction of the cardinal of Geneva, the future anti-pope, Clement VII (1378–1394). While the deed shocked contemporaries, it has led modern scholars, seeking to maintain Hawkwood's image as a "moral" captain, to minimize his involvement. His defenders reduce his role to a passive one, and make the claim that this bloody service convinced him to leave papal employment. However, if he was morally offended, Hawkwood could easily have turned away from Italy altogether; his pardon in England was approved a month after the massacre. In reality, his major motivation was money. Lost in the accounts of human tragedy at Cesena is the fact that the pope's mercenaries had gone without pay. The city's sack thus served as partial payment for the soldiers.

Hawkwood's abandonment of the papacy was brought about through the diplomatic efforts of the Milanese, his new employer. Bernabó Visconti brokered the deal, for which he took explicit credit. He employed as his envoy Ruggiero Cane, whom the condottieri had apparently known since at least 1371.⁴⁵ Bernabó sealed the deal with Hawkwood by arranging a marriage between the captain and his illegitimate daughter, Donnina. Donnina's dowry involved large cash payments as well as a cluster of estates northeast of Milan, in the towns of Pessano, Bornago, Carugate, Valera and Santa Maria alle Molgora.⁴⁶

Rather than metaphorical "marriage" to Florence, Hawkwood was, by 1377, quite literally married to Milan. His new wife, Donnina, was

⁴⁴ Biblioteca Riccardiana, Ms. 786, f. 36v.

⁴⁵ ASS, Conc 1793, #5; ASMa, AG, Busta 1602, #642. Gino Franceschini, "Soldati inglesi nell'alta valle del Tevere seicent' anni fa," *Bolletino della regia deputazione di Storia patria per L'Umbria* 42 (1945): 183. Cane attached himself to Hawkwood during the raid on Tuscany in 1375 and took the rather unusual role of helping the captain collect bribe money.

⁴⁶ An anonymous description of Hawkwood's wedding is in ASMa, AG, Busta 1602, no. 641. This is partially reproduced by *Documenti Diplomatici tratti dagli Archivi Milanesei*, ed. Luigi Osio, vols (1864; reprint, Milan, 1970), 1, pt 1:191–92. See also Temple-Leader and Marcotti, *Sir John Hawkwood*, 128. For Hawkwood's own letter relating to his marriage, see ASL, Anziani al Tempo della Libertà, 439, (no. 2012). For the lands given to Hawkwood see Caterina Santoro, *La politica finanziaria dei Visconti*, 2–3, (doc. 5).

a member of the city's ruling elite. The so-called triumph of Florentine diplomacy was actually a triumph for Milan. Nevertheless, this bit of diplomacy also had an English dimension to it. Hawkwood's marriage to Donnina Visconti took place shortly before the ascension of Richard II (1377–1399) to the English throne. Soon afterwards, Richard chose the mercenary as his representative in Milan to help arrange a marriage between himself and Bernabò's legitimate daughter, Caterina. This coincidence between English foreign policy and Hawkwood's actions is striking, and we cannot rule out the possibility that his own marriage was directed—or at least approved of—from home. In October, 1377, Richard sent the Franciscan friar, Walter Thorpe, to help the condottieri conduct negotiations with Milan.⁴⁷

Hawkwood's role as Richard's ambassador defined much of his subsequent career. For the next two years, he worked to arrange the marriage to Caterina, an effort that eventually placed him in close association with an English envoy, Geoffrey Chaucer. But this diplomatic service detracted from his military performance. Florentine officials of the period complained bitterly about his lack of military zeal. In their letters to him (always addressed to "dearest friend"), they appealed to his "virtue" and manliness and, significantly, his sense of pride as an Englishman.⁴⁸

But the Florentines apparently did not see the broader picture. In fall of 1377, Hawkwood expanded his diplomatic role by conducting negotiations with the papacy to bring an end to the war. It is not clear whether at this point he was pursuing Milanese or English objectives or both. For their part, the Florentines were appalled. They condemned his activities ("how can you possibly make treaties without our knowledge or that of Bernabò?") and urged him to make "a strong showing in the field."⁴⁹

By 1378, Hawkwood's reputation stood at a low point in Florence. After his visit to the city to confer with officials about his diplomatic efforts, the anonymous chronicler wrote, "May he never return!"⁵⁰ With peace talks underway, Hawkwood summarily withdrew from Tuscany

⁴⁷ Édouard Perroy, *L'Angleterre et le grand schisme d'occident* (Paris, 1933), 137; R. H. Jones, *The Royal Policy of Richard II: Absolutism in the Later Middle Ages* (Oxford, 1968), 83–84.

⁴⁸ Biblioteca Riccardiana, Ms. 786, ff. 60v–61r (September 27, 1377), 69v; Temple-Leader and Marcotti, *Sir John Hawkwood*, 133.

⁴⁹ Biblioteca Riccardiana, Ms. 786, ff. 55v, 61r.

⁵⁰ "Diario d'anonimo fiorentino dall'anno 1358 al 1389," ed. A. Gherardi in *Cronache dei secoli XIII e XIV* (Florence, 1876), 344.

and rode to Verona, an action that proved the primacy of his relationship with Milan over Florence. With Bernabò Visconti preparing to make war on Verona, Hawkwood arrived at the Veronese town walls in April, 1378. At the time he departed Tuscany, he was arguing with Florence over back pay.⁵¹

At Verona, Hawkwood continued to serve Richard II in an ambassadorial capacity, negotiating the marriage union with the Visconti. Talks reached a critical stage in the early summer of 1378, when Richard sent his envoys, Geoffrey Chaucer and Edward de Berkeley.⁵² The two men joined the mercenary leader and together they conferred with Bernabò Visconti.⁵³

These negotiations ultimately failed. The marriage plans were abandoned, and Richard II shifted his interest to the house of Luxemborg. Meanwhile, Hawkwood's diplomatic activities had caused the Verona campaign to bog down. While away in Milan, his army fell into disarray.⁵⁴ What had seemed to Bernabò an easy victory turned into a major disappointment. The Visconti duke blamed Hawkwood and his associate, Lutz von Landau, dismissing them from service, while preventing them from redeeming captives. In February, 1379, Bernabò vindictively stripped the Englishman of the lands he had been given for Donnina's dowry and the Milanese ruler published an edict granting a thirty-florin reward to anyone who killed or captured any mercenary serving either Hawkwood or Landau.⁵⁵

Bernabò's anger probably reflected not only his frustration at the failure of the Verona campaign, but also the failure of negotiations with King Richard. In any case, Hawkwood's relationship with Bernabò was now effectively ended; he would never again work for the house of Visconti.

At this point, Hawkwood turned to Tuscany, not for rapprochement with the Florentines, but at the head of a free company to recoup his

⁵¹ "Diario d'anonimo fiorentino," 35.

⁵² Saul, *Richard II*, 84; Perroy, *L'Angleterre*, 137–38.

⁵³ R. A. Pratt suggests that the talks were conducted between July 15 and August 2. R. A. Pratt, "Geoffrey Chaucer esq. and Sir John Hawkwood," *Journal of English Literary History* 16 (1949): 188–93; See also *Chaucer's Life Records*, ed. Martin M. Crow and Clair C. Olson (Oxford, 1966), 53–61.

⁵⁴ Evidence of this is in letter in the state archives at Mantua. ASMa AG, Busta 2388, no. 253; Busta 1595 (April 26, 1378), (July 29, 1378).

⁵⁵ Daniela Pizzagalli, *Bernabò Visconti* (Milan, 1994), 126–27. The peace accord that ended the Veronese war is in Caterina Santoro, *La Politica Finanziaria dei Visconti*, ed. Caterina Santoro, 3 vols. (Milan, 1976), 1:328–32 (doc. 455).

financial losses. Once again, he exploited political tensions by taking into his band exiles from the region. He invaded Florentine territory despite his sworn agreement, given at the end of his prior service, not to harass the city for five years. On June 10, 1379, Florence joined with Perugia, Siena, Arezzo, and Città di Castello, to sign a pact agreeing to hire Hawkwood's band in lieu of paying bribes.⁵⁶ According to Stefani, the Florentine chronicler who helped negotiate the deal, Hawkwood and his band broke faith with the commune by threatening Florence, then flossed over this breach by forcing themselves on the city at a considerable price. In the captain's words: "I will not make you pay me, but you [will] hire me . . . whether you want to or not."⁵⁷ The statement makes clear that even at this late date in Hawkwood's career, after nearly two decades in Italy, he was not viewed as a faithful or honest captain in Florence. For his part, he looked upon the city as a source of profit, to be attained through manipulation.

The 1379 raid, however brief it may have been, had long-term implications for his relationship with Florence. It produced earnings, which now allowed him to retire from active military service and take up a new life on estates in the Romagna given him by the pope during his recent service. This placed Hawkwood physically close to Florentine territory, near its northern border, just beyond the Appenines. His proximity necessitated especially close attention from the Florentines. They were enduring politically-tense years, marked by conspiracies growing out of the Ciompi Uprising and the establishment of a government of the lesser guildsmen. Gene Brucker has depicted the mood in Florence as "verging on paranoia."⁵⁸

Hawkwood's arrival in the Romagna also occasioned armed confrontations with his neighboring Romagnol lords, many of whom resented his presence. The condottieri engaged in a particularly intense feud with Astorre Manfredi, the ruler of Faenza, a conflict that strained Hawkwood's financial resources and inclined him toward further Florentine service. There developed, in short, a mutual need, which helped bring Florence and the mercenary leader together.

⁵⁶ ASMa, AG 2388, no. 326; ASF, Camera del Comune, Uscita, 238, f. 28r; Provisioni, registri, 68, f. 92v; *Cronaca Senese*, 675; Franceschini, "I soldati," 185.

⁵⁷ Marchionne di Coppo Stefani, *Cronaca fiorentina di Marchionne di Coppo Stefani*, ed. Niccolò Ridolico in *Rerum Italicarum Scriptores* [n.s.], (Città di Castello, 1903), 30, pt. 1:345.

⁵⁸ Gene Brucker, *The Civic World of Early Renaissance Florence* (Princeton, 1977), 75–76.

The arrival of the Hungarian prince, Charles of Durazzo, in Italy in the spring of 1380 hastened the process. Charles came to defend his interests in Naples against the French Angevins. His itinerary took him through Tuscany and caused great consternation in Florence.⁵⁹ At precisely this juncture, Hawkwood had arranged a truce with Astorre Manfredi. The Florentines decided to hire him as a means of speeding Charles through their territory. After his substantial economic losses, Hawkwood was eager to earn a salary. He signed a six-month contract as a Florentine captain of war.

Hawkwood performed his charge well. The continuing political tensions and the fear of mercenary bands spinning out of the conflict in Naples induced Florence to re-hire Hawkwood on two further occasions. The mutual benefit to both parties is clear from the contract of April, 1381, which authorized Hawkwood to lead his forces seventy miles beyond the territorial limits of Florence, in order to use them against his Romagnol enemies.⁶⁰ This was very uncommon in military contracts of the day. The document's preamble lauded its signatory for his "virtue" (*virtus*), but this now obvious formula masked a moral calculation on both sides. The internal debates within the *Signoria* reveal that Florentine authorities entertained decidedly mixed emotions about keeping Hawkwood on the payroll. Some officials felt he was too expensive and difficult to handle.⁶¹ On the other hand, what recommended him most was his military reputation, a reputation which alone discouraged enemies. The Florentines also appreciated his obvious disinterest in local politics, a trait that reflected his preoccupation with his native England.

The involvement with England is particularly evident during these years. In 1379 and 1380, Hawkwood invested heavily in buying up in estates and manors back home in his native county of Essex.⁶² Undoubtedly, he had begun this activity even earlier. There is also indication that he took advantage of the great Peasant Revolt of 1381 to increase his holdings. In Essex, an epicenter of the rebellion, the English captain purchased properties formerly belonging to Richard

⁵⁹ ASF, Camarlingho del Camera, Uscita 241, ff. 9r-11r.

⁶⁰ ASF, Provvisioni, registri, 70, ff. 26v-29v.

⁶¹ The deliberations are in ASF, CP 21, ff. 61v-62v, 67v-68r, 71r-72r.

⁶² *Calender of Close Rolls, II Richard, 1377-1381*, 367; *Essex Sessions of the Peace*, 14, 17.

Lyons, a wealthy financier to the crown and prominent landholder who had been beheaded by the rebels in London.⁶³

At about the same time, Hawkwood also began acquiring land near Florence, a development seen by Saunders as representing a key stage in the captain's relationship with his adopted city.⁶⁴ In December, 1381, he sold his Romagnol lands to Niccolò d'Este of Ferrara, conceding in effect his inability to defend them. In October, 1382, Hawkwood submitted a petition to Florentine officials seeking permission to purchase land within Tuscany. Rather than representing a new closeness, however, the transaction was emblematic of basic tensions that drove both sides. The condottieri demanded that the land be given free of charge, a privilege he had gained from other cities. For their part, Florentine officials refused to do this, agreeing only to allow Hawkwood to purchase estates in Florence, a concession that involved sidestepping a city statute that prevented foreigners from holding local property.⁶⁵ On this issue, it appears that Florence prevailed.

Hawkwood's "investment" in Florence was in any case part of a broader pattern of acquisition of land throughout the region. Already in November, 1381, he had received from Perugia, without charge, possession of a "mansione and cloister in the city."⁶⁶ At precisely the same time, he was negotiating with Florence for land, he was also writing to Lucca expressing interest in permanently settling there.⁶⁷ In 1383 and again early in 1384, he gained possession—though it is not entirely clear how—of the fortresses of Montecchio (now Montecchio Vesponi), located south of Arezzo, and of Migliari and Abbey del Pino.⁶⁸

These last two properties were of considerable strategic importance since they controlled the passage into Tuscany through the Valdichiana and overlooked a busy Roman road that brought merchants, pilgrims, and armies from Arezzo to Cortona and then on to Rome. This newly-acquired patrimony made Hawkwood a power to be reckoned with in north-central Italy.

⁶³ The sale occurred in May, 1382. *Calender of Close Rolls, Richard II, 1381–1385*, 137–38; Morant, *History and Antiquities of Essex*, 379–80.

⁶⁴ Saunders, *Condottieri*, 266.

⁶⁵ ASF, Provvisioni, 71, registri, ff. 126v–27r.

⁶⁶ Archivio di Stato di Perugia [ASPer], Consigli e Riformanze, 29, f. 188r–189v.

⁶⁷ ASL, Consiglio Generale, 8, 73 (March 17, 1382).

⁶⁸ Cronaca Senese, 702; Don Antonio Bacci, *Strade romane e medioevali nel territorio aretino* (Cortona, 1986), 148–204.

He acted accordingly. When the French noble, Enguerrand de Coucy, passed through Tuscany in the fall of 1384 on his way to Naples to fight against Charles of Durazzo, his route took him toward Cortona, past the fortresses controlled by Hawkwood.⁶⁹ According to past scholars, Hawkwood, now firmly allied to Florence, adhered to local policy by opposing Coucy.⁷⁰ But the actual situation was far different. Documents in the Ashburnham collection in the Biblioteca Laurenziana in Florence show that Hawkwood looked after his own interests, giving tacit support to Coucy (through a third party), while at the same time opening his castle at Montecchio to English soldiers in Florentine service.⁷¹

The above example makes clear the diverse motives that often lay behind Hawkwood's actions. The influence of England, and of Richard II in particular, remained strong. In 1381–1382, Richard's brother-in-law, Holy Roman Emperor, Wenzel of Luxemburg (1378–1400), indicated that he planned to enter Italy in support Pope Urban VI (1378–1389) who was fighting French opponents in Naples. At this time, the English king commanded Hawkwood and other English mercenaries to assist in the enterprise.⁷² The royal directive was rescinded only when Wenzel chose to stay home, due to lack of money.⁷³ It is quite possible that Richard influenced Hawkwood's decision to fight in Urban's Neapolitan campaigns of 1383, a decision usually attributed to Florentine influence.⁷⁴ Although the war proved profitless, it fit within the general outlines of Richard's policies, which supported the Italian pope over the French contender. Periodically, Hawkwood would become involved in Neapolitan affairs throughout the decade of the 1380s.⁷⁵

Even after his acquisition of local properties, Hawkwood was hardly a "Florentine" captain. To date, he had worked for the city for only seven

⁶⁹ "Ricordo della compra di Arezzo fatta dai Fiorentini, tratto del libro segreto di Guccio Benvenuti, del popolo di Santa Maria sopra Porta di Firenze (Nov 1383)," ed. Giovanni Grazzini in *Rerum Italicarum Scriptores*, 24, pt 1 (Città di Castello, 1909).

⁷⁰ Temple Leader and Marcotti, *Sir John Hawkwood*, 187.

⁷¹ Biblioteca Medicea Laurenziana de Firenze [BLF], Ashburnham Ms. 1830 II-548, II-549.

⁷² Rymer, *Foedera*, 4:114–6, 140; Perroy, *L'Angleterre et le grand schisme*, 159; Saul, *Richard II*, 83–88, 94.

⁷³ *Westminster Chronicle*, 30–31; Tyerman, *England and the Crusades*, 333–38.

⁷⁴ The degree of Hawkwood's participation in Neapolitan affairs is already apparent in 1382. In a letter dated June 26 of that year he was able to relay the maneuvers of the French Angevin army—which had not yet entered Italy—and also the names of the nobles and barons in it. ASL, CG 8, 170, f. 15r (July 26, 1382).

⁷⁵ Rymer, *Foedera*, 4:145; Perroy, *L'Angleterre et le grand schisme*, 280, 287–88.

years, never for more than three consecutively. During this time, his service had consisted mostly of defensive duties that included protecting the city from marauding bands, but not engaging them in actual battle. These facts help put into perspective his decision on July 1, 1385, to sign a contract with Giangaleazzo Visconti, who had deposed his uncle Bernabò two months earlier and then taken possession of the Milanese state. Scholars have portrayed this as a “shameful” act, out of character for the virtuous captain, tantamount to selling his “soul to the devil.”⁷⁶ But that judgment relies on acceptance of the notion that Hawkwood was by now an adoptive Florentine. Giangaleazzo Visconti is a “devil” only in terms of Florentine history and propaganda, stemming from the great war in 1390. On the other hand, when Hawkwood made the deal with the new Milanese ruler, most Italians viewed him as a liberator, a welcome alternative to his bellicose uncle, and this opinion was shared by the Florentines.

And while Temple-Leader accuses Hawkwood of selling his soul for “meager gain,” the contract was actually quite lucrative, calling for a bonus of 1000 florins and a pension of 3000 florins a year in return for his promise to serve Visconti when called.⁷⁷ This was considerably more lucrative than his Florentine pension of 1375. In addition, Giangaleazzo returned to the aging condottieri those Milanese lands that had been part of Donnina’s dowry.

Here again, we see an English angle. The day after Hawkwood signed the contract with Giangaleazzo, Richard II once again appointed him ambassador to Milan and sent an envoy, Nicholas Dagworth, who accompanied him to that city in order to discuss the king’s business.⁷⁸

IV

Only after 1387, following Hawkwood’s greatest military triumph at Castagnaro, did the Englishman finally enter a lasting period of service to Florence. This occurred in the context of growing tensions between Milan and Florence and their respective allies, which set off a massive

⁷⁶ Temple-Leader and Marcotti, *Sir John Hawkwood*, 190.

⁷⁷ *La Politica Finanziaria*, ed. Santoro, 3; Osio, *Documenti diplomatici*, 1:249; see also Temple-Leader and Marcotti, *Sir John Hawkwood*, 189–90; Cognasso, “L’Unificazione,” 522; *Calendar of State Papers and MSS., Milan* ed. Allen B. Hinds (London, 1912), 1.

⁷⁸ Public Record Office [PRO], England, C 47, 28/6.

military build-up, eventually leading to a war that involved most of north and central Italy. Both sides competed to recruit available mercenary captains. The Milanese enjoyed particular success in establishing long-term relations with such leaders. This impelled Florence yet again to employ the man who, after his victory at Castagnaro, was at the height of his military prestige.

Scholars have explained Hawkwood's decision to work for Florence as stemming from a personal grudge against Giangaleazzo, who, after deposing Bernabò, issued a "legal decree" (*processus*) against his uncle, which among other things impugned the honor of Bernabò's favorite mistress, Donnina de Porri, mother of Hawkwood's wife.⁷⁹ This interpretation is supported by the presence in Hawkwood's brigade of Carlo Visconti, Bernabò's son, who had escaped Milan after his father's capture and had arrived in Florence in May, 1388. At this time, the two men swore vengeance on Giangaleazzo. The Florentines had not wanted to recruit Carlo Visconti, whom they deemed a "base and foolish" man.⁸⁰ They both discouraged his participation and tried diplomatically to distance themselves from him. It was undoubtedly Hawkwood who hired him, suggesting that anger at Giangaleazzo was at least in part motivating him.

On the other hand, the notion of an angry John Hawkwood avenging his father-in-law is problematic. Hawkwood's relationship with Bernabò had collapsed in a most bitter fashion back in 1379. What is more, rash and angry behavior on the captain's part ran contrary to a career of cool-headed calculation that had become synonymous with his military persona. It was, in fact, a dispassionate and calculating Hawkwood that the Florentines wanted in their service, not a vengeful warrior. Although an intense military build-up was under way, neither side wanted to start a war; in fact, both went to substantial lengths to prevent doing so.

What commended Hawkwood to Florence throughout these years was a new, well-established reputation for caution and prudence. In practical terms, Hawkwood offered help to Florence in building up its forces, particularly with regard to recruiting English soldiers, who were

⁷⁹ Temple-Leader and Marcotti, *Sir John Hawkwood*, 190; Saunders, *Hawkwood*, 287. The *processus* is published in *Annales Mediolanenses*, cols. 788–800.

⁸⁰ BLF, Ashburnham 1830 III-43 (May 11, 1388).

considered the finest foreign mercenaries in Italy.⁸¹ For the captain, Florentine employment again filled a financial need. Evidence suggests that, despite his victory at Catagnaro, Paduan service had not been lucrative. In a petition to the Florentine city council, he bitterly complained of large debts and the need to sell some of his land.⁸²

This is not to discount the effect on Hawkwood of Carlo Visconti, who vociferously advocated war against Giangaleazzo. The contract he had signed with Giangaleazzo in 1385 had apparently fallen apart and there may well have been ill-will existing between the signatories. On the other hand, Hawkwood had personal motives for serving Florence. It brought him close to his own lands in Tuscany, which lay at the epicenter of tensions with Siena. In 1388 and 1389, the Florentines stationed his army near Cortona. But the diplomatic give-and-take of this complicated conflict proved frustrating to the condottieri, who had difficulties keeping an army in line in the face of often contradictory instructions. By 1389, the plague had broken out, rendering the situation even more untenable. Such problems probably account for Hawkwood's remark, often quoted by scholars, that "the deeds in Lombardy require action not show."⁸³ While these words would seem to confirm the captain's bellicose intentions toward Milan, it is more likely they express his growing frustrations with his current situation and his own employers.

Florentine officials entertained their own anxieties about Hawkwood. Debates within the *Signoria* reveal ambivalence among the city's executives concerning the captain's continued employment. Alessandro di Niccolò stressed the utilitarian nature of the relationship, arguing that "Hawkwood's person is greatly useful to the commune."⁸⁴ But Lotto Castellani spoke in favor of allowing the contract to lapse, citing both the money and anxiety it would spare the city, anxiety owing to the difficulty of managing Hawkwood.⁸⁵ Bono di Taddeo advocated avoiding foreign mercenaries altogether and instead employing a citizen cavalry

⁸¹ ASF, Dieci di Balia, Commisarie e legazioni, 1. ff. 77r-v; see also Hawkwood's activities in July, 1388 in trying to recruit John Beltoft. These are recounted in ASMa, AG, Busta 1099 # 118 (July 22, 1388).

⁸² ASF, Provvisioni, registri, 75, f. 209v.

⁸³ ASF, Dieci di balia, Legazioni e commissarie, 1 f. 158r.

⁸⁴ ASF, CP 26 ff. 215v-216v.

⁸⁵ ASF, CP 27, f. 23v.

of 200 men, a move that would have the added advantage of permitting the city to pay its soldiers less than the current market rate.⁸⁶

During this period, Hawkwood actually left Florentine employment on two occasions, first, in the spring and summer of 1388 and again in the fall of 1389, both times to go to Naples to fight the French Angevins. In so doing, he may again have been following English policy, perhaps even the direct instructions of King Richard, though we possess no specific evidence. He did not, as scholars assert, strictly adhere to Florentine foreign policy. Florence played only a moderate role in events in Naples. While the city supported the Hungarian claimant, it also tried to avoid alienating French Angevins, who were traditional allies.⁸⁷ Florentine officials kept a close watch on Hawkwood while he was in Naples, while at the same time closely monitoring the situation with Milan. Sources show that, as with everything regarding Hawkwood, there were profound tensions. When war seemed close at hand in May, 1389, the mercenary captain showed no inclination to return to Florence, greatly angering city officials.⁸⁸

Hawkwood did return to Florence in April, 1390, when the long-anticipated war between that city and Milan finally began. Florentine authorities sent him to Bologna to join the allied force assembling there. This constituted Hawkwood's last and most enduring service to his adopted home, during which he gained citizenship, an increase in his pension, dowries for daughters and ultimately an elaborate funeral and lasting memorial in the cathedral.⁸⁹ Hawkwood emerged in short a hero in the city, an admiration that must be judged sincere.

The Milanese war was the first time that Hawkwood engaged in offensive warfare directly on behalf of Florence. Yet, during this campaign, he did not win a battle in the field. His major action consisted of a great retreat from Milanese territory in summer of 1391 during which he crossed three rivers and a flooded plain, pursued by a Milanese army. He found himself deep in Milanese territory as part of an attempt to link up his forces with a French army led by Jean III, count of Armagnac.⁹⁰ Armagnac, however, was delayed, and Hawkwood

⁸⁶ ASF, CP 27, ff. 12v–13r.

⁸⁷ ASF, CP, ff. 38r–39v, 46v–48v, 63r–64r; Brucker, *Civic World*, 76–77, 114; Collino, "La Politica Fiorentino-Bolognese," 137–39.

⁸⁸ ASF, Dieci di balia, Legazioni e commissarie, 1, f. 199r.

⁸⁹ ASF, Capitoli, I, #79 ff. 160v–163v.

⁹⁰ Discussions in the Florentine Signoria relating to Armagnac are in ASF, CP 28 fols. 85v, 86r, 88v, 96r. see also *Storia di Milano*, 557. The correspondence between

ran short of supplies. Meanwhile, Milanese engineers cut through an embankment of the Adige River flooding the plain to his rear.⁹¹ Hawkwood was trapped, but he escaped by means of ingenuity. He signaled to the enemy captain, Jacopo dal Verme, his willingness to do battle, then left under the cover of night. After traversing the flooded plain, he crossed rivers already swollen by spring rains. The escape was the culmination of Hawkwood's career of dissimulation, his retreat was worthy of the nickname *acuto*.

Had Hawkwood not escaped, the Florentines would likely have lost the war. This was clear from what followed. The count of Armagnac arrived shortly after Hawkwood's retreat. The Milanese captain, dal Verme, doubled back and met Armagnac near the town of Alessandria. According to various accounts, the French army rushed boldly and incautiously into battle and was annihilated.⁹² The "rashness" of the French contrasted strongly with the "prudence" displayed by Hawkwood, and brought into relief the true military greatness of the English captain. His stature as a local hero was assured. Florentine officials voiced their approval directly to him in a letter of July 27, 1390 which applauded him as the "protector of the Florentine state."⁹³

V

Adulation for the man continued for the next fifty years. The merchant of Prato, Francesco Datini, made regular reference to Hawkwood in his correspondence with his friend, Lapo Mazzei. "Is it not true," Lapo wrote to Datini soon after Hawkwood's death, "that John Hawkwood himself was worth 500 lances?"⁹⁴ Giovanni Cavalcanti (d. 1451) described Hawkwood in his *Trattato Politico-Morale* as "an excellent man, . . . an outstanding captain" and a paradigm of "prudence."⁹⁵ The

Armagnac and Florence is published in P. Durrieu, *Les Gascons en Italie* (Auch, 1885). For the agreement with Florence of October 16, see 51–52.

⁹¹ *Cronica Volgare di Anonimo Fiorentino (Piero di Giovanni Minerbetti)*, ed. Elina Bellondi, *Rerum Italicarum Scriptores*, 17, pt. 2 (Bologna, 1937), 131.

⁹² See L. Mirot, *La politique française en Italie de 1380 à 1422. Les préliminaires de l'alliance florentine* (Paris, 1934); *Storia di Milano*, 558.

⁹³ ASF, Signori-Carteggi, Missive i Cancelleria 22 ff. 149r–v.

⁹⁴ *Lettere di un notaio a un mercante del secolo XIV*, ed. Cesare Guasti, 2 vols (Florence, 1880), 1:304, 424.

⁹⁵ Giovanni Cavalcanti, *Trattato Politico-Morale*, ed. Marcella Grendler (Geneva, 1973), 124, 214.

humanists Leonardo Bruni (d. 1444) and Poggio Bracciolini (d. 1459) though they disliked mercenaries in general, admired Hawkwood in particular. They portrayed him in their histories of Florence as an effective soldier. Leonardo Bruni said of Hawkwood's retreat that "no other captain . . . would have been able to save the army from such difficulty."⁹⁶ Bracciolini described Hawkwood in several places as a "wise leader."⁹⁷

The city's appreciation took more tangible forms. Hawkwood received an increase in his pension to 2,000 florins a year, dowries of 2000 florins for each of his three legitimate daughters, a pension of 1000 florins for his wife, "the noble lady, Donnina," and Florentine citizenship for himself and "his sons, and descendants in the male line, born and yet to be born."⁹⁸ legislation enacting these measures reads like the summary of Hawkwood's career in Temple-Leader and Gaupp. It praises Hawkwood as a soldier who

for a long time has fought most prudently, honorably and happily on our behalf and has been for long our devoted friend and has conducted himself with faith in the military matters of this commune.⁹⁹

Finally in 1393, the city made plans to commemorate its great captain (still alive) by means of a marble monument.

To understand the intense and lasting reaction in Florence to Hawkwood's service, it is necessary to stress the grave consternation that the Milanese war produced in the city. Milan had swallowed its neighbors and encircled Florence by means of an alliance with Siena. Officials believed that the very existence of the Florentine state was at stake, a fear that Hans Baron pinpointed as the genesis of civic humanism. In reality, both the fear of Milan and civic humanism developed before 1390 and co-existed well into the fifteenth century, as the Milanese threat periodically reasserted itself.¹⁰⁰

The public preoccupation in 1390 is clear from Florentine dispatches and instructions to ambassadors. A letter of December, 1390, instructed envoys to take special care to please Hawkwood since "our entire state

⁹⁶ Bruni, *Istoria fiorentina*, 539.

⁹⁷ Bracciolini, *Storia Fiorentina*, libro terzo, pages unnumbered, but I count as the sixteenth side from the beginning of chapter three.

⁹⁸ ASF, Capitoli, #79, ff. 160v–163v.

⁹⁹ *I Capitoli del comune di Firenze* (Florence, 1865), 1:50.

¹⁰⁰ Hans Baron, *The Crisis of the Early Renaissance* (Princeton, 1955).

is in his hands.” To this end, they gave the captain Christmas presents of 1000 florins, as well as subsidies at Easter.¹⁰¹

The city’s use of propaganda during the war is well-known. Scholars have long recognized how the conflict was as much a war of words as one of armies in the field. Giangaleazzo Visconti purportedly said that the rhetorical skills of the Florentine chancellor, Coluccio Salutati, were worth whole battalions. It was largely as a result of Salutati’s efforts, and those of subsequent Florentine chancellors, that the city of Milan has ever since been viewed as an evil entity, and Giangaleazzo as a species of devil. John Hawkwood figured prominently in this propaganda. As the Florentines demonized Milan, and cast their struggle as one of “liberty” versus “tyranny,” so too did they idealize Hawkwood, making him into an archetype of faithful and good service, when, as we have seen, he was hardly that. The language of the grants of citizenship and dowries to his daughters recounts a past that never really existed.

In the war of words, Hawkwood’s military feats became blown out of proportion. The Minerbetti chronicler placed his retreat after rather than before Armagnac’s defeat, adding greater luster to it. Minerbetti’s version found its way into the histories of Bruni and Bracciolini, and eventually into the work the great nineteenth-century historian of mercenaries, Ercole Ricotti, and thus to modern studies.¹⁰²

In truth during the legendary retreat of 1391, Hawkwood was a secondary concern of the Milanese commander, dal Verme, who soon gave up the chase and turned to meet Armagnac. The proper sequence of events is clear from the *Signoria’s* letters to Hawkwood, as well as from the account left by the chronicler of the house of Carrara who was closer to the action.¹⁰³ A strong case can be made that the real hero of the events of that summer was not Hawkwood, but his opponent Jacopo dal Verme, who succeeded not only in chasing the Florentine condottieri from the borders of Milan, but in defeating an entire French army, thus erasing a perilous threat to the Milanese

¹⁰¹ BML, Ashburnham 1830, III-106.

¹⁰² Bruni, *Istoria fiorentina*, 535–7; Donald J. Wilcox, *The Development of Florentine Humanist Historiography in the Fifteenth Century* (Cambridge, Mass., 1969), pp. 2–3. Ricotti, *Storia delle compagnie*, 2:191–93. The sixteenth century Florentine writer Scipio Ammirato must be credited with helping to set things right. In his *Istorie fiorentine*, Scipio placed the events in their proper order. Ammirato, *Istorie fiorentine*, 445–55.

¹⁰³ Gatari, *Cronaca*, 435.

state. It is a measure of the triumph of Florentine propaganda that this version never won acceptance.

It also must be pointed out that the citizenship and dowries Hawkwood gained from his service did not come as rewards for his actual martial deeds. These were granted before his retreat, indeed before he had even undertaken his offensive. The legislation is dated April, 1390, while he and his army were still preparing their assault. The rationale behind the largesse was to keep Hawkwood motivated and happy and, above all, to minimize the possibility that he would succumb to Milanese bribes. After all, Giangaleazzo had a penchant for corrupting captains. The grants also must be understood in terms of Giangaleazzo's actions with respect to his own captains, notably Jacopo dal Verme, who had already obtained citizenship and landed estates in Milan and Verona.¹⁰⁴ Mercenary captains were aware of the distinctions conferred upon others; thus Florence had little choice but to keep pace. How a city treated its captains constituted a very public dialogue, played out on the level of the commonwealth. It should come as no surprise that Hawkwood's windfall was followed in August, 1391, by a similar grant of citizenship to the German captain, Konrad Aichelberg, who had also served Florence in the war, albeit, not as effectively. It is worth noting that Aichelberg has not been "Florentinized" by modern scholars as has Hawkwood.¹⁰⁵

VI

The stylized nature of Hawkwood's image is perhaps most apparent in his funeral and death rites. He died on March 17, 1394, two years after the truce in the Milanese war. On March 20, he received an elaborate state funeral, recounted by numerous contemporaries.¹⁰⁶ Local shops were closed; citizens lined the streets. Hawkwood's body, dressed in vermillion velvets and golden brocades, moved in solemn procession from

¹⁰⁴ Archivio di Stato di Milano [ASM], Registri Panigarola, n. 1., ff. 150r-v; Archivio di Stato di Verona (ASVr) Archivio Zaleri-dal Verme cit cassetto, vi, n. 20.

¹⁰⁵ *Capitoli*, 50.

¹⁰⁶ The standard secondary account of Hawkwood's funeral, with documents, is Antonio Medin, "La morte di Giovanni Aguto," *Archivio Storico Italiano* 17-18 (1886): 161-71. The primary accounts include Minerbetti and Naddo da Montecatini, "Memorie storiche dal anno 1374 al anno 1398," ed. Ildefonso di San Luigi in *Delizie degli Eruditi Toscani*, 18:141.

the Piazza della Signoria to the Baptistery and finally to the cathedral for burial.¹⁰⁷ The modern scholar, Sharon Strocchia, characterized the ceremony as the most elaborate of an already flamboyant post-plague funerary style.¹⁰⁸

The ceremony reflected a sincere devotion to the man. But it also represented a pose. Strocchia has pointed out the didactic and symbolic functions of the funeral: how it, like all contemporary death rites, was a civic ritual, used by officials to project political themes and images. The burial of Hawkwood presented to the local populace a picture of “civic loyalty” and “communal triumph.” However, this event also had an external purpose, aimed at projecting those same images outside of the city, to other polities, and other mercenary captains. The propaganda aimed at mercenaries functioned as a means of recruitment, a message to them that the city rewarded good service.

Indeed, the Hawkwood funeral can only be properly understood in the context of the actions of the city’s enemies. Scholars have thoroughly ignored the fact that the death rites coincided with elaborate state funerals for mercenary captains in Siena, Florence’s nearest and most bitter opponent in the recent wars. The competing funerals formed a dialogue between two cities long embroiled in a many-sided rivalry. The ceremony for Hawkwood was bracketed by funerals in Siena for Giovanni Azzo degli Ubaldini and Gian “Tedesco” da Pietramala. Both men had served Siena in the conflict; and both were, in fact, Florentine exiles, hated in their native city. Ubaldini had been Siena’s most effective captain, until he died in 1391, probably the result of Florentine poison. His funeral in June of that year was spectacular, befitting, according to the local chronicler’s description, “a pope or an emperor.”

The rites for both Ubaldini and Hawkwood bear a striking similarity. Ubaldini’s body was carried in solemn procession from the central square to the cathedral, where it was interred. All the stores and shops in the city were closed.¹⁰⁹ As with Hawkwood, the ceremony reflected a sincere love for the deceased warrior, who had preformed excellently in the war. At the same time, the Siense well understood the effect of this funeral on its neighbor and enemy, Florence. Its scope, which the chronicler estimated as costing between two and three thousand

¹⁰⁷ Minerbetti, *Cronica Volgare*, 183.

¹⁰⁸ Sharon Strocchia, *Death and Ritual in Renaissance Florence* (Baltimore, 1992), 55, 79–82, 110.

¹⁰⁹ *Cronaca Senese*, 735–36.

florins, constituted fiscal negligence, given the financial state of Siena at that time. In fact, the city was staying afloat financially only as the result of large Milanese subsidies.¹¹⁰

Siena's second funeral was held for Gian "Tedesco" da Pietramala who died nine months after Hawkwood.¹¹¹ Pietramala had, like Ubaldini, commanded Siennese troops against Florence. But his performance was, by Siena's own account, lackluster, and just prior to his death, he had angered officials by aiding a band of Breton mercenaries who were at odds with the city.¹¹² Nevertheless, when Pietramala died, he received a lavish funeral, in line with those of Ubaldini and Hawkwood. Shops and businesses were closed; the populace lined the street; Pietramala's corpse was laid out in the cathedral. The Siennese chronicler assumed a standard hyperbolic tone, claiming that "there was no one at this time who remembers having seen or heard such magnificence and honor made to such a man."¹¹³

One wonders what Siena would have done had Pietramala actually been an effective soldier, and in good standing with civic leaders. In any case, his funeral makes little sense apart from its role in a continuing dialogue with Florence, as a means of countering the rite accorded Hawkwood. If the Siennese were unable to outdo the Florentines on the battlefield, they seemed determined to out do them in paying homage to their fallen captains.

This civic discourse had a wider scope than just the cities of Florence and Siena. Mercenary captains received state funerals and burials in cathedrals elsewhere in Italy, most notably in Venice.¹¹⁴ And while there is little evidence for similar events in Milan at this time, their absence is due to the fact that the city's leading captains remained alive. Nevertheless, the civic competition of the period encompassing Hawkwood's funeral points up dangers of taking at face value any images of

¹¹⁰ On the fiscal condition of Siena at this time, see William Caferro, *Mercenary Companies and the Decline of Siena* (Baltimore, 1998).

¹¹¹ Cronaca Senese, 747.

¹¹² *Ibid.*, 748.

¹¹³ *Ibid.*, 748.

¹¹⁴ Tibertino Brandolino, Hawkwood's comrade-in-arms from the Bagnacavallo days, found his final resting place in Venice, as did Jacopo de' Cavalli, who had fought with Hawkwood outside of Verona in the employ of Bernabó Visconti in 1379. Brandolino is buried at the church of San Francesco; Cavalli is in SS Giovanni e Paolo. Eve Borsook, *The Mural Painters of Tuscany* (Oxford, 1980), 75–76; Mallet, *Mercenaries and their Masters*, 129; W. Valentiner, "The equestrian statue of Paolo Savelli in the Frari," *Art Quarterly* 16 (1953): 281–92.

Hawkwood projected by Florentines. For the sake of propaganda, Hawkwood had to be a loyal communal employee. And so he was.

VII

The point was reinforced by the efforts to memorialize Hawkwood in art, an effort that culminated in Uccello famous fresco, painted in 1436. The city began by planning a marble monument to Hawkwood in December, 1395, just after the Pietramala funeral. This plan involved reworking an old wooden monument to Piero Farnese, an Italian mercenary captain who had served the city against Pisa.¹¹⁵ The monument evolved into an expanded project, likely conceived by the Florentine chancellor, Salutati, to erect a series of statues in the cathedral commemorating men of action and men of letters, including Dante, Boccaccio, Petrarch, and the humanist theologian, Luigi de' Marsigli.¹¹⁶ This grand scheme was later abandoned, and officials decided instead to commemorate Hawkwood with a painting by Agnolo Gaddi (d. 1396) and Giuliano Arrighi (known as Pesello, d. 1446). According to the speculation of scholars, this decision may have resulted from a lack of funds due to war and pestilence; or perhaps, more positively, from superiority of Florence in respect to painting technique.¹¹⁷ In any case, the city's actions occurred in conjunction with Sienese efforts to commemorate its own fallen heroes. Both Ubaldini and Pietramala were honored with equestrian statues (now both lost) placed in the Sienese cathedral, the latter purportedly carved in wood by Jacopo della Quercia.¹¹⁸ The Ubaldini monument, completed in 1391 or 1392, probably had an effect on the original plans to honor Hawkwood, while the subsequent statue dedicated to Pietramala helped keep the Florentine project alive.

The portrait of Hawkwood by Gaddi and Pesello was ultimately replaced by Paolo Uccello's fresco in 1436. Scholars have attributed the decision to redo the original to damage suffered from the elements as well as the overall refurbishing of the cathedral, which occurred prior

¹¹⁵ Alessandro Parronchi, *Paolo Uccello* (Bologna, 1974).

¹¹⁶ Borsook, *The Mural Painters*, 76.

¹¹⁷ Boskovits, *Pittura fiorentina*, 117–24, 295–304; B. Cole, *Agnolo Gaddi*, 39, 43–44, 66, 70.

¹¹⁸ H. W. Janson states that there were five equestrian monuments in Tuscany before 1400: Guidoriccio da Fogliano, Piero Farnese, Hawkwood, Gian "Tedesco" and Giovanni degli Ubaldini. The Pietramala memorial was destroyed in 1506. Janson, *The Sculpture of Donatello*, 157–58.

to its rededication in 1436 as Santa Maria del Fiore by Pope Eugenius IV (1431–1447).¹¹⁹ Nevertheless, the decision to honor Hawkwood anew more than forty years after his death has raised tantalizing questions, most notably why the city remained so devoted to him? Indeed, the choice seems all the more perplexing since, as Eve Borsook has pointed out, the plans for the Uccello fresco were initiated under the Albizzi government in 1433 and then completed by the Medici government in 1436—two regimes that had little love for one another.¹²⁰

The decision makes sense, however, in terms of a continuing dialogue among Italian city states regarding military men. Florentine governments had changed since Hawkwood's death, but the military situation had not. Florence remained at war with Milan, and the survival of the city was still in doubt. This, in conjunction with the uncertain service of its current mercenary captains, provided fertile ground in Florence for the propagation and projection of Hawkwood's legend. The Florentines remembered his great retreat and effective last service, but conveniently forgot the prior years of extortion, duplicity, and bad behavior.

More precisely this is the image officials wished to convey to the outside world. The political milieu has been examined by the art historian Wendy Wegener, who has noted that Uccello's commission dated to a moment when Florence was fighting the neighboring city of Lucca, then an ally of Milan. Lucca had honored its own mercenary captain, Niccolò Piccinino, with a fresco. The act resonated in Florence, where Piccinino had recently worked and had left under "suspicious circumstances."¹²¹ Piccinino's departure from Florentine service occasioned a *pittura infamant*, a portrait ridiculing him. The Hawkwood fresco followed, presenting the image of what a mercenary captain should be. Piccinino was the image of what a mercenary ought not to be.

The pose Uccello gave his Hawkwood confirms this larger political agenda. The great warrior sits atop his horse with the baton of

¹¹⁹ Temple Leader and Marcotti, *Sir John Hawkwood*, 294. Borsook, *Mural Painters*, 75 "a possible reason"; The window next to the original painting was repaired in 1400 and again fifteen years later, suggesting that the elements got to the fresco. *Il duomo di Firenze*, ed. Giovanni Poggi and Margaret Haines, 2 vols (Florence, 1988), 1:94–95. Ulisse Forni, *Manuale del pittore restauratore* (Florence, 1866), 23; John Pope Hennessy, *Paolo Uccello* (London/New York, 1969), 141.

¹²⁰ Borsook, *The Mural Painters*, 75.

¹²¹ Wegener, "That Practice of Arms," 142–58, quote on 158. Mallett has also stressed the propaganda value of the fresco. He saw it as a piece of Medici-inspired propaganda, intended to promote "the praiseworthiness of condottieri to a populace with mixed feelings." Mallett, *Mercenaries and their Masters*, 129.

command at his side, in the manner of a captain conducting an inspection of his troops. The gait of the horse is that of an “amble” (*ambio*), consistent with a slow and stately process of an honored commander. The placement of the legs confused Giorgio Vasari, who thought it a technical mistake.¹²² But the depiction was intentional and didactic. Uccello and his Florentine employers wanted an idealized Hawkwood, in a stance suggestive of a loyal communal servant. The epitaph affixed to the bottom of fresco by Bartolomeo Fortini de Orlandini was taken from the eulogy of Fabius Maximus, the great Roman general of the third century BC, who through his patience and commitment to the state had defeated Hannibal.¹²³

Conclusive proof of this interpretation comes from a recent study using ultraviolet rays on the extant design (*modello*) that Uccello submitted to earn his commission. It shows that the painter originally intended to depict Hawkwood in a more bellicose manner, in full armor from head to toe, with his baton slightly raised and his horse at the ready.¹²⁴ This was Hawkwood the warrior, an image that Florentine officials specifically did not want.¹²⁵ For this reason, Uccello’s first design was rejected, and he was asked to rework it.¹²⁶

It is the idealized, domesticated John Hawkwood that Uccello ultimately portrayed and it is this image of the captain that has been passed down to posterity. The real John Hawkwood was far different, as was his relationship with Florence. What remains is no more than a mask, a vestige of Florentine propaganda that has impeded a proper understanding of the man.

¹²² Giorgio Vasari, *Le vite de’ piu eccellenti pittori, scultori ed architettori*, with notes and annotations by Gaetano Milanesi (London, 1906), 211–2.

¹²³ Eve Borsook, “L’Hawkwood d’Uccello et le Vie de Fabius Maximus de Plutarque,” *Revue Art*, 55 (1982): 44–51.

¹²⁴ Lorenza Melli, “Nuove indagini sui disegni di Paolo Uccello agli Uffizi: Disegno sottostante, tecnica, funzione,” *Mitteilungen des Kunsthistorischen Institutes in Florenz* 42(1998): 6.

¹²⁵ The decision of the *operai* of the cathedral to make Uccello redo the painting has elicited much discussion among art historians, who have cited, among other things, problems with perspective and colors. D. Gioseffi cited problems of perspective (excessive foreshortening), as did B. Degenhart and A. Schmitt. Parronchi thought the problem one of colors. D. Gioseffi, “Complementi di prospettiva di Apollodor d’Atene, di Filippo, di Paolo e d’atre cose,” *Critica d’arte* 5 (1958): 131; B. Degenhart and A. Schmitt, *Corpus der Italienische Zeichnungen, 1300–1450*, 2 vols. (Berlin, 1960), 2:382; Parronchi, *Paolo Uccello*, 31.

¹²⁶ The specific complaint was that “it was not painted as it should be.” The document is quoted in Temple-Leader and Marcotti, *Sir John Manderville*, 295.

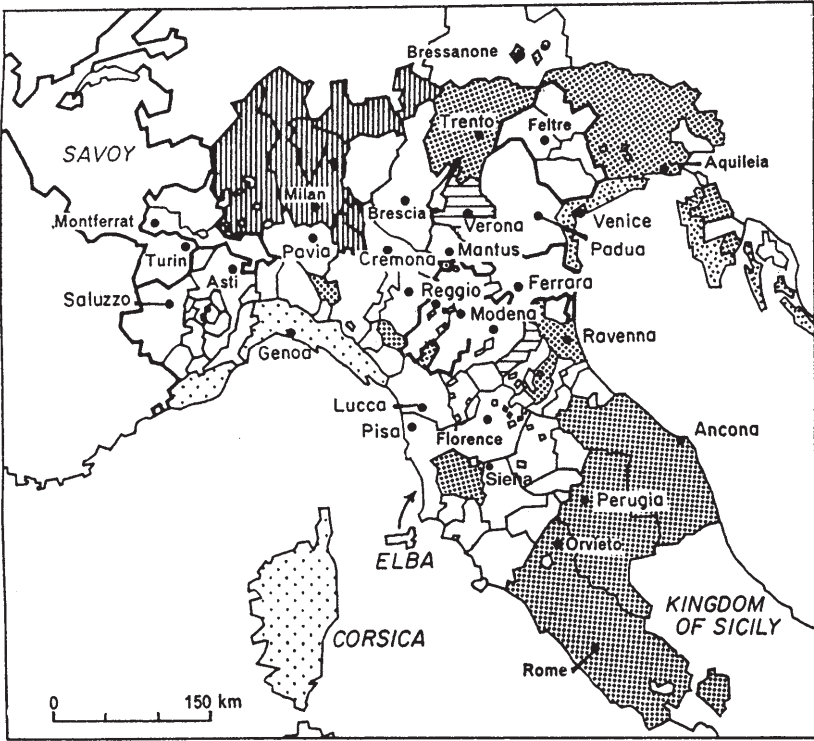

Map 11: Northern Italy.

THE AFTERLIFE OF A HERO:
BERTRAND DU GUESCLIN IMAGINED

Richard Vernier
Wayne State University (Emeritus)

In the chapel of the Montmuran Castle in Brittany, a stained-glass window chronicles in bright colors the history of that medieval stronghold. A nineteenth century work, it depicts the participants in various episodes clad in the fanciful *moyennâgeux* style favored by the genre painters of the Romantic-Victorian era: ladies, whether contemporaries of Eleanor of Aquitaine or of Joan of Arc, in pointed hennins; knights from the Crusades or the Hundred Years War, in the wasp-waisted armor of Renaissance jousts, with wide skirts and bright plumes. One of the scenes represented is that of the knighting of Bertrand du Guesclin in that very chapel, by the marshal of France, Arnoul d'Audrehem.

This image epitomizes two constant aspects of the du Guesclin legend. First, it illustrates an event that may or may not have happened. While the account recited by the local guide maintains that Bertrand, having saved the castle and the marshal from an English attack, was knighted at Montmuran on Maundy Thursday of 1354, the only source is the oral tradition transmitted in the seigniorial family of Montmuran, the Laval-Tinténiacs, and collected only in the late-sixteenth century by the Breton historian, Bertrand d'Argentré. The story dovetails attractively with the known fact that in 1372, Jeanne de Laval, granddaughter of the *châtelaine* who had been an eyewitness to the events of 1354, married the aging Bertrand. Unfortunately, the first biography of du Guesclin, Cuvelier's *Chanson de Bertrand du Guesclin*, written shortly after the constable's death, makes no mention of the Montmuran incident but states, on the authority of a previous written source, that Bertrand was knighted after the conclusion in 1357 of the siege of Rennes, by "Charles de Blois, whose subject he was."¹ It may indeed have been more appropriate for the emerging hero to be

¹ *La Chanson de Bertrand du Guesclin de Cuvelier*, ed. Jean-Claude Faucon (Toulouse, 1990–1993), ll. 2444–45.

dubbed by his “natural lord,” but there is no corroborating evidence to support either version.

The debated Montmuran episode is only one of the legendary anecdotes transformed by time and repetition into the perceived “facts” of popular history and colorful iconography. Bertrand’s early years in the Breton backwoods are naturally richer in such stories than his relatively well-documented and chronicled career in French service. Thus, the tales of his brawling teens, of his escape from the paternal tower, of his triumph—under the guise of an unknown squire—at the great ducal tourney of Rennes, have become imbedded in almost every biography since Cuvelier, despite suspicious similarities with more or less well-known episodes of chivalric or even classical literature.

Secondly, the stained-glass image in the Montmuran chapel illustrates the tendency of each subsequent period to emphasize—if not invent—a particular aspect of the du Guesclin legend, in accordance with its prevailing mood or ideology. In this instance, the representation is that of the devoted vassal, being rewarded for his loyalty by a grateful suzerain. The theatrical costumes and the body language suggested by the composition are characteristic of a specific phase of nineteenth-century Romanticism, a vision of the Middle Ages that satisfied at the same time a thirst for the picturesque, a nostalgia for the lost virtues of chivalry, and the royalist sentiment still prevalent in the French aristocracy. But what the Montmuran window represents is only a late chapter in the glorification of Bertrand du Guesclin as epic paladin—the new Roland.

This process can be said to have begun in the lifetime of the hero. We need only to think of the newsworthy aspect of the honors he reaped in a relatively short time: the rise of a knight of mediocre lineage, first to the county of Longueville (a traditional royal fief), then to the Castilian dukedom of Trastámara and the office of constable of France, could not fail to impress popular imagination. Moreover, Bertrand himself had a sure instinct for memorable speech and gesture: the famous reply to the Black Prince, boasting that there was “not a spinster in France/ But would earn [his] ransom by her spinning,” comes to mind.²

A less well-known episode occurred at the christening in 1372 of Charles V’s second son, Louis de Touraine. Standing as one of the godfathers, the constable was inspired to add a new rite to the liturgy:

² *Ibid.*, ll. 14555–56.

placing the hand of the newborn on the hilt of his sword, he exhorted the young prince to knightly valor worthy of his royal blood.³ Whether improvised or rehearsed, that display of close association with the victor of Pontvallain could only boost the prestige of the dynasty, a fact of which the Valois were fully conscious. The entombment of du Guesclin next to Charles V in the royal necropolis of Saint-Denis, the solemn service staged nine years later, as well as the commissioning of the Cuvelier epic, were not mere expressions of gratitude for services rendered, but the deliberate promotion of an already legendary model. At a time when the Valois monarchy had to face both foreign and domestic challenges, the example of the late constable's steadfast loyalty and prowess was a significant propaganda asset.

It was indeed in court circles, especially in the household of the young duke of Touraine (later, of Orléans) that Bertrand du Guesclin was made over into his posthumous self as "the Tenth Worthy," notably with the redaction of Cuvelier's *Chanson de Bertrand du Guesclin*. The very format of this verse chronicle—24,345 lines divided into single-rhyme paragraphs—marks it as a somewhat inflated attempt to recreate the eleventh- and twelfth century *chansons de geste*: the intent being clearly to elevate Bertrand to the legendary stature of a Roland or a William of Orange. This mediocre, infinitely tedious, and often wildly inaccurate narrative is the only contemporary biography of the constable, and thus it has been the primary source for all later attempts at retelling his story. Its success may be due in large part to the fact that, unlike other contemporary books of deeds (*e.g.* Boucicaut), the *Chanson* combines the appeal of rousing epic motifs with the suspenseful narrative of an extraordinary military career.

The du Guesclin story, from then on raised to the unassailable height of myth, not only invites parallels with the heroic deeds of Charlemagne's Twelve Peers, it also exploits a number of themes that have the perennial appeal of folk tales. One is that of the good-for-nothing turned hero, whose metamorphosis is, in Bertrand's case, heralded by various prophecies: the image of the brawling, uncouth little Breton would have as much appeal for generations of schoolboys as that of the victorious constable. That motif, reminiscent of Anderson's

³ Roland Delachenal, *Histoire de Charles V*, 5 vols. (1909–1931), 4:451–52; Richard Vernier, *Flower of Chivalry: Bertrand du Guesclin and the Hundred Years War* (Woodbridge, Suffolk, 2003), 167.

Ugly Duckling, twines with that of the Giant-killer: du Guesclin's early exploits as a forest partisan invite the sympathy that goes to the underdog—David *vs.* Goliath, Robin Hood, etc.

At a more literary level, Bertrand's guerrilla adventures also resemble those of the young Perceval in that, like the hero of the Grail, he wins his first fights in ignorance—or scorn—of the rules of chivalric combat. Thanks to the constable's wife, Tiphaine, who was schooled in astrology, du Guesclin's legend even has its share of magic, often a key ingredient of heroic romances. It could not fail to become imbedded in the national folklore.

In the wake of the *Chanson* and of the prose version of this interminable poem commissioned as early as 1387 (no doubt by an exasperated reader), at least three printed books were devoted in the fifteenth century to the life and deeds of the “valiant knight Bertrand du Guesclin.” Two more followed in the next century—not counting the 1588 *Histoire de Bretagne* in which d'Argentré added to the Cuvelier's font of stories a number of episodes drawn from local tradition, most notably the alleged knighting of du Guesclin at Montmuran. Then in 1618, Claude Ménard re-discovered, edited, and published the lost *Ur-text*—the 1387 prose chronicle patterned after Cuvelier. This was followed in 1666 and again in 1693 by Hay du Chastelet's *Histoire de Bertrand du Guesclin*, whose author draws on various documents and other chronicles to supplement the Cuvelier material. Guyard de Berville's two volumes, published in 1767, comprise the last serious biography to appear under the *ancien régime*, and a solid testimony to the fact that, four centuries after his death, the constable was far from forgotten.⁴

Nor had his portrayal undergone in that time a substantial transformation: the image simply acquired the patina of repetition, enhanced by the additional anecdotes illustrating the virtues that had earned Bertrand his posthumous status as “the Tenth Worthy.” If this vigorous afterlife requires an explanation other than the perennial popularity of good

⁴ Claude Ménard, *Histoire de messire Bertrand du Guesclin, connétable de France, duc de Molines, comte de Longueville et de Burgos [...] écrite en prose l'an 1387 à la requeste de mssire Jean d'Estouteville, capitain de Vernon-sur Seine et nouvellement mise en lumière par Me Claude Ménard, conseiller du Roy et Lieutenant et la Prévosté d'Angers* (Paris, 1618); Hay du Chastelet, *histoire de Bertrand du Guesclin, connestable de France et des royaumes de Leon, de Castille, de Cordove et de Séville, duc de Molines, comte de Longueville etc. composée nouvellement et donnée au public avec plusieurs pieces touchant la présente histoire, celle de France, d'Espagne, de ce temps la et particulièrement de Bretagne* (Paris, 1666–1693); Guyard de Berville, *Histoire de Bertrand du Guesclin, comte de Longueville, connétable de France* (Paris, 1767).

war stories, it is clear that, from the reign of Charles VI (1380–1422) to that of Louis XIV (1643–1715), the intent of du Guesclin's biographers was to present him as a shining example of the chivalric virtues that they regarded as the moral heartbeat of the régime. Moreover, the career of the constable could be seen as a model of the relationship between the crown and the nobility—in particular the lesser *noblesse de l'épée*—that proponents of an absolute monarchy regarded as the main bulwark against feudal magnates and others who might challenge royal authority.

Since they focused on the accounts of du Guesclin's prowess in the service of the French crown, biographers tended more and more to neglect episodes that had only indirect bearing on their main preoccupation, in particular, anything that could be construed as a blemish on the "flower of chivalry." Their emphasis on the successes of Charles V's constable on home ground is of course understandable, but it also meant that Bertrand's Spanish campaigns were treated more and more as mere side-shows to the main event—the reconquest of French provinces. The distortion is substantial, if we consider that Cuvelier devoted almost 45% of his epic to those Castilian episodes, which constitute one of the pinnacles of Bertrand's career. Created lord of Soria and duke of Molina by the grateful King Enrique II of Castile (1366/69–1379), alternatively courted and feared by Pere III of Aragon (1336–1387), it is now apparent that, between 1365 and 1370, du Guesclin was primarily involved in Peninsular affairs, strongly tempted to pursue other Mediterranean opportunities, and that his return to French service was far from a foregone conclusion. However, as biographers have been more interested in his role as leader of the French recovery under Charles V, this earlier Iberian phase of the constable's life is usually treated as an interlude—if not an anomaly—in his career.

Typical of this reduction process, Malet's 1928 *Histoire de France*—a standard high school textbook—boils down five years of controversial mayhem to this terse summary:

Du Guesclin led the Companies to Spain, where two brothers, the one backed by the English, the other by the French, were vying for the crown of Castile; Du Guesclin was taken by the English but, after being ransomed, he conquered Castile on behalf of Henry of Trastámara.⁵

⁵ Albert Malet, *Histoire de France* (Paris, 1928), 90.

We know of course that, although Bertrand had indeed “led the Companies to Spain,” many of the mercenaries had eventually drifted back and resumed their brigandage in France, where they could expect to reap more profit than in Castile, but generations of French *lycéens* were spared the anticlimax to that exploit.

Malet’s summary also omits any mention of du Guesclin’s complicity in the entrapment of King Pedro I of Castile (1350–1366/69), murdered by his half-brother Enrique de Trastámara, in the presence of the Breton knight.⁶ The constraints of a textbook do not alone explain such discretion, especially when we consider the treatment of the same episode under more prolix pens. The *Grand Larousse* encyclopedia, for example, characterized the French intervention in Spain—in fact a “régime change” operation serving Valois strategic interests—as nothing less than a defense of Christendom against Moslem hordes, and goes on to turn the story of Pedro’s murder upside down, by making the victim the aggressor: “It is said that [Don Pedro] tried to seize his brother’s dagger and attack du Guesclin. However it happened, the latter cut him down.”⁷ Thus improving on Cuvelier’s version, the hero punishes the treacherous villain. Even as late as 1977, the historian, Micheline Dupuy, dismisses the accounts of Spanish chroniclers with this testimonial to Bertrand’s chivalry: “Nothing in the life and character of the Breton knight can let us imagine that he would have stained his honor with such a crime.”⁸

Not quite all biographies have been so subservient to the stained-glass image of the “Tenth Worthy.” Towards the end of the nineteenth century, Siméon Luce’s painstaking search for archival documents produced an historically-informed account of du Guesclin’s early career. But Luce and other serious historians, such as Georges Minois, have had to consider at every step the issue of how far they could trust Cuvelier. As for the popular biographies, even the most recent do little more than rewrite earlier *vies romancées*, such as Vercel’s best-seller

⁶ For Pedro’s death at Montiel in 1369, see Pero López de Ayala, *Coronica del rey don Pedro*, ed. Constance L. and Heanon M. Wilkins (Madison, Wisc., 1985), 196–97; Clara Estow, *Pedro the Cruel of Castile, 1350–1369* (Leiden, 1995), 256–57; L. J. Andrew Villalon, “Pedro the Cruel: Portrait of a Royal Failure,” *Medieval Iberia: Essays on the History and Literature of Medieval Spain*, ed. Donald J. Kagay and Joseph T. Snow (New York, 1997), 201.

⁷ *Grand Larousse du XIX^e Siècle*. (Paris, nd), 1361.

⁸ Micheline Dupuy, *Bertrand du Guesclin, capitaine d’aventures, connétable de France* (Paris, 1977), 16.

of 1933, or Maran's particularly inept *L'Épée du roi* (1960).⁹ Intent on exploiting the *Chanson* for what it can yield of picturesque medievalism, their success is largely tied to an uncritical acceptance of the standard scenes of the legend.

However, while the perceived image of the *preux* Bertrand remained constant, it displayed varied facets of his persona, according to the needs of successive ages. While for the *ancien régime* the most valuable of knightly virtues was fidelity to the crown, the premium in post-Revolutionary France was on martial and egalitarian patriotism. A minor but significant detail from that period was the non-aristocratic and therefore politically-correct spelling of the hero's name as Duguesclin, the form preferred in republican schoolbooks and public inscriptions. More subtly, Bertrand's humble origins, his ungainly appearance, his blunt speech, became the positive virtues of a constable beloved of common soldiers but disliked and even feared by courtiers and shifty bureaucrats. Indeed, it was in large part his promotion of the Breton knight to high command that earned Charles V a place in the very small roster of "good kings" acknowledged by republican historiography. Even so, Albert Malet gives "Duguesclin" almost exclusive credit for a pragmatic strategy that was in fact the king's policy, and that could simply not have been applied without his authority. A later textbook, the 1957 history manual for primary schools, goes so far as to make the constable sole liberator of "all the Western provinces."¹⁰

In the wake of the French defeat of 1870 that resulted in the loss of Alsace and Lorraine, the hope of reconquest needed auspicious antecedents: none would fit better than the spectacular recovery accomplished five hundred years before, casting the victor of Cocherel and Pontvallain as forerunner of the desired *revanche*. This perspective not only informed such jingoistic efforts as a verse play by the arch-patriot Déroulède, it was also the subtext of some serious historical examinations of the period, notably Siméon Luce's already mentioned *Histoire de Bertrand du Guesclin et de son époque* (1876) and Roland Delachenal's five-volume *Histoire de Charles V* (1909–31). And it should come as no surprise that, after the Second World War, one of a spate of "new" biographies should unfurl the title of *Du Guesclin, connétable et maquisard*

⁹ Georges Minois, *Du Guesclin* (Paris, 1996); Roger Vercelet, *Du Guesclin* (Paris, 1932), translated by Marion Saunders as *Bertrand of Brittany: a Biography of Messire Du Guesclin* (London, 1934); René Maran, *Bertrand du Guesclin, L'Épée du Roi* (Paris, 1960).

¹⁰ David, Ferré, and Poitevin, *Histoire, Classe de fin d'études* (Paris, 1957), 74.

(R. Garnier, Tours, 1953), thus associating young Bertrand's band of irregulars in a fourteenth-century feudal contest with the partisans fighting the German occupants in 1940–1944.

However, in spite of the perceived relevance of his achievements to France's modern predicaments, du Guesclin's fame never equaled that of Joan of Arc. Regardless of personal merit, historical circumstances would suffice to explain the Maid's pre-eminence: while Bertrand's victories proved temporary—his lessons spectacularly forgotten at Agincourt—, Joan's triumphs ushered in the definitive French recovery in the reign of Charles VII. Her meteoric intervention not only evoked mythological Amazons and Biblical heroines, it was regarded as nothing less than a miracle, the reassuring sign that God favored France, and there remains about her—and her voices—the aura of the unexplained, irresistible to serious scholars and cranks alike. Moreover, while she was hailed as a saint long before her canonization in 1920, even the most ardent singers of his praise would balk at calling the Breton knight a saint—although Cuvelier comes close to bestowing on him a heavenly crown.¹¹ Last but not least, the Maid had come to be seen as an incarnation of that other feminine figure, *la France*. In Jules Michelet's words: "The Savior of France had to be a woman. France herself was a woman."¹² In short, she was overwhelmingly better qualified than du Guesclin as the definitive national hero. Thus she became so immediately identified with the salvation of France that, when in June, 1940, Charles De Gaulle adopted the Cross of Lorraine as the Free French emblem, everyone could immediately understand the reference. This is not to say that the constable had been eclipsed, but his popularity comes under the heading of patriotic folklore, rather than patriotic fervor.

Ironically, Joan herself evidently took Bertrand as her model of knightly prowess: the gift of a small gold ring that she sent to his widow, Jeanne de Laval, together with a self-deprecating message, testifies to her reverence for the memory of the constable. She might have been surprised by the imbalance between the amount of literature devoted respectively to herself and to the Breton knight. The Maid had the honor of being celebrated—and more often than not, transfigured—in

¹¹ *Chanson*, ll. 2070–79.

¹² Cited by Marina Warner, in *Joan of Arc. The Image of Female Heroism* (Berkeley & Los Angeles, 1981), 323, n. 34. Translation mine.

poetry, drama, and fiction, by a cosmopolitan roster of prominent playwrights and poets—from Christine de Pizan to Friedrich Schiller and George Bernard Shaw. She is the heroine of operas by Verdi and Tchaikovsky, the subject of oratorios by Honegger and Messiaen. In her *Seraphic Dialogue* (1955), Martha Graham has her dance a *pas de deux* with the Archangel Michael. Even her vilification by Shakespeare in *Henry VI, Part I*, and Voltaire's bawdy treatment of her pious legend in *La Pucelle d'Orléans* (1762), can be taken as homages of sorts to her perennial fame.¹³

In sharp contrast to that body of literary and other masterworks, the du Guesclin legend seems to have inspired only mediocre, and sometimes rather ludicrous efforts. While Joan has been celebrated through the ages by such great poets as François Villon, Charles Péguy, Paul Claudel and René Char, Cuvelier's only modern competitor is one Jean-Louis Lacour, an obscure but prolix nineteenth-century versifier, whose epic poem (*Bertrand*, 1847) weighs in at seven cantos and 406 pages! Perhaps because most of the purported biographies preempt the genre of fiction, no would-be Alexandre Dumas or Walter Scott has been inspired to exploit the adventures of du Guesclin. As in the case of Joan of Arc, it is the dramatic genre that provides the most notable instances of literary treatment. But at least three of the plays devoted to the Maid—Schiller's *Die Jungfrau von Orleans*, Shaw's *Saint Joan*, Jean Anouilh's *L'Alouette*—belong to the canon of world literature, whereas those featuring Bertrand have all sunk into deserved oblivion. Only one of these was from the pen of a major author—no less than Voltaire, whose *Adélaïde du Guesclin*, a 1734 tragedy in five acts and in verse, deserves notice both as a literary curiosity and for what it reveals of the eighteenth-century perception of medieval chivalry.¹⁴ In fact, du Guesclin does not appear in this play, but his exemplary presence, albeit posthumous, is felt throughout. The title character is a fictitious niece of the late constable, whom the improbable plot, recycled from other plays of Voltaire, places at a fictional siege of Lille as the love object in contention between a loyal knight and a treacherous grandee. The intent was probably to revitalize the neo-classical tragedy genre

¹³ For an overview of Joan's "afterlife," see Warner, *op. cit.*

¹⁴ Voltaire, "Adélaïde du Guesclin, Tragédie. Représentée pour la première fois le 18 janvier 1734 & remise au Théâtre le 9 septembre 1765. Donnée au public par M. Le Kain, Comédien ordinaire du Roi," in *Oeuvres complètes de Voltaire, avec des Remarques et des notes historiques, scientifiques et littéraires*, 75 vols. (Paris, 1828), 3:159–269.

by substituting national history for the stock subjects of antiquity, but it also partakes of the effort of the period to revive the awareness of their military duty in nobles reduced by Louis XIV to the condition of pensioned courtiers.

It is also on the theatrical stage that those two national icons have been most blatantly manipulated and made to speak in support of utterly anachronistic ideologies. Here again, Joan is honored with brilliant if tendentious treatment, especially at the hands of George Bernard Shaw and Jean Anouilh. In both plays, she is made to articulate concepts that would almost certainly have shocked her: as she confronts her judges, Shaw's Saint Joan speaks clearly as a forerunner of Protestantism, while Anouilh's heroine appears as a timeless, sweatsuit-clad reincarnation of his (rather than Sophocles') Antigone, the ultimate conscientious objector, on the thin edge of anarchism.

Messire Bertrand du Guesclin, the three acts in verse—with Prologue and Epilogue—authored in 1895 by the anti-Dreyfusard Déroulède, suffers badly by comparison: like Voltaire's earlier effort, it is a farrago of love and treason, only with more strident flag-waving, in which Bertrand's sister Julienne saves the castle betrayed by her suitor, who gets his just deserts. Perhaps the Gascon traitor is meant to stand for the "foreign" element, the "wops" (*mèteques*) that Déroulède and his cohorts blamed for the defeat of 1871, but if that is the message, it is hopelessly muddled.

In the twentieth century, fame was of course sanctioned by the cinema rather than the legitimate stage. Here again, interest in Joan of Arc has been cosmopolitan, with films not only from France, but also England, Denmark, Germany, Russia—and of course Hollywood. Following the example of such legendary actresses as Rachel and Sarah Bernhardt, Ingrid Bergman, and Jean Seberg achieved or at least consolidated their star status in the armor and cropped hair of the Maid. At least a dozen notable productions, including efforts by such prominent directors as Cecil B. DeMille, Carl Dreyer, Otto Preminger, and Robert Bresson, have brought Joan's story to the screen.

But as far as I have been able to ascertain, only one film has been devoted to Bertrand, the 1948 *Du Guesclin* directed by Bernard de Latour. The production, based on a script by Roger Verceles, reflects the still penurious condition of French cinema in the late forties. Latour's film is in black-and-white, and crowd-pleasing battle scenes, of the kind so successfully directed by Laurence Olivier in *Henry V* and *Richard III*, have generally been avoided: Cocherel is narrated as it might have been

in classical tragedy; Auray is acted out only as a nearly claustrophobic episode with Bertrand at bay, forced to surrender. The only lively action scene is that of the siege of Melun, with the well-preserved ramparts of Dinan standing for the tower from which du Guesclin falls into the moat. As cinematic evocations of medieval life go, *Du Guesclin* is no worse than most low-budget efforts, and better than some more opulent ones. Not unexpectedly, historical accuracy is sacrificed to dramatic exigencies: the “beautiful” Tiphaine (Junie Astor) is the mandatory “love interest” of a du Guesclin admittedly unused to flirting, but willing to try, while the script dispenses altogether with such complications as his Spanish campaigns. However, despite the vagueness of costuming (especially of feminine fashions) and the hilarious snapping-on of large portions of armor, the cast of repertory actors, led by Fernand Gravey in the title role, manages to convey the sense of the constable’s personality as tradition has it.

What is perhaps most notable about that 1948 film is its restraint: produced in the years immediately following the end of the Second World War, with recent memories of the Occupation and Resistance still shaping the political and cultural climate, it might have been expected to emphasize historical parallels, such as that between young Bertrand’s band of forest marauders and the modern *maquisards*. But Latour’s *Du Guesclin* (like Vercelet’s 1932 book) carries a more subdued political message, as the selfless, plain-spoken but low-born constable prevails against a passel of fractious royal princes offended by his promotion. While this is a fanciful interpretation of history (in fact the king’s brothers were steadfast in their support of Bertrand), the emphasis on du Guesclin’s humble origins, his blunt manners, and his unprepossessing appearance, was not a modern development: it simply continues Cuvelier’s rather incessant harping on the same motifs. The popular image of a du Guesclin promoted in the face of opposition by the royal princes may have served the political agenda of the Republic’s educational program (*viz.* to discredit the monarchy). The irony is that it was not from the quarter that Bertrand had to suffer obstruction and calumny, but from Charles’ “Marmousets,” the low-born royal bureaucrats who, like du Guesclin, had risen from the ranks.

While the egalitarian message of the du Guesclin legend—personal merit and the common touch prevailing against the privileges of birth and wealth—has served, in a rather diffuse manner, to illustrate the democratic ideology, it cannot be said that the figure of the constable was at any time appropriated by a particular wing of political opinion.

The story of Joan of Arc, on the contrary, became in the late-nineteenth century emblematic of a conservative, Catholic France overwhelmed by the ascendancy of the anti-clerical Third Republic. The electoral gains of the Left, and the often brutal confrontations that followed the separation of Church and State, were the background, and to a large extent the motivation, for her canonization, granted in 1920 as spiritual comfort for the oppressed faithful.¹⁵ However, both heroes share the distinction of having been vilified in the name of sometimes quite remote political causes: Voltaire's naughty burlesque of the Maid's virginity does not particularly signify, but in Shakespeare's *Henry VI* trilogy, which dramatizes the Lancastrian (and by extension the Tudor) legitimacy, Joan is seriously denounced as a witch.¹⁶

As for Bertrand du Guesclin, his role in Castile as pied piper of the mercenary Companies, together with his complicity in the murder of a legitimate ruler, have earned him in Spanish chronicles the unenviable reputation of a treacherous brigand. Nearer to home, he has sometimes been branded a "traitor" to the cause of "free Brittany." Although his lack of enthusiasm for the attempted annexation of the duchy in 1379 was viewed with suspicion by the French government, the sixteenth-century historian d'Argentré took him to task for "having taken arms against his country."¹⁷ In a less articulate manner, modern day separatists echoed this sentiment by twice blowing up the constable's statue in his native Broons, in July, 1977, and again in May, 1989. Lastly, even some French historians have been known to pass severe judgments or at least express some reservations about du Guesclin's moral character and/or military abilities. His most hostile critic, Edouard Perroy, goes so far as to declare him "incapable of winning a pitched battle, or of conducting a siege of some scope," and dismisses him altogether as a mere skirmisher, a vain and greedy mercenary captain.¹⁸

However severe, those negative judgment are likely to remain peripheral to the popular view of du Guesclin. French public opinion in general tends to regard Breton separatists as negligible cranks; it is unacquainted with Perroy's criticism of the constable, and even more profoundly ignorant of Spanish chronicles. Having sprung up immediately after his death—if not in his lifetime—the tradition

¹⁵ See Warner, *Joan*, 163–64.

¹⁶ *Henry VI, Part I*, I, 5.

¹⁷ Cited in Minois, *Du Guesclin*, 463.

¹⁸ Edouard Perroy, *The Hundred Years War* (London, 1951), 122–23.

that secured Bertrand's position in the gallery of national heroes is too deeply rooted in the kind of folklore that often passes for history. Regardless of how much light scholars may shed on the still-obscure aspects of the constable's career, he will be mostly remembered for its legendary highlights: boyhood brawls, guerrilla ruses, headlong assaults, and duels against all odds—the stuff of comic books. Among the books currently available in French on du Guesclin (at least seventeen titles), we find of course some serious works, ranging from a reprint of the *Bertrand du Guesclin, Connétable de France et de Castille* (1895), by Emile de Bonnechose, to Georges Minois's *Du Guesclin* (1996). But at least three of the more recent publications are clearly aimed at a juvenile readership, and the presence of a *bande dessinée* is further guarantee that the simplified Bertrand of our primary school books lives on.

PART SIX

FISCAL, LITERARY, AND PSYCHOLOGICAL
ASPECTS OF THE HUNDRED YEARS WAR

PURVEYANCE AND PEASANTS AT THE BEGINNING OF THE HUNDRED YEARS WAR: MADDICOTT REEXAMINED

Ilana Krug
York College of Pennsylvania

History has demonstrated repeatedly that there are always many more losers than winners in the theater of war, particularly when non-combatants are affected. Examples need not be as drastic as the tremendous losses of life in Hiroshima and Nagasaki at the hands of an atom bomb, nor as the mass enslavements following Roman conquests of lands surrounding the Mediterranean. In fact, war can adversely affect more than those caught in the crossfire. Purveyance, the system on which Edward III (1327–1377) depended for the effective victualing of his soldiers and garrisons during the Hundred Years War, readily illustrates how those required to pay for a war can easily become its victims.

The Emergence of Purveyance

In simple terms, purveyance was an undisputed royal prerogative that enabled the king to obtain from his realm, by compulsory sale, those goods that he needed for supplying his household or military. This involved a manipulation of the market system through the forstalling of markets and the establishment of rates favorable to the king and his purchasing agents. In effect, the crown created an atmosphere in which those peasants who had a surplus of victuals had no means of disposing of it except to the crown. In the case of household purveyance, representatives of the various divisions of the royal household, such as the scullery and the pantry, would scour the verge, a twelve-mile radius extending from the king's current place of residence, for the required items, typically foodstuffs. The officers routinely provided a receipt, known as a tally, to the person or house from whom the goods were taken, which could later be exchanged for money. Purveyance that provided supplies only for the king's household was characterized by small but frequent collections by royal officials. Conversely, military purveyance functioned on a much grander scale, with significantly

greater amounts of supplies collected from a much wider area. Thus, the machinery for administering military purveyances was necessarily more extensive and sophisticated. A hierarchy of royal officials worked closely with the local functionaries, especially the sheriffs and village bailiffs, to determine how much each region had to contribute. Like household purveyance, tallies were provided to those who contributed items to support the military.

Although purveyance was an old institution, reaching far back into Anglo-Norman times, its use expanded over time. In its early days, it was a loosely defined, poorly regulated system, that kings and nobles relied upon primarily for feeding their itinerant households.¹ According to contemporary critics, however, the early methods for supplying both households and armies seemed undistinguishable. Indeed, drawing upon complaints made in the *Anglo-Saxon Chronicle*, Matthew Strickland indicates that the methods used for gathering supplies by such Anglo-Norman rulers as William Rufus (1087–1100) and Robert Curthose, duke of Normandy (1087–1106), oldest sons of William the Conqueror (1066–1087), differed little from the plundering of enemy territory. Thus both household and army purveyance greatly damaged local agriculture and the peasant economy.² By the reign of Henry II (1154–1189), this form of forced scavenging became officially known as purveyance.³ Henry III (1216–1272) utilized the method on a grander scale, especially during the Barons' Wars of the 1260s. In *The Petitions of the Barons* of 1258, Simon de Montfort and his fellows complained bitterly about the increasing scale of purveyance.⁴

Under Edward I (1272–1307), who built upon the tradition of his father, the system of purveyance expanded even further, in both definition and practice. Like his father and great-grandfather before him, Edward used the royal prerogative to combine the supply of his household with that of his armies. As English armies increased in size during the thirteenth and fourteenth centuries, the need for supplies

¹ Frederick William Maitland, *Domesday Book and Beyond* (New York, 1966), 239.

² Matthew Strickland, *War and Chivalry* (Cambridge, 1996), 260.

³ Bryce Lyon, *A Constitutional and Legal History of Medieval England* (New York, 1960), 379.

⁴ G. L. Harriss, *King, Parliament and Public Finance in Medieval England to 1369* (Oxford, 1975), 58; R. F. Treharne, *The Baronial Plan of Reform 1252–1263* (1932; reprint, Manchester, 1971), 387.

grew exponentially.⁵ In 1296, for example, after his troops in Gascony had complained about the lack of sufficient victuals, Edward responded by ordering the purveyance of an unprecedented 100,000 quarters of grain.⁶

Engaged in nearly continuous warfare with Scotland for much of his reign, the next king, Edward II (1307–1327), expanded the geographical scope of purveyance to supply such strategic northern castles as Berwick.⁷ As the need for purveyances increased, so did the bureaucratic machinery that was established and refined to administer it. Thus when Edward III assumed the throne in 1327, he had at his disposal a developed system capable of tapping into the agricultural production of the entire country.

Maddicott's Purveyance

In his seminal 1975 essay entitled, “The English Peasantry and the Demands of the Crown 1294–1341,” J. R. Maddicott offered one of the first comprehensive examinations of the effect of war on medieval society at large.⁸ The demands the three Edwards made for financing their wars, he argued, must be taken into consideration when such thorny questions as peasant standards of living are asked. The major wartime burdens placed on the peasantry—direct levies on chattels, purveyance, and military service—had cumulative detrimental effects, especially when added to other harsh realities of peasant life, such as

⁵ Michael Prestwich estimates that Edward I's army that put down the Welsh rebellion of 1294–1295 numbered 31,000 men and the army mobilized for the 1298 battle of Falkirk included 26,000 infantry. Moreover, somewhere between 15,000 and 20,000 soldiers filled the ranks of Edward II's army that was routed mercilessly at Bannockburn in 1314, and an even larger army was recruited in 1322, easily pushing the 20,000 mark. Michael Prestwich, *Armies and Warfare in the Middle Ages: The English Experience* (New Haven, Conn., 1996), 117.

⁶ A quarter of grain was equivalent to eight bushels or sixty-four gallons (eight gallons to the bushel). Edward's agents only managed to collect 63,000 quarters during the 1296 campaign. Michael Prestwich, *The Three Edwards: War and State in England 1272–1377* (London, 1990), 121.

⁷ In 1316 alone, five major purveyances were ordered for supplying Berwick, in which victuals were taken from as far-away places as Southampton, Norfolk, and even across the Channel. *Calendar of Patent Rolls [CPR]*, 27 vols. (London, 1894–1916), Edward I, 2:466, 468–9, 484, 519, 543–44.

⁸ J. R. Maddicott, *The English Peasantry and the Demands of the Crown, 1294–1341*, Past and Present Supplement 1 (Oxford, 1975), 1–75.

overbearing lords, bad weather, and poor harvests. Maddicott's emphasis on the combined effects of the crown's economic demands is important for understanding the manifold burdens royal governments placed on the rural population, and a good reminder that such burdens rarely came in isolation.

Purveyance formed one of the centerpieces of Maddicott's investigation, and his conclusions concerning the practice have long been accepted by the scholarly community. In the opening years of the Hundred Years War, a period at the end of Maddicott's chronological focus, purveyance was indeed the cause for great complaint. Prone to extreme corruption, and based on an ancient royal prerogative that fell unevenly across the English countryside, purveyance was understandably unpopular. However, did purveyance fall onerously on a homogenous peasantry already struggling to scrape together a living while compelled to support the king's war? Was purveyance, as Maddicott suggests, that extra demand that pushed the peasants to the brink of starvation and caused some to flee their lands for lack of money? Although no standard work on purveyance has been published in the thirty years since Maddicott's essay, the extant documents of the 1330s shed considerable light on the royal supply system and necessitate a reassessment of Maddicott's conclusions concerning the practice and its effect on the peasantry.

Maddicott implied repeatedly that purveyance was simply an evil reality of a cold-hearted Edwardian administrative policy that reduced all peasants to penury or even worse.⁹ His investigation has provided the conventional wisdom on the pros and cons of purveyance and reinforced a general condemnation of the practice as unfair and harmful. Subsequent scholarship has hardly challenged this view. Unfortunately, the assumptions underlying—indeed, coloring—his argument convey a historically inaccurate image of the medieval English peasantry as a whole. Maddicott's argument repeatedly, if indirectly, suggests the notion of a homogeneous English peasantry and fails to address the economic diversity of the class. Instead, the peasants that appear in his work seem to constitute a monolithic and universally impoverished sector of society, barely managing to keep food on the table or a roof over their heads. It is a peasantry for whom any minor change to their normal routine or budget, such as a poor harvest, taxation, purvey-

⁹ *Ibid.*, 29.

ance, or even the collection of a private debt, would have been at best, troublesome, and at worst, disastrous. It is not the vibrant and highly stratified group, containing prosperous elements that emerges from the documents of the period.

Not surprisingly, Maddicott maintained that the burden of purveyance fell, or rather was imposed, on a poor, powerless peasantry that was unable to withstand it. Indeed, he claims that peasant populations contributing to purveyance were “massive, though not necessarily thriving.”¹⁰ Purveyances, in his view, stole essential foodstuffs from those least able to resist, and most in need of those very items. It was not a surplus that was taken, but rather, the very food needed to feed the family and the grain for planting the next season’s crop. Thus purveyance, for Maddicott, had strictly negative ramifications for local communities.

Assessing the Tax Records

Despite Maddicott’s argument to the contrary, there is little evidence to support the theory that purveyance placed an additional burden on a universally-impooverished peasantry. Fourteenth-century tax records indicate that only the upper echelons of peasant society, whose properties produced a significant surplus, were caught up in the purveyance web. Although Maddicott condemns the use of tax records in order to assess individual peasant wealth,¹¹ he bases this conclusion upon only one assessment—that of 1334 which was known to be undependable because of widespread concealment, undervaluation, and evasion. In 1334, the manner of assessment was changed so that only villages, and not individuals, were appraised. Thus, little information about the economic status, relative wealth, or financial damage wrought to individuals can be drawn from the records of that year. On the other hand, records for the subsidies of 1327 and 1332, which were disregarded by Maddicott, are in fact revealing.

¹⁰ *Ibid.*, 18.

¹¹ *Ibid.*, 18. J. F. Hadwin and Stuart Jenks also cautions scholars against using lay subsidy records to investigate the wealth of the English countryside. J. F. Hadwin, “The Medieval Lay Subsidies and Economic History,” *The Economic History Review*, [2nd ser.] 36:2 (May 1983): 214; Stuart Jenks, “The Lay Subsidies and the State of the English Economy (1275–1334),” *Vierteljahrsschrift für Sozial- und Wirtschaftsgeschichte* 85:1 (1998): 2.

Maddicott concluded that “the evidence does not lend itself to any closer analysis of the standing of those [contributing to purveyance].”¹² In fact, he claimed that a more specific determination of the peasants’ economic or social standing was impossible.¹³ Yet, the very tax evidence he condemns as inadequate reveals a good deal about the economic status of those routinely subject to this particular burden. By comparing names in these pre-1334 lay subsidy rolls with those found in indentures and inquest rolls, we are able to determine the economic group primarily responsible for making contributions. The vast majority of such individuals were from the middle and upper rungs of the peasantry. Very few of the poorest peasants, who paid almost no taxes, were called on to provide foodstuffs.¹⁴ A few examples here will be instructive.

The 1332 lay subsidy for the town of Boston in Lincolnshire, for example, shows the amounts paid by six individuals who also contributed to purveyances in 1339–1341. The townspeople on this list were assessed at 2s, 8s, 20s, and a mark. This valuation meant that a ratepayer’s chattels were technically worth ten times more than the tax assessment.¹⁵ The five people of the village of Lutton who contributed to a purveyance paid between 3s and 10s as their share of a fifteenth collected that year, even though almost a third of the village paid 20d or less.¹⁶ The results from Nottinghamshire are even more dramatic. Southwell, one of the more heavily purveyed villages, was relatively prosperous; the majority of its inhabitants paid between 2s and 6s to the subsidy of 1332. Those participating in the purveyance, however, paid as much as a mark. Of the nine people in the town of Newark

¹² Maddicott, *English Peasantry*, 58.

¹³ *Ibid.*, 68.

¹⁴ The amount arbitrarily chosen for this distinction was 20d or under for the tenth and fifteenth of 1332 and the twentieth of 1327. A tax assessment of 20d was certainly not a mark of poverty; naturally, those peasants considered poor—owning goods worth less than 12s—were not even assessed for taxation until 1334. However, 20d is a useful amount for noting whose goods were assessed at least at a rate of 12s. For ease, the same amount was used for both sets of taxation, even though a man paying 20d for a twentieth was theoretically better off than a man paying 20d for a tenth. The tenth and fifteenth was a single taxation with different percentages levied in urban and rural areas; this was not an uncommon practice, with the theory being those living in urban settings were more prosperous than those in rural areas, and thus should bear more of the responsibility of the taxation. For the percentages levied in taxation in this period, see W. M. Ormrod, “The Crown and the English Economy, 1290–1348,” in *Before the Black Death: Studies in the ‘Crisis’ of the Early Fourteenth Century*, ed. Bruce Campbell (Manchester, 1991), 153–54.

¹⁵ London, Public Record Office [PRO], E 179/135/14.

¹⁶ PRO, E 179/135/16.

who contributed goods, four were assessed between 3s and 9s, three between 13s and 15s, and the remaining two at 24s 8d and 26s 2d.¹⁷

This contrasts greatly with the contributions and contributors to household purveyance. In his excellent study on the subject, Chris Given-Wilson notes that household purveyance, as opposed to military purveyance, was characterized by frequent, but rather small collections, often gathering only a few bushels or quarters of grain, given the small amounts involved.¹⁸ The crown was more likely to require men of modest means to participate in a household purveyance. A record documenting grain collection in Cambridgeshire bears out this conclusion. In it, 657 individual indentures register the collection of less than a quarter of grain; only 103 entail larger amounts. None exceeded two quarters.¹⁹

The accounts indicate that individuals clearly contributed larger amounts to purveyances for military purposes than to sustain royal or aristocratic households. The less frequent but larger military purveyances were responsible for the accumulation of great amounts of grain and hundreds of animals in any given collection. For example, a military purveyance of 1338 carried out in seventeen northern counties netted some 1961 quarters of wheat, 2178 quarters of malt, 205 pig carcasses, 680 sheep, and a great many other commodities.²⁰ Another military purveyance made during the following year indicates not only the total amount of goods received, but also the number of individuals who contributed to each food category.²¹ Thus, it is possible to see that in Cambridgeshire during the year 1339, very near the beginning of the Hundred Years War, the average amount of wheat collected per individual was 5.6 quarters; of malt, 7 quarters; and of oats, 11.6 quarters. In Nottinghamshire and Derbyshire, these amounts came to 3, 4, and 4.4 quarters respectively. In short, for those involved in the

¹⁷ PRO, E 179/159/5.

¹⁸ Chris Given-Wilson, "Purveyance for the Royal Household, 1362-1413," *Bulletin of the Institute of Higher Research* 56 (1983): 51-53.

¹⁹ PRO, C 47/2/41/18/1; *CPR*, Edward III, 4:92. The Patent Rolls also comprise a rich source for understanding the complexities of household purveyance. For example, on June 16, 1338, writs of aid for one year were given to members of the queen dowager's household departments, allowing them to purvey only their immediate necessities. The departments mentioned in this document include the saucery, scullery, poultry, buttery, pantry, great kitchen, lesser kitchen, winery, and marshalsea, as well as the wardrobe, chamber, and hall.

²⁰ PRO, E 101/21/4.

²¹ PRO, E 101/21/40.

system contributions to a military purveyance dwarfed those made to the household.

The Purveyance Procedure

In order to understand the mechanisms of purveyance, one must first understand how the system interacted with local economies. Before a purveyance would even be ordered, the crown went to some lengths to guarantee suitable conditions and, in effect, to manipulate free markets to the king's advantage. Royal officials cancelled all markets and fairs in the region to be purveyed, effectively depriving peasants of their ability to sell surplus goods.²² The king then filled this economic vacuum by establishing "market conditions," which permitted him to be the sole purchaser of an entire region's surplus goods. Naturally, the inherent workings of the system were intimately tied to the network of rural markets and agricultural surpluses. It was, after all, the surplus normally destined for market that provided the goods siphoned off by the crown.²³

We must now turn to the immediate effects of purveyance on the local populace. Evidence would suggest that the English peasantry suffered far greater hardships from the manner in which purveyance might be carried out rather than any economic burden it imposed. The next section will review the administrative processes of purveyance and then determine how the system became riddled with corrupt practices.

The purveyance process began with a commission from the king, normally addressed in the form of a writ, to one or more officials known as purveyors whose duty it was to collect specific quantities of foodstuff or other necessities from certain counties. In the 1330s, the wording of these writs changed. Typical commissions for military purveyance from the reigns of Edward I and his son, Edward II, had

²² This was by no means passively accepted by people. Indeed, this effective suppression of free markets during purveyances was immensely unpopular as can be seen in complaints in Nottinghamshire and Derbyshire in 1339 about the king's forestalling of the markets in Nottingham, Derby, Newark and other market towns. *CPR* Edward III, 4:284.

²³ J. Masschaele, *Peasants, Merchants and Markets: Inland Trade in Medieval England 1150–1350* (New York, 1997), 39. J. Masschaele has long studied the distribution networks of late-medieval England that brought agricultural surpluses into the rural markets. Combining this knowledge with data from purveyance records, he has come to the conclusion that, "contributors [to purveyance] stand out as people of substance."

specified the amounts to be purveyed and where they were to be collected.²⁴ Edward III, however, simply provided the purveyor with a list of target counties rather than indicating specific sites. This put the official in a better position to gauge which regions could supply the required goods. For example, a royal commission of May, 1338, commands Stephen le Blount to gather 300 quarters of oats, 90 mutton carcasses, 20,000 horseshoes, and 200,000 nails in the city of London and various surrounding counties.²⁵

While this generalized method became more and more common under Edward, it was not universal: some purveyance orders well into the 1340s were still issued for individual counties. Of course, these latter commissions tended to be of local interest, and were often limited in duration. In August, 1338, fears that the French might attack Bristol led the king to instruct the constable of the castle to purvey the local area for supplies.²⁶ Similarly, in 1339, the king responded to fears concerning the Isle of Wight by issuing an order to the garrison of one of the island's largest fortresses, Carisbrook castle.²⁷

Under Edward, purveyances were normally specified for a particular period of time. With the completion of this period, the collected commodities were transported to the site specified in the commission writ. Many surviving directives of the 1330s and early 1340s indicate that purveyances were commonly ordered for the provisioning of specific castles, especially those threatened with enemy siege. In the past, purveyance had been used in this way to supply places like Berwick which lay along the Scottish marches.

As Edward's reign progressed, however, the crown increasingly instructed its purveyors to sell the goods collected and then forward the money to the royal coffers. The crown obviously thought it more efficient to take large amounts of money garnered from these sales and purchase victuals overseas. This may, in part, be an indication of hardships encountered in impressing sufficient numbers of ships to

²⁴ For example, an extensive commission from September 1316 stipulates amounts to be purveyed in individual wapentakes and ridings of Yorkshire for the purpose of driving back the Scots after the embarrassing defeat at Bannockburn. *CPR*, Edward II, 2:543–44.

²⁵ The counties named were: Kent, Surrey, Sussex, Wiltshire, Devon, Cornwall, Somerset, Dorset, Gloucester, Hereford, Worcester, Warwick, Shropshire, and Staffordshire. *Treaty Rolls Preserved in the Public Record Office, 1337–1339*, ed. John Ferguson (London, 1972), 104.

²⁶ *CPR*, Edward III, 4:118.

²⁷ *Ibid.*, 4:212.

carry bulky food items across the sea, or, more simply, a sign of lower prices abroad.

Purveyors often came to their appointed office with an extensive background in royal administration. In their new positions, these men were managers of a vital process on which military victory might depend. As purveyors, they answered to the king, but also had dealings with royal and local government. When given a commission involving several counties, they would generally need to appoint deputies to help supervise the huge and geographically-extensive operation. They managed a large staff, headed by sheriffs of the counties affected. These sheriffs, in turn, were in charge of numerous bailiffs, officers, and clerks. The bulk of the actual work was carried out at the county level, and it was the sheriff and his staff with whom most local people had their dealings. Sheriffs received their orders from the purveyor or his deputy, and then had the delicate business of seeking out individuals willing to contribute to the provisioning effort.²⁸

When wrapping up his work, the purveyor was responsible for creating a thorough report, documenting all aspects of the process, including where it had occurred. The king and the Exchequer demanded a strict accounting of all expenses, often including a list of goods that had rotted or were otherwise rendered unusable. The account of William of Dunstaple for a purveyance in seventeen counties in 1339 dutifully estimates how much of certain commodities were lost, at times even specifying that the damage to grain during storage was due to mice and rats.²⁹ Both the sheriff and purveyor supplied meticulous records, detailing what each individual contributed and often noting the price promised for these goods. A second account, provided by William of Dunstaple for a purveyance in Norfolk between May and July, 1338, lists thirteen individuals who contributed wheat, sixty-three who made available malted barley, three who supplied peas, twenty-six who provided hams, and one individual who sold the crown cheese.³⁰

The collection of purveyed goods was a highly structured procedure. Theoretically, before it began, the sheriff or bailiff designated people of means to contribute to it. To make the procedure more efficient, especially when the king insisted on speed (as was usual in periods of

²⁸ Lyon, *Constitutional and Legal History*, 394–95.

²⁹ PRO, E 101/21/4.

³⁰ PRO, E 101/20/13.

war), purveyors focused on the wealthier population of the villages which had more to spare.

Often, a collector was able to negotiate on the crown's behalf a "bonus" (*avantagium*) of the sort a merchant might receive for having purchased goods in bulk. In other words, the purveyor received goods worth more than the promised future payment by the Exchequer. According to R. Britnell, such an *avantagium* might be obtained by one of several tried-and-true expedients, including the use of the heaped measurement. In an attempt both to apply standardization throughout the country and comply with market norms, grain was measured by a level rather than heaped bushel. Alternatively, the *advantagium* might be given as an extra bushel for every eight quarters.³¹ During this period, it most often took the form of 21 bushels for every 20; in other words, the bailiff or sheriff would be able to take 21 bushels while only paying for 20. This benefit was spelled out very clearly in the indentures that guaranteed the local populace's participation. Such terms were also clearly specified in the final reports supplied by purveyors. These carefully noted how many bushels or quarters were received over and above the purchased amount.

What was not standardized in purveyance documentation was the price allowed for different goods. It was not uncommon for stipulated grain prices negotiated by the crown to vary from region to region, or even from village to village. While this may have been due in part to the different quality of the goods available in different places, it may also indicate a greater freedom on the king's part, as the sole purchaser, to dictate and adjust rates, generally to his own advantage. In the normal transactions, the sheriff would regularly draw up an indenture, specifying explicitly the amount and value of goods taken.

Purveyors and their underlings normally issued a tally stick as an official receipt for goods. The officials carved into these sticks specific markings denoting money amounts owed, rather than the quantity or type of goods taken. Such tallies were marked in pence, shillings and pounds.³² Once carved, such a stick would be split into two unequal

³¹ R. Britnell provides a thorough investigation into the "avantagium," concluding that purveyance had a large part to play in the development of the system. "*Advantagium Mercatoris*: A Custom in Medieval English Trade," *Nottingham Medieval Studies* 24 (1980): 37–50.

³² For example, a common mark was a deep cut indicating a £20 group. A late twelfth-century Latin treatise, called "The Dialogue Concerning the Exchequer," best

lengths, each of which contained an identical fiscal record and, in essence, functioned much like our modern-day carbon copies. The shorter part, called the foil, would be retained by the collector, and the longer part, called the stock, was kept by the person contributing to the purveyance.

In his purveyance commissions, Edward III repeatedly insisted that indentures and wooden tally stick receipts should be utilized only when ready cash was not available.³³ Whatever the king's preferences, however, the exchange of huge amounts of victuals and correspondingly large amounts of money rendered a cash-based method of payment unrealistic. After all, bailiffs or other collectors would not normally be carrying cash on their persons with which to pay for their goods,³⁴ especially in a period of increased lawlessness.³⁵

In theory, tax money and other royal revenues that were gathered by the sheriff in each county were supposed to be used first to pay back those people waiting to convert their tallies to cash. Only after this, would the remainder be sent on to the king.³⁶ In practice, this seldom happened; contributors were forced to take their tally sticks to the Exchequer, the body responsible for making cash payments. When someone presented his or her stock, it would be fitted together with the foil to make sure it was a legitimate tally. After validating his tally, the person would then be able to collect the cash owed by the crown. As Given-Wilson has pointed out, such a process must have been a nuisance at best, and a severe hardship at worst.³⁷ In fact, there are

describes the specific markings made on the wooden sticks. Ernest F. Henderson, *Select Historical Documents of the Middle Ages* (London, 1910), 38–40.

³³ For an example of such a provision, see Edward III's commission of 1340 to the sheriff of Southampton, Robert Daundley. *CPR*, Edward III, 4:423.

³⁴ Given-Wilson also stresses that it made more sense to pay initially with readily redeemable credit since carrying large amounts of cash would make the purveyors easy targets for theft. Given-Wilson, "Purveyance," 158.

³⁵ John Bellamy has argued that public disorder became a huge problem in the fourteenth century, as crime was on the rise and criminal bands became better organized. Furthermore, he has found the proportion of crime rose significantly when the king was out of the country. In the very period under investigation, Edward III was mainly on the Continent arranging alliances against France. See John Bellamy, *Crime and Public Order in England in the Later Middle Ages* (London, 1973); Richard W. Kaeuper, *War, Justice and Public Order: England and France in the Later Middle Ages* (Oxford, 1988).

³⁶ Purveyances could be used even to help settle individual accounts. In February, 1340, the king ordered proceeds from the sale of purveyed goods in Nottinghamshire and Derbyshire to be used to help pay back wages of Master Robert of Askeby. The proper letters patent were issued, and the sheriff given a tally as a receipt of this transaction. PRO, E 101/580/46.

³⁷ Given-Wilson, "Purveyance," 158.

cases on file of people who waited years to be repaid. It is little wonder, then, that as decades of war continued, the complaints about such royal malfeasance and inefficiency grew ever more shrill.

Whatever the means of payment, crown officials appropriately called receivers, would gather together all the goods that had been obtained through the various purveyances. Often, there would be one receiver per county, but sometimes, as in the case of Gilbert de Chyshall who was appointed to receive victuals in 1341,³⁸ a receiver might be responsible for the process in several counties. Castles had their own receivers, who made the initial calculation of what had been received and compared it with what had been ordered for the garrison. Unlike most of the other officials involved in purveyance, the receivers had relatively little contact with individual suppliers, interacting mainly with county sheriffs and bailiffs. Since the king had to trust his receivers with the task of actually gathering the goods, they constituted a very important part of any successful purveyance.

The documents clearly indicate that purveyance was a highly-structured, bureaucratic system, able to provide the king and his army with the needed victuals with greater ease than any prior method. It was generally reliable and efficient, and could be adapted to suit immediate, royal needs. However, purveyance was not without its drawbacks. In a period when unscrupulous men often held important offices, and when the king himself was often out of the country accompanied by his most able advisers, it is not surprising that purveyance seldom lived up to its potential.

The Issue of Payment

Maddicott used the problem of nonpayment for goods taken in purveyance in order to illustrate the system's negative affect on the peasantry. Yet despite his extensive lament over such non-payment during the period of the three Edwards, Maddicott does admit that "much that was taken was paid for."³⁹ What is more, the majority of the primary evidence supports this assertion. The fact that purveyance was such a highly-structured and well-documented system suggests that the king

³⁸ *CPR*, Edward III, 5:272.

³⁹ Maddicott, *English Peasantry*, 28.

intended to pay for those goods that his officers took. Once again, the royal records ultimately bear this out.⁴⁰

Regrettably, there are no surviving documents that record the repayment of individual peasants. Ample circumstantial evidence, however, makes a strong and compelling argument that they were indeed paid. Purveyance, with its extensive paper trail, could hardly end with one of its most important elements unfulfilled. Edward III dictated and enforced every last detail of the system, including the production of very specific accounts and reports. For a king who demanded thoroughness and precision in all phases of purveyance, the avoidance of the last step of the process seems out of character. Although the majority of complaints are unequivocally due to royal non-payment, it appears to be more a matter of not being paid during the purveyance transaction, rather than not being paid at all. In short, the principal complaint about purveyance payments had nothing to do with a royal failure to reimburse participants, but rather focused on how long the process took to complete.

Grievances would have multiplied exponentially had sheriffs, purveyors or their deputies simply refused to convert the tally sticks into cash to be drawn from county revenues, or worse, kept all the funds allocated by the Exchequer for themselves. This, however, was clearly not the case. Evidence of such blatant speculation would have been obvious to all. The king and his Exchequer officials would have noted overly large returns from various subsidies or county revenues that showed no sign of having been tapped to defray the costs of a purveyance. Without any indication that there existed a groundswell of complaint concerning non-payment for commodities taken in the crown's provisioning efforts, it hardly seems likely that English sovereigns or their governments neglected to re-pay contributors.

Corruption

Despite the best intentions of the crown, however, purveyance often failed to work as planned. This was due largely to the deliberate

⁴⁰ For example, a commission to John de la Ryvere, constable of the castle of Bristol, to purvey 100 quarters of wheat and 20 quarters of salt for victualing the castle, dated August 4, 1338, promises that the king will ensure repayment by the end of October. *CPR*, Edward III, 4:118.

corruption of the system on the part of those trusted to insure its proper performance. Like the collection of taxes or other subsidies, purveyance provided royal officials many opportunities to enrich themselves by manipulating the system. Official corruption was present on all levels of royal administration. Such malfeasance became the largest problem undermining the effectiveness of and popular cooperation with the system. Indeed, it was corruption, more than anything else, that eventually led to the discontinuance of military purveyance.

Contemporary indenture evidence suggests that a spirit of cooperation may have existed between peasants and local administrators, with only a mild current of discontent being directed against the obligations themselves. Contributors to purveyances seldom complained about the king's role in the process, but instead unleashed most of their venom against corrupt officials who were accused of abusing their power and acting contrary to the regulations stipulated in many statutes.

By contrast, Maddicott seems to argue that popular grievances were levied against the burden of purveyance rather than its corrupt administration. In reality, however, every example he evinces contradicts his own argument.⁴¹ What is more, when reviewing specific details from the 1340–1341 inquest in Lincolnshire, he himself admits that the complaints “were almost exclusively concerned with corruption and maladministration in the levying of the exactions, not with their oppressiveness as such.”⁴² In reality, people were not challenging the king's right to take goods for his own use; instead, they were incensed at the high-handed way the king's men carried out these royal demands. Information gleaned from evidence of the first decades of the Hundred Years War corroborates the picture of corruption drawn by such historians as W. S. Thomson for the late thirteenth century.⁴³

During the years 1340–1341, purveyors featured prominently in large-scale inquests into the conduct of royal officials. Here, they emerged as

⁴¹ For example, he discusses complaints made in Parliament in 1330 regarding undervaluation and miscalculation of goods taken in the counties of Somerset and Dorset, the numerous petitions concerning corrupt practices of purveyors and their staffs, and the inability of the king to protect the peasants from his officials. Maddicott, *English Peasantry*, 3, 27–9.

⁴² *Ibid.*, 62.

⁴³ W. S. Thomson, in his calendar of a 1298 Lincolnshire assize roll, pointed to official corruption as the main source of discontent with all types of taxation, purveyance included, among the lower rungs of English society in the late fourteenth century. W. S. Thomson, *A Lincolnshire Assize Roll for 1298* (Hereford, 1944), lvi–lvix, cxxv–cxxxvi.

the single-most hated royal functionary, being widely seen as disdainful of both personal property and the rule of law. Alongside purveyors in this rogues' gallery of royal officials came tax collectors, escheators, and wool collectors.⁴⁴ The alleged abuses fell into many categories: out right extortion; threats or the use of violence; seizing goods and not returning them until a fine was paid; improper measurement; lack of prompt payment; failure to issue tallies or receipts;⁴⁵ failure to record accurate information on the tallies; using false commissions or collecting several times from a single locality with the same commission; and skimming off the top so that the full amount of what was taken would not get back to the king.

Corruption eventually proved to be purveyance's downfall. Without better methods for local surveillance and effective policing, the often-absentee Edward III was powerless to stop the many forms of malfeasance that held his government in their grip, despite his well-intentioned statutes designed to curb the abuses. With no real means of enforcement, these reforms were little more than paper promises. The purveyance system as practiced under Edward is a prime example of how a sophisticated set of procedures lacking proper internal checks and balances can ultimately self-destruct, as military purveyance did in 1362 when Edward agreed to its discontinuation.

The Economic Impact of Purveyance

Maddicott actually adopted a rather cautious assessment when delineating the effect purveyance had on the English peasant economy of the

⁴⁴ In some cases, purveyors seem to have been surprisingly well-behaved, especially compared to other officials. The rolls for Oxford and Somerset list very few complaints about purveyors, with the great majority of the grievances being registered against collectors of taxes and wool. Additionally, it appears that even coroners were considered more corrupt than purveyors in Somerset. Predictably, a county as seldom purveyed as Herefordshire produced very few complaints about purveyors. But while the roll for Suffolk probably contains grievances against the widest variety of officials represented in the rolls, including tax and wool collectors, escheators, coroners, constables, admirals and members of the local administration such as sheriffs and bailiffs, purveyors still appear to have been the single-most deplored officials. PRO, JUST 1/715, JUST 1/716, JUST 1/770, JUST 1/337, JUST 1/858.

⁴⁵ While payment up front was rare, and the issuing of a tally was the usual method of payment, complaints in the inquest rolls list the two as distinct grievances. Indeed, some people accused a purveyance official of failing to provide either payment or a tally, thus indicating that these were perceived as separate problems and abuses.

fourteenth century. While reasserting his thesis concerning the considerable cumulative effect of royal demands on the peasantry, he admits that determining the precise results of any particular demand can be quite difficult to distinguish.⁴⁶ Gauging the true impact of purveyance on the English peasantry at this time may not be accomplished simply by measuring what was taken against what could be produced at any given time in any given region by any given person. Unfortunately, while existing records do contain considerable quantitative material, they supply insufficient details to paint any more than a general picture of how peasant economies fared under the continual impact of purveyance. Nevertheless, by comparing what we do know of its effects to other fiscal demands made by the crown, one can at least arrive at a general understanding of the systems's impact.

We can begin with a question that has long fascinated historians: which was more economically oppressive for the English peasantry—purveyance or direct taxation? For his part, Maddicott claims that purveyance was universally more highly disliked than taxation or any other levies. Once again, however, the evidence does not seem to bear him out.

Historians have already done a good deal of work on both the lay and clerical subsidies granted to Edward III, considering, in particular, the economic burden that such taxation had on society. W. M. Ormrod asserts that, by the 1330s, the English economy was weaker than it had been decades earlier under Edward I, and therefore less capable of providing what the crown required of it. Ormrod thus echoes Michael Prestwich's assertion that the main problem Edward III faced was the growing gap between funds the king needed to maintain his war machine and the amounts he could realistically expect to raise. Added to his military expenses were mounting debts which the king could not ignore for long. Ormrod draws a pessimistic picture of England's economy during the first decades of the Hundred Years War. Although he claims that a fuller understanding of purveyance might lead to an accurate picture of the effect of war on the local level,⁴⁷ he goes on to lament the difficulty of actually assessing the economic impact on the basis of existing data.

⁴⁶ Maddicott, *English Peasantry*, 30.

⁴⁷ Ormrod, "Crown," 175, 182–3; Prestwich, *Three Edwards*, 221.

Maddicott himself claimed that direct taxation by the English crown was “certainly less resented and less damaging than purveyance.”⁴⁸ Yet, the evidence preserved in economic, judicial, and literary documents indicates that, in fact, direct taxation proved far more economically burdensome, and was at least as strongly disliked as purveyance.⁴⁹ Using Ormrod’s research, we can gain a general idea of the economic impact of Edward’s taxation in the first years of the Hundred Years War. Between 1336 and 1339, royal tax gatherers brought approximately £177,000 into the crown’s coffers.⁵⁰ New assessment practices in 1334 widened the tax net, compelling earlier exempted parties to pay their share of the war subsidies.⁵¹ This effectively shifted the average weight of the tax burden downward to those of lesser means. Taxation escalated further in 1340 and 1341 when Edward introduced the “Ninth” (*Nonae*) which required rural and urban communities to give one-ninth of their wealth to the crown, netting approximately £65,000.⁵²

Under this steadily mounting fiscal pressure, both ratepayers and officials reported the destitution and depopulation that heavy taxation had brought to city and countryside alike.⁵³ The villages of Letcombe Bassett in Berkshire and Bix Brand in Oxfordshire, for example, pleaded poverty, while the men of Sunbury in Middlesex claimed that they had been forced to sell most of their sheep due to heavy taxation, and were

⁴⁸ Maddicott, *English Peasantry*, 14.

⁴⁹ *Ibid.*, 8, 14, 18. Here again I disagree with Maddicott’s conclusion when he affirmed that taxation, “was probably not generally or nationally [a grievous imposition], and it was certainly less resented and less damaging than purveyance.” Much of his point of view is based on faulty assumptions regarding the economic makeup of the English peasantry and its ability to withstand certain demands of the king. Purveyance, deliberately targeting the surplus goods of the wealthier members of peasant society, would certainly not affect peasant economies and livelihoods to the same degree as repeated taxes levied on all, including those no longer exempted for reasons of poverty.

⁵⁰ Ormrod, “Crown,” 153–54 (table 5.1).

⁵¹ Pamela Nightengale asserts that wartime economic demands created a strong impetus to resort to tax evasion. She suggests that under-declaration of sheep for lay subsidies was one method utilized by wool growers in response to the lower prices they received from the wool merchants who wished to pass down the burden of the *maltolt* of 1294, and it is possible that evidence from the 1330s would support this claim as well. Pamela Nightengale, “The Distribution of Wealth in Medieval England, 1275–1334,” *Economic History Review* 57, no. 1 (2004): 8.

⁵² Ormrod, “Crown,” 181.

⁵³ The greatest justification by far was that land assessed for the ninth lay within glebe lands, or within properties already assessed separately for clerical taxation, and thus, should not be taxed twice. *Nonarum Inquisitiones in Curia Scaccarii* (London, 1807).

thus unable to provide the assessed number of lambs.⁵⁴ The population of Sutton in Bedfordshire stated that not only were 180 acres of land uncultivated because of the impoverishment of the inhabitants, but since their fields had been burned by robbers prior to harvest, they possessed less grain than the assessment indicated.⁵⁵ If copious complaints found in the rolls are to be believed, not only were some of the peasants reduced to penury by the constant and systematic taxation, but others were actually forced to desert their holdings.

By comparison to direct taxes, purveyance was only levied irregularly and its burden was spread unevenly across the country. Certain counties were required to contribute to almost every purveyance, while others almost completely escaped the responsibility. Therefore, it is quite possible that a relatively prosperous farmer living in a heavily-purveyed country like Lincolnshire might see purveyance as a more burdensome and therefore more unwelcome royal demand than taxation, especially if he were not repaid for his goods, but was still expected to pay his taxes.

On the other hand, records generated by one receiver suggest that purveyance did not impact the countryside as much as a single subsidy did. In 1339, William of Wallingford stated that he had acquired in fourteen counties goods to the value of approximately £300, while spending another £100 or so on cartage and storage.⁵⁶ Admittedly this is but one account of one receiver, yet it does provide some idea of scale. It would take nearly ninety similar purveyances to equal the monetary worth accumulated during that year's lay subsidy. Even William of Dunstaple's huge purveyance of 1338 indicates that the collected items, excluding the large portion of live and dead animals for which no price is recorded, totaled a mere £800 and stood at one fortieth of the total raised in that year's lay subsidy.⁵⁷ Even a cursory perusal of surviving county inquest rolls from 1340–1341 illustrates that charges of corruption and abuse were by no means directed only against purveyors. According to the commissions given judges assigned to combatting corruption, a wide range of royal officials were slated for investigation. Collectors of wool, escheators, sheriffs, and tax collectors were all accused of malfeasance in varying degrees and forms.

⁵⁴ *Ibid.*, 4, 137, 198.

⁵⁵ *Ibid.*, 12.

⁵⁶ PRO, E 101/21/40.

⁵⁷ PRO, E 101/21/4.

Even in a county as heavily purveyed as Lincoln, complaints about purveyors and their staffs accounted for only thirty-seven percent of all grievances brought against royal officials. Local population directed thirty-eight percent of their total complaints against tax and wool collectors, thirteen percent against escheators, and a sizeable portion of the remaining fourteen percent against keepers of the king's horses. What is more, in the counties of Oxford and Somerset, purveyors were considered less of a nuisance than not only tax and wool collectors, but even coroners.

Literary sources confirm the relative burden of taxation in comparison to purveyance. While chroniclers, poets, and other authors occasionally mention purveyance, they do not do so with the same frequency or vehemence.⁵⁸ In the seventeen-stanza poem, "Song against the King's Taxes," the poet seems much more agitated over the king's constant taxation and wool levies than his purveyances. In fact, royal provisioning was mentioned only once at the end of the work. Furthermore, the anonymous author appears far more concerned about the economic ills he has suffered resulting from the forced sale of his chattels to pay the repeated taxes than he is about any royal purveyance of commodities. Tax collectors, not purveyors, are the malefactors in this literary picture. According to contemporary writers, extortion and embezzlement undertaken by the hated tax collectors had compelled the king to levy even greater taxation to compensate for their illegal activities.⁵⁹

⁵⁸ One of the bitterest attacks against purveyance was a lengthy treatise written in about 1331 and entitled *De Speculo Regis Edwardi III*; it was both a condemnation of the practices of the purveyors and an entreaty for the king to mend his ways and those of his officers. It again corroborates the assertion that corruption, rather than the burdens of the royal demand of purveyance, was the cause for discontent. In the treatise, the crimes of the king's offices are clearly presented, often with anecdotes. They are accused again and again of the same felonies from which they are seen answering in court: namely, failing to pay for goods they took, under-valuing the goods and hence paying less than they should, threatening or intimidating peasants through violence into handing over grain or animals, extortion, taking more than necessary, masquerading as purveyors by using fake licenses, failing to issue tallies, and recording less than actually taken. They are referred to as "robbers" (*latrones*), or specifically as *garciones*, indicating that the author believed it was the king's grooms who were often at fault. However, the *De Speculo* concerns specifically household, not military, purveyance, and, as such, is not necessarily representative of the complaints directed at the administrators of military purveyance. *De Speculo Regis Edwardi III*, ed. Joseph Moisant (Paris, 1891).

⁵⁹ *Thomas Wright's Political Songs of England from the Reign of John to that of Edward II*, ed. Peter Coss (Cambridge, 1996), 182; C. C. Dyer, "The Social and Economic Background to the Rural Revolt of 1381," in *The English Rising of 1381* (London, 1981), 21; Kaeuper, *War*, 329, 349.

An earlier poem, “The Song of the Husbandman,” expresses a similar lament. Although it dates to the reign of Edward’s grandfather, Edward I, it coincides with yet another period of very heavy purveyance. The husbandman’s complaints are as vivid as those in the later poem. He not only bemoans the extreme frequency and illegality with which taxes are levied, but also grieves over the severity of the demands, which forced him to sell most of his important possessions including seed grain and plough animals. Nowhere does the author ascribe his misfortune to the demands of purveyance. Instead, he blames the avarice of the tax collector for his misfortune.⁶⁰

Conclusion

That taxation was likely considered a harsher—and certainly more regular—burden than purveyance does not lessen the fact that the later practice proved to be burdensome, especially during the first decades of the Hundred Years War. If nothing else, the extreme corruption characteristic of all contemporary royal exactions greatly intensified the onerousness of purveyance, and caused it to become a hated practice, the discontinuation of which was increasingly demanded as time passed.

The scholarly world is indebted to Maddicott for his clear assessment of the impact of royal demands on the English peasantry in the early-fourteenth century. The fact that his conclusions concerning the effects of purveyance may be challenged does not diminish the value of his work. What is more, questions he asked have influenced other historians, and it is hoped that the issues raised in this essay will have the same effect.

⁶⁰ *Medieval English Political Writings*, ed. James M. Dean (Kalamazoo, Mich., 1996), 251–53; Kaeuper, *War*, 327–28.

THE GOOD, THE BAD, AND THE UGLY:
VISIONS OF BURGUNDY, FRANCE, AND ENGLAND
IN THE *OEUVRES* OF GEORGES CHASTELLAIN

L. B. Ross
University of New Mexico

By the time Georges Chastellain sat down in 1455 to write the *Chroniques* for his master, the Burgundian duke, Philip the Good (1419–1467), the Hundred Years War had for all intents and purposes ended. Despite the absence of any final peace treaty, England no longer posed a threat. The English had lost all of France except Calais, their last major property. Guienne had fallen two years earlier. In moments of lucidity, England's weak king, Henry VI (1422–1461), yearned for peace to share with his French queen, Margaret of Anjou, while the kingdom, thanks to a twist of poetic justice, was slipping into the baronial unrest that had plagued France a generation earlier.¹ At the same time, Franco-Burgundian relations were increasingly fraught with uncertainty. The uneasy peace brought about by the treaty of Arras of 1435, which for a brief moment had appeared to generate almost true friendship between France and its over-mighty vassal, was, by 1455, giving way to a coolness that forecast troubled times ahead. Within this scenario, Chastellain dedicates to Anglo-Franco-Burgundian relations a good half of his *Chroniques* and most of his other extant literary works. In all of these, he hammers persistently on one theme: France and Burgundy must be at peace, united as one family against England, the ever-present foe.

Chastellain did not pick the most auspicious moment for a rehashing of old hostilities, when even the most illustrious victim of past English occupation, King Charles VII (1429–1461), seemed content to bury the hatchet after his recent victories in Normandy and Guienne. The chronicler acknowledges political realities when he addresses his audience of French and Burgundian nobles, at the very opening of the

¹ Estelle Doudet remarks that hostilities with England were by then “*un souvenir*.” Estelle Doudet, “De l’allié à l’ennemi: la représentation des Anglais dans les oeuvres politiques de Georges Chastellain indiciaire de la Cour de Bourgogne,” in *Images de la guerre de cent ans: actes du colloque de Rouen, 23, 24 et 25 Mai 2000* (Paris, 2002), 81–94.

Chroniques, with protestations of impartiality: “[I am a] loyal Frenchman with my prince, daring to tell the truth against my own master [the duke of Burgundy] when need arises.”² But in reality his writings are a passionate, at times anguished, apology for Burgundian positions, filled with spite against England, and often with painful indignation against France.

I. *George Chastellain and his Chroniques*

Nothing in Chastellain’s origins prepares the reader for such intense partisanship. While he liked to present himself as a member of the Flemish gentry, according to Graeme Small, he was actually born into a Flemish merchant family from the city of Ghent, probably around 1415. His was a region and a social class that traditionally held close economic ties with England.³ His education, however, was French, which explains his extreme facility with that language and possibly his political choices as well. After graduating from the University of Louvain in 1431, he opted for a military career, and in 1434, became a squire in the armies of Duke Philip the Good of Burgundy.

He claims to have spent a decade in France (1435–1445) after his discharge, but Small demonstrates from documentary evidence that he actually went back to his hometown of Ghent, trying unsuccessfully to follow his father’s career in shipping. Having failed at business, and apparently under a cloud, he left for France, in all probability remaining there only between 1441 and 1444. At this time, he became close to Pierre de Brézé, seneschal of Poitou and later of Normandy, to whom he dedicated some of his early poetic works, and with whom he remained friends until the latter’s death at the battle of Montlhéry in 1465. His brief and shadowy residence in France probably cannot be

² Georges Chastellain, *Chroniques*, in *Oeuvres*, ed. Kervyn de Lettenhove, 7 vols. (1863–66; reprint Geneva, 1971), Book I, 1:12.

³ Graeme Small, *George Chastellain and the Shaping of Valois Burgundy* (Woodbridge and Rochester, 1997), 22–26. As Small observes, his family was part of a conservative guild that often sided with the dukes against the leaders of the frequent revolts, dismantling the belief, still held by de Lettenhove, that he was of the lineage of the castellans of Alost because of the shield that adorned his tomb. Chastellain, Book I, 1:ix.

construed to represent a significant formative period, even if the writer frequently alludes to it in an effort to build up its importance.⁴

It is a pity that we know so little about these years, however, because they could offer some clue as to the origin of his political obsession and cast light into his subsequent career move. Around 1446, at a time of formal peace between the two countries, he transferred once again to the service of Philip the Good, this time as *écuyer panetier*, and there he would remain for the rest of his life. Small speaks of a “porous membrane” of interchangeable service between France and Burgundy, a membrane through which the writer passed on several occasions, and at the time there seems to have been no hint of treason in Chastellain’s decision to make such a move.⁵ His motive, however, is unclear and muddled by his frequent statements of French loyalties. In 1455, he received from the duke the gift of a house in Valenciennes, where he retired for at least part of his life, and where he took up permanent residence after his master’s death in 1467. The gift coincides with his appointment as official historian to write chronicles recording “interesting and uplifting things” past and present.⁶ If, as it appears, he lived away from court at least part of the time to dedicate himself to his writings, he was not as close to the duke as he seems to imply. The same can be said of his relationship with the French king. Nevertheless, he undertook several secret missions for the duke and in 1457 became a member of his

⁴ Small, *George Chastellain*, 23, 37–39, 41–44. Chastellain mentions having served Charles VII, and having known some of his intimates, such as Agnès Sorel, the king’s half-sister, Marguerite of Valois, and King René, duke of Anjou. *Chroniques*, Book VI, in *Oeuvres*, 6:366 and *Oeuvres*, 7:75, and Georges Chastellain, *Chroniques: les fragments du Livre IV révélés par l’additional manuscript 54146 de la British Library*, ed. Jean-Claude Delclos (Geneva, 1991), 312. Another reference to his presence at the French court, veiled in allegory, is contained in an obscure poem, *L’oultré d’amour*, and *Le dit de vérité* (where he mentions being “raised” at the French court). Chastellain, 6:67–128, 254.

⁵ Unlike the defection of Commynes from ducal service in 1472 that was viewed in this light. Small, *George Chastellain*, 46, 81. But Delclos sees in his writings a burgeoning national sentiment, as he always describes actions and thoughts as belonging to the “nation de deçà” as distinct from those of France. Jean-Claude Delclos, *Le témoignage de Georges Chastellain, historiographe de Philippe le Bon et de Charles le Téméraire* (Geneva, 1980), 211.

⁶ Chastellain, 1:xxviii and n. 1. “choses nouvelles et morales.” De Lettenhove postulates that the reason for his choice of residence as early as 1455 may be due to his marriage, about which we have no information. *Oeuvres*, 1:xxvii. According to Small, he resided at least part of the time at court until 1464. Small, *George Chastellain*, 84.

council.⁷ Chastellain was knighted in 1473 by Philip's successor, Charles the Bold (1467–1477) in Valenciennes, where he died in 1475.⁸

While living at court or at home, he wrote poetry, prose, short plays, and histories, in a florid and emotional style that was much admired by contemporaries, among whom he enjoyed a high reputation as a literary figure, historian, and mentor of a younger generation of Burgundian chroniclers, such as Olivier de la Marche and Jean Molinet.⁹ Unlike them, however, he maintained considerable independence toward the subjects of his writings, littering his pages with personal observations that reflect his own intense partisanship. He wrote close enough to the events narrated or depicted in verse to be able to share with the reader his reactions to them and his wishes for a particular outcome. But in so doing, he also indulged in frequent inconsistencies that blur the logic of his message, a weakness that is particularly evident in passages dealing with Anglo-Franco-Burgundian relations. For example, his early poem *Le throne azuré*, composed around 1450 to celebrate the liberation of Normandy, is already notable for its vehemently anti-English tone, which sounds odd, given that his employer, the duke of Burgundy, had kept himself aloof during the reconquest of that territory, and had refused to break his truce with England.

And you, English, violators of the common weal,
 Murderers of people and devourers of lives,
 Ravenous wolves filled with diabolic hunger
 Bent on perturbing the entire Catholic faith
 Moved by the passion of insatiable desires,
 Leave, o leave your destructive pillage.
 You do not deserve such royal spoils,
 Your only inheritance is death.
 Think, o think, persecutors of men; [...]
 Too much has Fortune sheltered

⁷ Given his desire to show a close connection with the duke, it comes as some surprise that Chastellain never mentions his appointment to the council, at least in his extant works.

⁸ Small, *George Chastellain*, 68–69, 76, 112–13. His discretion in not mentioning his confidential missions stands in sharp contrast to Comynnes. Delclos, *Témoignage*, 45.

⁹ Both men acknowledge his role. Olivier de La Marche, *Mémoires d'Olivier de la Marche*, ed. Henri Beaune and J. D'Arbaumont, 4 vols. (Paris, 1883), 1:183–84 and Jean Molinet, *Chroniques*, ed. Georges Doutrepoint and Omer Jodogne, 3 vols. (Brussels, 1935–37), 1:170–71. Despite his high reputation in his own lifetime, however, and the abundant use of his *Chroniques* as source for the history of the period, Chastellain has been little studied as a person. Delclos, *Témoignage*, ix.

You, the most cursed people alive:
Get out of here, and may the devil follow you!¹⁰

True, at this point, in his career, Chastellain was not yet writing as a historian, and presumably was not bound to impartiality. However, it is remarkable that other contemporary writers, including Jean Chartier, the official chronicler of Charles VII, did not adopt such an outraged tone in relating the French conquests of 1449–1453. Nor did Jean Wavrin and Mathieu d'Escouchy, Burgundian authors writing unofficially, who present the English side through the filter of chivalric courtesy, while the Norman bishop, Thomas Basin, who saw his own region devastated by poor English administration, at times assumes a posture of amused detachment from the events in his biography of Charles VII.¹¹

Another work of this early period reveals Chastellain's independent political agenda vis-à-vis his patrons. Spurred by a period of rather neighborly relations, it seems that he was pursuing his own program of reconciliation between Burgundy and France with the work entitled *Complainte d'Hector*, a lengthy play in verse and prose, which portrays Alexander the Great in imaginary visits to the tombs of Hector and Achilles, where he brings about a reconciliation of their ghosts.¹² The play is a not-so-veiled allusion to the complicity of young Charles VII, then dauphin, in the murder of Duke John the Fearless, Philip's father, in 1419. The dead duke appears in the guise of the indignant Hector, who claims to have been killed by his rival not in fair combat but treasonably. Achilles, respectfully prodded by Alexander, ends up confessing his guilt, admits to having lost much reputation for this deed, exalts Hector as the "flower of honor," and asks forgiveness of him

¹⁰ Chastellain, *Chroniques*, 6:138.

¹¹ For the reconquest of Normandy, see Jean Chartier, *Chroniques de Charles VII, roi de France*, ed. A. Vallet de Viriville, 3 vols. (Paris, 1858), 2:67–69 and *Chronique*, ed. G. Du Fresne de Beaucourt, 3 vols. (Paris, 1863), 1:154–243. On the subject of French reconquest in general, see, for example, Chartier's even-handed account of the death in battle of Lord Talbot, ending with the words: *Et ainsi fut la fin de ce fameux et renommé chef anglois*. Chartier, *Chroniques*, 3:7. Wavrin copies from Monstrelet the portion covering this event. Jehan de Wavrin, *Anchiennes croniques d'Angleterre*, ed. L. M. E. Dupont, 3 vols. (Paris, 1858–63), 2:6. Basin regales the reader with a comic vignette of the panicky duke of Somerset. Thomas Basin, *Histoire de Charles VII*, ed. and trans. Charles Samaran, 2 vols. (Paris, 1933–44), 2:83–85.

¹² According to Small, this belongs to a peaceful interlude in 1454 coinciding with the marriage of the count of Charolais, Philip's heir, with the daughter of the duke of Bourbon. Small, *George Chastellain*, 99.

and of all princes and kings.¹³ The author's unrealistic expectation that Charles would follow the example with an open apology to Philip reveals a tendency on his part to create make-believe scenarios, which will be evident also in his historical masterpiece.¹⁴ The hoped-for reconciliation between France and Burgundy never occurred, and the two continued in their peace, without, however, a hint of friendship. The French king was cautiously assertive, the Burgundian duke cautiously independent, but neither side openly sponsored hostilities against the other.¹⁵

In 1455, in this frosty but not openly hostile atmosphere, Chastellain started writing his *Chroniques*, a narrative of events dating from the duke's accession in 1419 until the author's own time. For nearly two decades, Chastellain would continue this work, ending his narrative only in the year 1471. In that year, apparently disillusioned with the course of events, the author terminated all of his literary production carrying a political message. In a Burgundy at peace with France, Chastellain was expected to maintain a sympathetic and respectful attitude toward the French king. On the other hand, as Burgundian historiographer, his major praise was reserved for his own patron, Duke Philip, who plays a central role throughout his work. The chronicler's often extravagant enthusiasm for Philip seems quite heartfelt. The duke maintained what Chastellain reputed to be the perfect behavior toward France, deferential but still independent, and at times even protective.

As we shall see, this was a late evolution in Philip's stance, and one that Chastellain struggled in vain to detect in his master's youthful years, while he brushed aside the duke's lifelong friendliness toward England. To paraphrase Paul Archambault, it appears that the writer recruited his illustrious patron to defend his own political stance rather than vice versa.¹⁶ Chastellain's technique is also very distinctive, alternating dramatic scenes with disarming debates with his readers, in which he

¹³ Chastellain, *Chroniques* 6:193. "fleur d'honneur." The entire work is in Chastellain, *Chroniques* 6:167–202. For the allusion to the murder of Duke John in 1419, see Small, *George Chastelain*, 99–100.

¹⁴ See, for example, Charles VII's alleged attempts at averting a war with Burgundy. *Chroniques: les fragments du Livre IV*, 304–6.

¹⁵ Chastellain laments that the treaty of Arras would never bring more than a guarded peace "paix soupeçonneuse." *Chroniques: les fragments du Livre IV*, 313.

¹⁶ Archambault states that for Chastellain the great dukes were no more than "brick and mortar and bronze" to build his own immortality by celebrating them. Paul Archambault, *Seven French Chroniclers: Witnesses to History* (Syracuse, 1974), 85.

confesses his own perplexity and even errors of judgment, and engages their participation in his evolving thought process.

Regrettably, for reasons as yet unknown, the manuscript of the *Chroniques* has reached us only in fragments, and even those from a sixteenth-century copy, which was perhaps in itself incomplete.¹⁷ Chastellain originally divided his manuscript into seven books, from which segments of varying lengths survive. Books I and II alone deal with the period of the Hundred Years War. For much of this material, Chastellain is indebted to earlier writers, in particular, Enguerrand de Monstrelet. The extant portions reveal that the writer's position toward Burgundy, France, and England evolved considerably over time and with the changing behavior of their rulers.

II. *Burgundy's Dangerous Alliance*

Book I, Chastellain's least original, was probably written between 1455 and 1458, and apparently covered the years 1419–29, but its extant chapters do not go past 1422. For this period, which the author did not know firsthand, he worked from the text of Monstrelet, and in fact there is much similarity between their respective works, both being filled with a litany of sieges of French cities, surrenders, festivities in honor of the invader Henry V of England (1413–1422), and humiliations of the mad French king, Charles VI (1380–1422). Also like Monstrelet, he concludes this period with the death of the two kings.¹⁸

Yet there are significant differences. While Monstrelet's narrative is impartial and quite unemotional, Chastellain's own is passionately biased against England. At the same time, it focuses upon the humiliation of France by the Burgundians, and even more, by the English. This odd juxtaposition is especially notable when compared to the writer's frequent protestations of loyalty toward France. What is more, although the chronicler hints at his own close familiarity with the French court,

¹⁷ De Lettenhove's classical edition is based on a copy supplied by Gauthier Chastellain, son of the historian, in 1524, and destined for the queen of Hungary, regent of the Netherlands. The original has apparently been lost. Chastellain, 1:xlviii, and Delclos, *Témoignage*, ix, 1. This article follows Delclos's dating of the books and his opinion on spurious passages.

¹⁸ Delclos, *Témoignage*, 33–34 and Enguerrand de Monstrelet, *The Chronicles of Enguerrand de Monstrelet*, trans. Thomas Johnes, 2 vols. (London, 1840), 1:482–87. The dating of the book is in Delclos, *Témoignage*, 53–54.

the opening book of the *Chroniques* does not contain a single anecdote that could be traced to Charles VII or any of his intimates.

Chastellain's thesis is that a divided France called upon itself God's wrath and that Henry V was the Almighty's instrument, a rather conventional position with a convenient political message, as it saves face for the French, who in those early years suffered a series of defeats and never seemed able to form an organized front. In early pages, they appear a confused, anonymous mass of victims, among whom only a few individuals make a brief appearance: a neglected king, blissfully unaware of his deteriorating status, a queen who openly disowns her own son, and some citizens of besieged cities, noted for a brave but futile resistance. The dauphin, the future Charles VII, himself disappears into the shadows and even young Philip of Burgundy emerges with difficulty. The true protagonist of Book I is Henry V, a sinister, ubiquitous presence, who plays the villainous mastermind until his untimely death in 1422.

At the opening of the book, the author briefly recapitulates the events that led to the murder of Philip's father at Montereau in 1419. He mentions, but only in passing, Duke John's envy of the king's brother, Louis of Orléans, an envy that had led to the latter's murder in 1407, a "sad death" that, in turn, brought on his own assassination. He also dismisses the civil wars preceding the English invasion in a single page, apologizing for the rush, by explaining that he is anxious to get to the grief of young Philip, the innocent victim of deadly quarrels. The author evidently strives to obtain forgiveness for the murderous duke John by presenting him as the last bastion of defense against Henry V. Chastellain insists that, in the face of the threat of English invasion, John had made peace with the dauphin and had planned to fight the common enemy, a plan cut short by his untimely death. While John went in good faith to a meeting with the dauphin, some "false men," under the excuse of avenging their dead master Orléans, killed him in front of Charles, "then a young child" (and therefore innocent), and with this treasonous deed caused infinite grief to "poor France, their mother."¹⁹

In these few pages, the writer frames the conflict in terms that (almost) exonerate both the Burgundian duke, ready to redeem himself through a patriotic war, and the adolescent dauphin, victim of the plots

¹⁹ Chastellain, *Chroniques* in *Oeuvres*, 1:20–22 (bk. I).

of courtiers. Chastellain will barely mention John again and then only obliquely. In the *Temple de Boccace*, a work written several years later to console (and scold) the deposed Lancastrian queen of England, Margaret of Anjou, he introduces the duke and his victim Louis of Orléans as ghostly apparitions, without revealing their names, shameful reminders of fratricidal wars.²⁰ Significantly, while on the subject of murdered princes, in Book I he refers to Richard II in warm terms, the only English king to deserve his sympathy. The victim of court plots, Richard was “captured, humiliated, and led among jeers through London, on a small horse like a fool,” imprisoned and then “killed, murdered, and sadly exterminated” by order of the duke of Lancaster, who coveted the crown. According to the chronicler, Richard underwent this martyrdom because of his sympathies toward the French royal house.²¹ By implying that Richard was a good English king because he desired peace with France, unlike the usurper Lancaster and his descendants, also usurpers, Chastellain creates an aura of illegitimacy around Henry V’s claim to France, given that his claim to England was also invalid.

The narrative proper begins when the bishop of Tournai (reluctantly, as it seems) gets around to relating the tragic news to young Philip, then count of Charolais. The tedious and awkward scene is rendered static by the use of lofty dialog reminiscent of late classical theater, a far cry from the spontaneous dramatic style of subsequent chapters. Its purpose is to elicit sympathy for Philip and his beloved wife, Michelle, sister of the murderous dauphin. This is still a family quarrel, not a conflict between two countries, and Chastellain emphasizes its intimate atmosphere, with the new duke fainting amidst ladies swooning in tears. He calls the new duchess “poor little lady,” and dedicates an entire chapter to her inconsolable grief, caused by feelings of shame for the deed of her brother, and fear of losing her husband’s love. In this book, Michelle, and not her brother, represents and in fact rescues the honor of France, and the grateful author will dedicate another moving chapter to her untimely death.²²

The awkwardness of the passage, however, may also reveal Chastellain’s unease with the young duke’s subsequent action, his alliance

²⁰ Chastellain, *Chroniques in Oeuvres*, 7:85.

²¹ *Ibid.*, 1:26–27 (bk. I).

²² *Ibid.*, 1:51, 55–56, 341–44. “povrette dame” (one of the rare mentions of a woman’s feelings in the entire work). Both the bishop’s speech and the reactions of Philip and Michelle are in Book I, in *Oeuvres*, 1:44–51.

with Henry V, for which the chronicler produces a tortuous argument. Since the dauphin and his followers plan to associate themselves with the English against him, he is free to make a preventive alliance with the enemy. Against his own inclination, the young duke will simulate friendship in order to destroy not the realm but the few in it who are his mortal enemies. Chastellain's long and stilted oration ends with an incongruous invocation to "the splendid and glorious French throne," which Philip has been compelled to attack in order to avenge his father's murder. The chronicler has Philip making various statements of regret at having to harm innocent people tied to himself by blood and loyalty.

This sententious (and apparently made-up) speech, in the moralizing style of Seneca, seems a pretext for the author to justify the duke's upcoming treason. And in keeping with the theatrical atmosphere, it is answered by a chorus of courtiers, who praise the wisdom of the prince, who seems "more of an elderly Pompey than a young Caesar."²³

The presence of Henry V, whom the author (except on rare occasions) disdainfully calls simply "the English king" provides the tragedy with its catalyst and the reader with the first clue as to the author's lifelong hostility against England. Until this point, the personal animosity between Philip and Charles could have been resolved, had it not been for this alien figure who came between them to provide an only-too-ready tool of revenge for Philip, thereby enticing him, albeit reluctantly, into an English embrace. This interpretation also offers a clue to Chastellain's view of history as driven, acted, and suffered entirely by highly placed characters.²⁴ As the "little orphan" leaves the scene in an aura of hurt innocence, the villain enters the stage. In his palace in Rouen, Henry receives coldly the duke's ambassadors who have come to him to offer their master's alliance. After perfunctory condolences, he adds curtly, with words that "cut like razors," that the son had better be more active as an ally than the father had been and send troops immediately, or he would accept the dauphin's offer of peace.²⁵

As the war against Charles unfolds, Chastellain covers the action in a series of contrasting scenes designed to illustrate brutality on the English part and chivalrous behavior on the duke's. The English break

²³ Ibid., 1:59.

²⁴ As noted by Delclos, *Témoignage*, 331.

²⁵ Chastellain, *Chroniques in Oeuvres*, 1:71-73 (bk. I).

a truce and besiege Clermont, while the duke takes over Saint-Quentin by popular demand, with its inhabitants begging him to deliver them from their misery. Then the citizens of Troyes, where the parties convene to negotiate the fateful treaty in 1420, receive him enthusiastically.²⁶ At this point, the author focuses briefly on the dispossessed dauphin, who learns that he is deprived of his birthright “against all right, human and divine, and that, thanks to this unnatural alliance and friendship, he will be pitifully expelled and excluded from his inheritance.” Chastellain implies that the terms of the treaty are both unduly harsh and illegal, and that Philip would never have participated had it not been for his need to avenge his father. The young duke must dissimulate his hatred for the English king, as the latter marches like a conqueror from Rouen.²⁷

Reluctantly, the author gives only a few opening lines of the treaty of Troyes, in a departure from other chroniclers who cite the full text. Then he mentions despondently the “sad” wedding of the princess Catherine, consequence of the ill-conceived murder of the one man who could have stood up to the invader, “a sad death and a sad alliance” that results in the crown devolving to the enemy. As French cities are forced to capitulate to the new heir, the litany of conquests is interrupted by frequent references to the bizarre dance of the three unlikely partners: Henry, Philip, and Charles. An arrogant Henry, cold and brutal toward everyone, deigns to treat with respect only the powerful duke who holds the keys to his success. For his part, Philip, in so far as possible, avoids dealing either with his English ally or the French king who is at the point of dispossessing his progeny over the objections of his own vassals.²⁸

Occasionally, common people peek at the action from the sidelines. When the allies enter Paris, with Henry scowling at the gathered crowd, the author scorns “the poor French” forced to feast the conqueror, and who

then made good cheer of their own misfortune, disarray, and disgrace, as some thought it a greater happiness, in their old age, to live peacefully trampled under a tyrant, than as miserable but honorable champions under a legitimate heir, unfortunate like them.²⁹

²⁶ *Ibid.*, 1:106–7, 114.

²⁷ *Ibid.*, 1:120, 131.

²⁸ *Ibid.*, 1:135–36, 139, 159–63.

²⁹ *Ibid.*, 1:194.

In these pages, Chastellain deepens Monstrelet's somber tone to better convey the sense of oppression of a conquered and humiliated people. Paris has become "a new London," where the insufferable English invaders strut about "with their rough and arrogant manner of speech and behavior throughout the city that was completely occupied and subjugated by them." Here, they looked disdainfully at the people whose blood they shed at Agincourt. While in the city, both kings celebrate Pentecost, but visitors stream only to the Louvre, occupied by Henry and his queen. Despite the visitors' attempts to ingratiate themselves with their new ruler, Henry distributes offices just as he pleases among his own followers, reminding the chronicler of the seizure of Jerusalem and the desecration of the Ark.³⁰

At brief moments, the historian supplants the apologist, and Chastellain seems almost to warm up to Henry; still, he is careful with his praise. When he mentions the king's persuasive speech to his English subjects requesting more funds to continue his campaigns in France, the chronicler calls him "extremely wise and eloquent."³¹ The term "wise" (which Chastellain's more famous contemporary, Philippe de Commines, applied to Louis XI) has both positive and negative connotations. On the one hand, it is a tribute to the king's intelligence and ability to look after his own affairs. On the other hand, it implies a sort of cunning, not necessarily a proper quality associated with royalty, and even a lack of magnanimity.

In fact, this highly emotional writer prefers emotional figures, like the young duke of Burgundy, whatever the imperfections in his conduct. With evident relief, he leaves the negotiations surrounding the treaty of Troyes, turning instead to scenes of domestic bliss (rare in the *Chroniques*) when Philip is warmly greeted in Ghent by his wife. Thereafter, he extols the duke's heroics at his first battle at Mons-en-Vimeaux near Abbeville, in an attempt to present him as a victor in his own right, and not attached to a foreign invader. The justice of his cause is revealed in his "proud countenance" that demoralizes his adversaries. This quality so impresses the English king that he seeks battle with the dauphin to emulate his ally.³²

³⁰ Ibid., 1:198. The comment about the Ark is 1:203.

³¹ Ibid., 1:207.

³² Ibid., 1:204, 277–81.

The writer succeeds somewhat in tarnishing English victories and magnifying the (few) Burgundian ones with a careful choice of words and positioning of chapters. According to Chastellain, Henry's victories are followed by massacres: after defeating a French detachment, he has the prisoners drowned; when the city of Meaux refuses to surrender, he has the hostages publicly executed. The author lingers on the incredible courage of the besieged, who withdraw to their fortified market place anticipating a desperate last stand, while the encircling English submit them to incessant bombardment and intercept their food supplies. Chastellain is amazed at their courage and endurance in the face of mortal danger as they even manage to stage a mockery of Henry by parading a braying ass on the ramparts and yelling at the besiegers to come and rescue their king. In contrast Philip, like an "Octavian," generously frees some of the prisoners taken at the battle of Abbeville, striving "to rule both through the glory of virtue and through the reputation of victorious arms."³³

Book I is a long, depressing narrative of conquests, uneven fights, useless resistance, and shameful, incomprehensible compliance in high places. From within the general darkness, the duke is the only ray of sun. Noble in his intentions, his victories are legitimate, and his attachment to his royal line beyond doubt—witness his deference to the king and love for his wife. He is engaged in a personal quest against one man, not a war of destruction against "his" country. One has to read between the lines to detect where the writer disapproves of Philip's unnatural alliance, as he strives to present the duke as a power broker like his father and not a collaborator, to the point where his narrative omits episodes that show his deference to his English ally.³⁴ Yet Chastellain is caught in a paradox of his own making. Since he insists that Philip was such an important, even vital, element of English success, the reader could blame the duke even more for the part he played in acquiescing to Henry's domination, and ask why Philip did not consider postponing his private vendetta until after an English defeat.

Toward the end of the book, the author suddenly changes direction, when he depicts the dying Henry as finally redeeming himself with his eagerness to help the Burgundian duke when a looming battle with the dauphin seems near. Although Chastellain thanks God for removing

³³ *Ibid.*, 1:284. The siege of Meaux is discussed in 1:297–302.

³⁴ *Ibid.*, 1:115, n. 2. For example, the banquet that he staged for Henry's heralds.

the English conqueror, who had so humiliated France, he seems willing to forgive the dying king due to his final words that expressed regret at not having lived to go on a crusade with his gallant Burgundian ally, in whom he saw a heroic mind like his own.³⁵

Chastellain depicts the English nobles distraught at having lost their king who

had been a very wise prince and of great courage in all his undertakings, leaving them without hope of ever finding a similar one; [he] had always behaved with intelligence and had conducted all his affairs to a good end through his sagacity.³⁶

Chastellain renews this bizarre eulogizing of the sinister enemy, claiming him to be a just ruler, severe toward himself, impartial even with close relations, sober in speech, truthful, lofty in demeanor, diligent in his enterprises, and emanating an aura of authority. He adds, however, a qualifier to his praise: “[the English king] descended on France in a time of division, so that perhaps God, to chastise the sins of the French, allowed him more glory than health.” His praise of Henry contained a deliberate warning to the French whom he clearly blames for their own disgrace.

In another passage, the chronicler re-emphasizes this theme:

O French, ponder these words [...] you are fortunate and happy owners of a noble land; but the happiness of your possession, which is too vast, makes you excessively proud, for which often you have been chastised by the sword. Certainly, the glory of your humiliation does not belong to this English king; rather your pride is the cause of a disgrace born of having provoked the divine wrath against yourselves.³⁷

Chastellain may have intended this peroration more for the Frenchmen of his own day than those of 1420, who had, after all, been divided not so much by pride but by an unresolved political murder, one that was committed by a Burgundian duke. While this casuistry might save French honor, by reducing Henry to a depersonalized instrument of divine will, it clashes with Chastellain’s earlier thesis that the French were victims of their own misguided policies.³⁸

³⁵ *Ibid.*, 1:322, 328–29.

³⁶ *Ibid.*, 1:331, 324.

³⁷ *Ibid.*, 1:334–36.

³⁸ Estelle Doudet, who sees in Chastellain’s attacks against both English and “divided” French a reflection of his eschatological vision of history, notices that Henry V was cast in the role of God’s punishment. Doudet, “De l’allie,” 81–94.

III. *An Uncomfortable Guest*

A dramatic occurrence in 1456 ushered in a new and exceptionally prolific phase of Chastellain's writings, which were less pro-French. The flight of the rebellious dauphin, Louis, to the Burgundian court broke the tenuous thread of peace between France and Burgundy, bringing these two states once again to the brink of war. Book II, probably written between 1456 and 1461, reflects these renewed uncertainties in the relationship with France.³⁹ Significantly, the book opens with the year 1430, a historical moment that signaled a new independent attitude on Burgundy's part. The author recapitulates passages from Book I (passages now lost), in which Philip gave his sister in marriage to the duke of Bedford, the English lord who served as regent of France for his nephew, the boy king, Henry VI. This marital relationship had fostered "a very unique and special familiarity" between the two dukes, which lasted for a long time, at least in appearance." It was reinforced by what amounted to a joint governance of the realm.

Some tension arose between the two when Bedford attempted to bring Philip into the English order of the Garter, thus binding him more tightly to the English side. The attempt failed when Philip postponed any decision until he himself founded the Burgundian order of the Golden Fleece (*Toison d'Or*). According to Chastellain, the duke had undertaken this action in part to avoid any appearance of subjugation to the English king, but also "not loving all that cordially the English, and not wishing to remain their ally forever." Despite stressing the connection between Burgundy and the English regent, Chastellain continues to characterize Philip as "loyal French."⁴⁰ A semi-friendly tourney fought in Arras in 1430 between five French and five Burgundian knights offered the duke a fine opportunity to show his true feelings. When it ended with the French suffering a series of mishaps, a solicitous Philip sent his men to tend to their opponents' wounds. He later dismissed three of the French knights with rich gifts.

The chapter in the *Chroniques* dealing with these events has obvious political significance. In general, Chastellain, unlike other chivalric

³⁹ Delclos, *Témoignage*, 55. See Small, *George Chastelain*, 185–87, concerning the inevitability of war.

⁴⁰ Chastellain, *Chroniques* in *Oeuvres*, 2:10–14 (bk. II). But see p. 9 (n. 1): the young king Henry VI had made territorial concessions to the duke in 1423 and made him his lieutenant general in Paris in October 1429.

chroniclers such as Olivier de la Marche or Matthieu d'Escouchy, usually refrains from descriptions of tournaments. In this case, however, an unusually prolonged account presents the encounter as a form of diplomacy, suggesting that war, if transmuted into personal feats of courage, could adhere to canons of chivalry, thus presenting the potential for diplomatic solution. However, despite such contacts, a permanent peace eluded the two parties for another five years, during which time French victories left Burgundy looking ineffectual.⁴¹

The second book, which records a turning point in French fortunes, also reveals a serious inconsistency in Chastellain's political stance. Despite his alleged fondness for France, he displays toward the French heroine, Joan of Arc, an almost palpable hatred. It surpasses even the antipathy he earlier expressed for Henry V. Although Joan might have been mentioned in the lost portion of Book I, which deals with events of 1429, he now introduces her in connection with the siege of Compiègne, where *La Pucelle*, "whom the French made their idol," would be captured. At that point in the narrative, he briefly alludes to her prior successes, which rendered her famous,

in particular, for the siege of Orléans, where she worked wonders, and similarly for the expedition to Rheims, where she took the king to be crowned, and elsewhere in other great matters, in which she predicted events and their outcomes.

In depicting her conflict with the Burgundians, however, Chastellain shows his true feelings. "Acting proudly as a captain in charge of a large army," she rides out against the Burgundian besiegers followed by the French who foolishly believe "her mad delusions." Making a surprise attack on the enemy camp, she starts killing unarmed men and has one prisoner beheaded in vicious revenge for Burgundian resistance.⁴² Joan is captured during the retreat in which the French withdraw "sad and confused."⁴³

⁴¹ *Ibid.*, 2:17–26. Tournaments form the body of the *Livre des faits de messire Jacques de Lalaing*, a biography of the celebrated Burgundian knight attributed to Chastellain, which shows how the author, when writing a chivalric biography, could stick to the prescribed format. *Ibid.*, 8:1–259.

⁴² Chastellain, *Chroniques in Oeuvres*, 2:40–42–46–47 (bk 2). In reality, Joan tried to save the prisoner and it was the bailiff of Senlis who had him executed. This is a rare instance of the author getting his facts wrong.

⁴³ *Ibid.*, 2:48, 50.

In the ensuing trial for “all heresies, superstitions, and abuses” in which she had been implicated, a trial Chastellain takes pains to depict as fair and compassionate, *La Pucelle* is found guilty because she persists in her errors with “diabolical obstinacy,” and the church reluctantly releases her to the secular arm.⁴⁴ Chastellain’s depiction of Joan of Arc as an arrogant deluded murderess, rightly tried and executed for obstinately maintaining her religious heterodoxy, is every bit as devastating as any English account. In fact, the chronicler sides with the English in justifying the verdict of the ecclesiastical court, even though at the time when he was writing, Charles VII had already initiated the trial for her rehabilitation. Chastellain’s hostility goes well beyond official court attitudes as reflected in contemporary Burgundian writings and may be explained by his usual suspicion of unofficial religious figures. But it could also be suggested that it was due to his difficulty in accepting a valorous and successful fighter other than his duke who took the initiative of rescuing her king in the hour of need.⁴⁵

The extant portion of Book II breaks off not long after Joan’s trial, before the treaty of Arras (1435) that took Burgundy out of the war against France and cemented the duke’s independent status. Later books resume the narrative in the mid-1450s, the period immediately following the final French triumph of the Hundred Years War.⁴⁶

IV. Conclusion

Historians writing about Georges Chastellain have seen different things in his work. Declos observes that for this particular author, history is not primarily narrative, but commentary on contemporary or near-contemporary facts—what one might now call editorial journalism.

⁴⁴ Chastellain, *Chroniques* in *Oeuvres*, 2:203–04 (bk. II).

⁴⁵ See, for example, Le Franc’s admiring verses for The Maid in a poem dedicated to Duke Philip. For his dislike of powerful religious figures, see the account of the murderous friar who becomes an intimate of Charles VII, Chastellain, 2:53–54. Another hypothesis could be his dislike of commoners who came to influence rulers, but see his sympathetic portrait of Jacques Coeur in *Temple de Bocace*, where he calls him “homme plein d’industrie et de haut engin, subtil d’entendement et de haut entreprendre.” *Ibid.*, 7:91.

⁴⁶ Delclos, *Témoignage*, 61. The narrative resumes in Book III with the peaceful mood of 1454; however, Jean-Claude Declos, a major biographer of Chastellain, has argued that Book III is a spurious addition to the *Chroniques*. Book IV, of undoubted authenticity, picks up in 1456, with a new outbreak of hostilities between France and Burgundy.

Paul Archambault argues that, like other Burgundian court historians, Chastellain only manages “a confusing labyrinth of images,” lacking perspective and “sound judgment.” By contrast, Small attributes to the historical writing of Chastellain the possession of a goal and organizing principle not to be found in other contemporary works.⁴⁷

Ironically, the organizing principle noted by Small derives from the author’s having relentlessly focused on the theme of Anglo-Franco-Burgundian relations, in the interpretation of which he is too often inconsistent. Chastellain offers a good argument against historians becoming emotionally involved with their subjects. Throughout his writings, but particularly in the *Chroniques*, the author’s own opinion intrudes into the narrative, often to the point of overpowering the views held by those about whom he was writing. Despite a self-proclaimed deference, he is too often present in his pages, pleading with the reader for his own interpretation of the facts.

For Chastellain, history, including that of the Hundred Years War, was personal drama played out between a few actors in a circumscribed space, so unlike Froissart’s easy cavalcades through Europe, and rather anticipating the tight dramatic renderings of Shakespeare. In his earlier books, the author has a heroic figure in the person of the Burgundian duke, Philip the Good, on whom he can center his hopes and lavish praise. After 1470, however, his story lacks a true hero and his passionate partisanship gives way to disillusionment, leading him to abandon the narrative. The last of the Valois Burgundian line, Charles the Bold, with his seeming love of war for war’s sake, cannot for Chastellain’s purposes replace his father, Philip, who had led Burgundy through the final phases of the Hundred Years War.

Chastellain’s self-image as a French courtier serving a loyal French duke, a self-image that often flew in the face of hostility between France and Burgundy, differentiates him from less reflective, more one-sided Burgundian historians such as de la Marche and Molinet, men who saw their task as being not to judge, but to obey their masters. It is hard not to empathize with Chastellain’s inner turmoil as he tries to reconcile in his writings his two, often opposing loyalties; on the one hand, the kingdom of France, on the other, the duchy of Burgundy.

⁴⁷ Delclos, *Temoinage*, 3; Archambault, *Seven French Chroniclers*, 86; Small, *George Chastellain*, 162.

It is difficult to determine whether Chastellain ever re-evaluated his earlier writings in light of what followed: to wit, his hostile opinion of Henry V or his overly indulgent one of Philip the Good. But in the final pages of the *Chroniques*, the reader can hardly tell who are the good, the bad, and the ugly, as all the princes sooner or later filled each of these roles, a result of their power and position rather than their nationality. In so doing, they confound the talents of the writer who must scramble to reconcile and justify their actions.

MENTAL INCAPACITY AND THE FINANCING OF WAR IN MEDIEVAL ENGLAND¹

Wendy J. Turner
Augusta State University

The wars of the fourteenth century between the English and their neighbors the French and the Scots, impacted the mental health of those who campaigned and their families at home; furthermore, the wardship of some people with mental health issues in England indirectly assisted the English war effort. In all cases, the loss of mental capacity linked the individual and his family to a chain of events in the English legal system intended to both safeguard the person's property and to insure no loss of value to the crown and community.

I

Whenever possible, the crown would capitalize on this situation, using it to add wealth to the state. Some English gentlemen arrived home mentally broken by what they had experienced in battle and were, as such, unable to care for their lands or attend to their duties. Others complained of mistreatment at the hands of their captors, to whom they owed ransom. Although frowned upon in the case of gentlemen, wardens occasionally used torture or imprisonment as an encouragement for rapid payment of ransom. Such treatment, intentional or not, could destroy the mental health of those who suffered abuse.

When a fighting landholder arrived home mentally incapacitated, his family and the crown jointly made provisions to protect his welfare and to avoid any loss to his estate during his convalescence.

¹ Many thanks to Don Kagay for his encouragement of my work and of this paper in particular. I am also indebted to Andy Villalon for his kind words and tireless efforts at editing this volume with Don Kagay. I would also like to thank Mark Fissel, Susanne Jenks, and Nathan Yanasak for their assistance and encouragement. Special thanks to the Huntington Library, the British Academy, and Augusta State University for their financial support of my research.

All mentally-incompetent heirs, regardless of their involvement in war, became wards of the crown, and the income from their holdings became income for the king. Not infrequently, the monarchy used the income generated by these wardships to repay war-related debts or other royal expenses.

In medieval England, there were many categories and gradations of mental health and capacity. Landholders born with permanent mental incompetence, meaning they could not carry out their duties, were most often referred to as “ignorant” (*idiotae*),² “foolish or idiotic” (*fatui, fatuitatis*), and “not having full possessions of mental faculties” (*non compotes mentis*). Records describe landholders who became mentally incapacitated later, either as older children or as adults, in a manner similar to those born with limited capacity, though not as *idiotae*. Most often, those who lost their mental capacity were listed in the records as *fatui, non compotes mentis* or “insane” (*non sane mentis*). On the whole this paper is concerned with those mentally-incapacitated persons who held land since the crown drew income from that land. Other categories of mental illness and mental incompetence (such as the criminally insane) existed in medieval England, but are not within the scope of this paper.

Mental incapacity suffered on an actual battlefield affected an individual’s ability to wage war and, by extension, his survival. Injury in this context could lead to capture or death. Fighters who experienced a crack on the head or any type of concussive injury might either recover or decline in health depending on the severity of the wound. One person who incurred such an injury was Bartholomew de Sakeville. De Sakeville suffered an “acute fever” following a “blow to the head” from which he apparently never fully recovered.³ The most famous medical authority of the ancient world, Hippocrates, had counseled would-be surgeons to “go to war” in order to learn their trade and a later authority claims that “the battlefield became accepted as the school of surgery.”⁴ If a

² A legal term in England meaning “idiot,” “half-wit,” or “fool”; it has nearly the same meaning as the French term “*sol*.”

³ 1290–1309. The National Archives: Public Record Office (TNA: PRO) C 66/109/m 25; C 66/110/m 4; C 134/13/m 1; *Calendar of Inquisitions Post Mortem and other Analogous Documents Preserved in the Public Record Office [CIPM]*, Public Record Office, 20 vols. (London, 1904–1970), 5:79 (no. 149); *Calendar of the Patent Rolls [CPR], 1216–1509*, Public Record Office, 52 vols. (London, 1891–1901), Edward I, 2:362, 446.

⁴ Roy Porter, *The Greatest Benefit to Mankind: A Medical History of Humanity* (New York & London, 1997), 187.

person in battle sustained a head injury, physicians and surgeons might perform some corrective measures that achieved mixed results. As in the case of de Sakeville, they might save their patient's life, but not his mental capacity. A fifteenth-century commonplace book suggested as a remedy for "bones broken in a man's head" drawing them out with a plaster composed of "betony, vervain and rue" mixed with "honey and flour of rye and of wheat, and the white of an egg."⁵ The idea was to get the splinters of bone to work their way out so that the surgeon or physician could then remove them. This work (ca. 1443–1444) also suggested a remedy for patients whose skulls had been broken or crushed to the point that the patient could no longer speak:

Stamp violet and give him to drink first in wine. And if the right side of the head be hurt, stamp violet and bind it to the sole of the left foot. And if the left side of the head [be injured], lay it to the right foot. And the bone shall rise up, and the patient shall speak again.

This quotation suggests that medieval physicians understood that the right side of the brain affected the motor control of the left side of the body and vice versa.⁶

Chirurgia, an earlier work by Roger Frugard (c. 1180), remained popular at least through the fourteenth century and explained how and when to operate on a head injury, which he called "*la deverie*."⁷ He wrote that "*la deverie*" was to be translated into English as "mania or melancholia," both common medieval terms for conditions of mental incapacity. If the patient suffered a "cut [broken?] head" (*la teste tailleiz*) with a "shard [skull fragment]" (*le quir*), Frugard instructed surgeons first to bind the him,

Then, by opening the head with a tool that is called trepan,⁸ . . . [remove] the material of the malady, . . . which is at issue [causing the problem]. It

⁵ *A Leechbook or collection of medical recipes of the fifteenth century*, the text of ms. no. 136 of the Medical Society of London, trans. and ed. Warren R. Dawson (London, 1934), 41 (no. 89). The editor guesses the date from a mention of John, Duke of Somerset (John Beaufort), who became duke in 1443, and, following his recall from Normandy in 1444, died. If the edition is correct, then the manuscript dates to the period between his wounding (1443) and his death (1444).

⁶ As pointed out by the editor: *A Leechbook*, 261 (no. 843).

⁷ I have seen this in other places translated "devilry" or "possessed," but I believe it is closer to "thrashing."

⁸ Still in use today, a trepan is a saw used to open the skull.

is the “healthy wound” [the surgical opening made in the scalp... [that] is a cure for the previous wound.⁹

Frugard’s final statement captures the essence of much medieval English medicine: keep the patient calm, fix as much of the problem as possible, give the patient time to heal, and hope for the best. Although surgeons were necessary and good ones were highly regarded, on the whole, these men and their craft were not considered in the forefront of medicine in the Middle Ages.¹⁰

Those with head injuries were not the only soldiers who returned home suffering mental incapacity; a number of individuals had mental breakdowns following their service in battle or an imprisonment awaiting payment of their ransom. For example, Nigel Coppedene of Sussex murdered a neighbor and was pardoned because he was not mentally aware of his actions following his “sufferings as a prisoner of war.”¹¹ His experiences paralleled those of other captives. Henriet Gentian wrote that there were “‘eighteen serpents and other reptiles” in the dungeon into which he had been cast by his captor, Francois de la Palu, at Romenay.¹² According to Maurice Keen, such treatment would have justified any attempt by Henriet to escape his captivity. His justification for breaking parole increased immeasurably when the ransom did not arrive on time and Francois hammered out several of

⁹ Roger Frugard, *Chirurgia*, in *Anglo-Norman Medicine*, ed. Tony Hunt, 2 vols., (Cambridge, 1994), 53 (I. XXVI).

¹⁰ Porter, *Greatest Benefit*, 11, 186. It was during the time of the Hundred Years War that “in London a master surgeons’ guild had been founded in 1368; [and just after the war] the Mystery or Guild of the Barbers of London received its charter from Edward IV in 1462.” These merged into the Barber-Surgeons Company in 1540.

¹¹ 1306. TNA: PRO C 260/16/m 5b; JUST 1/934/m 3.

¹² M. H. Keen, *The Laws of War in the Late Middle Ages* (London, 1965), 180. Keen reports this as from Arch. Nat., X1a 4798, f. 190. He also reports that: “Jean le Gastelier, one of Robert Chesnel’s men, admitted to the judges at the Chatelet that his job in the company had been to beat prisoners ‘until they could stand no more,’ to encourage them to promise the largest possible sums” [Keen, *The Laws of War*, 191]. As Keen notes, this episode is from Duplés Agier, *Règistre Criminel du Chatelet de Paris*, Tome II, p. 95. See also: W. M. Ormrod, “The Domestic Response to the Hundred Years War,” in *Arms, Armies and Fortifications in the Hundred Years War*, ed., Anne Curry and Michael Hughes (Woodbridge, Suffolk, 1994), 83–102; Anne Curry, *The Hundred Years War* (New York, 1993); Jonathan Sumption, *The Hundred Years War: Trial by Battle* (Philadelphia, 1991); *The English Experience in France c. 1450–1558: War, Diplomacy, and Cultural Exchange*, ed. David Grummitt (Aldershot, 2002); and Michael K. Jones, “Ransom Brokerage in the Fifteenth Century,” in *Guerre et Société en France, en Angleterre et en Bourgogne XIV^e–XV^e Siècle*, ed. Philippe Contamine, Charles Giry-Deloison, and Maurice H. Keen (Lille, 1991), 221–35.

the prisoner's teeth.¹³ Although the captor's actions against his captive certainly would have created enormous stress, there are no records that point to him becoming mentally incapacitated.¹⁴ Others, however, were not so fortunate.

Legally, it was questionable as to whether or not a captor could continue to hold his prisoner if that person became mentally incapacitated. In *The Tree of Battles*, Honoré Bonet wrote that, "We find by written law and good reason agrees with this, that during his madness, a man out of his senses cannot be considered as an enemy by anyone whatsoever."¹⁵ Bonet reasoned that a person in this condition was just as liable to harm himself or even a close member of his family as to harm a foe because he did not know "whether he does well or ill."¹⁶ The author went on to stress that no victor holding a person for ransom should harm that person if he were mentally-incapacitated. In discussing the essence of nobility, he added:

consider well what nobility there would be in showing one's courage against a madman, or what gentility in making captive a man sick with so terrible a sickness, which should rouse all gentlemen to have pity and give help towards his cure.¹⁷

An exception was made for a person who regained his senses while incarcerated: he should promise not to make war again or agree to be ransomed.¹⁸

II

Some prisoners died under torture or in prison; others, like Nigel Coppedene, found their way back to England but had difficulty melding back into society. The impact at home was twofold: the incapacitated person had to be cared for and his property protected. On the one hand, English gentlemen physically injured in battle might have to undergo

¹³ Keen, *Laws*, 180 and Nicholas Wright, *Knights and Peasants: The Hundred Years War in the French Countryside* (Woodbridge, Suffolk, 1998), 64–65.

¹⁴ Keen, *Laws*, 243.

¹⁵ Honoré Bouvet, *The Tree of Battles of Honoré Bonet*, trans. G. Coopland (Liverpool, 1949), 182 (bk. 4, chap. 91).

¹⁶ *Ibid.*

¹⁷ *Ibid.*, 183 (bk. 4, chap. 91).

¹⁸ *Ibid.*, 183 (bk. 4, chap. 92).

an extensive convalesce in France before being healthy enough even to travel home. On the other hand, such men possessed the mental capacity to arrange these matters for themselves. By contrast, those landholders suffering residual effects from a head injury could not direct their own affairs and, as a result, became wards of the crown. That, in turn, often left their care in the hands of a relative.

When Bartholomew de Sakeville lapsed into mental disarray, his father had already died; consequently, his mother, Matilda, took control of his inheritance in both England and Ireland. Over time, the duties of managing Bartholomew's estate became too much for Matilda to handle, and she hired attorneys to manage the Irish properties. When she finally grew too infirm to care for Bartholomew's English lands, the crown assigned guardians enlisted from among other family members, individuals who were not in line to inherit.¹⁹

As with those whose mental incapacity sprang from battle, the aged who developed similar impediments could look forward to their wardships being assigned to relatives or close friends. Theoretically, in neither case could the agent draw a direct profit from their lands.²⁰ On the other hand, guardians could legitimately claim an allowance for their efforts on behalf of the impaired landholder. And while the royal government might not be able to extract a profit from a ward's lands, it could use such an "allowance" as a means to pay royal debts. In short, while the crown was not profiting directly, it was using the system to generate income for debt payment, thus freeing up other revenues that could be directed into the war effort.

Regulations for mental incompetents who had been born with their condition differed substantially. In such cases, guardians could be chosen at the king's pleasure, and profits accruing from their lands were owed to the crown.²¹ Nevertheless, here too the law stipulated that no

¹⁹ Guardians could not be the direct heirs of their wards for fear that they might harm the wards in order to profit by an early inheritance.

²⁰ "*Ei nullus hereditate suo propinquo vel extraneo committatur.*" "No one shall be entrusted to the care of a person who is claiming his inheritance, whether it is a relative of his or a stranger." *Leges Henrici Primi*, ed. and trans. L. J. Downer (Oxford, 1972), 224, (no. 70, 19). Dated sometime between 1108 and 1118. For more information on wardships, see: Scott L. Waugh, *The Lordship of England: Royal Wardships and Marriages in English Society and Politics 1217–1327* (Princeton, 1988).

²¹ If a person were born mentally incompetent, the crown would have the option of providing a guardian from among the family or choosing someone outside the family. Often the king used income from these lands to pay off his debts. Because incompetent

person who might benefit from the landholder's death could serve as his or her guardian.

From approximately 1265²² until some time after 1487,²³ the king of England continued to claim wardship of all mentally incompetent landholders.²⁴ The crown justified doing so on several grounds. For one thing, it wanted to make certain that all land was cared for and under cultivation. More importantly, it needed to harvest the income from lands under questionable lordship to help finance the on-going conflict with France. Such wardships became routine under Edward III (1327–1377), who used his escheators and special commissions to gather information about questions of age, inheritance, and mental health.

When an individual was clearly unable to care for his lands or carry out his feudal obligations, the crown appointed a guardian to oversee his person and property. This individual owed the crown all regular revenues generated by the property; on the other hand, he was permitted to keep any surplus that the property produced, provided he did not overwork or otherwise injure the land. Such guardians needed to be mindful of paying the crown on time. Upon occasion, the monarch might permit a guardian to whom he owed money to retain the income from a royal wardship as a means of re-paying the debt. In this way, the crown paid some of its debts without any immediate depletion of

heirs sometimes came to their inheritances early and remained in the status of ward for the rest of their lives, these were convenient sources of income. Although this type of action angered many families, there was little they could do, but wait until the mentally incompetent person died.

²² In 1265, Henry III claimed the right to all wardships of the mentally incompetent following the time of troubles. Although Henry put this into practice, its first appearance in writing is in the undated *Prerogativa Regis* that appears erroneously as part of the *Statutes of the Realm*.

²³ In 1487, Henry VII dismantled the wardship of the mentally incompetent when he stated in the Parliamentary Rolls: "all grants made by any of his progenitors, kings of England, of the custody of any idiot or lunatic, or of any manors, lands or tenements in which any of his progenitors had interest by reason of any such idiocy or lunacy, shall also be void and of no effect." Rosemary Horrox (ed.), "Henry VII: Parliament of November 1487, Text and Translation," in *The Parliament Rolls of Medieval England* [PROM], ed. C. Given-Wilson, et al., CD-ROM (Leicester, 2005), vol. VI, p. 403. Henry continued the system of wardship for persons with mental disabilities, yet with far less vigor than the kings of the fourteenth and fifteenth centuries before him. By this time, the system was damaged and never fully recovered.

²⁴ For more information, see Wendy J. Turner, "Afflicted with Insanity: The Care and Custody of the Feeble Minded in Late Medieval England," (Ph.D. diss., UCLA, 2000).

its accounts, while, at the same time, protecting property from destruction and neglect.

Guardians might be men of high or low social stature though all had to be free and able to care for the lands entrusted to them. The majority were gentry or nobility. Many, but certainly not all, were related to their wards. Some mental incompetents had a series of guardians over the course of their lifetimes, while others had only one.

A few of the incapacitated possessed large estates with multiple properties, and, in such cases, the crown divided the lands between multiple guardians. At the same time, some smaller inheritances were entrusted to the guardianship of several people. Such multiple guardianships were established for a variety of reasons: the safety of the mentally-incapacitated person, the maintenance of peace where the guardianship was contested, or the need to involve all sides of a family in responsibility for the afflicted individual.

While keeping the peace was important, the rent or income associated with these guardianships was an even more significant factor. Although the guardians could reimburse themselves for their work, it was their responsibility to care for and preserve the property for the benefit of the incompetent heirs. The crown kept watch over the guardians it had chosen by having its escheators check on the lands periodically to see that all was in order. It also instructed agents of the Exchequer to keep track of payments received.

While guardians could keep a portion of the income for their work, the bulk of the profit from such lands was supposed to come to the crown. Even small amounts added up, and the king needed every shilling he could get for the seemingly-endless expenses of the Hundred Years War. Sometimes, anticipated revenues were spelled out, while in other cases it became a process of on-going negotiation based on the changing yield of the properties. When Thomas Panes became the guardian of his relative, John de Panes, in 1364, the amount he owed the crown was clearly indicated in the documents; he was called upon to “render to the Exchequer 11l. 4s. 8d.” From the modest estate of the mentally-incapacitated Ralph de Clendon, the Exchequer brought in 3s. 4d. Ralph’s lands were placed in the care of a relative, John de Clendon, in 1358, who owed this sum to be paid “by equal portions at Michaelmas and Easter.”²⁵ Such phrasing is common for payments

²⁵ TNA: PRO C 60/159/m 12 and *Calendar of the Fine Rolls [CFR]*, Public Record Office. 22 vols. (London, 1911–1962), 7:68.

owed yearly, even when only small amounts were involved. In 1400, John Wilby and John Jolyf became joint guardians of Thomas Segere. Together they owed the Exchequer 4s. per year which they could pay in two installments.²⁶ That meant that each owed the Exchequer 1s. at Michaelmas and another at Easter. In another example, John Smale owed 13s. 4d. for the wardship of the manor of Astyngton, a part of Christina Goloffre's estate.²⁷

Another phrase commonly inserted in these agreements specified that the guardian "was to find sustenance" for the mentally-incapacitated individual. For example, Adam le Sauvage was to "find sustenance for the said John [le Eyr of Pateneye] and yearly render 6s. 8d. at the Exchequer, half to be paid on Michaelmas and half on Easter."²⁸ This same wording was used when John Lenyet²⁹ became guardian of his brother, Richard, in 1401. John was directed both to sustain Richard and to pay the Exchequer 5s. each year for the privilege of administering the wardship.³⁰ When all the afore-mentioned fees were added together, they comprised the tidy sum of 12l. 17s.

Whenever the crown made agreements involving multiple guardians³¹ over a single property or person, all of these guardians had to arrange with the treasury their schedule of payments. In 1397, John Clyvedon, John Merlond, and John Wykyng were given joint guardianship over William Brecore who held a third interest in the manor of Milton on Stoure, located in Dorset. Together, the three men came to an agreement with the treasurer concerning the payments and responsibilities.³² Similarly, in 1430, the king granted wardship over Richard Perys to Thomas and Hugh Kyngeslond, both of whom conducted similar fiscal negotiations with the treasurer.³³ The same was true of Robert Tillioll

²⁶ TNA: PRO C 60/204/m 12 and *CFR*, 12:54.

²⁷ *CFR*, 12:287. See also: TNA: PRO E 149/83/no. 12 and *CIPM* Henry IV, 18: no. 1012.

²⁸ TNA: PRO C 60/131/m 22 and *CFR*, 4:244.

²⁹ In some manuscripts this is "Levyot."

³⁰ TNA: PRO C 60/201/m32 and *CFR*, 11:223. See also: *CIPM* Henry IV, 18: no. 545.

³¹ Among the hundreds of these types of agreements that I have seen, all involving the "treasurer," also involve multiple guardians. That is not to say that there may not be one or two out there that provide for a single guardian.

³² TNA: PRO C 60/201/m32 and *CFR*, 11:223. See also: *CIPM* Richard II, 17: no. 987.

³³ *CFR*, 15:325; TNA: PRO C 60/238/m 6; *CFR*, 16:44. See also: TNA: PRO C 60/237/m9 and *CIPM*, 23: no. 304.

whose property had been entrusted to the joint custody of Richard Moresby and John Thwaytes.³⁴ In each of these instances, the fiscal agents of the crown set forth separate settlements for each guardian, even though they jointly held the property.

A few large estates had multiple guardians who exercised joint control over the entire property. While in some cases, the landlord had actually died while on campaign, in others, he had become feeble-minded as a result of his experiences in the wars. Robert fitz Neel “by chance became of unsound mind.”³⁵ This condition may well have been connected to his war service, although no specific mention was made of an actual injury. After having married and fathered several children, he became mentally-incapacitated and, in 1350, his lands were put in the care of William Croyser to whom the crown owed money.³⁶ Four years later, the king shifted guardianship over the estate into the joint care of the *chivaler*, Gerard de Braybrok, and Geoffrey Lucy.³⁷ These two men later received permission to lease the lands to Robert Elbrigge at 100s. per year. Thereafter, Robert did all of the work on the land, paying the pair the annual rent, while retaining for himself any further income generated. In 1364, the king again transferred custody of the properties, this time to his own eldest daughter, Isabel.³⁸ Robert fitz Neel’s situation provides just one of many examples of large estates continuing to generate much-needed revenue for the crown, faced with the strains of financing a war, after the owners became incapacitated.

The situation would have been dealt with in a different manner if a large estate had multiple guardians who all cared for different parts of the property. In that event, each guardian was quite independent of the others and each would have made individual arrangements with the treasurer or Exchequer. No separate agreement or coordination of efforts would have been necessary between these various individuals. A

³⁴ TNA: PRO C 60/242/m7.

³⁵ *CPR* Edward III, 10:256. See also: TNA: PRO C 60/151/m 20 and *CRF*, 6:252.

³⁶ *CFR*, 6:252. William Croyser was also part of the investigation commission into Robert’s mental status: TNA: PRO C 66/230/m 4d, C 135/111/m 7, and C 66/257/m 3. See also the calendars: *CPR* Edward III, 8:533, *Calendar of Inquisitions Miscellani [Chancery] [CIM]*, Henry III–Henry V, Public Record Office, 7 vols., (London, 1916–1968), ser. 1, v. 9, no. 589, and *CPR* Edward III, 11:273. Other parcels of land were placed under the guardianship of other people, such as Robert de Hadham (*CFR*, 6:402) and Thomas de Styrngham (*CFR*, 6:403).

³⁷ *CFR*, 6:407 and *CPR* Edward III, 10:172, 217.

³⁸ TNA: PRO C 66/246/m 17 (*CPR* Edward III, 10:256).

good example is the large estate of Henry Mortymer that descended to his son when Henry died in 1374. Henry's son, William, lived for many years as the ward of two men: John Ederyk cared for William's Welsh properties,³⁹ while William's uncle, Hugh Mortymer, had custody over his English properties.⁴⁰ John Ederyk, who worked at the Exchequer, was given the rent of 60s. from the Welsh properties as payment for his service to the crown with nothing due back to the Exchequer. In contrast, Hugh Mortymer owed the Exchequer twenty marks (13*l.* 6*s.* 8*d.*) per year; a substantial sum which was often presented by means of an attorney, since Hugh came and went from the war in France.

A number of properties that brought money into the royal coffers left the guardian and royal officials to negotiate the precise details of payment. In these cases, guardians could bargain with the king's representatives for an equitable assessment and fair pay schedule. Often, guardians were instructed to make these payments in even installments at Michaelmas and Easter and to "answer for the residue at the Exchequer." This meant that if the guardian actually made more than the royal representative had estimated, he might have to submit the excess on top of his payments, depending upon the agreement he had reached with the crown. For example, in 1340, Wolfard de Glistere was granted the guardianship of Thomas de Scorburch "so that he might answer at the Exchequer for the issues thereof if they ought to pertain to the king."⁴¹ In other words, after Wofard had paid any fees associated with the estate, made his payments to the crown, and taken his allowance, he still owed the king any other money he had earned from the land. Similarly, in 1362, the king gave Richard de Ravenser, his clerk, the wardship of Thomas de Ouneby,⁴² under an agreement stipulating that he was to "answer" to the Exchequer for profit accruing to the land. In 1403, when Henry de Pudesay gained custody of Thomas de Lawys,⁴³ and in 1423, when the crown granted Roger Shrigley the wardship of Thomas Wonton, the same condition applied.⁴⁴ All of these guardians

³⁹ TNA: PRO C 66/291/m19.

⁴⁰ *CFR*, 11:20. See also: *CIM*, 3: no. 949, TNA: PRO E 149/37/no. 9 and E 149/36/no. 6.

⁴¹ TNA: PRO C 60/140/m 24 and *CFR*, 5:171.

⁴² TNA: PRO C 60/163/m 16 and *CFR*, 7:227.

⁴³ *CFR*, 12:210–11. For more information on Lowys, see: TNA: PRO C 137/40/m 59, C 137/79/m 40, E 152/433/m 5 and *CIPM* Henry IV, 18: no. 868; 19: no. 752.

⁴⁴ TNA: PRO C 60/231/m 11. See also *CFR*, 15:64, 251; and TNA: PRO C 60/236/m 14.

had negotiated with royal officials for their schedule of payments; if, however, it became apparent that they were taking in much greater sums from the property, they would be compelled to turn over to the Exchequer either all or part of these excess revenues.

When, in 1406, John de Scardesburgh became the guardian of John Bertelot's properties in St. Albans,⁴⁵ the arrangement did not last, probably because the guardian neglected to pay the crown its share of the income. Hence, in the following year, William Wychtman replaced John de Scardesburgh in the guardianship.⁴⁶

While some of the properties involved were fairly minor, similar conditions could also apply to large estates. The numerous manors of John de Welyngton, tenant-in-chief of the king,⁴⁷ passed to his son of the same name, who had already been adjudged mentally incompetent (*idiota*). As a result, these lands were placed in the care of his nephew, John Wroth, "*chivaler*"⁴⁸ who was to render to the Exchequer "the incomes from the lands or as much as may be agreed upon between him and the king's council."⁴⁹ Wroth was expected to turn over the profit from Welyngton's property in return for the privilege of exercising wardship. Like any guardian, however, he could retain some of the income for his troubles and the records indicate that he did so. In short, the nephew of the incapacitated property holder reaped rewards for his own sanity, while the crown earned much needed income, some of which might be devoted to the war effort.

In special cases, when the property had been poorly maintained over a long period of time, leading to a decrease in the revenues it generated, the crown might demand an "increment." This meant an annual

⁴⁵ TNA: PRO C 60/211/m 12 and *CFR*, 13:28.

⁴⁶ TNA: PRO C 60/213/m 26 and *CFR*, 13:88 See also: *CIPM*, 18: no. 1186.

⁴⁷ John de Welyngton (both elder and younger) possessed at least twelve manors, plus portions of approximately seven other properties. Their manors in Somerset county: Wyke, Wethecombe, Brompton Rauf, Elworthy and Hoccombe; manors in Dorset county: Womberlegh, Rydelecombe, Lomene, Gydesham, Stokryvers, Beauforde and Langelegh with the bailiwick of the hundred of Westbuddelegh, a messuage and a carucate of land in Wamforde, and two-thirds of the manor of Hunschaue; in Cornwall county: two-thirds of the manors of Fawyton and Lanteglos, and two-thirds of the manor of Trevilias; and in Gloucester county: A moiety of two-thirds of the manor of Frompton Cutell.

⁴⁸ TNA: PRO C 60/200/m. 22; C 60/204/m. 21; C 60/206/m. 8; C 60/217/m 6; C 136/96/m. 1; C 137/86/m. 25; E 149/97/no. 11. See also: *CFR*, 11:198–203; 12:31–32, 134; 13:246; *CIPM* Richard II, 17: 344–48 (nos. 937–949); *CIPM* Henry IV, 19: 337–39 (nos. 946–51).

⁴⁹ *CFR*, 11:198.

supplement to the falling income in the amount owed to the Exchequer, thus assuring the crown that its revenues would not be diminished. In 1374, the king granted Robert Turnay of Ashelegh wardship over Robert Justice with an “increment” of 4*s.* yearly for as long as he held the property.⁵⁰ In 1433, Joan Poyndyngdon’s lands were jointly held by Nicholas Carewe, William Poulet, and Stephen Dubber at 6*s.* 8*d.* with increment of 8*d.* per year.⁵¹ In 1444, John Herward of Billerica became the guardian of his relative, John Hereward of Horndon. As part of their arrangement, the guardian was to deliver 6*s.* 8*d.* yearly to the Exchequer with an increment of 3*s.* 4*d.*⁵²

Traditionally, guardians had figured out ways to squeeze ever more money out of the estates of mentally-incompetent wards. They accomplished this by increasing the amount of land in production, an expedient that often led to its deterioration, or by selling off buildings and chattels. By providing for an increment, extra revenue generated by such practices often benefitted the Exchequer and not the guardian. What is more, the crown could still fine a guardian for “waste” of a property if his attempts at exploitation proved too extreme.

To further curb siphoning of excess profit away from the crown, royal officials even began to open guardianships over land to competitive bidding. For example, in 1437, William Whappelode gained custody of the estates of William Dunton of Chalfhunte, with the stipulation attached that he pay to the Exchequer 40*s.* per year. For his part, Whappelode was to receive 33*s.* 4*d.* yearly as his “allowance.” Instead of specifying an “increment,” however, the crown now made a provision that “if any other person shall be willing without fraud to give more by way of increment for the said keeping, then the said William Whappelode shall be bound to pay the larger sum.” In other words, if he wanted to continue in the position of guardian,⁵³ he would have to match the competitive bid or quit the guardianship.

Guardians could lose their position and income either for failure to pay the crown or for overworking or neglecting the property. When, in 1342, William de Burwardesle (the younger) became the guardian

⁵⁰ *CFR*, 13:225.

⁵¹ TNA: PRO C 60/240/m 10 and *CFR*, 16:148. In an unusual provision, this agreement specified a time limit (ten years) during which the three men would retain their guardianship. In most cases, such limits were not specified.

⁵² TNA: PRO C 60/251/m 5 and *CFR*, 17:293.

⁵³ *CFR*, 16:317.

of Nicholas de Glamorgan's estate, he was called upon to make two payments to the crown at "Easter and St. John the Baptist next," totaling 20*l.* for the land and 46*l.* 18*s.* 7.5*d.* for the goods and chattels.⁵⁴ A year later, when he failed to meet these commitments, William was immediately removed from his guardianship⁵⁵ and Thomas de Bourne was appointed in his place.⁵⁶ When Thomas died in 1355, John de Gildesburgh assumed the guardianship, the terms of which were still unchanged.⁵⁷ Guardianships were not allowed to sit empty for long; if unoccupied for more than a few weeks, either the royal escheator or the sheriff might step in for the interim, making the necessary payments to the Exchequer.

Guardianship/wardship regulation was not without its problems. Some individuals tried to circumvent royal directives by keeping the profits for themselves. Others tried diverting money to friends and relatives, while a few attempted to dupe the crown into allowing them to buy up lands that already had legitimate heirs. One example of a knight who found a way around the king's wardship rules was William Hemnale.⁵⁸ When his son and namesake was born, he set up a kind of "trust" for the infant with three of his friends: John Moriell, clerk; Hugh Lancastre, clerk; and Simon Blyaunt. In the event of his death in battle, the three "trustees" were to be temporarily enfeoffed with a manor of Brunham Westgate called Polstead Hall on the condition that they turn the property over to his son when the boy came of age. Consequently, at the death of Sir William when his son was only four years old, the wardship did not devolve to the king because of the terms of this earlier arrangement.⁵⁹

In an interesting twist, the three "trustees" retained the property even after William came of age because, by then, it had become apparent that the boy had been born a "fool and idiot." The property itself was worth 50 marks (33*l.* 6*s.* 8*d.*) per year and was held by knights' service.

⁵⁴ *CFR*, 5:296.

⁵⁵ *CFR*, 5:333.

⁵⁶ *CFR*, 5:335.

⁵⁷ *CFR*, 6:433. See also: *CIPM* Edward III, 11: no. 335. Wardships also gave the crown more power in other ways. In the course of the twelve years that Nicholas de Glamorgan remained in the king's hands, the king made six presentations to churches on the manor of Brampton.

⁵⁸ *CIM*, 7: no. 208.

⁵⁹ TNA: PRO C 137/51/m 58 and C 137/45/m 66, 67. See also: *CIPM* Henry IV, 19: nos. 154, 156–57 and v. 18, no. 1006.

When the king discovered this attempt to avoid his jurisdiction, he appointed new legal guardians, James Andrewe and John Beauver, who would turn over the 50 marks to the Exchequer while the king decided how to fine or otherwise punish the financially-creative trio.⁶⁰

William Hemnale was not alone in his attempts to find ways of circumventing fiscal obligations to the crown. In 1371, Sir Thomas de Wentenhal took charge of the lands of a mentally-incompetent vassal, Robert Launder.⁶¹ Sir Thomas went unchallenged for two years, caring for the land and reaping the profits until the crown fined him and appointed a guardian for Robert. Not surprisingly, some guardians formed an attachment to the properties of their mentally-incompetent wards and attempted to gain possession of them. When William de Wantyng of Estbury died suddenly in 1362, his insane sister, Joan, was his heir. The king appointed an escheator, John de Estbury, as her guardian. John was to pay the Exchequer £20 per annum for her lands at Estbury.⁶² For other properties, Joan had other guardians, including Walter de Wyght and Thomas Wynterborn.⁶³ In 1374, the escheator convinced royal officials to let him “buy” Joan’s property, neglecting to inform the court of two key facts: that she was mentally incompetent and that he was her guardian. The ruse was discovered and John was fined £20 to attain a pardon from the king, who then appointed Thomas Goiou as the new guardian under the same arrangement.⁶⁴

Occasionally, the crown retained revenues for reasons other than greed or malfeasance. John de Roches, a knight in the service of Edward Stradlyng, sold the manor of Bromlegh to his son, William. When William later became mentally incapacitated, his father took back control of the manor, probably to keep the income of 14*l.* in the family. Later on, he transferred the property to John de Brideport and his wife, Maud, the pair of whom may have been his son-in-law and daughter.⁶⁵ While the crown often looked askance at such arrangements, families understandably wanted to keep as much income in their hands as possible. John de Roches was not alone in trying to maintain control of family property. Land under the guardianship of the crown never

⁶⁰ *CFR*, 12:149.

⁶¹ *CIPM* Edward III, 12: no. 399.

⁶² TNA: PRO C 66/265/m 14, C 66/ 267/ m 14 and *CPR* Edward III, 12:186.

⁶³ Walter: *CPR* Edward III, 12:340. Thomas: *CPR* Edward III, 15:379.

⁶⁴ TNA: PRO C 66/290/m 26 and *CPR* Edward III, 15:418–9.

⁶⁵ *CIM*, 2:440–41 (no. 1780).

stayed in wardship forever, and, when released to the heirs, the income so long withheld from the family was usually a godsend.

The death of a mentally-incompetent landholder might upon occasion provide the monarchy with the means of creating a new knight-hood or filling an empty office. When Robert Tillioll died in 1436, his property was divided between his two sisters and their husbands, both of whom took oaths of fealty to the king. Christopher Moresby, husband of the older sister, Margaret, had already become a knight and had given his oath in anticipation of receiving his wife's half of the inheritance. For her part, Margaret's sister, Isabell, received her inheritance only after her husband, John Colvell, also took a similar oath.⁶⁶ Wardships of this sort could afford the king more control over his subjects as well as the monies they produced.

The care and custody of all lands of mentally-incompetent landholders diverted revenues to a crown deeply invested in war. The king could repay those to whom he owed money with wardships over the lands of mentally-incapacitated individuals. Payment would take the form of an allowance for managing the property rather than cash from the hard-pressed royal treasury. While some wards were born idiots, others lost their mental capacity as the result of battle or captivity. Not infrequently, such madness followed upon the torture of a captive awaiting the payment of his ransom. Despite the efforts of physicians to treat such men, most of their therapies proved futile. If an individual continued in this state, he would become a ward of the king of England. The crown was to protect his lands and preserve them for his heirs. For this protection, the profit which they generated went to serve the king and at least indirectly the war effort. In this way, mental incapacity and the royal methods taken to deal with it might help defray the mounting costs of the Hundred Years War.

⁶⁶ TNA: PRO C 60/242/m 7, *CFR*, 16:231. See also, *CFR*, 16:277 and C 60/243/m 12.

APPENDIX ONE: THE HUNDRED YEARS WAR AND GENEALOGICAL CHARTS

L. J. Andrew Villalon

The Hundred Years War was fought primarily between France and England in the years 1337–1453,¹ though (as we shall see in the course of these essays), it spilled over into surrounding regions such as Italy, Spain, the Low Countries, and western Germany. Viewed in a longer perspective, the war was really the last round in a 400-year struggle between two of medieval Europe’s major dynasties to determine which would control much if not all of France, a fact that has led several prominent historians to refer to the conflict as “the second Hundred Years War.”² On one side stood the Valois Dynasty, a cadet branch of the Capetians who had controlled France since the elevation of Hugh Capet to the kingship in 987.³ Against these Capetian-Valois kings were ranged the Plantagenets, a family that had ruled England since William the Conqueror, Duke of Normandy, had sailed across the channel in 1066 and seized the throne from its last Anglo-Saxon ruler.⁴

In the end, after many stunning reversals of fortune, the Capetian-Valois dynasty triumphed. In 1453, its current incumbent, Charles VII (1422–61), expelled his English rivals from all the lands they held on the continent, with the sole exception of the port city of Calais and its

¹ Although these are the dates usually assigned to the Hundred Years War, both involve chronological problems of the sort that characterize the conflict. For example, while Edward III began to gather allies for his conflict with the French in 1337, he did not actually launch an attack on that country until 1339 and he officially claimed the French crown only in 1340. And while the final expulsion of the English from all French territory but Calais occurred in 1453, no treaty ended the conflict at that time. Not recognizing that the war was for all intents and purposes over, England again dispatched armies to the continent in 1475 and 1492.

² James Westfall Thompson and Edgar Nathaniel Johnson, *An Introduction to Medieval Europe 300–1500* (New York, 1937), 879; arguably the finest medieval history text written in English.

³ For a list of Capetian-Valois monarchs who participated in the conflict, see the Genealogical Charts at the conclusion of this Appendix and the Genealogical lists in Appendix Two.

⁴ For a list of Plantagenet monarchs who participated in the conflict, see the Genealogical Charts at the conclusion of this Appendix and the Genealogical lists in Appendix Two.

environs. Calais, seized early in the conflict (1346–47), would not fall back into French hands until another war fought between the traditional enemies in the mid-sixteenth century.

While many factors helped precipitate the Hundred Years War, its most immediate cause lay in conflicting claims on the French crown.⁵ Having left behind three sons, Philip IV “the Fair” (1285–1314), whose actions had led to the creation of the Estates General (1302), the establishment of the Avignon Papacy (1305–1378)⁶ and destruction of the Templars (1307–1314),⁷ died in the full confidence that he, like his predecessors for many generations, had ensured succession by the direct line of Hugh Capet. Unfortunately for the Capetians, in just over a dozen years, each of his three sons succeeded to the throne, only to die without male issue: first came Louis X (1314–1316), then Philip V (1316–1322), and finally, Charles IV (1322–1328).

A minor crisis arose in 1316 when the French aristocracy passed over Louis’s daughters and transferred the crown to his younger brother. The same happened again in 1322 and 1328, though on the last occasion, the problem was rendered considerably more serious by the fact that there were now no more sons of Philip IV available to succeed. Consequently, in 1328, the nobles passed over not only Charles IV’s daughter, Blanche, but also his sister Isabelle; instead transferring the crown to a male line descended from Philip IV’s brother, Charles of Valois. To justify what amounted to *disinheritance* of the daughters, the

⁵ For the contributing causes to the conflict, see Malcolm Vale, *The Origins of the Hundred Years War: The Angevin Legacy 1250–1340* (Oxford, 1996); J. R. Maddicott, “The Origins of the Hundred Years War,” *History Today* 36 (1986): 31–37; G. P. Cuttino, “Historical Revision: The Causes of the Hundred Years War,” *Speculum* 39 (1956): 463–77.

⁶ G. Mollat, *The Popes at Avignon: The “Babylonian Captivity” of the Medieval Church*, trans. Janet Love (New York, 1963), 3–6; Yves Renouard, *The Avignon Papacy: The Popes in Exile 1305–1403*, trans. Denis Bethell (1954; reprint, New York, 1994), 13–15.

⁷ Malcolm Barber, *The Trial of the Templars* (Cambridge, 1978); *The Templars*, ed. Malcolm Barber and Keith Bate (Manchester, 2002), 243–328 (docs. 66–79); Alan Forey, *The Military Orders from the Twelfth to the early Fourteenth Centuries* (Toronto, 1992), 204–41. Among the numerous websites that deal with this most famous of crusading orders—a Google search conducted on April 3, 2004, produced “about 167,000” hits—there is one that is worth accessing, if only to see the intense “buff” interest in this subject: Templar History, Home of Templar History Magazine, www.templarhistory.com. (As of the same date, the site claimed 1,072,107 visitors.) Despite its highly commercialized nature, Templar History contains some interesting historical material, including English translations of a number of relevant documents (the accusations against the Templars, an anonymous tract defending them, Clement V’s bull *Vox In Excelso*, ordering that they be disbanded, etc.).

French reached far back into their history, citing a highly questionable legal precedent that has become known to historians as Salic Law, said to forbid the succession of a woman.

Most of the great nobles soon swore allegiance to Charles of Valois's son, Philip VI (1328–1350). This included the young English king, Edward III (1327–1377), who owed homage for the remaining Planagenet lands on the continent. Edward, however, possessed a rival claim to the French crown derived through his mother, Isabelle, the passed-over princess who in 1308 had married Edward II (1307–1327). Although the young English king did not choose to press the issue seriously until the late 1330s, tensions began to mount well before that time. Matters came to a head in 1337 when Philip VI confiscated Gascony and Edward III started casting about for military allies who might help him vindicate the claim that he would advance publicly three years later.⁸

What is called the Hundred Years War was by no means an unbroken century of conflict. Although this seemingly interminable struggle stretched out over nearly twelve decades, bursts of intense military activity alternated with years or even decades when hostilities were largely suspended. During each active phase, the fortunes of war tended to favor either one side or the other: for example, the years between 1345 and 1360 were characterized by an almost unbroken string of English victories, while those from 1369 to 1380 witnessed an equally dramatic turning of the tide in favor of France.

Traditional tripartite divisions of the Hundred Years War,⁹ while not incorrect, are most certainly inadequate if one wishes to convey any meaningful understanding of the ebb-and-flow that characterized

⁸ Powicke characterized this claim as the result of “family quarrels... [that] only gradually grew into national enmity.” F. M. Powicke, *King Henry III and Lord Edward: The Community of the Realm in the Thirteenth Century*, 2 vols. (Oxford, 1947), 1:161.

⁹ In his *History of the Middle Ages* (forerunner to *An Introduction to Medieval Europe*), Thompson divides the conflict into three chronological periods: 1337–1380, 1380–1415, 1415–1453. His contemporary, Edward Cheyney, advances a rather different periodization, albeit one that is also tripartite: 1337–1360, 1369–1415, 1415–1453. By contrast, in what is perhaps the best short account of the war written for the *Encyclopedia Britannica*, Charles Oman envisages six periods: 1338–1345, 1346–1360, 1360–1396, 1396–1414, 1414–1420, 1414–1422, 1423–1453. For reasons too detailed to go into, the editors do not adhere to any of these earlier periodizations. See James Westfall Thompson, *History of the Middle Ages 300–1500* (New York, 1931), 362; Edward P. Cheyney, *The Dawn of a New Era, 1250–1453* (New York, 1936), 158; *Encyclopedia Britannica* (Chicago, 1958), 11:889–93.

the conflict. Consequently, this brief summary of the struggle divides it into eight periods:

1. 1337–1345: Preliminary Maneuvering
2. 1345–1360: First Floodtide of English Victory
3. 1360–1369: The Short Hiatus
4. 1369–1380: The Tide Turns for France
5. 1380–1415: The Long Hiatus
6. 1415–1429: Another English Floodtide
7. 1429–1435: Another French Resurgence
8. 1435–1453: Final French Victory

1. Preliminary Maneuvering (1337–1345): Late in the 1330s, Edward III began to lay the groundwork for war. In 1337, he launched a diplomatic effort to gather allies on the northern and eastern borders of France, resulting in a loose federation of princes and nobles whose lands stretched from the North Sea nearly to Switzerland. Among them, the most prominent were the dukes and counts of Brabant, Hainault, Lorraine, Holland, Guelders, Bavaria, and the palatinate of the Rhine. At the same time, Edward attempted to maximize his revenues, expropriating with parliamentary approval half of the annual wool export and soliciting loans from international banking houses, several of which would go under when Edward was forced to declare bankruptcy a decade later. Concurrent efforts in the south were less successful as the Spanish kingdoms and Naples leaned toward France.

Meanwhile, pressure was brought on the key County of Flanders, whose ruler, Louis of Nevers, had maintained his loyal to the house of Valois. When Flemish leaders refused to renounce French sovereignty and place themselves under English protection, Edward imposed an embargo on the export of all English goods to France and Flanders. The resulting lack of English wool and food supplies inspired a Flemish uprising in 1377 that began in Ghent and spread to most other urban centers, including Bruges and Ypres. Its leader, a wealthy merchant named Jacob van Artevelde, arranged for Flemish neutrality in the coming struggle in return for England's lifting its embargo.

In 1338, Edward visited the continent, confirming the terms of his alliances and recruiting the Holy Roman Emperor who agreed to supply troops and to appoint him Vicar-General of the Empire west of the Rhine. The first campaign of the war occurred in autumn, 1339, when the king led an English army, backed by contingents from the

Low Countries, into northeastern France on a plundering raid that set the pattern for the devastating *chevauchees* of future decades. In 1340, Artevelde brought Flanders in on the English side of the conflict, by recognizing Edward III as the rightful king of France, a claim Edward voiced officially in the marketplace at Ghent.¹⁰

Despite this promising start, England accomplished very little by the initial campaign of 1339 or the protracted and unsuccessful siege of Tournai the following year. Edward's grand alliance began to fall apart almost as soon as it was put together when a number of allies either withdrew from the conflict or changed sides. Soon after Tournai, the king agreed to a truce (the first of many) that would remain in force until 1345; he then returned to England, not to return to the Low Countries.¹¹ Only one encounter of note occurred during this opening phase of the conflict: in June, 1340, an English fleet defeated one made up of French, Spanish, and Genoese ships off the port of Sluys, thus winning control of the sea for nearly three decades. It was here that the English longbow, the most feared missile weapon of the conflict, first demonstrated its extraordinary value in continental warfare.

Despite the five-year truce, conflict between England and France continued in the duchy of Brittany. In 1341, the childless death of the duke sparked a civil war between two claimants—the duke's brother, John of Monfort, and his niece's husband, Charles of Blois, a member of the French royal family. England and France quickly became involved on opposite sides: the English backing Montfort, while the French supported Charles. Neither the capture of Montfort soon after the war began, nor that of his opponent several years later diminished the intensity of the struggle, for in their absence, their redoubtable wives fought on without let-up. For over two decades, the war in Brittany would continue unabated and England and France, even in periods of truce, would face off through their Breton surrogates.

2. First Floodtide of English Victory (1346–1360): The second phase of the conflict began in 1345 when in late summer the five-year

¹⁰ G. P. Cuttino, *English Medieval Diplomacy* (Bloomington, Ind., 1985), 84. For a general treatment of medieval diplomacy and diplomatic practices, see Donald E. Queller, *The Office of Ambassador in the Middle Ages* (Princeton, N.J., 1967).

¹¹ Jonathan Sumption, *Trial by Battle*, 325–29; Kelly DeVries, "God, Leadership, Flemings, and Archery: Contemporary Perceptions of Victory and Defeat at the Battle of Sluys, 1340," *American Neptune* 55 (1995): 223–42.

truce ended. An English army landed at Bordeaux and began operations against the neighboring province of Gascony, the confiscation of which had helped touch off the conflict. Here, England's ranking soldier, the earl of Lancaster, led an outnumbered force to the first major land victories of the war at Bergerac and Auberoche.¹² In 1346, Edward III returned to continent, landing in Normandy and launching a six-week campaign of devastation as he marched northward toward Flanders. Overtaken by a far larger French army commanded by Philip VI, Edward made a stand near Crécy on August 26 where he won the first of a series of spectacular English victories that would characterize the Hundred Years War.¹³ With the French army in shambles, the king fled the battlefield. At Crécy, the heir to the English throne, Edward, Prince of Wales (d. 1376), better known to history as the Black Prince, began making a reputation as the foremost soldier of his age.¹⁴

Following the victory, the English king hurried northward and initiated the siege of Calais, which he took in the spring of 1347.¹⁵ To solidify England's hold on what would become her major port of entry to the continent, Edward expelled the French inhabitants and resettled the area with English colonists. Calais not only supplied England with an advance military outpost, it also provided a home for the wool staple.

Although the ravages of the Black Death (1347–1350) and another truce (1347–1355) temporarily halted fighting, hostilities again broke out in 1355 when the Black Prince conducted a devastating *chevauchée* through Armagnac, Languedoc, and the Toulousain. The following

¹² The principal biography of Henry de Grosmont, earl and later duke of Lancaster, is Kenneth Fowler's *The King's Lieutenant: Henry of Grosmont, First Duke of Lancaster 1310–1361* (London, 1969). For a careful analysis of the Bergerac campaign, see the recent article by Clifford J. Rogers, "The Bergerac Campaign (1345) and the Generalship of Henry of Lancaster," *The Journal of Medieval Military History* 2 (2004): 89–110.

¹³ Alfred H. Burne, *The Crécy War: A Military History of the Hundred Years War to the Peace of Brétigny* (1955; reprint, London, 1999), 169–223; Jules Viard, "La campagne de juillet-août 1346 et la bataille de Crécy," *Moyen Âge* 27 [2nd ser.] (1926): 1–84; Henri de Wailly, *Crécy, 1346: Anatomy of a Battle* (Poole, 1987).

¹⁴ Recent biographies of the Black Prince include: Richard Barber, *Edward Prince of Wales and Aquitaine: A Biography of the Black Prince* (1978; reprint, Woodbridge, 1996). Henry Dwight Sedgwick, *The Black Prince* (New York, 1993). For easy access to some of the standard contemporary documents dealing with the prince's life, see: Richard Barber, *The Life and Campaigns of the Black Prince* (London, 1979), a new version of which has recently come out with Boydell and Brewer.

¹⁵ Jules Viard, "Le siège de Calais, 4 septembre 1346–4 août 1347," *Moyen Âge* 30 [2nd ser.] (1929): 124–89; Kelly DeVries, "Hunger, Flemish Participation and the Flight of Philip VI: Contemporary Accounts of the Siege of Calais, 1346–47," *Studies in Medieval and Renaissance History* 12 [n.s.] (1991): 129–81.

year (1356), Edward led a similar filibustering expedition northward from his headquarters in Aquitaine.¹⁶

As had been the case with Crécy tens years earlier, the English army was cut off by a vastly superior French force commanded by the new French king, Jean II (1350–64) and his sons. On September 19, 1356, the prince was forced to stand and fight. The ensuing battle became the second great victory of his career, marked by the death or capture of much of the French nobility, including the French king and two of the princes who now found themselves in English hands. The *dauphin*¹⁷ (the future Charles V) barely managed to escape from the battlefield and, in his father's absence, he now became the regent of France.¹⁸

There followed four years during which the kingdom descended into one of the most chaotic periods of its history, as the very fabric of French society seemed to be dissolving. Although another short truce temporarily suspended open warfare, internal problems beset the beleaguered regent, including the establishment of a revolutionary government in Paris led by the provost of the merchants, Etienne Marcel, a serious attempt by the Estates General under Marcel's leadership to take over control of royal appointments and the kingdom's finances, and the great peasant uprising of 1358, known as the *Jacquerie*.¹⁹

By the end of the decade, the *dauphin* had weathered these challenges and managed to reestablish a measure of royal control. What is more, Edward III's last campaign of the period, the *chevauchée* of 1359, fizzled badly. Nevertheless, in 1360, Charles had no choice but to ratify the treaty negotiated at Brétigny and in large part confirmed at Calais, a treaty that called for the effective dismembering of France. In return for renouncing his claim on the French throne, Edward III received full sovereignty over vast stretches of southwestern France (Aquitaine, Gascony, Poitou) as well a lesser, but still impressive array of territories in the north. What is more, the French king's ransom was indeed

¹⁶ H. J. Hewitt, *The Black Prince's Expedition of 1355–1357* (Manchester, 1958); Barber, *Edward Prince of Wales* (1978; reprint, Woodbridge, 1996), 110–29.

¹⁷ The title *dauphin* referring to the heir apparent to the French throne first appeared shortly before the Hundred Years War. Having gained the Dauphiné for the French crown, Philip VI established it as the hereditary property of the heir to the throne. The title became comparable to the English “prince of Wales.”

¹⁸ J. M. Tourneur-Aumont, *La bataille de Poitiers (1356) et la construction de la France* (Paris, 1940); Barber, *Edward Prince of Wales*, 136–48.

¹⁹ J. Russell Major, *Representative Government in Early Modern France* (New Haven, Conn., 1980), 12–17; Lewis, *Later Medieval France*, 283–86.

that—three million gold crowns.²⁰ Only at the height of Plantagenet power during Henry II's reign had England's holdings on the continent been greater. The question now became, could the English maintain their position?

3. The Short Hiatus (1360–1369): The period was characterized by an uneasy peace between the two major combatants, during which the English governed much of western France. The key figure in this occupation was the Black Prince who, serving as governor of Aquitaine, held court in Bordeaux. Although his reputation as the foremost soldier of the age would be solidified by the events of this decade, the extravagance of his lifestyle, his inability to win the loyalty of the people whom he governed, and the financial crisis brought on by his campaign in Spain would together sew the seeds of future English defeat.

The period started inauspiciously for the French: by the terms of the treaty, Jean II was released from captivity and resumed the reigns of power from his far more talented son, Charles. The king returned only to find that the problems confronting his kingdom far outweighed his meager abilities. In 1363, after several years of “drift,” he did the most sensible thing of his entire reign: he seized a pretense to remove himself from the scene. When his son, Louis of Anjou, retained in England as a hostage, broke faith and fled, the debonair but ineffectual monarch voluntarily reentered his comfortable captivity across the channel, where he died the following year.

Jean's last act before departing would haunt the French monarchy for the rest of the Hundred Years War and beyond. Having secured the duchy of Burgundy for the crown, he promptly regranted it to his youngest son, Philip “the Bold” (1363–1404), who had earned his sobriquet fighting beside his father at Poitiers. At the same time, he convinced the emperor to invest Philip with the free county of Burgundy (Franche-Comté). Over the course of the next century, Philip's successors would progressively extend their control northward into the Low Countries, thus resurrecting what was, in effect, a “middle kingdom,” largely independent of French control, one that would continue to plague Jean's successors until reclaimed by his great-grandson, Louis XI (1461–1483) in 1477.

²⁰ John Le Parourel, “The Treaty of Brétigny, 1360,” *Transactions of the Royal Historical Society* [5th ser.] 10 (1960): 19–39.

The most difficult problem that Jean had briefly confronted and been utterly unable to resolve involved the so-called “free companies.” While the treaty of Brétigny put an end to *official* hostilities for nearly a decade, it did not spell peace. During this period, France experienced a serious threat from roving bands of soldiery, discharged by both sides for reasons of economy and then left to fend for themselves. These hard-bitten veterans banded together into quasi-military units known as “free companies,” sometimes numbering in the thousands, always living off the land and its civilian population. For those regions of France that experienced their depredations, peace and war became indistinguishable.²¹ In spring, 1361, the newly restored king dispatched the Count de la Marche to crush the companies; instead, it was the royal army that suffered a humiliating defeat at Brignais. After this, neither the government nor the population put up much further military resistance; some other means of dealing with the companies would have to be found.

John’s death in 1364 brought to the throne the one truly fine French monarch of the entire Hundred Years War, Charles V “the Wise” (1364–1380).²² At the same time, however, France suffered another setback. In September, 1364, at the battle of Auray, Charles of Blois, the French-backed duke of Brittany, suffered a crushing defeat at the hands of his opponent, John of Montfort.²³ Charles of Blois died on the field and his general, Bertrand DuGuesclin, was captured by the English commander of Montfort’s army, Sir John Chandos. The victory at Auray strengthened England’s hold on western France and rendered regular seaborne contact with Aquitaine far more certain. This and the concurrent end of a conflict between France and Navarre over the duchy of Normandy also led to the release of thousands of fighting men who, in their unemployed state, now swelled the companies’ ranks. The fact that their depredations were not as extensive in English-held territory led many contemporaries to accuse England of sponsoring their activities.

²¹ Kenneth Fowler, *Medieval Mercenaries*, 1 vol. to date (Oxford, 2001), 24–43.

²² The classic treatment of the reign is R. Delachenal, *Histoire de Charles V*, 5 vols. (Paris 1909–1931).

²³ A valuable aid to understanding the Breton question is Michael Jones, *Ducal Brittany 1364–1399: Relations with England and France during the Reign of Duke John IV* (Oxford, 1970).

Although a few of the companies had begun to filter across the Alps into Italy where they took service as mercenaries,²⁴ the majority remained an ever-present threat to France, a threat that Charles V now addressed. When an attempt failed to ship them off to fight the Turks in southeastern Europe, the French monarch looked for a solution closer to home. In 1365, he joined with the king of Aragon, Pere III “the Ceremonious” (1336–1387) and Pope Urban V (1362–1370) to engage the companies for service in Spain. The following year, under the leadership of the newly-ransomed Breton warrior, Bertrand DuGuesclin, and an English knight, Hugh Calveley, they intervened in the War of the Two Pedros (1356–1366) currently being fought between Aragon and Castile. Here, they decisively shifted the military balance, overthrowing the pro-English monarch of Castile, Pedro I “the Cruel” (1350–1369),²⁵ and replacing him with his pro-French half-brother, Enrique II (1366–1367, 1369–1379).²⁶

In 1367, these events forced the Black Prince to launch his own campaign south of the Pyrenees, culminating in his third great victory at Nájera. On April 3, he crushed the Castilian army and its Franco-Breton allies, putting Enrique to flight and taking large numbers of prisoners, including DuGuesclin. However, despite its military success, Edward’s campaign ultimately turned into a costly fiasco when the restored English ally, Pedro, failed to pay his war debts, leaving the prince and many in his army to suffer and fall sick during the hot Castilian summer. Having returned to Aquitaine, Edward tried to recoup his expenses by collecting an extremely unpopular hearth tax (*fouage*) throughout England’s continental lands.²⁷ The disgruntled Gascon lords resisted, appealing their case to the king of France as the prince’s overlord. Despite the fact that such an appeal breached the treaty of

²⁴ For the companies’ malignant influence on Italy, see William Caferro, *Mercenary Companies and the Decline of Siena* (Baltimore, 1998); “Slaying the Hydra-headed Beast: Italy and the Companies of Adventure in the Fourteenth Century,” in *Crusaders, Condottieri, and Cannon: Medieval Warfare Around the Mediterranean*, ed. Donald J. Kagay and L. J. Andrew Villalon, (Leiden, 2002), 285–304.

²⁵ The best English account of this king’s reign was written by Clara Estow, *Pedro the Cruel, 1350–1369* (Leiden, 1995).

²⁶ For a recent treatment of the Iberian invasions, see L. J. Andrew Villalon, “Seeking Castles in Spain: Sir Hugh Calveley and the Free Companies’ Mid-Fourteenth Century Iberian Intervention,” in *Crusaders, Condottieri, and Cannon*, 305–28.

²⁷ For the “hearth tax” (*fouage, focagium*) in France, see John Bell Henneman, *Royal Taxation in Fourteenth Century France: The Development of War Financing 1322–1356* (Princeton, NJ, 1971), 4–5, 310.

Brétigny, Charles seized the opportunity to reassert sovereignty over the lost province by summoning Edward to Paris for trial. When the prince threatened to march on Paris instead, the French king declared him delinquent. In response, Edward III now resumed his claim to the French crown and, in 1369, the conflict once again erupted.

4. The Tide Turns for France (1369–1380): The next decade witnessed a complete reversal in the fortunes of war. The English renewed their strategy of launching grand *chevauchees*, one of which was conducted by the duke of Lancaster in 1372, another by his younger brother, the earl of Buckingham, in 1379. Although such expeditions devastated wide swaths of French territory, they were unable to provoke one of those set piece battles that during previous phases of the struggle had become the grave of French chivalry. Instead, Charles V, with the aid of his constable, DuGuesclin, and the latter's fellow Breton, Olivier de Clisson,²⁸ initiated a military strategy amounting to guerrilla warfare. The war now settled down into a succession of sieges and smaller engagements during which the French overran English-held strongholds and picked off out-numbered units. This new strategy maximized the French advantage in numbers while neutralizing tactical factors that had favored the English such as superior military cohesion and the greater firepower that resulted from use of the longbow.

As DuGuesclin and Clisson seized the military initiative, England lost her three greatest warriors. First to fall was John Chandos, long the right-hand man of the Black Prince, who met his end in 1369 during a minor skirmish on the bridge of Lussac. Several years thereafter, the prince, increasingly debilitated by the disease he had contracted at the time of the Spanish campaign, was forced to abandon active military service. Edward conducted his last campaign, the siege of Limoges in 1370, from a litter; the following year, he returned to England after turning over command to his considerably less talented brother, John of Gaunt, duke of Lancaster. Edward's condition continued to deteriorate and in 1376, he died, without having ever come to the throne. The prince's other leading captain, Jean de Grailly, captal de Buch, was captured in 1372, during fighting that led up to the French reoc-

²⁸ John Bell Henneman, *Olivier de Clisson and Political Society in France Under Charles V and Charles VI* (Philadelphia, 1996).

cupation of La Rochelle. Refused ransom or exchange by Charles V, he died five years later in a French prison.

The major military action of this period that cost England the capital's services centered around the port of La Rochelle. Here, in 1372, a fleet made up largely of ships supplied by Enrique II of Castile attacked an English squadron bringing to the continent the new seneschal of Poitou, the earl of Pembroke, as well as large sums to pay English troops. During the ensuing two-day battle, the people of La Rochelle refused to take part and the English suffered a severe defeat, in which the earl and many of the surviving nobles were taken prisoner and the troop payments were lost.

The battle of La Rochelle effectively ended England's three decades of naval superiority. Not long thereafter, the port was retaken by the French. Throughout this period, John of Montfort progressively lost his hold on the duchy of Brittany, due largely to his alliance with the English and the resulting opposition of many Bretons, including DuGuesclin and Clisson. At different moments, he was forced to take refuge in Flanders and even back across the channel in England. Despite being restored by the English in 1379, Montfort recognized how the wind was blowing and immediately entered into negotiations with the French. In 1380, following the death of his old enemy, Charles V, he signed a treaty with the new king, Charles VI (1380–1422), effectively changing sides and denying the English an important entry point to the continent.

By 1380, France had regained most of the lands lost by the treaties of Brétigny and Calais; England's remaining hold on the continent was reduced to the regions around Bordeaux in the south and Calais in the north.

5. The Long Hiatus (1380–1415): A critical turning point came in 1380 when the principal architects of French victory, Charles V and DuGuesclin, died within a few months of one another. Their removal from the scene robbed the French campaign of reconquest of its impetus and set the stage for a long hiatus in the war. Although no treaty was ever signed, there were a number of truces, the most important of which, negotiated in 1396, was supposed to suspend fighting for thirty years. In fact, signing a truce, however prolonged, did not bring a complete cessation of hostilities. During these years, maritime encounters between England and France, sometimes aided by its ally, Castile, continued in and around the English Channel and ports on

both sides of the narrow waterway continued to face the possibility of attack by their former enemy.²⁹

Throughout this long hiatus, the attention of both countries turned inward. During the 1380s, France and England experienced severe social unrest, traceable in large part to the hardships resulting from decades of warfare. In 1381, the Peasant's Revolt³⁰ rocked English society while at virtually the same time, the French experienced the uprising of the *Mallotins* in such cities as Paris and Rouen.

The long and inauspicious reign of Charles VI began in a brief minority, during which the young king fell under the control of his uncles. In 1392, only a few years after achieving his majority, Charles suffered his first bout of insanity (he would eventually become known as Charles the Mad),³¹ after which the rest of his reign fell victim to an often-violent competition for power among noble factions. The most spectacular quarrel pitted the king's younger brother, Louis d'Orléans, against their most powerful uncle, Philip the Bold of Burgundy. In 1407, matters reached a crisis when the new Burgundian duke, Philip's son, John the Fearless (1404–1419), arranged the assassination of his cousin, Louis. The murder plunged France into a bloody civil war between the Burgundian and Orléanist-Armagnac factions, in which the contestants divided on a number of key issues, including whether or not to resume the struggle with England.³² This in-fighting, that continued to paralyze France for decades, would also become a key factor in English success during the next phase of the conflict.

Meanwhile, across the channel, events also conspired to prevent any renewal of the conflict. The death of Edward III in 1377 had brought to the throne his eleven-year-old grandson, Richard, son and heir of

²⁹ For an example of the low-level hostilities that continued even during the truce, see Guitierre Diaz de Gamez, *The Unconquered Knight: A Chronicle of the Deeds of Don Pero Niño, Count of Buelna*, trans. Joan Evans (1928, reprint, Woodbridge, Suffolk, 2004). A complete Spanish version of the work is also available: Guitierre Diaz de Games, *El Victorial, Crónica de Don Pero Niño, Conde de Buelna por su alférez*, ed. Juan de Mata Carriazo (Madrid, 1940).

³⁰ For the Peasant's Revolt, see Rodney Hilton, *Bond Man Made Free: Medieval Peasant Movements and the English Rising of 1381* (New York, 1973); Phillipp R. Schofield, *Peasant and Community in Medieval England 1200–1500* (Houndmills, 2003), 164–65; E. B. Fryde, *Peasants and Landlords in Later Medieval England* (Stroud, 1996), 1–6.

³¹ For the madness of Charles VI, see J. Saltel, *La folie du roi Charles VI* (Toulouse, 1907); E. Dupré, "La Folie de Charles VI roi de France," *Revue de Deux Mondes* 60 (1910): 835–66.

³² Burgundy and Armagnac also differed on the Great Schism (1378–1417), the former maintaining neutrality while the latter announced for Avignon.

the Black Prince. Here, as in France, a royal minority provided an occasion for the king's uncles to seize control of the government. For the first half of his reign, Richard faced an on-going struggle against the aristocratic factions that dominated English policy, a struggle that left little time to consider events in France, even if he had been inclined to do so. In fact, Richard appears to have aligned himself with the peace party.

Over the years, the English people, who had once supported the war, became increasingly disillusioned with the never-ending expense that produced less and less military success. England's attitude toward the conflict would only be hardened by the country's two major continental adventures of the period, both of which ended in failure: the notorious Norwich Crusade of 1383 that led to a parliamentary inquest aimed at its leaders and the duke of Lancaster's putative attempt to exercise his wife's claim on the Castilian throne three years later.

England sacrificed its best opportunity to renew the war on favorable terms when it failed to support the latest popular uprising in Flanders. Early in the 1380s, Philip von Artevelde, son of England's former ally, Jacob, assumed leadership in Ghent and in April, 1382, smashed Count Louis de Male's army before the gates of Bruges. Afterwards, many of the Flemish towns joined van Artevelde who assumed the title "regent of Flanders."

Both sides appealed for outside help: the count turned to the French monarchy and his son-in-law, the duke of Burgundy, while van Artevelde tried to resuscitate the old Anglo-Flemish alliance. Unfortunately for the Gantois, the English hesitated to become involved while the French launched a full scale invasion of Flanders led by the king, the duke of Burgundy, and the new constable of France, Clisson. When the two sides met at the battle of Roosebeke in November, 1382, a large Flemish force was virtually annihilated and Artevelde killed. Thereafter, most of Flanders surrendered to the French. Even though Ghent for a time continued to resist, England had lost its best opportunity for a long time to come.

In 1399, Richard's conflict with the English barony ended in his deposition and subsequent murder, bringing to the throne the Lancastrian Dynasty in the person of Henry IV (1399–1413), whose principal interest was to hold onto the throne he had usurped. Not until the succession of his war-like son, Henry V (1413–1422) would England once again turn its attention to France and put an end to the long hiatus in fighting with a spectacular victory.

6. Another English Floodtide (1415–1429): The second period of English victory began in 1415, when Henry V, the third royal to prove himself a great general (all were English), landed in France with the intention of resurrecting his dynasty's claim to the throne. He would be greatly aided in this endeavor by the enduring Armagnac-Burgundian split. Having besieged and captured the Norman port of Harfleur, his army marched toward Calais. On October 25, it smashed a vastly superior French force at Agincourt, producing yet another English victory to rival those of Edward III and the Black Prince.³³ Three years later, the king, having allied himself loosely with the Burgundian faction, conquered Normandy.³⁴ At about the same time, his ally, John the Fearless occupied Paris. Members of the Armagnac faction who escaped the slaughter that followed escaped south of the Loire River with the dauphin, the future Charles VII (1422–1461), where they established a shaky government.

Despite his English connection, the duke of Burgundy now began negotiations to end the civil war and form a united front against England. All possibilities of such an alliance ended for a time when, on September 10, 1419, during what was supposed to be a peace conference on the bridge of Montereau, an axe-wielding Armagnac supporter in the royal entourage murdered Duke John.³⁵ The dead man's son and successor, Philip the Good (1419–1467) immediately strengthened his ties with England and, in 1420, helped force on the French crown the humiliating treaty of Troyes. The second major treaty of the war proved even harsher than that of Brétigny six decades earlier. Setting aside the Valois dauphin, it established the English king as heir apparent to the French throne. To cement this agreement, Henry V now married Charles VI's daughter, Catherine, and quickly produced a successor to both realms, the future Henry VI (1422–1461, 1471).³⁶

In 1422, Charles VI died. Unfortunately for the English, the near simultaneous death of Henry V threw the whole issue back into question. Once again, France became a divided realm ruled by competing

³³ Christopher Hibbert, *Agincourt* (New York, 1978); Philippe Contamine, *Agincourt* (Paris, 1964); Nicholas H. Nicolas, *History of the Battle of Agincourt and of the Expedition of Henry the Fifth into France in 1415* (1833; reprint, London, 1971); Christopher Phillpotts, "The French Plan of battle during the Agincourt Campaign," *English Historical Review* 99 (1990): 59–66.

³⁴ Desmond Seward, *Henry V as Warlord* (London, 1987), 111–43.

³⁵ Lewis, *Later Medieval France*, 40–41.

³⁶ Seward, *Henry V*, 143–46; Cuttino, *English Medieval Diplomacy*, 19–24.

monarchs: In the north, the English duke of Bedford, with support from the house of Burgundy, governed in the name of his nephew, Henry VI; in the south, the Armagnac faction acknowledged Charles VII as king, even though he had neither been crowned nor consecrated at Rheims, the coronation site of medieval French kings. Cowering in his chateaux of Chinon and Bourges, the young monarch cut such a poor figure that he was nicknamed by friend and foe alike, “the king of Bourges.”

During the 1420s, Bedford continued to build on Henry V’s success. Defeating the French at the battle of Verneuil in 1424, he extended his control farther into central France and by 1429, he was besieging Orléans, preparatory to attacking the Armagnac holdings south of the Loire. Despite appearances, however, the English presence, poorly supported by the faction-ridden government surrounding the young king, was sustained less by real military force than by the inaction of Charles VII, the myth of English invincibility born of past victories, and the continuing support of the house of Burgundy.

7. Another French Resurgence (1429–1435): The critical turning point in the Hundred Years War came with what many regarded (and many still regard) as a miracle: in spring, 1429, an uneducated, seventeen year old peasant girl from Domrémy, named Joan of Arc, appeared at Chinon, headquarters of the erstwhile dauphin. Inspired by her “voices” whom she identified as Saints Catherine, Marguerite, and Michael, Joan claimed that it was her mission to conduct the dauphin to his coronation at Rheims and to free France from the English.

Having convinced the indolent monarch, she was sent to join a French army gathering for the relief of Orléans. The inspiration provided by her presence paid enormous dividends. Early in May, 1429, Joan participated prominently in the French victory that broke the English siege. A month later, she was present during another French triumph at Patay. And, in July, she led Charles on a triumphant procession through northern France that resulted in his belated coronation at Rheims.³⁷

For Joan, the coronation at Rheims proved to be the highpoint in a meteoric career. During September, 1429, without adequate support

³⁷ Marina Warner, *Joan of Arc, The Image of Female Heroism* (New York, 1981); Kelly DeVries, *Joan of Arc: A Military Leader* (Stroud, 1999). The proceedings of Joan’s trial are available in English; see: *The Trial of Joan of Arc, being the verbatim report of the proceedings from the Orleans Manuscript*, trans. W. S. Scott (Westport, Conn., 1956).

from her king, she failed to retake Paris. In May, 1430, while trying to break the siege of Compiègne, she was captured by the Burgundians who sold her to the English. Tried before an ecclesiastical court dominated by the English, Joan was found guilty of heresy and witchcraft and on May 30, 1431, she was burnt at the stake in the town square at Rouen. Despite her later failures, the Maid of Orléan supplied France with the inspiration that would ultimately lead to English defeat and, six centuries later, to her own canonization.³⁸

In 1435, the rise of French military fortunes initiated by Joan reached another important milestone at the Congress of Arras, called to explore the possibility of a peace treaty. Despite Burgundian warnings that the duchy intended to reach a peace with France, the English ambassadors arrogantly withdrew from the negotiations when their extravagant demands were not met. This left France and Burgundy free to sign a treaty that ceded extensive territories to the Burgundian duke in return for a guarantee that he would switch sides and aid Charles VII against the English. During the six years between 1429 and 1435, England lost both the initiative and its principal ally.

8. Final French Victory (1435–1453): While the events of the preceding period set the stage for a final decision, they did not bear full fruit until nearly two decades later. Although Charles VII recovered Paris in 1436, the troubles besetting his kingdom continued. In 1439, the Burgundians made a separate peace with England, effectively withdrawing from the war entirely in order to pursue their territorial ambitions in the Low Countries. In 1440, the new dauphin, the future Louis XI (1461–1483), organized a revolt (*la Praguerie*) against his father. Meanwhile, the “free company” scourge of the preceding century enjoyed a resurgence in the so-called *écorcheurs*, bands of out-of-work soldiers who lived up to their name by “flaying” whole regions of France.

In 1439, in the midst of these woes, the Estates General once again stepped into the breach, passing laws that afforded the crown a monopoly on military recruitment and training and that provided a direct tax known as the *taille* to support a new royal army. In 1445, the

³⁸ The sentence against Joan was reversed by the Nullification Trial of 1457. In 1909, Pius X beatified her and in 1920, during the pontificate of Benedict XV, Joan became Saint Joan. Thompson and Johnson (incorrectly) give the canonization date as 1919. Donald Attwater, *Avenel Dictionary of Saints* (New York, 1979), 187. Thompson and Johnson, *Medieval Europe*, 892.

much-needed military reforms reduced the private companies that were troubling the peace, merging many of them into the crown's newly-established cavalry force, the so-called *compagnies d'ordonnance*. Provision was also made for recruiting a native infantry, the "free archers" (*franc archiers*), whose name derived from the fact that as part of the condition for their service, they were freed from paying the *taille*. Perhaps the most significant reform involved a massive increase in the reliance on gunpowder weaponry that converted the French artillery into the finest in Europe.

In 1449, backed by a rejuvenated military establishment and employing the financial talents of men like Jacques Coeur,³⁹ Charles VII was now able to begin the final round of the conflict. Within a year, the French had won the battle of Formigny and driven the English from Normandy. Without pause, their army marched into Aquitaine, the longest-held and now last-remaining English stronghold in southern France. In 1450–51, the cities of Bayonne and Bordeaux were taken.

England's last gasp came when the neighboring region of Gascony, always troublesome to whomever held it, revolted against French control and called on the English for help. The government of Henry VI dispatched a force led by the last great veteran of Agincourt, John Talbot, earl of Shrewsbury. On July 17, 1453, Talbot and his Gascon allies were crushed at the battle of Castillon (Chatillon),⁴⁰ by a superior French army and its formidable artillery. Within several months, France had reclaimed the rebellious provinces and the Hundred Years War, for all intents and purposes, came to an end.

³⁹ Kathryn L. Reyerson, *Jacques Coeur: Entrepreneur and King's Bursar* (New York, 2005).

⁴⁰ Alfred H. Burne, "The Battle of Castillon, 1453," *History Today* 3 (1953), *History Today* 3 (1953): 249–56.

The Succession in 1328

Philip III, 1285

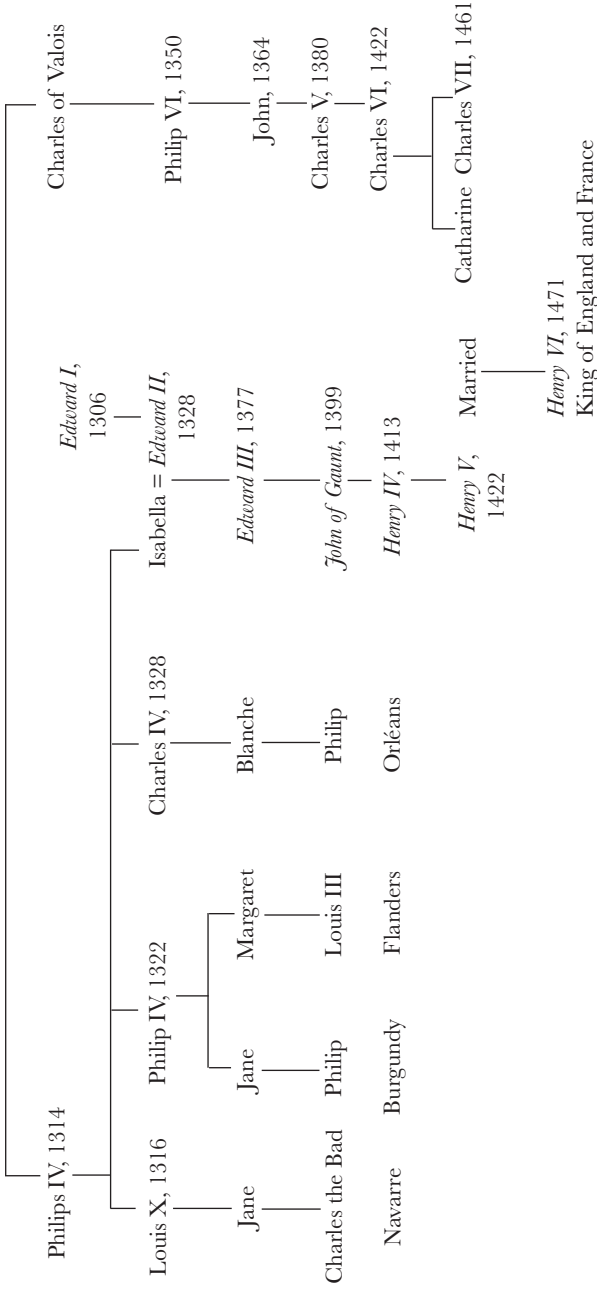

The dates, years of death, French kings, in black type. Descendants of Edward I, in italics.

Genealogy I

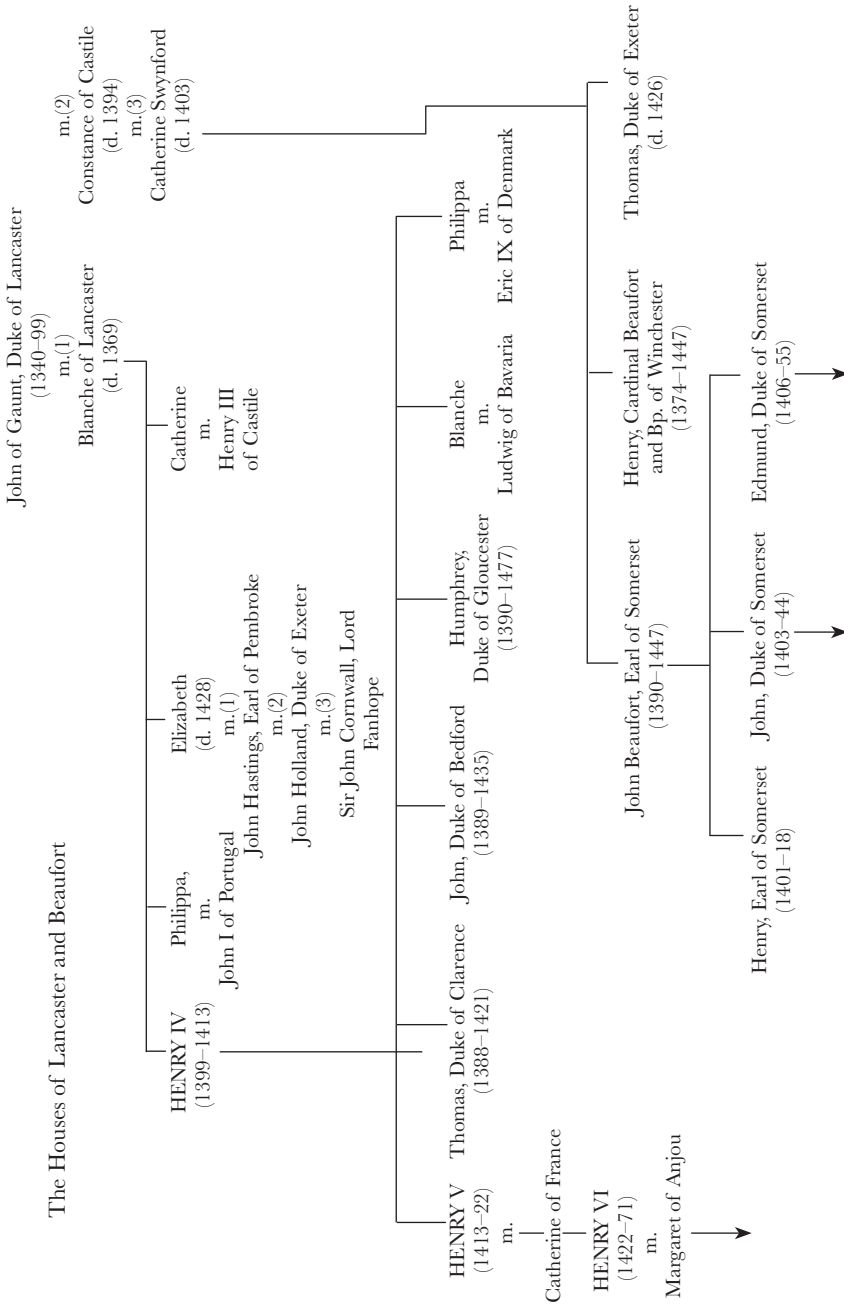

Genealogy 2

France, Burgundy, and Naples

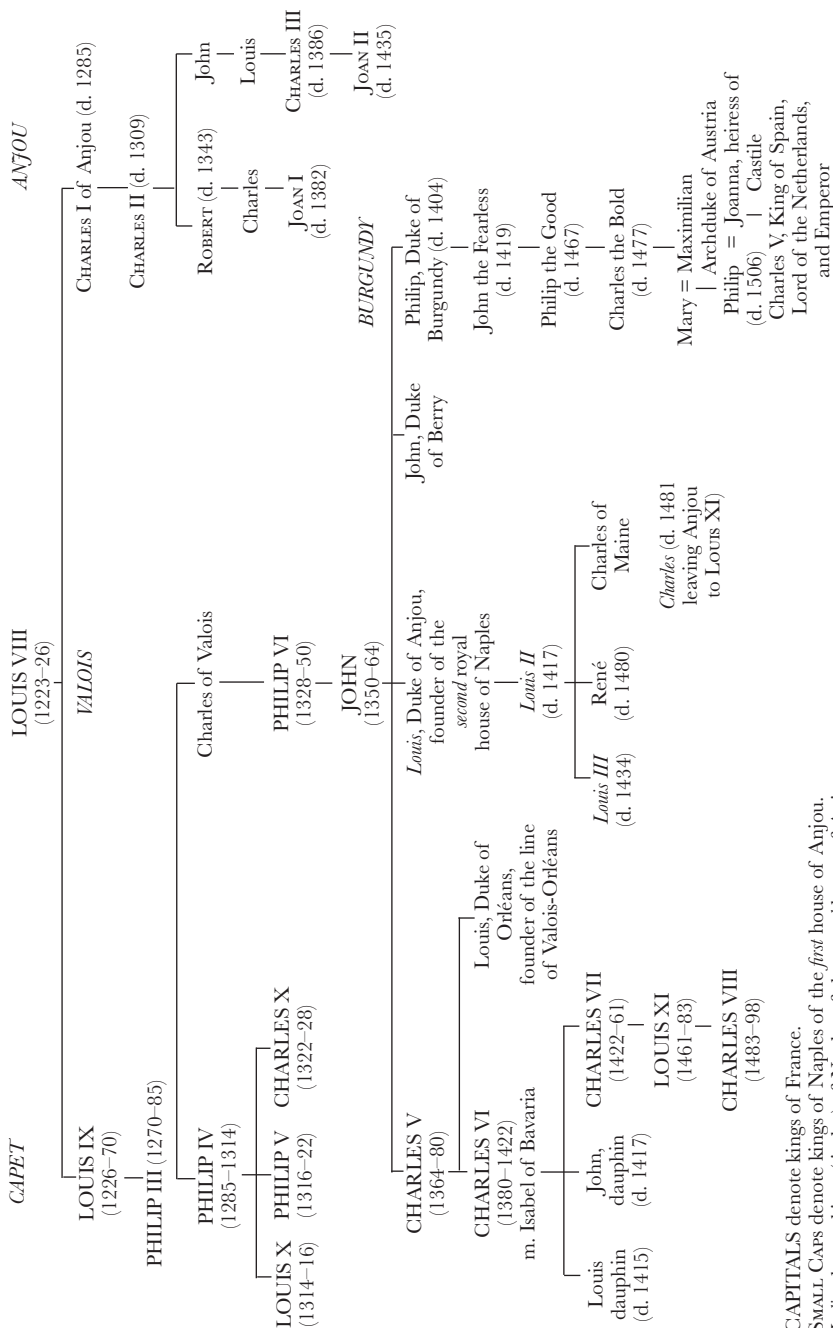

CAPITALS denote kings of France.

SMALL CAPS denote kings of Naples of the *first* house of Anjou.*Italics* denote kings (titular) of Naples of the *second* house of Anjou.

APPENDIX TWO: GENEALOGIES

- I. Medieval and Renaissance Popes
- II. Kings of England
- III. Kings of Scotland
- IV. Kings of France
- V. French Noble Houses
 - a. Anjou
 - b. Brittany
 - c. Burgundy
 - d. Foix
- VI. Low Countries
 - a. Brabant
 - b. Flanders
 - c. Guelders
 - d. Hainault
 - e. Holland
 - f. Jülich-Hengebach
- VII. Holy Roman Emperors
- VIII. Duchy of Milan
- IX. German Noble Houses
 - a. Hapsburg
 - b. Luxemburg
- X. Spanish Christian Rulers
 - a. Castile
 - b. Crown of Aragon
 - c. Navarre
 - d. Portugal
- XI. Muslim Rulers
 - a. Granada
 - b. Ottoman Turks
- XII. Byzantium

*Popes***Anti-popes*

Nicholas IV (1288–1292)
 Celestine V (1294)
 Boniface VIII (1294–1303)
 Benedict XI (1303–1304)

Avignon Papacy (1305–1378)

Clement V (1305–1314)
 John XXII (1316–1334)
 Nicholas V (1328–1330)*
 Benedict XII (1334–1342)
 Clement VI (1342–1357)
 Innocent VI (1352–1362)
 Urban V (1362–1370)
 Gregory XI (1370–1378)

Great Western Schism (1378–1417)

Urban VI (1378–1389) [Rome]
 Clement VII (1378–1394) [Avignon]
 Boniface IX (1389–1404) [Rome]
 Benedict XIII (1394–1424) [Avignon]
 Innocent VII (1404–1406) [Rome]
 Gregory XII (1406–1417) [Rome]

Council of Pisa (1409)

Alexander V (1409–1410) [Rome]
 John XXIII (1410–1415)*

Council of Constance (1414–1418)

Martin V (1417–1431)
 Clement VIII (1424–1429)*
 Benedict XIV (1424)*
 Eugene IV (1431–1447)
 Felix V (1439–1449)
 Nicholas V (1447–1455)

*European Rulers and Nobility**Kings of England*

Plantagenet Dynasty

Edward I (1272–1307)

Edward II (1307–1327)

Isabelle (1327–1330) [Regent for Edward III]

Roger Mortimer (1327–1330) [Regent for Edward III]

Edward III (1327–1377)

Richard II (1377–1399)

Lancaster Dynasty

Henry IV (1399–1413)

Henry V (1413–1422)

Henry VI (1422–1461)

York Dynasty

Edward IV (1461–1483)

Edward V (1483)

Richard III (1483–1485)

Kings of Scotland

William “the Lion” (1165–1214)

Alexander II (1214–1249)

Alexander III (1249–1286)

Margaret (1286–1290)

John Baliol (1292–1296)

Interregnum (1296–1306)

Robert I “the Bruce” (1306–1329)

David II (1329–1371)

Stuart Dynasty

Robert II Stuart (1371–1390)

Robert III (1390–1424)

James I (1424–1437)

James II (1437–1460)

James III (1460–1488)

Kings of France

Capetian Dynasty

- Philip IV (1285–1314)
- Louis X (1314–1316)
- Philip V (1316–1322)
- Charles IV (1322–1328)

Valois Dynasty

- Philip VI (1328–1350)
- John II (1350–1364)
- Charles V (1364–1380)
- Charles VI (1380–1422)
- Charles VII (1422–1461)
- Louis XI (1461–1483)
- Charles VIII (1483–1498)
- Louis XII (1498–1515)

French Noble Houses

Anjou

- Charles I (1266–1285)
- Charles II (1285–1309)
- Robert II (1309–1343)
- Joanna I (1342–1382)
- Charles III (1382–1386)
- Ladislas (1386–1414)

Brittany

- Arthur II (1305–1312)
- John III “the Good” (1312–1341)

War of Breton Succession (1341–1364)

- John IV (1341–1345)
- Charles of Blois (1341–1364)
- John V (1364–1399)
- John VI (1399–1442)
- Francis I (1442–1450)
- Peter II (1450–1457)
- Arthur III (1457–1458)

Francis II (1458–1488)
 Anne (1488–1514) *Marries Charles VIII of France*

Burgundy

Eudes IV (1315–1349)
 Philip I of Rouvre (1349–1361)

Valois Dukes

Philip “the Bold” (1364–1404)
 John “the Fearless” (1404–1419)
 Philip “the Good” (1419–1467)
 Charles “the Bold” (1467–1477)

Foix

Gaston I (1302–1315)
 Gaston II (1315–1343)
 Gaston III “Phoebus” (1343–1391)
 Matthew (1391–1398)
 Archimbald (1398–1423)
 John (1413–1436)
 Gaston IV (1413–1472)

Low Countries

Brabant

Henry II (1235–1248)
 Henry III (1248–1261)
 Henry IV (1261–1267)
 John I (1267–1294)
 John II (1294–1312)
 John III (1312–1355)
 Joanna (1355–1404)

Flanders

Guy de Dampierre (1278–1304)
 Robert of Béthune (1305–1322)
 John (1304–1331)
 Louis I (1322–1346)
 Louis II de Male (1346–1384) *succeeded by the Valois duke of Burgundy,
 Philip the Bold*

Guelders

House of Wassenberg

- Otto II (1229–1271)
- Reinoud I (1271–1318)
- Reinoud II (1318–1343)
- Reinoud III (1343–1361)
- Edward (1361–1371)
- Reinoud III (1371)

House of Jülich-Hengebach

- William I (1371–1402)
- Reinoud IV (1402–1423)

Hainault

- John I (1246–1257)
- John II (1257–1304)
- William III (1304–1337)
- William IV (1337–1345)
- William V (1356–1389)
- Albert (1389–1404)
- William VI (1404–1417)

Holland

- Floris IV (1222–1234)
- William II (1234–1256)
- Floris V (1256–1296)
- John I (1296–1299)
- John II (1300–1304)
- William III (1304–1337)
- William IV (1337–1345)
- Margaret (1345–1356)
- William V (1356–1389)
- Albert (1389–1404)
- William VI (1404–1417)

Holy Roman Emperors

Non-Dynastic

- Richard of Cornwall (1257–1262)

Alfonso X of Castile (1257–1284)
 Rudolf I of Hapsburg (1273–1291)
 Adolf of Nassau (1292–1298)
 Albert I of Habsburg (1298–1308)
 Henry VII of Luxemburg (1308–1313)
 Louis IV Wittelsbach (1314–1347)
 Frederick of Habsburg (1325–1330)
 Charles IV of Luxemburg (1347–1378)
 Günther of Schwarzburg (1347–1349)
 Wenzel of Luxemburg (1378–1400)
 Rupert of the Palatinate (1400–1410)
 Sigismund of Luxemburg (1410–1437)
 Jobst of Moravia (1410–1411)

Hapsburg Domination

Albert II (1438–1439)
 Frederick III (1440–1493)
 Maximilian I (1493–1513)

Duchy of Milan

Visconti Dukes

Gian Galeazzo Visconti (1395–1402)
 Gian Maria Visconti (1402–1412)
 Filippo Maria Visconti (1412–1447)

Ambrosian Republic (1447–1450)

Sforza Dukes

Francesco I Sforza (1450–1466)
 Galeazzo Maria Sforza (1466–1476)
 Gian Galeazzo Sforza (1476–1494)
 Lodovico Sforza (1494–1499/1500)
 King Louis XII of France (1499/1500–1512)
 Massimiliano Sforza (1512–1515)
 King Francis I of France (1515–1521)
 Francesco II Sforza (1521–1535)

Milan falls under Spanish rule

German Noble Houses

Hapsburg

- Rudolf I (1273–1291)
- Albert I (1308–1309)
- Frederick I (1325–1330)
- Albert II (1330–1358)
- Albert III (1358–1395)
- Albert IV (1397–1404)
- Albert V (1404–1439)
- Ladislas (1440–1459)

Luxemburg

- Henry VII (1308–1313)
- John of Bohemia (1310–1346)
- Charles IV (1346–1378)
- Wenceslas of Bohemia (1378–1400)
- Sigismund (1410–1437)

*Spanish Rulers**Castile*

- Alfonso X (1252–1284)
- Sancho IV (1284–1296)
- Fernando IV (1296–1312)
- Alfonso XI (1312–1350)
- Pedro I (1350–1366/69)
- Enrique II (1313–66/69–1379)
- Juan I (1379–1390)
- Enrique III (1390–1406)
- Juan II (1406–1454)
- Enrique IV (1454–1474)
- Isabella I (1474–1504) *married to Fernando II of Aragon*

Crown of Aragon

House of Barcelona

- Alfonso II [Alfons I] (1163–1196)
- Pedro II [Pere I] (1196–1213)

Jaime I [Jaume I] (1213–1276)
 Pedro III [Pere II] (1276–1285)
 Alfonso III [Alfons II] (1285–1291)
 Jaime II [Jaume II] (1291–1327)
 Alfonso IV [Alfons III] (1327–1336)
 Pedro IV [Pere III] (1336–1387)
 Juan I [Joan I] (1387–1395)
 Martín I [Martí I] (1395–1410)

Interregnum (1410–1412)

Trastámara Dynasty

Fernando I [Ferran I] (1412–1416)
 Alfonso V [Alfons IV] (1416–1458)
 Juan II [Joan II] (1458–1479)
 Fernando II [Ferran II] (1479–1516) *married to Isabella I*

Navarre

Charles I “the Bad” (1322–1328)
 Joanna II (1328–1349) *married to Philip of Evereux*
 Charles II (1349–1387)
 Charles III (1387–1425)
 Blanca (1425–1441) *married to Juan II of Aragon*
 Carlos of Viana (1421–1461) *regent in Navarre (1441–1451)*
Civil War (1451–1461)
 Blanca (1461–1464)
 Leonor (1464–1479) *marries Count Gaston IV of Foix*
 Francisco I (1479–1483)
 Catalina (1483–1512) *marries Jean d’Albret*

Portugal

Burgundian House

Afonso III (1245–1279)
 Dinis (1279–1325)
 Afonso IV (1325–1357)
 Pedro I (1357–1367)
 Fernando I (1367–1383)

Contest for Portuguese Throne (1383–1385)

Avis Dynasty

Juan I (1385–1433)

Eduardo I (1433–1438)

Afonso V (1438–1481)

Juan II (1481–1495)

Emanuel I (1495–1521)

*Muslim Rulers**Naşrid Dynasty of Granada*

Muḥammad I (1232–1273)

Muḥammad II (1273–1302)

Muḥammad III (1302–1309)

Naşr (1309–1314)

Ismāʿīl I (1314–25)

Muḥammad IV (1325–1333)

Yūsuf I (1333–1354)

Muḥammad V (1354–1359; 1362–1391)

Ismāʿīl II (1359–1360)

Muḥammad VI (1360–1362)

Yūsuf II (1391–1392)

Muḥammad VII (1392–1408)

Yūsuf III (1408–1417)

Muḥammad VIII (1417–1419; 1427–1429)

Muḥammad IX (1419–1427; 1429–1445; 1447–1453)

Yūsuf IV (1430–1432)

Muḥammad X (1445–1448)

Muḥammad XI (1448–1454)

Yūsuf V (1445, 1450, 1462–1463)

Saʿīd (1454–1464)

Abu'l-Ḥasan 'Alī (1464–1485)

Muḥammad XII (1482–1492)

Muḥammad XIII (1485–1487)

Ottoman Turks

- ‘Oşman I (1290–1326)
- Orkhân I (1326–1359)
- Murâd I (1359–1389)
- Bâyezîd I (1389–1402)
- Mehmed I (1402–1421)
- Murâd II (1421–1451)
- Mehmed II “the Conqueror” (1451–1481)

*Byzantine Rulers**Paleologi*

- Michael VIII (1260–1282)
- Andronicus II (1282–1328)
- Michael IX (1295–1320)
- Andronicus III (1328–1341)
- John V (1341–1391)
- John VI (1347–1354)
- Andronicus IV (1376–1379)
- John VII (1390)
- Manuel II (1391–1425)
- John VIII (1425–1448)
- Constantine XIII (1448–1453)

APPENDIX THREE: BATTLES, CAMPAIGNS, TREATIES

- 1337 Jacob Van Artevelde's Uprising in Ghent and other cities
- 1339 First English Campaign: Invasion of France from the Netherlands (Autumn)
- 1340 Sluys (June 24) (naval engagement)
Siege of Tournai (July–September)
Hennebont (naval engagement)
- 1345 English invasion of Gascony (Summer)
Bergerac (August)
Auberoche (October 21)
- 1346 Edward III's *chevauchée* through Normandy (Summer)
Crécy (August 26)
Vottem (July 18)
Cortay (naval engagement)
Neville's Cross (October 17)
- 1346–1347 Siege of Calais (August–August)
- 1347 Aiguillon (May)
Le Crotoye (naval engagement) (August 24)
- 1350 Winchelsea (naval engagement) (August 29)
- 1355 *Chevauchée* of the Black Prince through Armagnac and Languedoc (October–December)
- 1356 Poitiers (Maupertuis) (September 19)
- 1357 Cadsand (November 10)
- 1359 Edward III's unsuccessful *chevauchée* through northern France (November, 1359–April, 1360)

- 1360 **TREATY OF BRÉTIGNY (May)**
TREATY OF CALAIS (October)
- 1361 Brignais (April 6)
- 1364 Cocherel (May)
Auray (September 27)
- 1366 Free Company invasion of Castile (Winter-Spring)
Montauban (August 14)
- 1367 Black Prince's invasion of Castile (Winter-Spring)
Nájera (Navarette) (April 3)
- 1369 Montiel (March 13)
French attack on the Isle of Wight (naval engagement)
Burning of Portsmouth (naval engagement)
Lussac
- 1370 Siege and sack of Limoges (September)
Pont Valain (October 2)
- 1372 La Rochelle (June 22) (naval engagement)
Guernsey (naval engagement)
Duke of Lancaster's *chevauchée*
Chizai (July)
- 1379 Earl of Buckingham's *chevauchée*
- 1382 Beverhoutsveld (May 3)
Siege of Oudenaarde (November)
Roosebeke (Rosbecque; Westrozebeke) (November 27)
- 1385 Aljubarrota (August 14)
- 1387 Margate (March 24) (naval engagement)
- 1402 Homildon Hill (September)

- 1408 Othée (September 23)
- 1415 Siege of Harfleur (Autumn)
Agincourt (October 25)
- 1416 Seine Mouth (August 15) (naval engagement)
- 1418 Siege of Rouen (surrendered January 19)
- 1420 **TREATY OF TROYES (May)**
- 1421 Beaugé (March 22)
- 1423 Cravant (July 31)
- 1424 Verneuil (August 17)
- 1428–1429 Siege of Orléans (October–May)
- 1429 Herrings (Rouvray) (February 12)
Orléans (May 6–7)
Patay (June 18)
Siege of Paris (August)
- 1430 Siege of Compiègne (May)
- 1436 French retake Paris (April 13)
- 1450 Formigny (April 25)
Blancfort (November 1)
- 1453 Castillon (July 17)

BIBLIOGRAPHY

Primary Sources

- Ascham, Roger. *Toxophilus, The Schole of Shootinghe*. 1545. Reprint. New York, 1969.
- Baker, Geoffrey. *Galfridi Le Baker de Swinbroke, Chronicon Angliae Temporibus Edwardi II et Edwardi III*. Edited by J. A. Giles. Publication of the Caxton Society, 7. 1847. Reprint. New York, 1967.
- Basin, Thomas. *Histoire de Charles VII*. Edited by C. Samaran and H. De Saint-Rémy. 2 vols. Paris, 1933–1944.
- “La Bataille de trente Anglois et de trente Bretons.” Edited by H. R. Brush. *Modern Philology* 9 (1911–2): 511–44; 10 (1912–3): 82–136.
- The Battle of Agincourt: Sources and Interpretations* [CS]. Edited by Anne Curry Wodbridge, Suffolk, 2000.
- Berry Herald. *Le Chroniques du roi Charles VII*. In *CS*. 178–82.
- The Black Book of the Admiralty*. Edited by T. Twiss. London, 1871.
- Böhmer, J. H. *Regesta Imperii; Die Regeste des Kaiserreichs unter Kaiser Karl IV, 1346–1378*. Innsbruck. Reprint. Hildesheim, 1968.
- Bouvet, Honoré. *The Tree of Battles of Honoré Bonet*. Translated by G. Coopland. Liverpool, 1949.
- The Bruce*. Edited by W. W. Skeat. London, 1889.
- The Brut*. In *CS*. 89–96.
- Calendar of Entries in the Papal Registers Relating to Great Britain and Ireland*, vol. 2: *A.D. 1305–1342*. Edited by W. H. Bliss. London, 1895.
- Calendar of Inquisitions Miscellani. Henry III–Henry V*, Public Record Office. 7 vols. London, 1916–1968.
- Calendar of Inquisitions Post Mortem and other Analogous Documents Preserved in the Public Record Office*, Public Record Office. 20 vols. London, 1904–1970.
- Calendar of Patent Rolls*. 27 vols. London, 1894–1916.
- Calendar of Patent Rolls, Edward III: 1334–1338*. 1893. Reprint. Leichtenstein, 1972.
- Cerquiglini, Jacqueline. *Cent ballades d’amant et de dame par Christine de Pizan*. Paris, 1982.
- Chandos Herald. *Vie du Prince Noir*. Edited by Diana Tyson. Tübingen, 1975.
- La Chanson de Bertrand du Guesclin de Cuvelier*. Edited by Jean-Claude Faucon. Toulouse, 1990–1993.
- Chartier, Alain. *Le Quadrilogue Invectif*. Edited by E. Droz. Paris, 1923.
- Chartier, Jean. *Chroniques de Charles VII, roi de France*. Edited by A. Vallet de Viriville. 3 vols. Paris, 1858.
- Chartularium Universitatis Parisiensis*. Edited by H. Denifle and E. Chatelain. 4 vols. Paris, 1889–1897.
- Chastellain, Georges. *Chroniques*. In *Oeuvres*. Edited by Kervyn de Lettenhove. 7 vols. 1863–1866; reprint Geneva, 1971.
- Chaucer’s Life Records*. Edited by Martin M. Crow and Clair C. Olson. Oxford, 1966.
- . *Chroniques: les fragments du Livre IV révélés par l’additional manuscript 54146 de la British Library*. Edited by Jean-Claude Delclos. Geneva, 1991.
- Chronicon de Lanercost, MCCI–MCCCXLVI*. Edited by J. Stevenson. Edinburgh, 1839.
- Chronique anonyme du règne de Charles VI*. In *CS*. 114–6.
- Chronique de Jean le Bel*. Edited by Jules Viard and Eugène Déprez. 2 vols. Paris, 1906.
- Chronique de Jean le Fevre, Seigneur de Saint-Remy*. Edited by F. Morand. 2 vols. Paris, 1876–1881.

- Chronique de la Pucelle ou Chronique de Cousinot*. Edited by A. Vallet de Viriville. Geneva, 1976.
- Chronique de Ruisseauville*. In *CS*. 122–27.
- La Chronique d'Enguerran de Monstrelet*. Edited by L. Douet-D'Arçq. 6 vols. Paris, 1859.
- Chronique de Arthur de Richemont*. In *CS*, 182–84.
- Chronique de Perceval de Cagny*. Edited by H. Moranville. Paris, 1902.
- Chronique des quatre premier Valois (1327–1393)*. Edited by Simeon Luce. 1862. Reprint. New York, N.d.
- Chronique du Religieux de Saint-Denys contenant le règne de Charles VI de 1380 à 1422*. Edited and translated by M. Bellaguet. Introduction by Bernard Guenée. 6 vols in 3. Paris, 1994.
- Chronique normande de Pierre Cochon*. Edited by C. de Robillard de Beurepaire. Rouen, 1870.
- Chronique parisienne anonyme de 1316 à 1339*. Edited by A. Hellot, *Mémoires de la Société de l'Histoire de Paris et de l'Île de France*, 11. Paris, 1885.
- Colección de documentos inéditos del archivo general de la corona de Aragón*, Edited by Próspero Bofarull y Moscaró. 41 vols. Barcelona, 1847–1910.
- Colección de las cortes de los antiguos de Aragón y de Valencia y del principado de Cataluña*. Edited by Fidel Fita and Bienvenido Oliver, 27 vols. Madrid, 1896–1922.
- Crónica del Rey Don Alfonso el Onceno*. In *CRC* 2, BAE 66. Edited by E. Llaguno y Amírola. Madrid, 1953.
- La Cronica Domestica di Messer Donato Velluti*. Edited by Isidoro del Lungo and Guglielmo Volpi. Florence, 1914.
- Crónica del Rey Don Alfonso el Onceno*. In *CRC*, 2, BAE, 66. Edited by E. Llaguno y Amírola. Madrid, 1953.
- Croniques de London depuis l'an 44 Hen. III jusqu'à l'an 17 Edw. III*. Edited by George James Aungier, Camden Society 1844. Reprint. New York, 1968.
- D'Escoucy, Mathieu. "Chroniques." In *Collection des chroniques nationales françaises*. Edited by J. A. C. Bouchon. 9 vols. Paris, 1828. 1:164–205.
- Diaz de Gamez, Gutierre. *The Unconquered Knight. A Chronicle of the Deeds of Don Pero Nino, Count of Buelna*. Translated by Joan Evans. New York, 1928.
- Digges, Leonard and Thomas. *An Arithmetical Warlike Treatise Named Stratiticos*. London, 1579.
- Documenta selecta mutuas Arago-Cathalaunicae et ecclesiae relationes illustrantia*, ed. Joannes Vincke. (Barcelona, 1936).
- Documentos acerca de la peste negra en los dominios de la Corona de Aragon*. Edited by Amada López de Meneses. Zaragoza, 1956.
- Documentos de Pedro I*. Edited by Angel Luis Molina Molina. Murcia, 1978.
- Documents Historichs Catalans del segle XIV: Colecció de cartas familiars corresponents als regnats de Pere de Punyalet y Johan I*. Edited by Josep Coroleu. Barcelona, 1889.
- Dynter, Edmon de. *Chronique des ducs de Brabant*. In *CS*. 171–74.
- . *Chronique des ducs de Brabant par Edmond de Dynter*. Edited by P. D. X. De Ram. 6 vols. Brussels, 1854–1860.
- Ecrits politiques de Jean Juvenal des Ursins*. Edited by P. Lewis, 2 vols. Paris, 1978–1985.
- Elmham, Thomas. *Liber Metricus de Henrico Quinto*. London, 1858.
- . *Liber Metricus de Henrico Quinto*. In *CS* 40–48.
- England in the Later Middle Ages*. Edited by Derek Baker, 1968. Reprint. Cambridge, 1993.
- English Historical Documents 1327–1485*. Edited by A. R. Myers. London, 1969.
- Les Enseignements de Théodore Paléologue*. Edited by C. Knowles. London, 1983.
- The Epistle of the Prison of Human Life*. Edited by Josette A. Wisman. New York, 1984.
- Epistolari de Pere III*. Edited by Ramon Gubern, 1 vol. to date. Barcelona, 1955.
- Escouchy, Mathieu d'. *Chronique*. Edited by G. Du Fresne de Beaucourt. 3 vols. Paris, 1863–1864.

- Fabyan, Robert. *The New Chronicles of England and France*. Edited by Henry Ellis. London, 1811.
- FitzNigel, Richard. *Dialogue of the Exchequer*. Edited by Charles Johnson. Edinburgh, 1950.
- Florence of Worcester. *Chronicon*. Edited by B. Thorpe, 2 vols. London, 1848–1849. *Foedera, conventiones, litterae et cuiuscumque generis. Acta publica inter reges Angliae et alios quosvis imperatores, reges, pontifices, principes, vel communitates*. Edited by Thomas Rymer. 6 vols. London, 1816–1869.
- French Chronicle of London*. Edited by G. J. Aungier, *Camden Series*, 28. London, 1844.
- Froissart, Jean. *Oeuvres*. Edited by Kervyn de Lettenhove. 25 vols. Brussels, 1867–1877; Edited by S. Luce et al. 15 vols. to date. Paris, 1869–1975; *Chroniques: Dernière redaction du premier livre. Edition du manuscrit de Rome Reg. lat., 869*. Edited by George T. Ollier. Geneva, 1972; *Chroniques: Livre I. Le manuscrit d'Amiens. Bibliothèque municipale n-A 486*. Edited by George T. Dillier. 5 vols. Geneva, 1991–1998; Translated by Thomas Johnes as *Chronicles of England, France, and Spain and the Adjoining Countries from the Latter Part of the Reign of Edward II to the Coronation of Henry IV*. 2 vols. London, 1857; *Chronicles*, Translated by Geoffrey Brereton. Harmondsworth, 1968.
- Frontinus. *The Strategems and The Aqueducts of Rome*. Translated by Chares Bennett. London, 1925.
- Frulovisi, Tito Livio. *Vita Henrici Quinti*. In *CS*. 53–62.
- Galbert of Bruges. *The Murder of Charles the Good*. Edited and translated by James Bruce Ross. Toronto, 1991.
- Gallia regia*. Edited by G. Dupon-Ferrier. 6 vols. Paris, 1942–60.
- Gerald of Wales. *Journey Through Wales and The Description of Wales*. Translated by Lewis Thorpe. Harmondsworth, 1978.
- Gesta Henrici Quinti*. Edited and translated by Frank Taylor and John S. Roskell. Oxford, 1975.
- Les grandes chroniques de France*. Edited by Jules Viard. Société de l'Histoire de France. Vol. 438. Paris, 1937.
- Gray, T. *Scalacronica*. Edited by J. Stevenson. Edinburgh, 1836.
- Hardyng, John. *Chronicle in CS*, 78–85.
- Haynin, Jean de. *Mémoires*. Edited by R. Chalan. 2 vols. Mons, 1842.
- Historical Poems of the XIVth and XVth Centuries*. Edited by Russell Hape Rabbins. New York, 1959.
- John of Gaunt's Register, 1379–1383*. Edited by Robert Somerville. London, 1937.
- Journal d'un bourgeois de Paris de 1405–1449*. Edited by Colette Beaune. Paris, 1990.
- Journal d'un bourgeois de Paris sous Charles VI et Charles VII*. Edited by André Mary. Paris, 1929.
- Joustes de Saint-Inglebert, 1389–1390. Poème contemporain*. Edited by J. Pichon in *Partie inédite des chroniques de Sainte-Denis*. Paris, 1864.
- Juvénal des Ursins, Jean. *Histoire de Charles VI, roi de France in Choix des chroniques et mémoires sur l'Histoire de France*. Edited by J. A. C. Buchon. Paris, 1843.
- . *Histoire de Charles VI, roi de France*. In *CS*. 128–34.
- Klinefelter, Ralph A. ed. “‘The Siege of Calais’: A New Text.” *Publications of the Modern Language Association* 67 (1952): 888–95.
- Klerk, J. De. *De Brabantsche Yeesten of rymkronyk van Braband*. Edited by J. F. Willems and J. H. Bormans. 3 vols. Brussels, 1839–1869.
- Knighton, H. *Chronica de eventibus Angliae a tempore regis. Edgardis usque mortem regis. Ricardi secundi*. Edited by J.-R. Lumby, 2 vols. London, 1889–1895.
- Knighton's Chronicle, 1337–1396*. Edited by G. H. Martin. Oxford, 1995.
- Le Bel, J. *Chronique*. Edited by J. Viard and E. Deprez. 2 vols. Paris, 1904.
- A Leechbook or Collection of Medical Recipes of the Fifteenth Century*. Edited and translated by Warren R. Dawson London, 1934.

- Légende Bourguignonne*, in *Recueil de pièces historiques imprimées sous le règne de Louis XI*. Edited by E. Picot and H. Stein. Paris, 1923.
- Leges Henrici Primi*. Edited and Translated by L. J. Downer. Oxford, 1972.
- Legnano, Giovanni da. *Tractatus de bello, de represaliis et de duello*. Edited and translated by Thomas Erskine Holland. Washington, D.C., 1917.
- Lescot, Richard. *Chronique de Richard Lescot religieux de Saint-Denis (1328–1344) suivie de la continuation de cette chronique*. Edited by Jean Lemoine, Société de l'histoire de France. Paris, 1896.
- L'Honneur de la couronne de France: quatre libelles contre les anglais*. Edited by N. Pons. Paris, 1990.
- Lettere di un notaio a un mercante del secolo XIV*. Edited by Cesare Guasti, 2 vols Florence, 1880.
- Liber Pluscardensis*. Edited by Felix J. H. Skene. Edinburgh, 1877.
- Life of the Black Prince by the Herald of Sir John Chandos*. Edited by Mildred K. Pope and Eleanor C. Lodge. Oxford, 1910.
- A Lincolnshire Assize Roll for 1298*. Edited by W. S. Thomson. Hereford, 1944.
- Le livre des fais du bon messire Jehan le Maingre, dit Bouciquaut*. Edited by Denis Lalande. Paris, 1985.
- Lopes, Fernão. *The English in Portugal 1367–87: Extracts from the Chronicles of Dom Fernando and Dom João*. Edited and translated by Derek W. Lomax and R. J. Oakley. Warminster, 1988.
- López de Ayala, Pedro. *Crónica del Rey Don Pedro Primero*. CRC 1. BAE. 66. Madrid, 1953. 393–614.
- . *Crónica del Rey Don Enrique Segundo de Castilla*. In CRC 2. BAE 68. Madrid, 1953. 1–64.
- . *Crónica del Rey Don Juan Primero de Castilla e de Leon*. In CRC 2, BAE 68. Madrid, 1953, 65–159, 161–257.
- . *Crónica del Rey Don Enrique Tercero del Castilla e de Leon*. In CRC 2, BAE 68. Madrid, 1953.
- . *Coronica del rey don Pedro*. Edited by Constance L. and Heanon M. Wilkins. Madison, Wisc., 1985.
- Den huyster ende glorie van het hertogdom van Brabant*. 3 vols. Brussels, 1699.
- Machaut, Guillaume de. *Le confort d'un ami*. In *Oeuvres de Guillaume de Machaut*. Edited by E. Hoepfner. 3 vols. Paris, 1908–1921. 3:1–141.
- Machiavelli, Niccolò. *The Art of War*. Translated by Ellis Farnsworth. 1965; Reprint, New York, 1999.
- . *The Discourses*. Edited by Leslie J. Walker. New York, 1989.
- . *The Prince*. Translated by Luigi Ricci. New York, 1966.
- Maurice's Strategikon: Handbook of Byzantine Military Strategy*. Translated by George T. Dennis. Philadelphia, 1984.
- Medieval English Political Writings*. Edited by James M. Dean. Kalamazoo, Michigan, 1996.
- Mémoires de Pierre de Fenin*. Edited by E. Dupont. Paris, 1877.
- Memorials of London and London Life in the XIIIth, XIVth, and XVth Centuries*. Edited by Henry Thomas Riley. London, 1868.
- Mézières, Philippe de. *Letter to Richard II: A Plea Made in 1395 for Peace between England and France*. Translated by G. W. Coopland. Liverpool, 1975.
- Mieris, F. van. *Groot charterboek der graven van Holland, van Zeeland en heeren van Vriesland*. 4 vols. Leiden, 1753–1756.
- Molinet, Jean. *Chroniques*. Edited by Georges Doutrepont and Omer Jodogne. 3 vols. Brussels, 1935–1937.
- Monstrelet, Enguerrand de. *The Chronicles of Enguerrand de Monstrelet*. Translated by Thomas Johnes. 2 vols. London, 1840.
- . *Chronique*. Edited by L. Douet-d'Arcq. 15 vols. Paris, 1857–1862.
- . Jean Waurin, and Jean Le Fèvre, *Chroniques*. In CS. 141–71.

- Morosini, Antonio. *Chronique: Extraits relatifs a l'histoire de France*. Edited and translated by L. Dorez. 4 vols. Paris, 1898–1902.
- Nonarum Inquisitiones in Curia Scaccarii*. London, 1807.
- Oeuvres de Robert Blondel*, ed. A Héron. 2 vols. Rouen, 1891–1893.
- Orderic Vitalis. *The Ecclesiastical History*. Edited and translated by Marjorie Chibnall. 6 vols. Oxford, 1969–1980.
- Ordonnances des roys de France de la troisieme race*. Edited by M. de Lauriere. 21 vols. Paris, 1723–1849.
- Orihuela en sus documentos*. Edited by Antonio Luis Galiano Perez, Javier Sanchez Portas, and Victor Sanchez Gil, 4 vols. Murcia, 1984.
- The Parliament Rolls of Medieval England*. Edited by C. Given-Wilson, et al., CD-ROM. Leicester, 2005.
- Patrologiae cursus completus, Series latina*. Edited by J. P. Migne. 221 vols. Paris, 1845–1890.
- Pere III of Catalonia (Pedro IV of Aragon), *Chronicle*. Translated by Mary Hillgarth. Edited by J. N. Hillgarth. 2 vols. Toronto, 1980.
- Pérez de Guzmán, Fernán. *Generaciones y Semblanzas*. Edited by J. Dominguez Bodona. Madrid, 1965.
- Petrarch, an Anthology*. Edited by A. Bernardi and D. Thompson. New York, 1971.
- Plettisheim, Conrad. *Chronique rimée des guerres de Bourgogne*, in *Recueil de pieces historiques imprimées sous le règne de Louis XI*. Edited by E. Picot and H. Stein. Paris, 1923.
- Pizan, Christine de. *The Book of Deeds of Arms and of Chivalry*. Translated by William Caxton. Edited by A. T. P. Byles. Oxford, 1937.
- . *The Book of Deeds of Arms and of Chivalry*. Edited by Charity Cannon Willard. Translated by Sumner Willard. University Park, Penn., 1999.
- . *The Book of the City of Ladies*. Translated by Earl Jeffrey Richards. New York, 1998.
- . *Dieu de Jehanne d'Arc*. Edited by Angus J. Kennedy and Kenneth Varty. Oxford, 1977.
- The Poetical Works of Alain Chartier*. Edited by J. C. Laidlaw. Cambridge, 1974.
- Political Poems and Songs Relating to English History Composed during the Period from the Accession of Edward III to that of Richard III*. Edited by Thomas Wright, Rolls Series, 14. London, 1859.
- Proceedings and Ordinances of the Privy Council of England*. Edited by Sir Harris Nicolas. 7 vols. London, 1834–1837.
- Procès de condamnation et de réhabilitation de Jeanne d'Arc dite la Pucelle*. Edited by Jules Quicherat. 5 vols. Paris, 1841–1849.
- Procès en nullité de la condamnation de Jeanne D Arc*. Edited by Pierre Duparc. 5 vols. Paris, 1977–1988.
- Pseudo Elmham. *Vita et Gesta Henrici Quinti*. In *CS*, 63–74.
- Rabelais, François. *Gargantua and Pantagruel*. Chicago, 1952.
- Récits d'un bourgeois de Valenciennes*. Edited by Kervyn de Lettenhove. 1877. Reprint. Geneva, 1979.
- Recueil des Croniques et Anchiennes istories de la Grant Bretagne a present nomme Engleterre par Jehan de Waurin*. Edited by W. L. Hardy and E. L. C. P. Hardy. 5 vols. London, 1864–1891.
- Religieux de St. Denys. *Histoire de Charles VI*. In *CS*. 99–109.
- Repertorio Diplomatico Visconteo: Documenti dal 1263 al 1402*. Edited by Elia Lattes. 2 vols. Milan, 1918.
- Riezler, S. *Vatikanische Akten zur Deutschen Geschichte in der Zeit Kaiser Ludwigs des Baiern*. Innsbruck, 1891.
- Rotuli Parliamentorum: ut et petitiones, et placita in parlamento*. 7 vols. London, 1783–1832.
- Rymer, T. *Foedera, conventiones, litterae et cuiuscumque generis. Acta publica inter reges Angliae et alios quosvis imperatores, reges, pontifices, principes, vel communitates*. 6 vols. London, 1816–1869.

- Smythe, Sir John. *Certain Discourses*. London, 1590.
- Society at War: The Experience of England and France during the Hundred Years War*. Edited by C. T. Allmand. New York, 1973.
- Sturluson, Snorri. 'King Olaf Trygvason's Saga, *Heimskringla: A History of the Norse Kings*. Translated by Samuel Laing. London, 1907.
- The 'Templar of Tyre.' Part III of the 'Deeds of the Cypriots.'* Translated by Paul Crawford. Aldershot, 2003.
- Thesaurus Novus Anecdotorum*. Edited by Edmund Martene and Ursinus Durant. 5 vols. New York, 1717.
- Tractats de cavalleria*. Edited by Pere Bohigas. Barcelona, 1947.
- The Trial of Joan of Arc, being the verbatim report of the proceedings from the Orleans Manuscript*. Translated by W. S. Scott Westport, Conn., 1956.
- Tuesch, Hans Erhart. *Chronique rimée des guerres de Bourgogne*. In *Recueil de pièces historiques imprimées. sous le règne de Louis XI*. Edited by E. Picot and H. Stein. Paris, 1923.
- The Usages of Barcelona: The Fundamental Law of Catalonia*. Edited by Donald J. Kagay. Philadelphia, 1994.
- Vaissete, Dom J. and Dom Cl. Devic. *Histoire générale de Languedoc avec des notes et les pièces justificatives*. 18 vols. Toulouse, 1872–1892.
- van Dixmude, Olivier. *Merkwaardige gebeurtenissen vooral in Vlaenderen en Brabant van 1311 tot 1443*. Edited by J. J. Lambin. Ypres, 1835.
- Vasari, Giorgio. *Le vite de' piu eccellenti pittori, scultori ed architettori*, ed. Gaetano Milanesi. London, 1906).
- Vegetius. *Epitome of Military Science*. Translated by N. P. Milner. Liverpool, 1996.
- Velluti, Donato. *La Cronica Domestica di Donato Velluti*. Edited by Isodoro del Lungo e Guglielmo Volpi. Florence, 1914.
- Villani, Filippo. *Cronica di Matteo e Filippo Villani*. Florence, 1826.
- Villani, G. *Cronica di Matteo e Filippo Villani*. 6 vols. Florence, 1826.
- . *Istorie Fiorentine*. Edited by L. Muratori in *Rerum Italicarum Scriptores*. Rome, 1728.
- Villani, Matteo *Cronica: con la continuazione di Filippo Villani*. Parma, 1995.
- Vita et Gesta Henrici Quinti*. Edited by Frank Taylor and John S. Roskell. Oxford, 1975.
- The Voice of the Middle Ages*. Edited and translated by Catherine Moriarty. New York, 1989.
- von Aue, Hartmann. *Iwein*. Translated by John Wesley Thomas Lincoln. London, 1979.
- The Vows of the Heron (Les Voeux du Héron): A Middle French Vowing Poem*. Edited by John L. Grigsby and Norris L. Lacy. Garland Library of Medieval Literature. Series A. vol. 86. New York, 1992.
- Walsingham, Thomas. *St. Albans Chronicle*. In *CS*. 48–52.
- The Wardrobe Book of William de Norwell. 12 July 1338 to May 1340*. Edited by Mary Lyon, Bryce Lyon, and Henry Lucas. Brussels, 1983.
- The Wars of Edward III: Sources and Interpretations*. Edited by Clifford J. Rogers. Woodbridge, Suffolk, 1999.
- Waurin, Jehan de. *Anchiennes croniques d'Angleterre*. Edited by L. M. E. Dupont. 3 vols. Paris, 1858–1863.
- . *Recueil des Croniques et anchiennes istories de la Grant Bretagne, a present nomme Engleterre*. 5 vols. London: 1864–1891.

Secondary Sources

- Aberth, John. *Criminal Churchmen in the Age of Edward III: The Case of Bishop Thomas de Lisle*. University Park, Pa., 1996.
- . *From the Brink of the Apocalypse*. New York, 2001.

- Abulafia, David. *The Western Mediterranean Kingdoms 1200–1500: The Struggle for Dominion*. London, 1997.
- Agrait, Nicolás. “The Experience of War in Fourteenth-Century Spain: Alfonso XI and the Capture of Algeciras (1342–1344).” In *Crusaders, Condottieri, and Cannon: Medieval Warfare in Societies around the Mediterranean*. Edited by L. J. Andrew Villalon and Donald J. Kagay (Leiden, 2003). 213–38.
- . “The Reconquest during the Reign of Alfonso XI (1312–1350).” In *On the Social Origins of Medieval Institutions: Essays in Honor of Joseph F. O’Callaghan*. Edited by Donald J. Kagay and Theresa M. Vann. Leiden, 1998. 149–65.
- Ainsworth, Peter F. *Jean Froissart and the Fabric of History: Truth, Myth, and Fiction in the Chroniques*. Oxford, 1990.
- Allmand, Christopher. *Henry V*. Berkeley, 1992.
- Alomari i Canyelles, Antoni Ignasi. *L’armament I la defensa a la Mallorca medieval*. Palma, 1995.
- Anglo-Norman Medicine*. Edited by Tony Hunt. 2 vols. Cambridge, 1994.
- Anglo, Sydney. “How to Win at Tournaments: The Techniques of Chivalric Combat.” *Antiquaries Journal* 68 (1988): 248–64.
- . *The Martial Arts of Renaissance Europe*, New Haven, Conn., 2000.
- . *Spectacle, Pageantry, and Early Tudor Policy*, Oxford, 1997.
- Archambault, Paul. *Seven French Chroniclers: Witnesses to History*. Syracuse, 1974.
- Arié, R. Les échanges culturels entre le royaume Nasride de Grenade et les pays Musulmans de la Méditerranée.” *Aspects de l’Espagne musulmane. Histoire et culture*. Paris, 1997. 65–81.
- . *L’Espagne musulmane au temps des Nasrides (1323–1492)*. Paris, 1973.
- . *España musulmana (Siglos VIII–XV)*. Barcelona, 1983.
- Ariés, Philippe. *L’homme devant la mort*. Paris, 1977.
- Armstrong, Pete. *Bannockburn 1314: Robert Bruce’s Great Victory*. London, 2002.
- . *Stirling Bridge and Falkirk, 1297–98: William Wallace’s Rebellion*. London, 2003.
- Arnold, Thomas. *The Renaissance at War*. London, 2001.
- Arribas Palau, Antoni. *La conquista de Cerdeña por Jaime II de Aragón*. Barcelona, 1952.
- Arribas Palau, Mariano. *Las treugas entre Castilla y Granada firmadas por Fernando I de Aragón*. Tetuan, 1956.
- Arthurson, Ian. “The King’s Voyage into Scotland: The War that Never Was.” In *England in the Fifteenth Century: Proceedings from the 1986 Harlaxton Symposium*. Edited by D. Williams. Woodbridge, 1987. 1–22.
- Ascham, Roger. *Toxophilus, The Schole of Shootinghe*. 2nd Book. 1545; reprint, New York, 1969.
- Atiya, Aziz Suryal. *The Crusade of Nicopolis*. London, 1934.
- Attwater, Donald. *Avenel Dictionary of Saints*. New York, 1979.
- Augis, J. “La bataille de Verneuil (jeudi 17 août 1424) vue de Châteaudun.” *Bulletin de la société Dunoise* 16 (1932–35): 116–21.
- The Augustinian Tradition*. Edited by Gareth B. Matthews. Berkeley, 1999.
- Autrand, Françoise. *Charles V le Sage*. Paris, 1994.
- . “La Déconfiture. La Bataille de Poitiers (1356) à travers quelques textes français des XIV^e et XV^e siècles.” In *Guerre et société en France, en Angleterre et en Bourgogne XIV^e–XV^e siècle*. Edited by Philippe Contamine, Charles Giry-Deloison and Maurice Keen. Lille, 1991. 93–121.
- Avonds, P. “Brabant en Limburg 1100–1403.” *AGN*. 2 (1982): 452–82.
- . *Brabant tijdens de regering von hertog Jan III (1313–1356). De grote politieke krisissen*. Brussels, 1984.
- . *Brabant tijdens de regering van hertog Jan III (1312–1356). Land en Instellingen* (Brussels, 1991).
- . “Mechelen en de Brabantse steden (1312–1355).” *Bijdragen tot de Geschiedenis* 53 (1970): 17–80.

- Avout, J. d'. *La querelle des Armagnacs et des Bourguignons*. Paris, 1943.
- Axworthy, Roger Leonard. "The Financial Relationship of the London Merchant Community with Edward III, 1337 to 1377." Ph.d. diss., Royal Holloway, University of London, 2000.
- Ayton, Andrew. "English Armies in the Fourteenth Century." In *Arms, Armies and Fortifications in the Hundred Years War*. Edited by Anne Curry and Michael Hughes. Woodbridge, Suffolk, 1999. 21–38.
- . "The English Army at Crécy." In *Battle of Crécy*. 159–252.
- . *Knights and Warhorses*. Woodbridge, Suffolk, 1994.
- . "Knights, Esquires, and Military Service: The Evidence of the Armorial Cases before the Court of Chivalry" In *The Medieval Military Revolution. State, Society, and Military Change in Medieval and Early Modern Europe*. Edited by Andrew Ayton and J. L. Price. London, 1995. 91–104.
- . and Philip Preston. "Crécy and the Chroniclers." In *The Battle of Crécy, 1346*. Edited by Andrew Ayton and Philip Preston. Woodbridge, Suffolk, 2005. 287–350.
- . and Philip Preston. "Topography and Archery: Further Reflections on the Battle of Crécy." In *Battle of Crécy*. 351–78.
- Bacci, Antonio. *Strade romane e medioevali nel territorio aretino*. Cortona, 1986.
- Bakhtin, Mikhail. *Rabelais and His World*. Translated by Helene Iswolsky. Bloomington: Ind., 1984.
- Balestracci, Duccio. *Le armi, i cavalli, le oro: Giovanni Acuto e i condottieri del Trecento*. Rome, 2003.
- Balfour-Melville, E. W. M. *Edward III and David II*. London, 1954.
- Ballard, Mark. "'Du sang de Lancaestre, je suis extrait...': Did Charles the Bold Remain a Loyal Lancastrian?" In *L'Angleterre et les pays Bourguignons: Relations et comparaisons (XV^e–XVII^e siècles)*. Neuchâtel, 1995. 83–90.
- Barber, Malcolm. *The Trial of the Templars*. Cambridge, 1978
- . and Keith Bate, ed. *The Templars*. Manchester, 2002.
- Barber, Richard. *Edward: Prince of Wales and Aquitaine: A Biography of the Black Prince*. Woodbridge, Suffolk, 1996.
- . *The Knight and Chivalry*. New York, 1974.
- Baron, Hans. *The Crisis of the Early Renaissance*. Princeton, 1955.
- Barrow, G. W. S. *Robert Bruce and the Community of the Realm of Scotland*. London, 1965.
- The Battle of Neville's Cross, 1346*. Edited by David Rollason and Michael Prestwich Stamford, 1998.
- Bautista Vilar, Juan. *Historia de la ciudad de Orihuela*. 3 vols. Orihuela, 1975–.
- Bayley, Charles C. *War and Society in Renaissance Florence: The "De Militia" of Leonardo Bruni*. Toronto, 1961.
- Bean, J. M. W. "Henry IV and the Percies." *History* 44 (1959): 212–27.
- Beaumont, C. L. de. *Fencing: Ancient Art and Modern Sport*. New York, 1960.
- Becerra Hormigo M. "La conexión catalana en el derrocamiento de Isma'íl II." In *La frontera terrestre i marítima amb l'Islam*. Barcelona, 1988. 302–17.
- Before the Black Death: Studies in the 'Crisis' of the Early Fourteenth Century*. Edited by Bruce Campbell. Manchester, 1991.
- Bellamy, John. *Crime and Public Order in England in the Later Middle Ages*. London, 1973.
- Bellot, P. *Anales de Orihuela (siglos XIV–XVII)*. Edited by J. Torres Fontes. Oriola, 1954–1956.
- Benedetti, Alessandro. *Diaria De Bello Carolino*. New York, 1967.
- Bennett, Judith M. "Public Power and Authority in the Medieval English Countryside." In *Women and Power in the Middle Ages*. Edited by Mary Erlar and Maryanne Kowaleski. Athens, Ga., 1988. 18–36.
- Bennett, Matthew. *Agincourt 1415*. London, 1991.

- Berben, H. "Une guerre économique au moyen âge: L'embargo sur l'exportation des laines anglaises (1270–1274)." In *Etudes d'histoire dédiées à la mémoire de Henri Pirenne par ses anciens élèves*. Brussels, 1937. 1–17.
- Berman, Harold J. *Law and Revolution: The Formation of the Western Legal Tradition*. Cambridge, Mass., 1983.
- Bessa, Carlos. "Le Portugal 1383–1385: crise, art militaire et consolidation de l'indépendance." In *XXII. Kongreß der Internationalen Kommission für Militärgeschichte, Acta 22: Von Crécy bis Mohács Kriegswesen im späten Mittelalter (1346–1526)*. Vienna, 1997. 28–50.
- Binet, Sylvie. *Jeanne Hachette: l'héroïne de Beauvais*. Paris, 1995.
- Bisson, Thomas N. "Las finanzas del joven Jaime I (1213–1228)." In *X CHCA, Comunicaciones 1–2*:151–208.
- . *Fiscal Accounts of Catalonia under the Early Count-Kings (1151–1213)*. 2 vols. Berkeley, 1984.
- . "A General Court of Aragon (February, 1228)." *English Historical Review* 92 (1977): 107–24.
- Blanco Aguinaga, Carlos. "Sobre las nacionalidades de España, el estado de las autonomías y los estudios hispanística." In *Las Nacionalidades del estado español: una problemática cultural*. Edited by Cristina Dupláa and Gwendolyn Barnes. Minneapolis, 1986. 15–32.
- Blanco Nuñez, José María. "Las armadas de Castilla y Aragón durante la Guerra de los Cien Años." in *XXII Kongreß der Internationalen Kommission für Militärgeschichte Acta 22: Von Crécy bis Mohács Kriegswesen im späten Mittelalter (1346–1526)* (Vienna, 1997), 269–80.
- Bloch, Marc. *French Rural History: An Essay on its Basic Characteristics*. Translated by Janet Sondheimer. Berkeley, 1966.
- Blockmans, F. "De erfstrijd tussen Vlaanderen en Brabant in 1356." *Bijdragen en mededelingen betreffende de geschiedenis van Nederland* 69 (1953): 11–16.
- Blockmans, Wim P. "Voracious States and Obstructing Cities: An Aspect of State Formation in Preindustrial Europe." In *Cities and the Rise of States in Europe, A.D. 1000 to 1800*. Edited by Wim P. Blockmans and Charles Tilly. Boulder, Colo., 1994. 218–45.
- . and Walter Prevenier, *The Promised Lands: The Low Countries Under Burgundian Rule, 1369–1530*. Edited by Edward Peters. Translated by Elizabeth Fackelman. Philadelphia, 1999.
- Boase, T. S. R. *Death in the Middle Ages: Mortality, Judgement and Remembrance*. London, 1972.
- Boehm, Christopher. *Blood Revenge: The Enactment and Management of Conflict in Montenegro and Other Tribal Societies*. Philadelphia, 1984.
- Boffa, Sergio. "The Duchy of Brabant Caught Between France and England: Geopolitics and Diplomacy during the First Half of the Hundred Years War." In *The Hundred Years War: A Wider Focus*. Edited by L. J. Andrew Villalon and Donald J. Kagay. Leiden, 2005. 211–40.
- Boix y Ricarte, Vincente. *Crónica de la Provincia de Valencia*. 3 vols. Madrid, 1867.
- Boland, G. "Un siècle d'alliance interurbaines en Brabant." in *Miscellanea historica in honorem Alberti de Meyer*. 2 vols. Louvain, 1946. 1:613–25.
- Bonenfant, Paul. *Philippe le Bon, sa politique, son action*. Paris and Brussels, 1996.
- Bonner, Elizabeth. "Scotland's 'Auld Alliance' with France, 1295–1560." *History* 84 (1999): 5–30.
- Boone, Marc. *Gent en de Bourgondische hertogen, 1385–1453: Een sociaal-politieke studie van een staatsvormingsproces*. Brussels, 1990.
- Boonen, W. *Geschiedenis van Louvain geschreven in de jaren 1593 en 1594*. Edited by E. van Even. Louvain, 1880.

- Borsook, Eve. "L'Hawkwood d'Uccello et le Vie de Fabius Maximus de Plutarque." *Revue Art* 55 (1982): 44–51.
- Bourassin, Emmanuel. *Philippe le Bon*. Paris, 1999.
- Bradbury, Jim. *The Medieval Archer*. Woodbridge, Suffolk, 1985.
- . *The Medieval Siege*. Woodbridge, Suffolk, 1992.
- Brown, A. L. "The English Campaign in Scotland, 1400." In *British Government and Administration: Studies Presented to S. Chrimes*. Edited by H. Hearder and H. R. Loyn. Cardiff, 1974. 40–54.
- Brown, Chris. *The Second Scottish Wars of Independence, 1332–1363*. Stroud, 2002.
- . *William Wallace: The True Story of Braveheart*. Stroud, 2005.
- Brown, Elizabeth A. R. and Richard Famiglietti. *The Lit de Justice: Semantics, Ceremonial and the Parlement of Paris, 1300–1600*. Sigmaringen, 1993.
- Brucker, Gene. *The Civic World of Early Renaissance Florence*. Princeton, 1977.
- Brusten, Charles. *L'armée Bourguignonne de 1465 à 1468*. Brussels, 1954.
- . "Charles le Téméraire et la campagne de Neuss, 1474–75." *Publications du centre européen d'études burgundo-médiévales* 13 (1971): 67–73.
- Burke, Peter. *Popular Culture in Early Modern Europe*. New York, 1978.
- Burne, A. H. *The Agincourt War: A Military History of the Latter Part of the Hundred Years War from 1369 to 1453*. London, 1956.
- . "La bataille de Castillon, 1453: la fin de la guerre de cent ans." *Revue de histoire de Bourdeaux* n.s. 2 (1953): 293–305.
- . "The Battle of Castillon, 1453." *History Today* 3 (1953): 249–56.
- . *The Crécy War. A Military History of the Hundred Years War from 1337 to the peace of Bretigny, 1360*. London, 1999.
- Burns, Robert I., S. J. "The Catalan Company and the European Powers, 1305–1311." *Speculum* 29 (1954): 751–71.
- . *The Crusader Kingdom of Valencia: Reconstruction of a Thirteenth-Century Frontier*. 2 vols. Cambridge, Mass., 1967.
- . "The Many Crusades of Valencia's Conquest (1225–1280): An Historiographical Labyrinth." In *On the Social Origins*, 172–77.
- . "A Medieval Earthquake: Jaume I, Al-Azraq and the Early History of Onteniente in the Kingdom of Valencia." In X *CHCA, Comunicaciones* 1–2: 209–44.
- . "The Significance of the Frontier in the Middle Ages." In *Medieval Frontier Societies*, ed. Robert Bartlett and Angus MacKay. Oxford, 1996. 307–30.
- . and Paul E. Chevedden. *Negotiating Cultures: Bilingual Surrender Treaties in Muslim-Crusader Spain*. Leiden, 1999.
- Bynum, Caroline Walker. *Holy Feast and Holy Fast: Significance of Food to Medieval Women*. Berkeley, 1987.
- Caferro, William. "'The Fox and the Lion': The White Company and the Hundred Years in Italy." In *The Hundred Years War: A Wider Focus*. Edited by L. J. Andrew Villalon and Donald J. Kagay. Leiden, 2005. 179–210.
- . *The Mercenary Companies and the Decline of Siena*. Baltimore, 1998.
- . "Slaying the Hydra-headed Beast: Italy and the Companies of Adventure in the Fourteenth Century." In *Crusaders, Condottieri, and Cannon: Medieval Warfare Around the Mediterranean*. Edited by Donald J. Kagay and L. J. Andrew Villalon. Leiden, 2002. 285–304.
- Callahan, Leslie Abend. "The Widow's Tears: The Pedagogy of Grief in Medieval France and the Image of the Grieving Widow." In *Constructions of Widowhood and Virginity in the Middle Ages*. Edited by Cindy Carlson and Angela Jane Weisl. New York, 1999. 245–63.
- Calmet, D. *Histoire de Lorraine*. 7 vols. Nancy, 1747–1757.
- Calmette, Joseph. *Louis XI, Jean II et la révolution catalane*. Toulouse, 1903.
- Campbell, James. "England, Scotland and the Hundred Years War in the Fourteenth Century." In *Europe in the Late Middle Ages*. Edited by J. R. Hale, J. R. L. Highfield and B. Smalley. Evanston, Ill., 1965. 184–216.

- Caron, Marie-Thérèse. *Noblesse et pouvoir royal en France*. Paris, 1994.
- Carrerres Zacarés, S. *Libre de memòries de diversos sucesos e fets memorables e de coses senyalades de la ciutat e regne de València (1308–1644)*. Valencia: 1930.
- Carrier, Hubert. “Si vera est fama: Le retentissement de la bataille d’Othée dans la culture historique au XV^e siècle.” *Revue historique* 305 (2001): 639–70.
- Carson, Patricia. *James van Artevelde: The Man from Ghent*. Ghent, 1980.
- Caruana Gomez de Barreda, Jaime. “Los mayordomos de Aragón en los siglos XII y XIII.” *Revista de Archivos, Bibliotecas, y Museos* 62 (1953): 349–77.
- Castillo Cárceres, Fernando. “Analysis de una batalla: Najera 1367.” *Cuadernos de historia de Espana* 73 (1991): 107–46.
- Caturegli, Natale. *La Signoria di Giovanni dell’Agnolo*. Pisa, 1920.
- Cauchies, J.-M. “Charles le Hardi à Neuss (1474/75): Folie militaire ou contrainte politique.” *Publication du centre européen d’études bourguignonnes (XIV^e-XV^e siècles)* 36 (1996): 105–15.
- . *Louis XI et Charles le Hardi: De Péronne à Nancy (1468–1477): le conflit*. Brussels, 1996.
- . “Pouvoir législatif et genèse dans les principautés des Pays-Bas (XII^e-XV^e siècle).” in *Renaissance du pouvoir législatif et genèse de l’Etat*. Edited by A. Gouron and A. Rigaudière. Montpellier, 1988. 58–74.
- . “Le prince territorial au bas moyen âge dans les anciens Pays-Bas, Quinze années de recherches en Belgique (1975–1990),” in *Les princes et le pouvoir au moyen âge* (Paris, 1993), 35–48.
- Cavalcanti, Giovanni. *Trattato Politico-Morale*. Edited by Marcella Grendler. Geneva, 1973.
- Cazelles, Raymond. *La société politique et la crise de la royauté sous Philippe de Valois*. Paris, 1958.
- Champion, Pierre. *Guillaume de Flavy: Capitaine de Compiègne: Contribution à l’histoire de Jeanne d’Arc et à l’étude de la vie militaire et privée au XV^e siècle*. Paris, 1906.
- Charlier, Yves. “La bataille d’Othée et sa place dans l’histoire de la principauté de Liège.” *Bulletin de l’Institut archéologique liégeois* 97 (1985): 138–278.
- Chevalier, Bernard. “Les écosseis dans les armées de Charles VII jusqu’à la bataille de Verneuil.” In *Jeanne d’Arc: Une époque, un rayonnement*. Paris, 1982. 85–94.
- Chérest, Aimé. *L’Archiprêtre, épisodes de la guerre de cent ans au xiv^e siècle*. Paris, 1879.
- Chevedden, Paul E. “The Artillery of King James I the Conqueror.” In *Iberia and the Mediterranean World*. 2:47–94.
- Cinq-centième anniversaire de la bataille de Nancy (1477): Actes du Colloque organisé par l’institut de recherche régionale en sciences sociales, humaines et économiques de l’Université de Nancy II (Nancy, 22–24 septembre 1977)*. (Nancy, 1979).
- Clausewitz, Carl von. *On War*. Edited and Translated by Michael Howard and Peter Paret. Princeton, 1984.
- . *Principles of War*. Translated by Hans W. Gatzke. 1942; Reprint. Mineola, N.Y., 2003.
- Cockshaw, P. “L’assassinat du duc Jean de Bourgogne à Montereau: Études des sources.” In *Les Pays-Bas bourguignons: Histoire et institutions. Mélanges André Uytendaele*. Edited by J.-M. Duvosquel, J. Nazet, and A. Vanrie. Brussels, 1996. 145–62.
- Cognasso, Francesco. “Note e documenti sulla formazione dello stato visconteo.” in *Bollettino della Società Pavese di Storia Patria* 23 (Jan–Dec 1923): 23–169.
- . “L’Unificazione della Lombardia sotto Milano.” in *Storia di Milano*, ed. Carlo Castellaneta. Milan, 1955. 5: 408–14.
- Cohen, David. “Secular Pragmatism and Thinking about War in some Court Writings of Pere III el Cerimonios.” In *Crusaders, Condotieri, and Cannon*. 19–53.
- Conan Doyle, Sir Arthur. *The White Company*. 1891; reprint, New York, 1988.
- Contamine Philippe. “La guerre de siège au temps de Jeanne d’Arc.” *Dossiers de archéologie* 34 (May 1979): 11–20.

- . *Les relations politiques et les échanges commerciaux entre le duché de Brabant et l'Angleterre au moyen âge. L'étape des laines anglaises en Brabant et les origines du développement du port d'Anvers*. Paris, 1936.
- . "La théologie de la guerre à la fin du Moyen Age: La Guerre de Cent Ans, fut-elle une guerre juste?" In *Jeanne d'Arc: une époque, un rayonnement*. Paris, 1982. 9–21.
- . *War in the Middle Ages*. Translated by Michael Jones. Oxford, 1984.
- Coroleu y Iglada, José. *Las Cortes Catalanas*. Barcelona, 1876.
- Cosman, Madeleine Pelner. *Women at Work in Medieval Europe*. New York, 2000. 75–93.
- Coulton, G. G. *The Chronicler of European Chivalry*. London, 1930.
- . *Medieval Panorama: The English Scene from Conquest to Reformation*. Cambridge, 1938.
- Coville, A. *Les cabochiens et l'ordonnance de 1413*. Paris, 1888.
- Cowan, Edward J. "For Freedom Alone": *The Declaration of Arbroath, 1320*. East Linton, 2002.
- Cox, Eugene L. *The Green Count of Savoy, Amadeus VI and Transalpine Savoy in the Fourteenth Century*. Princeton, 1967.
- Crawford, Francis Marion. *Salve Venetia: Gleanings from Venetian History*. New York, 1905.
- Cruikshank, C. G. *Army Royal: Henry VIII's Invasion of France, 1513*. Oxford, 1969.
- . *The English Occupation of Tournai, 1513–1519*. Oxford, 1971.
- Curry, Anne. *Agincourt: A New History*. Stroud, UK, 2005.
- . "English Armies in the Fifteenth Century." In *Arms, Armies and Fortifications in the Hundred Years War*. Edited by Anne Curry and Michael Hughes. Woodbridge, Suffolk, 1994. 39–68.
- . *The Hundred Years War*. Houndmills, 2003.
- Cuttino, G. P. *English Medieval Diplomacy*. Bloomington, Ind., 1985.
- . "Historical Revision: The Causes of the Hundred Years War," *Speculum* 39 (1956): 463–77.
- Daniell, Christopher. *Death and Burial in Medieval England, 1066–1550*. London, 1997.
- Daumet, Georges. *Calais sous la domination Anglaise*. Arras, 1902.
- . *Étude sur L'Alliance de la France et de la Castille au XIV^e au XV^e Siècles*. Paris, 1898.
- Davies, R. R. *The Revolt of Owain Glyn Dwr*. Oxford, 1995.
- DeMarco, Patricia. "Inscribing the Body with Meaning: Chivalric Culture and the Norms of Violence in *The Vows of the Heron*." In *Inscribing the Hundred Years War in French and English Cultures*. Edited by Denise N. Baker. Albany, N.Y., 2000. 27–53.
- De Pauw, Linda Grant. *Battle Cries and Lullabies: Women in War from Prehistory to the Present*. Norman, Okla., 1998.
- . "Note supplémentaire en rapport sur le document inedit relatif à Jacques van Artevelde." *BCRH* [5th ser] 9 (1899): 197–201.
- De Sturler, J. "Une démarche politique inconnue de Jean III, duc de Brabant (1337–1338)." *RBPH* 14 (1932): 1319–27.
- DeVries, Kelly. "Calculating Profits and Losses during the Hundred Years War." In *Money, Markets and Trade in Late Medieval Europe: Essays in Honour of John H. A. Munro*. Edited by Lawrin Armstrong, Ivana Elbl, and Martin M. Elbl. Leiden, 2007. 187–209.
- . "Catapults Are not Atomic Bombs: Towards a Redefinition of 'Effectiveness' in premodern Military Technology." *War in History* 4, no. 4 (1997): 454–70.
- . "Contemporary Views of Edward III's Failure at the Siege of Tournai, 1340." *Nottingham Medieval Studies* 39 (1995): 70–105.
- . *A Cumulative Bibliography of Medieval Military History and Technology*. Leiden, 2002.
- . "The Effect of Killing the Christian Prisoners at the Battle of Nicopolis." In *Crusaders, Condothieri, and Cannon: Medieval Warfare in Societies Around the Mediterranean*. Edited by Donald J. Kagay and L. J. Andrew Villalon. Leiden, 2003. 167–72.

- . “The Forgotten Battle of Bevershoutsveld, 3 May 1382: Technological Innovation and Military Significance.” In *Armies, Chivalry and Warfare in Medieval Britain and France: Proceedings of the 1995 Harlaxton Symposium*. Edited by Matthew Strickland. Stamford, 1998. 289–302.
- . “God, Leadership, Flemings, and Archery: Contemporary Perceptions of Victory and Defeat at the Battle of Sluys, 1340.” *American Neptune* 55 (1995): 223–42.
- . “Gunpowder Weaponry at the Siege of Constantinople, 1453.” In *War, Army and Society in the Eastern Mediterranean, 7th–16th Centuries*. Edited by Yaacov Lev. Leiden, 1996. 343–62.
- . “Hunger, Flemish Participation and the Flight of Philip VI: Contemporary Accounts of the Siege of Calais, 1346–47,” *Studies in Medieval and Renaissance History* 12 [n.s.] (1991): 129–81.
- . “The Impact of Gunpowder Weaponry on Siege Warfare in the Hundred Years War.” In *The Medieval City Under Siege*. Edited by Ivy A. Corfis and Michael Wolff. Woodbridge, 1995. 227–44.
- . *Infantry Warfare in the Early Fourteenth Century*. Woodbridge, Suffolk, 1996.
- . “John the Fearless’ Way of War,” in *Reputation and Representation in Fifteenth Century Europe*. Edited by Douglas L. Biggs, Sharon D. Michalove, and A. Compton Reeves. Leiden, 2004. 39–55.
- . *Joan of Arc: A Military Leader*. Stroud, 1999.
- . *Medieval Military Technology*. Peterborough, Ont., 1992.
- . “The Reasons for the Bishop of Norwich’s Attack on Flanders in 1383.” In *Fourteenth Century England III*. Edited by W. M. Ormrod. Woodbridge, Suffolk., 155–65.
- . “The Rebellions of the Southern Low Countries’ Towns during the Fourteenth and Fifteenth Centuries.” In *Power and the City in the Netherlandic World*. Edited by Wayne te Brake and Wim Kibler. Leiden, 2006. 27–44.
- . with Robert D. Smith. *A History of Late Medieval Gunpowder Weapons: The Artillery of the Valois Dukes of Burgundy, 1363–1477*. 2005.
- . with Brett Steele. “Facing the New Military Technology: Non-Trace Italiane Anti-Gunpowder Weaponry Defenses, 1350–1550.” In *Colonels and Quartermasters: War and Technology in the Old Regime*. Forthcoming.
- De-Winter, Patrick M. “Art from the Duchy of Burgundy.” *The Bulletin of the Cleveland Museum of Art* 74 (Dec. 1987): 406–49.
- Degenhart, B. and A. Schmitt. *Corpus der Italiemische Zeichnungen, 1300–1450*. 2 vols. Berlin, 1960. Delachenal, Roland. *Histoire de Charles V*. 5 vols. Paris 1909–1931.
- Delbruck, Hans. *History of the Art of War*. Translated by Walter J. Renfro, Jr. 4 vols. 1920–1932; reprint, Westport, Conn., 1982.
- Delclos, Jean-Claude. *Le témoignage de Georges Chastellain, historiographe de Philippe le Bon et de Charles le Téméraire*. Geneva, 1980.
- Déprez, Eugene. “La Bataille de Nájera (3 Avril 1367) Le Communiqué du Prince Noir.” *Revue Historique* 161 (Janvier–Avril, 1921): 37–59
- . *Les préliminaires de la guerre de Cent Ans. La papauté, la France et l’Angleterre, 1328–1342*. Paris, 1902.
- Demuyne, R. “De gentsch oorlog (1379–1385): Oorzaken en karakter.” *Handelingen van de maatschappij voor geschiedenis en oudheid te Gent*, n.s. 5 (1951): 305–18.
- Des Marez, G. “Un document inédit relatif à Jacques van Artevelde.” *BCRH* [5e sér] 8 (1898): 305–10.
- Despriet, Philippe. “*Kortrijk 1302*”: Keerpunt in de Frans-Vlaamse oorlog, 1297–1305. Courtrai, 2002.
- Dhont J. “Les assemblées d’Etats en Belgique avant 1795.” *Recueils Société Jean Bodin* 24 (1966): 325–400.
- Dickinson, Joyceline Gledhill. *The Congress of Arras, 1435: A Study in Medieval Diplomacy*. Oxford, 1955.

- Ditchburn, David. *Scotland and Europe: The Medieval Kingdom and its Contacts with Christendom, 1215–1545*. 1 vol. to date. East Linton, Scotland, 2001.
- Do Paço, Afonso. "The Battle of Aljubarrota." *Antiquity* 37 (1963): 264–69.
- Dubois, Henri. *Charles le Téméraire*. Paris, 2004.
- Duffy, Séan. *Robert the Bruce's Irish Wars: The Invasions of Ireland, 1306–1329*. Stroud, 2002.
- DuFourcq, Charles E. *L'Espagne catalane et le Maghrib aux XIII^e et XIV^e siècles*. Paris, 1966.
- Dufresne, Linda. "Women Warriors: A Special Case from the Fifteenth Century: The *City of Ladies*." *Women's Studies* 23 (1994): 111–31.
- Dumolyn, Jan. *De Brugse opstand van 1436–1438*. Courtrai-Heule, 1997.
- , and Jelle Haemers. "Patterns of Urban Rebellion in Medieval Flanders." *Journal of Medieval History* 31 (2005): 369–93.
- Duncan, A. A. M. "Honi soit qui mal y pense: David II and Edward III, 1346–52." *Scottish Historical Review* 67 (1988): 113–41.
- . "The War of the Scots, 1306–23." *Transactions of the Royal Historical Society*, 6th ser., 2 (1992): 125–51.
- Dunlop, Annie I. *Scots Abroad in the Fifteenth Century*. London, 1942.
- Dupré, E. La Folie de Charles VI roi de France." *Revue de Deux Mondes* 60 (1910): 835–66.
- Durrieu, P. *Les Gascons en Italie*. Auch, 1885.
- Edge, David and John Miles Paddock. *Arms and Armor of the Medieval Knight*. London, 1996.
- Eisenhower, Dwight D. *Crusade in Europe*. Garden City, N.Y., 1948.
- Elliot, Frances Minto. *Old Court Life in Spain*. 2 vols. New York, 1894.
- Elshtain, Jean Bethke. *Women and War*. New York, 1987.
- Eltis, David. *The Military Revolution in Sixteenth-Century Europe*. London, 1995.
- The English Experience in France c. 1450–1558: War, Diplomacy, and Cultural Exchange*. Edited by David Grummitt. Aldershot, 2002.
- Epalza, Mikel de. "Islamic Social Structures in Muslim and Christian Valencia." In *Iberia and Mediterranean World*. 2: 179–90.
- Estal, Juan Manuel del. *Alicante: De villa a ciudad (1252–1490)*. Alicante, 1990.
- . *Orihuela de villa a ciudad: Compendio de una historia bicentenario desde Alfonso X el Sabio de Castilla al rey Magnánimo Alfonso V de Aragón (1243/50–1437/38)*. Alicante, 1996.
- Estow, Clara. *Pedro the Cruel of Castile, 1350–1369*. Leiden, 1995.
- . "Royal Madness in the *Crónica del Rey Don Pedro*." *Mediterranean Studies* 6 (1996): 13–28.
- European Memories of the Second World War*. Edited by Helmut Peitsch, Charles Burdett, and Claire Gorrara. New York, 1999.
- Fairon, E. "Un projet de démembrement du diocèse de Liège proposé par les Brabançons en 1332 et 1336." *BCRH* 78 (1909): 142–92.
- Favier, J. *La guerre de Cent Ans*. Verviers, 1980.
- Fernández Albaladejo, Pablo. "Cities and the State in Spain." In *Cities and the Rise of States in Europe, A.D. 1000 to 1800*. Edited by Charles Tilly and William P. Blockmans. Boulder, Colo., 1994.
- Ferrer i Mallol, M. T. "Causes i antecedents de la guerra dels dos Peres." *Boletín de la Sociedad Castellonense de Cultura* 43 (1987): 445–508.
- . "La frontera valenciana durant la guerra amb Castella." In *Pere el Cenmanios i la seva època*. Edited by Teresa Ferrer i Mallol. Barcelona, 1989. 245–357.
- . "Notes sobre la conquest del Múrcia per Jaume II (1296–1304)." In *Homenatge de la memòria del Prof Emlío Sáez. Aplec de estudis dels seus deixebles i col·laboradors*. Barcelona, 1989. 27–44.
- . *Organizació i defensa d'un territori fronterer: la governació d'Oriola en el segle XIV*. Barcelona, 1990.

- . “La organización militar en Cataluña en la Edad Media.” *Revista de Historia Militar*. extract. Madrid, 2000.
- . “Els primers diputats de la Generalitat de Catalunya (1359–1412).” In *Miscel·lània d’Homenatge a Miquel Coll i Alentorn en el seu vuitante aniversari*. Barcelona, 1984. 223–32.
- . “The Southern Valencian Frontier during the War of the Two Pedros.” In *The Hundred Years War. A Wider Focus*. Edited by L. J. Andrew Villalon and Donald J. Kagay, Leiden, 2005.
- Ferrill, Arther. *The Origins of War: From the Stone Age to Alexander the Great*. London, 1988.
- Ffoulkes, Charles and E. C. Hopkinson. *Sword, Lance, & Bayonet. A record of the Arms of the British, Army and Navy*. Cambridge, 1938.
- Filippini, Francesco. *Il Cardinale Egidio Albornoz*. Bologna, 1933.
- Fontseré Eduard and Josep Iglésies. *Recompilació de dades sísmiques de les terres catalanes entre 1100 i 1906*. Barcelona, 1971.
- Forey, Alan J. *The Military Orders from the Twelfth to the early Fourteenth Centuries*. Toronto, 1992.
- . “Women and the Military Orders in the Twelfth and Thirteenth Centuries.” *Studia monastica* 29 (1987): 63–72.
- Fowler, Kenneth. “Deux entrepreneurs militaires au XIV^e siècle: Bertrand Du Guesclin and Sir Hugh Calveley.” In *Le combattant au Moyen Âge*. Paris, 1995. 243–56.
- . “L’emploi des mercenaires por les pouvoirs ibériques e l’intervention militaire anglaise en Espagne (vers 1361–vers 1379).” In *Realidad e imágenes del poder: España a fines de la Edad Media*. Edited by A. Rucquoi. Valladolid, 1988. 23–55.
- . *Medieval Mercenaries*. 1 vol. to date. Oxford, 2001.
- . “Sir John Hawkwood and the English Condottieri in Trecento Italy.” In *Viajeros, peregrinos, mercaderes en el Occidente medieval*. Pamplona, 1992. 217–44.
- . “The Wages of War: The Mercenaries of the Great Companies.” In *Viajeros, peregrinos, mercaderes en el Occidente medieval*. Pamplona, 1992. 217–44.
- Fraioni, Deborah A. *Joan of Arc: the Early Debate*. Woodbridge, Suffolk, 2000.
- France, John. *Western Warfare in the Age of the Crusades, 1000–1300*. Ithaca, N.Y., 1999.
- Franquinet, G. D. “Les sièges de Maestricht en 1407 et 1408, avec annexes.” *Annales de la société historique et archéologique à Maestricht* 1 (1854–55): 205–37.
- Frédéric, Pierre. *La mort de Charles le Téméraire (5 janvier 1477)*. Paris, 1966.
- Freud, Sigmund. “Mourning and Melancholia.” In *Collected Papers*. Translated by Joan Riviere. 5 vols. London, 1950. 4:152–70.
- Fris, V. “La bataille de Gavre.” *Bulletin de la société d’histoire et d’archéologie de Gand* 18 (1910): 185–233.
- Froissart: Historian*. Edited by J. J. N. Palmer. Woodbridge, Suffolk, 1981.
- Fryde, E. B. *Peasants and Landlords in Later Medieval England*. Stroud, 1996.
- Funck-Brentano, Frantz. *Philippe le Bel et Flandre: Les origines de la guerre de cent ans*. Paris, 1896.
- Gaier, Claude. *L’industrie et le commerce des armes dans les anciennes principautés Belges du XIII^e à la fin du XV^e siècle*. Paris, 1963.
- . “L’Invincibilité anglaise et le grande arc après la guerre de cent ans: un mythe tenace.” *Tijdschrift voor geschiedenis* 91 (1978): 378–85.
- Galesloot, L. “Acte de Wenceslas et de Jeanne, duc et duchesse de Brabant, du 19 juillet 1356, concernant la ville de Bruxelles.” *BCRH*, [3e sér] 5 (1863): 21–24.
- . *Le livre des feudataires de Jean III, duc de Brabant (1312–1333)*. Brussels, 1865.
- . “Revendication du duché de Brabant par l’Empereur Sigismond (1414–1437).” *BCRH* [4e sér] 5 (1878): 437–70.
- Galiana, Fernando. *Historia de Jijona*. Alicante, 1995.
- García, Michel. *Obra y personalidad del Canciller Ayala*. Madrid, 1983.
- García de Diego, Vincente. *El dialecto aragonés*. Zaragoza, 1916.

- García de Valdeavellano y Arcimus, Luis. *Curso de historia de los institucionales españoles de los orígenes al final de edad media*. Madrid, 1968.
- García Fitz, Francisco. "La frontera castellano-granadina a fines del siglo XIII." in *Relaciones exteriores del Reino de Granada. IV Coloquio de historia medieval andaluza*. Edited by Cristina Segura Graiño. Almería, 1988. 23–35.
- Garrido i Valls, Josep-David. *La conquesta del sud Valencià i Múrcia per Jaume II*. Barcelona, 2002.
- . *Jaume I i el Regne de Múrcia*. Barcelona, 1997.
- Gaupp, Fritz. "The Condottiere John Hawkwood," *History* 23 (March 1939): 305–21.
- Geary, Patrick J. *Living with the Dead in the Middle Ages*. Ithaca, N.Y. 1994.
- Genicot, L. "Empereur et princes en Basse-Lotharingie. Suggestions de recherches." *Revue de l'université de Bruxelles* 5 (1970): 1–19.
- Gérard, Pierre. *La bataille de Nancy, son importance européen*. Paris, 1976.
- Given-Wilson, Christopher and Françoise Beriac. "Edward III's Prisoners of War: The Battle of Poitiers and its Context." *English Historical Review* 116 (2001): 802–33.
- Godding, P. "Le pouvoir urbain en Brabant au Moyen Age." in *Wavre 1222–1972*. Gembloux, 1973. 95–122.
- Gómez de Barreda, Jaime. "Los mayordomos de Aragón en los siglos XII y XIII." *Revista de Archivos, Bibliotecas y Museos* 62 (1953): 349–77.
- Gonzalez Anton, Luis. *Las Cortes de Aragón*. Zaragoza, 1978.
- . *Las uniones aragonesas y las cortes del reino (1283–1301)*. 2 vols. Zaragoza, 1975.
- Gouveia Montiero, João. *A Batalha Real. Aljubarrota—1385*, 2nd ed. Lisbon, 2003.
- Grandson 1476: Essai d'approche d'une action militaire du XV^e siècle*. Edited by Daniel Reichel. Lausanne, 1976.
- Greenland, Hilary. *The Traditional Archer's Handbook: A Practical Guide*. Bristol, 2001.
- Gutiérrez de Velasco, Antonio. "La conquista de Tarazona en la guerra de los Dos Pedros (Año 1357)." *Cuadernos de Historia "Jerónimo Zurita"* 10–11 (1960): 69–97.
- . "La contraofensiva aragonesa en la guerra de los Dos Pedros: Actitud militar y diplomática de Pedro IV el Ceremonioso (años 1358 a 1352)." *CHJZ* 14–15 (1963): 7–30.
- . "Las fortalezas aragonesas ante la gran ofensiva castellan en la guerra de los Dos Pedros." *CHJZ* 12–13 (1961): 7–39.
- . "Los ingleses en España (s. XIV)." *Estudios de Edad Media de la Corona de Aragón* 4 (1951): 230–56.
- . "Pierre IV et Bertrand Duguesclin." *Les cahiers de l'Iroise*, n.s. 17.2 (Apr–Jun 1970): 57–66.
- Haemers, Jelle. *De Gentse opstand (1449–1453). De strijd tussen rivaliserende netwerken om het stedelijke kapitaal*. Kortrijk-Heule, 2004.
- Haines, Roy Martin. *King Edward II: Edward of Carnarfon, His Life, His Reign, and its Aftermath, 1284–1330*. Montreal, 2003.
- Hale, John R. "The Early Development of the Bastion: An Italian Chronology." In *Europe in the Late Middle Ages*. Edited by John R. Hale. Evanston, 1965. 466–94.
- . *Renaissance Fortification: Art or Engineering?* London, 1977.
- Hall, Bert S. *Weapons and Warfare in Renaissance Europe: Gunpowder, Technology, and Tactics*. Baltimore, 1997.
- Harari, Yuval Noah. "Strategy and Supply in Fourteenth-Century Western European Invasion Campaigns." *The Journal of Military History* 64 (2000): 297–333.
- Harbinson, M. "Verneuil—The Events of 17 August 1424: an Examination of the Sources and the Account of Thomas Basin." *The Hobilar* 30 (1998): 18–22.
- Harbottle's Dictionary of Battles*. Edited by George Bruce. New York, 1981.
- Hardy, Robert. *Longbow: A Social and Military History*. London, 1995
- Harvey, L. P. *Islamic Spain, 1250 to 1500*. Chicago, 1990.

- Hay, Denys and John Law. *Italy in the Age of the Renaissance, 1380–1530*. London, 1989.
- Heath, E. G. *A History of Target Archery*. New York, 1973.
- Hèbert, Michel. "Aux origines des États de Provence: la 'cavalcade' générale," *CX Congrès National des Sociétés Savantes Montpellier, 1985*. 3 vols. Paris, 1986. 3:53–68.
- Henne, A. and A. Wauters, *Histoire de la ville de Bruxelles*. 4 vols. Brussels, 1968.
- Henneman, John Bell. *Olivier de Clisson and Political Society in France under Charles V and Charles VI*. Philadelphia, 1996.
- . *Royal Taxation in Fourteenth-Century France: The Development of War Financing (1322–1356)*. Princeton, 1971.
- Heers, Jacques. *Louis XI*. Paris, 2003.
- Hewitt, H. J. *The Black Prince's Expedition of 1355–1357*. Manchester, 1958.
- . *The Organization of War under Edward III*. New York, 1966.
- Hibbert, Christopher. *Agincourt*. New York, 1978.
- Hilton, Rodney. *Bond Man Made Free: Medieval Peasant Movements and the English Rising of 1381*. New York, 1973.
- Historia de España*. Edited by Ramon Menendez Pidal. 37 vols. Madrid, 1963–1984.
- Housely, Norman. "The Bishop of Norwich's Crusade, May 1383," *History Today* 33 (1983): 15–20.
- . *The Later Crusades from Lyons to Alcazar 1274–1580*. Oxford, 1992.
- Howell, Martha C. "Citizenship and Gender: Women's Political Status in Northern Medieval Cities." In *Women and Power*. 37–60.
- Hugenholtz, F. W. N. *Ridderkrijg en burgervrede. West-Europa aan de vooravond van de Honderdjarige Oorlog*. Haarlem, 1959.
- Hughes, Michael. "Fourteenth-Century French Raids on Hampshire and the Isle of Wight." In *Arms, Armies and Fortifications in the Hundred Years War*. Edited by Anne Curry and Michael Hughes. Rochester, N.Y., 1994. 121–44.
- Hunt, Edwin. *The Medieval Super Companies*. Oxford, 1994.
- Iglesia Font, J. "El fogaje de 1365–1370." *Memorias de la Real Academia de Ciencias y Artes* 34 (1962): 254–62.
- Izbicki, Thomas M. "The Punishment of Pride: Castilian Reactions to the Battle of Aljubarrota." In *Medieval Iberia: Essays on the History and Literature of Medieval Spain*. Edited by Donald J. Kagay and Joseph T. Snow. New York, 1997. 217–28.
- Jacob, E. F. *Henry V and the Invasion of France*. London, 1947.
- Jenkins, Helen. *Papal Efforts for Peace under Benedict XII, 1334–1342*. Philadelphia, 1933.
- Johnson, James Turner. *Ideology, Reason and the Limitation of War: Religious and Secular Concepts 1200–1740*. Princeton, 1975.
- . *Just War Tradition and the Restraint of War: A Moral and Historical Inquiry*. Princeton, 1981.
- Johnson, Richard. *The Nine Worthies of London*. London, 1811.
- Jones, Archer. *The Art of War in the Western World*. Urbana, Ill., 1987.
- Jones, Michael. "The Battle of Verneuil (17 August 1424): Towards a History of Courage." *War in History* 9 (2002): 375–411.
- . "The Breton Civil War." In *Froissart, Historian* Edited by J. J. N. Palmer. Woodbridge, Suffolk, 1981. 64–81.
- . *Ducal Brittany 1364–1399: Relations with England and France during the Reign of Duke John IV*. Oxford, 1970.
- . "Ransom Brokerage in the Fifteenth Century." In *Guerre et Société en France en Angleterre et en Bourgogne XIV–XV siècles*. Edited by Philippe Contamine, Chalres Giry-Deloison, and Maurice H. Keen. Lille, 1991. 221–35.
- . "War and Fourteenth-Century France." In *Arms*. 103–20.
- Kaeuper, Richard W. *Chivalry and Violence in Medieval Europe*. New York, 1999.

- Kagay, Donald J. "Army Mobilization, Royal Administration, and the Realm in the Thirteenth-Century Crown of Aragon." In *Iberia and the Mediterranean World of the Middle Ages: Essays in Honor of Robert I. Burns, S. J.* Edited by P. Chevedden, D. Kagay, and P. Padilla, 2 vols. Leiden, 1996. 95–115.
- . "Defending the Western and Southern Frontier in the War of the Two Pedros: An Experiment in Nation-Building." *Journal of the Georgia Association of Historians* 23 (2002): 77–108.
- . "The Defense of the Crown of Aragon during the War of the Two Pedros (1356–1366)." *Journal of Military History* 71 (2007): 11–34.
- . "The Emergence of 'Parliament' in the Thirteenth-Century Crown of Aragon: A View from the Gallery." In *On the Social Origins of Medieval Institutions: Essays in Honor of Joseph F. O'Callaghan*. Edited by Donald J. Kagay and Theresa M. Vann. Leiden, 1998. 223–42.
- . "A Government Besieged by Conflict: The Parliament of Monzón (1362–1363) as Military Financier." In *Hundred Years War*. 117–50.
- . "The National Defense Clause and the Emergence of the Catalan State: *Princeps namque* Revisited." In *Crusaders*. 57–100.
- . "Poetry in the Dock: The Court Culture of Joan Ion Trial (1396–1398)." *Journal of the Georgia Association of Historians* 22(2001): 48–99.
- . "Rebellion on Trial: The Aragonese *Unión* and its Uneasy Connection to Royal Law, 1265–1301." *Journal of Legal History* 18 (1997): 30–43.
- . "Rule and Mis-Rule in Medieval Iberia." *Journal of the Georgia Association of Historians* 21 (2000): 48–66.
- . "Structures of Baronial Dissent and Revolt under James I (1213–76)." *Mediaevistik* 1 (1988): 61–85.
- . "The 'Treasons' of Bemat de Cabrera: Government, Law, and the Individual in the Late-Medieval Crown of Aragon." *Mediaevistik* 13 (2000): 39–54.
- Kaiser, Robert E. "The Medieval English Longbow." *Journal of the Society of Archer-Antiquaries* 23 (1980): 21–29.
- Kantorowicz, Ernst J. *The King's Two Bodies: A Study in Medieval Political Theology*. Princeton, N.J. 1957.
- Keegan, John. *The Face of Battle*. New York, 1976.
- Keen, Maurice H. "The Changing Scene: Guns, Gunpowder, and Permanent Armies." In *Medieval Warfare: A History*. Edited by Maurice Keen. Oxford, 1999. 273–91.
- . *Chivalry*. New Haven, Conn., 1984.
- . *The Laws of War in the Late Middle Ages*. Toronto, 1965.
- . "Treason Trials Under the Law of Arms." *Transactions of the Royal Historical Society*, 5th ser., 12 (1962): 85–103.
- Keeny, Barnaby. "Military Science and the Development of Nationalism in England, 1272–1327." *Speculum* 22 (1947): 538–42.
- Kelley, Lawrence H. *War Before Civilization: The Myth of the Peaceful Savage*. New York, 1996.
- Kempeneer, A. "Les alienations de Malines au XIV^e siècle. Etude sur la situation politique de la seigneurie (1300–1357)." *Bulletin du cercle archéologique, littéraire et artistique de Malines* 15 (1905): 81–104; 17 (1907): 157–99; 18 (1908): 113–29.
- Kendall, Paul Murray. *Louis XI: The Universal Spider*. London, 1974.
- Knecht, Robert J. *Francis I*. Cambridge, 1982.
- Knight, Paul. *Henry V and the Conquest of France—1416–1453*. London, 1998.
- Ladero Quesada, Miguel Angel. "El ejercicio de poder real: Instituciones e instrumentos del gobierno." In *XV Congrés d'història de la corona d'Aragó [El poder real en la Corona de Aragón (Siglos XIV–XVI)]*. 5 vols. Zaragoza, 1993. *Ponencias*. 1:72–140.
- . *Fiscalidad y poder en Castilla (1252–1369)*. Madrid, 1993.
- . *Granada: Historia de un país islámico*. Madrid, 1989.
- Laenen, J. *Geschiedenis van Mechelen tot het einde der Middeleeuwen*. Malines, 1934.

- Lafaille, M. G. *Annales de la ville de Toulouse depuis la réunion de la Comté de Toulouse à la Couronne: avec un abrégé de l'ancienne histoire de cette ville: et un recueil de divers titres et actes pour servir de preuves au d'éclaircissement à ces Annales*. Toulouse, 1687–1701.
- Lalinde Abadía, Jesús. *La Corona de Aragón en el Mediterráneo medieval*. Zaragoza, 1979.
- . *La gobernación general en la Corona de Aragón*. Madrid, 1963.
- Lander J. R. "The Hundred Years War and Edward IV's 1475 Campaign in France." In *Tudor Men and Institutions: Studies in English Law and Government*. Edited by A. J. Slavin. Baton Rouge, La., 1972. 70–100.
- Lange, Joseph. "Pulchra Nussia: Die Belagerung der Stadt Neuss, 1474/75." In *Neuss, Burgund und das Reich*. Neuss, 1975. 9–190.
- Langlois, Charles-Victor. *Registres perdus des archives de la Chambre des comptes de Paris*. Paris, 1916.
- Last Things: Death and the Apocalypse in the Middle Ages*. Edited by Caroline Walker Bynum and Paul Freedman. Philadelphia, 2000.
- Laurent H. "Les conventions de Saint-Quentin Guin 1347). Contribution à l'histoire de la première phase de la guerre de Cent Ans dans les Pays-Bas." BCRH 91 (1927): 89–180.
- . *Un grand commerce d'exportation européen au moyen âge. La draperie des Pays-Bas en France et dans les pays méditerranéens (XII^e–XV^e siècle)* Paris, 1935.
- . and F. Quicke, "La guerre de la succession du Brabant (1356–1357)." *Revue du Nord* 13 (1927): 81–121.
- Le Blanc, Gratiën. "Toulouse: Les remparts du Faubourg Saint-Cyprien." *Mémoires de la société archéologiques du Midi de la France* 45 (1983–1984): 19–137.
- Le Goff, Jacques. *Medieval Callings*. Translated by Lydia G. Cochrane. Chicago, 1987.
- Le Patourel, J. "The Treaty of Brétigny, 1360." *Transactions of the Royal Historical Society* 10 (5th ser.) (1960): 19–39.
- Leguai, André. "La conquête de la Bourgogne par Louis XI." *Annales de Bourgogne* 49 (1977): 7–12.
- Leguay, Jean-Pierre. *La rue au moyen âge*. Rennes, 1984.
- Lennel, F. *Histoire de Calais*, vol 2: *Calais sous la domination Anglaise* Calais, 1910.
- Leroux, A. *Recherches critiques sur les relations politiques de la France avec l'Allemagne de 1292 à 1378*. Paris, 1882.
- Lesaffér, Randall. "Cedant arma togae. De vrede van Athis-sur-Orge (1305)." In *Omtrent 1302*, ed. Paul Trio, Dirk Heirbaut, and Dirk van den Auweele. Leuven, 2002. 161–81.
- Lewis, P. S. *Later Medieval France: The Polity*. New York, 1968.
- Liddell Hart, B. H. *Strategy*. New York, 1954.
- Liebman, C. J. "Un sermon de Philippe de Vilette, abbé de Saint-Denis, pour la levée de l'oriflamme (1414)." *Romania* 68 (1944–1945): 444–70.
- Liège et Bourgogne: Actes du colloque tenu à Liège les 28, 29 et 30 octobre 1968*. Liège, 1972.
- Lomas, Richard. *North-East England in the Middle Ages*. Edinburgh, 1992.
- Lombares, Michel de. "Castillon (17 juillet 1453), dernière bataille de la guerre de Cent Ans, première victoire de l'artillerie." *Revue historique des armées* 6 (1976): 7–31.
- Lomax, Derek W. *The Reconquest of Spain*. London, 1978.
- Lopez de Meneses, Amada. *Documentos acerca de la peste negra en los dominios de la Corona de Aragón*. Zaragoza, 1956.
- Lopez Perez, Maria D. *La Corona de Aragón y el Magreb en el siglo XIV (1311–1410)*. Barcelona, 1995.
- . "Las relaciones comerciales y diplomáticas entre la Corona de Aragón y los estados norteafricanos durante la Baja Edad Media." *Anuario de estudios medievales* 20 (1990): 149–69.
- Lopez Pizueta, Tomas. "Sobre la percepción del 'botvatge' en el siglo XIV: Una aportación al tema de la tasación directa en la Cataluña bajomedieval." In *Estudios sobre renta, fiscalidad y finanzas en la Cataluña bajomedieval*. Barcelona, 1993. 335–46.

- Lourie, Elena. "A Society Organized for War: Medieval Spain," *Past and Present* 35 (1966): 54–76.
- Lucas, H. S. "John III, Duke of Brabant, and the French Alliance, 1345–1347." *University of Washington Publications in the Social Sciences* 4 (1927): 5–63.
- . *The Low Countries and the Hundred Years War (1326–1347)*. Ann Arbor, Mich., 1929.
- Luttwak, Edward N. *Strategy: The Logic of War and Peace*. Cambridge, Mass., 1995.
- Lyon, Bruce D. *From Fief to Indenture: The Transition from Feudal to Non-Feudal Contract in Western Europe*. Cambridge, Mass., 1957.
- Macdonald, Alastair J. *Border Bloodshed: Scotland, England and France at War, 1369–1403*. East Linton, 2000.
- Mackenzie, W. M. *The Battle of Bannockburn: A Study in Mediaeval Warfare*. Glasgow, 1913.
- McFarlane, K. B. "War and Society, 1300–1600. England and the Hundred Years War." *Past and Present* 22 (1962): 3–13.
- McGlynn, Sean. "The Myths of Medieval Warfare." *History Today* 44/1 (January, 1994): 28–34.
- McLaughlin, Megan. *Consorting with Saints: Prayer for the Dead in Early Medieval France*. Ithaca, N.Y., 1994.
- McNamara, Jo Ann and Suzanne Wempe. "The Power of Women through the Family in Medieval Europe, 500–1000." In *Women and Power*. 83–101.
- McNamee, Colm. *The Wars of the Bruces: Scotland, England, and Ireland 1306–1328*. East Lothian, Scot., 1997.
- McRobbie, Kenneth. "The Concept of Advancement in the Fourteenth Century in the *Chroniques* of Jean Froissart." *Canadian Journal of History* 6 (1971): 1–19.
- Macia Serrano, Antonio. *Elche: La ciudad de misterio*. Madrid, 1964.
- Maddern, Philippa. *Violence and Social Order*. New York, 1992.
- Maddicott, J. R. *The English Peasantry and the Demands of the Crown, 1294–1341. Past and Present Supplement* Oxford, 1975.
- . "The Origins of the Hundred Years War." *History Today* 36 (1986): 31–37.
- Matland, Frederick William. *Domesday Book and Beyond*. New York, 1966.
- Major, J. Russel. *From Renaissance Monarchy to Absolute Monarchy*. Baltimore, 1994.
- Malet, Albert. *Histoire de France*. Paris, 1928.
- Mallett, Michael. *Mercenaries and their Masters*. Totowa, N.J., 1974.
- Malone, Patrick M. *The Skulking Way of War: Technology and Tactics among the New England Indians*. New York, 2000.
- Mancini, Dominic. *The Usurpation of Richard the Third*. Translated by C. A. J. Armstrong. 1969; reprint, London, 1989.
- Manni, Domenico M. "Commentario della vita del famoso capitano Giovanni Aguto Inglese, General condottiere d'armi fiorentini." In *Rerum Italicarum Scriptores*. Supplementum II. Florence, 1777.
- Manzano Rodriguez, Miguel Angel. *La intervencion de los Benimerines en la Peninsula Iberica*, Madrid, 1992.
- Maran, Rene. *Bertrand du Guesclin, L'Epee du Roi*. Paris, 1960.
- Marongiu, Antonio. *Medieval Parliaments: A Comparative Study*. London, 1968.
- Martí i Castell, Joan. *Els orgens de la llengua catalana*. Barcelona, 2001.
- Martin Rodriguez, Jose-Luis. "Les Corts catalanes del 1358." *Estudis d'història de la corona d'Aragó* 4 (1971): 71–86.
- . "Las cortes catalanes en la guerra castellano-aragonesa (1356–1365)." In *VIII Congrés d'història de la corona d'Aragó*. 2 vols. (Valencia, 1970). 2:79–90.
- . "Los cortes de Pedro el Ceremonioso." In *Pere el Cerimoniós*. 99–112.
- Martínez Aloy, José. *La diputación de la generalidad del reino de Valencia*. Valencia, 1930.
- Martínez Ferrando, J. E. *La trágica historia dels reis de Mallorca*. 1960; reprint, Barcelona, 1979.

- Meloni, G. *Genova e Aragona*. Padua, 1971.
- Menanche, Sophia. "Isabelle of France, Queen of England—A Reconsideration." *Journal of Medieval History* 10 (1984): 107–124.
- Miller, Richard B. *Interpretations of Conflict: Ethics, Pacifism and the Just-War Tradition*. Chicago, 1991.
- Minois, Georges. *Du Guesclin*. Paris, 1996.
- Miret y Sans, Joaquin. "Négociations de Pierre IV d'Aragon avec la cour de France (1366–1367)." *Revue hispanique* 13 (1905): 76–135.
- Mirot, L. *La politique française en Italie de 1380 à 1422, Les préliminaires de l'alliance florentine*. Paris, 1934.
- . and E. Deprez. "Les ambassades anglaises pendant la guerre de Cent Ans." *BEC* 59 (1898): 550–77; 60 (1899): 177–214; 61 (1900): 20–58, 570–71.
- Mitre Fernández, Emilio. "Castilla ante la Guerra de los Cien Años: actividad militar y diplomática de los orígenes de conflicto al fin de las grandes treguas (c. 1340–c. 1415)." In *XXXI Semana de Estudios Medievales, Estella, 18 a 22 de julio de 2004*. Pamplona, 2005. 199–236.
- Mohr, Friedrich. *Die Schlacht bei Rosebeke am 27. November 1382: Ein Beitrag zur mittelalterlichen Kriegsgeschichte*. Berlin, 1906.
- Mollat, G. *The Popes at Avignon: The "Babylonian Captivity" of the Medieval Church*. Translated by Janet Love. New York, 1963.
- Morel, Octave. *La grande chancellerie royale et l'expédition des lettres royales de l'avènement de Philippe de Valois à la fin du XIV^e siècle (1328–1400)*. Paris, 1900.
- Morsberger, Robert E. *Swordplay and the Elizabethan and Jacobean Stage*. Salzburg, Austria, 1974.
- Muhlberger, Steven. *Deeds of Arms: Formal of Combats in the Late Fourteenth Century*. Highland Village, Texas, 2005.
- Mund, S. "Antoine de Bourgogne, prince français et duc de Brabant (1404–1415)," *RBPH* 76 (1998): 319–55.
- Mundy, John Hine. *Society and Government at Toulouse in the Age of the Cathars*. Toronto, 1997.
- Die Murtenschlacht: Ein Schweizer Ereignis in Europas Geschichte zwischen Mittelalter und Neuzeit, 1476–1976*. Fribourg, 1976.
- Myers, A. R. *Parliaments and Estates in Europe to 1789*. London, 1975.
- Nader, Helen. *The Mendoza Family in the Spanish Renaissance 1350–1550*. Rutgers, N.J., 1979.
- Neillands, Robin. *The Hundred Years War*. New York, 1990.
- Newhall, Richard Ager. *The English Conquest of Normandy, 1416–24: A Study in Fifteenth Century Warfare*. New Haven, Conn., 1924.
- Nicholas, David. "The Scheldt Trade and the 'Ghent War' of 1379–85." *Bulletin de la commission royale d'histoire de Belgique* 144 (1978): 189–359.
- . *The Van Artevelde of Ghent: The Varieties of Vendetta and the Hero in History*. Ithaca, N.Y., 1988.
- Nicolas, Nicholas H. *History of the Battle of Agincourt and of the Expedition of Henry the Fifth into France in 1415*. 1833. Reprint. London, 1971.
- Nicholson, Helen. *Medieval Warfare*. New York, 2004.
- Nicholson, Ranald. *Edward III and the Scots: The Formative Years of a Military Career, 1327–1335*. Oxford, 1965.
- . "The Last Campaign of Robert Bruce," *English Historical Review* 77 (1962): 233–46.
- . *Scotland: The Later Middle Ages*. New York, 1974.
- . "The Siege of Berwick, 1333," *Scottish Historical Review* 40 (1961): 19–42.
- Nicolle, David. *Knights Hospitaller 1306–1565*. London, 2001.
- . *Nicopolis, 1396: The Last Crusade*. London, 1999.
- Nijhoff, I. A. *Gedenkwaardigheden uit'edegeschiedenis van Gelderland*. 8 vols. Arnhem, 1830–1875.

- Nikolaas Zannekin en de slag bij Kassel, 1328–1978: *Bijdrage tot de studie van de 14de eeuw en de landelijke geschiedenis van de Westhoek*. Diksmuide, 1978.
- Nora, Pierre, “Between Memory and History: Les lieux de mémoire.” *Representations*. Special issue. 26 (1989): 7–25.
- Oakeshott, Ewart. *Sword in Hand—A Brief Survey of the Knightly Sword*. Minneapolis, 2001.
- O’Callaghan, Joseph F. *A History of Medieval Spain*. Ithaca, N.Y., 1975.
- . “Kings and Lords in Conflict in Late Thirteenth-Century Castile and Aragon.” In *Iberia and the Mediterranean World*. 2:117–38.
- O’Connell, Robert L. *Of Arms and Men: A History of War, Weapons, and Aggression*. Oxford, 1989.
- Offer, H. S. “England and Germany at the Beginning of the Hundred Years’ War.” *English Historical Review* 54 (1939): 608–31.
- Oidtman, H. *Die Schlacht bei Baesweiler am 22 August 1371*. Geilenkirchen, 1905.
- Oman, Charles. *A History of War in the Middle Ages*. New York, 1924.
- . *A History of War in the Sixteenth Century*. 1937; reprint, London, 1989.
- Ormod, W. C. “The Domestic Response to the Hundred Years War.” In *Arms*, 83–102.
- Owen, Leonard V. D. *The Connection Between England and Burgundy During the First Half of the Fifteenth Century*. Oxford, 1909.
- Pagolo Morelli. Giovanni di. *Ricordi*. Florence, 1969.
- Palmer, J. J. N. *England, France and Christendom: 1377–99*. Chapel Hill, N.C., 1972.
- Palomeque Torres, Antonio. “Contribución al estudio del ejército en los estados de la reconquista.” *Anuario de Historia de l Derecho Español* 15 (1944): 231–53.
- Paravicini, Werner. *Karl der Kühne: Das Ende des Hauses Burgund*. Göttingen, 1976.
- Parker, Geoffrey. *The Military Revolution: Military Innovation and the Rise of the West, 1500–1800*. Cambridge, 1988.
- Parronchi, Alessandro. *Paolo Uccello*. Bologna, 1974.
- Pastor de la Roca, Jose. *Historia general de la ciudad y castillo de Alicante: Descripción de sus monumentos, antigüedades, y ruinas*. Alicante, 1854.
- Paxton, Frederick. *Christianizing Death: The Creation of a Ritual Process in Early Medieval Europe*. Ithaca, N.Y., 1990.
- The Peace of God: Social Violence and Religious Response in France around the Year 1000*. Edited by Thomas Head and Richard Landes. Ithaca, N.Y., 1992.
- Penman, Michael. *David II, 1329–71*. East Linton, 2004.
- Pepper, Simon. “Castles and Cannon in the Naples Campaign of 1494–95.” In *The French Descent into Renaissance Italy, 1494–95: Antecedents and Effects*. Edited by David Abulafia. Aldershot, 1995. 263–93.
- . and Nicholas Adams. *Firearms and Fortifications: Military Architecture and Siege Warfare in Sixteenth-Century Siena*. Chicago, 1986.
- Pernoud Regine and Marie-Veronique Clin. *Joan of Arc: Her Story*. Revised and translated by J. D. Adams. New York, 1998.
- Perroy, E. L. *L’Angleterre et le grand schisme d’occident*. Paris, 1933.
- . *La guerre de CentAns*. Paris, 1945. Translated by W. B. Wells as *The Hundred Years War*. New York, 1965.
- Phillpotts, Christopher. “The French Plan of Battle During the Agincourt Campaign.” *English Historical Review* 99 (1984): 59–64.
- Phillips, William D., Jr. “The Spanish Kingdoms and the Wider World in the Later Middle Ages.” In *Iberia and the Mediterranean World*, 2:407–30.
- Pirenne, Henri. *Early Democracies in the Low Countries: Urban Society and Political Conflict in the Middle Ages and the Renaissance*. Translated by J. V. Saunders. 1915; reprint, New York, 1963.
- Pizzagalli, Daniela. *Bernabò Visconti*. Milan, 1994.

- The Place of the Dead in Late Medieval and Early Modern Europe*. Edited by Bruce Gordon and Peter Marshall. Cambridge, 2000.
- Plaisse, André. *Charles dit le Mauvais, comte d'Evreux, roi de Navarre, capitaine de Paris*. Evreux, 1972.
- Pons Guri, J. M. "Un fogatjament desconegut de l'any 1358." *Boletín de Real Academia de Buenas Letras de Barcelona* 30 (1963–1964): 339–46.
- Porter, Roy. *The Greatest Benefit to Mankind: A Medical History of Humanity*. New York/London, 1997.
- Powell, James M. "The Role of Women in the Fifth Crusade." In *The Horns of Hattin*. Edited by B. Z. Kedar. Jerusalem, 1992. 294–301.
- Powicke, F. M. *King Henry III and Lord Edward: The Community of the Realm in the Thirteenth Century*. 2 vols. Oxford, 1947.
- . *Military Obligation in Medieval England*. 1962; Reprint, Oxford, 1947.
- Pratt, R. A. "Geoffrey Chaucer esq. and Sir John Hawkwood," *Journal of English Literary History* 16 (1949): 188–93.
- Prestwick Michael. *Armies and Warfare in the Middle Ages: The English Experience*. New Haven, Conn., 1996.
- . *Edward I*. London and New Haven, 1988.
- . *The Three Edwards: War and State in England, 1272–1377*. London, 1981.
- . *War and State in England 1272–1377*. 1980; reprint. London, 1996.
- Prims, F. *Geschiedenis van Antwerpen*. 10 vols. Brussels-Antwerp, 1910–1948.
- Prince, A. E. "A Letter of Edward the Black Prince describing the Battle of Nájera in 1367." *English Historical Review* vol. 41, no. 163 (July, 1926), 415–18.
- . "The Importance of the Campaign of 1327." *English Historical Review* 50 (1935): 299–302.
- Privité-Orton, C. W. *The Shorter Cambridge Medieval History*. 2 vols. 1952; reprint, Cambridge, 1979.
- Queller, Donald E. *The Office of Ambassador in the Middle Ages*. Princeton, N.J., 1967.
- Quicherat, Jules. *Rodrigue de Villandrando, l'un des combarrants pour l'Indépendance Française au Quinzième siècle*. Paris, 1879.
- Quicke, F. "Antoon I van Brabant." In *Geschiedenis van Vlaanderen*. Edited by R. van Roosbroeck. 6 vols. Brussels, 1938. 383–100.
- . "Jean de Saint-Amand, chanoine de Cambrai, chapelain du pape: faussaire, traître et espion (133 1368)," In *Etudes d'histoire dédiées à la mi mémoire de H. Pirenne* (Brussels, 1937), 265–88.
- . *Les Pays-Bas à la veille de la période bourguignonne (1345–1384). Contribution à l'histoire politique et diplomatique de l'Europe occidentale de la seconde moitié du XIV^e s.* Brussels, 1947.
- . "Les relations diplomatiques entre le roi des Romains Sigismond et la Maison de Bourgogne (fill 1416–début 1417)." *BCRH* 90 (1926): 193–241.
- Ransing, Gad. *The Bow: Some Notes on Its Origin and Development*. Lund, 1967.
- Reilly, Bernard F. *The Medieval Spains*. Cambridge, 1993.
- Renouard, Yves. *The Avignon Papacy: The Popes in Exile 1305–1403*, trans. Denis Bethell. 1954. Reprint. New York, 1994.
- Reyerson, Kathryn L. *Jacques Coeur: Entrepreneur and King's Bursar*. New York, 2005.
- Richard II: The Art of Kinship*. Edited by Anthony Goodman and James Gillespie. Oxford, 1999.
- Richardson, Bill. *Spanish Studies: An Introduction*. London, 2001.
- Richey, Stephen W. *Joan of Arc: The Warrior Saint*. Westport, Conn., 2003
- Ricotti, Ercole. *Storia delle compagnie di ventura in Italia*. 6 vols Turin, 1844.
- Robbins, Kevin C. "The Social Mechanisms of Urban Rebellion: A Case Study of Leadership in the 1614 Revolt at La Rochelle." *French Historical Studies* 19, no. 2 (Fall 1995): 559–90.

- Robins, Patricia. "Le mariage de Marguerite d'York et de Charles le Téméraire en 1468." *Handelingen van de koninklijke kring voor oudheidkunde, letteren en kunst van Mechelen* 95 (1991): 75–96.
- Rogers, Clifford J. "The Age of the Hundred Years War." In *Medieval Warfare*. 136–60.
- . "The Anglo-French Peace Negotiations of 1354–1360 Reconsidered." In *The Age of Edward III*. Edited by James Bothwell. New York, 2001. 193–213.
- . "The Battles of Bergerac (1345) and the Generalship of Henry of Lancaster." *Journal of Medieval Military History* II (2003): forthcoming.
- . "By Fire and Sword; *Bellum Hostile* and 'Civilians' in the Hundred Years' War." In *Civilians in the Path of War*. Edited by Mark Grimsley and Clifford J. Rogers. Lincoln, Neb., 2002. 33–78.
- . "A Continuation of the *Manuel d'histoire de Philippe VI* for the Years 1328–39." *English Historical Review* 114 (1999): 1256–66.
- . "The Military Revolutions of the Hundred Years' War" *The Journal of Military History* 57 (1993): 271–88.
- . "The Offensive/Defensive in Medieval Strategy." In *From Crécy to Mohács: Warfare in the Late Middle Ages (1346–1526)*. *Acta of the XXIIInd Colloquium of the International Commission of Military History*. Vienna, 1997. 158–71.
- . "The Scottish Invasion of 1346," *Northern History* 34 (1998): 51–69.
- . "An Unknown News Bulletin from the Siege of Tournai in 1340." *War in History* 5 (1998): 358–66.
- . *War Cruel and Sharp. English Strategy under Edward III, 1327–1360*. Woodbridge, Suffolk, 2000.
- . ed. *The Military Revolution Debate: Readings on the Military Transformation of Early Modern Europe*. Boulder, Colo., 1995.
- Rogers, Randall. *Latin Siege Warfare in the Twelfth Century*. Oxford, 1992.
- Rose, Walther. "König Johann der Blinde von Böhmen und die Schlacht bei Crécy (1346)." *Zeitschrift für historisches Waffenkunde* 7 (1915–17): 37–60.
- Rosenthal, Joel T. "Other Victims: Peeresses as War Widows, 1450–1500." In *Upon My Husband's Death: Widows in the Literature and History of Medieval Europe*. Edited by Louise Mirrer. Ann Arbor, Mich., 1992. 131–52.
- Rubio y Cambronero, Ignacio. *La Deputació del General de Catalunya*. 2 vols. Barcelona, 1950.
- Ruggiero, Guido. *Violence in Early Renaissance Venice*. New Brunswick, N.J., 1980.
- Ruiz, Teófilo. *From Heaven to Earth: The Reordering of Castilian Society, 1150–1350*. Princeton, N.J., 2004.
- Rule, Margaret. *The Mary Rose*. London, 1983.
- Russell, Josiah Cox. *Medieval Regions and their Cities*. Newton Abbot, 1972.
- Russell, P. E. *The English Intervention in Spain and Portugal in the time of Edward III and Richard II*. Oxford, 1955.
- Sabbe, J. *Vlaanderen in opstand, 1323–1328: Nikolaas Zannekin, Zeger Janszone en Willem de Deken*. Bruges, 1992.
- Salamagne, Alain. "L'attaque des places-fortes au XV^e siècle à travers l'exemple des guerres anglo et franco-bourguignonnes." *Revue historique* 289 (1993): 65–113.
- Salazar de Mendoza, Pedro. *Monarquía de España*. 2 vols. Madrid, 1770.
- Saltel, J. *La folie du roi Charles VI*. Toulouse, 1907.
- Sample, Dana L. "The Case of Robert of Artois (1309–1337)." Ph.D. diss. City College of New York, 1996.
- Sánchez Martínez Manuel. "La convocatoria del *usatge Princeps namque* en 1368 y sus repercusiones en la ciudad de Barcelona." *Barcelona Quaderns d'Història* 4 (2001): 79–107.
- Santamaria, Alvaro. "La expansion politico-militar de la corona de Aragón bajo la dirección de Jaime I: Baleares." In *Jaime I y su Epoca, X Congrès de la història de la corona d'Aragó*. 3 vols. Zaragoza, 1979. *Ponencias*. 93–146.

- Santorò, Caterina. *La Politica Finanziaria dei Visconti*. 2 vols. Milan, 1976.
- Sapori, Armando. *La crisi delle compagnie mercantili dei Bardi e dei Peruzzi*. Florence, 1926.
- . *Il Libro di commercio dei Peruzzi*. Milan, 1934.
- Sarasa Sánchez, Esteban. *Las Cortes de Aragón en la Edad Media*. Zaragoza, 1979.
- . *El privilegio general de Aragón: La defensa de las libertades aragonesas en la Edad Media*. Zaragoza, 1983.
- Saunders, Frances Stonor. *Hawkwood, Diabolical Englishman*. London, 2004.
- Sautier, Albert. *Papst Urban V und die Soldnerkompagnien in Italien in den Jahren 1362–1367*. Zurich, 1911.
- Schelle, Klaus. *Charles le Téméraire: La Bourgogne entre les lys de France et l'aigle de l'Empire*. Fayard, 1979.
- Schmitt, Jean-Claude. *Le revenants: Les vivants et les morts dans la société médiévale*. Paris, 1994.
- Schnerb, Bertrand. *Les Armagnacs et les Bourguignons: La maudite guerre*. Paris, 1988.
- . *L'état Bourguignon, 1363–1477*. Paris, 1999.
- . *Jean sans Peur: Le prince meurtrier*. Paris, 2005.
- . "Vassals, Allies, and Mercenaries: The French Army before and after 1346," In *Battle of Crécy*. 265–72.
- Schofield, Phillip R. *Peasant and Community in Medieval England 1200–1500*. Houndmills, 2003.
- Sedgwick, Henry Dwight. *The Life of Edward the Black Prince, 1330–1376*. New York, 1993.
- Seizer, Stephan. *Deutsche Sojdnier im Italien des Trecento*. Tübingen, 2001.
- Sermon, H. *Geschiedenis van Peeter Coutherele, meïer van Louvain, een volksvriend uit de XIV^e eeuw*. Antwerp, 1860.
- Sesma Muñoz, José Angel. "La fijación de fronteras económicas entre los estados de la Corona de Aragón." *Aragón en la Edad Media* 5 (1983): 155–61
- . and J. A. Armillas. *La Diputación de Aragón: El gobierno aragonés del Reino a la Comunidad Autónoma*. Zaragoza, n.d.
- Seward, Desmond. *Henry V as Warlord*. London, 1987.
- . *The Hundred Years War: The English in France 1337–1453*. New York, 1978.
- Sharpe, Reginald R. *London and the Kingdom: A History*. London, 1894.
- Sherborne, James. "The Battle of La Rochelle and the War at Sea, 1372–5." *Bulletin of the Institute of Historical Research* 42 (1969): 17–29.
- Shneidman, J. Lee. *The Rise of the Aragonese-Catalan Empire, 1200–1350*. 2 vols. New York, 1970.
- Silver, George. *Paradoxes of Defense*. London, 1599.
- Simpson, M. A. "The Campaign of Verneuil." *English Historical Review* 49 (1934): 93–100.
- Sitges, J. B. *Las mujeres del rey don Pedro I de Castilla*. Madrid: 1910.
- Small, Graeme. *George Chastellain and the Shaping of Valois Burgundy*. Woodbridge and Rochester, 1997.
- Smith, Angel and Clare Mar-Molinero. "The Myths and Realities of Nation-Building in the Iberian Peninsula." In *Nationalism and the Nation in the Iberian Peninsula: Competing and Conflicting Identities*. Edited by Clare Mar-Molinero and Angel Smith. Oxford, 1996. 1–32.
- Smith, Robert Douglas and Kelly DeVries. *The Artillery of the Dukes of Burgundy, 1363–1477*. Woodbridge, 2005.
- Smythe, Sir John. *Certain Discourses Militarie*. London: 1590.
- Socarrats, Johannes de. In *Tractatum Petri Alberti Canonici Barchinonensis de Consuetudines Cataloniae inter Dominos & Vassallosac Nonnullis Aliis que Commemoraciones Petri Alberti Apellantur*. Barcelona, 1551.
- Soisson, Jean-Pierre. *Charles le Téméraire*. Paris, 1999.

- Soldevila, Ferran. "A propòsit del servei del bovatge." *Anuario de Estudios Medievales* 1 (1954): 753–87.
- . *Història de Catalunya*. 3 vols. Barcelona, 1934.
- Spain in the Fifteenth Century 1369–1516*. Edited by Roger Highfield. Translated by Frances M. López-Morillas. New York, 1972.
- Spanish Cities of the Golden Age: The Views of Anton van den Wyngaerde*. Edited by Richard L. Kagan. Berkeley, 1989.
- Spiegel, Gabrielle. *The Chronicle Tradition of Saint Denis*. Leiden, 1978.
- Stengers, J. "Philippe le Hardi et les Etats de Brabant," In *Hommage au Professeur Paul Bonenfant (1899–1965)*. Brussels, 1965. 383–408.
- Strayer, Joseph R. *Medieval Statecraft and the Perspectives of History*. Princeton, N.J., 1971.
- Strickland, Matthew. *War and Chivalry: The Conduct and Perception of War in England and Normandy, 1066–1217*. Cambridge, 1996.
- Strocchia, Sharon. *Death and Ritual in Renaissance Florence*. Baltimore, 1992.
- Suárez Fernández, Luis. *El Chanciller Ayala y su Tiempo*. Vitoria, 1962.
- Sumption, Jonathan. *Trial by Battle*, vol. 1 of *The Hundred Years War*. Philadelphia, 1990.
- . *Trial by Fire*. Vol. 2 of *The Hundred Years War*. 2 vols. to date. Philadelphia, 1999.
- Sylvester, David. "Maritime Communities in Pre-Plague England: Winchelsea and the Cinque Ports." PhD diss., Fordham University, 1999.
- Tailleur, Miche. *Vivre à Toulouse sous l'Ancien Régime*. Paris, 2000.
- Tasis i Marca, Rafael. *Pere el Cerimoniós i els seus fills*. Barcelona, 1980.
- Taylor, Andrew. "Chivalric Conversation and Denial of Male Fear." In *Conflicted Identities and Multiple Masculinities: Men in the Medieval West*. Edited by Jacqueline Murray. New York, 1999. 169–88.
- TeBrake, William H. *A Plague of Insurrection: Popular Politics and Peasant Revolt in Flanders, 1323–1328*. Philadelphia, 1993.
- Temple-Leader, John and Giuseppe Marcotti. *Sir John Hawkwood*. London, 1889.
- Thielmans, Marie-Rose. *Bourgogne et Angleterre: relations politiques et économiques entre les Pays-Bas Bourguignonnes et l'Angleterre, 1435–1467*. Brussels, 1966.
- Thompson, James Westfall and Edgar Nathaniel Johnson, *An Introduction to Medieval Europe 300–1500*. New York, 1937.
- Torres Delgado, Cristóbal. *El antiguo reino nazari de Granada (1232–1340)*. Granada, 1974.
- Torres Fontes, J. *La reconquista de Murcia en 1266 por Jaime I de Aragón*. Murcia, 1987.
- Tourneur-Aumont J. M. *La bataille de Poitiers (1356) et la construction de la France*. Paris, 1940.
- Towns and Townspeople in the Fifteenth Century*. Edited by John A. F. Thomson. Wolfboro, N. H., 1988.
- The Traditional Bowyers' Bible*. Edited by J. Hamm. 3 vols. Azle, Tex., 1992–1994.
- The Trial of Joan of Arc*. Edited by W. S. Scott. Westport, Conn., 1956.
- Turner, Craig and Tony Soper. *Methods and Practice of Elizabethan Swordplay*. Carbondale, Ill., 1990.
- Trease, Geoffrey. *The Condottieri*. New York, 1971.
- Trehearne, R. F. *The Baronial Plan of Reform 1252–1263*. 1932. Reprint. Manchester, 1971.
- Tuchman, Barbara. *A Distant Mirror: The Calamitous Fourteenth Century*. New York, 1978.
- Turner, Victor. *The Ritual Process*. Chicago, 1969.
- Turner, Wendy J. "Afflicted with Insanity: The Care and Custody of the Feeble Minded in Late-Medieval England." Ph.D. diss., UCLA, 2000.
- Ubieto Arteta, Antonio. "La reconquista de Valencia y Murcia." In *X CHCA. Ponencias*. 149–65.

- Uyttebrouck, A. "Brabant-Limburg 1404–1482." *AGN* 2 (1982): 224–46.
- . *Le gouvernement du duchi de Brabant au bas moyen âge (1355–1430)*. 2 vols. Brussels, 1975.
- . "Le rôle politique des villes brabançonnes au bas moyen âge." *Bulletin trimestriel du Crédit Communal de Belgique* 116 (1976): 115–30.
- . and A. Graffart. "Quelques documents inédits concernant l'accession de la Maison de Bourgogne au duché de Brabant (1395–1404)." *BCRH* 137 (1971): 57–137.
- Valderon Baroque, Julio. *Enrique II de Castilla: La guerra civil y la consolidación del régimen (1366–1371)*. Valladolid, 1966.
- Vale, Malcolm. "A Burgundian Funeral Ceremony: Olivier de la Marche and the Obsequies of Adolf of Cleves, Lord of Revenstein." *EHR* 111:443 (Sept., 1996): 92–39.
- . *The Origins of the Hundred Years War: The Angevin Legaty 1250–1340*. Oxford, 1996.
- Vallière, P. E. de and P. E., Morat. *Le siège et la bataille, 1476*. Lausanne, 1926.
- Van Werveke, Hans. *Jacques van Artevelde*. Brussels, 1943.
- Vander Linden, H. *Geschiedenis van de stad Louwen*. Louvain, 1899.
- Vandermaesen, M. and M. Ryckaert. "De Genste opstand (1379–1385)," in *De witte Kaproenen: De Gentse opstand en de geschiedenis van de Brugse Leie*. Edited by Maurice Vandermaesen, Marc Ryckaert, and Maurits Coornaert. Ghent, 1979. 7–31.
- Vanderpol, Alfred. *La doctrine scolastique du droit du guerre*. Paris, 1919.
- Vaughn, Richard. *Charles the Bold: The Last Valois Duke of Burgundy*. London, 1973.
- . *The History of Valois Burgundy, 1384–1477*. Woodbridge, Suffolk, 2003.
- . *John the Fearless: The Growth of Burgundian Power*. London, 1966.
- . *Philip the Bold: The Formation of the Burgundian State*. London, 1962.
- . *Philip the Good: The Apogee of Burgundy*. London, 1970.
- Verbruggen, J. F. *The Art of War in Western Europe During the Middle Ages from the Eighth Century to 1340*. Translated by S. Williard and S. C. M. Southern. London, 1977.
- . *The Battle of the Golden Spurs: Courtrai, 11 July 1302*. Edited by Kelly DeVries. Translated by David Richard Ferguson. Woodbridge, 2002.
- . "Koning Edward III van Engeland te Vilvoorde in 1339 en 1340." *Diemaandelijks Ts Heemkt: Herlog Hendrik* 16 (1992): 6–20.
- . *Vlaanderen na de Guldensporenslag*. Bruges, 1991.
- . and Rolf Falt, *1302 opstand in Vlaanderen*. Tiel, 2002.
- Vercel, Roger. *Du Guesclin*. Paris, 1932.
- Vernier, Richard. *The Flower of Chivalry: Bertrand du Guesclin and the Hundred Years War*. Woodbridge, Suffolk, 2003.
- Viard, Jules. "La campagne de juillet-août 1346 et la bataille de Crécy." *Moyen Âge* 27 [2nd ser.] (1926): 1–84.
- . "Le siège de Calais, 4 septembre 1346–4 août 1347." *Moyen Âge* 30 [2nd ser.] (1929): 124–89.
- Vicens Vives, Jaime. *Manual de historia economica de España*. 2 vols. Barcelona, 1964.
- Villalon, L. J. Andrew. "Pedro the Cruel: Portrait of a Royal Failure." In *Medieval Iberia: Essays on the History and Literature of Medieval Spain*. Edited by Donald J. Kagay and Joseph T. Snow. New York, 1997. 201–16.
- . "Seeking Castles in Spain: Sir Hugh Calveley and the Free Companies' Mid-Fourteenth Century Iberian Intervention." In *Crusaders, Condotieri, and Cannon*. 305–28.
- . "Spanish Involvement in the Hundred Years War and the Battle of Nájera," in *The Hundred Years War: A Wider Focus*. Edited by L. J. Andrew Villalon and Donald J. Kagay. Leiden, 2005. 3–74.
- Villaret Amicie de. *Campagnes des Anglais dans l'Orléanais, la Beauce Chartrain et le Gatinais (1421–1428): L'armée sous Warwick et Suffolk au siège de Montargis. Campagnes de Jeanne d'Arc sur la Loire postérieures au siège d'Orléans*. Orléans, 1893.

- von Clausewitz, Carl. *On War*. Revised, edited and translated by Michael Howard and Peter Paret. Princeton, N.J., 1984.
- Vos, Luc de. "La bataille de Gavere le 23 juillet 1453. La victoire de l'organisation." In *XXII. Kongress der Internationalen Kommission für Militärgeschichte*, Acta 22: *Von Crécy bis Mohács Kriegszweien im späten Mittelalter (1346–1526)*. (Vienna, 1997). 145–57.
- Wagner, Eduard. *Cut and Thrust Weapons*. London, 1967.
- Wailly, Henri de. *Creçy, 1346: Anatomy of a Battle*. Poole, 1987.
- War and Border Societies in the Middle Ages*. Edited by Anthony Goodman and Anthony Tuck. London, 1992.
- War, Literature and Politics in the Late Middle Ages*. Edited by C. T. Allmand. New York, 1976.
- Warner, Marina. *Joan of Arc, The Image of Female Heroism*. New York, 1981.
- Warner, Philip. *The Medieval Castle: Life in a Fortress in Peace and War*. London, 1971.
- . *Sieges of the Middle Ages*. New York, 1968.
- Watson, Fiona. *Under the Hammer: Edward I and Scotland, 1286–1307*. East Linton, 1998.
- Waugh, Scott L. *The Lordship of England: Royal Wardships and Marriages in English Society and Politics, 1217–1327*. Princeton, N.J., 1988.
- Wauters, A. "La formation d'une armée brabançonne du temps du duc Jean III, de 1338–1339." *BCRH* (5e ser) 1 (1891): 192–205.
- Whetham, David. "Unorthodox Warfare in the Age of Chivalry: Surprise and Deception in the Hundred Years War." Ph.D. diss. King's College London, 2003.
- White, Lynn, Jr. *Medieval Technology and Social Change*. London, 1981.
- Wilcox, Donald J. *The Development of Florentine Humanist Historiography in the Fifteenth Century*. Cambridge, Mass., 1969.
- Wille, Erich. *Die Schlacht von Othée, 23 septembre 1408*. Berlin, 1908.
- Winter, Jay. *Sites of Memory, Sites of Mourning: The Great War in European Cultural History*. Cambridge, 1995.
- Wolff, Philippe. *Commerces et marchands de Toulouse (vers 1350–vers 1450)*. Paris, 1954.
- . "Doléances de la ville de Toulouse aux Etats de Languedoc de 1438." *Annales du Midi*, 55 (1942): 88–98.
- . *Histoire de Toulouse*. Toulouse, 1974.
- Women of Power: Queens, Regents, and Potentates*. Edited by Theresa M. Vann. Cambridge, 1993.
- Wright, N. A. R. *Knights and Peasants: The Hundred Years War in the French Countryside*. Rochester, N.Y., 1998.
- Wrong, George M. *The Crusade of 1383 Known as That of the Bishop of Norwich*. London, 1892.
- Wrottesley, George. *Creçy and Calais, from the Original Records in the Public Records Office*. London, 1898.
- Wurth-Paquet, F. X. "Table chronologique des chartes et diplômes relatifs à l'histoire de l'ancien pays de Luxembourg. Regne de Wenceslas de Bohême, comte, puis duc de Luxembourg. 1352–1383," *Publications de la section historique de l'institut grand-ducal de Luxembourg* 24 (1869): 1–202.
- Wylie, James Hamilton. *The Reign of Henry the Fifth*. 2 vols. 1914–1919; reprint, New York, 1968.
- Ziegler, Philip. *The Black Death*. New York, 1969.
- Zimmerman, K. "Die Schlacht bei Baesweiler am 22. August 1371." *Rheinische Vierteljahrsblätter* 11 (1941): 270–77.
- Zurita y Castro, Jeronimo. *Anales de la Corona de Aragon*. Edited by Angel Lopez Canelas, 9 vols. Zaragoza, 1967–1985.

INDEX

- Abbeville, battle of 29, 378–379
Abergavenny Castle 221
Abingdon Chronicle 219
Achilles 371
Adélaïde du Guesclin 337
Agincourt, battle of 7, 28, 32, 37ff.,
133ff., 227, 231–232, 336, 378
armor 44 n. 22
English forces 68
advance 68, 73 n. 127, 122–124
cavalry, charge of 73 n. 127, 95
n. 200, 123, 128
numbers 114–115, 120
events of 48
French forces 41, 59 n. 71, 409, 417
armor 69 n. 109
battle configuration 38, 82 n. 155
defeat of 70, 79, 89, 90 n. 184,
101, 101 n. 221, 103–106, 108,
135, 149, 251, 335
gros valet 57–58, 58 n. 69, 60, 60
n. 71, 61 nn. 75, 78–79, 62,
62 n. 84, 64–66, 66 n. 96, 69,
69 n. 107, 102, 108 n. 244
numbers 120 n. 281
prisoners, killing of 42, 58 n. 67,
99, 100, 100 n. 219, 103, 120
n. 281, 137–138, 412, 414
second line 41–42, 50, 58, 62–63,
63 n. 91, 64, 65 n. 95, 66, 79,
82 n. 155, 84 n. 166, 87 n. 178,
94, 101, 103–104, 108
vanguard 41, 49, 58, 63, 65, 79,
81 n. 155, 84 n. 166, 87, 89,
101
defeat of 79, 89
grief over 133–150
female 139, 143–145
imprisonment 139
memory of 133–150
mud 68 n. 103, 74–75, 75 n. 131,
78, 80 n. 151, 84–85, 89–90,
92–93, 93 n. 194, 103, 106, 125,
127, 127 n. 299, 128–129
war prisoners 100–101, 103, 137,
139, 144
weapons 73, 91
Agnello, Giovanni dell' 298, 300,
Agreda 170
Aichelberg, Konrad von 302, 321
Aimery, Jean 269, 271–272
Alberti, Spinello 303
alcabala 173, 174 n. 79
alcalde mayor 176
aldeas 195
Alençon, count of 271
Alexander 371
Alfaro 170
Alfonso X 189, 191 n. 33, 193–194
Alfonso XI 17, 156, 160, 174 n. 79,
176 n. 88
Alicante 154, 162–163, 166, 170–171,
173, 194
Aljubarrota, battle of 19, 19 n. 58,
21, 168
Almizra, treaty of 193
almogàvers 205, 205 n. 105
Amesbury 217
Andrew of Harclay 10
Anglo-Saxon Chronicle 219, 346
Anjou 266, 367, 375, 424, 427
Annan, battle of 10
Anthony, duke of Brabant 137
Araviana, battle of 163, 165, 178
Archambault, Paul 372, 372 n. 16,
384
archer's paradox 224–225, 242–243
archers, English 39, 41, 43 n. 15,
46 n. 25, 48–49, 49 n. 37, 53–54,
63, 63 nn. 90–91, 67, 69, 69 n. 109,
70–72, 81 n. 152, 82 n. 155,
86 n. 171, 93, 104, 109, 118, 122,
232–233, 235–241, 245–246, 248,
251
arrows 44 n. 22, 79, 244, 246
armor-piercing capability 44
n. 22, 78 n. 143, 87
energy 76 n. 135, 84 n. 165,
109 n. 248, 110, 214
palisades 53, 55, 70, 73, 77, 87
range 53, 70, 81 n. 152, 87
Archives Nationales 261 n. 2, 267

- Archivo Gonzaga 301, 301 n. 19, 306
 Archivo Segreto Vaticano 300, 304 n. 34
 Arezzo 310, 312
 Armagnac faction 28, 70 n. 111, 107 n. 242, 415, 417–418
 Arras 30, 266, 367, 372 n. 15, 381, 383
 congress of 28 n. 93, 29, 29 n. 97, 31, 419
 treaty of 28
 Arrighi, Giuliano 324
 arrow 40–41, 43, 43 n. 18, 44, 44 nn. 21–22, 45 n. 22, 48–49, 50, 52, 56 n. 59, 69, 70, 70 n. 109, 71, 71 n. 116, 72, 72 n. 118, 73–74, 74 n. 131, 75, 75 nn. 132–134, 76, 76 nn. 135, 137, 77, 77 nn. 140–142, 78, 78 n. 143, 79, 81, 81 nn. 152–153, 155, 82, 82 n. 155, 83, 83 nn. 159–160, 163, 84, 84 nn. 165–166, 87, 87 nn. 174–177, 88, 88 n. 180, 89–90, 90 n. 185, 93, 93 n. 193, 94–95, 102, 104, 106, 109, 109 n. 248, 110–112, 112–113 n. 257, 122, 128–129, 213–215, 215 nn. 4–5, 216–220, 220 n. 23, 221, 223–226, 226 n. 41–42, 227, 227 n. 46, 228, 228 n. 49, 229–230, 230 n. 50, 231–232, 233, 239, 239 n. 26, 240–241, 242 n. 30, 243, 243 n. 33, 244, 246–247, 247 n. 38, 248 n. 42
 parts 88, 113, 213, 217, 219, 221, 222, 224, 228, 231, 236, 240, 246
 fletching 224–225, 230
 stele 224
 range 41, 44 n. 21, 49 n. 34, 53, 63 n. 91, 67 n. 100, 70, 70 n. 109, 71, 73, 73 n. 128, 74, 74 n. 131, 75 n. 132, 76, 76 nn. 135–137, 77, 81, 81 n. 152, 82 n. 155, 83–84, 86 n. 173, 87, 87 n. 175, 95, 100, 105, 109–111, 113, 118, 120, 122–124, 127–128, 140, 214–216, 222, 227 n. 46, 228, 230–231, 233–234, 239–240, 242, 248, 248 n. 42, 249, 363
 size 222, 224, 227
 arrowhead 113, 216–217, 224, 226 n. 41, 229–230
 bodkin 226, 228–230
 Artevelde, Jacob van 23, 23 n. 67, 406–407, 435
 Artevelde, Philip van 24, 24 n. 71, 416
 Arthur III, duke of Brittany 138
 artillery 13, 173, 190, 203 n. 90, 420
 Astor, Junie 339
 Astyngton 395
 Atoleiros, battle of 19
 Auld Alliance 3, 8, 8 n. 13
 Auschwitz 98
 Autrand, Françoise 148
 Ayala, Pedro López de 157 n. 11, 164 n. 29, 167, 167 n. 40, 168, 169, 169 nn. 48, 50, 170, 170 n. 51, 174–175, 176 n. 88, 179–180, 204 nn. 97–98, 206 n. 114
 Ayton, Andrew 235–236, 238, 243 n. 33, 249 n. 43
 Baker, Geoffrey 52, 84 n. 166, 280, 281 n. 69
 Balearic Islands 162
 Balliol, Edward 10–11
 Bannockburn, battle of 9, 9 n. 18
 Bar, duke of 59 n. 71, 66, 143
 Barcelona 155 n. 5, 158, 166, 180, 196, 197 n. 56, 198
 Barker, Juliet 39
 Baron, Hans 319, 319 n. 100
 Barons' Wars 346
 Bashforth Impact Laboratory 225
 Basin, Thomas 57, 72, 96, 137, 371, 371 n. 11
Battle of the Thirty English and the Thirty Bretons 289
 Baugé, battle of 12, 14
 Baumgarten, Hannekin 299
 Beaumanoir, Jean de 285, 289–293
 Bel, Jean le 98 n. 213, 236, 265, 265 n. 12, 272, 272 n. 38, 274, 274 n. 41, 279, 279 n. 63, 286, 288–289, 290, 293
 Belmont, Andrew 300, 300 n. 16
 Benavides, Juan Alfonso de 164, 164 n. 30, 175
 Bennett, Matthew 38–39, 47–48, 49 n. 36, 55, 60, 81 n. 154, 106, 234, 227 n. 45
 Bergman, Ingrid 338
 Berkeley, Edward de 309
 Bernard, count of Armagnac 148
Bertrand du Guesclin, Connétable de France et de Castille 332 n. 4, 341

- Berville, Guyard de 332
- Berwick 11, 11 n. 26, 274, 347, 347 n. 7, 353
- Bevershoutsveld, battle of 24
- Bibliothèque Nationale 243 n. 32, 267, 267 n. 21
- Bix Brand 362
- Black Prince 17–18, 18 n. 54, 20–21, 155 n. 4, 181, 237, 250, 274, 330, 408, 408 n. 14, 409 n. 16, 410, 412–413, 416–417, 435–436
- Blangy, abbot of 141
- Blois, Charles de 329
- Bologna 304, 317
- Bonet, Honoré 391
- Boniface VIII 22, 425
- Bordeaux 7, 7 n. 11, 408, 410, 414, 420
- Bornago 307
- Borsook, Eve 325, 325 nn. 119–120, 326 n. 123
- Boson, William 304
- Boston 350
- Bosworth Field, battle of 4
- Boucicaud, marshal of France 64, 66, 138, 288
- Bourbon, duke of 58, 66, 107, 138, 143, 371 n. 12
- bowstring 83, 224–226, 245
- Brabant 24–25, 58 n. 69, 59 n. 71, 74 n. 129, 267, 269, 272, 279, 281–282, 424, 428
- Bracciolini, Poggio 319–320
- Bradbury, Jim 38, 46–48, 222 n. 30
- Brandeburg 285, 289–291
- Braybrok, Gerard de 396
- Brecore, William 395
- Bresson, Robert 338
- Brétigny, treaty of 40, 154, 199, 199 n. 70, 409, 411–414, 417, 436
- Brézé, Pierre de 368
- Brice, John 304
- Brignais, battle of 27, 180
- Bristol 353, 358 n. 40
- Britnell, R. 355, 355 n. 31
- Bruce, David II 10, 276
- Bruce, Robert 9, 9 n. 15, 10
- Bruges 13, 22, 24, 406, 416
- Bruni, Leonardo 319, 319 n. 96, 320, 320 n. 102
- Burgundian faction 28, 417
- Burgundy, duke of 4, 15, 25, 27–28, 28 n. 90, 30, 137, 149, 266 n. 18, 270–271, 278, 368, 370, 378, 416–417
- Burne, A. H. 39, 39 n. 8, 48, 57, 227 n. 45, 235
- Cabochien riots 28
- Cabrera, Bernal de 165–166
- Cagny, Perceval de 104 n. 234, 136, 141
- Calais 5, 5 n. 6, 11, 27–29, 31, 40, 40 n. 9, 41, 68, 90 n. 187, 114, 118, 138, 154, 367, 403, 403 n. 1, 404, 408–409, 414, 417
- Calais, treaty of 154
- Calatayud 154, 162, 180, 194, 197 n. 56, 202–203
- Cambalhaco, Philip de 276
- Cambrai 3
- Cambridgeshire 351
- camera del commune* 302
- Cane, Ruggiero 307, 307 n. 45
- capitaniae* 199
- Carlisle 9–10
- Caron, Marie-Thérèse 271, 271 nn. 32–33
- Carrara 320
- carta de población* 195
- cartas de protección* 195
- Carugate 307
- Cassel, battle of 5, 13, 23, 265
- Castagnaro, battle of 295, 314–315
- Castellani, Lotto 316
- Castile 17–20, 153–155, 155 n. 4, 156–164, 166–169, 174, 176, 176 n. 88, 179, 179 n. 98, 181–182, 185, 191–192, 192 n. 38, 193, 193 n. 42, 196, 199, 202–203, 206–208, 333–334, 340, 412, 414, 424, 430–431, 436
- Castillon, battle of 7, 7 n. 11, 420
- Cavalcanti, Giovanni 318, 318 n. 95
- cavalgadas* 161
- Cerda, Charles de la 17, 20
- Cesena 307
- Chamber of Accounts 267–268, 268 n. 25, 271
- Chanson de Bertrand du Guesclin* 329, 329 n. 1, 331
- Charlemagne 147
- Charlemagne's Twelve Peers 331
- Charles II “the Bad” 17–18, 20–21, 427, 432
- Charles III 20, 427, 432

- Charles IV 3, 5, 15, 15 n. 41, 16–17, 265, 265 n. 11, 269, 271, 273, 299, 404, 427, 430–431
- Charles of Artois, count of Eu 138
- Charles of Durazzo 311, 313
- Charles of Evreux 271
- Charles of Valois 269, 271, 404–405
- Charles the Bold 4, 7, 15, 15 n. 43, 16, 25, 29, 29 n. 99, 30 n. 102, 31 n. 107, 32, 370, 384
- Charles V 15, 18, 107 n. 240, 181, 330–331, 333, 335, 409, 411–414, 427
- Charles VI 15, 24, 27–28, 40, 106, 136, 142, 333, 373, 414–415, 415 n. 31, 417, 427
- Charles VII 12 n. 33, 29, 138, 336, 367, 369 n. 4, 371, 374, 383, 383 n. 45, 403, 417–420, 427
- Charles, duke of Orléans 138
- Charolais 59 n. 71, 371 n. 12, 375
- Chartier, Alain 139, 147
- Chartier, Jean 371
- Chartres, treaty of 28
- Chastelet, Hay du 332
- Chastellain, Georges 148, 367, 368 n. 3, 369 n. 4, 369, 369 n. 6, 370, 370 nn. 7, 9, 371–372, 372 nn. 15–16, 373, 373 n. 17, 374–380, 380 n. 38, 381, 382, 382 n. 41, 383, 383 nn. 45–46, 384–385
- Château-Gaillard 277, 277 n. 53
- Châtelet 268–269
- Chaucer, Geoffrey 308–309
- Cheapside 138
- Chinon, castle of 277
- Chirurgia* 389, 390 n. 9
- Chronicle of St. Omer* 238
- Chronique anonyme* 57, 107 n. 242, 122–123, 125
- Chronique d'Arthur de Richemont* 57
- Chronique de Normandie* 140
- Chronique de Ruisseauville* 42 n. 13, 49, 58, 71, 118
- Chronique des ducs de Brabant* 141
- Chronique Normande* 58
- Chroniques* 367–368, 368 n. 2, 369 n. 4, 370 n. 9, 371 nn. 10–11, 372, 372 n. 13, 373–374, 374 n. 19, 375 n. 20, 376 n. 25, 378, 381, 381 n. 40, 382 n. 42, 383 n. 44, 383 n. 46, 384–385
- Chysshull, Gilbert de 357
- Ciampi Uprising 310
- Città di Castello 310
- Clausewitz, Carl von 69, 186–187
- Clement VII 6, 307, 425
- Clendon, John de 394
- Clendon, Ralph de 394
- Clermont 377
- Clyvedon, John 395
- Cocherel, battle of 18, 335, 338, 436
- Coggeshale, William 304
- Cologne, archbishop of 270
- Combat of the Thirty 285–286, 288–290, 294
- Commynes, Philippe de 378
- Complainte d'Hector* 371
- Connor, battle of 9
- constable d'Albret 39, 64, 65 n. 95, 106, 107 n. 242, 143
- Constantinople 7, 7 n. 11
- Contamine, Philippe 39, 42 n. 14, 57, 60, 234
- Coppedene, Nigel 390–391
- Cortona 312–313, 316
- Costum d'Espanya* 191
- Coucy, Enguerrand de 304, 313
- Courtrai, battle of 22, 22 nn. 62–63
- Cravant, battle of 29, 100, 100 n. 221
- Crécy, battle of 15 n. 41, 16, 32, 48, 66, 220, 232, 235–236, 242, 245, 249
- Cremona 304
- Crónica de Pedro I* 169
- Cross of Lorraine 336
- Croyser, William 396, 396 n. 36
- Cumberland 11
- Curry, Anne 37 n. 1, 38, 38 n. 3, 39, 56 n. 56, 57, 58 n. 65, 59 n. 71, 60 nn. 71, 73, 96 n. 203, 114, 115 n. 265, 117–118, 118 n. 275, 124
- d'Albret, Seigneur 180
- d'Argentré, Bertrand 329
- d'Audrehem, Arnoul 329
- d'Escouchy, Mathieu 371, 382
- d'Este, Niccolò 312
- Dagworth, Nicholas 314
- Dalry, battle of 9
- Datini, Francesco 318
- Delachenal, Roland 335
- DeMille, Cecil B. 338
- Déprez, Eugène 263, 263 n. 7, 265 n. 12, 275 n. 47
- Dispenser, Henry (bishop of Norwich) 6, 6 nn. 8–9, 24, 24 n. 73, 26

- DeVries, Kelly 70–71, 71 n. 113, 153 n. 1, 228
- Die Jungfrau von Orleans* 337
- Diller, George 5 n. 7, 220, 280
- Dini, F. 296
- Dreyer, Carl 338
- Du Guesclin* 335, 335 n. 9, 338–339, 340 n. 17, 341
- Du Guesclin, connétable et maquisard* 335
- Dubois, Pierre 188
- Ducil Angeoissex* 144
- DuGuesclin, Bertrand 20, 181, 335, 411–414
- Dupplin Moor, battle of 10, 10 n. 25, 95 n. 200, 232
- Dynter, Edmond de 72, 141
- Edward I 8, 8 n. 14, 9, 60 n. 74, 217, 219–220, 232, 346, 347 nn. 5, 7, 352, 361, 365, 426
- Edward II 9, 9 n. 17, 10, 269, 347, 347 n. 5, 352, 353 n. 24, 405, 426
- Edward III 3, 4 n. 3, 5–6, 10, 10 n. 23, 11, 13, 15–18, 23, 26, 40, 45, 100 n. 219, 181, 243, 249, 261–262, 269, 272–275, 278–280, 283, 302–304, 345, 347, 351 n. 19, 352 n. 22, 353, 353 n. 26, 356, 356 nn. 33, 35, 357 n. 38, 358, 358 n. 40, 360–361, 393, 396 nn. 35–38, 400 n. 57, 401 nn. 61–64, 403 n. 1, 405–409, 413, 415, 417, 426
- Edward IV 4, 13, 30, 32, 426
- Edward, Black Prince 17–18, 18 n. 54, 20–21, 155 n. 4, 181, 237, 250, 274, 330, 408, 408 n. 14, 410, 412–413, 416–417, 435–436
- Edwin 217
- Eisenhower, Dwight 187
- Elbrigge, Robert 396
- Elche 171–172, 194
- Eleanor of Aquitaine 329
- Eliot, T. S. 149
- Elmham, Thomas 96, 118
- Engestorp, Robotus von 306
- Enrique II 18–20, 157 n. 11, 158, 166, 168 n. 45, 181, 333, 412, 414, 431
- Enrique, count of Trastámara 18, 20, 157, 163, 164 n. 29, 168, 168 n. 45, 178, 181, 192 n. 38, 202, 207, 334
- entradas* 203
- Epila, battle of 196
- Epistre de la prison de vie humaine* 135, 143–144
- Essex 304, 311
- Etampes, count of 271
- Eudes IV, duke of Burgundy 27, 428
- Eugenius IV 325
- Exchequer 119, 354–356, 358, 394–401
- Fadrigue 164, 164 n. 29, 175
- Falkirk, battle of 8, 232, 347 n. 5
- Favier, Jean 234
- Fenin, Pierre de 107–108, 141
- Ferdinand of Aragon 182
- Fernando I 18, 20, 432
- Fernando (Ferran) I “the Just” 18, 20
- Ferran 192 n. 38, 196, 196 n. 53
- Ferrill, Arther 216
- fides* 302
- Figueroa, Gómez Suarez de 164
- Flanders 4–6, 14, 22–24, 27, 143, 166, 220 n. 24, 271–272, 276, 280, 282, 406–408, 414, 416, 424, 428
- Flavy, Guillaume de 31, 31 n. 109
- Florence 295–303, 305–318, 318 n. 90, 319, 321–326
- Forget, Pierre 270
- Fowler, Kenneth 297
- Frederick III 15–16, 430
- Free Companies 18, 27, 154, 155 n. 4, 157, 180, 199, 301, 303, 309, 411, 419, 436
- French Chronicle of London* 280
- Froissart, Jean 5, 5 n. 7, 6, 7 n. 10, 44 n. 22, 47 n. 27, 90 n. 187, 233, 239–241, 243, 243 n. 33, 246, 247 n. 38, 265, 265 n. 12, 272, 273 n. 39, 274, 274 n. 42, 279, 280, 285, 286, 286 n. 8, 287–288, 288 n. 16, 289, 291, 293, 293 n. 32, 294, 304, 384
- frontalers* 199
- Frugard, Roger 389–390
- Frulovisi, Tito Livio 54
- fyrð* 220
- Gaddi, Agnolo 324
- Gascony 4 n. 3, 31, 261–263, 269, 273, 275, 284, 347, 405, 408–409, 420, 435
- Gaulle, Charles De 336
- Gaupp, Fritz 296, 297 n. 8, 319
- Gavere, battle of 25, 25 n. 80
- Gazzuolo 304
- Geneva Convention 100

- Genoa 158–159, 193 n. 42
 Gentian, Henri 390
 Geoffrey le Baker 52, 84 n. 166, 280
 Gerald of Wales 221
 Germany 15, 216, 272, 338, 403
Gesta Henrici Quinti 42 n. 13, 47
Geste des nobles français 107, 136
 Ghent 23–25, 276, 368, 378, 406–407, 416, 435
 Giovanni dei Bardi, Doffo di 301
 Given-Wilson, Chris 351, 356, 356 n. 34
 Glyn Dŵr, Owain 12, 12 n. 32
 Gold, William 304
 Golden Fleece, Order of the 381
 Goloffre, Christina 395
 Gomara 170
 Gough, Richard 295–296, 296 n. 2, 297
 Graham, Sir Robert 13
 Grailly, Jean de (captal de Buch) 18, 413
 Granada 160, 166, 172, 179, 179 nn. 95–96, 424, 433
Grandes chroniques 277–278
 Grandson, battle of 16, 16 n. 45, 30
 Grau 205
 Gravey, Fernand 339
 Great Company 303
 Guesclin, Bertrand du 18, 18 n. 54, 20, 181, 329–341, 411–414
 Guicciardini, Francesco 186
 Guienne 136, 181, 367
 Guillen of Burgundy, cardinal 162
 Guzmán, Leonor de 157–158, 176
- Halfway Oak 285, 291
 Halidon Hill, battle of 11, 13, 100 n. 219, 232
 Hardy, Robert 39, 46 n. 26, 216, 217 n. 13, 242, 242 n. 30, 244
 Harfleur, siege of 40, 45 n. 23, 114–115, 117, 417, 437
 Hastings, battle of 219–220
 Hawkwood, John 295–96, 296 n. 2, 297, 297 nn. 8–9, 298–299, 299 n. 14, 300–301, 301 n. 19, 302, 302 n. 21, 303–305, 305 n. 37, 306, 306 n. 42, 307, 307 nn. 45–46, 308, 308 n. 48, 309–313, 313 nn. 70, 74, 314, 314 nn. 26–27, 315, 315 n. 79, 316, 316 n. 81, 317–321, 321 n. 106, 322–323, 323 n. 114, 324–325, 325 n. 119, 326
- Hector 371
 helmets 43, 43 n. 15, 44 n. 22, 47, 61, 98, 109, 112 n. 257, 123 n. 284, 171, 247
 Henestrosa, Juan Fernández de 164
 Henry I 220
 Henry II 346, 410, 428
 Henry III 4 n. 3, 346, 393 n. 22, 428
 Henry IV 6, 12, 12 n. 32, 28, 416, 426, 428
 Henry V 6, 14, 28–29, 40, 78 n. 143, 81 n. 153, 106, 119, 138, 141, 148, 373–376, 380 n. 38, 382, 385, 416–418, 426
 Henry VI 13, 25, 30, 81 n. 153, 367, 381, 381 n. 40, 417–418, 420, 426
 Henry VI, Part I 337, 340 n. 16
 Henry VIII 5, 43, 76, 222
 Herrings, battle of the 13–14, 53 n. 47, 56 nn. 57, 59, 59 n. 70
 Hibbert, Christopher 39, 48, 88 n. 178
Histoire de Bertrand du Guesclin 332, 332 n. 4
Histoire de Bertrand du Guesclin et de son époque 335
Histoire de Bretagne 332
Histoire de Charles V 331 n. 3, 335
Histoire de France 333, 333 n. 5
 Holland, John 287
 Holmegaard 216
 Homildon Hill, battle of 12
 Humphrey (duke of Gloucester) 25–26
- Ibiza 159, 161, 166, 205
infantes de la Cerda 192, 192 n. 37
 Innocent VI 162, 198, 425
 Isabel of Castile 182
 Isle of Wight 353, 436
 Ismā'īl II 179, 433
- Jacquerie* 18, 18 n. 52, 409
 James II 13, 426
 James III 13, 426
 James, earl of Douglas 10, 12–13, 81 n. 153, 44 n. 22, 283
 Jativa 190, 190 n. 27
 Jaume I 190, 193, 202, 205 nn. 104–105, 432
 Jaume II 193, 432
 Jean I, duke of Bourbon 138
 Jean II 27, 409–410
 Jean III, count of Armagnac. 317–318
 Jean the Fearless (duke of Burgundy) 24–25, 27–29

- Jean, duke of Berry 27
 Jeanne III 27
 Jeanne of Evreux 271
 Jeanne of Valois 265
 Joan of Arc 14, 29, 31, 329, 336–338, 340, 382–383, 418
 Joanna (Joan) II 17, 20–21, 432
 João I 19
 Johanna I of Naples 306
 John III Comyn 9
 John III, duke of Brabant 270–273, 276, 428
 John of Gaunt 18–21, 287, 413
 John of Hainault 272, 283
 John the Fearless, duke of Burgundy 28 n. 90, 149, 371, 415, 417
 John XXII 10, 425
 Jolyf, John 395
 Jones, Michael K. 37 n. 1, 39, 57 n. 62, 122–125, 264, 264 n. 10
 Jones, Peter N. 112, 227–229
 Josselin, castle of 285
Journal d'un bourgeois de Paris 56 n. 57, 137
 Juan I 19, 168 n. 45, 431, 433
 Juan (Joan) I 20, 432
 Juan (Joan) II 20, 432
 Juan Manuel 189
justicia mayor 164
 Juvenal des Ursins, Jean 58, 96, 107 n. 242, 143, 147
 Kagay, Donald J. 153 n. 1, 155
 Keegan, John 38–40, 48, 54, 54 n. 54, 55–56, 70–71, 81 n. 152, 83 n. 159, 87 n. 178, 96–98, 127, 227, 227 n. 46
 Keen, Maurice 390, 390 n. 12
 Keranrais, Alain de 292
 Kyngeslond, Hugh 395
 Kyngeslond, Thomas 395
L'Honneur de la couronne de France 149
La Pucelle d'Orléans 337
 La Rochelle, battle of 19, 181, 414, 436
 Lacour, Jean-Louis 337
 Lancaster, duke of 375, 408 n. 12, 413, 416, 436
 Landau Lutz von 302, 309
 Latour, Bernard de 338–339
 Laval, Jeanne de 329, 336
 Le Fèvre, Jean 55 n. 56, 62 n. 84, 66 n. 98, 73 n. 127, 82 n. 157, 136
Le Quadrilogue invective 147
Le throne azure 370
 Lenyet, John 395
Les vœux du heron 261
 Lescot, Richard 274, 274 n. 43, 278, 278 nn. 59–60, 279 n. 61
 Letcombe Basett 362
levée en masse 187
 Lewis, P. S. 262, 262 n. 4
Liber Metricus 118
Liber Pusccardensis 96
Libro de Actas Capitulares 169
Libro de los Castigos 189
Libro de los Estados 189
Libro del Conde Lucanor 189
 Liddell-Hart, B. H. 187
 Lincolnshire 350, 359, 359 n. 43, 363
 Lionel, duke of Clarence 304
Livre des quatre dames 139
 Lochmaben Castle 11
 Logroño 170
 London 9, 138, 275, 283, 312, 353, 375, 378, 389 n. 5, 390 n. 10
 longbow 21, 43, 43 n. 18, 44–45 n. 22, 67 n. 100, 70, 71 n. 113, 73 n. 125, 81 n. 152, 103, 109, 109 n. 248, 110–111, 213–215, 215 nn. 3–4, 216–217, 218 n. 16, 220–222, 223 n. 35, 226 n. 42, 227–235, 237, 240–243, 246, 248, 251, 407, 413
 early history 21, 71, 213–214, 217, 220, 227
 Anglo-Saxon Britain 217, 220
 Norman Britain 217, 220
 Viking era 218–219
 effectiveness 70, 71 n. 113, 213, 227–228, 230, 232, 243
 physical description 218, 223
 technical aspects 211
 types 214, 223, 225, 229, 230 n. 50
 use in battle 21, 103, 213–216, 216 n. 6, 217–223, 223 n. 35, 227, 229–231, 234–235, 413
 Welsh 213, 217–219, 221, 232
 Longueville 330
Loquar in tribulatione 147
 Lot, Ferdinand 234
 Loudon Hill, battle 9, 9 n. 16
 Louis de Luxembourg, bishop of Thérouanne 141

- Louis I of Nevers (count of Flanders) 23
- Louis II of Male (count of Flanders) 23, 416
- Louis of Bourbon, count of Vendôme 138
- Louis of Orléans 27–28, 374–375
- Louis X 17, 22, 404, 427
- Louis XI 7, 15, 20, 29, 29 n. 99, 30–32, 378, 410, 419, 427
- Louis XIV 333, 338
- Lucas, Henry 263, 263 n. 8
- Lucca 306, 312, 325
- Luce, Siméon 5 n. 7, 334–335
- Lucy, Geoffrey 396
- Ludwig IV 15–16
- Lutton 350
- Lyons, Richard 311–312
- Machiavelli, Niccolo 186
- Maddicott, J. R. 345, 347–350, 357, 359–362, 362 n. 49, 365
- Mahaut, countess of Artois 263–264, 266 n. 18, 269
- Majorca 158, 190
- Manfredi, Astorre 310–311
- Manni, D. M. 295–296, 296 n. 2
- Manuel d'histoire de Philippe VI* 272
- Maran, René 335
- Marche, Olivier de la 370, 382, 384, 411
- Marcotti, Giuseppe 296
- Margaret of Anjou 367, 375
- Margaret of York 30, 30 n. 103
- María of Portugal 157
- Marmousets 339
- Marshal Boucicaut 64, 65 n. 95, 66, 66 n. 96, 67–68 90, 106, 107 n. 242, 138, 288, 331
- tactical plan for Agincourt 64, 66–68, 69 n. 107, 90, 107 n. 242, 138
- Martin (Marti) I 20, 432
- Mary of Berry 143–144
- Mary Rose* 43 n. 18, 109 n. 248, 215 n. 3, 217 n. 12, 222–224, 227, 242 n. 30
- Maurice 129 n. 303, 186
- Maximus, Fabius 326
- Mazzei, Lapo 318
- Meare Heath 216
- Meaux 62 n. 86, 266, 379, 379 n. 33
- Medin, A. 296
- Melun, siege of 339
- Mémoires de Pierre Fenin* 137
- Ménard, Claude 332
- mental incapacity 388–390, 392, 402
- cures 390–391
- types 395 n. 31
- wardship 387–388, 392, 392 n. 20, 393, 393 nn. 22–23, 395, 397–400, 402
- “allowance” 392, 397, 399, 402
- Merlond, John 395
- Messire Bertrand du Guesclin* 338
- Methven, battle of 9
- Michelet, Jules 336
- Michelle 375, 375 n. 22
- Migliari 312
- Milan 298–299, 301, 303–304, 307–309, 314–317, 319–321, 323, 325, 424, 430
- Milton on Stoure 395
- Minois, Georges 334, 341
- Molina 161, 169–170, 170 n. 51, 176, 333
- Molina Molina, Angel Luis 169
- Molinet, Jean 370, 370 n. 9, 384
- Monk of St. Denis’ 288
- Mons-en-Pévèle, battle of 22, 22 n. 63
- Mons-en-Vimeu, battle of 29
- Monstrelet, Enguerrand de 47, 59 n. 71, 73 n. 127, 74 n. 129, 104 n. 234, 120 n. 280, 136, 140, 371 n. 11, 373, 378
- Montecchio 312–313
- Montereau 374
- Montereau Bridge 29, 417
- Montferrat, marquis of 300
- Montfort, Simon de 346
- Montiel, battle of 18, 21, 206
- Montiel, castle of 157, 181
- Monthéry, battle of 29, 30 n. 101, 368
- Montmuran Castle 329
- Moresby, Richard 396
- Mortimer, Roger 10, 10 n. 22, 269, 426
- Mowbray, Thomas 287
- Muḥammad V 179, 179 n. 97, 433
- Muntaner, Ramón 191
- Murcia 155, 160, 164 n. 29, 165, 169–170, 170 n. 51, 171–174, 190, 190 n. 27, 193–194
- Murten, battle of 16, 16 n. 45, 30
- Murviedro 178, 204–205
- Myton, battle of 10

- Nájera, battle of 18, 20–21, 166, 168, 181, 206, 232
- Nancy, battle of 4, 31
- Naples 4 n. 1, 306, 311, 313, 317, 406
- Navarre 176 n. 88, 179, 181, 411, 424, 432
- Neel, Robert fitz 396
- Neuss, siege of 16, 16 n. 44, 30
- Nevers, duke of 137
- Neville, Ralph 11
- Neville, Richard 20
- Neville's Cross, battle of 11, 78 n. 143
- Newark 350, 352 n. 22
- Niccolò Alessandro di 316
- Nicopolis, battle of 27
- Nirenberg, David 146
- nobilitas* 302
- Nonae* 362
- Normandy 4 n. 3, 31, 149, 219, 273, 276, 291, 346, 367–368, 370, 371 n. 11, 389 n. 5, 408, 411, 417, 420, 435
- Nubia 216
- Offrid 217
- Oglio River 304
- Olivier, Laurence 338
- Ordenamiento of Alcalá* 171
- Orihuela 165, 171, 194, 204
- Orlandini, Bartolomeo Fortini de 326
- Orléans, duke of 58, 66, 107, 138
- Ormrod, W. M. 361–362
- Othée, battle of 25, 25 n. 76, 96 n. 200
- Otterburn, battle of 12, 12 n. 30
- Padilla, María de 164
- Palu, François de la 390
- Panes, John de 394
- Panes, Thomas 394
- Parellós, Francés de 159, 163
- Paris, university of 140
- Parlement of Paris 142, 268, 277
- Parma 304
- Patourel, John le 263, 263 n. 6
- Pavia 300
- pavises* 233–234, 245–247, 247 nn. 38, 40, 248, 248 n. 42
- Paxton, Frederick 134
- peasantry, English 348, 352, 361, 362 n. 49, 365
- Peasants Revolt 311
- Pedro I 17, 17 n. 50, 18–21, 154, 156, 167 n. 40, 174, 174 n. 79, 180, 185, 185 n. 2, 192 n. 38, 193 n. 42, 198, 202, 205, 412, 431–432
- Pedro I of Portugal 19
- Pedro IV 156
- Pedro IV (Pere III) 17, 20, 155 n. 4, 156–157, 162–163, 185–186, 192 n. 38, 193–194 n. 42, 196, 333, 412, 432
- Percy, Henry 11–12
- Périgord 262
- Perpignan 20, 196, 196 n. 56
- Perroy, Edouard 234, 263, 340
- Perugia 310, 312
- Perys, Richard 395
- Pessano 307
- Philip IV 22, 264, 404, 427
- Philip of Charolais 140
- Philip of Rouvres, duke of Burgundy 27
- Philip the Good 7, 25, 29, 29 n. 95, 31–32, 59 n. 71, 367–369, 384–385, 417
- Philip V 22, 27, 264, 266 n. 18, 269, 404, 427
- Philip VI 3, 4 n. 3, 5, 15, 17, 23, 57, 81 n. 153, 237, 249, 251, 261, 264–265, 265 n. 14, 267, 269, 271–273, 279, 282–283, 405, 408, 409 n. 17, 427
- Philippa of Hainault 6, 274
- Piacenza 159
- Piccinino, Niccolò 325
- Picquigny, treaty of 30
- Pietramala, Gian “Tedesco” da 322–324, 324 n. 118
- Pino, abbey del 312
- Pintoin, Michel 135, 138
- Pizan, Christine de 42 n. 14, 61 nn. 78–79, 76–77 n. 137, 106, 135, 143–145, 337
- Ploermel, castle of 285
- Poitiers, battle of 32, 69, 69–70 n. 109, 84 n. 166, 104, 104 n. 234, 138, 138 n. 27, 147–148, 232
- Polop 172
- Pontvallain, battle of 331, 335
- Portugal 4, 18–19, 154, 157, 166, 168, 179–180, 424, 432
- potestas* 207
- Pound, Ezra 149
- Preminger, Otto 338
- Preston, Philip 236, 237
- Prestwich, Michael 347 n. 5, 361
- Princeps namque* 198–199

- purveyance 345–347, 347 n. 7,
 348–351, 351 n. 19, 352, 352
 nn. 22–23, 353–355, 355 n. 31,
 356–359, 359 n. 43, 360, 360 n. 45,
 361–362, 362 n. 49, 363–364, 364
 n. 58, 365
 corruption, fiscal 348, 359, 359
 n. 43, 360, 363, 364 n. 14, 365
 economic impact 361–362
- Ranieri Peruzzi, Simone di 303, 305
 rate of fire commonplace 234, 236
 “Religieux of St-Denis” 135–138, 141,
 143–144, 147–148
 Rennes 329–330
repostero mayor 176, 176 n. 87
 Richard II 6, 11, 20, 308–309,
 313–314, 375, 426
 Richard III 4, 156, 338, 426
 Ricotti, Ercole 320
 Robert Curthose 346
 Robert of Artois 261, 261 n. 2,
 262–264, 265 n. 14, 266 n. 18,
 267–268, 270–273, 275–276,
 278–281, 283–284
 Robert of Béthune (count of
 Flanders) 22, 428
 Rochefort, Robert de 288
 Rogers, Clifford J. 13, 13 n. 37, 14,
 153 n. 1, 231, 233, 245
 Romsey, Richard 304
 Rosebeke, battle of 24, 24 n. 72
 Rouen 29, 136, 376–377, 415, 419,
 437
 Roxburgh Castle 11, 13
 Royal Military College of Science 225
 Roye, Renaud de 287
- Saga of Olaf Trygvason* 218, 220
 Sagebren, Henri 269, 271–272
Saint Joan 337–338, 419 n. 38
 Saint-Cloud, battle of 28
 Saint-Denis 77 n. 142, 265, 272, 274,
 278, 331
 Saint-Omer, battle of 278, 278 n. 60
 Saint-Quentin 377
 Sakeville, Bartholomew de 388–389,
 392
 Salutati, Coluccio 320, 324
 San Lúcar de Barrameda 159
 Santa Maria alle Molgora 307
 Sardinia 158
 Sauvage, Adam le 395
 Schnerb, Bertrand 251
- Seberg, Jean 338
 Segere, Thomas 395
 Segorbe 164
 Seneca 376
Seraphic Dialogue 337
 Seville 159, 164 n. 29, 172, 179–180
 shields 54, 70 n. 109, 78 n. 144, 90,
 171, 187, 233, 238, 246–247, 368
 n. 3
 Siena 310, 316, 319, 322–323, 323
 n. 110
Siete Partidas 189, 191, 194
Signoria 311, 316, 317 n. 90, 320, 322
 Simancas 167
 Simonetti, Simone 301
 skulking way of war 197
 Sluys, battle of 3, 23, 23 n. 68, 234,
 435
 Smale, John 395
 Small, Graeme 368
 Smythe, Sir John 44 n. 21, 222
 Soleuvre, treaty of 30
 Southwell 350
 St. Denis, chronicle of 47 n. 29, 49,
 57–58, 62 n. 86
 St. Ingelvert 287–288, 288 n. 16,
 289
 St. Louis 147
 Stephen I 221
 Sterz, Albert 300, 302 n. 22
 Stirling Bridge, battle of 8–9, 13
 Stretton, Mark 44 n. 21, 70 n. 109, 74
 n. 131, 229
 Strickland, Matthew 37 n. 1, 39, 43
 n. 17, 51 n. 41, 346
 Strocchia, Sharon 322
 Stuart, James I 12, 426
 Stuart, Robert III 12, 426
 Sumption, Jonathan 14, 234, 263–264,
 264 n. 9, 274, 274 n. 45
 Sutton 363
 Switzerland 4, 216, 406
 sword blades 171
- Taddeo, Bono di 316
 tally sticks 356, 358
 Tarazona 154, 161–162, 198
 Tello 163
Temple de Bocace 375, 383 n. 45
 Temple-Leader, John 296–297, 297
 n. 8, 302, 314, 319
 Terrar, treaty of 154, 178–179
 Teruel 194
The Battle of Agincourt 53

- The Petitions of the Barons* 346
 “The Song of the Husbandman” 365
The Tree of Battles 391
 Théroutanne 14, 141
 Thetford 218
 Thiérarche 3
 Thomson, W. S. 359, 359 n. 43
 Thorpe, Walter 308
 Thwaytes, John 396
 Tillioll, Robert 395, 402
 Tiphaine 332, 339
 Toledo, Gutier Fernández de 164,
 175–176, 176 n. 88, 177
 Torrellas, treaty of 160, 163
 Touraine, Louis de 330
 Tournai 62 n. 86, 375, 141
 Tournai, siege of 3, 14–15, 23, 23
 n. 68, 26, 280, 407, 435
 Towton, battle of 13
Toxophilus 224
 Tramecourt 41, 46 n. 26, 52, 67, 67
 n. 101, 68–69, 69 n. 107, 88 n. 178,
 90, 90 n. 183, 125
 trebuchet 173
Trésor des chartes 268
 Troyes 266, 377–378, 417, 437

 Ubaldini, Giovanni d’Azzo degli 305,
 322–324
 Uccello, Paolo 295, 298, 324–326,
 326 n. 125
Unam sanctam (papal bull) 22
Unión 196
 Urban V 303, 412, 425
 Urban VI 6, 313, 425
Usatges of Barcelona 198

 Vale, Malcolm 263, 263 n. 6, 264
 n. 10
 Valencia 154, 155 n. 4, 160, 162, 172,
 185, 190, 190 n. 27, 191, 193–194,
 196, 197 n. 57, 202, 204–205, 205
 n. 105
 Valenciennes 6, 30, 273, 369–370
 Valera 307
 Vasari, Giorgio 326
 Vaughan, Richard 26 n. 85, 28 n. 90,
 31
 Vegetius 186, 188 n. 19, 189
 Verbruggen, J. F. 234
 Vercel, Roger 338
 verge 345
 Vermandois 3, 62 n. 86

 Verme, Jacopo dal 318, 320–321
 Verneuil, battle of 7, 12, 14, 47, 418
 Verona 309, 321, 323 n. 114
 Villani, Matteo 235, 241, 243 n. 33
virtus 302, 311
 Visconti, Bernabò 299, 303, 307, 309,
 315, 323 n. 114
 Visconti, Carlo 315–316
 Visconti, Caterina 307–308
 Visconti, Donnina 299, 307–309,
 314–315
 Visconti, Giangaleazzo 314–316,
 320–321
 Vottem, battle of 23, 23 n. 69, 435

 Wallace, William 4, 8, 8 n. 14, 9
 Walsingham, Thomas 42 n. 13, 44
 n. 22, 67 n. 103, 72, 118, 121, 125
 war engines 172–173
 War of the Public Weal 7, 29, 32
 War of the Two Pedros 18, 18 n. 51,
 153, 153 n. 1, 154–155, 158, 160
 n. 17, 161, 166, 169 n. 49, 175,
 181–182, 185, 193, 197, 207, 412
 Wars of the Roses 4, 7, 31, 229
 Waurin, Jehan de 6–7, 53, 53 n. 48,
 55 n. 56, 57 n. 64, 73 n. 127, 74
 n. 129, 78, 82 n. 157, 107, 107
 nn. 240, 242, 118, 120 n. 280, 123,
 125, 136–137
 Wavrin, Jean 371, 371 n. 11
 Wegener, Wendy 325
 Wenzel of Luxemburg 313, 430
 Westminster 138
 Westrozebeke, battle of 61, 436
 White Company 295, 303
 William II Rufus 220
 William of Dunstaple 354, 363
 William of Wallingford 363
 William Rufus 346
 William the Conqueror 220, 346, 403
 Winchelsea, battle of 17, 435
 Winter, Jay 134, 149 n. 67
 Woodford, Sir John 52, 88 n. 178
 Wykyng, John 395
 Wylie, J. H. 38

 York 10–11, 30, 92 n. 190, 219, 426

 Zaragoza 154, 162, 204
 Zouche, William 11
 Zurita, Jerónimo 157 n. 9, 158, 197
 n. 60, 205

History of Warfare

History of Warfare presents the latest research on all aspects of military history. Publications in the series will examine technology, strategy, logistics, and economic and social developments related to warfare in Europe, Asia, and the Middle East from ancient times until the early nineteenth century. The series will accept monographs, collections of essays, conference proceedings, and translation of military texts.

Recent volumes in the series:

40. Wolff, D., Marks, S.G., Menning, B.W., Schimmelpenninck van der Oye, D., Steinberg, J.W. & S. Yokote (eds.). *The Russo-Japanese War in Global Perspective*. World War Zero, Volume II. 2007. ISBN-13 978 90 04 15416 2, ISBN-10 90 04 15416 7
41. Ostwald, J. *Vauban under Siege*. Engineering Efficiency and Martial Vigor in the War of the Spanish Succession. 2007. ISBN-13 978 90 04 15489 6, ISBN-10 90 04 15489 2
42. McCullough, R.L. *Coercion, Conversion and Counterinsurgency in Louis XIV's France*. 2007. ISBN 978 90 04 15661 6
43. Røksund, A. *The Jeune École*. The Strategy of the Weak. 2007. ISBN 978 90 04 15723 1
44. Hosler, J.D. *Henry II*. A Medieval Soldier at War, 1147-1189. 2007. ISBN 978 90 04 15724 8
45. Hoyos, D. *Truceless War*. Carthage's Fight for Survival, 241 to 237 BC. 2007. ISBN 978 90 04 16076 7
46. DeVries, K. *A Cumulative Bibliography of Medieval Military History and Technology, Update 2003-2006*. 2008. ISBN 978 90 04 16445 1
47. France, J. (ed.). *Mercenaries and Paid Men*. The Mercenary Identity in the Middle Ages. 2008. ISBN 978 90 04 16447 5
48. Meyer, J. (ed.). *British Popular Culture and the First World War*. 2008. ISBN 978 90 04 16658 5
49. Jones, H., J. O'Brien & C. Schmidt-Suppran (eds.). *Untold War*. New Perspectives in First World War Studies. 2008. ISBN 978 90 04 16659 2
50. Burgtorf, J. *The Central Convent of Hospitallers and Templars*. History, Organization, and Personnel (1099/1120-1310). 2008. ISBN 978 90 04 16660 8
51. Villalon, A.L.J. & D.J. Kagay (eds.). *The Hundred Years War (Part II)*. Different Vistas. 2008. ISBN 978 90 04 16821 3

