



# ANCIENT AMERICA

## 12

### **Generative Landscapes: The Step Mountain Motif in Tiwanaku Iconography**

*by*

SCOTT C. SMITH  
*Franklin & Marshall College*  
*scott.smith@fandm.edu*



BOUNDARY END ARCHAEOLOGY RESEARCH CENTER  
Barnardsville, NC 28709-0220 U. S. A.



GENERATIVE LANDSCAPES:  
THE STEP MOUNTAIN MOTIF IN TIWANAKU ICONOGRAPHY

Scott C. Smith

Franklin & Marshall College, Lancaster, Pennsylvania

First submitted October 2007

Revised and updated July 2011



RESUMEN

*Uno de los elementos más comunes hallados en el cuerpo iconográfico de Tiwanaku es el motivo de escalón. Una investigación sistemática de este motivo mediante un enfoque histórico-directo, indica que este motivo es la representación de una montaña sagrada. Esta conclusión no es sorprendente, pero la utilización de este motivo de escalón como punto de partida, permite la identificación de un completo sistema ideológico relacionado con el paisaje. Específicamente, las cuevas y las fuentes sagradas estaban conceptualizadas como los "ojos" de una montaña personificada y eran el punto de emergencia de los humanos, rebaños de camélidos y productividad agrícola. Los "ojos" de la montaña estaban conceptualizados como "áreas de florecimiento", invocando una metáfora floral la cual estaba reflejada en la iconografía de Tiwanaku. Las aves tenían la habilidad de atravesar estos puntos montañosos de liminalidad y los felinos fueron considerados como guardianes de estas fuentes sagradas. Estos conceptos asociados con el paisaje tienen sus raíces en las épocas antiguas de la cuenca del Lago Titicaca y son evidentes en la antigua tradición religiosa Yaya Mama.*

**A**lan Kolata and Carlos Ponce Sanginés (Kolata and Ponce S. 1992; Kolata 2003, 2004) have advanced an argument that the Akapana pyramid at the Middle Horizon (ca. AD 500–1100) site of Tiwanaku in the Lake Titicaca basin of Bolivia was, “conceived by the people of Tiwanaku as their principle emblem of the sacred mountain, a simulacrum of the highly visible, natural mountain *huacas* in the Quimsachata range” (Kolata and Ponce S. 1992:328). The elaborate canal system that drained the sunken court on the summit of the Akapana is argued to have been representative of the mountain springs in the Quimsachatas. John Janusek (2006) supports this argument and traces the development of Tiwanaku religion from Early Intermediate Period (ca. 200 BC–AD 500) ritual practices and symbolism through the expansion of the Tiwanaku state. Janusek (2006:486) argues that the integration of the Tiwanaku state hinged on the incorporation of long standing religious traditions regarding the natural world with a newer ideological corpus referencing solar cycles and a supreme ancestral deity.

This paper presents evidence garnered from iconographic analysis that adds support and depth to these arguments by identifying some of the meanings associated with the natural world depicted in Tiwanaku iconography. This paper provides evidential support for these elaborated by Kolata, Ponce Sanginés, and Janusek and advances new arguments regarding motifs associated with the Step Mountain. In particular, this paper establishes a series of concepts which indicate an origin mythology of emergence and fertility associated with mountain springs. Mountain springs are argued to have been conceptualized as eyes and are demonstrated to have been the point of origin for human, camelid, and agricultural fertility. The water flowing from these springs was often conceptualized as a serpent, and felines are argued to have been mediators between the earthly realm and the realm of fertile essence, acting sometimes as sentries guarding the mountain springs. These arguments have implications for broader debates about the origin and time depth of Middle Horizon beliefs as well (see Isbell and Knobloch 2006). Evidence will be presented that many of the concepts noted above predate Middle Horizon Tiwanaku and were present during the Early Horizon (ca. 800–200 BC) and Early Intermediate Period (ca. 200 BC–AD 500) in what has been called the Yaya Mama religious tradition (Chávez 2004; Mohr-Chávez 1988).

This analysis of Middle Horizon beliefs takes as its starting point an investigation of the Step motif common to Tiwanaku imagery. Paul Goldstein notes that, “[a]lthough stepped motifs appear in earlier altiplano art and architecture, the stair-step design became the single most frequent motif used on Tiwanaku decorated pottery and in other media” (2005:277). Despite the ubiquity and potential importance of the Step motif, at this point no consensus exists regarding this imagery and what it may depict. One hypothesis suggests that the Step motif, as it is represented on the Gateway of the Sun, is a dais or alternatively a stepped-platform structure such as the Akapana pyramid (Cook 1983:164; Stone-Miller 2002:133; Young-Sánchez 2004:46). A systematic iconographic investigation of this motif and its associated elements using the direct historical approach, however, suggests that the imagery is a depiction of a sacred mountain. This hypothesis is supported by iconographic, archaeological, linguistic, ethnohistoric, and ethnographic data. This paper will further address potential ideological meanings that may have been attributed to other elements commonly portrayed within the Step Mountain context such as llamas, birds, flowers, and felines.

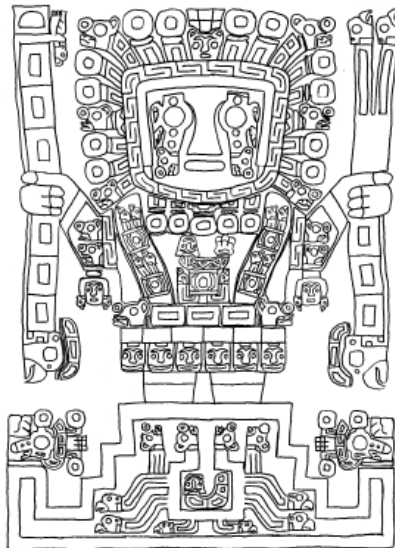
The most famous representation of the Step motif in Tiwanaku imagery is undoubtedly the central portion of the façade on the Gateway of the Sun (Figure 1a). This depicts a front-facing deity holding two staves standing on top of the Step motif. This figure is often referred to as the Gateway God, the Staff God, or the Front-Facing Deity (Figure 1b) (Cook 1983, 1984–1985; Demarest 1981; Isbell and Knobloch 2006). In the center of the Step motif is an enclosure from which serpent-like beings with feline and avian<sup>1</sup> heads emerge. The enclosure contains another animal that may be feline-headed, and the bases of either side of the Step motif extend out and then up and end in crowned feline heads. Other representations of the Step motif display similar compositions (Figure 2).

This paper examines in particular four artifact assemblages that exhibit Tiwanaku style iconography: stone monuments, ceramics, snuff trays, and textiles (see also Agüero P., et al. 2003; Conklin 1983; Haeberli 2002; Isbell and Knobloch 2006; Janusek 2003, 2006; Torres and Conklin 1995). Significant debate currently exists regarding the chronology of some of these assemblages. At least some of the snuff trays from San Pedro de Atacama that exhibit Tiwanaku style iconography have been dated to the Early Intermediate Period, and some examples from the textile assemblage discussed in this paper have been identified as early Tiwanaku (Young-Sánchez 2004) or as a separate stylistic sphere termed Pucara Provincial (Haeberli 2002). While exciting new arguments and hypotheses have originated from the works noted above, this paper takes the position that, by analyzing the four assemblages as a whole (a broadly Tiwanaku style), new insights can be garnered regarding patterns of religious belief during the Middle Horizon.

FIGURE 1. THE GATEWAY OF THE SUN AND THE STAFF GOD



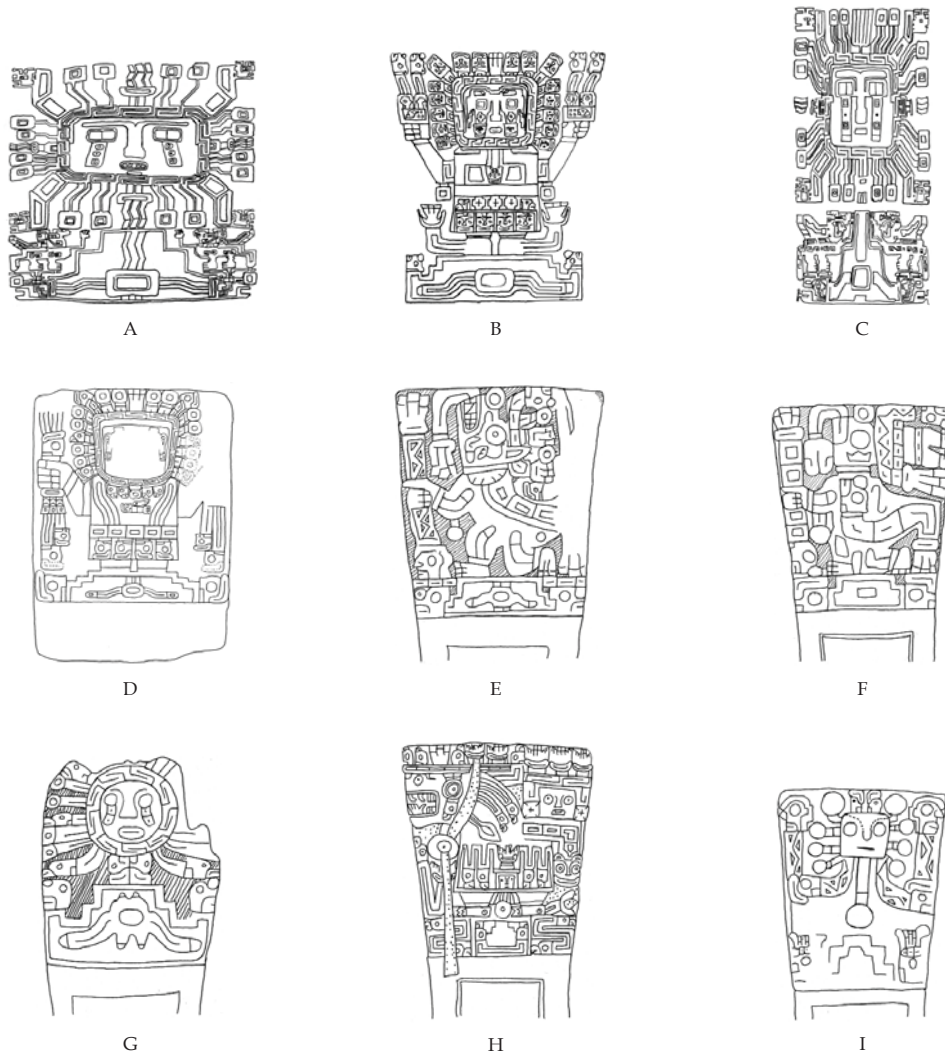
A



B

- A: THE GATEWAY OF THE SUN (ORIGINAL PAINTING BY PAOLA GUARDIA AFTER STONE-MILLER 2002:132, FIG. 103).
- B: THE CENTRAL FIGURE ON THE GATEWAY OF THE SUN AND THE STEP MOTIF (AFTER STONE-MILLER 2002:133, FIG. 104).

FIGURE 2. OTHER REPRESENTATIONS OF THE STEP MOTIF



- A: DETAIL OF STEP MOTIF FROM EARLY TIWANAKU STYLE TAPESTRY (AFTER YOUNG-SÁNCHEZ 2004:19, FIG. 1.9).
- B: DETAIL OF STEP MOTIF FROM THE BENNETT MONOLITH (AFTER YOUNG-SÁNCHEZ 2004:113, FIG. 4.15).
- C: DETAIL OF STEP MOTIF FROM EARLY TIWANAKU STYLE TAPESTRY TUNIC (AFTER YOUNG-SÁNCHEZ 2004:47, FIG. 2.26A).
- D: LLOJETA BLOCK SHOWING STEP MOTIF (AFTER AGÜERO P. ET AL. 2003:81, FIG. 18).
- E: TIWANAKU STYLE SNUFF TRAY FROM SAN PEDRO DE ATACAMA SHOWING STEP MOTIF (AFTER TORRES 2002:437, FIG. 8B).
- F: TIWANAKU STYLE SNUFF TRAY FROM SAN PEDRO DE ATACAMA SHOWING STEP MOTIF (AFTER TORRES AND CONKLIN 1995:97, FIG. 16c).
- G: TIWANAKU STYLE SNUFF TRAY FROM SAN PEDRO DE ATACAMA SHOWING STEP MOTIF (AFTER LLAGOSTERA M. 1995:56, FIG. 2c).
- H: TIWANAKU STYLE SNUFF TRAY FROM SAN PEDRO DE ATACAMA SHOWING STEP MOTIF (AFTER TORRES 2002:440, FIG. 10c).
- I: TIWANAKU STYLE SNUFF TRAY FROM SAN PEDRO DE ATACAMA SHOWING STEP MOTIF (AFTER LLAGOSTERA M. 2006:95, FIG. 7A).

## DIRECT HISTORICAL ANALOGY

Two types of analogies are commonly used by archaeologists: general comparative analogy and direct historical analogy (Lyman and O'Brien 2001). General comparative analogy, "refers to broad cross-cultural correlations among artifacts, their functions, and human behavior that may be observed widely throughout history as well as in the modern world" (Rice 2004:3). Direct historical analogy, also called the direct historical approach, is a form of ethnographic analogy that, "utilize[s] knowledge of the culture flourishing in the area at the time of European Contact to interpret archaeological finds in that same area" (Nicholson 1976:159). Julian Steward and W. D. Strong were early proponents of the direct historical approach (Steward 1942; Strong 1940). Essentially, the analyst works progressively back from the observable source (historically and ethnographically documented cultures) to the unobservable subject (prehistoric cultures of the same geographic region) utilizing multiple resources to improve the strength of the analogy (Lyman and O'Brien 2001). This approach has been utilized extensively in the analysis of ancient Mesoamerican iconography and has proved to be extremely productive (e.g., Coe 1973; Nicholson 1976; Saturno, et al. 2005; Taube 1985, 1992).

The strength of the direct historical approach depends crucially on continuity in both space and time between the source analogs and the subject of the historical analogy. As Rice notes, "the most appropriate, credible, and enlightening kinds of analogies in archaeology, then, are specific rather than general, and are drawn from known continuities through the direct-historical approach" (2004:4). In this analysis I draw on ethnographic research, ethnohistoric documentation, Contact period Aymara and Quechua dictionaries, and Inca art and architecture from the south central Andes as source analogs to reconstruct elements of Tiwanaku belief related to the Step motif. The geographic extent of these sources ranges from the Huarochiri region near Lima, Peru (roughly 850 kilometers northwest of Lake Titicaca), to the Atacama and Arica regions of northern Chile (roughly 700 kilometers south of Lake Titicaca). While these regions are relatively widely dispersed they all fall within an area of related pre-Columbian iconographic traditions referred to as the "Southern Andean Iconographic Series" or "SAIS" (Isbell and Knobloch 2006, 2009). Isbell and Knobloch relate that, "Pre-Hispanic societies obviously participating in the SAIS include Peru's Pucara, Provincial Pucara, and Wari; Bolivia's Yaya-Mama and Tiwanaku; and northern Chile's SAIS-Atacameño from Arica to San Pedro de Atacama" (2009:165). While obvious cultural and stylistic variability existed between these pre-Columbian societies, they share underlying religious commonalities that probably developed out of extensive interregional contact and exchange. I suggest that the underlying relatedness of religious beliefs characteristic of these widely dispersed ancient societies justifies my use of ethnographic and ethnohistoric sources from this same region.

Critics of this approach argue that cultures inherently change and manifest disjunctions of meaning, and that any attempt to understand the past by looking at the present is inherently fraught with uncertainty and will likely lead to false conclusions (Kubler 1967, 1970, 1973). While it is certainly true that meaning changes over time and that the role of historical disjunction can not be underestimated, it is equally true that continuities between the past and the present do exist. Indeed, while belief systems are constantly being redefined in response to historical situations, this process involves fitting a historical event into an established conceptual framework (Grove and Gillespie 1992; Sahlins 1985), a process that will necessarily create continuities in meaning. The task is to selectively elucidate these continuities and utilize them as the source analogs. Any attempt to read an ethnographic text onto the past verbatim is doomed to failure, but if we can isolate diverse continuities we can begin to create an understanding of past meaning. Reconstructing diverse continuities in belief also allows us to identify episodes of historical disjunction, when the meaning of particular motifs changed. This paper concludes by

discussing four examples of this temporal variability and hypothesizing about the social significance of these iconographic shifts.

I am careful throughout my use of the direct historical approach to attempt to trace continuities through time — to establish historical connections between modern analogs, ethnohistoric analogs, and the subject. This is a crucial process to strengthening an argument by analogy that depends on the historical connectedness of source and subject. Another way to significantly strengthen an analogy is to, “broaden the base for interpretation with the aim of identifying clusters of attributes that reliably co-occur” (Wylie 2002:150). As I will demonstrate throughout this paper the whole of my argument is strengthened by the co-occurrence of different compositional elements that reinforce the same ideological conception.

One specific counter-argument I anticipate relates to my use of Bertonio’s early 17th century Aymara dictionary as a source analog. Some authors have argued, drawing largely on linguistic data, that Aymara speaking people, who currently inhabit the southern region, did not enter the basin until the Late Intermediate Period (ca. AD 1100–1450), largely replacing the region’s inhabitants. This model was originally formulated by Torero (1970) who argued, based on his analysis of the relationship between Quechua and Aymara and also drawing on glottochronological dating methods, that Aymara speaking people invaded the Lake Titicaca basin from central Peru around AD 1200 (see Browman 1994).

Other scholars have also argued for a late invasion model of the spread of the Aymara language (e.g., Cerrón-Palomino 2000). Bouysse-Cassagne (1987) argues for a Late Intermediate Period invasion of Aymara speakers from the central coast of modern day Chile to the south, contra Torero and the others who propose an invasion from what is now Peru to the north. Bouysse-Cassagne bases her model partially on linguistic reconstructions but also largely on one origin myth recounted by the chronicler Pedro Cieza de León in 1544 that placed the homeland of the Lupaqa Aymara on the central Chilean coast, near Coquimbo (Browman 1994).

These arguments for the arrival of Aymara speakers during the Late Intermediate Period would seem to undermine, to some extent, my use of linguistic data as a source analog in an examination of Middle Horizon Tiwanaku (hereon referred to as Tiwanaku period)<sup>2</sup> iconography and belief; however, evidence against a Late Intermediate Period invasion of Aymara speakers is presented by archaeologists, who generally argue for the long term occupation of the region by Aymara speakers, perhaps in conjunction with other language communities. These arguments rest on the assumption that an invasion and replacement by a foreign people would create a sharp and visible discontinuity in the material record. This shift is generally not born out in the archaeological data. Multiple researchers have documented an uninterrupted ceramic chronology developing from the Tiwanaku period through the Late Intermediate Period to the Late Horizon (Inca), particularly when one looks at utilitarian wares (Browman 1994; McAndrews, et al. 1997; Stanish 2003). In this paper I will assume, based on the arguments outlined above, that continuity existed between the Middle Horizon and the Late Intermediate Period in the Lake Titicaca basin and that Aymara speaking people were present there during the Middle Horizon (probably coexisting with speakers of other languages).

## SACRED MOUNTAINS

Mountains have always played an integral role in Andean socioeconomic lifeways. Due to dramatic changes in altitude, ancient Andean peoples utilized economic strategies that exploited various ecological niches in the landscape. Single groups might have herded llamas in the high *puna* regions, grown crops in the more fertile river valleys, and also utilized riverine resources (Murra 1980). Coastal groups relied heavily on maritime resources but also cultivated crops further inland (MacNeish, et al. 1975; Moseley 1992; Spalding 1984). Economic aspects

aside, the Andean Cordillera makes a striking and formidable visual impression on the observer. It is not surprising that mountains have always been sacred elements of the prehistoric landscape throughout the Andes and continue today to be ritually charged places. The ubiquity of mountains as sacred elements of the landscape is generally not disputed by Andean scholars.

Prehistoric religious architecture often emulated the dramatic peaks and valleys of the Andean Cordillera. For example, Jerry Moore (1996:116–120) concludes that structures at sites such as La Galgada, Garagay, and Cardal utilized design features such as high angles of incidence and high degrees of visibility to emphasize the height of the construction, possibly in emulation of mountains. Other sites utilize design techniques that emphasize procession along a central axis and change in elevation. The colossal monumental complex at Sechín Alto consists of a series of long plazas which are enclosed by platform arms, directing procession northeast towards a 44 m high main mound. An individual proceeding toward the main mound would pass into and then out of a series of semi-subterranean temples before reaching the main mound, itself crowned by a semi-subterranean temple (Burger 1992a; Moore 1996). Directed ritual procession is a powerful means of conveying ideology, and the ideology that seems to have been evoked at Sechín Alto and many other Initial Period (ca. 1800–900 BC) monuments emphasized changes in elevation and, by extension, referenced the mountainous landscape of the Andes. Additionally, large Initial Period U-shaped temple complexes along the coast faced toward the mountains; the source of the rivers that provided fertility to the desert coasts. The central structures of these complexes also mimicked the form of the natural mountains (Burger 1992a; Moseley 1992; Townsend 1992).

In the Lake Titicaca basin, stepped platform structures have a long history. The earliest potential evidence of this architectural tradition dates to the Initial Period at the site of San Bartolomé-Wiscachani near the modern town of Juli. The site consists of a series of terraced platforms which probably supported domestic structures and culminated in a circular depression at the top (Stanish 2003:104–105). Stanish (*ibid.*:104), referencing a nearby petroglyph which may indicate procession from the circular depression to a hill, speculates that this site may represent the earliest evidence of ritual behavior in the Titicaca basin.

The ritual focus of the site of Pucara in the northern Lake Titicaca basin during the Early Intermediate Period was undoubtedly the large terraced platform called the Qalabaya (Klarich 2005). At the summit of this structure lay two semi-subterranean courts (Kidder II 1943; Klarich 2005). This pattern of design was also evident during the Middle Horizon at Tiwanaku with the construction of the Akapana and the Puma Punku (Manzanilla 1992; Vranich 1999). The Inca also utilized this ancient design plan in the construction of stepped platform structures, sometimes referred to as *ushnus*, such as the famous one located at Vilcashuaman (Figure 3) (Hemming 1982).

Regarding other archaeological evidence suggesting that the Inca considered mountains sacred, Johan Reinhard and Maria Constanza Ceruti have conducted research at several high altitude, mountain-summit sites that show evidence of Inca ritual activity (Ceruti 2004; Reinhard 1993, 2005). On Mount Ampato in the south central Andes, a mummified girl was recovered displaying evidence of blunt-force trauma, indicating possibly that the Inca state sacrificed this girl as an offering to the mountain deity. Reinhard believes this act symbolically incorporated the mountain deities of the region into the Inca ideological system (Reinhard 2005). Similarly, evidence of Inca ritual activity was uncovered at the summit of Mount Lulllaillaco on the border between Chile and Argentina, also indicating a ritual focus on mountains (Ceruti 2004; Reinhard 1993).

The Huarochirí manuscript, recorded in Quechua under the direction of Father Francisco de Ávila, further relates the extremely prominent role played by mountains in Andean cosmology (Salomon and Urioste 1991 [1598–1608]). Mountains were viewed as *huacas* by groups in the Huarochirí region and throughout the Inca Empire. The term *huaca* refers to



FIGURE 3. INCA USHNU AT VILCASHUAMAN



(ORIGINAL PAINTING BY LYNN H. SMITH AFTER PHOTO BY EDWARD RANNEY IN HEMMING 1982:184)

both a spiritual essence and the object in which the spiritual essence of the deity has been materialized (Salomon 1991). Huacas each had differing personalities and were conceived of, in some senses, as a superhuman society. There was a spatial component to huacas as well; each was seen to have a territory on the landscape, and Andean geography was conceptualized and referenced to the huacas. In Huarochirí, space was constructed as the relationship between the people, a huaca, and its territory (Salomon 1991:17; 1998). Maarten van de Guchte, discussing the relationship between huacas and Inca cognition of landscape, defines huacas as, “a material object or location which received ritual attention, and the ‘force’ which inhabited that object or location” (van de Guchte 1999:155). He defines three classes of huacas (*ibid.*:156–157). First, huacas marked places of cosmological importance or places where mythical events occurred. Second, huacas could be places of mediation between the earthly and supernatural realms. Finally, huacas were markers of identity. This conceptualization of huacas is evident in the Huarochirí Manuscript, which tells the story of the migration of a highland ethnic group, the Yauyos – who identified with the huaca, Paria Caca – down into the valleys of Huarochirí where they conquered a rival ethnic group, the Yuncas, who identified with the huaca, Chaupi Ñamca (Salomon and Urioste 1991 [1598–1608]).

Multiple illustrations in Felipe Guamán Poma de Ayala's early 17th century petition to King Phillip III of Spain depict Incas kneeling in supplication before mountains (Guamán Poma de Ayala 1980 [1615]:266). Various other chroniclers have documented the role of mountains in Inca belief (Albornoz 1989 [1581–1585]; Molina 1989 [1581–1585]; Ulloa Mogollon 1965 [1586]; Garcilaso de la Vega 1943 [1609]; Murúa 1946 [1590]; Polo Ondegardo 1916 [1571]).<sup>3</sup> The Inca traced their origins to a mountain called Tambu Toqo ("house of windows"), which is depicted and labeled in Guamán Poma de Ayala's illustrated document. In Inca mythology these founding ancestors then began journeying to locate a place to found their city, eventually arriving at a mountain, called Huanacauri, on top of which they beheld a propitious rainbow. One of the original Incas, Ayar Uchu, climbed this hill and became trapped at the summit, then becoming one of the most sacred huacas of the Inca Empire (Urton 1990). Pedro Sarmiento de Gamboa describes this mythological event:

"Ayar Uchu promised the youths that he would give them the gifts of valor, nobility, and knighthood, and with these last words he turned into stone. They constituted him the *huaca* of the Incas, giving it the name of Ayar Uchu Huanacauri. And so it always was, until the time of the Spaniards, the most venerated *huaca*, and the one that received the most offerings of any in the kingdom" (1942 [1572]:67, translation by author).

Late Horizon mountain worship was not limited to the Incas; ethnohistoric accounts documented relationships between other groups and the sacred landscape. For example, Garcilaso de la Vega, describing the Inca incursion and subjugation of the Lake Titicaca basin, writes that the inhabitants of the Cac-Yauiri region, "... assembled together on an isolated hill in that town that seemed as if it were made by hand, less than a quarter of a league high and round as a sugar loaf..., [and] because it was unique and beautiful, it was considered sacred by the Indians and they adored it and offered their sacrifices to it" (Garcilaso de la Vega 1943 [1609]:133, translation by author).

Similarly, Juan de Ulloa Mogollón, a Spanish official, relates that Contact period groups around the town of Cabanaconde in Peru traced their origins to a mountain they referred to as Gualca-Gualca. Paul Gelles notes that the modern residents of this region still revere this mountain (Gelles 2000; de Ulloa Mogollon 1965 [1586]). Ulloa Mogollón continues on to describe that reverence of different mountains and group identity was physically marked on people through cranial deformation. These groups sought to emulate the form of the revered mountain by shaping their skulls (de Ulloa Mogollon 1965 [1586], cited in Gelles 2000:29).

Modern groups continue to regard mountains as an essential component to the sacred landscape. Many origin myths surround mountains, and mountains are still seen as the guardian huacas that protect the community and engender fertility. Sacrifices and offerings are still made to mountain deities to ensure a productive growing season or fertility of camelid herds (Abercrombie 1998; Allen 2002; Bastien 1978; Castro and Aldunate 2003; Gelles 2000).

Some other terms Quechua speaking groups use to refer to mountains include: *apu*, *awki*, and *wamani* (Allen 2002; Gelles 2000). These terms all refer to the spirits or lords of the mountains. Aymara speaking groups have similar concepts, and some of the terms used to refer to mountain lords and spirits include: *samiri*, *uywiri*, *mallku*, and *achachila* (Abercrombie 1998; Dillon and Abercrombie 1988; Dransart 2002; Rasnake 1988a). These terms further indicate a sense of kinship with the landscape. The term *achachila* carries the connotation of "ancestor" or "old one" and is derived from the Aymara root word, *achachi*, meaning "old" (Bertonio 1993 [1612]). All of these terms indicate that mountains are personified by modern Andean groups. Indeed, in Isluga, an Aymara speaking community in northern Chile, one informant remarked anxiously about a mountain near the border with Bolivia: "Why is it looking at us and not at Bolivia?" (Dransart 2002:62).

Ethnographic data further suggest that modern groups generally conceptualize mountains as not only sacred but also as providers of fertility. Modern Aymara-speaking groups in Isluga refer to some mountains as “*aviador*,” which is a loan word from 17th century Spanish meaning, “provider” (Dransart 2002:59). Similarly, Thomas Abercrombie notes that modern residents of the Bolivian altiplano community of K’ulta offer a ritual libation to “*awiyaru*,” which he also links to the archaic Spanish verb *aviar* which means “to provision” (Abercrombie 1998:358).

Joseph Bastien, writing about modern residents of the region around Mount Kaata in Bolivia, notes that a step representation is the Kaatan symbol of the mountain (Bastien 1978:36). Following other authors (Kolata and Ponce Sanginés 1992; Kolata 2003), I suggest that, like the modern residents of Mount Kaata, the ancient residents of Tiwanaku used the Step motif to represent mountains. Further, as Kolata and Ponce Sanginés have argued, I suggest that these symbols were created in three dimensions as well as two (Kolata and Ponce Sanginés 1992; Kolata 2003). Both the Akapana and the Puma Punku structures at Tiwanaku are architectural versions of the Step Mountain motif and reference sacred mountains. The Akapana, constructed in approximately AD 600 (Vranich 2009), consisted of a series of seven terraces created by building double-walled, cellular, stone revetments that contained earthen fill (Vranich 2002) (Figure 4). The exterior walls of the basal terraces were constructed of monolithic, horizontally laid andesite ashlar interspersed with vertical pilasters (Kolata 1993; 2003; Manzanilla 1992; Vranich 2002; 2009).

The Puma Punku stepped platform is a distinct ritual complex at Tiwanaku located approximately one kilometer southwest of the Akapana and constructed at roughly the same time. The Puma Punku is more extensive than the Akapana, measuring approximately a half-kilometer east to west (Janusek 2004:133). The structure is positioned on a low escarpment that emphasized its height when viewed from the west (Vranich 1999). It is argued that ancient visitors to the site approached the Puma Punku from the west and ascended a set of stone steps to pass through carved gateways into the structure’s interior, which contained a sunken temple. On the east side of the Puma Punku, facing a large plaza, was a portico of carved stone portals set on massive sandstone slabs (Janusek 2004:133; Protzen and Nair 2002; Vranich 1999).

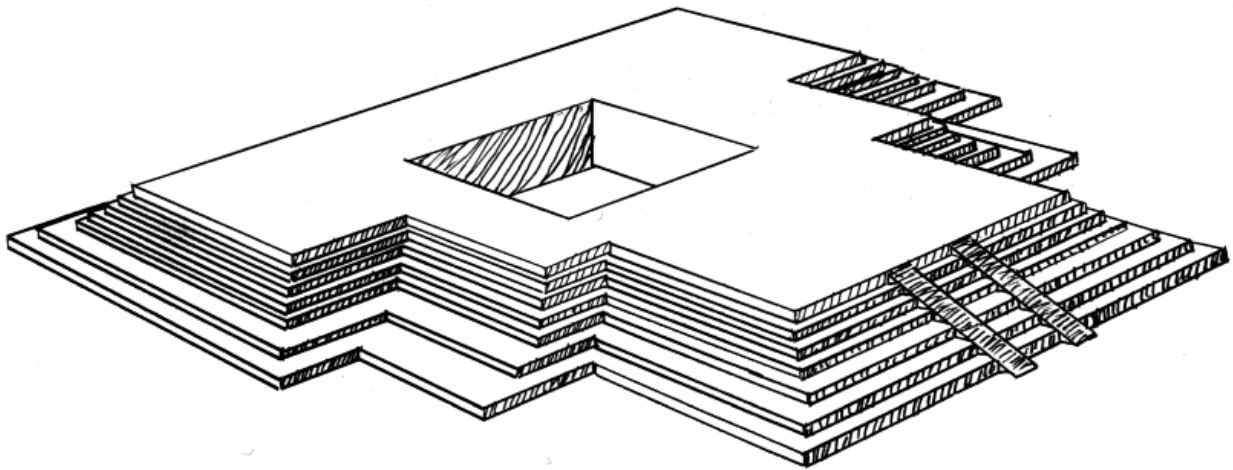
Stepped-platform mounds are also key architectural features at secondary Tiwanaku centers such as Omo M10 in Moquegua (Goldstein 2005:282–296) and Lukurmata (Bermann 1994:159–163; Rivera Sundt 1989). While it is possible that the iconographic Step motif simply portrays a stepped-platform mound as several scholars have suggested (see, for example, Cook 1983:164; Posnansky 1945a; Stone-Miller 2002:133; Young-Sánchez 2004:36), I argue here that both the Step motif and stepped-platform mounds served as symbols referencing the same set of underlying religious beliefs which venerated the sacred mountainous landscape.

## SERPENTS

The Step Mountain motif is almost always portrayed associated with serpent-like creatures. Often these serpentine beings emerge out of a central element of the mountain. The bases of the mountain on either side are also frequently depicted as serpents (see Figures 1b and 2, particularly Figure 2c). Serpents are common motifs throughout the Andes, both now and in prehistoric times, and are often conceptually linked to mountains. For example, informants from the modern town of Khonkho Liki Liki in the Lake Titicaca basin of Bolivia reported to the author that a gigantic monster serpent lives in the immediate region within the bowels of the most important mountain huaca, which is called the Jach’a Pukara.

Multiple lines of evidence suggest that serpents were symbolic of rivers and streams to prehistoric Andean groups. They further represented fertility and spiritual essence. Paul Gelles

FIGURE 4. ISOMETRIC DRAWING OF THE AKAPANA



(AFTER KOLATA 2003:184, FIG. 7.7)

notes that present day Quechua speaking residents of the community of Cabanaconde in the southern Peruvian highlands near Arequipa visualize rivers in the form of serpents. These serpent-rivers are gendered male as well, and the water is conceptualized to flow down the mountain to fertilize the gendered female earth. The annual maintenance of the canals and irrigation networks and the distribution of water is the responsibility of a water mayor, and the symbol of authority for this office is a serpent-headed staff (Gelles 2000:75-92).

Hans Buechler (Buechler and Buechler 1971:77), discussing the Aymara community of Compi, details a “rite of spring” called the Kachua festival which he associates with ensuring the fertility of crops. He describes how groups of boys and girls go up into the hills from the community and ritually play music, sing, dance, and exchange food. A mock marriage is performed between the head boy and girl, and then the entire group joins hands and dances down the hill in a “serpent dance” (ibid.). This festival emphasizes the connection between serpents, fertility, and rivers. The fertility of the adolescents is associated with the fertility of the crops. The serpent dance further takes the physical form of a river, winding its way down the hill to impregnate the fields below.

Catherine Allen (2002:36) relates that rivers and streams are the most tangible form of *sami* for Quechua speaking people of Sonqo in the southern Peruvian Highlands. *Sami* is the animating essence of the world and is manifested physically in water and light. Informants in Sonqo related that the souls of their ancestors travel around in water. Rivers are viewed as bringing life not just to crops but to the cosmos in general. They are conceptualized, “in terms of a vast circulatory system that distributes water throughout the cosmos...[r]ivers that flow out of highland lakes into the jungle are believed to return underground to their places of origin” (ibid.:36).

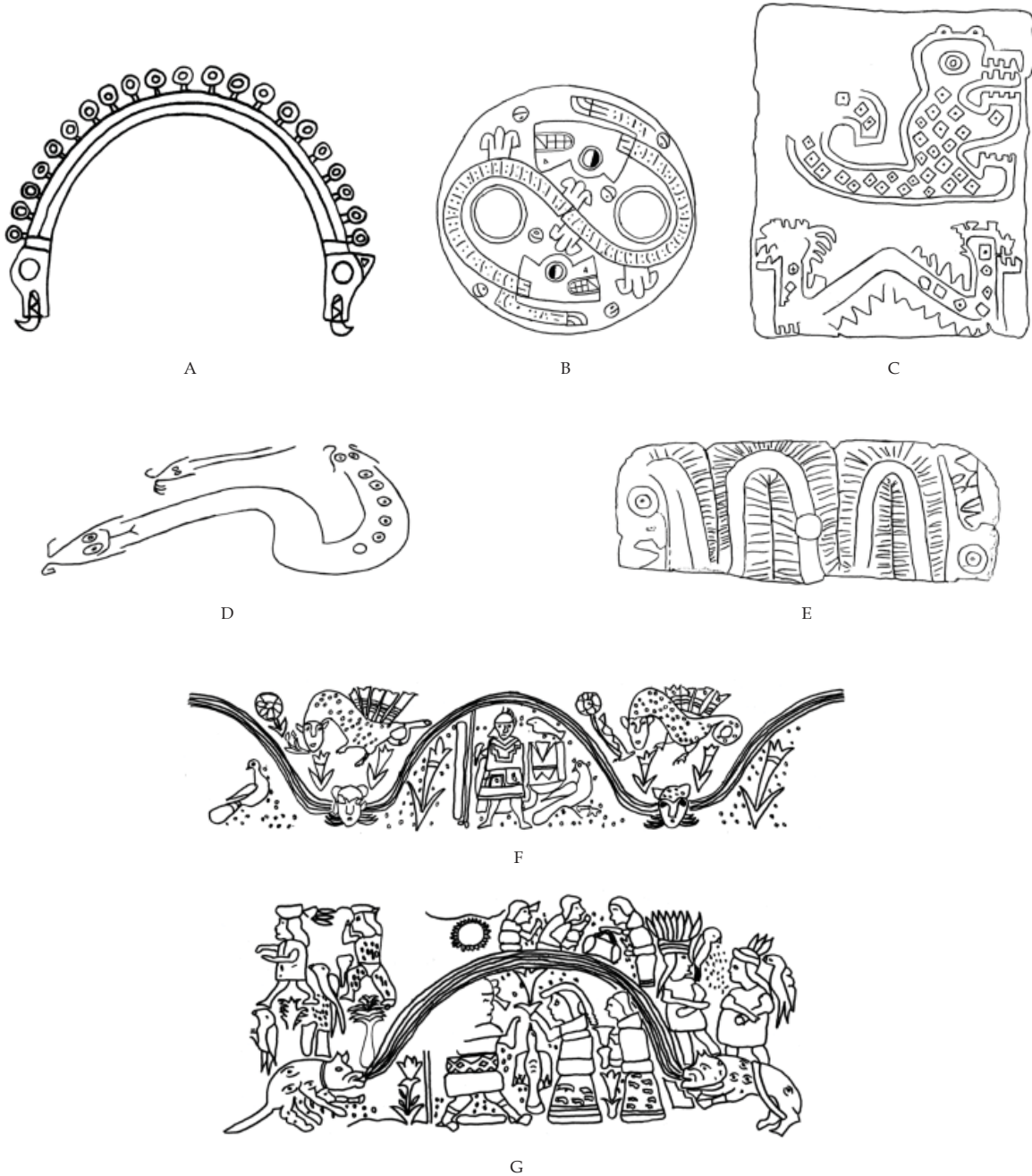
Water is believed to circulate from the great celestial river called Mayu (the Milky Way). Rain pours down on the mountains and then flows to the coast and is transferred back to Mayu by Yacana, a celestial llama who descends to earth to drink from the swollen rivers and then returns to the heavens (Allen 2002:36; Burger 1992b:275; Salomon and Urioste 1991 [1598–1608]:Ch. 29; Urton 1981:122–123). Allen elaborates on how water and thus *sami* is spread throughout the land: “K’uychi (Rainbow) facilitates the distribution of water on a local level. K’uychi is an *amaru* (great subterranean serpent) who lives in springs. Filled with water after a rain, he flies out of the spring and arches across the sky. Burying his head in a second spring, he siphons water through his body from one spring to another” (Allen 2002:36).

The early 17th century Huarochirí Manuscript (Salomon and Urioste 1991 [1598–1608]:Ch. 16, 205) also references the *amaru*. In describing the huaca Paria Caca’s battle with the fiery volcano, Huallallo Caruincho, the writer of the manuscript explains, “then Huallallo Caruincho turned loose a huge snake called the Amaru, a two-headed snake, thinking, ‘This’ll bring misfortune on Paria Caca!’” The translators of the manuscript remark that *amarus* are almost ubiquitous in Andean mythology. Inca mythology further described *amarus* as double-headed serpents from which several Incas, including Amaro-Topa Inca, took their surnames. The Inca created a temple called the Amaru-cancha in Cuzco, which was dedicated to this mythical being (Gisbert 1997:225). The antiquity and spatial extent of the *amaru* idea is demonstrated by representations dating as early as the Early Intermediate Period and found from the north coast of Peru as far south as Argentina and northern Chile (Figure 5) (see also Clados 2009). Additionally, *amarus* are portrayed in direct association with the Step Mountain motif on Early Intermediate Period Lima style vessels (Kroeber 1926; Thomas C. Patterson, personal communication, 2009).

*Amarus* are thought to emerge from springs, caves, and *tinkuy* (a Quechua term denoting a meeting of two things, in this case a point where two streams converge) and are associated strongly with rainbows (Allen 2002:36; Urton 1981). They are said to be, “double-headed, one head buried in each spring” (Urton 1981:115). An *amaru* then emerges from one spring to arc across the sky and bury its head in another spring. Inca and Colonial period *keros* often depict rainbows emerging from the mouths of felines and yielding rains upon Inca rulers (Figures 5f and 5g). Felines are also conceptually associated with serpents, rivers, and fertility and will be discussed below. Further, Dransart notes that, for the modern Aymara speaking community of Isluga in northern Chile, “colorful meteorological phenomena like the rainbow are perceived to be awesome, but also propitious because of their association with beneficial rains” (2002:90). Urton discusses the parallels between the *amaru* rainbow serpent and terrestrial serpents:

“The *amaru*, which rises out of a spring after rain, exhibits a climatological behavior pattern similar to terrestrial serpents which, at the end of the cold/dry season and at the beginning of the warm/rainy season, emerge from subterranean hibernation... [S]ince meteorological serpents (rainbows/*amarus*) only appear during the rainy part of the year, they exhibit a seasonal activity cycle similar to that of terrestrial reptiles” (Urton 1981:118).

FIGURE 5. ANDEAN REPRESENTATIONS OF AMARUS



- A: DETAIL OF MURAL FROM BATAN GRANDE IN NORTHERN PERU (AFTER KAUFFMANN DOIG 2002:418, FIG.1).  
 B: NASCA CERAMIC FRAGMENT (AFTER MENZEL 1964:PL. III, FIG. 8).  
 C: AGUADA STYLE (NORTHWEST ARGENTINA) TEXTILE RECOVERED FROM SAN PEDRO DE ATACAMA, CHILE (AFTER TORRES AND CONKLIN 1995:88, FIG. 9).  
 D: PETROGLYPH FROM CHICHITARA, PERU (AFTER SCHOBINGER 1997:FIG. 65).  
 E: AGUADA STYLE SPINDLE WHORL (AFTER DRANSART 1995:255, FIG. 7).  
 F: DETAIL OF SCENE FROM COLONIAL PERIOD KERO (AFTER FLORES O. ET AL. 1998:211).  
 G: DETAIL OF SCENE FROM COLONIAL PERIOD KERO (AFTER GÓMEZ 2003:177, FIG. 7c).

This passage also relates amarus to the agricultural cycle. Rainbows/amarus are created from water and light and thus are the conflation of the two most potent circulatory agents of sami, or spiritual and fertile essence (Allen 2002:34).

It is the contention of this paper that the serpent-like beings emanating from the Step Mountain in Tiwanaku imagery are representations of serpents and in all likelihood specifically amarus. The identification of these serpents as amarus is further reinforced by their common depiction in Tiwanaku imagery with puma heads. Numerous authors note that amarus are depicted by informants as incorporating feline characteristics (Allen 2002:176, 272; Cordy-Collins 1983:185; Hocquenghem 1983:5; Zuidema 1985:183). Further, the chronicler Joan de Santa Cruz Pachacuti Yamqui Salcamaygua relates an Inca story about an amaru that emerged from the mountain Pachatusan. The account describes the beast as, “half a league long, and thick – two and a half arms wide – with ears, fangs and a beard” (1993 [1613]:224, translation by author, emphasis added; see also Gisbert 1997:231). Inca imagery depicts amarus as beings with combined serpent and feline characteristics (Figures 6a and 6b), and Pucara and Tiwanaku imagery depict both serpents with puma heads and pumas with forked serpent tongues, possibly identifying these creatures as amarus as well (Figure 6c–6e). Since amarus are representative of rainbows, which are created from both water and light, these mythical beings seem to represent the quintessence of sami. Thus the serpents represented emerging from the Step Mountain in Tiwanaku art are representative of agricultural, human, and camelid fertility, and they are associated with the emergence of otherworldly spiritual essences.

Just as we see amaru serpent-rivers emerging from the iconographic Step Mountain, so, too, do serpent-rivers emerge from the architectural version. Archaeological investigation of the Akapana at Tiwanaku has documented a system of canals and drains that channeled rainwater along a path that alternated from the interior to the visible exterior of the structure, emulating the mountain springs of the Quimsachata mountain range to the south (Kolata and Ponce Sanginés 1992; Kolata 2003, 2004). At Lukurmata, as well, a series of canals and drains moved water from the sunken temple down the monumental stepped-platform mound (Kolata 2003:187–189). The stepped Puma Punku temple at Tiwanaku, which also has a network of drains (ibid.:193), is spatially associated with the Choquepacha spring, which shows evidence of having been ritually important during Tiwanaku times (Bruno 2000; Janusek 2008:123). These data support the idea that Tiwanaku ritual placed emphasis on streams and rivers flowing from the sacred mountainous landscape. The compositional similarity between the amaru serpent-rivers flowing from the Step Mountain motif in Tiwanaku iconography and drainage systems of Tiwanaku stepped-platform mounds tends to support the contention that residents of Tiwanaku conceptualized sacred mountain streams and rivers as amarus.

#### THE CENTRAL ELEMENT

Amarus in Tiwanaku iconography are often portrayed emerging out of a central element in the Step Mountain. This section explores concepts of emergence in greater detail and examines the central element pictured in the Step Mountain. While a variety of origin myths have been recorded in the Andes they almost invariably involve a theme of emergence. Abercrombie, in reference to the Aymara of K’ulta in Bolivia, relates:

“The myths we have surveyed share numerous themes and features. Creative culture-heroes fan out from a central origin point to bring forth multiple ancestors throughout Andean territory from rocks, springs, and hills that thereafter become conduits through which human societies have access to the gods and powers of initial times. The above- as well as below-ground paths through which creators and creation have flowed remain in the storytellers’ world as icons of the relationship among founding agencies” (1998:211).

FIGURE 6. INCA, TIWANAKU, AND PUCARA REPRESENTATIONS OF AMARUS



- A: INCA AMARU REPRESENTATION FROM COLONIAL PERIOD KERO (AFTER FLORES O. ET AL. 1998:211).  
 B: INCA AMARU REPRESENTATION FROM COLONIAL PERIOD KERO (AFTER FLORES O. ET AL. 1998:307).  
 C: DETAIL OF CARVING FROM THE PUCARA PLAZA STELA SHOWING SERPENTS WITH FELINE FEATURES (AFTER CHÁVEZ 1975:PL. V, FIG. 5).  
 D: DETAIL OF TIWANAKU PERIOD CERAMIC PITCHER FROM THE CH'iji JAWIRA SECTOR OF TIWANAKU SHOWING BEING WITH BOTH SERPENT AND FELINE ATTRIBUTES (AFTER RIVERA C. 2003:299, FIG. 11.4).  
 E: PUCARA STYLE CERAMIC SHERD SHOWING FELINE HEAD WITH SERPENT TONGUE (AFTER ROWE AND BRANDEL 1969-1970:FIG. 30).



Mountain springs are noted by Abercrombie to have been places of origin for ancestors. Recall that serpents and specifically amarus emerge from mountain springs as well and are symbolic of fertility. Both La Barre (1948:142) and Métraux (1934:23) affirm that Aymara groups in the early 20th century traced their origins to caves, mountain peaks, lakes, and rivers, and Métraux notes that caves were particularly formidable huacas. Generalizing, we can say that Aymara groups commonly viewed their origins in terms of emergence from mountain springs and caves. A common theme is origination in a watery underworld that is accessed in mountaintop localities. Tschopik (1951:194b) notes that among the Aymara of Chucuito a huaca known as the Chichera Boulder is held sacred. A woman who wishes to become pregnant makes an offering to a shallow cave on this hill. She deposits the offering and implores the spirit to grant her a child. In this example the cave is associated with otherworldly communication and with fertility.

Dransart (2002:59) relates that the people of Isluga in northern Chile refer to the points of origin for people and llamas as *juturi*. “*Juturi* is considered to be a deep hollow leading to the inner world (*manq’a pacha*) [sic]; it is regarded as being a point of creation, a place where llamas may enter this world” (ibid.:59). She continues on to discuss that mountain springs are often considered *juturi* (ibid.:60, 64). Related to this term is the word *juthuwi*, which according to Bertonio’s early 17th century Aymara dictionary means, “origin and place of beginning, burrow from which things emerge” (Bertonio 1993 [1612], translation by author). Further, the word *juthuña* means, “to exit, to originate, to be born from your place of beginning” (ibid., translation by author). Both of these terms indicate that early 17th century Lake Titicaca basin groups also conceptualized a point emergence or birthplace as a hollow in the ground.

Thus, mountain caves and springs are conceptualized as otherworldly portals and are extremely ritually charged places as a result. For the Aymara, afflictions such as syncope, fainting, and epilepsy are said to be caused by a condition known as *kalxa*, which means, “to be looked on by a spirit” (La Barre 1948:212). These spirits are said to emerge from wells, caves, springs, rivers, and mountains, all of which are portals between worlds (ibid.:212). One informant in Khonkho Liki Liki confirmed this belief to the author and related that a spring near her land had been behaving badly recently and had caused someone to become ill. In the same community, another informant remarked that a spring in the mountains above the community center was considered a very sacred place.

Salomon describes the importance of mountaintop caves as portals between the current world and the world of the ancestors for 18th century residents of Arequipa, Peru:

“A late [C]olonial account from Arequipa affords a close view, albeit one affected by clandestinity. The worshipers ascended to their ancestral caves by moonlight, in a group representing the whole kindred descended from the mummies. Arriving at the cave mouth, the worshipers whistled to ask entry...Quechua-speakers in secular context, the worshipers invoked their ancestors in Aymara... [Archivo de Arzobispado de Arequipa, 174(8?)-1754, Proceso de Gregorio Taco y otros por haber incitado a los indios de Andagua contra la administración del tributo, y por idolatrias y hechicerias, fol. 246r]” (Salomon 1995:323-324).

Salomon (ibid.:336) further relates that current residents of the Huarochirí region still refer to the human remains found in the caves of the region as, “the beautiful grandparents,” affirming that modern groups continue to regard the bones found in the caves as kin, as did the 18th century residents of the region mentioned above. Caves, then and now, are seen as the point of liminality between earthly and otherworldly realms.

Moreover, for these groups, the ancestors of the caves are responsible for the productive success of the community. The *mallquis* (ancestors) are offered sacrifices and libations in order to ensure the productive fertility (Salomon 1995:337). Salomon relates that, “[t]he

well-known fact that the word *mallqui* means not only 'mummified ancestor' but 'the tender plant to be planted' of 'any fruit tree' (González Holguín 1989 [1609]:224; Sherbondy 1986) is part of a more pervasive vegetative metaphor" (Salomon 1995:340). He further notes that one specific point of origin for a group in the region is conceptualized as a farm, implying that points of emergence are tied to the cyclical nature of both agricultural fertility and human spirituality. The soul emerges from this point in birth and then returns to be replanted in death (ibid.:341). The material reproduction of these communities is conceptually tied to the well-being of the ancestors.

Various chroniclers from the early Colonial period affirm that Contact period Andean groups conceptualized mountain caves and springs as points of emergence and portals between worlds. Cristóbal de Molina (1989 [1576]) relates that the huacas typically communicated through stones and fountains. Sarmiento de Gamboa, talking about the origin of Andean groups wrote, "... people came forth, some from lakes, others from fountains, valleys, caves, trees, caverns, stones and hills, spreading over the land and multiplying to form the nations which are today in Peru" (1942 [1572]:53, translation by author). The importance of caves and springs to the Inca is archaeologically evident from the carved shrines present at many of these locales. An altar in front of Choquequilla cave was carved in a Step motif, reinforcing the sacred mountain imagery (Figure 7b) (Hemming 1982). Additionally, the sacred spring above Cuzco at Tambo Machay (meaning "house of the cave") was enshrined by a terraced structure of platforms and niches. Indeed, the so-called "Bath of the Princess" at Ollantaytambo is a stunning representation of a sacred mountain spring (Figure 7a) (Hemming 1982).

Additionally, Inca mythology referenced a mythical origin at the Island of the Sun. The ancestors of the Inca were created on this island in Lake Titicaca and then traveled via subterranean routes to a place called Pacariqtambo (Urton 1990, 1999). The Spanish chronicler Sarmiento de Gamboa (1942 [1572]) relates that the Inca emerged from a central cave located on a mountain called Tambotoco, meaning, "house of windows." These windows are referred to as caves in other documents (Murúa 1946 [1590]; Polo Ondegardo 1916 [1571]; cited in Urton 1990). Guamán Poma de Ayala (1980 [1615]:79, 266) illustrates this famous mountain with multiple drawings in his manuscript (Figure 8). Indeed, in these illustrations the mountain has a stepped appearance. The name of the locality where this sacred mountain cave of origin is located is Pacariqtambo, which may be glossed as "house of origin," "house of production," and "way-stop of flowering" (Abercrombie 1998:197; Sarmiento de Gamboa 1942 [1572]:62; Urton 1990). The Quechua term *pacara* means "flower" or "blossom." In Aymara the term is the same, *paq'ara*, and has the same meaning. *Paqarinas* are then places of flowering, blossoming, or awakening (Abercrombie 1998:171; Forbes 1870; Urton 1990).

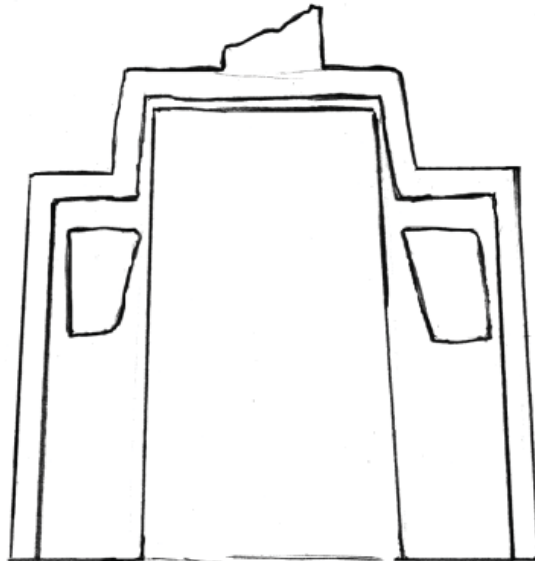
The concept of a paqarina as an ancestral place of blooming or emergence was not solely Incaic. Abercrombie relates that, "every province had shrines known as *wak'as*, [huacas] some of which were called (in Quechua) paqarinas, 'places of blooming,' marking where the first ancestors emerged" (1998:174). The ubiquity of this concept in the Andes at the time of Spanish contact was recorded by the chronicler Cristóbal de Albornoz (1989 [1581-1585]:171, 196), who related that as people were moved from place to place for *mit'a* service to the Inca they took a piece of clothing given to them from the head priest of their "*wak'a paqarisqa*" of their homeland. They were told by this religious leader:

"...not to forget the name of their origin and that, in the same way that they had in their homeland, they should reverence [sic] and worship their paqarisqa creator....If there are springs in their lands, they bring with them a cup of water, throw it with great ceremony into the springs in the places to which they are transplanted and give it the name of their paqarisqa with great solemnity..." (cited in Abercrombie 1998:187).

FIGURE 7. INCA STONE SCULPTURE REFERENCING  
MOUNTAIN CAVES AND SPRINGS



A



B

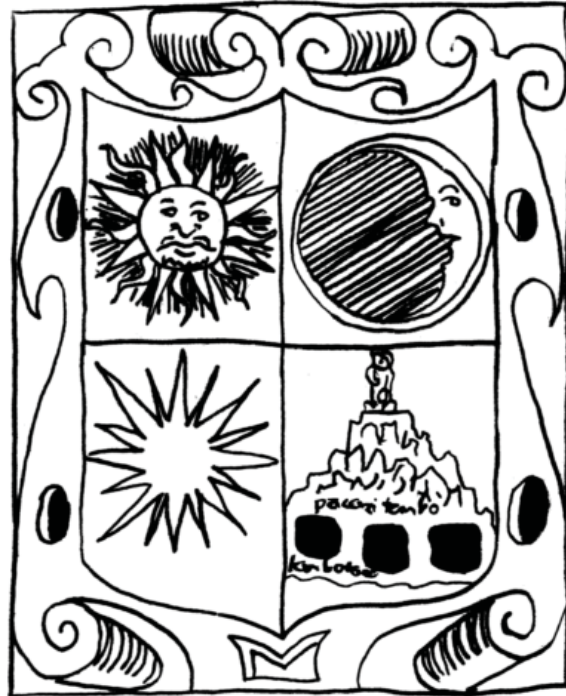
A: THE "BATH OF THE PRINCESS" AT OLLANTAYTAMBO, PERU (ORIGINAL PAINTING BY PAOLA GUARDIA AFTER PHOTO BY EDWARD RANNEY IN HEMMING 1982:115).

B: THE ALTAR AT CHOQUEQUILLA CAVE, PERU (AFTER PHOTO BY EDWARD RANNEY IN HEMMING 1982:159).

FIGURE 8. REPRESENTATIONS OF PAQARIQTAMBO BY GUAMAN POMA DE AYALA



A



B

A: FROM THE DRAWING ENTITLED, "ÍDOLOS DE LOS INGAS: INTI, UANA CAURI, TAMBO TOCO, PACARI TAMBO" (AFTER GUAMAN POMA DE AYALA 1980 [1615]:266).

B: FROM THE DRAWING ENTITLED, "PRIMER CAPÍTULO D[E] LOS INGAS: ARMAS PROPIAS" (AFTER GUAMAN POMA DE AYALA 1980 [1615]:79).

This account demonstrates that pre-Inca groups in the Andes conceptualized their place of origin as a *paqarina* or place of blossoming. These *paqarinas* were mountain springs and caves and represented human, camelid, and agricultural fertility. Indeed, "newborn animals and first fruits are themselves referred to as 'flowers' in libations" (Abercrombie 1998:501).

This information suggests that there was a general Andean concept of emergence of ancestors from mountain caves and springs. Since the serpent has been identified as symbolic of streams and rivers emerging from these mountain caves and springs, we can begin to assert that the central element of the Step Mountain motif in Tiwanaku imagery, from which serpents often emerge, is a sacred *paqarina*, or place of origin. This place of blossoming was representative of fertility and may have been conceptualized as a spring or cave (Figure 9).<sup>4</sup>

The Akapana at Tiwanaku, an architectural Step Mountain, also probably contained a *paqarina* in the form of a sunken temple or cistern at the summit of the pyramid (see Figure 4). This sunken temple was unfortunately destroyed in the 17th century by looters who excavated into the summit of the Akapana, but many archaeologists who have excavated at Tiwanaku are convinced of its existence in antiquity (Janusek 2004, 2008; Kolata 2003; Kolata and Ponce Sanginés 1992; Manzanilla 1992; Vranich 2009). Manzanilla and Woodard (1990:136) report that

FIGURE 9. PAQARINAS IN TIWANAKU IMAGERY



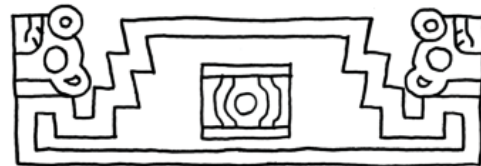
A



B



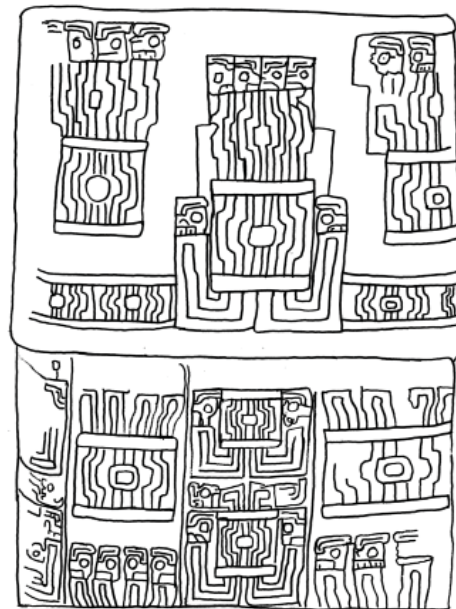
C



D



E



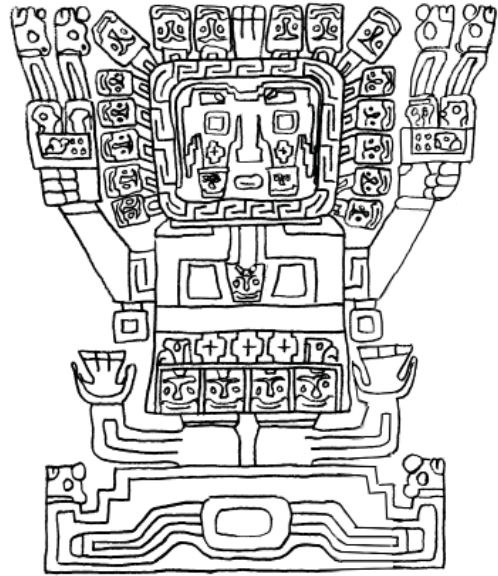
F

- A: DETAIL OF STEP MOUNTAIN MOTIF WITH CENTRAL ELEMENT FROM THE GATEWAY OF THE SUN (AFTER STONE-MILLER 2002:133, FIG. 104).
- B: DETAIL OF STEP MOUNTAIN MOTIF SHOWING CENTRAL ELEMENT FROM THE LOWER BAND ON THE GATEWAY OF THE SUN (AFTER POSNANSKY 1945B:PL. XLI, FIG. 1).
- C: DETAIL OF STEP MOUNTAIN MOTIF SHOWING CENTRAL ELEMENT FROM THE LOWER BAND ON THE GATEWAY OF THE SUN (AFTER POSNANSKY 1945B:PL. XLI, FIG. 2).
- D: DETAIL OF STEP MOUNTAIN MOTIF SHOWING CENTRAL ELEMENT FROM THE LOWER BAND ON THE GATEWAY OF THE SUN (AFTER POSNANSKY 1945B:PL. XLI, FIG. 3).
- E: CENTRAL-ELEMENT MOTIF FROM CENTRAL FIGURE ON THE GATEWAY OF THE SUN (AFTER POSNANSKY 1945B:PL. XLII, FIG. 3).
- F: DETAIL OF KOCHAMAMA STELA SHOWING SERPENTS EMERGING FROM A CENTRAL ELEMENT (AFTER POSNANSKY 1945A:FIG. 100A).

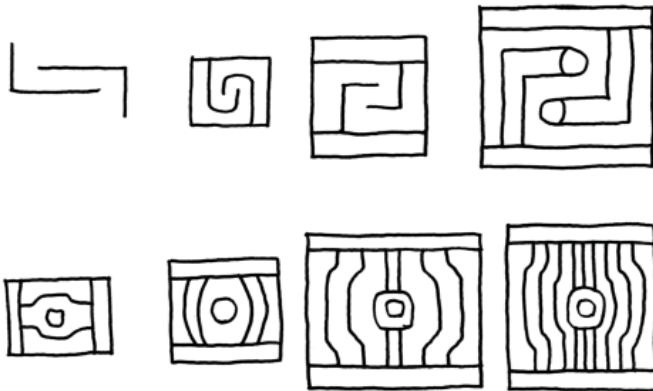
FIGURE 9. PAQARINAS IN TIWANAKU IMAGERY (CONTINUED)



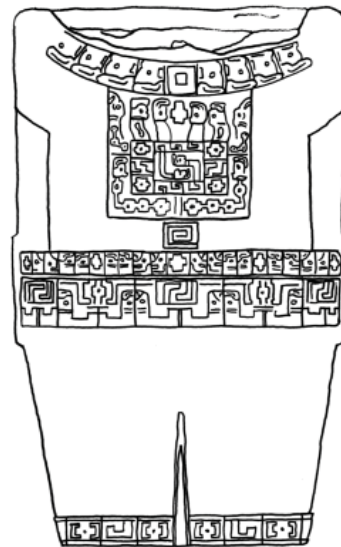
G



H



I



J

- G: DETAIL OF SCEPTER FROM THE GATEWAY OF THE SUN DEPICTED AS SERPENTS EMERGING FROM A CENTRAL ELEMENT (AFTER POSNANSKY 1945B:PL. XXXVII, FIG. 83).
- H: DETAIL OF THE BENNETT MONOLITH SHOWING SERPENTS EMERGING FROM A CENTRAL ELEMENT IN STEP MOUNTAIN MOTIF (AFTER YOUNG-SÁNCHEZ 2004:113, FIG. 4.15).
- I: VARIOUS DEPICTIONS OF CENTRAL ELEMENTS AS DRAWN BY ARTHUR POSNANSKY (AFTER POSNANSKY 1945B:128, FIGS. 14 AND 15).
- J: DRAWING OF THE PUTUNI MONOLITH FROM TIWANAKU SHOWING CENTRAL ELEMENT REPRESENTED BY DUAL SERPENTS ON BELT AND PECTORAL AREA (AFTER COUTURE AND SAMPECK 2003:251, FIG. 9.38).

the boundary walls of this sunken temple, as well as part of the drain, were detected using earth resistance remote sensing techniques. Indeed, other Tiwanaku stepped-platform mounds, such as the Puma Punku at Tiwanaku (Vranich 1999), the Wila Kollu at Lukurmata (Janusek 2004, Kolata 2003, Rivera Sundt 1989), and the M10 temple at Omo in Moquegua (Goldstein 2005), contained sunken temples on their summits, lending credence to the hypothesis that the Akapana also contained a sunken temple.

Stepped platforms with sunken temples representing paqarinas at their summits have significant time depth in the south central Andes, possibly dating back as far as the Initial Period at the Lake Titicaca basin site of San Bartolomé-Wiscachani (Stanish 2003:104–105). Inhabitants of the site of Pucara during the Early Intermediate Period further utilized this architectural design, creating the Qalabaya platform which had two sunken courts placed in its summit. This architectural pattern was also present at the Early Intermediate Period site of Khonkho Wankane in the Desagüadero Valley south of Tiwanaku (Smith 2007, 2009, 2011a, b). This tradition continued, as mentioned earlier, into Inca times. The Inca constructed stepped monuments, called *ushnus*, which are commonly described as administrative platforms (Hemming 1982), but in all likelihood also functioned as architectural representations of the sacred mountain like the structures mentioned above (see Figure 3). At the ushnu summit was a small circular hole to receive libations. Indeed, other authors indicate that this offertory hole was a conduit to the spiritual realm, or a paqarina (Abercrombie 1998:139). John Hoopes (2009) specifically traces the inspiration for the development of the Inca ushnu to the Akapana. The archaeological data tend to support the idea that the ancient Tiwanaku conceptualized sacred mountain springs and caves as points of emergence or paqarinas.

Further investigation reveals greater detail about how ancient residents of Tiwanaku may have envisioned these paqarinas. Modern groups living in the region of Pacariqtambo, where the Inca traced their ancestral emergence from a mountain cave, relate that the first of the various *ayllus*<sup>5</sup> to inhabit the region was the ayllu Nayhua. This ayllu is thought of as the first or supreme of the ten ayllus in the area. *Nayhua* is the local name for a colorful flower, an etymology that recalls the concept of the paqarina (Abercrombie 1998; Urton 1990). Further:

“...in Bertonio’s .... early seventeenth-century dictionary of Aymara, *nayra* is given as a synonym for *collana* (*qollana*); both terms are glossed as ‘the first.’ Bertonio also gives the following glosses for *nayra*: *nayra pacha* (ancient); *nayraja* (without, or before, time); *nayra* (the tip or beginning of something, such as a rope); *nayra* (eye, or eyes of the face); *nayra* (a seed of grain, such as maize or quinoa, etc.). Bertonio also says that *nayra ppia* is synonymous with *ttokho*. The latter is the Aymara form of the Quechua term *t’oqa* (window), as found in the earlier references to the caves (or windows) of origin at Tampu T’oqa. Thus, *qollana/nayra/nayhua* is the window, or opening – the first in the series and the point of origin – of the *ayllus* of Pacariqtambo” (Urton 1990:79).

As Urton points out in the passage above, the term *nayra*, one meaning of which is “eye,” is linked to the concept of ancestral emergence from a mountain spring or cave of origin. Additionally, Forbes (1870) defines the Aymara word *nayra* as meaning both “eye” and “first, in front, before.” Ancestral paqarinas or places of origin are thus indicated to be synonymous with eyes.

While Forbes (1870) and Bertonio (1993 [1612]) translate “eye” as *nayra*, Cole (1969) and Abercrombie (1998) relate that the similar word *layra* means “eye” for their informants and communities. Abercrombie further relates that among the K’ulta of Bolivia *layra timpu* refers to the “time of the ancestors.” The term *layra* in this community is a modifier used when referring to the founding ancestors of the community or the remote past (Dillon and Abercrombie 1988:55). *Layra*, “recall the generalized Andean concept of paqarina, which, as we’ve seen, were the openings in the earth from which ancestors sprang in pre-Columbian narrated pasts” (Abercrombie 1998:180).

Moreover, Bastien (1978:46) shows that Aymara communities near Mount Kaata trace their origins to lakes and springs on the mountain, which they refer to as the mountain's eyes. Bertonio (1993 [1612]) lists the Aymara term for the surface of the water as *uma nayrat'a*, which refers to the reflective surface of the water as an eye. Further, the Aymara of Chucuito Peru, in times of drought, make offerings to the eyes of the mountain shrine (Tschopik Jr. 1951:197). All of these references suggest that Aymara groups generally conceptualized their paqarinas, or places of origin, as the eyes of the sacred mountain.

There is evidence to suggest that the inhabitants of Tiwanaku also conceptualized their place of origin as a mountain eye. Disembodied heads portrayed on Tiwanaku ceramic keros and *tazones*, often referred to as anthropomorphic profile heads, frequently utilize a distinctive form to represent the eye (Figure 10). This form is almost identical to depictions of the central element in various Step Mountain representations (Figure 11). I suggest the central element of the Step Mountain is the eye of the mountain from which ancestral emergence can be traced. Some versions of the central element leave the actual point of emergence unmarked but show serpents or linear elements emerging (Figure 12). These elements portray in essence the same idea, a mythical cave or spring of emergence. Paqarinas, or places of blooming, during the Tiwanaku period were conceptualized as the eye of the sacred mountain, and these motifs carried with them powerful connotations of fertility for crops, herds, and humans.

Having established that during the Tiwanaku period the paqarina or point of emergence was conceptualized as the eye of the sacred mountain, we can begin to look for other representations involving eyes in Tiwanaku imagery and iconography from other contemporaneous cultures. A common motif in both Tiwanaku and Wari representations of faces are eyes that are crying (Figure 13). These streams of tears are generally referred to by scholars as "tear tracks" or "tear bands." In light of the identification of sacred mountain springs and watery caves as layra or eyes, it becomes apparent that the tear tracks represent streams or rivers. Indeed, many tear tracks terminate in representations of flowers and plants, emphasizing not only the connection of the tears with the rivers that make agricultural productivity possible, but also the connection of the layra or eye with the more generalized concept of paqarina or place of flowering (see Figure 13f-h).

## LLAMAS

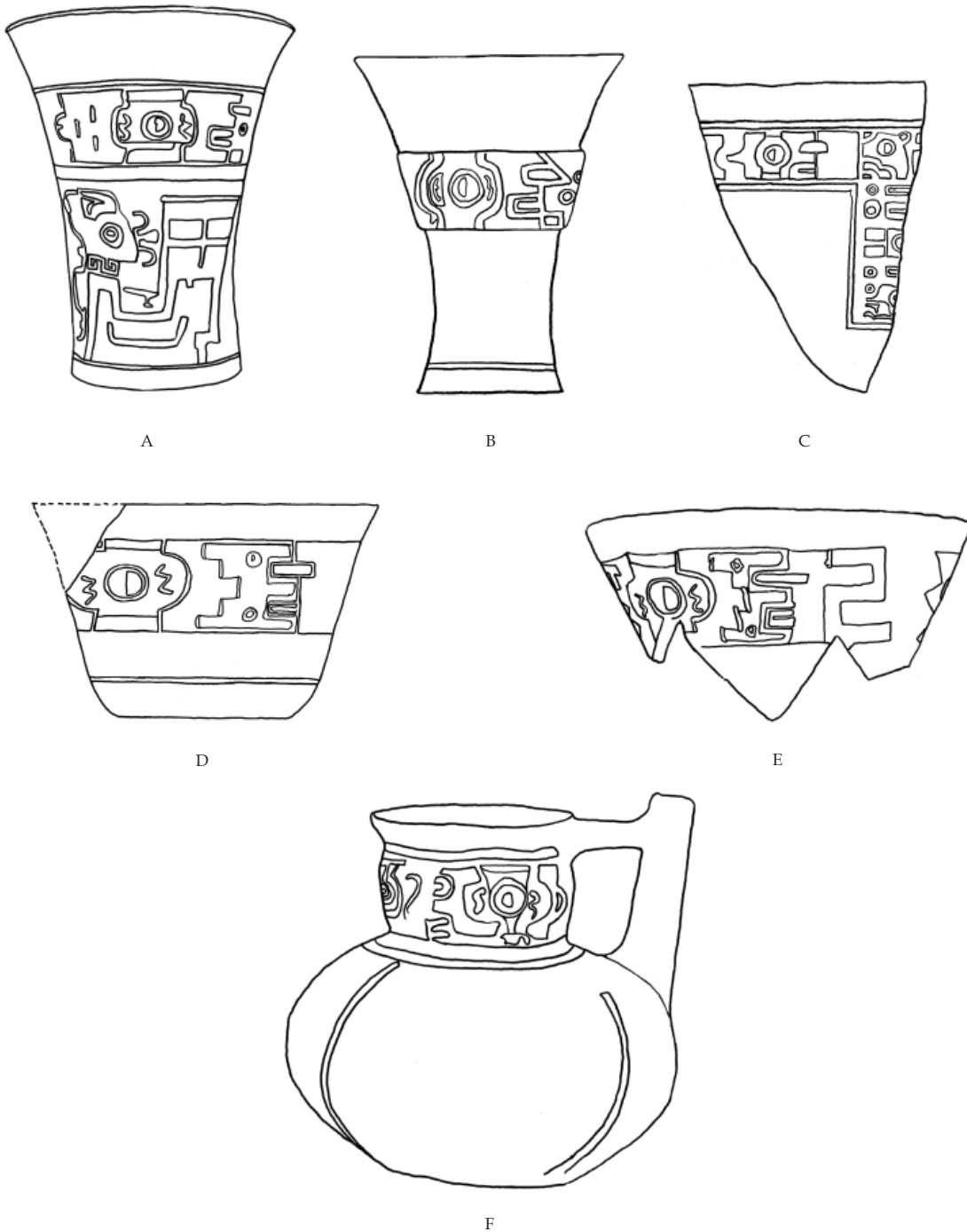
In Aymara mythology humans did not emerge alone from ancestral layra. Abercrombie remarks that, "especially interlinked were the destinies of humans and llamas, who traveled together from paqarinas in origin times and who travel together to the other world upon death" (1998:183). Residents of communities near Mount Kaata trace the origin of llamas to mountain lakes called *ñawi*, or "eyes." Both llamas and humans are said to have originated from and return to the head of the mountain. One mountain lake in particular, called Pachaqota, is said to symbolize death, fertilization, and llamas (Bastien 1978:195-196). Residents in the area of Ocongate share the same belief:

"It was a very long time before alpacas existed. When it first dawned, they were hidden under the earth where there are springs. Then, when the sun rose again, all the animals came out of a spring. For this reason, we make an offering to a spring and the lakes at the foot of Ausangate. If there had been no subterranean spring, we would not have had animals" (Gow and Gow 1975:142; translation by Urton 1981:114).

These passages demonstrate that, for multiple groups in the Andes, camelids were also thought to have emerged from sacred springs, possibly alongside ancestral humans. The association of llamas with water and rivers, specifically, is reinforced by the myth of Yacana related

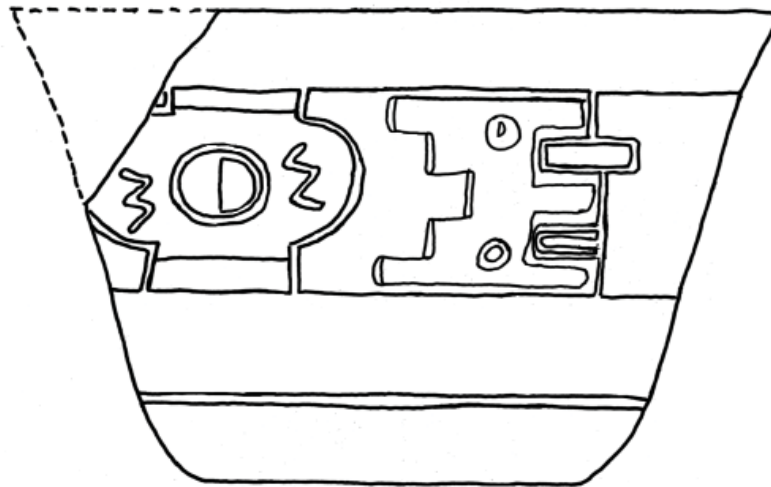


FIGURE 10. EYE REPRESENTATIONS FROM TIWANAKU TROPHY HEAD MOTIFS

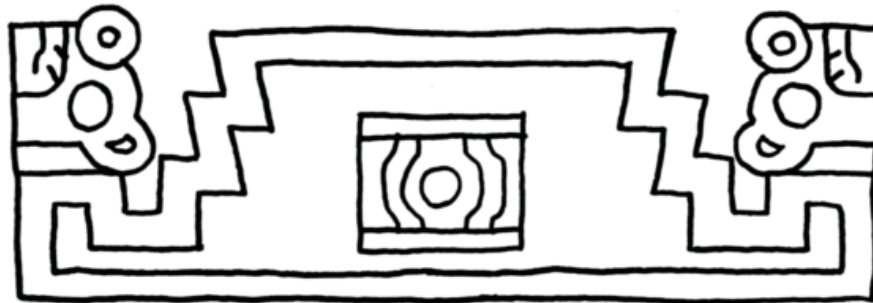


- A: TIWANAKU CERAMIC KERO DEPICTING EYE ELEMENT (AFTER KOLATA 1996:130).  
 B: TIWANAKU CERAMIC KERO SHOWING EYE ELEMENT (AFTER JANUSEK 2003:62, FIG. 3.38).  
 C: TIWANAKU CERAMIC KERO-SHAPED BASIN SHOWING EYE ELEMENT (AFTER JANUSEK 2003:75, FIG. 3.65).  
 D: TIWANAKU TAZÓN SHOWING EYE ELEMENT (AFTER COUTURE 2004:147, FIG. 5.28).  
 E: TAZÓN FRAGMENT DEPICTING EYE ELEMENT (AFTER PHOTO BY W. SCHÜLER IN JANUSEK 2003:66, FIG. 3.48A).  
 F: TIWANAKU VASIJA SHOWING EYE ELEMENT (AFTER EISLEB 1975:PL. 230).

FIGURE 11. THE EYE OF THE MOUNTAIN



A



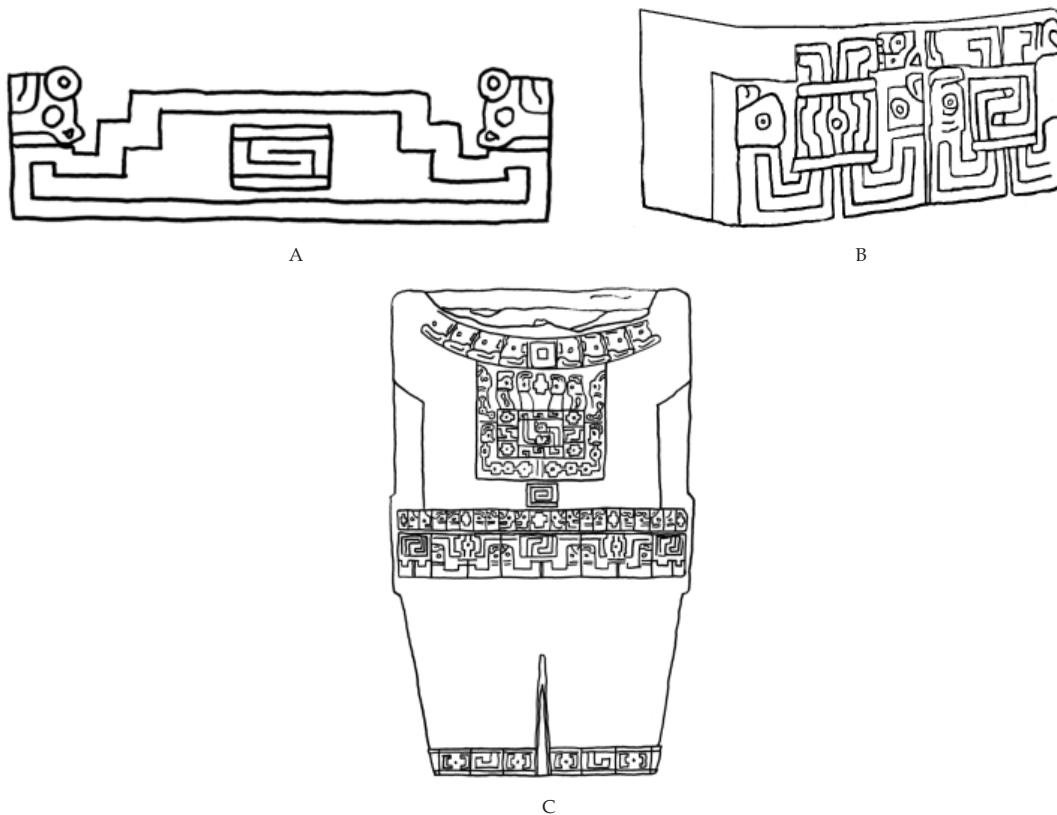
B

- A: TIWANAKU TAZÓN SHOWING EYE ELEMENT (AFTER COUTURE 2004:147, FIG. 5.28).  
 B: DETAIL OF STEP MOUNTAIN MOTIF FROM THE GATEWAY OF THE SUN SHOWING SAME EYE ELEMENT FROM TIWANAKU TROPHY-HEAD DEPICTIONS AS THE CENTRAL ELEMENT IN THE STEP MOUNTAIN MOTIF (AFTER POSNANSKY 1945B:PL. XLI, FIG. 3).

in the Huarochirí Manuscript. Yacana is a mythical llama who lives in the great Celestial River, Mayu (the Milky Way). She descends to the terrestrial realm to drink the water of the swollen rivers and then returns to Mayu to deposit the water, which is recycled to the mountain tops in the form of rain. The water then flows down the rivers to fertilize the fields below. Yacana, the celestial llama is thus seen as the source of fertility and is equated with the cycling and distribution of water (Salomon and Urioste 1991 [1598–1608]:Ch. 29; Urton 1981:111–114). The association of llamas with water and thus fertility is bolstered by the semantic relationship of the Aymara words *jawira*, meaning “river,” and *jawi*, meaning “fleece,” as well as “wet” or “water” (Dransart 1995:233–234). Indeed, llamas were offered in the past as fertility sacrifices to rivers and streams, and still today llama fetuses are particularly potent offerings (Zuidema 1985:220).

The chronicler Cristóbal de Molina (1989 [1576]:70) relates that the Incas also believed that llamas emerged from the same *paqarina* as humans. The idea that llamas were thought to have emerged from sacred springs is supported by an Incaic ritual drinking vessel that has two molded llamas and a seated figure inside (Allen 2002:145, Fig. 7). In the center of this bowl is a circular element (possibly an *ushnu*). When liquid was poured from the vessel it would have appeared as though the llamas were emerging from a sacred mountain spring. Abercrombie (1998:366, Fig.

FIGURE 12. UNMARKED POINTS OF EMERGENCE



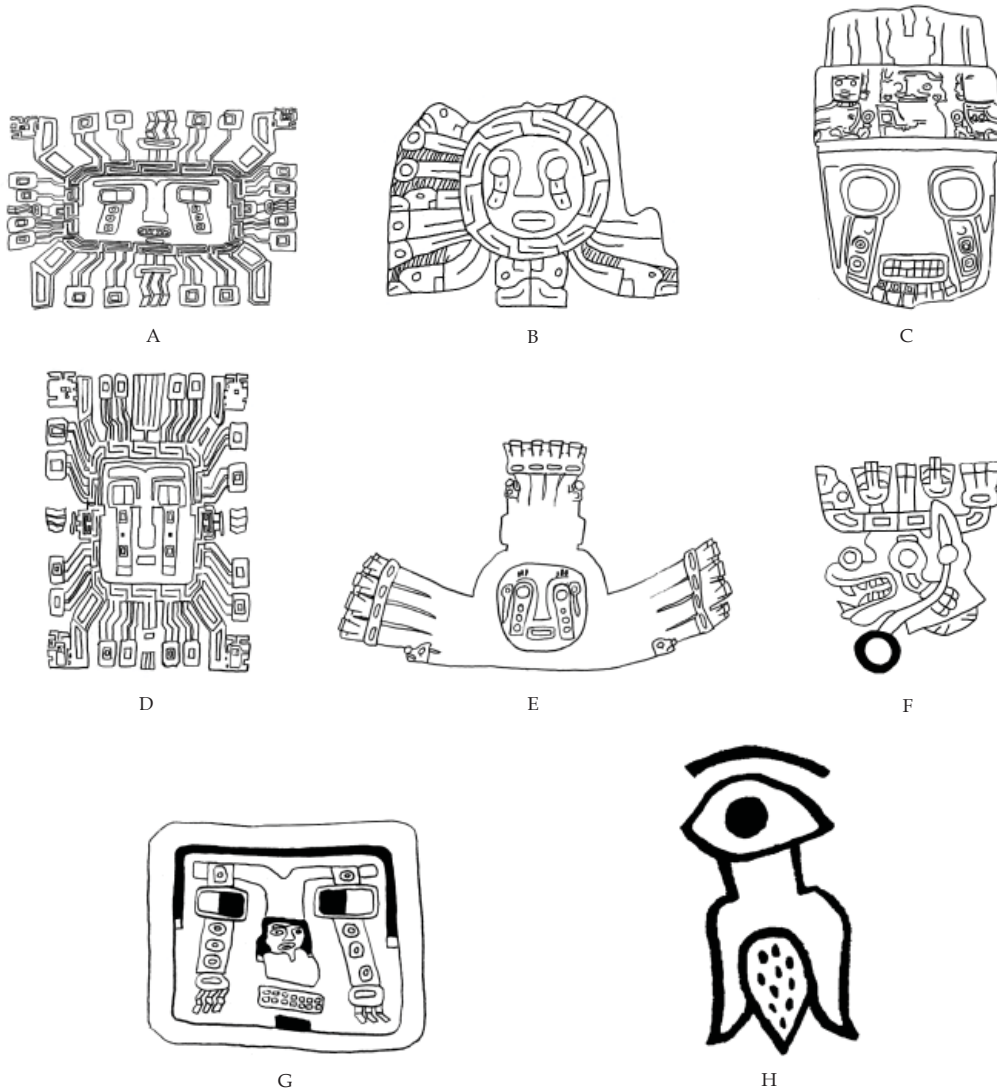
- A: DETAIL OF STEP MOUNTAIN MOTIF SHOWING UNMARKED POINT OF EMERGENCE FROM THE LOWER BAND ON THE GATEWAY OF THE SUN (AFTER POSNANSKY 1945B:PL. XLI, FIG. 1).
- B: DETAIL OF ÍDOLO PLANO STELA SHOWING BOTH THE EYE CENTRAL ELEMENT AND THE UNMARKED POINT OF EMERGENCE (AFTER POSNANSKY 1945A:FIG. 106).
- C: DRAWING OF THE PUTUNI MONOLITH FROM TIWANAKU SHOWING CENTRAL ELEMENT REPRESENTED BY DUAL SERPENTS (AFTER COUTURE AND SAMPECK 2003:251, FIG. 9.38).

7.5) notes a modern analog among the K'ulta of Bolivia. Furthermore, non-domesticated camelids (vicuñas and guanacos) are conceptualized as the herds of the mountain deities, and, similarly, the Inca referred to these herds as *intipllama* and conceptualized them as belonging to the Sun god, Inti (Dransart 2002:32, 66). Dillon and Abercrombie (1988:57) note that this belief is not only present in the Bolivian community of K'ulta but they affirm that it seems to be common throughout the region: "Throughout the Andes wild animals are said to be the domesticated animals of the mountain gods of the layra timpu (underworld), and hunting them seems always to be associated with the appropriation of chthonic power" (Dillon and Abercrombie 1988:57).

Abercrombie transcribes a detailed record of a sequence of 60 libations made to various huacas in K'ulta during a ritual honoring a deceased member of the community, noting:

"Item 36 [libation to *llantir muntu*] stands out as unique among *uywa ispira* libations. *Muntu* or *llantir muntu* is the most mysterious of all the deity forms, because no one is quite sure where or what it is. While all conceive of it as a mountain, which as the ultimate source and repository of great herds encompasses the llamas' *kumpriras* [deities], it does not lie in within K'ulta territory" (1998:357).

FIGURE 13. MIDDLE HORIZON TEAR TRACKS



- A: DETAIL OF TIWANAKU STYLE SNUFF TRAY FROM SAN PEDRO DE ATACAMA SHOWING TEAR TRACKS (AFTER LLAGOSTERA M. 1995:56, FIG. 2c).
- B: DETAIL OF SOLAR IMAGE WITH TEAR TRACKS FROM EARLY TIWANAKU STYLE TAPESTRY (AFTER YOUNG-SÁNCHEZ 2004:19, FIG. 1.9).
- C: DETAIL OF TIWANAKU STYLE MONOLITH FRAGMENT SHOWING TEAR TRACKS (AFTER LEHMANN AND UBBELOHDE-DOERING 1975:PL. 19).
- D: DETAIL OF SOLAR IMAGE WITH TEAR TRACKS FROM EARLY TIWANAKU STYLE TAPESTRY TUNIC (AFTER YOUNG-SÁNCHEZ 2004:47, FIG. 2.26a).
- E: TIWANAKU STYLE GOLD ORNAMENT SHOWING TEAR TRACKS (AFTER KOLATA AND PONCE S. 1992:326, FIG. 12).
- F: DETAIL OF TIWANAKU STYLE SNUFF TRAY FROM SAN PEDRO DE ATACAMA, CHILE, SHOWING LLAMA WITH TEAR TRACKS TERMINATING IN A FLOWER (AFTER LLAGOSTERA M. 1995:63, FIG. 6d).
- G: DETAIL FROM AN EARLY TIWANAKU STYLE TUNIC OF FACE WITH TEAR TRACKS TERMINATING IN PLANT ELEMENT (AFTER YOUNG-SÁNCHEZ 2004:42, FIG. 2.22).
- H: DETAIL OF NECK PORTION OF A WARI EFFIGY VESSEL SHOWING FACE WITH TEAR TRACKS TERMINATING IN PLANT ELEMENT (DRAWING BY AUTHOR).

*Muntu* is an Aymara term derived from the Spanish word *mundo* (world), which means, “other world,” where “the sun goes at night,” and the home of the dead (Abercrombie 1998:72). Abercrombie continues by relating that Llantir Muntu exists as a space inside a mountain that houses the great llama herds. In K’ulta this reference is analogous to the term for “ancestor’s mountain” to which the deceased travel (Abercrombie 1998:357). Additionally, burials with Tiwanaku style ceramics at cemetery sites in northern Chile often contain the corpses of both humans and camelids buried together, reinforcing the idea that ancient groups conceptualized both humans and llamas as emerging from the same place, and returning to it in death (Dransart 2002:26).

Dransart writes, regarding the modern residents of Isluga:

“... each social group has a specific relationship with certain hills with which it is intimately involved. *Uywiri* [the hill spirit] may grant individual people llamas or good fortune, or conversely they may ‘eat’ one’s llamas. Places that are particularly beneficent are known as *aviador*, a word meaning ‘provider,’ no longer used in modern Castilian Spanish” (2002:59).

In this way, modern groups envision that llamas originate in, and are the gift of, the deities of the sacred hills and mountains of the region (see also Silverblatt 1988:181).

Dillon and Abercrombie relate a similar idea with regard to the beliefs of the modern residents of K’ulta:

“The rites of August and February are oriented towards the herds, and the recipients of the sacrifices then performed are the hierarchically organized hill and mountain deities, including the local *uywiris* (herd caretakers) of household and hamlet and the *ayllu* and regional *mallkus* (condor-peaks) that rule them. ... Thus the libation sequences of sacrifices performed during all saints’ feasts and life-crisis rites enact a litany amounting to the ‘genealogy’ of hill and mountain deities ascribed to the animals, as the reassembled bones of sacrificed animals are returned to their source and placed in hilltop tombs” (1988:64).

In this quote, the fertility of the llama herds is shown to be the domain of the local hill and mountain deities, and the llamas themselves are thought to emerge from and return to mountain caves and springs.

An early Tiwanaku style gold ornament published by Young-Sánchez (2004:Fig. 3.28) possibly depicts a Middle Horizon version of what modern Aymara groups conceptualize as Llantir Muntu (Figure 14). This artifact shows an incised scene with a representation of a circular enclosure that houses a herd of llamas, the entrance of which takes the form of two feline heads. The relationship between felines, llamas, sacred mountains, and paqarinas will be discussed in detail below, but at this point it seems possible that the imagery on this gold ornament is a depiction of an ancient version of Llantir Muntu, the repository of the herds within the sacred mountain. Flanking the enclosure on this ornament are figures that appear to be herding llamas. This depiction is very similar to an associated motif on the Bennett Monolith (Figure 15). On the Bennett Monolith the circular enclosure is shown as the central element on the Step Mountain. Note that the ends of the circular enclosure on the gold ornament and the bases of the Step Mountain on the Bennett monolith are both delineated with feline heads.

Archaeological data from excavations on the Akapana support the idea that residents of Tiwanaku conceptualized the Step Mountain as the source of camelid fertility. A sacrificial offering of forty camelids was excavated on the summit of the Akapana, and an offering of fourteen camelids (mixed with human bones) was recovered on one of the basal steps of the

FIGURE 14. GOLD ORNAMENT DEPICTING MIDDLE HORIZON  
VERSION OF LLANTIR MUNTU



(DRAWING BY PAOLA GUARDIA AFTER YOUNG-SÁNCHEZ 2004:95, FIG. 3.28)

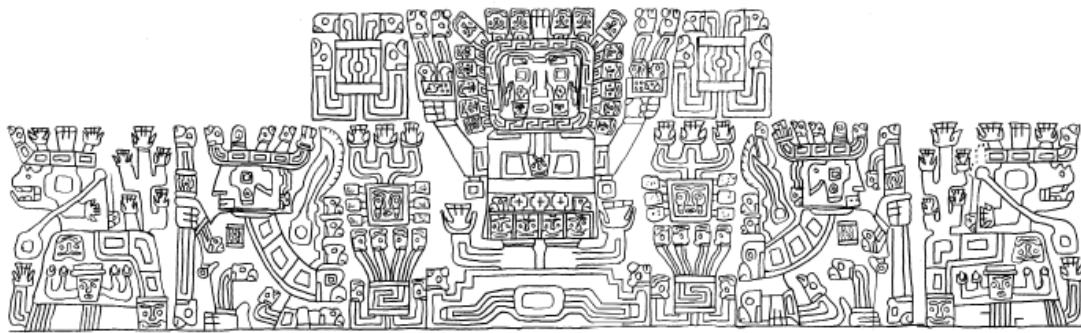
pyramid (Webster and Janusek 2003:359–362). These features are suggestive of an offering to the spiritual realm in exchange for fertility, as well as the origin of llamas inside the sacred mountain. Similar offerings have been recovered from other Tiwanaku period architectural Step Mountains. For example, Paul Goldstein (2005:297) relates that numerous young and fetal camelid sacrifices were encountered just outside the sunken temple at Omo M10. At Lukurmata as well, ancient residents interred fetal camelids as offerings near the sunken temple on the Wila Kollu stepped-platform mound (Janusek 2004:173). Moreover, a fascinating stone-lined, double-chamber tomb near Lukurmata reinforces the connection between ancestors and camelid fertility. This burial contained an adult human interred in the upper cist and a modeled llama effigy *incensario* in the bottom cist (Bermann 1994:199–202; Janusek 2004:174).

In many Tiwanaku depictions of llamas, the animals are covered with plants (Figure 16). This is not surprising given that both camelid pastoralism and agriculture were integral parts of Tiwanaku productive strategy, and both of these elements are strongly dependent on water from mountain streams and rivers. Both camelids and plants are thought to emerge from mountain springs, the eyes of the mountain, and these depictions seem to indicate that camelids were conceptualized as carrying plants out of the underworld. The relationship between llamas and

FIGURE 15. COMPARISON OF MOTIFS FROM A GOLD ORNAMENT  
AND THE BENNETT MONOLITH



A



B

A: DETAIL OF FIGURE 14.

B: DETAIL OF BENNETT MONOLITH (AFTER YOUNG-SÁNCHEZ 2004:113, FIG. 4.15).

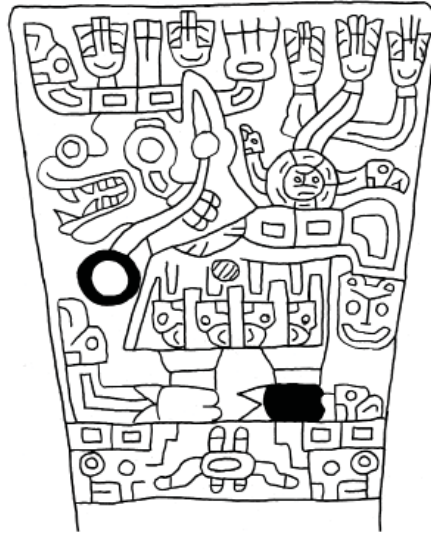
flowers is strong today and is particularly evident during ceremonies in which herd animals are marked as “flowering.” Rituals involving the marking of herd animals have been documented for many Andean groups. In the Aymara speaking community of Isluga the ceremony is called *wayñu*, and during these rituals colorful yarn “flowers” are attached to the pierced ears of the herd animals, who have been led into a ritual corral (Dransart 2002:82–100). Similar ritual adornments in other regions of the Andes are called *tika* which means “flower.” A llama is then sacrificed and its blood poured out into ritual containers. The herd “flowers” are then led out through the corral gate, which is flanked by two trees. This recalls the drawing by the chronicler Joan de Santa Cruz Pachacuti Yamqui Salcamaygua (1993 [1613]:198) of the *paqarina* of the Incas, which was also flanked by two trees (Dransart 2002:274). The flowering ceremony is intended to ensure the fertility of the herd and thus the economic success of the herd owners (ibid.:83). One informant in Isluga told the ethnographer that, “my *p’acalli* [sic] are my bank,” explicitly relating llamas (referred to as flowers) to economic success (ibid.:89).

Significant evidence supports the antiquity of the marking ceremony. Sarmiento de Gamboa writes, “... the *napa*, which is [the] principal insignia of nobility... is the sheep [llama] of the country, the color white, wearing a red cloth, on the top *earrings of gold*, and on the breast

FIGURE 16. TIWANAKU DEPICTIONS OF LLAMAS AND PLANTS



A



B



C



D

- A: DETAIL OF BENNETT MONOLITH SHOWING LLAMA AND ASSOCIATED PLANTS (AFTER YOUNG-SÁNCHEZ 2004:113, FIG. 4.15).
- B: TIWANAKU STYLE SNUFF TRAY FROM SAN PEDRO DE ATACAMA, CHILE, SHOWING LLAMA AND ASSOCIATED PLANTS (AFTER LLAGOSTERA M. 1995:63, FIG. 6D).
- C: TIWANAKU STYLE LLAMA EFFIGY INCENSE BURNER DECORATED WITH PLANTS (AFTER YOUNG-SÁNCHEZ 2004:56, FIG. 2.34).
- D: TIWANAKU STYLE SNUFF TRAY FROM SAN PEDRO DE ATACAMA, CHILE, SHOWING LLAMA AND ASSOCIATED PLANTS (AFTER DRANSART 2002:142).



a plate with red badges such as worn by rich Incas when they left the house, carried in front of all on a staff with a cross of feathers" (1942 [1572]:65, translation by author, emphasis added). For the Inca, llamas were not only sacred and emblematic of the Inca royalty, but they were also ritually marked in a similar way to modern herds. Tiwanaku depictions of llamas also show them with pierced ears, often with a rope passing through the base of the ear (see Figures 16a and b). These examples suggest that ancient groups living in the Lake Titicaca basin practiced the marking ceremony and likely conceptualized their llamas as flowers, a proposition supported by the fact that llamas are often covered in flowering plants. The relationship between llamas and flowers will be discussed in further detail below.

## BIRDS

Having suggested that ancient groups living in the Lake Titicaca basin conceptualized paqarinas or points of emergence as layra or eyes, we can begin to analyze another common feature of Tiwanaku eye depictions: the winged eye (Knobloch 2000). Not only are eyes commonly depicted with feathered wings (Figures 17a, b, and c) but so too are wings depicted with eyes in the center (Figures 17d, e, and f).

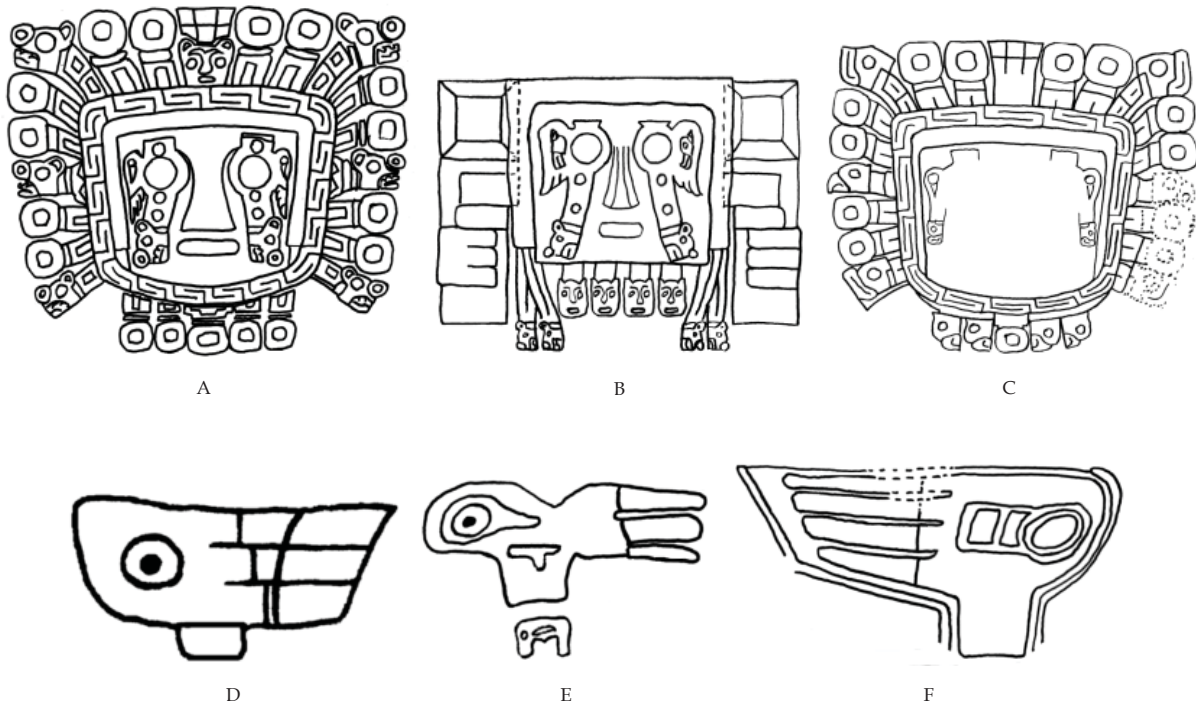
For modern groups living in the region, birds are able to move between the earthly and other-worldly realms. In this light, the association of bird characteristics with eyes makes sense, since the eyes of the mountain are portals between the realms. Dillon and Abercrombie discuss the role of water birds in K'ulta beliefs: "[B]irds are associated with original time [layra timpu] and with the origin, continuing in the present, of domesticated animals such as llamas and alpacas" (1988:56). These authors also argue that condors are sometimes thought of as able to transgress boundaries between the two realms:

"... today's Aymara must mediate the two [zones] by calling upon beings who have mediated the zones previously, whether through post death journey (ancestral souls), through proximity to both zones (mountain condors and saint-lightning), or by association with the negation of contrast (Chullpas, *condenados*, and the dead bodies of unbaptized infants, sometimes called *moros*)" (ibid.:63).

They reinforce this argument by mentioning one ritual in which ayllu leaders danced in front of the cemetery with mummified water birds draped around their necks (Dillon and Abercrombie 1988:70). Other lines of evidence suggest that in some cases ancestral souls are actually considered to be water birds. The authors reference Allen's (1982) work in Sonqo, where ancestors are referred to as *suq'a machulas*, which, in the community of K'ulta, is the name of a black water bird (Dillon and Abercrombie 1988:75). The relationship, however, between modern groups, ancestors, and people that populated the world of layra timpu or original time is difficult to discern because of the effects of the Spanish colonial incursion. The inhabitants of the previous world, the world of layra timpu, are often disassociated from modern groups, possibly because they are unbaptized and thus doomed within the colonial Catholic frame of reference (see Dillon and Abercrombie 1988).

Water birds are also reportedly used in rituals for both bringing forth and halting rain (ibid.:76). This makes sense when we remember that fertility, both agricultural and camelid, is thought to ultimately come from the sacred mountains and emerge from mountain springs. Birds then become allies for contacting and communicating with the other world where fertility is believed to originate. In Isluga, juturi, which are the points of emergence for camelids, are often watery places and are many times marked by the presence of water birds. The mythical *chullumpi* bird is said to be extremely powerful and to mark the existence of a juturi. Indeed,

FIGURE 17. TIWANAKU DEPICTIONS OF ASSOCIATED EYES AND WINGS



- A: DETAIL OF THE CENTRAL FIGURE ON THE GATEWAY OF THE SUN. NOTE THE EYES HAVE WINGS ATTACHED TO THEM (AFTER STONE-MILLER 2002:133, FIG. 104).
- B: DETAIL OF THE ANTICEPHALIC IDOL SHOWING EYES WITH WINGS (AFTER POSNANSKY 1945A:FIG. 130A).
- C: DETAIL OF THE LLOJETA BLOCK SHOWING WINGED EYES (AFTER AGÜERO P. ET AL. 2003:81, FIG. 18).
- D: DETAIL OF WING WITH EYE FROM A TIWANAKU SAHUMADOR (AFTER JANUSEK 2002:FIG. 6).
- E: DETAIL OF WING WITH EYE FROM A TIWANAKU ESCUDILLA (AFTER EISLEB 1975:PL. 153A).
- F: DETAIL OF WING WITH EYE FROM A TIWANAKU STYLE TAZÓN (AFTER EISLEB 1975:PL. 162A).

the chullumpi is said to be able to transform itself into a llama (Dransart 2002:64, 79). In multiple Aymara communities, folk taxonomies for camelids actually use the names for water birds when identifying the different llama types. Dransart (*ibid.*:79) discusses in detail the use of bird names for naming camelid types. The Aymara names for falcon, hawk, condor, eagle, linnet, goose, coot, duck, widgeon, flamingo, and gull, among others, all specify different types of camelids. This makes sense since we have established that camelids are believed to have emerged from watery mountain springs. These animals cross boundaries and, as a result, are strongly linked to birds, which are seen to be intermediaries between the earthly realm and the otherworldly realm. Other scholars have documented similar camelid taxonomies in other Aymara communities (Dillon and Abercrombie 1988; Flores Ochoa 1978).

A Quechua folk tale provides another line of evidence that modern Andean groups conceptualize birds as the mediators between realms. In this folk tale, told by Gloria Tamayo to Johnny Payne in Cuzco (Payne 2000:58), a young woman is tricked by a condor and flown to his mountaintop cave to be his wife. One day a hummingbird appears at the cave, and the young woman entreats help. The hummingbird returns to the young woman's home to tell her father what had happened and then helps to rescue her from the cave. In this tale the hummingbird is

the mediator between the earthly realm (the house of the young woman's father) and the realm of the mountain deity (the mountaintop cave of the condor). Abercrombie (1998) relates that, for the modern residents of K'ulta, people believe that hummingbirds are able to move between the two worlds (ibid.:48). Rasnake (1988a:147) relates that this belief is also present in the modern community of Yura in Bolivia. Bearing this in mind and recalling that the portals between the realms are conceptualized as flowers, we see that the hummingbird is the go-between. The early 17th century Huarochirí manuscript describes the mountain deity, Paria Caca, as being born into the earthly realm as five falcons which then transformed into humans (Salomon and Urioste 1991 [1598–1608]:59). In this myth the falcons are the medium between the earthly realm and the other-worldly realm, because they facilitate the birth of Paria Caca.

Early Colonial period and Inca keros often depict a similar theme. In these images birds are depicted flying downward directly toward a mountain or hill from which are blooming flowers and plants (Figures 18a–c). Other representations of this mountain (which will be discussed in greater detail below) show not a whole bird but just a tail feather emerging from the top of the mountain, as if the bird had entered the summit (Figure 18d). These images seem to demonstrate that the Inca also conceptualized birds as able to transgress boundaries between worlds that were located on mountain tops.

In this section I have discussed the role of both raptorial birds (especially condors) and water birds. In ethnographic and ethnohistoric documents these two classes of avians are broadly associated with the ability to transgress the boundaries between the earthly and spiritual realms. Tiwanaku iconography distinguishes between these two broad classes of birds. Raptorial birds (condors, eagles, and falcons) are most frequently portrayed in Tiwanaku imagery (see Korpisaari, et al. forthcoming). Water birds are less frequently portrayed but, when depicted, are often shown being grasped around the throat by a feline (see, for example, Young-Sánchez 2004:44, Fig. 2.23, 82, Fig. 3.13). Below I elaborate an argument that in Tiwanaku belief felines were viewed as the guardians of the mountain paqarinas, the boundaries between the earthly and spiritual realms that birds were able to cross. This may explain the consistent portrayal of water birds being grasped around the throat by felines.

Taking these arguments into account we can begin to understand “winged eyes” and “eyes within wings” in Tiwanaku iconography. Points of emergence or paqarinas were conceptualized as the eyes of the mountain for ancient Lake Titicaca basin residents. The presence of wings attached to these eyes is further evidence that these are portals between worlds, since birds are able to transgress the boundary between the two realms. The next section explores in more detail the relationship between feathers and flowers and flower imagery in general.

## FLOWERS

Throughout this paper I have referred in different circumstances to flower and plant imagery. Points of emergence have been demonstrated to have been conceptualized in general as paqarinas or places of blooming/flowering. Camelid herds that are born out of these paqarinas are viewed as flowers and marked as such in modern and ancient ceremonies. I have discussed the Inca origin myth of emergence from mountain caves at Pacariqtambo (“way-stop of flowering”). As Martínez (1976:271) points out, Bertonio (1993 [1612]) lists the Aymara verb for “to remember” as *amutaatha*, the root of which is *amu*, meaning “flower bud,” reinforcing the connection between the past and ancestors and flower imagery. Flower imagery has been argued to be a metaphor for both human fertility and also economic (agricultural and camelid) fertility. Fertility ultimately resided in the bowels of mountains, and a complex of ideas conceptualized this fertility as emerging at mountain springs from an otherworldly realm similar to modern conceptions of Llantir Muntu.

FIGURE 18. INCA REPRESENTATIONS OF BIRDS FLYING TOWARD MOUNTAINS



A



B



C



D

- A: DETAIL OF SCENE FROM 17TH CENTURY INCA KERO (AFTER FLORES O. ET AL. 1998:22).  
 B: DETAIL OF SCENE FROM COLONIAL PERIOD KERO (AFTER FLORES O. ET AL. 1998:306).  
 C: DETAIL OF SCENE FROM COLONIAL PERIOD KERO (AFTER FLORES O. ET AL. 1998:163).  
 D: DETAIL OF SCENE FROM COLONIAL PERIOD KERO SHOWING A MOUNTAIN WITH  
 SPROUTING PLANTS AND A FEATHER AT THE PEAK (AFTER FLORES O. ET AL. 1998:305).

Inca and early Colonial period kero imagery strengthens these arguments and provides some fascinating new indications. Flowers and plants are commonly pictured on keros (see Figure 18), which makes sense when one considers that keros were used to both drink the corn beer, *chicha*, which was the product of flowering plants, and to offer libations to the mountain rivers and streams, which are the source of agricultural fertility. Multiple keros portray a mountain scene in which rivers flow down from the mountain, and various Incas are gathered around offering libations to the mountains (Figures 19a and b). Plants and flowers are shown blooming along the riverbanks, and people are shown at the termini of these rivers planting crops. These images also portray various camelids by the riverbank or emerging from the mountain along with the river. Remembering that birds were conceptualized as able to transgress the mountain-spring paqarinas, it is not surprising they are shown in the composition as well, sometimes flying along the rivers. These rivers flow down from the mountains in three directions, and the sun is pictured above the mountains in the center of the composition, as is common in Tiwanaku imagery (Figures 19c and d). The mountains are shown to be the source of fertility and flowering, and the Incas are pictured offering the yields of this fertility (*chicha*) back to the mountain.

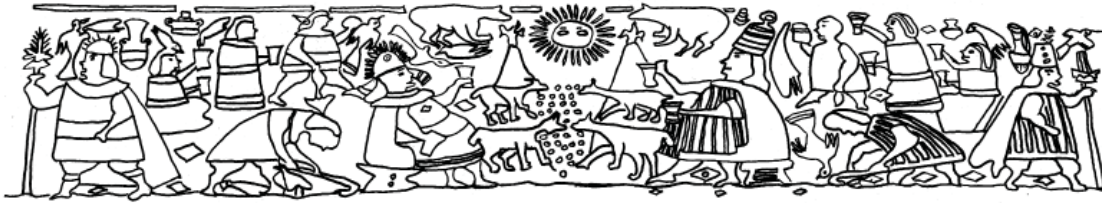
Another common kero image shows a mound, which I will argue is a hill or mountain representation, sprouting plants and flowers (see Figure 18). There is typically a bird pictured flying straight down into the hill, the significance of which I briefly discussed in the previous section. In both Inca and pre-Inca beliefs, I have argued, birds are able to transgress the boundaries between realms. Birds can access the realm of the ancestors through points of flowering called paqarinas. In these depictions, I will argue, the bird is flying toward the flowering mountain, moving between the earthly realm and the realm of the ancestors. In other mountain depictions the bird is shown having already entered the flowering mountain with just a tail feather left outside the mountain (see Figure 18d).

These depictions of tail feathers in association with flowering plants are particularly illuminating. In Tiwanaku imagery tail feathers and flowers are often depicted using the same trefoil element, which Isbell and Knobloch refer to as a, “bulb-based, three filleted tuft” (2006:321, 323) (Figure 20). A Tiwanaku textile headband from a grave in Pisagua, Chile, provides an interesting example of the conflation of feather and flower imagery (Conklin 1983). On the headband, a feline figure is shown with the flower/tail-feather element at the end of linear motifs emerging from both the toe and headdress (Figure 20c). Similarly, the flower/tail-feather element is also shown emerging out of the feet of the central individual on the Bennett Monolith (see Figure 2b).<sup>6</sup> This artistic relationship was underlain by an ideological connection between birds and flowers and is strongly suggestive that in Tiwanaku thought birds were seen as able to transgress realms through paqarinas or points of flowering.

The conceptual connection between flowers and birds is supported by the early 17th century Aymara term *wayta*, which, according to Bertonio (1993 [1612]), can mean either “flower” or “feather.” This flower/tail-feather element is commonly seen pictured on Tiwanaku snuff trays from San Pedro de Atacama (Llagostera M. 1995). In these compositions an individual, commonly referred to as the Sacrificer, who variously displays human or feline characteristics, is shown in genuflect position with a linear element emerging from the mouth, at the end of which is the flower/tail-feather element (Figure 21). This scene is analogous to later Inca depictions of amarus (beings with mixed serpent and feline attributes) with stream-like elements emerging from the mouth and terminating in flowers (Figures 22a and b). Further, the indigenous chronicler Guamán Poma de Ayala recorded a royal coat of arms that shows two amarus with linear elements emerging from their mouths that end in flowers (Figure 22c).

The linear element emerging from the Sacrificer’s mouth is likely either a depiction of water or a rainbow, which are conceptually related elements in Andean art. In Inca depictions,

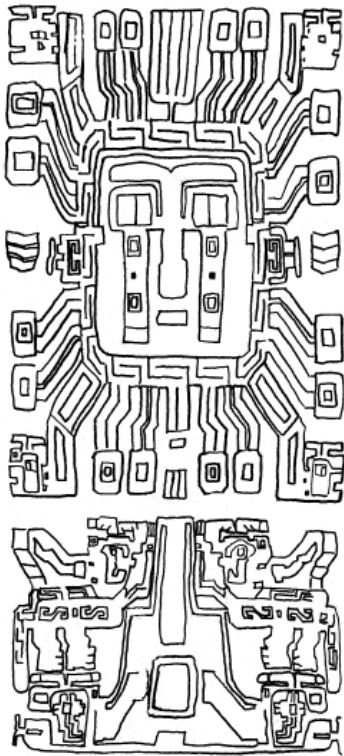
FIGURE 19. INCA AND TIWANAKU MOUNTAIN IMAGERY



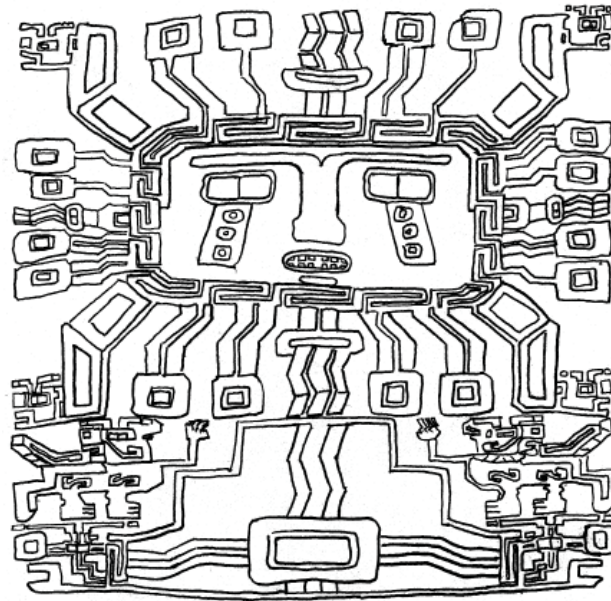
A



B



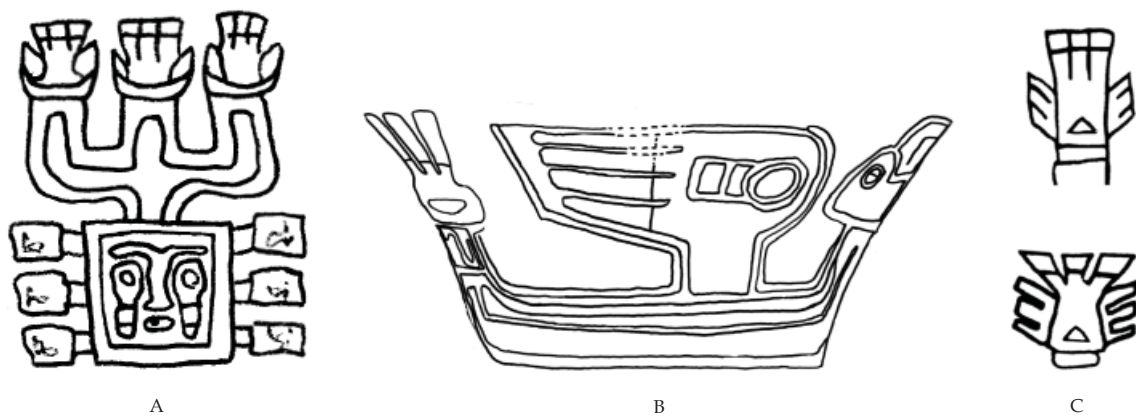
C



D

- A: DETAIL OF MOUNTAIN LIBATION SCENE FROM COLONIAL PERIOD KERO (AFTER FLORES O. ET AL. 1998:166).
- B: DETAIL OF MOUNTAIN LIBATION SCENE FROM 17TH CENTURY INCA KERO (AFTER FLORES O. ET AL. 1998:22).
- C: DETAIL OF MOUNTAIN SCENE FROM EARLY TIWANAKU STYLE TAPESTRY TUNIC (AFTER YOUNG-SÁNCHEZ 2004:47, FIG. 2.26A).
- D: DETAIL OF MOUNTAIN SCENE FROM EARLY TIWANAKU STYLE TAPESTRY (AFTER YOUNG-SÁNCHEZ 2004:19, FIG. 1.9).

FIGURE 20. TIWANAKU FLOWER/TAIL-FEATHER MOTIF

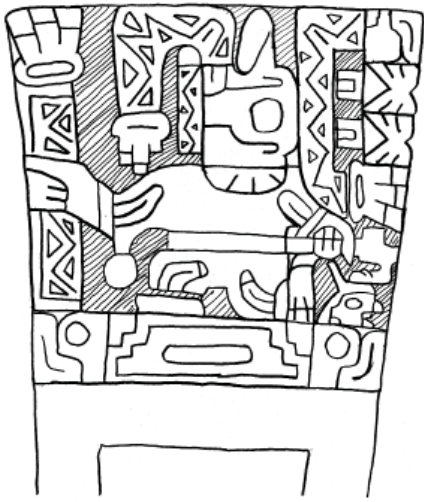


- A: DETAIL OF VESSEL SPROUTING FLOWERS FROM BENNETT MONOLITH (AFTER YOUNG-SÁNCHEZ 2004:113, FIG. 4.15).
- B: DETAIL OF BIRD ELEMENT FROM TIWANAKU TAZÓN. NOTE THE SAME TREFOIL ELEMENT USED FOR BOTH FLOWERS AND TAIL FEATHERS (AFTER EISLEB 1975:PL. 162A).
- C: DETAIL OF FLOWER/TAIL-FEATHER ELEMENT FROM A TIWANAKU HEADBAND RECOVERED FROM A GRAVE IN PISAGUA, CHILE (AFTER CONKLIN 1983:39, FIG. 24).

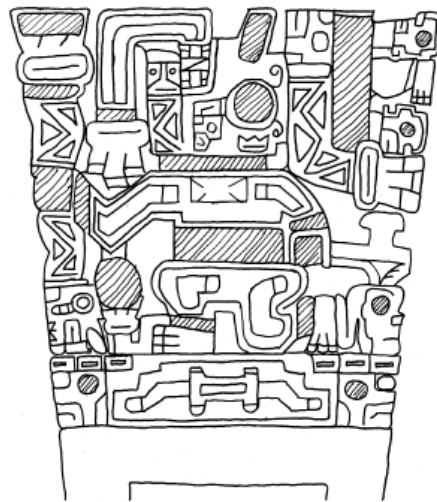
rainbows are commonly shown emerging from the mouths of felines and arcing over the heads of people, yielding rain (see Figures 5f and 5g). As mentioned earlier, rainbows are the quintessence of sami or fertile essence, because they are the combination of water and light and are often manifested in the form of amarus. An alternate possibility is that the linear element emerging from the Sacrificer's mouth represents wind or breath. Wind is also believed to be able to transgress the boundaries between the earthly realm and the realm of the ancestors (Abercrombie 1998; La Barre 1948; Tschopik Jr. 1951).

Sacred mountains during Inca times were seen as the source of flowering and fertility. This is also evident in Tiwanaku imagery. The Step Mountain shown on the Bennett Monolith is replete with flower and plant depictions, and many portrayals of mountains and bird feathers strengthen this link (see Figure 15b). The eyes of the sacred mountain were the location of mountain springs and caves and were the paqarinas or points of flowering/emergence, which makes sense, because these mountain springs were the source of water needed for both agriculture and camelid pastoralism. This formulation is remarkably similar to ancient Mesoamerican and southwestern U. S. ideologies (see Hays-Gilpin and Hill 2000; Taube 2004).

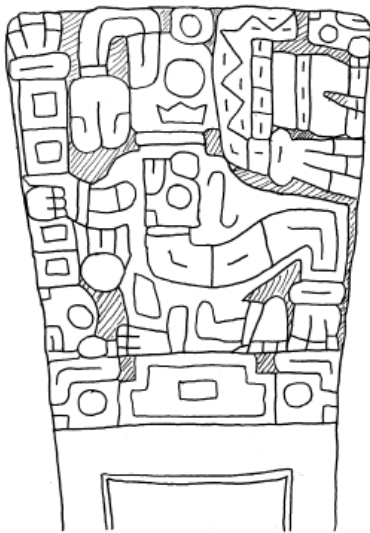
FIGURE 21. TIWANAKU STYLE SNUFF TRAYS FROM SAN PEDRO DE ATACAMA, CHILE, SHOWING THE SACRIFICER



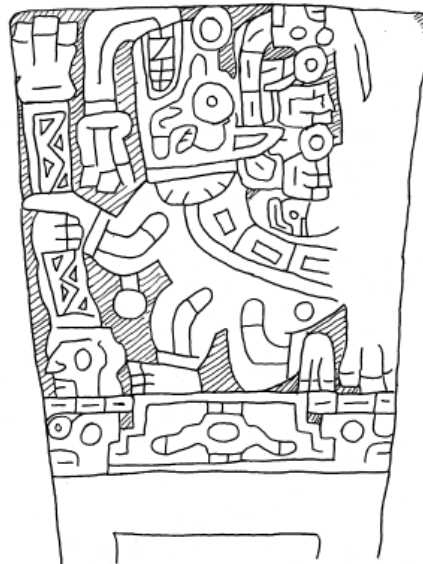
A



B



C

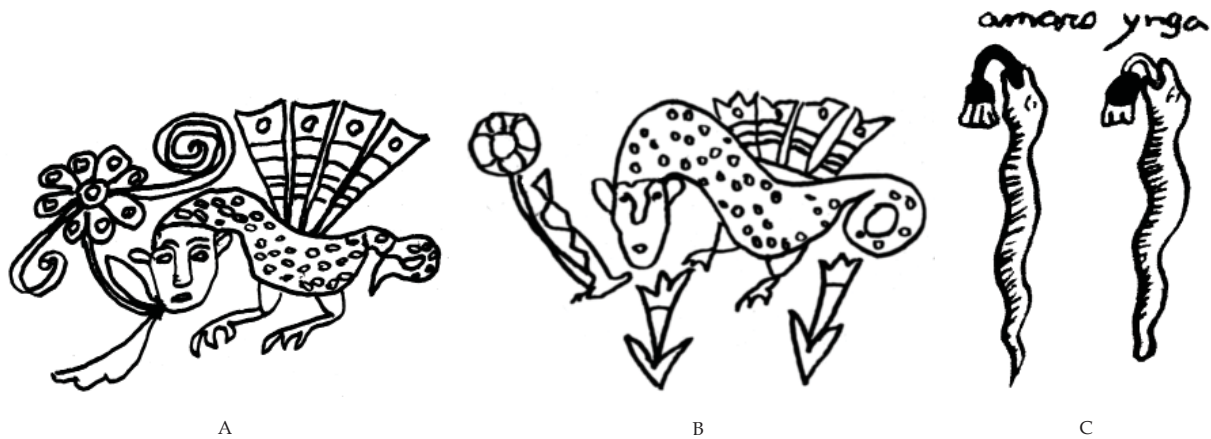


D

- A: HUMAN VERSION OF THE SACRIFICER. NOTE THE FLOWER/TAIL-FEATHER ELEMENT EMERGING FROM THE MOUTH (AFTER LLAGOSTERA M. 1995:63, FIG. 6A).
- B: HUMAN VERSION OF THE SACRIFICER. NOTE THE FLOWER/TAIL-FEATHER ELEMENT EMERGING FROM THE MOUTH (AFTER LLAGOSTERA M. 1995:63, FIG. 6B).
- C: ZOOMORPHIC VERSION OF THE SACRIFICER (AFTER TORRES AND CONKLIN 1995:97, FIG. 16C).
- D: ZOOMORPHIC VERSION OF THE SACRIFICER SHOWING FLOWER/TAIL-FEATHER ELEMENT EMERGING FROM MOUTH (AFTER LLAGOSTERA M. 1995:63, FIG. 6C).



FIGURE 22. INCA ANALOGS OF SNUFF TRAY IMAGERY



- A: DETAIL OF SCENE FROM COLONIAL PERIOD KERO SHOWING AN AMARU WITH FLOWER ELEMENT EMERGING FROM MOUTH (AFTER FLORES O. ET AL. 1998:307).
- B: DETAIL OF SCENE FROM COLONIAL PERIOD KERO SHOWING AN AMARU WITH FLOWER ELEMENT EMERGING FROM MOUTH (AFTER FLORES O. ET AL. 1998:211).
- C: DETAIL OF DRAWING BY GUAMAN POMA DE AYALA SHOWING TWO SERPENTS WITH FLOWER ELEMENTS EMERGING FROM THEIR MOUTHS. NOTE THAT GUAMAN POMA HAS SPECIFICALLY LABELED THESE AS AMARU (AFTER GUAMAN POMA DE AYALA 1980 [1615]:83).

## FELINES

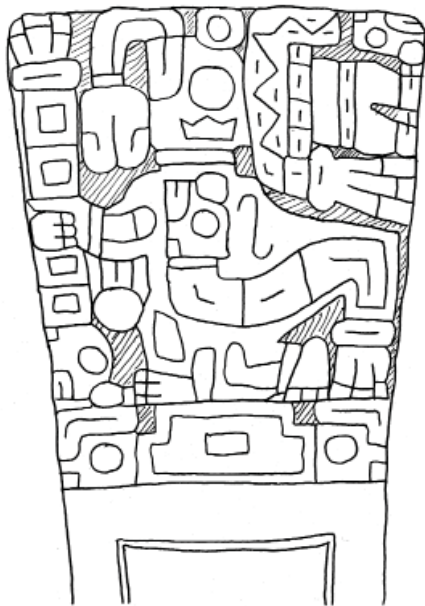
Feline representations are extremely common in Lake Titicaca basin iconography. They are one of the most dominant themes in ceramic iconography from Pucara (Figures 23a, b, and c), and they are prevalent in later Tiwanaku depictions as well (Figures 23d and e). Commonly, these felines are identified as pumas, but Tiwanaku iconography also portrays jaguars, melanistic jaguars or black panthers, and *titis* (Andean wild cats) (Korpisaari, et al. forthcoming). Scholars have generally recognized that felines or anthropomorphic beings with feline elements are often shown carrying trophy heads and axes, and in these instances they are seen as a variation of the Sacrificer (Janusek 2003:78; Llagostera M. 1995:61). In some cases the Sacrificer is shown with human features. In others he is shown as a feline, and sometimes both human and feline traits are mixed (Llagostera M. 1995) (Figure 24). Recalling that the meaning of sacrifice and libation in the Andes in general is often to provide offerings that ensure productive fertility, this section examines the feline in greater detail and in conjunction with its iconographic context, which is in many cases the Step Mountain (Figure 25).

FIGURE 23. PUCARA AND TIWANAKU FELINE IMAGERY



- A: PUCARA STYLE CERAMIC SHERD SHOWING FELINE IMAGERY (AFTER ROWE AND BRANDEL 1969-1970:FIG. 30).
- B: DETAIL OF PUCARA CERAMIC JAR SHOWING FELINE IMAGERY (AFTER ROWE AND BRANDEL 1969-1970:FIG. 62).
- C: DETAIL OF PUCARA CERAMIC ANNULAR-BASED VESSEL SHOWING FELINE IMAGERY (AFTER FRANQUEMONT 1986:FIG. 29).
- D: DETAIL OF TIWANAKU CERAMIC KERO SHOWING FELINE IMAGERY (AFTER JANUSEK 2003:63, FIG. 3.41).
- E: DETAIL OF EARLY TIWANAKU STYLE TAPESTRY SHOWING FELINE IMAGERY (AFTER YOUNG-SÁNCHEZ 2004:19, FIG. 1.9).

FIGURE 24. TIWANAKU SACRIFICER IMAGERY



A



B



C



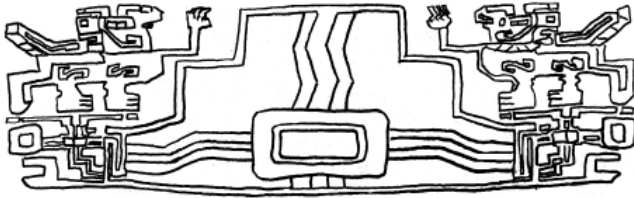
D



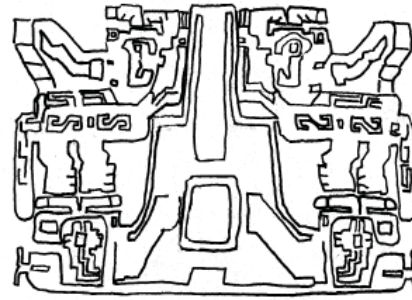
E

- A: ZOOMORPHIC VERSION OF THE SACRIFICER. NOTE FELINE NOSE ELEMENT (AFTER TORRES AND CONKLIN 1995:97, FIG. 16C).
- B: DETAIL OF TIWANAKU STYLE GOLD ORNAMENT SHOWING FELINE SACRIFICER (AFTER YOUNG-SÁNCHEZ 2004:95, FIG. 3.28).
- C: DRAWING OF CHACHAPUMA STONE SCULPTURE FROM IROHITO, BOLIVIA (AFTER ÁLVAREZ 1999).
- D: DETAIL OF CH'ALLADOR FROM PARITI, BOLIVIA, SHOWING FELINE SACRIFICER (AFTER VILLANUEVA C. 2007:56, FIG. 7).
- E: DETAIL OF CH'ALLADOR FROM PARITI, BOLIVIA, SHOWING FELINE SACRIFICER (AFTER VILLANUEVA C. 2007:56, FIG. 7).

FIGURE 25. TIWANAKU IMAGERY DEPICTING FELINES ASSOCIATED WITH THE STEP MOUNTAIN



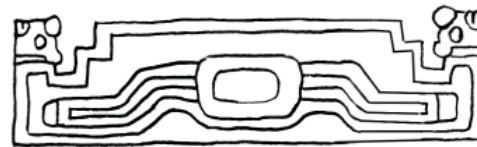
A



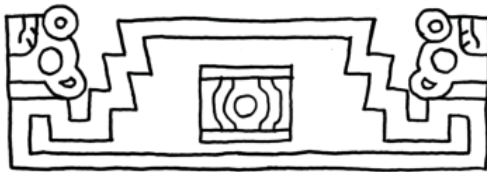
B



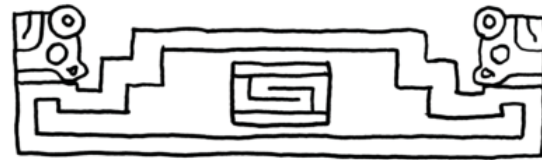
C



D



E



F

- A: DETAIL OF EARLY TIWANAKU STYLE TAPESTRY SHOWING FELINES STANDING ON THE BASES OF THE STEP MOUNTAIN (AFTER YOUNG-SÁNCHEZ 2004:19, FIG. 1.9).
- B: DETAIL OF EARLY TIWANAKU STYLE TAPESTRY TUNIC SHOWING FELINES STANDING ON THE BASES OF THE STEP MOUNTAIN (AFTER YOUNG-SÁNCHEZ 2004:47, FIG. 2.26A).
- C: DETAIL OF THE GATEWAY OF THE SUN SHOWING THE STEP MOUNTAIN WITH FELINE-HEADED BASES (AFTER STONE-MILLER 2002:133, FIG. 104).
- D: DETAIL OF THE BENNETT MONOLITH SHOWING THE STEP MOUNTAIN WITH FELINE-HEADED BASES (AFTER YOUNG-SÁNCHEZ 2004:113, FIG. 4.15).
- E: DETAIL OF STEP MOUNTAIN MOTIF WITH FELINE-HEADED BASES (AFTER POSNANSKY 1945b:PL. XLI, FIG. 3).
- F: DETAIL OF STEP MOUNTAIN MOTIF WITH FELINE-HEADED BASES (AFTER POSNANSKY 1945b:PL. XLI, FIG. 1).

Felines play a large role in the beliefs of various modern groups. In Isluga the wild cat is seen as the, “spiritual guardian of the domesticated animals” (Dransart 2002:28). In modern offering ceremonies mummified wild cats as well as chullumpi birds (which mark the presence of a juturi or point in the landscape from which llamas emerge) are utilized. Dransart remarks:

“A family may own one or two such mummified felines, stored inside the *q’ipi* bundle. They are placed on each side of the ritual table. *Titi* is the Aymara word wild cat, but during the *wayñu*, [the herd fertility ritual] it is never referred to as such. Instead, it is called *awatiri* (‘the herder’), for Isluga people regard this wild animal as being the supernatural herder of the llama and alpaca herds” (ibid.:92).

Indeed, Zuidema (1985:186) remarks that modern herders will hold their mummified felines and puma skins responsible when one of the herd has been killed. They beat and chastise the feline representations for failing to protect the herd.

These accounts suggest that felines are, in a general sense, implicated in herd fertility. As guardian of the herds it is understandable that felines are often depicted associated with the sacred mountain iconographic complex described above. Urton relates a strikingly similar conceptualization held by a modern group living near Pacariqtambo in southern Peru:

“Mountain springs are generally called *pukiyus*, although they are often referred to by the term *ñawi*, which means ‘eye’ and ‘origin.’ .... Several of these high mountain springs are also considered to be the places of origin of domesticated animals, especially cattle and sheep. It is believed that at the time of the new moon during the three rainiest months of the year (December to February), when water gushes forth from the mountain springs, baby cattle and sheep [and llamas] also frequently emerge from the springs .... Animals born of the mountain springs are considered to be especially fecund, reproducing at least once a year when fully mature. ... With human babies, the progenitor/progenitrix is Machu Compadre / Paya Comadre; with animals born from the springs, the progenitor/progenitrix is the puma who is simultaneously, a ‘child of the earth’ and Machu Compadre. The puma exercises dominion over these animals and can come at any time to reclaim them, especially if humans speak ill of him or mistreat the animals” (Urton 1985:259, 281).

In general, modern groups conceptualize felines as the guardians and spiritual herders of domesticated animals. They are further viewed as strongly associated with the earth and as symbols of boundaries. In Pacariqtambo they are referred to as “sons of the earth” and they are believed to be able to communicate with other-worldly realms. Pumas are further viewed in terms of ritual kinship. They are called Machu Compadre, invoking the *compandrazgo* relationship, because they are the guardians of the herds and associated with the sacred mountain springs from which the herds are believed to emerge (Urton 1985:255, 257). One informant in Khonkho Liki Liki related that pumas are said to emerge from the mountain springs above that community (Arik Ohnstad, personal communication, 2006). Zuidema writes, “[i]n terms of Andean ecology the puma, which belongs to the mountains, is ‘inside’; it lives near man and his cultivated fields and domesticated animals” (1985:231). It is not, then, surprising that pumas, and felines more generally are an integral component to Andean productive belief.

A *yatiri*, or shaman, whom I interviewed in Khonkho Liki Liki explained that for the residents of that community the Andean wild cat or *titi* is intimately associated with mountain springs and productive fertility. He related that when the *titi* leaves its home in the spring, the water ceases to flow. The only way to restore the flow of the water is to make an offering of a *titi*’s paw to the spring, after which the *titi* will return to its home.

There is significant evidence for the antiquity of these concepts. Dransart (2002:193, 237) describes two rock art panels in northern Chile near the border with Bolivia, which she dates to late pre-Hispanic times, as depicting the concept of the feline as guardian of the camelid herds (see also Berenguer Rodriguez and Martinez Cereceda 1986) (Figure 26). Rock art panel TU 60 depicts, "life-sized camelids, which face a more or less vertical fissure in the rock face. Immediately to the left of this crack, a life-sized puma confronts the camelids and faces the viewer's right" (Dransart 2002:193). The vertical fissure is significant, because it invokes the idea of camelids emerging from mountain springs and caves. Dransart continues, discussing a similar panel referred to as TU 54:

"In it, large camelids are arranged above a section that incorporates small camelids and aquatic birds. There is one large feline among the large camelids, drawn in profile and confronting a fissure in the rock face. The association between birds, felines and camelids was and still is widespread throughout Andean herding communities and ... it has acquired specific meanings that are expressed in the beliefs about the origins of camelids and in ritual in contemporary Isluga" (ibid.:237).

FIGURE 26. ROCK ART PANEL FROM NORTHERN CHILE DEPICTING FELINE AND LLAMAS SURROUNDING A FISSURE



(AFTER DRANSART 2002:193)

She further indicates that similar rock art panels have been noted elsewhere (Berenguer and Martínez C. 1986; cited in Dransart 2002:193).

The Inca also associated the puma, “with times and places of transition and transformation [sharing] this trait with other animals like the *amaru* (serpent, dragon) and the *uturuncu* (jaguar)” (Zuidema 1985:183). We have already established that it was common in Pucara, Tiwanaku, and Inca iconography to show serpents with feline attributes and felines with serpent attributes. Indeed, in many descriptions the *amaru* is explicitly a dragon (serpent-feline). All of these lines of evidence point to a conceptual relationship between pumas and serpents. Zuidema writes, “[o]ne symbolic use of the puma, the American lion, or his head, is to allow the sun or the rainbow to emerge from openings in the earth as if from springs of water” (ibid.:183). He continues, “[s]imilar ideas are expressed in other indigenous cultures of South America” (ibid.). Recalling that rainbows, as well as rivers, were often conceptualized as giant *amarus* we can begin to understand in a general way that pumas are linked to the boundaries or portals between the earthly realm and the spiritual realm. The puma is the guardian of the *paqarinas*. This idea is strongly represented in an Inca period stone portal at the site of Huanuco Pampa (Figure 27). Two inward facing felines flank this gateway, recalling also the pumas facing inward toward

FIGURE 27. INCA STONE DOORWAY WITH FELINES AS “SENTRIES”



(ORIGINAL PAINTING BY PAOLA GUARDIA AFTER PHOTO BY EDWARD RANNEY IN HEMMING 1982:199).

the rock-face fissures described by Dransart (2002) and discussed above. The effect produced is one in which the pumas are sentries or guardians of the portal.

The chronicler Pedro Cieza de León (1967 [1553]:Ch. 44) relates a tale about the battles between the Incas and the Chancas. He writes that when the Chancas were approaching Cuzco, the elite of the city sought out Inca Yupanqui, who had been somewhat ostracized because of the success of his brother, Inca Urco, who was away from the city. Fearing the destruction of Cuzco, the Inca nobles beseeched Inca Yupanqui to defend them. Although at first he declined, he eventually accepted and entered the plaza dressed in a puma skin to take up their defense (Zuidema 1985:204). The adornment of the puma skin symbolically marked the Inca as guardian of the city. Andean groups sometimes conceptualize community leaders as the *llantiru* or *awatiri* (herd leader) of the community or herd (Abercrombie 1998:342). Since the puma is often believed to be the spiritual guardian of llama herds, the adornment of puma skins by the Inca is understandable as a symbol of leadership.

Cristóbal de Molina, writing around 1575, described a related scene. After Inca Yupanqui donned the puma skin and accepted the duty to defend Cuzco, he is said to have journeyed to a spring called Sursurpuquio to seek an audience with the Sun God (Zuidema 1985:225). Molina describes the appearance of the Sun God:

“Out of the top of his head there issued three very brilliant rays like those of the Sun. Serpents were coiled around his arms where they came together, and on his head there was a *llyto* like that of the Inca. .... The head of a lion came out from between his legs, and on his back there was another lion whose legs appeared to embrace both shoulders of the man like a snake from top to bottom” (Molina 1989 [1581–1585]:60, translation by author).

In this passage, interaction with the spiritual realm can only occur at a mountain spring, and the Sun God is flanked above and below by felines. Felines, in this description, are integral to other-worldly communication, and, additionally, a serpent is depicted in the passage wrapped around the arms of the Sun God, an interesting image in light of the discussion above regarding serpents as able to transcend boundaries. The idea of the feline as a mediator or guardian of the spiritual realm is further indicated by a myth from the early 17th century Huarochirí manuscript. In this myth a man wins a competition by adorning a red puma skin he found near a spring and doing a dance which causes a rainbow to emerge from the spring (Salomon and Urioste 1991 [1598–1608]:58; Zuidema 1985:192). In this tale the man is able to appropriate otherworldly power by wearing the puma skin.

As alluded to earlier, felines often appear on Inca and early Colonial period keros with rainbows or breath elements emerging from their mouths (see Figure 5f, 5g, 6a, and 6b). These rainbows yield rain which falls on flowering plants below. Zuidema remarks that, “[m]any Incaic and modern myths refer to Apu Cañachuay, identifying it as a serpent or puma who governs the rains and who is lord of the llamas” (1985:228). Zuidema also comments on an altiplano ritual where puma skins are utilized to ensure a good harvest (ibid.:186). All of these lines of evidence suggest that the puma is strongly implicated in productive fertility: as guardian of the herds, mediator between this world and the spiritual realm, and as a provider of rains. As mentioned above, many Tiwanaku depictions show a feline as the Sacrificer (see Figure 24). These depictions denote the role of the puma as the mediator between the earthly realm and the spiritual realm, which was the source of both agricultural and camelid fertility. It is possible that the act of sacrifice was intended to ensure this fertility (see Benson and Cook 2001).<sup>7</sup>

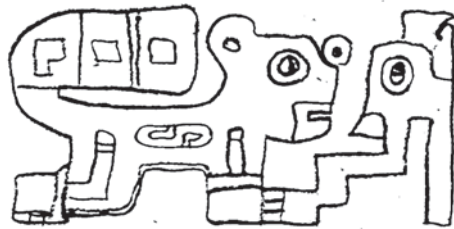
The other context in which felines are commonly shown in Tiwanaku imagery is in direct association with the Step Mountain. Felines are shown standing on the base of the mountain or, alternatively, as actually constituting the base of the mountains. Figure 25 presents



examples from various Tiwanaku monoliths of the feline in association with the Step Mountain. Additionally, felines in Tiwanaku iconography are frequently portrayed on ceramic vessels standing next to a simple step element that often terminates in an avian head (see Figure 28).

These depictions likely indicate that ancient Tiwanaku beliefs conceptualized felines as the guardians of the paqarinas or layra (points of emergence from the spiritual realm), which I have argued are located on sacred mountains. Excavations of Tiwanaku period architectural Step Mountains such as the Akapana, the Wila Kollu at Lukurmata, and the Omo M10 temple lend support to the idea that felines were conceptualized as mediators between the earthly and spiritual realms. A basalt puma sculpture, referred to as a *chachapuma*, was recovered from the lower steps of the Akapana (Figure 29), and there is some evidence to suggest that more *chachapumas* were originally present around the base of the structure (Janusek 2004, 2008; Kolata 2003). The *chachapuma* is holding a sacrificial trophy head, indicating that the feline is the Sacrificer. The *chachapuma* may have been conceptualized as a mediator between the earthly realm and the spiritual realm, which was accessed through the paqarina or layra located at the summit of the Akapana. Further, on the summit of the Akapana, in a residential structure adjacent to the now destroyed sunken temple or paqarina, excavators encountered a series of individuals buried in flexed, seated positions. Five of

FIGURE 28. FELINE AND STEP MOTIF COMMONLY DEPICTED ON TIWANAKU CERAMIC VESSELS



(AFTER VILLANUEVA C. 2007:57, FIG. 10)

these individuals faced a sixth seated individual who held a puma-shaped incensario in his hands (Kolata 2003:189; Manzanilla and Woodard 1990:136–137). These individuals are argued to have been religious specialists, and the individual holding the puma incensario is argued to have been a priest (Kolata 2003:189; Manzanilla and Woodard 1990:137). The use of a puma effigy vessel for ritual at the summit of the sacred Step Mountain makes sense when we recall that felines were the mediators between the earthly and spiritual realms.

Similarly, excavations at Lukurmata on the Wila Kollu stepped-platform mound near the sunken temple revealed a series of feline-shaped effigy incensarios buried in small cists. Similar buried feline incensarios were encountered in other areas of the Wila Kollu complex, and a flat-bottomed *escudilla* (a Tiwanaku period ceremonial vessel) displaying feline and condor imagery was also recovered (Bermann 1994:195; Janusek 2004:173). At Omo M10 as well, ritual offerings associated with the sunken temple typically consisted of zoomorphic effigy incensarios that were, “adorned with heads and tails of either pumas or raptorial birds” (Goldstein 2005:297). These archaeological data lend support to the argument that Tiwanaku beliefs conceptualized felines as the mediators between the earthly realm and the spiritual realm, which was accessed through sacred mountain paqarinas or layra.

FIGURE 29. CHACHAPUMA RECOVERED FROM BASE OF THE AKAPANA



(ORIGINAL PAINTING BY PAOLA GUARDIA AFTER YOUNG-SÁNCHEZ 2004:110, FIG. 4.13)

Returning once again to the gold ornament published by Young-Sánchez (2004:Fig. 3.28) (see Figure 14), which was identified above as representing an ancient conception of the spiritual realm from which the llama herds emerge, we see that the portal to this enclosure is flanked by two feline heads acting as sentries and spiritual guardians of the herd (Figure 30). This gold ornament and a textile tunic recently published by Young-Sánchez (2004:46–48, Fig. 2.26b) (Figure 31) suggest that sunken temples were architectural manifestations of *paqarinas* or *layra* in Tiwanaku belief. I have argued that the enclosure shown in Figures 14 and 30 was a representation of the otherworldly realm that some modern Aymara communities refer to as *Llantir Muntu*. This realm was accessed through mountain springs called *paqarinas* or *layra*, which were the eyes of the sacred mountain. I further identified this enclosure as the same central *layra* element typically portrayed in the Step Mountain (see Figure 11).

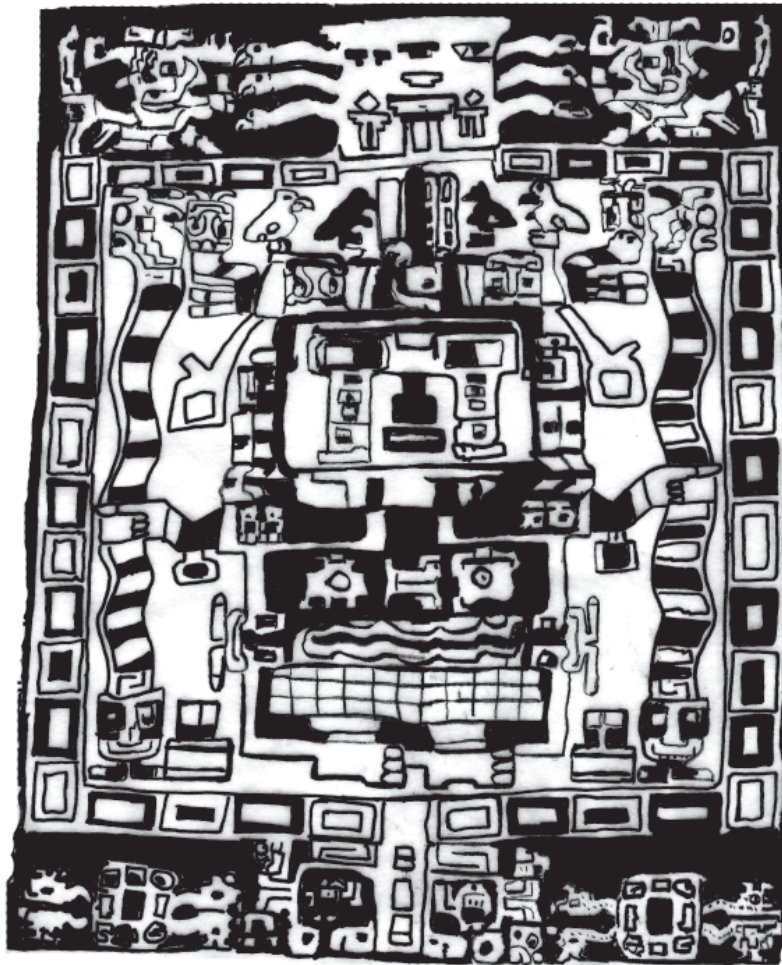
The image portrayed in Figure 31 shows a staff-bearing individual standing in the center of a square enclosure which is strongly reminiscent of the square or trapezoidal sunken temples of the region. The segmented border likely represents the segmented ashlar construction technique common to these sunken temples. The sunken temple in the image is accessed through a monolithic gateway very similar to the rear of the Gateway of the Sun as Young-Sánchez

FIGURE 30. DETAIL OF TIWANAKU GOLD ORNAMENT SHOWING FELINE HEADS MARKING ENTRANCE TO LLANTIR MUNTU



(AFTER YOUNG-SÁNCHEZ 2004:95, FIG. 3.28)

FIGURE 31. DETAIL OF ENCLOSURE FROM TIWANAKU STYLE TEMPLE TUNIC



(AFTER YOUNG-SÁNCHEZ 2004:48, FIG. 2.26B)

(2004:48) notes. The Gateway of the Sun may have originally stood as an entrance to the Puma Punku temple complex, a stepped platform with an interior sunken temple (Conklin 1991). Opposite the gateway is what appears to be another entrance to the enclosure flanked by two feline heads displayed similarly to the heads on the gold ornament mentioned above. It is likely that these felines are the guardians and mediators of this spiritual enclosure. It is also interesting to note that in this scene serpents are portrayed emerging from the gateway, marking it as a paqarina, and birds are shown populating the enclosure, which makes sense having established above that birds were conceptualized as being able to transgress the boundaries between the earthly and spiritual realms. This image allows me to hypothesize a link between the sunken-temple architectural form and the spiritual realm of productive fertility, Llantir Muntu, which was accessed through the layra or eyes of the sacred mountain of origin.

### SOME INITIAL INTERPRETIVE IMPLICATIONS

While the previous sections of this paper focused primarily on Tiwanaku period iconography and beliefs, this section extends the analysis to earlier imagery in order to develop an understanding of pre-Tiwanaku religious beliefs and to understand some of the changes that occurred during the consolidation of the Tiwanaku polity. Having established the symbolic association of llamas with water, fertility, and emergence from streams and caves located on sacred mountains during the Tiwanaku period, we can begin to look for other depictions of these themes aside from Step Mountain scenes. One prominent example of this is common to Yaya Mama style motifs. Yaya Mama was a regional religious tradition in the Lake Titicaca basin during the Early Horizon and Early Intermediate Period that was characterized by a common architectural and artistic style (Chávez 2004; Chávez and Mohr-Chávez 1975; Mohr-Chávez 1988).

Sergio Chávez (2004) argues that a great deal of continuity is evident between the Yaya Mama and later Tiwanaku styles, and I believe the arguments presented in this paper support this assertion. Yaya Mama style slabs and stelae depict a central circular enclosure surrounding a face (Figure 32). Arrow-headed serpents radiate from this central element, and two arms or legs commonly do, too (Chávez 1975, 2004; Chávez and Mohr-Chávez 1975). Flanking this central element are two llamas facing each other, often with their heads turned back. Seeing the prominent llamas depicted in association with an enclosure or hole from which serpents emerge suggests that this is a representation of a paqarina (place of blooming) or a layra (eye) of emergence, possibly from the ancient equivalent of Llantir Muntu, the resting place of the great herds. Alternatively, these two quadrupeds may represent pumas. Regardless, the same conclusion, that the central circular enclosure is a paqarina or layra, is supported.

This theme is given further support when one considers the imagery on the Arapa 3 Monolith from the same time period (Chávez 1975) (Figure 33a). This monolith depicts a Step Mountain with arrow-headed serpents in typical Yaya Mama style emerging from the base. The parallels with later Tiwanaku Step Mountain motifs are striking (see Figure 33b). Essentially, I believe the Arapa 3 Monolith and the Yaya Mama style slabs depict the same scene, only from different angles. The Yaya Mama style slabs show a top view of the scene depicted on the Arapa 3 Monolith. In the same way, the famous Andean Cross motif is likely a top view of a stepped pyramid. This argument is supported by Tiwanaku renderings of the Andean cross, which place a layra or eye in the center (Figure 34).

Furthermore, this paper has argued that ancient inhabitants of the Lake Titicaca basin conceptualized mountains as personified. Bearing this in mind we can look at other pre-Tiwanaku motifs in a new light. The Early Intermediate Period Stela 15 (also referred to as El Barbado [the bearded one]) from Tiwanaku provides an interesting example (Figure 35). This monument portrays a front-facing individual with one arm positioned above the other as is common to stelae from this

FIGURE 32. YAYA MAMA STYLE MOTIFS



A



B



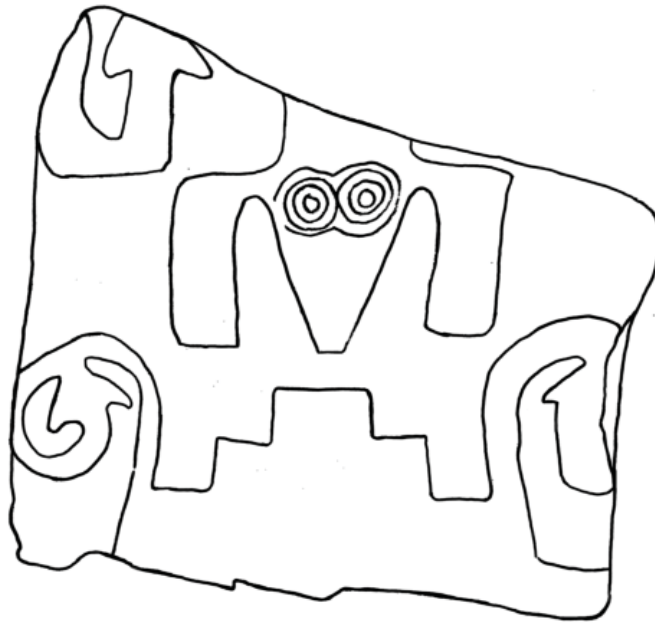
C

- A: YAYA MAMA STYLE CARVED STONE SLAB FROM COPACABANA, BOLIVIA (AFTER CHÁVEZ AND MOHR-CHÁVEZ 1975:PL. XXIV, FIG. 9).
- B: YAYA MAMA STYLE CARVED STONE SLAB FROM CHIRIPA, BOLIVIA (AFTER CHÁVEZ AND MOHR-CHÁVEZ 1975:PL. XXIV, FIG. 10A).
- C: YAYA MAMA STYLE STONE SCULPTURE FROM GUETRA PATA (AFTER SCHOBINGER 1997:199, FIG. 157).

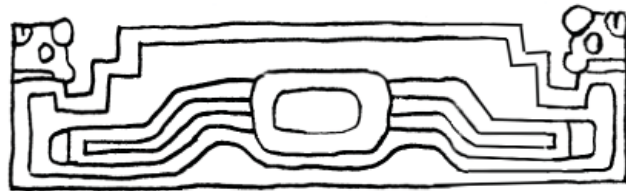
time period (see Ohnstad 2011 for a detailed discussion of Early Intermediate Period monoliths in the Lake Titicaca basin). A herd of camelids circle the face of the individual, and two inward facing pumas are shown below the individual's waist. Recalling that llamas were conceptualized in Tiwanaku times as emerging from the head and specifically the layra or eyes of the mountain, and that pumas were conceptualized as the guardians of the herds and were depicted as guarding the base or "foot" of the mountain, we can reasonably argue that the individual shown in Stela 15 personifies the sacred mountain. This argument is supported by the depictions of serpents running down the sides of the individual like rivers running down a mountain. Additionally, the small circle at the top of the individual's head may represent a mountain pool from which the circling camelids and serpent rivers emerged (Karl Taube, personal communication, 2009). The analysis of all the contextual elements surrounding Tiwanaku depictions of the Step Mountain has allowed us to establish the depiction of a personified sacred mountain in Yaya Mama style imagery despite the fact that the Step motif is not present. Many of these same motifs are portrayed on monoliths dating to the Early Intermediate Period from the nearby site of Khonkho Wankane (Ohnstad 2011).<sup>8</sup>

The understanding that a strong degree of religious continuity may have existed between the Yaya Mama tradition and Tiwanaku prompts an examination of other aspects associ-

FIGURE 33. ICONOGRAPHIC SIMILARITIES BETWEEN  
YAYA MAMA AND TIWANAKU



A

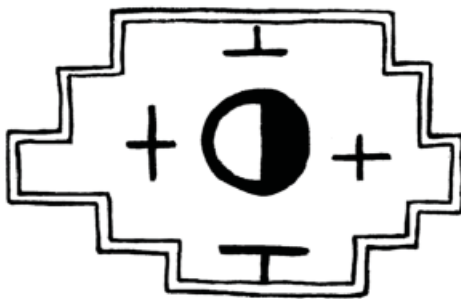


B

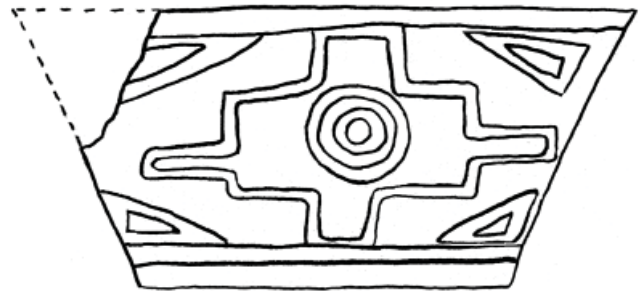
A: DETAIL OF THE ARAPA 3 MONOLITH (AFTER CHÁVEZ 1975:PL. IX, FIG. 12).

B: DETAIL OF BENNETT MONOLITH SHOWING STEP MOUNTAIN (AFTER YOUNG-SANCHEZ 2004:113, FIG. 4.15).

FIGURE 34. ANDEAN CROSS WITH CENTRAL EYE MOTIF



A



B

A: DETAIL OF TIWANAKU PORTRAIT VESSEL FROM CHEN CHEN, PERU (AFTER GOLDSTEIN 2005:260, FIG. 7.6).

B: DETAIL OF TIWANAKU TAZÓN (AFTER JANUSEK 2003:65, FIG. 3.47A).

FIGURE 35. STELA 15 (EL BARBADO) FROM TIWANAKU



(AFTER CHÁVEZ AND MOHR-CHÁVEZ 1975:PL. XXIII, FIG. 3)

ated with this religious complex in addition to imagery. I argued above that sunken temples during the Tiwanaku period were simulacra of paqarinas or layra, the eyes of the sacred mountain of origin. This architectural form, however, has its roots in the earlier Yaya Mama religious tradition. Chávez notes that the characteristic Yaya Mama sunken temples, “were located at the summit of high hills, on artificial mounds built almost at lake level, or at the foot of impressive cliffs” (2004:73). This indicates in a preliminary way that the Yaya Mama sunken temples may have been conceptualized in much the same way as the later Tiwanaku sunken court at the summit of the Akapana. Chávez continues, however, noting that the sunken court at Ch’isi near Copacabana contained cached offerings of, “native root and grain crops, fish, deer, camelids, guinea pigs, and birds” and further that, “silver foil cutouts of a feline and a camelid” were recovered from the sunken temple at Mallku Pukara (ibid.:74).

This paper has discussed the relationship of crop fertility, camelids, birds, and felines to sacred mountain springs called layra. These cached offerings and the spatial positioning of Yaya Mama sunken temples in direct association with natural or artificial mountains constitutes significant evidence that these spaces were architectural manifestations of the mountain spring paqarinas or places of blooming/emergence that were the sources of human and productive fer-

tility in the beliefs of the ancient Lake Titicaca basin. These sunken temples were the conceptual eyes of the sacred mountain during both the Tiwanaku and pre-Tiwanaku periods.

#### TIMING AND DISTRIBUTION OF MOTIFS

Complicating discussions about when and where the motifs and conceptions discussed in this paper originated is the likelihood that these icons were highly mobile (Ohnstad and Janusek 2007). Indeed, while obvious regional variability existed, there are similarities that link the whole of the south central Andes as one iconographic system (Isbell and Knobloch 2006, 2009). Ohnstad and Janusek (2007) propose that Early Horizon and Early Intermediate Period icons likely were spread throughout the Titicaca basin, the valleys near Arequipa and Moquegua, and the southern coastal regions near San Pedro de Atacama by llama caravans carrying textiles (see also Browman 1978). Joerg Haeblerli (2002) specifically dates some of the textiles thought to have been taken from the region around Arequipa, Peru, to the Early Intermediate Period between AD 200 and 400. He refers to these textiles by the term Pucara Provincial, because of their pre-Tiwanaku contexts and stylistic similarities to Pucara motifs. The primary textiles discussed in this paper share some stylistic similarities to the Pucara Provincial style discussed by Haeblerli (2002), and it is possible that they too date to the late Early Intermediate Period.

The Step motif, while a hallmark of Tiwanaku iconography, seems to have originated during the Early Intermediate Period, as evidenced by its common portrayal on Pucara Provincial style textiles. This argument is bolstered by the presence of the Step Mountain motif on several snuff tablets from San Pedro de Atacama that were recovered in association with ceramics dated to the same period (Ohnstad and Janusek 2007; Torres and Conklin 1995). This motif became more prevalent on textiles during the later centuries of the Early Intermediate Period and very common during the Tiwanaku period.

#### CONTINUITY AND CHANGE IN THE SOUTHERN LAKE TITICACA BASIN

The arguments developed in this section trace religious continuity between the pre-Tiwanaku and Tiwanaku periods. Specifically the Early Horizon and Early Intermediate Period roots of Tiwanaku that are apparent despite a strong stylistic shift that is associated with the emergence of the Tiwanaku polity. The identification of these continuities however, also highlights disjunctions between the two periods. This section will outline four specific disjunctions that demonstrate religious change leading up to the emergence Tiwanaku.

The first disjunction between earlier periods and the Tiwanaku period is the increasing use of the Step Mountain motif to portray the sacred mountain of origin. As discussed in preceding sections, it appears in an explicitly personified form on Yaya Mama monoliths throughout the southern Lake Titicaca basin. During the late Early Intermediate Period, a transition to portraying this mountain in a less explicitly personified way is evident, and during the Tiwanaku period this portrayal is prevalent. The use of a geometric design to portray sacred mountains may be related to the importance of weaving and textiles in the south central Andes. Stepped representations of mountains may also relate to terrace agricultural technologies. As I discuss in greater detail below, the use of the Step motif de-personified the sacred mountain of origin.

The second disjunction relates to an element not explicitly analyzed in this chapter: the rayed head. The rayed head is prevalent throughout the pre-Tiwanaku period, not only in the Lake Titicaca basin but in the southern Peruvian valleys and coast as well. During the later years of the Early Intermediate Period, the rayed head was also associated with the Step Mountain motif. During the Tiwanaku period, however, this element was portrayed as the head of a



human figure, as opposed to the disembodied version such as those portrayed on Early Intermediate Period textiles discussed above (compare Figures 2b and 2d with Figures 2a and 2c). This human figure, the Staff Deity, is shown holding a staff in each hand. The staff is a common element in southern Andean iconography, and modern communities living in the region view it as a symbol of politico-religious authority (e.g., Gelles 2000; Rasnake 1988b).

The third principal disjunction highlights the comparison of the Yaya Mama style monoliths in the southern Lake Titicaca basin with later Tiwanaku monoliths. As established earlier in this paper, the Yaya Mama style monoliths portray a mountain in the form of a person. The Tiwanaku period monoliths are carved in the form of a person but one who lacks the composite imagery identifying Formative monoliths as the sacred ancestral mountain. Instead, as Ohnstad and Janusek cogently argue (Janusek 2006; Ohnstad and Janusek 2007), a person is portrayed *wearing a textile* that displays the Tiwanaku period sacred imagery. The Tiwanaku period monoliths were executed in a more lifelike style, portraying the shape of the body and human features, such as arms, ears, feet, and the head, in relief. Whereas Yaya Mama monoliths were actual representations of the sacred ancestral mountain, Tiwanaku monoliths portrayed humans wearing and displaying representations of the sacred mountain.<sup>9</sup>

The last disjunction that emerges from this analysis relates to the concepts and imagery of sacrifice and felines in the southern Lake Titicaca basin. As discussed above, felines are argued to have been conceptualized as the guardians of the spiritual realm accessed through sacred mountain springs. Felines were believed to be the mediators between realms and responsible for both agricultural and herd fertility. A common portrayal of felines during the Tiwanaku period was as the Sacrificer pictured with a trophy head. This makes sense when it is remembered that the purpose of sacrifice was to ensure fertility. A disjunction becomes apparent, however, looking specifically at the iconography from the Early Horizon media in the southern Lake Titicaca basin. Whereas felines are common in this corpus, and likely have the same overall significance, they are not typically accompanied by trophy heads.

The portrayal of felines as sacrificers is common in other regions during earlier periods but not directly in the southern Lake Titicaca basin until Tiwanaku times. Sacrificers with trophy heads, some more feline and some more human, are evident in both Paracas and Nasca imagery as well as on some of the early snuff tablets from San Pedro de Atacama (see Moseley 2001:198; Pasztor 1998:111, Fig. 82; Sawyer 1972:108, Fig. 16; Torres and Conklin 1995). In the Lake Titicaca basin this cult is evident in northern regions (e.g., Pucara) but not in the southern iconography. I argue that the shift in the southern Titicaca basin to the portrayal of the Feline Sacrificer is coincident with a significant change in ritual practice as well. In the case of Nasca material culture, at least, imagery of the Sacrificer with trophy heads is accompanied by caches of decapitated heads and burials with headless individuals (Patterson 1991, 2004). The enactment of sacrifice in this violent manner is indicative of a shift in both ritual and political practice that might have occurred in the southern Lake Titicaca basin during the Tiwanaku period.<sup>10</sup>

The four disjunctions between Yaya Mama and Tiwanaku period religious iconography can help to elucidate some of the possible ideological processes involved in the emergence of Tiwanaku. I argue that chthonic power, which, during the pre-Tiwanaku period, was situated in the landscape, was co-opted during Tiwanaku times. A particular individual or group of individuals became, or tried to become, the embodiment of the focus of religious beliefs. I suggest that this shift was enacted in three ways that are apparent from this analysis. First, the previously personified sacred ancestral mountain was increasingly represented using the geometric Step motif, possibly indicating that religious agency was unmoored to some extent from the landscape. Second, by Tiwanaku times we see the previously separate rayed head portrayed as attached to an individual, who is pictured above the sacred mountain, which was by then portrayed using the Step Mountain motif. Finally, monolith sculptures began to represent actual individuals who

adorned themselves with the imagery of the sacred ancestral mountain. In this way, the chthonic power that was unmoored from the landscape began to be embodied in human form and appropriated by a particular individual or group of individuals during the Tiwanaku period.

Concurrently, ritual practices that were prevalent in other regions before the Tiwanaku period, which surely the earlier residents of the southern Lake Titicaca basin were aware of, began to become more prevalent at Tiwanaku itself. These practices, which elaborated on earlier and more innocuous concepts of sacrifice already present in the southern Lake Titicaca basin, depended on human sacrifice and decapitation to ensure productive success. Indeed, recent re-evaluation of the human burials from the Akapana pyramid shows strong evidence of public ritual human sacrifice (Blom, et al. 2003).

### SUMMARY

This paper used direct historical analogy to begin to understand the meaning of the Step motif present in much of Tiwanaku iconography. Using the insights gained from the analysis of Tiwanaku period imagery, this paper then refocused analysis on Formative period iconography. I suggest that the Step Mountain motif represented a sacred mountain that was the place of origin for both humans and camelids and the source of agricultural fertility. I noted that the central element in the Step Mountain motif is specifically a portal or point of transgression between earthly and otherworldly realms. I suggested that this point of origin was conceived as a mountain spring and envisioned as the eye of the mountain. Both serpents, which were representative of rivers and mountain streams, and camelids are argued to have emerged from the eyes of the mountain. These motifs relate to a larger plant theme in which these points of transgression were places of flowering or paqarinas. This relationship is strengthened by the identification of a motif that ancient Tiwanaku inhabitants seemed to have interchangeably used to represent flowers and bird tail feathers. Camelid, flower, and bird imagery are strongly and complexly interrelated.

The point of emergence has been argued to have been viewed as a place of blooming, and I further suggest that birds were conceptualized as able to transgress this point. Thus, the utilization of a single motif by ancient Tiwanaku inhabitants to represent both flowers and tail feathers is understandable. In this formulation, avians pictured with this element as tail feathers are emerging from the place of blooming. Similarly, depictions of the Sacrificer with this element at the end of a linear volute coming from the mouth possibly represent the flowering or productive fertility that results from a sacrifice offered to the otherworldly realm, the source of productive fertility. Camelids often appear in Tiwanaku iconography with flowers and plants. Remembering that camelids were conceptualized to have emerged from these places of blooming, the appearance of camelids with flowers and plants is logical. Felines often occur with the Step Mountain motif in Tiwanaku iconography and possibly represent guardians of the layra or points of emergence. Resulting from their close proximity to passages between the earthly and otherworldly realms, felines could communicate between the two. Thus, the Sacrificer figure often incorporates feline attributes, which is understandable considering its role in communicating with the otherworldly realm to ensure productive fertility.

Shifting focus to the pre-Tiwanaku Yaya Mama religious tradition, I argued that, while styles changed with the emergence of Tiwanaku, there was significant continuity between the two periods. While the Step motif (used later to represent the sacred mountain of origin, the Step Mountain) was depicted much less frequently before the Tiwanaku period, many of its compositional elements appear on Yaya Mama style monoliths in the form of the personified sacred mountain.

Disjunctions in iconography between pre-Tiwanaku and Tiwanaku periods shed light

on religious beliefs that help inform our understanding of the emergence of Tiwanaku. For example, chthonic power, which this study suggests was situated in the landscape during the pre-Tiwanaku period, was unmoored and embodied within a particular person or group of people during the Tiwanaku period. In addition, there was a shift in ritual practice from an emphasis on more abstract sacrifice to the adoption of practices from outside the region that advocated head taking as the means to ensure productive fertility.

#### ACKNOWLEDGMENTS

I would like to thank first and foremost Karl Taube who gave me constant encouragement and advice, and whose multiple readings of this paper have greatly improved its content and argument. I also would like to thank Wendy Ashmore, John Janusek, Arik Ohnstad, and Tom Patterson all of whom contributed greatly to my thinking on this topic through readings of various drafts and conversations. I am grateful as well to Antti Korpisaari and two anonymous reviewers whose comments have made this paper much stronger. I thank Jeffrey Splitstoser and George Stuart for their comments, attention, and patience. Additionally, I am grateful to Paola Guardia for creating some of the wonderful original artwork in the paper. The beautiful painting of Vilcachuaman was done by my mother, and my father did a great many of the drawings used in the monograph. Thanks to both of them for not only their artistic efforts but also for moral support. Finally, I would like to thank my wife Maribel Pérez Arias for her thoughtful comments and continual support. Research presented in this paper was supported in part by a Graduate Student Research Grant from the College of Humanities, Arts, and Social Sciences at the University of California, Riverside. Any errors are, of course, my own responsibility.

## ENDNOTES

- 1 Korpisaari, Sääksjärvi, and Salo (forthcoming) present a perceptive analysis of both avian and feline attributes in Tiwanaku art and argue that many avians commonly referred to as condors in the scholarly literature are eagles or falcons. Similarly, felines in Tiwanaku art are commonly referred to as pumas but the authors identify a variety of other species depicted including the titi or Andean mountain cat, the jaguar, and the melanistic jaguar or black panther.
- 2 In southern Lake Titicaca basin chronologies, Tiwanaku is a chronological period that comprises the Tiwanaku IV and V periods and is used when referring to Middle Horizon sites associated with the Tiwanaku polity or culture.
- 3 Thomas Besom (2009:66–67) provides a useful table of chroniclers who discuss mountain worship among the Inca.
- 4 In all likelihood this point of origin is a spring rather than a cave. Various informants in the community of Khonkho Liki Liki located about 30 km south of Tiwanaku informed me that there are no caves in the Quimsachata mountains that separate that community from Tiwanaku. Archaeologists John Janusek and Carlos Lemuz also related that they had encountered no caves during the course of their surveys in the Quimsachatas (personal communication, 2005).
- 5 In *The Hold Life Has*, Catherine Allen defines ayllu as an, “indigenous community or other social group whose members share a common focus” (Allen 2002:272).
- 6 Patricia Knobloch (2000) identifies a related trefoil element specifically as the hallucinogenic plant *Anadenanthera colubrina*.
- 7 In particular chapters by Benson (2001), Cook (2001), Frame (2001), and Proulx (2001) discuss the generative power of ritual sacrifice in the ancient Andes and its importance to productive fertility.
- 8 While working at the site of Khonkho Wankane during the summer of 2005, after this paper had been completed, I began talking to Arik Ohnstad regarding the iconography on Early Horizon and Early Intermediate Period monoliths at that site, which he had been analyzing. Ohnstad has independently come to some similar conclusions regarding a sacred ancestral mountain and mountain springs using a somewhat different methodology, lending even more credence to the formulations presented in this paper.
- 9 Ohnstad and Janusek (2007) argue that Early Horizon and Early Intermediate Period monoliths actually were the sacred ancestral mountain for groups living in these communities, an argument assisted by the fact that these monoliths were carved from the very rocks quarried from the nearby mountains.
- 10 Blom and Bandy (1999:118) note that an Early Chiripa phase (Early Horizon) burial at Chiripa contained, among remains from other individuals, “... the crania of two additional adults.” It is possible that these two crania represent early evidence of decapitation, however no data are presented to indicate that the crania were removed violently.

## REFERENCES

- ABERCROMBIE, THOMAS A.  
1998 *Pathways of Memory and Power: Ethnography and History Among an Andean People*. University of Wisconsin Press, Madison.
- AGÜERO P., CAROLINA, MAURICIO URIBE R., AND JOSÉ BERENGUER R.  
2003 La iconografía Tiwanaku: El caso de la escultura lítica. *Textos Antropológicos* 14(2):47-82.
- ALBORNOZ, CRISTÓBAL DE  
1989 [1581-1585] Instrucción para descubrir todas las guacas del Pirú y sus camayos y haziendas. In *Fábulas y mitos de los Incas*, Enrique Urbano y Pierre Duviols edition, edited by H. Urbano and P. Duviols, pp. 161-198. *Crónicas de América* 48. Historia 16, Madrid.
- ALLEN, CATHERINE J.  
1982 Body and Soul in Quechua Thought. *Journal of Latin American Lore* 8(2):179-196.  
2002 *The Hold Life Has: Coca and Cultural Identity in an Andean Community*, 2nd. ed. Smithsonian Institution Press, Washington, D. C., and London.
- ÁLVAREZ, ADRIÁN  
1999 *Informe del Proyecto de Exploración KOTAMAMA*. Dirección Nacional de Arqueología y Antropología, La Paz, Bolivia.
- BASTIEN, JOSEPH W.  
1978 *Mountain of the Condor: Metaphor and Ritual in an Andean Ayllu*. American Ethnological Society Monograph 64. West Publishing Co., St. Paul, Minn.
- BENSON, ELIZABETH P.  
2001 Why Sacrifice? In *Ritual Sacrifice in Ancient Peru*, edited by Elizabeth P. Benson and Anita G. Cook, pp. 1-20. University of Texas Press, Austin.
- BENSON, ELIZABETH P., AND ANITA G. COOK  
2001 *Ritual Sacrifice in Ancient Peru*. University of Texas Press, Austin.
- BERENGUER R., JOSÉ, AND JOSÉ LUIS MARTÍNEZ C.  
1986 El río Loa, el arte rupestre de Taira y el mito de Yakana. *Boletín del Museo Chileno de Arte Precolombino* 1:79-99.
- BERMANN, MARC  
1994 *Lukurmata: Household Archaeology in Prehispanic Bolivia*. Princeton University Press, Princeton, N. J.
- BERTONIO, P. LUDOVICO  
1993 [1612] *Transcripción del Vocabulario de la lengua Aymara*. Biblioteca del Pueblo Aymara, La Paz, Bolivia.
- BESOM, THOMAS  
2009 *Of Summits and Sacrifice: An Ethnohistoric Study of Inka Religious Practices*. University of Texas Press, Austin.
- BLOM, DEBORAH E., AND MATTHEW S. BANDY  
1999 Human Remains and Mortuary Analysis. In *Early Settlement at Chiripa, Bolivia: Research of the Taraco Archaeological Project*, edited by Christine A. Hastorf, pp. 117-122. University of California Archaeological Research Facility, Berkeley.
- BLOM, DEBORAH E., JOHN WAYNE JANUSEK, AND JANE E. BUIKSTRA  
2003 A Reevaluation of Human Remains from Tiwanaku. In *Tiwanaku and Its Hinterland: Archaeology and Paleoecology of an Andean Civilization 2: Urban and Rural Archaeology*, edited by Alan L. Kolata, pp. 435-446. Smithsonian Institution Press, Washington, D. C., and London.
- BOUYASSE-CASSAGNE, THÉRÈSE  
1987 *La Indentidad Aymara*. Hisbol, La Paz.
- BROWMAN, DAVID L.  
1978 Toward the Development of the Tiahuanaco (Tiwanaku) State. In *Advances in Andean Archaeology*, edited by David L. Browman. Mouton Publishers, The Hague and Paris.  
1994 Titicaca Basin Archaeolinguistics: Uru, Pukina and Aymara AD 750-1450. *World Archaeology* 26(2):235-251.
- BRUNO, MARIA C.  
2000 Sacred Springs: Preliminary Investigations of the Choquepacha Spring / Fountain,

- Tiwanaku, Bolivia. Paper presented at the 65th Annual Meeting of the Society for American Archaeology, Philadelphia.
- BUECHLER, HANS C., AND JUDITH-MARIA BUECHLER  
1971 *The Bolivian Aymara*. Case Studies in Cultural Anthropology. George Spindler and Louise Spindler, general editors. Holt, Rinehart and Winston, New York.
- BURGER, RICHARD L.  
1992a *Chavín and the Origins of Andean Civilization*. Thames and Hudson, London.  
1992b The Sacred Center of Chavín de Huántar. In *The Ancient Americas: Art from Sacred Landscapes*, edited by Richard F. Townsend, pp. 265–277. The Art Institute of Chicago and Prestel Verlag, Chicago and Munich.
- CASTRO, VICTORIA, AND CARLOS ALDUNATE  
2003 Sacred Mountains in the Highlands of the South-Central Andes. *Mountain Research and Development* 23(1):73–79.
- CERRÓN-PALOMINO, RODOLFO  
2000 El origen centroandino del aimara. In *Huari y Tiwanaku: Modelos vs. Evidencia, Primera Parte*, edited by Peter Kaulicke and William H. Isbell, pp. 131–142. Boletín de Arqueología PUCP 4. Pontificia Universidad Católica del Perú, Lima.
- CERUTI, MARÍA CONSTANZA  
2004 Human Bodies as Objects of Dedication at Inca Mountain Shrines (North-Western Argentina). *World Archaeology* 36(1):103–122.
- CHÁVEZ, SERGIO J.  
1975 The Arapa and Thunderbolt Stelae: A Case of Stylistic Identity with Implications for Pucara Influence in the Area of Tiahuanaco. *Ñawpa Pacha* 13:3–26.  
2004 The Yaya-Mama Religious Tradition as an Antecedent of Tiwanaku. In *Tiwanaku: Ancestors of the Inca*, edited by Margaret Young-Sánchez, pp. 70–93. Denver Art Museum and University of Nebraska Press, Lincoln and London.
- CHÁVEZ, SERGIO J., AND KAREN L. MOHR-CHÁVEZ  
1975 A Carved Stela From Taraco, Puno, Peru, and the Definition of an Early Style of Stone Sculpture from the Altiplano of Peru and Bolivia. *Ñawpa Pacha* 13:45–84.
- CIEZA DE LEÓN, PEDRO DE  
1967 [1553] *El Señorío de los Incas: 2a. parte de la Crónica del Perú*. Instituto de Estudios Peruanos, Lima.
- CLADOS, CHRISTIANE  
2009 New Perspectives on Tiwanaku Iconography. In *Tiwanaku: Papers from the 2005 Mayer Center Symposium at the Denver Art Museum*, edited by Margaret Young-Sánchez, pp. 101–114. The Frederick and Jan Mayer Center for Pre-Columbian and Spanish Colonial Art at the Denver Museum, Denver, Colo.
- COE, MICHAEL D.  
1973 The Iconology of Olmec Art. In *The Iconography of Middle American Sculpture*, edited by Ignacio Bernal and Elizabeth Kennedy Easby, pp. 1–12. The Metropolitan Museum of Art, New York.
- COLE, JOHN T.  
1969 The Human Soul in the Aymara Culture of Pumasara: An Ethnographic Study in the Light of George Herbert Mead and Martin Buber. Dissertation, Department of Anthropology, University of Pennsylvania. As seen in eHRAF World Cultures on February 15, 2005 (Accessible at <http://www.yale.edu/hraf/>).
- CONKLIN, WILLIAM J.  
1983 Pucara and Tiahuanaco Tapestry: Time and Style in a Sierra Weaving Tradition. *Ñawpa Pacha* 21:1–44.  
1991 Tiahuanaco and Huari: Architectural Comparisons and Interpretations. In *Huari Administrative Structure: Prehistoric Monumental Architecture and State Government*, edited by William H. Isbell and Gordon F. McEwan, pp. 281–291. Dumbarton Oaks Research Library and Collection, Washington, D. C.
- COOK, ANITA G.  
1983 Aspects of State Ideology in Huari and Tiwanaku Iconography: The Central Deity and the Sacrificer. In *Investigations of the Andean Past. Papers from the First Annual Northeast Conference on Andean Archaeology and Ethnohistory*, edited by Daniel H. Sandweiss, pp. 161–185. Cornell University Latin American Studies Program, Ithaca, N. Y.

- 2001 Huari D-Shaped Structures, Sacrificial Offerings, and Divine Rulership. In *Ritual Sacrifice in Ancient Peru*, edited by Elizabeth P. Benson and Anita G. Cook, pp. 137–163. University of Texas Press, Austin.
- CORDY-COLLINS, ALANA  
1983 Ancient Andean Art as Explained by Andean Ethnohistory: An Historical Review. In *Text and Image in Pre-Columbian Art: Essays on the Interrelationship of the Verbal and Visual Arts*, edited by Janet C. Berlo, pp. 181–196. BAR International Series 180. British Archaeological Reports, Oxford, U. K.
- COUTURE, NICOLE C.  
2004 Monumental Space, Courtly Style, and Elite Life at Tiwanaku. In *Tiwanaku: Ancestors of the Inca*, edited by Margaret Young-Sánchez, pp. 126–149. Denver Art Museum and University of Nebraska Press, Lincoln and London.
- COUTURE, NICOLE C., AND KATHRYN SAMPECK  
2003 Putuni: A History of Palace Architecture at Tiwanaku. In *Tiwanaku and Its Hinterland: Archaeology and Paleoecology of an Andean Civilization 2: Urban and Rural Archaeology*, edited by Alan L. Kolata, pp. 226–263. Smithsonian Institution Press, Washington, D. C., and London.
- DEMAREST, ARTHUR A.  
1981 *Viracocha: The Nature and Antiquity of the Andean High God*. Peabody Museum Monographs 6. Harvard University, Cambridge, Mass.
- DILLON, MARY, AND THOMAS ABERCROMBIE  
1988 The Destroying Christ: An Aymara Myth of Conquest. In *Rethinking History and Myth: Indigenous South American Perspectives on the Past*, edited by Jonathan D. Hill, pp. 50–77. University of Illinois Press, Urbana and Chicago.
- DRANSART, PENELOPE Z.  
1995 Inner Worlds and the Event of a Thread in Isluga, Northern Chile. In *Andean Art: Visual Expression and Its Relation to Andean Beliefs and Values*, edited by Penelope Z. Dransart, pp. 228–242. Worldwide Archaeology Series, 13. Avebury, Aldershot, U. K.
- 2002 *Earth, Water, Fleece and Fabric: An Ethnography and Archaeology of Andean Camelid Herding*. Routledge, London and New York.
- EISLEB, DIETER  
1975 *Altperuanische Kulturen I. Abteilung Amerikanische Archäologie 3*. Museum für Völkerkunde, Berlin.
- FLORES O., JORGE A.  
1978 Classification et dénomination des camélidés sud-américains. *Annales Economies, Sociétés, Civilisations Paris* 33(5–6):1006–1017.
- FLORES O., JORGE A., ELIZABETH K. ARCE, AND ROBERTO S. ARGUMEDO  
1998 *Qeros: arte inka en vasos ceremoniales*. Colección Arte y Tesoros del Peru. Banco de Crédito del Perú, Lima.
- FORBES, DAVID  
1870 On the Aymara Indians of Bolivia and Peru. *The Journal of the Ethnological Society of London, new series* 2:193–305. As seen in eHRAF World Cultures on February 15, 2005 (Accessible at <http://www.yale.edu/hraf/>).
- FRAME, MARY  
2001 Blood, Fertility, and Transformation: Interwoven Themes in the Paracas Necropolis Embroideries. In *Ritual Sacrifice in Ancient Peru*, edited by Elizabeth P. Benson and Anita G. Cook, pp. 55–92. University of Texas Press, Austin.
- FRANQUEMONT, EDWARD M.  
1986 The Ancient Pottery from Pucara, Peru. *Ñawpa Pacha* 24:1–30.
- GARCILASO DE LA VEGA, EL INCA  
1944 [1617] *Historia general del Perú (segunda parte de los Comentarios reales de los Incas)*. 3 vols. Ángel Rosenblat (general editor). Emecé Editores S. A., Buenos Aires, Argentina.
- GELLES, PAUL H.  
2000 *Water and Power in Highland Peru: The Cultural Politics of Irrigation and Development*. Rutgers University Press, New Brunswick, New Jersey, and London, U. K.

- GISBERT, TERESA  
1997 *El Amaru en la Iconografía de los keros / The Amaru in the Iconography of the Keros*. Journal of the Steward Anthropological Society 25(1 & 2):219-236.
- GOLDSTEIN, PAUL S.  
2005 *Andean Diaspora: The Tiwanaku Colonies and the Origins of South American Empire*. New World Diasporas, Kevin A. Yelvington (general editor). University Press of Florida, Gainesville.
- GÓMEZ, LUIS R.  
2003 El motivo «torre» en el escudo de Cuzco y en los queros y otras vasijas andinas de madera de época colonial, del Museo de América (Madrid). *Revista Española de Antropología Americana* 34:163-186.
- GONZÁLEZ HOLGUÍN, DIEGO  
1989 [1608] *Vocabulario de la lengua general de todo el Perú, llamada lengua qqichua o del Inca*. Universidad Nacional Mayor de San Marcos, Lima.
- GOW, DAVID, AND ROSALIND GOW  
1975 La alpaca en el mito y el ritual. *Allpanchis Phuturinga* 8:141-165.
- GROVE, DAVID C., AND SUSAN D. GILLESPIE  
1992 Ideology and Evolution at the Pre-State Level: Formative Period Mesoamerica. In *Ideology and Pre-Columbian Civilizations*, edited by Arthur A. Demarest and Geoffrey W. Conrad, pp. 15-36. School of American Research Advanced Seminar Series, Douglas W. Schwartz (general editor). School of American Research Press, Santa Fe, New Mexico.
- GUAMAN POMA DE AYALA, FELIPE  
1980 [1615] *El primer nueva corónica y buen gobierno* (3 vols.). Translated by Jorge L. Urioste. Colección América Nuestra a América Antigua 31. John V. Murra and R. Adorno, general editors. Siglo XXI, Mexico, D. F.
- HAEBERLI, JOERG  
2002 Tiempo y tradición en Arequipa, Perú, y el surgimiento del la cronología del tema de la deidad central / Time and tradition in Arequipa, Peru, and the development of a chronology for the central deity theme. In *Huari y Tiwanaku: Modelos vs. Evidencias, Segunda Parte*, edited by Peter Kaulicke and William H. Isbell, pp. 89-137. Translated by Helena Horta T. Boletín de Arqueología PUCP 5(2001), Peter Kaulicke (general editor). Pontificia Universidad Católica del Perú, Lima.
- HAYS-GILPIN, KELLEY, AND JANE H. HILL  
2000 The Flower World in Prehistoric Southwest Material Culture. In *Archaeology of Regional Interaction: Religion, Warfare, and Exchange across the American Southwest and Beyond*, edited by Michelle Hegmon, pp. 411-428. University Press of Colorado, Boulder.
- HEMMING, JOHN  
1982 *Monuments of the Incas*. Little, Brown and Company, Boston.
- HOCQUENGHEM, ANNE MARIE  
1983 The "Beauty" of the "Deer-Serpent-Jaguar." *CaMak* 1:4-7.
- HOOPES, JOHN W.  
2009 From Tiwanaku to Machu Picchu: Ushnus and the Architecture of Creation. In *Tiwanaku: Papers from the 2005 Mayer Center Symposium at the Denver Art Museum*, edited by Margaret Young-Sánchez, pp. 247-272. The Frederick and Jan Mayer Center for Pre-Columbian and Spanish Colonial Art at the Denver Museum, Denver, Colorado.
- ISELL, WILLIAM H., AND PATRICIA J. KNOBLOCH  
2006 Missing Links, Imaginary Links: Staff God Imagery in the South Andean Past. In *Andean Archaeology III: North and South*, edited by William H. Isbell and Helaine Silverman, pp. 307-351. Springer, New York.
- 2009 SAIS-The Origin, Development, and Dating of Tiahuanaco-Huari Iconography. In *Tiwanaku: Papers from the 2005 Mayer Center Symposium at the Denver Art Museum*, edited by Margaret Young-Sánchez, pp. 165-210. The Frederick and Jan Mayer Center for Pre-Columbian and Spanish Colonial Art at the Denver Museum, Denver, Colorado.
- JANUSEK, JOHN W.  
2002 Diversidad residencial y el surgimiento de la complejidad en Tiwanaku. In *Huari*



- y *Tiwanaku: Modelos vs. Evidencias, Segunda parte*, edited by Peter Kaulicke and William H. Isbell, pp. 251–294. *Boletín de Arqueología PUCP* 5(2001), Peter Kaulicke (general editor). Pontificia Universidad Católica del Perú, Lima.
- 2003 Vessels, Time, and Society: Toward a Ceramic Chronology in the Tiwanaku Heartland. In *Tiwanaku and Its Hinterland: Archaeology and Paleoecology of an Andean Civilization 2: Urban and Rural Archaeology*, edited by Alan L. Kolata, pp. 30–91. Smithsonian Institution Press, Washington, D. C., and London.
- 2004 *Identity and Power in the Ancient Andes: Tiwanaku Cities through Time*. Routledge, New York and London.
- 2006 The Changing 'nature' of Tiwanaku Religion and the Rise of an Andean State. *World Archaeology* 38(3):469–492.
- 2008 *Ancient Tiwanaku*. Cambridge University Press, Cambridge and New York.
- KAUFFMANN DOIG, FEDERICO  
2002 *Historia y arte del Perú antiguo*. Editorial Peisa: Empresa Editora La República, Lima.
- KIDDER II, ALFRED V.  
1943 *Some Early Sites in the Northern Lake Titicaca Basin: Expeditions to Southern Peru, Peabody Museum, Harvard University, Report No. 1*. Papers of the Peabody Museum of Archaeology and Ethnology 27(1). Harvard University, Cambridge, Mass.
- KLARICH, ELIZABETH A.  
2005 From the Monumental to the Mundane: Defining Early Leadership Strategies at Late Formative Pukara, Peru. Dissertation, Department of Anthropology, University of California, Santa Barbara.
- KNOBLOCH, PATRICIA J.  
2000 Wari Ritual Power at Conchopata: An Interpretation of *Anadenanthera Colubrina* Iconography. *Latin American Antiquity* 11(4):387–402.
- KOLATA, ALAN L.  
1993 *The Tiwanaku: Portrait of an Andean Civilization*. The Peoples of America. Alan L. Kolata and Dean Snow, general editors. Blackwell Publishers, Cambridge, Mass., and Oxford, U. K.
- 1996 *Valley of the Spirits: A Journey into the Lost Realm of the Aymara*. John Wiley and Sons, New York.
- 2003 Tiwanaku Ceremonial Architecture and Urban Organization. In *Tiwanaku and Its Hinterland: Archaeology and Paleoecology of an Andean Civilization 2: Urban and Rural Archaeology*, edited by Alan L. Kolata, pp. 175–201. Smithsonian Institution Press, Washington, D. C., and London.
- 2004 The Flow of Cosmic Power: Religion, Ritual, and the People of Tiwanaku. In *Tiwanaku: Ancestors of the Inca*, edited by Margaret Young-Sánchez, pp. 96–125. Denver Art Museum and the University of Nebraska Press, Lincoln and London.
- KOLATA, ALAN L., AND CARLOS PONCE S.  
1992 Tiwanaku: The City at the Center. In *The Ancient Americas: Art From Sacred Landscapes*, edited by Richard F. Townsend, pp. 317–333. The Art Institute of Chicago and Prestel Verlag, Chicago and Munich.
- KORPISAARI, ANTTI, ILARI E. SÄÄKSJÄRVI, AND MATTI SALO  
Forthcoming Evidencias de contactos entre la sierra, la ceja de selva y la selva baja en el arte de la cultura Tiwanaku. In *Proceedings of the Andes, Amazonas y Sus Transformaciones Colloquium (St. Andrews, Scotland, September 20–23, 2006)*, edited by Tristan Platt, Isabelle Dailant, Mark Harris and Gilles Rivière.
- KROEBER, A. L.  
1926 *The Uhle Pottery Collections from Chancay*. University of California Publications in American Archaeology and Ethnology 24(7):265–304. University of California Press, Berkeley.
- KUBLER, GEORGE  
1967 *The Iconography of the Art of Teotihuacan*. Studies in Pre-Columbian Art and Archaeology 4. Dumbarton Oaks, Washington, D. C.
- 1970 Period, Style, and Meaning in Ancient American Art. *New Literary History* 1–2:127–144.
- 1973 Science and Humanism among Americanists. In *The Iconography of Middle American Sculpture*, edited by Ignacio Bernal and Elizabeth Kennedy Easby,

- pp. 163–167. The Metropolitan Museum of Art, New York.
- LABARRE, WESTON  
1948 The Aymara Indians of the Lake Titicaca Plateau, Bolivia. *American Anthropologist* 50(1, Part 2):1–250. As seen in eHRAF World Cultures on February 15, 2005 (Accessible at <http://www.yale.edu/hraf/>).
- LEHMANN, WALTER, AND HEINRICH UBBELOHDE-DOERING  
1975 *The Art of Old Peru*. Hacker Art Books, New York.
- LLAGOSTERA M., AGUSTÍN  
1995 Art in the Snuff Trays of San Pedro de Atacama (Northern Chile). In *Andean Art: Visual Expression and its Relation to Andean Beliefs and Values*, edited by Penelope Z. Dransart, pp. 51–77. Avebury, Aldershot, U. K.  
2006 Contextualización e Iconografía de las Tabletas Psicotrópicas Tiwanaku de San Pedro de Atacama. *Chungara, Revista de Antropología Chilena* 38(1):83–111.
- LYMAN, R. LEE, AND MICHAEL J. O'BRIEN  
2001 The Direct Historical Approach, Analogical Reasoning, and Theory in Americanist Archaeology. *Journal of Archaeological Method and Theory* 8(4):303–342.
- MACNEISH, RICHARD S., THOMAS C. PATTERSON, AND DAVID L. BROWMAN  
1975 *The Central Peruvian Prehistoric Interaction Sphere*. Papers of the Robert S. Peabody Foundation for Archaeology 7. Robert S. Peabody Foundation for Archaeology, Andover, Mass.
- MANZANILLA, LINDA  
1992 *Akapana: Una pirámide en el centro del mundo*. Instituto de Investigaciones Antropológicas, Universidad Nacional Autónoma de México, México, D. F.
- MANZANILLA, LINDA, AND ERIC WOODARD  
1990 Restos Humanos Asociados a la Pirámide de Akapana (Tiwanaku, Bolivia). *Latin American Antiquity* 1(2):133–149.
- MARTÍNEZ S., GABRIEL  
1976 El sistema de los *uywiris* en Isluga. In *Homenaje al Dr. Gustavo Le Paige, SJ*, edited by H. Niemeyer, pp. 255–327. Anales de la Universidad del Norte 10. Universidad del Norte, Antofagasta, Chile.
- MCANDREWS, TIMOTHY L., JUAN ALBARRACIN-JORDAN, AND MARC BERMAN  
1997 Regional Settlement Patterns in the Tiwanaku Valley of Bolivia. *Journal of Field Archaeology* 24(1):67–83.
- MENZEL, DOROTHY  
1964 Style and Time in the Middle Horizon. *Nawpa Pacha* 2:1–105.
- MÉTRAUX, ALFRED  
1934 Contribution to Andean Folklore (Originally published as “Contribution au Folk-Lore Andin”). *Journal de la Société des Américanistes* 26(1):67–102. Translated from French by Pricilla Reynolds. As seen in eHRAF World Cultures on February 15, 2005 (Accessible at <http://www.yale.edu/hraf/>).
- MOHR-CHÁVEZ, KAREN L.  
1988 The Significance of Chiripa in Lake Titicaca Basin Developments. *Expedition* 30(3):17–26.
- MOLINA, CRISTÓBAL DE  
1989 [1576] Relación de las fábulas i ritos de los Ingas. In *Fábulas y mitos de los Incas*, edited by H. Urbano and P. Duviols, pp. 47–134. Enrique Urbano y Pierre Duviols edition. Crónicas de América 48. Historia 16, Madrid.
- MOORE, JERRY D.  
1996 *Architecture and Power in the Ancient Andes: The Archaeology of Public Buildings*. New Studies in Archaeology. Colin Renfrew, Wendy Ashmore, Clive Gamble and John O'Shea, general editors. Cambridge University Press, Cambridge, U. K.
- MOSELEY, MICHAEL E.  
1992 *The Incas and Their Ancestors: The Archaeology of Peru*. Thames and Hudson, New York.  
2001 *The Incas and Their Ancestors: The Archaeology of Peru*, Revised ed. Thames and Hudson, London.
- MURRA, JOHN V.  
1980 *The Economic Organization of the Inka State*. Research in Economic Anthropology, Supplement 1. JAI Press, Greenwich, Conn.

- MURÚA, FRAY MARTÍN DE  
1946 [1590–1609] *Los orígenes de los Inkas, crónica sobre el antiguo Perú escrita en el año de 1590*. Bio-bibliographical study by Raúl Porras Barrenechea. Los Pequeños grandes Libros de Historia Americana, First Series, 2. Imprenta Miranda, Lima.
- NICHOLSON, HENRY B. (EDITOR)  
1976 *Origins of Religious Art and Iconography in Preclassic Mesoamerica*. Latin American Center Publications, University of California, Los Angeles.
- OHNSTAD, ARIK  
2011 La Escultura Prehispánica de Khonkho Wankane, Jesús de Machaca, Bolivia. *Nuevos Aportes* 5(2011):119–142. (Accessible at <http://www.arqueobolivia.com>).
- OHNSTAD, ARIK, AND JOHN W. JANUSEK  
2007 The Development of “Tiwanaku Style” out of the Ideological and Political-Economic Landscapes of the Formative Period Titicaca Basin. Paper presented at the Southern Andean Iconographic Series: A Colloquium in Pre-Columbian Art and Archaeology, Universidad de Chile, Santiago.
- PACHACUTI YAMQUI SALCAMAYGUA, JOAN DE SANTA CRUZ  
1993 [1613] *Relación de antigüedades deste reyno del Pirú*, Facsimile ed. Ethnohistorical and linguistic study by Pierre Duviols and César Itier. *Travaux de l’Institut Français d’Études Andines* 74. *Archivos de Historia Andina* 17. Institut Français d’Études Andines and Centro de Estudios Regionales Andinos “Bartolomé de las Casas,” Lima and Cusco.
- PASZTORY, ESTHER  
1998 *Pre-Columbian Art*. Cambridge University Press, Cambridge and New York.
- PATTERSON, THOMAS C.  
1991 *The Inca Empire: The Formation and Disintegration of a Pre-Capitalist State*. Berg Publishers, New York and Oxford.  
2004 Class Struggle, State Formation, and Archaism: Some instances from ancient Peru. *Journal of Social Archaeology* 4(3):288–306.
- PAYNE, JOHNNY  
2000 *She-Calf and Other Quechua Folk Tales*. University of New Mexico Press, Albuquerque.
- POLO ONDEGARDO  
1916 [1571] Relación de los fundamentos acerca del notable daño que resulta de no guardar a los indios sus fueros. In *Informaciones acerca de la religión y gobierno de los Incas*, Vol. 1, pp. 45–188. Biographical notes and concordances of texts by Horacio H. Urteaga. Colección de Libros y Documentos referentes a la Historia del Perú 3–4. Sanmartí, Lima.
- POSNANSKY, ARTHUR  
1945a *Tiwanaku: The Cradle of American Man / Tiwanaku: la cuna del hombre americano*, Vol. 1. Translated by James F. Shearer. J. J. Augustin, New York.  
1945b *Tiwanaku: The Cradle of American Man / Tiwanaku: la cuna del hombre americano*, Vol. 2. Translated by James F. Shearer. J. J. Augustin, New York.
- PROTZEN, JEAN-PIERRE, AND STELLA NAIR  
2002 Pumapunku: Plataformas y portales. In *Huari y Tiwanaku: Modelos vs. Evidencias, Segunda parte*, edited by Peter Kaulicke and William H. Isbell, pp. 309–336. *Boletín de Arqueología PUCP* 5(2001), Peter Kaulicke (general editor). Pontificia Universidad Católica del Perú, Lima.
- PROULX, DONALD A.  
2001 Ritual Uses of Trophy Heads in Ancient Nasca Society. In *Ritual Sacrifice in Ancient Peru*, edited by Elizabeth P. Benson and Anita G. Cook, pp. 119–136. University of Texas Press, Austin.
- RASNAKE, ROGER  
1988a Images of Resistance to Colonial Domination. In *Rethinking History and Myth: Indigenous South American Perspectives on the Past*, edited by Jonathan D. Hill, pp. 136–156. University of Illinois Press, Urbana and Chicago.  
1988b *Domination and Cultural Resistance: Authority and Power Among an Andean People*. Duke University Press, Durham and London.

- REINHARD, JOHAN  
 1993 Llullaillaco: An Investigation of the World's Highest Archaeological Site. *Latin American Indian Literatures Journal* 9(1):31-54.  
 2005 *The Ice Maiden: Inca Mummies, Mountain Gods, and Sacred Sites in the Andes*. National Geographic Society, Washington, D. C.
- RICE, PRUDENCE M.  
 2004 *Maya Political Science: Time, Astronomy, and the Cosmos*. University of Texas Press, Austin.
- RIVERA C., CLAUDIA  
 2003 *Ch'iji Jawira: A Case of Ceramic Specialization in the Tiwanaku Urban Periphery*. In *Tiwanaku and Its Hinterland: Archaeology and Paleoecology of an Andean Civilization 2: Urban and Rural Archaeology*, edited by Alan L. Kolata, pp. 296-315. Smithsonian Institution Press, Washington, D. C., and London.
- RIVERA S., OSWALDO  
 1989 Resultados de la excavación en el centro ceremonial de Lukurmata. In *Arqueología de Lukurmata*, Vol. 2, edited by Alan L. Kolata, pp. 59-89. Instituto Nacional de Arqueología, La Paz.
- ROWE, JOHN H., AND CATHERINE T. BRANDEL  
 1969-1970 Pucara Style Pottery Designs. *Ñawpa Pacha* 7-8:1-16.
- SAHLINS, MARSHALL  
 1985 *Islands of History*. University of Chicago Press, Chicago.
- SALOMON, FRANK  
 1991 Introductory Essay: The Huarochirí Manuscript. In *The Huarochirí Manuscript: A Testament of Ancient and Colonial Andean Religion*, pp. 1-38. Translated by Frank Salomon and George L. Urioste. Annotated by Frank Salomon. Transcription by George L. Urioste. University of Texas Press, Austin.  
 1995 "The Beautiful Grandparents:" Andean Ancestor Shrines and Mortuary Ritual as Seen Through Colonial Records. In *Tombs for the Living: Andean Mortuary Practices: A Symposium at Dumbarton Oaks 12th and 13th October 1991*, edited by Tom D. Dillehay, pp. 315-353. Dumbarton Oaks Research Library and Collection, Washington, D. C.
- 1998 How the Huacas Were: The Language of Substance and Transformation in the Huarochirí Quechua Manuscript. *Res: Anthropology and Aesthetics* 33(Spring 1998):7-17.
- SALOMON, FRANK, AND GEORGE L. URIOSTE (EDITORS)  
 1991 [1598-1608] *The Huarochirí Manuscript: A Testament of Ancient and Colonial Andean Religion*. Translated by Frank Salomon and George L. Urioste. Annotated by Frank Salomon. Transcription by George L. Urioste. University of Texas Press, Austin.
- SARMIENTO DE GAMBOA, PEDRO  
 1942 [1572] *Historia de los Incas*, edited by Ángel Rosenblat. Colección Hórreo. Emecé Editores, Buenos Aires.
- SATURNO, WILLIAM A., KARL A. TAUBE, AND DAVID STUART  
 2005 *The Murals of San Bartolo, El Petén, Guatemala: Part I. The North Wall*. Ancient America 7. Center for Ancient American Studies, Barnardsville, N. C.
- SAWYER, ALAN R.  
 1972 The Feline in Paracas Art. In *The Cult of the Feline: A Conference in Pre-Columbian Iconography, October 31st and November 1st, 1970*, edited by Elizabeth P. Benson, pp. 91-116. Dumbarton Oaks Research Library and Collections, Washington, D. C.
- SCHOBINGER, JUAN  
 1997 *Arte Prehistórico de América*. Jaca Book and Consejo Nacional para la Cultura y las Artes, Milan and México.
- SHERBONDY, JEANNETTE  
 1986 *Mallki: Ancestros y cultivo de arboles en los Andes*. Ministerio de Agricultura, Instituto Nacional Forestal y de Fauna, Organización de las Naciones Unidas para la Agricultura y la Alimentación, Lima.
- SILVERBLATT, IRENE  
 1988 Political Memories and Colonizing Symbols: Santiago and the Mountain Gods of Colonial Peru. In *Rethinking History and Myth: Indigenous South American*

- Perspectives on the Past*, edited by Jonathan D. Hill, pp. 174–194. University of Illinois Press, Urbana and Chicago.
- SMITH, SCOTT C.  
 2007 Spatial Practices and the Constitution of a Late Formative Built Environment: Architecture at Khonkho Wankane, Bolivia. Paper presented at the 72nd Annual Meeting of the Society for American Archaeology, Austin, Texas.  
 2009 Venerable Geographies: Spatial Dynamics, Religion, and Political Economy in the Prehistoric Lake Titicaca Basin, Bolivia. Dissertation, Department of Anthropology, University of California, Riverside.  
 2011a Ceremonialism and the Social Relations of Production during the Late Formative Period (200 BC–AD 500) in the Southern Lake Titicaca Basin, Bolivia. Paper presented at the 76th Annual Meeting of the Society for American Archaeology, Sacramento, Calif.  
 2011b La Arquitectura del Formativo Tardío en Khonkho Wankane, Bolivia. *Nuevos Aportes* 5:71–98.
- SPALDING, KAREN  
 1984 *Huarochirí: An Andean Society under Inca and Spanish Rule*. Stanford University Press, Stanford.
- STANISH, CHARLES  
 2003 *Ancient Titicaca: The Evolution of Complex Society in Southern Peru and Northern Bolivia*. University of California Press, Berkeley, Los Angeles, and London.
- STEWART, JULIAN H.  
 1942 The Direct Historical Approach to Archaeology. *American Antiquity* 7(4):337–343.
- STONE-MILLER, REBECCA  
 2002 *Art of the Andes from Chavín to Inca*, 2nd ed. World of Art. Thames and Hudson, London.
- STRONG, WILLIAM D.  
 1940 From History to Prehistory in the Northern Great Plains. In *Essays in Historical Anthropology of North America Published in Honor of John R. Swanton in Celebration of His Fortieth Year with the Smithsonian Institution*, pp. 353–394. Smithsonian Miscellaneous Collections 100. Smithsonian Institution, Washington, D. C.
- TAUBE, KARL A.  
 1985 The Classic Maya Maize God: A Reappraisal. In *Fifth Palenque Round Table, 1983*, edited by Virginia M. Fields, pp. 171–181. The Pre-Columbian Art Research Institute, San Francisco.  
 1992 *The Major Gods of Ancient Yucatan*. Studies in Pre-Columbian Art and Archaeology 32. Dumbarton Oaks Research Library and Collection, Washington, D. C.  
 2004 Flower Mountain: Concepts of Life, Beauty and Paradise among the Classic Maya. *Res: Anthropology and Aesthetics* 45:69–98.
- TORERO, ALFREDO  
 1970 Lingüística e historia de la Sociedad Andina. *Anales Científicos de la Universidad Agraria* 8(3–4):231–264.
- TORRES, CONSTANTINO M.  
 2002 Iconografía Tiwanaku en la Parafernalia Inhalatoria de los Andes Centro-Sur. In *Huari y Tiwanaku: Modelos vs. Evidencias, Segunda parte*, edited by Peter Kaulicke and William H. Isbell, pp. 427–454. Boletín de Arqueología PUCP 5(2001), Peter Kaulicke (general editor). Pontificia Universidad Católica del Perú, Lima.
- TORRES, CONSTANTINO M., AND WILLIAM J CONKLIN  
 1995 Exploring the San Pedro de Atacama / Tiwanaku Relationship. In *Andean Art: Visual Expression and Its Relation to Andean Beliefs and Values*, edited by Penelope Z. Dransart, pp. 78–108. Avebury, Aldershot, U. K.
- TOWNSEND, RICHARD F. (EDITOR)  
 1992 *The Ancient Americas: Art From Sacred Landscapes*. The Art Institute of Chicago and Prestel Verlag, Chicago and Munich.
- TSCHOPIK JR., HARRY  
 1951 *The Aymara of Chucuito, Peru. 1. Magic*. Anthropological Papers of the American Museum of Natural History 44(2). American Museum of Natural History, New York.

- ULLOA MOGOLLON, JUAN DE  
1965 [1586] Relación de la provincia de los Collaguas para la descripción de las Indias que su majestad manda hacer. In *Relaciones Geográficas de Indias*, Vol. 1, edited by Marcos Jiménez de la Espada, pp. 326–333. Biblioteca de Autores Españoles: Perú 183. Atlas, Madrid.
- URTON, GARY  
1981 Animals and Astronomy in the Quechua Universe. *Proceedings of the American Philosophical Society* 125(2):110–127.  
1985 Animal Metaphors and the Life Cycle in an Andean Community. In *Animal Myths and Metaphors in South America*, edited by Gary Urton, pp. 251–284. University of Utah Press, Salt Lake City.  
1990 *The History of a Myth: Pacariqtambo and the Origin of the Inkas*. University of Texas Press, Austin.  
1999 *Inca Myths*. University of Texas Press and the British Museum Press, Austin and London.
- VAN DE GUCHTE, MAARTEN  
1999 The Inca Cognition of Landscape: Archaeology, Ethnohistory, and the Aesthetic of Alterity. In *Archaeologies of Landscape: Contemporary Perspectives*, edited by Wendy Ashmore and A. Bernard Knapp, pp. 149–168. Blackwell Publishers, Malden, Mass., and Oxford, U. K.
- VILLANUEVA C., JUAN E.  
2007 Las escudillas del rasgo 1 en la Isla de Pariti: Interpretación y consideraciones desde un enfoque iconográfico. *Chachapuma: Revista de Arqueología Boliviana* 1:53–63.
- VRANICH, ALEXEI N.  
1999 Interpreting the Meaning of Ritual Spaces: The Temple Complex of Pumapunku, Tiwanaku, Bolivia. Dissertation, Department of Anthropology, University of Pennsylvania, Philadelphia.
- 2002 La Pirámide de Akapana. In *Huari y Tiwanaku: Modelos vs. Evidencias, Segunda parte*, edited by Peter Kaulicke and William H. Isbell, pp. 295–308. Boletín de Arqueología PUCP 5(2001), Peter Kaulicke (general editor). Pontificia Universidad Católica del Perú, Lima.
- 2009 The Development of the Ritual Core of Tiwanaku. In *Tiwanaku: Papers from the 2005 Mayer Center Symposium at the Denver Art Museum*, edited by Margaret Young-Sánchez, pp. 11–34. The Frederick and Jan Mayer Center for Pre-Columbian and Spanish Colonial Art at the Denver Museum, Denver.
- WATSON, PATTY JO  
1979 The Idea of Ethnoarchaeology: Notes and Comments. In *Ethnoarchaeology – Implications of Ethnography for Archaeology*, edited by C. Kramer, pp. 277–287. Columbia University Press, New York.
- WEBSTER, ANN D., AND JOHN W. JANUSEK  
2003 Tiwanaku Camelids: Subsistence, Sacrifice, and Social Reproduction. In *Tiwanaku and Its Hinterland: Archaeology and Paleoecology of an Andean Civilization 2: Urban and Rural Archaeology*, edited by Alan L. Kolata, pp. 343–362. Smithsonian Institution Press, Washington, D. C., and London.
- WYLIE, ALISON  
2002 *Thinking From Things: Essays in the Philosophy of Archaeology*. University of California Press, Berkeley, Los Angeles, and London.
- YOUNG-SÁNCHEZ, MARGARET (EDITOR)  
2004 *Tiwanaku: Ancestors of the Inca*. Denver Art Museum and University of Nebraska Press, Lincoln and London.
- ZUIDEMA, R. TOM  
1985 The Lion in the City: Royal Symbols of Transition in Cuzco. In *Animal Myths and Metaphors in South America*, edited by Gary Urton, pp. 183–250. University of Utah Press, Salt Lake City.

# ANCIENT AMERICA ONLINE

## Editors

George Stuart  
Jeffrey C. Splitstoser



## Board of Advisors

Jeffrey Splitstoser, Institute for Andean Studies, University of California, Berkeley  
Joel Skidmore, Precolumbia Mesoweb Press, San Francisco, California  
Vincas Steponaitis, University of North Carolina at Chapel Hill  
David Stuart, University of Texas at Austin  
George Stuart, Boundary End Archaeology Research Center, Barnardsville, North Carolina

*Ancient America* is a peer-reviewed series of original papers on American archaeology and art history, including epigraphy, ethnohistory, ethnology, and linguistics. This series is published online by the **Boundary End Archaeology Research Center** through the website [precolumbia.com/bearc](http://precolumbia.com/bearc) on an irregular schedule for free downloading. Back issues Nos. 2 through 10, as well as special publications of the Center, are available in print form through the same website.

**The Boundary End Archaeology Research Center**, founded in 1985 as the Center for Maya Research, provides coverage of current research in the Americas. The Center is organized and operated exclusively for charitable and educational purposes within the meaning of sections 170(c)2(B), 501(c)(3), 2055(a)(2), and 2522(a)(2) of the Internal Revenue Code of 1954.

(FID NO. 52-1372456)

Please send inquiries to:

**BOUNDARY END ARCHAEOLOGY RESEARCH CENTER**  
**ONE WALKER CREEK ROAD**  
**BARNARDSVILLE, N. C. 28709-0220 • U.S.A.**  
[maya84@mac.com](mailto:maya84@mac.com)

[WWW.PRECOLUMBIA.COM/BEARC](http://WWW.PRECOLUMBIA.COM/BEARC)

ISSN: 1531-2097  
COPYRIGHT © 2012