

Aircraft Design: Synthesis and Analysis



Version 0.99, January 2001

Copyright 1997-2001 by Desktop Aeronautics, Inc.

This is a pre-release development version of a system of programs and textbook material to be released shortly on CD. Send comments to the address shown below.

Note that version 0.99 has been designed to exploit the features of Netscape Navigator 4.0 and Internet Explorer 5.0. Some parts of the program will not function properly on some platforms with earlier versions. We recommend at least Netscape 4.05 or MSIE 4.0

Aircraft Design: Synthesis and Analysis

Contents

0. Preface

0.1 Instructions

0.2 General References

1. Introduction

1.1 Historical Notes

1.1.1 Aerodynamics

History

1.1.2 Boeing History

1.1.3 Airbus History

1.1.4 Invention of the

Airplane

1.2 Aircraft Origins

1.2.1 New Aircraft

Development

1.2.2 The Airline

Industry

1.3 Future Aircraft

1.4 References

2. The Design

Process

2.1 Market Determination

2.2 Design Requirements and Objectives

2.3 Exercise 1: Design Requirements

2.4 Design Optimization

2.5 Computational Methods

3. Fuselage Layout

3.1 Cross Section Design

3.1.1 Exercise 2: Cross Section

3.2 Fuselage Shape

3.2.1 Exercise 3:

Copyright Notice

This textbook is copyright by Desktop Aeronautics, Inc.. Figures and text were either prepared originally for this book or used with permission. In certain cases royalty payments have been arranged. No part of this document may be reproduced in any form without express written permission from:

Desktop Aeronautics
P.O. Box 20384
Stanford, CA 94309
(650) 424-8588 (Phone)
(650) 424-8589 (FAX)
info@desktopaero.com

Please contact Desktop Aeronautics for information on CD and disk-based versions of this work. See the [Desktop Aeronautics Home Page](#) on the World Wide Web.

[Fuselage Layout](#)

3.3 [FARs Related to Fuselage Design](#)

3.3.1 [Seating-Related Items](#)

3.3.2 [Emergency Egress](#)

3.3.3 [Emergency Demonstration](#)

3.4 [Fuselage Design for SSTs](#)

4. [Drag](#)

4.1 [Parasite Drag](#)

4.1.1 [Skin Friction Coefficient](#)

4.1.2 [Form Factor](#)

4.1.3 [Wetted Area](#)

4.1.4 [Control Surface Gap Drag](#)

4.1.5 [Nacelle Base Drag](#)

4.1.6 [Fuselage Upsweep Drag](#)

4.1.7 [Miscellaneous Drag Items](#)

4.2 [Induced Drag](#)

4.3 [Compressibility Drag](#)

4.3.1 [Introduction](#)

4.3.2 [Predicting Mdiv](#)

4.3.3 [3D Effects and Sweep](#)

4.3.4 [Computing CDc](#)

4.3.4.1 [Computational Example](#)

4.4 [Supersonic Drag](#)

4.4.1 [Volume Wave Drag](#)

4.4.2 [Lift-Dependent Wave Drag](#)

4.4.3 [Program for Wave Drag Calculation](#)

4.5 [Wing-Body Drag Polar](#)

5. [Airfoils](#)

5.1 [History and Development](#)

5.2 [Airfoil Geometry](#)

5.3 [Pressure Distributions](#)

[5.4 Cp and Performance](#)
[5.5 Relating Geometry and Cp](#)
[5.5.1 Cp and Curvature](#)
[5.5.2 Interactive Calculations](#)
[5.6 Airfoil Design](#)
[5.7 Typical Design Problems](#)
[5.7.1 Thick Sections](#)
[5.7.2 High Lift Sections](#)
[5.7.3 Laminar Sections](#)
[5.7.4 Transonic Sections](#)
[5.7.5 Low Reynolds Number Sections](#)
[5.7.6 Low Cm Sections](#)
[5.7.7 Multiple Design Points](#)
[5.8 Airfoil Design Program](#)

[6. Wing Design](#)

[6.1 Wing Geometry](#)
[6.1.1 Wing Geometry Drawing](#)
[6.2 Wing Design Parameters](#)
[6.3 Lift Distributions](#)
[6.3.1 About Wing Lift Distributions](#)
[6.3.2 Geometry and Lift Distributions](#)
[6.3.3 Lift Distributions and Performance](#)
[6.4 Wing Design in More Detail](#)
[6.5 Nonplanar Wings and Winglets](#)
[6.6 Wing Layout Issues](#)
[6.7 Wing Analysis Program](#)
[6.8 Supersonic Wings](#)

[7. High-Lift Systems](#)

[7.1 Introduction](#)
[7.2 General Approach](#)
[7.4 Estimating CLmax](#)

- 7.5 [CLmax for SSTs](#)
- 7.6 [Wing-Body CLmax Calculation](#)

8. Stability and Control

- 8.1 [Introduction](#)
- 8.2 [Static Longitudinal Stability](#)
 - 8.2.1 [Stability and Trim Calculation](#)
- 8.3 [Dynamic Stability](#)
- 8.4 [Longitudinal Control](#)
- 8.5 [Lateral Control](#)
- 8.6 [Tail Design and Sizing](#)
- 8.7 [FARs related to Stability](#)
- 8.8 [FARs related to Control](#)

9. Propulsion

- 9.1 [Basic Concepts](#)
- 9.2 [Installation](#)
 - 9.2.1 [Engine Placement](#)
 - 9.2.2 [Nacelle Design](#)
 - 9.2.3 [Supersonic Considerations](#)
- 9.3 [Performance & Engine Data](#)
 - 9.3.1 [Thrust vs. Speed and Altitude](#)
 - 9.3.2 [SFC and Efficiency](#)
 - 9.3.3 [Large Turbofan Data](#)
 - 9.3.4 [Small Turbofans Data](#)
 - 9.3.5 [Engines for SST's](#)
- 9.4 [Engine Model](#)

10. Structure and Weights

- 10.1 [Structural Loads](#)
 - 10.1.1 [Design Airspeeds and Placards](#)
 - 10.1.2 [Placard](#)

Calculation

10.1.3 V-n Diagrams

10.1.4 V-n Diagram

Calculation

10.1.5 FAR Structures

Requirements

10.1.6 FAR Gust Rules

10.2 Structural Design

10.3 Weight Estimation

10.3.1 Component

Weights

10.3.2 Sample Weight

Statements

10.3.3 Total Weights

10.4 Balance

10.5 Weight Calculation

11. Performance

Estimation

11.1 Take-Off Field

Length

11.1.1 Take-Off

Calculation

11.2 Landing Field

Length

1.2.1 Landing

Calculation

11.3 Climb Performance

11.3.1 Climb Calculation

11.4 Cruise Performance

and Range

11.4.1 Range Calculation

11.5 FARs Related to

Aircraft Performance

11.5.1 FARs Related to

Take-Off

11.5.2 FARs Related to

Climb

11.5.3 FARs Related to

Landing

12.Noise

12.1 Introduction

12.2 The Nature of Noise

12.3 Noise Sources

12.4 Noise Reduction

12.5 FAA Regulations

[12.6 Noise Estimation](#)

[12.7 FAA Part 36](#)

[13. Cost](#)

[13.1 DOC and IOC](#)

[13.2 ATA Method](#)

[13.4 Airplane prices](#)

[13.5 Consumer Price](#)

[Index](#)

[14. Optimization and Trade Studies](#)

[14.1 Performance Trade Studies](#)

[14.2 About the Variables...](#)

[14.3 Notes on Optimization](#)

[14.4 Optimization Program](#)

[14.5 Airplane Top View](#)

[14.6 Airplane 3-D View and Summary](#)

[15. Aircraft Subsystems](#)

[16. Appendices](#)

[16.1 Standard Atmosphere](#)

[16.2 Unit Converter](#)

[16.3 Summary of Project Inputs](#)

[16.4 Summary of Results](#)

[16.5 Common Acronyms and Abbreviations](#)

Aircraft Design: Synthesis and Analysis



Version 0.99, January 2001
Copyright 1997-2001 by Desktop Aeronautics, Inc.

This is a pre-release development version of a system of programs and textbook material to be released shortly on CD. Send comments to the address shown below.

Note that version 0.99 has been designed to exploit the features of Netscape Navigator 4.0 and Internet Explorer 5.0. Some parts of the program will not function properly on some platforms with earlier versions. We recommend at least Netscape 4.05 or MSIE 4.0

Copyright Notice

This textbook is copyright by Desktop Aeronautics, Inc.. Figures and text were either prepared originally for this book or used with permission. In certain cases royalty payments have been arranged. No part of this document may be reproduced in any form without express written permission from:

Desktop Aeronautics
P.O. Box 20384
Stanford, CA 94309
(650) 424-8588 (Phone)
(650) 424-8589 (FAX)
info@desktopaero.com

Please contact Desktop Aeronautics for information on CD and disk-based versions of this work. See the [Desktop Aeronautics Home Page on the World Wide Web](#).

Preface

About AA241

This material is based on course notes for the class AA241A and B, a graduate level course in aircraft design at Stanford University. The course involves individual aircraft design projects with problem sets and lectures devoted to various aspects of the design and analysis of a complete aerospace system. Students select a particular type of aircraft to be designed and, in two academic quarters, define the configuration using methods similar to those used in the aircraft industry for preliminary design work. Together with the vehicle definition and analysis, basic principles of applied aerodynamics, structures, controls, and system integration, applicable to many types of aerospace problems are discussed. The objective of the course is to present the fundamental elements of these topics, showing how they are applied in a practical design.

About the Web Version of These Notes

This internet-based version of *Aircraft Design: Synthesis and Analysis* is an experiment. It is the forerunner of a new type of textbook whose pages may be distributed throughout the world and accessible via the world-wide-web. The text will be evolving over the next few months; new items will be added continually.

This may turn out to be a true "Hitchhiker's Guide To Aircraft Design" if people are interested in contributing. You are welcome to send revisions, suggestions, pictures, or complete sections. I will review them and consider including them (with credits) where appropriate. Send submissions (in html, gif, or jpeg form) to [Ilan Kroo](#).

Why a Digital Textbook?

There are several reasons for using this format for the course notes:

- They are easily updated and changed -- important for aircraft design so that new examples and methods can be added.
- Analysis routines can be built into the notes directly. The book permits you to build up a design as you progress through the chapters.
- The format permits easy access to information and organizes it in a way that cannot be done in hardcopy.
- It is inexpensive to include color pictures and video.

- It is possible, by providing just a couple of custom pages, to tailor the textbook for a particular course. If the material on supersonic flow is not appropriate for the class, a new outline and contents page may be created that avoids reference to that material.

About the Authors



Ilan Kroo is a Professor of Aeronautics and Astronautics at Stanford University. He received a degree in Physics from Stanford in 1978, then continued graduate studies in Aeronautics, leading to a Ph.D. degree in 1983. He worked in the Advanced Aerodynamic Concepts Branch at NASA's Ames Research Center then returned to Stanford as a member of the Aero/Astro faculty. Prof. Kroo's research in aerodynamics and aircraft design has focussed on the study of innovative airplane concepts and multidisciplinary optimization. He has participated in the design of high altitude aircraft, human-powered airplanes, America's Cup sailboats, and high-speed research aircraft. He was one of the principal designers of the SWIFT, tailless sailplane design and has worked with the Advanced

Research Projects Agency on high altitude long endurance aircraft. He directs a research group at Stanford consisting of about ten Ph.D. students and teaches aircraft design and applied aerodynamics at the graduate level. In addition to his research and teaching interests, Prof. Kroo is president of Desktop Aeronautics, Inc. and is an advanced-rated hang glider pilot.

Richard Shevell was the original author of several of these chapters. He worked in aerodynamics and design at Douglas Aircraft Company for 30 years, was head of advanced design during the development of the DC-9 and DC-10, and taught at Stanford University after that for 20 years. To a large extent, this is his course.

Copyright Notice

Important: These notes are in development and have not been released for public use. Certain figures and computations are in draft form and should not be used for critical applications.

This textbook is copyright by Desktop Aeronautics, Inc. Figures and text were either prepared originally for this book or used with permission. In certain cases royalty payments have been arranged. No part of this document may be reproduced in any form without express written permission from:

Desktop Aeronautics
P.O. Box A-L
Stanford, CA 94309

(415) 424-8588 (Phone)

(415) 424-8589 (FAX)

info@desktopaero.com

Please contact Desktop Aeronautics for information on CD versions of this work. See the [Desktop Aeronautics](#) Home Page on the World Wide Web.

Instructions

This version of Aircraft Design: Synthesis and Analysis is intended for use with Netscape Navigator, version 4.0 or later, or with Microsoft's Internet Explorer, version 4.0 or later. The text makes use of frames, javascript, and Java, so be sure your browser supports this and that these features are enabled. Please see the help available from Netscape or Microsoft for using the browser software.

Navigating

To navigate through this text, click on the topic shown in the frame to the right. The browser remembers where you have been, and sections that you have already visited are displayed in another color. To reset the history information so that all section names are displayed in the default color, follow the browser instructions on clearing the history or disk cache.

We have minimized the use of embedded hypertext links as we have found this often confuses students trying to navigate through a textbook. It also makes it difficult to expand or delete sections to form a custom version of the text (see below). This means that most of the navigation is done through the table of contents. A rather complete table of contents can also be found in the prefatory information and active links on this page will also work. Some hypertext links are used, but most are restricted to single level pages with additional detail, as might be found in an extended footnote.

Printing

Most pages in the text can be printed directly from the browser. Make sure to specify color or greyscale printing for improved photo images. The chapter and section numbers are generated by javascript on the fly, and some browsers will omit the numbers from the printed heading name. Also, at the time of this release, no platform-independent printing strategy is available for java applets. To print the results from one of the interactive computations, you may need to capture the screen image and send it to the printer. This can be done on most platforms, but the approach depends on the operating system.

Frames

If you are confused by navigating with frames, please read the material available from the Netscape or Microsoft sites and be patient. Many people do not like frame-based pages, but after years of experimentation, we have found that this really does seem to work best for this text. Let us know if you have other ideas.

You may resize the frames to make more or less of the table of contents visible. The best size depends on

the size of your monitor and your personal preferences -- experiment. Also, because you may want to make as much of the content visible in the available screen space, we recommend that you hide some of the toolbar or directory areas at the top of the screen. You can do this from the browser preferences or options menus.

Trouble-Shooting

If you have other difficulties, please check the [Desktop Aeronautics](http://www.desktopaero.com) web site:

<http://www.desktopaero.com> for further suggestions and any fixes that may be posted.

General References

Kuchemann, J., *Aerodynamic Design of Aircraft*, Pergammon Press, 1982.

Shevell, R.S., *Fundamentals of Flight*, Prentice Hall, 1983.

Schlichting H. and Truckenbrodt E., *Aerodynamics of the Airplane*, McGraw-Hill, 1979.

Torenbeek, E., *Synthesis of Subsonic Airplane Design*, Delft Univ. Press, 1982.

Taylor, J., ed., *Jane's All the World's Aircraft*, Jane's Publishing Inc., Annual.

Articles in *Aviation Week & Space Technology*, McGraw-Hill.

Raymer, D., *Aircraft Design-A Conceptual Approach*, AIAA, 1992.

Roskam, J., *Aircraft Design*, Published by the author as an 8 volume set, 1985-1990.

Nicolai, L.M., *Fundamentals of Aircraft Design*, METS, Inc., 6520 Kingsland Court, San Jose, CA, 95120, 1975.

Stinton D., *The Design of the Airplane*, van Nostrand Reinhold, New York, 1983.

Thurston D., *Design for Flying*, Second Edition, Tab Books, 1995.

[Aircraft Design Information Sources](#) by W.H. Mason at VPI is an excellent annotated bibliography on many aspects of aircraft design and is available on the web.

Introduction



This chapter includes a discussion of the history of aircraft development, some notes on aircraft origins (how a new aircraft comes to be developed), a few ideas on future aircraft types and technology, and a number of references and links to related sites.

- [Historical Notes](#)
- [Aircraft Origins](#)
- [Future Aircraft](#)
- [References](#)

History of Transport Aircraft and Technology

There are numerous interesting books on the history of aircraft development. This section contains a few additional notes relating especially to the history of aircraft aerodynamics along with links to several excellent web sites. Among the conventional references of interest are the history section in Shevell's Fundamentals of Flight and John Anderson's book on the history of aerodynamics (see [References](#)).

Here are some additional links with aeronautical history.

- [Some historical notes on the history of aircraft and aerodynamics.](#)
- [Boeing History](#)
- [Airbus History](#)
- [Milestones in the History of Flight \(Air and Space Museum\)](#)
- [Invention of the Airplane](#)
- [The Octave Chanute Pages](#)
- [AIAA 1903 Wright Flyer Project](#)
- [The Wright Brothers](#)

References

History

General History:

Anderson, J., *A History of Aerodynamics: And Its Impact on Flying Machines*, Cambridge Univ Press, 1997.

Dalton, S., *The Miracle of Flight*, McGraw-Hill, 1980.

Kuchemann, D., *Aerodynamic Design of Aircraft, A Detailed Introduction to the Current Aerodynamic Knowledge*, 1978.

Shevell, R., *Fundamentals of Flight*, Prentice Hall, 1983.

Taylor, J., Munson, K. eds., *History of Aviation*, Crown Publishers, 1978.

Early Development:

Chanute, O., *Progress in Flying Machines*, The American Engineer and Railroad Journal, N.Y., 1894. Now available as a Dover paperback.

Lilienthal, O., *Birdflight as the Basis of Aviation*, first published in German 1889, translation published by Longmans, Green, & Co., London 1911.

Proceedings of the International Conference on Aerial Navigation, Chicago, The American Engineer and Railroad Journal, N.Y., 1893.

Aircraft Origins

Newhouse, J., *The Sporty Game*, Wiley, 1984.

Sabbagh, K., *21st-Century Jet : The Making and Marketing of the Boeing 777*, Scribner, 1996.

Irving, C., *Wide-Body: The Triumph of the 747*, William Morrow and Company, Inc., N.Y., 1993.

Related Web Sites

[British Airways overview of the airline industry](#)

Historical Notes

It was not long ago that people could only dream of being able to fly.

The dream was the subject of great myths and stories such as that of Icarus and his father Daedalus and their escape from King Minos' prison on Crete. Legend has it that they had difficulty with structural materials rather than aerodynamics.

A few giant leaps were made, with little forward progress. Legends of people attempting flight are numerous, and it appears that people have been experimenting with aerodynamics for thousands of years. Octave Chanute, quoting from an 1880's book, *La Navigation Aeriene*, describes how *Simon the Magician* in about 67 A.D. undertook to rise toward heaven like a bird. "The people assembled to view so extraordinary a phenomenon and Simon rose into the air through the assistance of the demons in the presence of an enormous crowd. But that St. Peter, having offered up a prayer, the action of the demons ceased..."



(Picture from a woodcut of 1493.)

In medieval times further work in applied aerodynamics and flight were made. Some rather notable people climbed to the top of convenient places with intent to commit aviation.

Natural selection and survival of the fittest worked very effectively in preventing the evolution of human flight.



As people started to look before leaping, several theories of flight were propounded (e.g. Newton) and arguments were made on the impossibility of flight. This was not a research topic taken seriously until the very late 1800's. And it was regarded as an important paradox that birds could so easily accomplish this feat that eluded people's understanding. Octave Chanute, in 1891 wrote, "Science has been awaiting the great physicist, who, like Galileo or Newton, should bring order out of chaos in aerodynamics, and reduce its many anomalies to the rule of harmonious law."



(A Galapagos hawk -- Photo by Sharon Stanaway)

Papers suggested that perhaps birds and insects used some "vital force" which enabled them to fly and which could not be duplicated by an inanimate object. Technical meetings were held in the 1890's. The ability of birds to glide without noticeable motion of the wings and with little or negative altitude loss was a mystery for some time. The theory of aspiration was developed; birds were in some way able to convert the energy in small scale turbulence into useful work. Later this theory fell out of favor and the birds' ability attributed more to proficient seeking of updrafts. (Recently, however, there has been some discussion about whether birds are in fact able to make some use of energy in small scale air motion.)

The figure here is reproduced from the 1893 book, First International Conference on Aerial Navigation. The paper is called, "The Mechanics of Flight and Aspiration," by A.M. Wellington. The figure shows the flight path of a bird climbing without flapping its wings. Today we know that the bird is circling in rising current of warm air (a thermal).

Designs were made before people had the vaguest idea about how aircraft flew. Leonardo Di Vinci designed ornithopters in the late 1400's, modeled on his observations of birds. But apart from his work, most designs were pure fantasy.

The first successes came with gliders. Sir George Cayley wrote a book entitled "On Aerial Navigation" in 1809. He made the first successful glider in 1804 and a full-size version five years later at the age of 36. For many years thereafter, though, aeronautics was not taken seriously, except by a small group of zealots. One of these was William Henson who patented the Aerial Steam Carriage, shown here, in 1842. The aircraft was never built, but was very well publicized (with the idea of raising venture capital). Both the design and the funding scheme were ahead of their time.

Some rather ambitious designs were actually built. The enormous aeroplane built in 1894 by Sir Hiram Maxim and shown below, weighed 7,000 lbs (3,200 kg) and spanned over 100 ft (30 m).

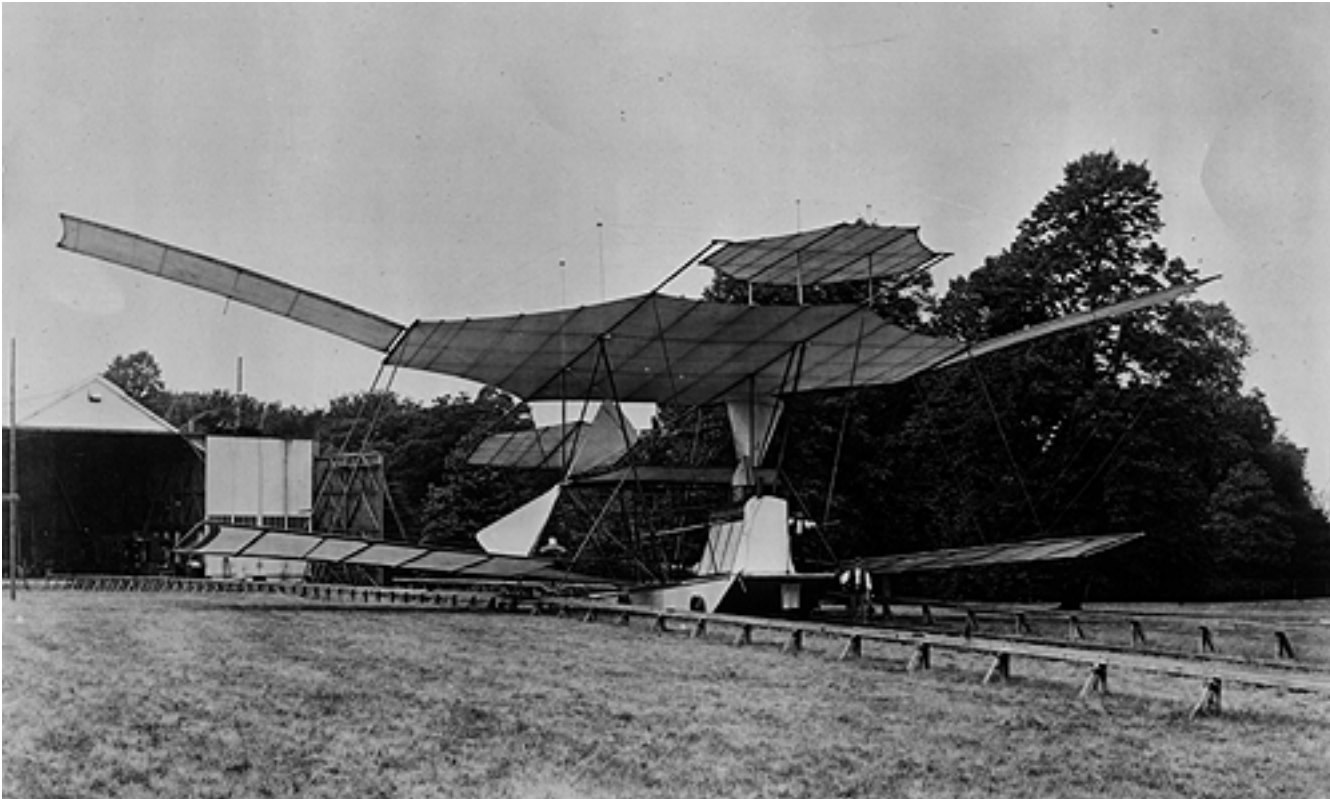

In Germany in the 1860's Otto Lilienthal took a more conscientious approach with tests on a whirling arm, ornithopter tests suspended from a barn, and finally flight tests of a glider design. He studied the effect of airfoil shape, control surfaces, propulsion systems, and made detailed measurements of bird flight. His book, ["Birdflight as the Basis of Aviation"](#) was an important influence on later pioneers.



This was one of Lilienthal's last flights. He was killed in 1896 by a gust-induced stall too near the ground.

From Lilienthal's first flights in the 1890's, to the Wright brother's glider flights and powered aircraft, evolution was quick.



Orville Wright soars a glider in 50 mi/hr (80 km/hr) winds for 10 minutes at Kitty Hawk, Oct. 24, 1911. This was one of the first applications of a aft horizontal tail on the Wright aircraft. From Aero Club of America Bulletin, Jan. 1912.

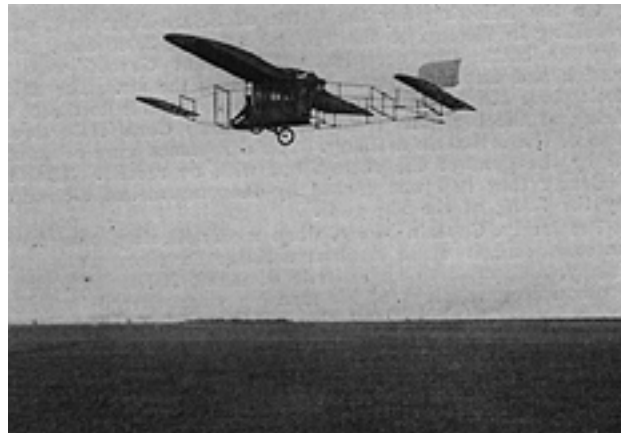

The first 'Aerial Limousine', 1911. "The limousine has doors with mica windows and seats for four persons fitted with pneumatic cushions, the pilot seats in front. A number of flights have been made, with and without passengers, with entire success."



The Boeing 777, Courtesy Boeing Commercial Airplane Group.

It is truly amazing how quickly this has happened: we tend to think of the dawn of flight as something from Greek mythology, but it has been only about 100 years since people first flew airplanes.

Of course other things happen quickly too. When the 747 was designed calculators were big whirring contraptions which sat on desks and could not do square roots. The earlier transports, still flying today, were designed when calculators were women who worked the computing machines.

The picture below shows the computational grid for a modern calculation of the flow over 737 wing with flaps and slats deployed.

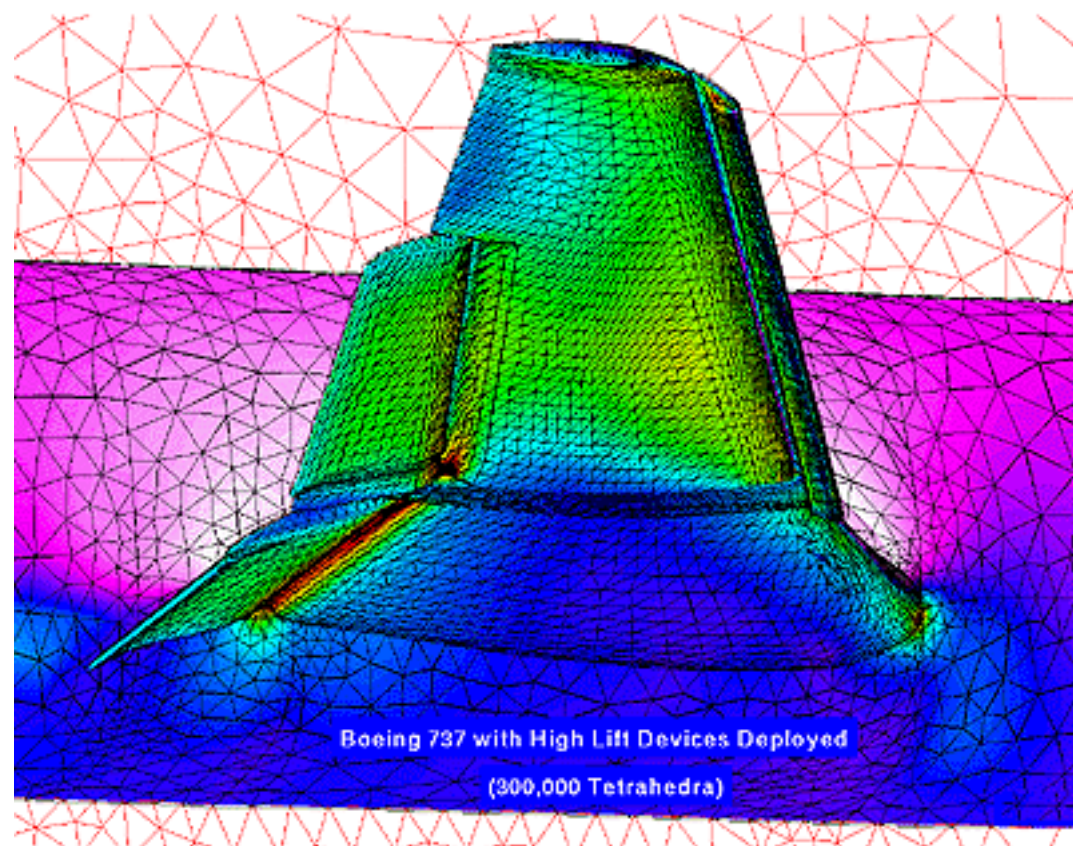

Image from NASA Ames Research Center

The revolution in computing has changed the way we do computational applied aerodynamics, but we still utilize a variety of methods. Computation, ground-based testing, and finally, flight tests.

The plot shows the computer power required to perform the indicated calculations in about 15 minutes using 1985 algorithms. Using more modern [supercomputers](#) and now, parallel machines, this time is dropping dramatically. Yet, we are still a long way from routine applications of direct Navier-Stokes simulations or LES.



The Cray C916 Supercomputer

Projects such as NASA's [Numerical Aerodynamic Simulation](#) program continue to develop simulation software that takes advantage of recent advances in computer hardware and software.

In this class we will talk about the methods used to compute aerodynamics flows. We will use simple methods on personal computers and design airfoil sections. We will analyze wings and talk about the elements of wing design. We will be talking about fundamental concepts that can be demonstrated with simple programs but which form the basis for modern computational methods. We will discuss how these methods work, what they can and cannot do. We will use results from analytical studies, wind tunnel tests, and CFD to discuss wing and airplane design.

While we discuss aircraft a great deal, the concepts and methods are relevant to a wide range of applications: Weather prediction, boat design, disk drive aerodynamics, architectural applications, and land-based vehicles.

The aerodynamics of bumble bees, disk heads, weather, and many other things is not a solved problem. While it is impressive that the methods in use today do so well, we are still not able to predict many flows.

Early Attempts

There are records of people doing this as far back as the eleventh century: Oliver of Malmesbury, an English Benedictine monk studied mathematics and astrology, earning the reputation of a wizard. He apparently build some wings, modeled after those of Deadalus. An 1850's history of Balloons by Bescherelle describes the legend of his experiments. "Having fastened them to his hands, he sprang from the top of a tower against the wind. He succeeded in sailing a distance of 125 paces; but either through the impetuosity or whirling of the wind, or through nervousness resulting from his audacious enterprise, he fell to the earth and broke his legs. Henceforth he dragged a miserable, languishing existance, attributing his misfortune to his having failed to attach a tail to his feet."



In 1178, a 'Saracen' of Constantinople undertook to sail into the air from the top of the tower of the Hippodrome in the presence of the Emperor, Manuel Comnenus. The attempt is described in a history of Constantinople by Cousin, and recounted in several 19th century books on Aerial Navigation. "He stood upright, clothed in a white robe, very long and very wide, whose folds, stiffened by willow wands, were to serve as sails to receive the wind. All the spectators kept their eyes intently fixed upon him, and many cried, 'Fly, fly, O Saracen! Do not keep us so long in suspense while thou art weighing the wind!' The Emperor, who was present, then attempted to dissuade him from this vain and dangerous enterprise. The Sultan of Turkey in Asia, who was then on a visit to Constantinople, and who was also present at this experiment, halted between dread and hope, wishing on the one hand for the Saracen's success, and apprehending on the other that he should shamefully perish. The Saracen kept extending his arms to catch the wind. At last, when he deemed it favorable, he rose into the air like a bird; but his flight was as unfortunate as that of Icarus, for the weight of his body having more power to draw him downward than his artificial wings had to sustain him, he fell and broke his bones, and such was his misfortune that instead of sympathy there was only merriment over his misadventure."

In the late fourteenth century there are reports of partial success by an Italian mathematician Giovanni Dante. He is said to have successfully sailed over a lake, but then attempted to repeat the trick in honor of a wedding. "Starting from the highest tower in the city of Perugia, he sailed across the public square and balanced himself for a long time in the air. Unfortunately, the iron forging which managed his left wing suddenly broke, so that he fell upon the Notre Dame Church and had one leg broken. Upon his recovery he went to teach mathematics at Venice." According to Stephen Dalton, in *The Miracle of Flight*, "Four years later, John Damian, Abbot of Tunland and physician of the Scottish court of King James IV, attempted to fly with wings from the battlements of Stirling Castle." He is also not credited with being the first to fly.

Birdflight as the Basis of Aviation

Lilienthal's book is full of interesting comments such as this one from the introduction:

"With each advent of spring, when the air is alive with innumerable happy creatures; when the storks on their arrival at their old northern resorts fold up the imposing flying apparatus which has carried them thousands of miles, lay back their heads and announce their arrival by joyously rattling their beaks; when the swallows have made their entry and hurry through our streets and pass our windows in sailing flight; when the lark appears as a dot in the ether and manifests its joy of existence by its song; then a certain desire takes possession of man. He longs to soar upward and to glide, free as the bird, over smiling fields, leafy woods and mirror-like lakes, and so enjoy the varying landscape as fully as only a bird can do."



In addition to his romantic view of aeronautics, Otto Lilienthal was a careful observer of nature, an innovative scientist, practical engineer, and determined experimenter. His observations of bird twist and camber distributions, instrumented experiments to compute lift and drag, and flight tests of many glider configurations helped to transform aerodynamics into a serious field of inquiry at the end of the 19th century.

Origins of Commercial Aircraft

Aircraft come into being for a number of reasons. New aircraft may be introduced because of new technology or new requirements, or just to replace their aging predecessors. Commercial aircraft programs are driven by demand and air travel is booming (over 2 trillion revenue passenger miles (RPMs) by the year 2000 and 5-6% forecasted growth).

TOTAL WORLD PASSENGER TRAFFIC

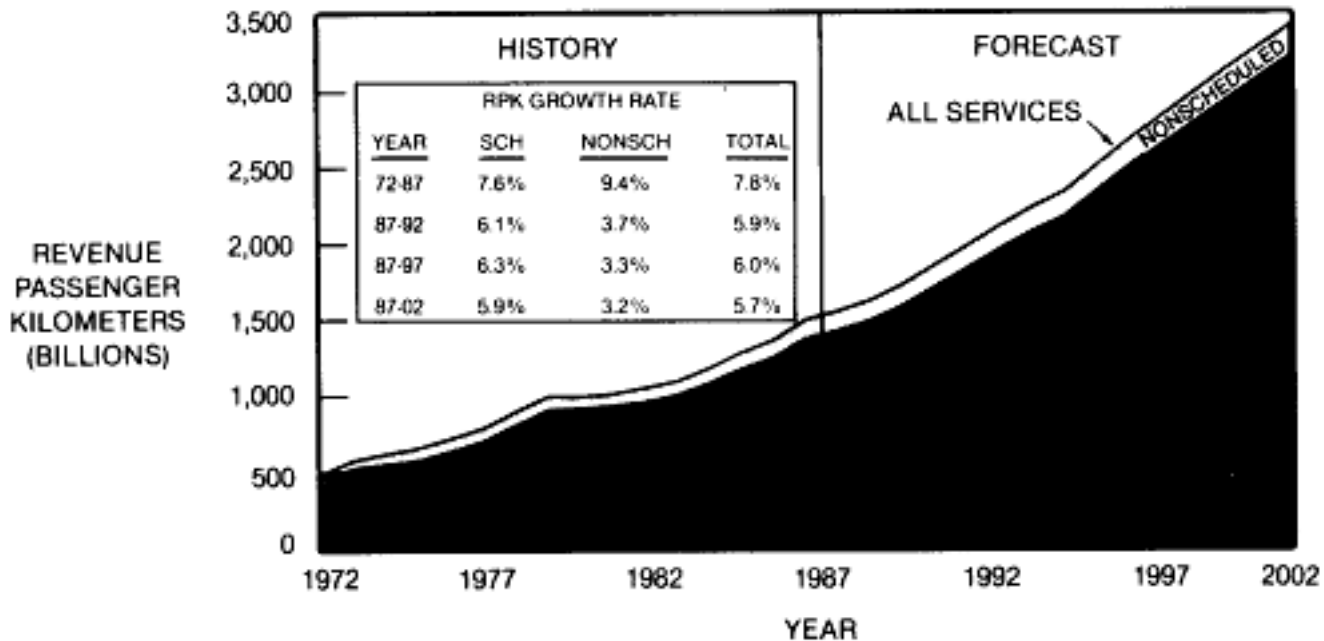

The market for new aircraft is the difference between the required and available RPMs, and as can be seen from the curve below, current in service aircraft and aircraft on order do not come close to filling the projected demand. It has been projected that 6000 new commercial aircraft will be required between 1988 and 2002, representing a market of about \$300 billion.

PASSENGER AIRCRAFT CAPACITY SUPPLY FORECAST

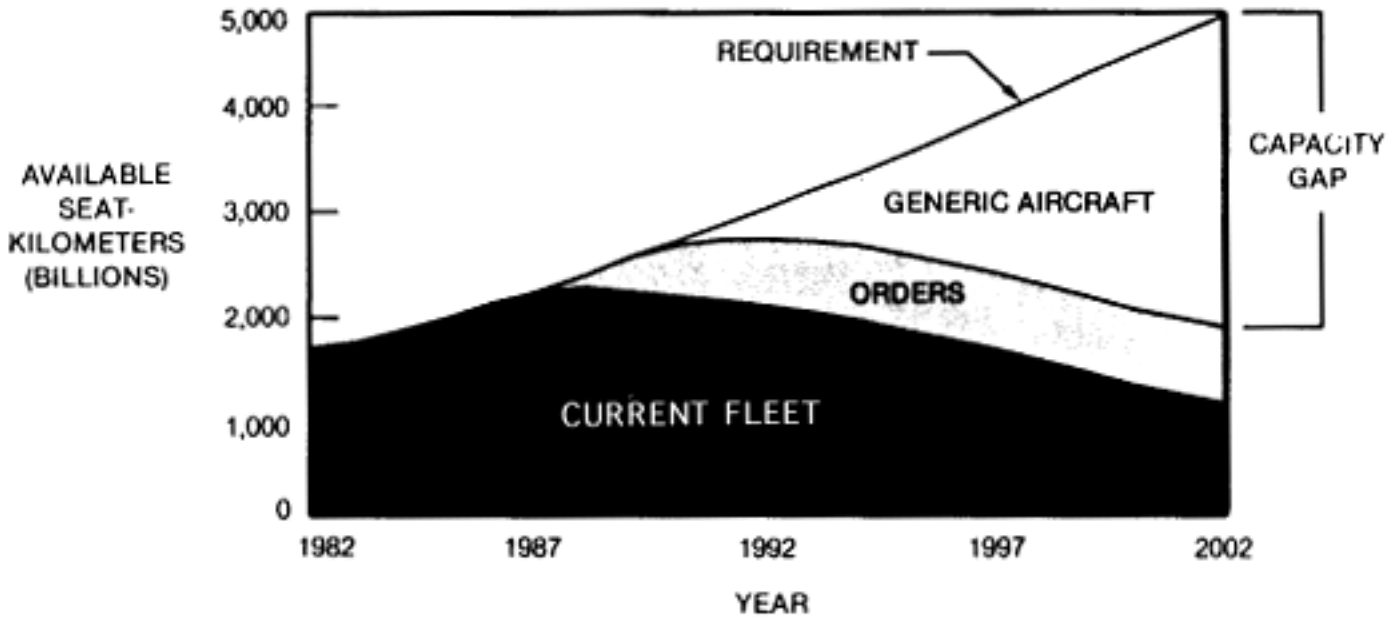

In fact, for many years, commercial aircraft have represented one of the few areas in which the United States has achieved a favorable trade balance.

U.S. Manufacturer's Trade Balances (1985)

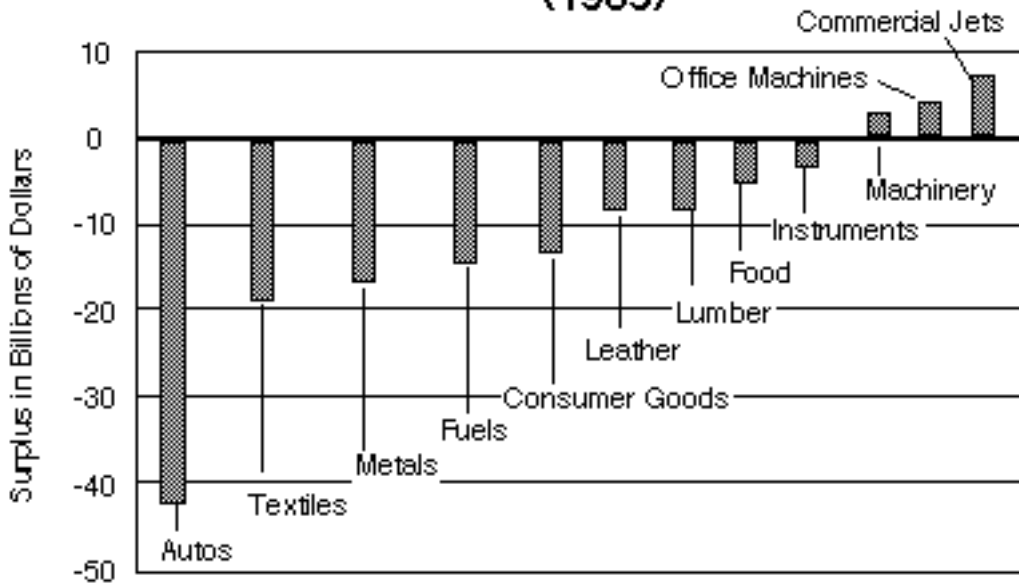

Why doesn't everyone go out and start an airplane company? It seems that there are enormous amounts of money to be made. History has shown that this is not so easy. In fact the saying goes, "If you want to make a small fortune, start with a large fortune and invest in aviation."

Airplanes are very expensive, risky projects. The plot below shows the cumulative gain or loss in an airplane project during its life. This curve is sometimes called the "you bet your company" curve, for

obvious reasons. The plot was drawn in 1985 and the scale has changed. It was recently (1995) estimated that a new large airplane project at Boeing would take 20 billion dollars to develop.

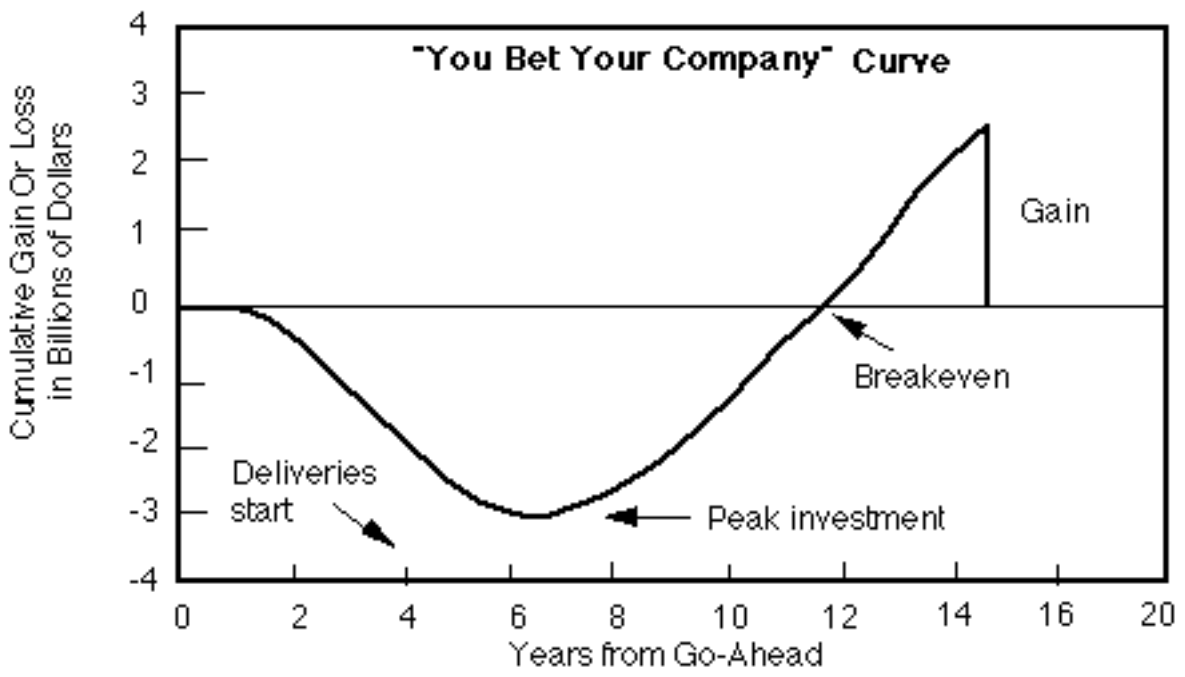

Thus, commercial airplane programs are risky propositions and companies are not likely to assume even more risk on projects that rely on unproven technology. This is one reason that innovative concepts are not likely to be tried out on the next generation commercial airliner and why aircraft such as the A340 look so much like their ancestors, such as the Boeing 707.

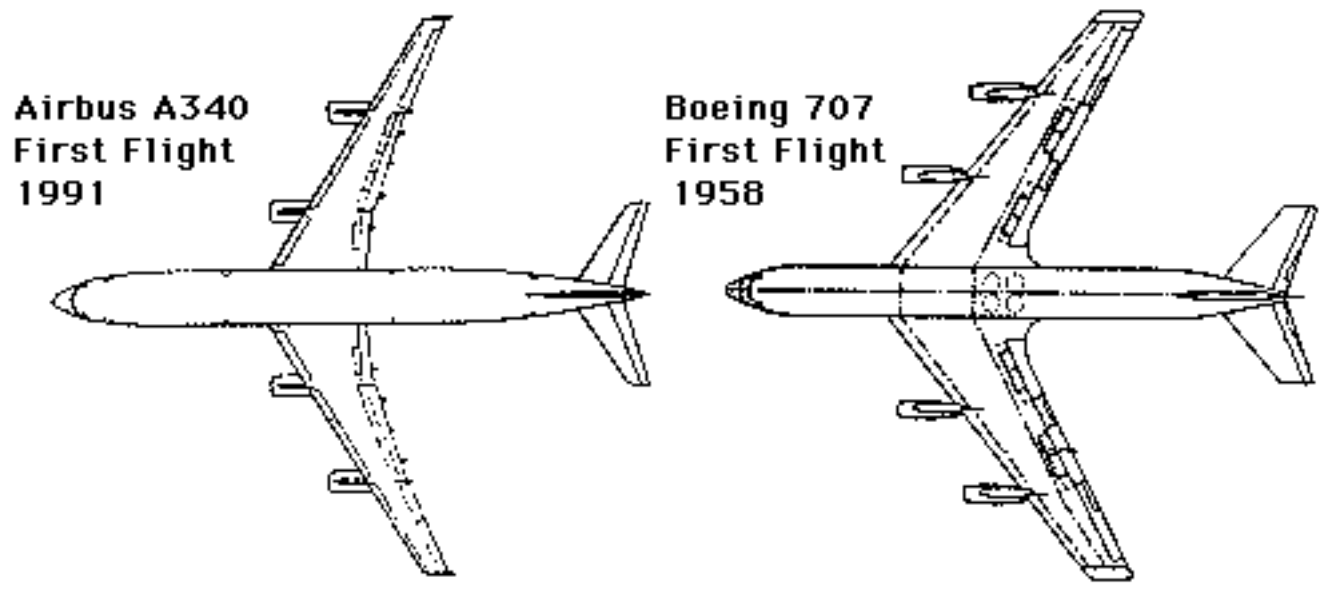

One approach to minimize the risk involved in new aircraft development is to base the design as much as possible on an older design. Thus the DC-9-10, a 77,000 lb, 80 passenger airplane grew into a DC-9-20, then the -30, -40, -50, -80 then on to the MD-80 and MD-90 series. The MD-90 weighs as much as 172,000 lbs and can carry 150 passengers. This design was then shrunk to make a more contemporary version of the DC-9-30, called the MD95 and later renamed the Boeing 717 following the merger of McDonnell-Douglas and Boeing in 1997.

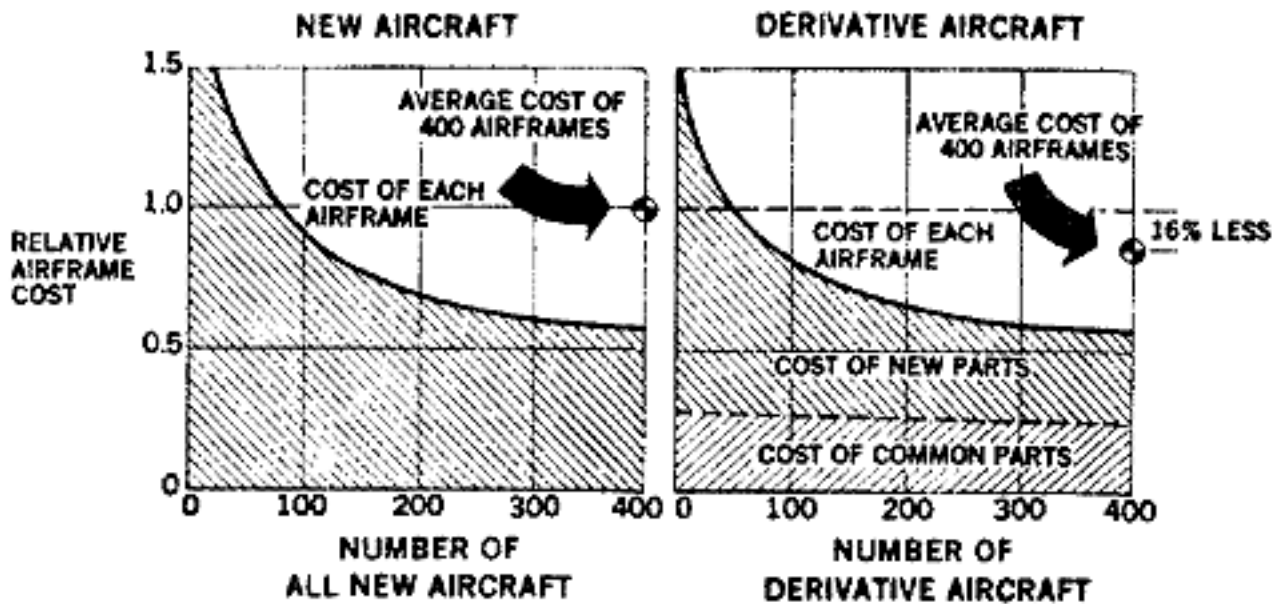

NOTES: DERIVATIVE AIRFRAME IS 40% COMMON.
PROGRAM FOLLOWS 250 BASIC AIRFRAMES.

DERIVATIVE AIRFRAME COST SAVINGS

Another approach might be to start small...but even for small airplanes there are difficulties. Along with the investment risk, there is a liability risk which is of especially great concern to U.S. manufacturers of small aircraft. It is often cited as one of the primary reasons for the dramatic decline in new single engine aircraft in this country.

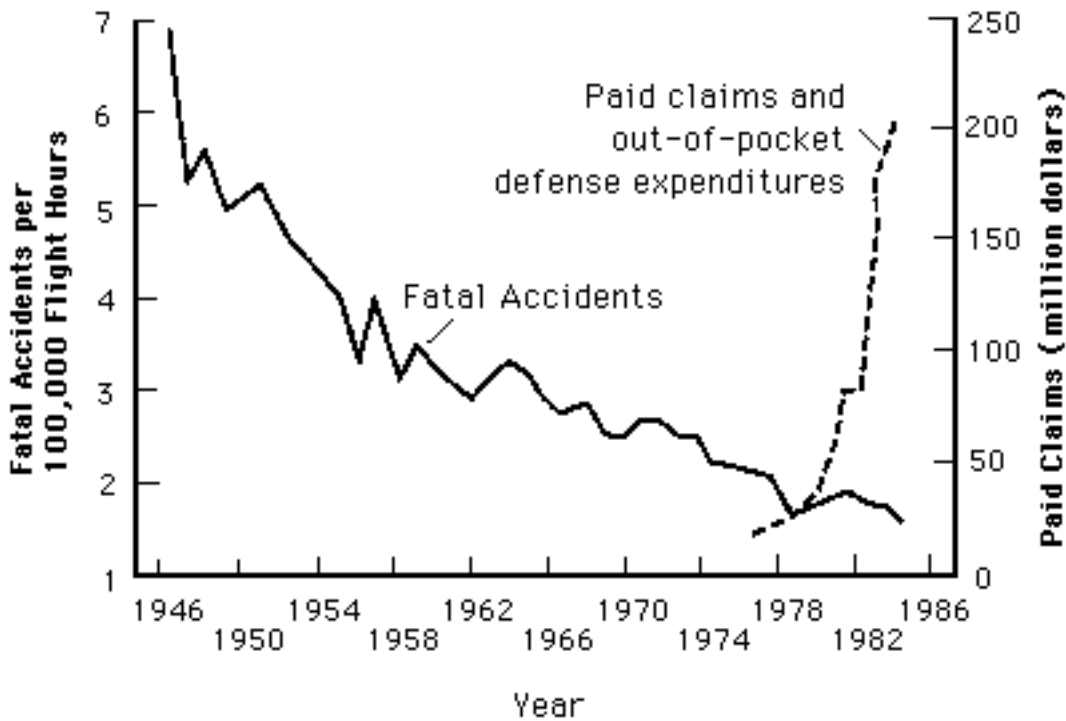

So the development of a new airplane is still a Sporty Game, as detailed in John Newhouse's book by that name.

Why is a new airplane project undertaken?

Generally to make money. But it is much more complicated than just having a better product as the [discussion of new aircraft development](#), by Richard Shevell, suggests.

The reason that *new* airplane projects begin is:

1. New technology or new processes become available that provide the aircraft company with a competitive advantage.
2. New roles and missions are identified that can be addressed much more effectively with an airplane designed for that application.

This is true for military and recreational aircraft as well as commercial aircraft.

New Aircraft Development: Reflections and Historical Examples

by Richard Shevell

What makes any group of people decide that they're going to build a new airplane? In the capitalistic world, the basic motivation is always profit. After all, the thing that makes an aircraft company exist is the desire of the stockholders to make money. If the aircraft company continually fails to make a profit, the stock goes down, and eventually the company may become bankrupt. In many countries, aircraft companies are all or partially government-owned. Sometimes a project is promoted for national prestige or as a make-work program to employ a skilled work force. Even then, however, it is usually necessary that a reasonable chance to make a profit be demonstrated.

In recent years, aircraft projects have been initiated, even in so-called capitalistic countries, without a strong likelihood of profit. In some cases there may be a potential economic justification in long term future, but private capital does not exist to exploit it. In other cases the economics of the project are doubtful, or hopeless, but other national needs are judged to justify government financial support.

The Concorde program is a good example. Probably the British and the French Governments have voluminous studies that show how much money the companies building the Concorde will eventually make and prove that the participating Governments will eventually get all their money back. Once these reports are in hand, the governments can proceed to subsidize the program whether it ever happens or not. In the United States, we have seen the same thing with the Supersonic Transport in which the capital requirements are so great that no aircraft company or consortium of companies can begin to handle them. The Douglas Aircraft Company dropped out the SST competition in 1963. At that time, a study showed that if Douglas could borrow all the money required to build the SST at 6% interest and had an agreement with the lender that if the project did not succeed, none of the money had to be paid back, even then Douglas Aircraft Co. could not have afforded to go into the program. The interest charges alone on the investment over the ten-year cycle of development were more than the net worth of the Company. In this case the doubtful economics and changing national priorities finally terminated the program.

An aircraft company is also motivated by the need to keep its facilities busy. One of the major problems in the aircraft industry has been the extremely cyclic nature of the aircraft production rate. This is brought about by the fact that when an airline decides to buy new-type airplanes, it usually doesn't want them delivered at a slow rate. The airline decides, for example, that it's going to outrun its competitors and it wants enough of those airplanes to put at least a couple of lead flights on each important route. Then there's another reason; once the airline pays for all the maintenance equipment, space parts, loading equipment, and for the training of crews to fly and maintain the airplane, it is not desirable to be flying only a few of them. There is a sort of critical mass of aircraft that makes any sense for a big airline. Training people at Los Angeles, New York and three intermediate places to service, maintain and load an

airplane that only comes through once a day is a terribly inefficient thing.

A special case, of course, is the small country with a small airline that can afford only a couple of airplanes. In such case, the airline cannot really afford even these but because of national prestige, they feel they cannot afford not to buy the airplanes. Furthermore, in recent years, the small airlines have developed a very sensible approach to this problem. Very often, an airline in Europe, Africa, or Asia that has 1 to 2 707's will contract with an airline like TWA or United Air Lines to do some of their maintenance. For example United Air Lines does the major maintenance for many small airlines at its San Francisco overhaul base. Then the smaller airline does not have to make a huge investment in equipment and United Airlines gains from spreading the overhead cost of its expensive facility.

In general, the airlines buy airplanes in big blocks. When an airline buys a sizable number of airplanes much larger than their previous type, both their load factors and their capital funds are abruptly reduced and they cannot consider buying more airplanes for a while. So, there's always a lull in demand and this has happened again and again and again. When the DC-6 came out in 1946, American bought 25 and United bought 25. By 1948, the Douglas plant was practically empty. Douglas had saturated the market. By 1951, DC-6's and DC-7's could not be built fast enough. In 1958-59, Boeing and Douglas introduced the jet transport. By 1961 again, the airlines were in financial trouble and 707 and DC-8 production was down to a trickle. The increase from 130 or 140 seats in standard 707's and DC-8's or 200 seats in a stretched DC-8, to 360 seats in the 747 was an enormous jump and that, together with the serious business recession in 1970-71, led to lack of repeat orders for the 747. Later the 747 order rate rose to a very satisfactory level.

The merger of the Douglas Aircraft Co. with McDonnell Aircraft was forced by this cyclic problem. In 1961-62 Douglas was building one DC-8 a month. That was the total production of transports at Long Beach. The employment was reduced to under 10,000. Then came the sudden big build up in worldwide air traffic, plus the fact that Douglas came out with the DC-9 which started selling beyond anyone's dreams. Furthermore, after several years of effort by the engineering department to convince management to improve the DC-8, the management finally decides that this was the time to develop the DC-8 series 60 and the orders poured in for that. And in two years the Douglas Company tried to go from 10,000 to 40,000 people. It was also a time of a tight labor market when few people were looking for work in the aircraft industry. So, the DC-9's and DC-8's were being built by carpenters, hairdressers, barbers and people with all sorts of skills, none of which had anything to do with building airplanes. And the man hours required to build the airplanes literally tripled. Now, if Douglas had been able to keep its facilities busy in 1961 and not let employment drop so low, it would have had sufficient experienced people to provide a base for expansion.

This cyclic problem goes on all through the history of the aircraft business. The intelligent aircraft management (and I think now that probably all the companies are well aware that this is essential) does everything it can to level the work load. It tries to discourage the airlines from requesting excessively fast deliveries - in an effort to spread the deliveries over a longer period. Each company tries to initiate a new project in the engineering phase so that about the time the workload on an old project is plummeting, a build-up starts on the new one, thereby leveling out the peaks and the valleys. On the other hand, one cannot just say you need a product and therefore decide to build something which has no market. Of

course that may level out your peaks and valleys so you no longer have the oscillations. In fact, you may find that your production rate has been permanently leveled out at zero because there is no company. A company never goes into a new project unless it thinks it can make a profit. Experience shows that if you are ever going to break even, you had better think that you're going to make a profit.

Now, what are the requirements for a profit? The prime requirement for a profit is a large enough market. The number of factors involved in a market are very great.

First, there is the basic travel growth pattern which will be discussed in more detail later. There's the capacity of the projected-airplane. If you build the wrong size, just after you have spent several hundred million dollars in development, somebody else will come and build the right size and you'll have to take your airplanes and sell them off as unique lunchrooms. History has a few of those. There was large engine airplane built in the twenties called the Fokker F-32. It was a four engine airplane with a nacelle under each wing with each nacelle having both a tractor propeller in front and a pusher in back. And it was magnificent to behold. But it was much too big for the traffic. And within a couple of years the F-32's literally were being used for lunchrooms. It was the wrong size.

Then you have to have passenger demand for your airplane. The airlines will often emphasize that aircraft economy data alone may be meaningless. Suppose an airplane is produced with a ten percent lower cost per seat mile. The airlines may say "that's just great, but what does it mean if the people don't come into our gate?" A new airplane must have all the features desired by the public and you have to know and anticipate what those features are. As an example, in history, the Boeing 247 had many of the technical advances of the DC-3. It was built only a year or two ahead of the DC-3. Most of you have never heard of a Boeing 247 because it was too small and after Boeing built something like 65 of them it disappeared from production. It was a fine looking airplane and it still is today. But it was a ten passenger airplane. The DC-3 came along with 21 seats, a floor to ceiling height permitting people to walk down the aisle without bending over, a more spacious feeling in the cabin, and a higher cruise speed. And all of a sudden, nobody ever bought another Boeing 247. The DC-3 took over the world. So, you have to have passenger demand for your airplane. It should be mentioned that the DC-3 also benefited from significant technological advances such as gull engine cowls, wing flaps, more powerful engines and structural efficiency improvements.

First among the items that contribute to passenger appeal is speed. The whole function of air travel is to go fast and the airplane second best in speed, if it is second by a significant amount, has little chance of economic survival. The next important factor is comfort. Comfort is affected by a great many items, such as seat width, seating arrangement such as the triple seat versus the double seat, leg room, interior noise, vibration, good beverage facilities, entertainment systems, and storage for brief cases and coats. Another important comfort factor is ride roughness which depends on wing loading, cruise altitude and wing sweep. Baggage retrieval is a very important factor. Design of the airplane cargo holds, containerization and associated ground systems for rapid transportation of baggage to the pick-up area all vital to this phase of an airline trip. A delay of 15 minutes in baggage retrieval can produce a substantial reduction in effective overall speed, about 10% or 40 knots on a 1000 mile flight. All of these things could make a passenger prefer one airplane to another. Usually all airplanes of a given generation are about equal in order to remain competitive, unless a slightly later design is able to introduce and innovation which the

earlier airplane cannot duplicate because of the cost of changing tooling.

An overriding requirement in all airplanes is safety. I purposely did not list safety first because it is so self-evident. If one has some new invention that increases speed or reduces cost but not compromises safety, it cannot even be considered. The extensive government safety requirements must be satisfied. The requirements cover all safety-related phases of flight including strength, fatigue, stability and control, emergency performance, and emergency design such as fire resistance and control, and evacuation. Thus we have uniformly high standards of safety both because the companies in the commercial business are really ethical on this point and also Big Brother is constantly watching over their shoulders to eliminate any concern about ever being tempted from the straight and narrow path.

The next important characteristic is range. In order to get the market, the airplane has to be designed to cover the distances required by the passengers and the airplanes at that time. If the market is growing a great deal internationally, a new airplane tailored to the transcontinental routes with poor ability to do the international job, will face a severely reduced market. If market studies show a sufficient need for aircraft of a shorter range, then you may design for the 700 to 1000 mile range successfully, e.g. the DC-9 and the 737. Companies look for niches that can be filled in the spectrum of airplane range and payload.

BOEING NEW AIRPLANE FAMILY

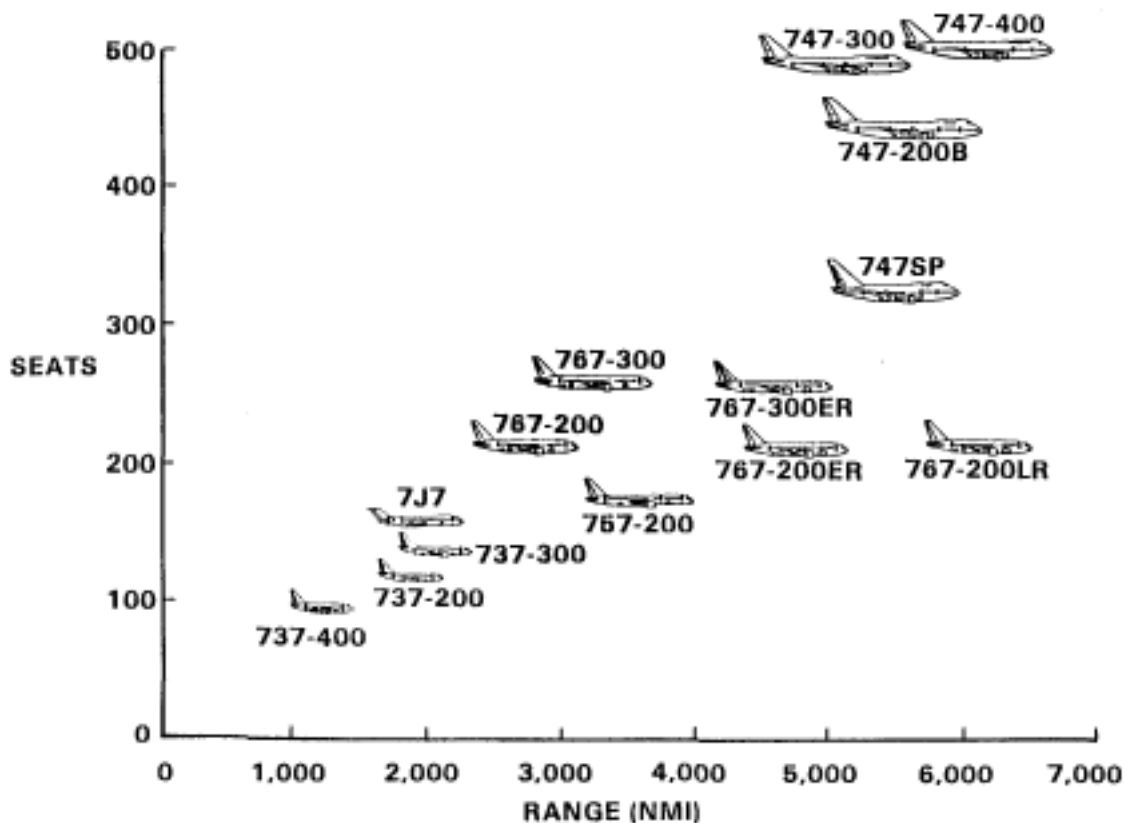

Then there is the total operating cost. I emphasize "total" because operating cost is basically broken up into two parts. There is direct cost that deals with flight crew, fuel, maintenance, depreciation, and insurance. You can determine direct cost in a fairly logical way. The indirect costs are the costs of the loading equipment, the ramp space, terminal space, cabin attendants, food, advertising, selling tickets,

management, etc. If cost is not competitive, an airplane cannot be sold. One of the things that is killing the helicopter, and the helicopter is incidentally being killed in the commercial business, is that the total operating cost is so high. This is partly due to the high maintenance of the helicopter. But it is also due to the fact that when you run an airline with a very short flight, it costs you just as much to board a passenger, to sell a ticket, to advertise, to load the airplane, to load the baggage as if the passengers were going three thousand miles. And you collect \$15 to \$30. Total operating cost is probably the major measure of effectiveness of aircraft. Fuel usage is also very important but shows up in cost also.

Another vital design factor today is community acceptability. Community acceptability primarily concerns noise and air pollution, visible and invisible. In addition, there are the requirements of the airport community itself, namely runway length, runway strength, ramp parking areas, loading docks, etc. The subject of runway flotation, i.e., the wheel loading on the runway, is a vital consideration in landing gear design as is the radius of turn. Airplane design to minimize ram space per passenger is an important factor in airport compatibility.

Now another very important thing is the manufacturer's reputation for dependability, reliability, and service. An airplane is terribly complex. You know the problems of getting a T.V. set or car serviced; they're bad enough. An airplane has the complexity of a T.V. set and a car a hundred times over. So the manufacturer has to provide a vast system for supplying parts, technical assistance and training. An airline receiving a new airplane like a DC-10 or 747 will find it absolutely useless unless it has previously obtained pilot training, mechanic training, special tools, special loading stands, and a tremendous amount of equipment. The dependability of the service and emphasizing an airplane design that minimizes the required services is vital.

An item of less technical nature, but of equal importance in market determination is the manufacturer's presidents' charming golf. The ability of a president of a manufacturer to establish a good relationship with the airline president and to inspire confidence, a process often done over a beaker after a golf game, is often significant. In spite of the fact that most airlines go through very elaborate technical analysis of new aircraft and come out with books 3 inches thick comparing the competitive airplanes, the purchase decision usually is made by one man. Very often someone takes the grand engineering evaluation and simply files it. The only time it's important is when an airplane is deficient. If an airplane is really deficient, then the prejudices will have to get swept away, and that airplane will lose. But in this world, the major aircraft companies are all very capable. So it's unlikely that there's any terrible blunder pulled by any one of them. As a matter of fact if there is one or two deficiencies, it's not unheard of for an airline president to say to a manufacturer "we really want to buy your airplane, but my engineers tell me that your landing gear is going to fail from fatigue in a short time." That is the same thing as saying "go fix that landing gear design and I'll buy your airplane." So, it gets fixed. Although this type of decision is not dominant, I'm sure it's not wrong to say that ten to twenty percent of the airplanes purchased come from this kind of relationship.

Now another very important factor in evaluating the market size, is the airline's financial position. If the airlines of the world are having trouble keeping their financial heads above water, they're not going to be able to buy a new fleet.

Market timing is timing is tremendously important. Suppose we have decided to initiate a project. Our company needs a new project and we are sure that it can be profitable. But if we are right that the world needs the selected airplane but wrong about when they needed it, then we may end up in bankruptcy. Sometimes, people go into a project with the hope that it will work. In past years when aircraft were less complicated there were several examples of airplane types for which the first airplane completely saturated the market. One example is the Douglas DC-4E. I will bet there are many of you who have never heard of the DC-4E, an airplane with a triple vertical tail. In fact it would be easy to jump to conclusion that this was an artist's joke with an old Lockheed Constellation tail on a Douglas DC-4. In the middle thirties, very shortly after the DC-3 came out, the airlines contracted with Douglas to build a 40-passenger airplane, the DC-4E. By the time the DC-4E was built, the technology had moved so fast that the airlines and Douglas realized that it was a blunder. It had a 2100 sq. ft. wing to carry 40 people. The same useful work was being accomplished with 1/3 less wing and tail structure. The reasons for the large improvement were that the original DC-4E did not have wing flaps of an efficient type, was underpowered, and had to comply with a federal regulation prohibiting stalling speeds higher than 65 mph. When the economics of the DC-4E were compared with those of an airplane with more powerful engines, a better flap technology, and a less restrictive law, the DC-4E was discontinued.

There is another example of one airplane saturating the market. In the 1947 Lockheed built an airplane called the Constitution. This airplane was enormous double decker, a design idea that was not duplicated until the Boeing 747's small upper deck, originally used only as a lounge was stretched in late 1980's to hold about 35 pass. The Constitution was bought by Pan American Airlines. In order to demonstrate that they were the pioneers in the air travel development, probably to justify the federal financial aid they received for so long, Pan American Airways always bought the biggest airplane available whether it was the most sensible thing or not. The Constitution was the biggest airplane in the world at that time and was never heard from again. The difficulty with both the DC-4E and the Constitution was that they appeared too early. The market was not ready for them and neither was the technology. Market timing is very, very important.

So much for the failures. Now let us examine some successes. In 1952 Boeing built a prototype of the 707 jet transport while Douglas management was following the policy of "never cut a piece of metal until you see the green of the customer's money." When the engineering analyses showed that an economical jet transport could be built, Boeing could take people for a ride in wonderful jet transport and Douglas had only color pictures of an airplane-to-be. It was a tribute to Douglas' skill in engineering salesmanship and in preparing presentations on swept wing drag, swept wing stall characteristics, and Dutch Roll stability that at least one major airline wrote in their evaluation study that Boeing had an airplane flying but Douglas understood why it flew. Nevertheless Boeing achieved a strong lead in jet transport sales which Douglas struggled to overcome for years.

The B747 is another example of really jumping ahead and leap frogging the competition. In order to start a project early enough so that competitors such as Douglas and Lockheed would not be financially able to compete, Boeing started selling this 360 passenger airplane (mixed class) in 1966. ("Mixed class" refers to interior arrangements with first class passenger accommodation in the front of the cabin and coach in the rear. Normally about 15% of the seats are first class.) I have mentioned the B-747 as a successful example but its financial success was in doubt for years and a profit for the project was

delayed for many years. Two years after the B-747 production engineering began, Douglas and Lockheed started projects about 2/3 the size of the B-747. originally built for domestic service the Douglas DC-10 was soon extended to the range of the 747 but with a smaller size. On many routes, 360 passenger airplanes are too large. On may routes, 360 passenger airplanes are too large. After the Lockheed L-1011 the Douglas DC-10 were offered, the re-orders for the 747 were being greatly reduced. The situation for Boeing was aggravated by the fact that the economic recession in 1970-71 reduced travel growth for both business and pleasure. In 1973, the future of the 747 seemed a little indefinite and Boeing's financial situation was poor. By 1975 the economic recovery was followed by an air traffic resurgence and B-747 orders improved. Then reduced fares stimulated a large air travel increase and 747 orders grew to a high level that insured that the project will be profitable. But Boeing faced a few years of very low production when the airlines found the smaller airplanes more suitable. The B-747 was too big, too soon.

Another example of a timing error is the Boeing 737. By the time Boeing decided to build the 737 over half of the market had been taken by Douglas and 10% by the British BAC 111. Still another example is the Lockheed 1649 which was a long range version of the famous Constellation. TWA forced Lockheed into the design, a major change from the basic Constellation, in order to compete with the Douglas DC-7C. Only about 40 of them were sold and a great deal of money must have been lost on that project. Timing is one of the very important factors.

Related to timing is the important matter of competition. The overall market may be strong and a great airplane design may be under consideration. However, if there are two other companies six months or a year ahead of you, with many of the major airlines having already spoken for their airplane, you may be finished before you start.

A vital decision factor is the ability to sell a an airplane for a profitable price. How can you sell the airplane at a profit? The sign that you have seen that says "This is a non-profit corporation but we did not mean it that way, " is really more true than humorous in the aircraft industry. Among the historical examples is Convair which would have gone completely out of existence if they did not belong to General Dynamics Corporation which could withstand the \$400 million loss on the CV-880 and CV-990 airplanes. These airplanes were great flying machines. If you ever happened to ride on them with their large windows, 4 abreast seating and excellent flying qualities, you may have found them preferable, from a passenger's point of view, to more successful aircraft. It is a tragedy that people who could create this magnificent craft derived only disaster from it. Several had heart attacks and most of the rest lost their jobs as result of the financial problems that struck Convair. Convair's problem was a case of bad timing and bad sizing. Convair arrived late in the market place, and compounded the error by choosing the wrong size. Aiming at a somewhat smaller and faster airplane, they failed to make it small enough to attract a truly different market. The higher design speed introduced severe technological risk which proved very costly especially in the higher speed 990. Furthermore, their original customer was Howard Hughes' TWA. Hughes' eccentric demands were an automatic invitation to financial disaster since they involved development for specialized customer rather than for a broad market.

One important aspect of selling at a profitable price is having an understandable technical risk. "Understandable" means knowing that the technical problems can be solved with a reasonable amount of expenditure. One of the reasons that Douglas dropped out of the SST program in 1963 was that the

technical risk was known to be tremendous. There were great problems in the SST not only in the aerodynamics and structure but also in the machinery involved in the systems, the hydraulic fluids, the gaskets and sealants, and the lubricants. At the high temperatures involved everything was a question. While all of these problems are capable of solution, the cost of development was high and indefinite. The cost of manufacture of the final product -- so many ways not yet specified-- was also unknown but certain to be high. Thus the eventual economics of operation were a grave concern.

Even in a less bold design, it is possible to find after initial flight tests that substantial changes, costing many millions of dollars are required. Thus an understandable technical risk is something that the prudent management will want to have well in hand.

Another important factor affecting price is obtaining some degree of standardization. The airplane manufacturers would like to have complete standardization among all customers. The automobile industry gets to build hundreds of thousands of cars and they all look alike. They do offer many different paint colors and features, but the design is based on the most complex car, with the other models obtained by leaving parts off. Unfortunately airlines usually want changes that involve substitution, not simply omission.

An airplane involves complexity that is almost unbelievable. The DC-9 was sold to about 33 customers. There were 4 different basis types of DC-9 using 4 combinations of 3 fuselage lengths and 2 wings. (In 1973, Douglas offered a 4th fuselage length.) In addition there were cargo versions of two of them. Most of the 33 airlines wanted a different cockpit arrangement. You can never get two pilots who want to put their airspeed indicator in the same place. It sounds ridiculous and it is ridiculous. On the DC-9 there were about 30 different compass systems. The question of where you put the indicator, the location of the flux gate and here you run the wiring were selected differently by 30 airlines. These kinds of changes require re-engineering and a vast communication system to the purchasing and manufacturing departments. Custom design and manufacture is a significant factor in raising airplane costs.

Just to process the paper to tell someone to move one wire is expensive. I know of one case, where the standard airplane had a mirror on a wall of a cockpit. Some airline said that they didn't want it and they wanted the manufacturer to remove it. The usual paper work was filled out and a price quotation for the change was developed. The cost of removing the mirror was \$500. The airline woke up to the fact that it was much cheaper to buy the mirror and have a mechanic remove it with a screwdriver and throw it in the trash. The reason that it was so expensive to remove a mirror was that it required instructions to the appropriate people not to buy the mirror, not to send the mirror to the right place, not to install it, and to an inspector not to get hysterical because the mirror was missing. Somebody had to produce all the paper, transmit it, read it and file it, consuming a lot a man-hours. A large transport manufacturing system is not designed for that kind change.

Some degree of standardization is essential. In the case of the DC-10 the initial customers, American and United Airlines, cooperated in setting the specifications. Their engineers worked with Douglas engineers, and later additional customers joined the conferences. The cockpits are very standard and a great deal of equipment is standard. However, in the battle for standardization some things are just hopeless. One story about standardization is hard to believe. The toggle switches in airplanes are such that, whether they are

on the ceiling or on a pedestal, the switches are moved forward to the "on" position. TWA for many years had developed a training process in which the pilot was supposed to think in circular terms -- that when he moved his hand in a circle, forward on the bottom and aft on the top, he turned things on. So TWA toggle switches had to switch on with a backward motion on the ceiling. Thus on the DC-9, all toggle switches are moved forward to be turned on, except for TWA.

In summary, in order to have a reasonable expectation of a profitable market for a new airplane, one must have an understood and reasonable technical risk, the correct size airplane to obtain an adequate total market, a satisfactory competitive situation, and a reasonable amount of standardization.

The foregoing discussion was written in the early 1970's and updated in 1977 and 1987. Although based on the early history of air transportation, the discussion is still correct with the following exceptions:

1. The relevance of the personal relationships between the presidents of the airlines and the presidents of the manufacturers is no longer so important. The major aircraft manufacturers and airlines were founded by giants who headed their respective companies for decades. Bill Paterson of United, C.R. Smith of American, Eddie Rickenbacher of Eastern, Donald Douglas, Bob Gross of Lockheed, Bill Allen of Boeing, and other builders of the industry are gone, so the great mutual respect between individuals is not what it used to be.
2. Foreign subsidized competition is a new element. The European Airbus, a company financed by the French, British, and German governments, has emerged as a very competent aircraft manufacturer. Because their worries about losing their company are mitigated by their governments' history of forgiving debt, if necessary, Airbus can proceed with projects that prudent financial people might avoid. This aspect of the transport aircraft scenario is discussed in the discussion that follows this section.
3. Because of government financial interests in Airbus and in many of the world's airlines, non-economic and non-technical factors sometimes warp airplane purchase decisions. For example, a country may offer nuclear fuel to another country whose airline is about to buy some transport aircraft; the nuclear fuel sale may be dependent on the aircraft contract going to the right manufacturer.
4. Significant progress has been made in streamlining the configuration management using computer-based systems. This is particularly true in the recent Boeing 777 development.

Future Technology and Aircraft Types

The following discussion is based on a presentation by Ilan Kroo entitled, *Reinventing the Airplane: New Concepts for Flight in the 21st Century*.



When we think about what may appear in future aircraft designs, we might look at recent history. The look may be frightening. From first appearances, anyway, nothing has happened in the last 40 years!

There are many causes of this apparent stagnation. The first is the enormous economic risk involved. Along with the investment risk, there is a liability risk which is of especially great concern to U.S. manufacturers of small aircraft. One might also argue that the commercial aircraft manufacturers are not doing too badly, so why argue with success and do something new? These issues are discussed in the previous section on the origins of aircraft.

Because of the development of new technologies or processes, or because new roles and missions appear for aircraft, we expect that aircraft will indeed change. Most new aircraft will change in evolutionary ways, but more revolutionary ideas are possible too.

This section will discuss several aspects of future aircraft including the following:

- Improving the modern airplane
- New configurations
- New roles and requirements

Improving the Modern Airplane

Breakthroughs in many fields have provided evolutionary improvements in performance. Although the aircraft configuration looks similar, reductions in cost by nearly a factor of 3 since the 707 have been achieved through improvements in aerodynamics, structures and materials, control systems, and (primarily) propulsion technology. Some of these areas are described in the following sections.

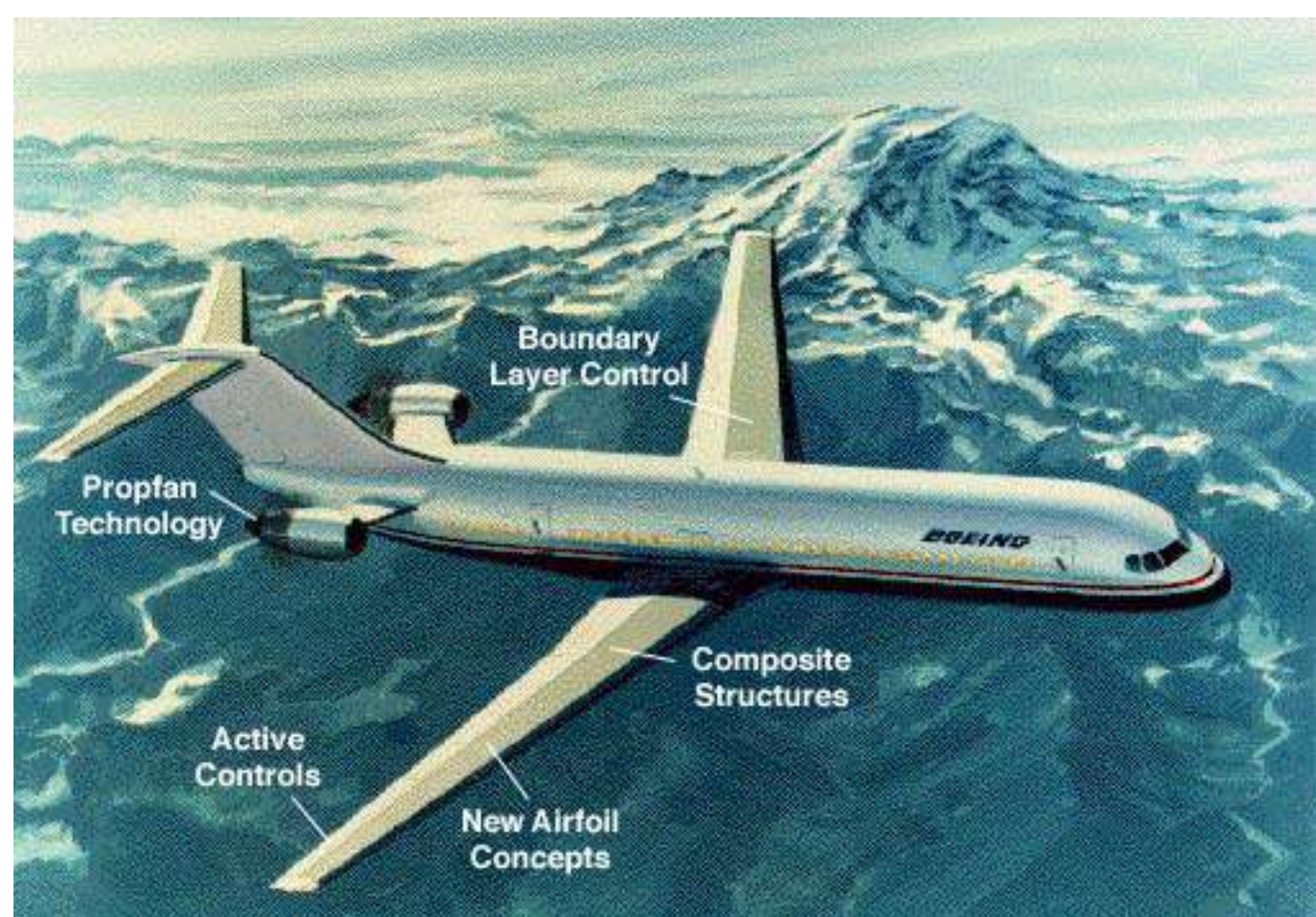

Active Controls

Active flight control can be used in many ways, ranging from the relatively simple angle of attack limiting found on airplanes such as the Boeing 727, to maneuver and gust load control investigated early with L-1011 aircraft, to more recent applications on the Airbus and 777 aircraft for stability augmentation.

Reduced structural loads permit larger spans for a given structural weight and thus a lower induced drag. As we will see, a 10% reduction in maneuver bending load can be translated into a 3% span increase without increasing wing weight. This produces about a 6% reduction in induced drag.

Reduced stability requirements permit smaller tail surfaces or reduced trim loads which often provide both drag and weight reductions.

Such systems may also enable new configuration concepts, although even when applied to conventional designs, improvements in performance are achievable. In addition to performance advantages the use of these systems may be suggested for reasons of reliability, improved safety or ride quality, and reduced pilot workload, although some of the advantages are arguable.

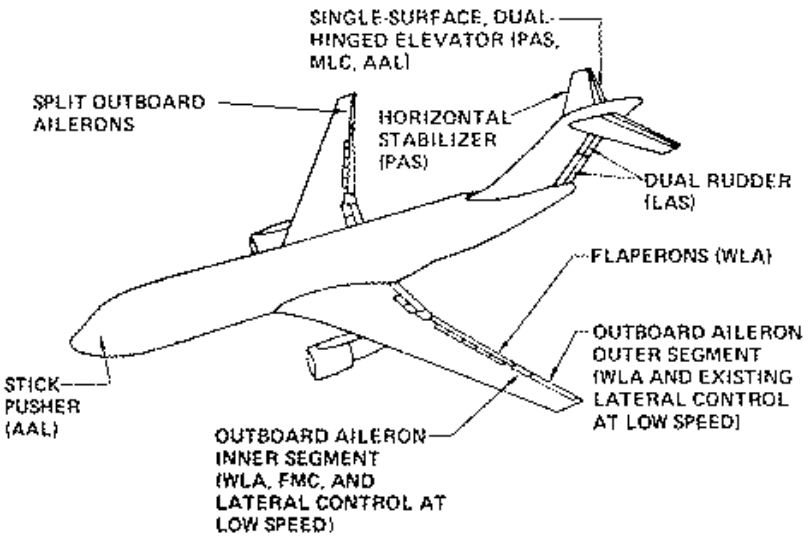

New Airfoil Concepts

Airfoil design has improved dramatically in the past 40 years, from the transonic "peaky" sections used on aircraft in the 60's and 70's to the more aggressive supercritical sections used on today's aircraft. The figure below illustrates some of the rather different airfoil concepts used over the past several decades.

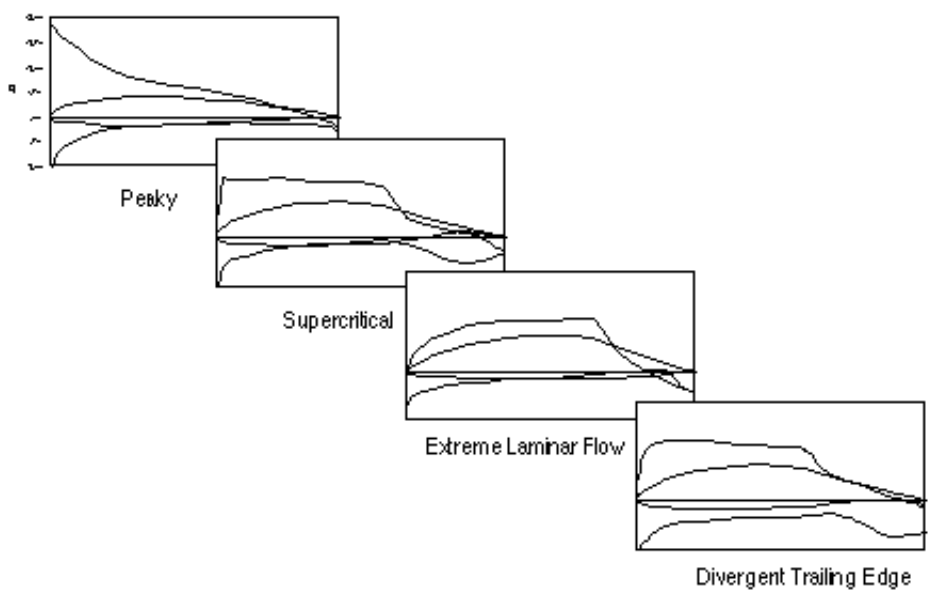

Continuing progress in airfoil design is likely in the next few years, due in part to advances in viscous computational capabilities. One example of an emerging area in airfoil design is the constructive use of separation. The examples below show the divergent trailing edge section developed for the MD-11 and a cross-section of the Aerobie, a flying ring toy that uses this unusual section to enhance the ring's stability.



Flow Near Trailing Edge of DTE Airfoil and Aerobie Cross-Section

Flow Control

Subtle manipulation of aircraft aerodynamics, principally the wing and fuselage boundary layers, can be used to increase performance and provide control. From laminar flow control, which seeks to reduce drag by maintaining extensive runs of laminar flow, to vortex flow control (through blowing or small vortex generators), and more recent concepts using MEMS devices or synthetic jets, the concept of controlling aerodynamic flows by making small changes in the right way is a major area of aerodynamic research. Although some of the more unusual concepts (including active control of turbulence) are far from practical realization, vortex control and hybrid laminar flow control are more likely possibilities.

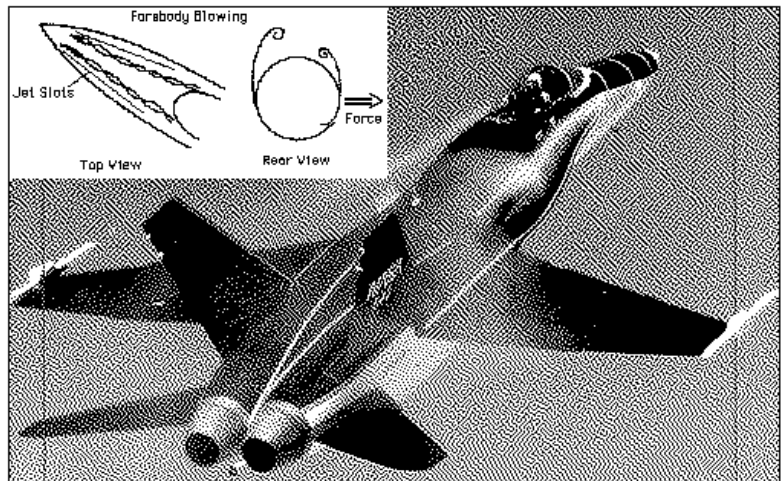

Structures

Structural materials and design concepts are evolving rapidly. Despite the conservative approach taken by commercial airlines, composite materials are finally finding their way into a larger fraction of the aircraft structure. At the moment composite materials are used in empennage primary structure on commercial transports and on the small ATR-72 outer wing boxes, but it is expected that in the next 10-20 years the airlines and the FAA will be more ready to adopt this technology.

New materials and processes are critical for high speed aircraft, UAV's, and military aircraft, but even for subsonic applications concepts such as stitched resin film infusion (RFI) are beginning to make cost-competitive composite applications more believable.

Propulsion

Propulsion is the area in which most evolutionary progress has been made in the last few decades and which will continue to improve the economics of aircraft. Very high efficiency, unbelievably large turbines are continuing to evolve, while low cost small turbine engines may well revolutionize small aircraft design in the next 20 years. Interest in very clean, low noise engines is growing for aircraft ranging from commuters and regional jets to supersonic transports.

Multidisciplinary Optimization

In addition to advances in disciplinary technologies, improved methods for integrating discipline-based design into a better system are being developed. The field of multidisciplinary optimization permits detailed analyses and design methods in several disciplines to be combined to best advantage for the system as a whole.

The figure here shows the problem with sequential optimization of a design in individual disciplines. If the aerodynamics group assumes a certain structural design and optimizes the design with respect to aerodynamic design variables (corresponding to horizontal motion in the conceptual plot shown on the right), then the structures group finds the best design (in the vertical degree of freedom), and this process is repeated, we arrive at a converged solution, but one that is not the best solution. Conventional trade studies in 1 or 2 or several parameters are fine, but when hundreds or thousands of design degrees of freedom are available, the use of more formal optimization methods are necessary.

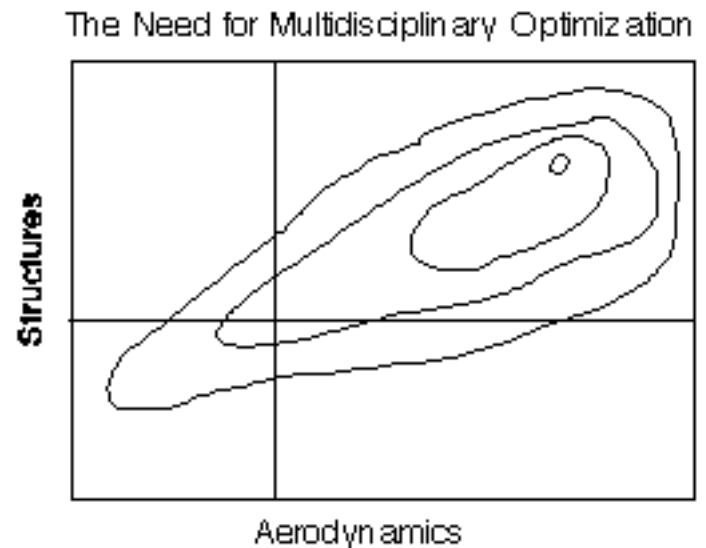

Although a specific technology may provide a certain drag savings, the advantages may be amplified by exploiting these savings in a re-optimized design. The figure to the right shows how an aircraft was redesigned to incorporate active control technologies. While the reduced static margin provides small performance gains, the re-designed aircraft provides many times that advantage. Some typical estimates for fuel savings associated with "advanced" technologies are given below. Note that these are sometimes optimistic, and cannot be simply added together.

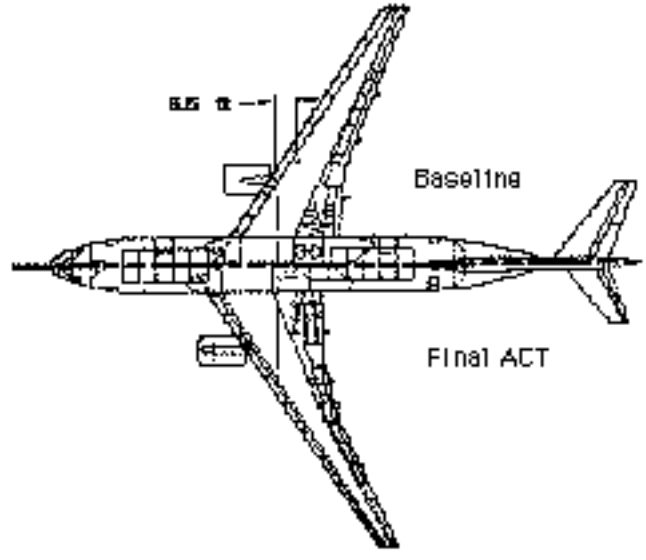
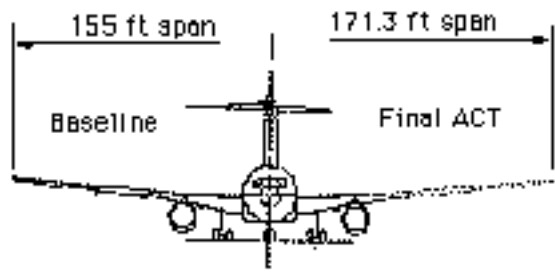

- Active Control 10%
- Composites 20%
- Laminar Flow 10%
- Improved Wing 10%
- Propulsion 20%
-
- Total: 70% ??

New Configuration Concepts

Apart from evolutionary improvements in conventional aircraft, revolutionary changes are possible when the "rules" are changed. This is possible when the configuration concept itself is changed and when new roles or requirements are introduced.

The following images give some idea of the range of concepts that have been studied over the past few years, some of which are currently being pursued by NASA and industry.

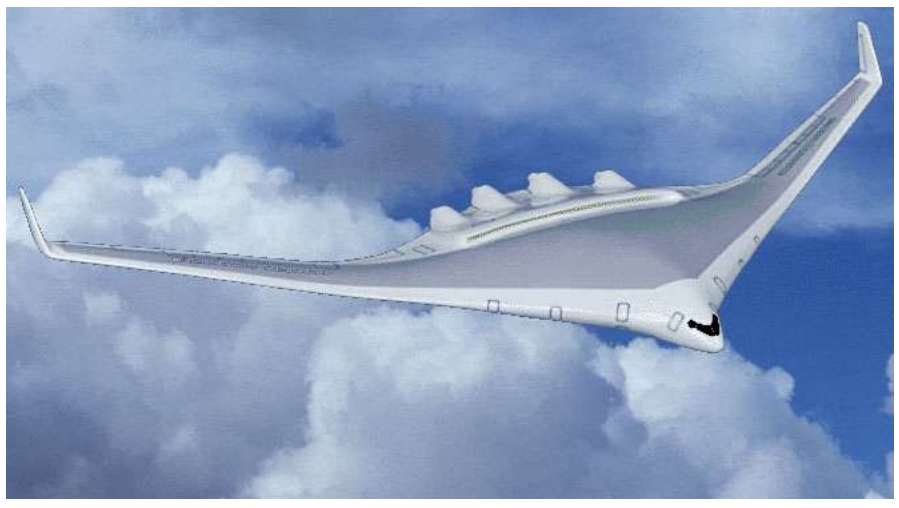

Blended Wing Body



Joined Wing



Oblique Flying Wing

New Roles and Requirements

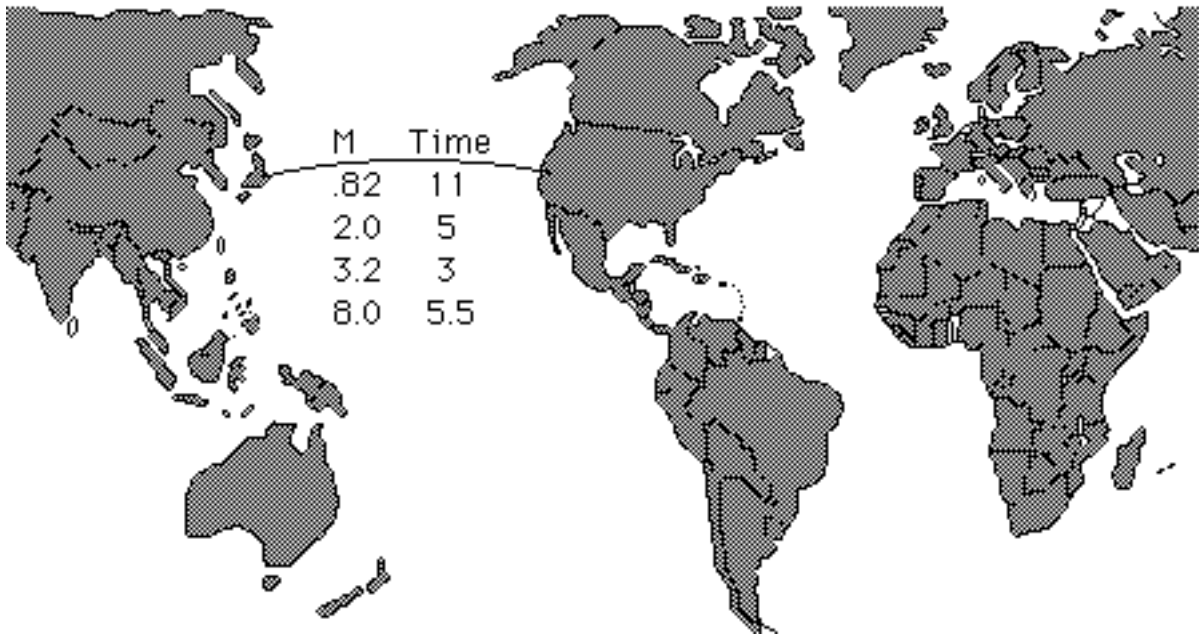

Pacific Rim Travel



Supersonic transportation



Low Observables

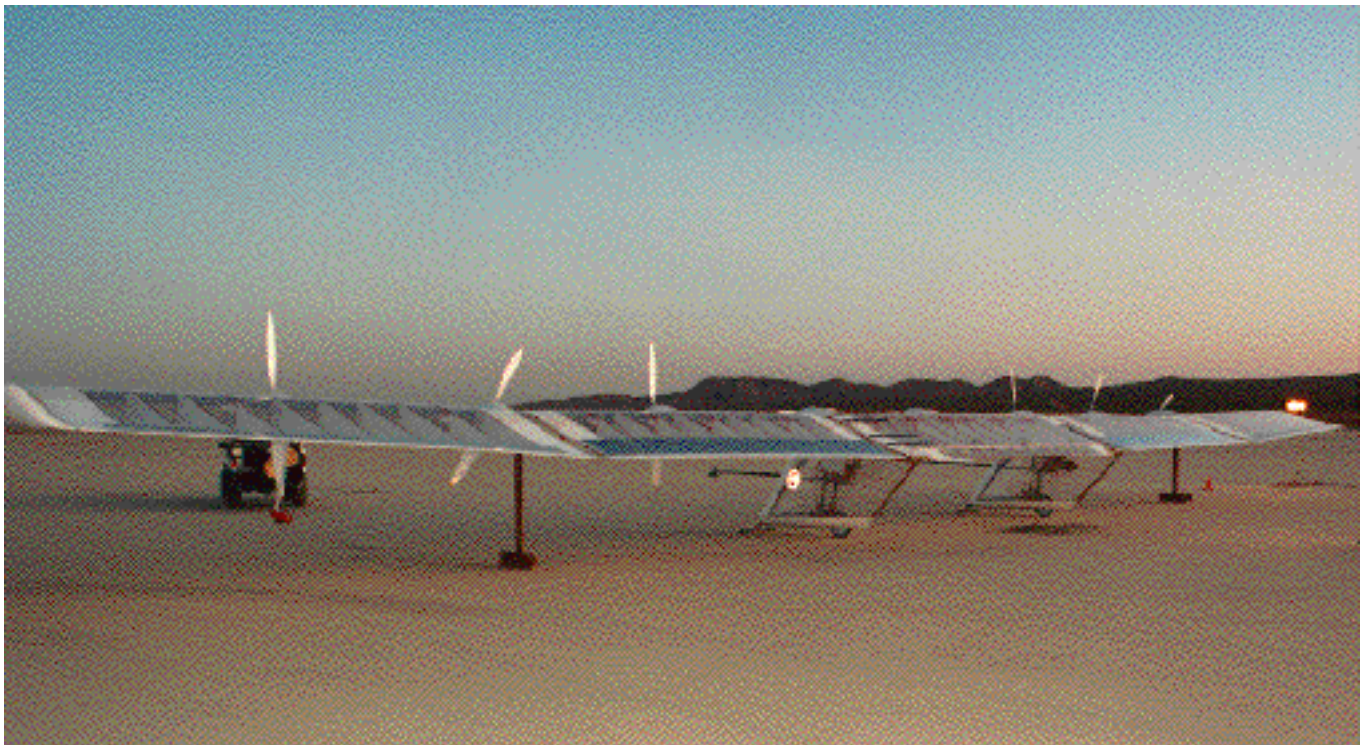

Autonomous Air Vehicles



Halo Autonomous Air Vehicle for Communications Services (an AeroSat)

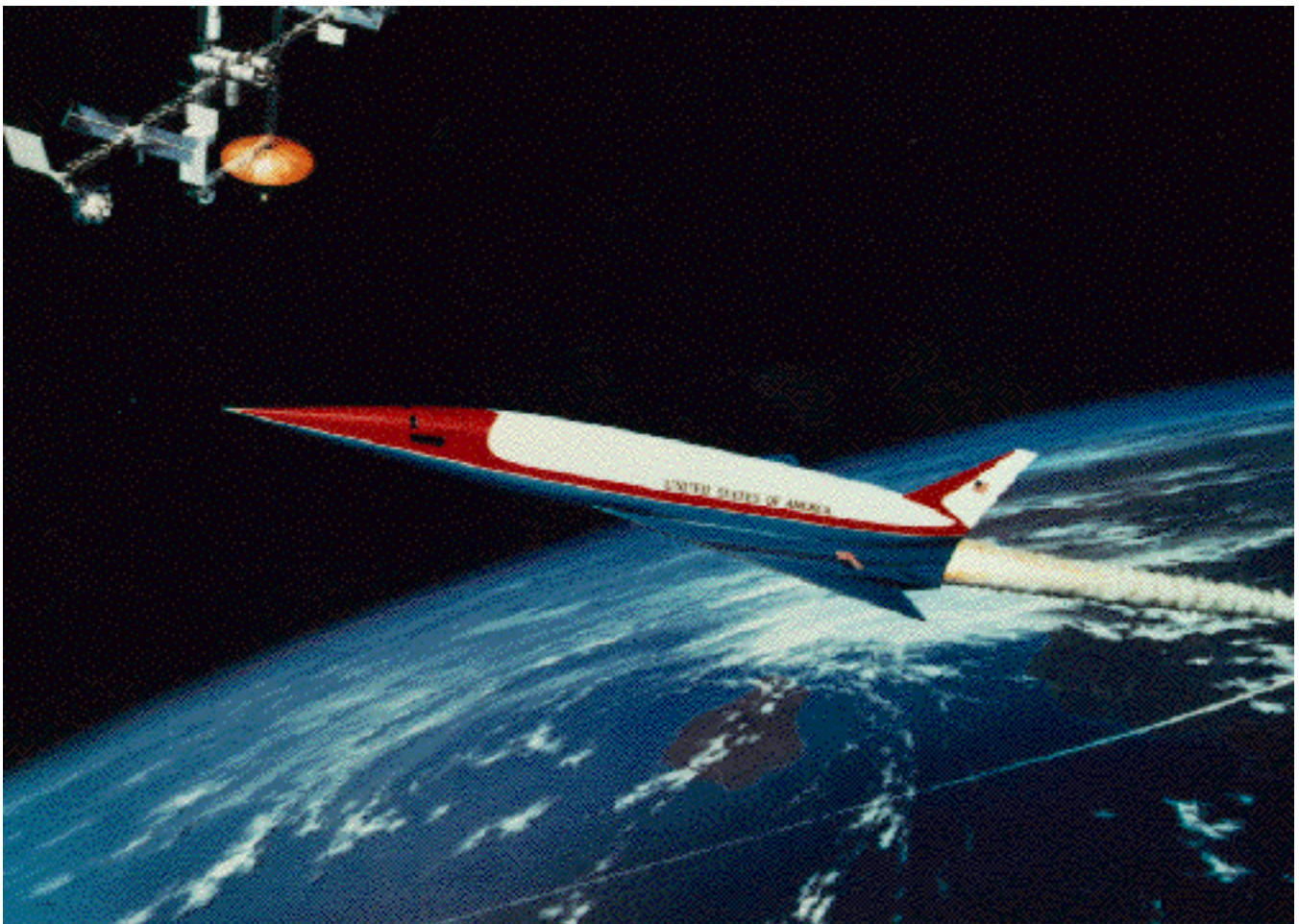

Conclusions

- Improved understanding and analysis capabilities permit continued improvement in aircraft designs
 - Exploiting new technologies can change the rules of the game, permitting very different solutions
 - New objectives and constraints may require unconventional configurations
 - Future progress requires unprecedented communication among aircraft designers, scientists, and computational specialists
-

The Airline Industry

In order to understand how new aircraft might fit into the current market, one must understand the "customer". For commercial transport aircraft manufacturers, the customers are the airlines. For business aircraft, military programs, or recreational aircraft, the market behaves quite differently.

The following discussion, intended to provide an example of an up-to-date view of one market, is excerpted from the British Airways web site, Jan. 2000. (See <http://www.britishairways.com/inside/factfile/industry/industry.shtml>)

INDUSTRY OVERVIEW

Air travel remains a large and growing industry. It facilitates economic growth, world trade, international investment and tourism and is therefore central to the globalization taking place in many other industries.

In the past decade, air travel has grown by 7% per year. Travel for both business and leisure purposes grew strongly worldwide. Scheduled airlines carried 1.5 billion passengers last year. In the leisure market, the availability of large aircraft such as the Boeing 747 made it convenient and affordable for people to travel further to new and exotic destinations. Governments in developing countries realized the benefits of tourism to their national economies and spurred the development of resorts and infrastructure to lure tourists from the prosperous countries in Western Europe and North America. As the economies of developing countries grow, their own citizens are already becoming the new international tourists of the future.

Business travel has also grown as companies become increasingly international in terms of their investments, their supply and production chains and their customers. The rapid growth of world trade in goods and services and international direct investment have also contributed to growth in business travel.

Worldwide, IATA, International Air Transport Association, forecasts international air travel to grow by an average 6.6% a year to the end of the decade and over 5% a year from 2000 to 2010. These rates are similar to those of the past ten years. In Europe and North America, where the air travel market is already highly developed, slower growth of 4%-6% is expected. The most dynamic growth is centered on the Asia/Pacific region, where fast-growing trade and investment are coupled with rising domestic prosperity. Air travel for the region has been rising by up to 9% a year and is forecast to continue to grow rapidly, although the Asian financial crisis in 1997 and 1998 will put the brakes on growth for a year or two. In terms of total passenger trips, however, the main air travel markets of the future will continue to be in and between Europe, North America and Asia.

Airlines' profitability is closely tied to economic growth and trade. During the first half of the 1990s, the industry suffered not only from world recession but travel was further depressed by the Gulf War. In

1991 the number of international passengers dropped for the first time. The financial difficulties were exacerbated by airlines over-ordering aircraft in the boom years of the late 1980s, leading to significant excess capacity in the market. IATA's member airlines suffered cumulative net losses of \$20.4bn in the years from 1990 to 1994.

Since then, airlines have had to recognize the need for radical change to ensure their survival and prosperity. Many have tried to cut costs aggressively, to reduce capacity growth and to increase load factors. At a time of renewed economic growth, such actions have returned the industry as a whole to profitability: IATA airlines' profits were \$5bn in 1996, less than 2% of total revenues. This is below the level IATA believes is necessary for airlines to reduce their debt, build reserves and sustain investment levels. In addition, many airlines remain unprofitable.

To meet the requirements of their increasingly discerning customers, some airlines are having to invest heavily in the quality of service that they offer, both on the ground and in the air. Ticketless travel, new interactive entertainment systems, and more comfortable seating are just some of the product enhancements being introduced to attract and retain customers.

A number of factors are forcing airlines to become more efficient. In Europe, the European Union (EU) has ruled that governments should not be allowed to subsidize their loss-making airlines. Elsewhere too, governments' concerns over their own finances and a recognition of the benefits of privatization have led to a gradual transfer of ownership of airlines from the state to the private sector. In order to appeal to prospective shareholders, the airlines are having to become more efficient and competitive.

Deregulation is also stimulating competition, such as that from small, low-cost carriers. The US led the way in 1978 and Europe is following suit. The EU's final stage of deregulation took effect in April 1997, allowing an airline from one member state to fly passengers within another member's domestic market. Beyond Europe too, 'open skies' agreements are beginning to dismantle some of the regulations governing which carriers can fly on certain routes. Nevertheless, the aviation industry is characterized by strong nationalist sentiments towards domestic 'flag carriers'. In many parts of the world, airlines will therefore continue to face limitations on where they can fly and restrictions on their ownership of foreign carriers.

Despite this, the airline industry has proceeded along the path towards globalization and consolidation, characteristics associated with the normal development of many other industries. It has done this through the establishment of alliances and partnerships between airlines, linking their networks to expand access to their customers. Hundreds of airlines have entered into alliances, ranging from marketing agreements and code-shares to franchises and equity transfers.

The outlook for the air travel industry is one of strong growth. Forecasts suggest that the number of passengers will double by 2010. For airlines, the future will hold many challenges. Successful airlines will be those that continue to tackle their costs and improve their products, thereby securing a strong presence in the key world aviation markets.

NORTH AMERICAN INDUSTRY OVERVIEW

The commercial aviation industry in the United States has grown dramatically since the end of World War II. In 1945 the major airlines flew 3.3 billion revenue passenger miles (RPMs). By the mid 1970s, when deregulation was beginning to develop, the major carriers flew 130 billion RPMs. By 1988, after a decade of deregulation, the number of domestic RPMs had reached 330 billion (*Source: Winds of Change*).

The United States is the largest single market in the world, accounting for 33 per cent of scheduled RPMs (41 per cent of total scheduled passengers) in 1996. The most significant change in the history of the industry came in 1976 when the Civil Aeronautics Board (CAB) asked Congress to dismantle the economic regulatory system and allow the airlines to operate under market forces. This changed the face of commercial aviation in the United States. Congress passed the Airline Deregulation Act in 1978, easing the entry of new companies into the business and giving them freedom to set their own fares and fly whatever domestic routes they chose.

Deregulation of the industry was followed quickly by new entrants, lower fares and the opening of new routes and services to scores of cities. The growth in air traffic brought on by deregulation's first two years ended in 1981 when the country's professional air traffic controllers went on strike. Traffic surged again after 1981, adding 20 million new passengers a year in the post strike period, reaching a record 466 million passengers in 1990.

In 1989 events began which severely damaged the economic foundations of the industry. The Gulf crisis and economic recession caused the airlines to lose billions of dollars. The industry experienced the first drop in passenger numbers in a decade, and by the end of the three-year period 1989-1992 had lost about US\$10 billion - more than had been made since its inception. Great airline names like Pan American and Eastern disappeared, while others, such as TWA and Continental Airlines, sought shelter from bankruptcy by going into Chapter 11.

Today the domestic industry in the US is a low cost, low fare environment. Most of the major airlines have undergone cost restructuring, with United Airlines obtaining employee concessions in exchange for equity ownership. Some airlines sought the protection of Chapter 11 bankruptcy to restructure and reduce costs and then emerged as strong low-cost competitors. The majority have entered into cross-border alliances to improve profitability through synergy benefits.

In 1993 President Clinton appointed the National Commission to ensure a strong competitive industry. Its recommendations seek to establish aviation as an efficient, technologically superior industry with financial strength and access to global markets.

Another key recommendation by the Commission was that foreign airlines should be allowed to invest up to 49 per cent of the equity in US airlines and in return, obtain up to 49 per cent of the voting rights. Current US law allows foreign investment up to 49 per cent of the equity with voting rights of up to 25

per cent. An amendment to existing law requires an Act of Congress.

Autumn 1996 saw the UK and US Governments hold bilateral talks with the intention of negotiating an 'Open Skies' arrangement between the two countries. The result of these talks is eagerly awaited by airlines on both sides of the Atlantic.

The last few years have seen the proliferation of airline alliances as the so called 'global carriers' of the future are created. North American carriers have been very much at the forefront of this activity, and today much of the world aviation market is shared between several large global alliances, including KLM/NorthWest, Atlantic Excellence alliance, STAR, and the British Airways / American Airlines alliance which also includes Canadian Airlines and Qantas. The latter still awaits regulatory approval on both sides of the Atlantic.

The Aircraft Design Process

The aircraft design process is often divided into several stages, as shown in the figure below. This chapter deals with some of the basic concepts in product development.

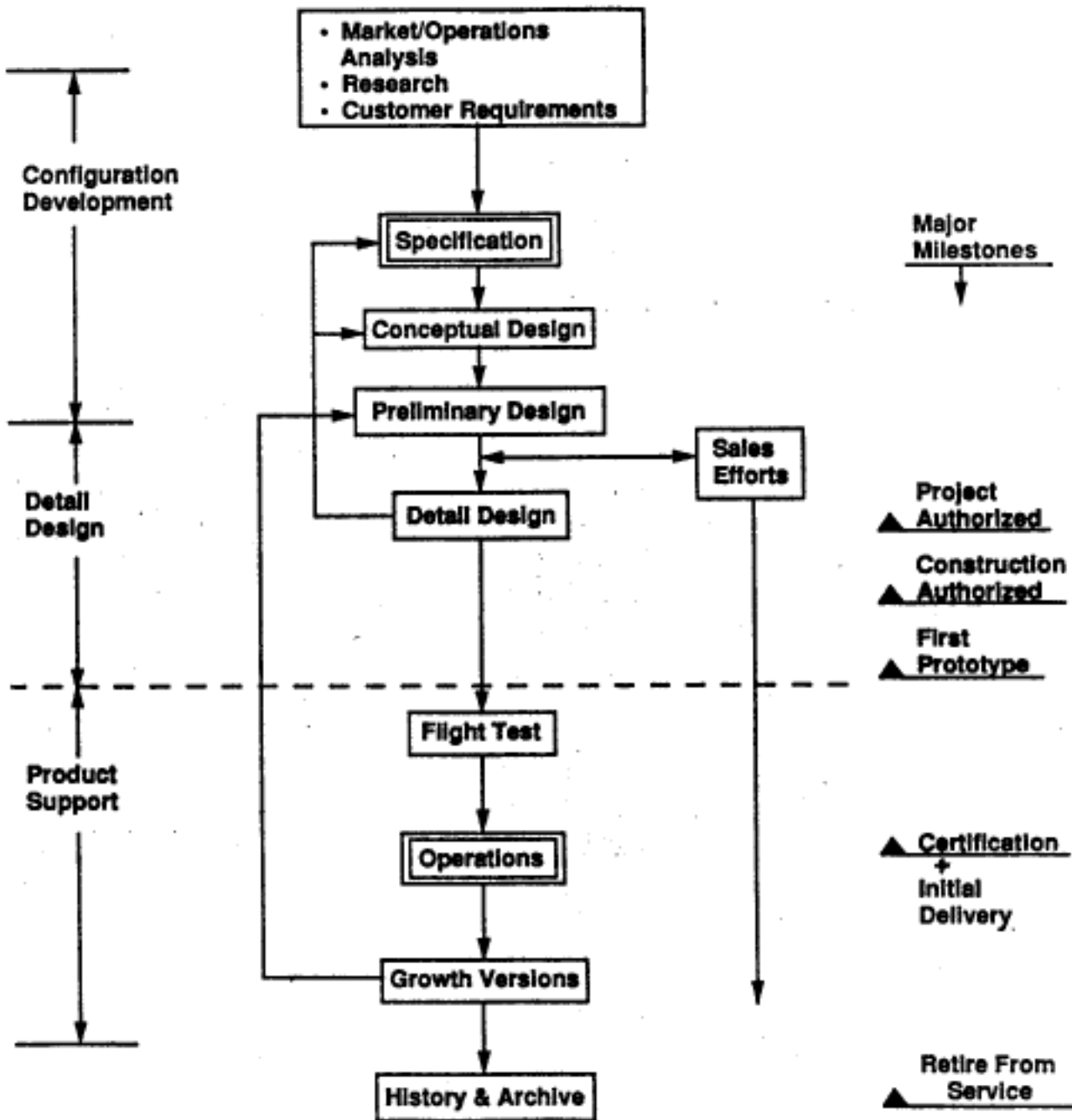

- [Market Determination](#)

- [Design Requirements and Objectives](#)
 - [Design Optimization](#)
 - [The Role of Computational Methods in Aircraft Design](#)
 - [Exercise 1: Design Requirements](#)
-

Market Determination

The most current data is available from manufacturers and airlines. Links on this page take you to an excellent market summary by Boeing and data from British Airways.

- [Boeing Market Outlook](#)
- [Air Passenger Traffic Statistics \(Worldwide\)](#)
- [Traffic Forecasts \(Worldwide\)](#)
- [Passenger Traffic in the US Domestic Market](#)
- [Traffic Forecasts \(US\)](#)

SCHEDULED AIR TRAFFIC

DEVELOPMENT OF WORLD* SCHEDULED AIR TRAFFIC 1970-1994

Calendar year	International				Total			
	Passengers carried (m)	Index	RPKs (bn)	Index	Passengers carried (m)	Index	RPKs (bn)	Index
1970	75	100	162	100	383	100	460	100
1971	80	107	173	107	411	107	494	107
1972	88	117	206	127	450	117	560	122
1973	98	131	236	146	489	128	618	134
1974	102	136	250	154	515	134	656	143
1975	108	144	270	167	534	139	697	152
1976	118	157	302	186	576	150	764	166
1977	129	172	332	205	610	159	818	178
1978	143	191	385	238	679	177	936	203
1979	158	211	440	272	754	197	1,060	230
1980	163	217	466	288	748	195	1,089	237
1981	173	231	494	305	752	196	1,119	243
1982	170	227	497	307	765	200	1,142	248
1983	173	231	511	315	798	208	1,190	259
1984	184	245	555	343	847	221	1,277	278
1985	194	259	590	364	899	235	1,367	297
1986	198	264	603	372	960	251	1,452	316
1987	222	296	688	425	1,027	268	1,589	345
1988	243	324	761	470	1,082	283	1,705	371
1989	262	349	824	509	1,119	292	1,780	387
1990	280	373	893	551	1,165	304	1,894	412
1991	266	355	860	531	1,133	296	1,843	401
1992	302	403	982	606	1,152	301	1,929	419

1993	320	427	1,043	644	1,128	295	1,946	423
1994 (prelim)	340	453	1,136	701	1,203	314	2,086	453

** Including The Commonwealth of Independent States.*

Source: ICAO

[Click for On Holiday](#)

[British Airways](#)

[Industry](#)

TRAFFIC FORECASTS

Industry forecasts indicate that demand will grow at a rate of some six per cent per annum over the next ten years. The table below summarises the most recent traffic forecasts from IATA, Airbus Industrie, Boeing, and McDonnell Douglas. IATA forecasts indicate that Pacific markets will continue to be the most important growth markets in the world. South East Asian markets are forecast to grow between 1994 and 1998 at an average growth of 9.3 per cent, with North East Asia at 9.5 per cent. North America and Europe are forecast to grow at lower rates (some four per cent and 5.6 per cent respectively), but from a much larger base.

Source	Date of Forecast	Forecast Period	Measure	Average Annual Growth (%)
IATA	October 1994	1994-1998	International scheduled passengers	6.6
Airbus Industrie	March 1995	1994-2004	Total world RPKs	5.4
Boeing	May 1995	1994-2005	International RPKs	5.7
			Total world RPKs	5.5
McDonnell Douglas	1994	1993-2013	Total world scheduled RPKs	5.7

[Back](#) **Industry**

Home	Feedback	Site Guide
----------------------	--------------------------	----------------------------



Aircraft Aerodynamics and Design Group

Welcome to the Aircraft Aerodynamics and Design Group, a research lab in [Stanford University](#)'s Department of [Aeronautics and Astronautics](#). This server is an experimental in-house server. See our main home page at: <http://aero.stanford.edu>.

The Aircraft Aerodynamics and Design Group at Stanford University is involved with research in applied aerodynamics and aircraft design. Our work ranges from the development of computational and experimental methods for aerodynamic analysis to studies of unconventional aircraft concepts and new architectures for multidisciplinary design optimization.

Our research group consists of about a dozen people including doctoral students, post-docs, and faculty. Our work is currently supported by NASA Ames and Langley Research Centers, Boeing Commercial Airplane Group, and Lockheed-Martin. The [Flight Research Laboratory](#) is the part of our group involved with flight experiments. See this link for more detail.

If you are interested in this type of work and are associated with a potential sponsor, we'd like to hear from you. Some of the best graduate students in the country may be able to help in your field and are currently looking for research support.

Last update 1/99
by [Ilan Kroo](#)

[Click for On Holiday](#)

[British Airways](#)

[Industry](#)

SCHEDULED AIR TRAFFIC

North America forms the largest global market, accounting for some 43 per cent of scheduled passengers carried worldwide, and 42 per cent of scheduled RPKs in 1993, according to statistics from ICAO. After North America, Europe is the next largest market in the industry, with 25 per cent of scheduled passengers and 26 per cent scheduled RPKs.

Development of scheduled air traffic of North American* airlines 1976-1993

Calendar year	International				Total			
	Passengers carried (m)	Index	RPKs (bn)	Index	Passengers carried (m)	Index	RPKs (bn)	Index
1976	22	100	60	100	241	100	314	100
1977	23	104.5	66	110.0	259	107.5	338	107.6
1978	25	113.6	78	130.0	293	121.6	393	125.2
1979	30	136.4	95	158.3	334	138.6	455	144.9
1980	31	140.9	99	165.0	317	131.5	445	141.7
1981	32	145.5	100	166.7	299	124.1	431	137.3
1982	30	136.4	98	163.3	303	125.7	442	140.8
1983	31	140.9	105	175.0	321	133.2	468	149.0
1984	34	154.5	118	196.7	352	146.1	513	163.4
1985	34	154.5	124	206.7	382	158.5	561	178.7
1986	36	163.6	125	208.3	431	178.8	622	198.1
1987	42	190.9	151	251.7	459	190.5	681	216.9
1988	48	218.2	180	300.0	475	197.1	726	231.2
1989	50	227.3	197	328.3	472	195.9	744	236.9

1990	55	250.0	221	368.3	485	201.2	783	249.4
1991	51	231.8	212	353.3	469	194.6	760	242.0
1992	55	250.0	239	398.3	484	200.8	806	256.7
1993	57	259.1	245	408.3	487	202.1	814	259.2

* *By region of carrier registration Source: ICAO*

[Back](#) [Industry](#)

[Home](#) [Feedback](#) [Site Guide](#)

[Click for Executive Club](#)[British Airways](#)[Industry](#)

TRAFFIC FORECASTS

According to traffic forecasts produced by IATA and leading aircraft manufacturers, demand for air travel in North America will grow at approximately four per cent per annum over the next ten years. Whilst the mature North American market is forecast to grow at a lower rate than the world average of some six per cent, in terms of incremental traffic growth, it is expected to outperform the other five major world markets. The table below summarises the most recent forecasts.

Source	Date of forecast	Forecast period	Region	Measure	Average annual growth (%)
IATA	October 1994	1994 - 1998	Intra North America	Passengers carried	3.1
Boeing	May 1995	1995 - 2010	US domestic	RPKs	4.0
Mc Donnell Douglas	November 1994	1993 - 2013	US domestic Intra North America	RPKs RPKs	4.0 4.1
Airbus Industrie	May 1995	1995 - 2004	Intra North America	RPKs	4.2

[Back](#) [Industry](#)[Home](#) [Feedback](#) [Site Guide](#)

Design Requirements and Objectives

One of the first steps in airplane design is the establishment of design requirements and objectives. These are used to formally document the project goals, ensure that the final design meets the requirements, and to aid in future product development. The specific DR&O's are based on customer requirements, certification requirements, and company policy (often in the form of a design standards manual). They have evolved from rather simple letters to very complex system engineering documents.

Early aircraft were developed in response to very simple requirements as demonstrated by the Army's contract with the Wright brothers. The agreement shown below requests one (1) heavier than air flying machine to be delivered in 6 1/2 months -- although even then fine print was included in the Signal Corps Specification Number 486. (Click on the image below for a readable version.)

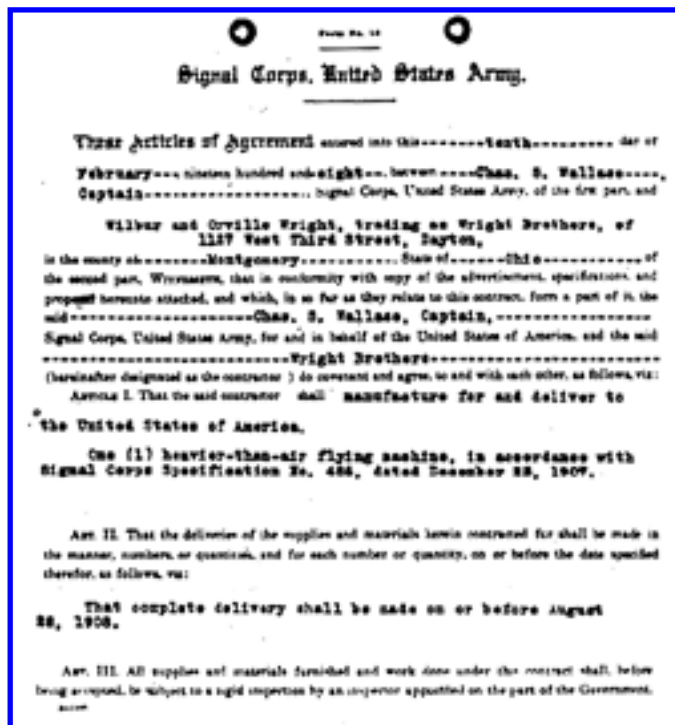

Twenty five years later, a letter from Transcontinental and Western Air brought about the birth of the DC-1 through a page list of specifications shown below.

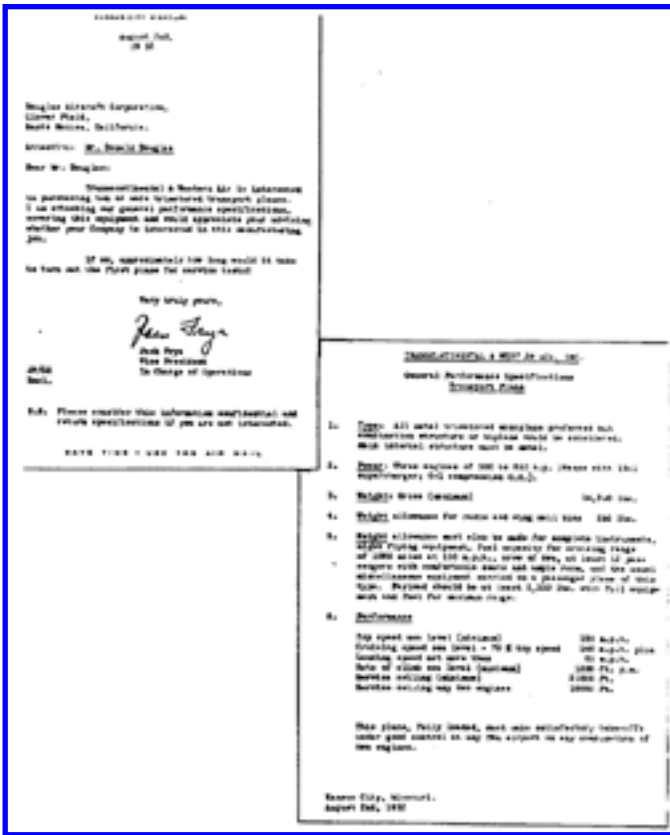

Today, complex sets of requirements and objectives include specification of airplane performance, safety, reliability and maintainability, subsystems properties and performance, and others. Some of these are illustrated in the table below, based on a Boeing chart

Transport Aircraft Design Objectives and Constraints

Issue	Civil	Military
Dominant design criteria	Economics and safety	Mission accomplishment and survivability
Performance	Maximum economic cruise	Adequate range and response
	Minimum off-design penalty in wing design	Overall mission accomplishment
Airfield environment	Moderate-to-long runways	Short-to-moderate runways
	Paved runway	All types of runway surfaces
	High -level ATC and landing aides	Often spartan ATC, etc.
	Adequate space for ground maneuver and parking	Limited space available

System complexity and mechanical design	Low maintenance- economic issue Low system cost Safety and reliability Long service life	Low maintenance- availability issue Acceptable system cost Reliability and survivability Damage tolerance
Government regulations and community acceptance	Must be certifiable (FAA, etc.) Safety oriented Low noise mandatory	Military standards --Performance and safety -- Reliability oriented Low noise desirable --Good neighbor in peace -- Dectability in war

A list of some of the typical high-level design requirements for an example supersonic transport study project are given in the table below.

Design Requirements for a Transpacific Supersonic Transport

Payload	300 passengers at 175 lbs. and 40 lbs. of baggage each.
Crew	2 pilots and 10 flight attendants at 175 lbs. and 30 lbs. of baggage each.
Range	Design range of 5,500 nm, followed by a 30 min. loiter
Cruise	Mach 2.5 at 65,000 ft. Outbound and inbound subsonic cruise legs at Mach 0.95, 45,000 ft
Take-off and Landing	FAR 25 field length of 12,000 ft. Standard days, $W_{land} = 0.85 W_{take-off}$
Fuel	JP-4
Materials	Advanced aluminum where applicable
Thermal Protection	As required, rely on passive systems when feasible, use active systems only when necessary
Certification Base	FAR 25, FAR 36 (noise requirements)

Many of the design requirements are specified by the relevant Federal Air Regulations (FAR's) in the

U.S. or the Joint Airworthiness Requirements (JAR's) in Europe. These regulations are divided into portions that apply to commercial aircraft, general aviation, sailplanes, and even ultralight aircraft. The applicable regulations for aircraft with which we will be dealing depend on the aircraft category and are grouped as described in the tables below:

Aircraft Categories

Characteristic	General Aviation	Normal	Transport
Maximum takeoff weight, lb	<12,500	<12,500	Unrestricted
Number of engines	> 0	> 1	> 1
Type of engine	All	Propeller Only	All
Minimum crew: Flight crew Cabin attendants	One None	Two None for < 20 pax	Two None for < 10 pax
Maximum number of occupants	10	23	Unrestricted
Maximum operating altitude, ft	25,000	25,000	Unrestricted

FAR Applicability

Regulations Covering:	General Aviation	Normal	Transport
Airplane airworthiness standards	Part 23	Part 23	Part 25
Engine airworthiness standards	Part 33	Part 33	Part 33
Propeller airworthiness standards	Part 35	Part 35	Part 35
Noise	Part 36 Appendix F	Part 36 Appendix F	Part 36
General operation and flight rules	Part 91	Part 91	Part 91
Large aircraft / airline operation	--	--	Part 121

Agricultural / Travel clubs / Air taxi	Part 137	Part 135	Part 123
---	----------	----------	----------

In addition to the regulatory requirements, the primary airplane design objectives include a specification of the number of passengers or cargo capability, target cruise speeds, and ranges. These are often established by extensive marketing studies of target city pairs, current market coverage and growth trends, and customer input.

Signal Corps, United States Army.

These Articles of Agreement entered into this-----tenth----- day of
February--- nineteen hundred and **eight---**, between **---Chas. S. Wallace---**,
 Captain-----, Signal Corps, United States Army, of the first part, and

**Wilbur and Orville Wright, trading as Wright Brothers, of
 1127 West Third Street, Dayton,**

in the county of-----**Montgomery**-----, State of-----**Ohio**----- of
 the second part, **WRIGHTBROS.**, that in conformity with copy of the advertisement, specifications, and
 proposal herewith attached, and which, in so far as they relate to this contract, form a part of it, the
 said-----**Chas. S. Wallace, Captain,**-----
 Signal Corps, United States Army, for and in behalf of the United States of America, and the said
 -----**Wright Brothers**-----
 (hereinafter designated as the contractor) do covenant and agree, to and with each other, as follows, viz:

Article I. That the said contractor shall manufacture for and deliver to
 the United States of America,

**One (1) heavier-than-air flying machine, in accordance with
 Signal Corps Specification No. 486, dated December 25, 1907.**

Art. II. That the deliveries of the supplies and materials herein contracted for shall be made in
 the manner, numbers, or quantities, and for each number or quantity, on or before the date specified
 therefor, as follows, viz:

**That complete delivery shall be made on or before August
 28, 1908.**

Art. III. All supplies and materials furnished and work done under this contract shall, before
 being accepted, be subject to a rigid inspection by an inspector appointed on the part of the Government.

August 2nd,
1932Douglas Aircraft Corporation,
Clover Field,
Santa Monica, California.Attention: Mr. Donald Douglas

Dear Mr. Douglas:

Transcontinental & Western Air is interested in purchasing ten or more trimotored transport planes. I am attaching our general performance specifications, covering this equipment and would appreciate your advising whether your Company is interested in this manufacturing job.

If so, approximately how long would it take to turn out the first plane for service tests?

Very truly yours,

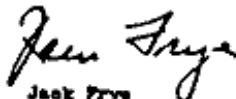

Jack Frye
Vice President
In Charge of Operations

JF/GS
Encl.

P.S. Please consider this information confidential and return specifications if you are not interested.

SAVE TIME - USE THE AIR MAIL

The letter and specifications that brought about the birth of the DC-1 which changed the concept of commercial transports for all times.

TRANSCONTINENTAL & WESTERN Air, INC.General Performance Specifications
Transport Plane

1. Type: All metal trimotored monoplane preferred but combination structure or biplane would be considered. Main internal structure must be metal.
2. Power: Three engines of 500 to 650 h.p. (Wespe with 10-1 supercharger; 6-1 compression O.K.).
3. Weight: Gross (maximum) 14,200 lbs.
4. Weight allowance for radio and wing mail bins 350 lbs.
5. Weight allowance must also be made for complete instruments, night flying equipment, fuel capacity for cruising range of 1080 miles at 150 m.p.h., crew of two, at least 12 passengers with comfortable seats and ample room, and the usual miscellaneous equipment carried on a passenger plane of this type. Payload should be at least 2,300 lbs. with full equipment and fuel for maximum range.
6. Performance

Top speed sea level (minimum)	185 m.p.h.
Cruising speed sea level - 75 % top speed	146 m.p.h. plus
Landing speed not more than	85 m.p.h.
Rate of climb sea level (minimum)	1200 ft. p.m.
Service ceiling (minimum)	21000 ft.
Service ceiling any two engines	10000 ft.

This plane, fully loaded, must make satisfactory take-offs under good control at any TWA airport on any combination of two engines.

Kansas City, Missouri.
August 2nd, 1932

Techniques for Aircraft Configuration Optimization

This section is an overview of the design process - a more philosophical discussion before plunging into the details of compressibility drag prediction, high-lift systems, etc.. The specific approach to the design problem used here will be discussed later, but now we will step back and discuss the big picture of aircraft design optimization.

Overview

You may have heard that a particular new airplane was designed on the computer. Just what this means and what can or cannot be computed-aided is not obvious and while design and analysis methods are being computerized to a greater degree than was possible earlier, there are great practical difficulties in turning the design task entirely over to the computers.

The design process has, historically, ranged from sketches on napkins (Fig. 1) to trial, error, and natural selection (Fig. 2), to sophisticated computer-aided design programs (Fig. 3).

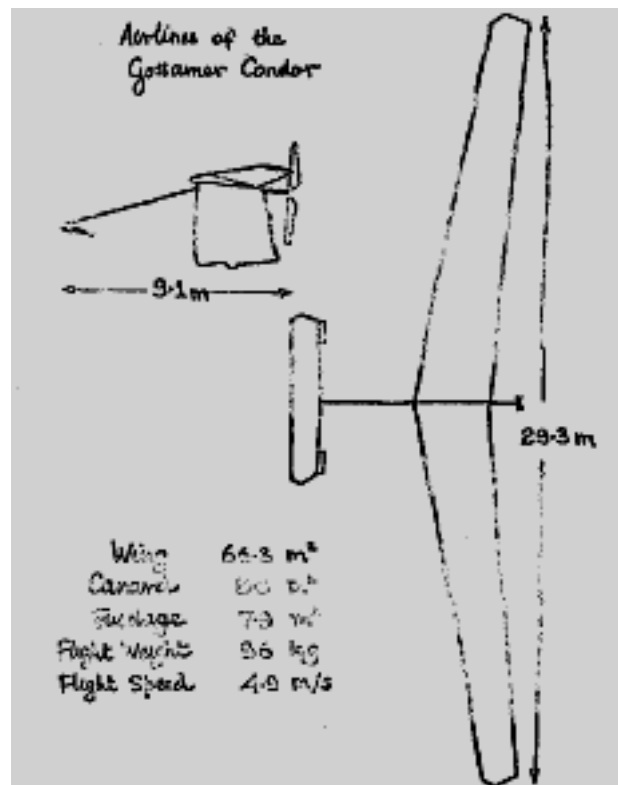

Figure 1. Aircraft concepts can start with very rough sketches, as did the human powered airplane, the

Gossamer Condor.



Figure 2. Aircraft Design By Trial and Error

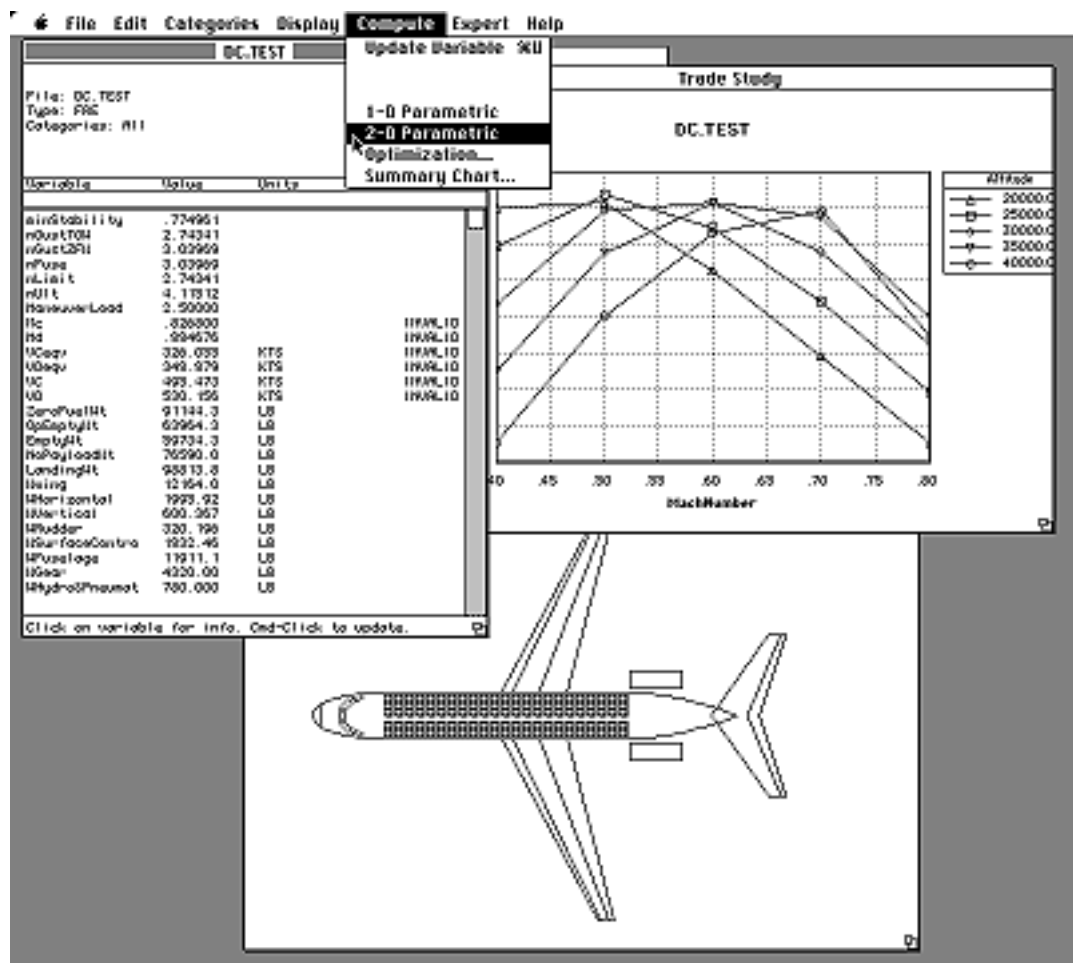

Figure 3. Computer-Aided Design of Aircraft

Because the process is so complex, involving hundreds or thousands of computer programs, many people at many locations, it is difficult to manage and companies are continuing to try to improve on the strategy. In the early days of airplane design, people did not do much computation. The design teams tended to be small, managed by a single Chief Designer who knew about all of the design details and could make all of the important decisions. Modern design projects are often so complex that the problem has to be decomposed and each part of the problem tackled by a different team. The way in which these teams should work together is still being debated by managers and researchers.

The goal of these processes, whatever form they take, is to design what is, in some sense, the best airplane. To do this requires that we address three basic issues:

1. What do we mean by best?
2. How can we estimate the characteristics of designs so we can compare two designs in a quantitative way?
3. How do we choose the design variables which yield an optimum?

The first of these questions is perhaps the most important one, for if we don't know what we are trying to achieve, or if we select the wrong goal, it doesn't matter how good the analysis method may be, nor how efficient is our optimization procedure. Nevertheless, this question is often not given sufficient attention in many optimization studies.

Defining the Objective

If we were to examine advertisements for aircraft it might seem that the definition of the best aircraft is very simple. Madison Ave. Aircraft Company sells the fastest, most efficient, quietest, most inexpensive airplane with the shortest field length. Unfortunately such an airplane cannot exist. As Professor Bryson puts it, "You can only make one thing best at a time." The most inexpensive airplane would surely not be the fastest; the most efficient would not be the most comfortable. Similarly, the best aerodynamic design is rather different from the best structural design, so that the best overall airplane is always a compromise in some sense (see Fig 4.). The compromise can be made in a rational way if the right measure of performance is used. Structural weight and lift to drag ratio, for example, become parts of a larger equation. The left hand side of this equation is termed the figure of merit or objective and depends on the intended application for the aircraft.

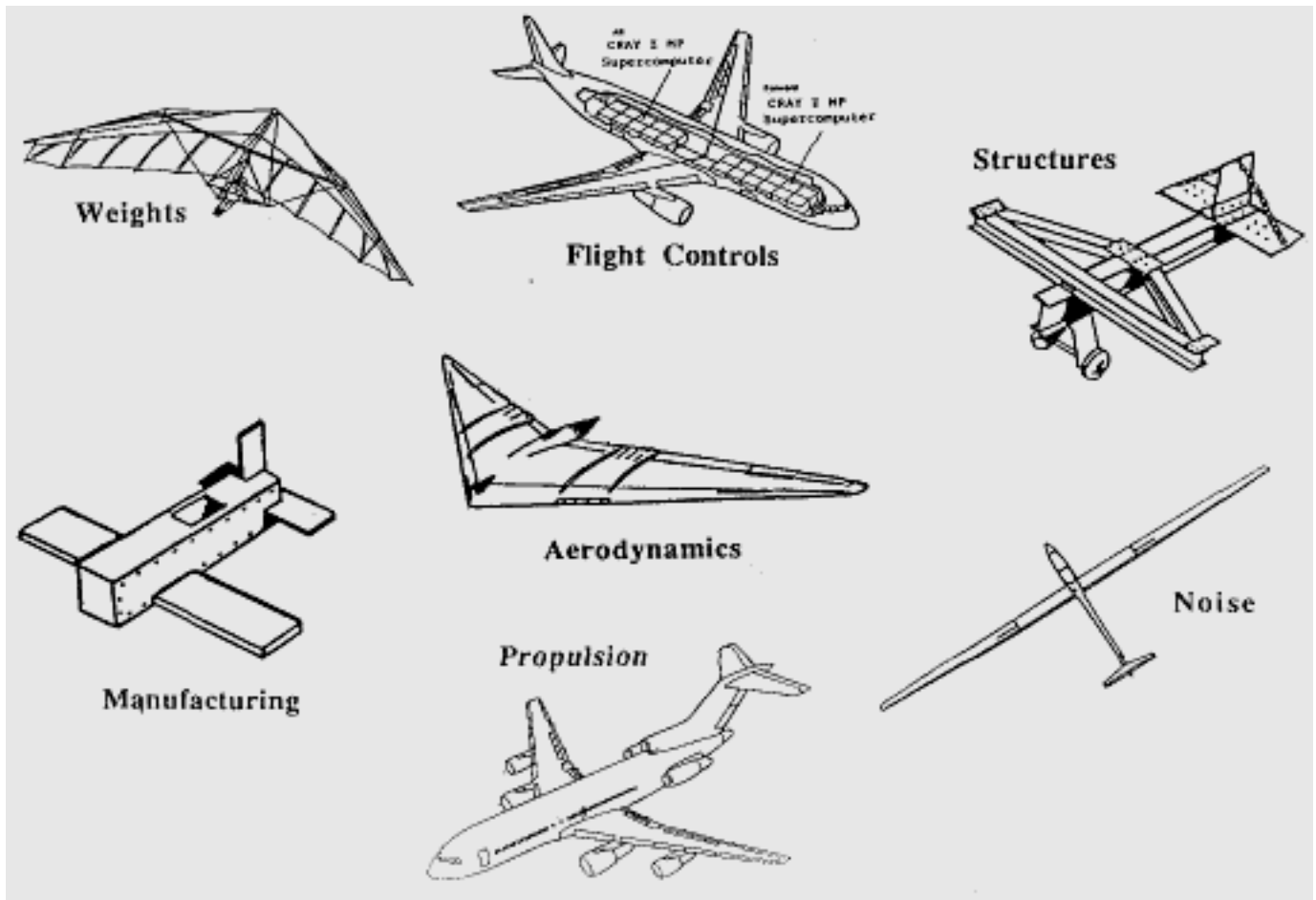

Figure 4. One can only make one thing best at a time.

Various quantities have been used for this purpose including those listed below. This list is applicable to commercial transport aircraft and is in order of increasing sophistication. Many studies of new aircraft currently use direct operating cost as a measure of performance. This quantity is a more representative measure of the aircraft's performance than is a number such as gross weight since it is sensitive to fuel costs and other important variables. While some estimate of fuel prices, depreciation rates, insurance, labor rates, etc. must be made in order to compute direct operating cost, it is not necessary to estimate airline traffic, fares, and other difficult-to-project variables which would be necessary for computing numbers such as profit or return on investment.

Possible measures of performance:

1. Minimum empty weight
2. Minimum take-off weight (includes some measure of efficiency as fuel weight is included)
3. Minimum direct operating cost (a commonly-used measure)
4. Minimum total operating cost (a bit more difficult to estimate)
5. Minimum system cost over X years (life-cycle cost)
6. Maximum profit
7. Maximum return on investment
8. Maximum payload per \$ (Sometimes used for military aircraft)

Analyses and Modeling

Once we have decided on the definition of "best" we must find a way of relating the "design variables" to the goal. This process is shown schematically, below.

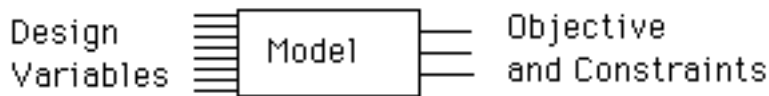

For aircraft design, this process is often extremely complex. The number of parameters needed to completely specify a 747 is astronomical. So one uses a combination of approximation, experience, and statistical information on similar aircraft to reduce the number of design variables to a manageable number. This may range from 1 or 2 for back-of-the-envelope feasibility studies to hundreds or even thousands of variables in the case of computer-assisted optimization studies. Even when the situation is simplified the model is usually very complicated and difficult. One generally must use a hierarchy of analysis tools ranging from the most simple to some rather detailed methods.

Calculating the drag of even a simple wing is not just a matter of specifying span and area. Other parameters of importance include: taper, sweep, Reynolds number, Mach number, C_L or alpha, twist, airfoil sections, load factor, distribution of bugs, etc.

This can be programmed and available as an analysis tool, but one must be very cautious. Which of these variables is included in the model? What if the wing is operating at 100,000 Reynolds number? Has it been compared with experiment in this regime?

As the design progresses, more information becomes available, and more refined analyses become part of the design studies. The expertise of a designer, these days, involves knowing what needs to be computed at what time and identifying the appropriate level of approximation in the analyses.

One of the most important, but least well understood parts of the design process is the conceptual design phase. This involves deciding on just what parameters will be used to describe the design. Will this be a flying wing? A twin-fuselage airplane? Often designers develop several competing concepts and try to develop each in some detail. The final concept is "down-selected" and studied in more detail.

Design Iteration and Optimization

The last question which must be addressed seems the most straightforward but is full of subtlety and potential pitfalls. There are several methods by which one chooses the design variables leading to the "best" design. All of these require that many analyses be carried out—often thousands of times. This requires that the model be simplified to the point that it is fast enough, but not to the point that it is worthless. (Einstein's saying comes to mind here: "Things should be as simple as possible, but no

simpler.") When the design may be described by only a few parameters, the process is very simple. One investigates several cases, and usually can easily see where the optimum occurs. (Even this may be difficult if the computations are extremely time consuming and theories called 'design of experiments', 'response surfaces', and Taguchi methods are currently used to solve such problems.) When the number of variables is more than a few, more formal optimization is required. Two approaches to optimization are commonly used.

1) *Analytic results:* When the objective function can be represented analytically, it is sometimes possible to construct derivatives with respect to the design variables and produce a set of simultaneous equations to be solved for the optimum. The idea is that a necessary condition for an optimum (without constraints) is: $dJ / dx_i = 0$ for all i . This approach is very useful for fundamental studies, but requires great simplification (often oversimplification). One can see how useful this is in example cases. Consider the determination of the C_L for maximum lift to drag ratio, L/D . If we write: $C_D = C_{Dp} + C_L^2 / AR$ and $L/D = C_L / C_D$, then L/D is maximized when C_D / C_L is minimized or $(C_D / C_L) / C_L = 0$.

This implies that: $0 = (C_{Dp} / C_L + C_L / AR) / C_L = -C_{Dp} / C_L^2 + 1 / AR$.

The result is that at maximum L/D : $C_{Dp} = C_L^2 / AR$. That is, the zero-lift drag is equal to the lift-dependent drag. This simple result is very useful, but one must be careful that the analysis is applicable. When the aspect ratio or C_{Dp} is very high, the drag departs from the simple model at the computed optimal C_L . When the problem involves constraints, the derivative is not zero at the optimum, but a similar analytic approach is possible by introducing Lagrange multipliers, λ . In such a case, when the constraints are represented by $g_i = 0$ the condition for an optimum is: $d(J + \lambda_j g_j) / dx_i = 0$ and $g_i = 0$.

2) *Numerical optimization:* In most aircraft design problems, the analysis involves iteration, table look-ups, or complex computations that limit the application of such analytical results. In these cases, direct search methods are employed. The following are schemes that have been used in aircraft design:

a. Grid searching: A structured approach to surveying the design space in which designs are evaluated at points on a grid. The disadvantage with this approach is that as the number of variables increases, the number of computations increases very quickly. If one evaluated designs with just five values of each parameter, the number of computations would be 5^n where n is the number of design variables. Note that when $n = 10$, we require almost 10 million design evaluations.

b. Random searches: A less structured approach that does not require as many computations as the design variables increase, is the random search. It also does not guarantee that the best solution will be found. This method is sometimes used after some of the more sophisticated methods, described below, have gotten stuck.

c. Nonlinear Simplex or Polytope Method: In this case, $n+1$ points are evaluated in an n -dimensional design space. One moves in the direction of the best point until no improvement is found. At that point, the distance between points is reduced and the method tries to refine the search direction. This method is described in more detail in the book, "Numerical Recipes". It is very simple and robust, but very

inefficient when one must consider more than a few design variables. Nevertheless, it has been used in aircraft optimization.

d. Gradient methods: These methods involve computation of the gradient of the objective function with respect to the design variables. The gradient vector points in the direction of the steepest slope. Moving in this direction changes the objective function most rapidly. Several forms of gradient methods are used. The most simple of these is the method of steepest descents in which the design variables are changed to move in the direction of the gradient. This method is usually modified to make it more robust and efficient. Variants on this theme include the conjugate gradient method and quasi-Newton methods that estimate values of the second derivatives (Hessian matrix) to improve the estimate of the best search direction. Most of these methods use the gradient information to establish a search direction and then perform a one-dimensional search in this direction.

So that's it. We just put it on the computer and press Return and out pops a 777, right?

Not really. Despite its obvious utility, numerical optimization seems to have been talked about a lot more than it has been used. It certainly is talked about a great deal. Prof. Holt Ashley gave the AIAA Wright Brothers Lecture in 1982. It was entitled, "On Making Things the Best -- Aeronautical Uses of Optimization". For this lecture, he surveyed the relevant literature and found 4550 papers on optimal control, 2142 on aerodynamic optimization, 1381 on structural optimization. A total of 8073 papers, along with surveys, texts, etc.. But Ashley had a hard time finding a single case where this formal procedure was employed by industry. In his paper he cites the results of an informal survey he conducted on the uses of optimization.

Typical responses included:

- From an aeronautical engineer, experienced in civil and aeronautical structures, "One of the reasons that I stopped work in optimization was my dismay ... that there were so very few applications."
- From a Dean of Engineering who has known the field for over a quarter century: "I do not recollect any applications."
- From a foremost specialist on synthesis with aeroelastic constraints, "I am sorry, but I don't really have any..."
- From a recently-retired senior design engineer, describing events at his aerospace company, "For fifteen years I beat my head against a stone wall ... The end was: formal optimization techniques were never used in aircraft design (even to this day!). The company was forced to use them in its subsequent ICBM and space programs."

A great deal has changed in the past decade, however, and optimization techniques are (only now) starting to become a standard tool for engineering design. Why has it taken so long for these methods to become well-used, and why, still, are the methods not used everywhere?

There are a host of reasons:

1) First, the analysis, itself, of a complete aircraft configuration is rather complex, even without the optimization. Program size and complexity are such that only very well-documented and well-maintained computer programs can be used. These programs are often written by many people (some of whom have retired) over many years and it is very difficult for an individual to know what the program can and cannot do. Many grandiose plans for completely integrated aircraft design systems have fallen by the wayside because they quickly become unmanageable.

2) Any analysis makes certain approximations and leaves certain things out. Optimizers, however, may not understand that certain considerations have been omitted. Optimizers are notorious for breaking programs. They exploit any weakness in the analysis if that will lead to a "better" answer. Even when the result appears reasonable, several difficult-to-quantify factors are often omitted: the compatibility with future growth versions for instance, or the advantages associated with fleet commonality. Moreover, optimums are, by definition, flat, so that leaving something out of the objective can cause large discrepancies in the answer - the optimum is never optimal. Some examples are shown in figures 5 and 6. These are examples in which real-life testing, rather than reliance on simulation, is critical.

3) Ruts, creativity, and local minima: New technology changes the assumptions, constraints, experience. An optimizer is limited to consider those designs that are described by the selected parameter set. Thus, an optimizer and analysis that was written to design conventional structures may not know enough to suggest the use of composites. An optimizer did not invent the idea of folding tips for a 777, nor would it create winglets, canards, active controls, or laminar flow, unless the programmer anticipated this possibility, or at least permitted the possibility, in the selection of design variables. (Figure 7.)

4) Noisy objective functions: When the analysis involves table look-ups or requires iterative intermediate computations, the objective function can appear to vary in a non-smooth fashion. This causes difficulties for many optimizers, especially those that require derivative information.

5) The dangers of sub-optimization: It is tempting to fix many design variables and select a few at a time to optimize, then fix these and vary others. This is known as partial optimization or sub-optimization and, while it makes each study more understandable, it can lead to wrong answers. One must be very careful about the selection of design variables and avoid partial optimization.

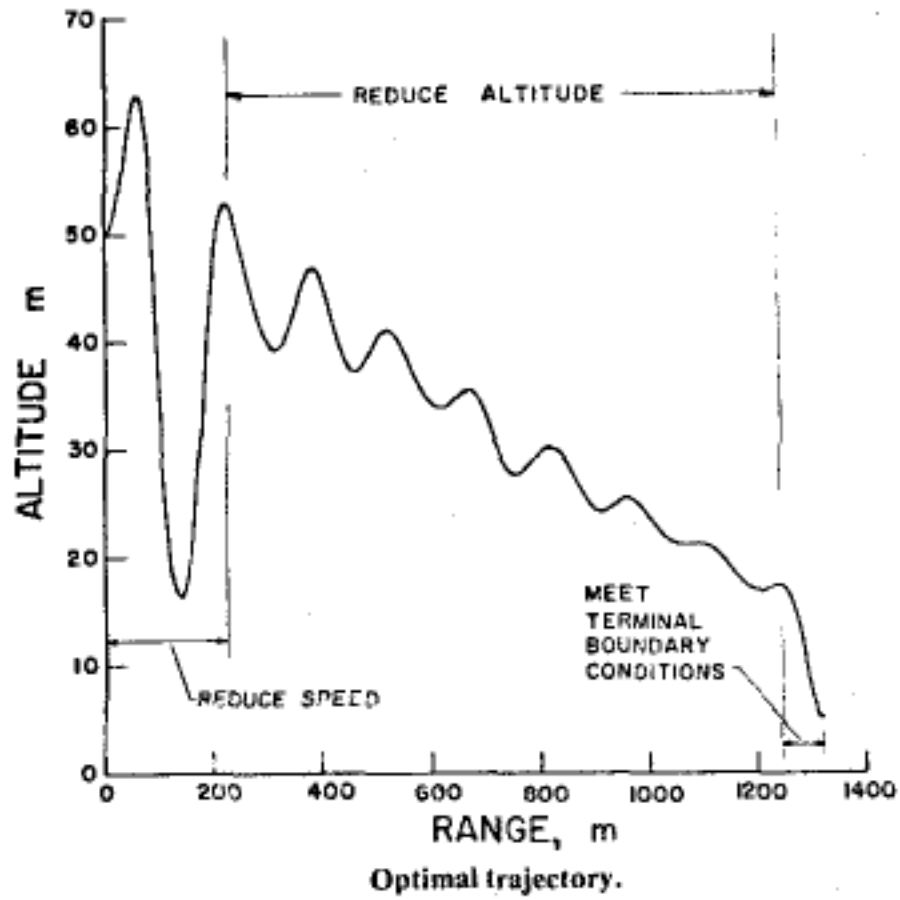

Figure 5. "Optimal" Flight Path for Landing a Sailplane - An example of what happens when the analysis does not include sufficient constraints.

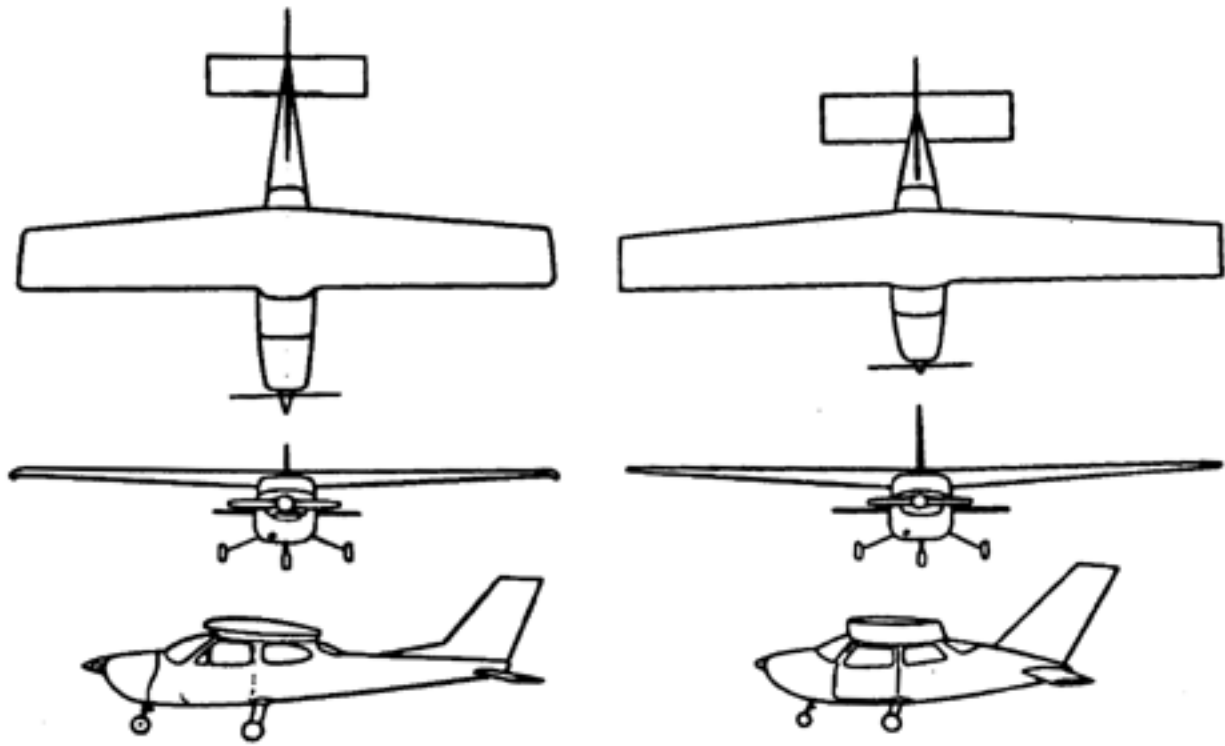

Figure 6. "Optimal" Redesign of Cessna Cardinal. Optimizer has exploited simplified lateral stability constraints.

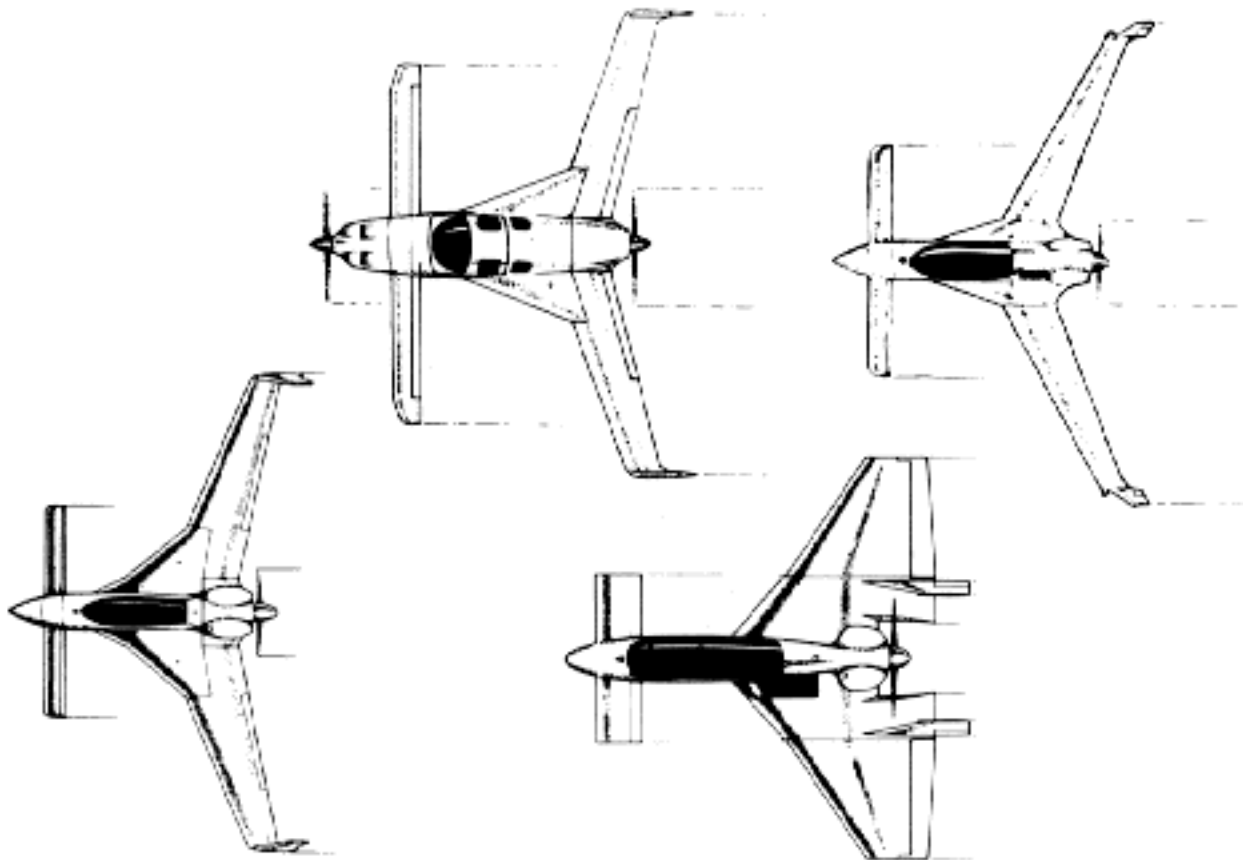

Figure 7. A Variety of Designs Not Likely Invented by an Optimizer

6) Finally, optimization is sometimes not needed as there are few feasible designs may exist. In aircraft design, problems are often constraint-bound. That is, the constraints, themselves dictate the values of the design variables. When many constraints are active at the optimum, the value of the gradient is not zero, and a modification the gradient methods are needed. One approach to constrained optimization is simply to add a penalty to the objective function when the constraints are violated. Such penalty function methods sometime work, but lead to rather difficult design space topologies and can cause problems for the optimizer. Often the constraints are visualized (at least as they affect up to two design variables) in a plot called a summary chart. Examples are shown on the following pages.

A variety of new approaches are being explored to avoid these difficulties. Improved software development environments reduce some of the problems of communication, maintenance, etc.. Simply changing the computer language (even from Fortran IV to Fortran 90) helps in understanding and maintaining the program. Artificial intelligence (AI) is being used in several ways to improve the efficiency of aircraft design. The ideas are beginning to be described in conference and journal papers on the subject. Watch for articles in Aerospace America, AIAA Journal of Aircraft, and similar publications.

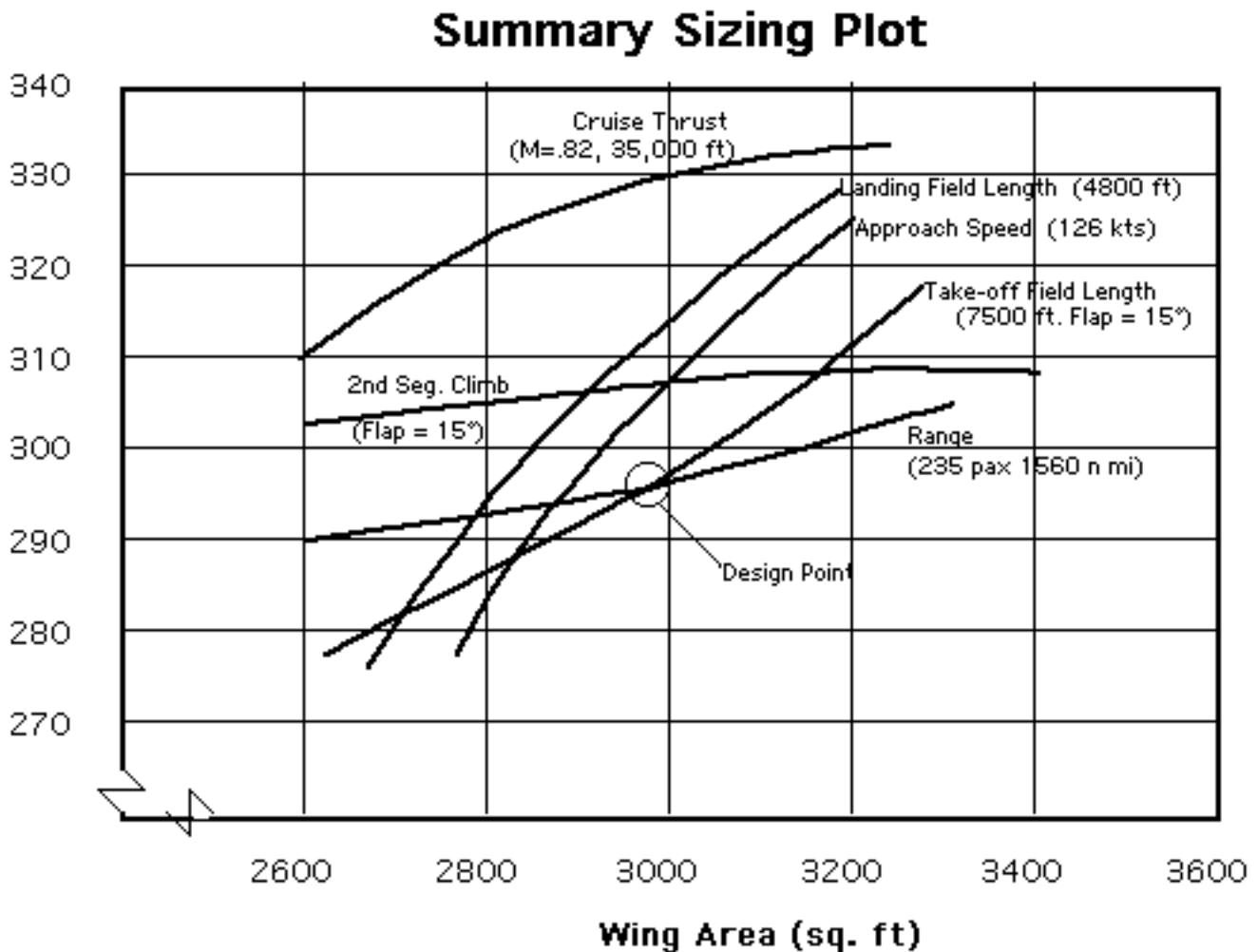

Figure 8. Example Summary Chart Showing Constraints - Sometimes little room exists in design space once the constraints are satisfied.

Excercise 1: Design Requirements

Enter some of the prime design requirements and objectives for your aircraft below. By clicking on the map, you may choose destination and departure locations. The range and block time are computed here.

Computational Methods in Aircraft Design

Juan Alonso

Computational methods have revolutionized the aircraft design process. Prior to the mid sixties aircraft were designed and built largely without the benefit of computational tools. Design information was mostly provided by the results of analytic theory combined with a fair amount of experimentation. Analytic theories continue to provide invaluable insight into the trends present in the variation of the relevant parameters in a design. However, for detailed design work, these theories often lack the necessary accuracy, especially in the presence of non-linearities (transonic flow, large structural deflections, real-life control systems). With the advent of the digital computer and the fast development of the field of numerical analysis, a variety of complex calculation methods have become available to the designer. Advancements in computational methods have pervaded all disciplines: aerodynamics, structures, propulsion, guidance and control, systems integration, multidisciplinary optimization, etc.

Role of Computational Methods

The role of computational methods in the aircraft design process is to provide detailed information to facilitate the decisions in the design process at the lowest possible cost and with adequate turnaround (turnaround is the required processing time from the point a piece of information is requested until it is finally available to the designer in a form that allows it to be used). In summary, computational methods ought to:

- Allow the simulation of the behavior complex systems beyond the reach of analytic theory.
- Provide detailed design information in a timely fashion.
- Enhance our understanding of engineering systems by expanding our ability to predict their behavior.
- Provide the ability to perform multidisciplinary design optimization.
- Increase competitiveness and lower design/production costs.

Computational methods are nothing but tools in the aircraft designer's toolbox that allow him/her to complete a job. In fact, the aircraft designer is often more interested in the interactions between the disciplines that the methods apply to (aerodynamics, structures, control, propulsion, mission profile) than in the individual methods themselves. This view of the design process is often called multidisciplinary design (one could also term it *multidisciplinary computational design*). Moreover, a designer often wants to find a combination of design choices for all the involved disciplines that produces an overall better airplane. If the computational prediction methods for all disciplines are available to the designer, optimization procedures can be coupled to produce *multidisciplinary design optimization* (MDO) tools. In a nutshell, via a combination of analytic methods and simple computational tools, this is what we will try to accomplish in AA241: an optimum aircraft design for a specifically chosen mission.

The current status of computational methods is such that the use of a certain set of tools has become routine practice at all major aerospace corporations (this includes simple aerodynamic models, linear structural models, and basic control system design). However, a vast amount of work remains to be done in order to make more refined non-linear techniques reach the same routine use status. Moreover, MDO work has been performed using some of the simpler models, but only a few attempts have been made to couple high-fidelity non-linear disciplines to produce optimum designs.

Potential Problems Arising from the Misguided Use of Computational Techniques

Although computational methods are a wonderful resource to facilitate the process of aircraft design, their misuse can have catastrophic consequences. The following considerations must be always in your mind when you decide to accept as valid the results of a computational procedure:

- *A solution is only as good as the model that is being solved:* if you try to solve a problem with high non-linear content using a computational method designed for linear problems your results will make no sense.
- *The accuracy of a numerical solution depends heavily on the sophistication of the discretization procedure employed and the size of the mesh used.* Lower order methods with underresolved meshes provide solutions where the margin of error is quite large.

- *The range of validity of the results of a given calculation depends on the model that is at the heart of the procedure:* if you are using an inviscid solution procedure to approximate the behavior of attached flow, but the actual flow is separated, your results will make no sense.
- *Information overload.* Computational procedures flood the designer with a wealth of information that sometimes is complete nonsense! When analyzing the results provided by a computational method do not concentrate on how beautiful the color pictures are, be sure to apply your knowledge of basic principles, and make sure that the computational results follow the expected trends.

Let's examine the status of the more relevant aerospace disciplines to which computational methods have been applied. These include applied aerodynamics, structural analysis, and control system design.

Computational Aerodynamics

Computational methods first began to have a significant impact on aerodynamics analysis and design in the period of 1965-75. This decade saw the introduction of panel methods which could solve the linear flow models for arbitrarily complex geometry in both subsonic and supersonic flow. It also saw the appearance of the first satisfactory methods for treating the nonlinear equations of transonic flow, and the development of the hodograph method for the design of shock free supercritical airfoils.

Panel methods are based on the distribution of surface singularities on a given configuration of interest, and have gained wide-spread acceptance throughout the aerospace industry. They have achieved their popularity largely due to the fact that the problems can be easily setup and solutions can be obtained rather quickly on today's desktop computers. The calculation of potential flows around bodies was first realized with the advent of the surface panel methodology originally developed at the Douglas company. During the years, additional capability was added to these surface panel methods. These additions included the use of higher order, more accurate formulations, the introduction of lifting capability, the solution of unsteady flows, and the coupling with various boundary layer formulations.

Panel methods lie at the bottom of the complexity pyramid for the solution of aerodynamic problems. They represent a versatile and useful method to obtain a good approximation to a flow field in a very short time. Panel methods, however, cannot offer accurate solutions for a variety of high-speed non-linear flows of interest to the designer. For these kinds of flows, a more sophisticated model of the flow equations is required. The figure below (due to Pradeep Raj) indicates a hierarchy of models at different levels of simplification which have proved useful in practice. Efficient flight is generally achieved by the use of smooth and streamlined shapes which avoid flow separation and minimize viscous effects, with the consequence that useful predictions can be made using inviscid models. Inviscid calculations with boundary layer corrections can provide quite accurate predictions of lift and drag when the flow remains attached, but iteration between the inviscid outer solution and the inner boundary layer solution becomes increasingly difficult with the onset of separation. Procedures for solving the full viscous equations are likely to be needed for the simulation of arbitrary complex separated flows, which may occur at high angles of attack or with bluff bodies. In order to treat flows at high Reynolds numbers, one is generally forced to estimate turbulent effects by Reynolds averaging of the fluctuating components. This requires the introduction of a turbulence model. As the available computing power increases one may also aspire to large eddy simulation (LES) in which the larger scale eddies are directly calculated, while the influence of turbulence at scales smaller than the mesh interval is represented by a subgrid scale model.

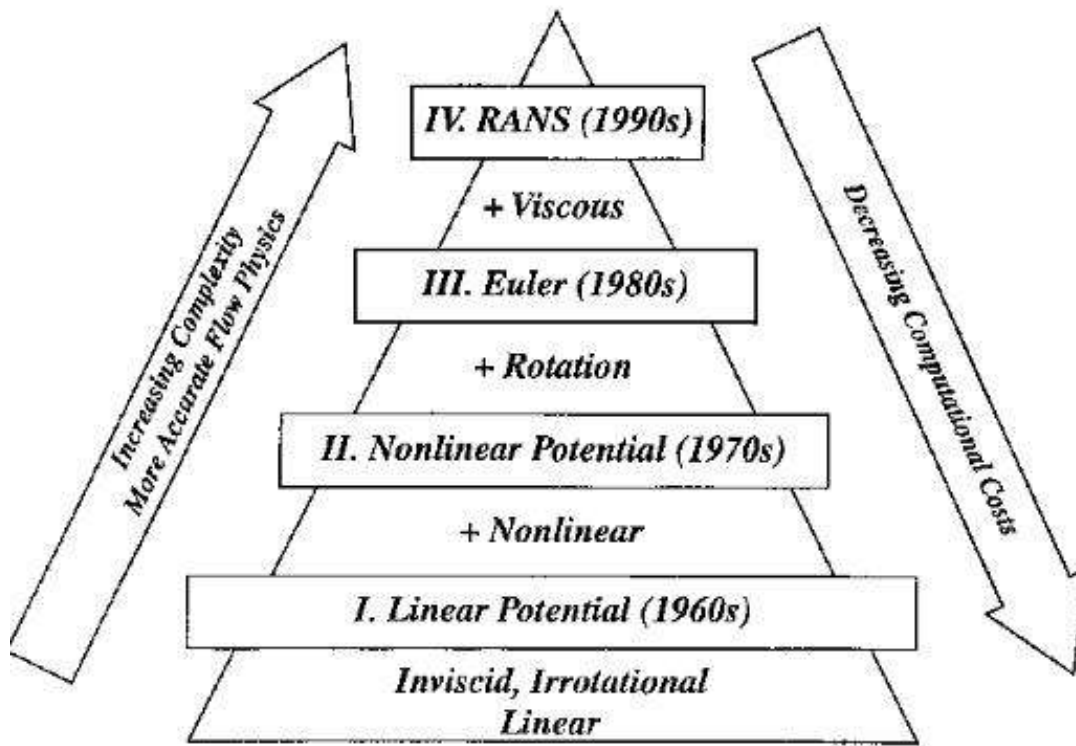

Figure 1: Hierarchy of Aerodynamic Models with Corresponding Complexity and Computational Cost.

Computational Cost

Computational costs vary drastically with the choice of mathematical model. Panel methods can be effectively used to solve the linear potential flow equation with personal computers (with an Intel 486 microprocessor, for example). Studies of the dependency of the result on mesh refinement have demonstrated that inviscid transonic potential flow or Euler solutions for an airfoil can be accurately calculated on a mesh with 160 cells around the section, and 32 cells normal to the section. Using multigrid techniques 10 to 25 cycles are enough to obtain a converged result. Consequently airfoil calculations can be performed in seconds on a Cray YMP, and can also be performed on 486-class personal computers. Correspondingly accurate three-dimensional inviscid calculations can be performed for a wing on a mesh, say with $192 \times 32 \times 48 = 294,912$ cells, in about 20 minutes on a high-end workstation (SGI R10000), in less than 3 minutes using eight processors, or in 1 or 2 hours on older workstations such as a Hewlett Packard 735 or an IBM 560 model.

Viscous simulations at high Reynolds numbers require vastly greater resources. Careful studies have shown that between 20 and 32 cells in the normal direction to the wall are required for accurate resolution of the boundary layer. In order to maintain reasonable aspect ratio in all the cells in the mesh (for reasons of numerical accuracy and convergence) on the order of 512 cells are necessary in the direction wrapping around the wing, and at least 64 cells are required in the spanwise direction. This leads to over 2 million cells for a minimally resolved viscous wing calculation. Reynolds Averaged Navier-Stokes calculations of this kind can be computed in about 1 hour on a Cray C-90 computer or over 10 hours in a typical high-end workstation. These computations not only require powerful processors; they also need computers with large memory sizes (1-2 Gb for this kind of calculations).

Sample Panel Method Calculations

C130 Hercules Lifting Calculation

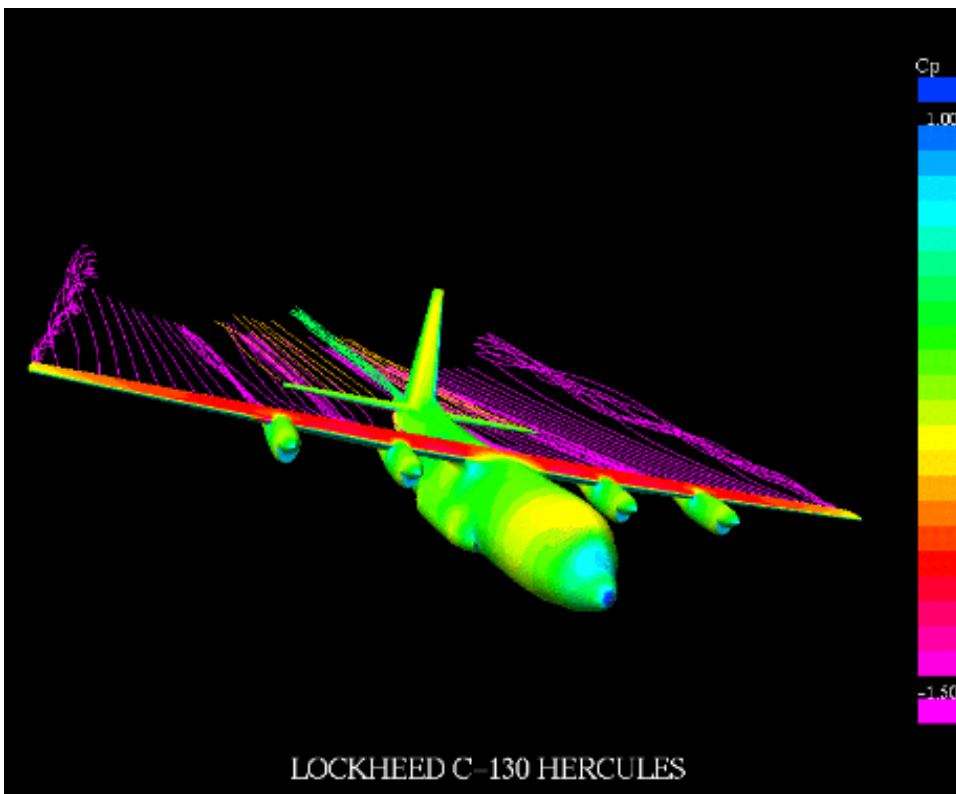

Calculation from VSAERO from [Analytical Methods](#)

Whitbread Race Sailboat



Hull, keel and bulb arrangement of Whitbread-race sailboat (courtesy of Dr. J. C. Vassberg)

Indy-500 Car

Indy Race Car

151,776 Panels

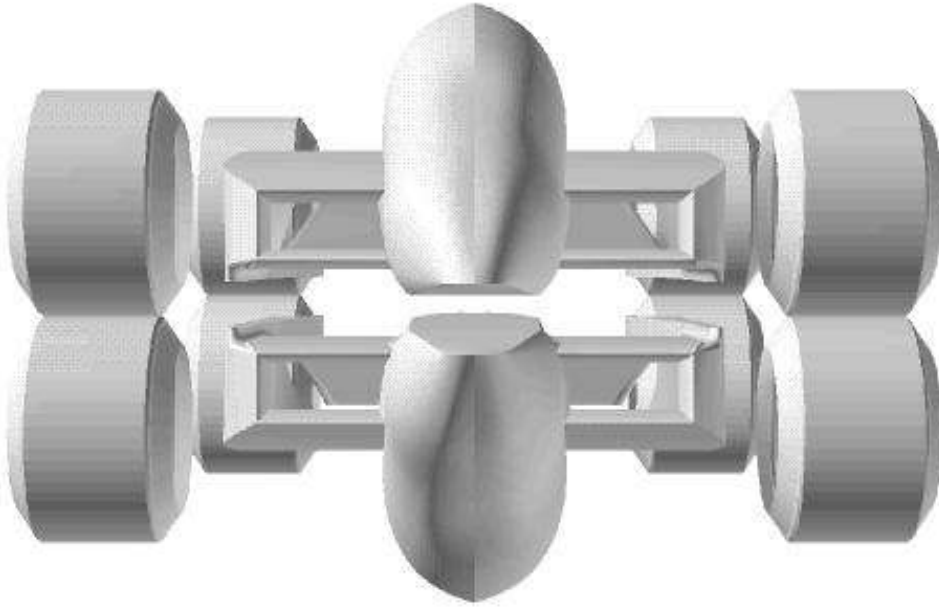

Geometry using the method of images to simulate ground effect (courtesy of Dr. J. C. Vassberg)

Indy Race Car

151,776 Panels

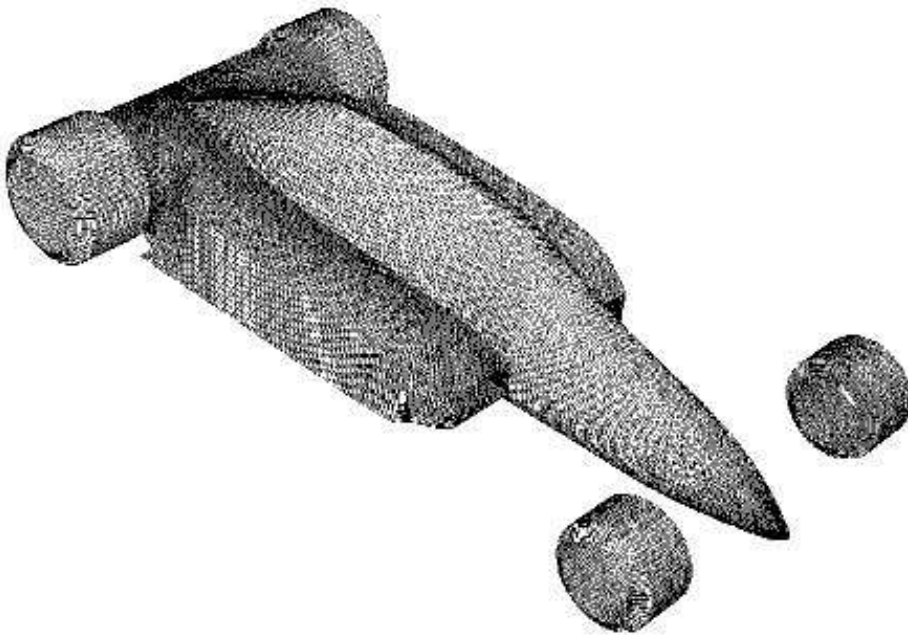

Geometry showing surface panelization (courtesy of Dr. J. C. Vassberg)

Indy Race Car

151,776 Panels

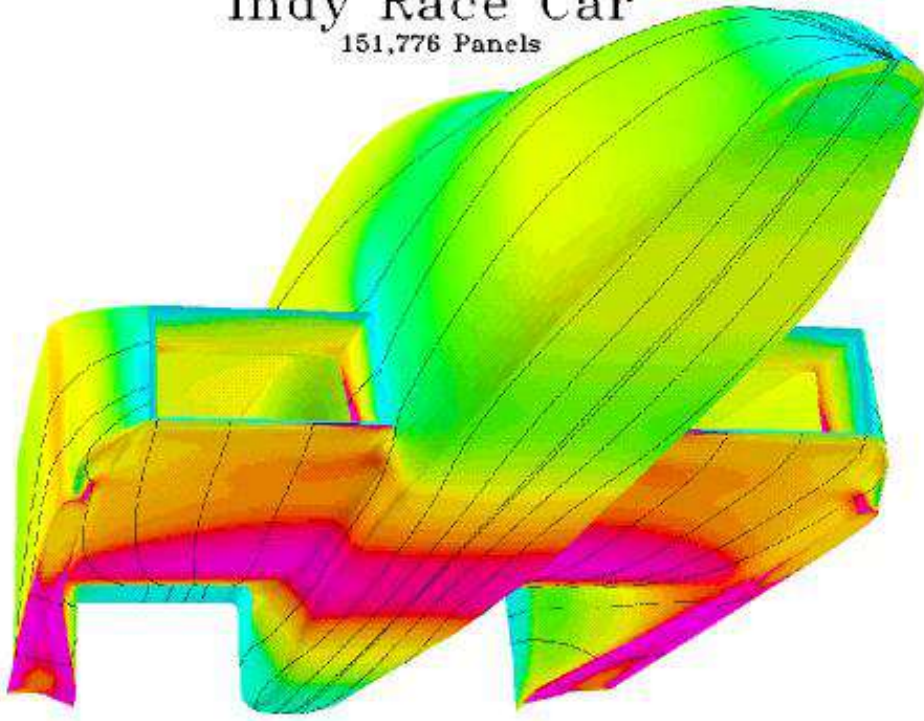

Pressure color contours and surface streamlines for the underside of the car (courtesy of Dr. J. C. Vassberg)

Sample Euler Calculations

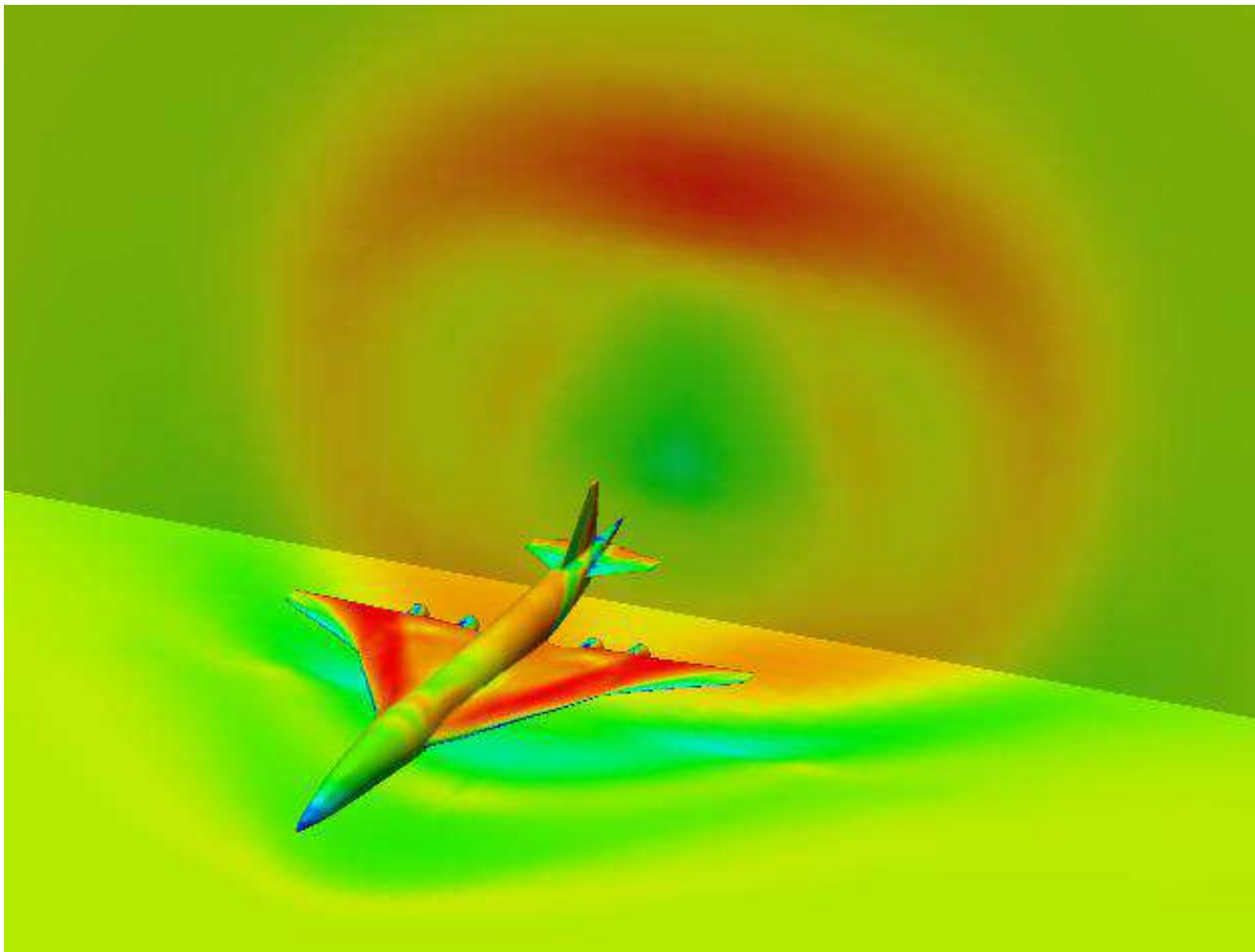

Unstructured Euler (inviscid) calculation on a generic HSCT (High-Speed-Civil-Transport) configuration. Pressure contours showing Mach cone footprint on vertical and horizontal cutting planes beneath and behind the aircraft.

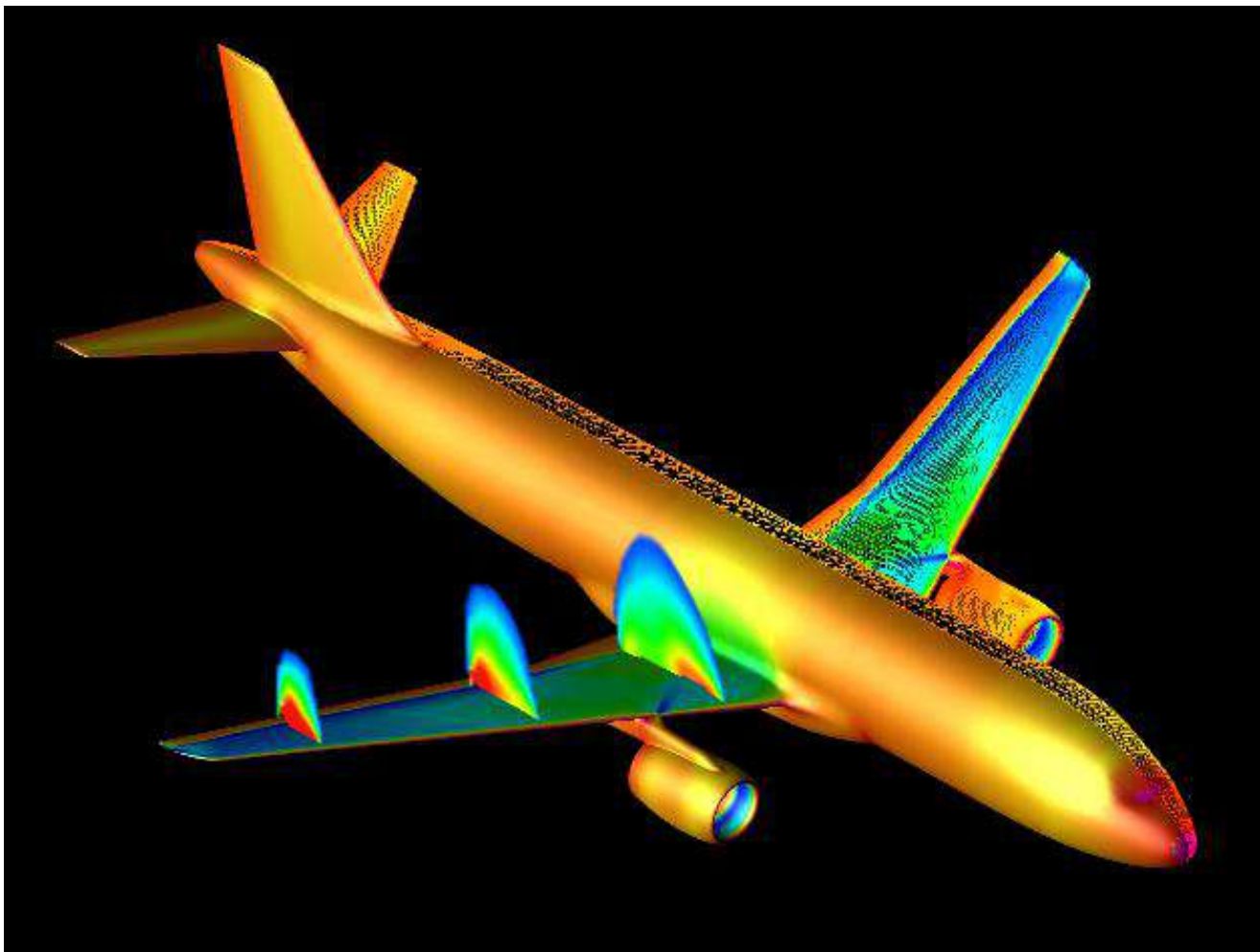

Airbus A-320 flow solution and unstructured mesh

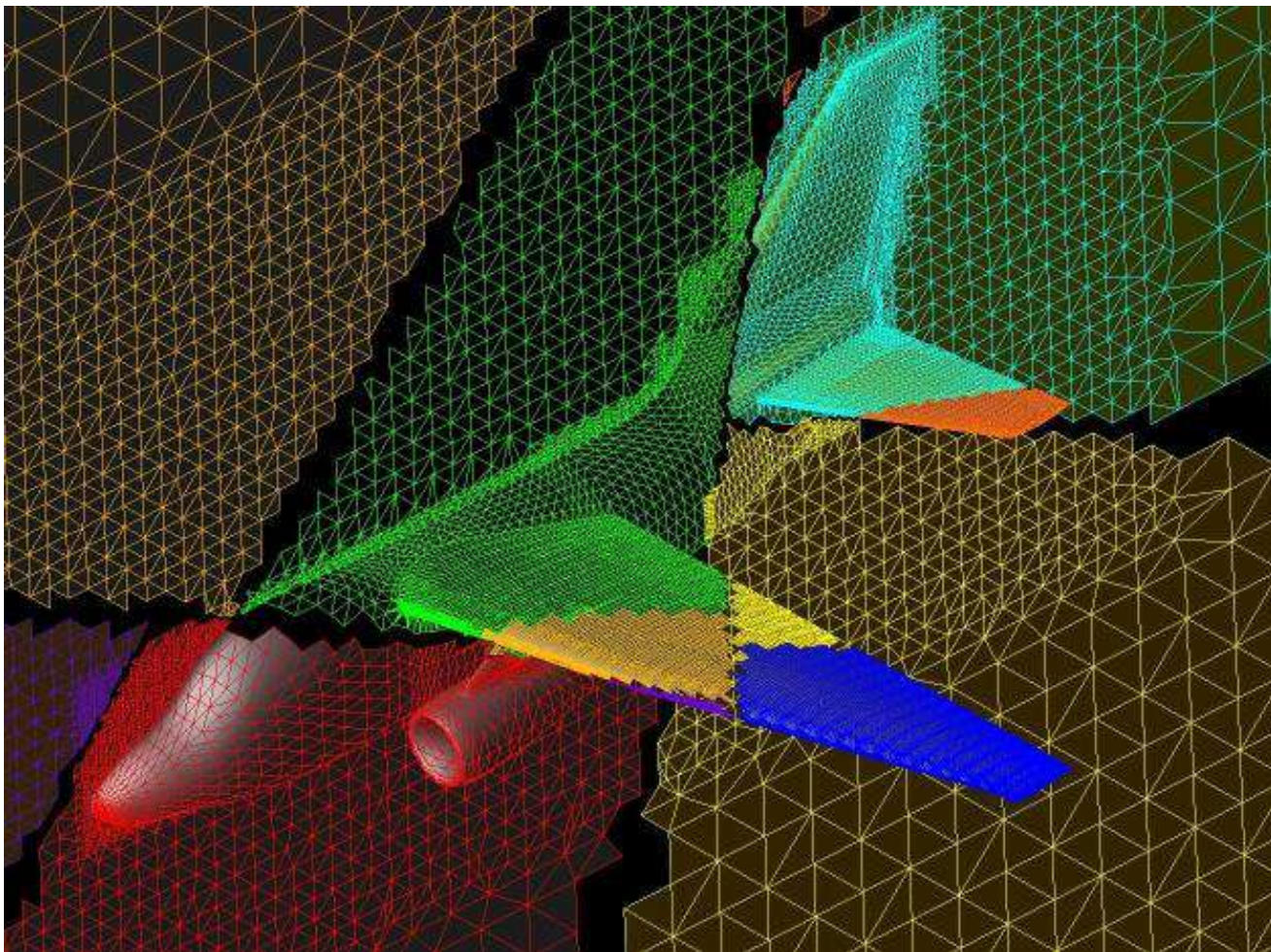

Parallel computation on an unstructured mesh showing the domain decomposition of 16 processors of a distributed memory computer.

Sample Navier-Stokes Calculations

Transonic Business Jet
FLO107-MB Solution
Baldwin-Lomax Turbulence Model
Mach = .82 240 Blocks 5.8 Million Mesh Points

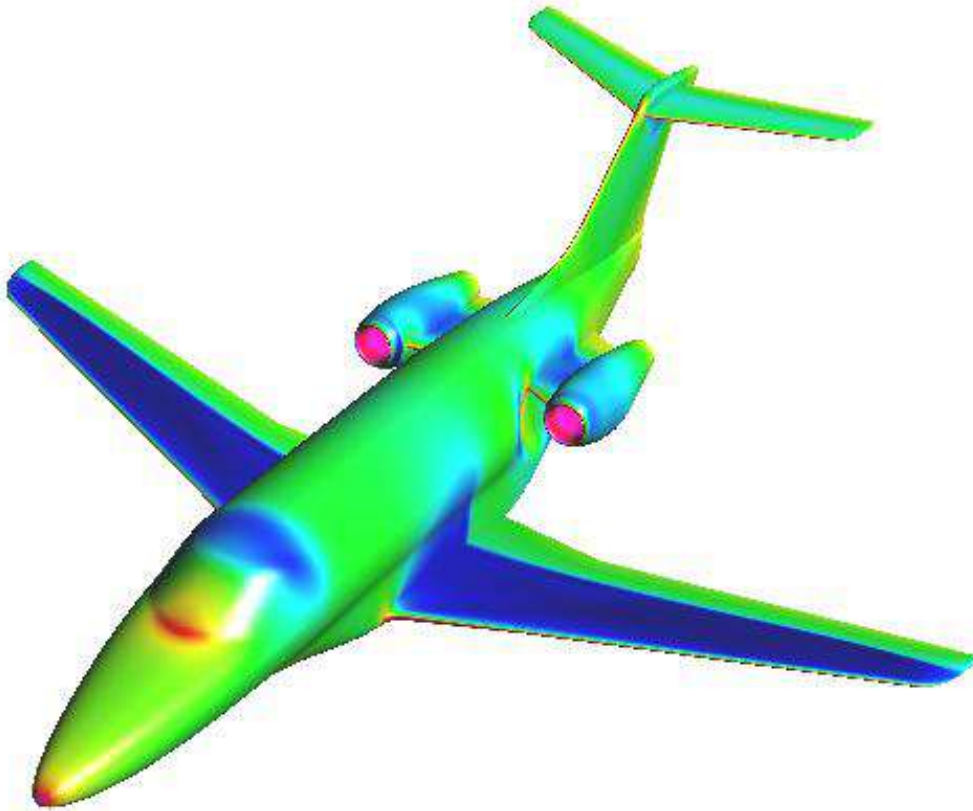

Viscous Calculation on a full configuration Raytheon-Beechcraft Premier business jet. Parallel computation on 32 processors of an [Origin2000](#).

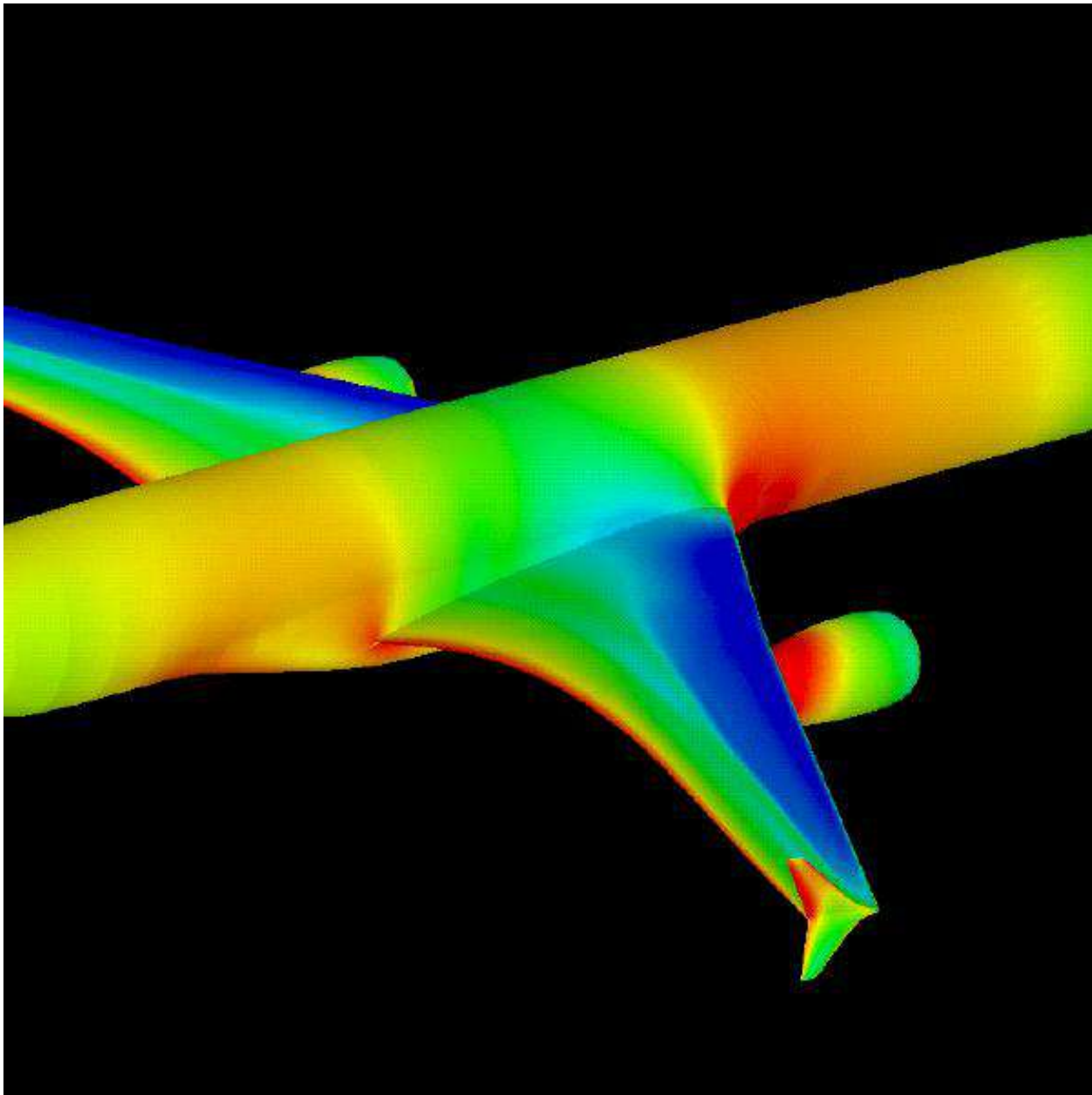

Viscous computation of a full configuration McDonnell Douglas MDXX with optimized wing. Approximate mesh size: 6,000,000 cells. Computation time: 4 hours on 32 processors of an IBM SP2.

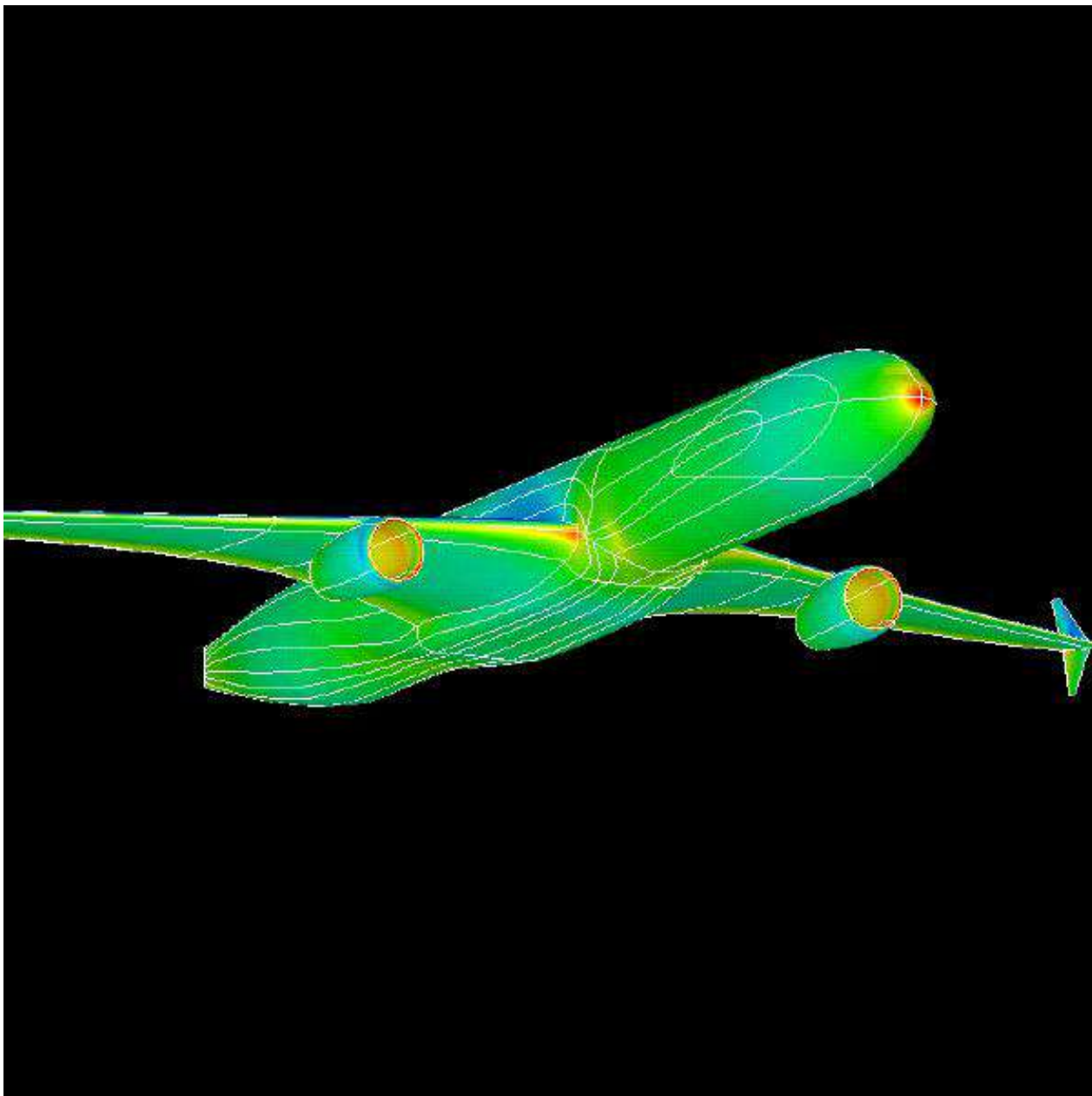

Viscous computation of a full configuration McDonnell Douglas MDXX with optimized wing. Approximate mesh size: 6,000,000 cells. Computation time: 4 hours on 32 processors of an IBM SP2. White lines denote mesh boundaries on the multiblock structured mesh.

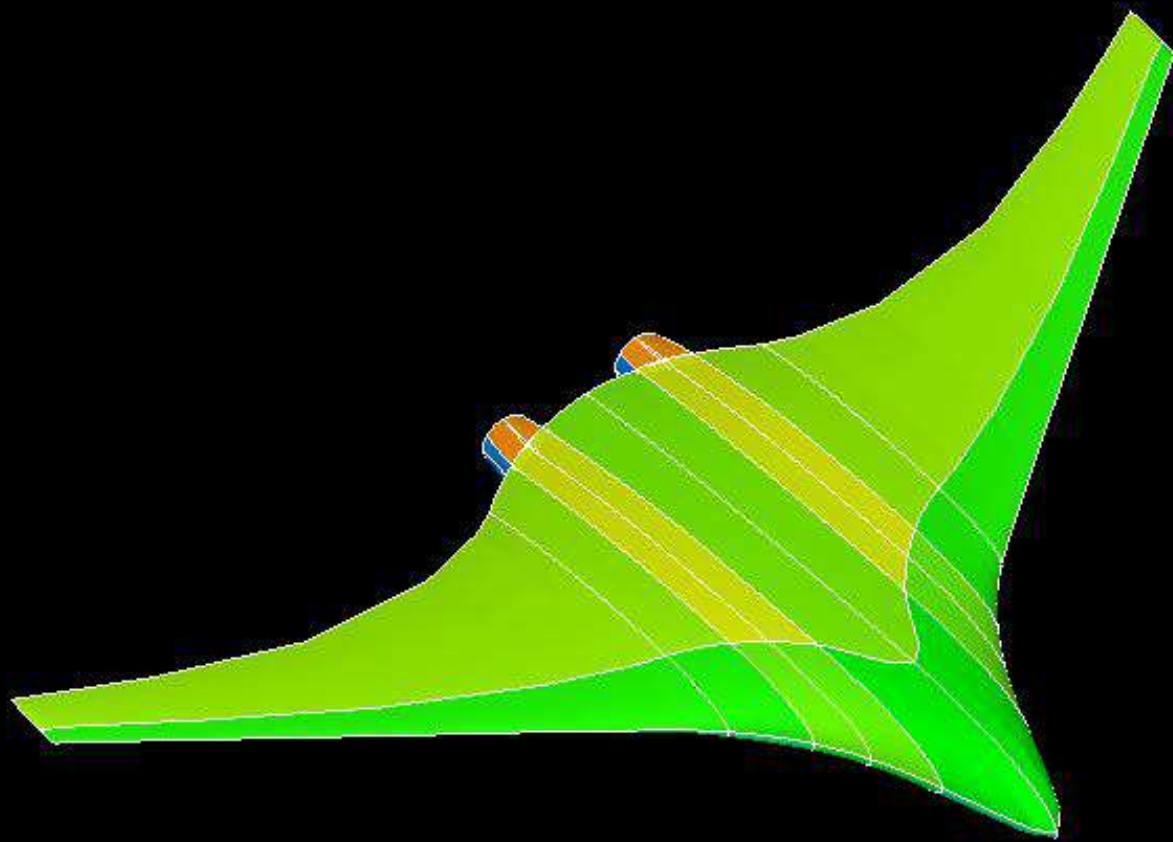

McDonnell Douglas X2C Blended Wing Body Configuration. Multiblock Mesh.

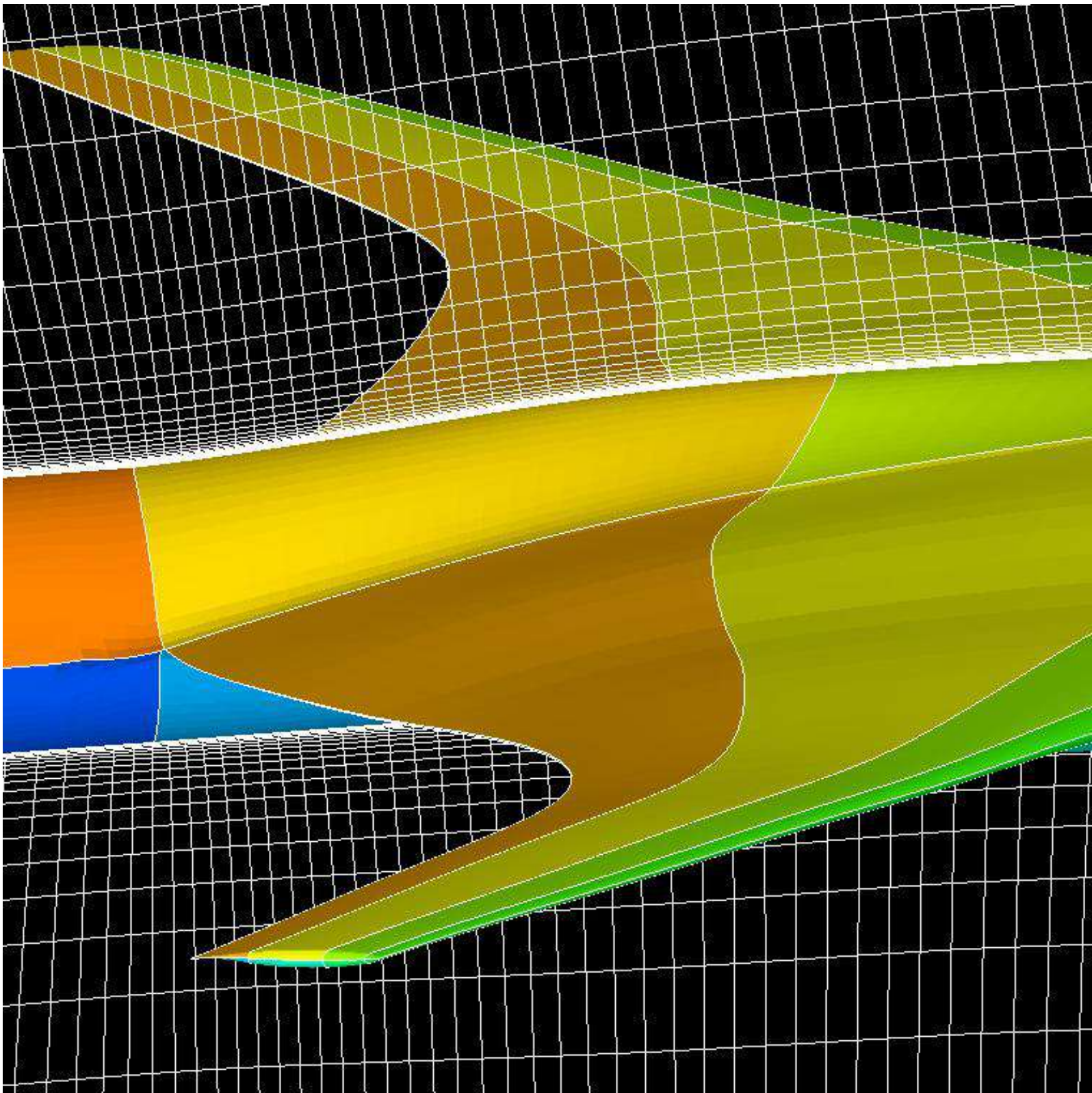

Detail of viscous mesh for wind tunnel model (notice sting in the rear part of the aircraft) of the Blended Wing Body Configuration. Notice the extreme bunching towards the surface of the airplane in order to resolve the high Reynolds number boundary layer.

Structural Analysis

Computational methods for structural analysis have reached an even higher level of maturity and several software packages that incorporate this technology are widely used throughout the aerospace industry. These programs are used to perform static and dynamic structural stress analysis in the linear and non-linear regimes, fatigue analysis, heat transfer calculations, etc.

Similarly to computational aerodynamics programs, structural analysis software is composed of numerical methods that solve the discretized structural equations of motion on a suitable mesh that is created from the geometry of the configuration in question. These numerical methods can also be used to optimize the shape of a given structure by repeated application of the analysis procedure with a suitable coupling to an optimization algorithm.

A few links to some of the more popular software packages are included below:

- [MSC/NASTRAN](#)
- [ANSYS](#)
- [ABAQUS](#)

In preliminary aircraft design one is typically more interested in the structural weight and performance of the principal load bearing structures (wing, fuselage, empennage). However, in the detailed design phase, computational structural analysis often includes a very large percentage of the aircraft components and parts that will be subject to static or dynamic loads.

Control System Design

The design of complex linear and non-linear control systems in aircraft has also benefited greatly from the appearance of computational methods. These systems range from components of an aircraft (hydraulic actuators, propulsions systems, fly-by-wire systems) to the control of the speed and attitude of the aircraft itself (autopilots, take-off and landing systems, oscillation damping systems).

Traditionally, control systems for aircraft and aircraft components were designed using linearized models of the plant and classical control theory. Large simplifications of the models were introduced because of the inability to easily handle large numbers of inputs and outputs in the system.

Software packages like [MATLAB and SIMULINK](#), and [MATRIXX](#) can routinely simulate the behavior of very large and complex control systems including some limited amount of non-linearities. The figure below shows the interactive design of a control system using SIMULINK.

The SIMULINK block library features an extensive library of components for quickly building dynamic systems graphically.

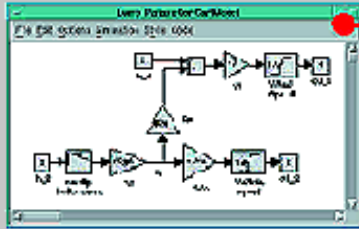

Above, hierarchical models let you add structure and organization to your most complex systems.

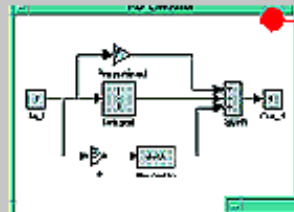
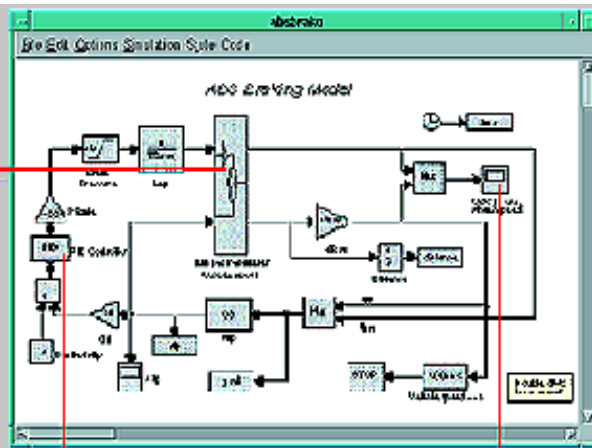

SIMULINK's mask facility gives you the option of creating custom dialog boxes and executing MATLAB's design and analysis commands during initialization.

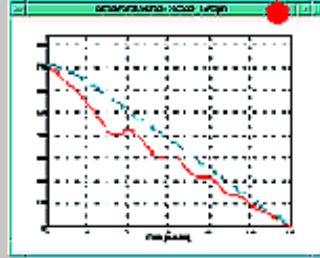
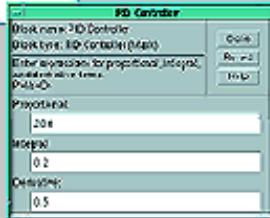

Scope and Autoscale Graph blocks enable you to monitor simulations "live," while To Workspace and From Workspace blocks let you share signals with the MATLAB workspace.

Computational Work in this Course

In this class we would like you to become familiar with a few computational tools so that you have some exposure to common industrial design practices. These computational tools will mainly be used to complement your work in some of the homework assignments. In particular, for aerodynamic design, we will be using the following tools:

- Airfoil design: Panel method with boundary layer coupling
- Airfoil analysis: Two-dimensional Euler solver for transonic flows.
- Wing design and analysis: Three-dimensional full potential flow solver with or without boundary layer coupling.

These tools are meant to assist you in coming up with better aircraft designs, but the bulk of the work will still be done using traditional techniques.

Cabin Layout and Fuselage Geometry

The design of the fuselage is based on payload requirements, aerodynamics, and structures. The overall dimensions of the fuselage affect the drag through several factors. Fuselages with smaller fineness ratios have less wetted area to enclose a given volume, but more wetted area when the diameter and length of the cabin are fixed. The higher Reynolds number and increased tail length generally lead to improved aerodynamics for long, thin fuselages, at the expense of structural weight. Selection of the best layout requires a detailed study of these trade-offs, but to start the design process, something must be chosen. This is generally done by selecting a value not too different from existing aircraft with similar requirements, for which such a detailed study has presumably been done. In the absence of such guidance, one selects an initial layout that satisfies the payload requirements.

The following sections are divided into several parts: the selection of cabin cross-section dimensions, determination of fuselage length and shape, FAR's related to fuselage design and seating, and finally considerations related to supersonic aircraft.

Cross-Section Design



It is often reasonable to start the fuselage layout with a specification of the cross-section: its shape and dimensions.

Cross-Section Shape

Most fuselage cross-sections are relatively circular in shape. This is done for two reasons

1. By eliminating corners, the flow will not separate at moderate angles of attack or sideslip
2. When the fuselage is pressurized, a circular fuselage can resist the loads with tension stresses, rather than the more severe bending loads that arise on non-circular shapes.

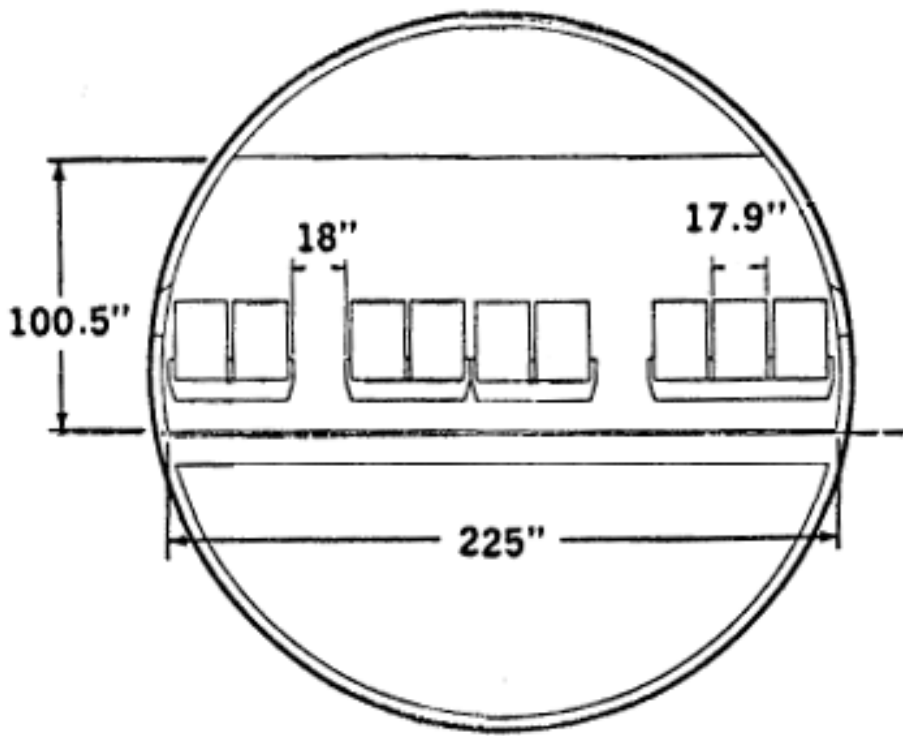

Many fuselages are not circular, however. Aircraft with unpressurized cabins often incorporate non-circular, even rectangular cabins in some cases, as dictated by cost constraints or volumetric efficiency.



Shorts 360
Aisle Height 6' 4"
Max Width 6' 4"



ATR-42
Aisle Height 6' 3"
Max Width 8' 5"

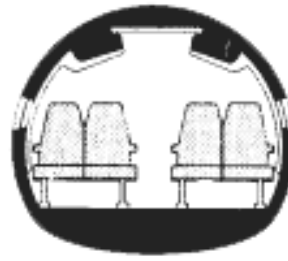

CN-235
Aisle Height 6' 2"
Max Width 8' 9"



DHC-8
Aisle Height 6' 0"
Max Width 8' 2"

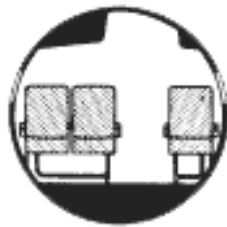

EMB-120
Aisle Height 5' 10"
Max Width 7' 1"



SF-340
Aisle Height 6' 0"
Max Width 7' 1"

Sometimes substantial amounts of space would be wasted with a circular fuselage when specific arrangements of passenger seats and cargo containers must be accommodated. In such cases, elliptical or double-bubble arrangements can be used. The double-bubble geometry uses intersecting circles, tied together by the fuselage floor, to achieve an efficient structure with less wasted space.

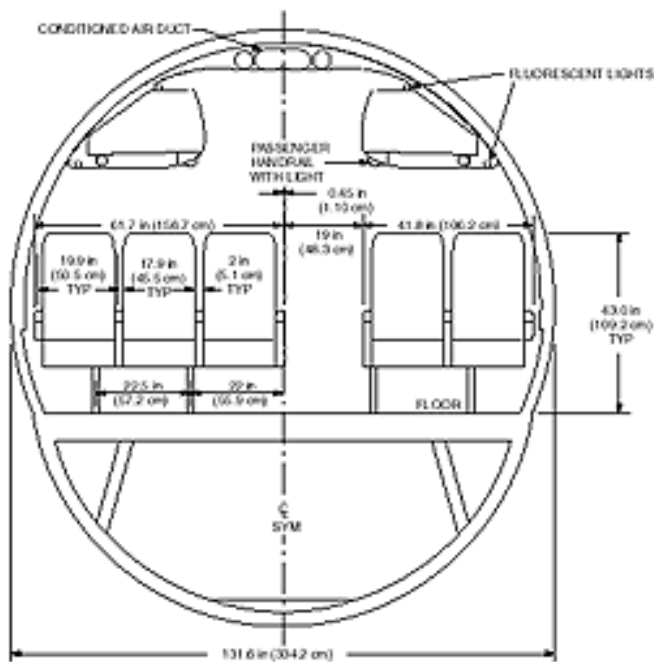

PASSENGER CABIN CROSS-SECTION COACH
717-200

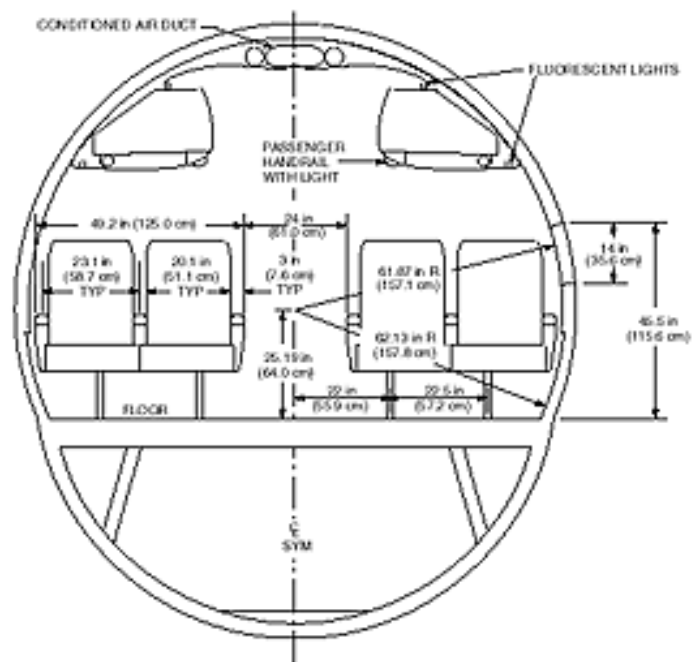

PASSENGER CABIN CROSS-SECTION
FIRST CLASS
717-200

Fuselage Diameter

The dimensions are set so that passengers and standard cargo containers may be accommodated. Typical dimensions for passenger aircraft seats are shown by way of the several examples below.

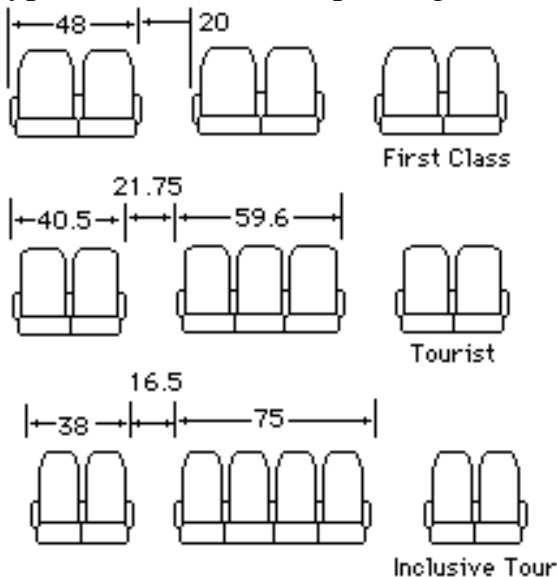

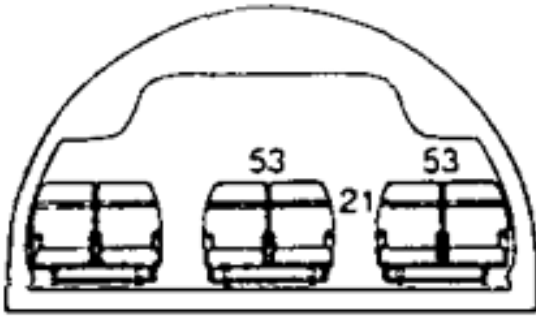

First class

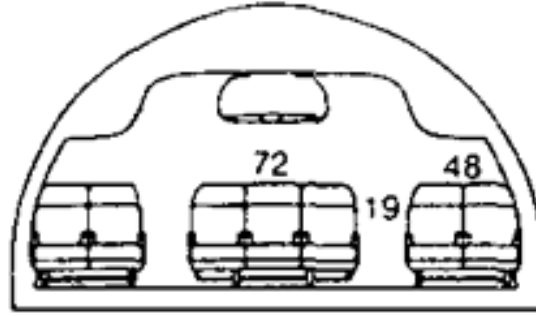

Business class

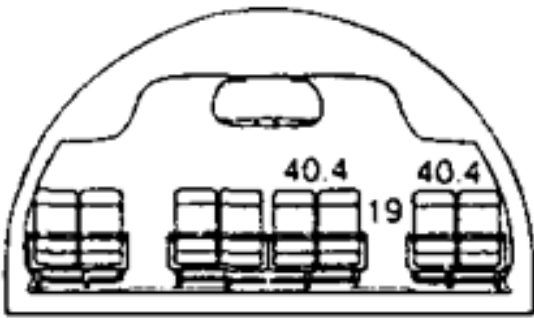

Economy class

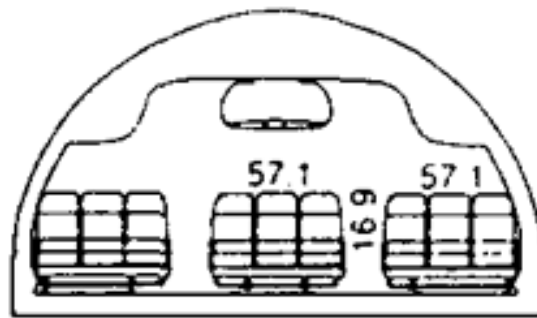

High density

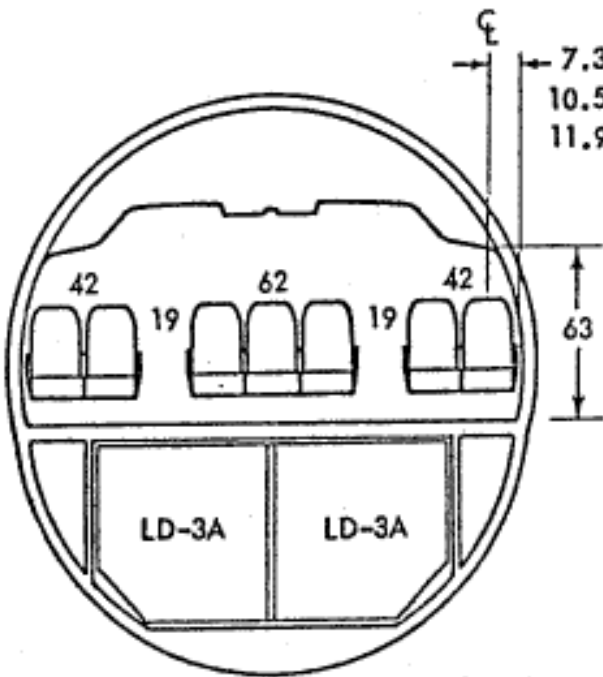

7.30 HEAD
10.58 SHOULDER
11.94 ARM

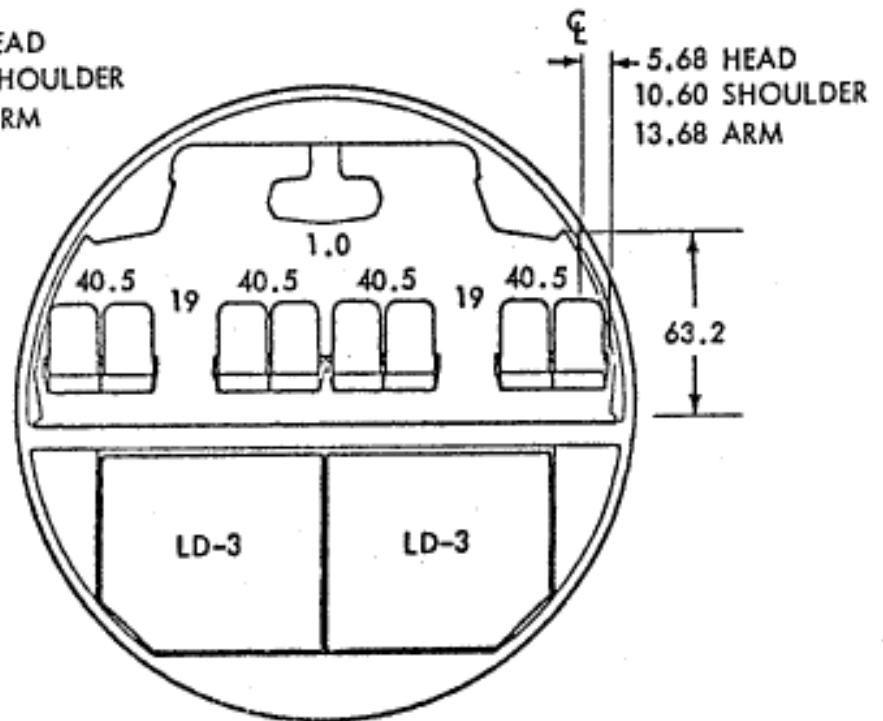

5.68 HEAD
10.60 SHOULDER
13.68 ARM

In addition, space must be available for cargo: either revenue cargo or luggage. Typical cargo weighs 10 lb/ft³ while luggage averages 12.5 lb/ft³ (Torenbeek). Passengers are generally allotted 35 to 40 lbs for

bags. This means about 4 ft³ per passenger for baggage. Most large airplanes have much more room than this, thus allowing space for revenue cargo. 767/ MD-11 / 747 values are more like 12 ft³ per person, although this is not a requirement. A 757 provides about 10 ft³ per passenger of bulk cargo volume. Since substantial income is generated by revenue cargo, it is often desirable to allow room for extra cargo. The preferred approach is to accommodate standard size containers, some of which are shown below.

All dimensions in inches.

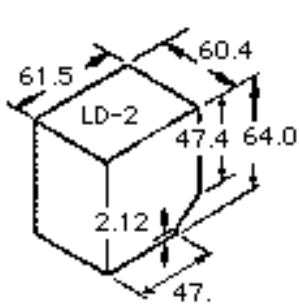

Volume: 120 cft
GW 2700 lbs

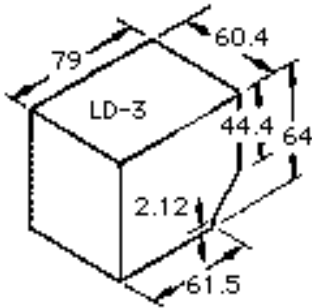

Volume: 158 cft
GW 3500 lbs

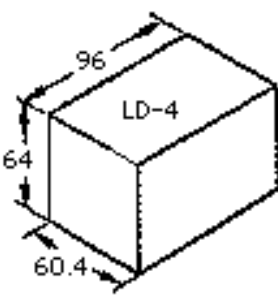

Volume: 195 cft
GW 5400 lbs

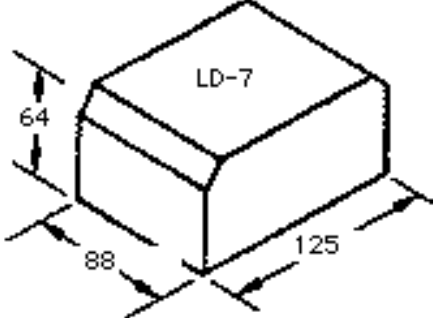
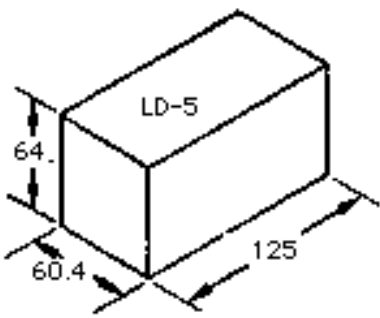

One must provide for a sidewall clearance of about 3/4" to account for shell deflection, seat width tolerances, and seat track location tolerances. Finally, the fuselage frame, stringers, and insulation thickness must be added to determine the fuselage outer diameter. Typically, the outer diameter is about 4% larger than the cabin diameter.

Business Jets

The diameter of smaller aircraft such as commuters and business aircraft is dictated by similar considerations, although cargo is not carried below the floor and the cabin height is much more a market-driven decision.

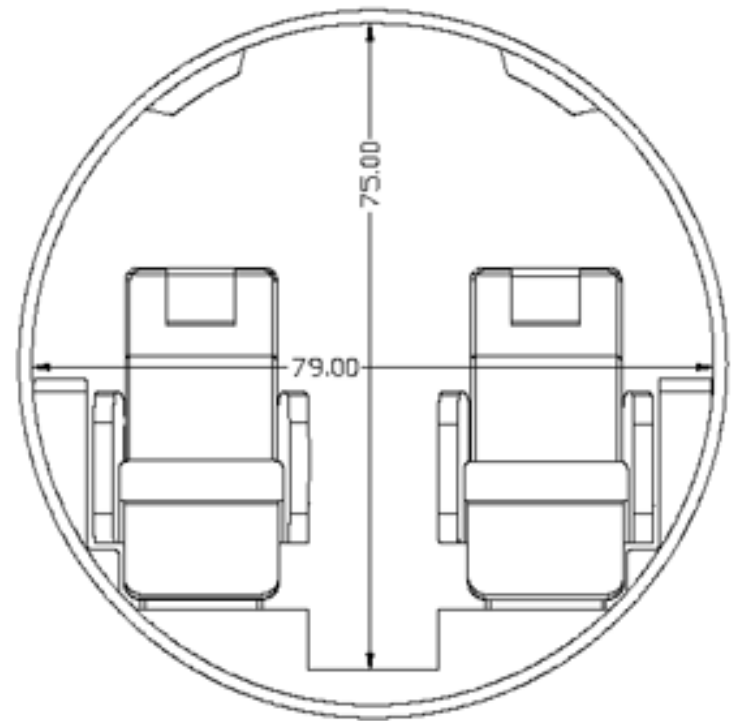
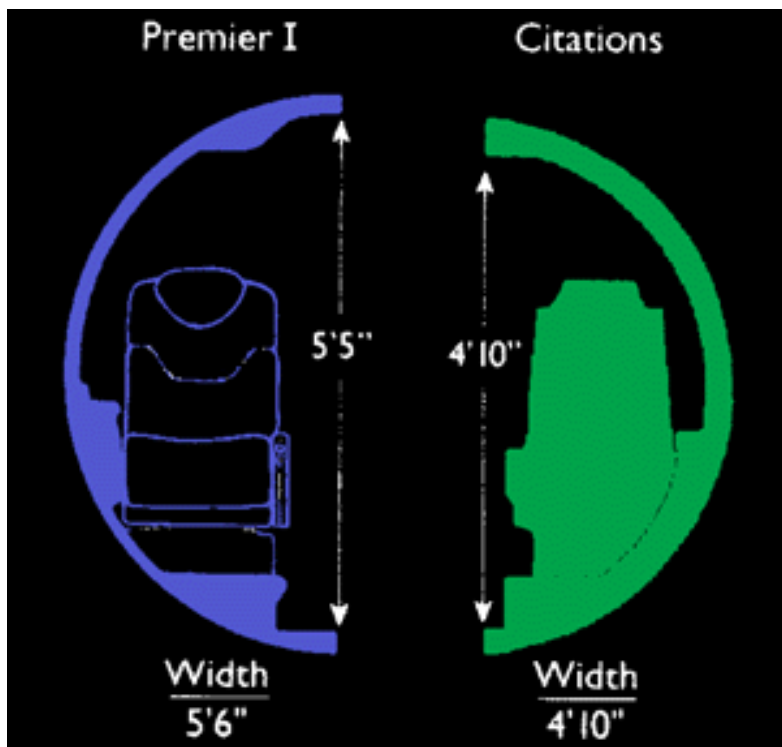

The interiors of business aircraft are laid out more flexibly than are commercial transports. Interior appointments often cost millions of dollars and can be very luxurious, especially for the larger long range aircraft such as the Gulfstream V or Global Express. Business aircraft based on commercial transports such as the Boeing Business Jet provide even greater possibilities.

Very Large Aircraft

Recent interest in very large aircraft suggests that additional creative possibilities exist for the aircraft interior. The figure below illustrates some concepts for large aircraft fuselage cross sections as described by Douglas Aircraft in 1966.

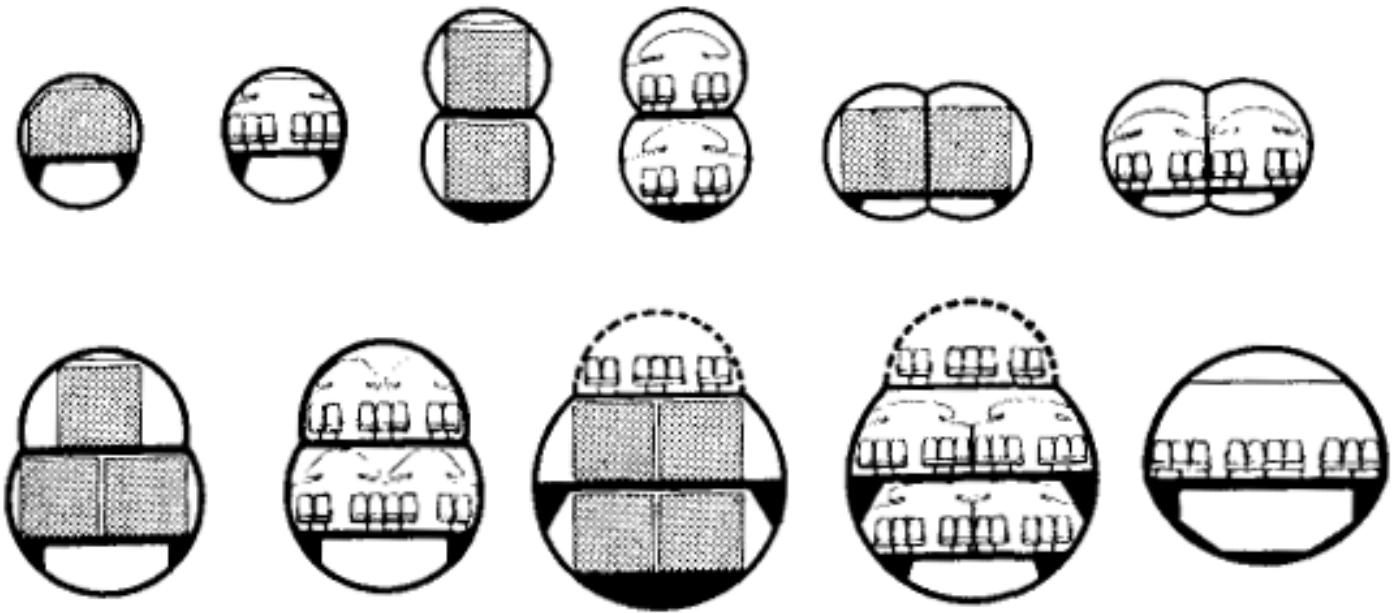

Some of the cross-sections that Douglas considered for a very large aircraft project, with a conventional cross-section to provide scale. A prime requirement was efficient accommodation of an 8'x8' container.

More recently, aircraft such as the A380 have been designed with interesting interior possibilities. The figures below show some of the options that were considered in the early design process.





The cross section of the A380 departs from the double-bubble concept with a rather eccentric ellipse as shown in the cross sections below.

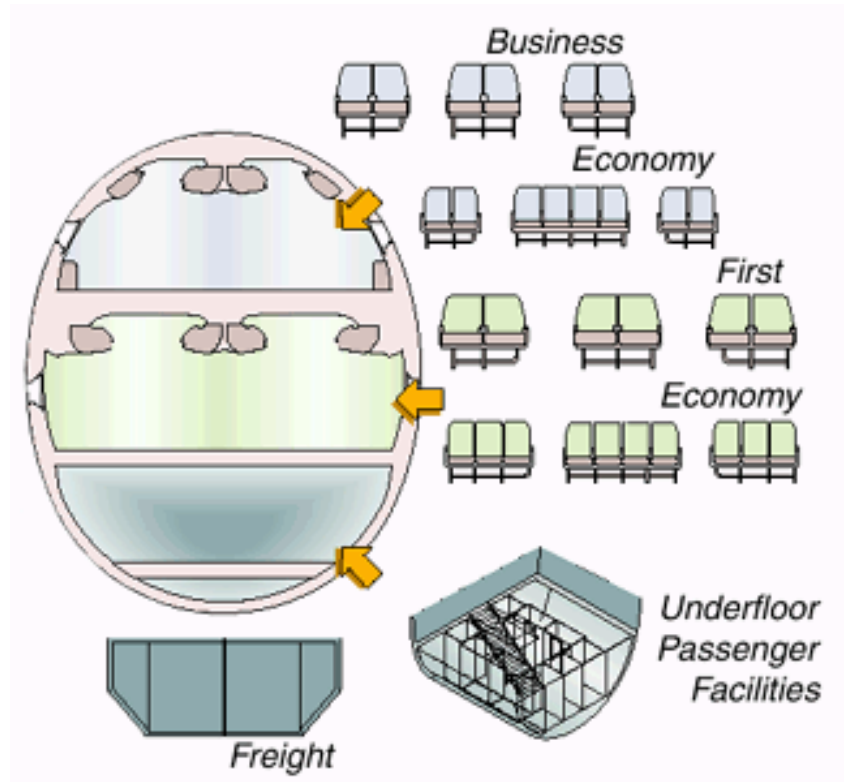
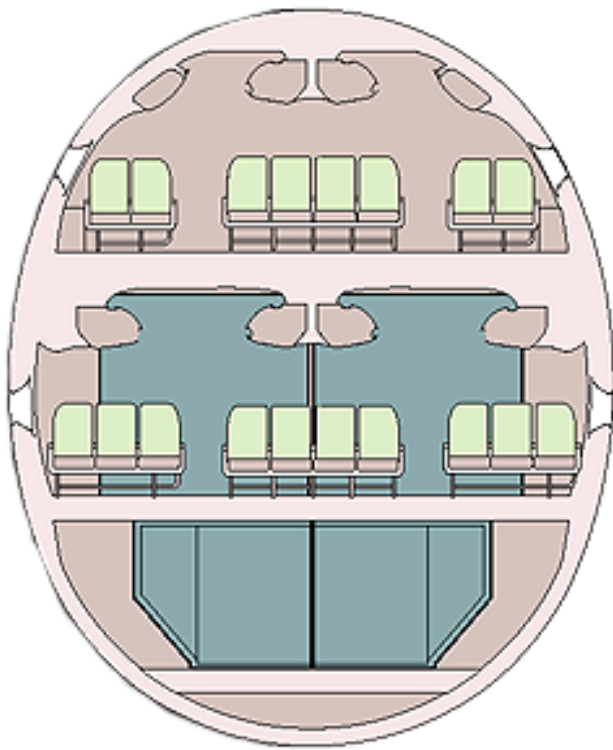

The table available here gives the external [cross-section dimensions and seating layouts](#) for a number of aircraft. Use the interactive layout computation in [exercise 2](#) to check your hand layout.

Sample Cross-section Dimensions and Seating Layouts

N per XSection	Max Abreast	NDecks	Layout	Width	Height	Aircraft Name
2	2	1	11	64	60	Lear25
2	2	1	11	65	70	DHC6
2	2	1	11	94	94	GIV
4	4	1	22	110	101	DHC7
4	4	1	22	104	104	Dash8-300
4	4	1	22	113	113	Concorde
5	5	1	23	134	134	BAC111
5	5	1	23	130	130	F100
5	5	1	23	131.5	143	MD80/717
6	6	1	33	148	-	737/757
6	6	1	33	147	-	DC8
6	6	1	33	140	140	BAE146
6	6	1	33	155.5	-	A320
7	7	1	232	198	217	767
7	7	1	232	186	-	7J7
8	8	1	242	222	-	A300/A310/A330/A340
9	9	1	252	237	237	MD11
9	9	1	252	235	235	L1011
9	9	1	252	244	244	777
16	9	2	333/232	266	336	A3xx Study (1994)
16	10	2	343/33	256	308	747
18	10	2	343/242	266	336	A380 Coach
19	11	2	353/242	-	-	MD-12 (study)
19	11	2	2342/242	307	373	Boeing NLA (study)
26	10	3	343/343/33	261	403	A 3-deck guess
29	12	3	343/363/232	335	403	Based on Douglas Study

Exercise 2: Fuselage Cross-Section

Enter fuselage cross-section parameters.

About the input variables:

- **Seat Width:** The width of the seat including armrests associated with that seat (inches).
- **Aisle Width:** The width of the aisle in inches.
- **Main Deck Seat Layout:** Distribution of seats and aisles written as an integer. 32 means 3 seats together, then an aisle, then 2 seats. 353 means a twin aisle airplane with 3 seats then an aisle, then 5 seats in the center, then another aisle, then another 3 seats.
- **Upper Deck Seat Layout:** On airplanes with an upper deck the seat layout as described above. If the airplane has a single deck, enter 0. At the moment the cross-section is not drawn with an upper deck.
- **Height / Width:** The ratio of fuselage maximum height to width.
- **Floor Height:** The vertical offset of the floor from the center of the cabin in units of cabin height. A value of 0 places the floor at the fuselage centerline, while a value of 0.5 would place the floor at the lowest point on the fuselage. Typical value: 0.15.

Fuselage Shape

Planform Layout

Cabin Dimensions

The figure below shows a generic fuselage shape for a transport aircraft. The geometry is often divided into three parts: a tapered nose section in which the crew and various electronic components are housed, a constant section that contains the passenger cabin, and a mildly tapered tail cone.

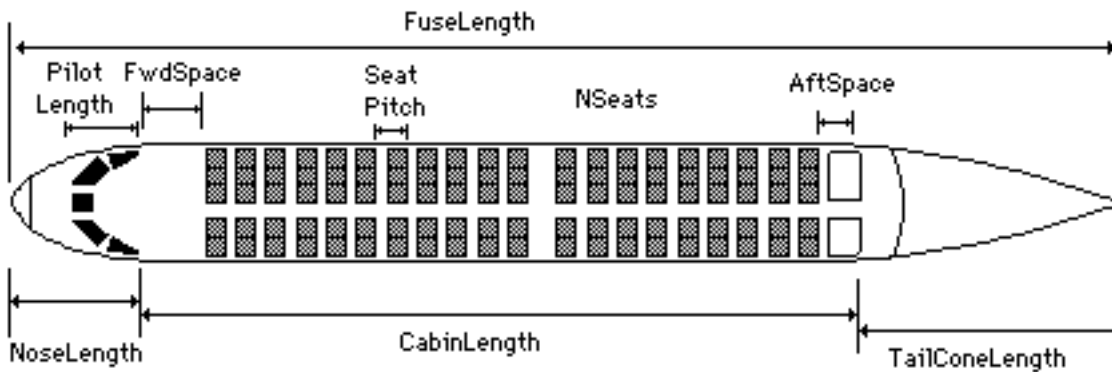

Note that passengers or other payload may extend over more than just the constant section, especially when the fuselage diameter is large. Because of the long tail cone sections, the pressurized payload section often extends back into this region.

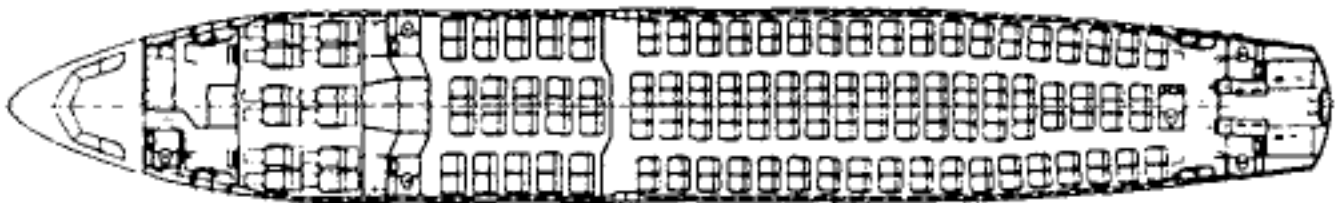

187 passengers (12 first class, 35 business class, 140 economy class)

Additional area is required for lavatories, galleys, closets, and flight attendant seats. The number of lavatories depends on the number of passengers, with about 40 passengers per lavatory, a typical value. One must allow at least 34" x 38" for a standard lavatory. Closets take from a minimum 3/4" per passenger in economy class to 2" per first class passenger. Room for food service also depends on the airline operation, but even on 500 mi stage lengths, this can dictate as much as 1.5" of galley cabinet

length per passenger. Attendant seats are required adjacent to door exits and may be stowed upright, but clear of exit paths. In addition, emergency exits must include clear aisles that may increase the overall length of the fuselage. The requirements are described in the FAR's.

On average the floor area per person ranges from 6.5 ft² for narrow body aircraft to 7.5 ft² for wide-bodies in an all-tourist configuration. A typical 3-class arrangement requires about 10 ft² per person. The figures below show two layouts for the 717. Note the fuselage nose and tailcone shapes.

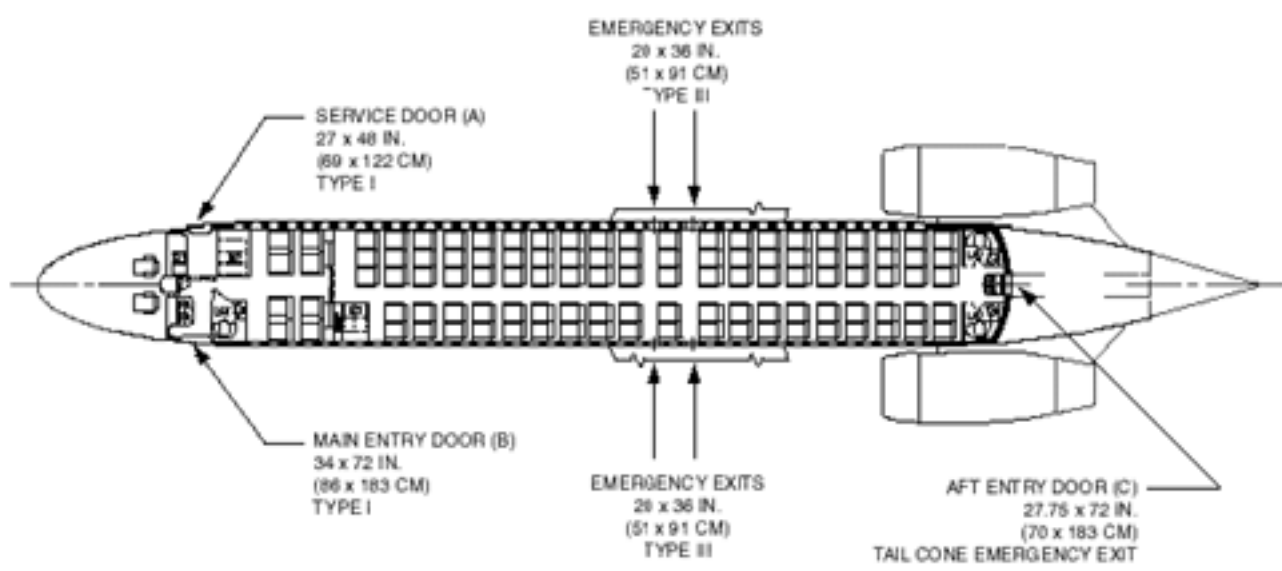

Two-Class 717 configuration with 8 first-class seats with 36" pitch and 98 coach seats with 32" pitch.

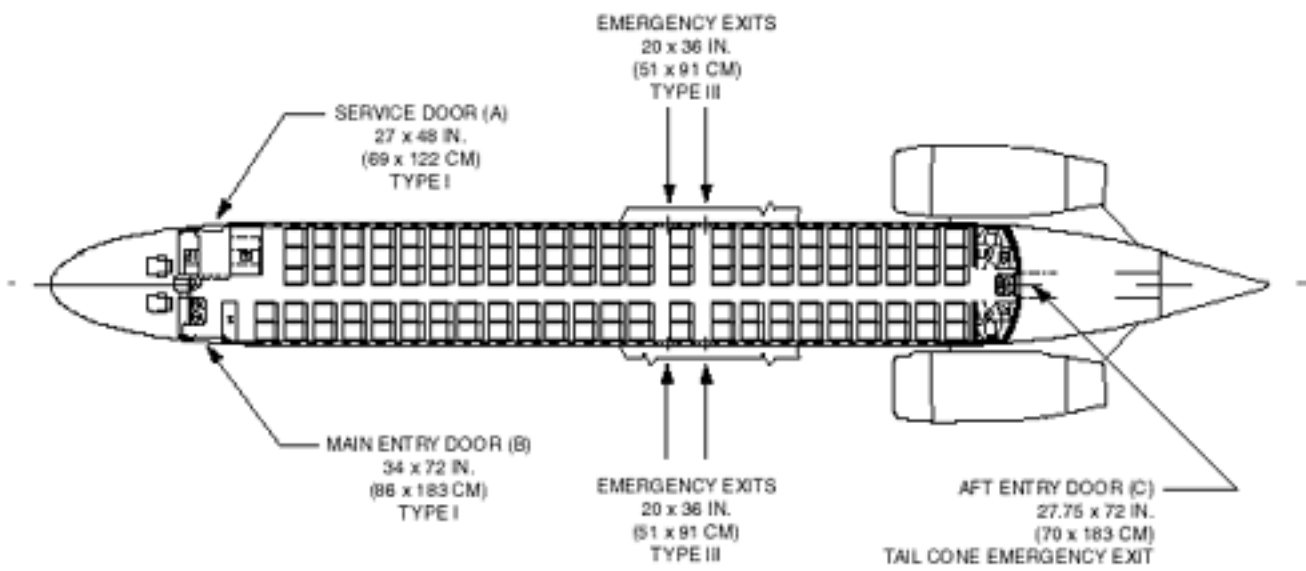

Single-class 717 configuration with 117 seats at 32" and 31" pitch.

In addition to providing space for seats, galleys, lavatories, and emergency exits as set by regulations, the aircraft layout is important for maintenance and studies are done early in the program to determine that

the layout is compatible with required ground services.

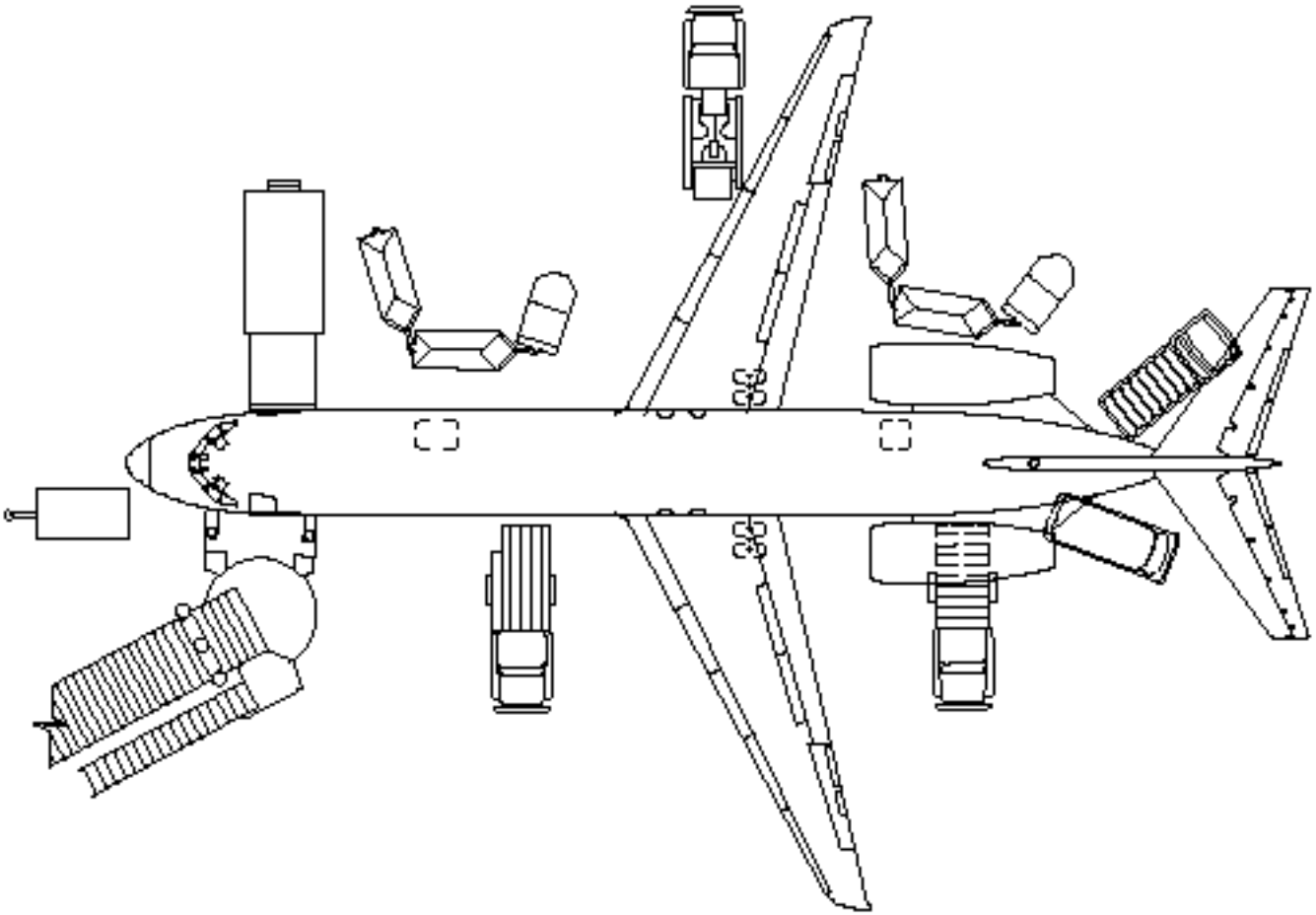

Aerodynamics

The fuselage shape must be such that separation and shock waves are avoided when possible. This requires that the nose and tail cone fineness ratios be sufficiently large so that excessive flow accelerations are avoided. Figure 2 shows the limit on nose fineness ratio set by the requirement for low wave drag on the nose.

Effect of Nose Fineness on Drag Divergence Mach Number

Typical Transport Aircraft Shapes

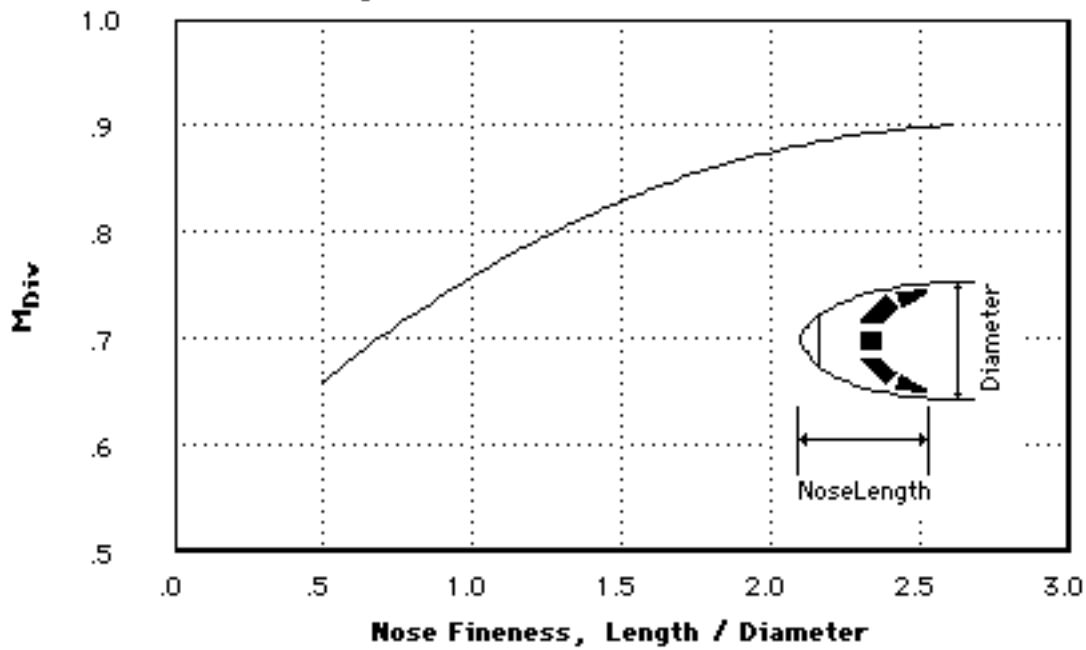

Even when the Mach number is low, constraints on fuselage pressure gradients limit nose fineness ratios to values above about 1.5. The tail cone taper is chosen based on similar considerations and generally falls in the range of 1.8 to 2.0. The details of fuselage shaping may be determined by looking at the pressure distributions.

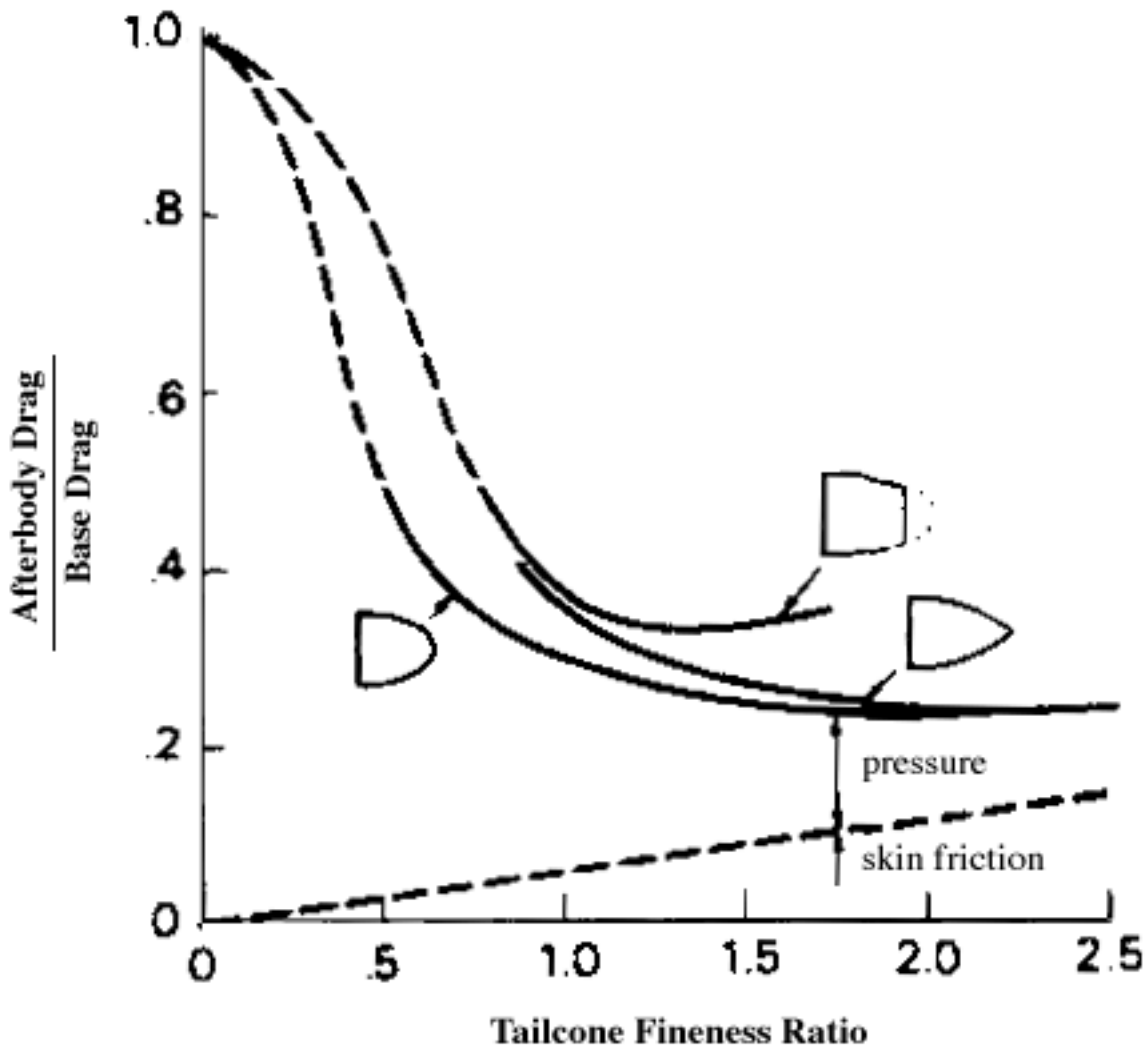

Several rules result from these analyses: The transition from nose to constant section, and constant section to tail cone should be smooth - free of discontinuities in slope (kinks). The tail cone slopes should resemble those shown in the examples. That is, the slope must change smoothly and the trailing edge should not be blunt. The closure angle near the aft end should not be too large (half angle less than 14° - 20°).

Considerations Related to Fuselage Side-View

The shape of the fuselage in side view is determined based on visibility requirements for the cockpit and ground clearance of the tail cone. Usually aft-fuselage upsweep is required to provide the capability of rotating to high angles of attack on the ground (often about 14°). The upsweep cannot be set without estimating the length of the main gear, but this can be done early in the design process by comparison with similar aircraft.

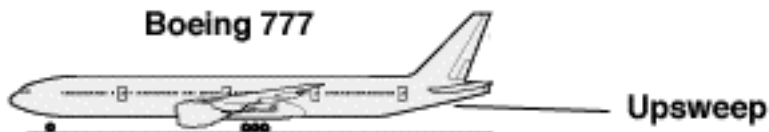

Exercise 3: Fuselage Top View

Enter fuselage seating parameters.

About the input variables:

- **Number of Seats:** The total number of seats to be included at the specified effective pitch.
- **Seat Pitch:** The average longitudinal distance between seats. This drawing includes only a single seat pitch, while most aircraft will be divided into 2 or 3 classes with rather different seat pitch. Use an effective value that produces the correct cabin length.
- **Nose Fineness:** The ratio of nose length to maximum diameter. The nose section is defined as the section that extends from the forwardmost point on the aircraft to the maximum diameter section.
- **Tailcone Fineness:** The ratio of tailcone length to maximum diameter. The tailcone section is defined as the section the end of the constant section to the aft end of the fuselage.
- **Forward Extra Space:** The distance (in feet for now) from the start of the constant section to the first row of seats. This parameter is used to add extra space for galleys or closets, or may be made negative if seats extend into the "nose" section of the fuselage.
- **Aft Extra Space:** The distance (in feet for now) from the end of the constant section to the last row of seats. This parameter is used to add extra space for galleys or closets, or may be made negative if seats extend into the tailcone section of the fuselage.

The layout is based on the cross-section geometry specified in [exercise 2](#).

Fuselage and Seating-Related FARs

FAA Regulations Affecting Fuselage Design

A number of federal regulations have a major effect on the fuselage layout and sizing. Included here are links to portions of FAR Part 25 that influence fuselage design.

[Seating-Related Items](#)

[Emergency Egress](#)

[Emergency Demonstration](#)

FARs Related to Seating

Sec. 25.815 Width of aisle.

The passenger aisle width at any point between seats must equal or exceed the values in the following table:

Passenger seating capacity	Minimum passenger aisle width (inches)	
	Less than 25 in. from floor	25 in. and more from floor
10 or less	/1/ 12	15
11 through 19	12	20
20 or more	15	20

/1/ A narrower width not less than 9 inches may be approved when substantiated by tests found necessary by the Administrator.

Sec. 25.817 Maximum number of seats abreast.

On airplanes having only one passenger aisle, no more than three seats abreast may be placed on each side of the aisle in any one row.

Sec. 25.783 Doors.

(a) Each cabin must have at least one easily accessible external door.

(b) There must be a means to lock and safeguard each external door against opening in flight (either inadvertently by persons or as a result of mechanical failure or failure of a single structural element either during or after closure). Each external door must be openable from both the inside and the outside, even

though persons may be crowded against the door on the inside of the airplane. Inward opening doors may be used if there are means to prevent occupants from crowding against the door to an extent that would interfere with the opening of the door. The means of opening must be simple and obvious and must be arranged and marked so that it can be readily located and operated, even in darkness. Auxiliary locking devices may be used.

(c) Each external door must be reasonably free from jamming as a result of fuselage deformation in a minor crash.

(d) Each external door must be located where persons using them will not be endangered by the propellers when appropriate operating procedures are used.

(e) There must be a provision for direct visual inspection of the locking mechanism to determine if external doors, for which the initial opening movement is not inward (including passenger, crew, service, and cargo doors), are fully closed and locked. The provision must be discernible under operational lighting conditions by appropriate crewmembers using a flashlight or equivalent lighting source. In addition, there must be a visual warning means to signal the appropriate flight crewmembers if any external door is not fully closed and locked. The means must be designed such that any failure or combination of failures that would result in an erroneous closed and locked indication is improbable for doors for which the initial opening movement is not inward.

(f) External doors must have provisions to prevent the initiation of pressurization of the airplane to an unsafe level if the door is not fully closed and locked. In addition, it must be shown by safety analysis that inadvertent opening is extremely improbable.

(g) Cargo and service doors not suitable for use as emergency exits need only meet paragraphs (e) and (f) of this section and be safeguarded against opening in flight as a result of mechanical failure or failure of a single structural element.

(h) Each passenger entry door in the side of the fuselage must qualify as a Type A, Type I, or Type II passenger emergency exit and must meet the requirements of Secs. 25.807 through 25.813 that apply to that type of passenger emergency exit.

(i) If an integral stair is installed in a passenger entry door that is qualified as a passenger emergency exit, the stair must be designed so that under the following conditions the effectiveness of passenger emergency egress will not be impaired:

(1) The door, integral stair, and operating mechanism have been subjected to the inertia forces specified in Sec. 25.561(b)(3), acting separately relative to the surrounding structure.

(2) The airplane is in the normal ground attitude and in each of the attitudes corresponding to collapse of one or more legs of the landing gear.

(j) All lavatory doors must be designed to preclude anyone from becoming trapped inside the lavatory, and if a locking mechanism is installed, it be capable of being unlocked from the outside without the aid of special tools.

Sec. 25.785 Seats, berths, safety belts, and harnesses.

(a) A seat (or berth for a nonambulant person) must be provided for each occupant who has reached his or her second birthday.

(b) Each seat, berth, safety belt, harness, and adjacent part of the airplane at each station designated as occupiable during takeoff and landing must be designed so that a person making proper use of these facilities will not suffer serious injury in an emergency landing as a result of the inertia forces specified in Secs. 25.561 and 25.562.

(c) Each seat or berth must be approved.

(d) Each occupant of a seat that makes more than an 18-degree angle with the vertical plane containing the airplane centerline must be protected from head injury by a safety belt and an energy absorbing rest that will support the arms, shoulders, head, and spine, or by a safety belt and shoulder harness that will prevent the head from contacting any injurious object. Each occupant of any other seat must be protected from head injury by a safety belt and, as appropriate to the type, location, and angle of facing of each seat, by one or more of the following:

(1) A shoulder harness that will prevent the head from contacting any injurious object.

(2) The elimination of any injurious object within striking radius of the head.

(3) An energy absorbing rest that will support the arms, shoulders, head, and spine.

(e) Each berth must be designed so that the forward part has a padded end board, canvas diaphragm, or equivalent means, that can withstand the static load reaction of the occupant when subjected to the forward inertia force specified in Sec. 25.561. Berths must be free from corners and protuberances likely to cause injury to a person occupying the berth during emergency conditions.

(f) Each seat or berth, and its supporting structure, and each safety belt or harness and its anchorage must be designed for an occupant weight of 170 pounds, considering the maximum load factors, inertia forces, and reactions among the occupant, seat, safety belt, and harness for each relevant flight and ground load condition (including the emergency landing conditions prescribed in Sec. 25.561). In addition--

(1) The structural analysis and testing of the seats, berths, and their supporting structures may be determined by assuming that the critical load in the forward, sideward, downward, upward, and rearward

directions (as determined from the prescribed flight, ground, and emergency landing conditions) acts separately or using selected combinations of loads if the required strength in each specified direction is substantiated. The forward load factor need not be applied to safety belts for berths.

(2) Each pilot seat must be designed for the reactions resulting from the application of the pilot forces prescribed in Sec. 25.395.

(3) The inertia forces specified in Sec. 25.561 must be multiplied by a factor of 1.33 (instead of the fitting factor prescribed in Sec. 25.625) in determining the strength of the attachment of each seat to the structure and each belt or harness to the seat or structure.

(g) Each seat at a flight deck station must have a restraint system consisting of a combined safety belt and shoulder harness with a single-point release that permits the flight deck occupant, when seated with the restraint system fastened, to perform all of the occupant's necessary flight deck functions. There must be a means to secure each combined restraint system when not in use to prevent interference with the operation of the airplane and with rapid egress in an emergency.

(h) Each seat located in the passenger compartment and designated for use during takeoff and landing by a flight attendant required by the operating rules of this chapter must be:

(1) Near a required floor level emergency exit, except that another location is acceptable if the emergency egress of passengers would be enhanced with that location. A flight attendant seat must be located adjacent to each Type A emergency exit. Other flight attendant seats must be evenly distributed among the required floor level emergency exits to the extent feasible.

(2) To the extent possible, without compromising proximity to a required floor level emergency exit, located to provide a direct view of the cabin area for which the flight attendant is responsible.

(3) Positioned so that the seat will not interfere with the use of a passageway or exit when the seat is not in use.

(4) Located to minimize the probability that occupants would suffer injury by being struck by items dislodged from service areas, stowage compartments, or service equipment.

(5) Either forward or rearward facing with an energy absorbing rest that is designed to support the arms, shoulders, head, and spine.

(6) Equipped with a restraint system consisting of a combined safety belt and shoulder harness unit with a single point release. There must be means to secure each restraint system when not in use to prevent interference with rapid egress in an emergency.

(i) Each safety belt must be equipped with a metal to metal latching device.

- (j) If the seat backs do not provide a firm handhold, there must be a handgrip or rail along each aisle to enable persons to steady themselves while using the aisles in moderately rough air.
- (k) Each projecting object that would injure persons seated or moving about the airplane in normal flight must be padded.
- (l) Each forward observer's seat required by the operating rules must be shown to be suitable for use in conducting the necessary enroute inspection.

FARs Related to Emergency Evacuation

Sec. 25.801 Ditching.

(a) If certification with ditching provisions is requested, the airplane must meet the requirements of this section and Secs. 25.807(e), 25.1411, and 25.1415(a).

(b) Each practicable design measure, compatible with the general characteristics of the airplane, must be taken to minimize the probability that in an emergency landing on water, the behavior of the airplane would cause immediate injury to the occupants or would make it impossible for them to escape.

(c) The probable behavior of the airplane in a water landing must be investigated by model tests or by comparison with airplanes of similar configuration for which the ditching characteristics are known. Scoops, flaps, projections, and any other factor likely to affect the hydrodynamic characteristics of the airplane, must be considered.

(d) It must be shown that, under reasonably probable water conditions, the flotation time and trim of the airplane will allow the occupants to leave the airplane and enter the liferafts required by Sec. 25.1415. If compliance with this provision is shown by buoyancy and trim computations, appropriate allowances must be made for probable structural damage and leakage. If the airplane has fuel tanks (with fuel jettisoning provisions) that can reasonably be expected to withstand a ditching without leakage, the jettisonable volume of fuel may be considered as buoyancy volume.

(e) Unless the effects of the collapse of external doors and windows are accounted for in the investigation of the probable behavior of the airplane in a water landing (as prescribed in paragraphs (c) and (d) of this section), the external doors and windows must be designed to withstand the probable maximum local pressures.

Sec. 25.803 Emergency evacuation.

(a) Each crew and passenger area must have emergency means to allow rapid evacuation in crash landings, with the landing gear extended as well as with the landing gear retracted, considering the possibility of the airplane being on fire.

(b) [Reserved]

(c) For airplanes having a seating capacity of more than 44 passengers, it must be shown that the maximum seating capacity, including the number of crewmembers required by the operating rules for

which certification is requested, can be evacuated from the airplane to the ground under simulated emergency conditions within 90 seconds. Compliance with this requirement must be shown by actual demonstration using the test criteria outlined in [appendix J of this part](#) unless the Administrator finds that a combination of analysis and testing will provide data equivalent to that which would be obtained by actual demonstration.

(d) [Reserved]

(e) [Reserved]

Sec. 25.807 Emergency exits.

(a) Type. For the purpose of this part, the types of exits are defined as follows:

(1) Type I. This type is a floor level exit with a rectangular opening of not less than 24 inches wide by 48 inches high, with corner radii not greater than one-third the width of the exit.

(2) Type II. This type is a rectangular opening of not less than 20 inches wide by 44 inches high, with corner radii not greater than one-third the width of the exit. Type II exits must be floor level exits unless located over the wing, in which case they may not have a step-up inside the airplane of more than 10 inches nor a step-down outside the airplane of more than 17 inches.

(3) Type III. This type is a rectangular opening of not less than 20 inches wide by 36 inches high, with corner radii not greater than one-third the width of the exit, and with a step-up inside the airplane of not more than 20 inches. If the exit is located over the wing, the step-down outside the airplane may not exceed 27 inches.

(4) Type IV. This type is a rectangular opening of not less than 19 inches wide by 26 inches high, with corner radii not greater than one-third the width of the exit, located over the wing, with a step-up inside the airplane of not more than 29 inches and a step-down outside the airplane of not more than 36 inches.

(5) Ventral. This type is an exit from the passenger compartment through the pressure shell and the bottom fuselage skin. The dimensions and physical configuration of this type of exit must allow at least the same rate of egress as a Type I exit with the airplane in the normal ground attitude, with landing gear extended.

(6) Tail cone. This type is an aft exit from the passenger compartment through the pressure shell and through an openable cone of the fuselage aft of the pressure shell. The means of opening the tailcone must be simple and obvious and must employ a single operation.

(7) Type A. This type is a floor level exit with a rectangular opening of not less than 42 inches wide by 72 inches high with corner radii not greater than one-sixth of the width of the exit.

(b) Step down distance. Step down distance, as used in this section, means the actual distance between the bottom of the required opening and a usable foot hold, extending out from the fuselage, that is large enough to be effective without searching by sight or feel.

(c) Over-sized exits. Openings larger than those specified in this section, whether or not of rectangular shape, may be used if the specified rectangular opening can be inscribed within the opening and the base of the inscribed rectangular opening meets the specified step-up and step-down heights.

(d) Passenger emergency exits. Except as provided in paragraphs (d) (3) through (7) of this section, the minimum number and type of passenger emergency exits is as follows:

(1) For passenger seating configurations of 1 through 299 seats:

Passenger seating configuration (crewmember seats not included)	Emergency exits for each side of the fuselage			
	Type I	Type II	Type III	Type IV
1 through 9				1
10 through 19			1	
20 through 39		1	1	
40 through 79	1		1	
80 through 109	1		2	
110 through 139	2		1	
140 through 179	2		2	

Additional exits are required for passenger seating configurations greater than 179 seats in accordance with the following table:

Additional emergency exits (each side of fuselage)	Increase in passenger seating configuration allowed
---	---

Type A	110
Type I	45
Type II	40
Type III	35

(2) For passenger seating configurations greater than 299 seats, each emergency exit in the side of the fuselage must be either a Type A or Type I. A passenger seating configuration of 110 seats is allowed for each pair of Type A exits and a passenger seating configuration of 45 seats is allowed for each pair of Type I exits.

(3) If a passenger ventral or tail cone exit is installed and that exit provides at least the same rate of egress as a Type III exit with the airplane in the most adverse exit opening condition that would result from the collapse of one or more legs of the landing gear, an increase in the passenger seating configuration beyond the limits specified in paragraph (d) (1) or (2) of this section may be allowed as follows:

(i) For a ventral exit, 12 additional passenger seats.

(ii) For a tail cone exit incorporating a floor level opening of not less than 20 inches wide by 60 inches high, with corner radii not greater than one-third the width of the exit, in the pressure shell and incorporating an approved assist means in accordance with Sec. 25.809(h), 25 additional passenger seats.

(iii) For a tail cone exit incorporating an opening in the pressure shell which is at least equivalent to a Type III emergency exit with respect to dimensions, step-up and step-down distance, and with the top of the opening not less than 56 inches from the passenger compartment floor, 15 additional passenger seats.

(4) For airplanes on which the vertical location of the wing does not allow the installation of overwing exits, an exit of at least the dimensions of a Type III exit must be installed instead of each Type IV exit required by subparagraph (1) of this paragraph.

(5) An alternate emergency exit configuration may be approved in lieu of that specified in paragraph (d) (1) or (2) of this section provided the overall evacuation capability is shown to be equal to or greater than that of the specified emergency exit configuration.

(6) The following must also meet the applicable emergency exit requirements of Secs. 25.809 through 25.813:

(i) Each emergency exit in the passenger compartment in excess of the minimum number of required emergency exits.

(ii) Any other floor level door or exit that is accessible from the passenger compartment and is as large or

larger than a Type II exit, but less than 46 inches wide.

(iii) Any other passenger ventral or tail cone exit.

(7) For an airplane that is required to have more than one passenger emergency exit for each side of the fuselage, no passenger emergency exit shall be more than 60 feet from any adjacent passenger emergency exit on the same side of the same deck of the fuselage, as measured parallel to the airplane's longitudinal axis between the nearest exit edges.

(e) Ditching emergency exits for passengers. Ditching emergency exits must be provided in accordance with the following requirements whether or not certification with ditching provisions is requested:

(1) For airplanes that have a passenger seating configuration of nine seats or less, excluding pilots seats, one exit above the waterline in each side of the airplane, meeting at least the dimensions of a Type IV exit.

(2) For airplanes that have a passenger seating configuration of 10 seats or more, excluding pilots seats, one exit above the waterline in a side of the airplane, meeting at least the dimensions of a Type III exit for each unit (or part of a unit) of 35 passenger seats, but no less than two such exits in the passenger cabin, with one on each side of the airplane. The passenger seat/exit ratio may be increased through the use of larger exits, or other means, provided it is shown that the evacuation capability during ditching has been improved accordingly.

(3) If it is impractical to locate side exits above the waterline, the side exits must be replaced by an equal number of readily accessible overhead hatches of not less than the dimensions of a Type III exit, except that for airplanes with a passenger configuration of 35 seats or less, excluding pilots seats, the two required Type III side exits need be replaced by only one overhead hatch.

(f) Flightcrew emergency exits. For airplanes in which the proximity of passenger emergency exits to the flightcrew area does not offer a convenient and readily accessible means of evacuation of the flightcrew, and for all airplanes having a passenger seating capacity greater than 20, flightcrew exits shall be located in the flightcrew area. Such exits shall be of sufficient size and so located as to permit rapid evacuation by the crew. One exit shall be provided on each side of the airplane; or, alternatively, a top hatch shall be provided. Each exit must encompass an unobstructed rectangular opening of at least 19 by 20 inches unless satisfactory exit utility can be demonstrated by a typical crewmember.

Sec. 25.809 Emergency exit arrangement.

(a) Each emergency exit, including a flight crew emergency exit, must be a movable door or hatch in the external walls of the fuselage, allowing unobstructed opening to the outside.

(b) Each emergency exit must be openable from the inside and the outside except that sliding window

emergency exits in the flight crew area need not be openable from the outside if other approved exits are convenient and readily accessible to the flight crew area. Each emergency exit must be capable of being opened, when there is no fuselage deformation--

(1) With the airplane in the normal ground attitude and in each of the attitudes corresponding to collapse of one or more legs of the landing gear; and

(2) Within 10 seconds measured from the time when the opening means is actuated to the time when the exit is fully opened.

(c) The means of opening emergency exits must be simple and obvious and may not require exceptional effort. Internal exit-opening means involving sequence operations (such as operation of two handles or latches or the release of safety catches) may be used for flight crew emergency exits if it can be reasonably established that these means are simple and obvious to crewmembers trained in their use.

(d) If a single power-boost or single power-operated system is the primary system for operating more than one exit in an emergency, each exit must be capable of meeting the requirements of paragraph (b) of this section in the event of failure of the primary system. Manual operation of the exit (after failure of the primary system) is acceptable.

(e) Each emergency exit must be shown by tests, or by a combination of analysis and tests, to meet the requirements of paragraphs (b) and (c) of this section.

(f) There must be a means to lock each emergency exit and to safeguard against its opening in flight, either inadvertently by persons or as a result of mechanical failure. In addition, there must be a means for direct visual inspection of the locking mechanism by crewmembers to determine that each emergency exit, for which the initial opening movement is outward, is fully locked.

(g) There must be provisions to minimize the probability of jamming of the emergency exits resulting from fuselage deformation in a minor crash landing.

(h) When required by the operating rules for any large passenger-carrying turbojet-powered airplane, each ventral exit and tailcone exit must be--

(1) Designed and constructed so that it cannot be opened during flight; and

(2) Marked with a placard readable from a distance of 30 inches and installed at a conspicuous location near the means of opening the exit, stating that the exit has been designed and constructed so that it cannot be opened during flight.

Sec. 25.810 Emergency egress assist means and escape routes.

(a) Each nonoverwing landplane emergency exit more than 6 feet from the ground with the airplane on the ground and the landing gear extended and each nonoverwing Type A exit must have an approved means to assist the occupants in descending to the ground.

(1) The assisting means for each passenger emergency exit must be a self-supporting slide or equivalent; and, in the case of a Type A exit, it must be capable of carrying simultaneously two parallel lines of evacuees. In addition, the assisting means must be designed to meet the following requirements:

(i) It must be automatically deployed and deployment must begin during the interval between the time the exit opening means is actuated from inside the airplane and the time the exit is fully opened. However, each passenger emergency exit which is also a passenger entrance door or a service door must be provided with means to prevent deployment of the assisting means when it is opened from either the inside or the outside under nonemergency conditions for normal use.

(ii) It must be automatically erected within 10 seconds after deployment is begun.

(iii) It must be of such length after full deployment that the lower end is self-supporting on the ground and provides safe evacuation of occupants to the ground after collapse of one or more legs of the landing gear.

(iv) It must have the capability, in 25-knot winds directed from the most critical angle, to deploy and, with the assistance of only one person, to remain usable after full deployment to evacuate occupants safely to the ground.

(v) For each system installation (mockup or airplane installed), five consecutive deployment and inflation tests must be conducted (per exit) without failure, and at least three tests of each such five-test series must be conducted using a single representative sample of the device. The sample devices must be deployed and inflated by the system's primary means after being subjected to the inertia forces specified in Sec. 25.561(b). If any part of the system fails or does not function properly during the required tests, the cause of the failure or malfunction must be corrected by positive means and after that, the full series of five consecutive deployment and inflation tests must be conducted without failure.

(2) The assisting means for flightcrew emergency exits may be a rope or any other means demonstrated to be suitable for the purpose. If the assisting means is a rope, or an approved device equivalent to a rope, it must be--

(i) Attached to the fuselage structure at or above the top of the emergency exit opening, or, for a device at a pilot's emergency exit window, at another approved location if the stowed device, or its attachment, would reduce the pilot's view in flight;

(ii) Able (with its attachment) to withstand a 400-pound static load.

(b) Assist means from the cabin to the wing are required for each Type A exit located above the wing and having a stepdown unless the exit without an assist means can be shown to have a rate of passenger egress at least equal to that of the same type of nonoverwing exit. If an assist means is required, it must be automatically deployed and automatically erected, concurrent with the opening of the exit and self-supporting within 10 seconds.

(c) An escape route must be established from each overwing emergency exit, and (except for flap surfaces suitable as slides) covered with a slip resistant surface. Except where a means for channeling the flow of evacuees is provided--

(1) The escape route must be at least 42 inches wide at Type A passenger emergency exits and must be at least 2 feet wide at all other passenger emergency exits, and

(2) The escape route surface must have a reflectance of at least 80 percent, and must be defined by markings with a surface-to-marking contrast ratio of at least 5:1.

(d) If the place on the airplane structure at which the escape route required in paragraph (c) of this section terminates, is more than 6 feet from the ground with the airplane on the ground and the landing gear extended, means to reach the ground must be provided to assist evacuees who have used the escape route. If the escape route is over a flap, the height of the terminal edge must be measured with the flap in the takeoff or landing position, whichever is higher from the ground. The assisting means must be usable and self-supporting with one or more landing gear legs collapsed and under a 25-knot wind directed from the most critical angle. The assisting means provided for each escape route leading from a Type A emergency exit must be capable of carrying simultaneously two parallel lines of evacuees. For other than Type A exits, the assist means must be capable of carrying simultaneously as many parallel lines of evacuees as there are required escape routes.

Sec. 25.813 Emergency exit access.

Each required emergency exit must be accessible to the passengers and located where it will afford an effective means of evacuation. Emergency exit distribution must be as uniform as practical, taking passenger distribution into account; however, the size and location of exits on both sides of the cabin need not be symmetrical. If only one floor level exit per side is prescribed, and the airplane does not have a tail cone or ventral emergency exit, the floor level exit must be in the rearward part of the passenger compartment, unless another location affords a more effective means of passenger evacuation. Where more than one floor level exit per side is prescribed, at least one floor level exit per side must be located near each end of the cabin, except that this provision does not apply to combination cargo/passenger configurations. In addition--

(a) There must be a passageway leading from the nearest main aisle to each Type I, Type II, or Type A emergency exit and between individual passenger areas. Each passageway leading to a Type A exit must be unobstructed and at least 36 inches wide. Passageways between individual passenger areas and those

leading to Type I and Type II emergency exits must be unobstructed and at least 20 inches wide. Unless there are two or more main aisles, each Type A exit must be located so that there is passenger flow along the main aisle to that exit from both the forward and aft directions. If two or more main aisles are provided, there must be unobstructed cross-aisles at least 20 inches wide between main aisles. There must be--

(1) A cross-aisle which leads directly to each passageway between the nearest main aisle and a Type A exit; and

(2) A cross-aisle which leads to the immediate vicinity of each passageway between the nearest main aisle and a Type 1, Type II, or Type III exit; except that when two Type III exits are located within three passenger rows of each other, a single cross-aisle may be used if it leads to the vicinity between the passageways from the nearest main aisle to each exit.

(b) Adequate space to allow crewmember(s) to assist in the evacuation of passengers must be provided as follows:

(1) The assist space must not reduce the unobstructed width of the passageway below that required for the exit.

(2) For each Type A exit, assist space must be provided at each side of the exit regardless of whether the exit is covered by Sec. 25.810(a).

(3) For any other type exit that is covered by Sec. 25.810(a), space must at least be provided at one side of the passageway.

(c) The following must be provided for each Type III or Type IV exit--(1) There must be access from the nearest aisle to each exit. In addition, for each Type III exit in an airplane that has a passenger seating configuration of 60 or more--

(i) Except as provided in paragraph (c)(1)(ii), the access must be provided by an unobstructed passageway that is at least 10 inches in width for interior arrangements in which the adjacent seat rows on the exit side of the aisle contain no more than two seats, or 20 inches in width for interior arrangements in which those rows contain three seats. The width of the passageway must be measured with adjacent seats adjusted to their most adverse position. The centerline of the required passageway width must not be displaced more than 5 inches horizontally from that of the exit.

(ii) In lieu of one 10- or 20-inch passageway, there may be two passageways, between seat rows only, that must be at least 6 inches in width and lead to an unobstructed space adjacent to each exit. (Adjacent exits must not share a common passageway.) The width of the passageways must be measured with adjacent seats adjusted to their most adverse position. The unobstructed space adjacent to the exit must extend vertically from the floor to the ceiling (or bottom of sidewall stowage bins), inboard from the exit

for a distance not less than the width of the narrowest passenger seat installed on the airplane, and from the forward edge of the forward passageway to the aft edge of the aft passageway. The exit opening must be totally within the fore and aft bounds of the unobstructed space.

(2) In addition to the access--

(i) For airplanes that have a passenger seating configuration of 20 or more, the projected opening of the exit provided must not be obstructed and there must be no interference in opening the exit by seats, berths, or other protrusions (including any seatback in the most adverse position) for a distance from that exit not less than the width of the narrowest passenger seat installed on the airplane.

(ii) For airplanes that have a passenger seating configuration of 19 or fewer, there may be minor obstructions in this region, if there are compensating factors to maintain the effectiveness of the exit.

(3) For each Type III exit, regardless of the passenger capacity of the airplane in which it is installed, there must be placards that--

(i) Are readable by all persons seated adjacent to and facing a passageway to the exit;

(ii) Accurately state or illustrate the proper method of opening the exit, including the use of handholds; and

(iii) If the exit is a removable hatch, state the weight of the hatch and indicate an appropriate location to place the hatch after removal.

(d) If it is necessary to pass through a passageway between passenger compartments to reach any required emergency exit from any seat in the passenger cabin, the passageway must be unobstructed. However, curtains may be used if they allow free entry through the passageway.

(e) No door may be installed in any partition between passenger compartments.

(f) If it is necessary to pass through a doorway separating the passenger cabin from other areas to reach any required emergency exit from any passenger seat, the door must have a means to latch it in open position. The latching means must be able to withstand the loads imposed upon it when the door is subjected to the ultimate inertia forces, relative to the surrounding structure, listed in Sec. 25.561(b).

FARs Related to Evacuation Demonstration

FAR Part 25, Appendix J: Emergency Evacuation Demonstration

The following test criteria and procedures must be used for showing compliance with Sec. 25.803:

(a) The emergency evacuation must be conducted either during the dark of the night or during daylight with the dark of night simulated. If the demonstration is conducted indoors during daylight hours, it must be conducted with each window covered and each door closed to minimize the daylight effect. Illumination on the floor or ground may be used, but it must be kept low and shielded against shining into the airplane's windows or doors.

(b) The airplane must be in a normal attitude with landing gear extended.

(c) Unless the airplane is equipped with an off-wing descent means, stands or ramps may be used for descent from the wing to the ground. Safety equipment such as mats or inverted life rafts may be placed on the floor or ground to protect participants. No other equipment that is not part of the emergency evacuation equipment of the airplane may be used to aid the participants in reaching the ground.

(d) Except as provided in paragraph (a) of this Appendix, only the airplane's emergency lighting system may provide illumination.

(e) All emergency equipment required for the planned operation of the airplane must be installed.

(f) Each external door and exit, and each internal door or curtain, must be in the takeoff configuration.

(g) Each crewmember must be seated in the normally assigned seat for takeoff and must remain in the seat until receiving the signal for commencement of the demonstration. Each crewmember must be a person having knowledge of the operation of exits and emergency equipment and, if compliance with Sec. 121.291 is also being demonstrated, each flight attendant must be a member of a regularly scheduled line crew.

(h) A representative passenger load of persons in normal health must be used as follows:

- (1) At least 40 percent of the passenger load must be female.
 - (2) At least 35 percent of the passenger load must be over 50 years of age.
 - (3) At least 15 percent of the passenger load must be female and over 50 years of age.
 - (4) Three life-size dolls, not included as part of the total passenger load, must be carried by passengers to simulate live infants 2 years old or younger.
 - (5) Crewmembers, mechanics, and training personnel, who maintain or operate the airplane in the normal course of their duties, may not be used as passengers.
- (i) No passenger may be assigned a specific seat except as the Administrator may require. Except as required by subparagraph (g) of this paragraph, no employee of the applicant may be seated next to an emergency exit.
- (j) Seat belts and shoulder harnesses (as required) must be fastened.
- (k) Before the start of the demonstration, approximately one-half of the total average amount of carry-on baggage, blankets, pillows, and other similar articles must be distributed at several locations in aisles and emergency exit access ways to create minor obstructions.
- (l) No prior indication may be given to any crewmember or passenger of the particular exits to be used in the demonstration.
- (m) The applicant may not practice, rehearse, or describe the demonstration for the participants nor may any participant have taken part in this type of demonstration within the preceding 6 months.
- (n) The pre-takeoff passenger briefing required by Sec. 121.571 may be given. The passengers may also be advised to follow directions of crewmembers but not be instructed on the procedures to be followed in the demonstration.
- (o) If safety equipment as allowed by paragraph (c) of this appendix is provided, either all passenger and cockpit windows must be blacked out or all of the emergency exits must have safety equipment in order to prevent disclosure of the available emergency exits.
- (p) Not more than 50 percent of the emergency exits in the sides of the fuselage of an airplane that meets all of the requirements applicable to the required emergency exits for that airplane may be used for the demonstration. Exits that are not to be used in the demonstration must have the exit handle deactivated or must be indicated by red lights, red tape, or other acceptable means placed outside the exits to indicate fire or other reason why they are unusable. The exits to be used must be representative of all of the emergency exits on the airplane and must be designated by the applicant, subject to approval by the Administrator. At least one floor level exit must be used.
- (q) Except as provided in paragraph (c) of this section, all evacuees must leave the airplane by a means

provided as part of the airplane's equipment.

(r) The applicant's approved procedures must be fully utilized, except the flight crew must take no active role in assisting others inside the cabin during the demonstration.

(s) The evacuation time period is completed when the last occupant has evacuated the airplane and is on the ground. Provided that the acceptance rate of the stand or ramp is no greater than the acceptance rate of the means available on the airplane for descent from the wing during an actual crash situation, evacuees using stands or ramps allowed by paragraph (c) of this Appendix are considered to be on the ground when they are on the stand or ramp.

Additional Considerations for Supersonic Aircraft

Additional Considerations for Supersonic Aircraft

At supersonic speeds the shape and dimensions of the fuselage have a strong effect on the aircraft drag. Supersonic wave drag increases quickly as the fuselage volume increases and the fineness ratio is reduced. For this reason, the cabin diameter is kept as small as possible and the cabin length increased.

The figure below shows a Aerospatiale design for the fuselage of a Mach 2.0 transport (Avion de Transport Supersonique Futur, ATSF).

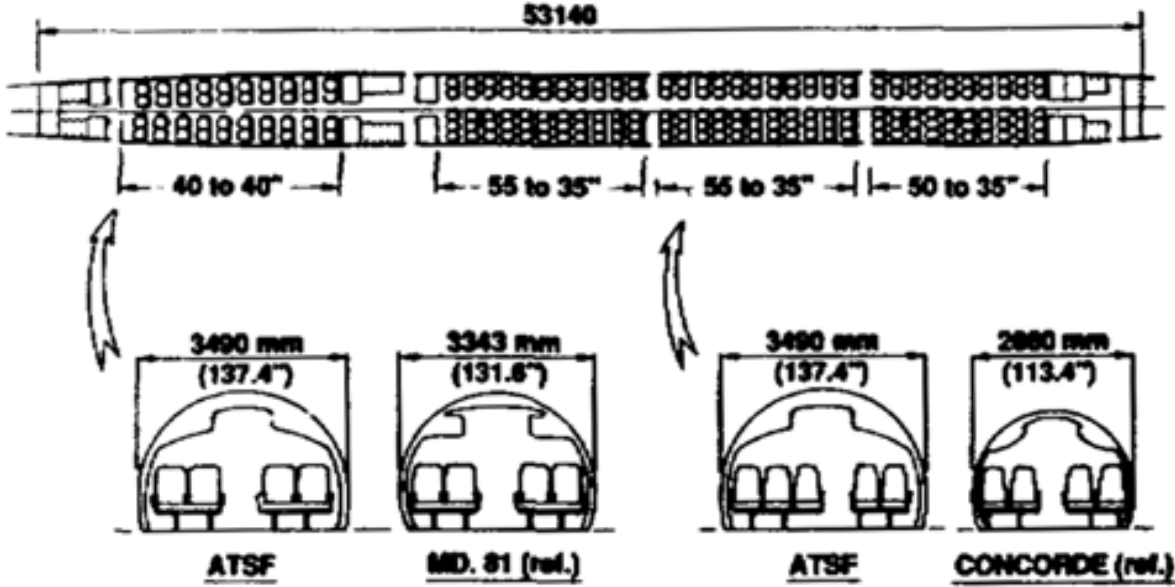

TWO CLASS LAYOUT
40 FIRST CLASS (F) , 160 ECONOMY (Y)

Note that the diameter and seat layout is similar to the MD-80, but the fuselage is much longer. The Concorde diameter of 113 inches is very small because of the strong impact of fuselage diameter on wave drag.

The requirement for a high overall fineness ratio is reflected in the fuselage geometries shown below.

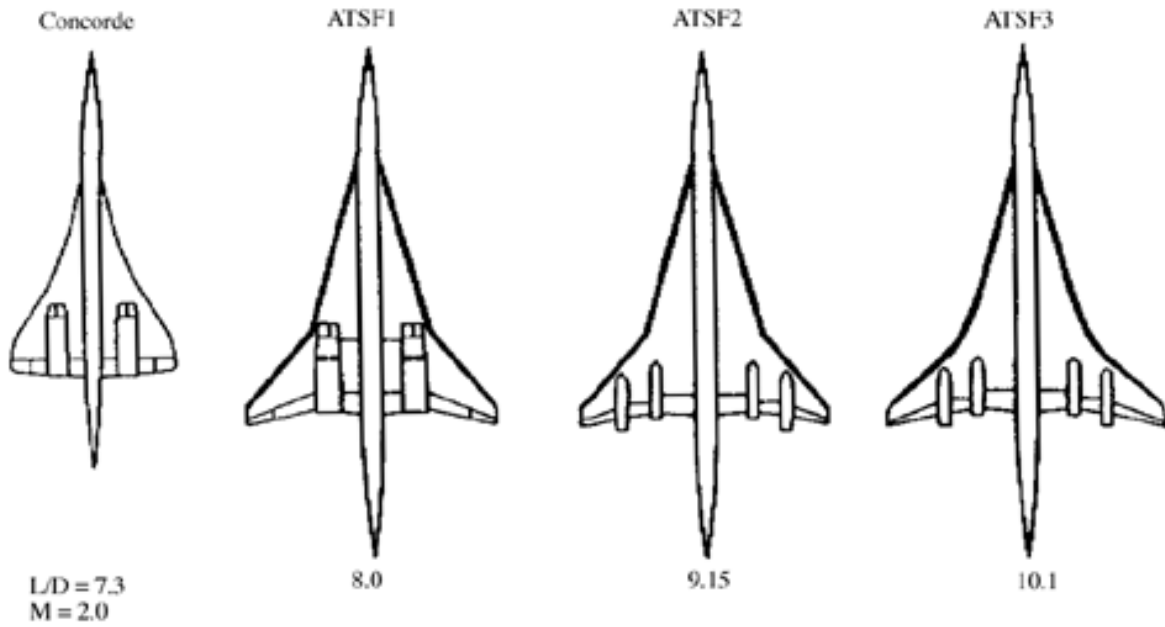

For comparison, a Boeing design for a high speed civil transport is shown below.

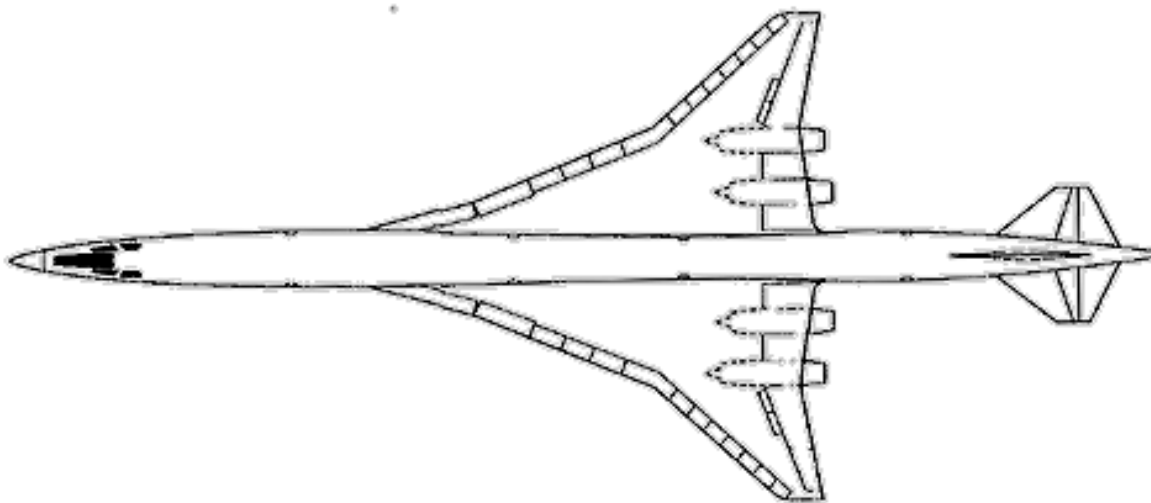

Current Baseline Airplane

Maximum takeoff weight	700,000 lb
Fuselage length	310 ft
Wing span	130 ft
Triclass seating	292 passengers
Cruise speed	Mach 2.4
Design range	5,000 nmi
Takeoff field length	11,000 ft
Approach speed	155 kn

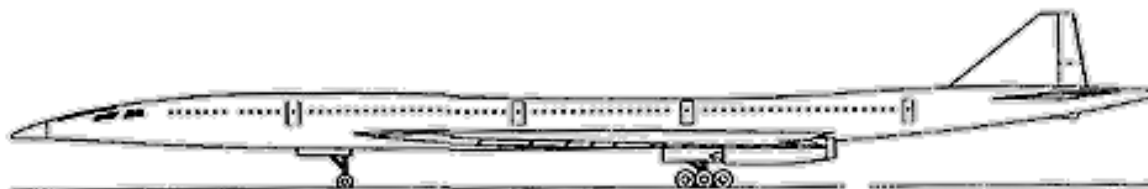

Note that the Boeing design has a fuselage whose diameter varies over the cabin section. This is done to reduce

the interference wave drag between wing and fuselage. This was not done on the Concorde as it was felt that the increase in production costs would be too high. Indeed the variable cross-section introduces many difficulties and affects the seating arrangement as shown below.

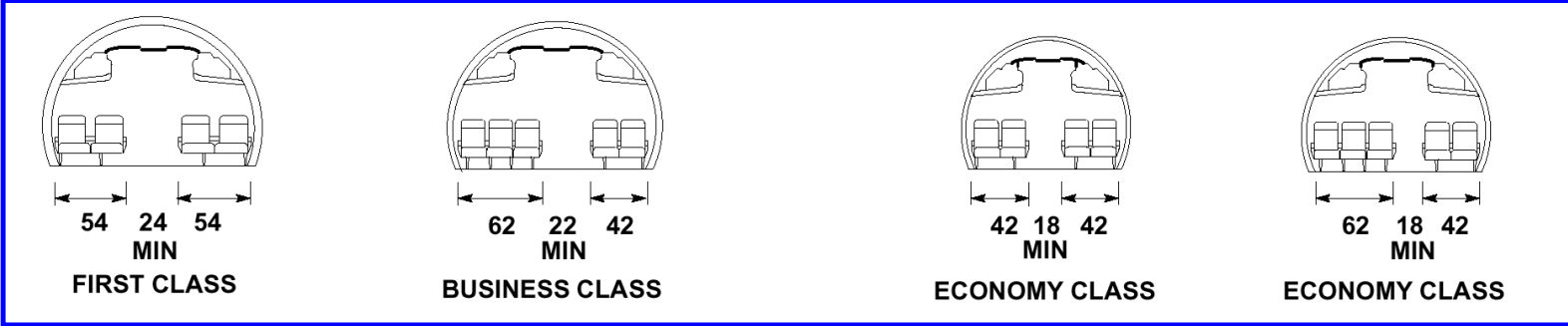
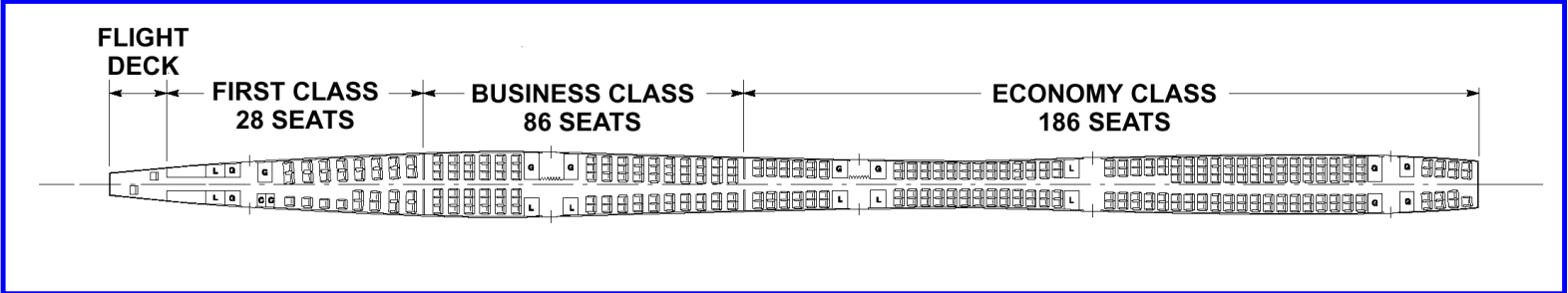
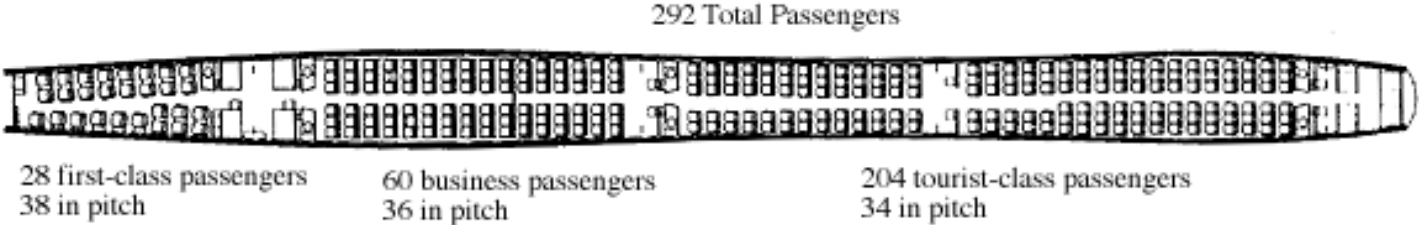

The supersonic business jet represents a somewhat less ambitious entry into commercial supersonic flight. Since supersonic wave drag depends on volume, the motivation for a smaller cabin cross-section is greater, and high fineness ratios are required. The drawings below illustrate the fuselage and cabin design for a supersonic business jet by Reno Aeronautical Corporation.

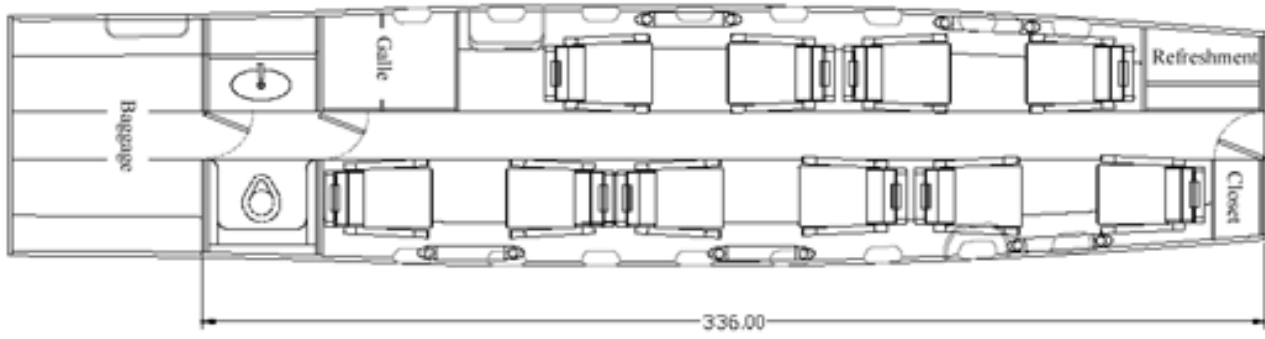
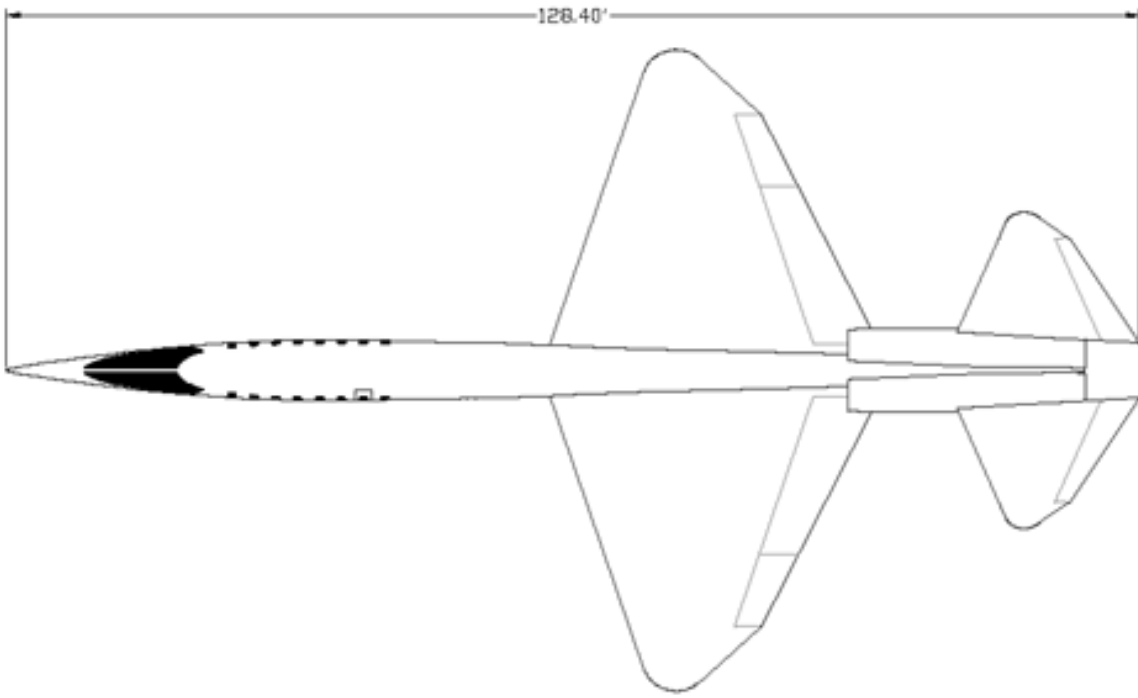

**FLIGHT
DECK**

**FIRST CLASS
28 SEATS**

**BUSINESS CLASS
86 SEATS**

**ECONOMY CLASS
186 SEATS**

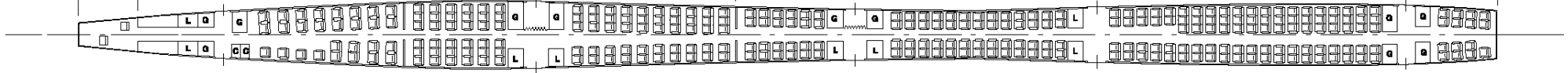

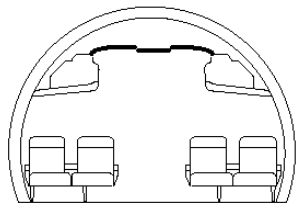

54 24 54
MIN

FIRST CLASS

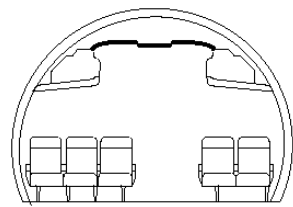

62 22 42
MIN

BUSINESS CLASS

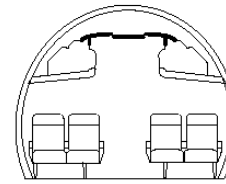

42 18 42
MIN

ECONOMY CLASS

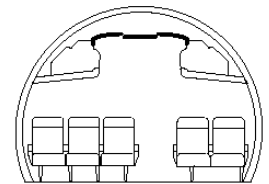

62 18 42
MIN

ECONOMY CLASS

Drag

Drag Bookkeeping

Drag may be divided into components in several ways:

To highlight the change in drag with lift:

Drag = Zero-Lift Drag + Lift-Dependent Drag + Compressibility Drag

To emphasize the physical origins of the drag components:

Drag = Skin Friction Drag + Viscous Pressure Drag + Inviscid (Vortex) Drag + Wave Drag

The latter decomposition is stressed in these notes. There is sometimes some confusion in the terminology since several effects contribute to each of these terms. The definitions used here are as follows:

Compressibility drag is the increment in drag associated with increases in Mach number from some reference condition. Generally, the reference condition is taken to be $M = 0.5$ since the effects of compressibility are known to be small here at typical conditions. Thus, compressibility drag contains a component at zero-lift and a lift-dependent component but includes only the increments due to Mach number (C_L and Re are assumed to be constant.)

Zero-lift drag is the drag at $M=0.5$ and $C_L = 0$. It consists of several components, discussed on the following pages. These include viscous skin friction, vortex drag due to twist, added drag due to fuselage upsweep, control surface gaps, nacelle base drag, and miscellaneous items.

The *Lift-Dependent drag*, sometimes called induced drag, includes the usual lift-dependent vortex drag together with lift-dependent components of skin friction and pressure drag.

For the second method:

Skin Friction drag arises from the shearing stresses at the surface of a body due to viscosity. It accounts for most of the drag of a transport aircraft in cruise.

Viscous pressure drag also is produced by viscous effects, but not so directly. The pressure

distribution is modified by the presence of a boundary layer. Although in 2-D inviscid flow the pressures on forward and aft surfaces balance so that no drag is produced, the effect of the boundary layer leads to an imperfect canceling of these pressures so some additional drag is created.

Inviscid or vortex drag is produced by the trailing vortex wake of a three-dimensional lifting system.

Wave drag is produced by the presence of shock waves at transonic and supersonic speeds. It is the result of both direct shock losses and the influence of shock waves on the boundary layer. The wave drag is often decomposed into a portion related to lift and a portion related to thickness or volume.

In these notes, a somewhat more detailed drag breakdown is used. The total drag is expressed as the sum of the following components:

Drag =
Non-lifting skin friction and pressure drag
+ Fuselage Upsweep Drag
+ Control Surface Gap Drag
+ Nacelle Base Drag
+ Miscellaneous Items

+ Vortex Drag
+ Lift-Dependent Viscous Drag
+ Wave Drag (Lift-Dependent and Volume-Dependent)

The first five of these items do not change as the lift changes and are taken together as the parasite drag. This is not quite the same as the drag at zero lift because the zero lift drag may include vortex drag when the wing is twisted. Another drag item that is sometimes considered separately is trim drag, the drag increment associated with the required tail load to trim the aircraft in pitch. Here we consider trim drag in the discussion of vortex drag of the lifting system.

Nomenclature

The drag is often expressed in dimensionless form:

$$C_D = \frac{\text{Drag}}{\frac{\rho}{2} V^2 S_{\text{ref}}}$$

where S_{ref} is the reference area. The reference area is not so clear when the wing is not a simple tapered planform, but for the purposes of this class, it is taken to be the projected area of the equivalent

trapezoidal wing planform.

The parasite drag is often written in terms of the equivalent flat plate drag area, f :

$$f = C_{D_p} S_{ref} = \frac{\text{Parasite Drag}}{\frac{\rho}{2} V^2}$$

Drag Components

Subsequent sections deal in some detail with each of the components of the aircraft drag. The drag associated with compressibility is treated in the following chapter.

The [parasite drag](#) components include:

- Non-lifting skin friction and viscous pressure drag
- Fuselage Upsweep Drag
- Control Surface Gap Drag
- Nacelle Base Drag
- Miscellaneous Items

The [lift-dependent drag](#) contributions include:

- Vortex Drag
- Lift-Dependent Viscous Drag

The [wave drag](#) contributions may include:

- Transonic compressibility drag
 - Supersonic volume wave drag
 - Supersonic lift-dependent wave drag
-

Parasite Drag

The parasite drag of a typical airplane in the cruise configuration consists primarily of the skin friction, roughness, and pressure drag of the major components. There is usually some additional parasite drag due to such things as fuselage upsweep, control surface gaps, base areas, and other extraneous items. Since most of the elements that make up the total parasite drag are dependent on Reynolds number and since some are dependent on Mach number, it is necessary to specify the conditions under which the parasite drag is to be evaluated. In the method of these notes, the conditions selected are the Mach number and the Reynolds number corresponding to the flight condition of interest.

The basic parasite drag area for airfoil and body shapes can be computed from the following expression:
 $f = k c_f S_{\text{wet}}$

where the skin friction coefficient, c_f , which is based on the exposed wetted area includes the effects of roughness, and the form factor, k , accounts for the effects of both superelevations and pressure drag. S_{wet} is the total wetted area of the body or surface.

Computation of the overall parasite drag requires that we compute the drag area of each of the major components (fuselage, wing, nacelles and pylons, and tail surfaces) and then evaluate the additional parasite drag components described above.

We thus write:

$$C_{D_p} = \sum k_i c_{f_i} S_{\text{wet}_i} / S_{\text{ref}} + C_{D_{\text{upsweep}}} + C_{D_{\text{gap}}} + C_{D_{\text{nac_base}}} + C_{D_{\text{misc}}}$$

where the first term includes skin friction, and pressure drag at zero lift of the major components. c_{f_i} is the average skin friction coefficient for a rough plate with transition at flight Reynolds number. Equivalent roughness is determined from flight test data.

These computations are divided into evaluation of the following terms:

- [Skin friction coefficient, \$c_f\$](#)
 - [Form factor, \$k\$](#)
 - [Wetted area, \$S_{\text{wet}}\$](#)
 - [Control surface gap drag](#)
 - [Aft-fuselage upsweep drag](#)
 - [Nacelle base drag](#)
 - [Miscellaneous items](#)
-

Skin Friction and Roughness Drag

Skin Friction Coefficient

The skin friction coefficients are sometimes based on experimental data for flat plates with various amounts of roughness. In the present method, experimental results for turbulent flat plates are fit and combined with basic laminar flow boundary layer theory to produce the data in the figure below. The data apply to insulated flat plates with transition from laminar to turbulent flow specified as a fraction of the chord length ($x_t / c = 0$ represents fully turbulent flow.) The data are total coefficients; that is, they are average values for the total wetted area of a component based on the characteristic length of the component.

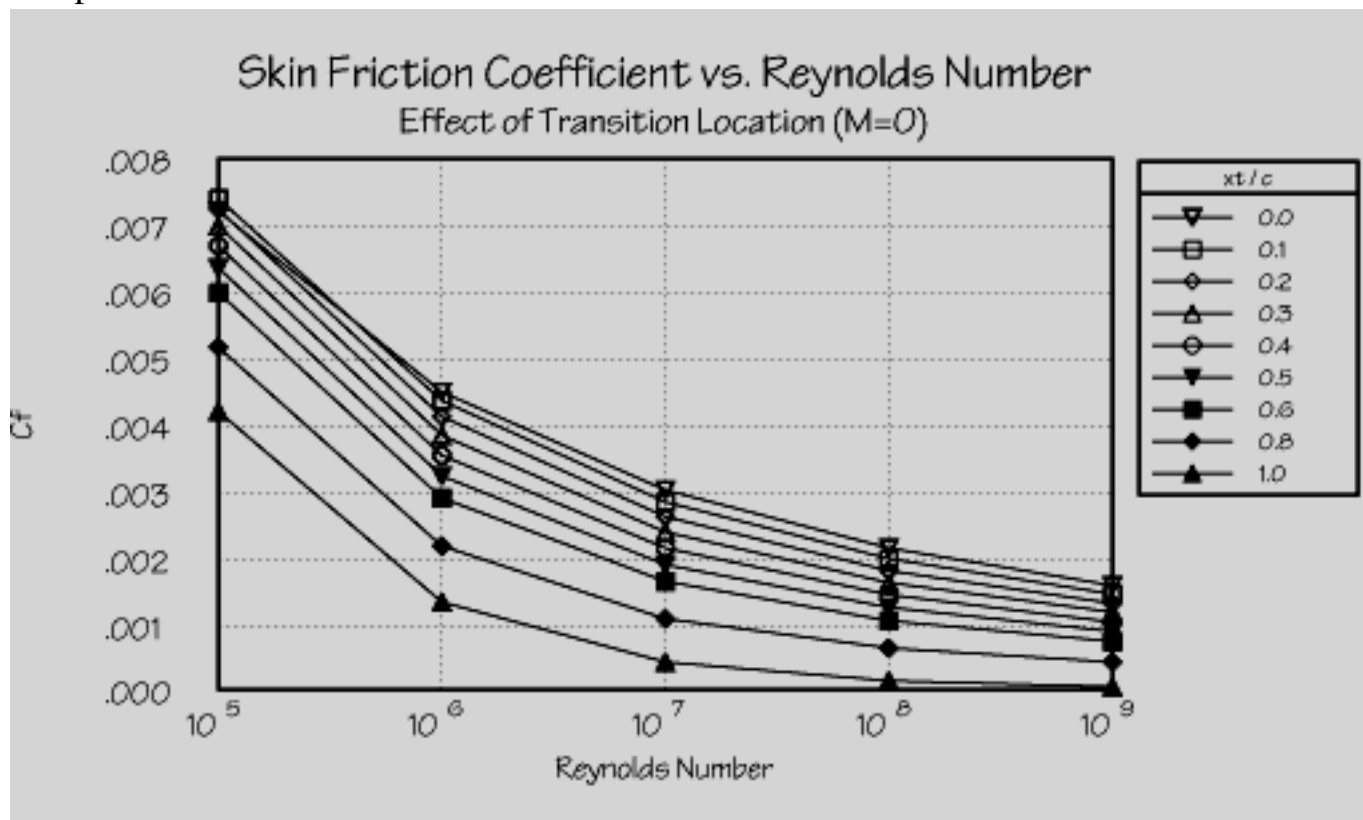

When the skin friction is plotted on a log-log scale the curves are nearly straight lines, but the actual variation of C_f is more pronounced at lower Reynolds numbers.

Skin Friction Coefficient vs. Reynolds Number

Effect of Transition Location ($M=0$)

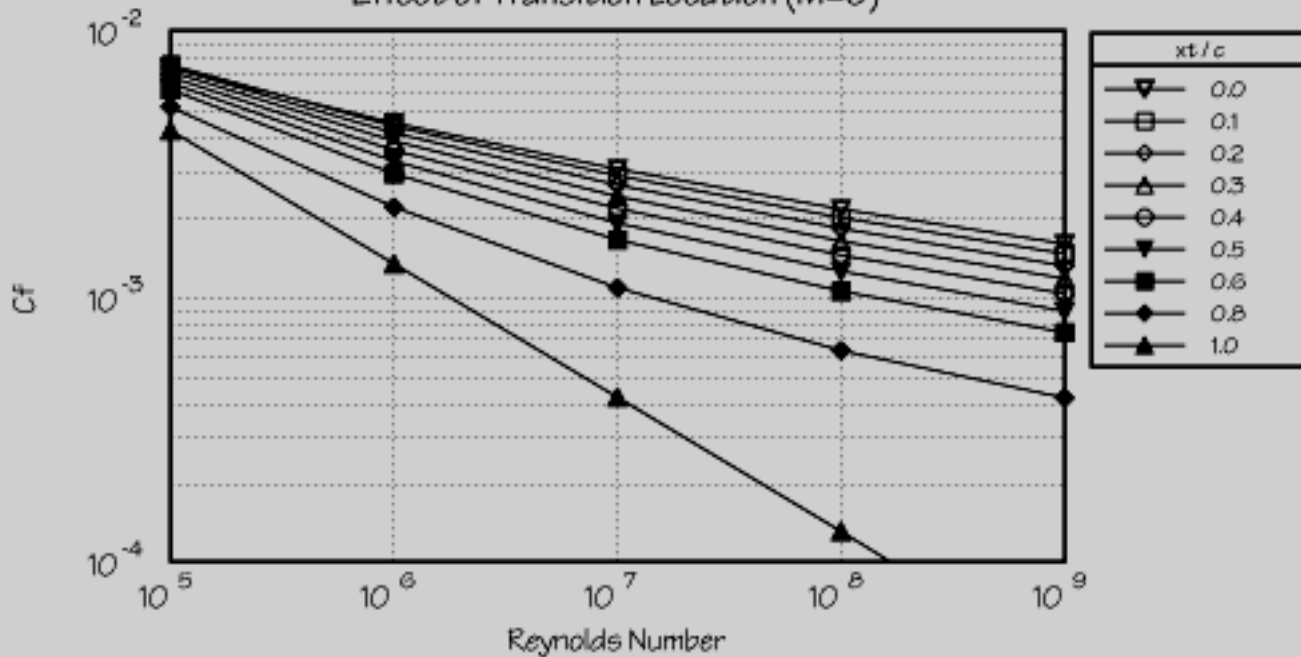

For fully turbulent plates, the skin friction coefficient may be approximated by one of several formula that represent simple fits to the experimentally-derived curves shown in the above figure. For incompressible, flow:

$$c_f = \frac{.455}{(\log Re)^{2.58}} \quad \text{or} \quad c_f = \frac{0.074}{Re^{0.2}}$$

The logarithmic fit by von Karman seems to be a better match over a larger range of Reynolds number, but the power law fit is often more convenient. (Note that the log in the above expression is log base 10, not the natural log, denoted \ln here.)

In the computation of Reynolds number, $Re = \rho V l / \mu$, the characteristic length, l , for a body (fuselage, nacelle) is the overall length, and for the aerodynamic surfaces (wing, tail, pylon) it is usually the *exposed* mean aerodynamic chord. The values of density (ρ), velocity (V), and viscosity μ are obtained from standard atmospheric conditions at the point of interest. For our purposes we often use the initial cruise conditions. Atmospheric data may be computed in the atmospheric calculator included [here](#).

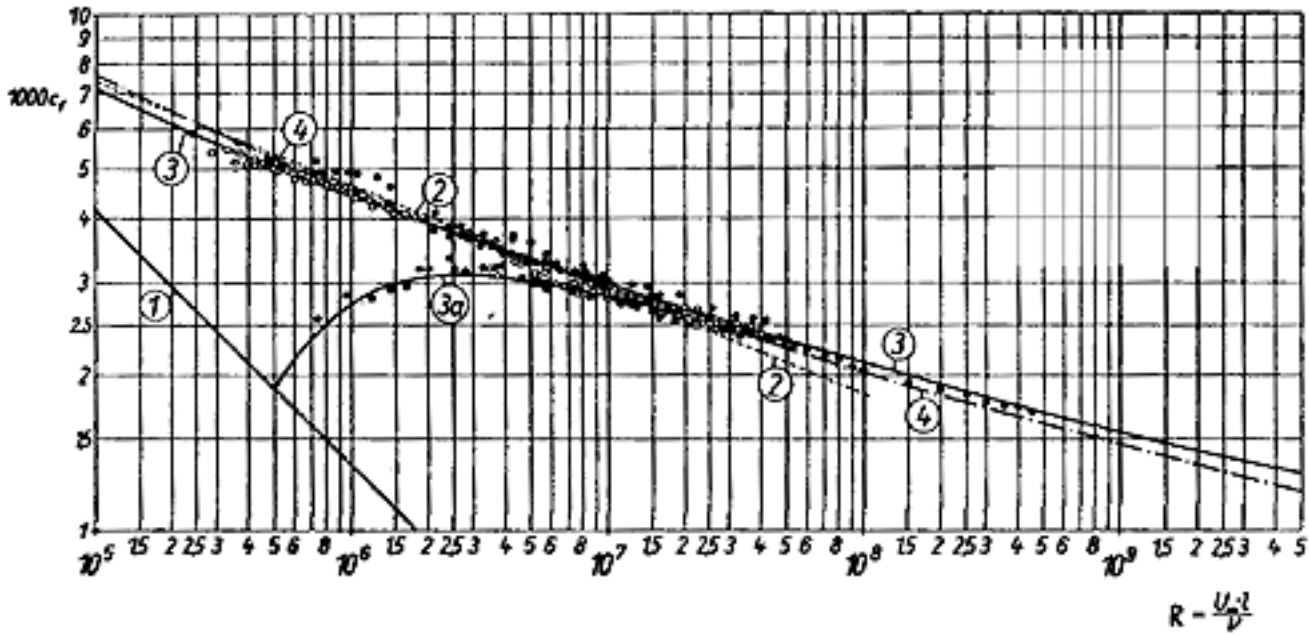

Experimental measurements of skin friction coefficient compared with curve fits. Note scatter and transition between laminar and turbulent flow.

Roughness

It is, for all practical purposes, impossible to explicitly define the incremental drags for all of the protruding rivets, the steps, the gaps, and bulges in the skin; the leakage due to pressurization; etc. Instead, in the method of these notes, an overall markup is applied to the skin friction drag to account for drag increments associated with roughness resulting from typical construction procedures. Values of the roughness markup factor have been determined for several subsonic jet transports by matching the flight-test parasite drag with that calculated by the method described in these notes. The values so determined tend to be larger for smaller airplanes, but a 6%-9% increase above the smooth flat values shown in the figure is reasonable for initial design studies. Carefully-built laminar flow, composite aircraft may achieve a lower drag associated with roughness, perhaps as low as 2-3%.

The drag assigned to roughness also implicitly accounts for all other sources of drag at zero lift that are not explicitly included. This category includes interference drag, some trim drag, drag due to unaligned control surfaces, drag due to landing gear door gaps, and any excess drag of the individual surfaces. Consequently the use of the present method implies the same degree of proficiency in design as that of the airplanes from which the roughness drag correlation was obtained.

Effect of Mach Number

The friction coefficient is affected by Mach number as well. The figure below shows that this effect is small at subsonic speeds, but becomes appreciable for supersonic aircraft. For this course, the effect may be approximated from the plot below, but a computational approach is described by Sommer and Short in

NACA TN 3391 in 1955. The idea is that aerodynamic heating modifies the fluid properties. If one assumes a wall recovery factor of 0.89 (a reasonable estimate), and fully-turbulent flow, the wall temperature may be estimated from:

$$\frac{T_w}{T_\infty} = 1 + 0.178M_\infty^2$$

An effective incompressible temperature ratio is defined:

$$\frac{T^v}{T_\infty} = 1 + 0.035M_\infty^2 + 0.45\left(\frac{T_w}{T_\infty} - 1\right)$$

leading to an effective Reynolds number:

$$\frac{R'}{R_\infty} = \frac{(T_\infty + 216)}{(T^v + 216)} \left(\frac{T_\infty}{T^v}\right)^{1.5}$$

when the viscosity ratio is given by the Sutherland formula (with T in units of °R):

The compressible skin friction coefficient is then given by:

$$c_f = \frac{T_\infty}{T^v} c'_{f_{inc}}$$

where $c'_{f_{inc}}$ is the incompressible skin friction coefficient, computed at the Reynolds number R' .

Finally, the ratio of compressible C_f to incompressible C_f at the same Reynolds number is:

$$\frac{c_f}{c'_{f_{inc}}} = \left(\frac{T_\infty}{T^v}\right) \left(\frac{R_\infty}{R'}\right)^{0.2}$$

The net result is shown in the plot below.

Effect of Mach Number on Turbulent Skin Friction

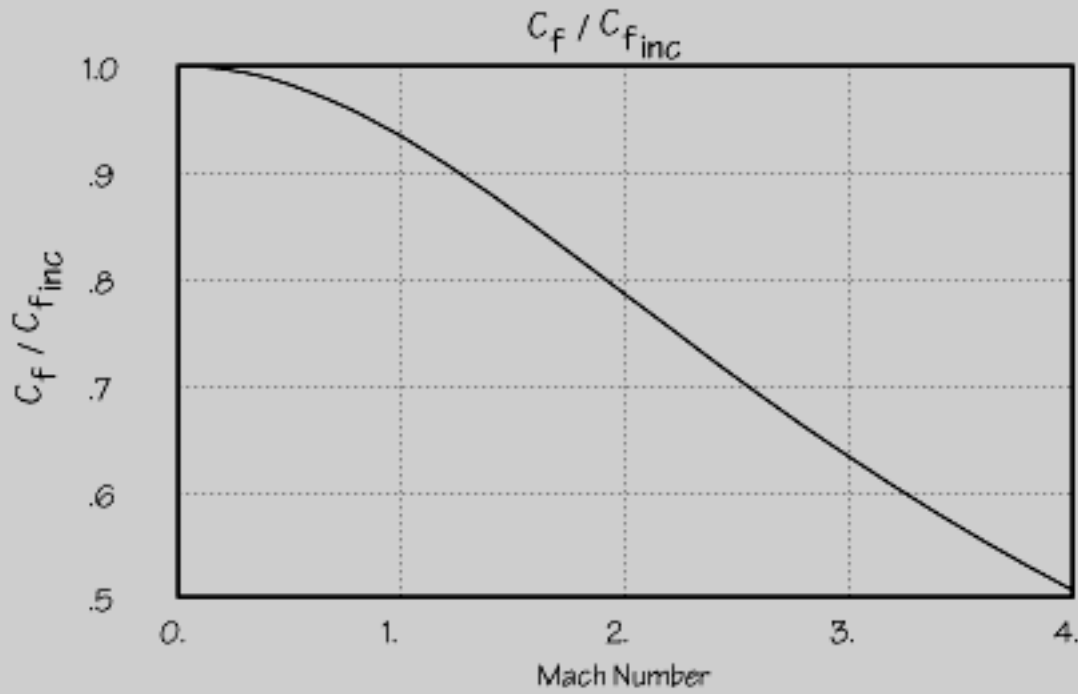

Note that the difference in C_f between Mach 0 and Mach 0.5 is about 3%.

A [program for computing \$C_f\$](#) is available here.

Skin Friction Calculation

This page can be used to compute the skin friction coefficient for a flat plate at a specified flight condition.

Altitude:

Mach:

Reference Length:

Transition x/l :

C_f :

Form Factor

The parasite drag associated with skin friction and pressure drag is determined by incrementing the flat plate results by a factor, k , to account for pressure drag and the higher-than-freestream surface velocities:

$$f = k c_f S_{\text{wet}}$$

The principal cause of increased drag is the increased surface velocity (supervelocity) due to thickness. For a given airfoil we can compute the maximum increase in velocity. This can also be done for a range of airfoil thickness ratios, wing sweeps, and Mach numbers to determine the form of variation with these parameters. After that one must still resort to experimental data to correlate the actual drag increment associated with skin friction and pressure drag. Such a variation is shown in the figure below at a Mach number of 0.5 for a family of airfoils similar to those used on commercial transports. Additional details on how this is computed are available [here](#).

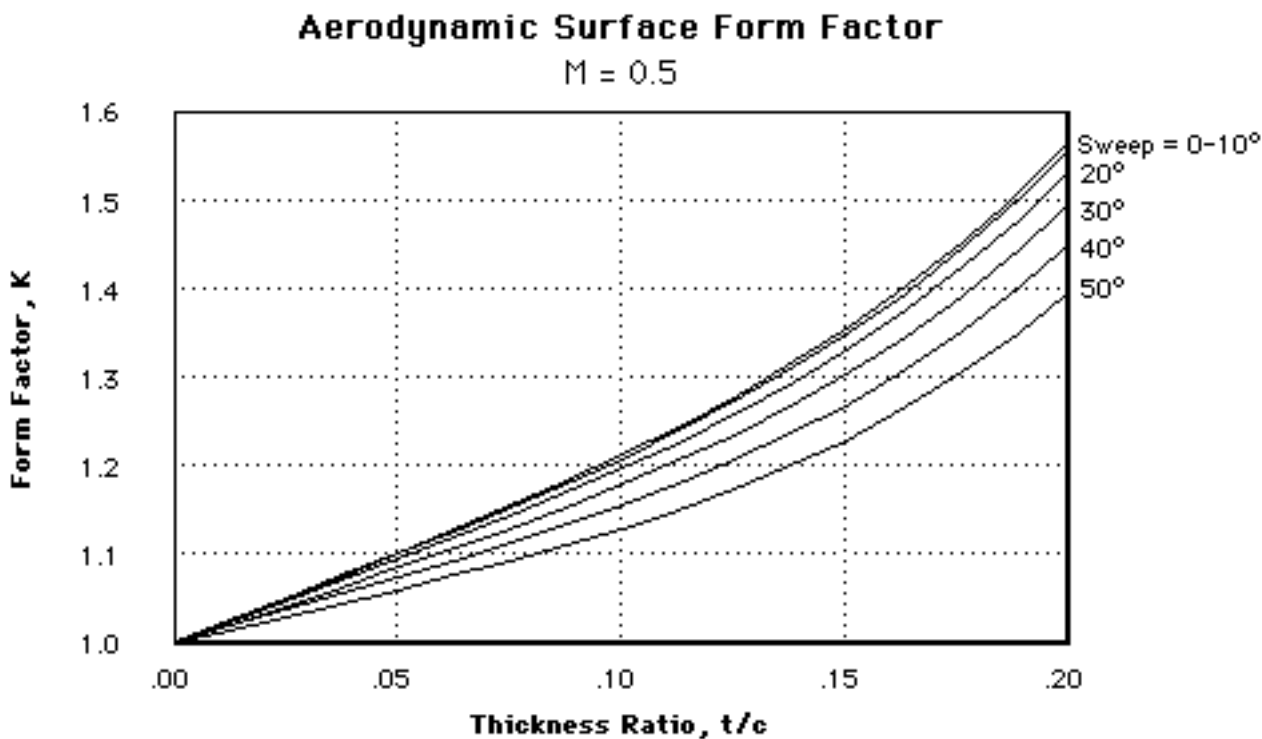

The fineness ratio of the fuselage affects the fuselage drag by increasing the local velocities and creating a pressure drag. The increase in skin friction due to higher-than-freestream velocities can be estimated by considering the symmetric flow around a body of revolution.

For bodies of revolution, the increase in surface velocity due to thickness is smaller than for 2-D shapes. The maximum velocity can be computed as a function of fineness ratio, assuming a family of fuselage shapes. The actual surface velocity distribution depends strongly on the shape of the body: paraboloids

have about half again as much maximum perturbation velocity as ellipsoids, and fuselages with constant cross sections are quite different, but the idea here is to represent the correct trend theoretically, and then obtain empirical constants. The results are shown in the figure below with [details available through this link](#).

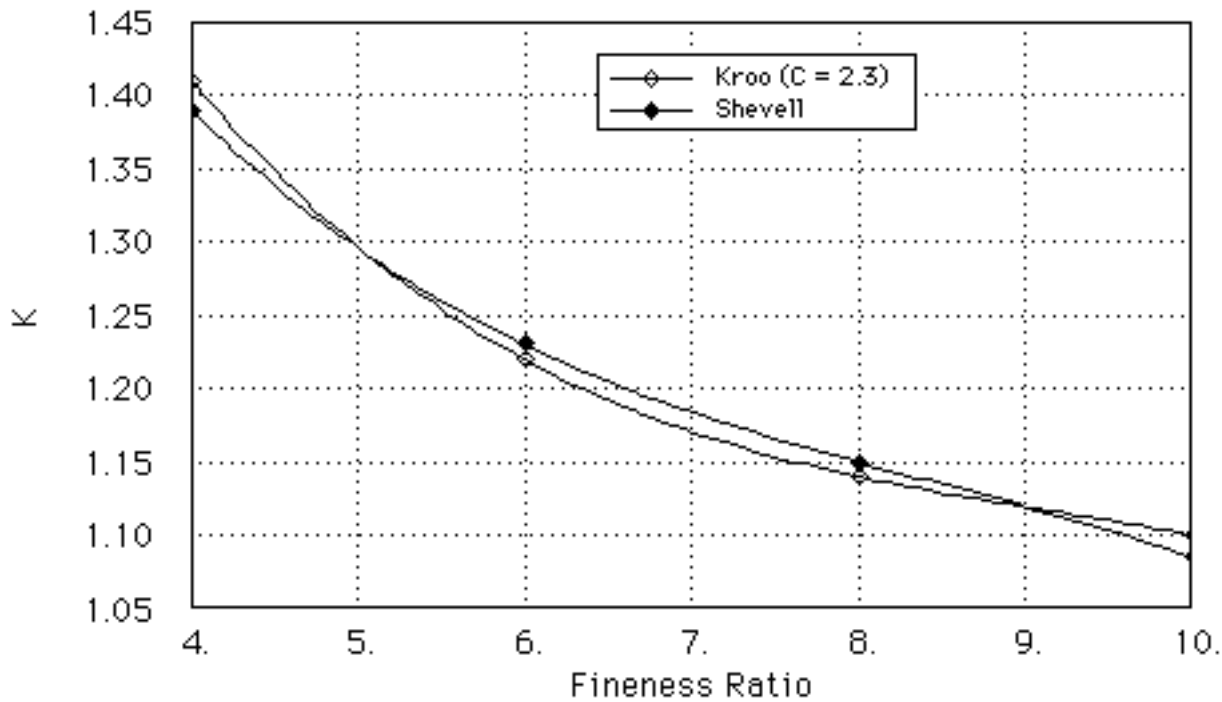

When the body has a non-circular cross-section, the effective diameter may be computed from:

$$D_{\text{effective}} = (4 S / \pi)^{1/2}$$

where S is the maximum cross-sectional area.

Nacelles may also be modeled as bodies of revolution, with an effective fineness ratio given by:

$$\frac{L}{D} = \frac{\text{Nacelle Length} + \text{Inlet Diameter}}{\sqrt{\frac{4}{\pi} \left(A_{\text{max}} - \frac{A_{\text{exit}} + A_{\text{inflow}}}{2} \right)}}$$

Here, A_{exit} = total exit area

A_{inflow} = effective inlet area based on mass flow, approximately = $0.8 A_{\text{inlet}}$

A_{max} = maximum nacelle cross-section area

Typically A_{inlet} is approximately $0.7 A_{\text{max}}$.

Form Factor for Lifting Surfaces

The principal cause of increased drag is the increased surface velocity (supervelocity) due to thickness. This may be computed as follows for wing-like surfaces. Consider an infinite swept wing with a perturbation due to thickness of:

$\Delta U_n(x)$ and define $\Delta U' = \Delta U_n / U_\infty$. The surface velocity is then:

$$U = U_\infty + \Delta U_n \cos \Lambda \quad \text{and} \quad V = \Delta U_n \sin \Lambda$$

and resultant is:

$$U_{\text{tot}}^2 = U^2 + V^2 = U_\infty^2 + \Delta U_n^2 + 2 U_\infty \Delta U_n \cos \Lambda$$

The skin friction drag coefficient is given by:

$$\begin{aligned} C_D &= C_f U_{\text{tot}}^2 / U_\infty^2 U / U_{\text{tot}} S_{\text{wetted}} / S \\ &= C_f U U_{\text{tot}} / U_\infty^2 S_{\text{wetted}} / S \\ &= C_f (U_\infty + \Delta U_n \cos \Lambda) (U_\infty^2 + \Delta U_n^2 + 2 U_\infty \Delta U_n \cos \Lambda)^{0.5} / U_\infty^2 S_{\text{wetted}} / S \\ &= C_f (1 + \Delta U' \cos \Lambda) (1 + \Delta U'^2 + 2 \Delta U' \cos \Lambda)^{0.5} S_{\text{wetted}} / S \\ &= C_f [(1 + 2 \Delta U' \cos \Lambda + \Delta U'^2 \cos^2 \Lambda) (1 + \Delta U'^2 + 2 \Delta U' \cos \Lambda)]^{0.5} S_{\text{wetted}} / S \\ &= C_f [1 + \Delta U'^2 + 2 \Delta U' \cos \Lambda + 2 \Delta U' \cos \Lambda + 4 \Delta U'^2 \cos^2 \Lambda + \Delta U'^2 \cos^2 \Lambda + \text{HOTs}]^{0.5} S_{\text{wetted}} / S \\ &= C_f [1 + 4 \Delta U' \cos \Lambda + \Delta U'^2 (1 + 5 \cos^2 \Lambda) + \text{HOTs}]^{0.5} S_{\text{wetted}} / S \\ &\approx C_f [1 + 2 \Delta U' \cos \Lambda + \Delta U'^2 (1 + 5 \cos^2 \Lambda) / 2] S_{\text{wetted}} / S \end{aligned}$$

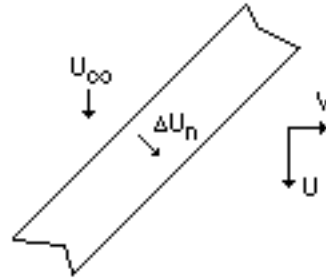

Ignoring the reduction in c_f due to Reynolds number and Mach number changes associated with the increased local velocity, because this cannot be computed at all well and because c_f varies weakly with these:

$$k = 1 + 2 \Delta U' \cos \Lambda + \Delta U'^2 (1 + 5 \cos^2 \Lambda) / 2$$

Now in incompressible flow, $\Delta U' = C t/c$, even for large t/c (with t/c measured in the normal direction). In 2-D subsonic flow:

$$\Delta U' = C t/c \cos \Lambda (1 - M_n^2)^{-0.5} = C t/c \cos \Lambda / \beta$$

$$\text{So: } k = 1 + 2 C t/c \cos^2 \Lambda / \beta + C^2 \cos^2 \Lambda t/c^2 (1 + 5 \cos^2 \Lambda) / 2 \beta^2$$

$$k = 1 + \frac{2 C (t/c) \cos^2 \Lambda}{\sqrt{1 - M_\infty^2 \cos^2 \Lambda}} + \frac{C^2 \cos^2 \Lambda (t/c)^2 (1 + 5 \cos^2 \Lambda)}{2 (1 - M_\infty^2 \cos^2 \Lambda)}$$

The value of k is given in the next figure and compared with other methods and experimental data. A value for C of about 1.1 agrees best with the rather scattered data. When $M \cos \Lambda > 1$, there is not a

velocity increase due to t/c and so we take $C=0$.

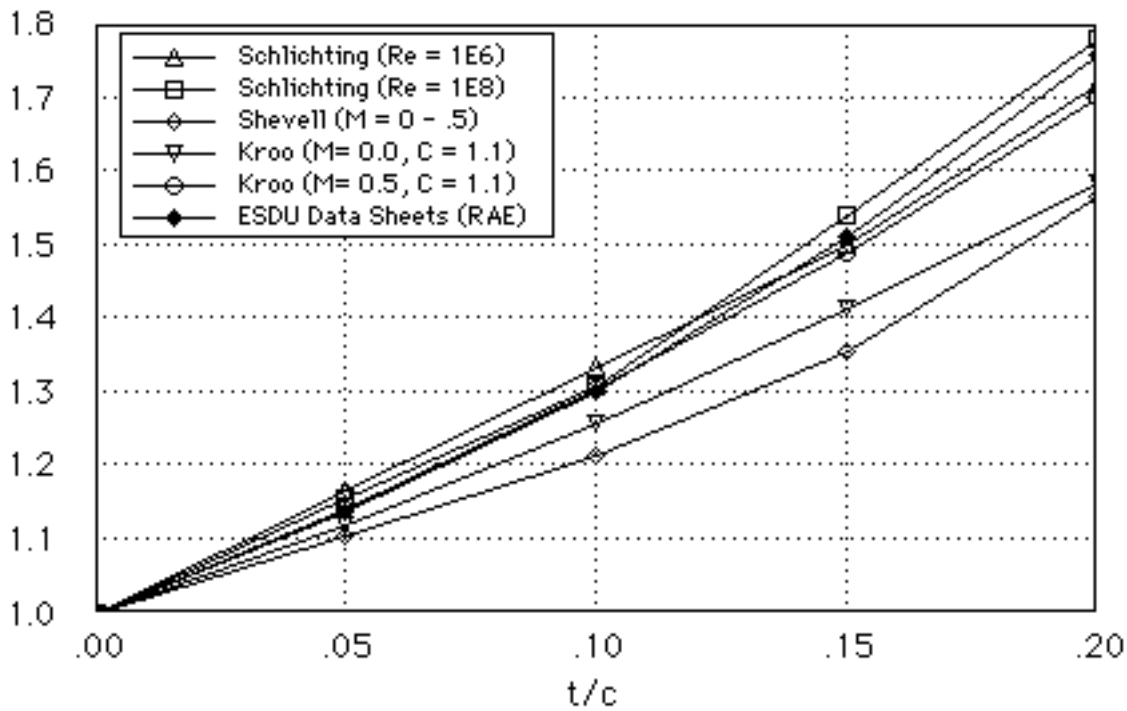

Form Factor Calculation

This calculator may be used to compute the form factor for a lifting surface.

t/c :

Mach:

Sweep:

K:

Form Factor for Bodies

The fineness ratio of the fuselage affects the fuselage drag by increasing the local velocities and creating a pressure drag. The increase in skin friction due to higher-than-freestream velocities can be estimated by considering the symmetric flow around a body of revolution.

For bodies of revolution, the increase in surface velocity due to thickness is smaller than for 2-D shapes.

From potential flow theory, the maximum velocity over an ellipse with thickness ratio t/c is:

$$\Delta u_{\max} / U_0 = t/c.$$

The maximum velocity increase on an ellipsoid of revolution is given by the potential flow solution:

$$\Delta u_{\max} / U_0 = a / (2-a) / (1-M^2)^{0.5}, \text{ where } a = 2(1-M^2) d^2 / D^3 (\tanh^{-1} D - D)$$

and $D = (1 - (1-M^2) d^2)^{0.5}$, and $d = \text{diameter} / \text{length}$.

The actual surface velocity distribution depends strongly on the shape of the body: paraboloids have about half again as much maximum perturbation velocities as ellipsoids, and fuselages with constant cross-sections are quite different, but the idea here is to represent the correct trend theoretically, and then obtain empirical constants. If a sort of average perturbation velocity is represented by $C \Delta u_{\max}$ then the form factor, k , for bodies may be written:

$$k = (1 + C \Delta u_{\max} / U_0)^2.$$

The figure below shows that a factor, $C=2.3$ leads to reasonable agreement with the purely empirical method given by Shevell.

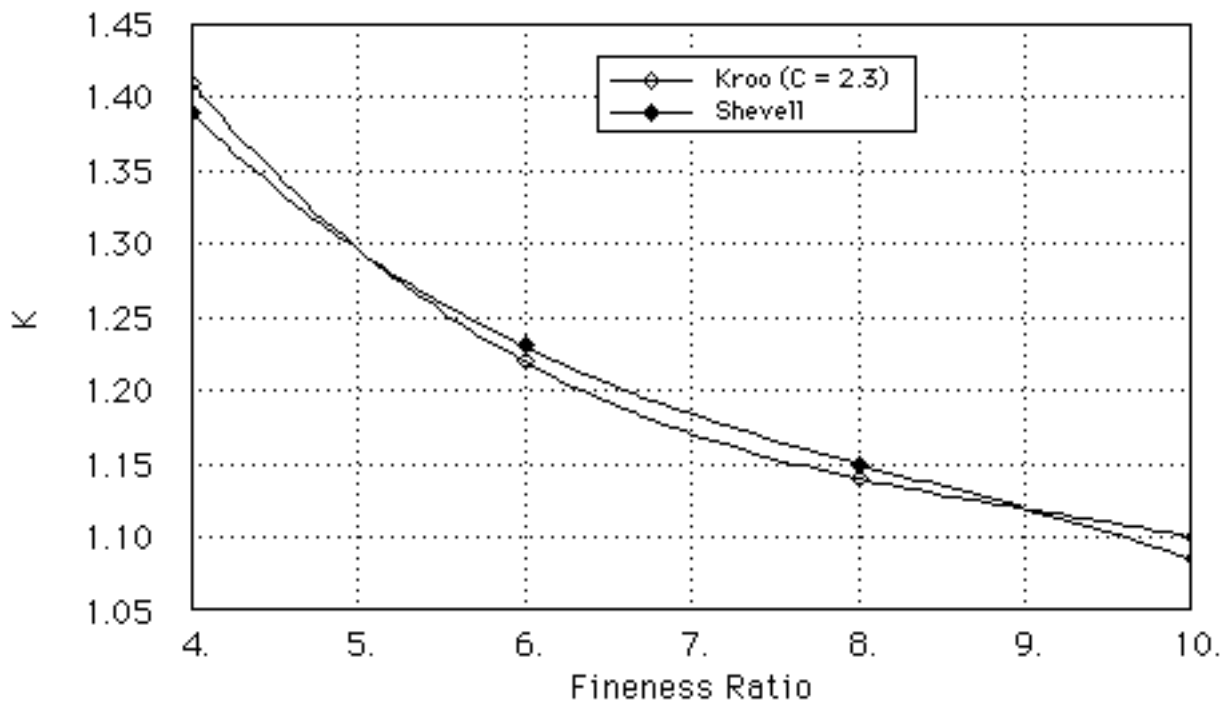

At supersonic speeds, the optimum body shape is closer to a paraboloid, but the velocity distribution is quite different. The maximum velocity no longer occurs at the middle of the body, and the flow is decelerated over more of the area. In fact, based on linear theory, the net form factor is 1.0.

Form Factor Calculation

This calculator may be used to compute the form factor for a lifting surface.

Fineness Ratio:

Mach:

K:

Wetted Area Calculations

In order to compute the skin friction drag, it is necessary to multiply this coefficient by the wetted area. For wing-like surfaces, the wetted area is related to the exposed planform area. It is a bit more than twice the exposed area because the arc length over the upper and lower surfaces is a bit longer than the chord:

$$S_{\text{wetted}} \approx 2.0 (1 + 0.2 t/c) S_{\text{exposed}}$$

The exposed area is that portion of the wing planform that is exposed to the airflow. It does not include the part of the wing buried in the fuselage, but does include any chord extensions.

For bodies, the wetted area can be computed by adding the contribution of the nose section, constant section, and tapered tail cone. This requires knowledge of the actual fuselage shape, but for typical transport aircraft, the wetted area of the nose and tail cone may be approximated by:

$$S_{\text{wetted_nose}} = .75 \pi D L_{\text{nose}} \quad S_{\text{wetted_tail}} = .72 \pi D L_{\text{tail}}$$

where D is the diameter of the constant section and L is the length of the nose or tail cone. For elliptically-shaped fuselage cross-sections, of width W , and height H , an approximate formula for the perimeter may be used to estimate an effective diameter. One such expression is given below.

$$D_{\text{eff}} = (W/2 + H/2) (64 - 3 R^4) / (64 - 16 R^2)$$

$$\text{where: } R = (H-W)/(H+W)$$

Control Surface Gap Drag

The parasite drag also includes extra drag due to gaps at the control surfaces. This is best estimated based on experimental data. The drag depends on the detailed design of the controls, but for the purposes of this course we take the drag increment to be:

$$f_{\text{gaps}} = .0002 \cos^2 \text{Sweep} S_{\text{affected}}$$

where S_{affected} is the area of the wing, horizontal tail, or vertical tail affected by control surfaces. This is typically about $0.3 S_{\text{wing}}$, $1.0 S_{\text{horiz}}$, and $0.9 S_{\text{vert}}$, but the detailed layout should be used. The correction for sweep is included since the component of the dynamic pressure normal to the gap is the significant term.

Fuselage Upsweep Drag

The drag due to the upward curvature of the aft fuselage is the sum of a fuselage pressure drag increment due to the upsweep and a drag increment due to a loss of lift. Because of the loss of lift, the airplane must fly at a higher wing lift coefficient in order to maintain the required net airplane C_L . This causes an increase in lift-dependent drag. The total upsweep drag may be written:

$$\Delta C_{D\pi_{\text{upsweep}}} = (\Delta C_{D\pi_{\text{upsweep}}})_{a=\text{const}} + (\Delta C_{L\pi_{\text{upsweep}}})_{a=\text{const}} * (\partial C_D / \partial C_L)$$

The change in drag with C_L (i.e. dC_D / dC_L) varies with both airplane lift coefficient and Mach number (by virtue of its dependence on the wing compressibility characteristics.) For a first approximation, a single value may be used; 0.04 is typical. The geometric parameter used to correlate upsweep drag with fuselage shape is the vertical displacement of the fuselage centerline in the tail cone above the fuselage reference plane. The vertical position of the center of cross-sectional area is measured, not at the end of the fuselage, but at a point that is located 75% of the total upsweep length. The parameter is thus $(h/l)_{.75 l_t}$. This is to minimize the effect of modifications at the very aft end of the fuselage that do not produce much change in the effective upsweep.

The total upsweep drag increment (including each of the two terms discussed previously) increases with the parameter, $(h/l)_{.75 l_t}$, according to the following expression, derived from wind tunnel data:

$$C_{D\pi_{\text{upsweep}}} = 0.075 (h/l)_{.75 l_t}$$

The subscript π denotes the fact that this C_D is nondimensionalized by fuselage maximum cross-sectional area, rather than reference wing area. To obtain the increment in C_D based on wing area, remember to multiply by the ratio of fuselage cross section area to wing area. Typical values of $C_{D\pi_{\text{upsweep}}}$ are around 0.006. This translates into about 0.0007 based on wing area for a DC-9.

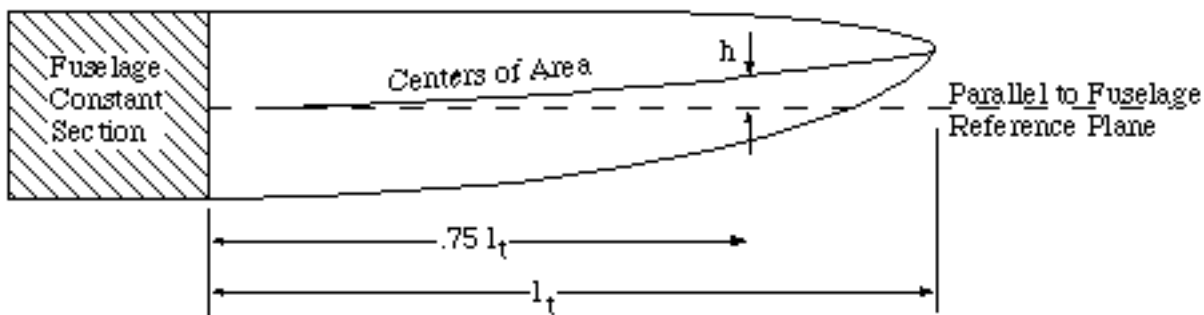

Fuselage Upsweep Geometry

Two points are of interest with regard to aft-fuselage upsweep:

1. Tests of fuselage shapes in the absence of the wing yield results that greatly overestimate the magnitude of the upsweep drag.

2. Wind tunnel test results have indicated that the loss of lift due to upsweep is significantly greater than just the download on the aft fuselage, which suggests that there is a flow change over the wing and forward fuselage due to the aft-fuselage upsweep. Also, the net change in pitching moment due to upsweep is an increased nose-down moment instead of a nose-up moment that might be expected. As a result, the loss in lift does not complement the download on the tail that is required to trim the airplane. In fact, the effect of upsweep is to slightly increase the airplane trim drag.

Nacelle Base Drag

Among the many items that are included in an explicit manner, one usually estimates the drag increment associated with a small gap between the engine nozzle and the nacelle. Nacelle base drag is a small item, but is representative of the types of drag components that one tries to model in a realistic manner.

Most turbofan engines maintain a gap between the engine nozzle and nacelle of about 1/2 inch. Flow separates and creates a base drag area that may be estimated as the base area (.5 inch times the circumference at the nozzle exit) multiplied by a drag coefficient of about 0.2.

$$\text{So } C_{D_{\text{nacelle_base}}} = 0.5/12 * \pi * D_{\text{exit}} * 0.2 / S_{\text{ref}}$$

with the nozzle exit diameter measured in feet.

Drag of Miscellaneous Items

In addition to the basic parasite drag of the major components, the drag due to aft-fuselage upsweep, and control surface gaps, there is usually other parasite drag that must be taken into account. This is the drag associated with the air conditioning system, various cooling systems, and the many necessary protuberances that exist on an airplane. The classification of the items to be included in the miscellaneous drag category-and hence to be separately listed-and of the items to be implicitly included in the roughness drag, is somewhat arbitrary. Neither extreme is very attractive. That is, it is impractical to account for every last protuberance on the airplane separately. yet, on the other hand, some of these items can be significant, so that failure to account for them separately could cause the airplane drag to be underestimated. In the method of this course, such items are included in the miscellaneous drag category. These items include the air conditioning system, flap hinge and track covers, wing fences, and any unique protuberances. Items for which the drag is an implicit part of the 'roughness' markup include cabin leakage, normal antennas, nacelle compartment cooling, canopies, pressure and temperature probes, windshield wipers, and miscellaneous inlets and exhausts.

In accounting for the drag caused by the air conditioning system, only losses associated with the cooling air are to be included. No engine bleed losses are included. However, any thrust recovery resulting from the efficient discharge of cabin air should be included in this evaluation. The parasite drag of any specific protuberance should be calculated by applying the methods discussed previously.

If the design of the airplane has not progressed to the point where a detailed calculation of the drag of the air conditioning system and other items can be made, the drag of these miscellaneous items can be assumed to be about 1.5% of the total airplane parasite drag. This estimate is based on the drag of such items on the DC-8-62, -63, and on the DC-9. The breakdown of the miscellaneous drag for these airplanes is shown in the following table. (Numbers are percent of total airplane parasite drag.)

Item / Airplane	DC-8-62	DC-8-63	DC-9-10	DC-9-20	DC-9-30
Flap Hinge Covers	0.12	0.12	0.69	0.97	0.69
Air Conditioning System (incl. thrust recovery)	0.84	0.82	0.25	0.24	0.24
Vortilon	-	-	0.30	0.29	0.29
Fence and Stall Strip	-	-	0.99	-	-
Miscellaneous	0.25	0.25	-	-	-
Total	1.21%	1.19%	2.23%	1.50%	1.22%

Lift-Dependent Drag Items

The total drag coefficient includes the parasite drag and other components:

$$C_D = C_{D_p} + C_{D_{\text{vortex}}} + C_{D_{\text{lift-dependent viscous}}} + C_{D_{\text{compressibility}}}$$

This is sometimes written:

$$C_D = C_{D_p} + C_{D_i} + C_{D_c}$$

The second term, is often called the induced drag, but it includes more than just the inviscid drag associated with induced velocities from the wake. For purposes of this analysis, the "induced" drag is customarily divided into viscous and inviscid parts. The inviscid (vortex) drag includes a zero-lift term due to twist, and lift-dependent parts that depend on the twist and planform. The remaining portion of the "induced" drag, the so-called viscous part, is chiefly due to the increase of skin friction and pressure drag with changes in angle of attack. Such increases come about because of the increased velocities on the upper surface of the wing leading to higher shear stresses and more severe adverse gradients with corresponding increase in pressure drag. As in the case of parasite drag, the "induced" drag also includes several miscellaneous effects not accounted for in a simple theoretical study. Additional empirically-estimated terms arise from fuselage vortex drag, nacelle-pylon interference, changes in trim drag with angle of attack, and a change in drag due to engine power effects (either inlet or exhaust).

Inviscid Part

For twisted wings, the inviscid drag may be written:

$$C_{D_{\text{inviscid}}} = \frac{C_L^2}{\pi AR u s} + a_0 \theta C_L v + (a_0 \theta)^2 w$$

The last term is present at zero-lift and is the zero-lift drag due to twist. The first term is the vortex drag associated with the untwisted wing.

The factor, s , accounts for the added lift-dependent drag caused by the modification of the span loading due to the addition of the fuselage. Its value is presented in the figure below for various ratios of the fuselage width (or diameter) to wing span. The values of this factor are obtained from a solution for the minimum induced drag of a lifting line in combination with a circular fuselage of infinite length and at zero angle of attack. A [simple explanation of this effect](#) is available for interested readers using this link. Although the analysis was made only for a mid-wing location, the results are used in this method for all wing locations. These results are probably slightly conservative for application to low-wing designs. However, the use of these results for wing installations with large root incidence angles does not fully predict the detrimental effect of the fuselage on the wing span-load distribution. It has been shown that

with large wing incidences there is a much greater deficiency in the lift "carry-over" on the fuselage. The value of 's' is usually between .965 and .985. For initial studies assuming a value of .975 will lead to no more than a 1% error in lift dependent drag, but if the chart below is available, use that.

Lift-Dependent Drag Factor for Fuselage Interference

$$\text{Fit: } 1 - .0407 x - 1.792 x^2$$

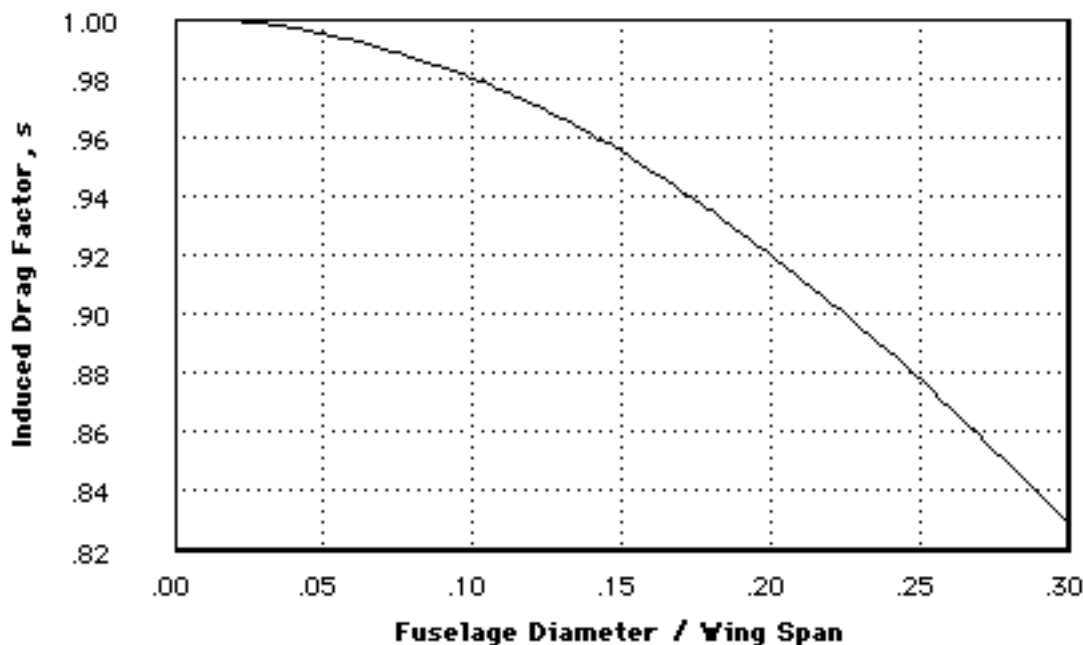

Apart from this factor, the expression for inviscid drag of the wing alone shows how planform and twist affect the drag. Simple finite wing theory shows that if the distribution of lift over the wing is elliptical, the inviscid drag is minimized with a given span, lift, and flight condition. We can make the span loading nearly elliptical with suitable choices of wing planform and twist and so should be able to approach the ideal minimum value quite closely. We can use the expression above, in fact, to solve for the twist angle that produces the minimum C_{D_i} for a given planform. Generally, twists that are somewhat greater than that required for minimum induced drag are used. This is often done to improve handling or reduce induced drag at low speeds. Thus, the total inviscid drag is somewhat greater than the ideal minimum: $C_L^2 / \pi AR$.

For most transport-like configurations taper ratios are chosen in the 0.20 to 0.35 region where the value of u is close to 0.99. (The values of u, v, and w depend only on the planform.) The lift-dependent twist term can actually contribute a negative drag increment. If the taper and sweep are higher than ideal, for example, the wing can be "washed-out" (negative twist) to bring the loading closer to elliptical.

Rather than evaluate the u, v, and w terms in the expression above, designers generally now rely on computations of a specific wing planform and twist distribution to estimate the vortex drag. If a wing-body analysis code is available, the lift carry-over can be estimated well and there is no need for the fuselage s-term either. In many cases, though, initial wing design studies will be performed without the fuselage and the fuselage correction factor, s, applied to these results.

Trim Drag

When the tail of an airplane carries some load, several drag components are increased: the tail itself has vortex drag and lift-dependent viscous drag, but the lift of the wing must be changed to obtain a specified airplane C_L :

$$C_{L_{\text{Airplane}}} = C_{L_{\text{Airplane}}} + C_{L_{\text{tail}}} (S_{\text{tail}} / S_{\text{wing}})$$

The increase in wing C_L means that the wing vortex and lift-dependent viscous drag increases. In addition, wing compressibility drag is affected.

To compute this, we first must calculate the lift carried by the tail. For most transport aircraft without active controls this is about 5% of the airplane lift, but in the wrong (downward) direction. We could then compute the vortex drag of the combined wing/tail system and then add in viscous and compressibility increments. The difficulty with this is that unless we know the airplane center of gravity (CG) location, we cannot compute the tail load and in the early stages of the analysis, we do not know the airplane CG location. Sometimes we make rough estimates of the CG. When this is not possible, we can rely on more detailed computations done on other aircraft which show trim drag of about 1% to 2% of airplane drag. Airplane designs can easily be created with very high trim drag values, though. We will discuss this in connection with tail design in subsequent chapters.

Viscous Part

Over most of the flight regime of interest, the viscous part of the "induced" drag may be approximated by a parabolic variation with C_L . Thus we write:

$$C_{D_{i_{\text{viscous}}}} = K C_{D_p} C_L^2$$

Ideally, this drag contribution should be estimated for the individual airplane components, with factors such as the influence of wing leading edge geometry, wing camber, wing thickness ratio, wing sweep, pylon interference, fuselage upsweep, tail induced drag, power effects, etc. taken into account. Since the information required to do this usually does not exist in preliminary design, it is assumed that a new airplane will be similar enough to previous airplanes that the viscous part of the lift-dependent drag can be represented by the equation above, with the K factor determined from previous flight test data. The wing contribution, including the effect of sweep, is included separately from the contributions of the other components. The form of the expression for lift-dependent viscous drag may be derived by combining simple sweep theory with the equation for airfoil superelevations due to circulation.

The value of the factor K has been determined from flight test data for the DC-8-62 and 63 and for the DC-9-10, -20, and -30 airplanes to be approximately 0.38.

When each of these effects is added together, the total drag is seen to vary quadratically with C_L . In fact, apart from the lift dependent twist term, the drag polar is a parabola and would form a straight line when plotted vs. C_L^2 . Since the lift-dependent twist term is usually very small, we expect that the C_D vs. C_L^2 will be nearly straight. This is often the case. The drag polar can thus be approximated, over most of the range of interest by the two-parameter expression:

$$C_D = C_{D_p} + \frac{C_L^2}{\pi AR e}$$

'e' is a parameter which expresses the total variation of drag with lift. It is sometimes called the span efficiency factor or Oswald efficiency factor after Dr. W.B. Oswald who first used it. It would be 1.0 for an elliptically-loaded wing with no lift-dependent viscous drag, but for practical aircraft 'e' varies from about 0.75 to 0.90.

We can predict the value of 'e' by computing the inviscid drag from a lifting surface method and adding the lift-dependent viscous drag:

$$C_D = C_{D_p} + C_{D_{i_inviscid}} + K C_{D_p} C_L^2 = C_{D_p} + C_L^2 / (\pi AR e_{inviscid}) + K C_{D_p} C_L^2$$

So if $C_D = C_{D_p} + C_L^2 / (\pi AR e)$

then:

$$e = \frac{1}{\pi AR \left(\frac{1}{\pi AR e_{inviscid}} + K C_{D_p} \right)} = \frac{1}{\frac{1}{e_{inviscid}} + \pi AR K C_{D_p}}$$

The figure below shows a typical variation in e with aspect ratio, sweep, and C_{D_p} . The chart was constructed by assuming $u = 0.99$ and $s = 0.975$, and it works quite well, although the calculation should be done in detail for a specific airplane. C_{D_p} for jet transports typically varies from about .0140 for aircraft with small ratios of body wetted area to wing wetted area (707 or DC-8) to .0210 for short range aircraft with a relatively large fuselage. The wide-body tri-jets lie in the middle of this range. Note that this plot shows typical values, the actual value of 'e' for a particular airplane should be computed as described above.

Effect of AR and C_{Dp} on e Typical Results

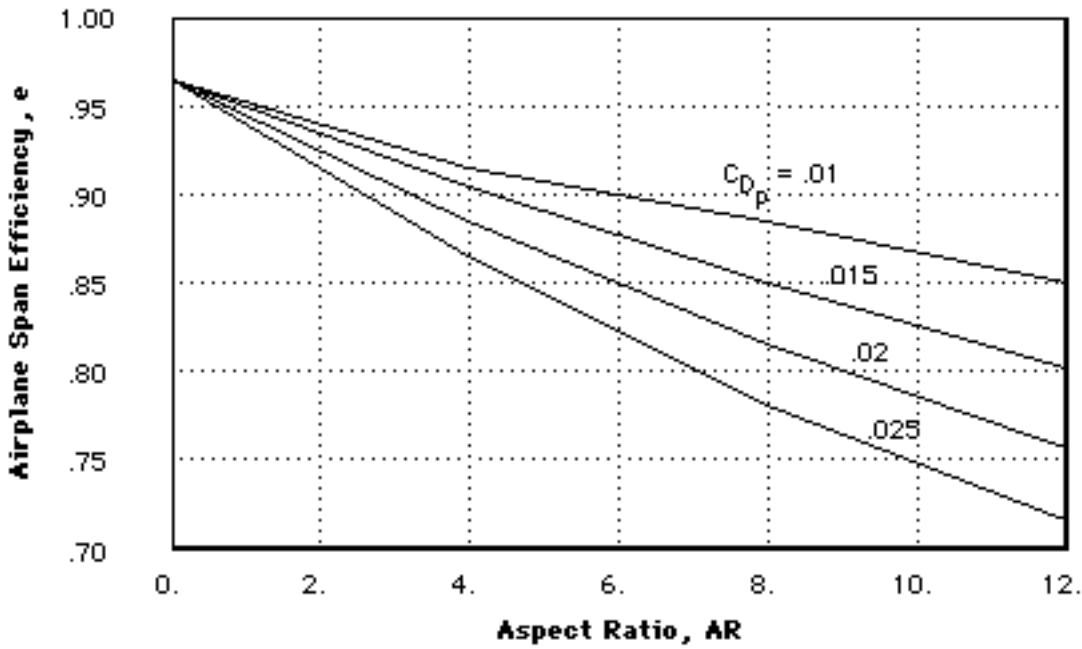

Aircraft with wing-mounted propellers have a further reduction in 'e' due to the downwash behind inclined propellers. The exact effect is difficult to calculate but a reduction of about 4% is reasonable.

Fuselage Effect on Induced Drag

One may estimate the drag associated with fuselage interference in the following manner:

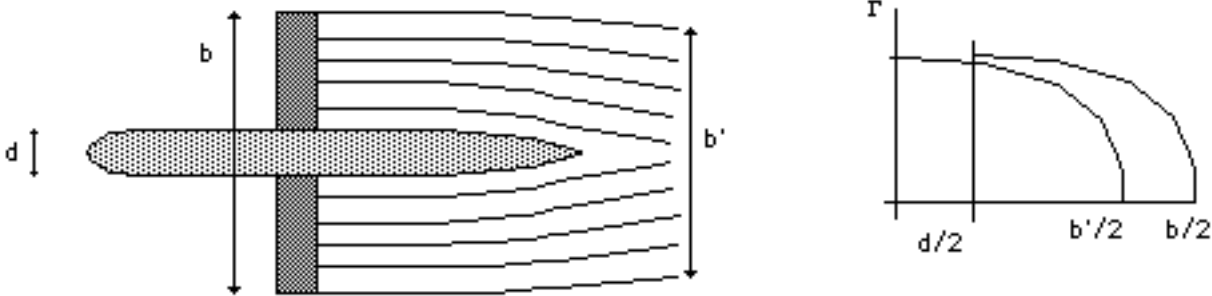

If the flow were axially symmetric and the fuselage were long, then mass conservation leads to:

$$b'^2 = b^2 - d^2.$$

For minimum drag with fixed lift, the downwash in the far wake should be constant, so the wake vorticity is just like that associated with an elliptical wing with no fuselage of span, b' . The lift on the wing-fuselage system is computable from the far-field vorticity, so the span efficiency is:

$$e = 1 - d^2 / b^2.$$

In practice, one does not achieve this much lift on the fuselage. Assuming a long circular fuselage and computing the lift based on images, the resulting induced drag increment is about twice the simple theoretical value, so:

$$s = 1 - 2 d^2 / b^2.$$

Transonic Compressibility Drag

This section deals with the effect of Mach number on drag from subsonic speeds through transonic speeds. We concentrate on some of the basic physics of compressible flow in order to estimate the incremental drag associated with Mach number.

The chapter is divided into the following sections:

- [Introduction](#)
- [Predicting \$M_{div}\$ and \$M_{cc}\$](#)
- [3-D Effects and Sweep](#)
- [Predicting \$C_{Dc}\$](#)

Notation for this chapter:

C_L Airplane lift coefficient

ΔC_{Dc} Incremental drag coefficient due to compressibility

M_{cc} Crest critical Mach number, the flight Mach number at which the velocities at the crest of the wing in a direction normal to the isobars becomes sonic

M_0 The flight Mach number

β Prandtl-Glauert Factor $(1-M_0)^{1/2}$

t/c Average thickness to chord ratio, in the freestream direction, for the exposed part of the wing

V_0 The flight speed

ΔV Surface perturbation velocity

$\Lambda_{c/4}$ Wing quarter-chord sweepback angle, degrees

Λ_c Sweepback angle of isobars at wing crest, degrees

γ Ratio of specific heats, 1.40 for air.

Compressibility Drag: Introduction

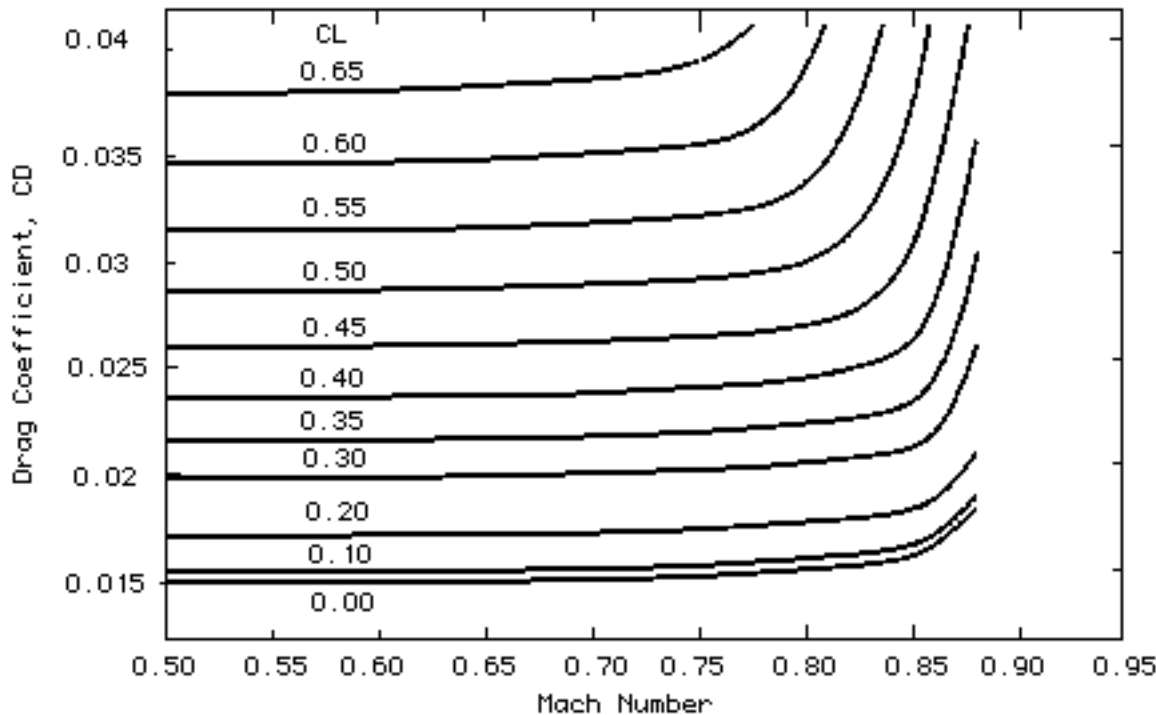

The low speed drag level is often defined at a Mach number of 0.5, below which the airplane drag coefficient at a given lift coefficient is generally invariant with Mach number. The increase in the airplane drag coefficient at higher Mach numbers is called compressibility drag. The compressibility drag includes any variation of the viscous and vortex drag with Mach number, shock-wave drag, and any drag due to shock-induced separations. The incremental drag coefficient due to compressibility is designated C_{D_c} .

In exploring compressibility drag, we will first limit the discussion to unswept wings. The effect of sweepback will then be introduced. For aspect ratios above 3.5 to 4.0, the flow over much of the wing span can be considered to be similar to two-dimensional flow. Therefore, we will be thinking at first in terms of flow over two-dimensional airfoils.

When a wing is generating lift, velocities on the upper surface of the wing are higher than the freestream velocity. As the flight speed of an airplane approaches the speed of sound, i.e., $M > 0.65$, the higher local velocities on the upper surface of the wing may reach and even substantially exceed $M = 1.0$. The existence of supersonic local velocities on the wing is associated with an increase of drag due to a reduction in total pressure through shockwaves and due to thickening and even separation of the boundary layer due to the local but severe adverse pressure gradients caused by the shock waves. The drag increase is generally not large, however, until the local speed of sound occurs at or behind the 'crest' of the airfoil, or the 'crestline' which is the locus of airfoil crests along the wing span. The crest is the

point on the airfoil upper surface to which the freestream is tangent, Figure 1. The occurrence of substantial supersonic local velocities well ahead of the crest does not lead to significant drag increase provided that the velocities decrease below sonic forward of the crest.

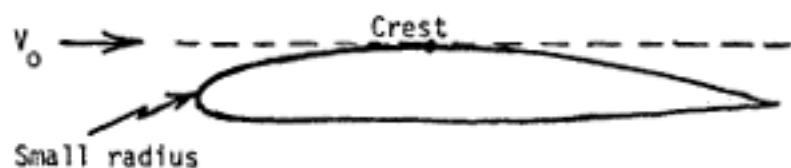

Fig. 1 Definition of the Airfoil Crest

A shock wave is a thin sheet of fluid across which abrupt changes occur in p , ρ , V and M . In general, air flowing through a shock wave experiences a jump toward higher density, higher pressure and lower Mach number. The effective Mach number approaching the shock wave is the Mach number of the component of velocity normal to the shock wave. This component Mach number must be greater than 1.0 for a shock to exist. On the downstream side, this normal component must be less than 1.0. In a two-dimensional flow, a shock is usually required to bring a flow with $M > 1.0$ to $M < 1.0$. Remember that the velocity of a supersonic flow can be decreased by reducing the area of the channel or streamtube through which it flows, When the velocity is decreased to $M = 1.0$ at a minimum section and the channel then expands, the flow will generally accelerate and become supersonic again. A shock just beyond the minimum section will reduce the Mach number to less than 1.0 and the flow will be subsonic from that point onward.

Whenever the local Mach number becomes greater than 1.0 on the surface of a wing or body in a subsonic freestream, the flow must be decelerated to a subsonic speed before reaching the trailing edge. If the surface could be shaped so that the surface Mach number is reduced to 1.0 and then decelerated subsonically to reach the trailing edge at the surrounding freestream pressure, there would be no shock wave and no shock drag. This ideal is theoretically attainable only at one unique Mach number and angle of attack. In general, a shock wave is always required to bring supersonic flow back to $M < 1.0$. A major goal of transonic airfoil design is to reduce the local supersonic Mach number to as close to $M = 1.0$ as possible before the shock wave. Then the fluid property changes through the shock will be small and the effects of the shock may be negligible. When the Mach number just ahead of the shock becomes increasingly larger than 1.0, the total pressure losses across the shock become greater, the adverse pressure change through the shock becomes larger, and the thickening of the boundary layer increases.

Near the nose of a lifting airfoil, the streamtubes close to the surface are sharply contracted signifying high velocities. This is a region of small radius of curvature of the surface, Figure 1, and the flow, to be in equilibrium, responds like a vortex flow, i.e. the velocity drops off rapidly as the distance from the center of curvature is increased. Thus the depth, measured perpendicular to the airfoil surface, of the flow with $M > 1.0$ is small. Only a small amount of fluid is affected by a shock wave in this region and the effects of the total pressure losses caused by the shock are, therefore, small. Farther back on the airfoil, the curvature is much less, the radius is larger and a high Mach number at the surface persists much further out in the stream. Thus, a shock affects much more fluid. Furthermore, near the leading edge the boundary layer is thin and has a full, healthy, velocity profile. Toward the rear of the wing, the boundary

layer is thicker, its lower layers have a lower velocity and it is less able to keep going against the adverse pressure jump of a shock. Therefore, it is more likely to separate.

For the above reasons supersonic regions can be carried on the forward part of an airfoil almost without drag. Letting higher supersonic velocities create lift forward allows the airfoil designer to reduce the velocity at and behind the crest for any required total lift and this is the crucial factor in avoiding compressibility drag on the wing.

The unique significance of the crest in determining compressibility drag is largely an empirical matter although many explanations have been advanced. One is that the crest divides the forward facing portion of the airfoil from the aft facing portion. Supersonic flow, and the resulting low pressures (suction) on the aft facing surface would contribute strongly to drag. Another explanation is that the crest represents a minimum section when the flow between the airfoil upper surface and the undisturbed streamlines some distance away is considered, figure 2. Thus, if $M > 1.0$ at crest, the flow will accelerate in the diverging channel behind the crest, this leads to a high supersonic velocity, a strong suction and a strong shock.

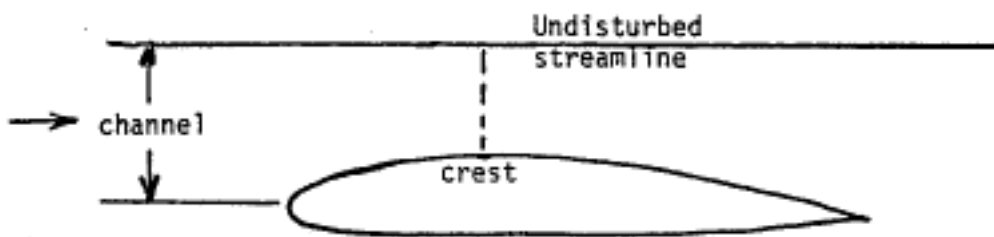

Fig. 2 One View of the Airfoil Crest

The freestream Mach number at which the local Mach number on the airfoil first reaches 1.0 is known as the critical Mach number. The freestream Mach number at which $M = 1.0$ at the airfoil crest is called the crest critical Mach number, M_{cc} . The locus of the airfoil crests from the root to the tip of the wing is known as the crestline.

Empirically it is found that the drag of conventional airfoils rises abruptly at 2 to 4% higher Mach number than that at which $M = 1.0$ at the crest (supercritical airfoils are a bit different as discussed briefly later). The Mach number at which this abrupt drag rise starts is called the drag divergence Mach number, M_{Div} . This is a major design parameter for all high speed aircraft. The lowest cost cruising speed is either at or slightly below M_{Div} depending upon the cost of fuel.

Since C_p at the crest increases with C_L , M_{Div} generally decreases at higher C_L . At very low C_L , the lower surface becomes critical and M_{Div} decreases, as shown in Figure 3.

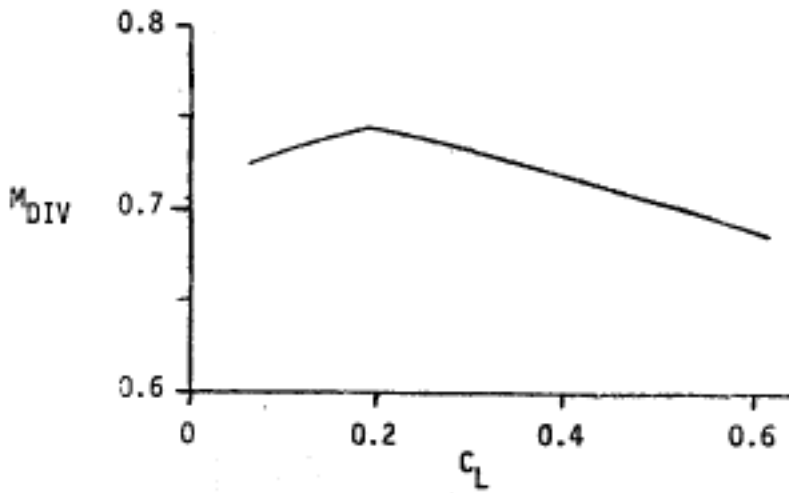

Fig. 3 Typical Variation of Airfoil M_{DIV} with C_L

The drag usually rises slowly somewhat below M_{DIV} due to the increasing strength of the forward, relatively benign shocks and to the gradual thickening of the boundary layer. The latter is due to the shocks and the higher adverse pressure gradients resulting from the increase in airfoil pressures because C_p at each point rises with $(1-M_0^2)^{-1/2}$. The nature of the early drag rise is shown in Figure 4.

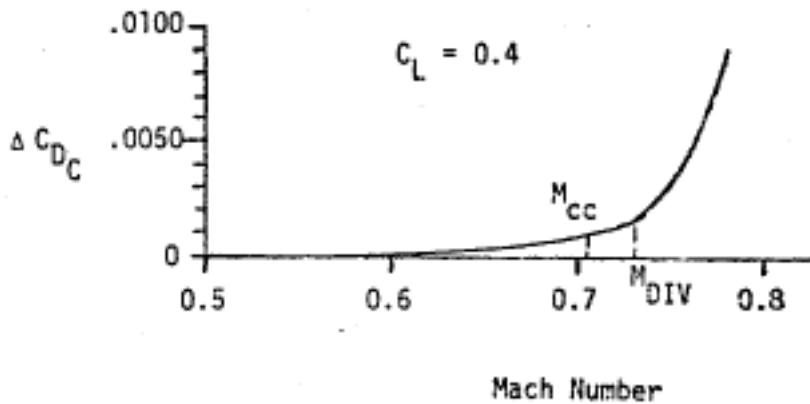

Figure 4. Typical Variation Of C_{Dc} with Mach Number

There is also one favorable drag factor to be considered as Mach number is increased. The skin friction coefficient decreases with increasing Mach number as shown in figure 5. Below Mach numbers at which waves first appear and above about $M=0.5$, this reduction just about increased drag from the higher adverse pressure gradient due to Mach. Therefore, the net effect on drag coefficient due to increasing Mach $M = 0.5$ is usually negligible until some shocks occur on the wing or favorable effect of Mach number on skin friction is very significant sonic Mach number, however.

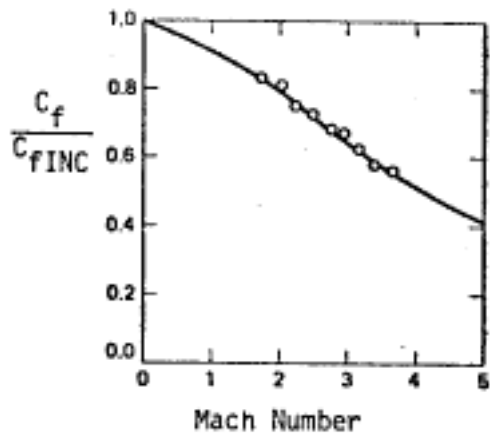

Figure 5. The Ratio of the Skin Friction Coefficient in Compressible Turbulent Flow to the Incompressible Value at the Same Reynolds Number

Compressibility Drag: M_{Div}

Since M_{Div} is 2 to 4% above M_{cc} (we shall see that the '2 to 4%' is dependent on wing sweepback angle), we can predict the drag rise Mach number, M_{Div} if we can predict M_{cc} . If we can identify the pressure drop or more conveniently the local pressure coefficient, C_p , required on an airfoil to accelerate the flow locally to exactly the speed of sound, measured or calculated crest pressures can be used to determine the freestream Mach numbers at which $M= 1.0$ at the crest. If p is the pressure at a point on an airfoil of an unswept wing, the pressure coefficient is

$$C_p = \frac{p - p_\infty}{\frac{1}{2} \rho_\infty U_\infty^2}$$

The C_p may be expressed in terms of the local and freestream Mach numbers. Under the assumption of adiabatic flow:

$$C_p = \frac{1}{0.7 M_\infty^2} \left[\left(\frac{1 + 0.2 M_\infty^2}{1 + 0.2 M^2} \right)^{3.5} - 1 \right]$$

By definition, when local Mach number $M= 1.0$, $C_p = C_p^*$, the critical pressure coefficient. Thus,

$$C_p^* = \frac{1}{0.7 M_\infty^2} \left[\left(\frac{1}{1.2} + \frac{M_\infty^2}{6.0} \right)^{3.5} - 1 \right]$$

Here is a simple calculator that provides C_p^* given a value for freestream Mach number using these equations.

Freestream Mach:

C_p^* :

A graph of this equation is shown in figure 6. If the C_p at the crest is known, the value of M_0 for which the speed of sound occurs at the crest can be immediately determined. The above discussion applies to unswept wings and must be modified for wings with sweepback.

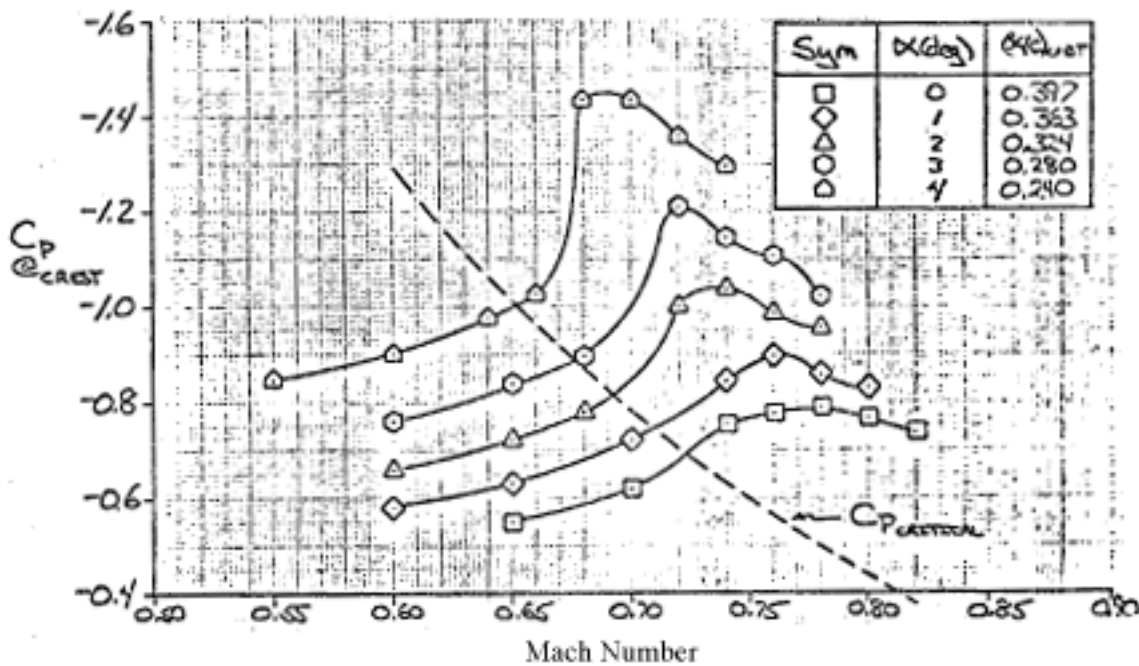

Figure 6. Variation of Pressure Coefficient at the Crest on a Modern Peaky Airfoil, $t/c = 0.104$, $Re = 14.5$ Million

It will be noted from Figure 6 that the airfoil information required is $C_{p_{crest}}$ versus M . In Figure 6, typical wind tunnel airfoil crest C_p variations with M are shown for several angles of attack. M_{cc} occurs when the $C_{p_{crest}}$ versus M curve for a given angle of attack intersects the curve of C_p^* versus M . A few percent above this speed, the abrupt drag rise will start at M_{Div} . The approximate relationship between M_{Div} and M_{cc} is given in the next section.

If the airfoil pressure distribution is calculated by one of various complex theoretical methods at $M = 0$, the value of the crest C_p can be plotted versus M_0 using the Prandtl-Glauert approximation:

$$C_p \approx \frac{C_{p_{inc}}}{\sqrt{1 - M_\infty^2}}$$

or the somewhat more involved Karman-Tsien relationship:

$$C_p \approx \frac{C_{p_{inc}}}{\sqrt{1 - M_\infty^2} + \frac{C_{p_{inc}}}{2} (1 - \sqrt{1 - M_\infty^2})}$$

The value of C_p at the crest is an important design characteristic of high speed airfoils. In general, $C_{p_{crest}}$ at a given C_L is dependent upon the thickness ratio (ratio of the maximum airfoil thickness to the chord) and the shape of the airfoil contour.

We have been describing a method of predicting M_{cc} which is useful in evaluating a particular airfoil design and in understanding the nature of the process leading to the occurrence of significant additional drag on the wing. Often in an advanced design process the detailed airfoil pressure distribution is not available. The airfoil is probably not even selected. It is still possible to closely estimate the M_{cc} from Figure 7. This graph displays M_{cc} as a function of airfoil mean thickness ratio t/c and C_L . It is based on studies of the M_{cc} of various airfoils representing the best state of the art for conventional 'Peaky' type airfoils typical of all existing late model transport aircraft. The significance of the term 'peaky' is discussed in the chapter on airfoils. Use of the chart assumes that the new aircraft will have a well developed peaky airfoil and that the upper surface of the wing is critical for compressibility drag rise. Implied in the latter assumption is a design that assures that elements other than the wing, i.e. fuselage, nacelles, etc., have a higher M_{div} than the wing. Up to design Mach numbers greater than .92 to .94 this is attainable. Furthermore, it is assumed that the lower surface of the wing is not critical. This assumption is always valid at the normal cruise lift coefficients but may not be true at substantially lower lift coefficients. Here the wing twist or washout designed to approach elliptical loading at cruise and to avoid first stalling at the wing tips, may lead to very low angles of attack on the outer wing panel. The highest $C_{p_{crest}}$ may then occur on the lower surface, a condition not considered in developing figure 7. Thus the chart may give optimistic values of M_{cc} at lift coefficients more than 0.1 to 0.15 below the design cruise lift coefficients.

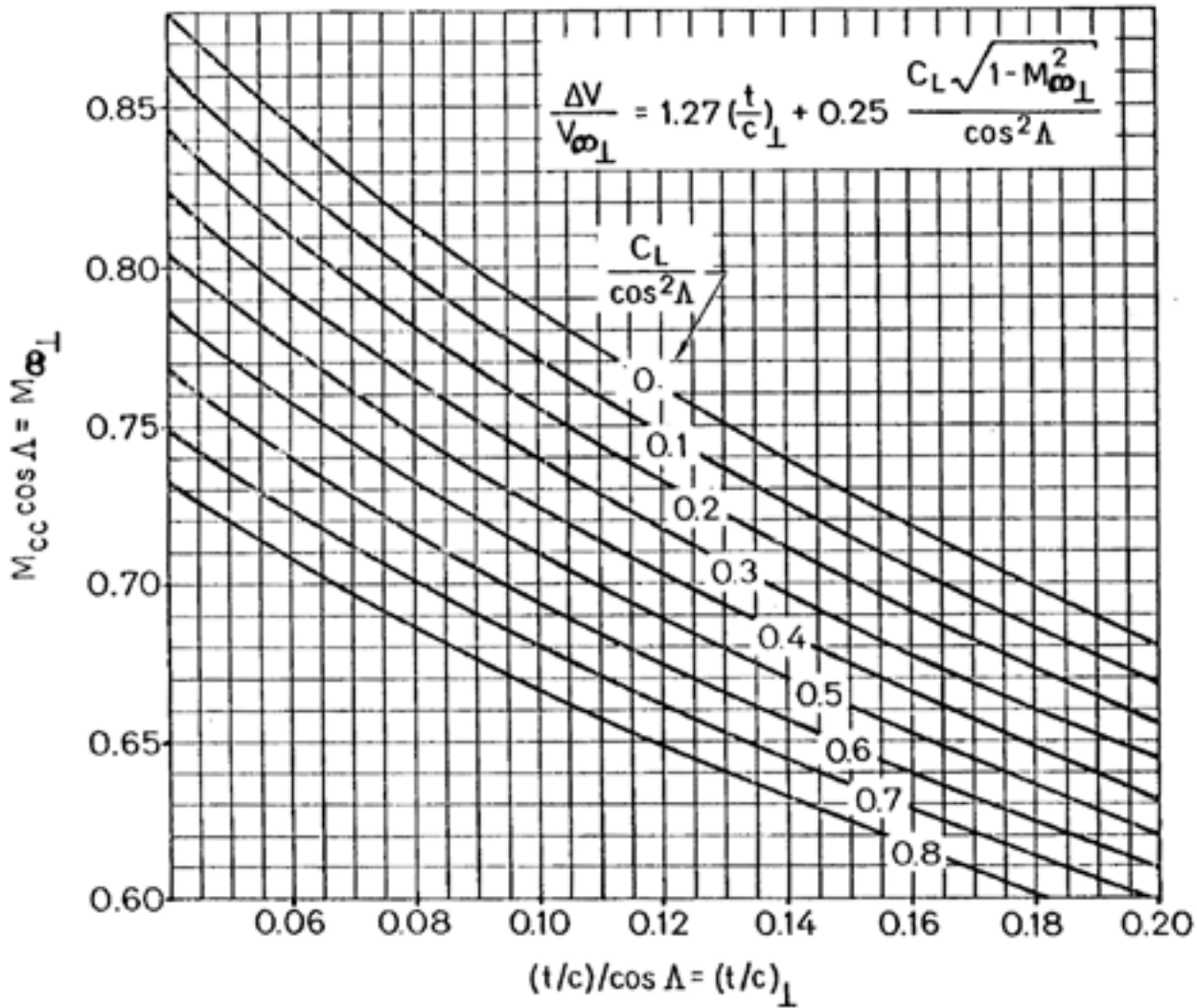

Figure 7 Crest Critical Mach Number vs. C_L and t/c for a Family of Peaky Airfoil Sections

Figure 7 does not apply directly to airfoils with pressure distributions that look significantly different from the peaky airfoil family. Modern supercritical airfoils, discussed in later chapters, can achieve higher drag divergence Mach numbers than those suggested by the figure. Although the performance of such airfoil families is often a closely guarded company secret, the effect can be approximated by adding an increment to the value of M_{cc} shown in the figure. A very aggressive supercritical section might achieve a drag divergence Mach number increment of 0.06, while more typically the increment is 0.03 to 0.04 above the peaky sections.

Compressibility Drag: 3D Effects and Sweep

The previously described method applies to two-dimensional airfoils, but can be used effectively in estimating the drag rise Mach number of wings when the effects of sweep and other 3-D effects are considered.

Average t/c

In Figure 7 the mean thickness ratio t/c is the average t/c of the exposed wing weighted for wing area affected just as the mean aerodynamic chord, MAC , is the average chord of the wing weighted for wing area affected. The mean thickness ratio of a trapezoidal wing with a linear thickness distribution is given by:

$$t/c_{avg} = (t_{root} + t_{tip}) / (C_{root} + C_{tip})$$

This equation for t/c_{avg} is based on a linear thickness (not linear t/c) distribution. This results from straight line fairing on constant % chord lines between airfoils defined at root and tip. The same equation is valid on a portion of wing correspondingly defined when the wing has more than two defining airfoils. The entire wing t/c_{avg} can then be determined by averaging the t/c_{avg} of these portions, weighting each t/c_{avg} by the area affected. Note that C_{root} and C_{tip} are the root and tip chords while t_{root} and t_{tip} are the root and tip thicknesses. b is the wing span and y is the distance from the centerline along the span.

Sweptback Wings

Almost all high speed subsonic and supersonic aircraft have sweptback wings. The amount of sweep is measured by the angle between a lateral axis perpendicular to the airplane centerline and a constant percentage chord line along the semi-span of the wing. The latter is usually taken as the quarter chord line both because subsonic lift due to angle of attack acts at the quarter chord and because the crest is usually close to the quarter chord.

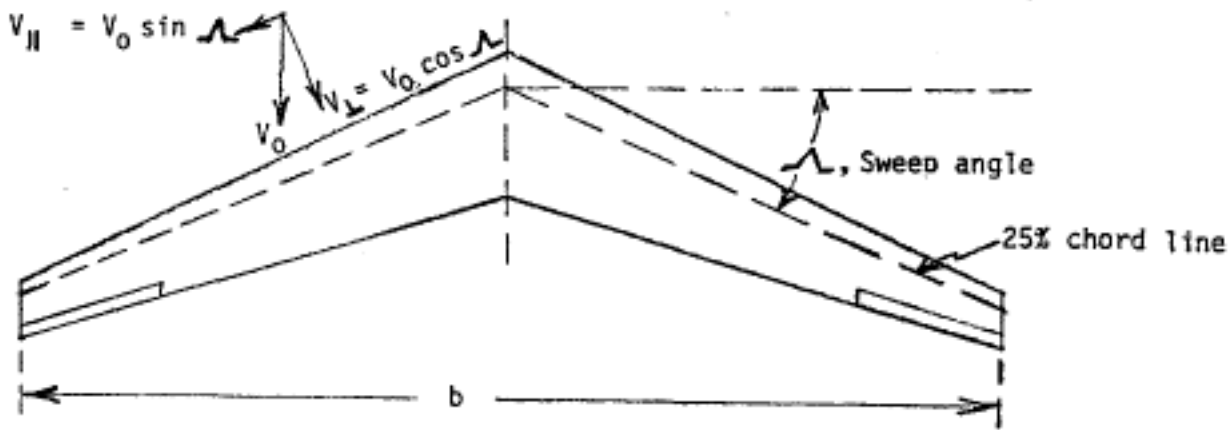

Figure 8. Velocity Components Affecting a Sweptback Wing

Sweep increases M_{cc} and M_{Div} . The component of the freestream velocity parallel to the wing, $V_{||}$, as shown in figure 8 does not encounter the airfoil curvatures that produce increased local velocities, reduced pressures, and therefore lift. Only the component perpendicular to the swept span, V_{\perp} , is effective. Thus on a wing with sweep angle, Λ :

$$V_{0eff} = V_0 \cos \Lambda$$

$$M_{0eff} = M_0 \cos \Lambda$$

$$q_{0eff} = q_0 \cos^2 \Lambda$$

The meaningful crest critical Mach number, M_{cc} , is the freestream Mach number at which the component of the local Mach number at the crest, perpendicular to the isobars, first reaches 1.0. These isobars or lines of constant pressure coincide closely with constant percent chord lines on a well-designed wing.

Since $q_{0effective}$ is reduced, the C_L based on this q and the C_p at the crest, also based on $q_{0effective}$ will increase, and M_{cc} and M_{Div} will be reduced. Furthermore, the sweep effect discussion so far has assumed that the thickness ratio is defined perpendicular to the quarter chord line. Usual industry practice is to define thickness ratio parallel to the freestream. This corresponds to sweeping the wing by shearing in planes parallel to the freestream rather than by rotating the wing about a pivot on the wing centerline. When the wing is swept with constant freestream thickness ratio, the thickness ratio perpendicular to the quarter chord line increases. The physical thickness is constant but the chord decreases. The result is a further decrease in sweep effectiveness below the pure cosine variation. Thus, there are several opposing effects, but the favorable one is dominant.

In addition to increasing M_{cc} , sweepback slightly increases the speed increment between the occurrence of Mach 1.0 flow at the crest and the start of the abrupt increase in drag at M_{Div} . Using a definition for M_{Div} as the Mach number at which the slope of the C_D vs. M_0 curve is 0.05 (i.e. $dC_D/dM = 0.05$), the following empirical expression closely approximates M_{Div} :

$$M_{Div} = M_{cc} [1.02 + .08 (1 - \cos \Lambda)]$$

Other 3-D Effects

The above analysis is based on two-dimensional sweep theory and applies exactly only to a wing of infinite span. It also applies well to most wings of aspect ratio greater than four except near the root and tip of the wing where significant interference effects occur.

The effect of the swept wing is to curve the streamline flow over the wing as shown in Figure 9. The curvature is due to the deceleration and acceleration of the flow in the plane perpendicular to the quarter chord line.

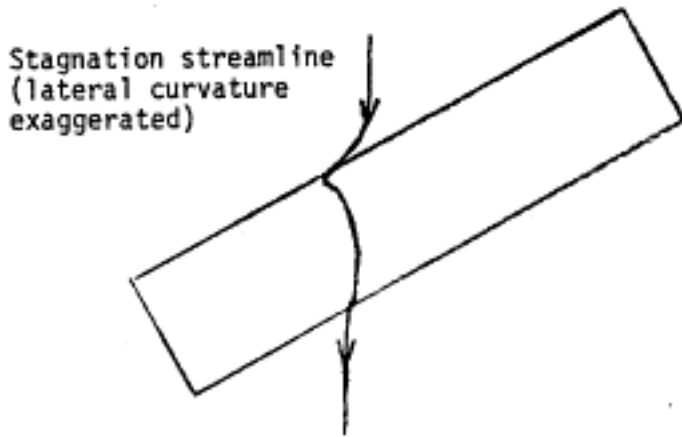

Figure 9. Stagnation Streamline with Sweep

Near the wing tip the flow around the tip from the lower to upper surface obviously alters the effect of sweep. The effect is to unsweep the spanwise constant pressure lines known as isobars. To compensate, the wing tip may be given additional structural sweep, Figure 10.

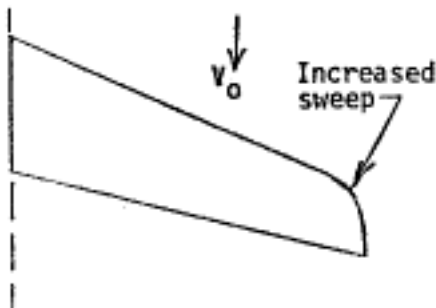

Figure 10. Highly Swept Wing Tip

It is at the wing root that the straight fuselage sides more seriously degrade the sweep effect by interfering with curved flow of figure 9. Airfoils are often modified near the root to change the basic pressure distribution to compensate for the distortions to the swept wing flow. Since the fuselage effect is to increase the effective airfoil camber, the modification is to reduce the root airfoil camber and in some cases to use negative camber. The influence of the fuselage then changes the altered root airfoil pressures back to the desired positive camber pressure distribution existing farther out along the wing span.

This same swept wing root compensation can be achieved by adjusting the fuselage shape to match the

natural swept wing streamlines. This introduces serious manufacturing and passenger cabin arrangement problems so that the airfoil approach is used for transports. Use of large fillets or even fuselage shape variations is appropriate for fighters. The designing of a fuselage with variable diameter for transonic drag reasons is sometimes called 'coke-bottling'. At $M= 1.0$ and above, there is a definite procedure for this minimization of shock wave drag. It is called the "area rule" and aims at arranging the airplane components and the fuselage cross-sectional variation so that the total aircraft cross-sectional area, in a plane perpendicular to the line of flight, has a smooth and prescribed variation in the longitudinal (flight) direction. This is discussed further in the section on supersonic drag.

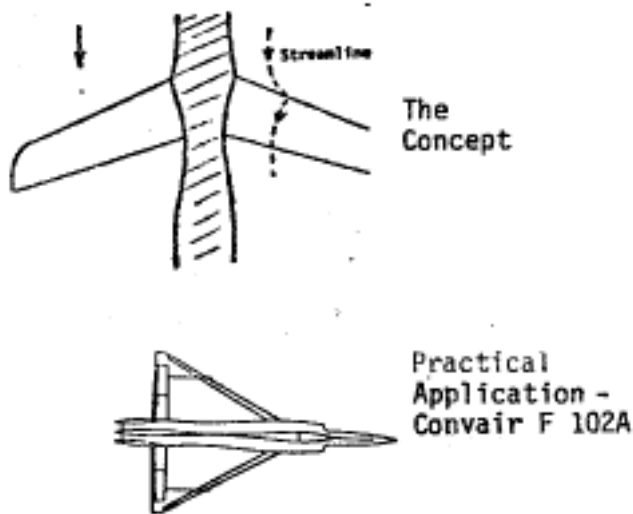

Figure 11. 'Coke-Bottled' Fuselage

The estimates provided by Figure 7 and the equation for M_{Div} assume that the wing root intersection has been designed to compensate for the 'unsweeping' effect of the fuselage either with airfoil or fuselage fairing treatment. If this is not done, M_{Div} will be reduced or there will be a substantial drag rise at Mach numbers lower than M_{Div} . For all aircraft there is some small increase in drag coefficient due to compressibility at Mach numbers below M_{Div} as illustrated in Figure 4.

Compressibility Drag: Computing C_{D_c}

The increment in drag coefficient due to compressibility, C_{D_c} , from its first appearance to well beyond M_{Div} can be estimated from Figure 12 where C_{D_c} is normalized by dividing by $\cos^3\Lambda$ and plotted against the ratio of freestream Mach number, M_0 to M_{cc} . Actual aircraft may have slightly less drag rise than indicated by this method if very well designed. A poor design could easily have higher drag rise. The differences arise from early shocks on some portion of the wing or other parts of the airplane. Figure 12 is an empirical average of existing transport aircraft data.

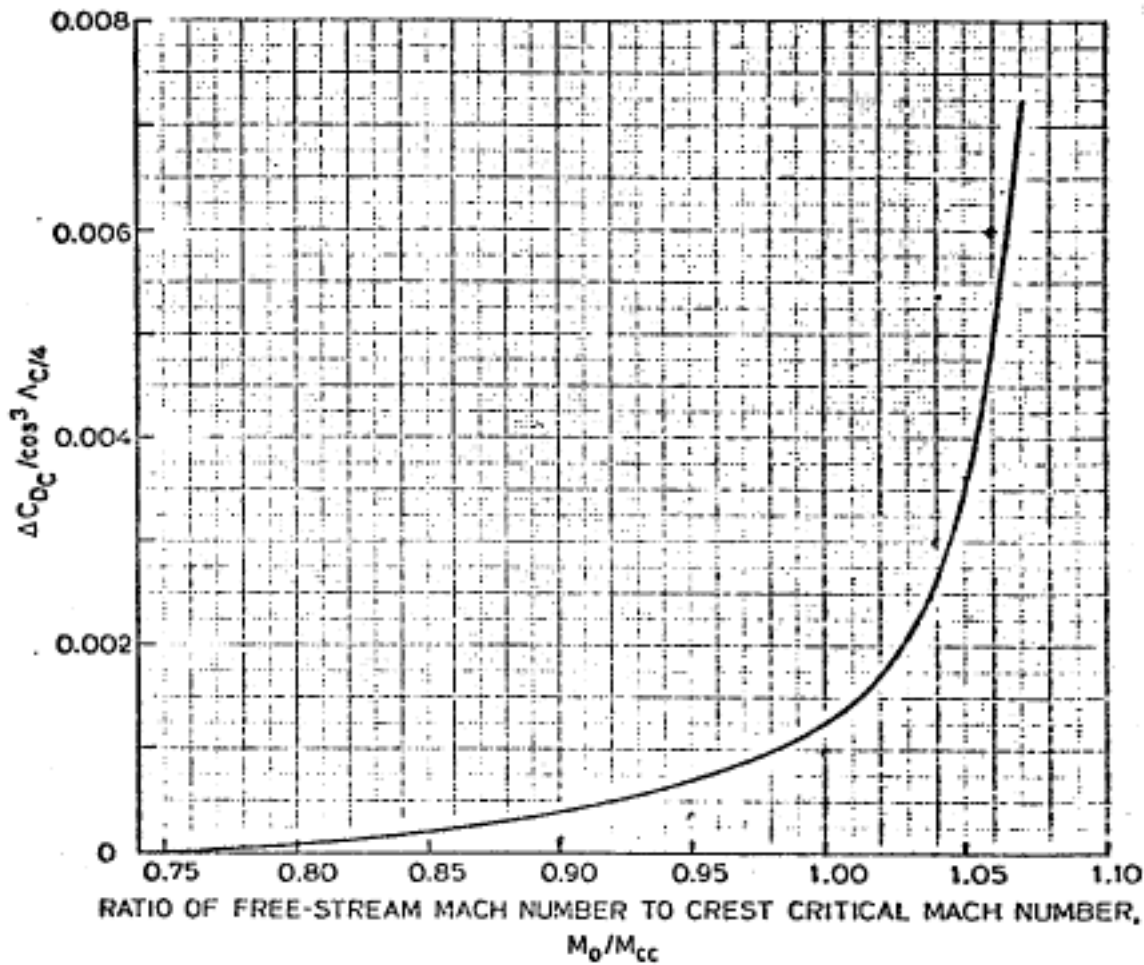

Figure 12 Incremental Drag Coefficient Due To Compressibility

In summary, the method for estimating compressibility drag is as follows:

1. Determine the crest critical Mach number for the values of lift coefficient being studied from figure 7 for the appropriate values of the wing quarter chord sweep angle and the average thickness ratio for the exposed part of the wing.
2. Determine the incremental drag coefficient due to compressibility from figure 12 for the crest-critical

Mach numbers from step 1.

When this method is used, the following limitations should be kept in mind:

1. The method assumes that the dominant factor in the airplane compressibility drag characteristics at cruising conditions is the wing. This means that the other components must have drag-divergence Mach numbers higher than that of the wing and that interference must be kept to a minimum in order for this method to be applicable.
2. The estimates for the crest critical Mach number in terms of the wing sweep angle, thickness ratio measured in the freestream direction, and lift coefficient are based on peaky airfoil sections. This method would not be reliable for significantly different types of airfoil sections.

One further note is in order. The expression "drag divergence Mach number" or M_{Div} is the Mach number at which the drag begins to rise abruptly. It is usually desirable to cruise close to M_{Div} . Numerous definitions of 'rise abruptly' have been used including:

- a. $M_{Div} = M$ for $C_{Dc} = .0014$, or some other value varying from .0010 to .0025
- b. $M_{Div} = M$ for $dC_D/dM = .03$ or .05 or 0.10
- c. $M_{Div} = M$ at constant lift coefficient for $M C_L/C_D$, a term in the range expression, equals 99% of the maximum $M C_L/C_D$

Method (c) is most meaningful and corresponds approximately to $(dC_D/dM) = .03$ and usually to $C_{Dc} = .0012$ to .0016.

The M_{Div} for bodies can be related to the occurrence of critical Mach number, or sonic velocity, at or behind the longitudinal station of maximum cross-sectional area. This is analogous to the crest theory of M for airfoils. Another factor is present on bodies, however, namely that the expanding forward portion of the body tends to thin the boundary layer and make it less likely to separate. Generally the M_{Div} of bodies can be assumed to be about 3% above the Mach number at which sonic velocity occurs at the maximum cross-sectional area.

Compressibility Drag Example

NACA 0012 Airfoil, $CL = 0.5$

The following figures show the development of the flow field around a two-dimensional NACA 0012 airfoil section in the Mach number range 0.50 - 0.90. The data was obtained with a two-dimensional Euler flow solver. Since the program solves the Euler equations, only the compressibility drag due to the presence of shock waves is accounted for. Other effects such as shock-induced separation cannot be predicted with this model.

The different shades of color represent the changing values of Mach number in the flow domain. Red represents regions of *high* Mach number (mostly on the upper surface where the flow is being accelerated) and blue represents regions of *low* Mach number (mostly at the stagnation point regions in the leading and trailing edge areas).

The sonic line (contour line where the Mach number is exactly 1.0) is shown as a faint white line when sonic flow exists. The flow is presented for the following Mach numbers:

- [Mach 0.50](#)
- [Mach 0.55](#)
- [Mach 0.60](#)
- [Mach 0.65](#)
- [Mach 0.70](#)
- [Mach 0.75](#)
- [Mach 0.80](#)
- [Mach 0.85](#)
- [Mach 0.90](#)

The appearance of drag in the compressible regime is directly related to the existence of shock waves and the consequent total pressure losses and entropy creation. This [image](#) shows the entropy field for the Mach 0.80 condition. As you can see, in an inviscid calculation, entropy is created at the shock and is convected downstream with the flow. Ahead of the shock the dark blue color indicates that no entropy has been generated and that the level of entropy there is that of the free stream. In a viscous calculation, additional entropy would be generated in the boundary layer.

With an average angle of attack of 3.966 degrees for these flow solutions, you can get an idea of the location of the crest for this airfoil. The following two figures are plots of the coefficient of drag of the airfoil vs. Mach number at two different scales. From these plots and the images of the flow field, you

should be able to get an idea of the relationships between *critical Mach number*, M_c , *crest critical Mach number*, M_{cc} , and *divergence Mach number*, M_{div} .

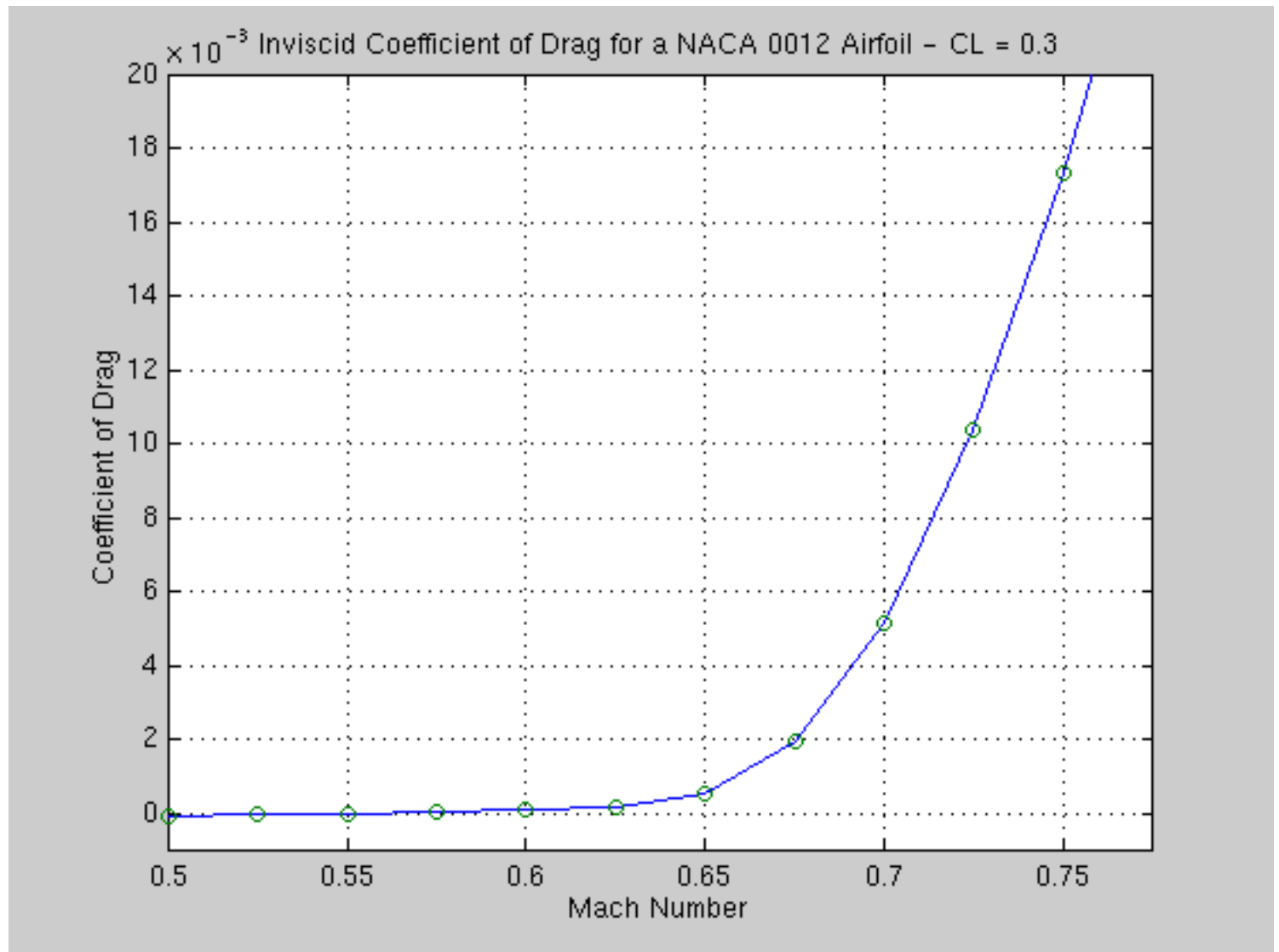

Notice that the scale in the following plot is quite large. Drag divergence occurs somewhere between Mach 0.65 and 0.70 for this airfoil. For carefully designed supercritical airfoils M_{div} achieves a higher value (around 0.80 - 0.85).

Inviscid Coefficient of Drag for a NACA 0012 Airfoil - $C_L = 0.3$

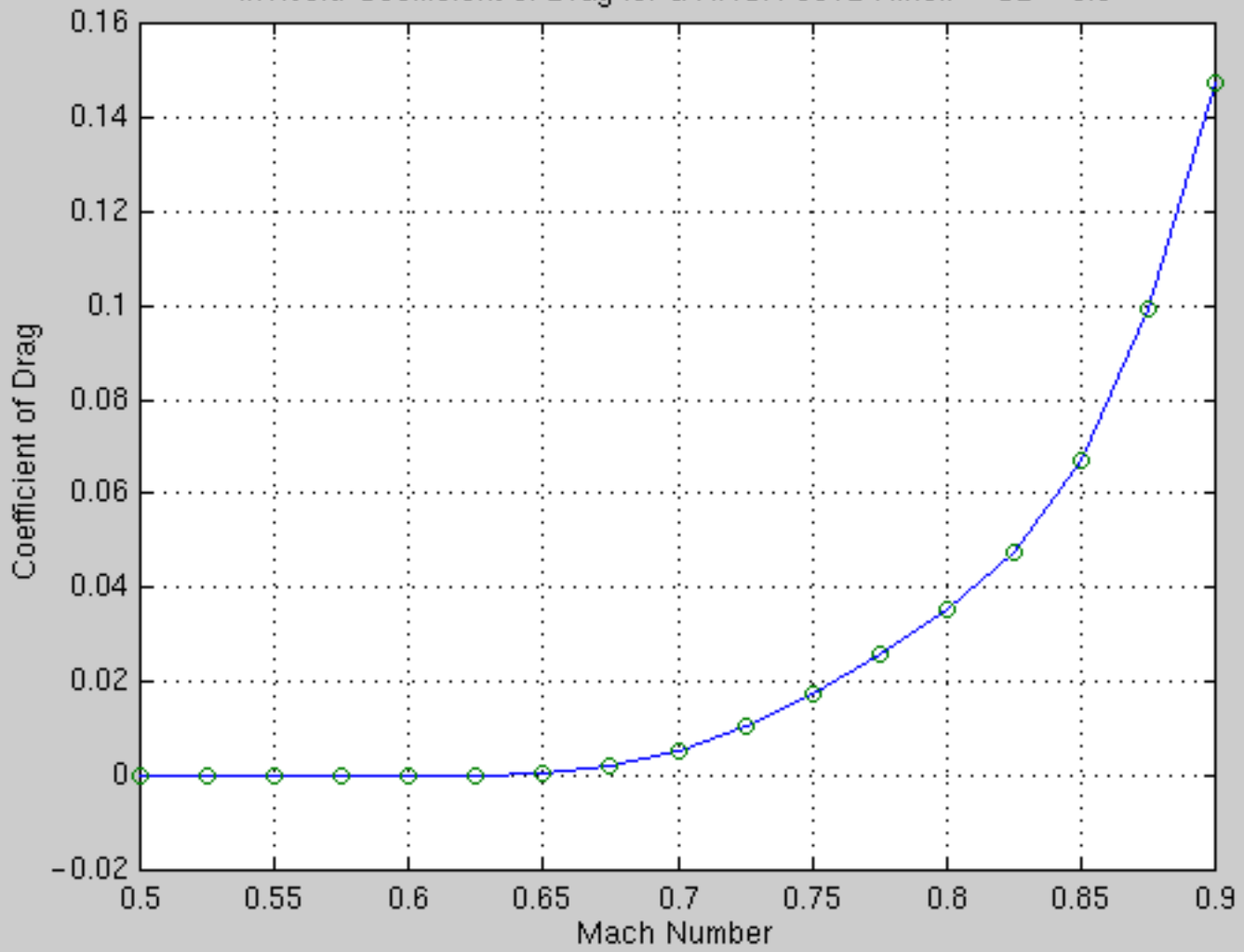

These results courtesy of: jjalonso@stanford.edu

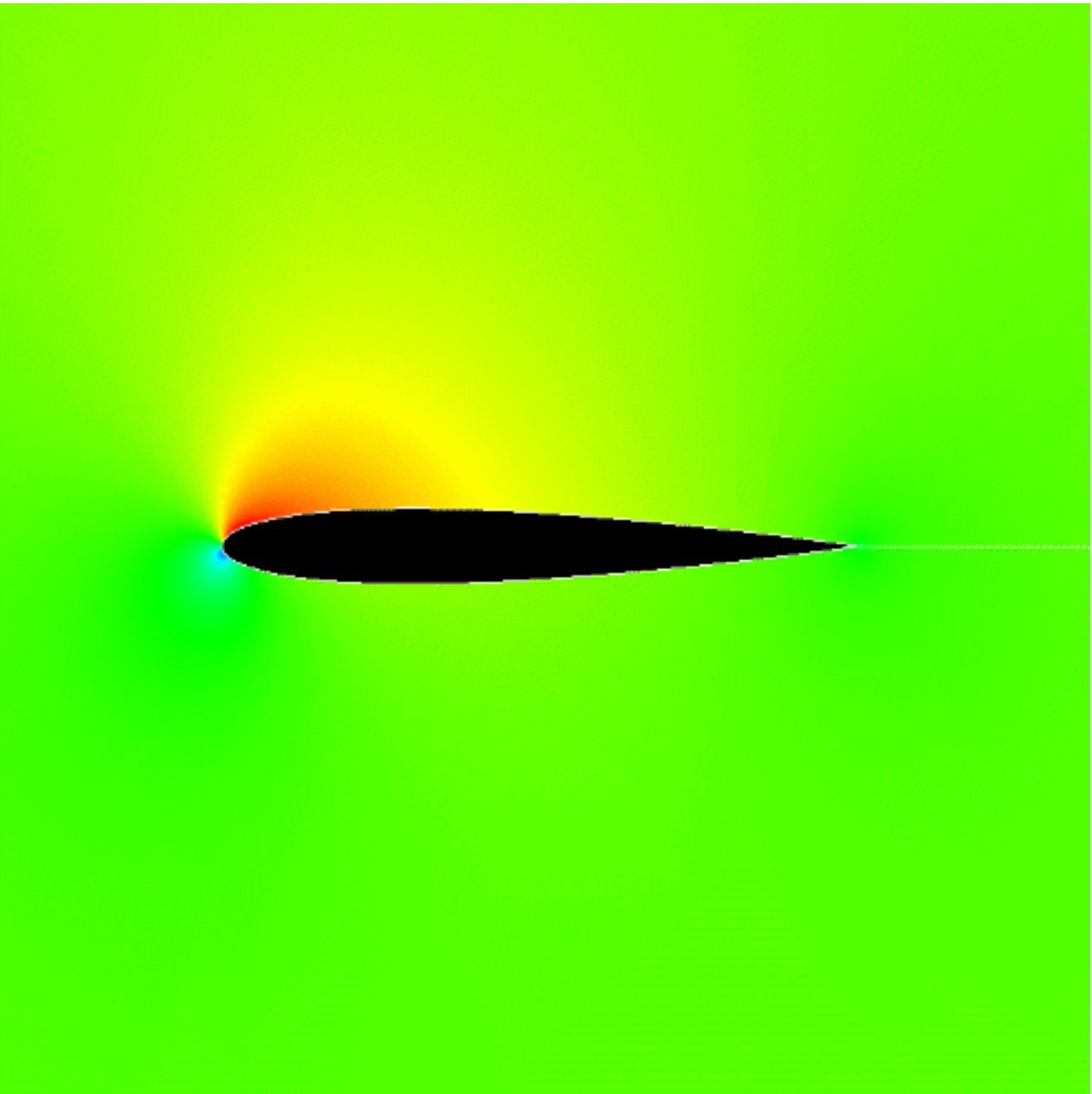



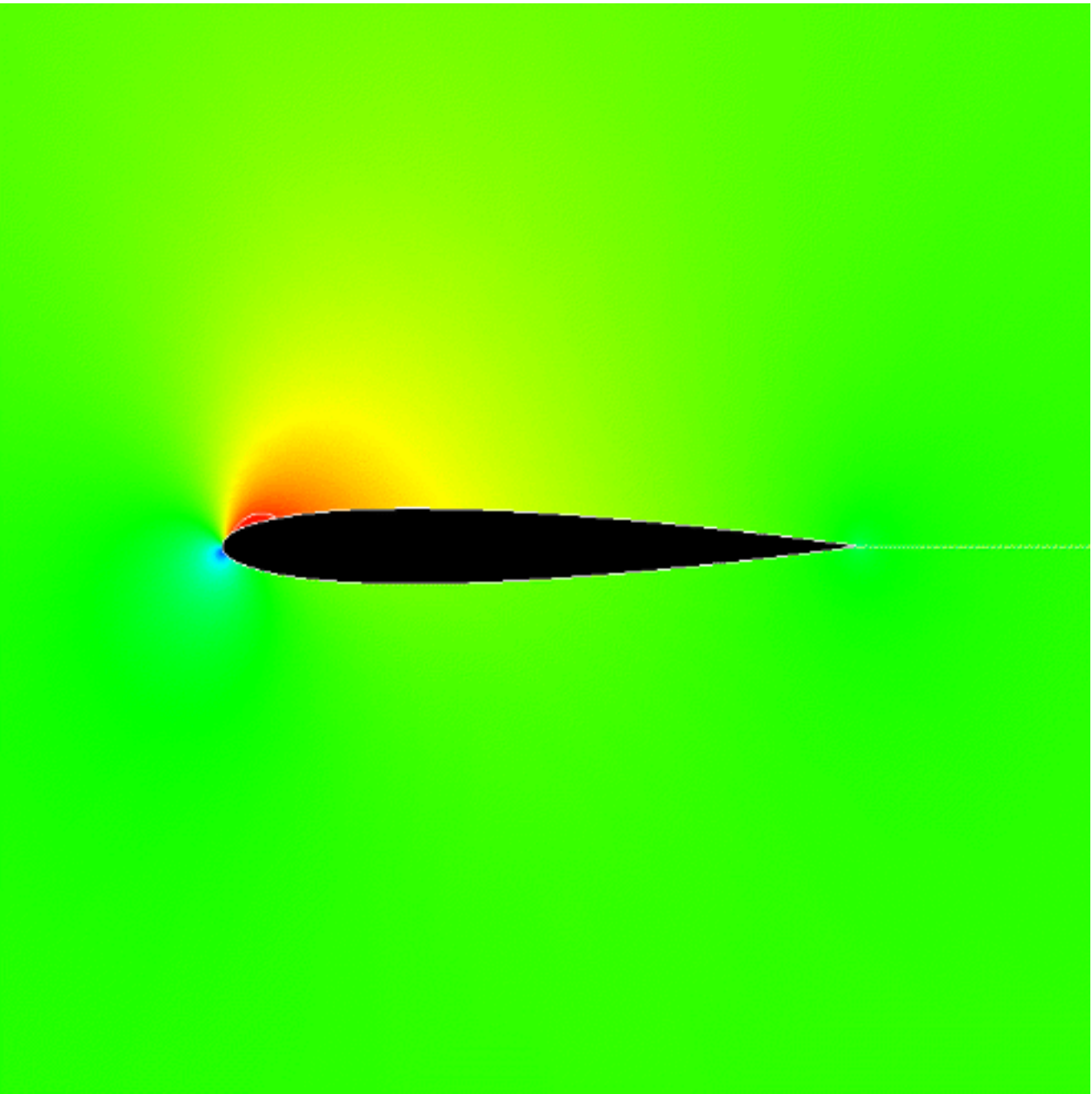



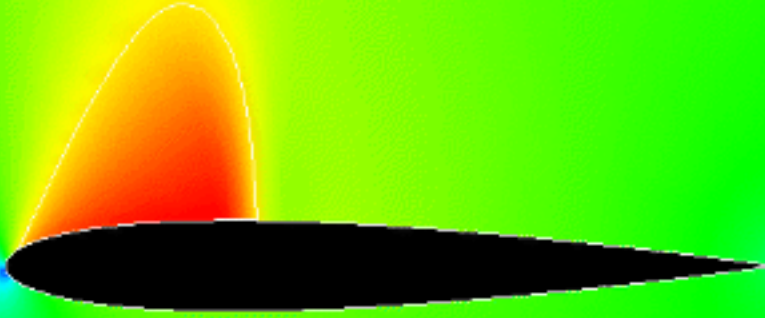

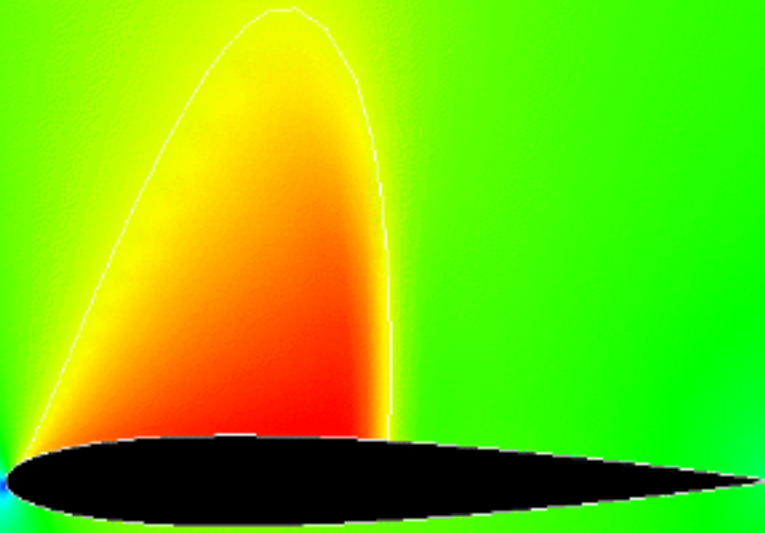

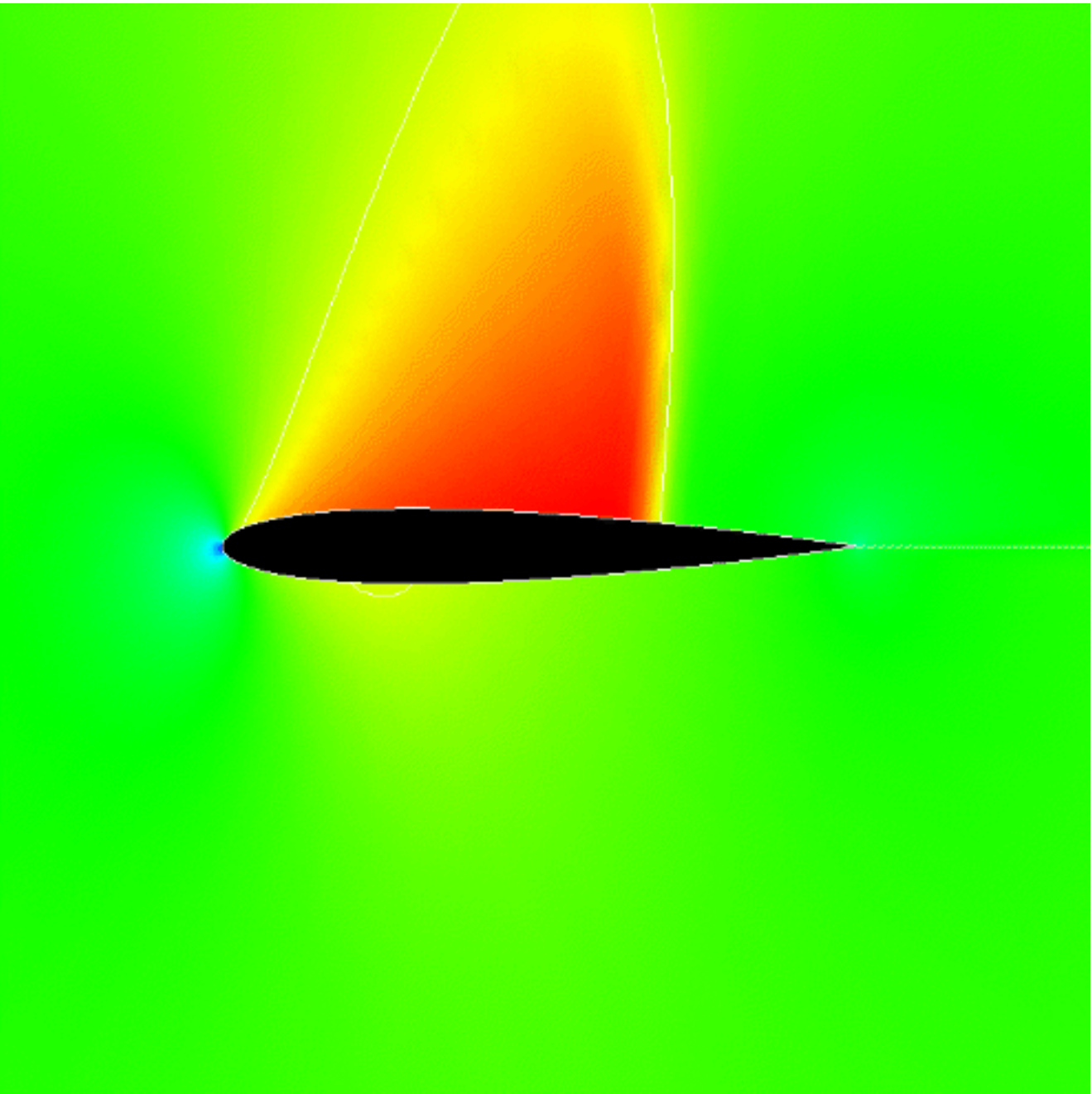

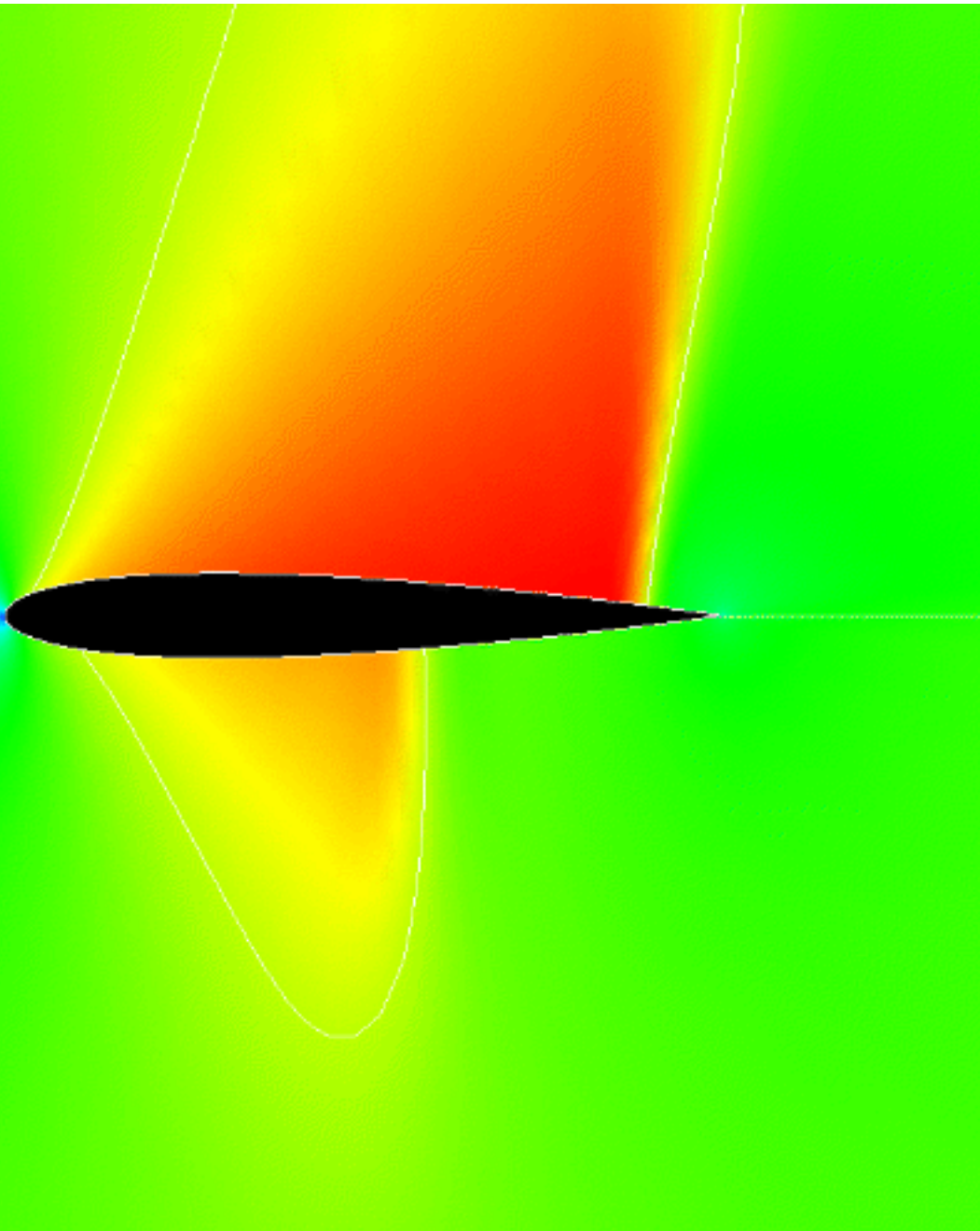

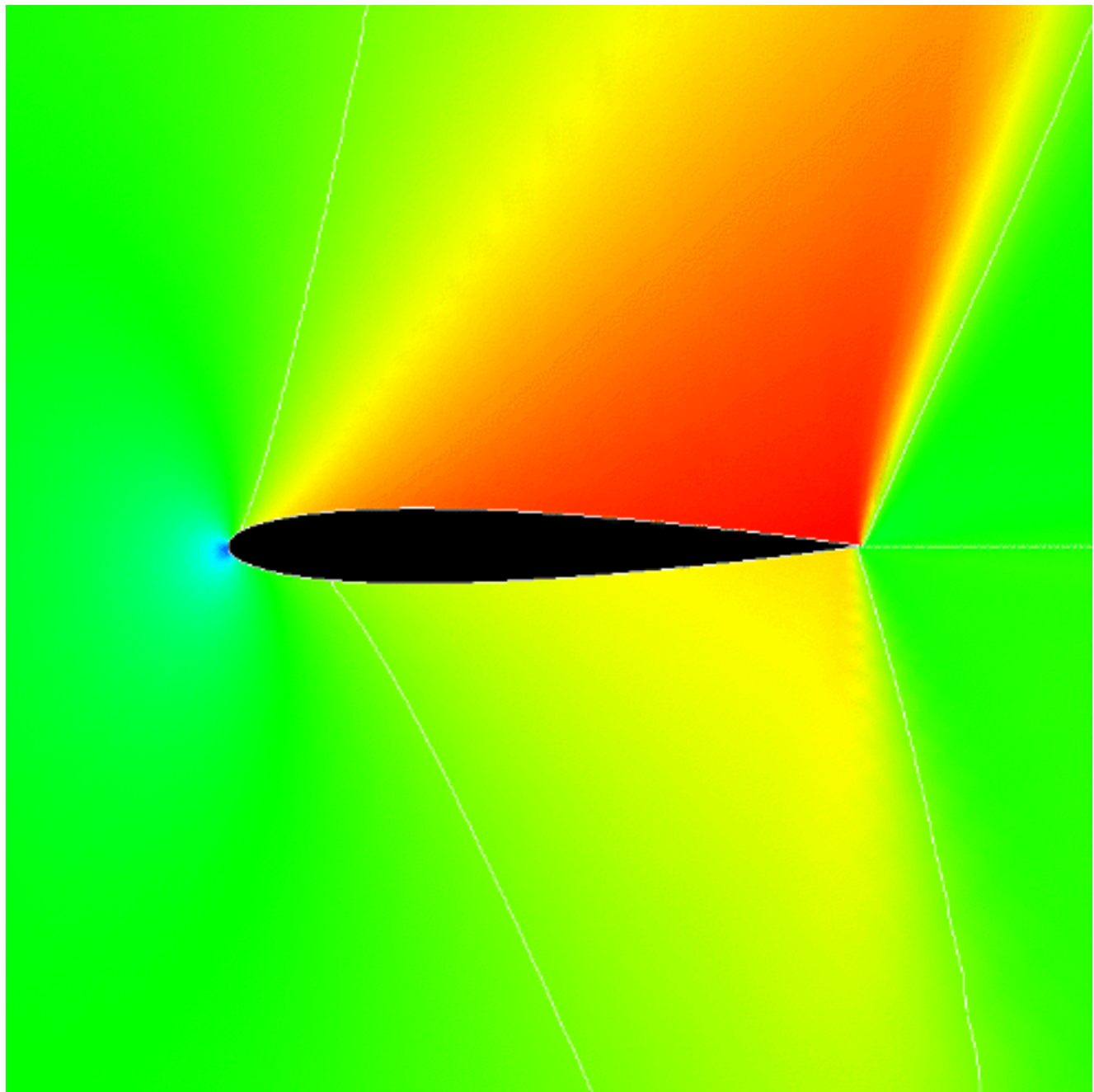

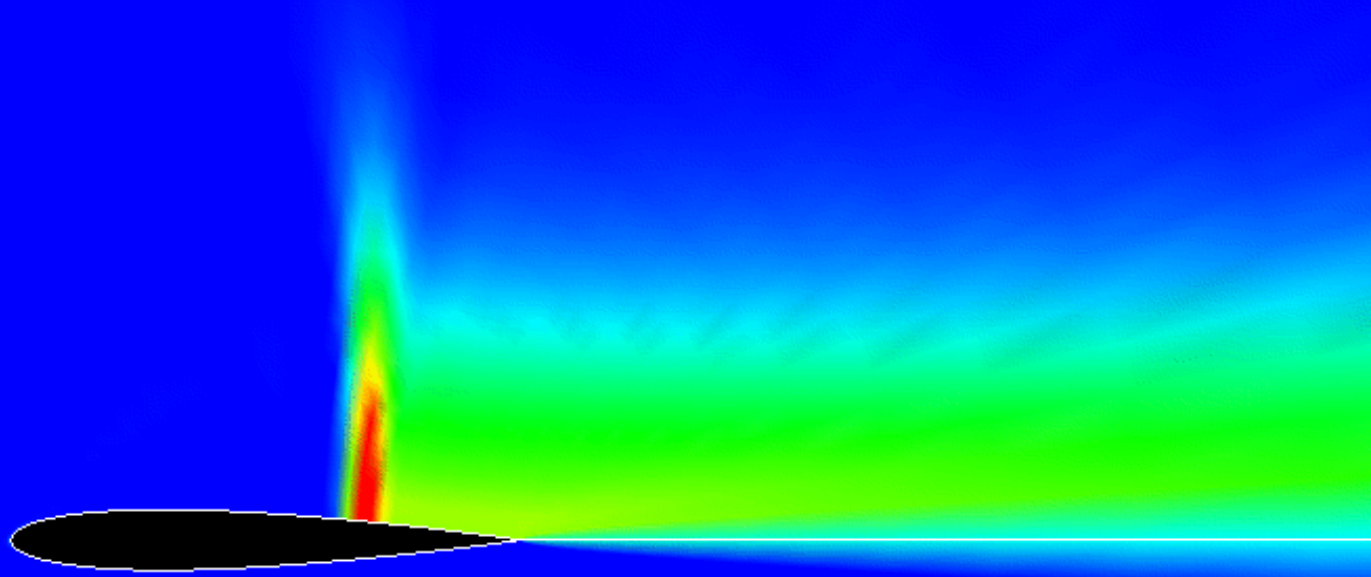

Supersonic Drag

As the Mach number increases further, the drag associated with compressibility continues to increase. For most commercial aircraft this limits the economically feasible speed. If one is willing to pay the price for the drag associated with shock waves, one can increase the flight speed to Mach numbers for which the above analysis is not appropriate.

In supersonic flow an aircraft has lift and volume-dependent wave drag in addition to the viscous friction and vortex drag terms:

$$\text{Drag} = \underbrace{q K S}_{\text{friction}} + \underbrace{\frac{\text{Lift}^2}{q\pi b^2}}_{\text{vortex}} + \underbrace{\frac{M^2-1}{2} \frac{\text{Lift}^2}{q\pi l^2}}_{\text{lift-dependent wave}} + \underbrace{q \frac{128}{\pi} \frac{\text{Volume}^2}{l^4}}_{\text{volume wave}}$$

This approximate expression was derived by R.T. Jones, Sears, and Haack for the minimum drag of a supersonic body with fixed lift, span, length, and volume.

The expression holds for low aspect ratio surfaces. Notice that unlike the subsonic case, the supersonic drag depends strongly on the airplane length, l . This section describes some of the approaches to computing supersonic wave drag components including:

[Wave Drag Due to Volume](#)

[Wave Drag Due to Lift](#)

[Program for Computing Wing Wave Drag](#)

Volume Wave Drag

One can compute the wave drag on a body of revolution relatively easily. For a paraboloid of revolution the drag coefficient based on frontal area is:

$$C_{D\pi} = \frac{10.67}{(L/D)^2}$$

For a body with minimum drag with a fixed length and maximum diameter, the result is:

$$C_{D\pi} = \frac{9.87}{(L/D)^2}$$

Note that even with a fineness ratio ($L/D = \text{length} / \text{diameter}$) of 10, the drag coefficient is about 0.1 -- a large number considering that typical total fuselage drag coefficients based on frontal area are around 0.2.

Minimum Drag Bodies

In the 1950's Sears and Haack solved for the shape of a body of revolution with minimum wave drag. These results provide guidance for initial estimates of volume wave drag, even before the detailed geometry is known. Two solutions are shown below.

1. Given maximum diameter and length:	2. Given volume and length:
$\left(\frac{r}{r_0}\right)^2 = \sqrt{1-x^2} - x^2 \ln \frac{1+\sqrt{1-x^2}}{x}$	$\left(\frac{r}{r_0}\right)^2 = (1-x^2)^{3/2}$
$C_D = 4\pi^2 r_0^2 / l^2$	$C_D = \frac{9}{2}\pi^2 r_0^2 / l^2$ or $D = \frac{128q}{\pi} \frac{\text{Vol}^2}{l^4}$

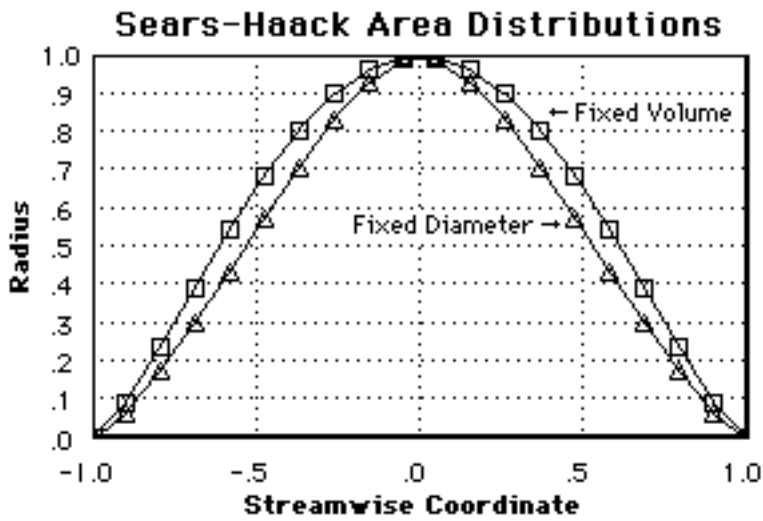

General Shapes

When the body does not have the Sears-Haack shape, the volume dependent wave drag may be computed from linear supersonic potential theory. The result is known as the supersonic area rule. It says that the drag of a slender body of revolution may be computed from its distribution of cross-sectional area according to the expression:

$$D = -\frac{\rho U_{\infty}^2}{4\pi} \int_0^1 \int_0^1 A''(x_1) A''(x_2) \ln |x_1 - x_2| dx_1 dx_2$$

where A'' is the second derivative of the cross-sectional area with respect to the longitudinal coordinate, x .

For configurations more complicated than bodies of revolution, the drag may be computed with a panel method or other CFD solution. However, there is a simple means of estimating the volume-dependent wave drag of more general bodies. This involves creating an equivalent body of revolution - at Mach 1.0, this body has the same distribution of area over its length as the actual body.

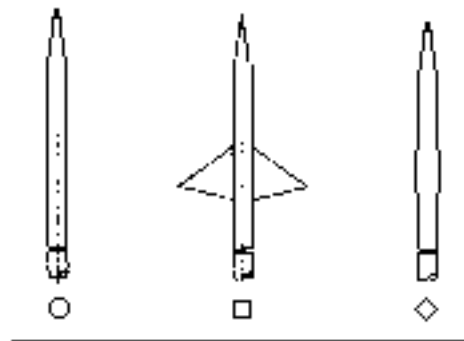
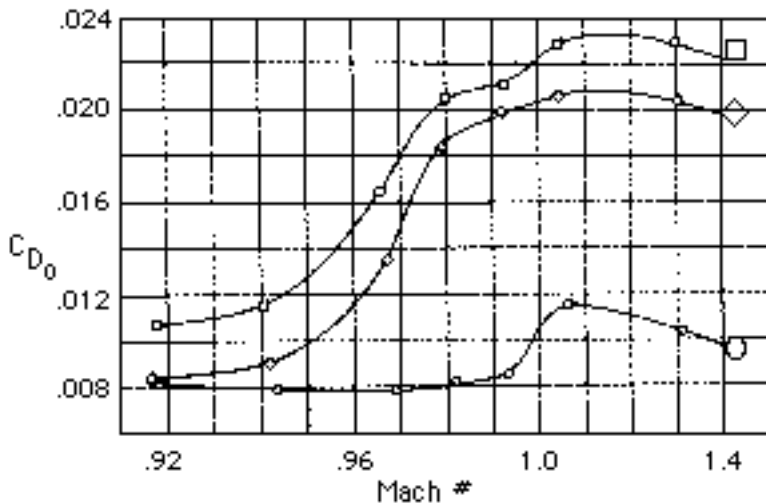

At higher Mach numbers the distribution of area is evaluated with oblique slices through the geometry. A body of revolution with the same distribution of area as that of the oblique cuts through the actual geometry is created and the drag is computed from linear theory.

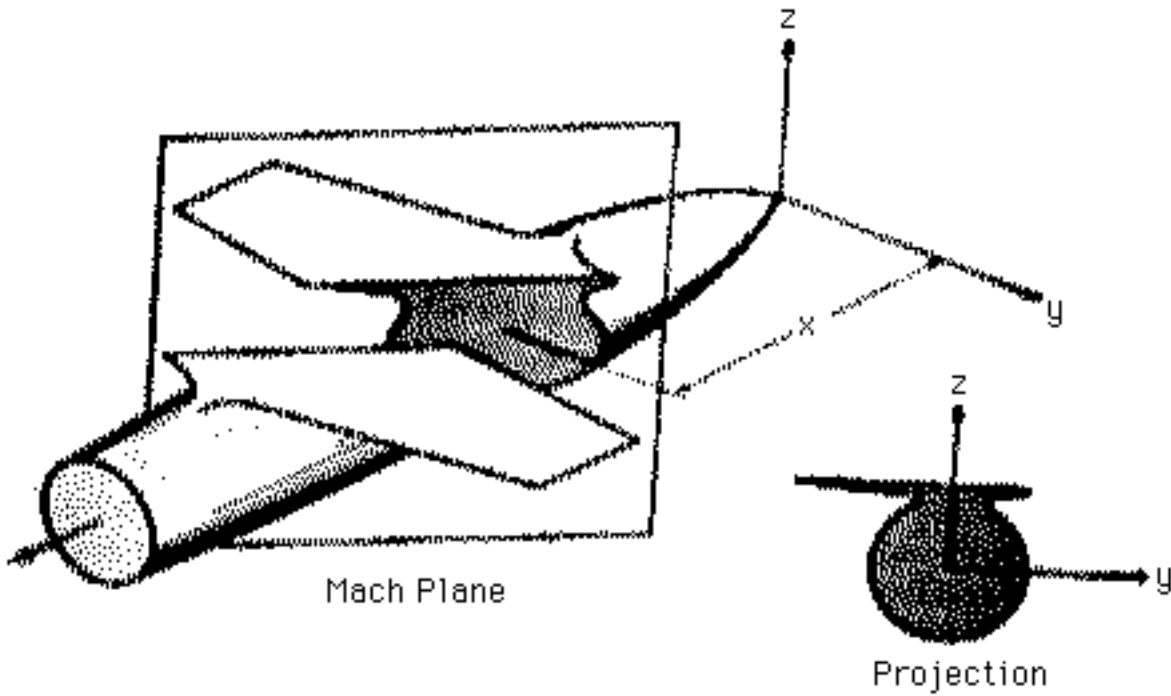

The angle of the plane with respect to the freestream is the Mach angle, $\sin \theta = 1/M$, so at $M=1$, the plane is normal to the flow direction, while at $M = 1.6$ the angle is 38.7° (It is inclined 51.3° with respect to the $M = 1$ case.)

The actual geometry is rotated about its longitudinal axis from 0 to 2π and the drag associated with each equivalent body of revolution is averaged.

$$D = -\frac{\rho U_\infty^2}{8\pi^2} \int_0^{2\pi} \int_0^1 \int_0^1 A''(x_1, \theta) A''(x_2, \theta) \ln |x_1 - x_2| dx_1 dx_2 d\theta$$

A comparison of actual and estimated drags using this method is shown below.

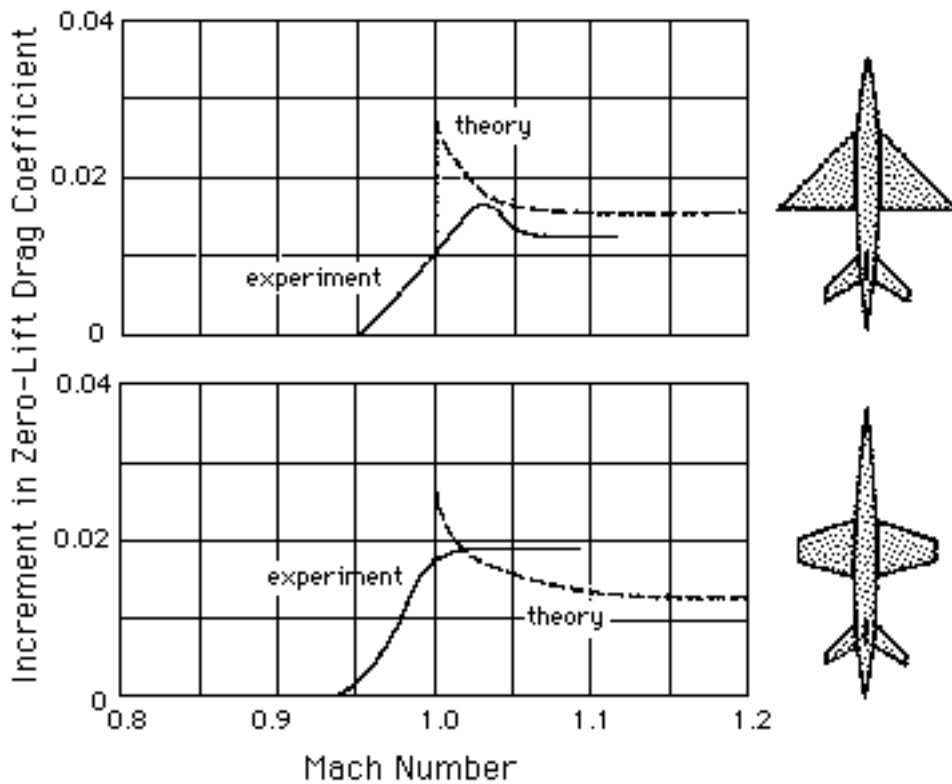

At the earliest stages of the design process, even this linear method may not be available. For conceptual design, we may add wave drag of the fuselage and the wave drag of the wing with a term for interference that depends strongly on the details of the intersection. For the first estimate in AA241A we simply add the wave drag of the fuselage based on the Sears-Haack results and volume wave drag of the wing with a 15% mark-up for interference and non-optimal volume distributions.

For first estimates of the volume-dependent wave drag of a wing, one may create an equivalent ellipse and use closed-form expressions derived by J.H.B. Smith for the volume-dependent wave drag of an ellipse. For minimum drag with a given volume:

$$C_{D_{ow}} = \frac{t^2}{b^2} \left[\frac{\beta^2 + 2b^2/a^2}{(\beta^2 + b^2/a^2)^{3/2}} \right]$$

where t is the maximum thickness, b is the semi-major axis, and a is the semi-minor axis. β is defined by: $\beta^2 = M^2 - 1$. Note that in the limit of high aspect ratio ($a \rightarrow \infty$), the result approaches the 2-D result for minimum drag of given thickness:

$$C_D = 4 (t/c)^2 / \beta$$

Based on this result, for an ellipse of given area and length the volume drag is:

$$C_D = \frac{128}{\pi S} \frac{Vol^2}{l^4} K_0 \quad \text{with} \quad K_0 = \frac{2x^2 + 1}{(4x^2 + 1)^{3/2}} \quad \text{and} \quad x = \frac{2}{\pi} \frac{\beta s}{l}$$

where s is the semi-span and l is the overall length.

The figure below shows how this works.

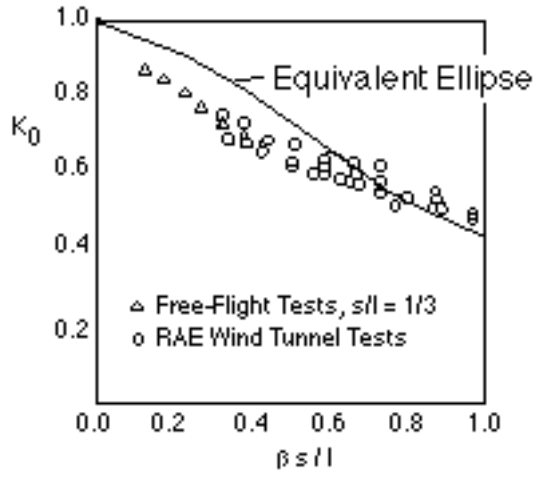

Volume-dependent wave drag for slender wings with the same area distribution. Data from Kuchemann.

Wave Drag Due to Lift

The expression given for wave drag due to lift: $\frac{M^2-1}{2} \frac{\text{Lift}^2}{\rho \pi l^2}$

holds for wings of very low aspect ratio.

A more general expression is derived by R.T. Jones in "Minimum Drag of Airfoils at Supersonic Speeds", J. of Aero Sciences, Dec. 1952.

The combined vortex and wave drag may be written:

$$C_D = \frac{C_L^2}{\pi AR} \sqrt{1 + (M^2-1) \left(\frac{\pi AR}{4}\right)^2}$$

This expression approaches the correct limits for ellipses as $M \rightarrow 1$ and as $AR \rightarrow 0$ or infinity. The assumption here is that the lift distribution is elliptical in all directions, an assumption that is not realized exactly in practice.

Jones also gives an expression for the wave drag due to lift for a yawed ellipse, showing that there is an optimum sweep angle. At $M = 1.4$, a 10:1 yawed ellipse at 55° has less than 1/2 of the wave drag of the ellipse with 0° or 90° of yaw.

When the planform shape is not elliptical, it may be better to form an equivalent ellipse with the same area and length rather than one with the same aspect ratio as the real wing. In this case:

$$C_{D_{wl}} = \frac{\pi l^2}{16 S} C_L^2 \left[\sqrt{1 + (M^2-1) \left(\frac{4 S}{\pi l^2}\right)^2} - 1 \right]$$

Here, S is the wing area and l is the overall length. This choice preserves the average wing pressure difference and agrees well with experimental data for well-designed supersonic wings.

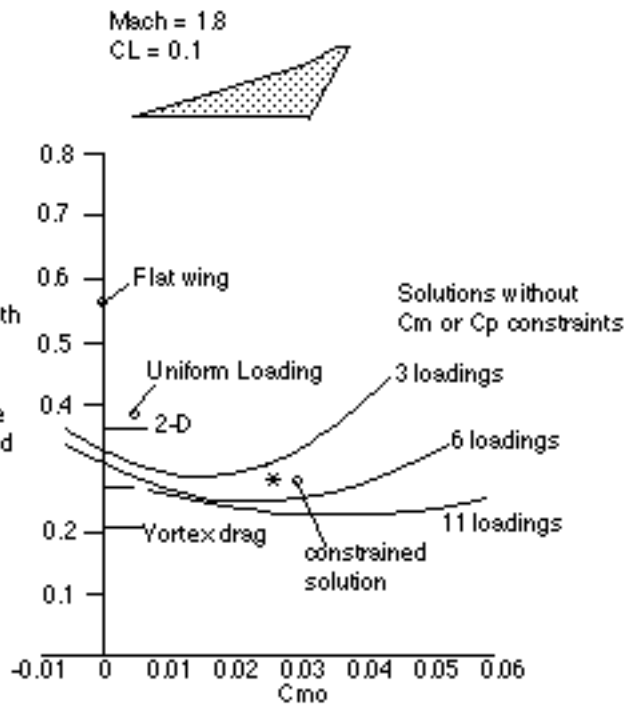
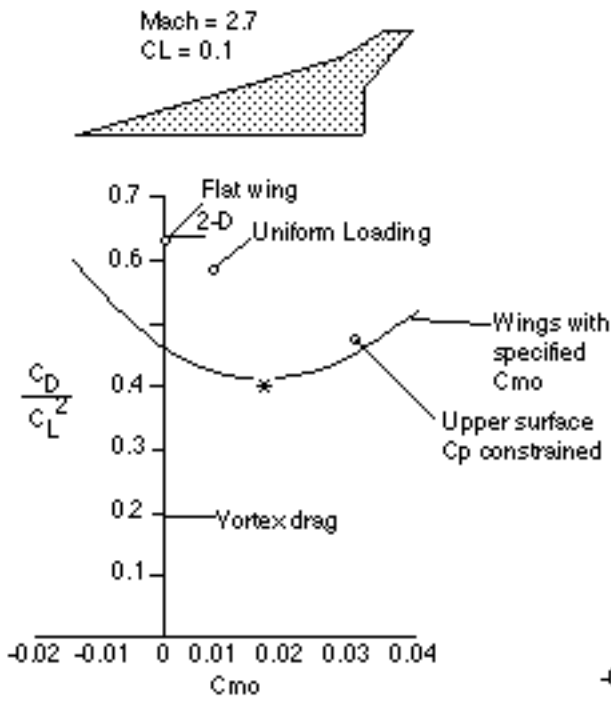

Supersonic Drag Due To Lift Computed by Present Method (*) and Boeing Optimization Results

Supersonic Wing Drag Calculation

A program for computation of these drag components is provided here. It may be used to compute the various components of supersonic drag for a wing of given area, length, span, and t/c at a specified Mach number and C_L . The program uses the formulas for drag of an equivalent ellipse as described on the previous pages of this chapter.

Inputs

Mach Number:

C_L :

AR:

AR_{length} :

t/c:

Results

C_{Dw} (lift):

C_{Dw} (volume):

C_{Di} :

$e_{\text{effective}}$:

The computations are based on the following code:
with the definitions:

```
beta = sqrt(mach*mach-1.0)
```

and:

```
x = pi*arl/4
```

The wave drag due to lift is:

```
cdwl = cl*cl*x/4*(sqrt(1+beta^2/x^2)-1)
```

The wave drag due to volume is:

```
cdwv = 4*tc^2*(beta^2+2*x^2)/(beta^2+x^2)^1.5
```

The vortex drag takes the usual form:

$$c_{di} = c_l^2 / (\pi \cdot ar)$$

The effective span efficiency is defined here as the drag of a low-speed ellipse (with the same span and lift) to the total lift-dependent drag of this wing

$$e_{\text{effective}} = c_{di} / (c_{di} + c_{dwl})$$

Wing-Body Drag Polar

Computations here show the various components of drag as they vary with CL. The program computes drag based on the methods of this chapter, based on data for the current wing and fuselage. Before running this program, be sure that you have entered the wing and fuselage geometry parameters on pages such as the Wing Analysis page, the Airfoil Design page, and the Fuselage layout pages. Alternatively an entire input set may be entered in the data summary page of the appendix.

Airfoil Design

Outline of this Chapter

The chapter is divided into several sections. The first of these consist of an introduction to airfoils: some history and basic ideas. The latter sections deal with simple results that relate the airfoil geometry to its basic aerodynamic characteristics. The latter sections deal with the process of airfoil design.

- [History and Development](#)
- [Airfoil Geometry](#)
- [Pressure Distributions](#)
- [Relation between \$C_p\$ and Performance](#)
- [Relating Geometry and \$C_p\$](#)
- [Design Methods and Objectives](#)
- [Some Typical Design Problems](#)
- [Airfoil Design Program](#)

History of Airfoil Development

The earliest serious work on the development of airfoil sections began in the late 1800's. Although it was known that flat plates would produce lift when set at an angle of incidence, some suspected that shapes with curvature, that more closely resembled bird wings would produce more lift or do so more efficiently. H.F. Phillips patented a series of airfoil shapes in 1884 after testing them in one of the earliest wind tunnels in which "artificial currents of air (were) produced from induction by a steam jet in a wooden trunk or conduit." Octave Chanute writes in 1893, "...it seems very desirable that further scientific experiments be made on concavo-convex surfaces of varying shapes, for it is not impossible that the difference between success and failure of a proposed flying machine will depend upon the sustaining effect between a plane surface and one properly curved to get a maximum of 'lift'."

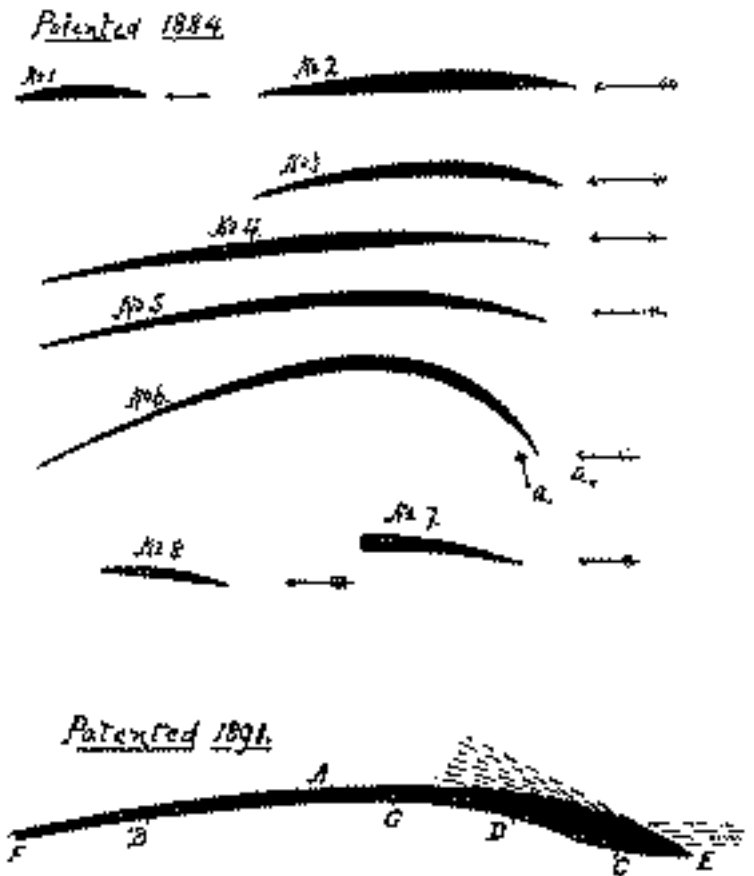

At nearly the same time Otto Lilienthal had similar ideas. After carefully measuring the shapes of bird wings, he tested the airfoils below (reproduced from his 1894 book, "Bird Flight as the Basis of Aviation") on a 7m diameter "whirling machine". Lilienthal believed that the key to successful flight was wing curvature or camber. He also experimented with different nose radii and thickness distributions.

Airfoils used by the Wright Brothers closely resembled Lilienthal's sections: thin and highly cambered. This was quite possibly because early tests of airfoil sections were done at extremely low Reynolds number, where such sections behave much better than thicker ones. The erroneous belief that efficient airfoils had to be thin and highly cambered was one reason that some of the first airplanes were biplanes.

The use of such sections gradually diminished over the next decade.

A wide range of airfoils were developed, based primarily on trial and error. Some of the more successful sections such as the Clark Y and Gottingen 398 were used as the basis for a family of sections tested by the NACA in the early 1920's.

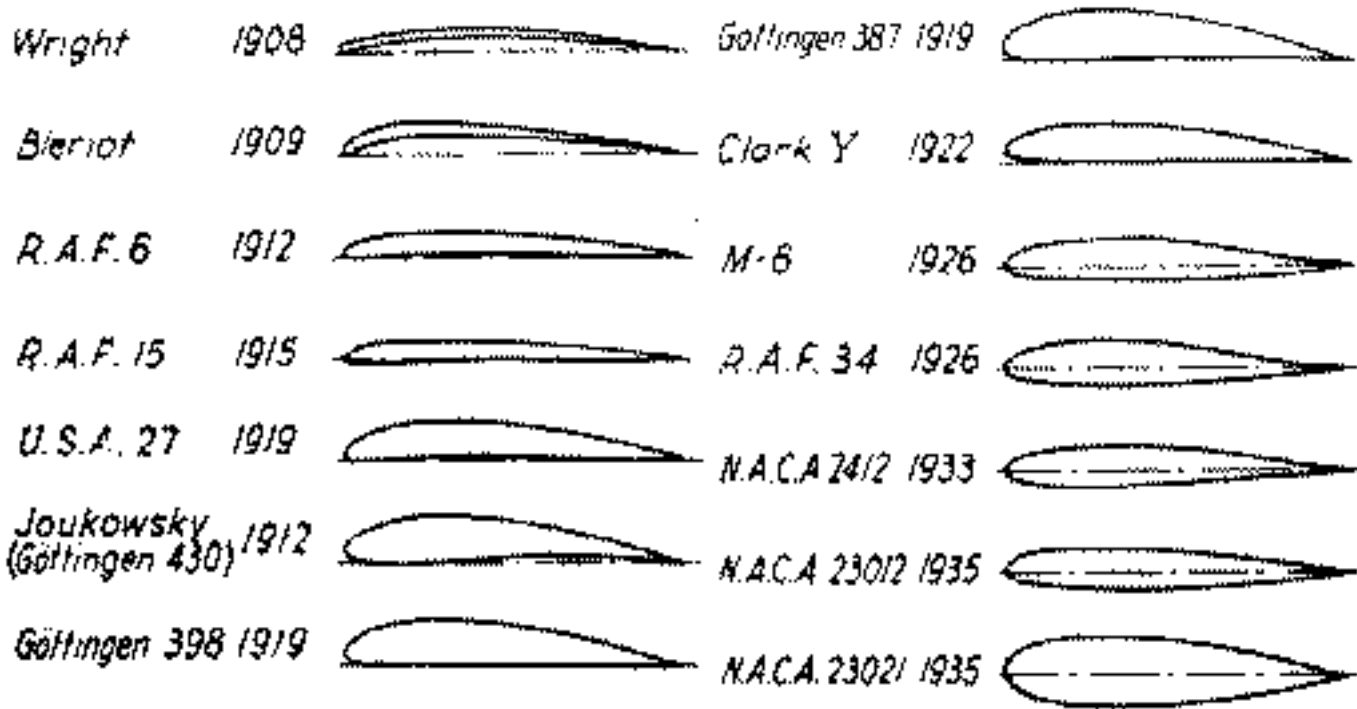

In 1939, Eastman Jacobs at the NACA in Langley, designed and tested the first laminar flow airfoil sections. These shapes had extremely low drag and the section shown here achieved a lift to drag ratio of about 300.

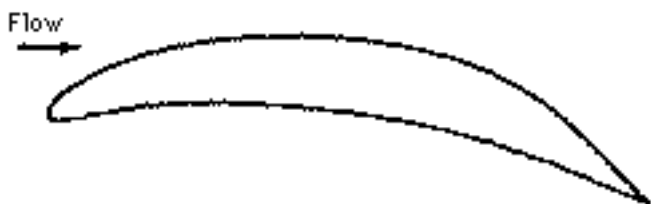

A modern laminar flow section, used on sailplanes, illustrates that the concept is practical for some applications. It was not thought to be practical for many years after Jacobs demonstrated it in the wind tunnel. Even now, the utility of the concept is not wholly accepted and the "Laminar Flow True-Believers Club" meets each year at the homebuilt aircraft fly-in.

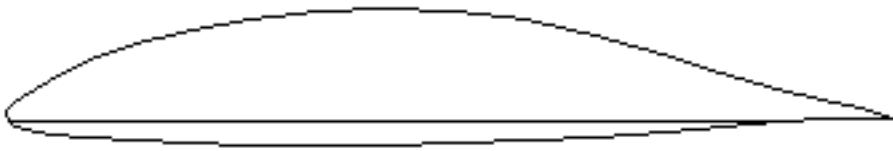

One of the reasons that modern airfoils look quite different from one another and designers have not settled on the one best airfoil is that the flow conditions and design goals change from one application to the next. On the right are some airfoils designed for low Reynolds numbers.

At very low Reynolds numbers (<10,000 based on chord length) efficient airfoil sections can look rather peculiar as suggested by the sketch of a dragonfly wing. The thin, highly cambered pigeon wing is similar to Lilienthal's designs. The Eppler 193 is a good section for model airplanes. The Lissaman 7769 was designed for human-powered aircraft.

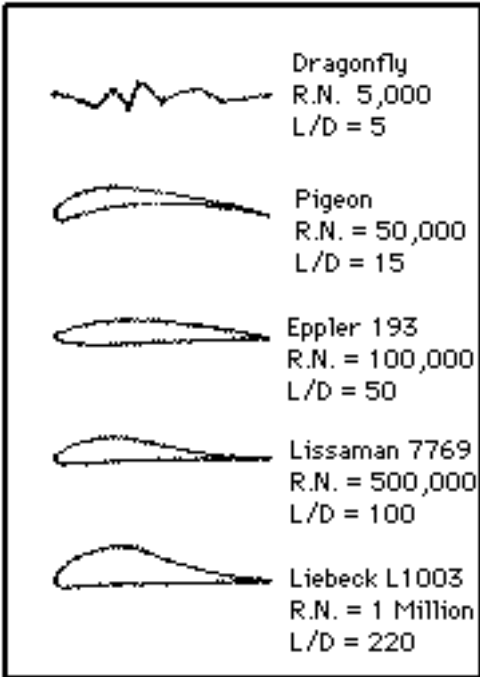

Unusual airfoil design constraints can sometimes arise, leading to some unconventional shapes. The airfoil here was designed for an ultralight sailplane requiring very high maximum lift coefficients with small pitching moments at high speed. One possible solution: a variable geometry airfoil with flexible lower surface.

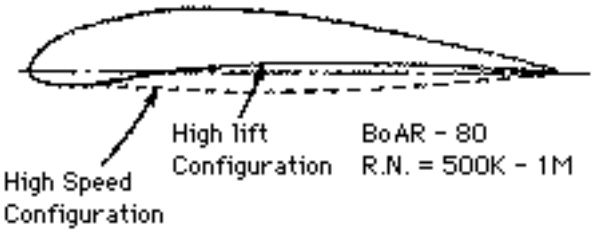

The airfoil used on the Solar Challenger, an aircraft that flew across the English Channel on solar power, was designed with an totally flat upper surface so that solar cells could be easily mounted.

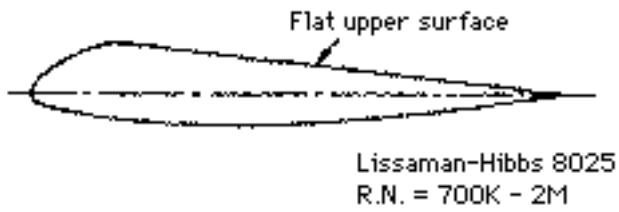

The wide range of operating conditions and constraints, generally makes the use of an existing, "catalog" section, not best. These days airfoils are usually designed especially for their intended application. The remaining parts of this chapter describe the basic ideas behind how this is done.

Airfoil Geometry

Airfoil geometry can be characterized by the coordinates of the upper and lower surface. It is often summarized by a few parameters such as: maximum thickness, maximum camber, position of max thickness, position of max camber, and nose radius. One can generate a reasonable airfoil section given these parameters. This was done by Eastman Jacobs in the early 1930's to create a family of airfoils known as the NACA Sections.

The NACA 4 digit and 5 digit airfoils were created by superimposing a simple meanline shape with a thickness distribution that was obtained by fitting a couple of popular airfoils of the time:

$$+- y = (t/0.2) * (.2969*x^{0.5} - .126*x - .3537*x^2 + .2843*x^3 - .1015*x^4)$$

The camberline of 4-digit sections was defined as a parabola from the leading edge to the position of maximum camber, then another parabola back to the trailing edge.

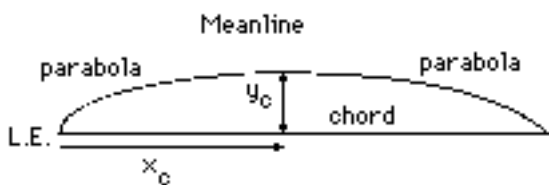

NACA 4-Digit Series:

4	4	1	2
max camber in % chord	position of max camber in 1/10 of c	max thickness in % of chord	

After the 4-digit sections came the 5-digit sections such as the famous NACA 23012. These sections had the same thickness distribution, but used a camberline with more curvature near the nose. A cubic was faired into a straight line for the 5-digit sections.

NACA 5-Digit Series:

2	3	0	1	2
approx max	position		max thickness	
camber	of max camber		in % of chord	
in % chord	in 2/100 of c			

The 6-series of NACA airfoils departed from this simply-defined family. These sections were generated from a more or less prescribed pressure distribution and were meant to achieve some laminar flow.

NACA 6-Digit Series:

6	3,	2	-	2	1	2
Six-	location	half width		ideal Cl	max thickness	
Series	of min Cp	of low drag		in tenths	in % of chord	
	in 1/10 chord	bucket in 1/10 of Cl				

After the six-series sections, airfoil design became much more specialized for the particular application. Airfoils with good transonic performance, good maximum lift capability, very thick sections, very low drag sections are now designed for each use. Often a wing design begins with the definition of several airfoil sections and then the entire geometry is modified based on its 3-dimensional characteristics.

Airfoil Pressure Distributions

The aerodynamic performance of airfoil sections can be studied most easily by reference to the distribution of pressure over the airfoil. This distribution is usually expressed in terms of the pressure coefficient:

$$C_p = \frac{p - p_\infty}{\frac{1}{2} \rho U_\infty^2}$$

C_p is the difference between local static pressure and freestream static pressure, nondimensionalized by the freestream dynamic pressure.

What does an airfoil pressure distribution look like? We generally plot C_p vs. x/c .

x/c varies from 0 at the leading edge to 1.0 at the trailing edge. C_p is plotted "upside-down" with negative values (suction), higher on the plot. (This is done so that the upper surface of a conventional lifting airfoil corresponds to the upper curve.)

The C_p starts from about 1.0 at the stagnation point near the leading edge...

It rises rapidly (pressure decreases) on both the upper and lower surfaces...

...and finally recovers to a small positive value of C_p near the trailing edge.

Various parts of the pressure distribution are depicted in the figure below and are described in the following sections.

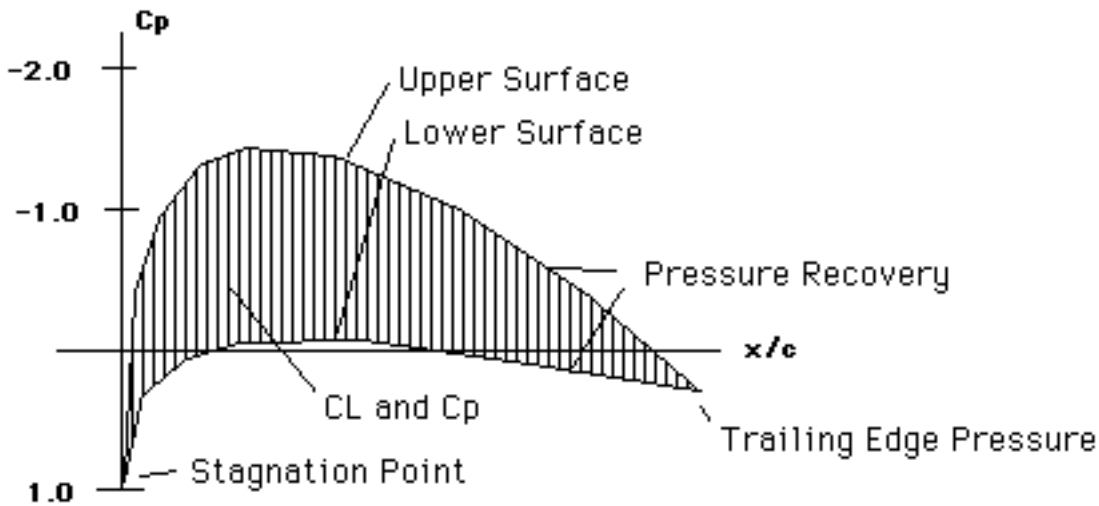

- **Upper Surface**
 The upper surface pressure is lower (plotted higher on the usual scale) than the lower surface C_p in this case. But it doesn't have to be.
- **Lower Surface**
 The lower surface sometimes carries a positive pressure, but at many design conditions is actually pulling the wing downward. In this case, some suction (negative $C_p \rightarrow$ downward force on lower surface) is present near the midchord.
- **Pressure Recovery**
 This region of the pressure distribution is called the pressure recovery region. The pressure increases from its minimum value to the value at the trailing edge. This area is also known as the region of adverse pressure gradient. As discussed in other sections, the adverse pressure gradient is associated with boundary layer transition and possibly separation, if the gradient is too severe.
- **Trailing Edge Pressure**
 The pressure at the trailing edge is related to the airfoil thickness and shape near the trailing edge. For thick airfoils the pressure here is slightly positive (the velocity is a bit less than the freestream velocity). For infinitely thin sections $C_p = 0$ at the trailing edge. Large positive values of C_p at the trailing edge imply more severe adverse pressure gradients.
- **C_L and C_p**
 The section lift coefficient is related to the C_p by: $C_L = \int (C_{p_l} - C_{p_u}) dx/c$
 (It is the area between the curves.)
 with $C_{p_u} =$ upper surface C_p
 and recall $C_L =$ section lift / ($q c$)
- **Stagnation Point**
 The stagnation point occurs near the leading edge. It is the place at which $V = 0$. Note that in

incompressible flow $C_p = 1.0$ at this point. In compressible flow it may be somewhat larger.

We can get a more intuitive picture of the pressure distribution by looking at some examples and this is done in some of the following sections in this chapter.

Airfoil Pressures and Performance

The shape of the pressure distribution is directly related to the airfoil performance as indicated by some of the features shown in the figure below.

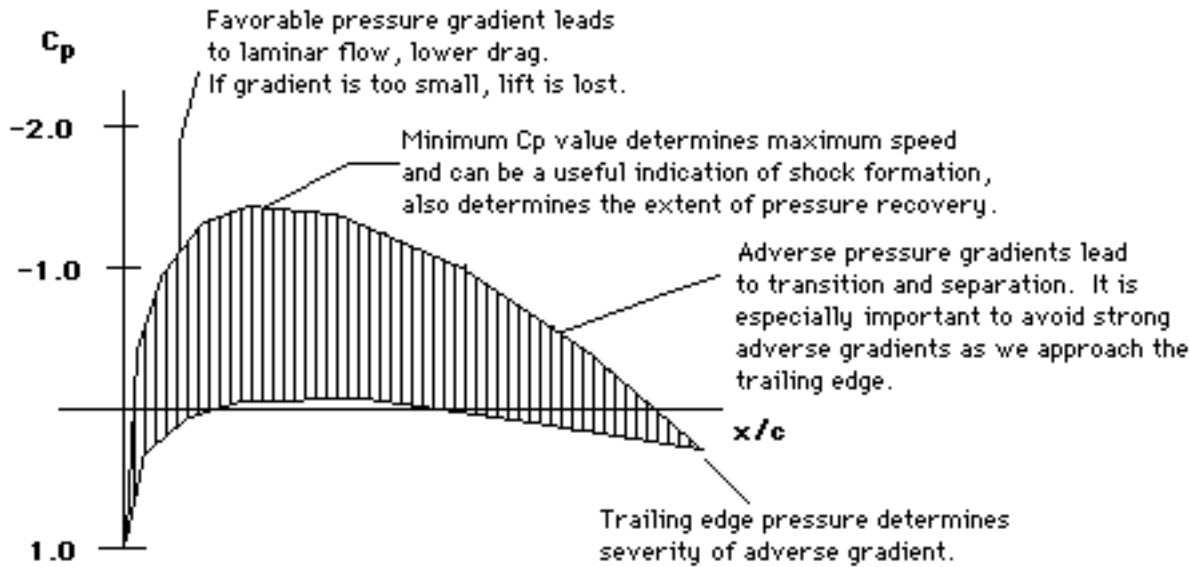

Most of these considerations are related to the airfoil boundary layer characteristics which we will take up later, but even in the inviscid case we can draw some conclusions. We may compute the maximum local Mach numbers and relate those to lift and thickness; we can compute the pitching moment and decide if that is acceptable.

Whether we use the inviscid pressures to form qualitative conclusions about the section, or use them as input to a more detailed boundary layer calculation, we must first investigate the close relation between the airfoil geometry to these pressures.

Relating Airfoil Geometry and Pressures

The relationship between airfoil geometry and airfoil pressure distributions can be predicted numerically solving the relevant field equations. But it can also be understood in a rather intuitive way.

We first look at the effect of changes in surface curvature (Click on figure to look in more detail.)

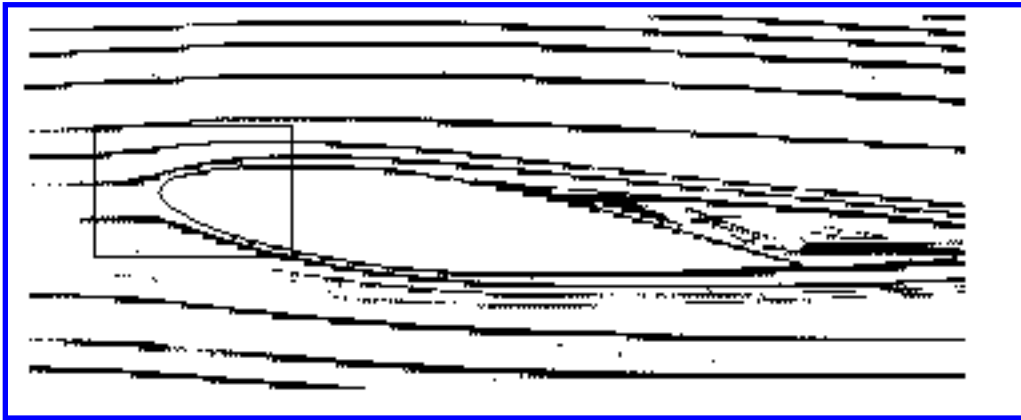

The figure below shows how the airfoil pressures vary with angle of attack. Note that the "nose peak" becomes more extreme as the angle increases.

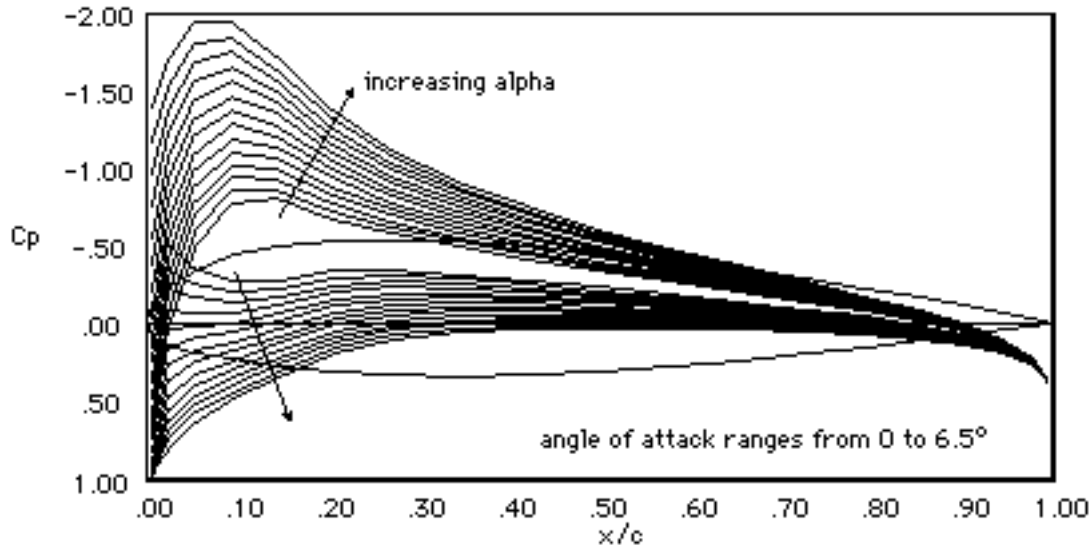

To make this a bit more clear, you may use the small java program below to change the angle of attack and see its effect on C_p , C_l , and C_m . Click on the upper half of the plot to increase the angle of attack, alpha, and on the lower portion to decrease it.

Let's consider, in more detail the relationship between airfoil geometry and airfoil pressure distributions. The next few examples show some of the effects of changes in camber, leading edge radius, trailing edge angle, and local distortions in the airfoil surface.

A reflexed airfoil section has reduced camber over the aft section producing less lift over this region, and therefore less nose-down pitching moment. In this case the aft section is actually pushing downward and C_m at zero lift is positive.

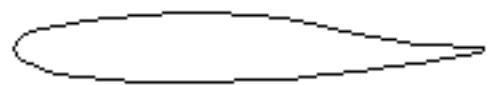
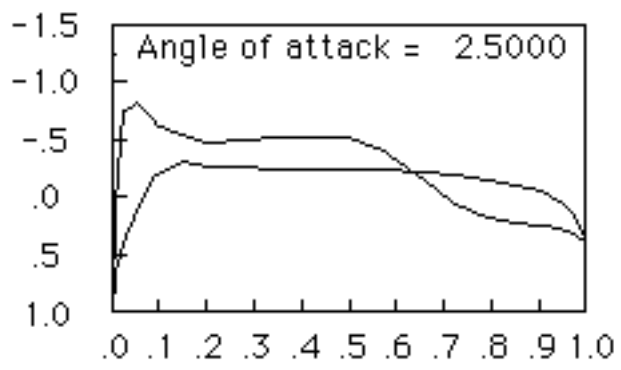

A natural laminar flow section has a thickness distribution that leads to a favorable pressure gradient over a portion of the airfoil. In this case, the rather sharp nose leads to favorable gradients over 50% of the section.

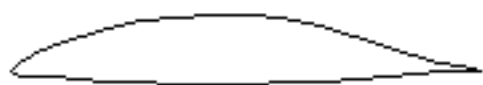
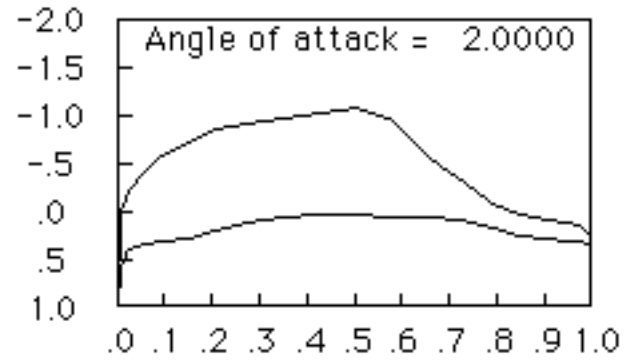

This is a symmetrical section at 4° angle of attack.

Note the pressure peak near the nose. A thicker section would have a less prominent peak.

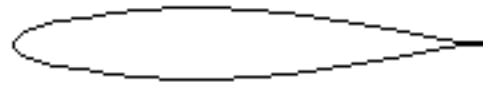
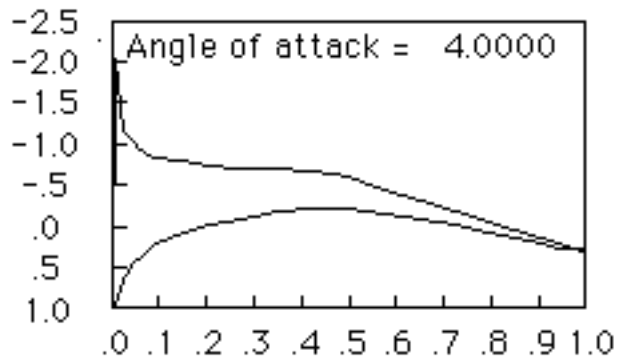

Here is a thicker section at 0°. Only one line is shown on the plot because at zero lift, the upper and lower surface pressure coincide.

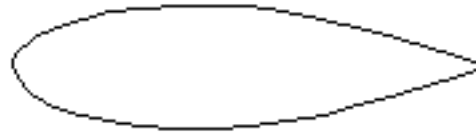
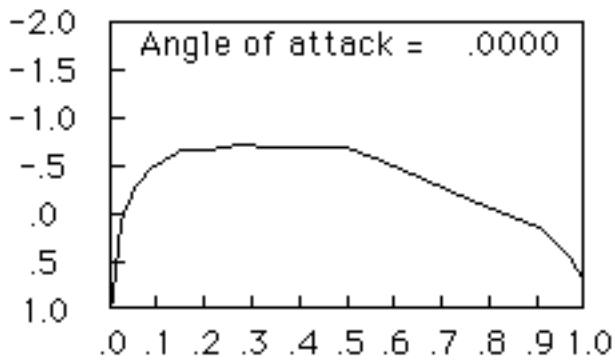

A conventional cambered section.

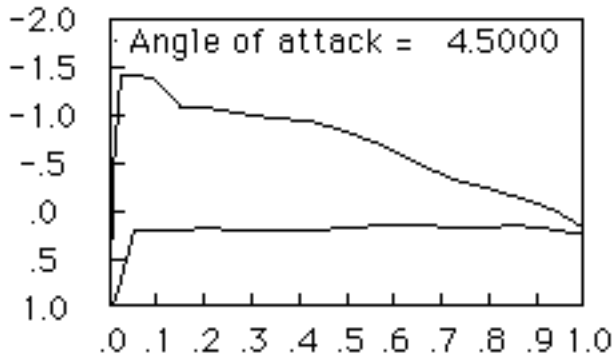

An aft-loaded section, the opposite of a reflexed airfoil carries more lift over the aft part of the airfoil. Supercritical airfoil sections look a bit like this.

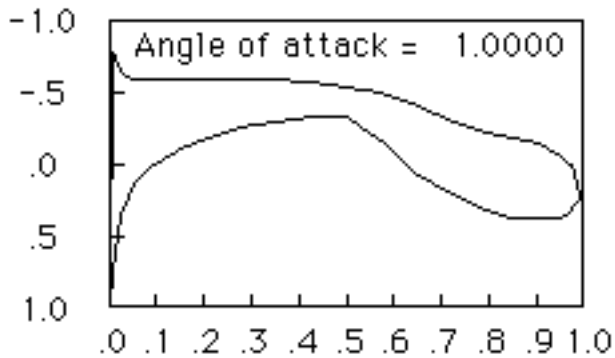

The best way to develop a feel for the effect of the airfoil geometry on pressures is to interactively modify the section and watch how the pressures change. A Program for ANalysis and Design of Airfoils (PANDA) does just this and is available from [Desktop Aeronautics](#). A very simple version of this program, is built into this text and allows you to vary airfoil shape to see the effects on pressures. (Go to [Interactive Airfoil Analysis](#) page by clicking here.) The full version of PANDA permits arbitrary airfoil shapes, permits finer adjustment to the shape, includes compressibility, and computes boundary layer properties.

An intuitive view of the C_p -curvature relation

For equilibrium we must have a pressure gradient when the flow is curved.

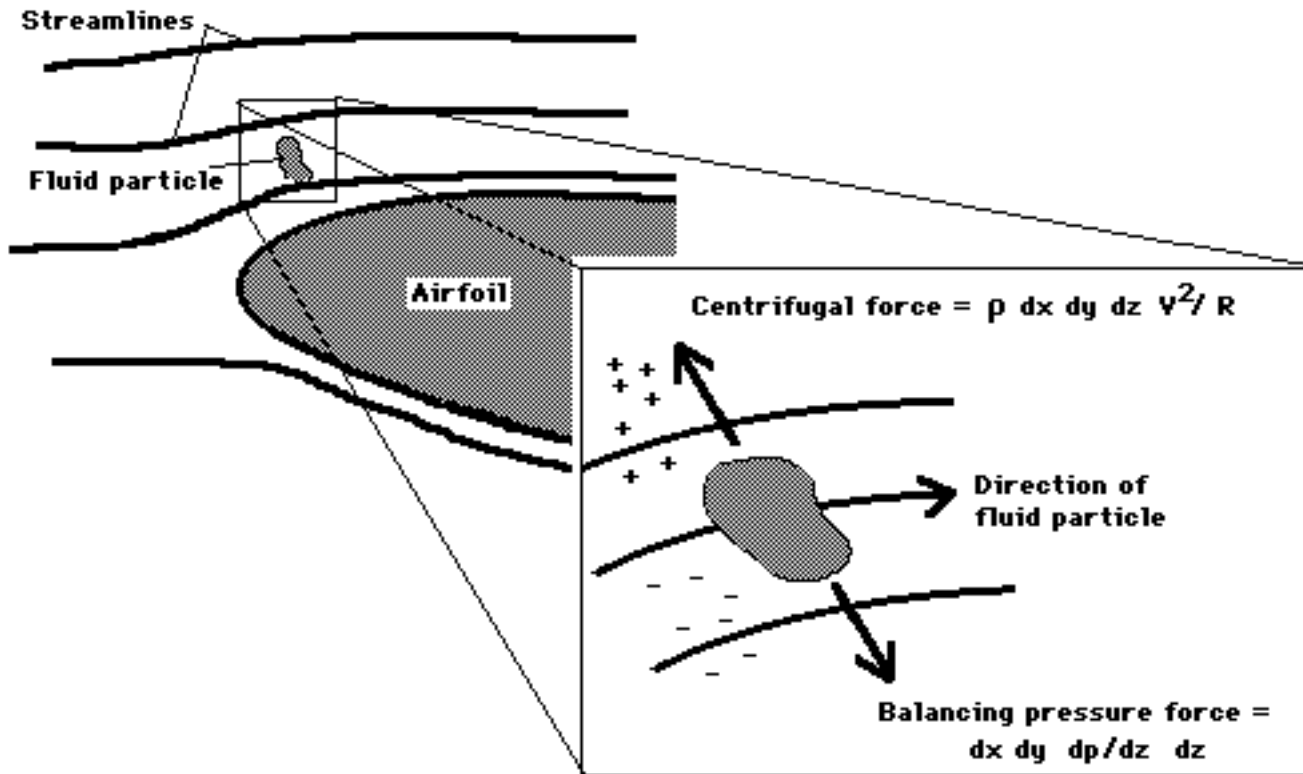

In the case shown here, the pressure must increase as we move further from the surface. This means that the surface pressure is lower than the pressures farther away. This is why the C_p is more negative in regions with curvature in this direction. The curvature of the streamlines determines the pressures and hence the net lift.

Interactive Airfoil Analysis

Introduction

The program built into this page allows you to experiment with the effect of airfoil shape and angle of attack on the pressure distribution.

Instructions

Click on the top part of the plot to increase the angle of attack; clicking on the lower portion reduces alpha. Drag the handles shown on the upper or lower surfaces to modify the shape of the section and watch the effects on C_p .

Suggested Exercises

Change the airfoil thickness and note the effect on upper and lower surface pressures. Notice how thickness affects the C_p at the trailing edge. Create a pressure peak near the nose on the upper or lower side by changing the angle of attack. Change the camber near the nose to remove the pressure peak. Try to create a positive pitching moment section, a very thin, highly cambered section, and a symmetrical section.

Technical Details

This program uses a combination of thin airfoil theory and conformal mapping to very quickly compute pressures on an airfoil. A method like this was used in the 1950's to compute airfoil pressure distributions before Java was invented. The section shape is very simple as well: upper and lower surfaces consist of a quadratic in \sqrt{x} and a quadratic in $(1-x)$, patched together at the control points. This provides just 4 degrees of freedom, but does lead to curves that look like airfoils.

Airfoil Design Methods

The process of airfoil design proceeds from a knowledge of the boundary layer properties and the relation between geometry and pressure distribution. The goal of an airfoil design varies. Some airfoils are designed to produce low drag (and may not be required to generate lift at all.) Some sections may need to produce low drag while producing a given amount of lift. In some cases, the drag doesn't really matter - it is maximum lift that is important. The section may be required to achieve this performance with a constraint on thickness, or pitching moment, or off-design performance, or other unusual constraints. Some of these are discussed further in the section on [historical examples](#).

One approach to airfoil design is to use an airfoil that was already designed by someone who knew what he or she was doing. This "design by authority" works well when the goals of a particular design problem happen to coincide with the goals of the original airfoil design. This is rarely the case, although sometimes existing airfoils are good enough. In these cases, airfoils may be chosen from catalogs such as Abbott and von Doenhoff's Theory of Wing Sections, Althaus' and Wortmann's Stuttgarter Profilkatalog, Althaus' Low Reynolds Number Airfoil catalog, or Selig's "Airfoils at Low Speeds".

The advantage to this approach is that there is test data available. No surprises, such as an unexpected early stall, are likely. On the other hand, available tools are now sufficiently refined that one can be reasonably sure that the predicted performance can be achieved. The use of "designer airfoils" specifically tailored to the needs of a given project is now very common. This section of the notes deals with the process of custom airfoil design.

Methods for airfoil design can be classified into two categories: direct and inverse design.

Direct Methods for Airfoil Design

The direct airfoil design methods involve the specification of a section geometry and the calculation of pressures and performance. One evaluates the given shape and then modifies the shape to improve the performance.

The two main subproblems in this type of method are

1. the identification of the measure of performance
2. the approach to changing the shape so that the performance is improved

The simplest form of direct airfoil design involves starting with an assumed airfoil shape (such as a NACA airfoil), determining the characteristic of this section that is most problematic, and fixing this problem. This process of fixing the most obvious problems with a given airfoil is repeated until there is

no major problem with the section. The design of such airfoils, does not require a specific definition of a scalar objective function, but it does require some expertise to identify the potential problems and often considerable expertise to fix them. Let's look at a simple (but real life!) example.

A company is in the business of building rigid wing hang gliders and because of the low speed requirements, they decide to use a version of one of Bob Liebeck's very high lift airfoils. Here is the pressure distribution at a lift coefficient of 1.4. Note that only a small amount of trailing edge separation is predicted. Actually, the airfoil works quite well, achieving a C_{lmax} of almost 1.9 at a Reynolds number of one million.

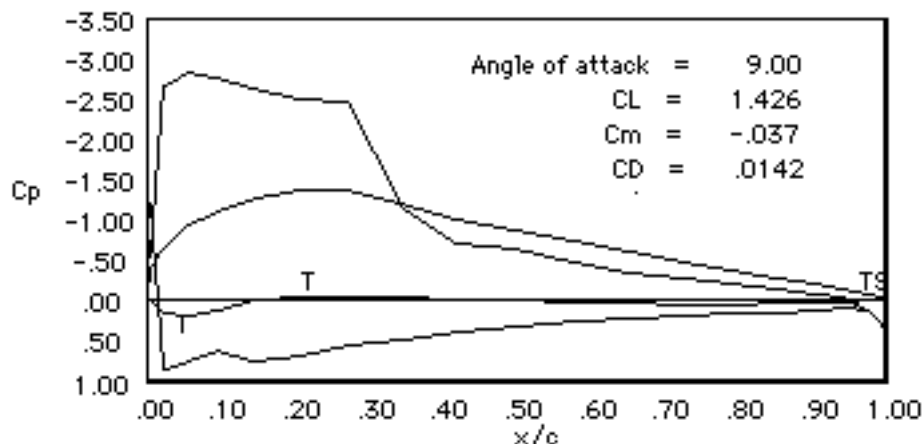

This glider was actually built and flown. It, in fact, won the 1989 U.S. National Championships. But it had terrible high speed performance. At lower lift coefficients the wing seemed to fall out of the sky. The plot below shows the pressure distribution at a C_l of 0.6. The pressure peak on the lower surface causes separation and severely limits the maximum speed. This is not too hard to fix.

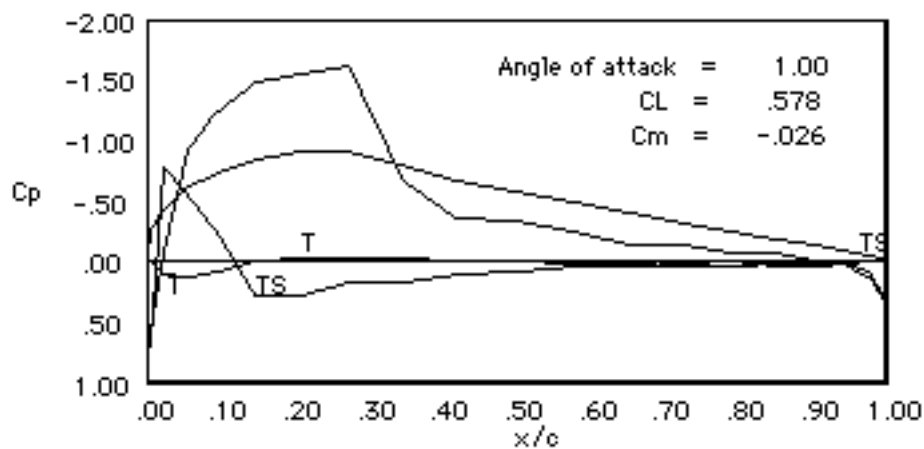

By reducing the lower surface "bump" near the leading edge and increasing the lower surface thickness aft of the bump, the pressure peak at low C_l is easily removed. The lower surface flow is now attached, and remains attached down to a C_l of about 0.2. We must check to see that we have not hurt the C_{lmax} too much.

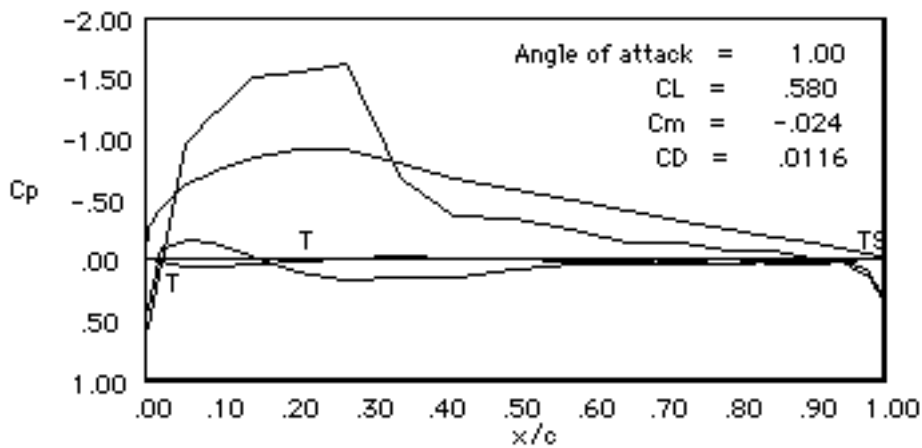

Here is the new section at the original design condition (still less than $C_{l_{max}}$). The modification of the lower surface has not done much to the upper surface pressure peak here and the $C_{l_{max}}$ turns out to be changed very little. This section is a much better match for the application and demonstrates how effective small modifications to existing sections can be. The new version of the glider did not use this section, but one that was designed from scratch with lower drag.

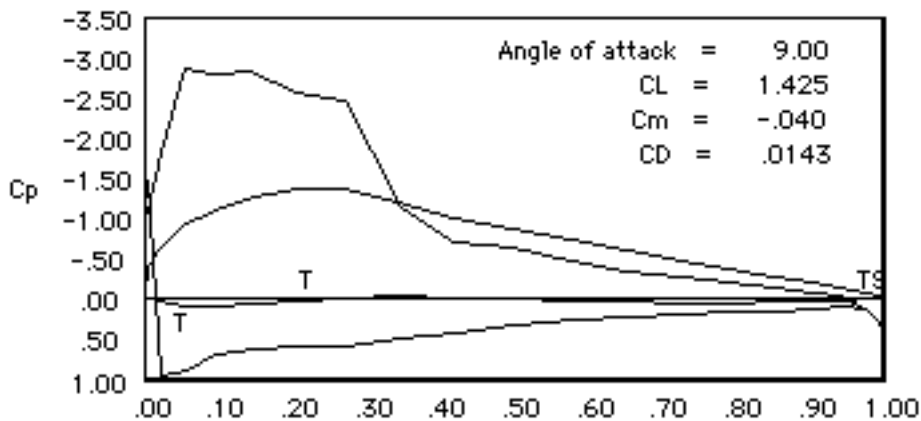

Sometimes the objective of airfoil design can be stated more positively than, "fix the worst things". We might try to reduce the drag at high speeds while trying to keep the maximum C_L greater than a certain value. This could involve slowly increasing the amount of laminar flow at low C_l 's and checking to see the effect on the maximum lift. The objective may be defined numerically. We could actually minimize C_d with a constraint on $C_{l_{max}}$. We could maximize L/D or $C_l^{1.5}/C_d$ or $C_{l_{max}} / C_d @ C_{l_{design}}$. The selection of the figure of merit for airfoil sections is quite important and generally cannot be done without considering the rest of the airplane. For example, if we wish to build an airplane with maximum L/D we do not build a section with maximum L/D because the section C_l for best C_l/C_d is different from the airplane C_L for best C_L/C_D .

Inverse Design

Another type of objective function is the target pressure distribution. It is sometimes possible to specify a

desired C_p distribution and use the least squares difference between the actual and target C_p 's as the objective. This is the basic idea behind a variety of methods for inverse design. As an example, thin airfoil theory can be used to solve for the shape of the camberline that produces a specified pressure difference on an airfoil in potential flow.

The second part of the design problem starts when one has somehow defined an objective for the airfoil design. This stage of the design involves changing the airfoil shape to improve the performance. This may be done in several ways:

1. By hand, using knowledge of the effects of geometry changes on C_p and C_p changes on performance.
2. By numerical optimization, using shape functions to represent the airfoil geometry and letting the computer decide on the sequence of modifications needed to improve the design.

Typical Airfoil Design Problems

Regardless of the design goals and constraints, one is faced with some common problems that make airfoil design difficult. This section deals with the common issues that arise in the following design problems:

- [Design for maximum thickness](#)
- [Design for maximum lift](#)
- [Laminar boundary layer airfoil design](#)
- [High lift or thickness transonic design](#)
- [Low Reynolds number airfoil design](#)
- [Low or positive pitching moment designs](#)
- [Multiple design points](#)

Thick Airfoil Design

The difficulty with thick airfoils is that the minimum pressure is decreased due to thickness. This results in a more severe adverse pressure gradient and the need to start recovery sooner. If the maximum thickness point is specified, the section with maximum thickness must recover from a given point with the steepest possible gradient. This is just the sort of problem addressed by Liebeck in connection with maximum lift. The thickest possible section has a boundary layer just on the verge of separation throughout the recovery.

The thickest section at $Re = 10$ million is 57% thick, but of course, it will separate suddenly with any angle of attack.

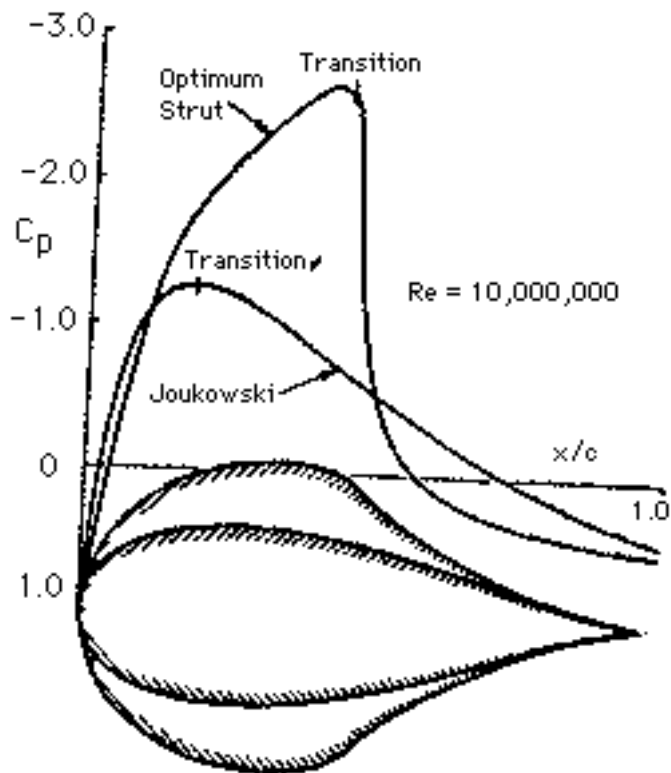

High Lift Airfoil Design

To produce high lift coefficients, we require very negative pressures on the upper surface of the airfoil. The limit to this suction may be associated with compressibility effects, or may be imposed by the requirement that the boundary layer be capable of negotiating the resulting adverse pressure recovery. It may be shown that to maximize lift starting from a specified recovery height and location, it is best to keep the boundary layer on the verge of separation*. Such distributions are shown below for a Re of 5 million. Note the difference between laminar and turbulent results.

The thickest section at Re = 10 million is 57% thick, but of course, it will separate suddenly with any angle of attack.

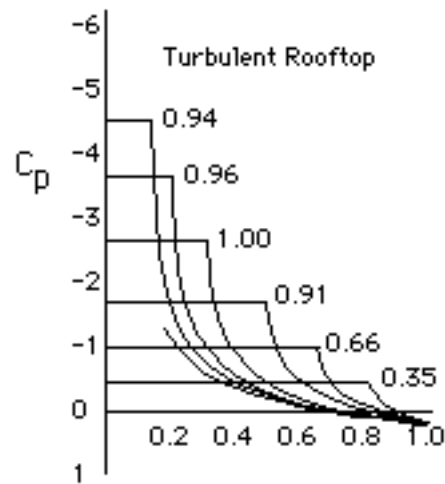
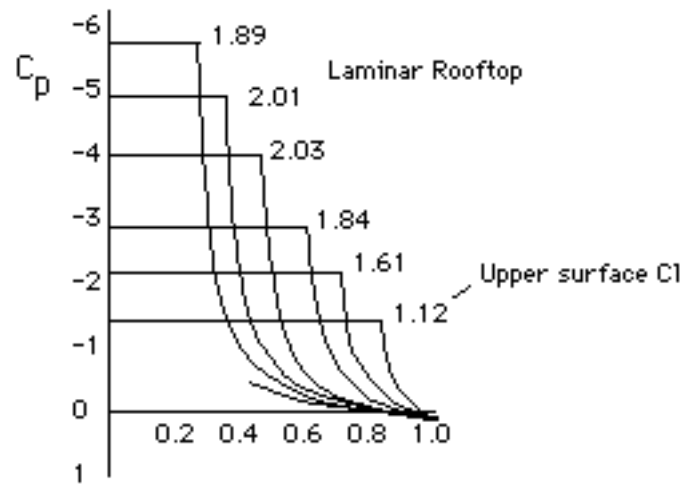

For maximum airfoil lift, the best recovery location is chosen and the airfoil is made very thin so that the lower surface produces maximum lift as well. (Since the upper surface C_p is specified, increasing thickness only reduces the lower surface pressures.)

Well, almost. If the upper surface C_p is more negative than -3.0, the perturbation velocity is greater than freestream, which means, for a thin section, the lower surface flow is upstream. This would cause separation and the maximum lift is achieved with an upper surface velocity just over $2U$ and a bit of thickness to keep the lower surface near stagnation pressure.

Liebeck's Famous Maximum Lift Airfoil

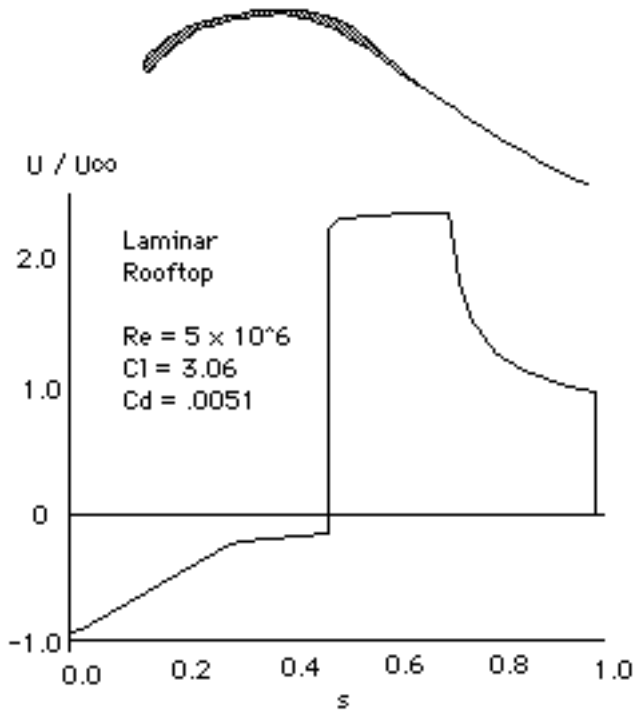

A more detailed discussion of this topic may be found in the section on [high lift systems](#).

*This conclusion, described by Liebeck, is easily derived if Stratford's criterion or the laminar boundary layer method of Thwaites is used. For other turbulent boundary layer criteria, the conclusion is not at all obvious and indeed some have suggested (Kroo and Morris) that this is not the case.

High-Lift Systems

Outline of this Chapter

The chapter is divided into four sections. The introduction describes the motivation for high lift systems, and the basic concepts underlying flap and slat systems. The second section deals with the basic ideas behind high lift performance prediction, and the third section details the specific method used here for estimating $C_{L_{\max}}$. Some discussion on maximum lift prediction for supersonic aircraft concludes the chapter.

- [Introduction and Basic Concepts](#)
- [High Lift Prediction: General Approach](#)
- [High Lift Prediction: Specific Conceptual Design Approach](#)
- [Estimating Maximum Lift for Supersonic Transport Aircraft](#)
- [Wing-Body \$C_{L_{\max}}\$ Calculation Page](#)

High Lift Systems -- Introduction

A wing designed for efficient high-speed flight is often quite different from one designed solely for take-off and landing. Take-off and landing distances are strongly influenced by aircraft stalling speed, with lower stall speeds requiring lower acceleration or deceleration and correspondingly shorter field lengths. It is always possible to reduce stall speed by increasing wing area, but it is not desirable to cruise with hundreds of square feet of extra wing area (and the associated weight and drag), area that is only needed for a few minutes. Since the stalling speed is related to wing parameters by:

$$V_{\text{stall}} = (2 W / (S \rho C_{L_{\text{max}}}))^{1/2}$$

It is also possible to reduce stalling speed by reducing weight, increasing air density, or increasing wing $C_{L_{\text{max}}}$. The latter parameter is the most interesting. One can design a wing airfoil that compromises cruise efficiency to obtain a good $C_{L_{\text{max}}}$, but it is usually more efficient to include movable leading and/or trailing edges so that one may obtain good high speed performance while achieving a high $C_{L_{\text{max}}}$ at take-off and landing. The primary goal of a high lift system is a high $C_{L_{\text{max}}}$; however, it may also be desirable to maintain low drag at take-off, or high drag on approach. It is also necessary to do this with a system that has low weight and high reliability.

This is generally achieved by incorporating some form of trailing edge flap and perhaps a leading edge device such as a slat.

Flap Geometry

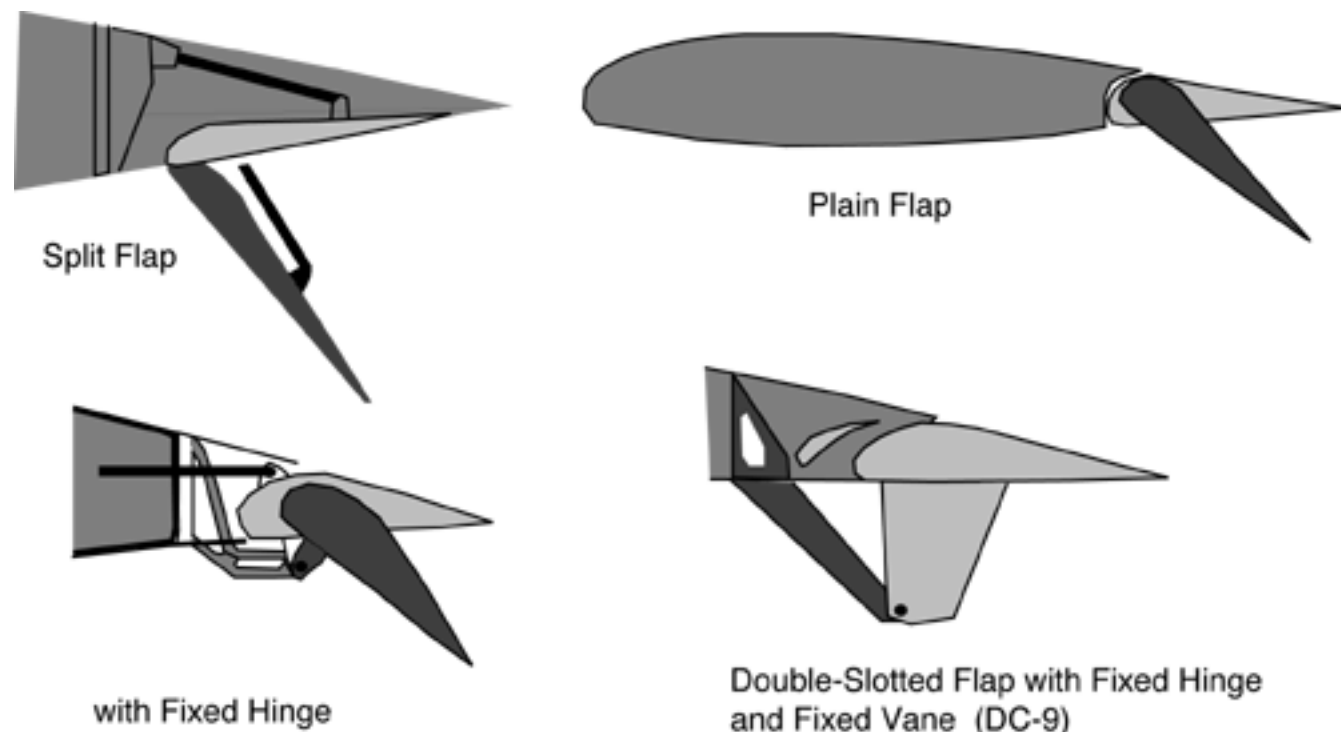

Figure 1. Flap System Geometries



Figure 2. The triple-slotted flap system used on a 737.

Figure 3 shows a double-slotted flap and slat system (a 4-element airfoil). Here, some of the increase in CL_{max} is associated with an increase in chord length (Fowler motion) provided by motion along the flap track or by a rotation axis that is located below the wing.

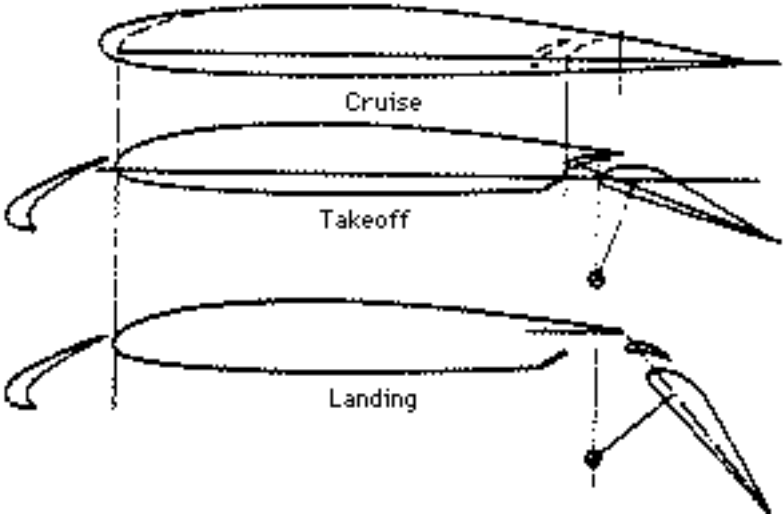

Figure 3. Double-Slotted Flap and Slat System

Modern high lift systems are often quite complex with many elements and multi-bar linkages. Here is a double-slotted flap system as used on a DC-8. For some time Douglas resisted the temptation to use tracks and resorted to such elaborate 4-bar linkages. The idea was that these would be more reliable. In practice, it seems both schemes are very reliable. Current practice has been to simplify the flap system and double (or even single) slotted systems are often preferred.

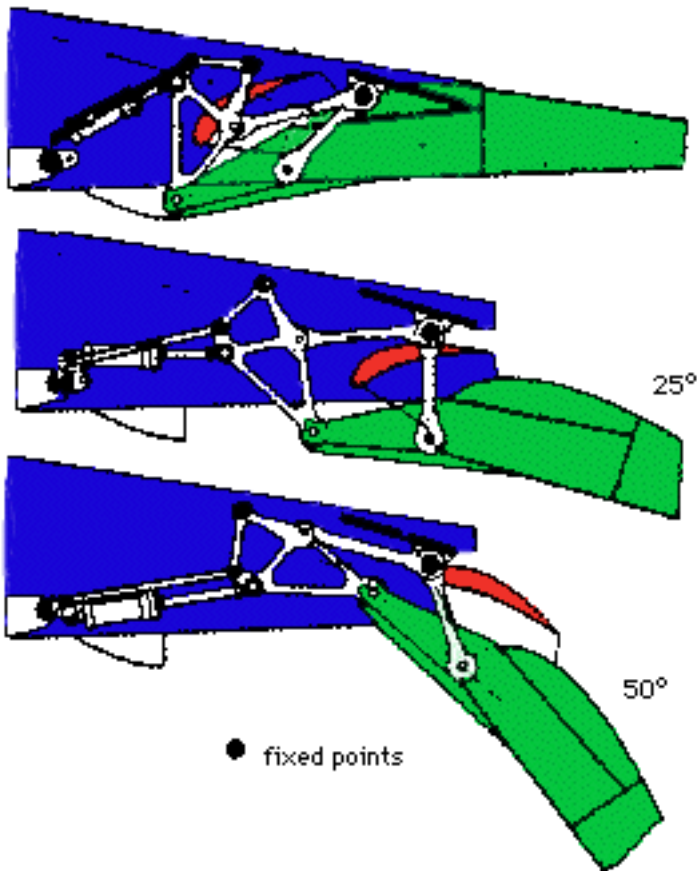

Figure 4. Motion of a Double-Slotted Flap

Flap Aerodynamics

Flaps change the airfoil pressure distribution, increasing the camber of the airfoil and allowing more of the lift to be carried over the rear portion of the section. If the maximum lift coefficient is controlled by the height of the forward suction peak, the flap permits more lift for a given peak height. Flaps also increase the lift at a given angle of attack, important for aircraft which are constrained by ground angle limits. Typical results are shown in figure 5 from data on a DC-9-30, a configuration very similar to the Boeing 717.

DC-9-30 Tail-Off Lift

Mach 0.2, Slats Retracted

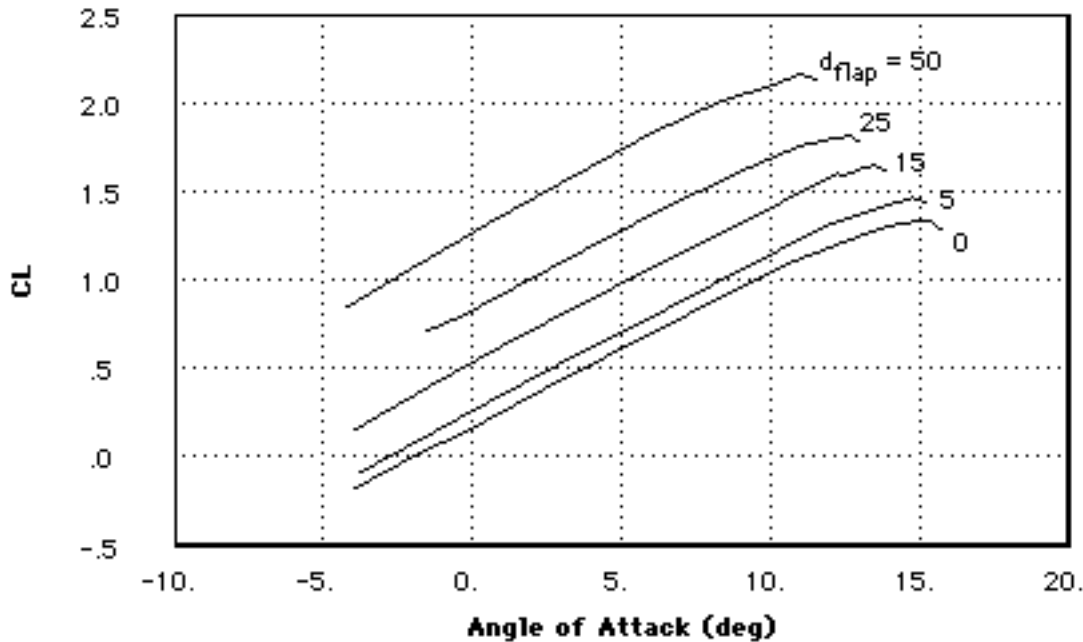

Figure 5. DC-9-30 CL vs. Flap Deflection and Angle-of-Attack

Slotted flaps achieve higher lift coefficients than plain or split flaps because the boundary layer that forms over the flap starts at the flap leading edge and is "healthier" than it would have been if it had traversed the entire forward part of the airfoil before reaching the flap. The forward segment also achieves a higher $C_{l_{max}}$ than it would without the flap because the pressure at the trailing edge is reduced due to interference, and this reduces the adverse pressure gradient in this region.

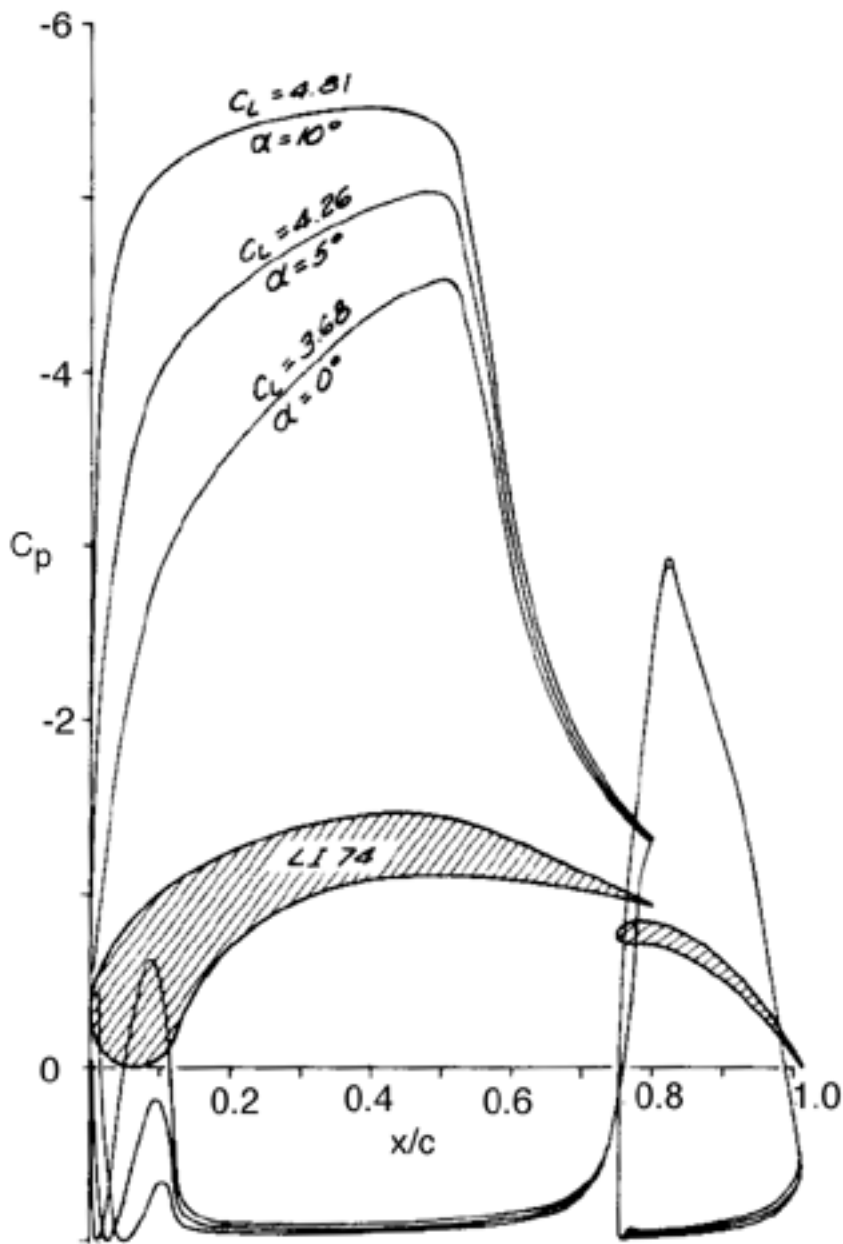

Figure 6. Maximum Lift Slotted Section.

The favorable effects of a slotted flap on $C_{l_{\max}}$ was known early in the development on high lift systems. That a 2-slotted flap is better than a single-slotted flap and that a triple-slotted flap achieved even higher C_l 's suggests that one might try more slots. Handley Page did this in the 1920's. Tests showed a $C_{l_{\max}}$ of almost 4.0 for a 6-slotted airfoil.

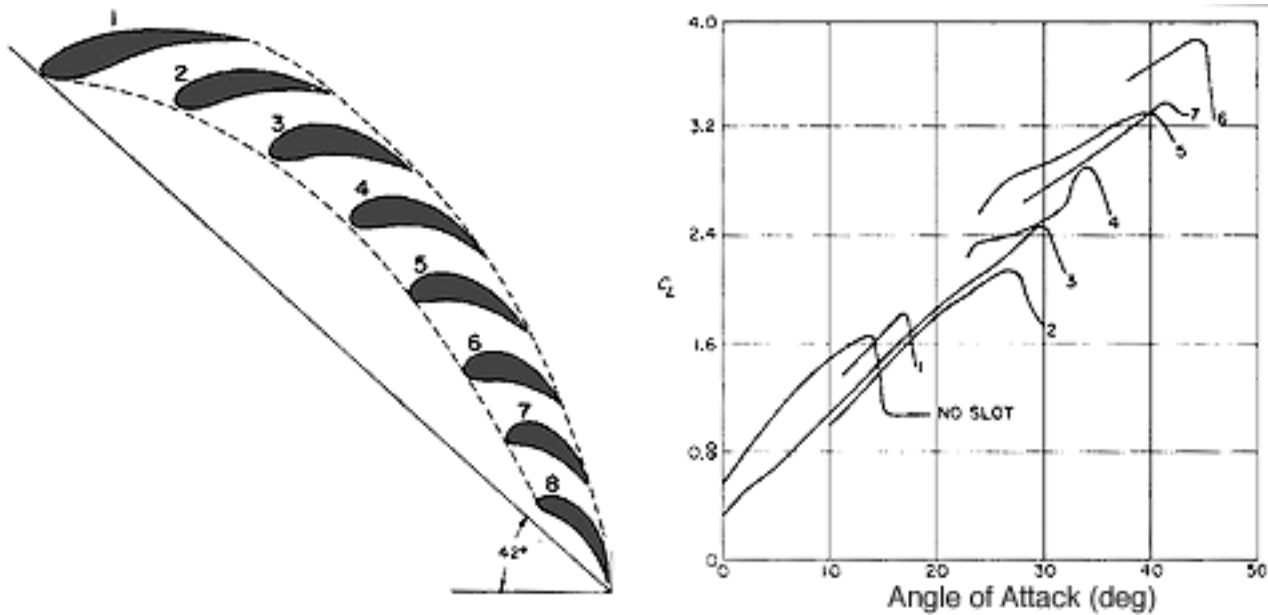

Figure 7. Results for a multi-element section from 1921.

Leading Edge Devices

Leading edge devices such as nose flaps, Kruger flaps, and slats reduce the pressure peak near the nose by changing the nose camber. Slots and slats permit a new boundary layer to start on the main wing portion, eliminating the detrimental effect of the initial adverse gradient.

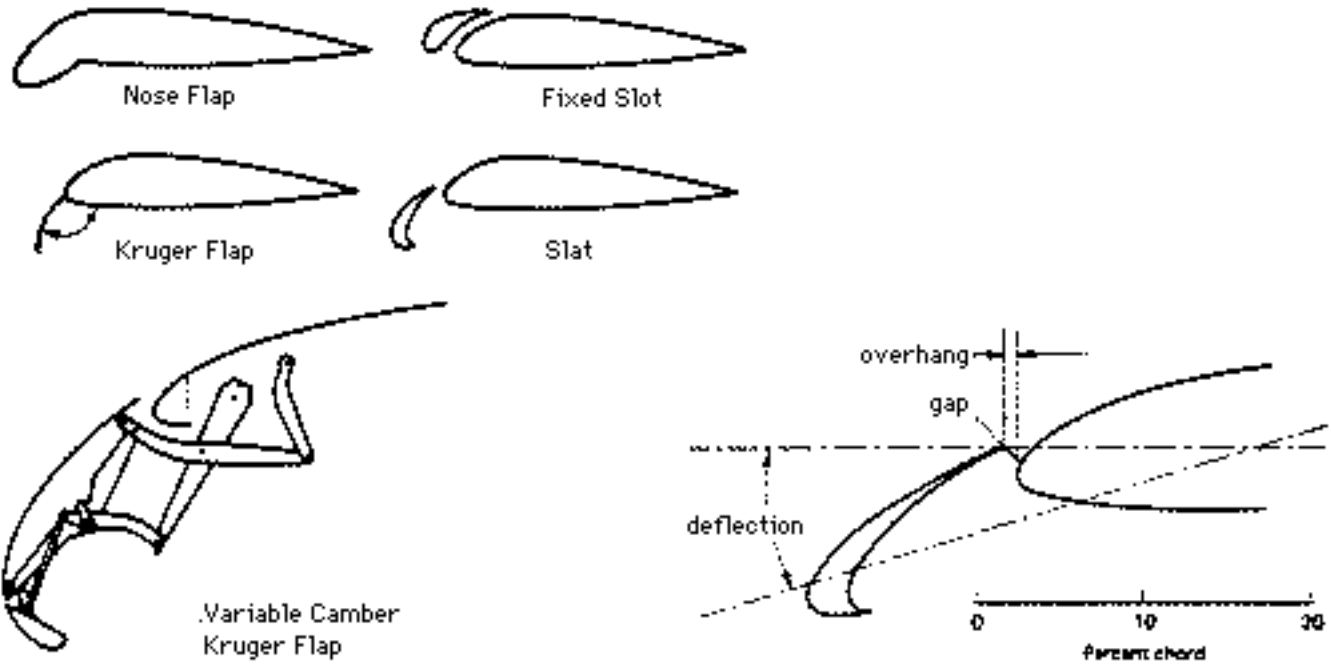

Figure 8. Leading Edge Devices

Slats operate rather differently from flaps in that they have little effect on the lift at a given angle of attack. Rather, they extend the range of angles over which the flow remains attached. This is shown in

figure 9.

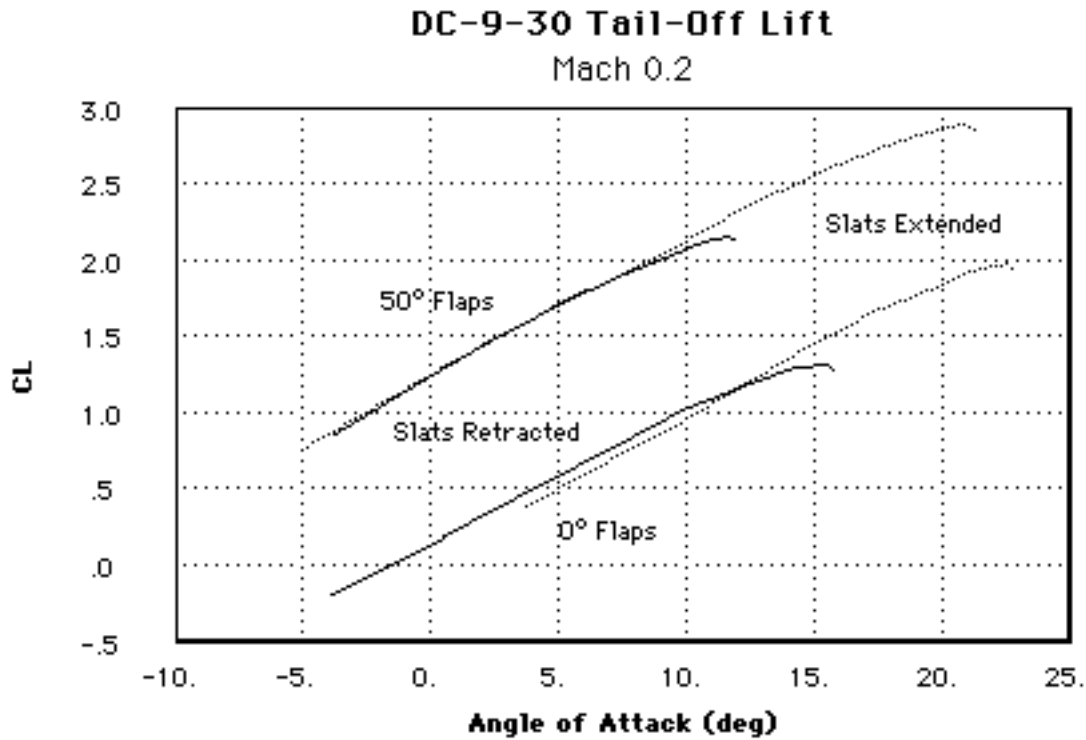

Figure 9. Effect of Slats on Lift Curve. Dotted curves are slats extended; solid curves show slats retracted.

Today computational fluid dynamics is used to design these complex systems; however, the prediction of $C_{L_{max}}$ by direct computation is still difficult and unreliable. Wind tunnel tests are also difficult to interpret due to the sensitivity of $C_{L_{max}}$ to Reynolds number and even freestream turbulence levels.

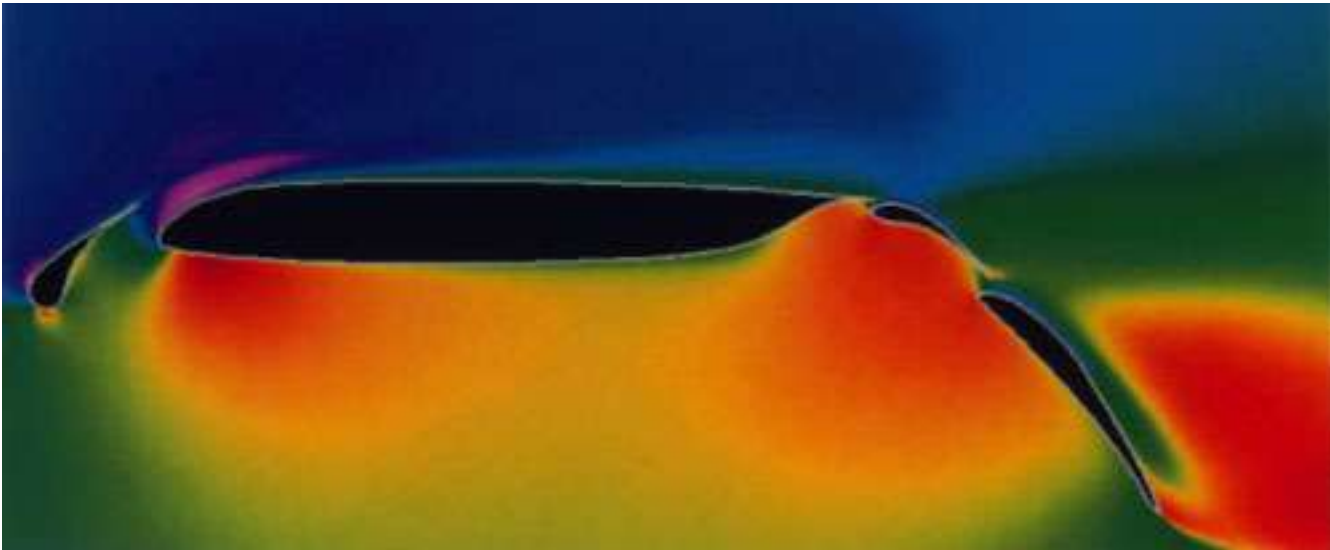

Figure 10. Navier Stokes computations of the flow over a 4-element airfoil section (NASA)

Maximum Lift Prediction -- General Approach

The calculation of $C_{L_{\max}}$ is difficult because we must deal with a flow that is viscous, compressible, and highly three-dimensional. Generally, one does not use a Navier-Stokes calculation to estimate maximum lift. This is partly because it takes a very long time to generate a grid and then solve the equations. However, it is also difficult to estimate the effects of stall strips, fences, and vortex generators that are routinely used on wings and are essential to obtaining acceptable stalling characteristics. Thus, the more usual approach is as follows. The distribution of pressure on the wing is computed from a 3-D panel method. The pressure distributions along streamwise strips are used as input to a two dimensional boundary layer calculation in which the onset of separation is predicted. The actual maximum lift coefficient is based on the boundary layer data, sometimes supplemented with 2-D wind tunnel data.

In the absence of even 2D boundary layer computations, a variety of simpler rules are used. One of these, the pressure difference rule, has been applied frequently to aircraft with high lift systems. Experiments show that the difference between the peak C_p and the C_p at the trailing edge at $C_{L_{\max}}$ varies with Mach number and Reynolds number. This has been correlated in a number of proprietary rules, but for turbulent sections at low Mach number, it varies roughly from 7 or 8 at a Reynolds number of 1 million to as much as 13 or 14 at 6 million and above. Viscous corrections are made to the results of an inviscid panel method (including a reduction in effective flap deflection due to boundary layer decambering) and then the pressure difference rule applied to each section along the span.

This method usually works well, but many approximations are made. The process of high lift prediction therefore relies strongly on wind tunnel data. But, since the flow is sensitive to changes in Reynolds number, good 3-D measurements are rare. This is often one of the areas of greatest uncertainty in aircraft design.

At the early stages of design, it is not possible to run even a panel code and 2-D boundary layer analysis. In such cases, one may compute the distribution of wing lift with a vortex lattice method or Weissinger model and compare the distribution of section C_l with the $C_{L_{\max}}$, estimated from 2-D data. One provides some margin against stalling of the outer panels to account for aileron deflections and spanwise boundary layer flow. When flaps are deflected, sections just outboard of the flap tend to stall early according to this method. In reality, the flow near the flap edge induces effective camber in the adjacent sections and so their maximum lift coefficient is increased. This effect must be included if reliable estimates of $C_{L_{\max}}$ are to be obtained using this "critical section" approach.

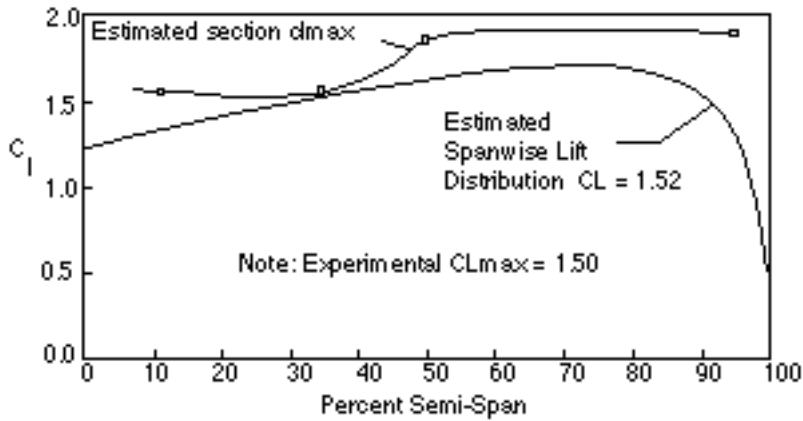

Figure 1. Critical Section Method for $C_{L_{max}}$ Prediction: Compute C_L at which most critical 2D section reaches $C_{l_{max}}$.

One might be concerned that the use of 2-D maximum lift data is completely inappropriate for computation of wing $C_{L_{max}}$ because of 3-D viscous effects. This issue was investigated by the N.A.C.A. in Report 1339. A figure from this paper is reproduced below (Figure 2). It indicates that the "clean wing" $C_{L_{max}}$ is, in fact, rather poorly predicted by the critical section method. However, when wing fences are used to prevent spanwise boundary layer flow, the $C_{l_{max}}$ is increased dramatically and does follow the 2-D results quite well over the outer wing sections. The inboard $C_{l_{max}}$ is considerably higher than would be expected by strip theory, but inboard section $C_{l_{max}}$ values are generally reduced with the use of stall strips or other devices to make them stall before the tips. Thus, the tip $C_{l_{max}}$ and lift distribution determine what the inboard $C_{l_{max}}$ must be to obtain good stall behavior.

Figure 2. Effect of fences on the section lift coefficients of a sweptback wing. Sweep = 45° AR = 8.0,

taper = .45, NACA 63(1)A-012 section. Data from NACA Rpt. 1339 Note the result that with fences, outer panel section C_l 's are nearly their 2-D values.

Maximum Lift Prediction -- Specific Conceptual Design Method

When the distribution of lift is not computed, it is still possible to make a rough estimate of maximum lift capability. This section describes a simple method appropriate for early design of conventional aircraft.

Outer Panel Section $C_{l_{max}}$

One starts by estimating the section $C_{l_{max}}$ of the outer wing panels. If the airfoil is known, this value may be based on experimental data or computations. A typical variation of section $C_{l_{max}}$ with thickness for peaky-type transport aircraft airfoils is shown in figure 1. Note that outer panel airfoil thickness ratio is generally less than the average value. Assuming that the outer panel has a t/c about 90% of the average value is reasonable. The increase in $C_{l_{max}}$ with thickness up to about 12%-15% reflects the larger nose radius of the thicker airfoils. Increased nose radius reduces the leading edge suction peak, the associated adverse pressure gradient, and the tendency to stall. Since supercritical airfoils have large nose radii, their $C_{l_{max}}$ is about 0.1 greater than the conventional sections shown here.

Figure 1. Section $C_{l_{max}}$ for Various Families of Airfoils.

The section $C_{l_{max}}$ is also affected by Reynolds number. Some data on this effect is shown in figure 2.

The effect of Reynolds number is sometimes very difficult to predict as it changes the location of laminar transition and boundary layer thickness. Thin airfoils are less Reynolds number sensitive, thick sections are more sensitive and show effects up to 15 million.

Figure 2. Effect of Reynolds Number

Recent experiments have suggested that, especially for slotted flap systems, significant variations with Reynolds number may occur even above Reynolds numbers of 6 to 9 million. But for initial design purposes, the variation of $C_{l_{max}}$ with Reynolds number may be approximated by:

$$C_{l_{max}} = C_{l_{max_ref}} * (Re / Re_{ref})^{0.1}$$

Relating Wing $C_{L_{max}}$ to Outer Panel $C_{l_{max}}$

The plot in figure 3 shows the ratio of wing $C_{L_{max}}$ to the section $C_{l_{max}}$ of the outer wing panel as a function of wing sweep angle and taper ratio. This plot was constructed by computing the span load distribution of wings with typical taper ratios and twist distributions. The results include a reduction in $C_{L_{max}}$ due to tail download of about 0.05, a value typical of conventional aircraft; they also include a suitable margin against outer panel stall. (This margin is typically about 0.2 in C_l .)

When estimating the $C_{l_{max}}$ of the wing outer panel, one should use the chord of the outer panel (typ. at about 75% semi-span) to compute the Reynolds number effect on that section.

Effect of Sweep and Taper on C_{Lmax}

AR = 8.00 M = .20

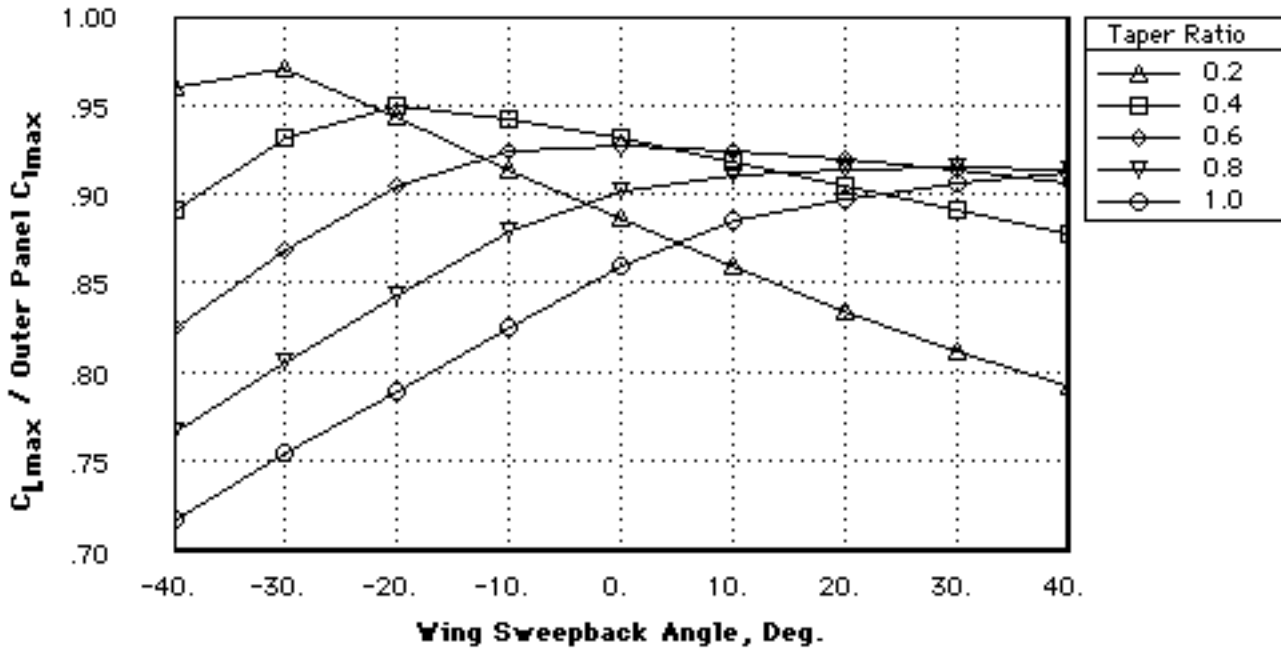

Figure 3. Effect of Taper and Sweep on Wing / Outer Panel C_{Lmax}

Additional corrections to wing C_{Lmax}

FAR Stall Speed

The formula for stalling speed given earlier in this section refers to the speed at which the airplane stalls in unaccelerated (1-g) flight. However, for the purposes of certifying a transport aircraft, the Federal Aviation Agency defines the stalling speed as the minimum airspeed flyable at a rate of approach to the stall of one knot per second. Slower speeds than that corresponding to 1-g maximum lift may be demonstrated since no account is taken of the normal acceleration. The maximum lift coefficient calculated from the FAA stall speed is referred to as the minimum speed C_{Lmax} or C_{Lmax_Vmin} . The increment above the 1-g C_{Lmax} is a function of the shape of the lift, drag, and moment curves beyond the stall. These data are not usually available for a new design but examination of available flight test data indicate that C_{Lmax_Vmin} averages about 11% above the 1-g value (based on models DC-7C, DC-8, and KC-135). A typical time history of the dynamic stall maneuver is shown in figure 4.

Figure 4. Typical Record of Dynamic Stall Maneuver Power-off Stall, Thrust Effect Negligible, Trim Speed 1.3 to 1.4 V_s , Wings Held Level, Speed Controlled by Elevator

FAR Stall C_L is value of C_{Ls} when $\Delta V/\Delta t = 1\text{kt/sec}$ and: $C_{Ls} = 2W / S \rho V_s^2$

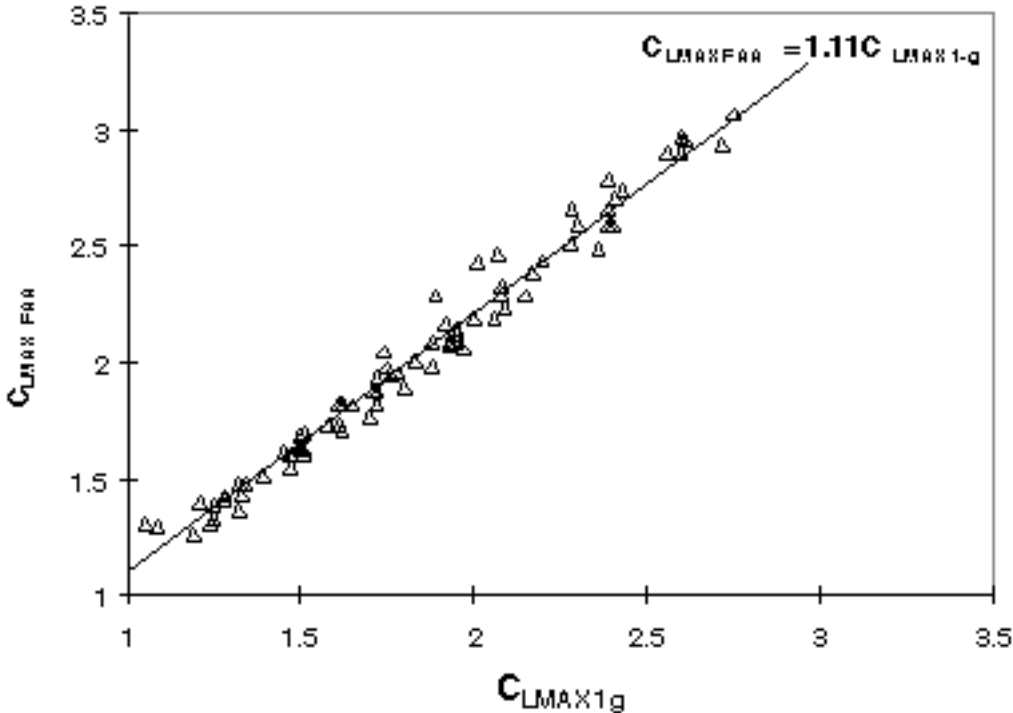

Figure 5. Flight Data showing FAA C_{Lmax} vs. C_{Lmax} based on 1-g flight.

Wing-Mounted Engines

The presence of engine pylons on the wings reduces C_{Lmax} . On the original DC-8 design, the reduction associated with pylons was 0.2. When the pylons are "cut-back" so they do not extend over the top of the leading edge, the reduction can be kept to within about 0.1 with respect to the best clean-wing value.

Increment in C_{Lmax} Due to Slats

When leading edge slats are deployed, the leading edge pressure peak is suppressed. The introduction of a gap between the leading edge device and the wing leading edge increases the energy of boundary layer above what it would have been without a gap. For this reason, the section lift coefficient is increased dramatically. The specific amount depends on the detailed design of the slat, its deflection, and the gap size. For the purposes of our preliminary design work, the value is estimated based on Douglas designs shown in figure 6. The effect of sweep reduces the lift increment due to slats by the factor shown in figure 7. A better method would include the observation that when leading edge devices are employed, the favorable effect of nose radius (and increased t/c) would not be realized. Although this data applies for 5 deg of flap deflection, this slat increment can be used for preliminary estimates at all flap angles.

C_{Lmax} Increment Due to Slats

Typical 2-D Section with 5 deg Flap

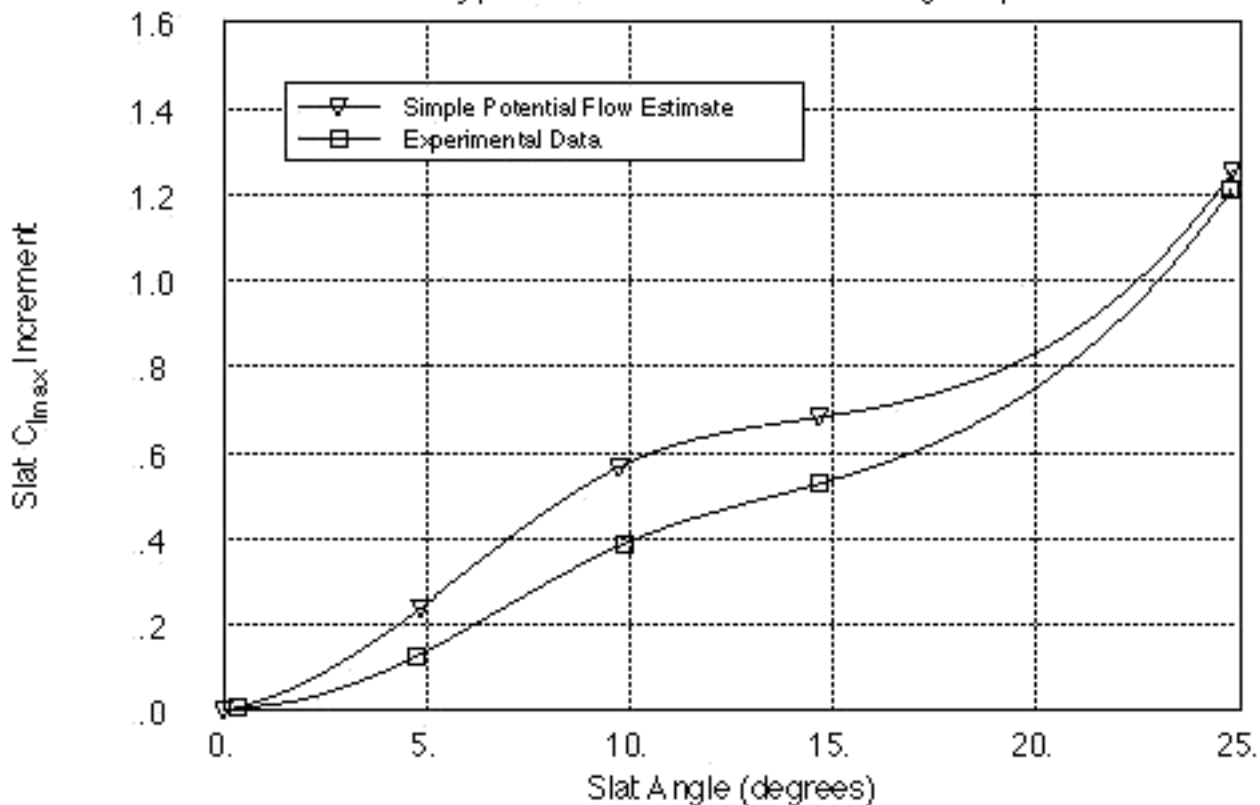

Figure 6. Effect of slat deflection on C_{Lmax} increment due to slats. Prediction based on maximum Mach number constraint. This data is for a 17% slat.

Effect of Sweep on Slat $C_{L_{max}}$ Increment

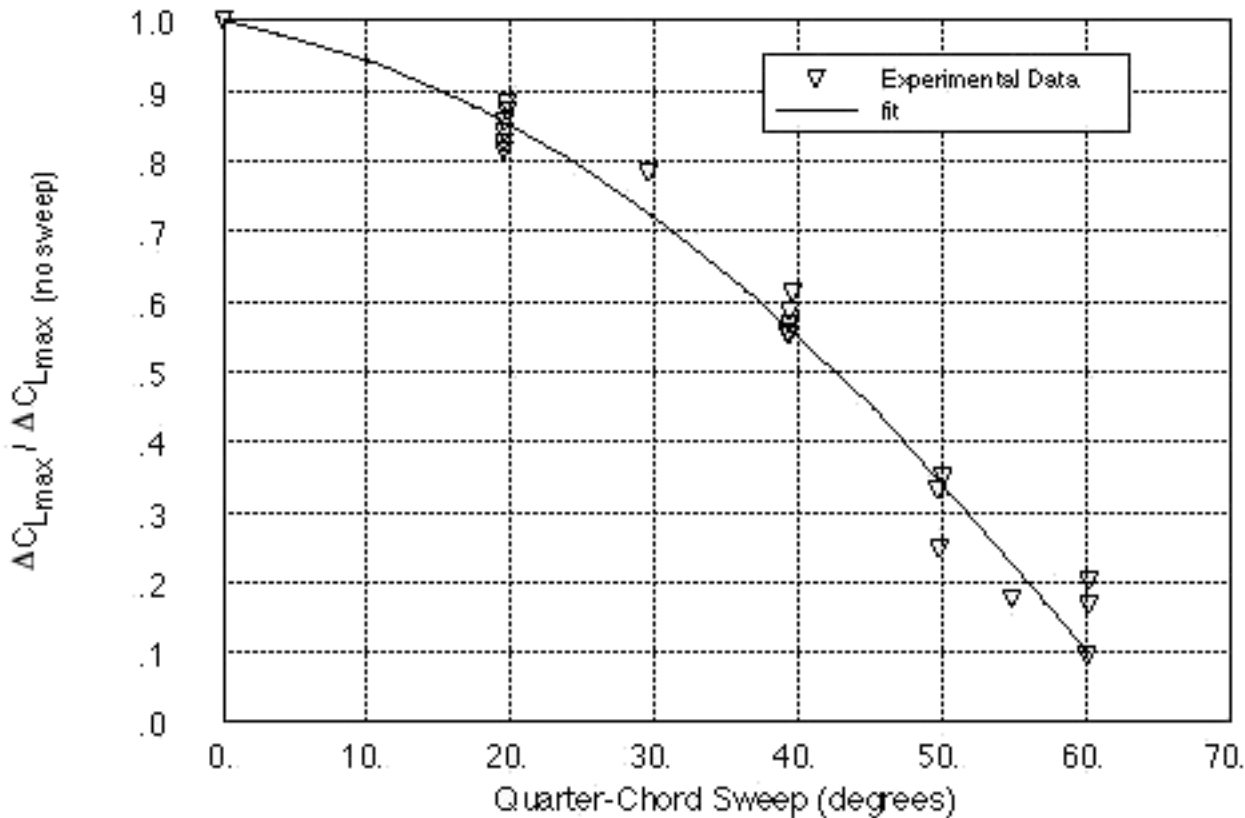

Figure 7. Effect of wing sweep on slat maximum lift increment.

Increment in $C_{L_{max}}$ Due to Flaps

A simple method for estimating the $C_{L_{max}}$ increment for flaps is described by the following expression. It is highly approximate and empirical, but the next level of sophistication is very complex, and sometimes not much more accurate.

$$\Delta C_{L_{max_flaps}} = S_{wf} / S_{ref} \Delta C_{L_{max_flaps}} K(\text{sweep})$$

where:

S_{wf} = wing area affected by flaps (including chord extension, but not area buried in fuselage)

S_{ref} = reference wing area

$\Delta C_{L_{max_flaps}}$ = increase in two-dimensional $C_{L_{max}}$ due to flaps

K = an empirical sweepback correction

The wing area affected by flaps is estimated from a plan view drawing. Typical flaps extend over 65% to 80% of the exposed semi-span, with the outboard sections reserved for ailerons. The resultant flapped area ratios are generally in the range of 55% to 70% of the reference area. (See table at the end of this section.)



$\Delta C_{l_{max_flaps}}$ is determined empirically and is a function of flap type, airfoil thickness, flap angle, flap chord, and sweepback. It may be estimated from the expression:

$$\Delta C_{l_{max_flaps}} = K1 K2 \Delta C_{l_{max_ref}}$$

$\Delta C_{l_{max_ref}}$ is the two-dimensional increment in $C_{l_{max}}$ for 25% chord flaps at the 50 deg landing flap angle and is read from the experimentally-determined curve below at the mean thickness ratio of the wing.

$C_{l_{max}}$ Increment Due to Flaps
Optimized 2-Slot 25% Flap at 50 deg.

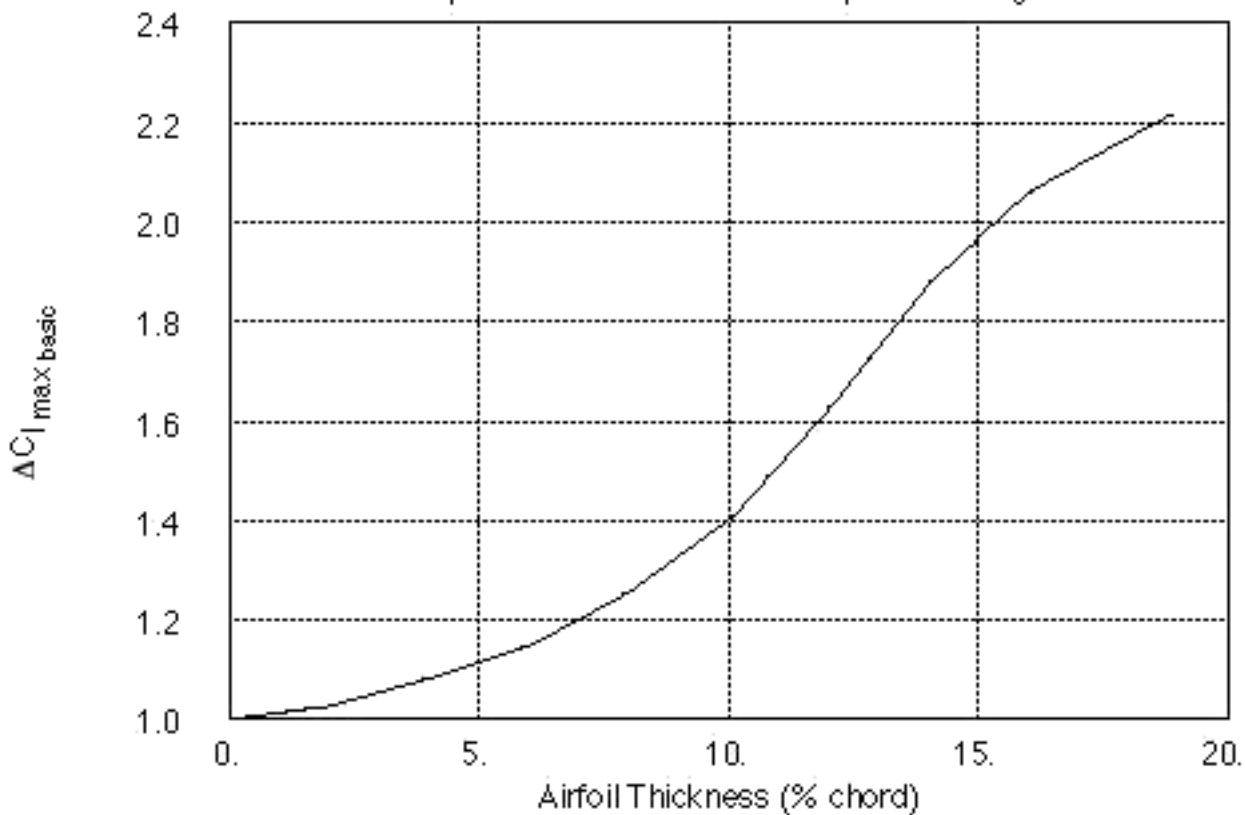

Figure 8. Section $C_{l_{max}}$ increment due to flaps. The results are for double slotted flaps. For single slotted flap multiply this value by 0.93. For triple slotted flaps, multiply by 1.08.

$K1$ is a flap chord correction factor. It includes differences between the flap chord to wing chord ratio of the actual design to that of the reference wing with 25% chord flaps.

K1 – Flap Chord Correction Factor

2 Slot Flap

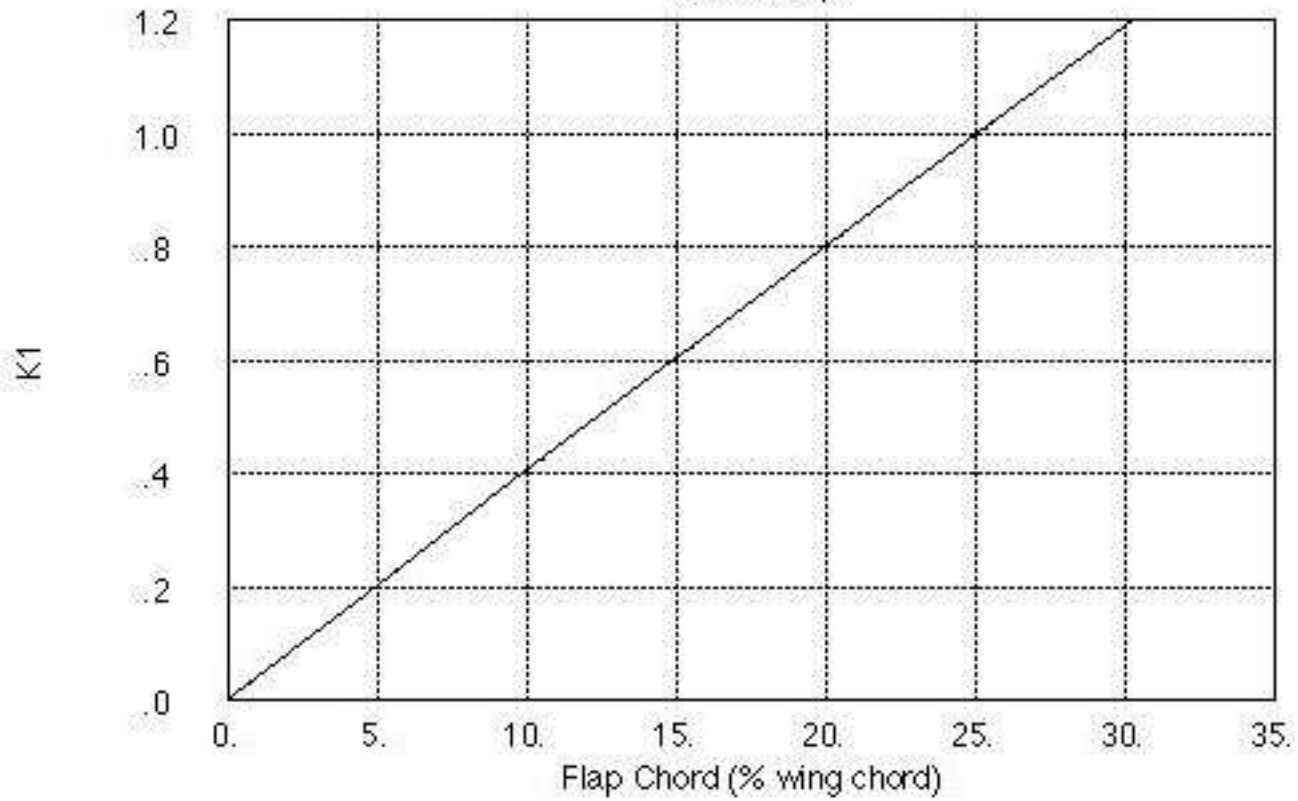

Figure 9. Effect of Flap Chord.

K2 accounts for the effect of flap angles other than 50 deg.

K2 – Flap Motion Correction Factor

2 Slot Flap

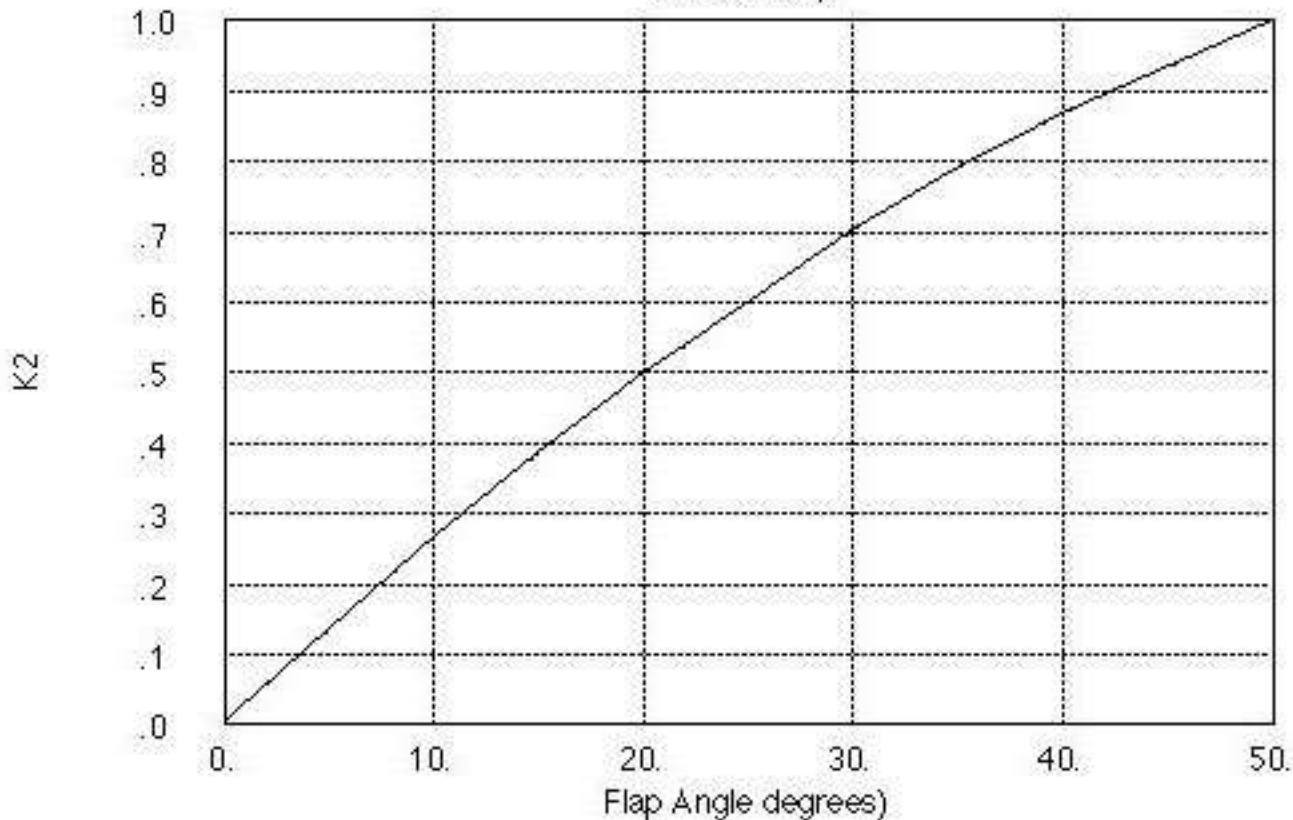

Figure 10. Flap Motion Correction Factor

$K(\text{sweep})$ is an empirically-derived sweep-correction factor. It may be estimated from:

$$K = (1 - 0.08 \cdot \cos^2(\text{Sweep})) \cos^{3/4}(\text{Sweep})$$

Effect of Mach Number

The formation of shocks produces significant changes in the airfoil pressure distribution and limits the maximum lift coefficient. In fact, a strong correlation exists between the $C_{L_{\max}}$ of a slat and the C_1 at which flow near the slat becomes supersonic. In general, as the freestream Mach number is increased, the aircraft $C_{L_{\max}}$ is reduced. The figure below shows this effect for the DC-9-30.

Estimated Effect of Mach Number on C_{Lmax}

Tail-Off 1-g Estimates from Flight Test

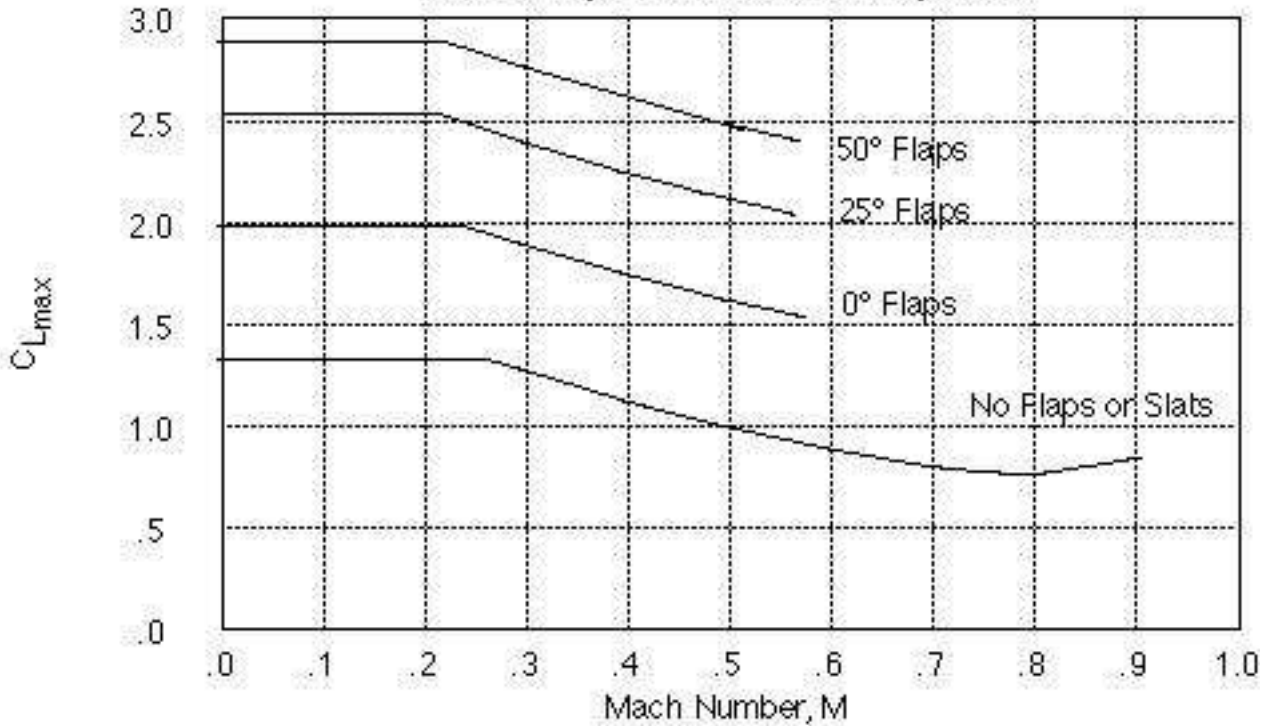

Figure 11. Effect of Mach number on maximum lift.

As a first approximation this data can be used to estimate the effect for another aircraft as follows:

$$C_{Lmax}(M) = C_{Lmax_l.s.} * C_{Lmax_ref}(M') / C_{Lmax_l.s.ref}$$

Where:

$C_{Lmax_l.s.}$ is the C_{Lmax} at low speed (Mach number < 0.3)

and M' = Modified Mach number based on equivalent normal Mach = $M * \cos(\text{sweep}) / \cos(\text{DC-9 sweep})$, where the DC-9, which provides the reference data here, has a sweep of 24.5 deg.

The final figures show the approximate C_{Lmax} values for a number of aircraft.

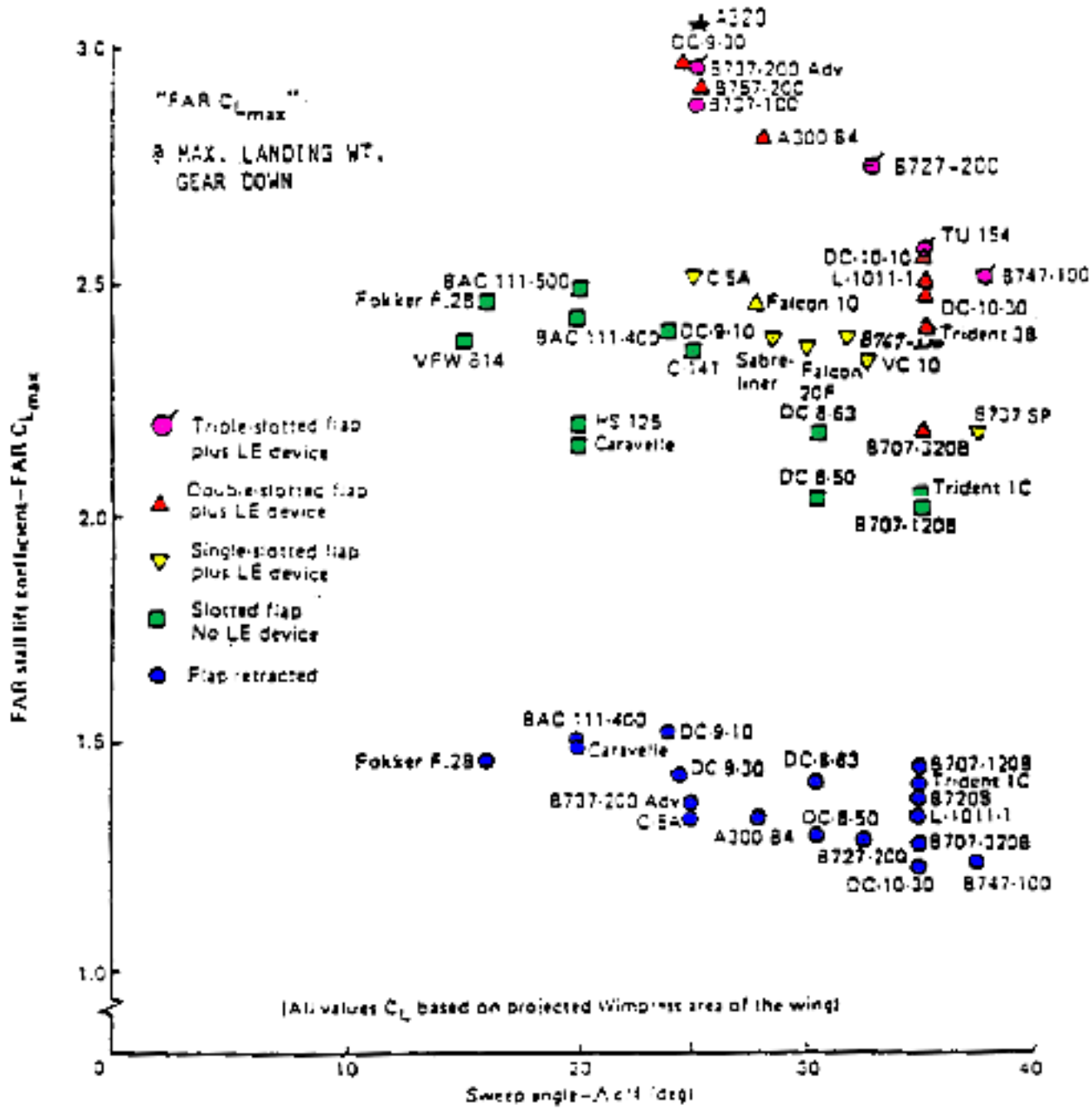
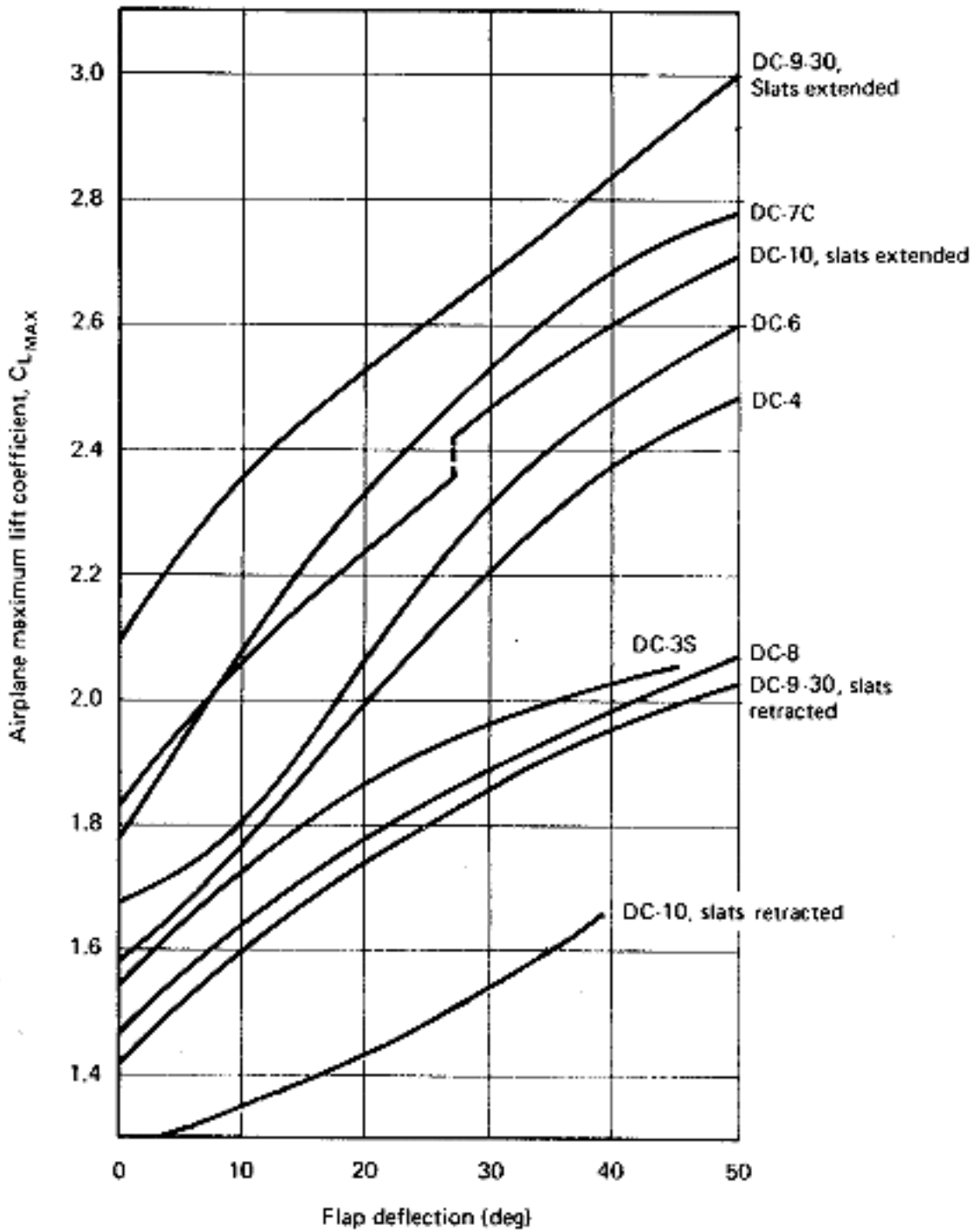

Figure 12. C_{Lmax} Values for a variety of transport aircraft.



Airplane	S_{wf} / S_{ref}	Flap Type	Flap Chord Ratio	Sweep (deg)
DC-3S	0.575	Split	0.174	10
DC-4	0.560	Single Slot	0.257	0
DC-6	0.589	Double Slot	0.266	0
DC-7C	0.630	Double Slot	0.266	0
DC-8	0.587	Double Slot	0.288	30.5
DC-9-30	0.590	Double Slot	0.360	24.5

DC-10-10	0.542	Double Slot	0.320	35
----------	-------	-------------	-------	----

Figure 13. Effect of Flap and Slat Deflections on C_{Lmax} for several Douglas airplanes. The results are based on the FAA measured stall speeds and reflect the 1 kt/sec deceleration.

Low Aspect Ratio Wings at High Angles of Attack



At high angles of attack, several phenomena usually distinct from the cruise flow appear. Usually part of the wing begins to stall (separation occurs and the lift over that section is reduced). An approximate way to predict when this will occur on well-designed high aspect ratio wings is to look at the C_l distribution over the wing and determine the wing C_L at which some section (the critical section) reaches its 2-D maximum C_l .

When the sweep is very large, or aspect ratio low, this approach does not work. Separation tends to occur near the leading edge of the wing, but unlike in the low sweep situation, the separated region is not large and does not reduce the lift. Instead, the flow rolls up into a vortex that lies just above the wing surface.



Attached Flow



Flow with Leading Edge Vortices

Rather than reducing the lift of the wing, the leading edge vortices, increase the wing lift in a nonlinear manner. The vortex can be viewed as reducing the upper surface pressures by inducing higher velocities on the upper surface.

The net result can be large as seen on the plot here.

75° Delta, $M = 0$.

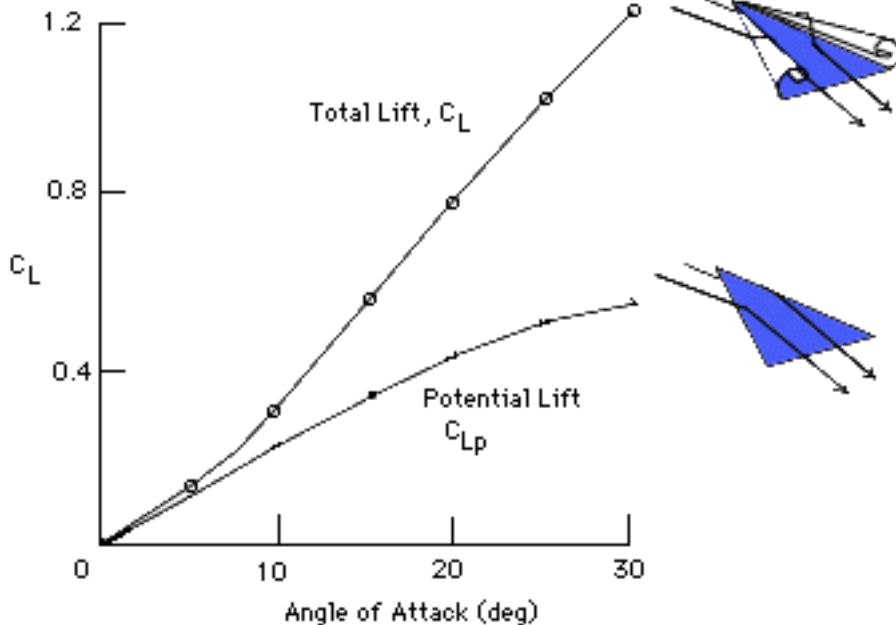

The effect can be predicted quantitatively by computing the motion of the separated vortices using a nonlinear panel code or an Euler or Navier-Stokes solver.

This figure shows computations from an unsteady non-linear panel method. Wakes are shed from leading and trailing edges and allowed to roll-up with the local flow field. Results are quite good for thin wings until the vortices become unstable and "burst" - a phenomenon that is not well predicted by these methods. Even these simple methods are computation-intensive.

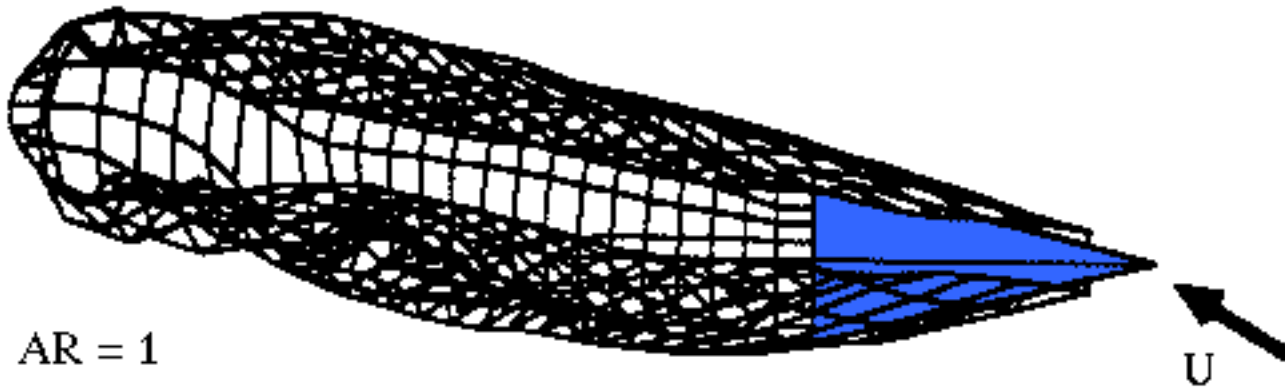

$$AR = 1$$

$$\alpha = 21^\circ \quad \beta = 10^\circ$$

Polhamus Suction Analogy

A simple method of estimating the so-called "vortex lift" was given by Polhamus in 1971. The Polhamus suction analogy states that the extra normal force that is produced by a highly swept wing at high angles of attack is equal to the loss of leading edge suction associated with the separated flow. The figure below shows how, according to this idea, the leading edge suction force present in attached flow (upper figure) is transformed to a lifting force when the flow separates and forms a leading edge vortex (lower figure).

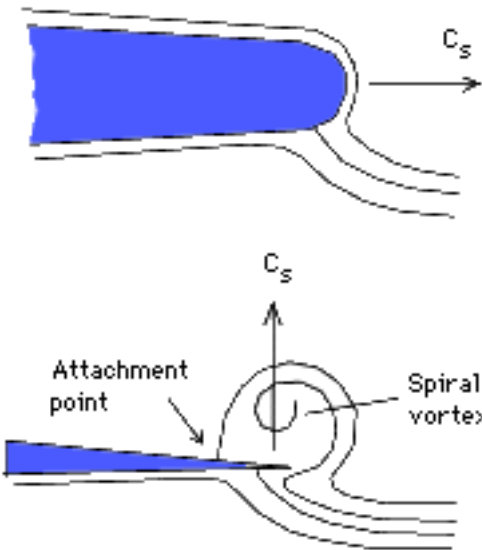

The suction force includes a component of force in the drag direction. This component is the difference between the no-suction drag:

$$C_{D_i} = C_n \sin \alpha, \text{ and the full-suction drag: } C_L^2 / \pi AR$$

where α is the angle of attack.

The total suction force coefficient, C_s , is then:

$$C_s = (C_n \sin \alpha - C_L^2 / \pi AR) / \cos \Lambda$$

where Λ is the leading edge sweep angle. If this acts as an additional normal force then:

$$C_n' = C_n + (C_n \sin \alpha - C_L^2 / \pi AR) / \cos \Lambda$$

and in attached flow:

$$C_L = C_{L_a} \sin \alpha \text{ with } C_n = C_L \cos \alpha$$

$$\begin{aligned} \text{Thus, } C_n' &= C_L \cos \alpha + (C_L \cos \alpha \sin \alpha - C_L^2 / \pi AR) / \cos \Lambda \\ &= C_{L_a} \sin \alpha \cos \alpha + (C_{L_a} \sin \alpha \cos \alpha \sin \alpha - (C_{L_a} \sin \alpha)^2 / \pi AR) / \cos \Lambda \\ &= C_{L_a} \sin \alpha \cos \alpha + C_{L_a} / \cos \Lambda \sin^2 \alpha \cos \alpha - C_{L_a}^2 / (\pi AR \cos \Lambda) \sin^2 \alpha \end{aligned}$$

$$\begin{aligned} C_L' &= C_{L_a} [\sin \alpha \cos^2 \alpha + \sin^2 \alpha \cos^2 \alpha / \cos \Lambda - C_{L_a} / (\pi AR \cos \Lambda) \cos \alpha \sin^2 \alpha] \\ &= C_{L_a} \sin \alpha \cos \alpha (\cos \alpha + \sin \alpha \cos \alpha / \cos \Lambda - C_{L_a} \sin \alpha / (\pi AR \cos \Lambda)) \end{aligned}$$

If we take the low aspect ratio result: $C_{L_a} = \pi AR/2$, then:

$$C_L' = \pi AR/2 \sin \alpha \cos \alpha (\cos \alpha + \sin \alpha \cos \alpha / \cos \Lambda - \sin \alpha / (2 \cos \Lambda))$$

Cross-Flow Drag Analogy

An even simpler method of computing the nonlinear lift is to use the cross-flow drag analogy. The idea is to add the drag force that would be associated with the normal component of the freestream velocity and resolve it in the lift direction. The increment in lift is then simply: $\Delta C_L = C_{D_x} \sin^2 \alpha \cos \alpha$.

The plot below shows each of these computations compared with experiment for a 80° delta wing (AR = 0.705). In these calculations a cross-flow drag coefficient of 2.0 was used.

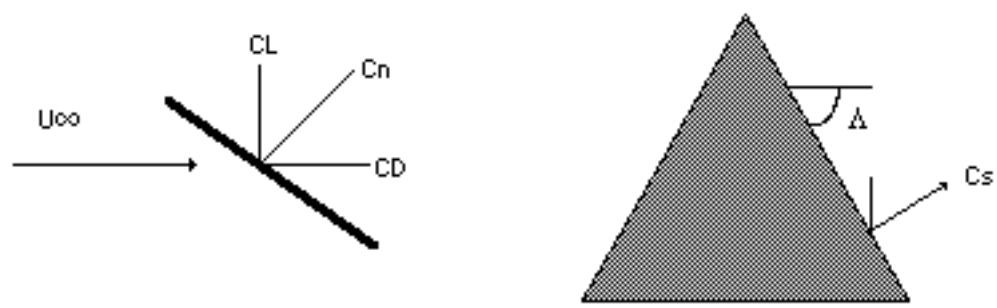

Nonlinear Lift of Delta Wing

AR = .705

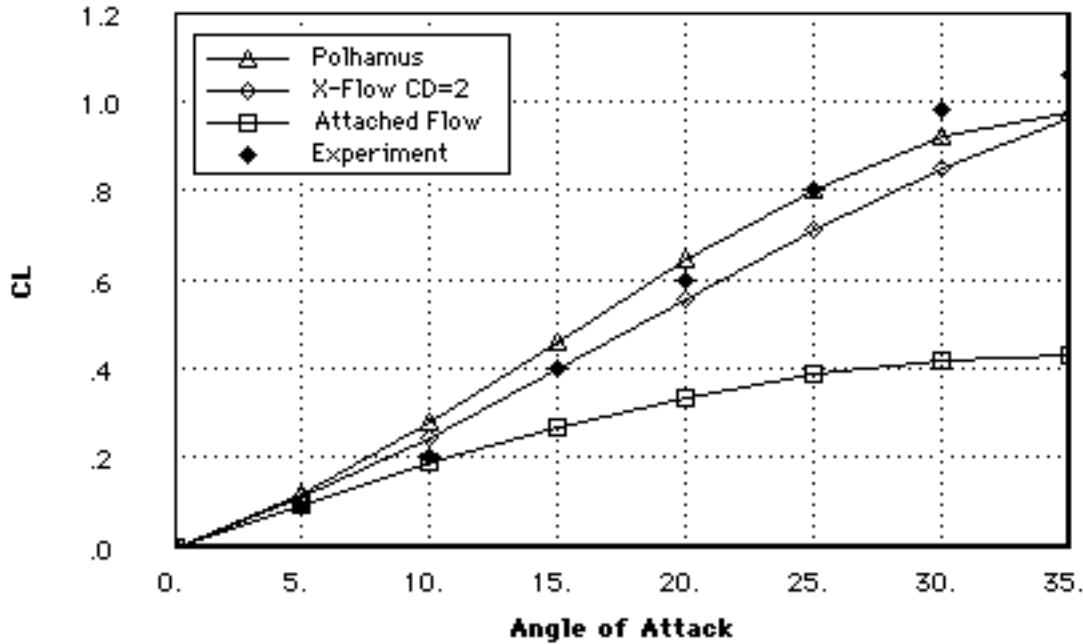

Another case with much higher aspect ratio is shown below. Note that the very simple model seems to do nearly as well as the more involved suction analogy.

Nonlinear Lift Predictions

60 deg Delta (AR 2.3)

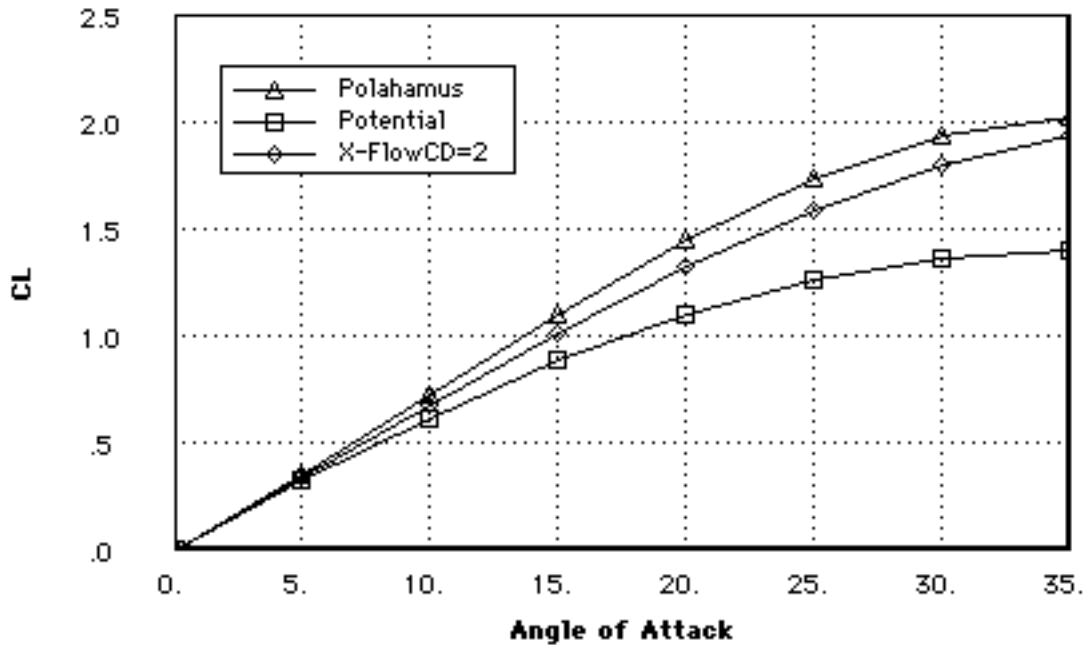

The maximum lift of a low aspect ratio wing is significantly increased by the presence of these vortices and is limited either by vortex bursting or by allowable angle of attack. Vortex bursting is a phenomenon

in which the structured character of the vortex is destroyed resulting in a loss of most of the vortex lift. It occurs due to adverse pressure gradients acting on the vortex. When the vortex burst occurs on the wing (as opposed to downstream of the wing) the lift drops substantially. Although there are some empirical methods for predicting vortex burst, the phenomenon is quite complex and difficult to predict accurately. For many SST designs, however, the maximum C_L may be predicted by assuming that the vortex does not burst at the maximum permissible angle of attack. Because of the length of the fuselage, this angle may be restricted to a value of 10-13 degrees. Using this value in the above expression for C_L leads to a reasonable estimate for maximum lift on such designs.

A flow pattern, similar to that of the highly swept delta wing, is found at the tips of low aspect ratio wings and over fuselages. The vortex formation significantly increases the lift in these cases as well. Especially in the case of fuselage vortices, the airplane stability is affected. Interaction with downstream surfaces is often important, but hard to predict. Computations of lift at a specified angle using the cross-flow drag analogy can easily include the component associated with fuselage lift as well.

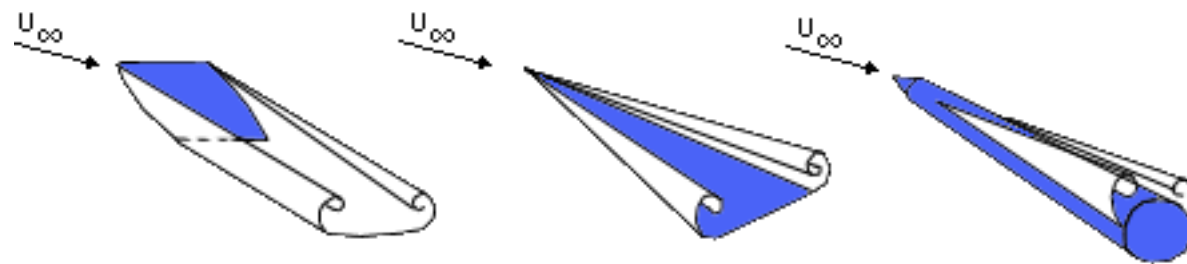

Flaps are often not used on SST designs due to difficulties with longitudinal trim. Designs with tail surfaces or canards can employ some flaps, increasing the effective α limit by 2-3 degrees. Clearly, conventional slats do not help these designs as they produce little change in C_L at a given angle of attack. However, studies have shown that some types of leading edge vortex flaps, intended to strengthen the leading edge vortices can be used to further increase the maximum usable C_L .

Wing-Body Maximum CL

The program computes wing $C_{L_{max}}$ using the methods described in this chapter, and based on data for the current wing and fuselage. Before running this program, be sure that you have entered the wing and fuselage geometry parameters on pages such as the Wing Analysis page, Airfoil Design page, and the Fuselage layout pages. Alternatively an entire input set may be entered in the data summary page of the appendix. The plot shows the variation in $C_{L_{max}}$ with flap deflection with a slat deflection of 0 deg and 20 deg.

Laminar Airfoil Design

Laminar flow may be useful for reducing skin friction drag, increasing maximum lift, or reducing heat transfer. It may be achieved without too much work at low Reynolds numbers by maintaining a smooth surface and using an airfoil with a favorable pressure gradient. The section below shows how the pressures may be tailored to achieve long runs of laminar flow on upper and/or lower surfaces.

Again, the Stratford-like pressure recovery is helpful in achieving the maximum run of favorable gradient on either upper or lower surfaces.

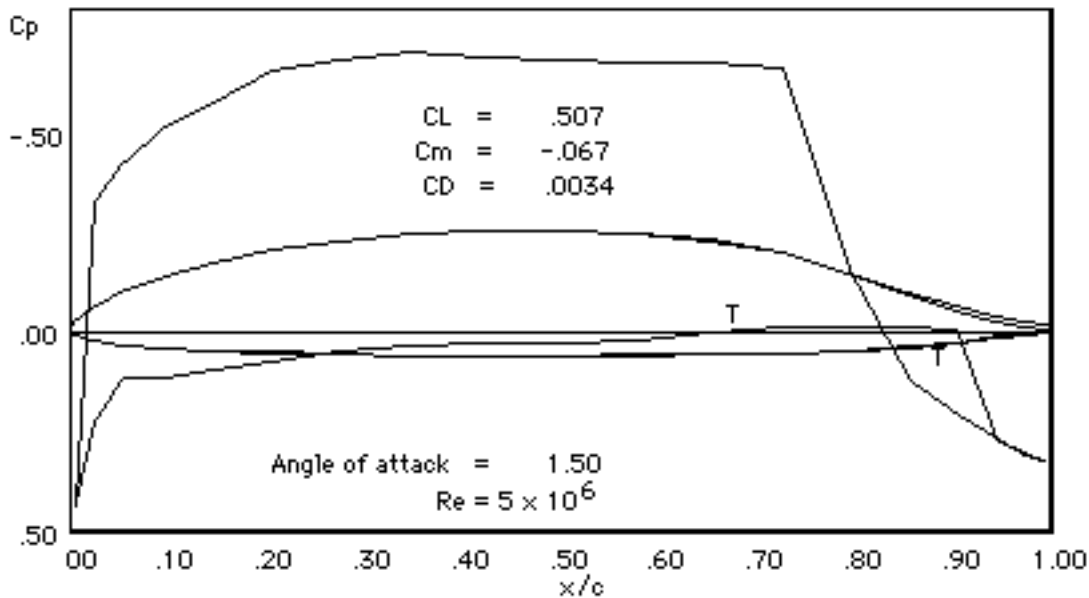

Transonic Airfoil Design

The transonic airfoil design problem arises because we wish to limit shock drag losses at a given transonic speed. This effectively limits the minimum pressure coefficient that can be tolerated. Since both lift and thickness reduce (increase in magnitude) the minimum C_p , the transonic design problem is to create an airfoil section with high lift and/or thickness without causing strong shock waves. One can generally tolerate some supersonic flow without drag increase, so that most sections can operate efficiently as "supercritical airfoils". A rule of thumb is that the maximum local Mach numbers should not exceed about 1.2 to 1.3 on a well-designed supercritical airfoil. This produces a considerable increase in available C_l compared with entirely subcritical designs.

Supercritical sections usually refer to a special type of airfoil that is designed to operate efficiently with substantial regions of supersonic flow. Such sections often take advantage of many of the following design ideas to maximize lift or thickness at a given Mach number:

- Carry as much lift as is practical on the aft portion of the section where the flow is subsonic. The aft lower surface is an obvious candidate for increased loading (more positive C_p), although several considerations discussed below limit the extent to which this approach can be used.
- Make sure that sufficient lift is carried on the forward portion of the upper surface. As the Mach number increases, the pressure peak near the nose is diminished and without additional blunting of the nose, possible extra lift will be lost in this region.
- The lower surface near the nose can also be loaded by reducing the lower surface thickness near the leading edge. This provides both lift and positive pitching moment.
- Shocks on the upper surface near the leading edge produce much less wave drag than shocks aft of the airfoil crest and it is feasible, although not always best, to design sections with forward shocks. Such sections are known as "peaky" airfoils and were used on many transport aircraft.
- The idea of carefully tailoring the section to obtain locally supersonic flow without shockwaves (shock-free sections) has been pursued for many years, and such sections have been designed and tested. For most practical cases with a range of design CL and Mach number, sections with weak shocks are favored.

One must be cautious with supercritical airfoil design. Several of these sections have looked promising initially, but led to problems when actually incorporated into an aircraft design. Typical difficulties include the following.

- Too much aft loading can produce large negative pitching moments with trim drag and structural weight penalties.
- The adverse pressure gradient on the aft lower surface can produce separation in extreme cases.

- The thin trailing edge may be difficult to manufacture.
- Supercritical, and especially shock-free designs often are very sensitive to Mach and C_L and may perform poorly at off-design conditions. The appearance of "drag creep" is quite common, a situation in which substantial section drag increase with Mach number occurs even at speeds below the design value.

The section with pressures shown below is typical of a modern supercritical section with a weak shock at its design condition. Note the rooftop C_p design with the minimum C_p considerably greater above C_p^* .

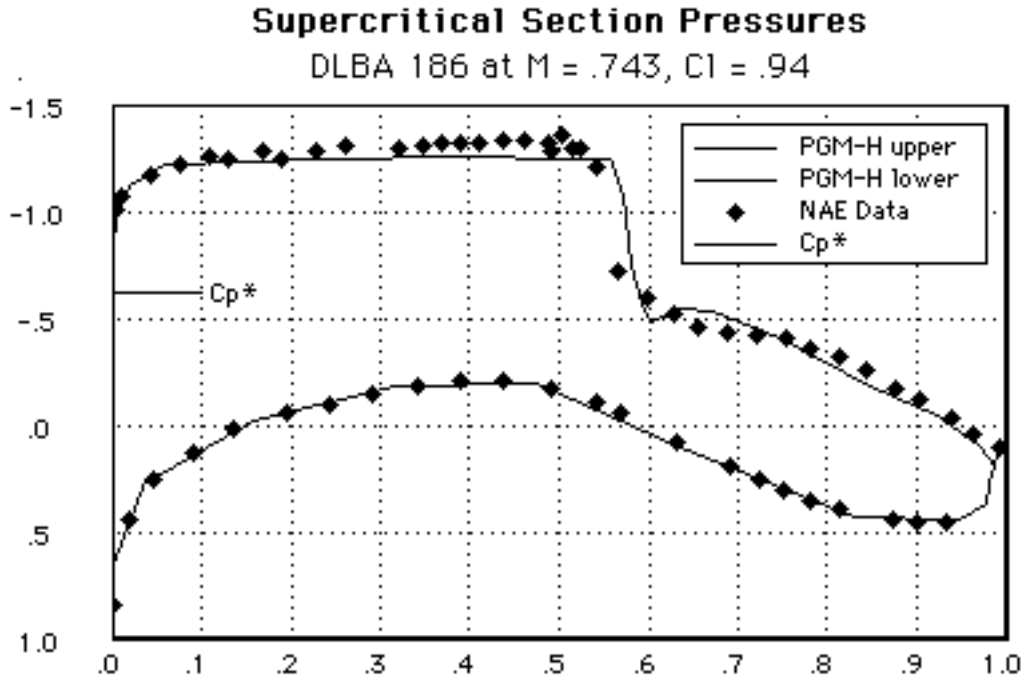

Low Reynolds Number Airfoil Design

Low Reynolds numbers make the problem of airfoil design difficult because the boundary layer is much less capable of handling an adverse pressure gradient without separation. Thus, very low Reynolds number designs do not have severe pressure gradients and the maximum lift capability is restricted.

Low Reynolds number airfoil designs are cursed with the problem of too much laminar flow. It is sometimes difficult to assure that the boundary layer is turbulent over the steepest pressure recovery regions. Laminar separation bubbles are common and unless properly stabilized can lead to excessive drag and low maximum lift.

At very low Reynolds numbers, most or all of the boundary layer is laminar. Under such conditions the boundary layer can handle only gradual pressure recovery. Based on the expressions for laminar separation, one finds that an all-laminar section can generate a C_L of about 0.4 or achieve a thickness of about 7.5%, (Try this with PANDA.)

Low Moment Airfoil Design

When the airfoil pitching moment is constrained, it is not always possible to carry lift as far back on the airfoil as desired. Such situations arise in the design of sections for tailless aircraft, helicopter rotor blades, and even sails, kites, and giant pterosaurs. The airfoil shown here is a Liebeck section designed to perform well at low Reynolds numbers with a positive C_{m0} . Its performance is not bad, but it is clearly inferior in C_{lmax} when compared to other sections without a C_m constraint. ($C_{lmax} = 1.35$ vs. 1.60 for conventional sections at $Re = 500,000$.)

The thickest section at $Re = 10$ million is 57% thick, but of course, it will separate suddenly with any angle of attack.

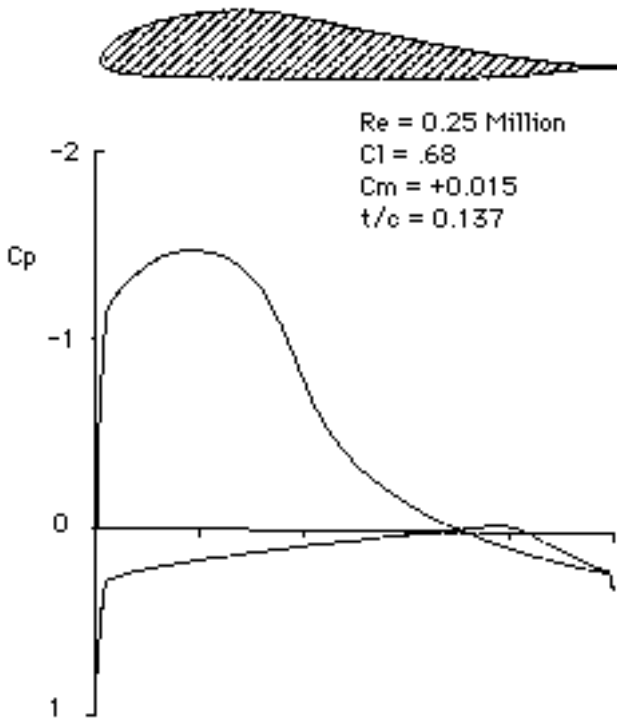

Multiple Design Point Airfoils

One of the difficulties in designing a good airfoil is the requirement for acceptable off-design performance. While a very low drag section is not too hard to design, it may separate at angles of attack slightly away from its design point. Airfoils with high lift capability may perform very poorly at lower angles of attack.

One can approach the design of airfoil sections with multiple design points in a well-defined way. Often it is clear that the upper surface will be critical at one of the points and we can design the upper surface at this condition. The lower surface can then be designed to make the section behave properly at the second point. Similarly, constraints such as C_{mo} are most effected by airfoil trailing edge geometry.

When such a compromise is not possible, variable geometry can be employed (at some expense) as in the case of high lift systems.

Interactive Airfoil Design

This page lets you select and modify a family of airfoils to suit the specific needs of your aircraft. Specify the section t/c and type (0 is a conventional peaky section, 1 is a rather aggressive supercritical section). The resulting pressure distribution is shown below. The parameter x_t/c lets you force transition to turbulent flow at the indicated chordwise position. Setting $x_t/c = 1.0$ corresponds to free transition while setting it to a small value such as 0.05 forces mostly turbulent flow.

Hints: Change angle of attack by either entering a value or by clicking on the angle of attack displayed on the plot. Holding down shift while clicking reduces alpha. You may also change scale by clicking on the C_p axis labels. Also note that you may modify the airfoil shape by clicking on the upper or lower surface to add thickness near the point where you have clicked. Hold down the shift key while clicking to remove thickness. The boundary layer computations indicate transition to turbulent flow (T), laminar separation (LS), or turbulent separation (TS). If you change parameters, click recompute to enter these values, but note that the airfoil is regenerated as well based on the specified section type and t/c .

Wing Design



There are essentially two approaches to wing design. In the direct approach, one finds the planform and twist that minimize some combination of structural weight, drag, and CL_{max} constraints. The other approach involves selecting a desirable lift distribution and then computing the twist, taper, and thickness distributions that are required to achieve this distribution. The latter approach is generally used to obtain analytic solutions and insight into the important aspects of the design problem, but is difficult to incorporate certain constraints and off-design considerations in this approach. The direct method, often combined with numerical optimization is often used in the latter stages of wing design, with the starting point established from simple (even analytic) results.

This chapter deals with some of the considerations involved in wing design, including the selection of basic sizing parameters and more detailed design. The chapter begins with a general discussion of the goals and trade-offs associated with wing design and the initial sizing problem, illustrating the complexities associated with the selection of several basic parameters. Each parameter affects drag and structural weight as well as stalling characteristics, fuel volume, off-design performance, and many other important characteristics.

Wing lift distributions play a key role in wing design. The lift distribution is directly related to the wing geometry and determines such wing performance characteristics as induced drag, structural weight, and stalling characteristics. The determination of a reasonable lift and Cl distribution, combined with a way of relating the wing twist to this distribution provides a good starting point for a wing design. Subsequent analysis of this baseline design will quickly show what might be changed in the original design to avoid problems such as high induced drag or large variations in Cl at off-design conditions.

A description of more detailed methods for modern wing design with examples is followed by a brief discussion of nonplanar wings and winglets.

- [Wing Geometry Definitions](#)
- [Wing Design Parameters](#)

- [Lift Distributions](#)
- [Wing Aerodynamic Design in More Detail](#)
- [Nonplanar Wings and Winglets](#)
- [Wing Layout Issues](#)
- [Wing Analysis Program](#)

Wing Geometry Definitions

The wing geometry may be specified in several ways. This section defines a few commonly used terms and how to compute them.

Wing Areas

The definition of wing area is not obvious and different companies define the areas differently. Here, we always take the reference wing area to be that of the trapezoidal portion of the wing projected into the centerline. The leading and trailing edge chord extensions are not included in this definition and for some airplanes, such as Boeing's Blended Wing Body, the difference can be almost a factor of two between the "real" wing area and the "trap area". Some companies use reference wing areas that include portions of the chord extensions, and in some studies, even tail area is included as part of the reference area. For simplicity, we use the trapezoidal area in this text.

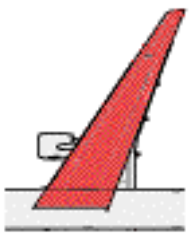

Reference Wing Area

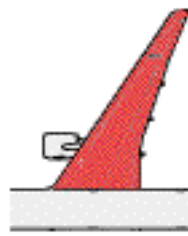

Exposed Wing Area

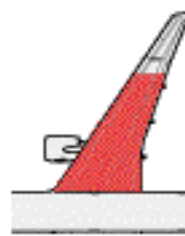

Area Affected by Flaps

In addition to the reference area, we use the exposed planform area depicted above in the calculation of skin friction drag and the wetted area which is a bit more than twice the exposed planform area.

Wing Span and Aspect Ratio

Of all the parameters that might be defined without a footnote, span seems to be the most unambiguous; however, even this is not so clear. The small effect of wing bending on the geometric span can become very measurable when the wing includes winglets. We ignore the differences here, but suggest that a reference span should be measured on the ground with a prescribed fuel load since this is the only condition in which it may be conveniently verified.

Aspect ratio is often used in place of the dimensional span in many of the aerodynamic equations of interest. Aspect ratio, or AR, is roughly the ratio of span to average wing chord. It may be computed by: $AR = b^2 / S_{ref}$. It is important that the same definition of reference area be used in the definition of aspect

ratio as is used in the definition of coefficients such as C_L and C_D .

Reference Lengths

Various wing reference lengths are used in aerodynamic computations. One of the most important of these is the mean aerodynamic chord, or M.A.C.. The M.A.C. is the chord-weighted average chord length of the wing, defined as:

$$\text{M.A.C.} \equiv \frac{2}{S} \int_0^{b/2} c^2 dy$$

For a linearly tapered (trapezoidal) wing, this integral is equal to:

$$\text{M.A.C.} = 2/3 (C_{\text{root}} + C_{\text{tip}} - C_{\text{root}} C_{\text{tip}} / (C_{\text{root}} + C_{\text{tip}}))$$

For wings with chord extensions, the MAC may be computed by evaluating the MAC of each linearly-tapered portion then taking an average, weighted by the area of each portion. In many cases, however, the MAC of the reference trapezoidal wing is used.

The M.A.C. is often used in the nondimensionalization of pitching moments. The M.A.C. of just the exposed area is also used to compute the reference length for calculation of Reynolds number as part of the wing drag estimation. The M.A.C. is chosen instead of the simpler mean geometric chord for quantities whose values are weighted more strongly by local chord that is reflected by their contribution to the area.

Wing Design Parameters

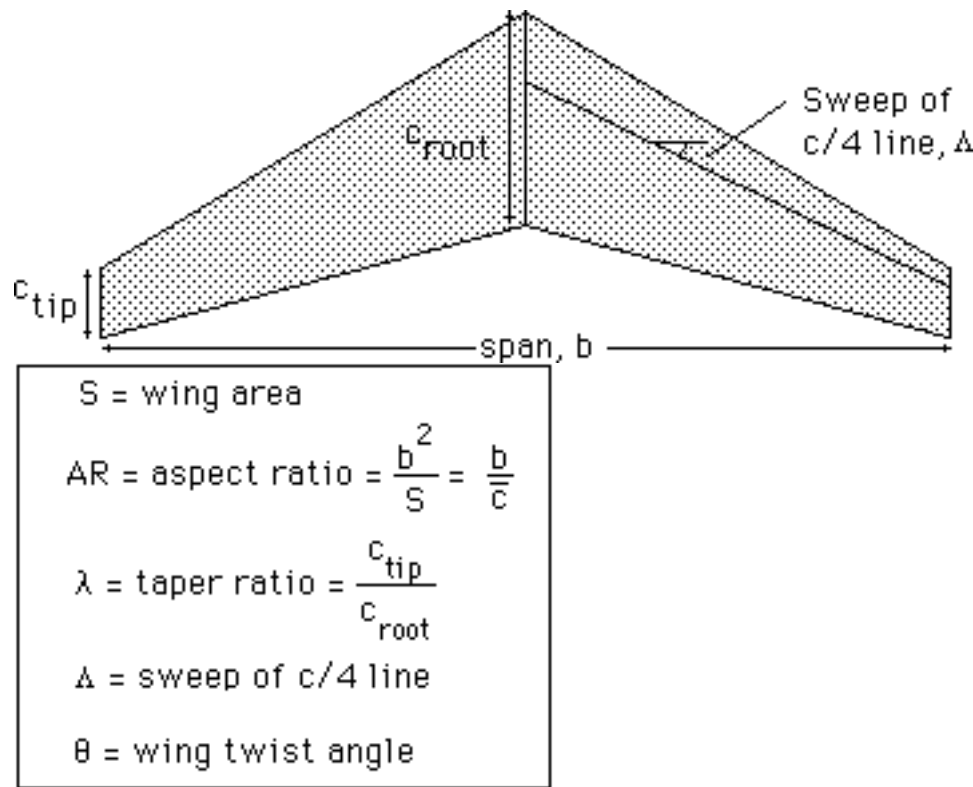

Span

Selecting the wing span is one of the most basic decisions to be made in the design of a wing. The span is sometimes constrained by contest rules, hangar size, or ground facilities but when it is not we might decide to use the largest span consistent with structural dynamic constraints (flutter). This would reduce the induced drag directly.

However, as the span is increased, the wing structural weight also increases and at some point the weight increase offsets the induced drag savings. This point is rarely reached, though, for several reasons.

1. The optimum is quite flat and one must stretch the span a great deal to reach the actual optimum.
2. Concerns about wing bending as it affects stability and flutter margin as span is increased.
3. The cost of the wing itself increases as the structural weight increases. This must be included so that we do not spend 10% more on the wing in order to save .001% in fuel consumption.
4. The volume of the wing in which fuel can be stored is reduced.

5. It is more difficult to locate the main landing gear at the root of the wing.
6. The Reynolds number of wing sections is reduced, increasing parasite drag and reducing maximum lift capability.

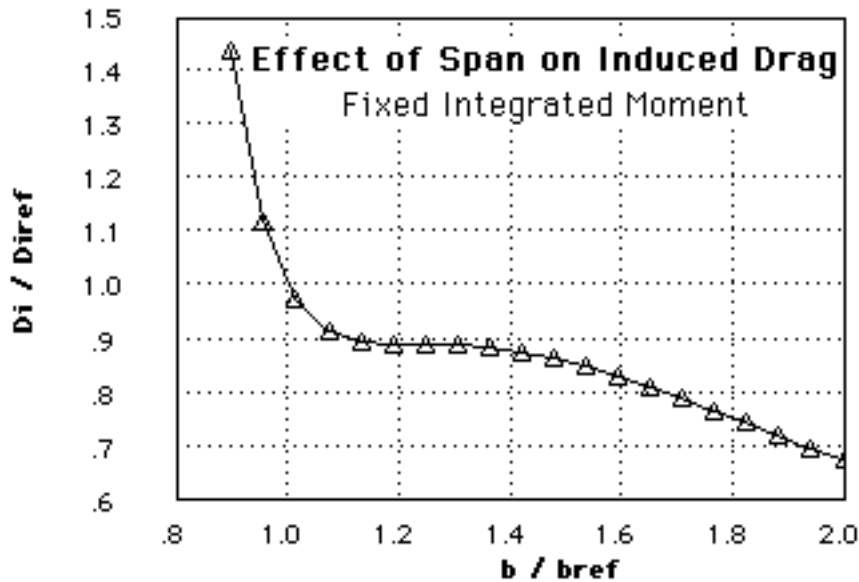

On the other hand, span sometimes has a much greater benefit than one might predict based on an analysis of cruise drag. When an aircraft is constrained by a second segment climb requirement, extra span may help a great deal as the induced drag can be 70-80% of the total drag.

The selection of optimum wing span thus requires an analysis of much more than just cruise drag and structural weight. Once a reasonable choice has been made on the basis of all of these considerations, however, the sensitivities to changes in span can be assessed.

Area

The wing area, like the span, is chosen based on a wide variety of considerations including:

1. Cruise drag
2. Stalling speed / field length requirements
3. Wing structural weight
4. Fuel volume

These considerations often lead to a wing with the smallest area allowed by the constraints. But this is not always true; sometimes the wing area must be increased to obtain a reasonable CL at the selected

cruise conditions.

Selecting cruise conditions is also an integral part of the wing design process. It should not be dictated a priori because the wing design parameters will be strongly affected by the selection, and an appropriate selection cannot be made without knowing some of these parameters. But the wing designer does not have complete freedom to choose these, either. Cruise altitude affects the fuselage structural design and the engine performance as well as the aircraft aerodynamics. The best CL for the wing is not the best for the aircraft as a whole. An example of this is seen by considering a fixed CL, fixed Mach design. If we fly higher, the wing area must be increased by the wing drag is nearly constant. The fuselage drag decreases, though; so we can minimize drag by flying very high with very large wings. This is not feasible because of considerations such as engine performance.

Sweep

Wing sweep is chosen almost exclusively for its desirable effect on transonic wave drag. (Sometimes for other reasons such as a c.g. problem or to move winglets back for greater directional stability.)

1. It permits higher cruise Mach number, or greater thickness or CL at a given Mach number without drag divergence.
2. It increases the additional loading at the tip and causes spanwise boundary layer flow, exacerbating the problem of tip stall and either reducing CLmax or increasing the required taper ratio for good stall.

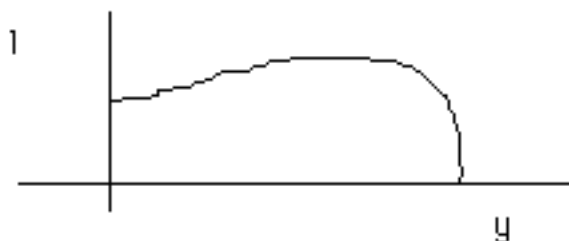

3. It increases the structural weight - both because of the increased tip loading, and because of the increased structural span.

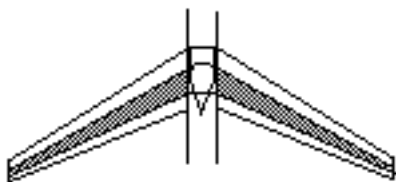

4. It stabilizes the wing aeroelastically but is destabilizing to the airplane.
5. Too much sweep makes it difficult to accommodate the main gear in the wing.

Much of the effect of sweep varies as the cosine of the sweep angle, making forward and aft-swept wings similar. There are important differences, though in other characteristics.

Thickness

The distribution of thickness from wing root to tip is selected as follows:

1. We would like to make the t/c as large as possible to reduce wing weight (thereby permitting larger span, for example).
2. Greater t/c tends to increase CL_{max} up to a point, depending on the high lift system, but gains above about 12% are small if there at all.
3. Greater t/c increases fuel volume and wing stiffness.
4. Increasing t/c increases drag slightly by increasing the velocities and the adversity of the pressure gradients.
5. The main trouble with thick airfoils at high speeds is the transonic drag rise which limits the speed and CL at which the airplane may fly efficiently.

Taper

The wing taper ratio (or in general, the planform shape) is determined from the following considerations:

1. The planform shape should not give rise to an additional lift distribution that is so far from elliptical that the required twist for low cruise drag results in large off-design penalties.
2. The chord distribution should be such that with the cruise lift distribution, the distribution of lift coefficient is compatible with the section performance. Avoid high Cl 's which may lead to buffet or drag rise or separation.
3. The chord distribution should produce an additional load distribution which is compatible with the high lift system and desired stalling characteristics.
4. Lower taper ratios lead to lower wing weight.
5. Lower taper ratios result in increased fuel volume.
6. The tip chord should not be too small as Reynolds number effects cause reduced Cl capability.
7. Larger root chords more easily accommodate landing gear.

Here, again, a diverse set of considerations are important.

The major design goal is to keep the taper ratio as small as possible (to keep the wing weight down) without excessive Cl variation or unacceptable stalling characteristics.

Since the lift distribution is nearly elliptical, the chord distribution should be nearly elliptical for uniform Cl 's. Reduced lift or t/c outboard would permit lower taper ratios.

Evaluating the stalling characteristics is not so easy. In the low speed configuration we must know something about the high lift system: the flap type, span, and deflections. The flaps- retracted stalling characteristics are also important, however (DC-10).

Twist

The wing twist distribution is perhaps the least controversial design parameter to be selected. The twist must be chosen so that the cruise drag is not excessive. Extra washout helps the stalling characteristics and improves the induced drag at higher Cl 's for wings with additional load distributions too highly weighted at the tips.

Twist also changes the structural weight by modifying the moment distribution over the wing.

Twist on swept-back wings also produces a positive pitching moment which has a small effect on trimmed drag. The selection of wing twist is therefore accomplished by examining the trades between cruise drag, drag in second segment climb, and the wing structural weight. The selected washout is then just a bit higher to improve stall.

Wing Lift Distributions

As in the design of airfoil sections, it is easier to relate the wing geometry to its performance through the intermediary of the lift distribution. Wing design often proceeds by selecting a desirable wing lift distribution and then finding the geometry that achieves this distribution.

In this section, we describe the lift and lift coefficient distributions, and relate these to the wing geometry and performance.

- [About Wing Lift and \$C_l\$ Distributions](#)
- [Relating Wing Geometry and Lift Distribution](#)
- [Lift Distributions and Performance](#)

About Lift and Cl Distributions

The distribution of lift on the wing affects the wing performance in many ways. The lift per unit length $l(y)$ may be plotted from the wing root to the tip as shown below.

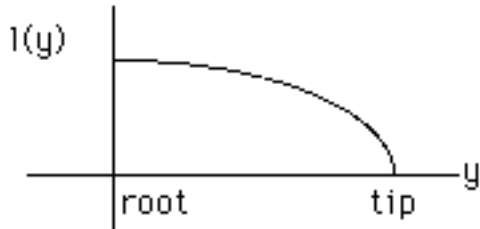

In this case the distribution is roughly elliptical. In general, the lift goes to zero at the wing tip. The area under the curve is the total lift.

The section lift coefficient is related to the section lift by: $C_l(y) = \frac{l(y)}{q c(y)}$

So that if we know the lift distribution and the planform shape, we can find the Cl distribution.

The lift and lift coefficient distributions are directly related by the chord distribution. Here are some examples:

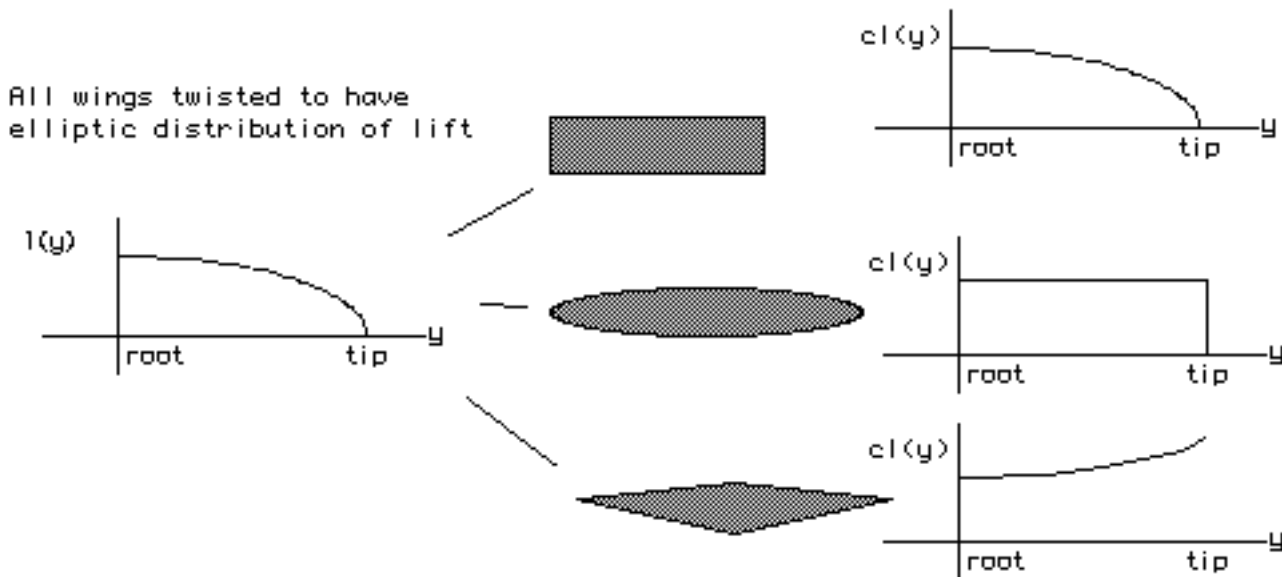

The lift and Cl distributions can be divided into so-called basic and additional lift distributions. This division allows one to examine the lift distributions at a couple of angles of attack and to infer the lift distribution at all other angles. This is especially useful in the process of wing design.

The distribution of lift can be written:

$$l = C_L l_a + \theta l_b$$

Here, the distributions $\{l_a\}$ and $\{l_b\}$ are the wing lift distributions with no twist at $CL = 1$ and with unit twist at zero lift respectively. The first term, $CL \{l_a\}$, is called the additional lift. It is the lift distribution that is added by increasing the total wing lift. $\theta \{l_b\}$ is called the basic lift distribution and is the lift distribution at zero lift.

Why is this useful? Consider the following example.

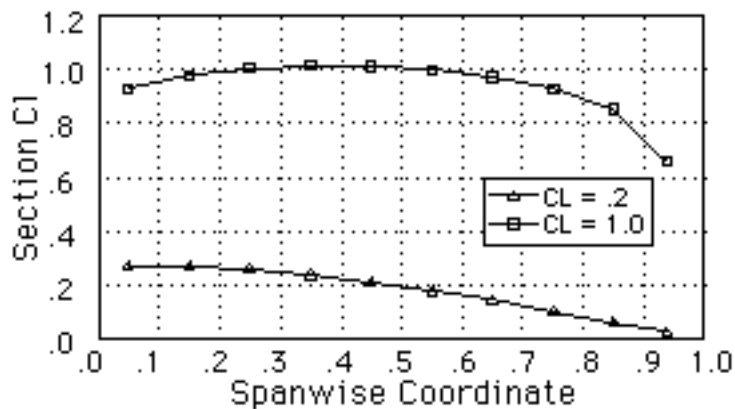

We can use the data at these two angles of attack to learn a great deal about the wing.

From the expression above:

$$\{l_a\} = (\{l_{C_L = 1}\} - \{l_{C_L = 0.2}\}) / 0.8$$

or:

$$\{C_l\} = C_L \{C_{l_a}\} + \theta \{C_{l_b}\}$$

The additional lift distribution, $CL \{l_a\}$ may be interpreted graphically as shown below.

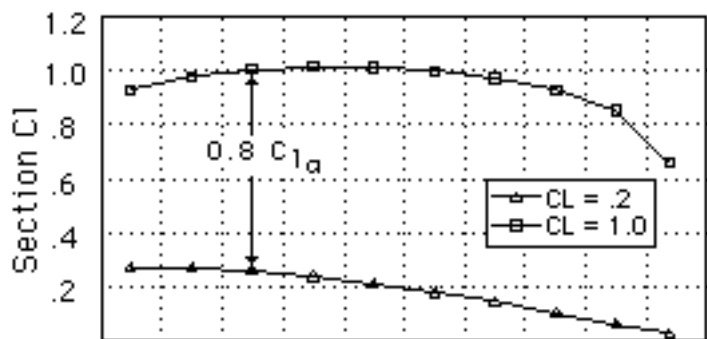

The additional lift coefficient distribution at $CL = 1.0$ is plotted below. Note that it rises upward toward the tip -- this is indicative of a wing with a very low taper ratio or a wing with sweep-back.

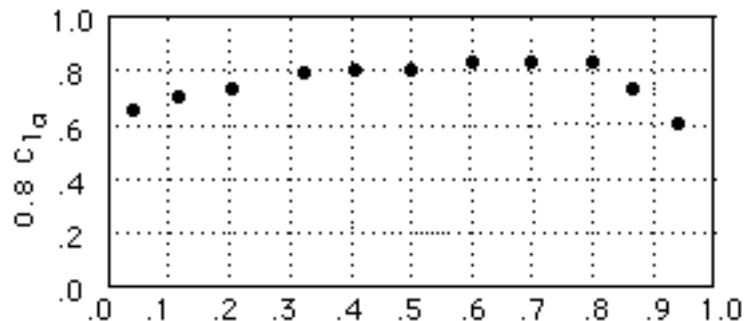

The basic lift distribution is negative near the tip implying that the wing has washout.

Wing Geometry and Lift Distributions

The wing geometry affects the wing lift and C_l distributions in mostly intuitive ways. Increasing the taper ratio (making the tip chords larger) produces more lift at the tips, just as one might expect:

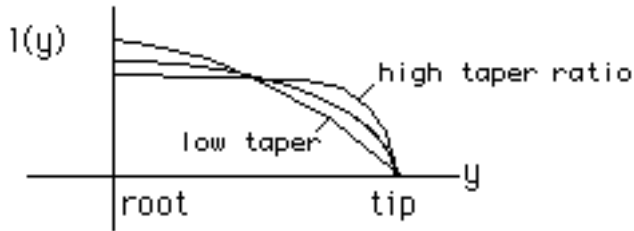

But because the section C_l is the lift divided by the local chord, taper has a very different effect on the C_l distribution.

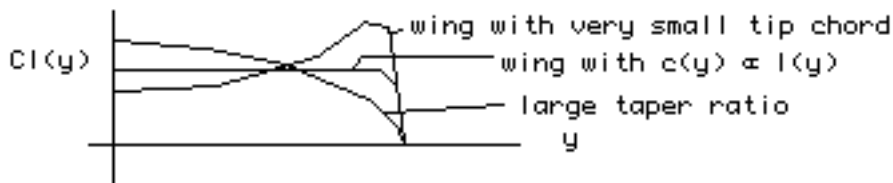

Changing the wing twist changes the lift and C_l distributions as well. Increasing the tip incidence with respect to the root is called wash-in. Wings often have less incidence at the tip than the root (wash-out) to reduce structural weight and improve stalling characteristics.

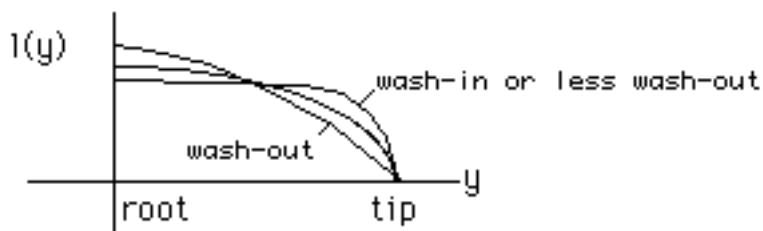

Since changing the wing twist does not affect the chord distribution, the effect on lift and C_l is similar.

Wing sweep produces a less intuitive change in the lift distribution of a wing. Because the downwash velocity induced by the wing wake depends on the sweep, the lift distribution is affected. The result is an increase in the lift near the tip of a swept-back wing and a decrease near the root (as compared with an unswept wing).

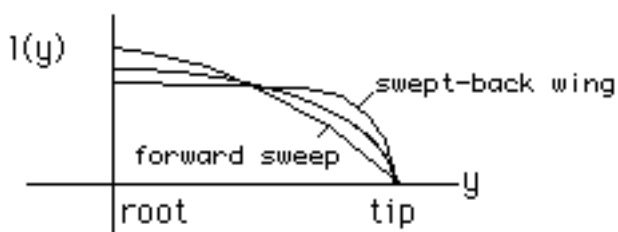

This effect can be quite large and causes problems for swept-back wings. The greater tip lift increases structural loads and can lead to stalling problems.

The effect of increasing wing aspect ratio is to increase the lift at a given angle of attack as we saw from the discussion of lifting line theory. But it also changes the shape of the wing lift distribution by magnifying the effects of all other parameters.

Low aspect ratio wings have nearly elliptic distributions of lift for a wide range of taper ratios and sweep angles. It takes a great deal of twist to change the distribution. Very high aspect ratio wings are quite sensitive, however and it is quite easy to depart from elliptic loading by picking a twist or taper ratio that is not quite right.

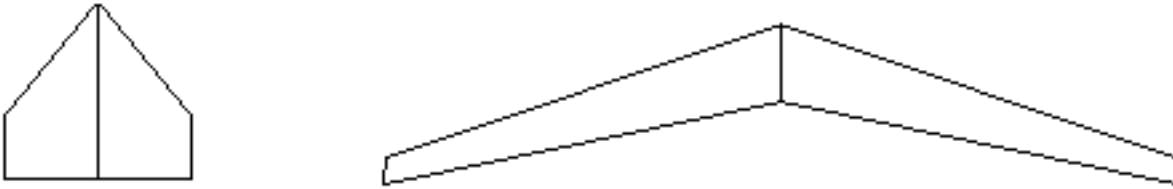

Note that many of these effects are similar and by combining the right twist and taper and sweep, we can achieve desirable distributions of lift and lift coefficient.

For example: Although a swept back wing tends to have extra lift at the wing tips, wash-out tends to lower the tip lift. Thus, a swept back wing with washout can have the same lift distribution as an unswept wing without twist.

Lowering the taper ratio can also cancel the influence of sweep on the lift distribution. However, then the C_l distribution is different.

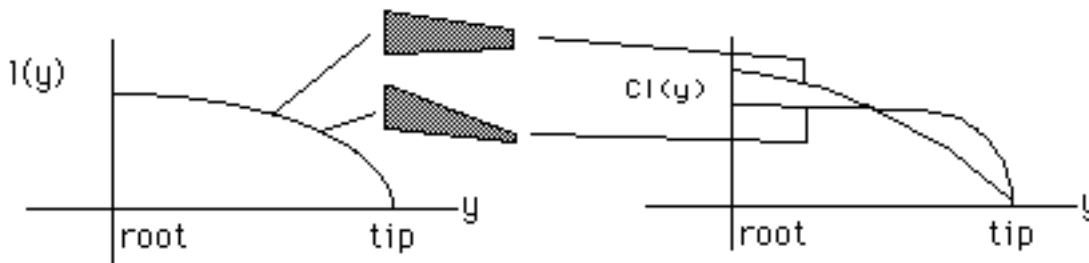

Today, we can relate the wing geometry to the lift and C_l distributions very quickly by means of rapid computational methods. Yet, this more intuitive understanding of the impact of wing parameters on the distributions remains an important skill. A Java-based wing analysis program is available at the end of this chapter.

Lift Distributions and Performance

Wing design has several goals related to the wing performance and lift distribution. One would like to have a distribution of $Cl(y)$ that is relatively flat so that the airfoil sections in one area are not "working too hard" while others are at low Cl . In such a case, the airfoils with Cl much higher than the average will likely develop shocks sooner or will start stalling prematurely.

The induced drag depends solely on the lift distribution, so one would like to achieve a nearly elliptical distribution of section lift. On the other hand structural weight is affected by the lift distribution also so that the ideal shape depends on the relative importance of induced drag and wing weight.

With taper, sweep, and twist to "play with", these goals can be easily achieved at a given design point. The difficulty appears when the wing must perform well over a range of conditions.

One of the more interesting tradeoffs that is often required in the design of a wing is that between drag and structural weight. This may be done in several ways. Some problems that have been solved include:

- Minimum induced drag with given span -- Prandtl
- Minimum induced drag with given root bending moment -- Jones, Lamar, and others
- Minimum induced drag with fixed wing weight and constant thickness -- Prandtl, Jones
- Minimum induced drag with given wing weight and specified thickness-to-chord ratio -- Ward, McGeer, Kroo
- Minimum total drag with given wing span and planform -- Kuhlman

... there are many problems of this sort left to solve and many approaches to the solution of such problems. These include some closed-form analytic results, analytic results together with iteration, and finally numerical optimization.

The best wing design will depend on the construction materials, the arrangement of the high-lift devices, the flight conditions (CL , Re , M) and the relative importance of drag and weight. All of this is just to say that it is difficult to design just a wing without designing the entire airplane. If we were just given the job of minimizing cruise drag the wing would have a very high aspect ratio. If we add a constraint on the wing's structural weight based on a trade-off between cost and fuel savings then the problem is somewhat better posed but we would still select a wing with very small taper ratio. High t/c and high sweep are often suggested by studies that include only weight and drag.

The high lift characteristics of the design force the taper ratio and sweep to more usual values and therefore must be a fundamental consideration at the early stages of wing design. Unfortunately the estimation of CL_{max} is one of the more difficult parts of the preliminary design process. An example of this sensitivity is shown in the figure below.

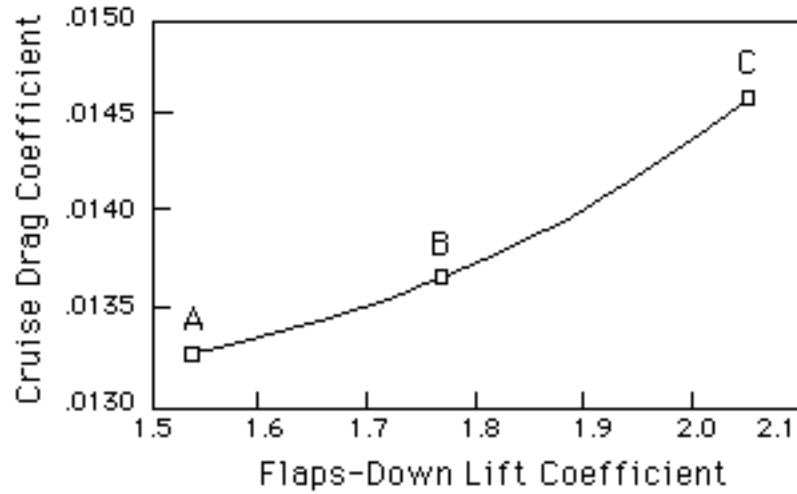
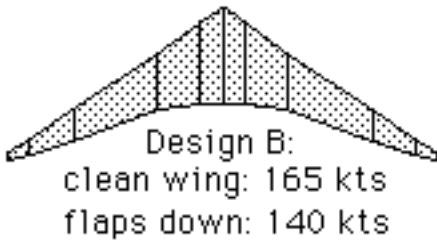

The effect of a high lift constraint on optimal wing designs. Wing sweep, area, span, and twist, chord, and t/c distributions were optimized for minimum drag with a structural weight constraint. (Results from work of Sean Wakayama.)

Wing Design in More Detail

The determination of a reasonable lift and C_l distribution, combined with a way of relating the wing twist to this distribution provides a good starting point for a wing design. Subsequent analysis of this baseline design will quickly show what might be changed in the original design to avoid problems such as high induced drag or large variations in C_l at off-design conditions.

Once the basic wing design parameters have been selected, more detailed design is undertaken. This may involve some of the following:

- Computation or selection of a desired span load distribution, then inverse computation of required twist.
- Selection of desired section C_p distribution at several stations along the span and inverse design of camber and/or thickness distribution.
- All-at-once multivariable optimization of the wing for desired performance.

Some examples of these approaches are illustrated below.

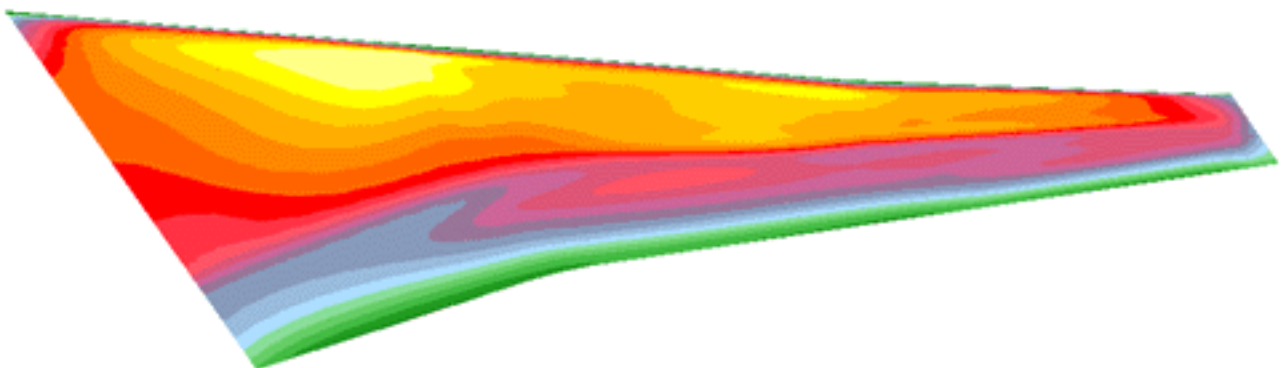
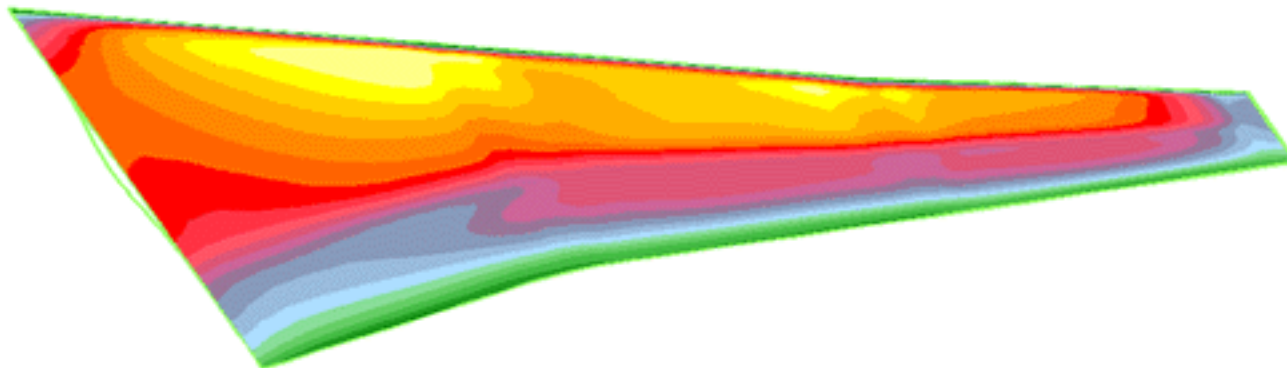
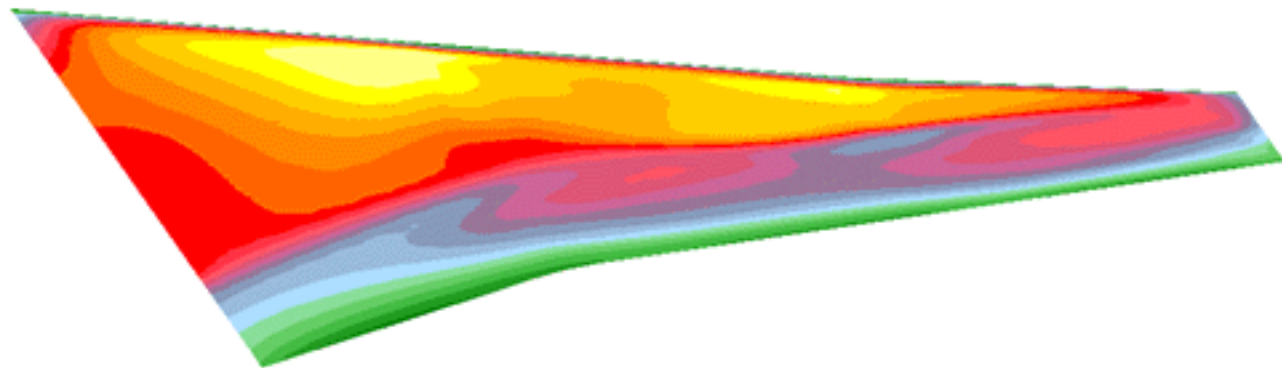

This figure illustrates inverse wing design using the DISC (direct iterative surface curvature) method. The starting pressures are shown (top), followed by the target (middle), and design (bottom); light yellow = low pressure and green = high pressure. This is an inverse technique that has been used very successfully with Navier-Stokes computations to design wings in transonic, viscous flows.

Below is an example of wing design based on "fixing" a span load distribution. When the 737 was re-engined with high bypass ratio turbofans, a drag penalty was avoided by changing the effective wing twist distribution.

737-300 Flaps 15° Wing Spanload

Paneling—Flaps 15° Configuration

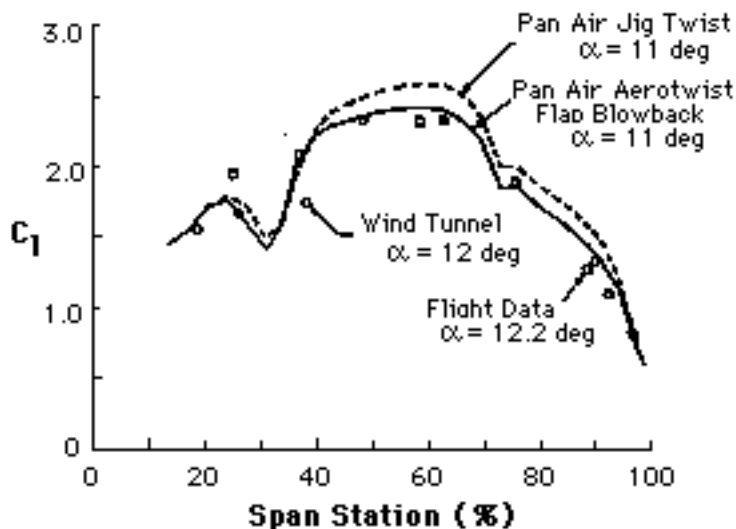
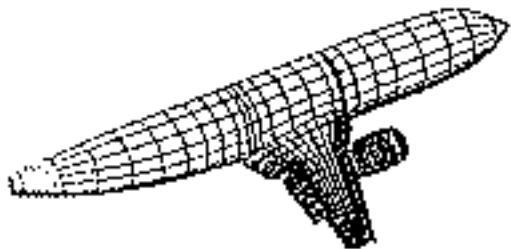

The details of the pressure distribution can then be used to modify the camber shape or wing thickness for best performance. This sounds straightforward, but it is often very difficult to accomplish this, especially when it takes hours or days to examine the effect of the proposed change. This is why simple methods with fast turnaround times are still used in the wing design process.

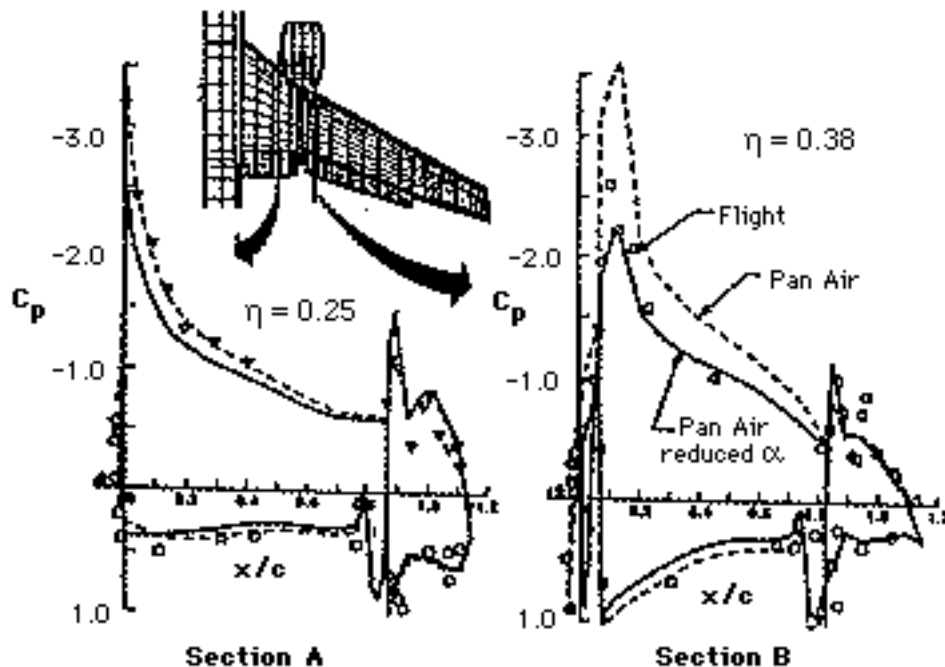

As computers become faster, it becomes more feasible to do full 3-D optimization. One of the early efforts in applying optimization and nonlinear CFD to wing design is described by Cosentino and Holst, *J. of Aircraft*, 1986.

In this problem, a few spline points at several stations on the wing were allowed to move and the optimizer tried to maximize L/D.

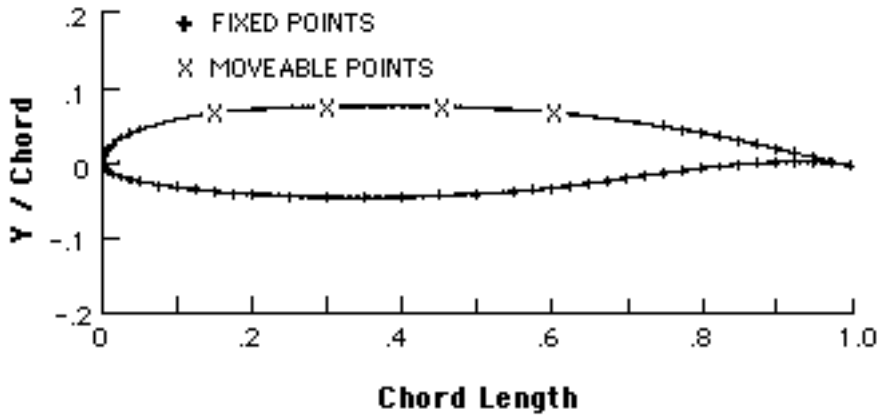
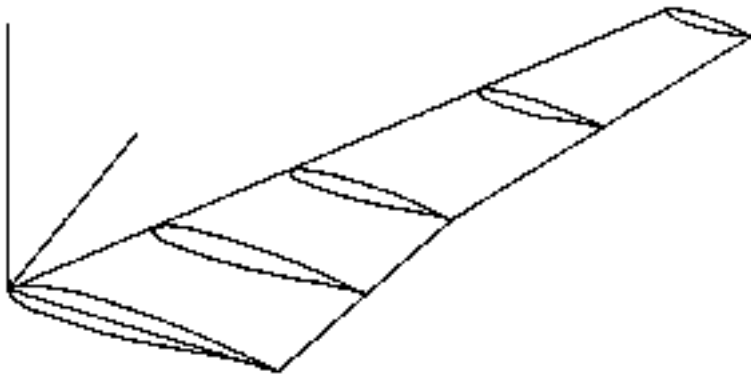

Although this was an inviscid code, the design variables were limited, and the objective function simplistic, current research has included more realistic objectives, more design degrees of freedom, and better analysis codes.

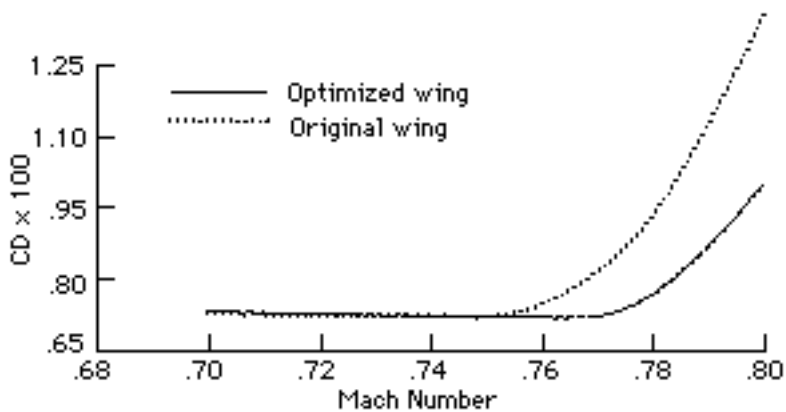
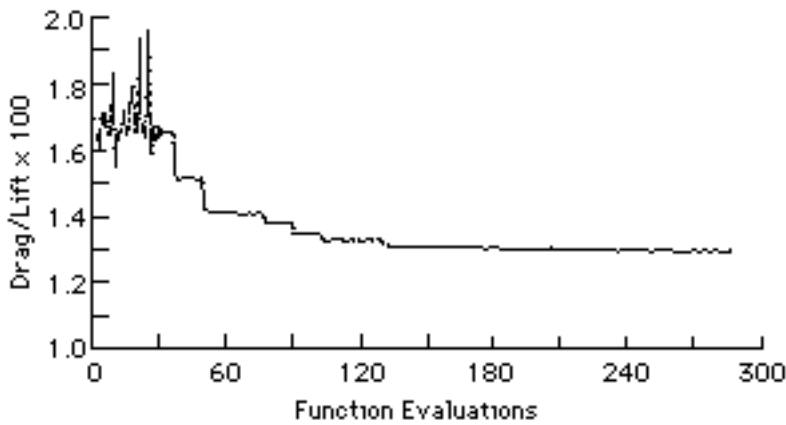

--but we are still a long way from having "wings designed by computer."

Nonplanar Wings and Winglets

One often begins the wing design problem by specifying a target C_p distribution and/or span loading and then modifying the wing geometry (either manually, by direct inverse, or by nonlinear optimization). In the case of planar wings, the elliptic loading results provide a useful benchmark in the creation of target loadings. (For high aspect ratio wings, 2D airfoil results may provide a useful reference for the chordwise loading.)

More complex methods for creating target C_p 's are beyond the scope of this discussion, but we have little guidance at all when the wing is nonplanar.

This section deals with the problem of optimal loading for nonplanar lifting surfaces. It is easily generalized to multiple surfaces.

When the wing is not planar, many of the previous simple results are no longer valid. Elliptic loading does not lead to minimum drag and the span efficiency can be greater than 1.0.

Here we will describe a method for computing the minimum induced drag for planar and nonplanar wings. First, consider the distribution of downwash for minimum drag. This can be obtained by using the method of restricted variations as follows.

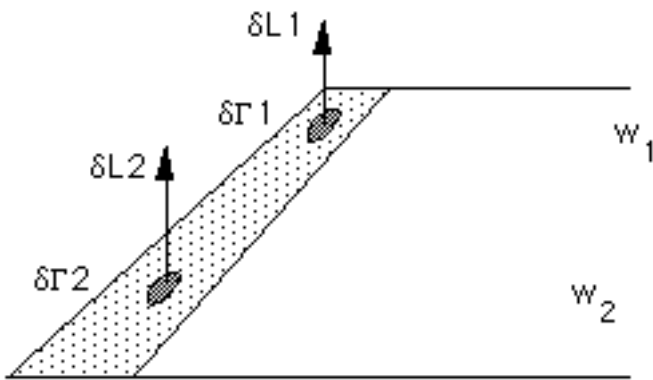

We consider an arbitrary variation in the circulation distribution represented by $\delta\Gamma_1$ and $\delta\Gamma_2$ which do not change the lift:

$$\delta L = \rho U_\infty \delta\Gamma_1 + \rho U_\infty \delta\Gamma_2 = 0$$

This implies: $\delta\Gamma_1 = -\delta\Gamma_2$

If the drag was minimized by the initial distribution:

$$\delta D = \rho/2 w_1 \delta\Gamma_1 + \rho/2 w_2 \delta\Gamma_2 = 0$$

So, $w_1 = w_2$

That is, the downwash is constant behind a planar wing with minimum drag.

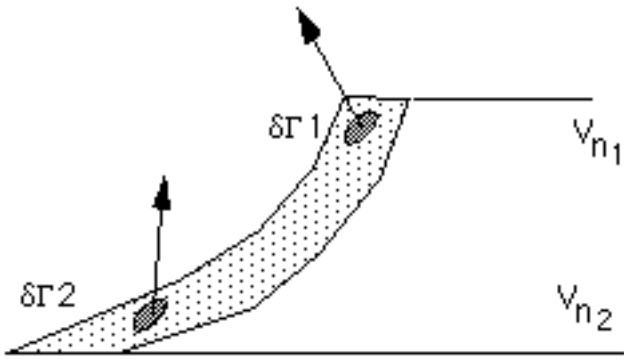

In the general case, with multiple surfaces or nonplanar wings, the same approach may be used. In this case, the condition for constant lift is:

$$\delta L = \rho U_{\infty} \delta \Gamma_1 \cos \theta_1 + \rho U_{\infty} \delta \Gamma_2 \cos \theta_2 = 0$$

where theta is the local dihedral angle of the lifting surface.

For minimum drag:

$$\delta D = \rho/2 V_{n1} \delta \Gamma_1 + \rho/2 V_{n2} \delta \Gamma_2 = 0$$

where V_n is the induced velocity in the Trefftz plane in a direction normal to the wake sheet (the normalwash).

In this case,
$$\delta \Gamma_1 \cos \theta_1 = - \delta \Gamma_2 \cos \theta_2$$

so, $V_n = k \cos \theta$.

The normalwash is proportional to the local dihedral angle. Thus, the sidewash on optimally-loaded winglets is 0, for example.

We may then solve for the distribution of circulation that produces this distribution of normalwash.

Alternatively, one may use a more direct optimization approach. With the circulation distribution represented as the row vector, $\{\Gamma\}$ and the wake modeled as a collection of line vortices of strength $\{\Gamma_w\}$, we may write the wake vorticity in terms of the surface circulation, based on a discrete vortex model as shown below.

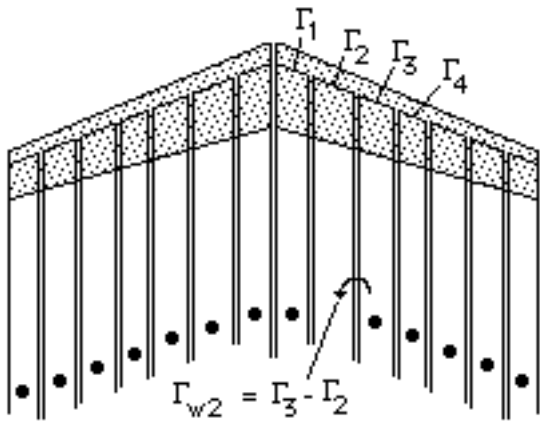

The drag is then given by: $D = \rho/2 \{V_n\} \cdot \{\Gamma\}$

where V_n is the normal wash in the Trefftz plane computed using the Biot Savart law.

$\{V_n\}$ is related to the circulation strengths by:

$$\{V_n\} = [VIC] \{\Gamma\}$$

where [VIC] is a function of the geometry.

$$\text{So, } D = \rho/2 [VIC] \{\Gamma\} \cdot \{\Gamma\}$$

The lift is also a function of the circulations:

$$L = \rho U \{\Gamma\} \cdot \{\cos \theta\}$$

with theta the local dihedral angle.

Finally, the optimal values of $\{\Gamma\}$ are given by setting

$$(D + \lambda(L - L_{ref})) \Gamma_i = 0 \text{ where } \lambda \text{ is a Lagrange multiplier.}$$

This problem is sometimes done as homework, but some results are summarized below:

- When the wing/winglet combination is optimized for minimum drag at fixed span, it achieves about the same drag as a planar wing with a span increased by about 45% of the winglet height.
- The wing lift distribution is as shown below with increased lift outboard compared with the no winglet case.

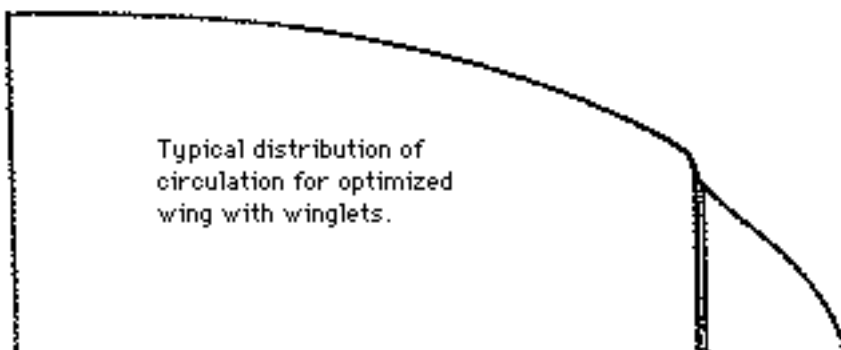

This increased tip loading along with the extra bending moment of the winglet leads to increased

structural weight. When a bending moment constraint replaces the span constraint, wings with winglets are seen to have about the same minimum drag as the stretched-span planar wings. This is shown below.

Induced drag of wings with winglets and planar wings all with the same integrated bending moment (related to structural weight). Note that solutions to the left of the span ratio = 1.0 line are not meaningful.

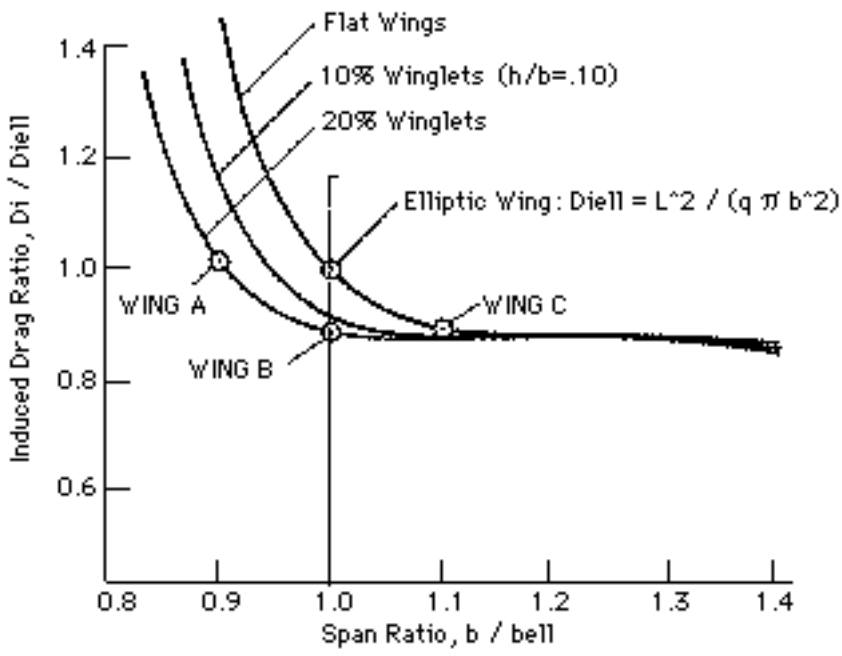

The same approach may be taken for general nonplanar wake shapes. The figure below summarizes some of these results, showing the maximum span efficiency for nonplanar wings of various shapes with a height to span ration of 0.2.

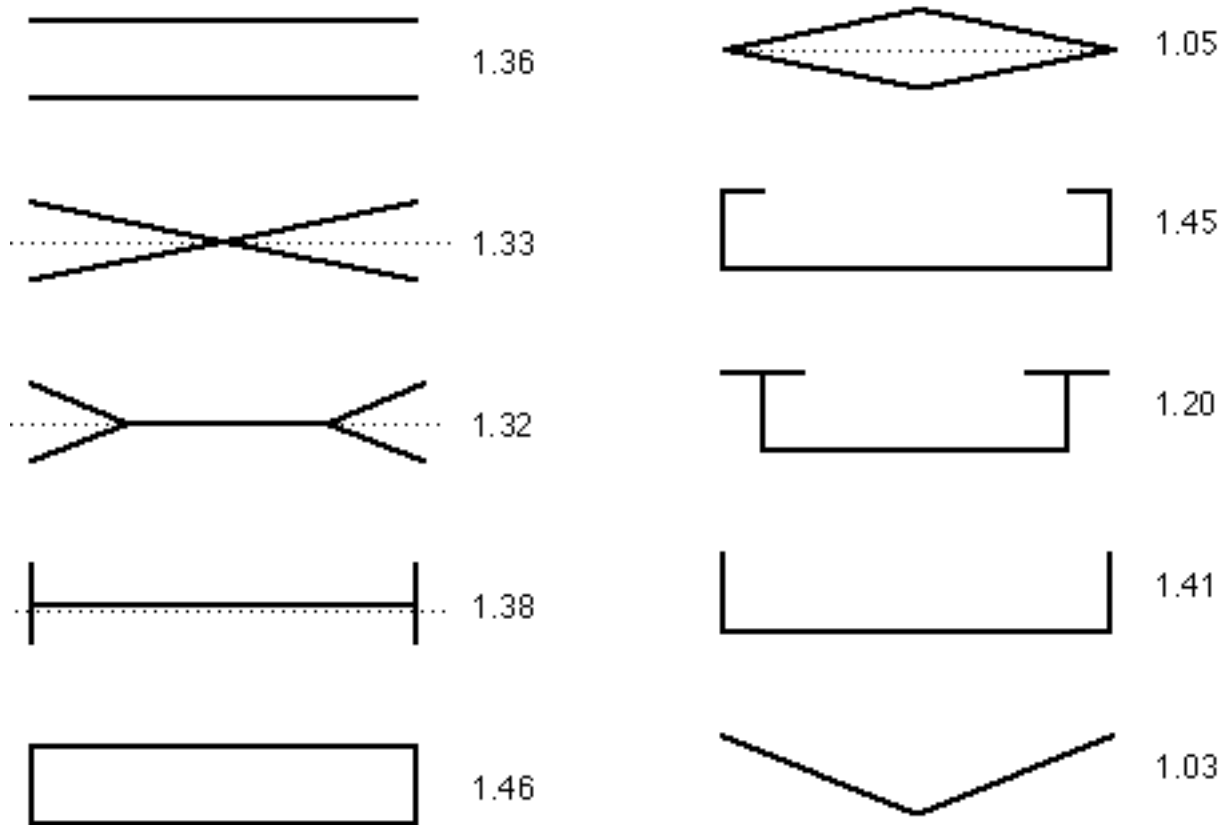

Several points should be made about the preceding results.

1. The result that the sidewash on the winglet (in the Trefftz plane) is zero for minimum induced drag means that the self-induced drag of the winglet just cancels the winglet thrust associated with wing sidewash. Optimally-loaded winglets thus reduce induced drag by lowering the average downwash on the wing, not by providing a thrust component.
2. The results shown here deal with the inviscid flow over nonplanar wings. There is a slight difference in optimal loading in the viscous case due to lift-dependent viscous drag. Moreover, for planar wings, the ideal chord distribution is achieved with each section at its maximum C_l/C_d and the inviscid optimal lift distribution. For nonplanar wings this is no longer the case and the optimal chord and load distribution for minimum drag is a bit more complex.
3. Other considerations of primary importance include:
 - Stability and control
 - Structures
 - Other pragmatic issues

More details on the design of nonplanar wings may be found in a recent paper, "[Highly Nonplanar Lifting Systems](#)," accessible here.

Wing Layout

Having decided on initial estimates for wing area, sweep, aspect ratio, and taper, an initial specification of the wing planform is possible. Three additional considerations are important:

High and Low Wings

High wing aircraft have the following advantages: The gear may be quite short without engine clearance problems. This lowers the floor and simplifies loading, especially important for small aircraft or cargo aircraft that must operate without jet-ways. High wing designs may also be appropriate for STOL aircraft that make use of favorable engine-flap interactions and for aircraft with struts. Low wing aircraft are usually favored for passenger aircraft based on considerations of ditching (water landing) safety, reduced interference of the wing carry-through structure with the cabin, and convenient landing gear attachment.

Wing Location on the Fuselage

The wing position on the fuselage is set by stability and control considerations and requires a detailed weight breakdown and c.g. estimation. At the early stages of the design process one may locate the aerodynamic of the wing at the center of constant section or, for aircraft with aft-fuselage-mounted engines, at 60% of constant section. (As a first estimate, one may take the aerodynamic center to be at the quarter chord of the wing at the location for which the local chord is equal to the mean aerodynamic chord.)

For low-wing aircraft, the main landing gear is generally attached to the wing structure. This is done to provide a sufficiently large wheel track. The lateral position of the landing gear is determined based on roll-over requirements: one must be able to withstand certain lateral accelerations without falling over.

The detailed computation requires knowledge of landing gear length, fuselage mass distribution, and ground maneuver requirements. For our purposes, it is sufficient to assume that the main gear wheel track is about 1.6 fuselage diameters. For general aviation aircraft or commuters with gear attached to turbo-prop nacelles, the value is usually much larger.

Airplane	ytrack / fuse dia. (approx)
737-200	1.39
747-200	1.67
757-200	1.85
767-300	1.67
E-3 Sentry	1.62
Citation III	1.49
Lear 55	1.25

Gulfstream III	1.70
MD-80	1.37
DC-10-30	1.76
Sweringen Metro III	2.61

It is desirable to mount the main landing gear struts on the wing spar (usually an aft spar) where the structure is substantial. However, the gear must be mounted so that at aft c.g. there is sufficient weight on the nose wheel for good steering. This generally means gear near the 50% point of the M.A.C. . For wings with high sweep, high aspect ratio, or high taper ratio, the aft spar may occur forward of this point. In this case a chord extension must be added. The drawing here shows the gear mounted on a secondary spar attached to the rear spar and the addition of a chord extension to accommodate it.

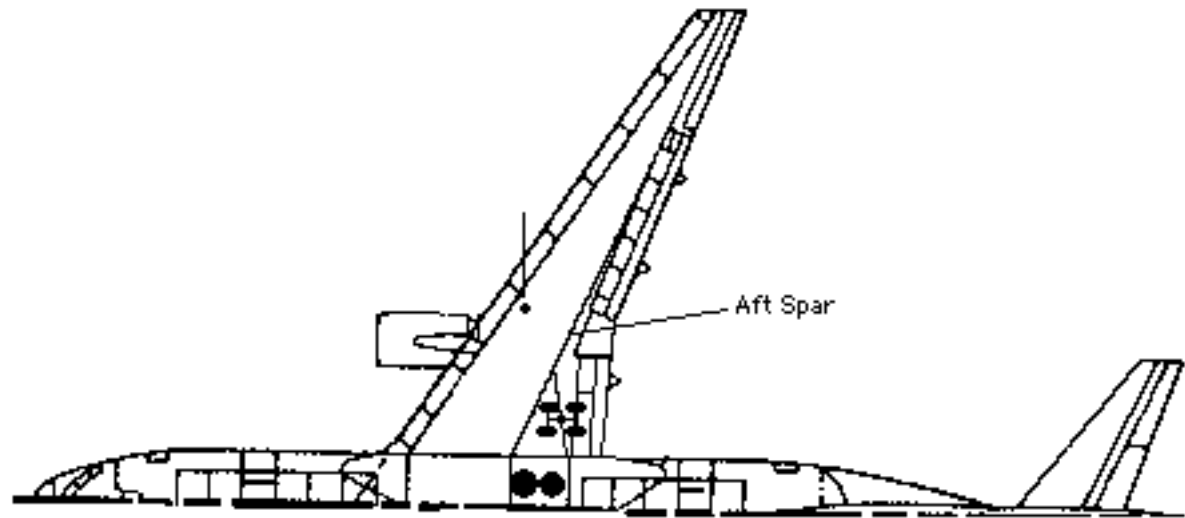

Exercise 5: Wing Lift Distribution

This page computes the lift and Cl distribution for wings with chord extensions.

Wing Geometry

The program computes wing various aspects of the wing geometry. Before running this program, be sure that you have entered the fuselage geometry parameters on the Fuselage layout pages. The values entered here are then used on other pages that require wing geometric data

Supersonic Wing Design

Sweep may be used to produce subsonic characteristics for a wing, even in supersonic flow. At some point, though, sweep is no longer very effective in delaying the effects of compressibility. That is, the difficulties associated with sweep outweigh the advantages as the required sweep angle gets very large. When the Mach number normal to the leading edge becomes greater than 1, the airfoil sections behave according to linear supersonic theory, with the associated wave drag.

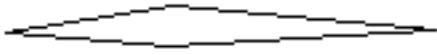

For a double wedge: $C_d = C_l^2 (M^2-1)^{0.5}/4 + 4 (t/c)^2 / (M^2-1)^{0.5}$

For a parabolic section: $C_d = C_l^2 (M^2-1)^{0.5}/4 + 16/3 (t/c)^2 / (M^2-1)^{0.5}$

As in 2D, such supersonic wings are more easily analyzed than their subsonic counterparts, though. Consider the point (A) on the wing shown below. Its effect on the flow cannot propagate upstream because disturbances travel at the speed of sound and the freestream is traveling faster than this. This fact is called the law of forbidden signals and implies that disturbances originating at (A) can only affect the darker shaded area. Similarly, points outside the forward-going Mach cone (lightly shaded area) cannot affect the flow at point A.

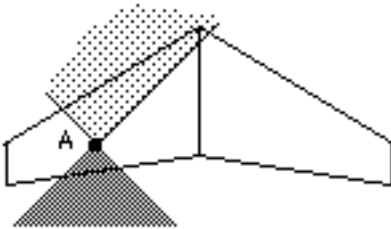

This means that points on the tips of a supersonic wing can only affect a small part of the wing. The rest of the wing behaves as if it did not know about the wing tips and (except for the effects of sweep and taper) the rest of the wing may be treated as a set of 2-D sections. More detailed analysis shows that in the tip regions behave very much like 2-D sections with their lift curve slope reduced by 50%.

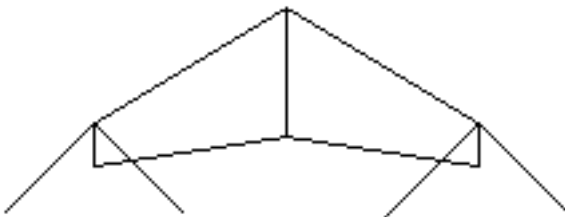

To avoid this loss of lift, the tip sections of supersonic wings are sometimes truncated so that no part of the wing is affected by the tips:

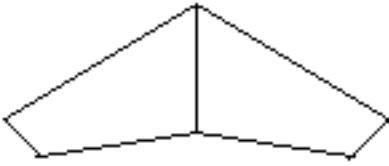

Sections with supersonic leading edges generally have more wave drag than sections with subsonic leading edges which can develop leading edge suction. For wings with sufficient sweep an important part of the design problem is to properly distribute the lift and volume over the length and span. The applet below shows some of the considerations involved in doing this.

Supersonic Wing Design Game

The purpose of this game is to distribute lift over the length and span of a wing to minimize drag. The idea is that there are several approaches to obtaining a desired lift distribution. Click on the squares to add or remove lift from a particular place. The goal is to achieve an elliptic distribution of lift over the length and span of the wing. The score represents the deviation from the ideal loading. To assist in designing your wing the ideal and actual loadings are shown as row and column totals. Also each cell is labeled with the amount by which adding or removing lift will change the score. Clicking on the design button will automatically select those cells that help most, starting with your current design and proceeding for a number of generations.

Here are some designs with a score of 0.

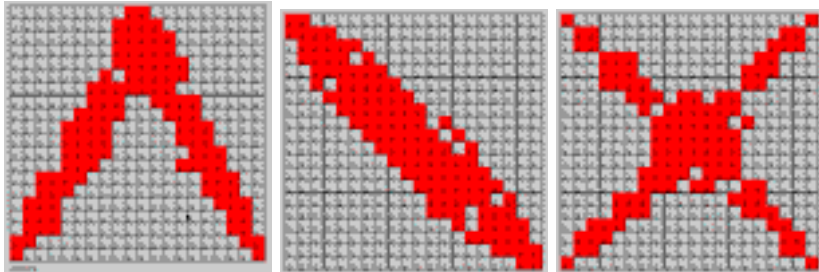

Stability and Control

Outline of this Chapter

The chapter is divided into several sections. The first of these consist of an introduction to stability and control: basic concepts and definitions. The latter sections deal with more detailed stability and control requirements and tail design.

- [Introduction and Basic Concepts](#)
- [Static Longitudinal Stability](#)
- [Dynamic Stability](#)
- [Longitudinal Control Requirements](#)
- [Lateral Control Requirements](#)
- [Tail Design and Sizing](#)
- [FAR's Related to Stability](#)
- [FAR's Related to Control and Maneuverability](#)

Stability and Control: Introduction

The methods in these notes allow us to compute the overall aircraft drag. With well-designed airfoils and wings, and a careful job of engine and fuselage integration, L/D's near 20 may be achieved. Yet some aircraft with predicted L/D's of 20 have actual L/D's of 0 as exemplified by any paper airplane contest. Many aircraft have been dismal failures even though their predicted performance is great. In fact, most spectacular failures have to do with stability and control rather than performance.

This section deals with some of the basic stability and control issues that must be addressed in order that the airplane is capable of flying at all. The section includes a general discussion on stability and control and some terminology. Basic requirements for static longitudinal stability, dynamic stability, and control effectiveness are described. Finally, methods for tail sizing and design are introduced.

The starting point for our analysis of aircraft stability and control is a fundamental result of dynamics: for rigid bodies motion consists of translations and rotations about the center of gravity (c.g.). The motion includes six degrees of freedom: forward and aft motion, vertical plunging, lateral translations, together with pitch, roll, and yaw.

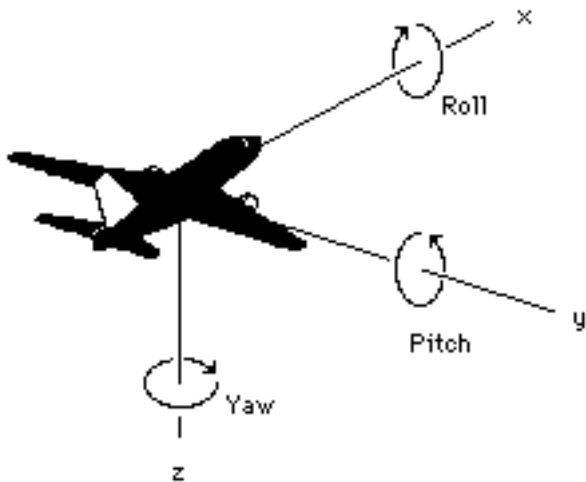

Definitions

The following nomenclature is common for discussions of stability and control.

Forces and Moments

Quantity	Variable	Dimensionless Coefficient	Positive Direction
Lift	L	$C_L = L/qS$	'Up' normal to freestream
Drag	D	$C_D = D/qS$	Downstream

Sideforce	Y	$CY = Y/qS$	Right, looking forward
Roll	l	$Cl = l / qSb$	Right wing down
Pitch	M	$Cm = M/qSc$	Nose up
Yaw	N	$Cn = N/qSb$	Nose right

Angles and Rates

Quantity	Symbol	Positive Direction
Angle of attack	α	Nose up w.r.t. freestream
Angle of sideslip	β	Nose left
Pitch angle	Θ	Nose up
Yaw angle	Ψ	Nose right
Bank angle	Φ	Right wing down
Roll rate	p	Right wing down
Pitch rate	q	Nose up
Yaw rate	r	Nose Right

Aircraft velocities, forces, and moments are expressed in a body-fixed coordinate system. This has the advantage that moments of inertia and body-fixed coordinates do not change with angle of attack, but a conversion must be made from lift and drag to X force and Z force. The body axis system is the conventional one for aircraft dynamics work (x is forward, y is to the right when facing forward, and z is downward), but note that this differs from the conventions used in aerodynamics and wind tunnel testing in which x is aft and z is upward. Thus, drag acts in the negative x direction when the angle of attack is zero. The actual definition of the coordinate directions is up to the user, but generally, the fuselage reference line is used as the direction of the x axis. The rotation rates p, q, and r are measured about the x, y, and z axes respectively using the conventional right hand rule and velocity components u, v, and w are similarly oriented in these body axes.

Basic Concepts

Stability is the tendency of a system to return to its equilibrium condition after being disturbed from that point. Two types of stability or instability are important.

A static instability

A dynamic instability

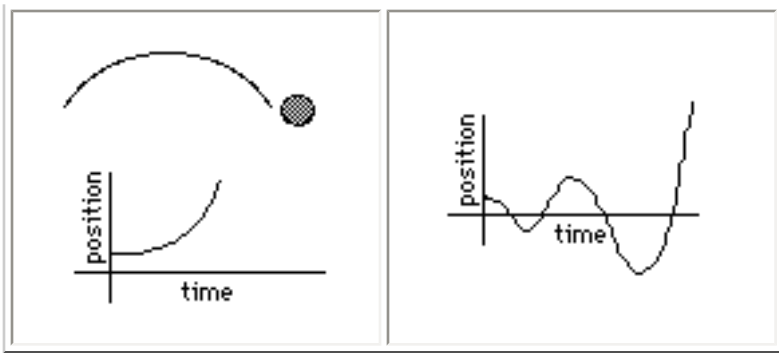

An airplane must be a stable system with acceptable time constants. In general we want the dynamics to be acceptable, actually more than just stable -- we need appropriate damping and frequency. To assure this, a careful analysis of the dynamic response and controllability is required. The dynamic equations of motion are shown below, expressed in body axes. The top six equations are just forms of $F=ma$ and $M=I d\Omega / dt$ for each of the coordinate directions. The bottom three equations are kinematic expressions relating angular rates to the orientation angles Θ, Φ, Ψ , angles describing the airplane pitch, roll, and heading angles.

In general, we must solve these nonlinear, coupled, second order differential equations to describe the dynamics of the airplane. Many simplifying assumptions are often justified and make the analysis more simple.

If we linearize the equations we find that there exist 5 interesting modes of dynamic motion. These are discussed further in the section on dynamic stability. But one of the useful results is that we usually obtain sets of nearly independent modes: those associated with symmetric, longitudinal motion, and those related to lateral motion. The modes are, of course, coupled for asymmetric aircraft such as oblique wings and the motion can be coupled by nonlinear effects such as pitching moment produced by large sideslip angles or alpha-dependent yawing moments that appear on fighters at high angles of attack, but for many cases the approximate decoupling is useful.

$$m \left[\frac{du}{dt} + qw - rv \right] = F_x - mg \sin \Theta$$

$$m \left[\frac{dv}{dt} + ru - pw \right] = F_y + mg \cos \Theta \sin \Phi$$

$$m \left[\frac{dw}{dt} + pv - qu \right] = F_z + mg \cos \Theta \cos \Phi$$

$$M_x = I_{xx} \frac{dp}{dt} - I_{xz} \frac{dr}{dt} + [I_{zz} - I_{yy}] qr - I_{xz} pq$$

$$M_y = I_{yy} \frac{dq}{dt} + [I_{xx} - I_{zz}] rp + I_{xz} [p^2 - r^2]$$

$$M_z = -I_{xz} \frac{dp}{dt} + I_{zz} \frac{dr}{dt} + [I_{yy} - I_{xx}] pq + I_{xz} qr$$

$$p = \frac{d\Phi}{dt} - \frac{d\Psi}{dt} \sin \Theta$$

$$q = \frac{d\Theta}{dt} \cos \Phi + \frac{d\Psi}{dt} \sin \Phi \cos \Theta$$

$$r = -\frac{d\Theta}{dt} \sin \Phi + \frac{d\Psi}{dt} \cos \Phi \cos \Theta$$

Longitudinal Static Stability

Stability and Trim

In designing an airplane we would compute eigenvalues and vectors (modes and frequencies) and time histories, etc. But we don't need to do that at the beginning when we don't know the moments of inertia or unsteady aero terms very accurately. So we start with static stability.

If we displace the wing or airplane from its equilibrium flight condition to a higher angle of attack and higher lift coefficient:

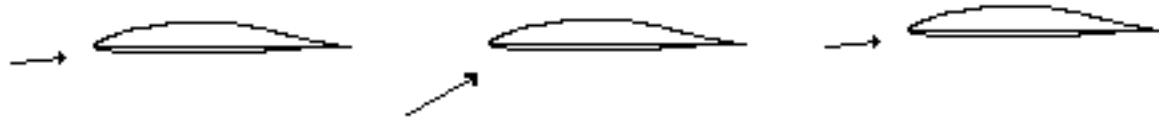

we would like it to return to the lower lift coefficient.

This requires that the pitching moment about the rotation point, C_m , become negative as we increase C_L :

$$\frac{\partial C_m}{\partial C_L} < 0$$

Note that: $C_m = C_{m_0} - \frac{x}{c} C_L$

A diagram of an airfoil with a center of gravity (c.g.) marked by a black dot to the left of the airfoil. A horizontal line with an 'x' at its end extends from the c.g. to the aerodynamic center of the airfoil. A vertical arrow labeled C_L points upwards from the aerodynamic center.

where x is the distance from the system's aerodynamic center to the c.g..

So, $\frac{\partial C_{m_{c.g.}}}{\partial C_L} = -\frac{x}{c} = -\text{static margin}$

If x were 0, the system would be neutrally stable. x/c represents the margin of static stability and is thus called the static margin. Typical values for stable airplanes range from 5% to 40%. The airplane may therefore be made as stable as desired by moving the c.g. forward (by putting lead in the nose) or moving the wing back. One needs no tail for stability then, only the right position of the c.g..

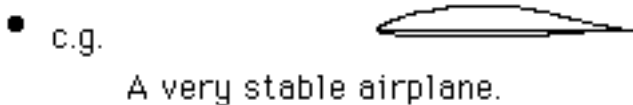

Although this configuration is stable, it will tend to nose down whenever any lift is produced. In addition to stability we require that the airplane be trimmed (in moment equilibrium) at the desired C_L .

This implies that: $C_{m_{c.g.}} = C_{m_0} - \frac{x}{c} C_L = 0$

With a single wing, generating a sufficient C_m at zero lift to trim with a reasonable static margin and C_L is not so easy. (Most airfoils have negative values of C_{m_0} .) Although tailless aircraft can generate sufficiently positive C_{m_0} to trim, the more conventional solution is to add an additional lifting surface such as an aft-tail or canard. The following sections deal with some of the considerations in the design of each of these configurations.

Pitching Moment Curves

If we are given a plot of pitching moment vs. C_L or angle of attack, we can say a great deal about the airplane's characteristics.

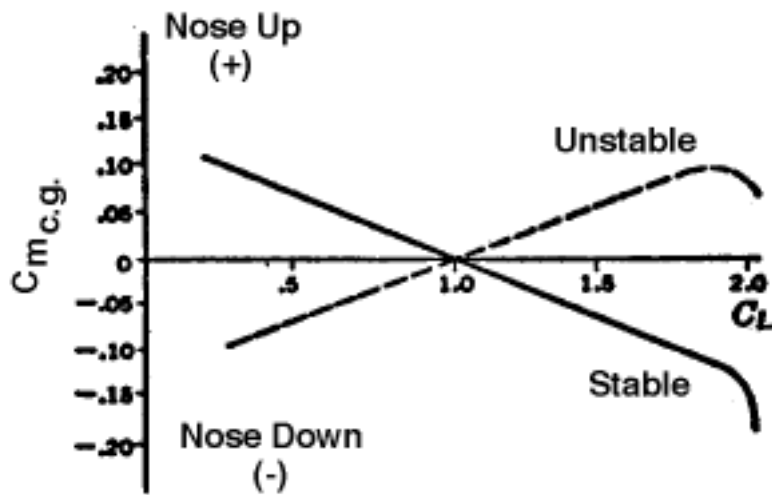

For some aircraft, the actual variation of C_m with alpha is more complex. This is especially true at and beyond the stalling angle of attack. The figure below shows the pitching characteristics of an early design version of what became the DC-9. Note the contributions from the various components and the highly nonlinear post-stall characteristics.

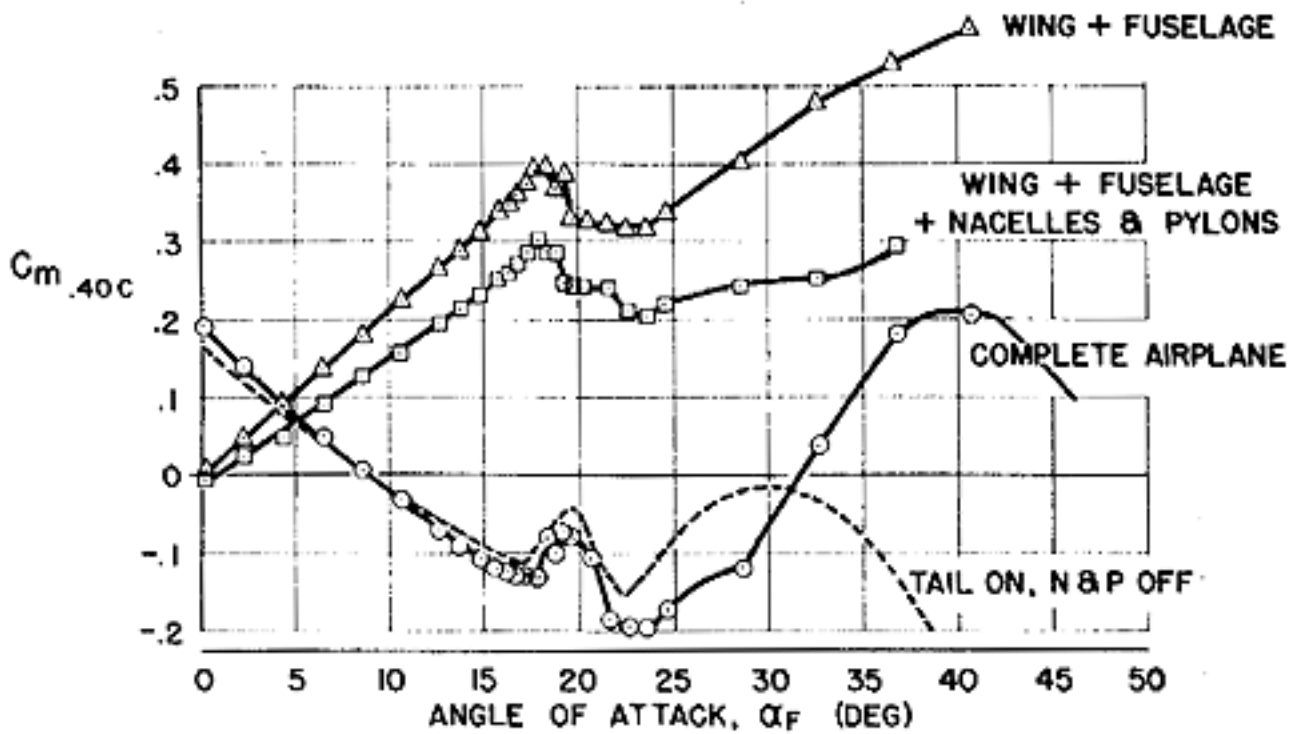

Equations for Static Stability and Trim

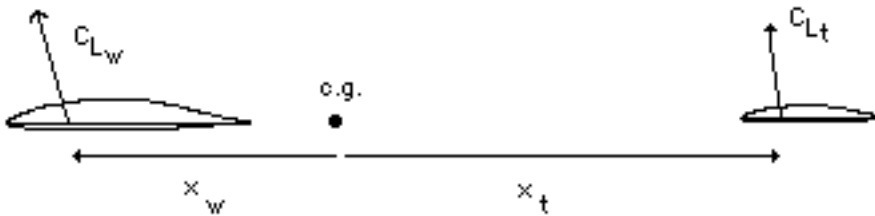

The analysis of longitudinal stability and trim begins with expressions for the pitching moment about the airplane c.g..

$$C_{m_{c.g.}} = \frac{x_{c.g.}}{\bar{c}} C_{L_w} - \frac{l_h S_h}{\bar{c} S_w} C_{L_h} + C_{m_{a.c.w}} + C_{m_{c.g.}, body}$$

Where:

$x_{c.g.}$ = distance from wing aerodynamic center back to the c.g. = x_w

\bar{c} = reference chord

C_{L_w} = wing lift coefficient

l_h = distance from c.g. back to tail a.c. = x_t

S_h = horizontal tail reference area

S_w = wing reference area

C_{L_h} = tail lift coefficient

$C_{m_{acw}}$ = wing pitching moment coefficient about wing a.c. = $C_{m_{ow}}$

$C_{m_{c.g.body}}$ = pitching moment about c.g. of body, nacelles, and other components

The change in pitching moment with angle of attack, C_{m_α} , is called the pitch stiffness. The change in pitching moment with C_L of the wing is given by:

$$\frac{\partial C_{m_{c.g.}}}{\partial \alpha} = \frac{x_{c.g.}}{\bar{c}} C_{L_{\alpha w}} - \frac{l_h S_h}{\bar{c} S_w} C_{L_{\alpha h}} + \frac{\partial C_{m_{c.g.body}}}{\partial \alpha}$$

Note that: $\frac{\partial C_{m_{c.g.}}}{\partial \alpha} = 0$ when $\frac{x_{c.g.}}{\bar{c}} = \frac{l_h S_h}{\bar{c} S_w} \frac{C_{L_{\alpha h}}}{C_{L_{\alpha w}}} - \frac{1}{C_{L_{\alpha w}}} \frac{\partial C_{m_{c.g.body}}}{\partial \alpha}$

The position of the c.g. which makes $dC_m/dC_L = 0$ is called the neutral point. The distance from the neutral point to the actual c.g. position is then:

$$\frac{\Delta c.g.}{\bar{c}} = \frac{x_{c.g.}}{\bar{c}} - \frac{l_h S_h}{\bar{c} S_w} \frac{C_{L_{\alpha h}}}{C_{L_{\alpha w}}} + \frac{1}{C_{L_{\alpha w}}} \frac{\partial C_{m_{c.g.body}}}{\partial \alpha}$$

This distance (in units of the reference chord) is called the static margin. We can see from the previous equation that:

$$\text{static margin} = -\frac{\Delta c.g.}{\bar{c}} \approx -\frac{\partial C_{m_{c.g.}}}{\partial C_{L_w}}$$

(A note to interested readers: This is approximate because the static margin is really the derivative of $C_{m_{c.g.}}$ with respect to C_{L_A} , the lift coefficient of the entire airplane. Try doing this correctly. The algebra is just a bit more difficult but you will find expressions similar to those above. In most cases, the answers are very nearly the same.)

We consider the expression for static margin in more detail:

$$\text{static margin} = -\frac{x_{c.g.}}{\bar{c}} + \frac{l_h S_h}{\bar{c} S_w} \frac{C_{L_{\alpha h}}}{C_{L_{\alpha w}}} - \frac{1}{C_{L_{\alpha w}}} \frac{\partial C_{m_{c.g.body}}}{\partial \alpha}$$

The tail lift curve slope, $C_{L_{\alpha h}}$, is affected by the presence of the wing and the fuselage. In particular, the wing and fuselage produce downwash on the tail and the fuselage boundary layer and contraction reduce the local velocity of flow over the tail. Thus we write:

$$C_{L_{\alpha h}} = C_{L_{\alpha h 0}} \left(1 - \frac{\partial \epsilon}{\partial \alpha}\right) \eta_h$$

where: $C_{L_{\alpha h 0}}$ is the isolated tail lift curve slope.

The isolated wing and tail lift curve slopes may be determined from experiments, simple codes such as the wing analysis program in these notes, or even from analytical expressions such as the DATCOM formula:

$$C_{L_{\alpha}} \approx \frac{2\pi AR}{2 + \sqrt{(AR/\eta)^2(1 + \tan^2 \Lambda - M^2) + 4}}$$

where the oft-used constant η accounts for the difference between the theoretical section lift curve slope of 2π and the actual value. A typical value is 0.97.

In the expression for pitching moment, η_h is called the tail efficiency and accounts for reduced velocity at the tail due to the fuselage. It may be assumed to be 0.9 for low tails and 1.0 for T-Tails.

The value of the downwash at the tail is affected by fuselage geometry, flap angle wing planform, and tail position. It is best determined by measurement in a wind tunnel, but lacking that, lifting surface computer programs do an acceptable job. For advanced design purposes it is often possible to approximate the downwash at the tail by the downwash far behind an elliptically-loaded wing:

$$\epsilon \approx \frac{2C_{L_w}}{\pi AR_w} \quad \text{So,} \quad \frac{\partial \epsilon}{\partial \alpha} \approx \frac{2C_{L_{\alpha w}}}{\pi AR_w}$$

We have now most of the pieces required to predict the airplane stability. The last, and important, factor is the fuselage contribution. The fuselage produces a pitching moment about the c.g. which depends on the angle of attack. It is influenced by the fuselage shape and interference of the wing on the local flow. Additionally, the fuselage affects the flow over the wing. Thus, the destabilizing effect of the fuselage depends on: L_f , the fuselage length, w_f , the fuselage width, the wing sweep, aspect ratio, and location on the fuselage.

Gilruth (NACA TR711) developed an empirically-based method for estimating the effect of the fuselage:

$$\frac{\partial C_{m_{fuse}}}{\partial C_L} = \frac{K_f w_f^2 L_f}{S_w \bar{c} C_{L_{\alpha w}}}$$

where:

$C_{L_{\alpha_w}}$ is the wing lift curve slope per radian

Lf is the fuselage length

wf is the maximum width of the fuselage

Kf is an empirical factor discussed in NACA TR711 and developed from an extensive test of wing-fuselage combinations in NACA TR540.

Kf is found to depend strongly on the position of the quarter chord of the wing root on the fuselage. In this form of the equation, the wing lift curve slope is expressed in rad⁻¹ and Kf is given below. (Note that this is not the same as the method described in Perkins and Hage.) The data shown below were taken from TR540 and Aerodynamics of the Airplane by Schlichting and Truckenbrodt:

Position of 1/4 root chord on body as fraction of body length	Kf
.1	.115
.2	.172
.3	.344
.4	.487
.5	.688
.6	.888
.7	1.146

Finally, nacelles and pylons produce a change in static margin. On their own nacelles and pylons produce a small destabilizing moment when mounted on the wing and a small stabilizing moment when mounted on the aft fuselage.

With these methods for estimating the various terms in the expression for pitching moment, we can satisfy the stability and trim conditions. Trim can be achieved by setting the incidence of the tail surface (which adjusts its CL) to make $C_m = 0$:

$$C_m = C_{m_{a.c.}} + C_{L_w} \frac{x_w}{\bar{c}} - C_{L_h} \frac{S_h l_h}{S_w \bar{c}} + \text{fuselage effects} = 0$$

Stability can simultaneously be assured by appropriate location of the c.g.:

$$\frac{\partial C_m}{\partial C_{L_w}} = \frac{x_w}{\bar{c}} - \frac{C_{L_{\alpha_h}} S_h l_h}{C_{L_{\alpha_w}} S_w \bar{c}} + \text{fuselage effects} \approx -\text{static margin}$$

Thus, given a stability constraint and a trim requirement, we can determine where the c.g. must be located and can adjust the tail lift to trim. We then know the lifts on each interfering surface and can

compute the combined drag of the system.

Dynamic Stability

The evaluation of static stability provides some measure of the airplane dynamics, but only a rather crude one. Of greater relevance, especially for lateral motion, is the dynamic response of the aircraft. As seen below, it is possible for an airplane to be statically stable, yet dynamically unstable, resulting in unacceptable characteristics.

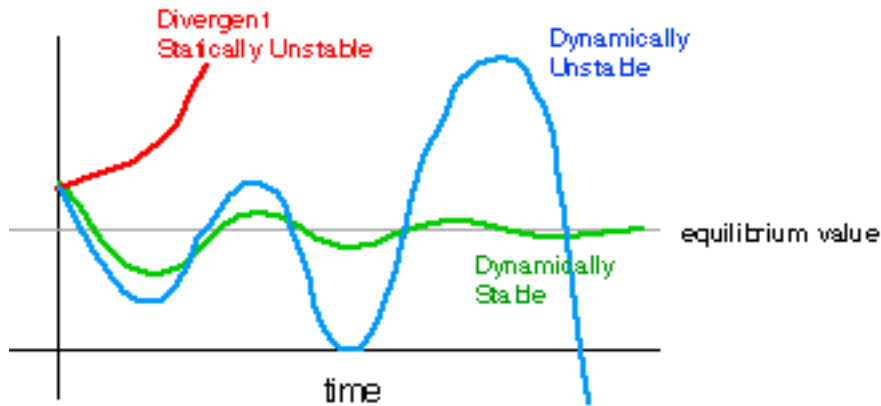

Just what constitutes acceptable characteristics is often not obvious, and several attempts have been made to quantify pilot opinion on acceptable handling qualities. Subjective flying qualities evaluations such as Cooper-Harper ratings are used to distinguish between "good-flying" and difficult-to-fly aircraft. New aircraft designs can be simulated to determine whether they are acceptable. Such real-time, pilot-in-the-loop simulations are expensive and require a great deal of information about the aircraft. Earlier in the design process, flying qualities estimate may be made on the basis of various dynamic characteristics. One can correlate pilot ratings to the frequencies and damping ratios of certain types of motion as in done in the U.S. Military Specifications governing airplane flying qualities. The figure below shows how the short-frequency longitudinal motion of an airplane and the load factor per radian of angle of attack are used to establish a flying qualities estimate. In Mil Spec 8785C, level 1 handling is considered "clearly adequate" while level 3 suggests that the airplane can be safely controlled, but that the pilot workload is excessive or the mission effectiveness is inadequate.

Short Period Frequency Requirements

Mil Spec 8785-C

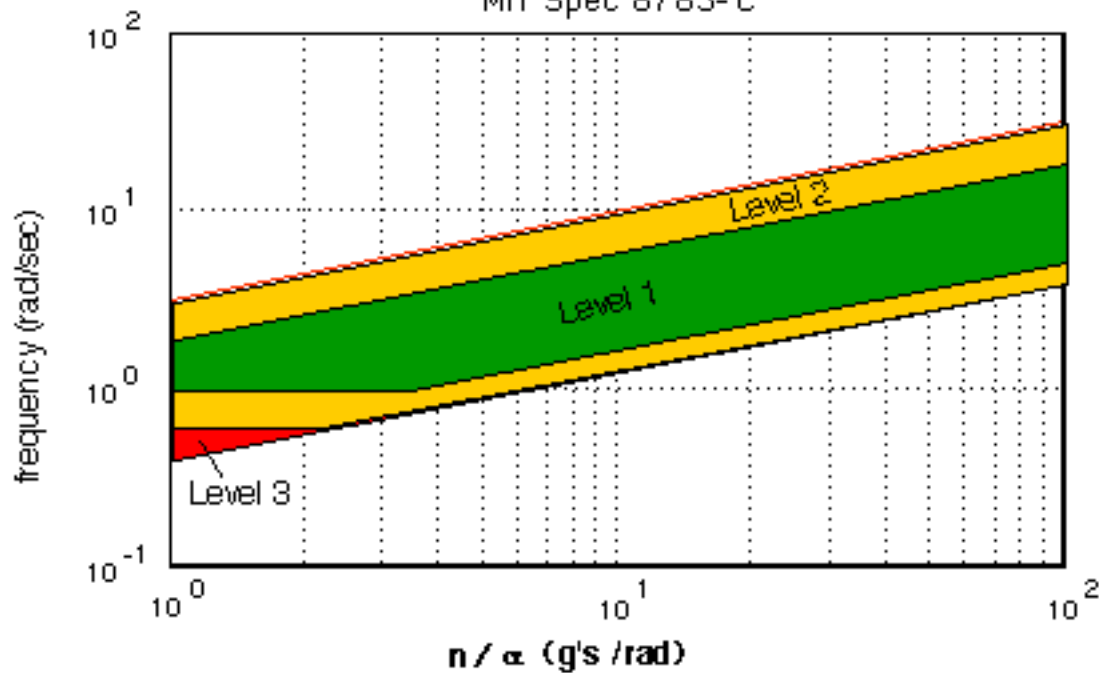

Rather than solve the relevant equations of motion, we describe here some of the simplified results obtained when this is done using linearized equations of motion.

When the motions are small and the aerodynamics can be assumed linear, many useful, simple results can be derived from the 6 degree-of-freedom equations of motion. The first simplification is the decoupling between symmetric, longitudinal motion, and lateral motion. (This requires that the airplane be left/right symmetric, a situation that is often very closely achieved.) Other decoupling is also observed, with 5 decoupled modes required to describe the general motion. The stability of each of these modes is often used to describe the airplane dynamic stability.

Modes are often described by their characteristic frequency and damping ratio. If the motion is of the form: $x = A e^{(n + i \omega) t}$, then the period, T , is given by: $T = 2\pi / \omega$, while the time to double or halve the amplitude of a disturbance is: t_{double} or $t_{\text{half}} = 0.693 / |n|$. Other parameters that are often used to describe these modes are the undamped circular frequency: $\omega_n = (\omega^2 + n^2)^{1/2}$ and the damping ratio, $\zeta = -n / \omega_n$.

Longitudinal Stability

When the aircraft is not perturbed about the roll or yaw axis, only the longitudinal modes are required to describe the motion. These modes usually are divided into two distinct types of motion.

Short-Period

The first, short period, motion involves rapid changes to the angle of attack and pitch attitude at roughly constant airspeed. This mode is usually highly damped; its frequency and damping are very important in

the assessment of aircraft handling. For a 747, the frequency of the short-period mode is about 7 seconds, while the time to halve the amplitude of a disturbance is only 1.86 seconds. The short period frequency is strongly related to the airplane's static margin, in the simple case of straight line motion, the frequency is proportional to the square root of $C_{m\alpha} / C_L$.

Phugoid

The long-period of phugoid mode involves a trade between kinetic and potential energy. In this mode, the aircraft, at nearly constant angle of attack, climbs and slows, then dives, losing altitude while picking up speed. The motion is usually of such a long period (about 93 seconds for a 747) that it need not be highly damped for piloted aircraft. This mode was studied (and named) by Lanchester in 1908. He showed that if one assumed constant angle of attack and thrust=drag, the period of the phugoid could be written as: $T = \pi \sqrt{2} U/g = 0.138 U$. That is, the period is independent of the airplane characteristics and altitude, and depends only on the trimmed airspeed. With similarly strong assumptions, it can be shown that the damping varies as $\zeta = 1 / (\sqrt{2} L/D)$.

Lateral Dynamics

Three dynamic modes describe the lateral motion of aircraft. These include the relatively uninteresting roll subsidence mode, the Dutch-roll mode, and the spiral mode.

The roll mode consists of almost pure rolling motion and is generally a non-oscillatory motion showing how rolling motion is damped.

Of somewhat greater interest is the spiral mode. Like the phugoid motion, the spiral mode is usually very slow and often not of critical importance for piloted aircraft. A 747 has a nonoscillatory spiral mode that damps to half amplitude in 95 seconds under typical conditions, while many airplanes have unstable spiral modes that require pilot input from time to time to maintain heading.

The Dutch-roll mode is a coupled roll and yaw motion that is often not sufficiently damped for good handling. Transport aircraft often require active yaw dampers to suppress this motion.

High directional stability ($C_{n\beta}$) tends to stabilize the Dutch-roll mode while reducing the stability of the spiral mode. Conversely large effective dihedral (rolling moment due to sideslip, $C_{l\beta}$) stabilizes the spiral mode while destabilizing the Dutch-roll motion. Because sweep produces effective dihedral and because low wing airplanes often have excessive dihedral to improve ground clearance, Dutch-roll motions are often poorly damped on swept-wing aircraft.

Longitudinal Control Requirements

Control power is usually critical in sizing the tail.

Some very large airplane designs are cruise trim critical. The tail is sized to be buffet free or below drag divergence at dive Mach number. Drag divergence is used as a measurement of likelihood of elevator control reversal. Drag divergence is accompanied by strong shocks on the suction side of the stabilizer. Deflecting the elevator to diminish lift in this condition can improve the flow behind the shock, increasing lift instead of reducing it and causing a control reversal. Typically the tail would be designed to be below drag divergence at dive Mach number and at its mid center of gravity cruise lift coefficient, a lift coefficient of 0.2 to 0.3. For actively-controlled airplanes in cruise, the tail may carry almost no load at mid CG, positive load at aft CG, and negative load at forward CG. In this case the tail is probably designed to be divergence free at dive Mach number and at its worst cruise lift coefficient.

Control requirements at low speed are usually critical. One requirement that determines the elevator sizing is a go around maneuver. The airplane begins in approach trim, flaps down, stabilizer set for 1g flight, no elevator. By deflecting the elevator only, the pilot should be able to get a pitch acceleration of 5 deg/s², minimum. On new aircraft with no stretch history, the elevator would be designed to provide 10 deg/s² pitch acceleration. 8 deg/s² is desirable.

Nosewheel liftoff may be a critical constraint, especially on advanced aircraft because of a trend toward moving the center of gravity aft relative to the aerodynamic center. In this maneuver, the aircraft is trimmed for climbout at $V_2 + 10$ knots, which is about 1.3 V_{stall} . The elevator should generate enough moment to crack the nosewheel off the ground and provide 3 deg/s² pitch acceleration. In designing the tail, one would shoot for 6 deg/s² pitch acceleration.

The approach trim constraint is often critical. This constraint involves a 1g level acceleration from approach speed, 1.3 V_{stall} , to maximum flaps extended speed, V_{FE} , which is typically 1.8 V_{stall} . The aircraft begins in approach trim and must reach V_{FE} using only the elevator, not the stabilizer, to retrim. In approaching V_{FE} , the angle of attack decreases and must be accompanied by deflecting the elevator down. For trim at 1.3 V_{stall} , however, the stabilizer is deflected up to generate download. At V_{FE} , the stabilizer and elevator end up working against each other. At this condition, the tail must be 2 deg below stall.

Icing affects estimation of maximum section lift. With evaporative anti-icing systems the properties of the clean section can be used. For aircraft without ice protection, the tail should be oversized by as much as 30%.

At V_{FE} , it is common for the wing flap to be stalled. Because of the low angle of attack, there is no flow through the wing slat. Flow separates on the lower surface of the slat, and this disturbance impinges on the flap causing it to stall.

Takeoff normally does not stall the tail. The elevator typically has a limited throw. This usually keeps the tail within 2 deg of its stall angle of attack. Maximum stabilizer deflections of about 12 deg and a maximum elevator deflections around 25 deg are typical of transport aircraft.

Pitching moments from landing gear are usually small and act opposite to one's intuition. The gear struts block the flaps and reduce their nose down pitching moment. The gear also cause a slight increase in lift.

Structural sizing for fins are often set by a tail stop maneuver. Pilot applies a maximum rudder input, limited by either a pedal stop or a mechanical stop in the fin. The airplane sideslips and is carried by its inertia beyond its equilibrium sideslip angle. From the maximum equilibrium sideslip, the pilot releases the pedals causing the airplane to swing back and oscillate around zero sideslip. The maximum fin loads encountered during this maneuver are used to size the fin structure. For this reason, some companies use rudder throw limiters that provide full deflection, typically +/-30 deg, up to 160 knots, then decrease maximum deflection inversely proportional with dynamic pressure.

Lateral Control Requirements

For older and current aircraft up through the very large aircraft designs, stability requirements such as Dutch roll were an issue in sizing the vertical tail. In these aircraft, despite the presence of active control systems, the design philosophy was that the aircraft should be flyable with all electronics dead. An alternate philosophy is to examine how much reliance is placed on the control system and estimate the number of failures expected based on statistical data on failure rates. Control systems would then be designed with sufficient redundancy to achieve two orders of magnitude more reliability than some desired level.

This alternate philosophy that trusts active control may be used by some companies for future advanced aircraft design work; it will probably be used in any HSCT design. Some basic control will still be available even without active control in that pitch trim and rudder will still be mechanically activated. In the future, vertical tails will not be sized for Dutch roll, so long as the control system has sufficient authority to stabilize the airplane.

There is a limit to the instability that can be tolerated; the control system cannot be saturated. For this purpose, the rudder should be designed to return aircraft from a 10° sideslip disturbance at any altitude. For reliability, rudders may be split into upper and lower halves, with independent signals and actuators plus redundant processors.

The critical control sizing constraint is often VMCG, minimum controlled ground speed. In this condition, flight is straight and unaccelerated laterally. Nose gear reaction is zero. Aerodynamic moments must balance engine thrust with one engine out and creating windmilling drag, and the other engine at max thrust plus a thrust bump for a "hot" engine. If the moment balance is done about the aircraft center of gravity, main gear reactions caused by rudder sideforce must be considered. If the main gear reactions were ignored, rudder force would be underestimated by 15% to 20%. Alternately, the moment balance can be done about the main gear center, which lies in line with the gear and halfway between them. Engine thrust imbalance should be controllable with full rudder deflection.

VMCG is relatively independent of flap setting or aircraft weight because it is primarily a matter of balancing engine thrust imbalance with the rudder. Flaps may affect rudder performance sometimes because of aerodynamic interaction. Aircraft weight does not enter the moment balance because, when moments are taken about the main gear, there are no ground moment reactions and there are no inertial forces because there is no lateral acceleration. The engine thrust imbalance is constant because full thrust is always used for takeoff, regardless of aircraft weight. To determine a required VMCG speed, one would examine an aircraft in its lightest commercial weight. This would be the weight with a minimum passenger load to break even on a particular range, say a 30% passenger load. At low takeoff weights, more flaps will be used as a result of optimizing flap deflection for best lift to drag in second segment climb. The light weight and large flap deflection should reduce speeds for second segment climb and rotation. In establishing the balanced field length for this condition, VMCG should be set at the speed where second segment climb or rotation becomes critical. For aircraft such as the DC9 or DC10 this

speed is about 110 knots. For heavier aircraft, VMCG is higher, 120 knots.

VMCA, minimum control airspeed, is usually not critical because dynamic pressure is higher, making the rudder more effective, the thrust imbalance is smaller, because of thrust lapse, plus the airplane is allowed to sideslip to trim. The VMCG condition is at zero sideslip; rudders may be double hinged to enable large lift coefficients to be achieved on the fin at this condition.

While VMCG is critical for 2 engine airplanes, on 4 engine airplanes VMCL2 may be critical. In this landing condition, 2 engines are out on same side of the airplane while the other two are at max takeoff thrust. The rudder is more effective since this is done at approach speed, $1.3 V_{stall}$.

One airborne condition that might size the rudder is a crosswind landing decrab. This condition is at $1.3 V_{stall}$ with a 35 knot crosswind. The rudder is used to control an aerodynamic sideslip of 13° to 15° . Increasing the vertical tail area does not help here because it increases the resistance to sideslip. If this condition is critical the proportion of rudder to vertical tail area should be adjusted.

Tail Design and Sizing

Tail Design

Introduction

Tail surfaces are used to both stabilize the aircraft and provide control moments needed for maneuver and trim. Because these surfaces add wetted area and structural weight they are often sized to be as small as possible. Although in some cases this is not optimal, the tail is generally sized based on the required control power as described in other sections of this chapter. However, before this analysis can be undertaken, several configuration decisions are needed. This section discusses some of the considerations involved in tail configuration selection.

A large variety of tail shapes have been employed on aircraft over the past century. These include configurations often denoted by the letters whose shapes they resemble in front view: T, V, H, +, Y, inverted V. The selection of the particular configuration involves complex system-level considerations, but here are a few of the reasons these geometries have been used.

The conventional configuration with a low horizontal tail is a natural choice since roots of both horizontal and vertical surfaces are conveniently attached directly to the fuselage. In this design, the effectiveness of the vertical tail is large because interference with the fuselage and horizontal tail increase its effective aspect ratio. Large areas of the tails are affected by the converging fuselage flow, however, which can reduce the local dynamic pressure.

A T-tail is often chosen to move the horizontal tail away from engine exhaust and to reduce aerodynamic interference. The vertical tail is quite effective, being 'end-plated' on one side by the fuselage and on the other by the horizontal tail. By mounting the horizontal tail at the end of a swept vertical, the tail length of the horizontal can be increased. This is especially important for short-coupled designs such as business jets. The disadvantages of this arrangement include higher vertical fin loads, potential flutter difficulties, and problems associated with deep-stall.

One can mount the horizontal tail part-way up the vertical surface to obtain a cruciform tail. In this arrangement the vertical tail does not benefit from the endplating effects obtained either with conventional or T-tails, however, the structural issues with T-tails are mostly avoided and the configuration may be necessary to avoid certain undesirable interference effects, particularly near stall.

V-tails combine functions of horizontal and vertical tails. They are sometimes chosen because of their increased ground clearance, reduced number of surface intersections, or novel look, but require mixing of rudder and elevator controls and often exhibit reduced control authority in combined yaw and pitch maneuvers.

H-tails use the vertical surfaces as endplates for the horizontal tail, increasing its effective aspect ratio. The vertical surfaces can be made less tall since they enjoy some of the induced drag savings associated with biplanes. H-tails are sometimes used on propeller aircraft to reduce the yawing moment associated with propeller slipstream impingement on the vertical tail. More complex control linkages and reduced ground clearance discourage their more widespread use.

Y-shaped tails have been used on aircraft such as the LearFan, when the downward projecting vertical surface can serve to protect a pusher propeller from ground strikes or can reduce the 1-per-rev interference that would be more severe with a conventional arrangement and a 2 or 4-bladed prop. Inverted V-tails have some of the same features and problems with ground clearance, while producing a favorable rolling moments with yaw control input.

Specific design guidelines:

The tail surfaces should have lower thickness and/or higher sweep than the wing (about 5° usually) to prevent strong shocks on the tail in normal cruise. If the wing is very highly swept, the horizontal tail sweep is not increased this much because of the effect on lift curve slope. Tail t/c values are often lower than that of the wing since t/c of the tail has a less significant effect on weight. Typical values are in the range of 8% to 10%.

Typical aspect ratios are about 4 to 5. T-Tails are sometimes higher (5-5.5), especially to avoid aft-engine/pylon wake effects.

AR_v is about 1.2 to 1.8 with lower values for T-Tails. The aspect ratio is the square of the vertical tail span (height) divided by the vertical tail area, b_v^2 / S_v .

Taper ratios of about .4 to .6 are typical for tail surfaces, since lower taper ratios would lead to unacceptably small Reynolds numbers. T-Tail vertical surface taper ratios are in the range of 0.85 to 1.0 to provide adequate chord for attachment of the horizontal tail and associated control linkages.

Tail Sizing

Horizontal tails are generally used to provide trim and control over a range of conditions. Typical conditions over which tail control power may be critical and which sometimes determine the required tail size include: take-off rotation (with or without ice), approach trim and nose-down acceleration near stall. Many tail surfaces are normally loaded downward in cruise. For some commercial aircraft the tail download can be as much as 5% of the aircraft weight. As stability requirements are relaxed with the application of active controls, the size of the tail surface and/or the magnitude of tail download can be reduced. Actual tail sizing involves a number of constraints that are often summarized on a plot called a scissors curve. An example is shown below.

- NOSEWHEEL-LIFT-OFF ($V_{lim} = 310.5$ KNOTS, $\delta_c = -25^\circ$)
- - - TRIMMED AT $V = 1.4 V_{lim}$ (WITH TAIL ICE, $\alpha_{trim} = 14.14^\circ$, $\delta_c = -14.14^\circ$)
- - - TRIMMED AT $V = 1.3 V_{lim}$ (WITHOUT TAIL ICE, $\alpha_{trim} = 14.55^\circ$, $\delta_c = -14.6^\circ$)
- - - $V = 1.25 V_{lim}$ (AT $\alpha_{FNAC} = 13.75^\circ$ IN GROUND EFFECT, $\alpha = -15^\circ$, $\delta_c = -25^\circ$)
- - - $V = 1.25 V_{lim}$ (PULLING $1.2g$'s IN GROUND EFFECT, $\alpha = -15^\circ$, $\delta_c = -25^\circ$)
- - - AFT CENTER OF GRAVITY (V_{lim} AT 10,000 FT.)

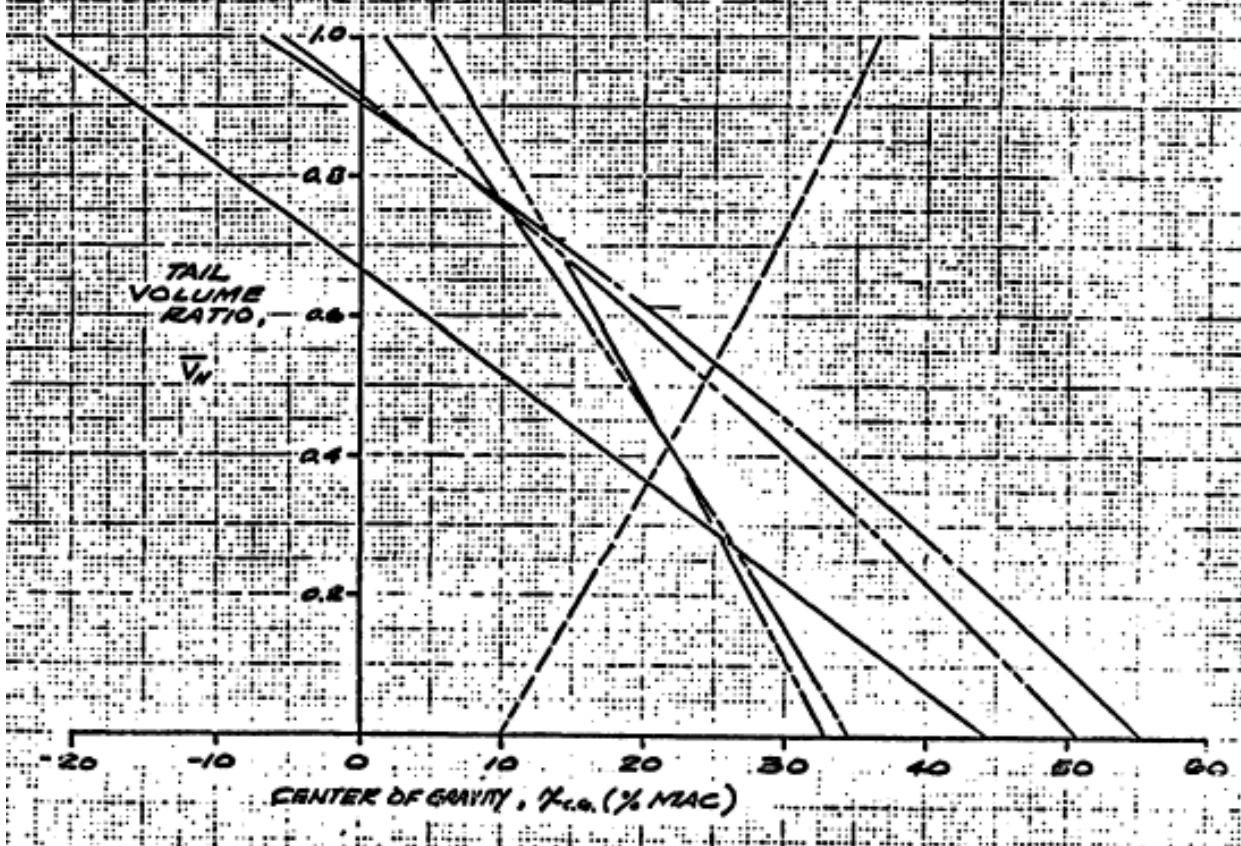

Scissors curve used for sizing tail based on considerations of stability and control.

Statistical Method

For the purposes of early conceptual design it is useful to estimate the required size of tail surfaces very simply. This can be done on the basis of comparison with other aircraft.

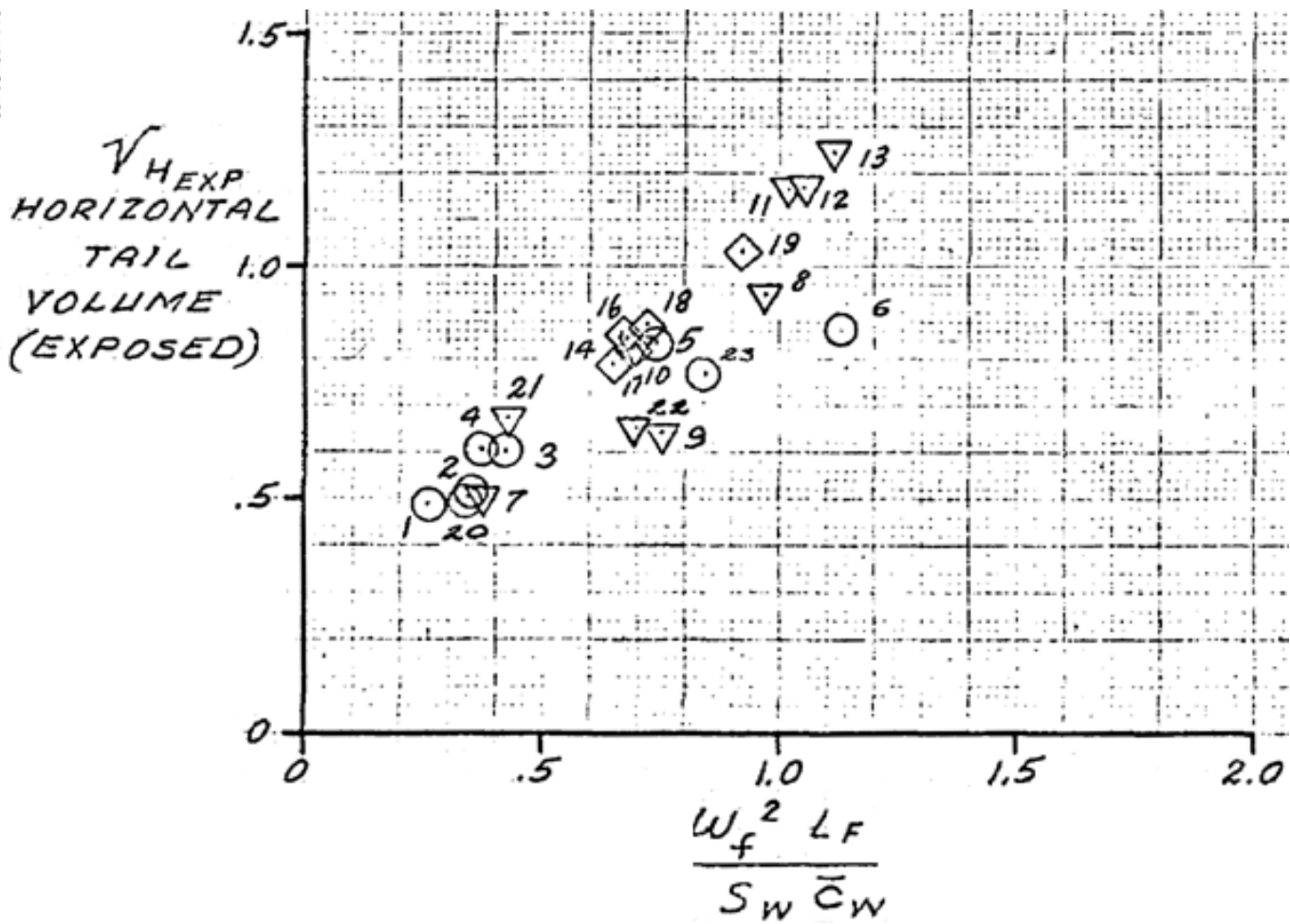

Correlation of aircraft horizontal tail volume.

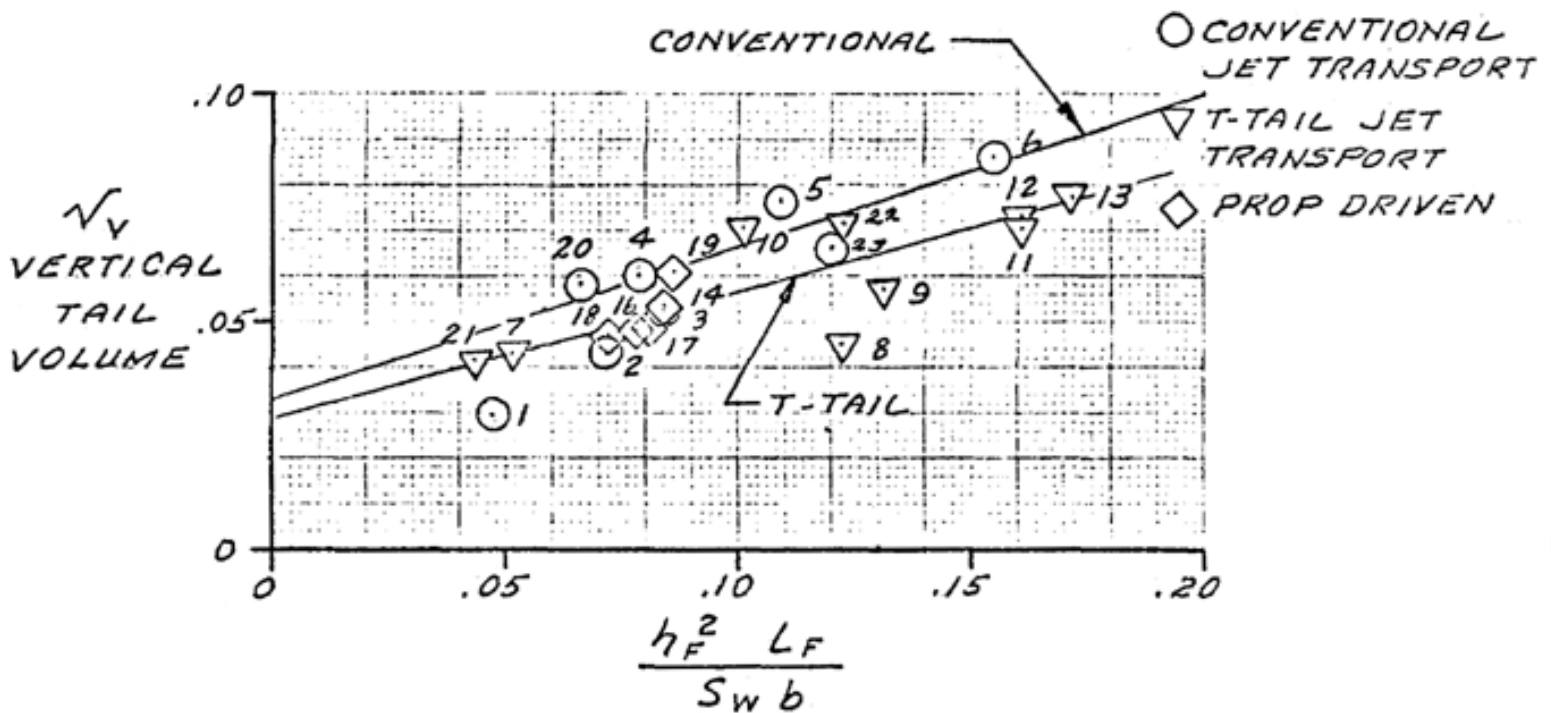

Correlation of aircraft vertical tail volume as a function of fuselage maximum height and length.

The above correlations are based on old airplane designs (as are most statistical methods). Some reduction in tail volumes are possible with stability augmentation. In any case, this tail sizing method is only used to establish a starting point for further analysis. The airplanes included above are:

1 Comet	9 DH-121	17 DC-6B
2 DC-8-50	10 B-727	18 DC-7
3 DC-8-61	11 DC-9-10	19 C-133
4 B-720	12 DC-9-30	20 C-990
5 B-747	13 DC-9-40	21 VC-10
6 B-737-200	14 DC-7C	22 C-5
7 C-141	15 DC-4	23 DC-10-10
8 BAC-111	16 DC-6	

The correlation is based on a fuselage destabilizing parameter:

h_f is the fuselage height

w_f is the fuselage width

L_f is the fuselage length

S_w , c_w , and b are the wing area, MAC, and span.

and provides a rough estimate for the required horizontal tail volume ($V_h = l_h S_h / c_w S_w$) and vertical tail volume ($V_v = l_v S_v / b S_w$). Recall that l_h and l_v are the distances from the c.g. to the a.c. of the horizontal and vertical tails

Rational Method

The following procedure may be used to compute the required tail size for a given stability level as a function of c.g. position. It assumes that the critical airplane control requirement is nosewheel rotation, although this is just one of many possible constraints.

For c.g. positions ranging from the leading edge of the M.A.C. to about 60% of the M.A.C. compute and plot the required tail volume coefficient,

$$V_h = \frac{l_h S_h}{S_w \bar{c}}$$

for the desired level of static stability. The minimum static margin would typically be about .10 but it must be increased because bending of the wing and the fuselage at high speeds reduces the rigid airplane stability. (Assume a change in sm of about -.10 for swept wing transport aircraft. sm changes due to aeroelasticity can usually be neglected in preliminary design of general aviation aircraft.) In addition, the desired static margin may be increased by about .10 for T-tail airplanes to improve high angle of attack stability.

In order to compute the required tail volume, you will need to find the distance from the c.g. to the wing a.c.. The position of the wing a.c. may be computed using the program Wing that was used in a previous assignment. The lift curve slope of the isolated tail and wing may also be computed using this program.

Control Power

The second requirement for the horizontal tail is that it provide sufficient control power. It must not only be possible to trim the airplane in cruise but also in more critical conditions. Typical critical conditions include: Rotation and nosewheel lift-off on take-off at forward c.g., trim without tail stall at maximum flap extension speed, and trim at forward c.g. with landing flaps at C_{Lmax} .

For this exercise we will consider only the problem of take-off rotation. We assume that the tail incidence and elevator angle settings are such that the horizontal tail can achieve a certain maximum lift coefficient C_{LHmax} (in the downward direction). The force required from the tail to rotate the airplane depends on the wing and body pitching moments to some extent but largely on the weight moment about the rear wheels.

Center of Gravity Range Design Trends

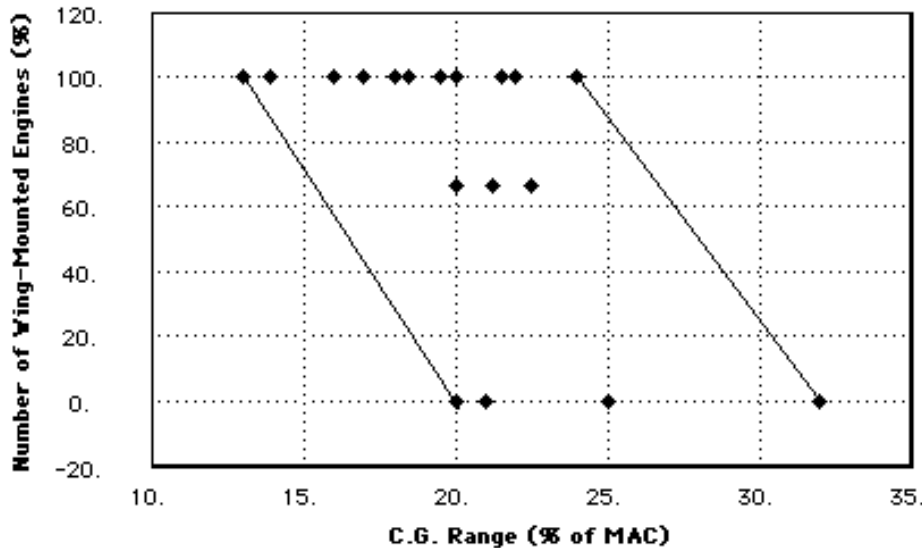

At aft c.g. the force is smallest, but a certain amount is required since the c.g. must lie in front of the rear wheels to prevent the airplane from tipping over on its tail. Actually, the requirement is not so much to avoid tipping backward but rather providing sufficient weight on the nosewheel to permit acceptable traction for steering. This is satisfied with about 8% of the weight on the forward wheels. With this load on the forward wheels, the moment about the rear wheels due to the forward position of the c.g. is at least: $|M| = .08 l_g W$ where l_g is the distance from the main gear to the nose gear.

The pitching moment coefficient at take-off is then:

$$C_{m_{\text{wheels}}} = \frac{.08 \Delta l_g W}{q S_w \bar{c}} + C_{m_{\text{zero}}}$$

We will ignore the aerodynamic term for now, although a detailed study would include this. For rotation, then, the load on the tail must be:

$$C_{L_h} = -C_{m_{\text{wheels}}} \left(\frac{S_w \bar{c}}{S_h l_h} \right) = -C_{m_{\text{wheels}}} \frac{1}{V_h}$$

The minimum tail volume required can then be calculated with the assumed C_{LHmax} . (For airplanes with variable incidence stabilizers and elevators $C_{LHmax} = 1.0$ will be an acceptable estimate.)

At forward c.g. positions, a larger tail is required since the moment about the rear wheels is:

$$M = M_{\text{aft-c.g.}} + W \Delta c.g.$$

(Note that $\Delta c.g.$ is the c.g. range. It is not the static margin, discussed earlier.)

$$\text{So, } C_{m_{\text{aft-c.g.}}} = C_{m_{\text{aft-c.g.}}} + C_{L_{TD}} \frac{\Delta c.g.}{\bar{c}}$$

The required tail volume may be determined from this analysis at the forward c.g. position. It may be interesting to compare your results with the statistical method shown in the previous section. Also note that we have previously estimated the main gear position at 50% of the MAC. If we desire 8% of the load on the nose gear at aft c.g. this means that the main gear must be located .08 lg behind the aft c.g.

Sec. 25.171 General.

The airplane must be longitudinally, directionally, and laterally stable in accordance with the provisions of Secs. 25.173 through 25.177. In addition, suitable stability and control feel (static stability) is required in any condition normally encountered in service, if flight tests show it is necessary for safe operation.

[Doc. No. 5066, 29 FR 18291, Dec. 24, 1964, as amended by Amdt. 25-7, 30 FR 13117, Oct. 15, 1965]

Sec. 25.173 Static longitudinal stability.

Under the conditions specified in Sec. 25.175, the characteristics of the elevator control forces (including friction) must be as follows:

(a) A pull must be required to obtain and maintain speeds below the specified trim speed, and a push must be required to obtain and maintain speeds above the specified trim speed. This must be shown at any speed that can be obtained except speeds higher than the landing gear or wing flap operating limit speeds or VFC/MFC, whichever is appropriate, or lower than the minimum speed for steady unstalled flight.

(b) The airspeed must return to within 10 percent of the original trim speed for the climb, approach, and landing conditions specified in Sec. 25.175 (a), (c), and (d), and must return to within 7.5 percent of the original trim speed for the cruising condition specified in Sec. 25.175(b), when the control force is slowly released from any speed within the range specified in paragraph (a) of this section.

(c) The average gradient of the stable slope of the stick force versus speed curve may not be less than 1 pound for each 6 knots.

(d) Within the free return speed range specified in paragraph (b) of this section, it is permissible for the airplane, without control forces, to stabilize on speeds above or below the desired trim speeds if exceptional attention on the part of the pilot is not required to return to and maintain the desired trim speed and altitude.

[Amdt. 25-7, 30 FR 13117, Oct. 15, 1965]

Sec. 25.175 Demonstration of static longitudinal stability.

Static longitudinal stability must be shown as follows:

(a) Climb. The stick force curve must have a stable slope at speeds between

85 and 115 percent of the speed at which the airplane--

(1) Is trimmed, with--

(i) Wing flaps retracted;

(ii) Landing gear retracted;

(iii) Maximum takeoff weight; and

(iv) 75 percent of maximum continuous power for reciprocating engines or the maximum power or thrust selected by the applicant as an operating limitation for use during climb for turbine engines; and

(2) Is trimmed at the speed for best rate-of-climb except that the speed need not be less than 1.4 VS1.

(b) Cruise. Static longitudinal stability must be shown in the cruise condition as follows:

(1) With the landing gear retracted at high speed, the stick force curve must have a stable slope at all speeds within a range which is the greater of 15 percent of the trim speed plus the resulting free return speed range, or 50 knots plus the resulting free return speed range, above and below the trim speed (except that the speed range need not include speeds less than 1.4 VS1, nor speeds greater than VFC/MFC, nor speeds that require a stick force of more than 50 pounds), with--

(i) The wing flaps retracted;

(ii) The center of gravity in the most adverse position (see Sec. 25.27);

(iii) The most critical weight between the maximum takeoff and maximum landing weights;

(iv) 75 percent of maximum continuous power for reciprocating engines or for turbine engines, the maximum cruising power selected by the applicant as an operating limitation (see Sec. 25.1521), except that the power need not exceed that required at VMO/MMO; and

(v) The airplane trimmed for level flight with the power required in paragraph (b)(1)(iv) of this section.

(2) With the landing gear retracted at low speed, the stick force curve must have a stable slope at all speeds within a range which is the greater of 15 percent of the trim speed plus the resulting free return speed range, or 50 knots plus the resulting free return speed range, above and below the trim speed (except that the speed range need not include speeds less than 1.4 VS1, nor speeds greater than the minimum speed of the applicable speed range prescribed in paragraph (b)(1), nor speeds that require a stick force of more than 50 pounds), with--

(i) Wing flaps, center of gravity position, and weight as specified in paragraph (b)(1) of this section;

(ii) Power required for level flight at a speed equal to $VMO + 1.4 VS1/2$; and

(iii) The airplane trimmed for level flight with the power required in paragraph (b)(2)(ii) of this section.

(3) With the landing gear extended, the stick force curve must have a stable slope at all speeds within a range which is the greater of 15 percent of the trim speed plus the resulting free return speed range, or 50 knots plus the resulting free return speed range, above and below the trim speed (except that the speed range need not include speeds less than 1.4 VS1, nor speeds greater than VLE, nor speeds that require a stick force of more than

50 pounds), with--

(i) Wing flap, center of gravity position, and weight as specified in paragraph (b)(1) of this section;

(ii) 75 percent of maximum continuous power for reciprocating engines or, for turbine engines, the maximum cruising power selected by the applicant as an operating limitation, except that the power need not exceed that required for level flight at VLE; and

(iii) The aircraft trimmed for level flight with the power required in paragraph (b)(3)(ii) of this section.

(c) Approach. The stick force curve must have a stable slope at speeds between 1.1 VS1 and 1.8 VS1, with--

(1) Wing flaps in the approach position;

(2) Landing gear retracted;

(3) Maximum landing weight; and

(4) The airplane trimmed at 1.4 VS1 with enough power to maintain level flight at this speed.

(d) Landing. The stick force curve must have a stable slope, and the stick force may not exceed 80 pounds, at speeds between 1.1 VS0 and 1.3 VS0 with--

(1) Wing flaps in the landing position;

(2) Landing gear extended;

(3) Maximum landing weight;

(4) Power or thrust off on the engines; and

(5) The airplane trimmed at 1.4 VS0 with power or thrust off.

[Doc. No. 5066, 29 FR 18291, Dec. 24, 1964, as amended by Amdt. 25-7, 30 FR 13117, Oct. 15, 1965]

Sec. 25.177 Static lateral-directional stability.

(a) [Reserved]

(b) [Reserved]

(c) In straight, steady sideslips, the aileron and rudder control movements and forces must be substantially proportional to the angle of sideslip in a stable sense; and the factor of proportionality must lie between limits found necessary for safe operation throughout the range of sideslip angles appropriate to the operation of the airplane. At greater angles, up to the angle at which full rudder is used or a rudder force of 180 pounds is obtained, the rudder pedal forces may not reverse; and increased rudder deflection must be needed for increased angles of sideslip. Compliance with this paragraph must be demonstrated for all landing gear and flap positions and symmetrical power conditions at speeds from 1.2 VS1 to VFE, VLE, or VFC/MFC, as appropriate.

(d) The rudder gradients must meet the requirements of paragraph (c) at speeds between VMO/MMO and VFC/MFC except that the dihedral effect (aileron deflection opposite the corresponding rudder input) may be negative provided

the divergence is gradual, easily recognized, and easily controlled by the pilot.

[Doc. No. 24344, Amdt. 25-72, 55 FR 29774, July 20, 1990; 55 FR 37607, Sept. 12, 1990]

55 FR 29756, No. 140, July 20, 1990

SUMMARY: These amendments to the Federal Aviation Regulations (FAR) update the standards for type certification of transport category airplanes for clarity and accuracy, and ensure that the standards are appropriate and practicable for the smaller transport category airplanes common to regional air carrier operation.

EFFECTIVE DATE: August 20, 1990.

Sec. 25.181 Dynamic stability.

(a) Any short period oscillation, not including combined lateral-directional oscillations, occurring between 1.2 VS and maximum allowable speed appropriate to the configuration of the airplane must be heavily damped with the primary controls--

- (1) Free; and
- (2) In a fixed position.

(b) Any combined lateral-directional oscillations ("Dutch roll") occurring between 1.2 VS and maximum allowable speed appropriate to the configuration of the airplane must be positively damped with controls free, and must be controllable with normal use of the primary controls without requiring exceptional pilot skill.

Sec. 25.143 General.

(a) The airplane must be safely controllable and maneuverable during--

- (1) Takeoff;
- (2) Climb;
- (3) Level flight;
- (4) Descent; and
- (5) Landing.

(b) It must be possible to make a smooth transition from one flight condition to any other flight condition without exceptional piloting skill, alertness, or strength, and without danger of exceeding the airplane limit-load factor under any probable operating conditions, including--

(1) The sudden failure of the critical engine;

(2) For airplanes with three or more engines, the sudden failure of the second critical engine when the airplane is in the en route, approach, or landing configuration and is trimmed with the critical engine inoperative; and

(3) Configuration changes, including deployment or retraction of deceleration devices.

(c) If, during the testing required by paragraphs (a) and (b) of this section, marginal conditions exist with regard to required pilot strength, the "strength of pilots" limits may not exceed the limits prescribed in the following table:

Values in pound of force as applied to the control wheel or rudder pedals	Pitch	Roll	Yaw
For temporary application	75	60	150
For prolonged application	10	5	20

(d) In showing the temporary control force limitations of paragraph (c) of this section, approved operating procedures or conventional operating practices must be followed (including being as nearly trimmed as possible at the next preceding steady flight condition, except that, in the case of takeoff, the airplane must be trimmed in accordance with approved operating procedures).

(e) For the purpose of complying with the prolonged control force limitations of paragraph (c) of this section, the airplane must be as nearly trimmed as possible.

[Doc. No. 5066, 29 FR 18291, Dec. 24, 1964, as amended by Amdt. 25-42, 43 FR 2321, Jan. 16, 1978]

Sec. 25.145 Longitudinal control.

(a) It must be possible at any speed between the trim speed prescribed in Sec. 25.103(b)(1) and V_s , to pitch the nose downward so that the acceleration to this selected trim speed is prompt with--

- (1) The airplane trimmed at the trim speed prescribed in Sec. 25.103(b)(1).
- (2) The landing gear extended;
- (3) The wing flaps (i) retracted and (ii) extended; and
- (4) Power (i) off and (ii) at maximum continuous power on the engines.

(b) With the landing gear extended, no change in trim control, or exertion of more than 50 pounds control force (representative of the maximum temporary force that readily can be applied by one hand) may be required for the following maneuvers:

(1) With power off, flaps retracted, and the airplane trimmed at 1.4 V_{S1} , extend the flaps as rapidly as possible while maintaining the airspeed at approximately 40 percent above the stalling speed existing at each instant throughout the maneuver.

(2) Repeat paragraph (b)(1) except initially extend the flaps and then retract them as rapidly as possible.

(3) Repeat paragraph (b)(2) except with takeoff power.

(4) With power off, flaps retracted, and the airplane trimmed at 1.4 V_{S1} , apply takeoff power rapidly while maintaining the same airspeed.

(5) Repeat paragraph (b)(4) except with flaps extended.

(6) With power off, flaps extended, and the airplane trimmed at 1.4 V_{S1} , obtain and maintain airspeeds between 1.1 V_{S1} , and either 1.7 V_{S1} , or V_{FE} , whichever is lower.

(c) It must be possible, without exceptional piloting skill, to prevent loss of altitude when complete retraction of the high lift devices from any position is begun during steady, straight, level flight at 1.1 V_{S1} for propeller powered airplanes, or 1.2 V_{S1} for turbojet powered airplanes, with--

(1) Simultaneous application of not more than takeoff power taking into account the critical engine operating conditions;

(2) The landing gear extended; and

(3) The critical combinations of landing weights and altitudes.

If gated high-lift device control positions are provided, retraction must be shown from any position from the maximum landing position to the first gated position, between gated positions, and from the last gated position to the full retraction position. In addition, the first gated control position from the landing position must correspond with the high-lift devices configuration used to establish the go-around procedure from the landing configuration. Each gated control position must require a separate and distinct motion of the control to pass through the gated position and must have features to prevent inadvertent movement of the control through the gated position.

[Doc. No. 5066, 29 FR 18291, Dec. 24, 1964, as amended by Amdt. 25-23, 35 FR 5671, Apr. 8, 1970; Amdt. 25-72, 55 FR 29774, July 20, 1990]

SUMMARY: These amendments to the Federal Aviation Regulations (FAR) update the standards for type certification of transport category airplanes for clarity and accuracy, and ensure that the standards are appropriate and practicable for the smaller transport category airplanes common to regional air carrier operation.

EFFECTIVE DATE: August 20, 1990.

Sec. 25.147 Directional and lateral control.

(a) Directional control; general. It must be possible, with the wings level, to yaw into the operative engine and to safely make a reasonably sudden change in heading of up to 15 degrees in the direction of the critical inoperative engine. This must be shown at 1.4Vs1 for heading changes up to 15 degrees (except that the heading change at which the rudder pedal force is 150 pounds need not be exceeded), and with--

(1) The critical engine inoperative and its propeller in the minimum drag position;

(2) The power required for level flight at 1.4 VS1, but not more than maximum continuous power;

(3) The most unfavorable center of gravity;

(4) Landing gear retracted;

(5) Flaps in the approach position; and

(6) Maximum landing weight.

(b) Directional control; airplanes with four or more engines. Airplanes with four or more engines must meet the requirements of paragraph (a) of this section except that--

(1) The two critical engines must be inoperative with their propellers (if applicable) in the minimum drag position;

(2) [Reserved]

(3) The flaps must be in the most favorable climb position.

(c) Lateral control; general. It must be possible to make 20 deg. banked turns, with and against the inoperative engine, from steady flight at a speed equal to 1.4 VS1, with--

(1) The critical engine inoperative and its propeller (if applicable) in the minimum drag position;

(2) The remaining engines at maximum continuous power;

(3) The most unfavorable center of gravity;

(4) Landing gear (i) retracted and (ii) extended;

(5) Flaps in the most favorable climb position; and

(6) Maximum takeoff weight.

(d) Lateral control; airplanes with four or more engines. Airplanes with four or more engines must be able to make 20 deg. banked turns, with and against the inoperative engines, from steady flight at a speed equal to 1.4 VS1, with maximum continuous power, and with the airplane in the configuration prescribed by paragraph (b) of this section.

(e) Lateral control; all engines operating. With the engines operating, roll response must allow normal maneuvers (such as recovery from upsets produced by gusts and the initiation of evasive maneuvers). There must be enough excess lateral control in sideslips (up to sideslip angles that might be required in normal operation), to allow a limited amount of maneuvering and to correct for gusts. Lateral control must be enough at any speed up to VFC/MFC to provide a peak roll rate necessary for safety, without excessive control forces or travel.

[Doc. No. 5066, 29 FR 18291, Dec. 24, 1964, as amended by Amdt. 25-42, 43 FR 2321, Jan. 16, 1978; Amdt. 25-72, 55 FR 29774, July 20, 1990]

55 FR 29756, No. 140, July 20, 1990

SUMMARY: These amendments to the Federal Aviation Regulations (FAR) update the standards for type certification of transport category airplanes for clarity and accuracy, and ensure that the standards are appropriate and practicable for the smaller transport category airplanes common to regional air carrier operation.

EFFECTIVE DATE: August 20, 1990.

Sec. 25.149 Minimum control speed.

(a) In establishing the minimum control speeds required by this section, the method used to simulate critical engine failure must represent the most critical mode of powerplant failure with respect to controllability expected in service.

(b) VMC is the calibrated airspeed at which, when the critical engine is suddenly made inoperative, it is possible to maintain control of the airplane with that engine still inoperative and maintain straight flight with an angle of bank of not more than 5 degrees.

(c) VMC may not exceed 1.2 VS with--

(1) Maximum available takeoff power or thrust on the engines;

(2) The most unfavorable center of gravity;

(3) The airplane trimmed for takeoff;

(4) The maximum sea level takeoff weight (or any lesser weight necessary to show VMC);

(5) The airplane in the most critical takeoff configuration existing along the flight path after the airplane becomes airborne, except with the landing gear retracted;

(6) The airplane airborne and the ground effect negligible; and

(7) If applicable, the propeller of the inoperative engine--

(i) Windmilling;

(ii) In the most probable position for the specific design of the propeller control; or

(iii) Feathered, if the airplane has an automatic feathering device acceptable for showing compliance with the climb requirements of Sec. 25.121.

(d) The rudder forces required to maintain control at VMC may not exceed 150 pounds nor may it be necessary to reduce power or thrust of the operative engines. During recovery, the airplane may not assume any dangerous attitude or require exceptional piloting skill, alertness, or strength to prevent a heading change of more than 20 degrees.

(e) VMCG, the minimum control speed on the ground, is the calibrated airspeed during the takeoff run at which, when the critical engine is suddenly made inoperative, it is possible to maintain control of the airplane using the rudder control alone (without the use of nosewheel steering), as limited by 150 pounds of force, and the lateral control to the extent of keeping the wings level to enable the takeoff to be safely continued using normal piloting skill. In the determination of VMCG, assuming that the path of the airplane accelerating with all engines operating is along the centerline of the runway, its path from the point at which the critical engine is made inoperative to the point at which recovery to a direction parallel to the centerline is completed may not deviate more than 30 feet laterally from the centerline at any point. VMCG must be established with--

(1) The airplane in each takeoff configuration or, at the option of the applicant, in the most critical takeoff configuration;

(2) Maximum available takeoff power or thrust on the operating engines;

(3) The most unfavorable center of gravity;

(4) The airplane trimmed for takeoff; and

(5) The most unfavorable weight in the range of takeoff weights.

(f) VMCL, the minimum control speed during landing approach with all engines operating, is the calibrated airspeed at which, when the critical engine is suddenly made inoperative, it is possible to maintain control of the airplane with that engine still inoperative and maintain straight flight with an angle of bank of not more than 5 degrees. VMCL must be established with--

(1) The airplane in the most critical configuration for approach with all engines operating;

(2) The most unfavorable center of gravity;

(3) The airplane trimmed for approach with all engines operating;

(4) The maximum sea level landing weight (or any lesser weight necessary to show VMCL); and

(5) Maximum available takeoff power or thrust on the operating engines.

(g) For airplanes with three or more engines, VMCL-2, the minimum control speed during landing approach with one critical engine inoperative, is the calibrated airspeed at which, when a second critical engine is suddenly made inoperative, it is possible to maintain control of the airplane with both engines still inoperative and maintain straight flight with an angle of bank of not more than 5 degrees. VMCL-2 must be established with--

- (1) The airplane in the most critical configuration for approach with the critical engine inoperative;
- (2) The most unfavorable center of gravity;
- (3) The airplane trimmed for approach with the critical engine inoperative;
- (4) The maximum sea level landing weight (or any lesser weight necessary to show VMCL-2);
- (5) The power or thrust on the operating engines required to maintain an approach path angle of 3 degrees when one critical engine is inoperative; and
- (6) The power or thrust on the operating engines rapidly changed, immediately after the second critical engine is made inoperative, from the power or thrust prescribed in paragraph (g)(5) of this section to--
 - (i) Minimum available power or thrust; and
 - (ii) Maximum available takeoff power or thrust.

(h) The rudder control forces required to maintain control at VMCL and VMCL-2 may not exceed 150 pounds, nor may it be necessary to reduce the power or thrust of the operating engines. In addition, the airplane may not assume any dangerous attitudes or require exceptional piloting skill, alertness, or strength to prevent a divergence in the approach flight path that would jeopardize continued safe approach when--

- (1) The critical engine is suddenly made inoperative; and
- (2) For the determination of VMCL-2, the power or thrust on the operating engines is changed in accordance with paragraph (g)(6) of this section.

[Doc. No. 5066, 29 FR 18291, Dec. 24, 1964, as amended by Amdt. 25-42, 43 FR 2321, Jan. 16, 1978; Amdt. 25-72, 55 FR 29774, July 20, 1990; 55 FR 37607, Sept. 12, 1990]

55 FR 29756, No. 140, July 20, 1990

SUMMARY: These amendments to the Federal Aviation Regulations (FAR) update the standards for type certification of transport category airplanes for clarity and accuracy, and ensure that the standards are appropriate and practicable for the smaller transport category airplanes common to regional air carrier operation.

EFFECTIVE DATE: August 20, 1990.

Trim

Sec. 25.161 Trim.

(a) General. Each airplane must meet the trim requirements of this section after being trimmed, and without further pressure upon, or movement of, either the primary controls or their corresponding trim controls by the pilot or the automatic pilot.

(b) Lateral and directional trim. The airplane must maintain lateral and directional trim with the most adverse lateral displacement of the center of gravity within the relevant operating limitations, during normally expected conditions of operation (including operation at any speed from 1.4 VS1 to VMO/MMO).

(c) Longitudinal trim. The airplane must maintain longitudinal trim during--

(1) A climb with maximum continuous power at a speed not more than 1.4 VS1, with the landing gear retracted, and the flaps (i) retracted and (ii) in the takeoff position;

(2) A glide with power off at a speed not more than 1.4 VS1, with the landing gear extended, the wing flaps (i) retracted and (ii) extended, the most unfavorable center of gravity position approved for landing with the maximum landing weight, and with the most unfavorable center of gravity position approved for landing regardless of weight; and

(3) Level flight at any speed from 1.4 VS1, to VMO/MMO, with the landing gear and flaps retracted, and from 1.4 VS1 to VLE with the landing gear extended.

(d) Longitudinal, directional, and lateral trim. The airplane must maintain longitudinal, directional, and lateral trim (and for the lateral trim, the angle of bank may not exceed five degrees) at 1.4 VS1 during climbing flight with--

(1) The critical engine inoperative;

(2) The remaining engines at maximum continuous power; and

(3) The landing gear and flaps retracted.

(e) Airplanes with four or more engines. Each airplane with four or more engines must maintain trim in rectilinear flight--

(1) At the climb speed, configuration, and power required by Sec. 25.123(a) for the purpose of establishing the rate of climb;

(2) With the most unfavorable center of gravity position; and

(3) At the weight at which the two-engine-inoperative climb is equal to at least 0.013 VS02 at an altitude of 5,000 feet.

[Doc. No. 5066, 29 FR 18291, Dec. 24, 1964, as amended by Amdt. 25-23, 35 FR 5671, Apr. 8, 1970; Amdt. 25-38, 41 FR 55466, Dec. 20, 1976]

Static Stability and Trim

This program uses the concepts described in this chapter to compute the airplane static margin and tail loads to trim. The program uses data entered on pages dealing with the fuselage layout, wing geometry, tail geometry, and high lift systems.

Propulsion Systems



In these notes a very short introduction to aircraft propulsion is given, followed by a more comprehensive discussion of installation and issues affecting aircraft conceptual design. This chapter includes the following topics:

- [Basic Concepts](#), including engine types, considerations on choosing number of engines, and some basic sizing rules.
- [Installation](#), describing some of the considerations in nacelle design and placement as well as some specific geometry data
- [Performance](#), including some typical engine data.

Propulsion Systems: Basic Concepts

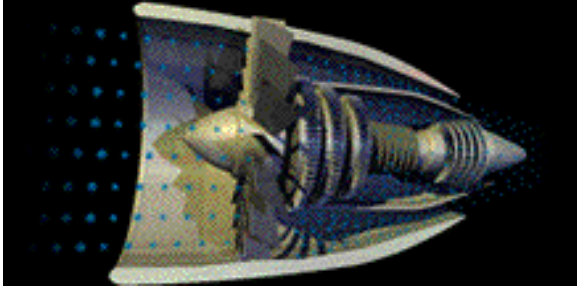

The operation of a propulsion system may be viewed simply as shown below. A fluid enters the system at speed V_0 with a mass flow of \dot{m} . It exits at speed V_e , and mass is added to the outflow at a rate \dot{m}_f . The force exerted by this system includes the rate of change of momentum through the system and a pressure term:



$$T = \dot{m}(V_e - V_0) + \dot{m}_f V_e + A_e(p_e - p_0)$$

This equation for thrust holds for systems ranging from chemical and electric rockets to ramjets, turbojets, and propeller-driven aircraft.

Engine Types

Rockets

The expression is simplest in the case of a rocket operating outside the atmosphere. In this case, the thrust is simply given by:

$$T = \dot{m} V_e$$

where V_e is the exit velocity of the exhaust flow. The exhaust gases may be the by-products of the rocket fuel combustion, or just unburned expanded gas, or any other mass. In the case of electric rocket propulsion, small droplets of Mercury or other heavy material are accelerated in an electric field to produce thrust. The fuel (or other mass) flow for a given thrust is minimized by achieving high exit velocities. Typical values of exit velocity are 3000 to 4000 m/s (10000-13000 ft/sec) for liquid propellant rockets.

There is a large advantage to be gained if one does not have to carry all of the mass used to generate thrust. This can be seen by examining the total energy required to produce the change in momentum. The

rate of change of energy is given by:

$$\frac{dE}{dt} = \frac{\dot{m}}{2} (V_e^2 - V_0^2) + \frac{\dot{m}_f}{2} V_e^2$$

Thus, to produce the most thrust with the least energy consumption, it is best to do so with a large value of \dot{m}/dt and a small change in U . This is because the energy required varies with U^2 while the momentum change is linear in U . This basic principal applies to many systems. It is why helicopters have large diameter rotors, wings need large spans, and propellers are more efficient than jets at low speeds. This concept serves to distinguish the several types of propulsion systems, as discussed in the following sections.

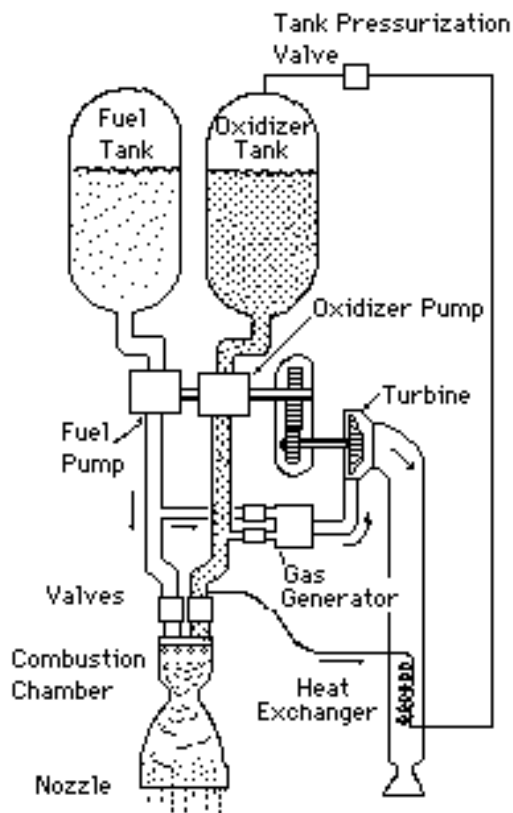

Ramjets

Ambient air can be used, not only to provide oxidizer for burning fuel, but also as a source of mass. This is done most simply in the ramjet engine.

The ramjet has no moving parts. High speed air enters the inlet, is compressed as it is slowed down, is mixed with fuel and burned in the combustion chamber, and is finally expanded and ejected through the nozzle. For the combustion process to be efficient, the air must be compressed sufficiently. This is possible only when the freestream Mach number exceeds about 3, and so ramjets have been practical for only a few missile applications. A hybrid engine, part turbojet, part ramjet, was also used on the SR-71 high speed reconnaissance aircraft and is a topic of current research interest for several possible hypersonic applications.



Turbojets

When additional compression is required of the intake air, a separate compressor may be added to the ramjet as shown in the figure below. A single-stage centrifugal compressor was used until about 1953. Such a compressor could produce an increase in total pressure of about 4. More modern axial compressors can produce overall pressure ratios (OPR) of about 8.5 with a single stage and by including several stages of compression, pressure ratios of 13 have been achieved on turbojet engines. For the turbofan designs discussed in the next section, the multi-stage compressors achieve pressure ratios of 25-30, enabling efficient operation at subsonic speeds.

In order to power the compressor, a windmill is placed in the engine exhaust-in principal that is what the turbine stage does. The turbine is located downstream of the combustor and is connected to the compressor blades with a shaft. It extracts power from the flow in the same way that a windmill extracts power.

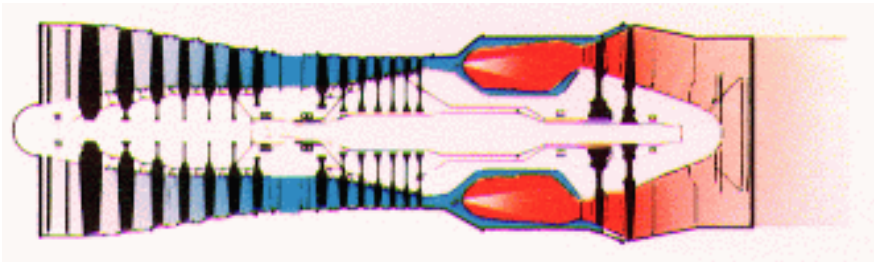

Turbofans

Increased efficiency at low speeds requires that the mass of air affected by the engine be increased. However, for a given rate of fuel burned, there is a corresponding mass of air that should be mixed with the fuel and one cannot simply force more air through the combustor. Instead, one may route some of the air around the combustor and turbine, and so bypass the engine core. Engines are characterized by their bypass ratio (BPR), the ratio of mass flux bypassing the combustor and turbine to the mass flux through the core. Engines with bypass ratios of 0 are called straight jets or sometimes turbojets. Engines with bypass ratios of 1 to 2 are generally termed low bypass ratio turbofans. High bypass turbofans found on most current transport aircraft have BPR's of 5-8. It is sometimes necessary to drive the first few stages of the compressor (fan) at a slower speed than the high pressure stages, so twin-spool engines or even triple spool engines (three separate shafts from turbine to compressor stages) are common. Gearing between the turbine and fan stages is also possible to provide more optimal fan performance. More detail is shown in the figures on the following pages.

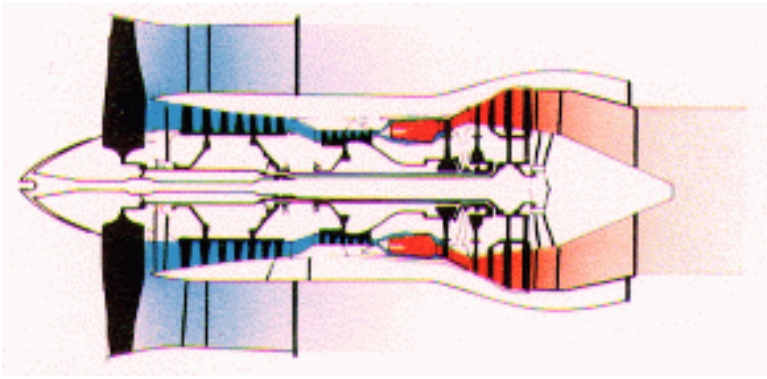

The figure below shows a Pratt and Whitney 4084 engine used on the 777. The diameter of this 84,000 lb thrust engine with nacelle is only somewhat smaller than the diameter of a 717.



Turboprops

When the bypass ratio is increased to 10-20 for very efficient low speed performance, the weight and wetted area of the fan shroud (inlet) become large, and at some point it makes sense to eliminate it altogether. The fan then becomes a propeller and the engine is called a turboprop. Turboprop engines provide efficient power from low speeds up to as high as $M=0.8$ with bypass ratios of 50-100.

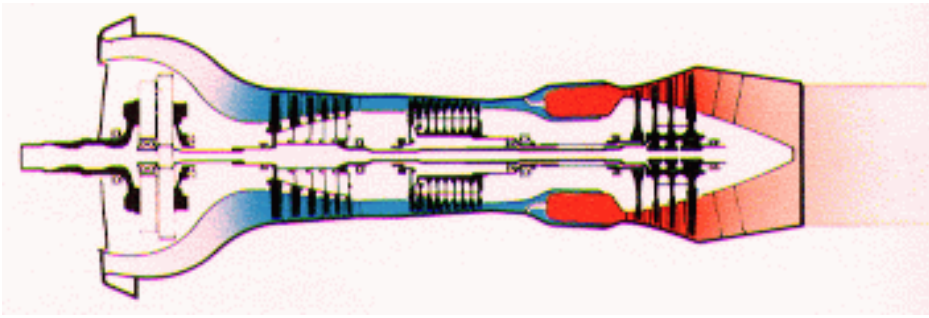

Advanced Turboprops and Ultra-high Bypass Ratio Turbofans

One can increase the efficiency of turbofans from their current values of 35% - 40% to values close to 45% by further increasing the bypass ratio. Advanced designs with bypass ratios of 12-25 are sometimes termed advanced ducted propellers or ADP's. Although the propulsive efficiency of such designs is very high, they are often less desirable than the engines with more moderate bypass ratios. This is due to the difficulties of installing these very large diameter engines, especially on low-wing configurations, and on the weight and drag penalties associated with the large duct.

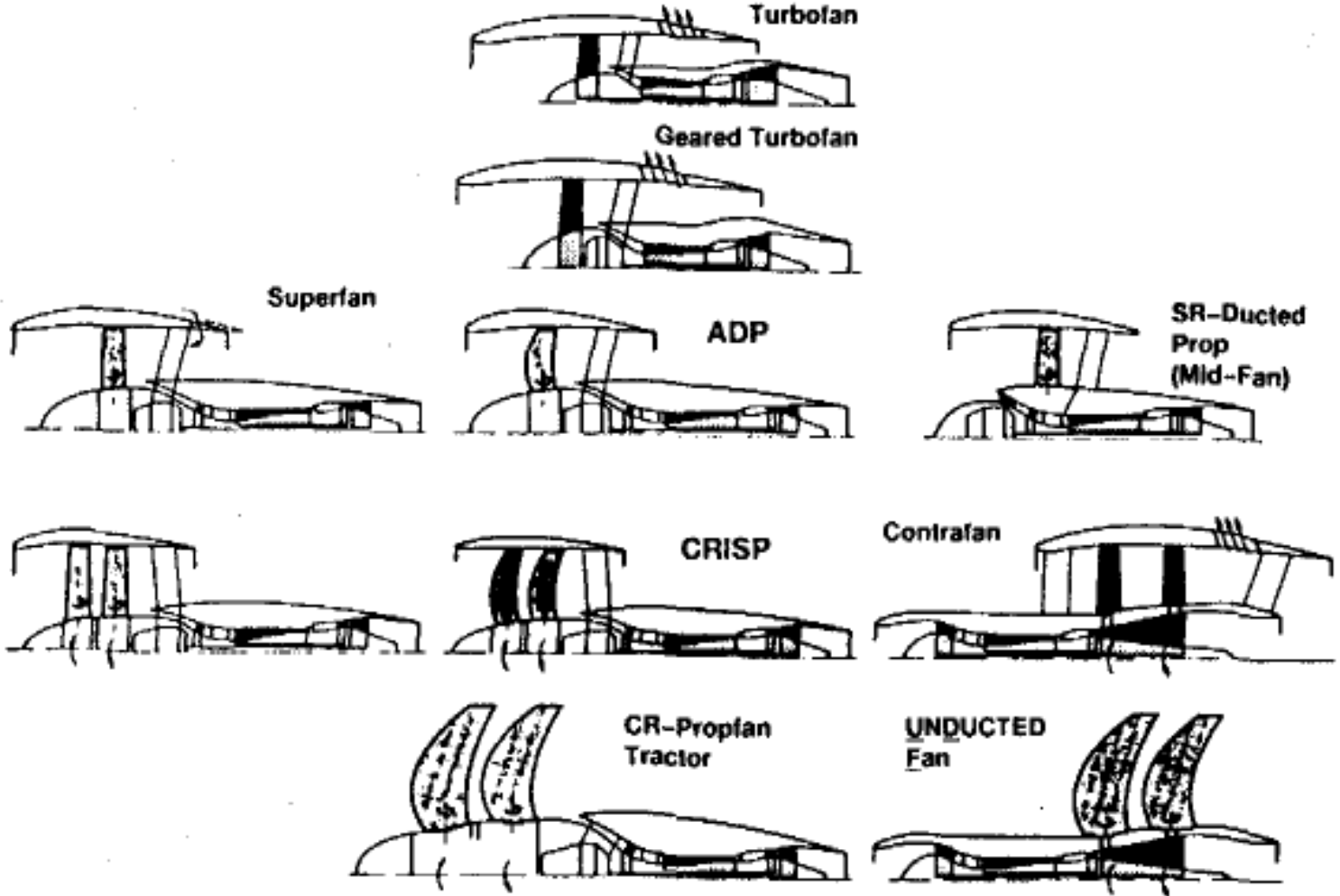

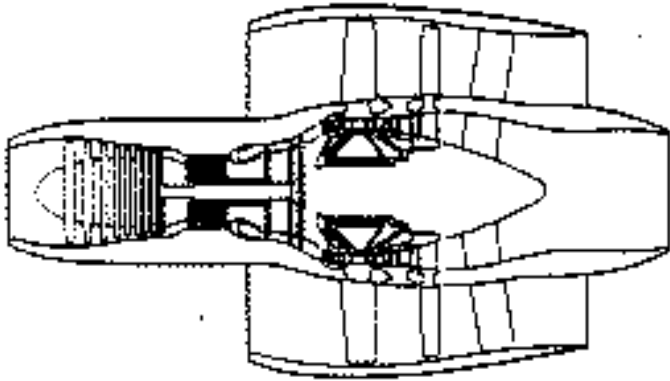

An unusual ADP with the fan located aft and attached directly to the turbine. Note the stator vanes in both turbine and fan sections to reduce swirl losses.

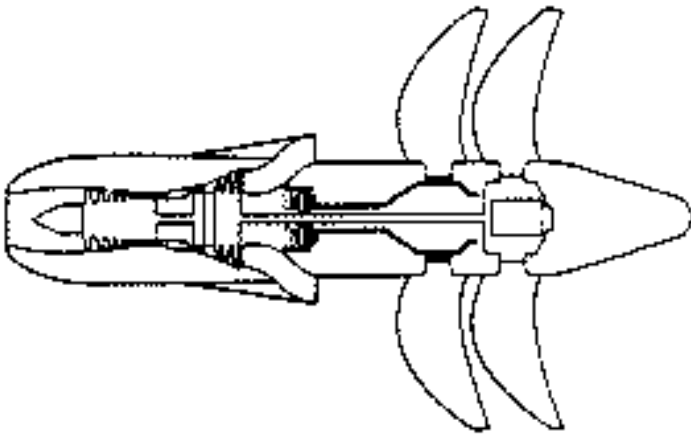

A counter-rotating prop-fan. At some value of bypass ratio, the advantages associated with the duct are overwhelmed by the weight and drag of the duct itself. Bypass ratio 50, ductless propfans such as the one shown here have been proposed for aircraft that fly up to Mach 0.8.

Propellers / Piston Engines

It is possible, of course, to power the propeller by any available means, from turbine to piston engine, electric motor to rotary engine, rubber bands to human muscle. In many of these cases, the bypass ratio is infinite. Very high efficiency especially at low speeds is possible, although as the propeller diameter is increased, installation issues become more severe.

Engines for Supersonic Aircraft

The following discussion from Boeing describes the recent thrust of engine development work for the high speed civil transport (HSCT).

Considerable effort has been devoted to improvement of engine specific fuel consumption (SFC) at subsonic conditions over the past 20 years. The original U.S. SST had very poor subsonic SFC. High subsonic SFC penalizes the mission performance by reducing the efficiency during subsonic

mission legs and by requiring larger amounts of reserve fuel. The key to good subsonic and supersonic SFC is a variable-cycle engine. The major objective for a future HSCT application is to provide some degree of engine cycle variability that will not significantly increase the cost, the maintenance requirements, or the overall complexity of the engine. The variable-cycle engine must have a good economic payoff for the airline while still providing more mission flexibility and reducing the reserve fuel requirements so that more payload can be carried. In the past, variable-cycle engines were designed with large variations in bypass ratio to provide jet noise reduction. However, these types were complicated and did not perform well. Today, the trend is toward turbojets or low-bypass engines that have the ability to improve off-design performance by adjustment of compressor bleed or by a relatively small variation in bypass ratio. The current engine offerings from Pratt & Whitney and General Electric fall into this category. Both of these engines will require an effective jet noise suppressor. Rolls-Royce/SNECMA favors other approaches. One is a tandem fan that operates as a turbojet cycle for cruise but opens a bypass inlet and nozzle for higher flow at subsonic speeds. A second approach is to increase the bypass ratio by incorporating an additional fan and turbine stream into the flow path at subsonic speeds.

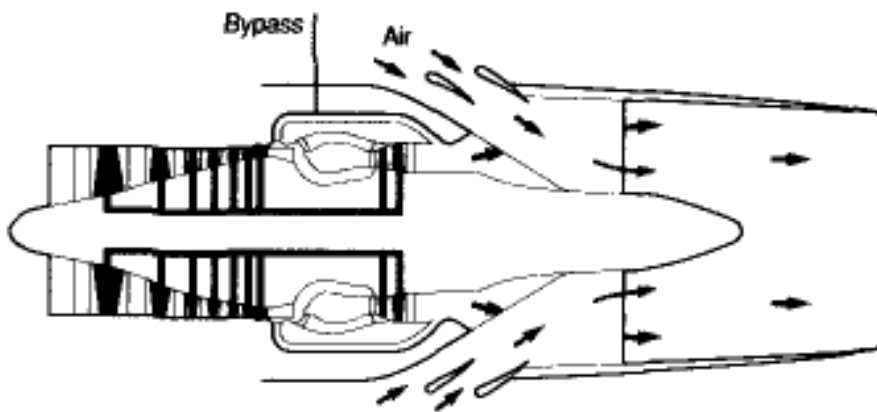

**Turbine-Bypass
Turbojet Engine**

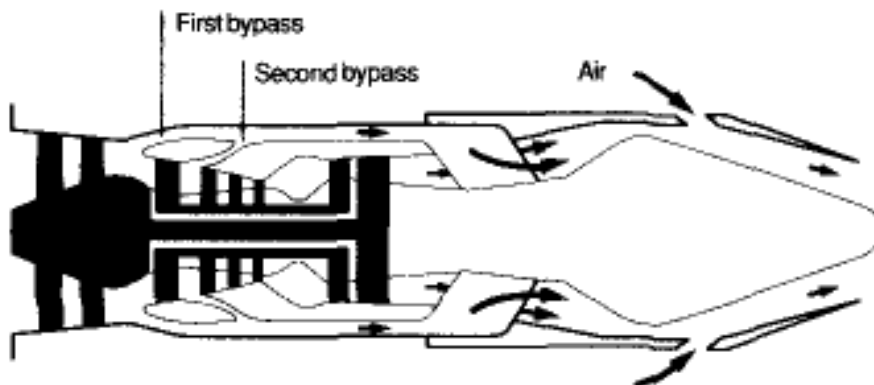

**Double-Bypass
Turbofan Engine**

Some additional information on current supersonic engine development efforts from NASA Lewis

follows:

Following are five of the most promising engine concepts studied.

(1) Turbine bypass engine (TBE) is a single spool turbojet engine that possesses turbofan-like subsonic performance, but produces the largest jet velocity of all the concepts. Hence, it needs a very advanced technology mixer-ejector exhaust nozzle with about 18 decibels (dB) suppression ability to attain FAR 36 Stage III noise requirements without over sizing the engine and reducing power during take off. This level of suppression could be reached if the ejector airflow equals 120 percent of the primary flow.

(2) The Variable Cycle Engine (VCE) which alters its bypass ratio during flight to better match varying requirements. However, although its original version defined in the 1970's relied on an inverted velocity profile exhaust system to meet less stringent FAR 36 Stage II noise goals, the revised version needs a more powerful 15 dB suppression solution. A 60 percent mass flow augmented mixer-ejector nozzle together with modest engine oversizing would satisfy this requirement. It should not be inferred from the above that the TBE needs a 120 percent mass flow augmented mixer-ejector nozzle while the VCE only needs one that is 60 percent. There is uncertainty concerning the best combination of mass flow augmentation, acoustic lining, and engine oversizing for both engines.

(3) A relative newcomer, the fan-on-blade ("Flade") engine is a variation of the VCE. It has an auxiliary third flow stream deployed during takeoff by opening a set of inlet guide vanes located in an external annular duct surrounding the VCE. The auxiliary annular duct is pressurized by extension to the fan blades and is scrolled into the lower half of the engine prior to exhausting to provide a fluid acoustic shield. It also requires a relatively modest mixer-ejector exhaust nozzle of approximately 30 percent flow augmentation.

(4) The fourth concept is the mixed flow turbofan (MFTF) with a mixer-ejector nozzle.

(5) The final engine concept is a TBE with an Inlet Flow Valve (TBE/IFV). The IFV is activated during takeoff to permit auxiliary inlets to feed supplementary air to the rear compressor stages while the main inlet air is compressed by just the front compressor stages. While a single spool TBE/IFV still needs a mixer-ejector exhaust nozzle, it seems possible to avoid that complexity with a two-spool version because of greater flow handling ability in the takeoff mode.

Data on several specific engines is provided in the section on [engine performance](#). Links to manufacturers' sites are provided in that section as well.

How Many Engines?

One of the questions to be answered early in the conceptual design stage is how many engines will be desirable. The recent trend is definitely toward fewer engines, with twin engine aircraft becoming the most

popular design. This has become possible for larger aircraft as the thrust of engines has climbed to levels that were nearly unimaginable not long ago. 100,000+ lb sea level static thrust engines are now available.

The interest in large twin engine aircraft come from the greater economy afforded by using fewer engines. Current engine prices are such that it is less expensive to obtain a specified sea level static thrust level with two large engines than with three or four smaller ones.

However, when more engines are used, the system is more reliable. And it is not just the propulsion system that is more reliable. When additional electrical generators or hydraulic pumps are available, overall system reliability is improved. However, it is more likely that at least one engine will fail.

These considerations limited the use of twin engine aircraft for long flights. The U.S. operating rules limited two and three engine aircraft to routes over which the airplane could not be more than 60 minutes from an alternate airport after an engine had failed. In 1964, three-engine turbine-powered aircraft were exempted from this rule. More recently, the FAA approved extended range operations for twin engine aircraft requiring that the aircraft stay within 120 minutes (with engine failure) of an appropriate airport and 180 minute ETOPS are becoming more common.

Probability of Engine Failure

Failed Engines:	1	2	3	4
Total Engines:				
1	P	-	-	-
2	2P	P ²	-	-
3	3P	3P ²	P ³	-
4	4P	6P ²	4P ³	P ⁴

The probability, P, in this table depends on the particular engine and the flight duration, but for typical high bypass ratio turbines, the in-flight shutdown rate varies from .02 to .1 per 1000 hours, with the higher rates associated with engines in their introduction. A value of 0.05 is a typical average.

In addition to questions of reliability, several other considerations are important in the selection of the number of engines.

Twin Engine Aircraft: must meet climb requirements with one engine out. This means that the available thrust is reduced by more than 50% (more because of the extra drag associated with the failed engine and the need to trim with asymmetric thrust). Engine failure on a four-engine aircraft reduces the thrust by a bit more than 25%. This means that twins have engines that are often oversized for long range cruise. This adds weight, cost, and drag.

Four Engine Aircraft: must meet second segment climb requirements with 75% or so of installed power, usually leading to a better match with cruise performance, but the larger number of engines mean more parts, more maintenance, and more cost. The distribution of engine mass over the wing can reduce the bending loads on the wing, but may also result in greater penalties to prevent flutter.

Tri-jets: are a compromise losing favor. The third engine creates a problem with installation as discussed in the next section.

There are sometimes other considerations that are dominant in the selection of number of engines. General aviation aircraft are generally required to have a stall speed not greater than 61 knots if they have only one engine (although now this requirement may be waived). This is a major reason that most higher speed GA airplanes are twins. The BAE-146, a small four-engine feeder aircraft was designed to operate out of small airports without extensive maintenance facilities. It was desirable to be able to fly to a larger facility after one engine had failed. By using four engines, the aircraft is allowed to take-off with just three operating engines on a ferry mission (no passengers) to be repaired elsewhere.

The choice of number of engines is most strongly related to engine sizing. Typical ratios of aircraft sea-level static thrust to take-off weight are given below:

Typical T/W for
Various Transport
Aircraft

Aircraft Type:	T/W
Twin	.3
Tri-jet	.25
4-Engine	.2
Twin Exec. Jet	.4
SST	.4

Note: the data for commercial aircraft above come from Jane's All the World's Aircraft.

SST numbers include:

0.40 from a Japanese study (see References), 0.385 (Langley Study), .380 (Concorde w/ afterburners), .28 (Boeing Study w/ Turbine Bypass Engine concept of Pratt and Whitney), .24-.30 (Langley Study assuming 'advanced engines'), .36 (1970's U.S. SST), .398 (Douglas AST 1975 study), .32 (Douglas Mach 3.2 study airplane, 1989)

One starts with these rough estimates of thrust-to-weight ratio, selects an engine from the currently available list, and sometimes scales the basic engine as needed.

Propulsion Systems: Performance

This section deals more specifically with engine performance. It is divided into the following subsections:

[Thrust Variation with Speed and Altitude](#)

[SFC and Efficiency](#)

Specific Engine Data

[Large turbofans](#)

[Small turbofans](#)

[Engines for supersonic aircraft](#)

In addition, information is available from the following engine manufacturer's links:

[CFM-56 Family](#)

[Pratt and Whitney 4000](#)

[GE Commercial Aircraft Engines](#)

[GE-90 Design and Technology](#)

[Rolls-Royce page](#) with information on the Trent, RB211, Allison AE3007, and Williams FJ-44 engines.

Thrust Variation with Speed and Altitude

The following pages provide examples of the kind of information provided by engine manufacturers. Data on sfc and thrust as a function of Mach number, altitude, throttle setting and power extraction are generally provided in the form of plots and now as software based cycle decks.

Unlike propeller-powered aircraft for which the power output is approximately constant with changes in speed, turbojets produce a more constant thrust with speed. Modern turbofans are somewhat in-between constant thrust jets and constant power propeller systems. Significant reductions in net thrust are associated with increasing speed and altitude.

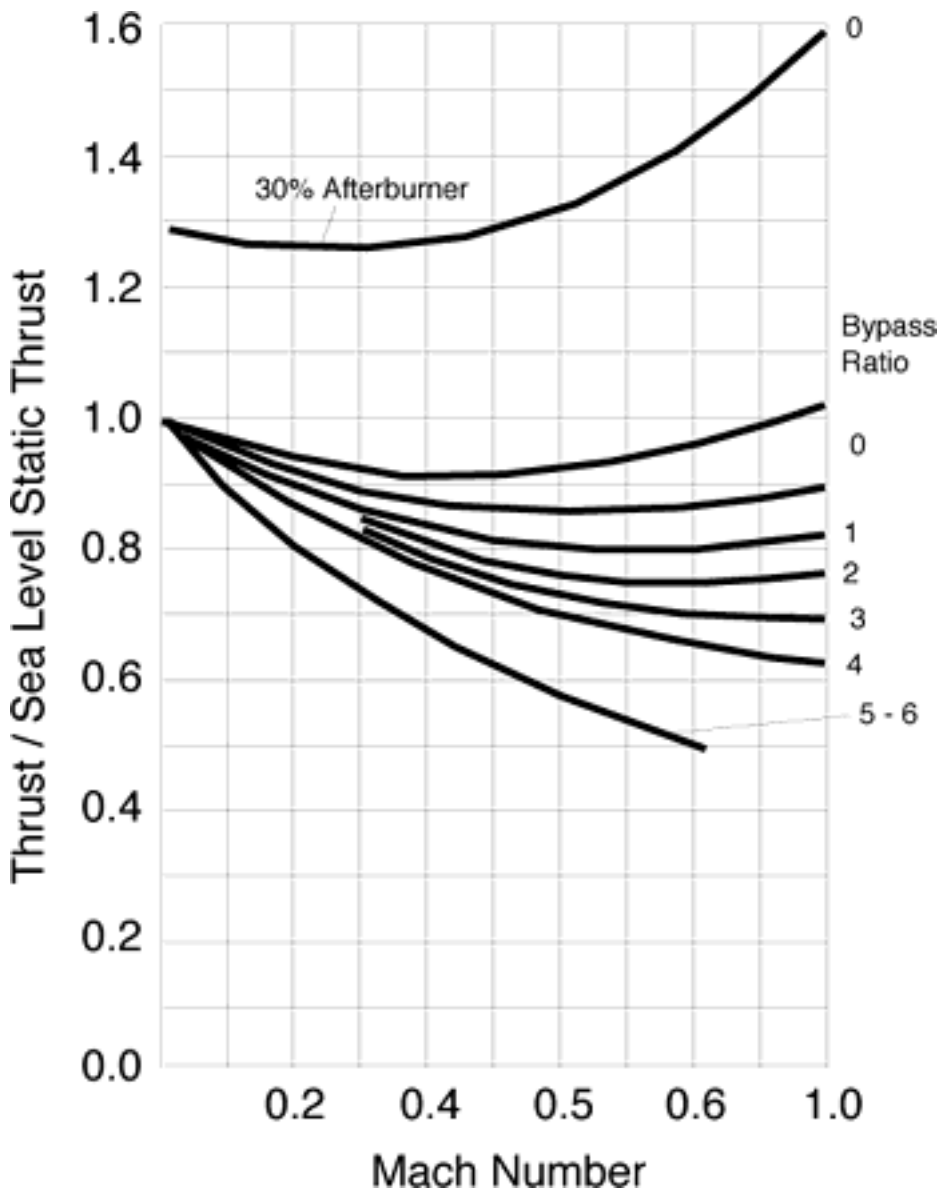

Typical trend of thrust vs. speed for turbojets and turbofans with varying bypass ratio at sea level.

A particular engine's thrust performance usually cannot be inferred well from generic cycle decks and it is common now to begin an aircraft design study with a number of computer decks from the different engine manufacturers. This is because many possible constraints on engine pressures, temperatures, and RPM's may be critical at different operating points. Many engines are flat-rated, meaning that they might

actually be able to produce much more thrust at low altitudes and speeds, but they are limited (often in software) to lower thrust levels to extend engine life and reduce maximum loads. Thus some supersonic engines show very little reduction in thrust from sea-level static conditions to Mach 1 at 30,000 ft.

Actual engine performance differs from the basic engine data in a number of ways. The air bled from the compressor for air conditioning, the power extracted for hydraulic pumps and alternators, and inlet and exhaust duct losses reduce engine thrust. The exact amount depends, of course, on the requirements of the accessories, the engine size, and the inlet and duct design, but reasonable estimates for conventional inlets are:

- 1) Thrust is reduced by 3.5% below engine specification levels
- 2) Specific fuel consumption is increased by 2.0%

During the take-off the air conditioning bleed is often shut-off automatically to avoid the thrust loss. The remaining thrust loss is about 1%. If a long or curved (S-bend) inlet is involved as in center engine installations, an additional thrust loss of 3% and a specific fuel consumption increase of 1-1/2% may be assumed. This additional loss applies only to the affected engine.

Specific Fuel Consumption and Overall Efficiency

The engine performance may be described in several ways. One of the useful parameters is specific fuel consumption, or s.f.c. For turbojets and fans, the s.f.c. is usually expressed as the thrust specific fuel consumption or t.s.f.c.. It is defined as the weight of the fuel burned per unit time, per unit thrust. In English units, t.s.f.c. is usually quoted in lbs of fuel per hour per lb of thrust or just lb/hr/lb or 1/hr. (In SI units the t.s.f.c. is sometime expressed in kg/hr/kN.)

For turboprop or piston engines, the s.f.c. is often expressed as a power specific fuel consumption, i.e. weight of fuel per unit time per unit power delivered to the propeller. This quantity is often denoted b.s.f.c. (for brake-power s.f.c.) and has units of 1/length. It is expressed in the unwieldy, but familiar English units of lb / hr / h.p..

The overall efficiency of the propulsion system is given by:

$$\eta = \text{Power Available to Aircraft} / \text{Rate of Energy Consumption} = T V / w h$$

where T = thrust, V= aircraft speed, w = rate of fuel consumption (weight/unit time), and h = specific energy of the fuel (energy / unit weight).

In terms of the s.f.c.: $\eta = V / \text{tsfc } h$.

One must be careful to use consistent units in this expression.

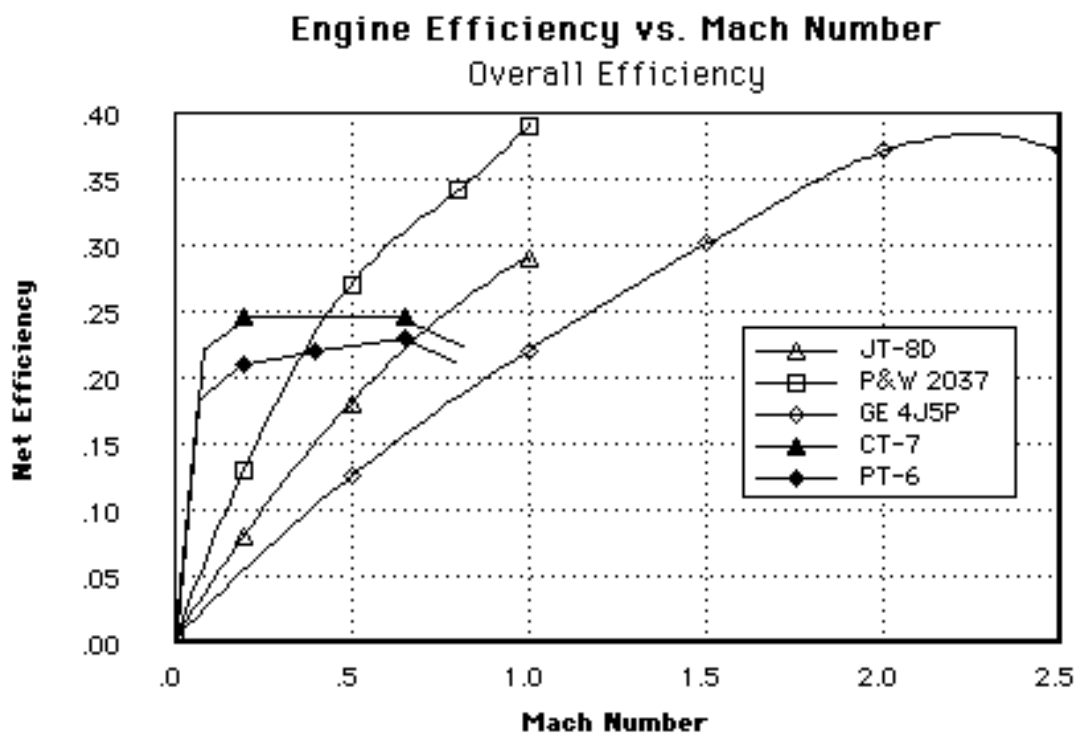

Overall efficiency of several engines vs. Mach number.

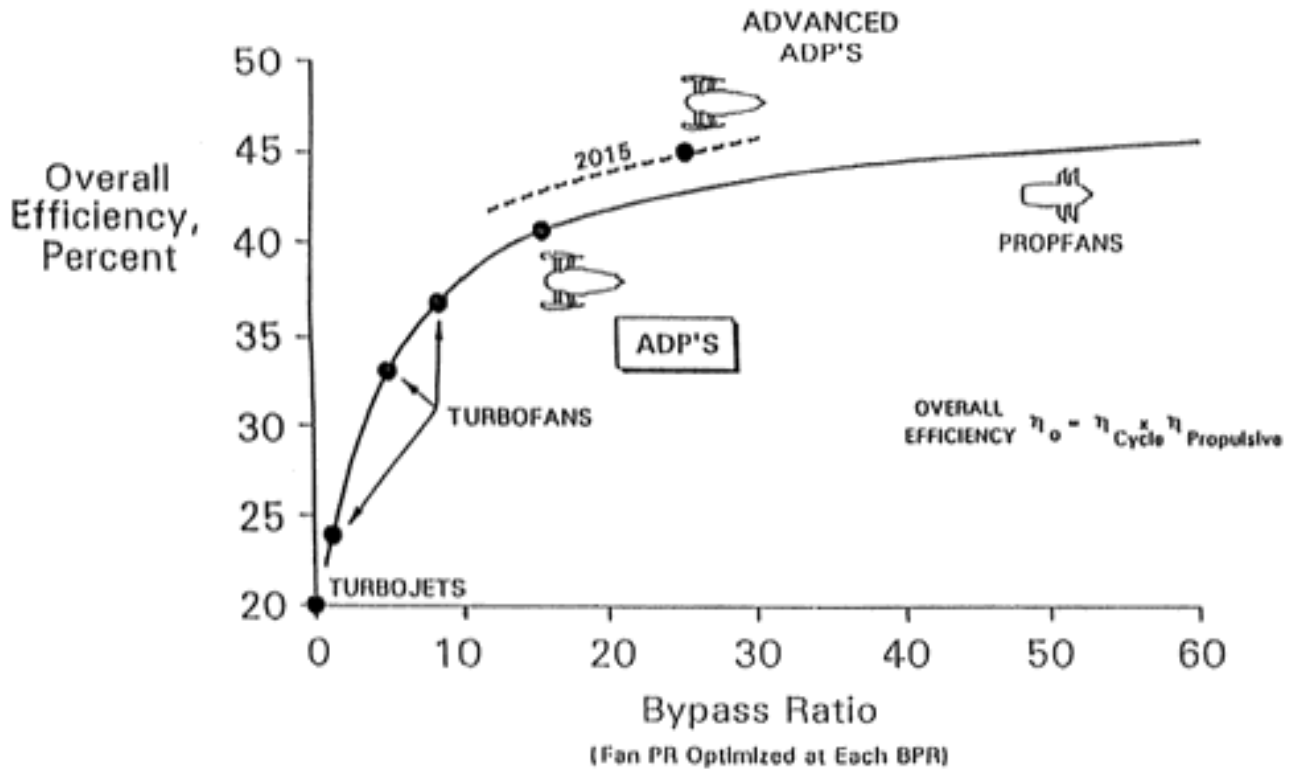

Overall efficiency vs. bypass ratio for large commercial turbine engines. (From Dennis Berry, Boeing)

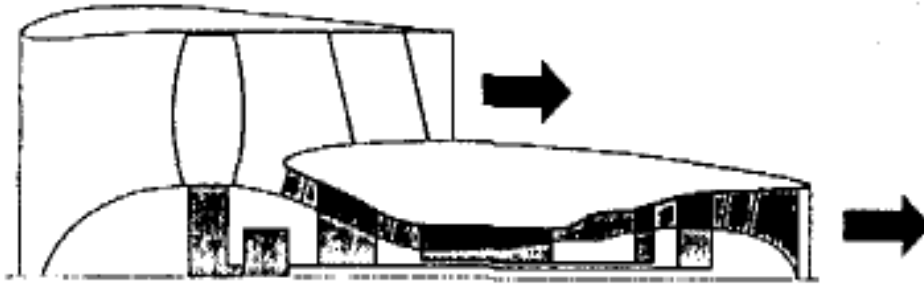

$$\eta_{tot} = \eta_{Prop} \times \eta_{Core}$$

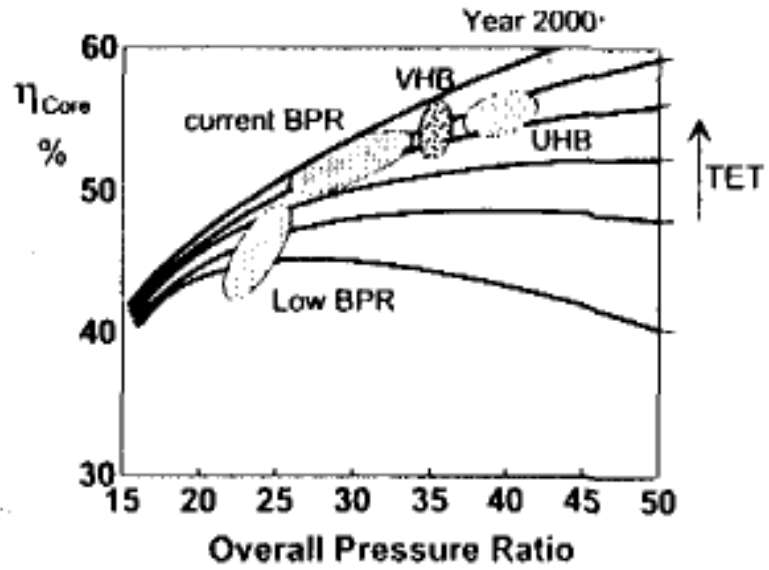
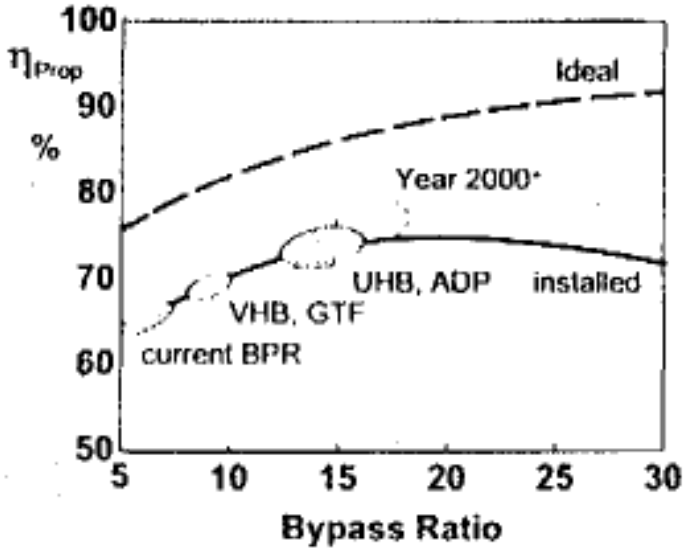

Trends in advanced engine efficiency.

Subsonic Engine Efficiencies:

(At about min sfc throttle setting 80% at typical cruise conditions)

GE90	.361
PW4000	.348
PW2037	.351 (M.87 40K)
PW2037	.335 (M.80 35K)
CFM56-2	.305
TFE731-2	.234

Data on Large Turbofan Engines

These pages contain some basic data and pictures of larger turbofan engines.

PW4000 112-INCH FAN ENGINE

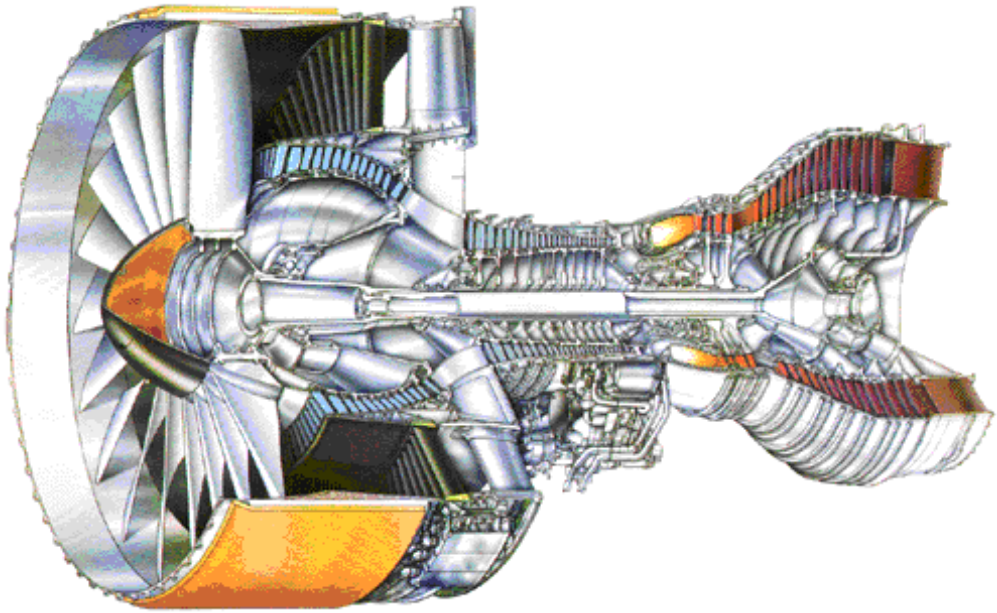

Cut-away showing the PW4000-Series of Engine

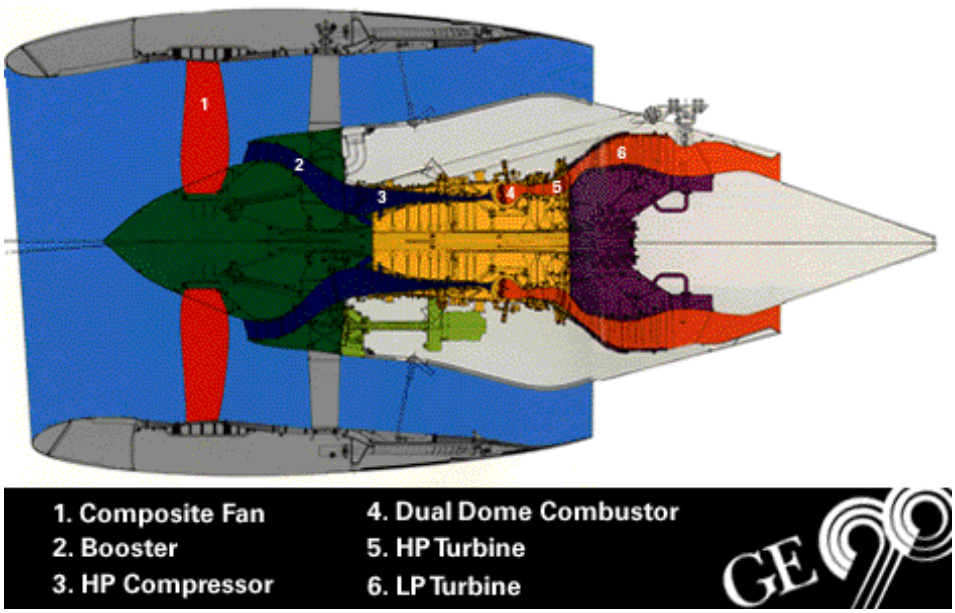

Cross-Section of GE-90 Engine

Some Basic Data

Engine	SLS Thrust	SLS SFC	Max Diam	Length	Wt	BPR	Cruise sfc	Applications
ALF502R-6	7500	0.415	50	65.6	1375	-	-	Bae-146
TFE731-2	3500	0.493	39.4	51	725	2.67	0.87	Citation
TFE731-20	3650	0.441	39.4	51	885	-	-	Lear 45
BR710	20000	0.39	52.9	87	3520	-	-	G-V, Global Express
AE3007	7580	0.39	43.5	106.5	1581	-	-	Citation10, Embraer RJ145
CFM56-2-C1	22200	0.36	72	95.7	4635	6	0.64	A340
CF34-3B	9220	0.35	49	103	1670		-	Canadair Challenger, RJ
CF6-80C2B1F	58000	0.316	106	168	9499		0.605	B747-400
GE90-90B	90000		134	204	16644	9	.55 (est)	B777-200/300
V2500-A1	25000	0.36	67.5	126	5210	5.4	0.543	A319-321
RB211-524H	60600		86.3	125	9499	4.1	0.603	747-400 / 767-300
Tay 620	13850	0.43	60	102	3185	3.04	0.69	Fokker 70/100
Trent 800	92000	0.35	110	172	14400	6.5	0.56	777
JT8D-217	20850	0.53	56.3	154	4430	1.74	0.71	MD-80
PW2037	38250	0.33	84.8	146.8	7160	5.8	0.563	757, C-17
PW4098	98000		112	191.7	16165	5.8	.56 (est)	777
FJ44-1	1900	0.456	20.9	41.9	445			CitationJet
FJ44-2	2300		23.7	40.2	448	3.28		Raytheon Premier
JT3-D-7	19000	0.55	52.9	134.4	4300		0.79	
JT8D-11	15000	0.62	43	120	3310		0.82	
JT9D-3A	43500	0.346	95.6	128.2	8608		0.6	
ADP	65500		120	200	9500	12	0.53	Hypothetical 2015 Engine
ADP	70000		144	200	12500	20	0.49	
GE4	69000	0.9	90	296.04	13243		1.47	B2707 SST Design Mach 2
GE21J11B14	65000	0.8	74.16	282			1.35	SCAR study Mach 2.6
Olympus 593	38000	1.39	49	150	6780		1.195	Concorde
TBE-M1.6	70600	0.875			9252		1.12	NASA MACH 1.6 STUDY
TBE-M2.0	69000	0.873			9278		1.2	NASA MACH 2.0 STUDY
TBE-2.4	65500	0.929			9587		1.31	NASA MACH 2.4 STUDY
Rolls VCE	49460	0.55					1.1	HSCT Design Study

Rolls Tandem	49460	0.55	1.09	HSCT Design Study
-----------------	-------	------	------	-------------------

Small Engines Summary

There are not many engines in the 2000lb to 4000lb thrust class appropriate for small turbofan aircraft. Here is the list of all viable turbofan engines (1K-10K lb thrust) currently in production or under development in the west (source: AW&ST, Janes, Web). Engines that have afterburners or have very low bypass ratio (SFC of 1.0 and up) are not listed here.

Engine	Thrust [lb]	SFC	D	Length	Weight,lb	Application
Allied Signal						//www.alliedsignal.com/
F109-GA-100	1330	0.39	31"	44"	439	Squalus, Phoenix FanJet
TFE731	3500-5000	0.51-.40	40"	50"	734-988	Cessna/Falcon/Lear/Astra
ATF3	5400	0.50	34"	103"	1120	Falcon, HU25
CFE 738	6000	0.37	48"	99"	1325	With GE. Falcon 2000
F124	6300	0.81	36"	70"	1100	Aero Vodochody L-139
ALF502/507	6700-7800	0.43-0.41	50"	65"	1350	Ch 600, Bae-146, AvroRJ
Allison						
AE3007	7200	0.39	43"	106"	1580	Citation-X, Global-Hawk
General Electric						
CF700	4500	0.65	37"	54"	767	Falcon, Sabreliner
CF/TF-34	9200	0.35	49"	103"	1670	Challenger 601/RJ,A-10
IHI (Japan)						
F-3	3700	0.70	22"	79"	458	Kawasaki T-4
TF-40	7300	0.74	30"	114"	1690	Mitsubishi T-2, F-1
P&W/P&Wc/MTU						
JT15D	3000	0.55	28"	61"	630	Citation 5, Beechjet 400
PW500/530/545	3000-4500	0.44	27"	70"	765	Citation Bravo, Excel
PW305/306	4500-6500	0.39	38"	81"	1040	Learjet 60

Williams/Rolls-Royce						
F107/F112	700	N/A	12"	40"	146	ALCM, Tomahawk
FJX-2	700	N/A	14"	41"	100	V-Jet 2
FJ44-1,2	1900-2300	0.456	21"	40"	445	Premier, Darkstar, SJ30

The FJX engine is currently being developed by Williams as part of a NASA program and has caused considerable excitement in the general aviation community. Here are some recent updates from NASA.

The GAP Turbine engine (FJX-2) is on its way to becoming reality. Hardware is being built, components are being tested and we expect to have the first complete engine ready for testing by August of this year. In addition to the FJX-2 turbofan, we are developing a the turboprop version of the engine (TSX-2) for ground testing in 1999. The FJX-2 will be flight demonstrated in the V-Jet II aircraft but the TSX-2 will not be flight tested as part of the GAP program, our main emphasis is on the fan version of the engine. This engine has many unique design features with a KISS (keep-it-simple-stupid) design philosophy to keep the costs down to the lowest possible level. This does not mean a low performance engine however, at less than 100 lbs. weight for 700 lbs. thrust and a fuel consumption rate per pound of thrust similar to larger modern turbofan engines this will be a world class engine. The FAA is participating in the program to ensure that the new and innovative design features of this engine will meet all certification requirements in a cost effective manner.

The first FJX-2 turbofan engine was fully assembled on December 18, 1998, by Williams International in Walled Lake, Michigan, marking a major milestone in the GAP program. On December 22, 1998, the first operational test of the new FJX-2 engine was conducted in the Williams static test facility. The engine was then disassembled for inspection and found to be in excellent condition. The engine is now being reassembled and will continue to be developed to a flight worthy status over the next 18 months.

The development of the FJX-2 engine commenced in December 1996 under a Cooperative Agreement between NASA/GRC and Williams International. The engine will be integrated into the V-Jet II concept aircraft and flight demonstrated at the EAA Oshkosh AirVenture in late July 2000.

Selected Data on Supersonic Engines

From NASA AIAA 92-1027 TBE

Design Mach	1.6	2	2.4
SLSThrust (klb)	70.6	69	65.5
Engine Weight	9252	9278	9587
Total Weight	14595	15521	17424
Cruise sfc	1.118	1.199	1.31

Some thrust and sfc lapse rates: (From 92-1027, Concorde brochure, Boeing CR, SAE901890, SAE1892)

M	h	T	sfc	eta	source
0	0	70610	0.8746	0	AIAA92-1027
1.6	45000	29528	1.118	0.346	
0	0	69035	0.8728	0	AIAA92-1027
2	55000	21911	1.1991	0.404	
0	0	65482	0.9293	0	AIAA92-1027
2.4	65000	18955	1.31	0.443	
0	0	38050			Concorde Brochure
2	60000	6791	--		
0	0	52730	--	0	Boeing CR
0.9	30000?	42q	0.98	0.22	
2.4	60000?	25q	1.28	0.454	
2	--	--	1.2	0.403	SAE 1890
0	0	49460	0.548	0	Rolls VCE
0.95	31000	7868	0.845	0.279	

1.3	35000	12930	0.902	0.351	
2	60000	8711	1.1	0.44	
0	0	-----	1.39	0	Rolls Olympus Data
0.95	31000	-----	1.025	0.23	
1.3	35000	-----	1.415	0.224	
2	60000	-----	1.195	0.405	
0	0	49460	0.551		Rolls Tandem Fan
0.95	31000	7868	0.816	0.288	
1.3	35000	12930	0.893	0.354	
2	60000	8711	1.094	0.437	

Overall engine efficiencies at cruise:

Mach	eta	eta_goal	source
1.0	.38	.38	Douglas CR pg47
2.0	.42	.45	"
3.2	.46	.56	"
5.0	.50	.58	"

Some rough additional rules from a Rolls-Royce SNECMA paper:

Nacelle isolated drag = 4.6% T (friction) + 4.4% T (wave)

SLSTH/Weng = 5.28

TOThrust = .37 GTOW (Concorde)

Propulsion Systems: Installation

This section deals with engine installation issues for preliminary design. The detailed integration of propulsion system and airframe is very complex, requiring some of the most sophisticated aerodynamic tools that are currently available, but some of the basic considerations are discussed in the following sections including:

[Engine Placement](#)

[Nacelle Design and Engine Geometry](#)

[Supersonic Aircraft Engine Layout](#)

Engine Placement

The arrangement of engines influences the aircraft in many important ways. Safety, structural weight, flutter, drag, control, maximum lift, propulsive efficiency, maintainability, and aircraft growth potential are all affected.

Engines may be placed in the wings, on the wings, above the wings, or suspended on pylons below the wings. They may be mounted on the aft fuselage, on top of the fuselage, or on the sides of the fuselage. Wherever the nacelles are placed, the detailed spacing with respect to wing, tail, fuselage, or other nacelles is crucial.

Wing-Mounted Engines

Engines buried in the wing root have minimum parasite drag and probably minimum weight. Their inboard location minimizes the yawing moment due to asymmetric thrust after engine failure. However, they pose a threat to the basic wing structure in the event of a blade or turbine disk failure, make it very difficult to maximize inlet efficiency, and make accessibility for maintenance more difficult. If a larger diameter engine is desired in a later version of the airplane, the entire wing may have to be redesigned. Such installations also eliminate the flap in the region of the engine exhaust, thereby reducing C_{Lmax} .

For all of these reasons, this approach is no longer used, although the first commercial jet, the deHavilland Comet, had wing-root mounted engines. The figure shows Comet 4C ST-AAW of Sudan Airways.



The following figure, from the May 1950 issue of Popular Science, shows the inlet of one of the Comet's engines. "Four turbine engines are placed so close of centerline to plane that even if two on one side cut out, pilot has little trouble maintaining straight, level flight."

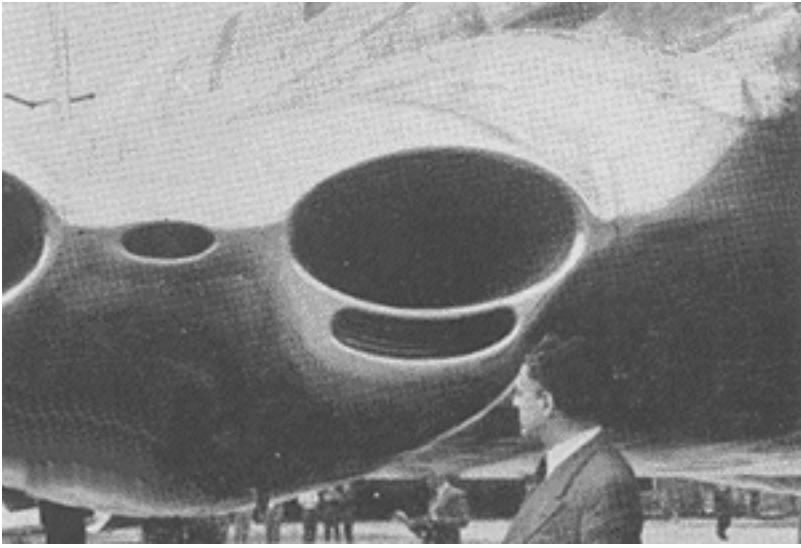

Wing-mounted nacelles can be placed so that the gas generator is forward of the front spar to minimize wing structural damage in the event of a disk or blade failure. Engine installations that do not permit this, such as the original 737 arrangement may require additional protection such as armoring of the nacelle, to prevent catastrophic results following turbine blade failure. This puts the inlet well ahead of the wing leading edge and away from the high upwash flow near the leading edge. It is relatively simple to obtain high ram recovery in the inlet since the angle of attack at the inlet is minimized and no wakes are ingested.

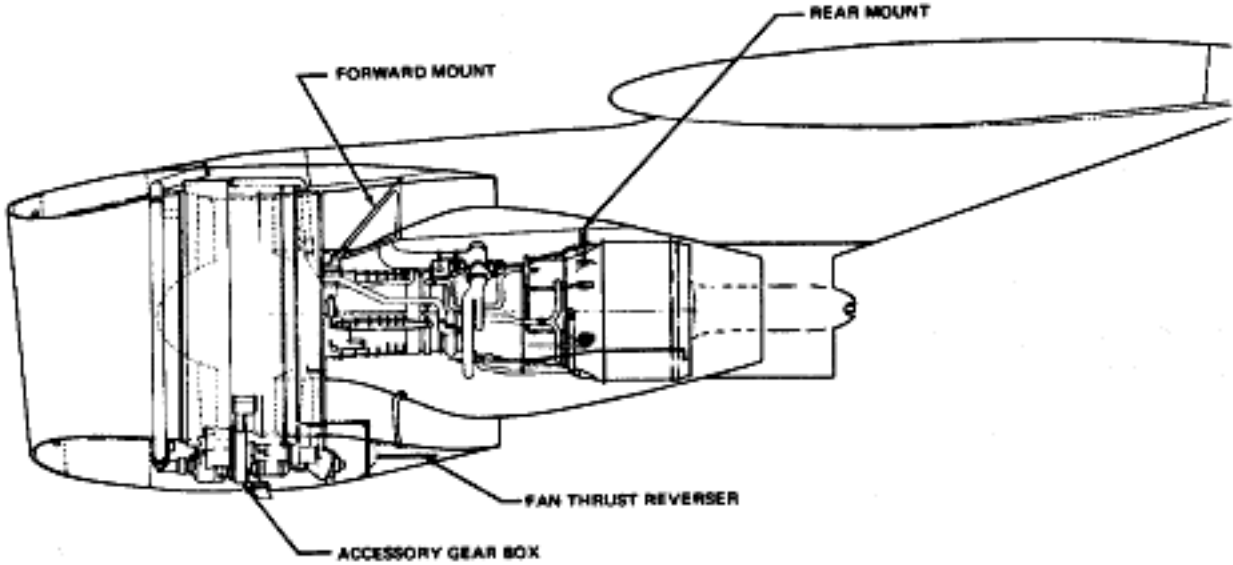

In the days of low bypass ratio turbofans, it was considered reasonable to leave a gap of about 1/2 the engine diameter between the wing and nacelle, as shown in the sketch of the DC-8 installation below.

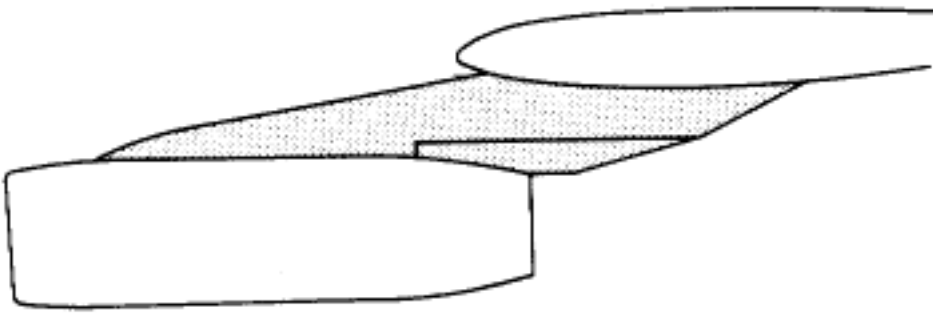

As engine bypass ratios have increased to about 6 - 8, this large gap is not acceptable. Substantial work has been undertaken to minimize the required gap to permit large diameter engines without very long gear.

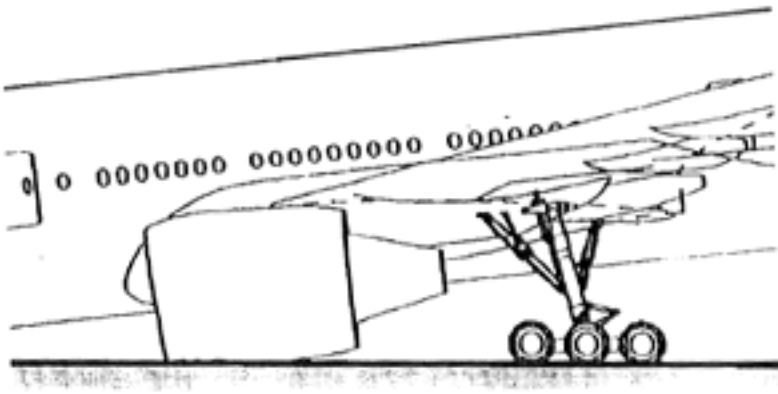

Current CFD-based design approaches have made it possible to install the engine very close to the wing as shown in the figure below. The 737 benefited especially from the closely mounted engines, permitting this older aircraft design to be fitted with high bypass ratio engines, despite its short gear.

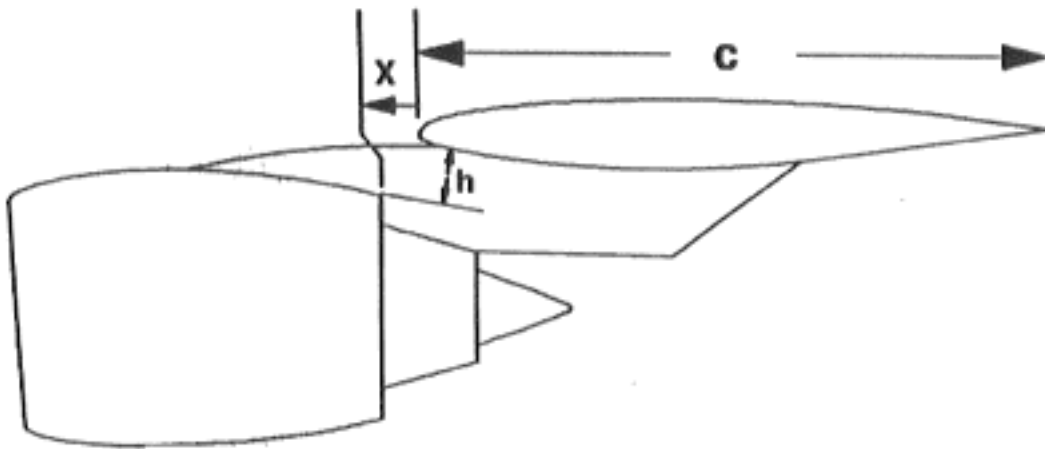

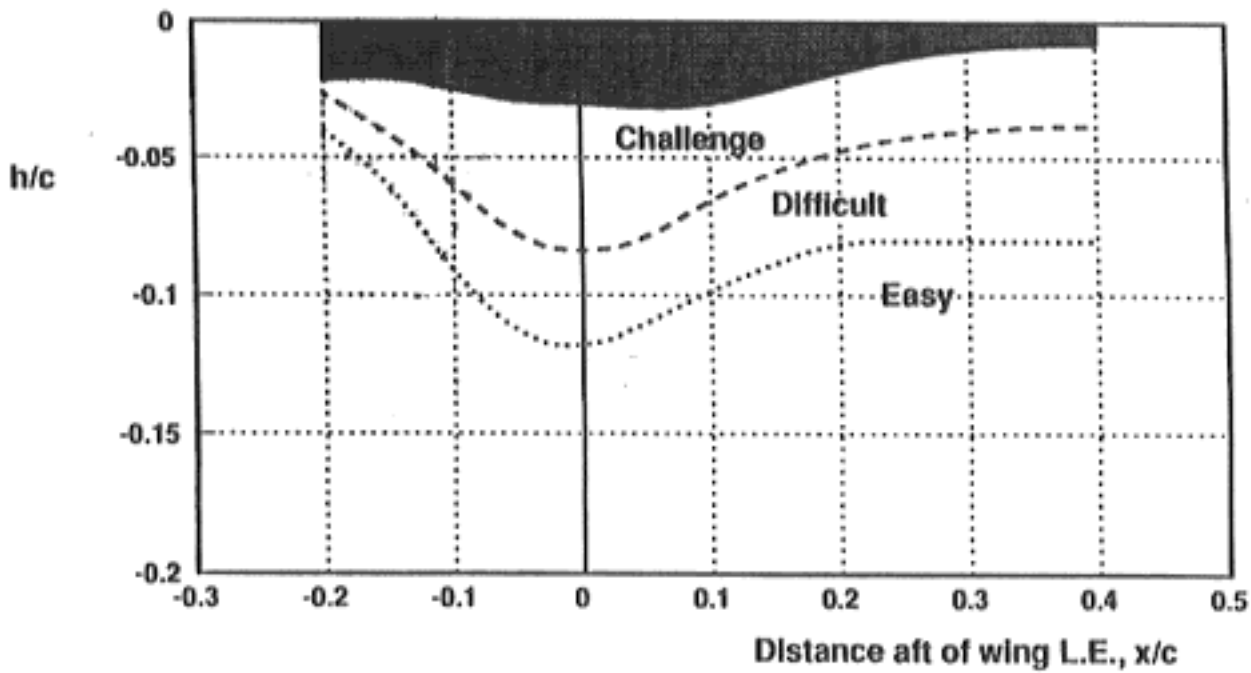

Laterally nacelles must be placed to avoid superposition of induced velocities from the fuselage and nacelle, or from adjoining nacelles. This problem is even greater with respect to wing-pylon-nacelle interference and requires nacelle locations to be sufficiently forward and low to avoid drag increases from high local velocities and especially premature occurrence of local supersonic velocities. The figure below from Boeing shows some of the difficulty in placing the engines too close to the fuselage.

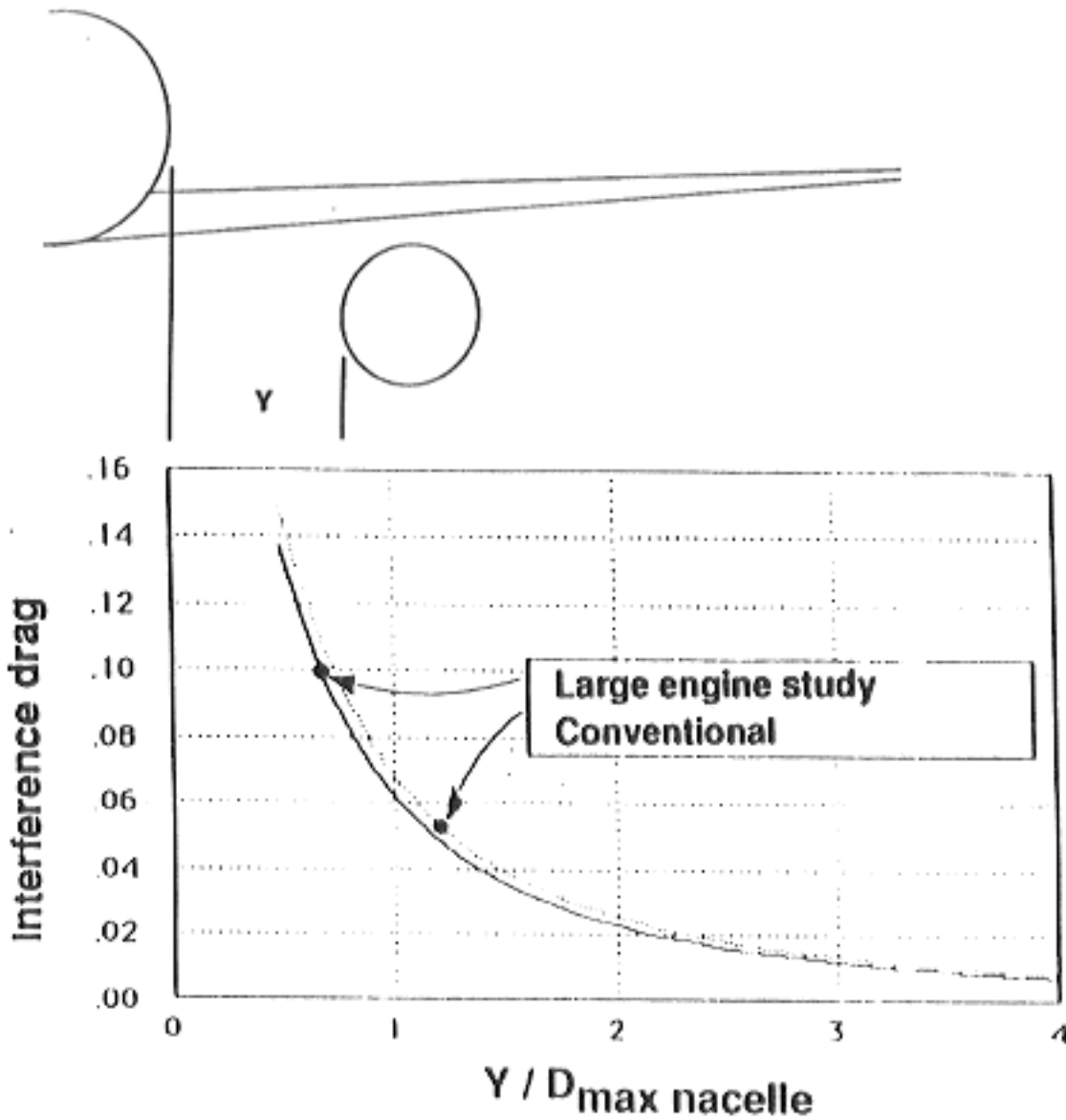

Influence of lateral nacelle position on interference drag

Structurally, outboard nacelle locations are desirable to reduce wing bending moments in flight but flutter requirements are complex and may show more inboard locations to be more favorable. The latter also favors directional control after engine failure. Finally, the lateral position of the engines affects ground clearance, an issue of special importance for large, four-engine aircraft.



Another influence of wing-mounted nacelles is the effect on flaps. The high temperature, high 'q' exhaust impinging on the flap increases flap loads and weight, and may require titanium (more expensive)

structure. The impingement also increases drag, a significant factor in take-off climb performance after engine failure. Eliminating the flap behind the engine reduces C_{Lmax} . A compromise on the DC-8 was to place the engines low enough so that the exhaust did not hit the flap at the take-off angle (25 deg. or less) and to design a flap 'gate' behind the inboard engine which remained at 25 deg. when the remainder of the flap extended to angles greater than 25 deg. The outboard engines were placed just outboard of the flap to avoid any impingement. On the 707, 747, and the DC-10, the flap behind the inboard engine is eliminated and this area is used for inboard all-speed ailerons. Such thrust gates have been all but eliminated on more recent designs such as the 757 and 777.

Pylon wing interference can and does cause serious adverse effects on local velocities near the wing leading edge. Drag increases and C_{Lmax} losses result. A pylon which goes over the top of the leading edge is much more harmful in this regard than a pylon whose leading edge intersects the wing lower surface at 5% chord or more from the leading edge.

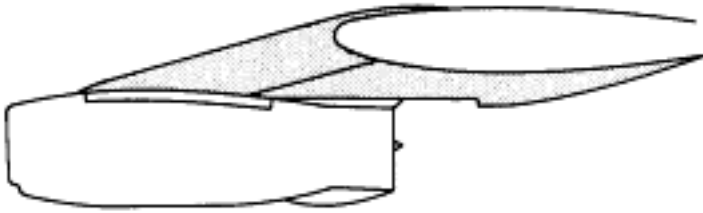

The original DC-8 pylon wrapped over the leading edge for structural reasons. Substantial improvements in C_{Lmax} and drag rise were achieved by the "cut-back pylon" shown in previous figures. The figures below show the effect of this small geometry change on wing pressures at high speeds.

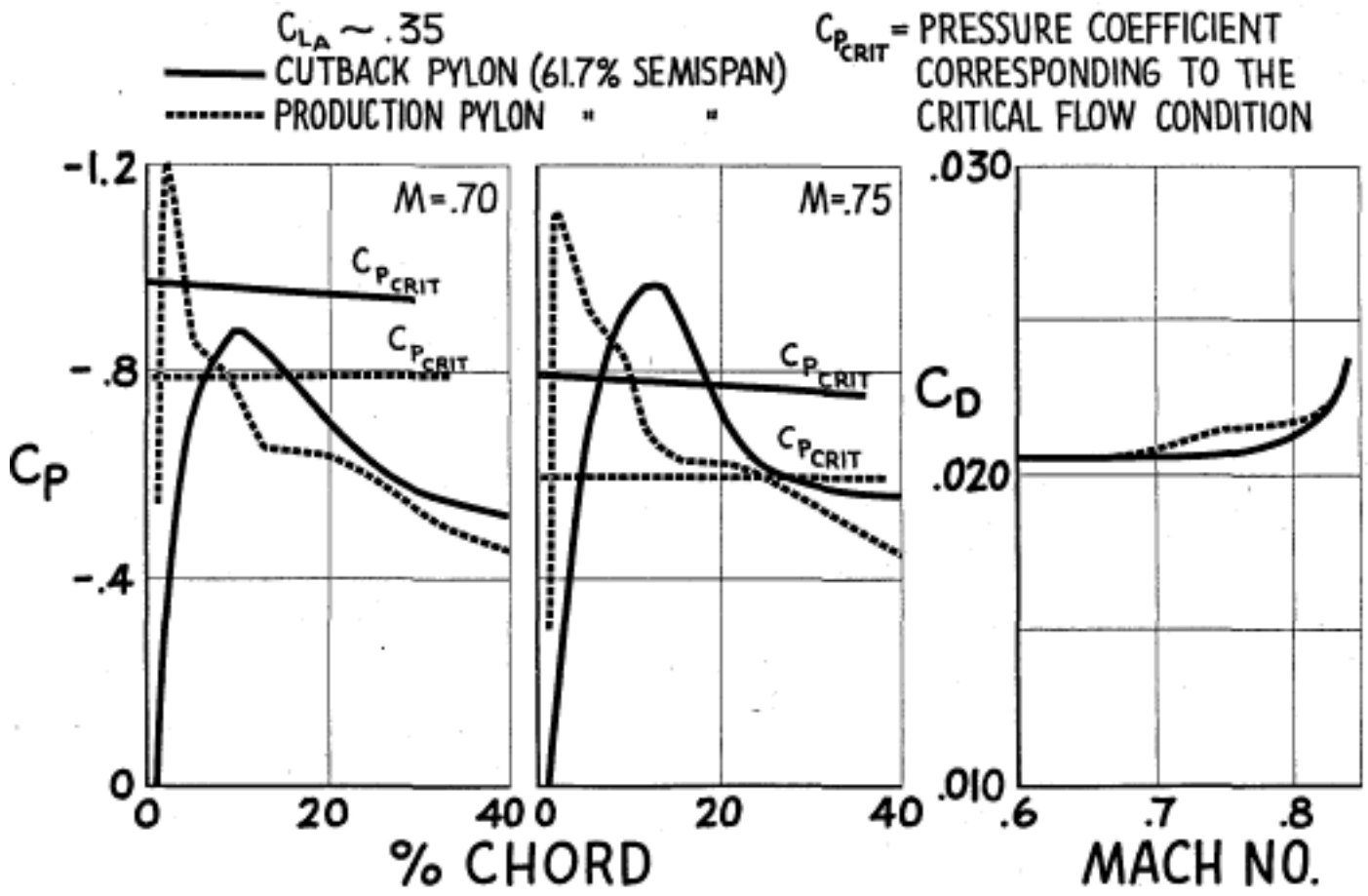

Pressure Coefficient in vicinity of outboard pylons of DC-8.

WING PRESSURE DISTRIBUTIONS
4% LEADING EDGE EXTENSION - 7% SEMISPAN MODEL
PRODUCTION PYLONS

$M = 0.80$
 $C_L = 0.40$

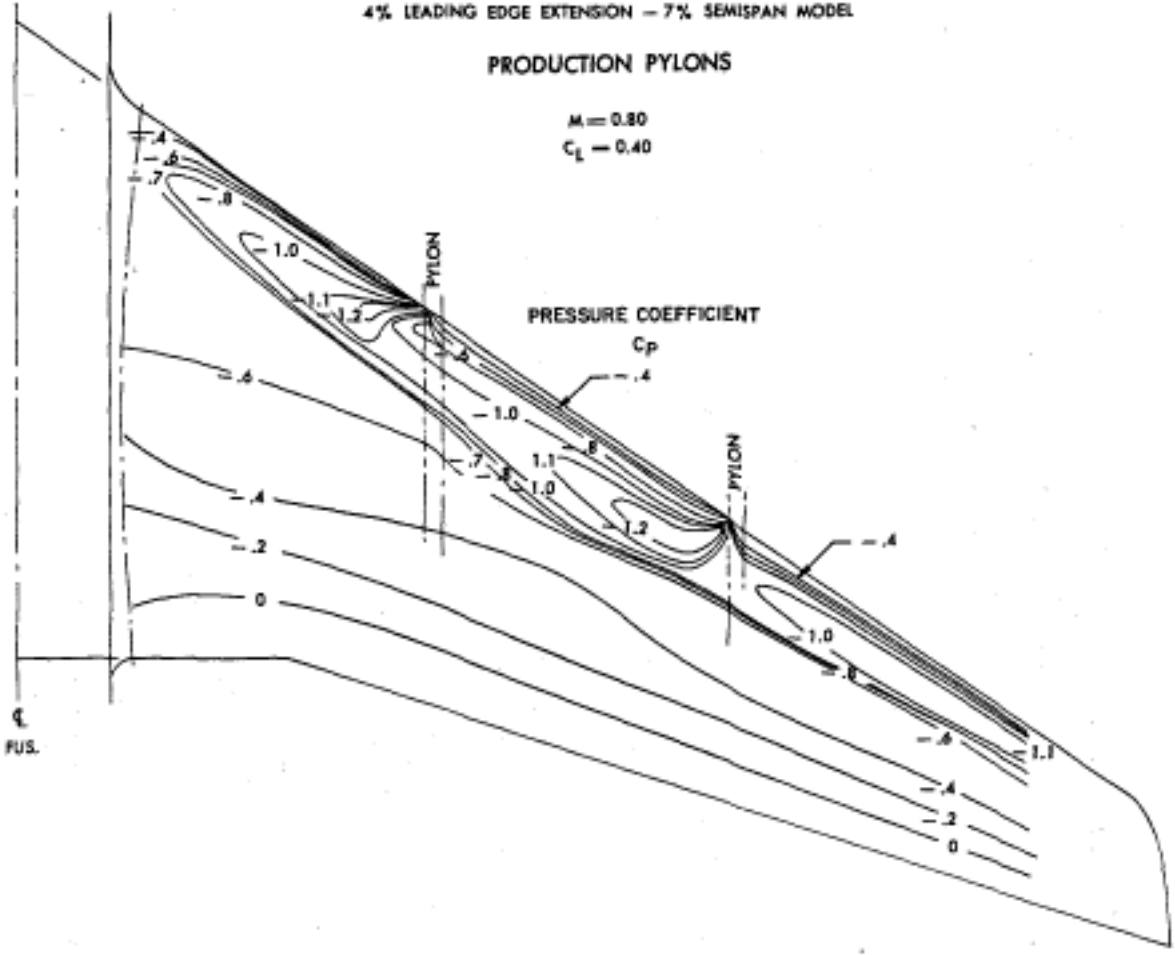

FUS.

WING PRESSURE DISTRIBUTIONS
4% LEADING EDGE EXTENSION - 7% SEMISPAN MODEL

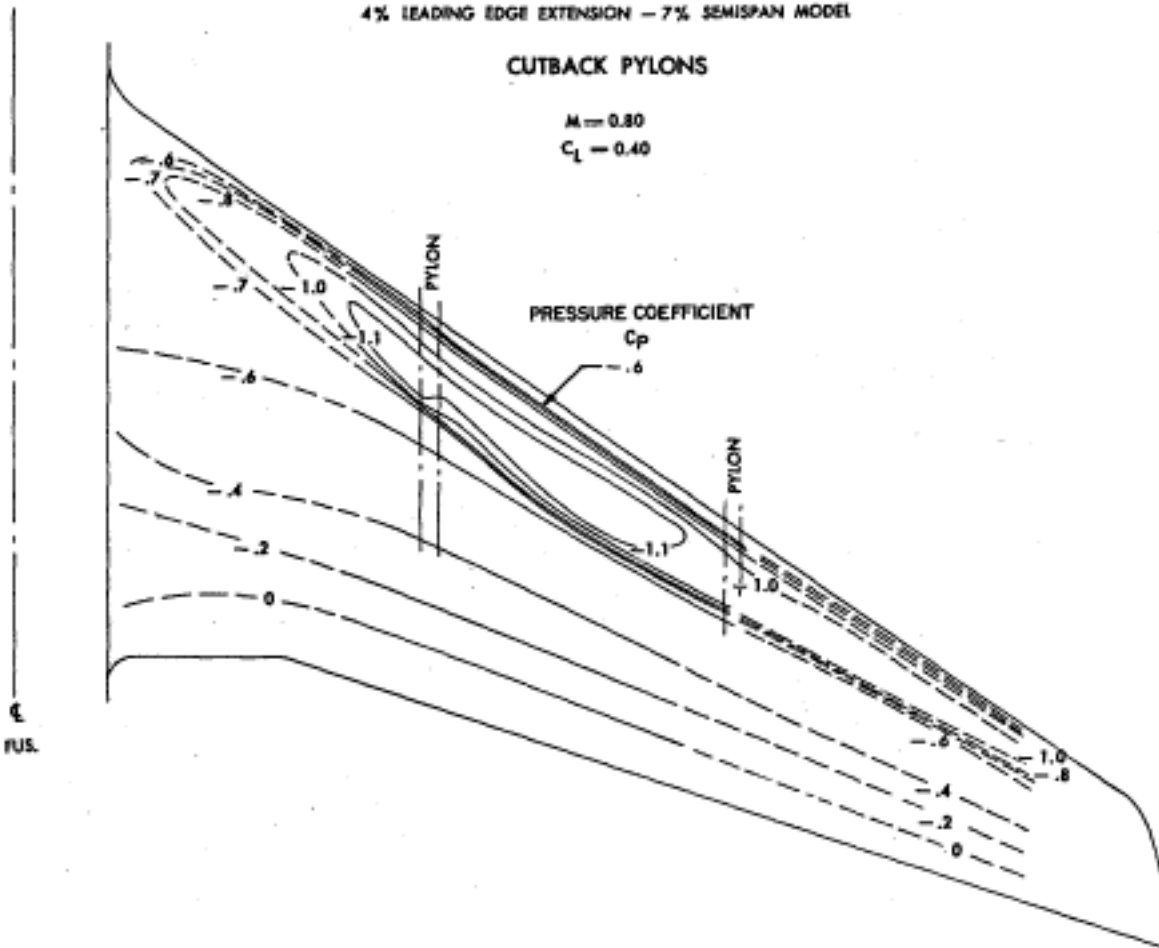

In addition, wing pylons are sometimes cambered and oriented carefully to reduce interference. This was tested in the mid 1950's, although the gain was small and many aircraft use uncambered pylons today.

One disadvantage of pylon mounted nacelles on low wing aircraft is that the engines, mounted close to the ground, tend to suck dirt, pebbles, rocks, etc. into the inlet. Serious damage to the engine blades can result. It is known as foreign object damage. In about 1957 Harold Klein of Douglas Aircraft Co. conducted research into the physics of foreign object ingestion. He found that the existing vorticity in the air surrounding the engine inlet was concentrated as the air was drawn into the inlet. Sometimes a true vortex was formed and if this vortex, with one end in the inlet, touched the ground, it became stable and sucked up large objects on the ground. Klein developed a cure for this phenomenon. A small high pressure jet on the lower, forward portion of the cowl spreads a sheet of high velocity air on the ground and breaks up the end of the vortex in contact with the ground. The vortex, which has to be continuous or terminate in a surface, then breaks up completely. This device, called the blowaway jet, is used on the DC-8 and the DC-10. Even with the blowaway jet, an adequate nacelle-ground clearance is necessary.

The stiffness of the pylon for wing mounted engines is an important input into the flutter characteristics. Very often the design problem is to develop a sufficiently strong pylon which is relatively flexible so that its natural frequency is far from that of the wing.

Aft Fuselage Engine Placement

When aircraft become smaller, it is difficult to place engines under a wing and still maintain adequate wing nacelle and nacelle-ground clearances. This is one reason for the aft-engine arrangements. Other advantages are:

Greater $C_{L_{max}}$ due to elimination of wing-pylon and exhaust-flap interference, i.e., no flap cut-outs.

Less drag, particularly in the critical take-off climb phase, due to eliminating wing-pylon interference.

Less asymmetric yaw after engine failure with engines close to the fuselage.

Lower fuselage height permitting shorter landing gear and airstair lengths.

Last but not least - it may be the fashion.

Disadvantages are:

The center of gravity of the empty airplane is moved aft - well behind the center of gravity of the payload. Thus a greater center of gravity range is required. This leads to more difficult balance problems and generally a larger tail.

The wing weight advantage of wing mounted engines is lost.

The wheels kick up water on wet runways and special deflectors on the gear may be needed to avoid water ingestion into the engines.

At very high angles of attack, the nacelle wake blankets the T-tail, necessary with aft-fuselage mounted engines, and may cause a locked-in deep stall. This requires a large tail span that puts part of the horizontal tail well outboard of the nacelles.

Vibration and noise isolation for fuselage mounted engines is a difficult problem.

Aft fuselage mounted engines reduce the rolling moment of inertia. This can be a disadvantage if there is significant rolling moment created by asymmetric stalling. The result can be an excessive roll rate at the stall.

Last but not least - it may not be the fashion.

It appears that in a DC-9 size aircraft, the aft engine arrangement is to be preferred. For larger aircraft, the difference is small.

An aft fuselage mounted nacelle has many special problems. The pylons should be as short as possible to minimize drag but long enough to avoid aerodynamic interference between fuselage, pylon and nacelle. To minimize this interference without excessive pylon length, the nacelle cowl should be designed to

minimize local velocities on the inboard size of the nacelle. On a DC-9 a wind tunnel study compared cambered and symmetrical, long and short cowls, and found the short cambered cowl to be best and lightest in weight. The nacelles are cambered in both the plan and elevation views to compensate for the angle of attack at the nacelle.

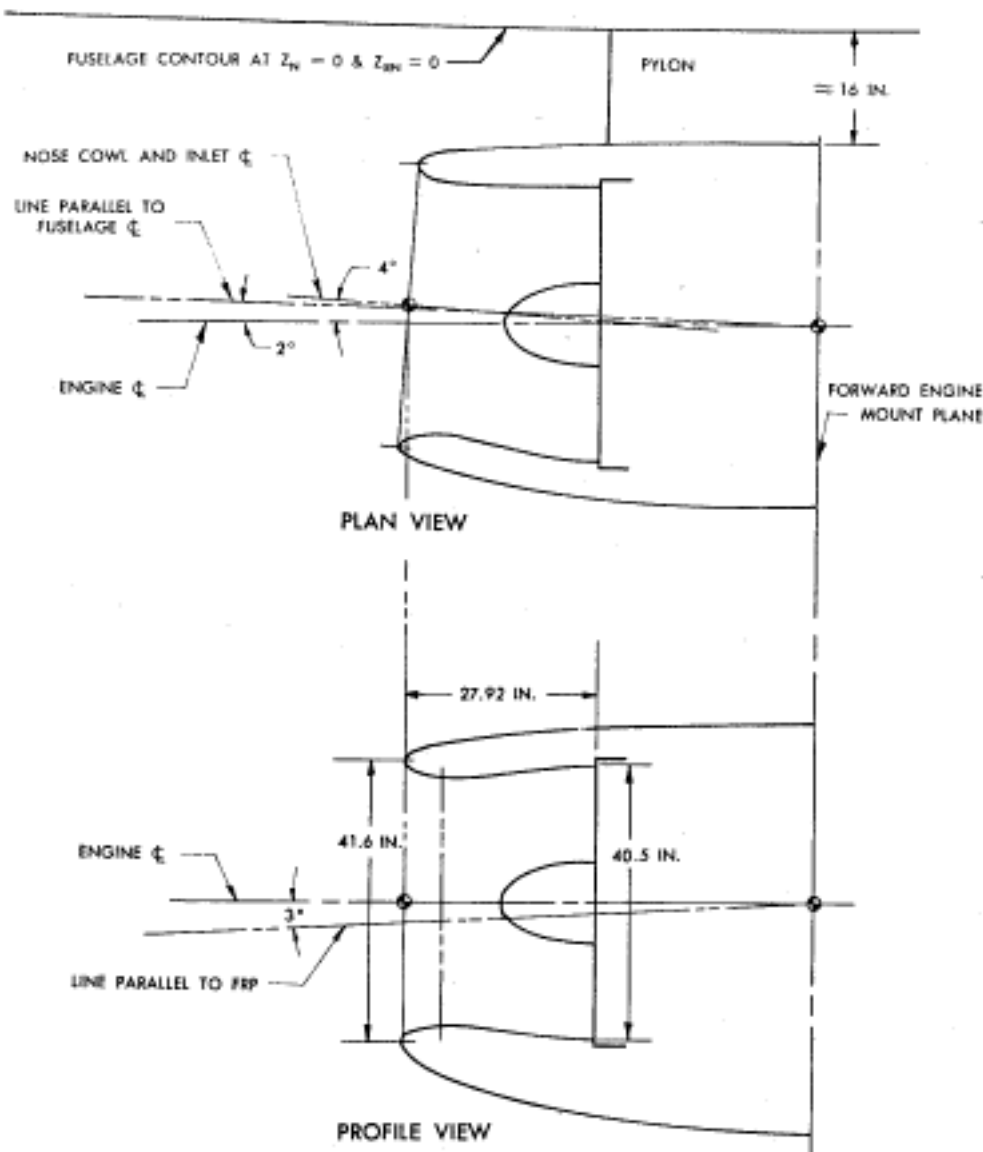

With an aft engine installations, the nacelles must be placed to be free of interference from wing wakes. The DC-9 was investigated thoroughly for wing and spoiler wakes and the effects of yaw angles, which might cause fuselage boundary layer to be ingested. Here efficiency is not the concern because little flight time is spent yawed, with spoilers deflected or at high angle of attack. However, the engine cannot tolerate excessive distortion.

Three-Engine Designs

A center engine is always a difficult problem. Early DC-10 studies examined 2 engines on one wing and one on the other, and 2 engines on one side of the aft fuselage and one on the other, in an effort to avoid a

center engine. Neither of these proved desirable. The center engine possibilities are shown below.

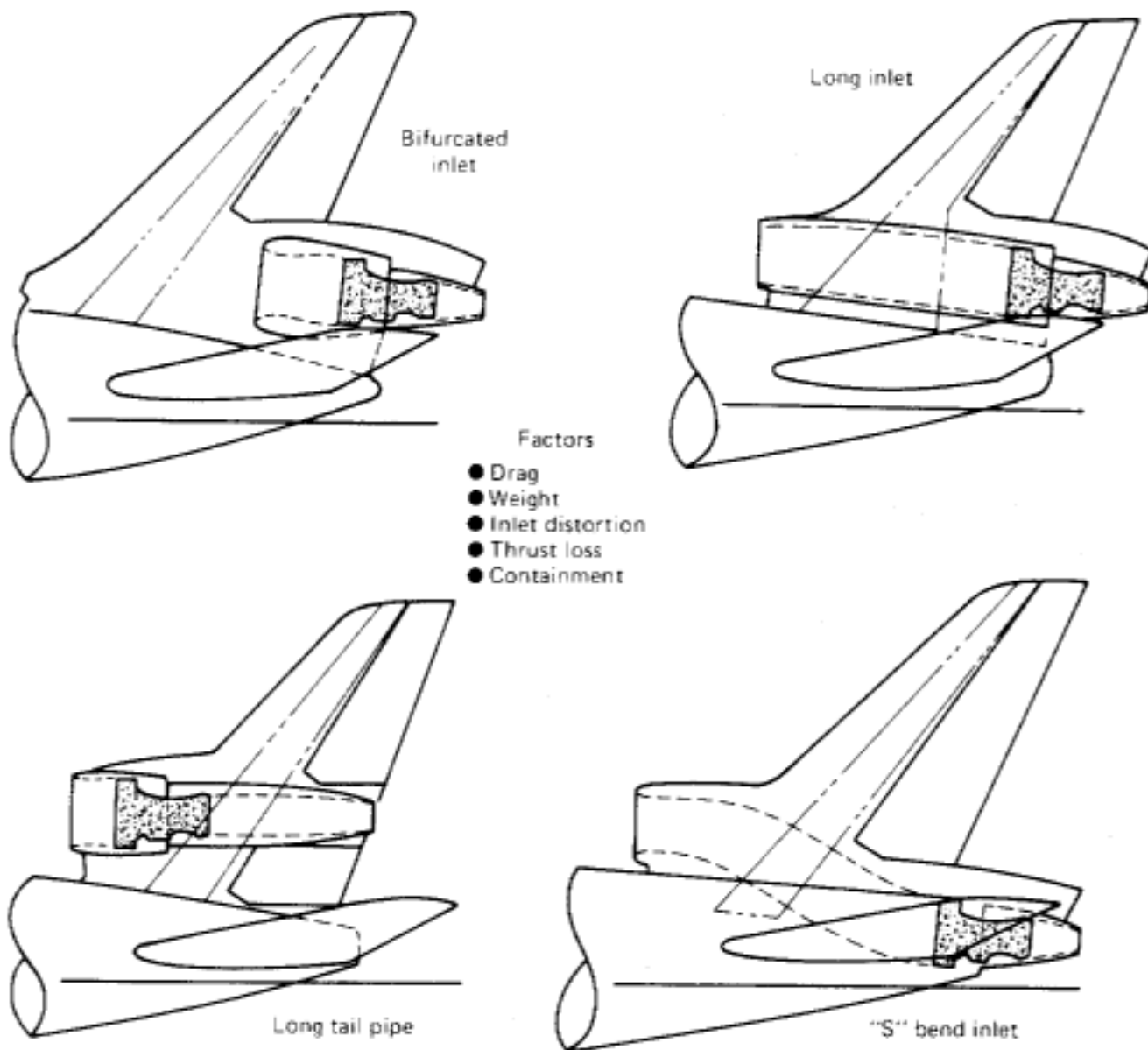

Each possibility entails compromises of weight, inlet loss, inlet distortion, drag, reverser effectiveness, and maintenance accessibility. The two usually used are the S-bend which has a lower engine location and uses the engine exhaust to replace part of the fuselage boattail (saves drag) but has more inlet loss, a distortion risk, a drag from fairing out the inlet, and cuts a huge hole in the upper fuselage structure, and the straight through inlet with the engine mounted on the fin which has an ideal aerodynamic inlet free of distortion, but does have a small inlet loss due to the length of the inlet and an increase in fin structural weight to support the engine.

Such engines are mounted very far aft so a ruptured turbine disc will not impact on the basic tail structure. Furthermore, reverser development is extensive to obtain high reverse thrust without interfering with control surface effectiveness. This is achieved by shaping and tilting the cascades used to reverse the flow.

Solutions to the DC-10 tail engine maintenance problems include built-in work platforms and provisions for a bootstrap winch system utilizing beams that are attached to fittings built into the pylon structure. Although currently companies are developing virtual reality systems to evaluate accessibility and maintenance approaches, designers considered these issues before the advent of VRML. The figure below is an artist's concept of a DC-10 engine replacement from a 1969 paper entitled "Douglas Design for Powerplant Reliability and Maintainability".

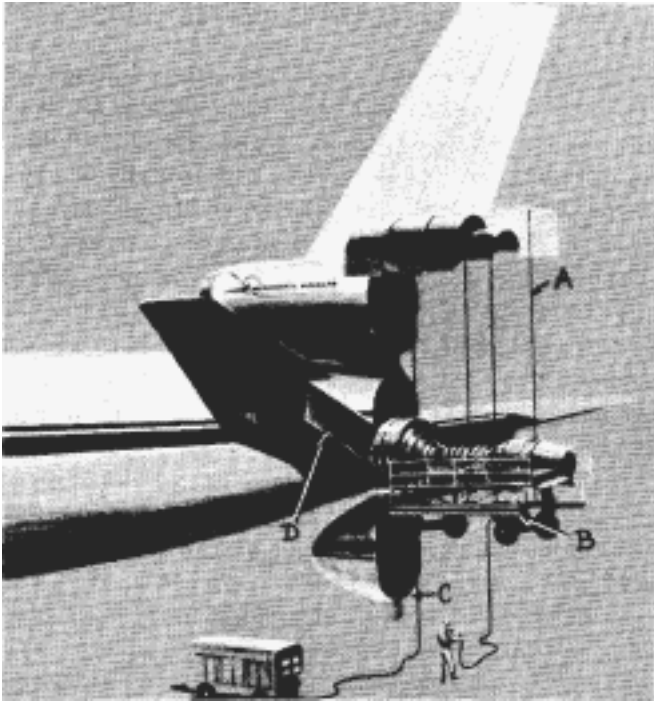

Nacelle Design and Sizing

The design of the nacelle involves both the external shape and the inlet internal geometry. The design of the engine inlet is generally the job of the airframe manufacturer, not the engine manufacturer and is of great importance to the overall efficiency.

The outer curvature of the cowl nose is as important as the inner contour shape. The cowl nose contour must be designed to avoid excessive local velocities in high speed flight. Here the design philosophy is somewhat similar to the fuselage and wing approach; supercritical velocities can be permitted far forward on the cowl provided the local velocities are subsonic well forward of the location of the maximum nacelle diameter. Many tests of cowling shapes have been made by NASA and various aircraft companies to determine desirable contours. Cowls are often cambered to compensate for the high angles of attack at which aircraft operate.

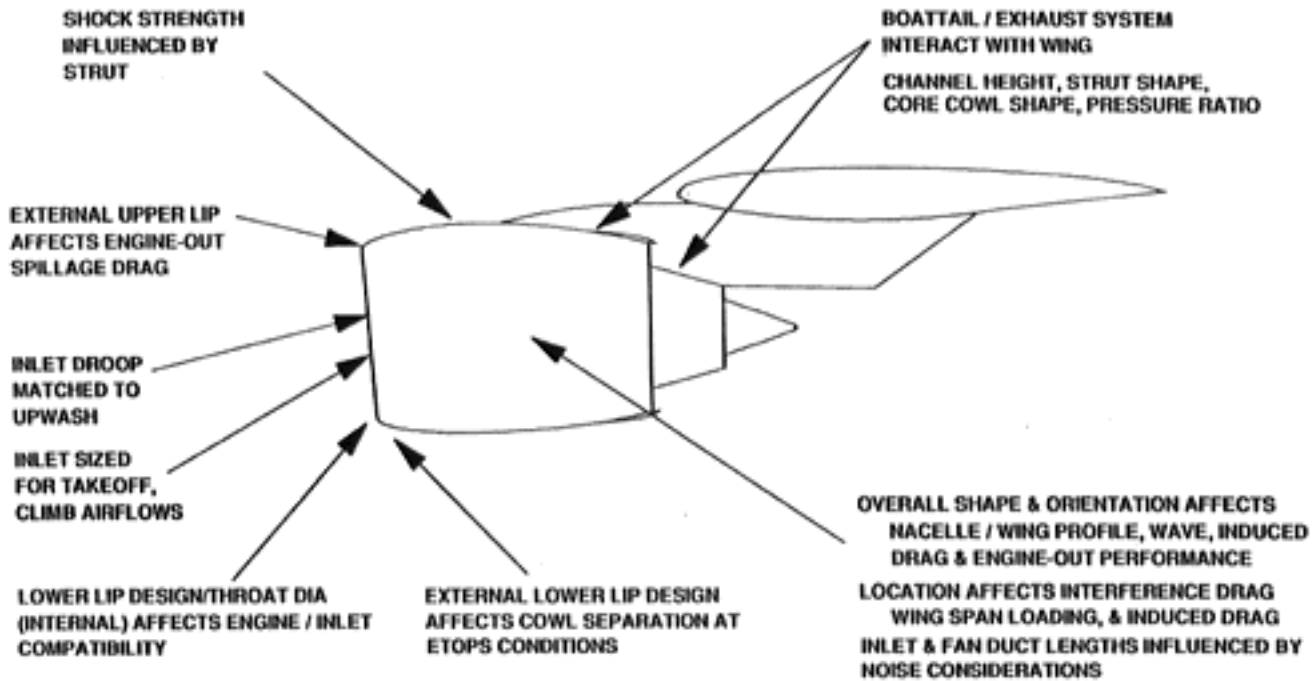

Some examples of nacelle designs and wing-mounted installations are shown below.

767



777

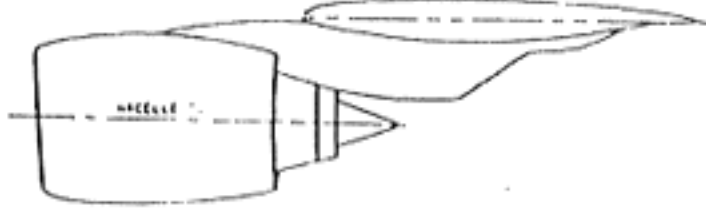

A330

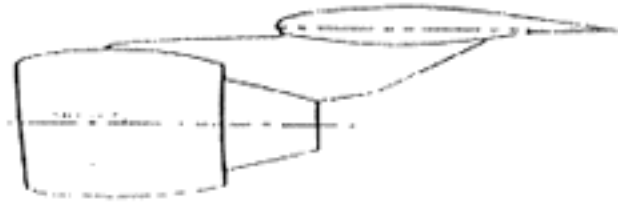

A320

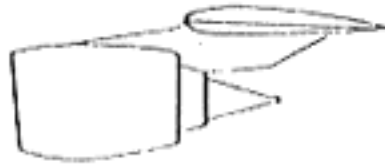

A310



MD-11



Commonality between engine installations, left and right, wing and tail, etc. is made as complete as possible. Airlines keep spare engines in a neutral configuration, i.e., with all parts installed that are common to all engine positions. Only the uncommon parts must be added to adapt the engine to a particular position. A neutral engine for the DC-10 consists of the basic engine with all accessories installed, generator electrical leads coiled, certain hydraulic and fuel lines not installed, nose cowl not installed, and engine control system not installed.

One of the most difficult design problems is fitting all the necessary equipment within the slender pylon. Fuel lines, pneumatic lines, engine and reverser controls, electrical cables, and numerous instrumentation leads must fit closely and yet permit maintenance access. The nacelle is made as small as possible but must provide space for all accessories plus ventilation for accessory and engine cooling.

One can use some of the pictures in this section for initial nacelle sizing when the actual engine dimensions are known. The nacelle diameter tends to be roughly 10% greater than the bare engine to accommodate various engine systems. The inlet itself extends about 60% of the diameter in front of the

fan face, and the actual inlet area is about 70% of the maximum area, although this varies depending on the engine type. For initial sizing, a representative engine may be selected and scaled (within reason) to the selected thrust level. One would expect the engine dimensions to vary with the square root of the thrust ratio (so that the area and mass flow are proportional to thrust). Statistically, the scaling is a bit less than the square root. The plots below show the variation in nacelle diameter and length as the thrust varies. The concept is sometimes called "rubberizing" an engine. Using the 85" diameter 38,250 lb PW2037 as a reference and scaling diameter by thrust to the 0.41 power yields reasonable diameters for engines over a very large thrust range. Somewhat more scatter is found in engine length but a 0.39 power thrust scaling is reasonable here as well. We note that the plots below show engine diameter and length, rather than nacelle dimensions. The nacelle must be scaled up as described above.

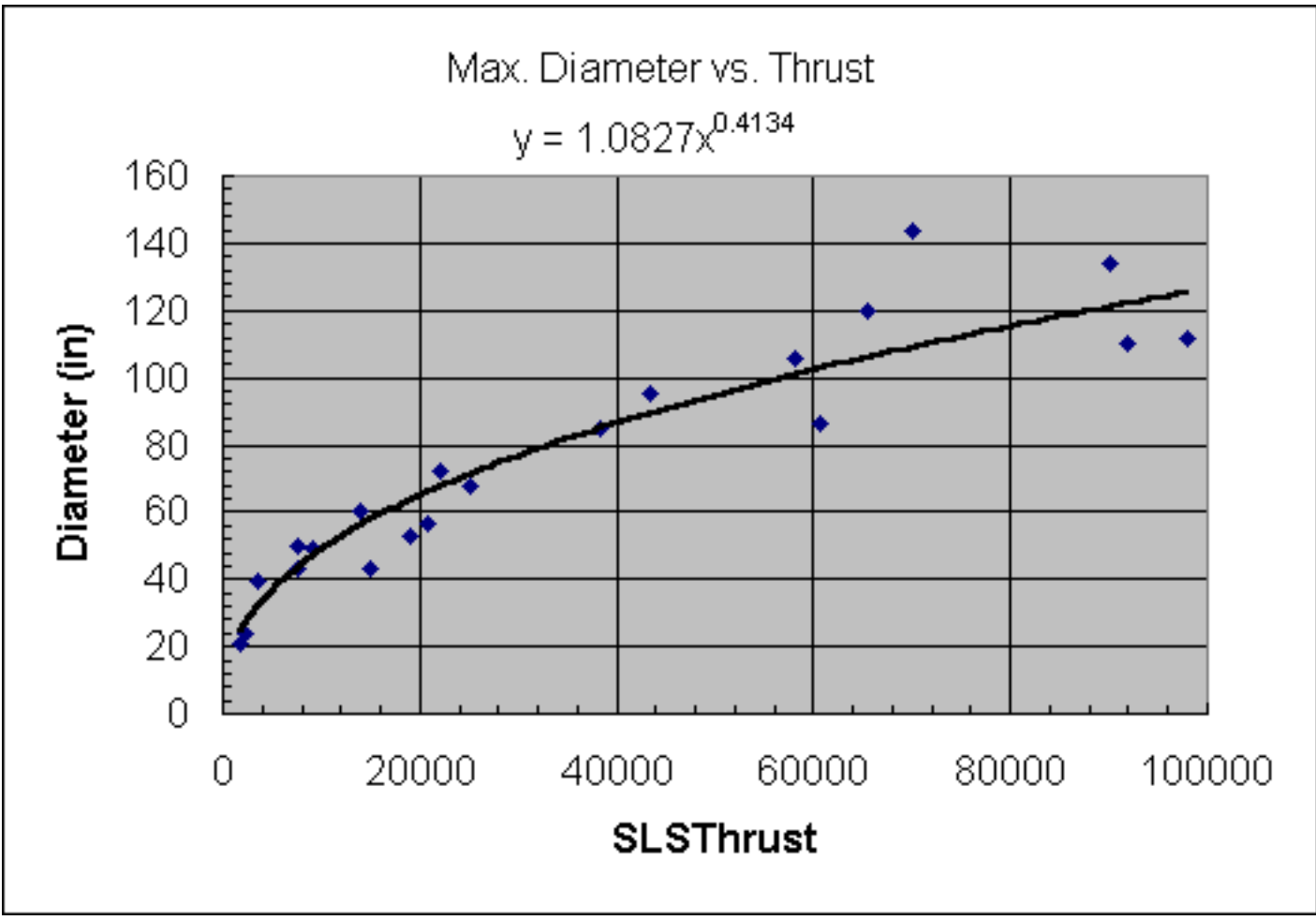

Engine Length vs. Thrust

$$y = 2.4077x^{0.3876}$$

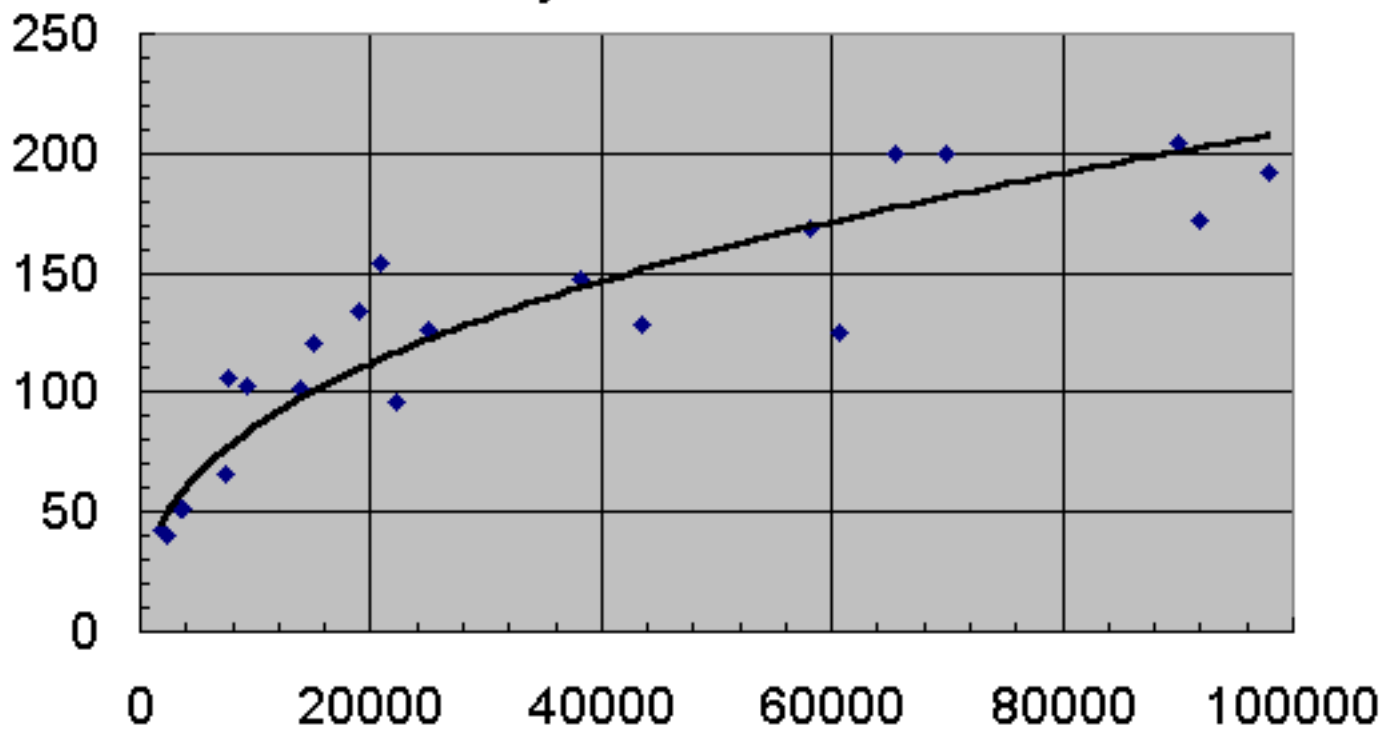

Engine Installation for Supersonic Aircraft

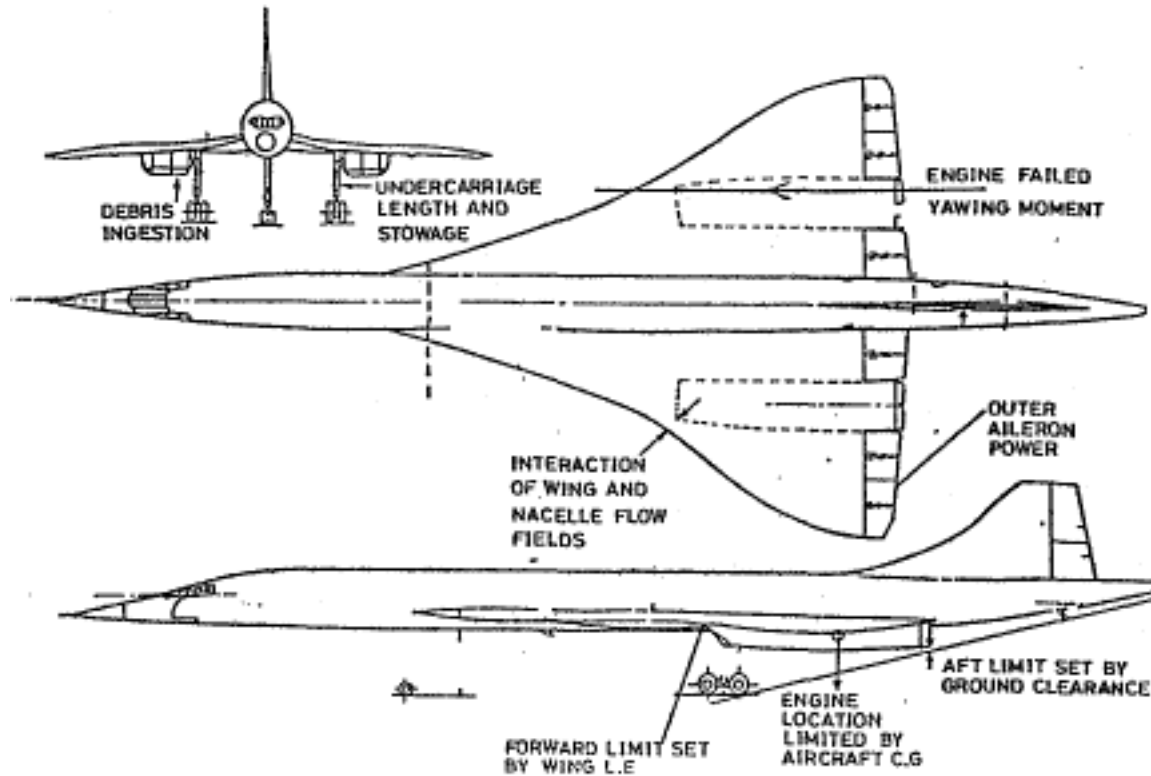



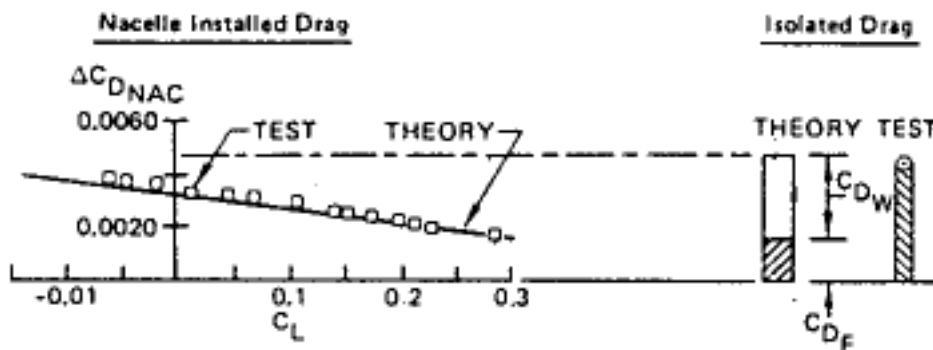

Factors affecting supersonic aircraft engine positioning.

The presence of volume-dependent wave drag means that the location of the engines may make a large difference to drag. In particular, interference of the nacelles with the fuselage, wing, and other nacelles is very sensitive to the relative position and orientation of the nacelles. The nacelle placement for supersonic aircraft can take advantage of favorable interference and detailed studies have shown that aft wing placement of engines can reduce the drag of the installation to little more than that associated with the skin friction drag of the nacelles.

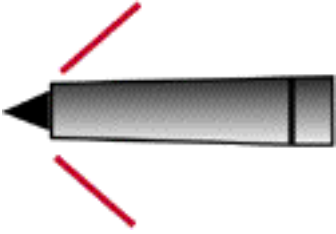

Some of the interference effects are listed in the table below:

Effects of Nacelle on Lift and Drag

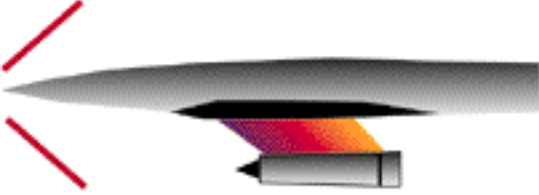
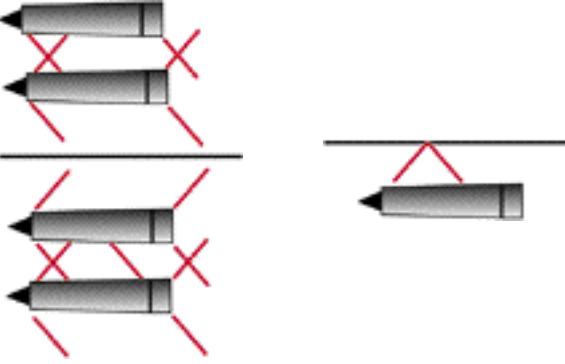
Interference Drag	Interference Lift
<p data-bbox="185 407 542 445">Nacelle Pressure Drag</p> 	<p data-bbox="727 432 1049 512">Nacelle Interference Increases Wing Lift</p> 
<p data-bbox="175 751 548 831">Nacelle-On-Wing/Body Interference</p> 	<p data-bbox="711 751 1065 831">Wing Interference Decreases Nacelle Lift</p> 
<p data-bbox="224 1050 503 1129">Wing-On-Nacelle Interference</p> 	
<p data-bbox="136 1402 587 1440">Mutual Nacelle Interference</p>  <p data-bbox="55 1843 331 1881">Adjacent Nacelles</p> <p data-bbox="337 1822 672 1902">Self-Interference from Wing Reflection</p>	

In addition to wave drag and lift considerations, nacelle placement is influenced by a variety of practical considerations such as:

Inlets must be placed away from main gear to avoid excessive water ingestion.

Inlets must be located in an area of the wing with uniform flow, away from the leading edge shock to assure inlet stability. The inlets are often separated from each other laterally to improve the inlet stability as well.

The longitudinal position is constrained by structure, ground clearance, rotor burst, and flutter considerations. The spanwise position is governed by these same issues as well as engine-out yawing moment.

Nacelle Design

The nacelle size for SST engines follows different rules from those of subsonic engines. Nacelles tend to be much longer because of the length dependence of wave drag and because more substantial speed reduction must occur in the inlet. Typical inlet losses are still much higher than for subsonic inlets. Initial nacelle sizing can be based on many previous detailed studies and experience with the Concorde.

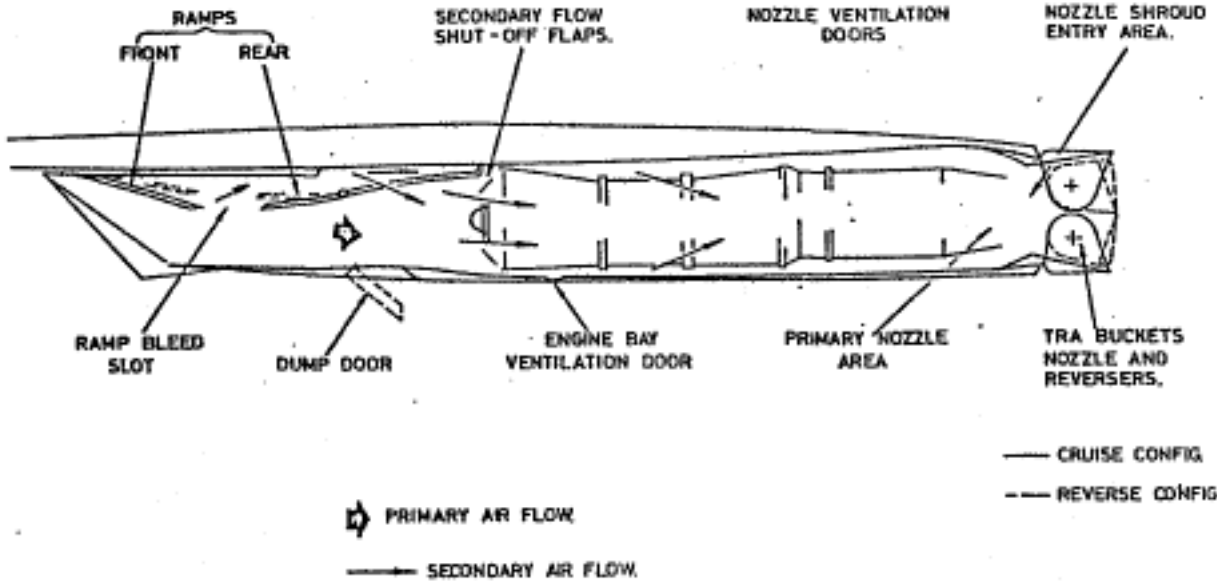

Some data on a Turbine Bypass Engine (from 1992 Langley AIAA Paper), based on: Onat, E.; Klass, G.W.: A Method to Estimate Weight and Dimensions of Large and Small Gas Turbine Engines. NASA CR 159481, 1979.

TBE Sample Engine Summary

Design Mach Number:	1.6	2.0	2.4
----------------------------	------------	------------	------------

Weights:			
Bare Engine + Accessories, lb	9,252	9,278	9,567
Inlet / Nacelle, lb	1,343	2,243	3,837
Nozzle, lb	4,000	4,000	4,000
Total, lb	14,596	15,521	17,424
Nacelle Dimensions:			
Length, ft	31.83	31.74	34.92
Maximum Diameter (at engine), ft	6.20	6.20	6.20
Reference Diameter (at exit), ft	4.47	4.96	5.92
Inlet Capture Diameter, ft	4.53	6.01	5.52
Maximum Area, ft ²	30.19	30.19	30.19
Reference Area, ft ²	15.69	19.32	23.93
Inlet Capture Area, ft ²	16.12	19.71	23.93
Performance (installed):			
Takeoff:			
Design Corrected Mass Flow, lb/sec	700	700	700
Installed Net Thrust, lb	70,610	69,035	65,482
Overall Pressure Ratio	29.07	29.18	18.93
Specific Fuel Consumption lb/hr/lb	0.8756	0.8728	0.9293
Cruise:			
Cruise Altitude, ft	45000	55000	65000
Installed Net Thrust, lb	29,628	21,911	18,955
Overall Pressure Ratio	27.50	21.30	12.04
Specific Fuel Consumption, lb/hr/lb	1.1177	1.1991	1.3098
Overall Efficiency, percent	34.51	40.21	44.18

Propulsion Systems: Engine Model

About the Parameters:

# of Engines:	Total number of engines installed
S.L.S. Thrust:	The installed sea level static thrust per engine.
sfc / sfc_ref	Ratio of s.f.c. of this engine to that of the reference engine
Engine Type	Engine Type from the following list: <ol style="list-style-type: none">1. High bypass turbofan (PW 2037)2. Low bypass turbofan (JT8-D)3. UDF (Propfan)4. Generic Turboprop5. Reserved6. SST Engine7. SST Engine with improved lapse rate
Mach	Mach Number
Altitude	Altitude in ft.

Aircraft Structures

Why worry about structures?

Structural design is of critical importance to aircraft safety, but also plays a key role in aircraft cost and performance. The airplane cost is related to the structural design in complex ways, but typically aircraft end up costing \$200-\$500 per pound (with sailplanes and military aircraft such as the B-2 demonstrating the spread in this figure -- the B-2 reportedly costs more per ounce than gold).

In addition to its direct impact on aircraft cost, the aircraft structural weight affects performance. Every pound of airplane structure means one less pound of fuel when the take-off weight is specified. So in the range equation:

$$R = (V/c) (L/D) \ln(W_{\text{initial}}/W_{\text{final}})$$

one might think of the first term representing the role of propulsion, the second term aerodynamics, and the third term, structures.

In order to estimate the aircraft cost and empty weight, we must estimate the weight of each of the components; to do this, we need to understand how these components' structure is sized; and to do this, we need to estimate the loads that they will have to support. This chapter is divided into three main sections which deal with each of these issues. Starting with a section on [load prediction](#), including placard diagrams and V-n diagrams, the chapter continues with a discussion of [structural design](#), including structural concepts, critical design constraints, and sizing methods. The final section involves a conceptual design level method for estimating component [weights and c.g.'s](#).

Aircraft Structural Loads

Introduction

Before the structure can be designed, we need to determine the loads that will be imposed on the aircraft. This section deals with the general issue of aircraft loads and how they are predicted at the early stages of the design process.

Each part of the aircraft is subject to many different loads. In the final design of an aircraft structure, one might examine tens of thousands of loading conditions of which several hundred may be critical for some part of the airplane. In addition to the obvious loads such as wing bending moments due to aerodynamic lift, many other loads must be considered. These include items such as inertia relief, the weight and inertial forces that tend to reduce wing bending moments, landing loads and taxi-bump loads, pressurization cycles on the fuselage, local high pressures on floors due to high-heeled shoes, and many others.

These loads are predicted using Navier-Stokes computations, wind tunnel tests, and other simulations. Static and dynamic load tests on structural components are carried out to assure that the predicted strength can be achieved. The definition of strength requirements for commercial aircraft is specified in FAR Part 25 and this section deals with those requirements in more detail.

Some Definitions

Many of the load requirements on aircraft are defined in terms of the load factor, n . The load factor is defined as the component of aerodynamic force perpendicular to the longitudinal axis divided by the aircraft weight. Assuming the angle of attack is not large, $n = L/W$. This is the effective perpendicular acceleration of the airplane in units of g , the acceleration due to gravity.

The FAA establishes two kinds of load conditions:

- Limit Loads are the maximum loads expected in service. FAR Part 25 (and most other regulations) specifies that there be no permanent deformation of the structure at limit load.
- Ultimate loads are defined as the limit loads times a safety factor. In Part 25 the safety factor is specified as 1.5. For some research or military aircraft the safety factor is as low as 1.20, while composite sailplane manufacturers may use 1.75. The structure must be able to withstand the ultimate load for at least 3 seconds without failure.

The remainder of this section deals with the computation of the limit load factor with additional detail on:

- Design Airspeeds and the [Placard Diagram](#)
- The [V-n Diagram](#)
- Text of FAA gust criteria ([FAR 25 App. G](#))
- Text of FAA structures requirements ([FAR 25.301](#))

Placard Diagram

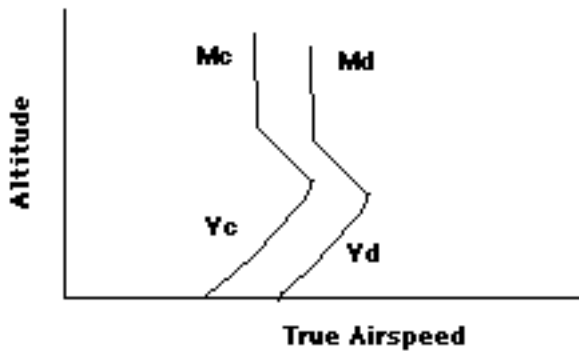

The placard diagram is an envelope diagram that shows the structural design airspeeds as a function of altitude. These speeds are specified by the FAR's in sometimes obscure ways and the following outline describes these rules in simpler terms.

1) The structural design cruise Mach number, M_c , may be specified by the designer, but it need not exceed the maximum speed in level flight (at maximum continuous power). To maintain operational flexibility, this is generally the value chosen for M_c . For most transonic aircraft this value is about 6% above the typical cruise speed. So:

$M_c = M_{mo}$, the maximum operating Mach number, about $1.06 M_{cruise}$.

2) The design dive Mach number, M_D is approximately the maximum operating Mach number plus 7%. It is required to be $1.25 M_c$ unless an analysis of a 20 sec. dive at 7.5 degrees followed by a 1.5 g pullout shows the maximum Mach to be less. It usually does, and M_D ends up only about 7% more than M_c .

3) The design dive speed V_D is about $1.15 V_c$ for transport aircraft, based on a rational analysis (again 20 sec. at 7.5 degree dive). It must be $1.25 V_c$ unless otherwise computed.

The chart is constructed by deciding on a structural design altitude. The altitude at the "knee" of the placard diagram is selected based on operational requirements. We generally do not need the aircraft to withstand gusts at Mach 0.8 at sea level, but we do not want to restrict the Mach number at 30,000 ft. Thus, this altitude is typically chosen to be between 25,000 and 28,000 ft. At this altitude and above, the V_c - M_c line corresponds to M_c . Below this altitude, V_c corresponds to V_{ceqv} at the design altitude. That is, we construct the line of true speed vs. altitude as determined by M_c (note the kink at the edge of the stratosphere). We continue the line below our chosen altitude at constant dynamic pressure (constant equivalent airspeed).

The V_D line is about $1.15 V_c$ until the Mach number reaches M_D .

Especially for supersonic aircraft it is often not necessary to operate at high equivalent airspeeds at low

altitudes. So, another kink in the placard diagram is sometimes introduced. The Concorde, for example, is placarded to 400 kts IAS at subsonic speeds (below 32,000ft).

Concorde Placard Diagram

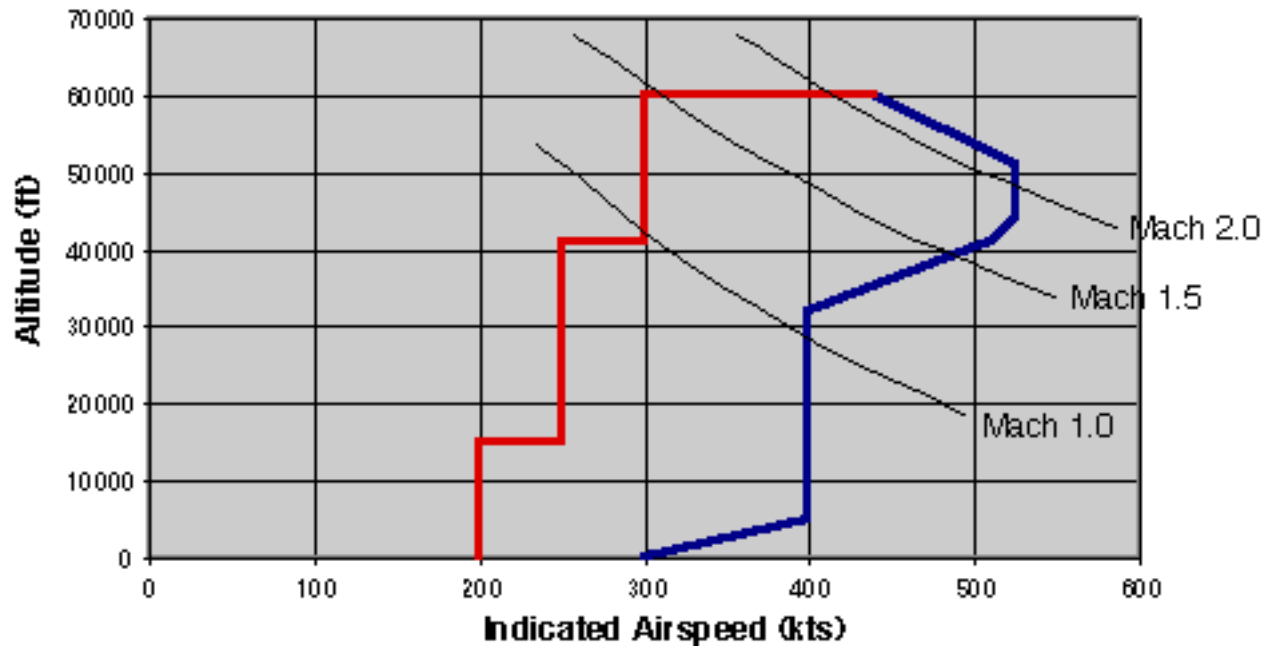

Other Design Airspeeds

In addition to V_c and V_D , several other airspeeds are important in the definition of the aircraft's operating envelope.

V_A is the design maneuvering speed. It must be greater than: $V_{s1} * \sqrt{n}$, with V_{s1} the flaps-up stall speed and n the maneuver load factor. It need not be greater than V_c or the speed at which n is reached at C_{Lmax} .

V_B is the design speed for maximum gust intensity. It is defined in one of two ways. Basically, it is the airspeed at which the required vertical gust, produces maximum CL on the aircraft. However, V_B need not be greater than $V_{s1} * \sqrt{n_g}$ where n_g is the gust load factor at V_c and V_s is the stalling speed with flaps retracted. V_B also need not be more than V_c .

V_c must be 43 knots greater than V_B except it need not exceed the maximum level flight airspeed at maximum continuous power. If V_D is limited by Mach number, V_c may be limited to a given Mach. (This is the usual case in AA 241.)

V_F is the design flap speed. It is a function of flap position and stalling speed and restricts the speeds at which flaps may be deployed.

It must be $> 1.6 V_{s1}$ with TO flaps and MTOW

It must be $> 1.8 V_{s1}$ with approach flaps and max landing weight

It must be $> 1.8 V_{s0}$ with landing flaps and max landing weight

V-n Diagram

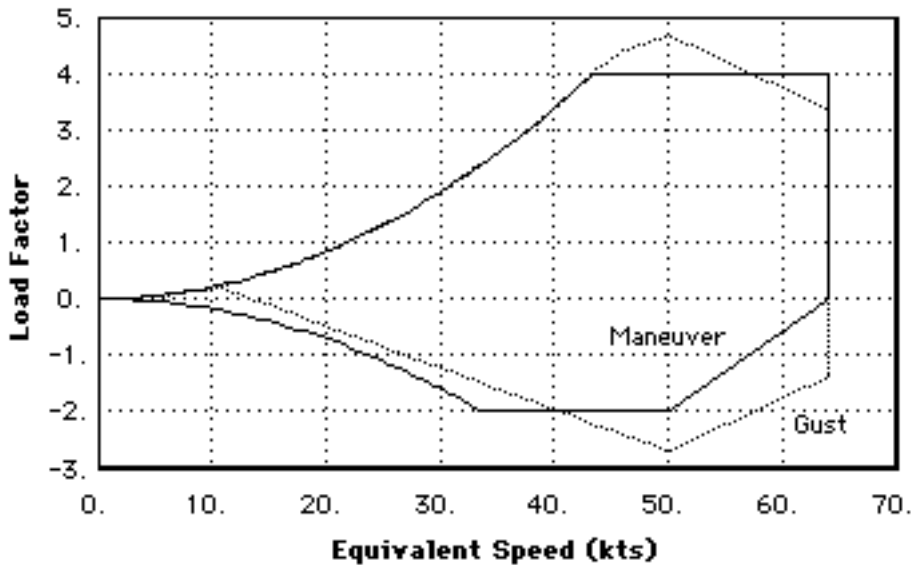

Maneuver Diagram

This diagram illustrates the variation in load factor with airspeed for maneuvers. At low speeds the maximum load factor is constrained by aircraft maximum C_L . At higher speeds the maneuver load factor may be restricted as specified by FAR Part 25.

The maximum maneuver load factor is usually +2.5. If the airplane weighs less than 50,000 lbs., however, the load factor must be given by: $n = 2.1 + 24,000 / (W + 10,000)$
 n need not be greater than 3.8. This is the required maneuver load factor at all speeds up to V_c , unless the maximum achievable load factor is limited by stall.

The negative value of n is -1.0 at speeds up to V_c decreasing linearly to 0 at V_D .

Maximum elevator deflection at V_A and pitch rates from V_A to V_D must also be considered.

Gust Diagram

Loads associated with vertical gusts must also be evaluated over the range of speeds.

The FAR's describe the calculation of these loads in some detail. Here is a summary of the method for constructing the V-n diagram. Because some of the speeds (e.g. V_B) are determined by the gust loads, the process may be iterative. Be careful to consider the alternative specifications for speeds such as V_B .

The gust load may be computed from the expression given in FAR Part 25. This formula is the result of

considering a vertical gust of specified speed and computing the resulting change in lift. The associated incremental load factor is then multiplied by a load alleviation factor that accounts primarily for the aircraft dynamics in a gust.

$$n = 1 + \frac{K_g a U_e V_e}{498 \text{ W/S}}$$

with: $a = (dC_L/d\alpha)$

U_e = equivalent gust velocity (in ft/sec)

V_e = equivalent airspeed (in knots)

K_g = gust alleviation factor

$$K_g = \frac{0.88 \mu}{5.3 + \mu} \quad \text{with} \quad \mu = \frac{2 (W/S)}{\rho c a g}$$

Note that c is the mean *geometric* chord here.

The FAA specifies the magnitude of the gusts to be used as a function of altitude and speed:

Gust velocities at 20,000 ft and below:

66 ft/sec at V_B

50 ft/sec at V_C

25 ft/sec at V_D .

Gust velocities at 50,000 ft and above:

38 ft/sec at V_B

25 ft/sec at V_C

12.5 ft/sec at V_D .

These velocities are specified as equivalent airspeeds and are linearly interpolated between 20000 and 50000 ft.

So, to construct the V-n diagram at a particular aircraft weight and altitude, we start with the maximum achievable load factor curve from the maneuver diagram. We then vary the airspeed and compute the gust load factor associated with the V_B gust intensity. The intersection of these two lines defines the velocity V_B . Well, almost. As noted in the section on design airspeeds, if the product of the 1-g stall speed, V_{s1} and the square root of the gust load factor at V_C (n_g) is less than V_B as computed above, we can set $V_B = V_{s1} \sqrt{n_g}$ and use the maximum achievable load at this lower airspeed.

Next we compute the gust load factor at V_C and V_D from the FAA formula, using the appropriate gust velocities. A straight line is then drawn from the V_B point to the points at V_C and V_D .

Additional Notes on Computations

1) The lift curve slope may be computed from the DATCOM expression:

$$C_{L\alpha} = \frac{2\pi AR}{2 + \sqrt{AR^2 \beta^2 / \kappa^2 (1 + \tan^2 \Delta_{c/2} / \beta^2) + 4}}$$

where β is the Prandtl-Glauert factor: $\beta = \text{sqrt}(1-M^2)$

and κ is an empirical correction factor that accounts for section lift curve slopes different from 2π . In practice κ is approximately 0.97. This expression provides a reasonably good low-speed lift curve slope even for low aspect ratio wings. The effect is an important one as can be seen from the data for a DC-9 shown below. The maximum lift curve slope is about 50% greater than its value at low Mach numbers.

Variation of Lift Curve Slope with Mach Number
DC-9-30 Tail-Off

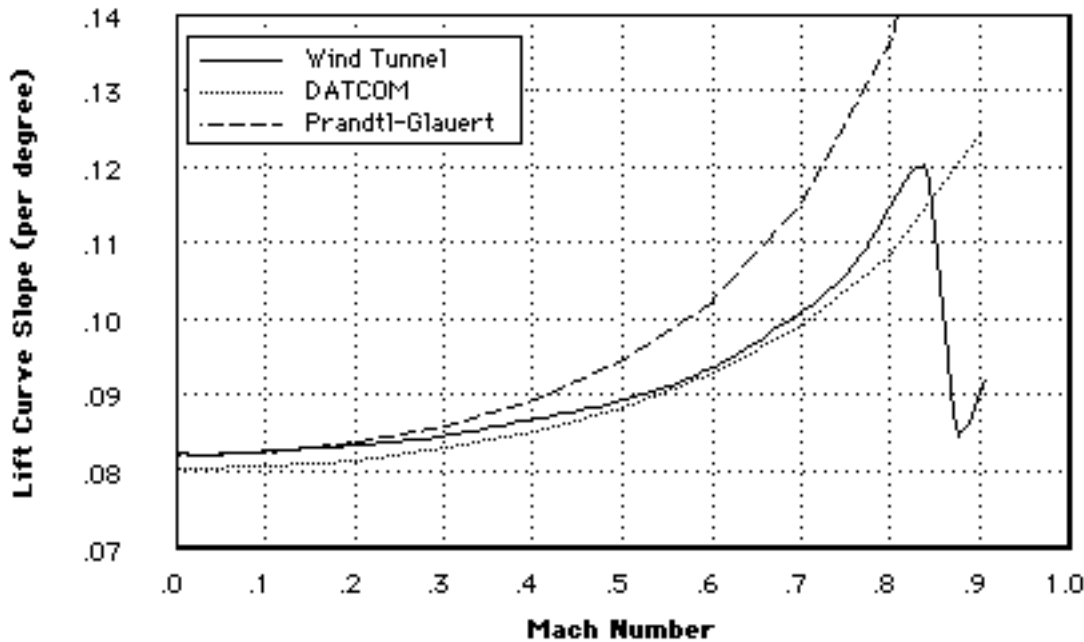

2) Recall $C_{L_{max}}$ may vary with Mach number as discussed in the high-lift section.

Details in FAR 25, not included here:

Check at all altitudes, weights, loading distributions.

Include pitching rates and pitch accelerations (dq/dt):

maximum elevator deflection at V_A

Checked maneuver with $dq/dt = 39 n (n-1.5) / V$ rad/sec² or lower if not possible

For loads use this dq/dt at speeds from V_A to V_D combined with 1-g loads

also check: $dq/dt = -29 n (n-1.5) / V$ combined with the positive maneuver load from $V_A - V_D$

Tail load due to gust can include full downwash and K_g -factor.

Continuous Gust Design Criteria

Appendix G to Part 25--Continuous Gust Design Criteria

The continuous gust design criteria in this appendix must be used in establishing the dynamic response of the airplane to vertical and lateral continuous turbulence unless a more rational criteria is used. The following gust load requirements apply to mission analysis and design envelope analysis:

(a) The limit gust loads utilizing the continuous turbulence concept must be determined in accordance with the provisions of either paragraph (b) or paragraphs (c) and (d) of this appendix.

(b) Design envelope analysis. The limit loads must be determined in accordance with the following:

(1) All critical altitudes, weights, and weight distributions, as specified in Sec. 25.321(b), and all critical speeds within the ranges indicated in paragraph (b)(3) of this appendix must be considered.

(2) Values of A (ratio of root-mean-square incremental load root-mean-square gust velocity) must be determined by dynamic analysis. The power spectral density of the atmospheric turbulence must be as given by the equation--

$$f(V) = s^2 L / (\pi) \frac{1 + 8/3 (1.339 LV)^2}{[1 + (1.339 LV)^2]^{11/6}}$$

where:

f=power-spectral density (ft./sec.)²/rad./ft.

s=root-mean-square gust velocity, ft./sec.

V=reduced frequency, radians per foot.

L=2,500 ft.

(3) The limit loads must be obtained by multiplying the A values determined by the dynamic analysis by the following values of the gust velocity

U:

(i) At speed V_c: U=85 fps true gust velocity in the interval 0 to 30,000 ft. altitude and is linearly decreased to 30 fps true gust velocity at 80,000 ft. altitude. Where the Administrator finds that a design is comparable to a similar design with extensive satisfactory service experience, it will be acceptable to select U at V_c less than 85 fps, but not less than 75 fps, with linear decrease from that value at 20,000 feet to 30 fps at 80,000 feet. The following factors will be taken into account when assessing comparability to a similar design:

(1) The transfer function of the new design should exhibit no unusual characteristics as compared to the similar design which will significantly affect response to turbulence; e.g., coalescence of modal response in the frequency regime which can result in a significant increase of loads.

(2) The typical mission of the new airplane is substantially equivalent to

that of the similar design.

(3) The similar design should demonstrate the adequacy of the U selected.

(ii) At speed VB: U is equal to 1.32 times the values obtained under paragraph (b)(3)(i) of this appendix.

(iii) At speed VD: U is equal to 1/2 the values obtained under paragraph (b)(3)(i) of this appendix.

(iv) At speeds between VB and Vc and between Vc and VD: U is equal to a value obtained by linear interpolation.

(4) When a stability augmentation system is included in the analysis, the effect of system nonlinearities on loads at the limit load level must be realistically or conservatively accounted for.

(c) Mission analysis. Limit loads must be determined in accordance with the following:

(1) The expected utilization of the airplane must be represented by one or more flight profiles in which the load distribution and the variation with time of speed, altitude, gross weight, and center of gravity position are defined. These profiles must be divided into mission segments or blocks, for analysis, and average or effective values of the pertinent parameters defined for each segment.

(2) For each of the mission segments defined under paragraph (c)(1) of this appendix, values of A and No must be determined by analysis. A is defined as the ratio of root-mean-square incremental load to root-mean-square gust velocity and No is the radius of gyration of the load power spectral density function about zero frequency. The power spectral density of the atmospheric turbulence must be given by the equation set forth in paragraph (b)(2) of this appendix.

(3) For each of the load and stress quantities selected, the frequency of exceedance must be determined as a function of load level by means of the equation--

$$N(y) = \sum_{b1A} t N_o \left[P_1 \exp \left(- \frac{|Y - Y_{one=g}|}{b1A} \right) + P_2 \exp \left(- \frac{|Y - Y_{one=g}|}{b2A} \right) \right]$$

where--

t=selected time interval.

y=net value of the load or stress.

Yone=g=value of the load or stress in one-g level flight.

N(y)=average number of exceedances of the indicated value of the load or stress in unit time.

SUM =symbol denoting summation over all mission segments.

No, A=parameters determined by dynamic analysis as defined in paragraph (c)(2) of this appendix.

P1, P2, b1, b2=parameters defining the probability distributions of root-mean-square gust velocity, to be read from Figures 1 and 2 of this appendix.

The limit gust loads must be read from the frequency of exceedance curves at a frequency of exceedance of 2×10^{-5} exceedances per hour. Both positive and negative load directions must be considered in determining the limit loads.

(4) If a stability augmentation system is utilized to reduce the gust loads, consideration must be given to the fraction of flight time that the system may be inoperative. The flight profiles of paragraph (c)(1) of this appendix must include flight with the system inoperative for this fraction of the flight time. When a stability augmentation system is included in the analysis, the effect of system nonlinearities on loads at the limit load level must be conservatively accounted for.

(d) Supplementary design envelope analysis. In addition to the limit loads defined by paragraph (c) of this appendix, limit loads must also be determined in accordance with paragraph (b) of this appendix, except that--

(1) In paragraph (b)(3)(i) of this appendix, the value of $U=85$ fps true gust velocity is replaced by $U=60$ fps true gust velocity on the interval 0 to 30,000 ft. altitude, and is linearly decreased to 25 fps true gust velocity at 80,000 ft. altitude; and

(2) In paragraph (b) of this appendix, the reference to paragraphs (b)(3)(i) through (b)(3)(iii) of this appendix is to be understood as referring to the paragraph as modified by paragraph (d)(1).

[...Illustration appears here...]

Figure 1 (graph)

[...Illustration appears here...]

Figure 2 (graph)

FAR Structural Design Criteria

Subpart C--Structure

General

Sec. 25.301 Loads.

(a) Strength requirements are specified in terms of limit loads (the maximum loads to be expected in service) and ultimate loads (limit loads multiplied by prescribed factors of safety). Unless otherwise provided, prescribed loads are limit loads.

(b) Unless otherwise provided, the specified air, ground, and water loads must be placed in equilibrium with inertia forces, considering each item of mass in the airplane. These loads must be distributed to conservatively approximate or closely represent actual conditions. Methods used to determine load intensities and distribution must be validated by flight load measurement unless the methods used for determining those loading conditions are shown to be reliable.

(c) If deflections under load would significantly change the distribution of external or internal loads, this redistribution must be taken into account.

[Doc. No. 5066, 29 FR 18291, Dec. 24, 1964, as amended by Amdt. 25-23, 35 FR 5672, Apr. 8, 1970]

Sec. 25.303 Factor of safety.

Unless otherwise specified, a factor of safety of 1.5 must be applied to the prescribed limit load which are considered external loads on the structure. When a loading condition is prescribed in terms of ultimate loads, a factor of safety need not be applied unless otherwise specified.

[Amdt. 25-23, 35 FR 5672, Apr. 8, 1970]

Sec. 25.305 Strength and deformation.

(a) The structure must be able to support limit loads without detrimental permanent deformation. At any load up to limit loads, the deformation may not interfere with safe operation.

(b) The structure must be able to support ultimate loads without failure for at least 3 seconds. However, when proof of strength is shown by dynamic tests simulating actual load conditions, the 3-second limit does not apply. Static tests conducted to ultimate load must include the ultimate deflections and ultimate deformation induced by the loading. When analytical methods are used to show compliance with the ultimate load strength requirements, it must be shown that--

(1) The effects of deformation are not significant;

(2) The deformations involved are fully accounted for in the analysis; or
(3) The methods and assumptions used are sufficient to cover the effects of these deformations.

(c) Where structural flexibility is such that any rate of load application likely to occur in the operating conditions might produce transient stresses appreciably higher than those corresponding to static loads, the effects of this rate of application must be considered.

(d) The dynamic response of the airplane to vertical and lateral continuous turbulence must be taken into account. The continuous gust design criteria of Appendix G of this part must be used to establish the dynamic response unless more rational criteria are shown.

(e) The airplane must be designed to withstand any vibration and buffeting that might occur in any likely operating condition up to VD/MD, including stall and probable inadvertent excursions beyond the boundaries of the buffet onset envelope. This must be shown by analysis, flight tests, or other tests found necessary by the Administrator.

(f) Unless shown to be extremely improbable, the airplane must be designed to withstand any forced structural vibration resulting from any failure, malfunction or adverse condition in the flight control system. These must be considered limit loads and must be investigated at airspeeds up to VC/MC.

[Doc. No. 5066, 29 FR 18291, Dec. 24, 1964, as amended by Amdt. 25-23, 35 FR 5672, Apr. 8, 1970; Amdt. 25-54, 45 FR 60172, Sept. 11, 1980; Amdt. 25-77, 57 FR 28949, June 29, 1992]

57 FR 28946, No. 125, June 29, 1992

SUMMARY: This amendment revises the airworthiness standards of the Federal Aviation Regulations (FAR) for type certification of transport category airplanes concerning vibration, buffet, flutter and divergence. It clarifies the requirement to consider flutter and divergence when treating certain damage and failure conditions required by other sections of the FAR and adjusts the safety margins related to aeroelastic stability to make them more appropriate for the conditions to which they apply. These changes are made to provide consistency with other sections of the FAR and to take into account advances in technology and the evolution of the design of transport airplanes.

EFFECTIVE DATE: July 29, 1992.

Sec. 25.307 Proof of structure.

(a) Compliance with the strength and deformation requirements of this subpart must be shown for each critical loading condition. Structural analysis may be used only if the structure conforms to that for which

experience has shown this method to be reliable. The Administrator may require ultimate load tests in cases where limit load tests may be inadequate.

(b) [Reserved]

(c) [Reserved]

(d) When static or dynamic tests are used to show compliance with the requirements of Sec. 25.305(b) for flight structures, appropriate material correction factors must be applied to the test results, unless the structure, or part thereof, being tested has features such that a number of elements contribute to the total strength of the structure and the failure of one element results in the redistribution of the load through alternate load paths.

[Doc. No. 5066, 29 FR 18291, Dec. 24, 1964, as amended by Amdt. 25-23, 35 FR 5672, Apr. 8, 1970; Amdt. 25-54, 45 FR 60172, Sept. 11, 1980; Amdt. 25-72, 55 FR 29775, July 20, 1990]

Flight Loads

Sec. 25.321 General.

(a) Flight load factors represent the ratio of the aerodynamic force component (acting normal to the assumed longitudinal axis of the airplane) to the weight of the airplane. A positive load factor is one in which the aerodynamic force acts upward with respect to the airplane.

(b) Considering compressibility effects at each speed, compliance with the flight load requirements of this subpart must be shown--

(1) At each critical altitude within the range of altitudes selected by the applicant;

(2) At each weight from the design minimum weight to the design maximum weight appropriate to each particular flight load condition; and

(3) For each required altitude and weight, for any practicable distribution of disposable load within the operating limitations recorded in the Airplane Flight Manual.

[Doc. No. 5066, 29 FR 18291, Dec. 24, 1964, as amended by Amdt. 25-23, 35 FR 5672, Apr. 8, 1970]

Flight Maneuver and Gust Conditions

Sec. 25.331 General.

(a) Procedure. The analysis of symmetrical flight must include at least the conditions specified in paragraphs (b) through (d) of this section. The following procedure must be used:

(1) Enough points on the maneuvering and gust envelopes must be investigated to ensure that the maximum load for each part of the airplane

structure is obtained. A conservative combined envelope may be used.

(2) The significant forces acting on the airplane must be placed in equilibrium in a rational or conservative manner. The linear inertia forces must be considered in equilibrium with thrust and all aerodynamic loads, while the angular (pitching) inertia forces must be considered in equilibrium with thrust and all aerodynamic moments, including moments due to loads on components such as tail surfaces and nacelles. Critical thrust values in the range from zero to maximum continuous thrust must be considered.

(3) Where sudden displacement of a control is specified, the assumed rate of control surface displacement may not be less than the rate that could be applied by the pilot through the control system.

(4) In determining elevator angles and chordwise load distribution (in the maneuvering conditions of paragraphs (b) and (c) of this section) in turns and pull-ups, the effect of corresponding pitching velocities must be taken into account. The in-trim and out-of-trim flight conditions specified in Sec. 25.255 must be considered.

(b) Maneuvering balanced conditions. Assuming the airplane to be in equilibrium with zero pitching acceleration, the maneuvering conditions A through I on the maneuvering envelope in Sec. 25.333(b) must be investigated.

(c) Maneuvering pitching conditions. The following conditions involving pitching acceleration must be investigated:

(1) Maximum elevator displacement at VA. The airplane is assumed to be flying in steady level flight (point A1, Sec. 25.333(b)) and, except as limited by pilot effort in accordance with Sec. 25.397(b), the pitching control is suddenly moved to obtain extreme positive pitching acceleration (nose up). The dynamic response or, at the option of the applicant, the transient rigid body response of the airplane, must be taken into account in determining the tail load. Airplane loads which occur subsequent to the normal acceleration at the center of gravity exceeding the maximum positive limit maneuvering load factor, n , need not be considered.

(2) Specified control displacement. A checked maneuver, based on a rational pitching control motion vs. time profile, must be established in which the design limit load factor specified in Sec. 25.337 will not be exceeded. Unless lesser values cannot be exceeded, the airplane response must result in pitching accelerations not less than the following:

(i) A positive pitching acceleration (nose up) is assumed to be reached concurrently with the airplane load factor of 1.0 (Points A1 to D1, Sec. 25.333(b)). The positive acceleration must be equal to at least

$$\frac{39n}{v} \quad (n-1.5), \quad (\text{Radians/sec.}/2/ \quad)$$

where--

n is the positive load factor at the speed under consideration, and V is the airplane equivalent speed in knots.

(ii) A negative pitching acceleration (nose down) is assumed to be reached concurrently with the positive maneuvering load factor (Points A2 to D2,

Sec. 25.333(b)). This negative pitching acceleration must be equal to at least

$$\frac{-26n}{v^{n-1.5}}, \text{ (Radians/sec./2/)}$$

where--

n is the positive load factor at the speed under consideration; and V is the airplane equivalent speed in knots.

(d) Gust conditions. The gust conditions B' through J' Sec. 25.333(c), must be investigated. The following provisions apply:

(1) The air load increment due to a specified gust must be added to the initial balancing tail load corresponding to steady level flight.

(2) The alleviating effect of wing down-wash and of the airplane's motion in response to the gust may be included in computing the tail gust load increment.

(3) Instead of a rational investigation of the airplane response, the gust alleviation factor Kg may be applied to the specified gust intensity for the horizontal tail.

[Doc. No. 5066, 29 FR 18291, Dec. 24, 1964, as amended by Amdt. 25-23, 35 FR 5672, Apr. 8, 1970; Amdt. 25-46, 43 FR 50594, Oct. 30, 1978; 43 FR 52495, Nov. 13, 1978; 43 FR 54082, Nov. 20, 1978; Amdt. 25-72, 55 FR 29775, July 20, 1990; 55 FR 37607, Sept. 12, 1990]

Sec. 25.333 Flight envelope.

(a) General. The strength requirements must be met at each combination of airspeed and load factor on and within the boundaries of the representative maneuvering and gust envelopes (V-n diagrams) of paragraphs (b) and (c) of this section. These envelopes must also be used in determining the airplane structural operating limitations as specified in Sec. 25.1501.

(b) Maneuvering envelope.

[...Illustration appears here...]

(c) Gust envelope.

[...Illustration appears here...]

Sec. 25.335 Design airspeeds.

The selected design airspeeds are equivalent airspeeds (EAS). Estimated values of VS0 and VS1 must be conservative.

(a) Design cruising speed, VC. For VC, the following apply:

(1) The minimum value of VC must be sufficiently greater than VB to provide for inadvertent speed increases likely to occur as a result of severe atmospheric turbulence.

(2) In the absence of a rational investigation substantiating the use of other values, VC may not be less than $V_B + 43$ knots. However, it need not exceed the maximum speed in level flight at maximum continuous power for the corresponding altitude.

(3) At altitudes where VD is limited by Mach number, VC may be limited to a selected Mach number.

(b) Design dive speed, VD. VD must be selected so that VC/MC is not greater than $0.8 VD/MD$, or so that the minimum speed margin between VC/MC and VD/MD is the greater of the following values:

(1) From an initial condition of stabilized flight at VC/MC, the airplane is upset, flown for 20 seconds along a flight path 7.5 deg. below the initial path, and then pulled up at a load factor of 1.5 g (0.5 g acceleration increment). The speed increase occurring in this maneuver may be calculated if reliable or conservative aerodynamic data is used. Power as specified in Sec. 25.175(b)(1)(iv) is assumed until the pull-up is initiated, at which time power reduction and the use of pilot controlled drag devices may be assumed;

(2) The minimum speed margin must be enough to provide for atmospheric variations (such as horizontal gusts, and penetration of jet streams and cold fronts) and for instrument errors and airframe production variations. These factors may be considered on a probability basis. However, the margin at altitude where MC is limited by compressibility effects may not be less than 0.05 M.

(c) Design maneuvering speed VA. For VA, the following apply:

(1) VA may not be less than $VS_1 \sqrt{n}$ where--

(i) n is the limit positive maneuvering load factor at VC; and

(ii) VS_1 is the stalling speed with flaps retracted.

(2) VA and VS must be evaluated at the design weight and altitude under consideration.

(3) VA need not be more than VC or the speed at which the positive CN max curve intersects the positive maneuver load factor line, whichever is less.

(d) Design speed for maximum gust intensity, VB. For VB, the following apply:

(1) VB may not be less than the speed determined by the intersection of the line representing the maximum position lift CN max and the line representing the rough air gust velocity on the gust V-n diagram, or $(\sqrt{ng}) VS_1$, whichever is less, where--

(i) ng is the positive airplane gust load factor due to gust, at speed VC (in accordance with Sec. 25.341), and at the particular weight under consideration; and

(ii) VS_1 is the stalling speed with the flaps retracted at the particular weight under consideration.

(2) VB need not be greater than VC.

(e) Design flap speeds, VF. For VF, the following apply:

(1) The design flap speed for each flap position (established in accordance with Sec. 25.697(a)) must be sufficiently greater than the operating speed

recommended for the corresponding stage of flight (including balked landings) to allow for probable variations in control of airspeed and for transition from one flap position to another.

(2) If an automatic flap positioning or load limiting device is used, the speeds and corresponding flap positions programmed or allowed by the device may be used.

(3) VF may not be less than--

(i) 1.6 VS1 with the flaps in takeoff position at maximum takeoff weight;

(ii) 1.8 VS1 with the flaps in approach position at maximum landing weight, and

(iii) 1.8 VS0 with the flaps in landing position at maximum landing weight.

(f) Design drag device speeds, VDD. The selected design speed for each drag device must be sufficiently greater than the speed recommended for the operation of the device to allow for probable variations in speed control. For drag devices intended for use in high speed descents, VDD may not be less than VD. When an automatic drag device positioning or load limiting means is used, the speeds and corresponding drag device positions programmed or allowed by the automatic means must be used for design.

[Doc. No. 5066, 29 FR 18291, Dec. 24, 1964, as amended by Amdt. 25-23, 35 FR 5672, Apr. 8, 1970]

Sec. 25.337 Limit maneuvering load factors.

(a) Except where limited by maximum (static) lift coefficients, the airplane is assumed to be subjected to symmetrical maneuvers resulting in the limit maneuvering load factors prescribed in this section. Pitching velocities appropriate to the corresponding pull-up and steady turn maneuvers must be taken into account.

(b) The positive limit maneuvering load factor "n" for any speed up to V_n may not be less than $2.1 + 24,000 / (W + 10,000)$ except that "n" may not be less than 2.5 and need not be greater than 3.8--where "W" is the design maximum takeoff weight.

(c) The negative limit maneuvering load factor--

(1) May not be less than -1.0 at speeds up to VC; and

(2) Must vary linearly with speed from the value at VC to zero at VD.

(d) Maneuvering load factors lower than those specified in this section may be used if the airplane has design features that make it impossible to exceed these values in flight.

[Doc. No. 5066, 29 FR 18291, Dec. 24, 1964, as amended by Amdt. 25-23, 35 FR 5672, Apr. 8, 1970]

Sec. 25.341 Gust loads.

(a) The airplane is assumed to be subjected to symmetrical vertical gusts in level flight. The resulting limit load factors must correspond to the conditions determined as follows:

(1) Positive (up) and negative (down) rough air gusts of 66 fps at VB must be considered at altitudes between sea level and 20,000 feet. The gust velocity may be reduced linearly from 66 fps at 20,000 feet to 38 fps at 50,000 feet.

(2) Positive and negative gusts of 50 fps at VC must be considered at altitudes between sea level and 20,000 feet. The gust velocity may be reduced linearly from 50 fps at 20,000 feet to 25 fps at 50,000 feet.

(3) Positive and negative gusts of 25 fps at VD must be considered at altitudes between sea level and 20,000 feet. The gust velocity may be reduced linearly from 25 fps at 20,000 feet to 12.5 fps at 50,000 feet.

(b) The following assumptions must be made:

(1) The shape of the gust is

$$U = \frac{U_{de}}{2} \left(1 - \cos \frac{2\pi s}{25C} \right)$$

where--

s=distance penetrated into gust (ft);

C=mean geometric chord of wing (ft); and

U_{de}=derived gust velocity referred to in paragraph (a) (fps).

(2) Gust load factors vary linearly between the specified conditions B' through G', as shown on the gust envelope in Sec. 25.333(c).

(c) In the absence of a more rational analysis, the gust load factors must be computed as follows:

$$n = 1 + \frac{K_g U_{de} V_a}{498 (W/S)}$$

where--

$$K_g = \frac{0.88 \mu_g}{5.3 + \mu_g} = \text{gust alleviation factor;}$$

$$\mu_g = \frac{2(W/S)}{rCag} = \text{airplane mass ratio:}$$

U_{de}=derived gust velocities referred to in paragraph (a) (fps);

r=density of air (slugs cu. ft.);

W/S=wing loading (psf);

C=mean geometric chord (ft);

g=acceleration due to gravity (ft/sec**2);

V=airplane equivalent speed (knots); and

a=slope of the airplane normal force coefficient curve C_{NA} per radian if the

gust loads are applied to the wings and horizontal method. The wing lift curve slope CAL per radian may be used when the gust load is applied to the wings only and the horizontal tail gust loads are treated as a separate condition.

[Doc. No. 5066, 29 FR 18291, Dec. 24, 1964, as amended by Amdt. 25-72, 55 FR 29775, July 20, 1990; 55 FR 37607, Sept. 12, 1990]

Sec. 25.343 Design fuel and oil loads.

(a) The disposable load combinations must include each fuel and oil load in the range from zero fuel and oil to the selected maximum fuel and oil load. A structural reserve fuel condition, not exceeding 45 minutes of fuel under the operating conditions in Sec. 25.1001(e) and (f), as applicable, may be selected.

(b) If a structural reserve fuel condition is selected, it must be used as the minimum fuel weight condition for showing compliance with the flight load requirements as prescribed in this subpart. In addition--

(1) The structure must be designed for a condition of zero fuel and oil in the wing at limit loads corresponding to--

(i) A maneuvering load factor of +2.25; and

(ii) Gust intensities equal to 85 percent of the values prescribed in Sec. 25.341; and

(2) Fatigue evaluation of the structure must account for any increase in operating stresses resulting from the design condition of paragraph (b)(1) of this section; and

(3) The flutter, deformation, and vibration requirements must also be met with zero fuel.

[Doc. No. 5066, 29 FR 18291, Dec. 24, 1964, as amended by Amdt. 25-18, 33 FR 12226, Aug. 30, 1968; Amdt. 25-72, 55 FR 29775, July 20, 1990; 55 FR 37607, Sept. 12, 1990]

Sec. 25.345 High lift devices.

(a) If flaps are to be used during takeoff, approach, or landing, at the design flap speeds established for these stages of flight under Sec. 25.335(e) and with the flaps in the corresponding positions, the airplane is assumed to be subjected to symmetrical maneuvers and gusts within the range determined by--

(1) Maneuvering to a positive limit load factor of 2.0; and

(2) Positive and negative 25 fps derived gusts acting normal to the flight path in level flight.

(b) The airplane must be designed for the conditions prescribed in paragraph (a) of this section, except that the airplane load factor need not exceed 1.0, taking into account, as separate conditions, the effects of--

(1) Propeller slipstream corresponding to maximum continuous power at the design flap speeds V_F , and with takeoff power at not less than 1.4 times the stalling speed for the particular flap position and associated maximum weight; and

(2) A head-on gust of 25 feet per second velocity (EAS).

(c) If flaps or similar high lift devices are to be used in en route conditions, and with flaps in the appropriate position at speeds up to the flap design speed chosen for these conditions, the airplane is assumed to be subjected to symmetrical maneuvers and gusts within the range determined by--

(1) Maneuvering to a positive limit load factor as prescribed in Sec. 25.337(b); and

(2) Positive and negative derived gusts as prescribed in Sec. 25.341 acting normal to the flight path in level flight.

(d) The airplane must be designed for landing at the maximum takeoff weight with a maneuvering load factor of 1.5g and the flaps and similar high lift devices in the landing configuration.

[Doc. No. 5066, 29 FR 18291, Dec. 24, 1964, as amended by Amdt. 25-46, 43 FR 50595, Oct. 30, 1978; Amdt. 25-72, 55 FR 29775, July 20, 1990; 55 FR 37607, Sept. 12, 1990]

Sec. 25.349 Rolling conditions.

The airplane must be designed for rolling loads resulting from the conditions specified in paragraphs (a) and (b) of this section. Unbalanced aerodynamic moments about the center of gravity must be reacted in a rational or conservative manner, considering the principal masses furnishing the reacting inertia forces.

(a) Maneuvering. The following conditions, speeds, and aileron deflections (except as the deflections may be limited by pilot effort) must be considered in combination with an airplane load factor of zero and of two-thirds of the positive maneuvering factor used in design. In determining the required aileron deflections, the torsional flexibility of the wing must be considered in accordance with Sec. 25.301(b):

(1) Conditions corresponding to steady rolling velocities must be investigated. In addition, conditions corresponding to maximum angular acceleration must be investigated for airplanes with engines or other weight concentrations outboard of the fuselage. For the angular acceleration conditions, zero rolling velocity may be assumed in the absence of a rational time history investigation of the maneuver.

(2) At V_A , a sudden deflection of the aileron to the stop is assumed.

(3) At V_C , the aileron deflection must be that required to produce a rate of roll not less than that obtained in paragraph (a)(2) of this section.

(4) At V_D , the aileron deflection must be that required to produce a rate of roll not less than one-third of that in paragraph (a)(2) of this section.

(b) Unsymmetrical gusts. The condition of unsymmetrical gusts must be considered by modifying the symmetrical flight conditions B' or C' (in Sec. 25.333(c)) whichever produces the critical load. It is assumed that 100 percent of the wing air load acts on one side of the airplane and 80 percent

acts on the other side.

[Doc. No. 5066, 29 FR 18291, Dec. 24, 1964, as amended by Amdt. 25-23, 35 FR 5672, Apr. 8, 1970]

Sec. 25.351 Yawing conditions.

The airplane must be designed for loads resulting from the conditions specified in paragraphs (a) and (b) of this section. Unbalanced aerodynamic moments about the center of gravity must be reacted in a rational or conservative manner considering the principal masses furnishing the reacting inertia forces:

(a) Maneuvering. At speeds from VMC to VD, the following maneuvers must be considered. In computing the tail loads, the yawing velocity may be assumed to be zero:

(1) With the airplane in unaccelerated flight at zero yaw, it is assumed that the rudder control is suddenly displaced to the maximum deflection, as limited by the control surface stops, or by a 300-pound rudder pedal force, whichever is less.

(2) With the rudder deflected as specified in paragraph (a)(1) of this section, it is assumed that the airplane yaws to the resulting sideslip angle.

(3) With the airplane yawed to the static sideslip angle corresponding to the rudder deflection specified in paragraph (a)(1) of this section, it is assumed that the rudder is returned to neutral.

(b) Lateral gusts. The airplane is assumed to encounter derived gusts normal to the plane of symmetry while in unaccelerated flight. The derived gusts and airplane speeds corresponding to conditions B' through J' (in Sec. 25.333(c)) (as determined by Secs. 25.341 and 25.345(a)(2) or Sec. 25.345(c)(2)) must be investigated. The shape of the gust must be as specified in Sec. 25.341. In the absence of a rational investigation of the airplane's response to a gust, the gust loading on the vertical tail surfaces must be computed as follows:

$$L_t = \frac{K_{gt} U_{de} V_{at} S_t}{498}$$

where--

L_t = vertical tail load (lbs.);

$$K_{gt} = \frac{0.88 + \mu_{gt}}{5.3 + \mu_{gt}} = \text{gust alleviation factor;}$$

$$\mu_{gt} = \frac{2W}{p C_{tga} S_t} \left(\frac{K}{l_t} \right)^2 = \text{lateral mass ratio;}$$

Ude=derived gust velocity (fps);
p=air density (slugs/cu. ft.);
W=airplane weight (lbs.);
St=area of vertical tail (ft.**2);
Ct=mean geometric chord of vertical surface (ft.);
at=lift curve slope of vertical tail (per radian);
K=radius of gyration in yaw (ft).;
lt=distance from airplane c.g., to lift center of vertical surface (ft.);
g=acceleration due to gravity (ft./sec.**2); and
V=airplane equivalent speed (knots).

[Doc. No. 5066, 29 FR 18291, Dec. 24, 1964, as amended by Amdt. 25-23, 35 FR 5672, Apr. 8, 1970; Amdt. 25-46, 43 FR 50595, Oct. 30, 1978; Amdt. 25-72, 55 FR 29775, July 20, 1990; 55 FR 37608, Sept. 12, 1990; 55 FR 41415, Oct. 11, 1990]

Aircraft Structural Design

Introduction

Although the major focus of structural design in the early development of aircraft was on strength, now structural designers also deal with fail-safety, fatigue, corrosion, maintenance and inspectability, and producibility.

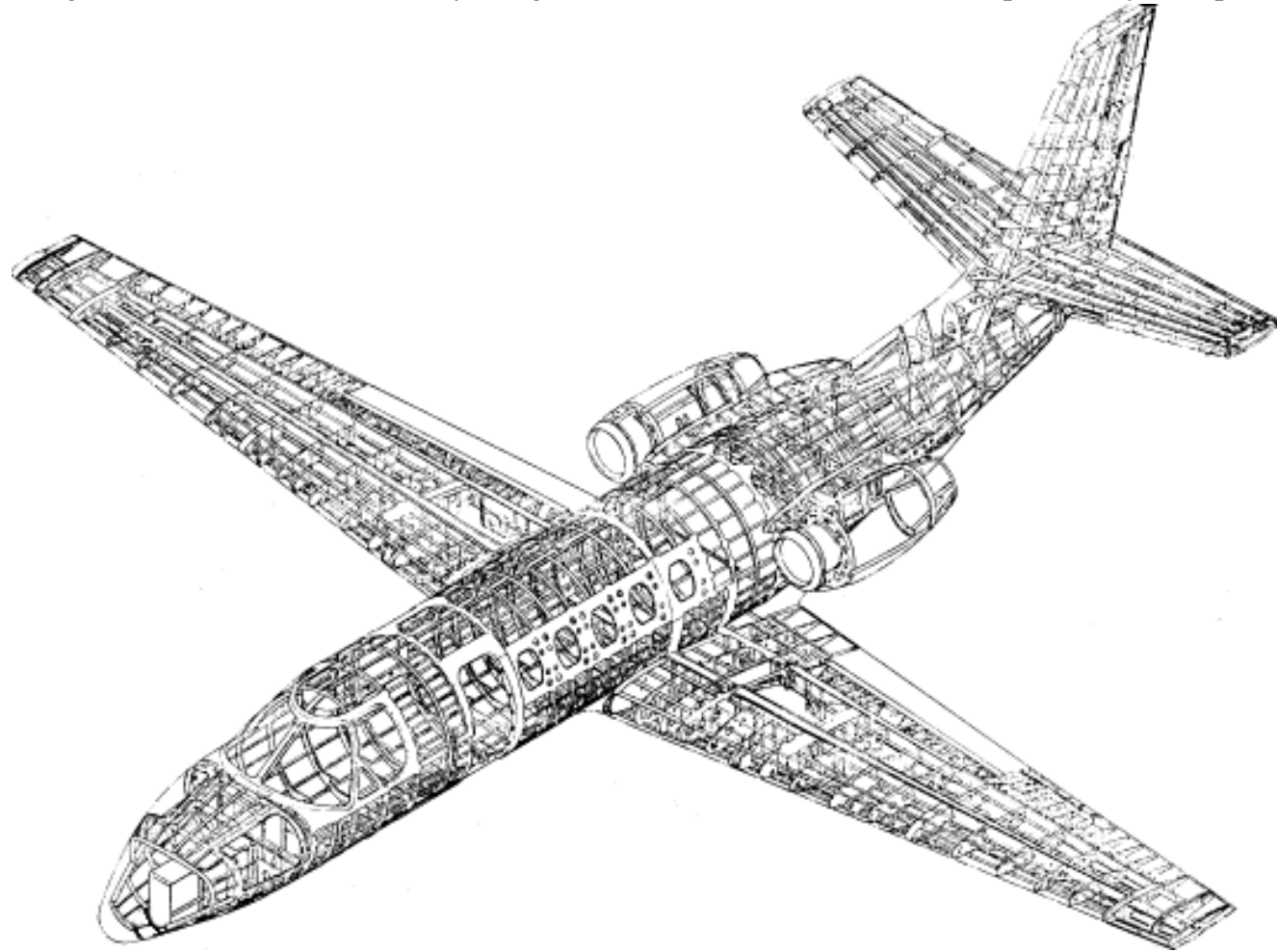

Structural Concepts

Modern aircraft structures are designed using a semi-monocoque concept- a basic load-carrying shell reinforced by frames and longerons in the bodies, and a skin-stringer construction supported by spars and ribs in the surfaces.

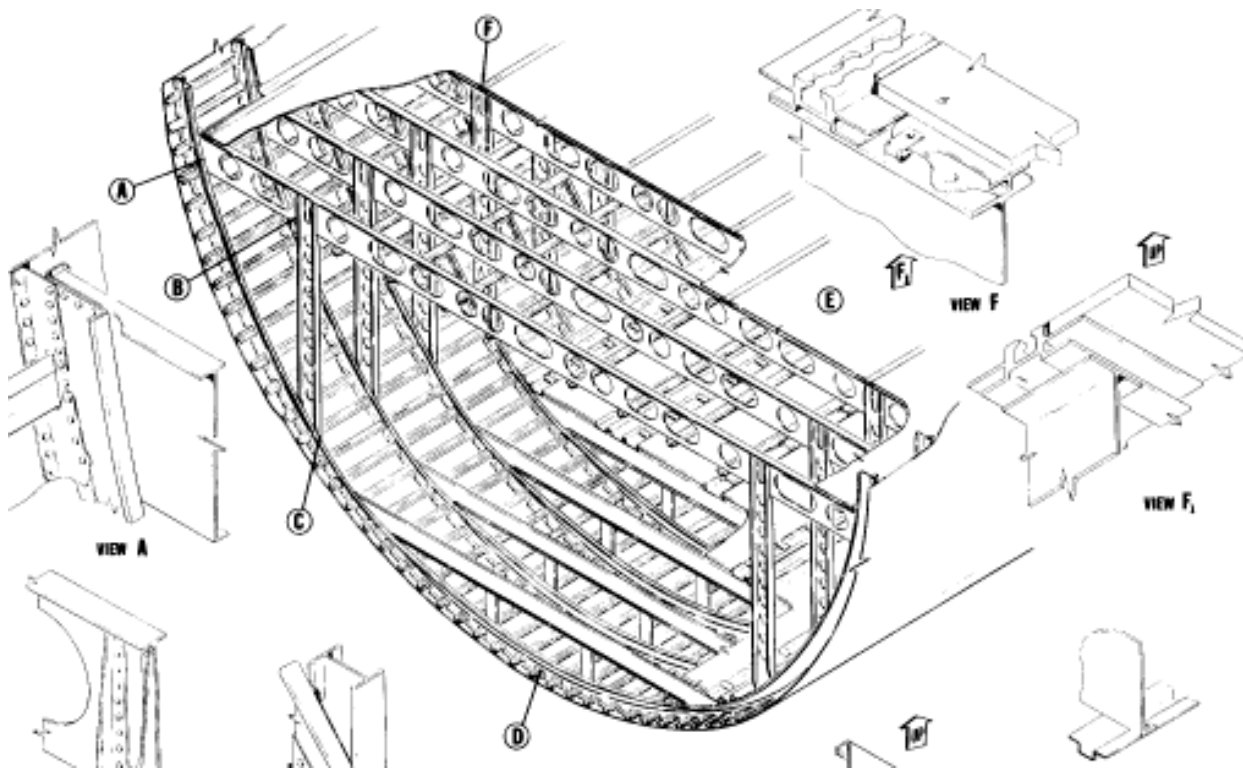

Proper stress levels, a very complex problem in highly redundant structures, are calculated using versatile computer matrix methods to solve for detailed internal loads. Modern finite element models of aircraft components include tens-of-thousands of degrees-of-freedom and are used to determine the required skin thicknesses to avoid excessive stress levels, deflections, strains, or buckling. The goals of detailed design are to reduce or eliminate stress concentrations, residual stresses, fretting corrosion, hidden undetectable cracks, or single failure causing component failure. Open sections, such as Z or J sections, are used to permit inspection of stringers and avoid moisture accumulation.

Fail-safe design is achieved through material selection, proper stress levels, and multiple load path structural arrangements which maintain high strength in the presence of a crack or damage. Examples of the latter are:

- a) Use of tear-stoppers
- b) Spanwise wing and stabilizer skin splices

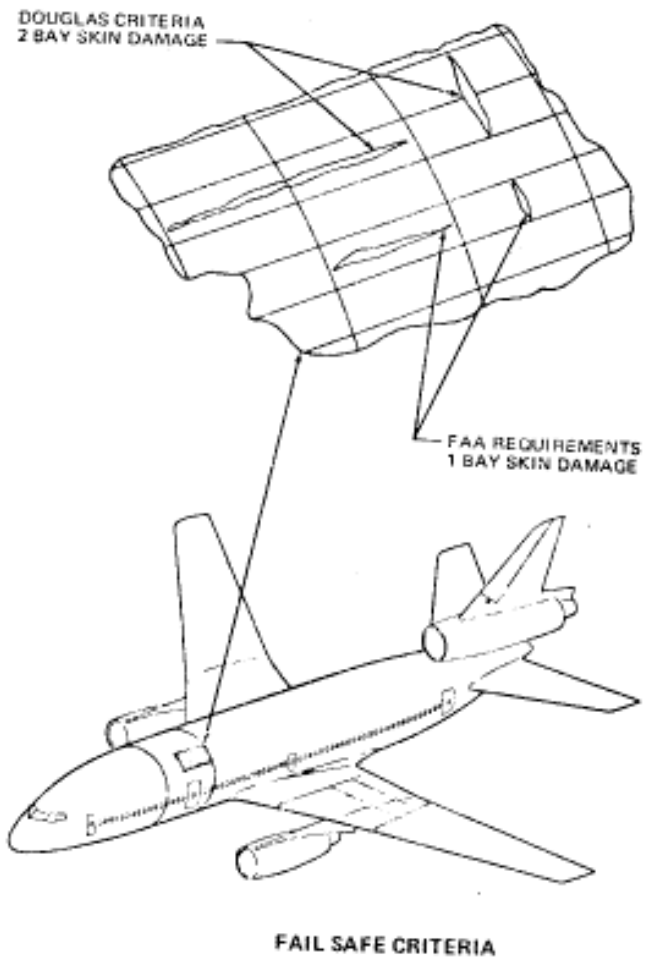

Analyses introduce cyclic loads from ground-air-ground cycle and from power spectral density descriptions of continuous turbulence. Component fatigue test results are fed into the program and the cumulative fatigue damage is calculated. Stress levels are adjusted to achieve required structural fatigue design life.

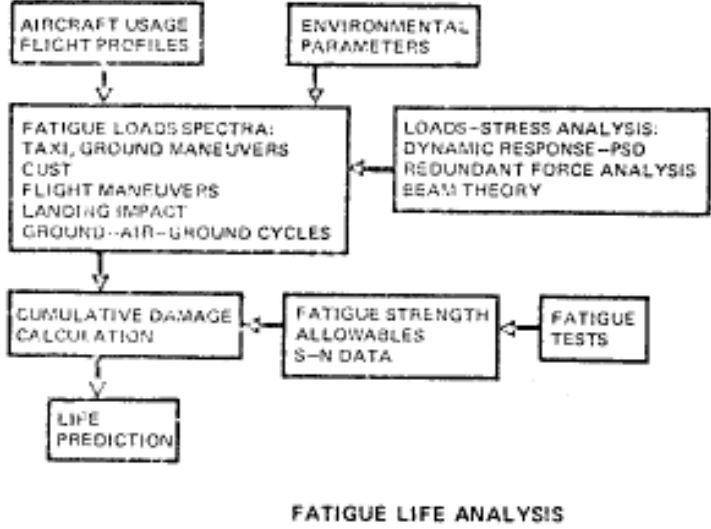

Design Life Criteria -- Philosophy

Fatigue failure life of a structural member is usually defined as the time to initiate a crack which would tend to

reduce the ultimate strength of the member.

Fatigue design life implies the average life to be expected under average aircraft utilization and loads environment. To this design life, application of a fatigue life scatter factor accounts for the typical variations from the average utilization, loading environments, and basic fatigue strength allowables. This leads to a safe-life period during which the probability of a structural crack occurring is very low. With fail-safe, inspectable design, the actual structural life is much greater.

The overall fatigue life of the aircraft is the time at which the repair of the structure is no longer economically feasible.

Scatter factors of 2 to 4 have been used to account for statistical variation in component fatigue tests and unknowns in loads. Load unknowns involve both methods of calculation and type of service actually experienced.

Primary structure for present transport aircraft is designed, based on average expected operational conditions and average fatigue test results, for 120,000 hrs. For the best current methods of design, a scatter factor of 2 is typically used, so that the expected crack-free structural life is 60,000 hrs, and the probability of attaining a crack-free structural life of 60,000 hrs is 94 percent as shown in the following figure and table.

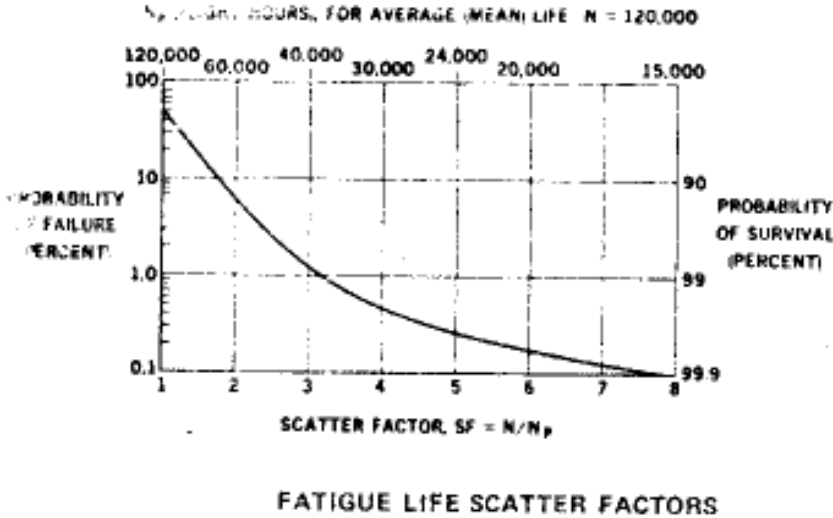

s.f. = N / N_p	Probability of Survival (%)	N_p (Flight Hours) ($N = 120,000$ hrs)	N_p (Years) (3,000 flight hrs / year)
2.0	94.0	60,000	20
2.5	97.5	48,000	16
3.0	98.8	40,000	13.3
3.5	99.3	34,300	11.4
4.0	99.54	30,000	10.0

With fail-safe design concepts, the usable structural life would be much greater, but in practice, each manufacturer has different goals regarding aircraft structural life.

Materials

Choice of materials emphasizes not only strength/weight ratio but also:

- Fracture toughness
- Crack propagation rate
- Notch sensitivity
- Stress corrosion resistance
- Exfoliation corrosion resistance

Acoustic fatigue testing is important in affected portions of structure.

Doublers are used to reduce stress concentrations around splices, cut-outs, doors, windows, access panels, etc., and to serve as tear-stoppers at frames and longerons.

Generally DC-10 uses 2024-T3 aluminum for tension structure such as lower wing skins, pressure critical fuselage skins and minimum gage applications. This material has excellent fatigue strength, fracture toughness and notch sensitivity. 7075-T6 aluminum has the highest strength with acceptable toughness. It is used for strength critical structures such as fuselage floor beams, stabilizers and spar caps in control surfaces. It is also used for upper wing skins.

For those parts in which residual stresses could possibly be present, 7075-T73 material is used. 7075-T73 material has superior stress corrosion resistance and exfoliation corrosion resistance, and good fracture toughness. Typical applications are fittings that can have detrimental preloads induced during assembly or that are subjected to sustained operational loads. Thick-section forgings are 7075-T73, due to the possible residual stresses induced during heat treatment. The integral ends of 7075-T6 stringers and spar caps are overaged to T73 locally. This unique use of the T73 temper virtually eliminates possibility of stress corrosion cracking in critical joint areas.

Miscellaneous Numbers

Although the yield stress of 7075 or 2024 Aluminum is higher, a typical value for design stress at limit load is 54,000 psi. The density of aluminum is $.101 \text{ lb} / \text{in}^3$

Minimum usable material thickness is about 0.06 inches for high speed transport wings. This is set by lightning strike requirements. (Minimum skin gauge on other portions of the aircraft, such as the fuselage, is about 0.05 inches to permit countersinking for flush rivets.

On the Cessna Citation, a small high speed airplane, 0.04 inches is the minimum gauge on the inner portion of the wing, but 0.05 inches is preferred. Ribs may be as thin as 0.025 inches. Spar webs are about 0.06 inches at the tip.

For low speed aircraft where flush rivets are not a requirement and loads are low, minimum skin gauge is as low as 0.016 inches where little handling is likely, such as on outer wings and tail cones. Around fuel tanks (inboard wings) 0.03 inches is minimum. On light aircraft, the spar or spars carry almost all of the bending and shear loads. Wing skins are generally stiffened. Skins contribute to compression load only near the spars (which serve as stiffeners in a limited area). Lower skins do contribute to tension capability but the main function of the skin in these cases is to carry torsion loads and define the section shape.

In transport wings, skin thicknesses usually are large enough, when designed for bending, to handle torsion loads.

Fuel density is 6.7 lb/gallon.

Structural Optimization and Design

Structures are often analyzed using complex finite element analysis methods. These tools have evolved over the past decades to be the basis of most structural design tasks. A candidate structure is analyzed subject to the predicted loads and the finite element program predicts deflections, stresses, strains, and even buckling of the many elements. The designed can then resize components to reduce weight or prevent failure. In recent years, structural optimization has been combined with finite element analysis to determine component gauges that may minimize weight subject to a number of constraints. Such tools are becoming very useful and there are many examples of substantial weight reduction using these methods. Surprisingly, however, it appears that modern methods do not do a better job of predicting failure of the resulting designs, as shown by the figure below, constructed from recent Air Force data.

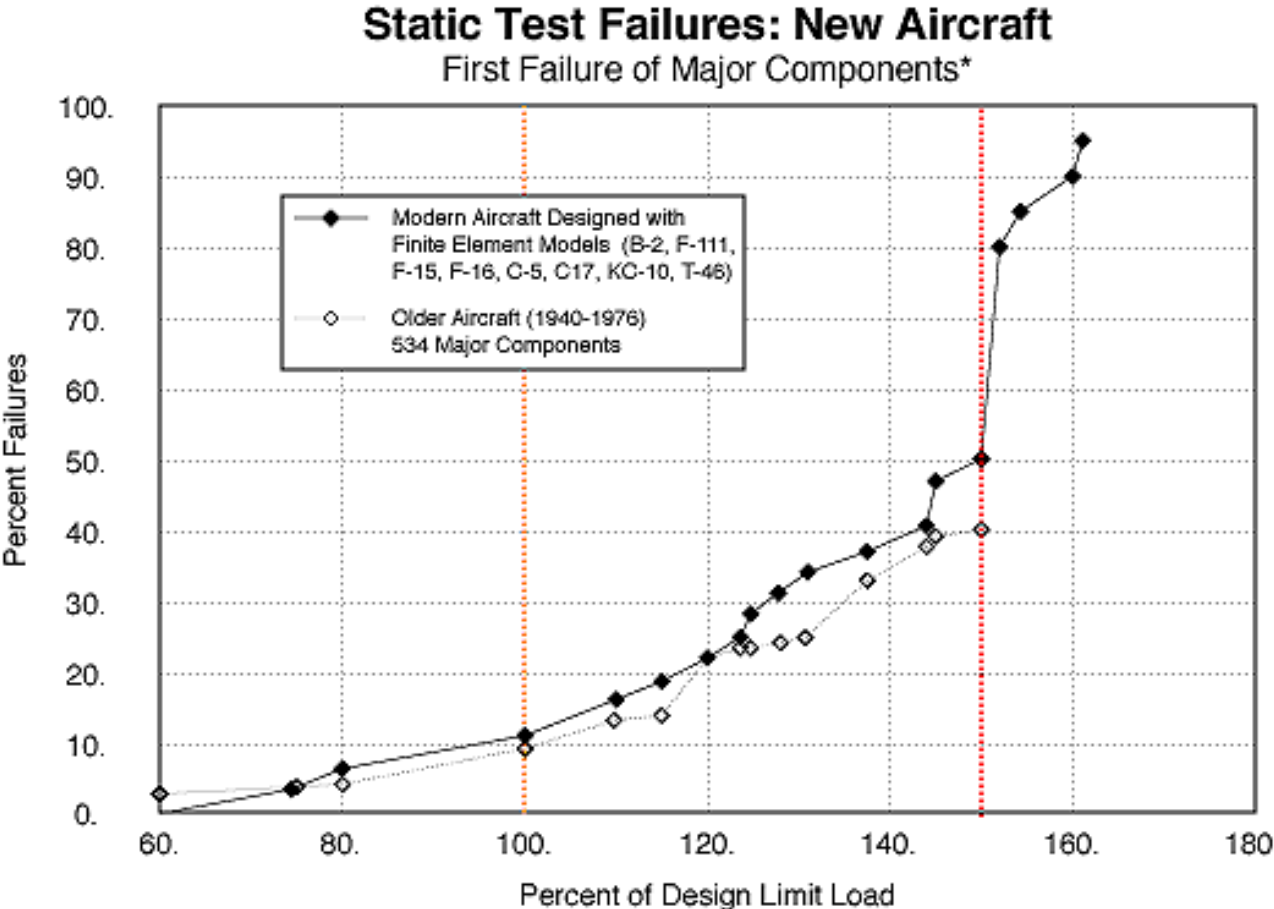

* Wing, Fuselage, Vertical Tail, Horizontal Tail, Landing Gear, Unique Major Components

Aircraft Weight Estimation

Overview

The multitude of considerations affecting structural design, the complexity of the load distribution through a redundant structure, and the large number of intricate systems required in an airplane, make weight estimation a difficult and precarious career. When the detail design drawings are complete, the weight engineer can calculate the weight of each and every part--thousands of them--and add them all up...and indeed this is eventually done. But in the advanced design phase, this cannot be done because there are no drawings of details. In the beginning, the advanced design engineer creates only a 3-view and some approximate specifications. The rest of the design remains undefined.

One may start the design process with only very simple estimates of the overall empty weight of the aircraft based purely on statistical results. Some of these correlations are not bad, such as the observation that the ratio of empty weight to gross weight of most airplanes is about 50%. Of course, this is a very rough estimate and does not apply at all to aircraft such as the Voyager or other special purpose designs.

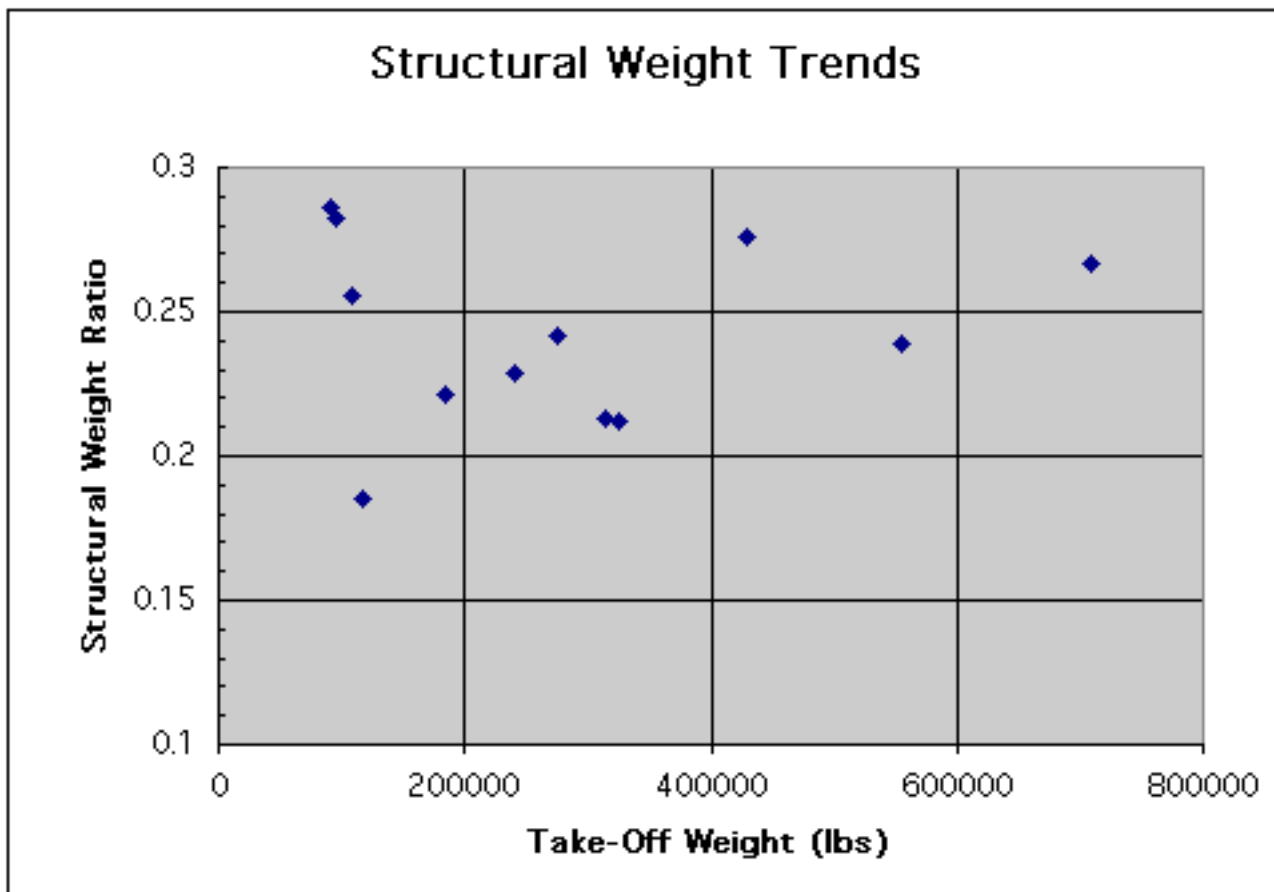

One of the interesting aspects of this data is that it does not seem to follow the expected "square-cube" law. We might expect that the stress in similar structures increases with the linear dimensions if the imposed load is proportional to the structural weight because the latter grows as the cube of the linear dimension while the material cross-section carrying the load grows as the square. There are several

reasons that the relationship is not so simple:

1. Some aircraft components are not affected very much by the square-cube law.
2. New and better materials and techniques have helped empty weight.
3. Higher wing loadings are used for larger aircraft.
4. Some portions of airplanes have material size fixed by minimum "handling" thickness.

The figures below show some of this effect. They are from a classic paper by F.A. Cleveland entitled, "Size Effects in Conventional Aircraft Design" (J. of Aircraft, Nov. 1970).

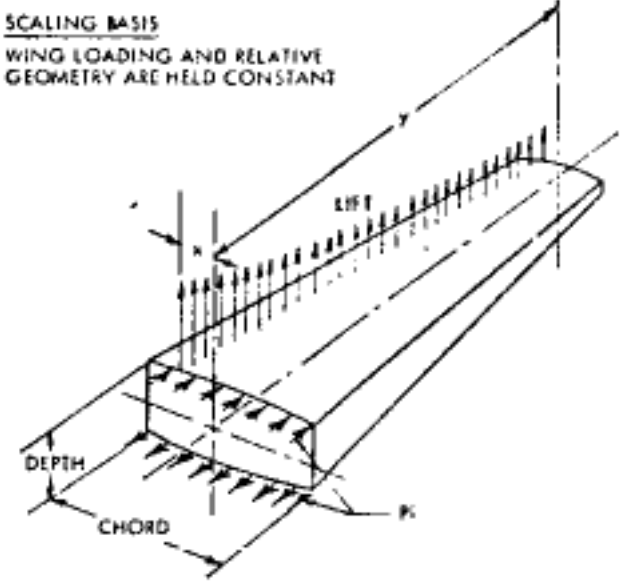

ITEM	AIRPLANE	
	A	B
GROSS WEIGHT	1	2
PAYLOAD	1	2
CHORD OF BOX	1	$\sqrt{2}$
DEPTH OF BOX	1	$\sqrt{2}$
DEPTH X CHORD	1	2
BENDING MOMENT = $(LIFT \cdot x)$	1	$2\sqrt{2}$
P_1 = SURFACE LOADING INTENSITY = $\frac{\text{BENDING MOMENT}}{\text{DEPTH X CHORD}}$	1	$\sqrt{2}$
WING WEIGHT	1	$2\sqrt{2}$

*(AXIAL LOAD PER INCH IN SURFACES OF WING BOX BEAM)

" As might be expected there is a considerable diversity of scaling among components. This is particularly apparent between the airframe components where the square-cube law has a strong influence, as on the lifting surfaces, and those where it has little effect, as on the fuselage. The landing gear, powerplant, and air-conditioning system, tend to increase gross weight, but the electrical system, electronics, instruments ice-protection and furnishings are affected more by mission requirements than by aircraft size. On balance, the overall factor of about 2.1 reflects the tendency of the square/cube law to project a modestly increasing structural weight fraction with size."

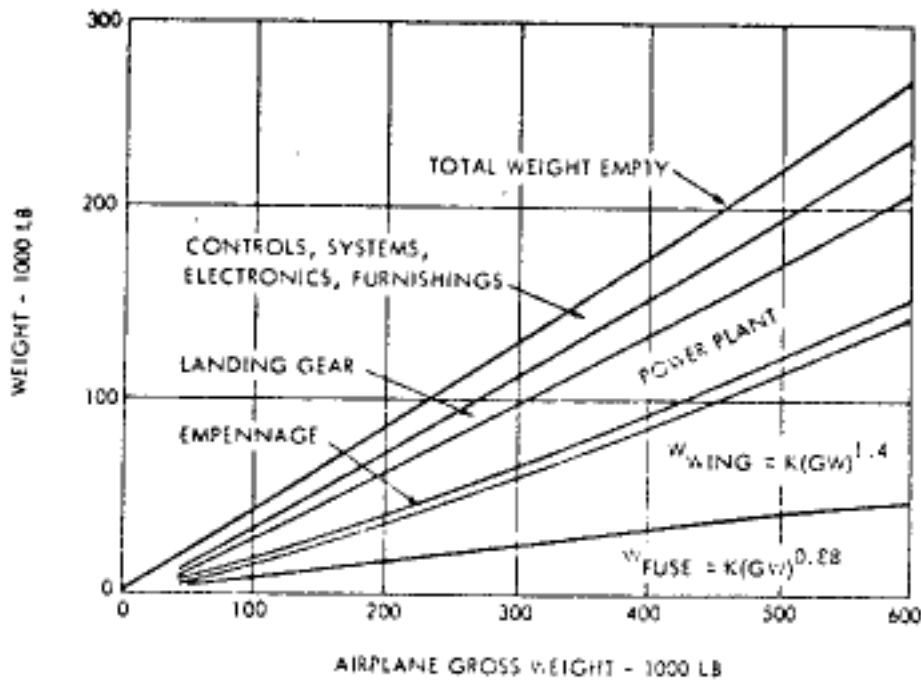

The next step in weight estimation involves a component build-up, in much the same fashion as we considered aircraft drag. This is the approach described here. It involves a combination of structural analysis and statistical comparisons, with the complexity of the analysis dependent on the available information and computational resources.

If the analysis is too simple or the statistical parameters are not chosen properly, these correlations have dubious validity. In some cases such correlations can be expected to hold for a very restricted class of aircraft, or to hold with accuracy sufficient for presentation only on log-log plots. It is very important that the method be based on the fundamental physics of the design rather than on an ad-hoc correlation parameter. One must also be cautious of the self-fulfilling nature of such correlations. If one expects, based on historical precedent that a wing should weigh 20,000 lbs, one may work hard to reduce the weight if the original design weighs 25,000 lbs. When the design is finally brought down to the initial estimate the project leader may be satisfied, and the new design appears as a point on the next edition of the plot.

The following sections provide methods for estimating the component weights for advanced design purposes. Some of the sections (e.g. wing weight estimation) provide a more in-depth discussion of the derivation of the method and comparisons with several aircraft. The correlations vary from fair to very good, and provide a reasonable basis for estimating weights. They are based on a variety of sources, from published methods of aircraft manufacturers to methods developed by NASA and some developed originally here. We do not use Boeing's method or Douglas' method because these methods constitute some of the most proprietary parts of the preliminary design systems in use at these companies.

Component Weight Methods

In the following sections, aircraft weights are divided into the following components. Each company divides the weight into different categories, so it is sometime difficult to compare various components

from different manufacturers. Here we divide the system into the following categories:

- Wing
- Horizontal Tail
- Vertical Tail
- Fuselage
- Landing Gear
- Surface Controls
- Propulsion System
- APU
- Instruments and Navigation
- Hydraulics and Pneumatics
- Electrical System
- Electronics
- Furnishings
- Air Conditioning and Anti-Ice
- Crew
- Flight Attendants
- Operating Items
- Payload
- Fuel

Sample Weight Statements

Companies typically present a summary of these items in an airplane weight statement. Some examples are available from this link.

Total Weights

The component weights are grouped together to form a number of total weights that are routinely used in aircraft design. This section lists some of the typical weights and their definitions.

Component Weights

1. Wing

The wing weights index is related to the fully-stressed bending weight of the wing box. It includes the effect of total wing load (at the ultimate load factor, N_{ult}), span (b), average airfoil thickness (t/c), taper (λ), sweep of the structural axis (Δ_{ea}), and gross wing area (S_{wg}). The total wing weight is based on this bending index and actual data from 15 transport aircraft. [Additional information on the wing weight](#) computation is provided from this link.

$$W_{wing} = 4.22 S_{wg} + 1.642 \times 10^{-6} \frac{N_{ult} b^3 \sqrt{TOW ZFW} (1+2\lambda)}{(t/c)_{avg} \cos^2 \Delta_{ea} S_{wg} (1+\lambda)} \quad (\text{lbs})$$

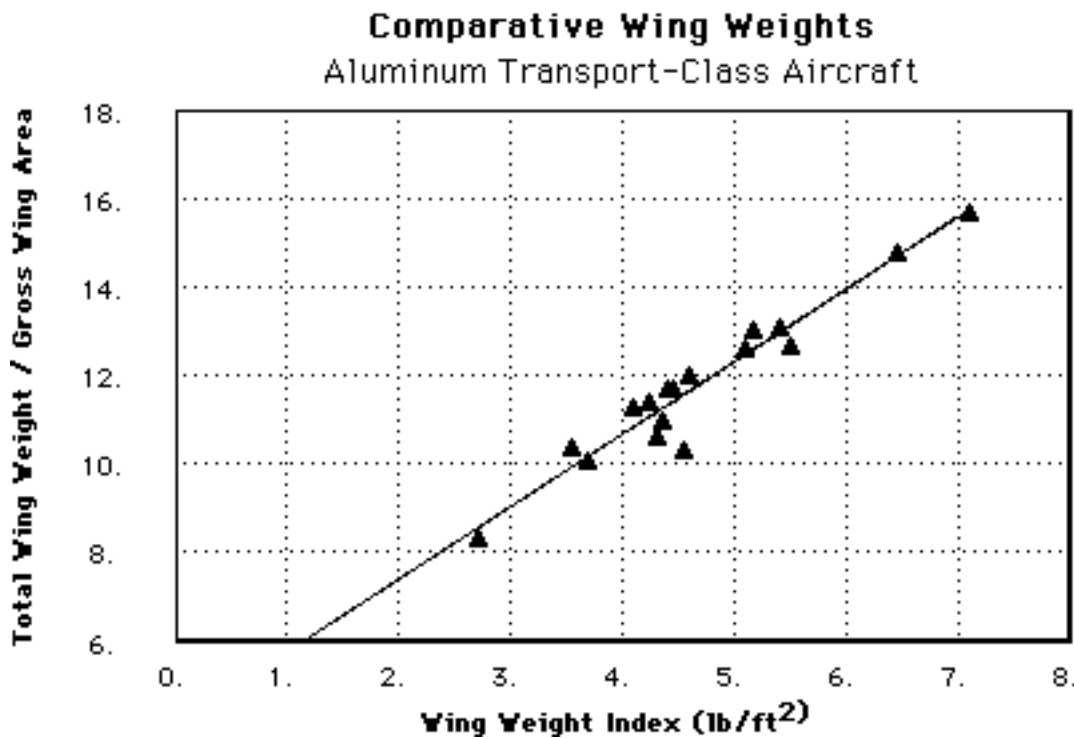

2. Horizontal Tail

The horizontal tail weight, including elevator, is determined similarly, but the weight index introduces both exposed and gross horizontal tail areas as well as the tail length (distance from airplane c.g. to aerodynamic center of the horizontal tail). The method assumes that the elevator is about 25% of the horizontal tail area. Several sources suggest treating V-tails as conventional horizontal tails with the area and span that would be obtained if the v-tail dihedral were removed.

$$W_{\text{horiz}} = 5.25 S_{He} + 0.8 \times 10^{-6} \frac{N_{\text{ult}} b_H^3 \text{TOW MAC}_w \sqrt{S_{He}}}{(tc)_{\text{avg}} \cos^2 \Delta_{ea} l_H S_{Hg}^{1.5}} \quad (\text{lbs})$$

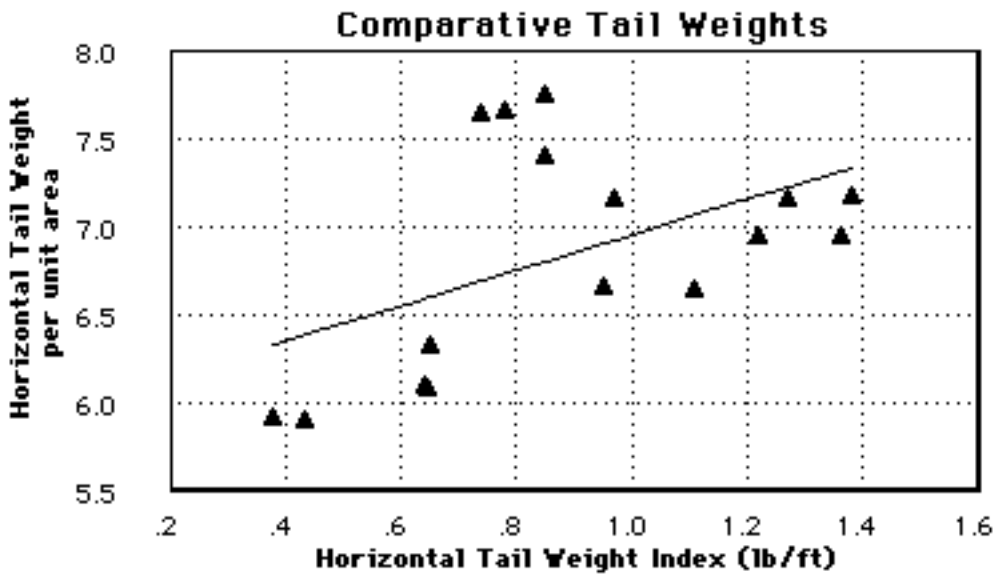

3. Vertical Tail and Rudder

This graph shows the vertical fin (vertical tail less rudder) weight. The rudder itself may be assumed to occupy about 25% of S_V and weighs 60% more per unit area. The weight of the vertical portion of a T-tail is about 25% greater than that of a conventional tail; a penalty of 5% to 35% is assessed for vertical tails with center engines. (The formula below does not include the rudder weight, but S_V is the area of the vertical tail with rudder.)

$$W_{\text{vert}} = 2.62 S_v + 1.5 \times 10^{-5} \frac{N_{\text{ult}} b_v^3 (8.0 + 0.44 \frac{\text{TOW}}{S_{\text{wg}}})}{(t/c)_{\text{avg}} \cos^2 \Delta_{\text{ea}}} \quad (\text{lbs})$$

(lbs)

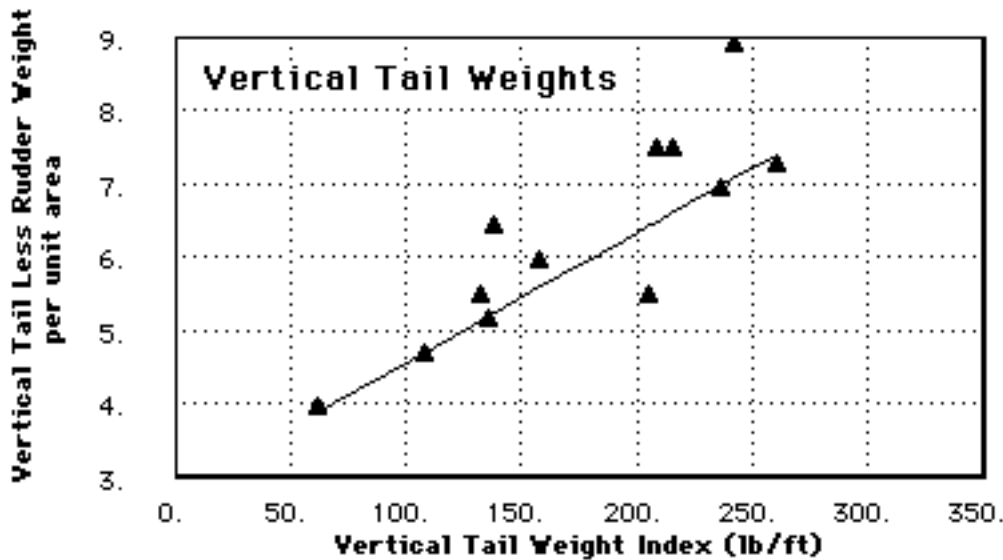

4. Fuselage

Fuselage weight is based on gross fuselage wetted area (without cutouts for fillets or surface intersections and upon a pressure-bending load parameter.

The pressure index is: $I_p = 1.5E-3 * P * B$

The bending index is: $I_b = 1.91E-4 N * W * L / H^2$

where: P = maximum pressure differential (lb / sq ft)

B = fuselage width (ft)

H = fuselage height (ft)

L = fuselage length (ft)

N = limit load factor at ZFW

W = ZFW_{max} - weight of wing and wing-mounted engines, nacelles and pylons.

The fuselage is pressure-dominated when: $I_p > I_b$.

When fuselage is pressure dominated: $I_{\text{fuse}} = I_p$

When fuselage is not pressure-dominated: $I_{\text{fuse}} = (I_p^2 + I_b^2) / (2 I_b)$

To better represent the distributed support provided by the wing, the effective fuselage length is taken to be the actual fuselage length minus the wing root chord / 2.

The fuselage weight is then:

$$W_{\text{fuse}} = (1.051 + .102 * I_{\text{fuse}}) * S_{\text{fuse}}$$

Subtract 8.5% for all-cargo aircraft.

Total Fuselage Weight

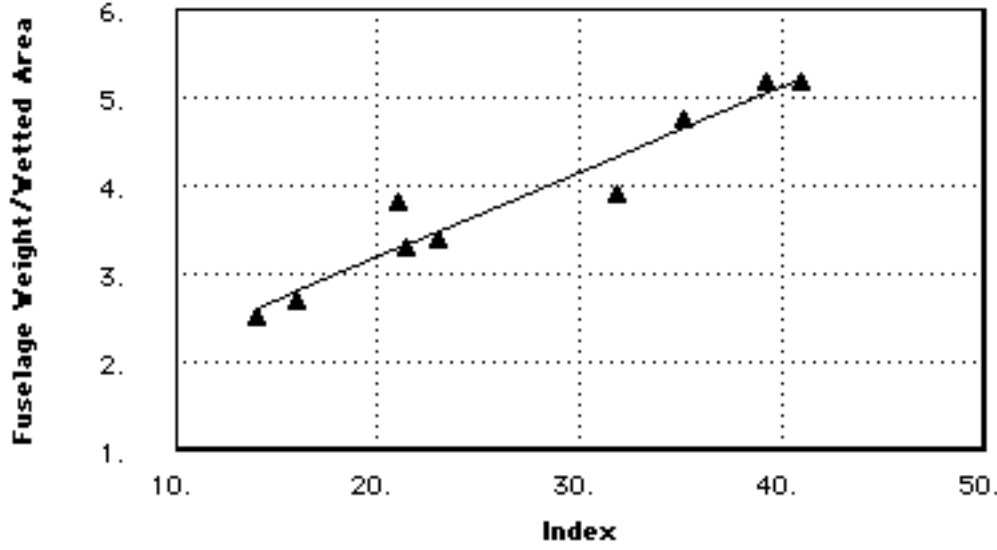

5. Landing Gear

Gear weight is about 4.0% of the take-off weight. This is the total landing gear weight including structure, actuating system, and the rolling assembly consisting of wheels, brakes, and tires. The rolling assembly is approximately 39% of the total gear weight:

$$W_{gear} = 0.04 \text{ TOW}$$

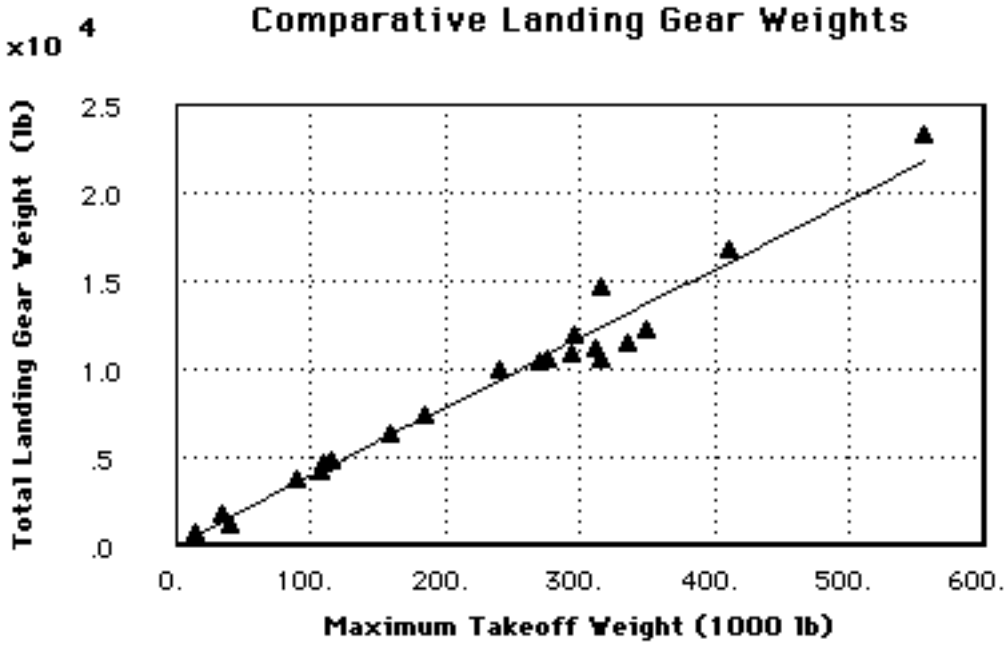

6. Surface Controls

Surface controls are the systems associated with control surface actuation, not the control surfaces themselves. This system weight depends primarily on the area of the horizontal and vertical tails.

$$W_{sc} = I_{sc} * (S_H + S_V)$$

where:
 $I_{sc} = 3.5$ (lb / sq ft) for fully-powered controls
 2.5 for part-power systems
 1.7 for full aerodynamic controls.

7. Propulsion System

The propulsion system weight is about 60% greater than that of the dry engine alone. The engine structural section, or nacelle group, and the propulsion group which includes the engines, engine exhaust, reverser, starting, controls, lubricating, and fuel systems are handled together as the total propulsion weight. This weight, which includes nacelle and pylon weight, may be estimated as:

$$W_{propulsion} = 1.6 W_{engine\ dry\ weight}$$

The correlation below may be used if engine dry weight is not available.

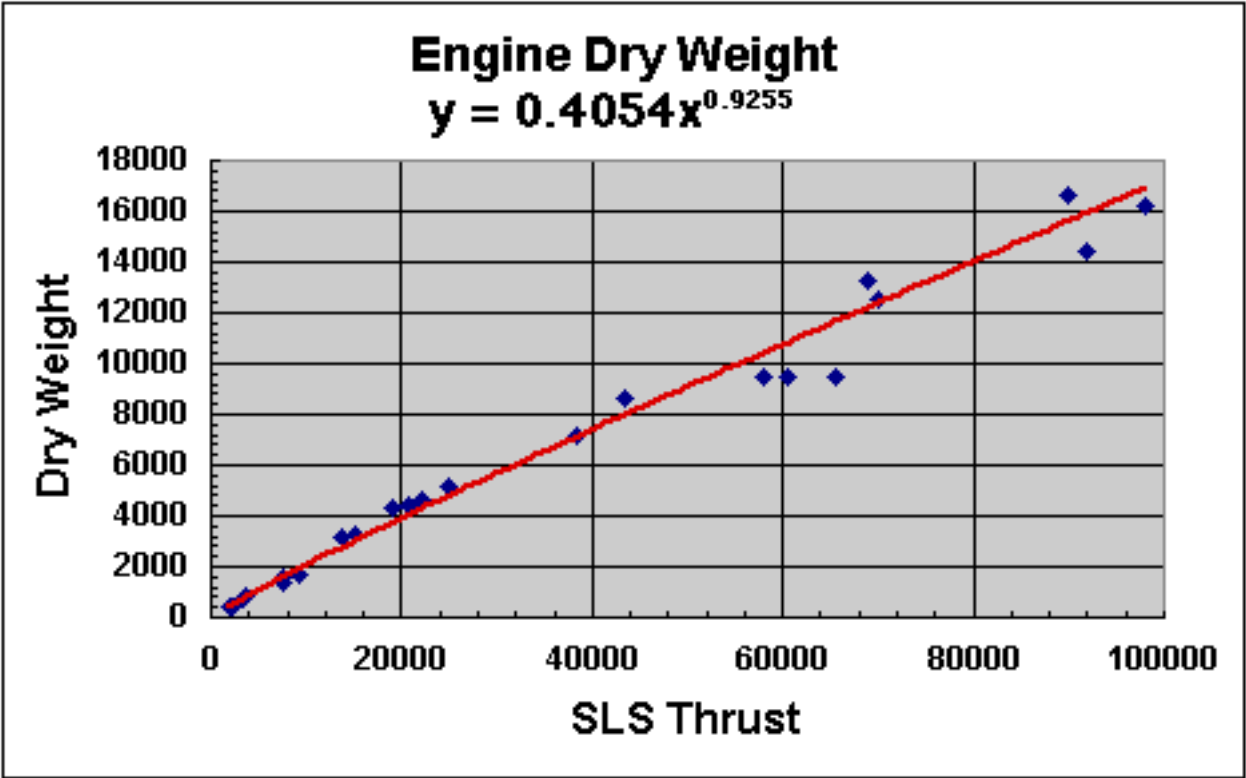

8. Auxiliary Power Unit (APU)

Smaller airplanes may not have an APU, but if it is there, its weight may be estimated by:

$$W_{\text{apu}} (\text{lbs}) = 7 * N_{\text{seats}}$$

We will assume that there is no APU for airplanes with fewer than 9 seats.

9. Instruments and Navigational Equipment

$W_{\text{Inst\&Nav}} = 100$ lbs for business jet, 800 lb for domestic transport, 1200 lb for long range or overwater operation.

10. Hydraulics and pneumatics

$$W_{\text{hyd\&pneu}} (\text{lb}) = .65 * S_{\text{ref}} (\text{ft}^2)$$

11. Electrical

$W_{\text{electrical}} (\text{lb}) = 13 * N_{\text{seats}}$ or use 1950. lbs for cargo aircraft. Note that this correlation does not work well for smaller aircraft and should be replaced with a more representative value if known.

12. Electronics

$W_{\text{electronics}} = 300$ lbs for business jet, 900 lbs domestic transport, 1500 lbs long range

13. Furnishings

Furnishings are often divided into accommodations proportional to the number of actual passenger seats installed, and furnishings-other, which is a function of the total cabin size and is found as a function of the number of all-coach passengers that can be fit into the fuselage.

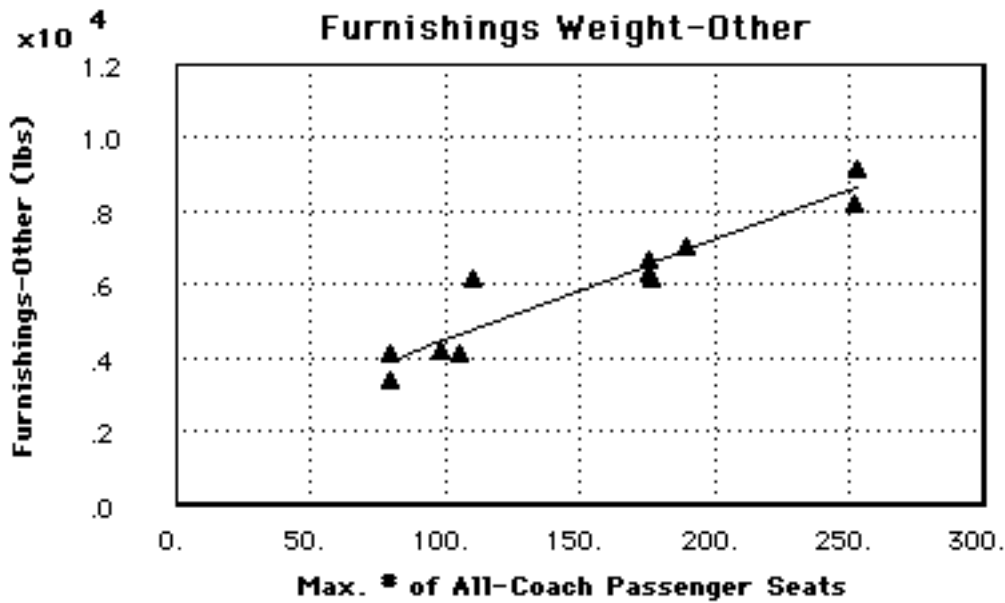
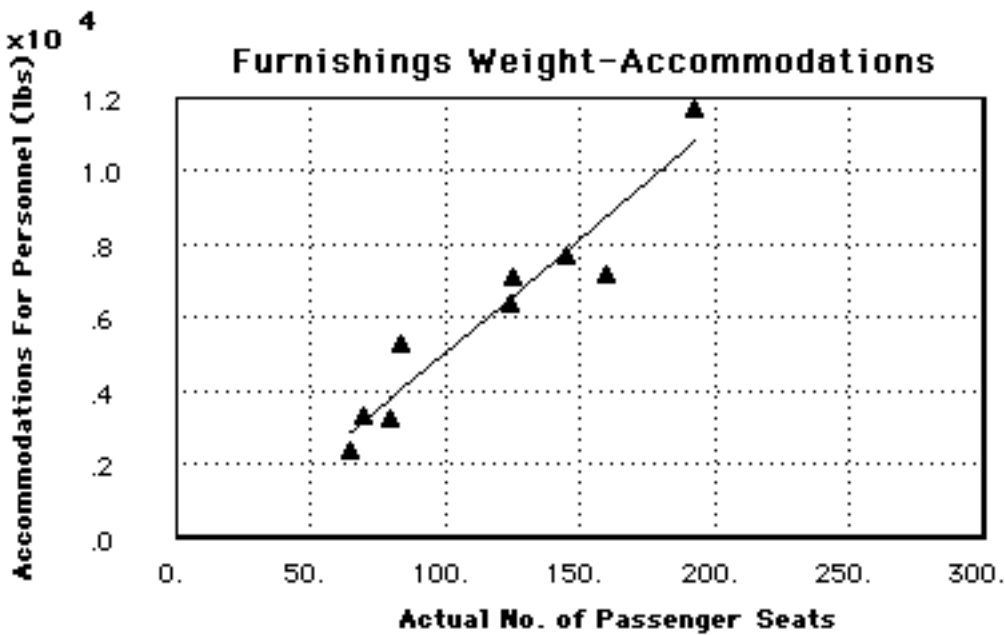

Here we will not distinguish between the actual number of seats and the maximum number. Similarly, a more accurate furnishings weight is based on the actual division of seats between first class and coach, and the maximum number of seats that can be installed on the aircraft. For our purposes we simply use:

$$W_{\text{furnish}} (\text{lbs}) (43.7 - .037 * N_{\text{seats}}) * N_{\text{seats}} + 46. * N_{\text{seats}}$$

When the number of seats exceeds 300, we use:

$$W_{\text{furnish}} (43.7 - .037 * 300) * N_{\text{seats}} + 46. * N_{\text{seats}}$$

For overwater or long range aircraft, we add another 23 lbs per seat. For business jets, most anything is possible.

14. Air conditioning and anti-ice

Data on these systems suggest a very large scatter. We use:

$$W_{\text{aircond}} (\text{lbs}) = 15 * N_{\text{seats}}$$

although this is probably too high for very large aircraft.

15. Operating Items Less Crew

$$W_{\text{operitems}} (\text{lbs}) = 17 * N_{\text{pax}}, \text{ Short range, austere}$$

$$28 * N_{\text{pax}}, \text{ medium range, coach or business jet}$$

$$40 * N_{\text{pax}}, \text{ long range, first class}$$

16. Flight Crew

$$W_{\text{crew}} = 180 + 25 \text{ lbs per flight-deck crew member}$$

17. Flight attendants

There are typically 20-30 pax / attend, although the FAA rules do not require this many. Currently flight attendant weights include just 130 lbs and 20 lbs of baggage, although this would probably be considered low by today's standards.

$$W_{\text{attend}} = 130 + 20 \text{ lbs per attendant}$$

18. Payload

Typically 205 lbs / passenger (165 per person + 40 lbs baggage) is used by major U.S. airlines. 210 lbs/passenger is sometimes assumed for international operations. One generally allocates 4.5 ft³ per passenger for baggage volume or 5.2 ft³ for international operations.

The aircraft may also carry cargo as desired. An added cargo weight of 20lbs / pax is reasonable in the determination of maximum zero fuel weight if no other guidelines are available. Typical passenger load factors (actual / maximum) range from 60% to 70%.

For cargo aircraft 8.9 lbs/ft³ is typical of containerized cargo, while bulk cargo occupies about 7.7 lb / ft³. Typical cargo load factors are 40% for containerized and 25% for bulk cargo.

Wing Weight

The wing weight is taken as the sum of two terms, a portion that varies directly with the wing area and a part that varies in proportion to the amount of material required to resist the applied bending loads. This estimate is done statistically, but is based on an index that is related to the weight of a fully-stressed beam. A [derivation](#) is given here.

Wing Weight Breakdown

	DC-8-55	DC-10-10	STOL Study
Wing Bending Material	13,115	21,830	5,983
Wing Spars, Webs, Stiffeners	2,301	2,822	1,136
Bending, Spars, Webs, Stiffeners	15,416	24,652	7,119
Ribs	1,463	2,333	825
Wing Box Weight	22,718	33,623	10,387
Total Wing Weight	33,604	49,298	20,861
Bending / Total	.387	.443	.287
Box / Total	.676	.682	.498

Detailed Wing Weight Buildup

Item	Weight (lbs)
Bending Material	
upper surface	13,211
lower surface	14,250
Shear Material	4,004
Ribs and Bulkheads	4,570
Leading Edge	1,910
Trailing Edge	1,450
Tips	125
Slats and Supports	3,400

Spoilers and Supports	650
Ailerons and Supports	1,305
Flaps and Supports	5,960
Wing/Fuselage Fairing	960
Wing Fuselage Attach	1,000
Main Gear Doors	160
Exterior Finish	190
Primer and Sealant	30
Total	53,175

Derivation of the Wing Weight Index

Consider a section of a wing structural box assumed symmetrical about a neutral axis. If we consider only the bending stress in the wing upper and lower skins, then, the bending moment is related to the normal stress by:

$$M_b = 2 \sigma \frac{A t}{2} = \sigma A \frac{t}{2}$$

where M_b is the bending moment at the spanwise section under consideration, t is the section thickness, and A is the total cross sectional area of the stressed material. If the skins are carrying a given allowable stress then:

$$\sigma_{\text{allow}} = \frac{2 M_b(y)}{tA}$$

or:

$$A = \frac{2 M_b(y)}{t \sigma_{\text{allow}}}$$

The weight of this material is then:

$$W_b = 2 \int_0^{b/2} \rho A dy = \frac{4 \rho}{\sigma [t/c]} \int_0^{b/2} \frac{M_b}{c} dy$$

where an average value of t/c is used. If the wing has a linear chord distribution then:

$$c(y) = \frac{S}{b} \left(\frac{2}{1+\lambda} \right) (1 - \eta(1 - \lambda))$$

where η is the dimensionless span statio, $2y/b$. The wing bending moment is related to the lift by:

$$M_b(y) = \int_y^{b/2} l(y) y \, dy = \frac{L_{\text{total}}}{b} \int_y^{b/2} \frac{1}{(L/b)_{\text{avg}}} y \, dy$$

Combining these expressions leads to:

$$W_b = \frac{4 \rho}{\sigma[t/c]} \frac{L_{\text{total}}}{b} \int_0^{b/2} \int_y^{b/2} [1/(L/b)_{\text{avg}}] y/c \, dy \, dy$$

$$= \frac{2 \rho b^3 L_{\text{total}}}{\sigma S [t/c]} \int_0^1 \int_{\eta^2}^1 [1/(L/b)_{\text{avg}}] [(\eta(1+\lambda))/(1-\eta(1-\lambda))] d\eta \, d\eta$$

The double integral may be evaluated for a given shape of the lift distribution. When a simple shape is assumed, the effect of sweep is added, and the total lift is set equal to the ultimate load factor times a sort of average between zero fuel weight and maximum take-off weight, we obtain:

$$W_b \propto \frac{\rho b^3 n_{\text{ult}} [\sqrt{(ZFW) (TOW)}] (1+2\lambda)}{\sigma S [t/c] (1+\lambda) \cos^2 \Lambda}$$

The actual wing weight will be larger than this because the material is not fully-stressed and because shear material is also needed. We correlate actual wing weights to this index to produce a wing weight estimate.

Sample Aircraft Weight Statements

Small Commercial Aircraft

Aircraft System	CITATION-500	MDAT-30	MDAT-50	F-28	MDAT-70	DC-9-10	BAC-111	DC-9-30	737-200	727-100
Wing System	1,020	3,143	4,360	7,526	5,910	9,366	9,817	11,391	11,164	17,682
Tail System	288	1,010	1,193	1,477	1,505	2,619	2,470	2,790	2,777	4,148
Body System	930	4,276	5,692	6,909	7,118	9,452	11,274	11,118	11,920	17,589
Lighting Gear System	425	1,379	1,874	2,564	2,440	3,640	3,465	4,182	4,038	7,244
Nacelle System	241	948	1,294	866	1,684	1,462	1,191	1,462	1,515	2,226
Propulsion System (less Dry Engine)	340	1,140	1,338	988	1,702	1,478	1,788	2,190	1,721	3,052
Flight Controls System (less Auto Pilot)	196	600	699	1,404	805	1,102	1,655	1,434	2,325	2,836
Auxiliary Power System	0	343	400	320	460	805	719	817	855	0
Instrument System	76	300	300	267	300	490	504	575	518	723
Hydraulic and Pneumatic System	94	257	300	406	345	681	1,391	753	835	1,054
Electrical System	361	617	825	953	1,040	1,631	1,610	1,715	2,156	2,988
Avionics System (incl. Auto Pilot)	321	586	586	923	586	1,039	1,368	1,108	1,100	1,844
Furnishings and Equipment System	794	2,657	3,548	3,535	4,772	6,690	7,771	8,594	9,119	11,962
Air Conditioning System	188	325	435	520	550	1,016	1,062	1,110	1,084	1,526
Anti-icing System	101	384	448	520	511	472	234	474	113	639
Load and Handling System	2	20	20	--	20	19	9	57	--	15
Empty Weight (less Dry Engine)	5,377	17,985	23,312	29,178	29,748	41,962	46,328	49,770	51,240	75,528
Dry Engine Weight	1,002	2,480	3,373	4,327	4,392	6,113	5,434	6,160	6,212	9,322
Empty Weight (M.E.W.)	6,379	20,465	26,685	33,505	34,140	48,075	51,762	55,930	57,452	84,850
Takeoff Gross Weight	11,650	34,480	46,850	62,000	61,000	86,300	99,650	108,000	104,000	161,000

Larger Commercial Aircraft

Aircraft System	727-200	707-320	DC-8-55	DC-8-62	DC-10-10	L-1011	DC-10-40	747	SCAT-15*
Wing System	18,529	28,647	34,909	36,247	48,990	47,401	57,748	88,741	83,940
Tail System	4,142	6,004	4,952	4,930	13,657	8,570	14,454	11,958	8,590
Body System	22,415	22,299	22,246	23,704	44,790	49,432	46,522	68,452	54,322
Lighting Gear System	7,948	11,216	11,682	11,449	18,581	19,923	25,085	32,220	28,720
Nacelle System	2,225	3,176	4,644	6,648	8,493	8,916	9,328	10,830	15,650
Propulsion System (less Dry Engine)	3,022	5,306	9,410	7,840	7,673	8,279	13,503	9,605	6,310
Flight Controls System (less Auto Pilot)	2,984	2,139	2,035	2,098	5,120	5,068	5,188	6,886	10,777
Auxiliary Power Plant System	849	0	0	0	1,589	1,202	1,592	1,797	--
Instrument System	827	550	1,002	916	1,349	1,016	1,645	1,486	3,400
Hydraulic and Pneumatic Group	1,147	1,557	2,250	1,744	4,150	4,401	4,346	5,067	10,670
Electrical System	2,844	3,944	2,414	2,752	5,366	5,490	5,293	5,305	6,002
Avionics System (incl. Auto Pilot)	1,896	1,815	1,870	2,058	2,827	2,801	3,186	4,134	4,178
Furnishings and Equipment System	14,702	16,875	15,884	15,340	38,072	32,829	33,114	48,007	20,615
Air Conditioning System	1,802	1,602	2,388	2,296	2,386	3,344	2,527	3,634	2,820
Anti-icing System	666	626	794	673	416	296	555	413	210
Load and Handling System	19	--	55	54	62	--	62	228	--
								-896	
Empty Weight (less Dry Engine)	86,017	105,756	116,535	118,749	203,521	198,968	224,148	297,867	256,204
Dry Engine Weight	9,678	19,420	16,936	17,316	23,229	30,046	25,587	35,700	45,020
Empty Weight (M.E.W.)	95,695	125,176	133,471	136,065	226,750	229,014	249,735	333,567	301,224
Takeoff Gross Weight	175,000	312,000	325,000	335,000	430,000	430,000	565,000	775,000	631,000

Military Aircraft

	C-130A	C-130E	KC-135A	C-133B	C-141A	C-5A	AST(M) *
Wing System	10,593	11,647	24,719	27,064	34,262	81,782	20,560
Tail System	3,190	3,409	4,958	6,147	5,745	12,344	8,730
Body System	14,045	14,241	17,850	32,119	28,578	115,216	29,025
Landing Gear System	4,441	5,077	10,698	11,062	10,529	37,628	9,360
Nacelle System	2,685	2,674	2,547	3,939	5,630	8,472	4,711
Propulsion System (less Dry Engines)	6,427	9,489	6,489	10,719	5,780	6,813	5,761
Flight Controls System (less Autopilot)	1,228	1,444	1,749	1,385	3,448	6,936	4,668
Auxiliary Power Plant System	482	460	0	1,584	635	1,067	651
Instrument System	559	550	382	563	899	734	994
Hydraulic and Pneumatic System	922	875	1,393	1,526	2,163	4,317	2,465
Electrical System	1,680	2,289	2,333	2,526	3,015	3,300	2,068
Avionics System (incl. Autopilot)	2,201	2,657	2,231	2,630	2,938	4,130	2,919
Furnishings and Equipment System	3,265	4,770	1,374	4,549	4,362	7,811	6,870
Airconditioning System	1,108	1,064	743	1,746	1,547	2,602	906
Anti-icing System	932	785	350	1,575	598	233	552
Load and Handling System	61	61	--	105	104	273	150
Empty Weight (less Dry Engine)	53,819	61,492	77,816	109,239	110,233	293,658	100,390
Dry Engine Weight	6,680	7,195	14,862	11,186	18,407	28,999	12,280
Empty Weight (M.E.W.)	60,499	68,687	92,678	120,425	128,640	322,657	112,670
Takeoff Gross Weight	108,000	155,000	275,000	286,000	316,100	728,000	163,500

* Estimated

Total Weights

The component weights are grouped together to form a number of total weights that are routinely used in aircraft design. This section lists some of the typical weights and their definitions.

- Maximum Taxi Weight
- Maximum Brake Release Weight
- Maximum Landing Weight
- Maximum Zero-Fuel Weight
- Operational Empty Weight
- Manufacturer's Empty Weight

The weights are defined as follows:

MAXIMUM TAXI WEIGHT

The certified maximum allowable weight of the airplane when it is on the ground. This limit is determined by the structural loading on the landing gear under a specified set of conditions and/or wing bending loads.

MAXIMUM BRAKE RELEASE WEIGHT

The certified maximum weight of the airplane at the start of takeoff roll. Maximum Brake Release Weight will always be less than Maximum Taxi Weight to allow for fuel burned during taxi. Brake release weight, in operation, may be limited to values less than Maximum Brake Release Weight by airplane performance, and/or airfield characteristics.

MAXIMUM LANDING WEIGHT

The certified maximum weight of the airplane at touch-down. This limit is determined by the structural loads on the landing gear, but not under the same conditions that determine maximum taxi weight. Landing weight, in operation, may also be limited to values less than Maximum Landing Weight by airplane performance and/or airfield characteristics.

MAXIMUM ZERO FUEL WEIGHT

The maximum weight of the airplane without usable fuel.

OPERATIONAL EMPTY WEIGHT

Manufacturer's empty weight plus standard and operational items. Standard items include unusable fuel, engine oil, emergency equipment, toilet fluid and chemicals, galley, buffet and bar structure, etc. Operational items include crew and baggage, manuals and navigational equipment, removable service equipment for cabin, galley and bar, food and beverages, life vests, life rafts, etc.

MANUFACTURER'S EMPTY WEIGHT

Weight of the structure, powerplant, furnishings, systems, and other items of equipment that are

considered an integral part of a particular airplane configuration. It is essentially a "dry" weight, including only those fluids contained in a closed system (such as hydraulic fluid).

Other totals that are commonly used include:

Actual take-off weight

Maximum take-off weight

Landing weight

Zero payload weight

The airplane zero fuel weight is the sum of each of the components as shown below. Note that the actual zero fuel weight is generally less than the maximum zero fuel weight. The maximum zero fuel weight, may in fact exceed the zero fuel weight that is possible for this particular aircraft, but the structure is designed to handle the larger values to accommodate future growth.

$$\begin{aligned} W_{zfw} = & W_{wing} + W_{horiz} + W_{vert} + W_{rud} + W_{fuse} \\ & + W_{crew} + W_{opitems} + W_{aircond} + W_{electn} + W_{electc} \\ & + W_{surfc} + W_{gear} + W_{hydpnu} + W_{propul} + W_{attend} \\ & + W_{pax} + W_{bags} + W_{cargo} + W_{other} \\ & + W_{inst} + W_{apu} + W_{furnish} \end{aligned}$$

$$W_{payload} = W_{pax} + W_{bags} + W_{cargo}$$

$$W_{mt} = W_{zfw} - (W_{payload} + W_{crew} + W_{attend} + W_{opitems})$$

$$W_{reserv} = .08 * W_{zfw}$$

$$W_{fuel} = TOW - W_{zfw} - W_{reserv}$$

$$W_{nopay} = W_{mt} + W_{fuel} + W_{reserv} + W_{crew} + W_{attend} + W_{opitems}$$

Landing weight includes 1/2 maneuver fuel

$$W_{land} = W_{zfw} + W_{reserv} + .0035 * TOW$$

$$W_{owe} = W_{zfw} - W_{payload}$$

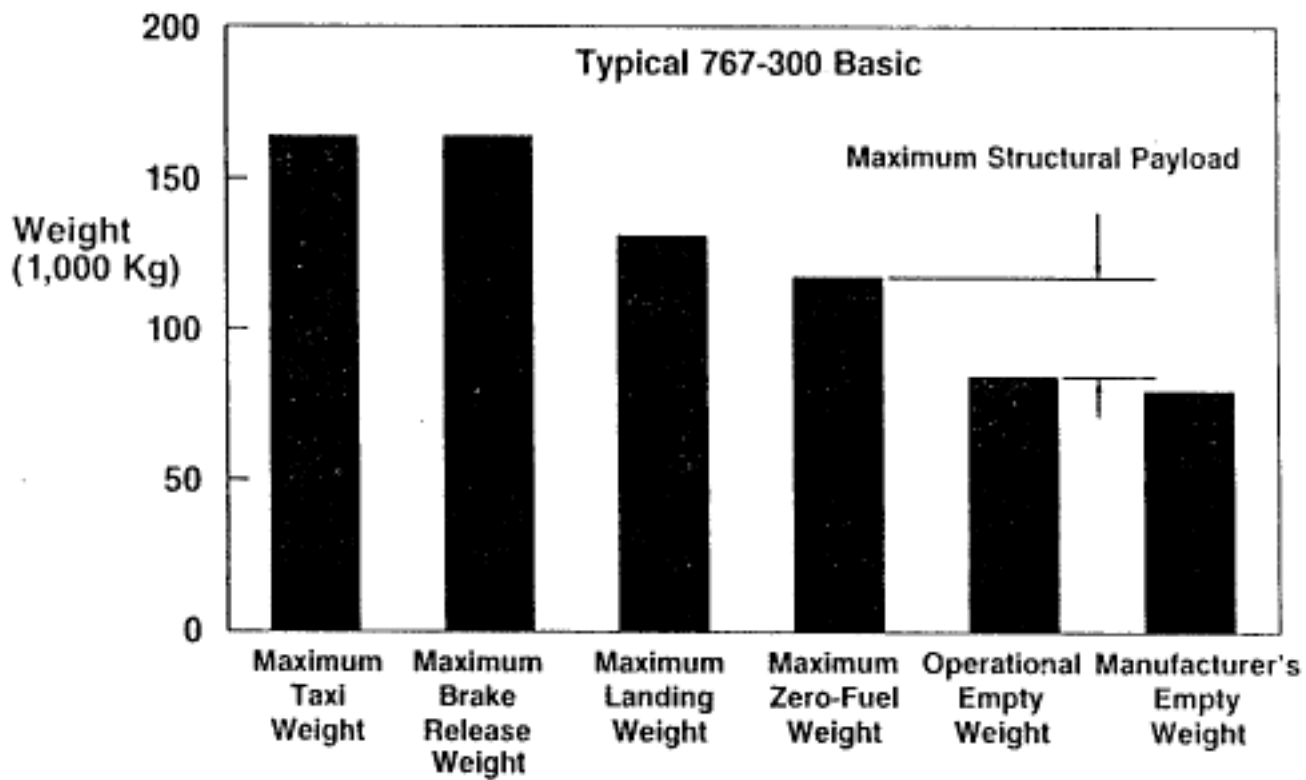

Interactive Placard Diagram

The placard diagram for your aircraft is shown above. The input parameters may be specified here and are defined as follows:

Init. Cruise Altitude: Initial cruise altitude (ft)

Cruise Mach: Design cruise Mach number

Altitude at V_c : Altitude for which the airplane is to be capable of operating at the design Mach number (ft)

Note that the V_c altitude (also known as the "knee" of the placard) determines the maximum dynamic pressure for which the aircraft is to be designed. Typical values for transonic aircraft are in the 26,000 - 28,000 ft range.

For SST's, the placard is often more complex, but one should choose the V_c altitude here to produce a reasonable low altitude maximum speed. The Concorde, for example, has a V_c speed of about 400 kts EAS up to 30,000 ft. A cruise Mach number of 2.0 and a V_c altitude of 57,000 ft leads to this value of V_c . The Concorde actually allows higher q 's above 32,000 ft, but for our calculations of gust loads, this simpler placard will suffice.

Interactive V-n Diagram

The V-n diagram for your aircraft is shown above based on parameters specified elsewhere. See the placard diagram for calculation of the design airspeeds V_c and V_d .

Balance

Balance, the proper placement of the center of gravity (c.g.) with respect to the aerodynamic center of the wing, is a vital element of a proper, and safe, flying airplane. In order to attain proper stability the c.g. must never, under any condition of fuel loading, passenger loading, cargo loading or landing gear retraction or extension, be aft of the aft stability limit. For proper control, usually trim in the landing approach configuration or nose wheel lift off, the c.g. must never be forward of the most forward aerodynamic limit.

After completing the first weight estimate of a configuration, the center of gravity of the airplane should be estimated. A moment schedule should be constructed listing each element of the airplane, its weight and the location of its center of gravity. The c.g.'s are located by their distances from two mutually perpendicular axes. These axes may be arbitrarily chosen but the horizontal axis is usually taken parallel to the fuselage floor and the vertical axis is best selected near the estimated airplane c.g. The moments of each element about the origin are then determined and the total used to establish the empty airplane c.g. If the wing is not suitably located, it must be shifted forward or aft and the moment calculation readjusted. Note that relocating the wing also may move engines and landing gear as well as requiring tail size changes because the tail length (moment arm) is altered.

Having determined the empty center of gravity, a loading diagram showing the effect of the most forward likely loading and the most aft likely loading of passengers and cargo is drawn. To this is added the effect of fuel loading.

An example of a loading diagram, often called a "potato" curve, is shown in Fig. 1.

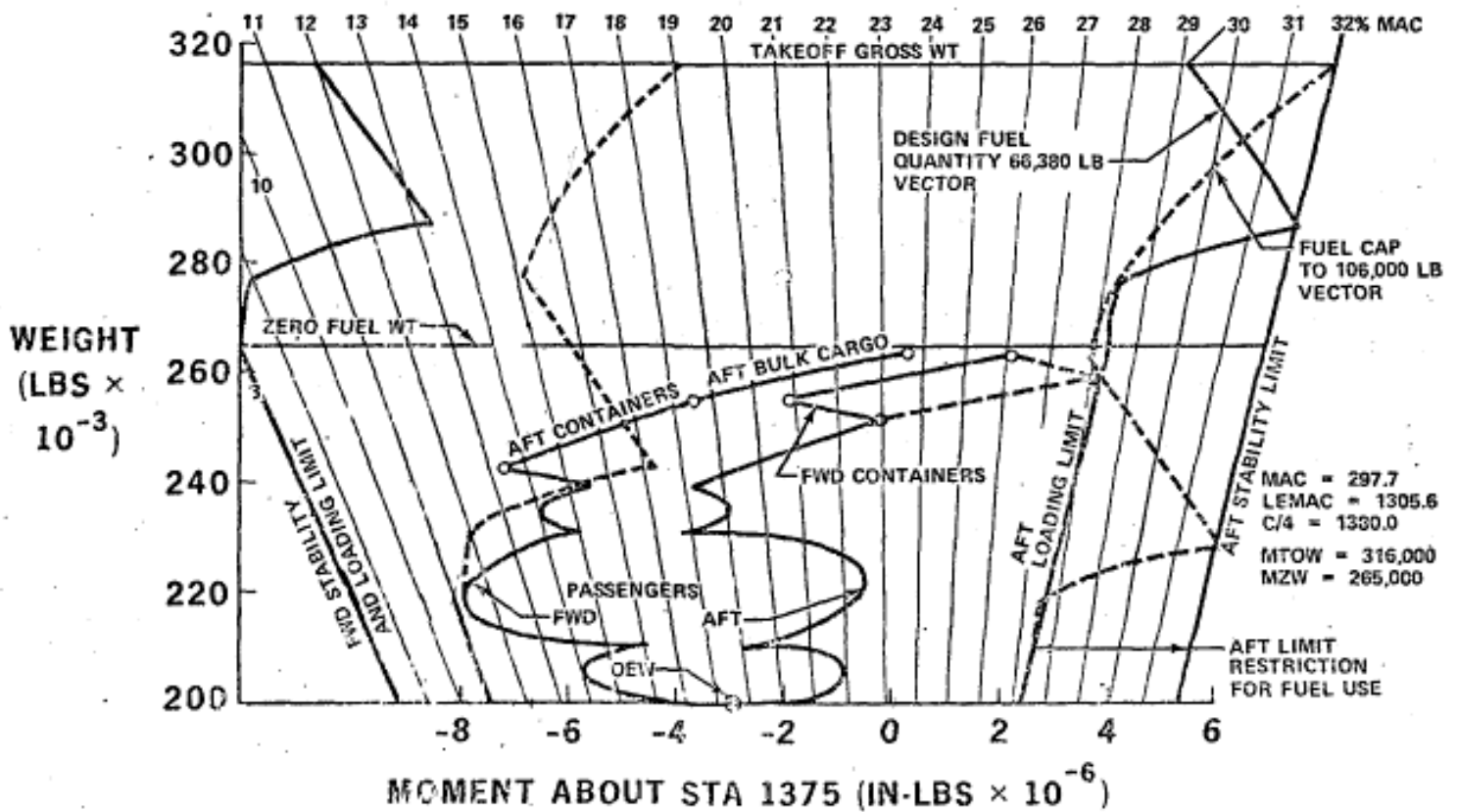

Figure

1. Balance Study showing changes in C.G. with loading.

The goal of a proper loading situation is unrestricted loading so that neither cargo nor passenger must be programmed. Usually some cargo loading restrictions are accepted to avoid passenger restrictions. On some airplanes, however, passenger seating is controlled under some conditions, e.g., with small loads, block the last 8 rows of seats.

A key element of loading flexibility is the fuel system. With unswept wings, there is little change in c.g. with fuel burn off but with swept wings the effect of fuel on c.g. is large. Fuel system, design, and fuel system management, is often strongly influenced by the requirements of center of gravity control. An example of this is shown in Figure 2 which illustrates the fuel management program assumed for the loading diagram of Figure 1.

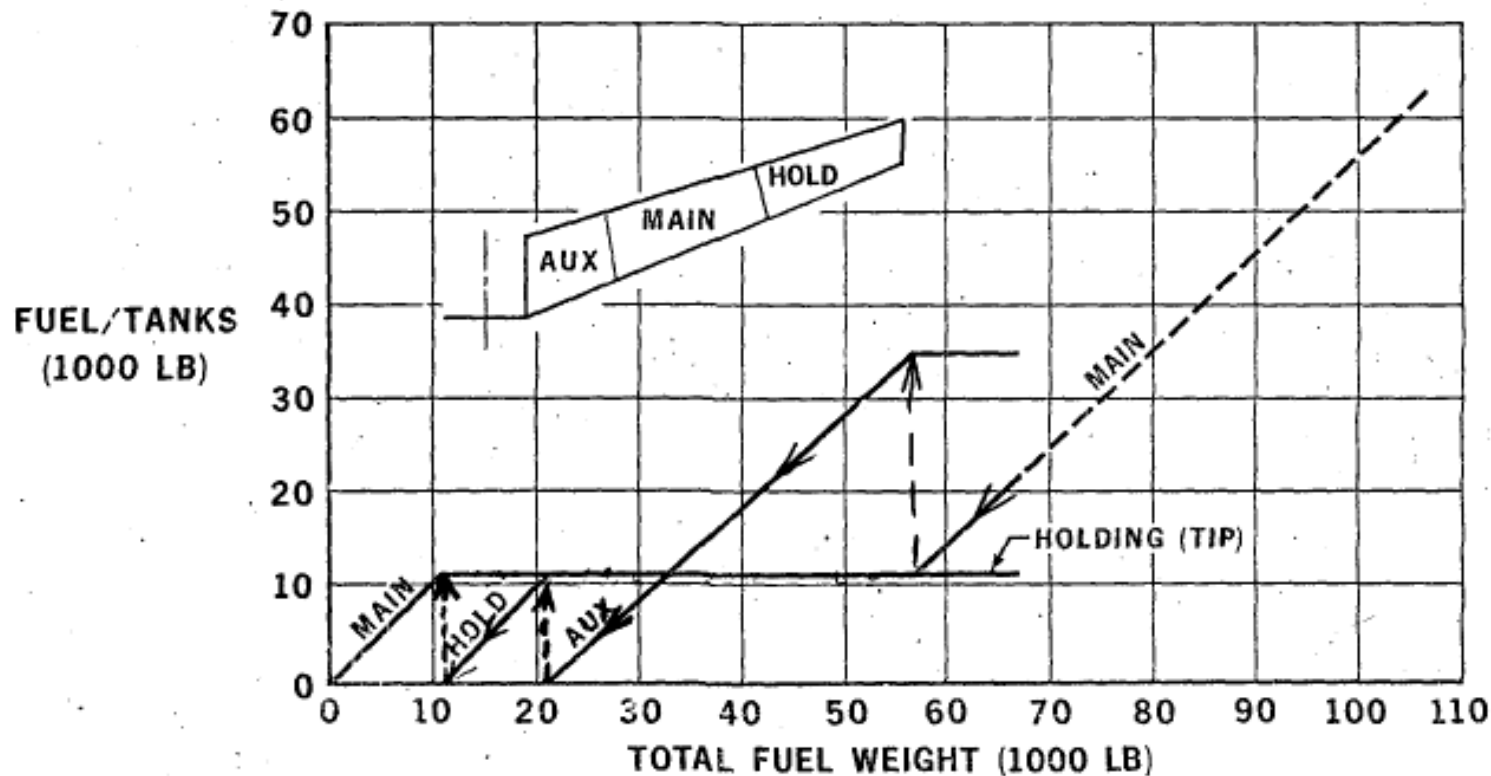

Figure 2. Fuel usage schedule.

For initial design studies, the following locations for component c.g. are used here:

Wing	30% chord at wing MAC
Horiz. Tail	30% Chord at 35% semi-span
Vertical	30% chord at 35% of vertical height
Surface Controls	40% chord on wing MAC
Fuselage	45% of fuselage length
Main Gear	located sufficiently aft of aft c.g. to permit 5% - 8% of load on nose gear
Hydraulics and pneumatics	75% at wing c.g., 25% at tail c.g.
Air / Anti-Ice	End of fuse nose section
Propulsion	50% of nacelle length for each engine
Electrical	75% at fuselage center, 25% at propulsion c.g.
Electronics and Instruments	40% of nose section
APU	Varies
Furnishings, pasengers, baggage, cargo, operating items, flight attendants	From layout. Near 51% of fuselage length

Crew

45% of nose length

Fuel

Compute from tank layout

Weight Calculations

Weights are computed by this applet, based on data from this page and several others. The program first computes a variety of geometric parameters based on your input definition. It then computes a placard diagram, and constructs a V-n diagram at the maximum take-off weight and at the maximum zero fuel weight. It uses the computed maneuver and gust loads to estimate the weight of various components shown above. The text field is editable so you may copy the results and paste them elsewhere, but the program does not permit direct specification of each component (for reasons of consistency). The input parameters specific to this page include:

Max. T.O. Weight: The design maximum take-off weight in lbs.

A parameter used to estimate various weights that depend on how the airplane is to be used. Current values are:

Aircraft Type:

1. Domestic short range, austere accommodations
2. Domestic, med range, med comfort
3. Long range, overwater
4. Small Business Jet
5. All cargo
6. Commuter
7. SST

Cabin Altitude: Pressure altitude of the cabin at the maximum altitude.

Maximum Altitude: Maximum design altitude for determining fuselage pressure loads.

Controls Type: 1= aerodynamic, 2 = part-power, 3 = fully-powered control surfaces

Passengers: Actual number of passengers for the design range mission.

Struct. Wt.
Factor:

A multiplicative factor that may be used to change the calculated value of wing, tail, and fuselage weights. A typical value for composite construction might be 0.85 if we are optimistic.

W_{other}

The weight of specific items that may be unique to your airplane and are not computed here. W_{other} may also be used to correct the program's calculations if the weight of specific items is known to differ from the statistical calculation here.

W_{cargo}

Cargo weight carried in addition to the specified passenger load.

Max. Extra
Payload

The payload weight increment that the airplane is designed to carry on shorter range missions. If your design mission is 5000 mi with 500 passengers, but you would like the airplane to be able to carry 600 passengers on shorter hops. Specify 600 seats, 500 passengers, and assign the extra weight associated with another 100 passengers and bags to the max. extra payload so that the design max zero fuel weight is properly computed.

Aircraft Performance

Aircraft performance includes many aspects of the airplane operation. Here we deal with a few of the most important performance measures including airfield performance, climb, and cruise. The following sections describe how each of these may be calculated at the early stages of design, by combining fundamental calculations with statistical data from actual aircraft.

Each of these performance measures will be used as a constraint in the airplane optimization process and are among many constraints imposed by the FARs.

- [Take-off field length](#)
 - [Landing field length](#)
 - [Climb performance](#)
 - [Cruise performance and range](#)
-

Take-Off Field Length

Introduction

Although the take-off field length may seem like a performance characteristic of secondary importance, it is very often one of the critical design constraints. If the required runway length is too long, the aircraft cannot take-off with full fuel or full payload and the aircraft economics are compromised.

For example, In some cases aircraft take-off from San Jose and fly all the way to San Francisco (about 40 miles) before making their first refueling stop. This is because the field length is insufficient to take-off with full fuel in San Jose and the tanks are topped off at SFO where the runways are longer. Since this kind of operating restriction is not desirable, the aircraft is designed to meet take-off field length requirements for selected airports with full payload and fuel.

This constraint often sets the aircraft wing area, engine size, or high lift system design.

To compute the required take-off distance, we consider the take-off profile shown below.

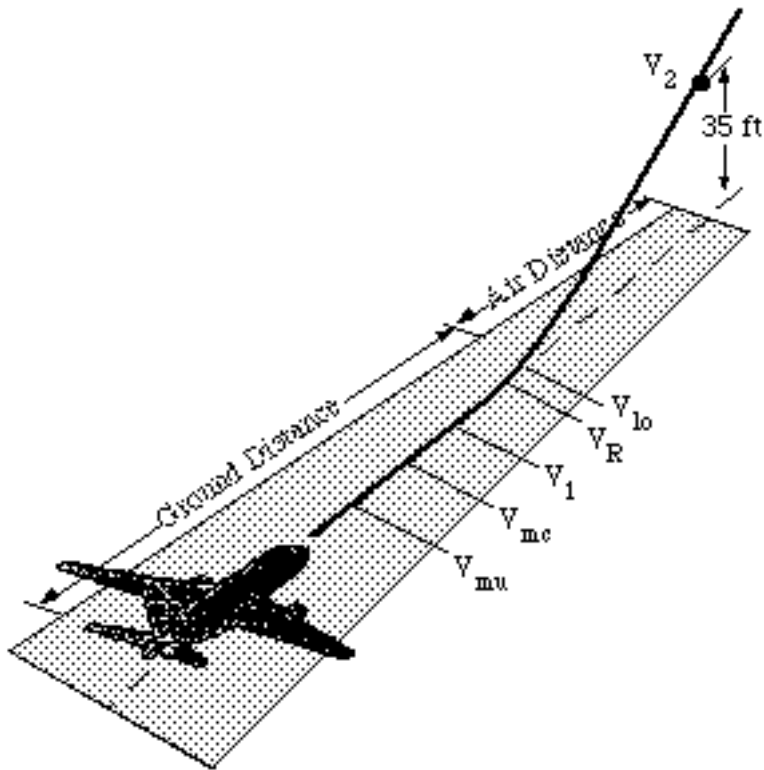

Important Speeds

The following speeds are of importance in the take-off field length calculation:

V_{mu} Minimum Unstick Speed. Minimum airspeed at which airplane can safely lift off ground and continue take-off.

V_{mc} Minimum Control Speed. Minimum airspeed at which when critical engine is made inoperative, it is still possible to recover control of the airplane and maintain straight flight.

V_{mcg} Minimum control speed on the ground. At this speed the aircraft must be able to continue a straight path down the runway with a failed engine, without relying on nose gear reactions.

V₁ Decision speed, a short time after critical engine failure speed. Above this speed, aerodynamic controls alone must be adequate to proceed safely with takeoff.

V_R Rotation Speed. Must be greater than V₁ and greater than 1.05 V_{mc}

V_{lo} Lift-off Speed. Must be greater than 1.1 V_{mu} with all engines, or 1.05 V_{mu} with engine out.

V₂ Take-off climb speed is the demonstrated airspeed at the 35 ft height. Must be greater than 1.1 V_{mc} and 1.2 V_s, the stalling speed in the take-off configuration.

Further information on these design speeds are given in the relevant sections of FAR part 25, including those dealing specifically with take-off and also those dealing with control requirements.

[FARs related to take-off](#)

[FARs related to control](#)

Estimating the Required Field Length

The calculation of take-off field length involves the computation of the distance required to accelerate from a stop to the required take-off speed, plus a climb segment. Since the acceleration distance is typically about 80% of the total distance, we first consider this portion.

The distance required to accelerate to the speed V_{lo} can be computed by noting that:

$$dV = a dt \text{ and } dx = V dt = V/a dV$$

so:

$$x = \int_0^{V_{lo}} \frac{V}{a} dV = \frac{1}{2} \int_0^{V_{lo}} \frac{dV^2}{a}$$

If the acceleration is assumed to vary as: $1/a = 1/a_0 + kV^2$ then:

$$x = \frac{1}{2} \int_0^{V_{lo}^2} \left(\frac{1}{a_0} + k V^2 \right) dV^2 = \frac{V_{lo}^2}{2 a_0} + \frac{k V_{lo}^4}{4} = \frac{V_{lo}^2}{2} \left(\frac{1}{a} \right) V_{lo} \sqrt{2}$$

So, we could either integrate the acceleration numerically or use an average value, computed at .70 of the lift-off speed.

Ignoring the small speed change between lift-off and the 35 ft screen height, we can take $V_{lo} = 1.2 V_s$.

Then, $V_{lo} = 1.2 (2 W) / (\rho S C_{L_{max}})$.

With, $a = F / m = T - D / m$ (where T =Thrust, D =total drag including ground resistance, m =take-off mass), the expression for acceleration distance becomes:

$$x = 1.44 W^2 / (g \rho S C_{L_{max}} (T - D))$$

This expression is not very useful directly because it is difficult to estimate the drag, and we must add the climb portion of the take-off run. More importantly, commercial take-off distances assume engine failure at the worst possible time. If the engine fails sooner, the pilot can stop in a shorter distance. If the engine fails at a higher speed, the airplane can continue the take-off and reach a height of 35 feet in a shorter distance. This worst time corresponds to the critical engine failure speed $V_{EF_{crit}}$. It is assumed that the pilot recognizes the engine failure and takes action a short time* later, at which time the speed is called the decision speed, V_1 . At a speed higher than V_1 , the pilot must continue the take-off; at a lower speed he or she must stop.

The commercial take-off problem is very complex, involving acceleration on all engines, acceleration with one engine inoperative, deceleration after engine failure, and climb with one engine inoperative. This means that the design of spoilers, braking system, and rudder will affect the FAR take-off field length.

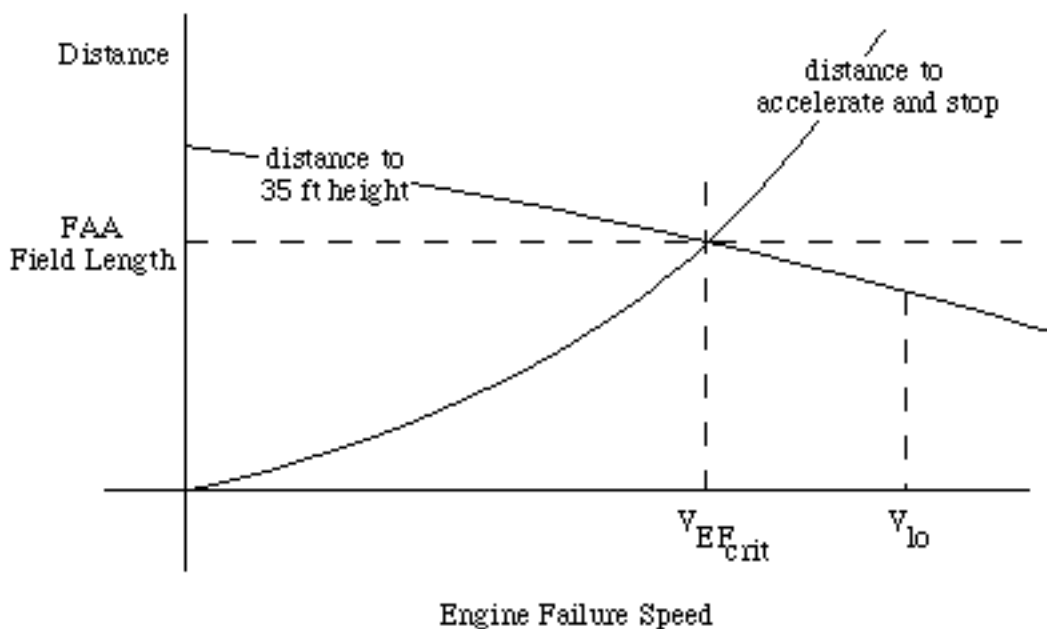

The preliminary design computations, therefore, include correlation of the primary design parameters

with actual demonstrated performance. The correlation parameter is closely related to that which appears in the simple analytical analysis on the previous pages. Examples of the correlations for take-off field length with engine failure are shown in the figure below. The propeller data is much more uncertain due to variations in propeller efficiency.

The FAA take-off field length in some cases may be set, not by the field length based on engine failure, but on the all-engines operating performance. If the all-engines runway length multiplied by 1.15 exceeds the 1-engine-out field length, the larger value is used. For four-engine aircraft the all engines operating condition times 1.15 is usually critical.

Fits have been made to the FAR field length requirements of 2,3,and 4 engine jet aircraft vs. the parameter:

$$\text{Index} = \frac{W^2}{\sigma C_{L_{\max}} S_{\text{ref}} T_{.7 V_{LO}}}$$

W is the take-off gross weight (lbs).

S_{ref} is the reference wing area (sq ft).

σ is the ratio of air density under the conditions of interest which might well be a hot day in Denver or another high altitude airport.

$C_{L_{\max}}$ is the aircraft maximum lift coefficient in the take-off configuration.

T is the total installed thrust (all engines running). It varies with speed and must be evaluated at 70% of the lift-off speed which we take as $1.2 V_g$. The variation of thrust with speed shown here may be used for this calculation if detailed engine data is not available.

For 2 engine aircraft: $\text{TOFL} = 857.4 + 28.43 \text{ Index} + .0185 \text{ Index}^2$

For 3 engine aircraft: $\text{TOFL} = 667.9 + 26.91 \text{ Index} + .0123 \text{ Index}^2$

For 4 engine aircraft: $\text{TOFL} = 486.7 + 26.20 \text{ Index} + .0093 \text{ Index}^2$

Since for four engine aircraft, the all-engines operating (with 15% pad) case is critical, one may use this fit for the all-engines operating case with 2 or 3 engines as well. Note that the 15% markup is already included.

FAR Take-Off Field Length

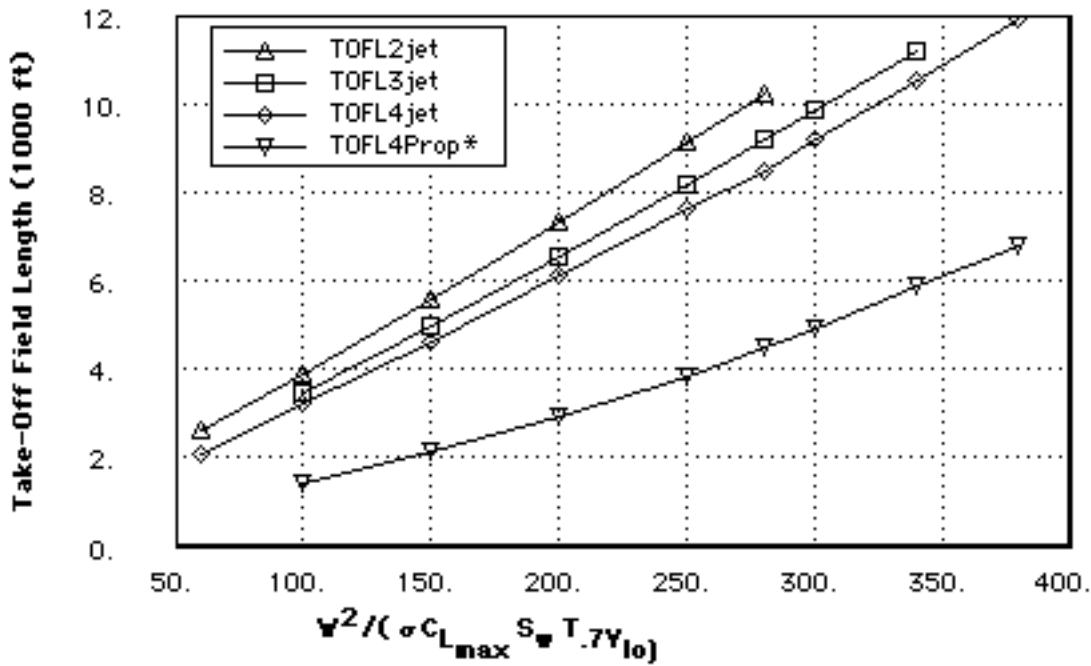

The figure below illustrates the installed thrust vs. speed for a number of engine types for use in this calculation.

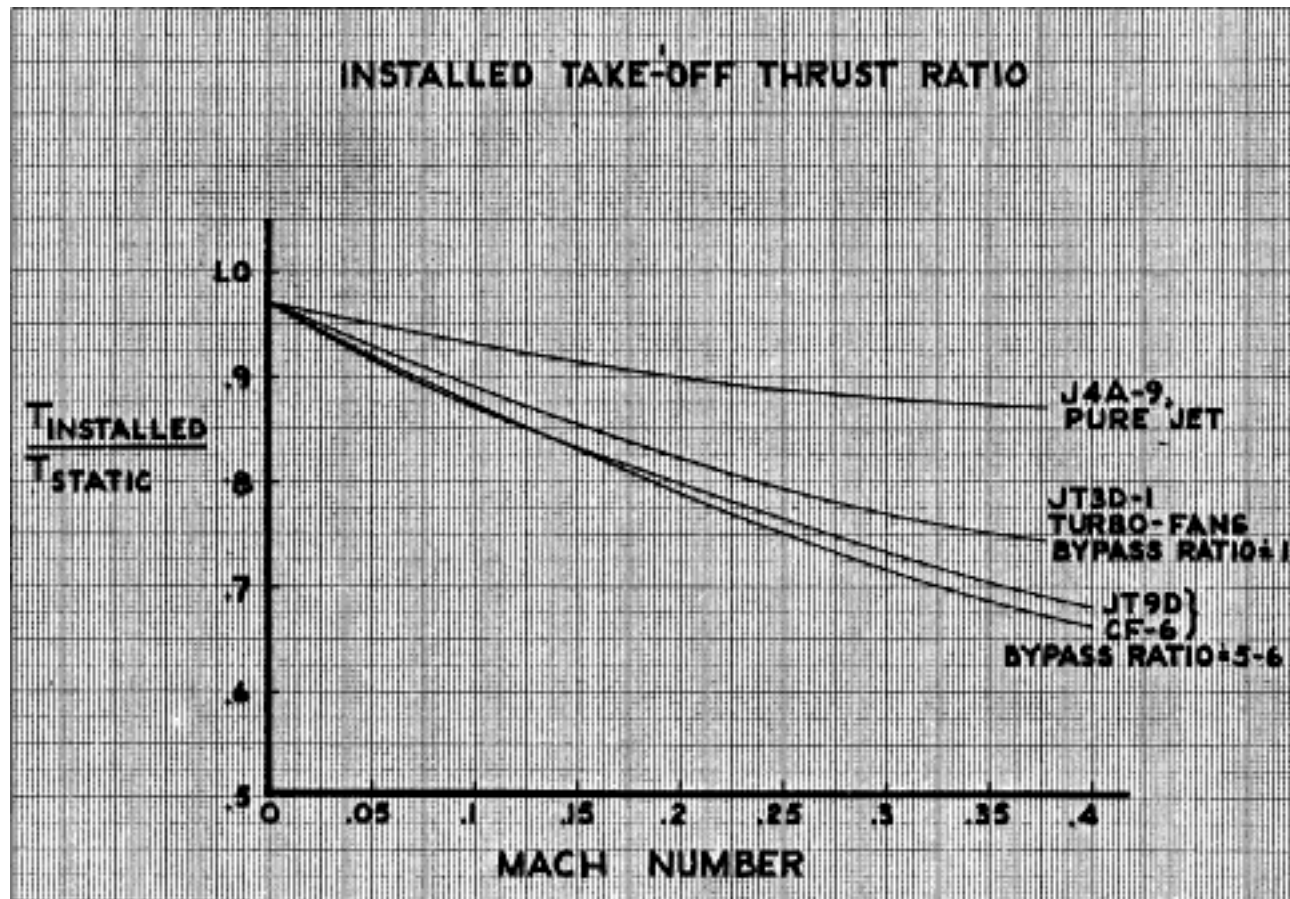

I. Kroo 4/20/96

Sec. 25.105 Takeoff.

(a) The takeoff speeds described in Sec. 25.107, the accelerate-stop distance described in Sec. 25.109, the takeoff path described in Sec. 25.111, and the takeoff distance and takeoff run described in Sec. 25.113, must be determined--

(1) At each weight, altitude, and ambient temperature within the operational limits selected by the applicant; and

(2) In the selected configuration for takeoff.

(b) No takeoff made to determine the data required by this section may require exceptional piloting skill or alertness.

(c) The takeoff data must be based on--

(1) A smooth, dry, hard-surfaced runway, in the case of land planes and amphibians;

(2) Smooth water, in the case of seaplanes and amphibians; and

(3) Smooth, dry snow, in the case of skiplanes.

(d) The takeoff data must include, within the established operational limits of the airplane, the following operational correction factors:

(1) Not more than 50 percent of nominal wind components along the takeoff path opposite to the direction of takeoff, and not less than 150 percent of nominal wind components along the takeoff path in the direction of takeoff.

(2) Effective runway gradients.

Sec. 25.107 Takeoff speeds.

(a) V_1 must be established in relation to VEF as follows:

(1) VEF is the calibrated airspeed at which the critical engine is assumed to fail. VEF must be selected by the applicant, but may not be less than V_{mcG} determined under Sec. 25.149(e).

(2) V_1 , in terms of calibrated airspeed, is the takeoff decision speed selected by the applicant; however, V_1 may not be less than VEF plus the speed gained with the critical engine inoperative during the time interval between the instant at which the critical engine is failed, and the instant at which the pilot recognizes and reacts to the engine failure, as indicated by the pilot's application of the first retarding means during accelerate-stop tests.

(b) V_{2MIN} , in terms of calibrated airspeed, may not be less than--

(1) 1.2 V_S for--

(i) Two-engine and three-engine turbopropeller and reciprocating engine powered airplanes; and

(ii) Turbojet powered airplanes without provisions for obtaining a significant reduction in the one-engine-inoperative power-on stalling speed;

(2) 1.15 V_S for--

(i) Turbopropeller and reciprocating engine powered airplanes with more than three engines; and

(ii) Turbojet powered airplanes with provisions for obtaining a significant reduction in the one-engine-inoperative power-on stalling speed; and

(3) 1.10 times VMC established under Sec. 25.149.

(c) V₂, in terms of calibrated airspeed, must be selected by the applicant to provide at least the gradient of climb required by Sec. 25.121(b) but may not be less than--

(1) V₂MIN, and

(2) VR plus the speed increment attained (in accordance with Sec. 25.111(c)(2)) before reaching a height of 35 feet above the takeoff surface.

(d) VMU is the calibrated airspeed at and above which the airplane can safely lift off the ground, and continue the takeoff. VMU speeds must be selected by the applicant throughout the range of thrust-to-weight ratios to be certificated. These speeds may be established from free air data if these data are verified by ground takeoff tests.

(e) VR, in terms of calibrated airspeed, must be selected in accordance with the conditions of paragraphs (e) (1) through (4) of this section:

(1) VR may not be less than--

(i) V₁;

(ii) 105 percent of VMC;

(iii) The speed (determined in accordance with Sec. 25.111(c)(2)) that allows reaching V₂ before reaching a height of 35 feet above the takeoff surface; or

(iv) A speed that, if the airplane is rotated at its maximum practicable rate, will result in a VLOF of not less than 110 percent of VMU in the all-engines-operating condition and not less than 105 percent of VMU determined at the thrust-to-weight ratio corresponding to the one-engine-inoperative condition.

(2) For any given set of conditions (such as weight, configuration, and temperature), a single value of VR, obtained in accordance with this paragraph, must be used to show compliance with both the one-engine-inoperative and the all-engines-operating takeoff provisions.

(3) It must be shown that the one-engine-inoperative takeoff distance, using a rotation speed of 5 knots less than VR established in accordance with paragraphs (e)(1) and (2) of this section, does not exceed the corresponding one-engine-inoperative takeoff distance using the established VR. The takeoff distances must be determined in accordance with Sec. 25.113(a)(1).

(4) Reasonably expected variations in service from the established takeoff procedures for the operation of the airplane (such as over-rotation of the airplane and out-of-trim conditions) may not result in unsafe flight characteristics or in marked increases in the scheduled takeoff distances established in accordance with Sec. 25.113(a).

(f) VLOF is the calibrated airspeed at which the airplane first becomes airborne.

Sec. 25.109 Accelerate-stop distance.

(a) The accelerate-stop distance is the greater of the following distances:

(1) The sum of the distances necessary to--

(i) Accelerate the airplane from a standing start to VEF with all engines operating;

(ii) Accelerate the airplane from VEF to V1 and continue the acceleration for 2.0 seconds after V1 is reached, assuming the critical engine fails at VEF; and

(iii) Come to a full stop from the point reached at the end of the acceleration period prescribed in paragraph (a)(1)(ii) of this section, assuming that the pilot does not apply any means of retarding the airplane until that point is reached and that the critical engine is still inoperative.

(2) The sum of the distances necessary to--

(i) Accelerate the airplane from a standing start to V1 and continue the acceleration for 2.0 seconds after V1 is reached with all engines operating; and

(ii) Come to a full stop from the point reached at the end of the acceleration period prescribed in paragraph (a)(2)(i) of this section, assuming that the pilot does not apply any means of retarding the airplane until that point is reached and that all engines are still operating.

(b) Means other than wheel brakes may be used to determine the accelerate-stop distance if that means--

(1) Is safe and reliable;

(2) Is used so that consistent results can be expected under normal operating conditions; and

(3) Is such that exceptional skill is not required to control the airplane.

(c) The landing gear must remain extended throughout the accelerate-stop distance.

(d) If the accelerate-stop distance includes a stopway with surface characteristics substantially different from those of a smooth hard-surfaced runway, the takeoff data must include operational correction factors for the accelerate-stop distance. The correction factors must account for the particular surface characteristics of the stopway and the variations in these characteristics with seasonal weather conditions (such as temperature, rain, snow, and ice) within the established operational limits.

[Doc. No. 5066, 29 FR 18291, Dec. 24, 1964, as amended by Amdt. 25-42, 43 FR 2321, Jan. 16, 1978]

Sec. 25.111 Takeoff path.

(a) The takeoff path extends from a standing start to a point in the takeoff at which the airplane is 1,500 feet above the takeoff surface, or at which the transition from the takeoff to the en route configuration is completed and a speed is reached at which compliance with Sec. 25.121(c) is shown, whichever point is higher. In addition--

(1) The takeoff path must be based on the procedures prescribed in Sec. 25.101(f);

(2) The airplane must be accelerated on the ground to VEF, at which point the critical engine must be made inoperative and remain inoperative for the rest of the takeoff; and

(3) After reaching VEF, the airplane must be accelerated to V2.

(b) During the acceleration to speed V2, the nose gear may be raised off the ground at a speed not less than VR. However, landing gear retraction may not be begun until the airplane is airborne.

(c) During the takeoff path determination in accordance with paragraphs (a) and (b) of this section--

(1) The slope of the airborne part of the takeoff path must be positive at each point;

(2) The airplane must reach V2 before it is 35 feet above the takeoff surface and must continue at a speed as close as practical to, but not less than V2, until it is 400 feet above the takeoff surface;

(3) At each point along the takeoff path, starting at the point at which the airplane reaches 400 feet above the takeoff surface, the available gradient of climb may not be less than--

(i) 1.2 percent for two-engine airplanes;

(ii) 1.5 percent for three-engine airplanes; and

(iii) 1.7 percent for four-engine airplanes; and

(4) Except for gear retraction and propeller feathering, the airplane configuration may not be changed, and no change in power or thrust that requires action by the pilot may be made, until the airplane is 400 feet above the takeoff surface.

(d) The takeoff path must be determined by a continuous demonstrated takeoff or by synthesis from segments. If the takeoff path is determined by the segmental method--

(1) The segments must be clearly defined and must be related to the distinct changes in the configuration, power or thrust, and speed;

(2) The weight of the airplane, the configuration, and the power or thrust must be constant throughout each segment and must correspond to the most critical condition prevailing in the segment;

(3) The flight path must be based on the airplane's performance without ground effect; and

(4) The takeoff path data must be checked by continuous demonstrated takeoffs up to the point at which the airplane is out of ground effect and its speed is stabilized, to ensure that the path is conservative relative to the continuous path.

The airplane is considered to be out of the ground effect when it reaches a height equal to its wing span.

(e) For airplanes equipped with standby power rocket engines, the takeoff path may be determined in accordance with section II of Appendix E.

[Doc. No. 5066, 29 FR 18291, Dec. 24, 1964, as amended by Amdt. 25-6, 30 FR 8468, July 2, 1965; Amdt. 25-42, 43 FR 2321, Jan. 16, 1978; Amdt. 25-54, 45 FR 60172, Sept. 11, 1980; Amdt. 25-72, 55 FR 29774, July 20, 1990]

55 FR 29756, No. 140, July 20, 1990

SUMMARY: These amendments to the Federal Aviation Regulations (FAR) update the standards for type certification of transport category airplanes for clarity and accuracy, and ensure that the standards are appropriate and practicable for the smaller transport category airplanes common to regional air carrier operation.

EFFECTIVE DATE: August 20, 1990.

Sec. 25.113 Takeoff distance and takeoff run.

(a) Takeoff distance is the greater of--

(1) The horizontal distance along the takeoff path from the start of the takeoff to the point at which the airplane is 35 feet above the takeoff surface, determined under Sec. 25.111; or

(2) 115 percent of the horizontal distance along the takeoff path, with all engines operating, from the start of the takeoff to the point at which the airplane is 35 feet above the takeoff surface, as determined by a procedure consistent with Sec. 25.111.

(b) If the takeoff distance includes a clearway, the takeoff run is the greater of--

(1) The horizontal distance along the takeoff path from the start of the takeoff to a point equidistant between the point at which VLOF is reached and the point at which the airplane is 35 feet above the takeoff surface, as determined under Sec. 25.111; or

(2) 115 percent of the horizontal distance along the takeoff path, with all engines operating, from the start of the takeoff to a point equidistant between the point at which VLOF is reached and the point at which the airplane is 35 feet above the takeoff surface, determined by a procedure consistent with Sec. 25.111.

[Doc. No. 5066, 29 FR 18291, Dec. 24, 1964, as amended by Amdt. 25-23, 35 FR 5671, Apr. 8, 1970]

Landing Field Length

Introduction

Landing distances consist basically of two segments: the air run from a height of 50 feet to the surface accompanied by a slight deceleration and flare, and the ground deceleration from the touchdown speed to a stop as shown in the figure below.

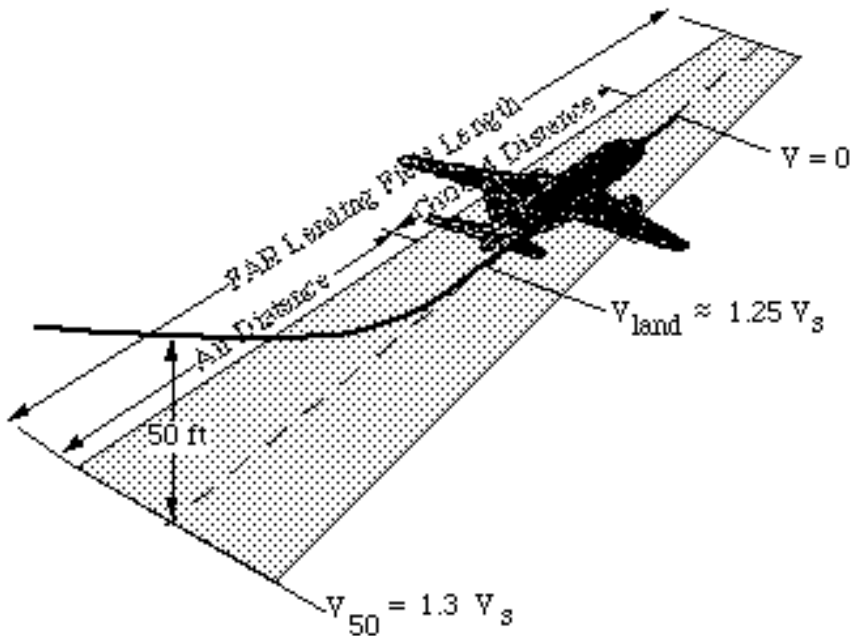

Detailed requirements for landing are described in [FAR 25.125](#).

Estimating the Required Field Length

The air run can be approximated by a steady state glide plus an air deceleration at constant altitude. In this case, the air distance is given by:

$$d_{air} = 50 \left(\frac{L}{D_{eff}} \right) + \frac{V_{50}^2 - V_{land}^2}{2a}$$

D_{eff} is the effective drag, $T-D$, and produces the acceleration, a . Since the maneuver is slight, if we take $L = W$ the expression becomes:

$$d_{air} = 50 \left(\frac{L}{D_{eff}} \right) + \frac{L/D_{eff}}{2g} (V_{50}^2 - V_{land}^2)$$

The ground deceleration distance is: $d_g = V_L^2 / 2a = V_L^2 W / 2gR$

where: $R =$ the effective average resistance or total stopping force $= \mu (W - L) + D$

$\mu =$ braking coefficient of friction

$D =$ drag including drag of flaps, slats, and spoilers

Since the lift and drag vary with V^2 and the touch down speed is typically about $1.25 V_s$, the average resistance and d_g are functions of V_s^2 .

Note that d_{air} and d_g are related to V_{50}^2 and V_L^2 . Both of these speeds are fixed percentages above V_s for safety reasons, thus, we expect the landing distance to be related to V_s^2 plus an offset to account for the glide from 50 ft., which depends only on the L/D in the landing configuration. Thus for similar airplanes with similar L/D values and equivalent braking systems (i.e. similar values of μ), landing distances should be reasonably correlated with V_s^2 .

The figure below shows the FAR landing field lengths on dry runways for seven transport airplanes plotted against the square of the stalling speed in the landing configuration. This configuration involves extended gear and usually full flap deflection. In recent years alternate lower flap deflection has been provided to reduce the power required on the approach along the usual three degree ILS (instrument landing system) descent to the landing runway. The purpose of this lower flap angle is to reduce the community noise below the approach path. The figure shows the landing data for two different flap angles for some airplanes.

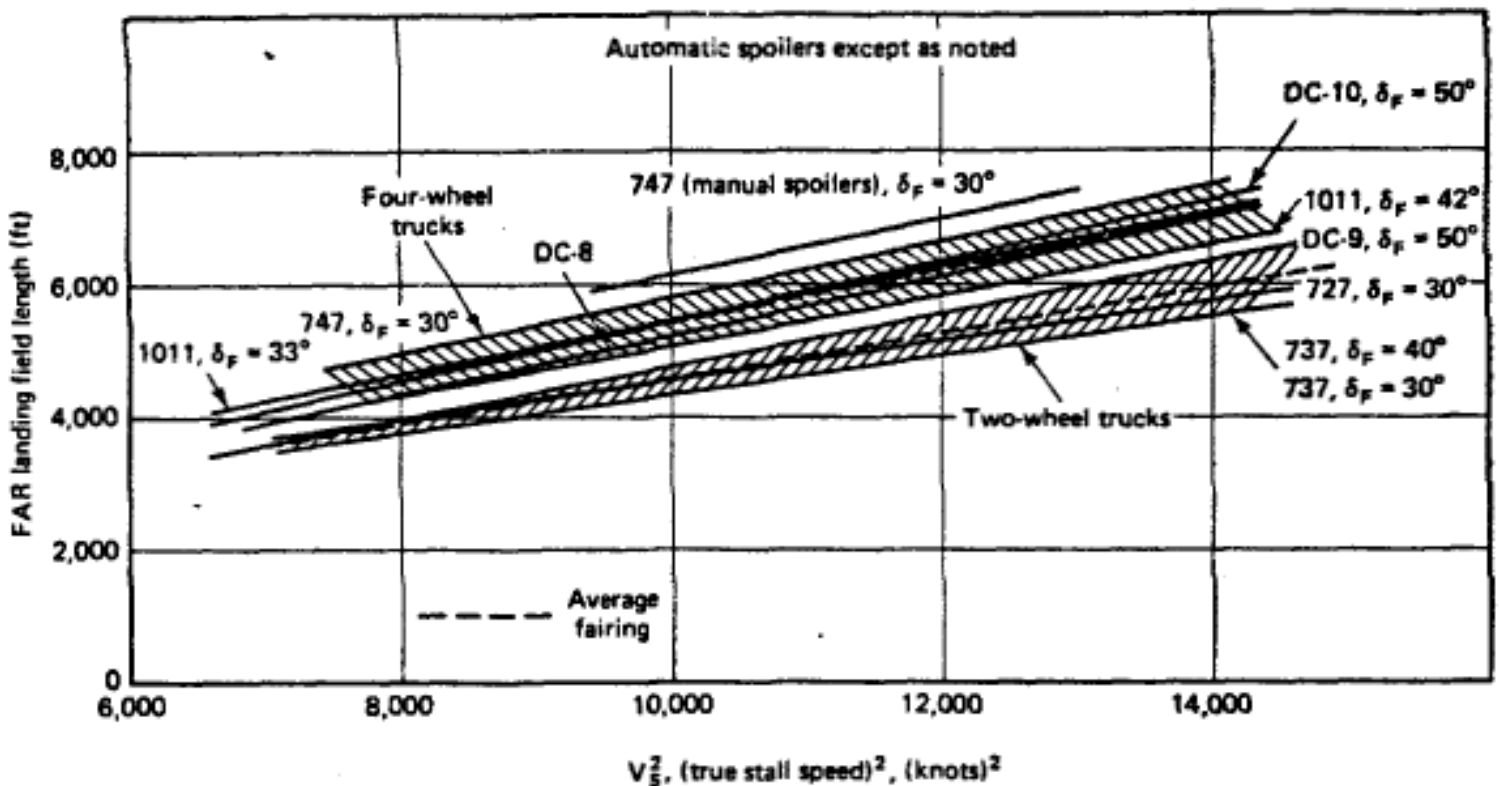

The FAR landing field length is defined as the actual demonstrated distance from a 50 ft. height to a full

stop increased by the factor $1/0.60$, a 67% increase. Although the individual points are omitted for clarity, the curves of landing field length vs. V_s^2 are almost linear. However, there are significant differences between the various airplanes. These differences are due to variations in the effective L/D in the air run, in the effective coefficient of friction, μ , and in the drag in the ground deceleration.

Although flap drag plays a significant role in the air run, the pilot's control of the throttles is: usually more important. If more power is maintained during the air run, the effect is the same as a higher effective L/D ratio. Furthermore, the touchdown speed is important since the wheel brakes are much more effective in retarding the airplane than the air drag during the air run. The sooner the airplane touches down and starts braking, the shorter the total distance will be. Thus, the human factor plays a large role in landing distances. The official landing distance is partly a reflection of how hard the flight test pilot worked to optimize the landing. In practice, this is dependent on how important the landing field length is to the usefulness of the airplane. If the landing distance is much shorter than the take-off distance, a little longer flight test landing may not be detrimental.

Mechanical devices have a large influence on landing distances. Automatic spoilers are operated by the rotation of the wheels at touch-down. The spoilers greatly decrease the lift, dump the weight on the wheels and thereby make the brakes effective. Manual spoilers, operated by the pilot, involve a delay. Even two seconds at speeds of 200 ft/sec. can increase the stopping distance by almost 400 ft. Including the safety factor of 67%, the effect on the field length can be close to 600 ft. With one exception, the curves on the figure are for automatic spoilers. In the 747 example on the chart, manual spoilers are shown to cost 400 ft. in field length. The adjustment of anti-skid braking systems can also affect the average braking coefficient of friction during the deceleration.

These factors explain why all aircraft are not the same in the figure. In addition, there is a difference between the large aircraft with four wheel landing trucks and those with two wheel trucks. It appears that the effective coefficient of friction is less for wheels rolling immediately behind other wheels. Thus, we have shown a scatter band for the four wheel truck aircraft and another band for the two wheel truck aircraft. The dashed fairings are in the center of the bands and are within 6% of the extremes of the scatter bands.

The dashed average fairings in the figure represent a reasonable way to estimate landing field lengths. The landing field length prediction is a function only of the square of the true stall speed.

This data is based on transport aircraft with highly developed anti-skid braking systems. Aircraft with simple brakes and without spoilers will have considerably longer stopping distances than are built into the curves. However, quoted landing distances for small aircraft are sometimes based only on the ground run without a safety factor. The total distance over a 50 ft. height with the $1/0.6$ factor is about 2.5 times as long.

Reverse thrust is not used in determining the dry runway field length, either for landing or for the accelerate and stop portion of the take-off problem. It is considered a 'pad'. To establish wet runway landing performance one may either add 15% to the dry runway results (which already have the 67% safety factor), or one may perform a very realistic test with 3° glide slope approach, 80% worn tires, a higher than normal approach speed and thrust reversers on all but one engine. A 15% pad is then added to that test.

Sec. 25.125 Landing.

(a) The horizontal distance necessary to land and to come to a complete stop (or to a speed of approximately 3 knots for water landings) from a point 50 feet above the landing surface must be determined (for standard temperatures, at each weight, altitude, and wind within the operational limits established by the applicant for the airplane) as follows:

(1) The airplane must be in the landing configuration.

(2) A stabilized approach, with a calibrated airspeed of not less than 1.3 VS, must be maintained down to the 50 foot height.

(3) Changes in configuration, power or thrust, and speed, must be made in accordance with the established procedures for service operation.

(4) The landing must be made without excessive vertical acceleration, tendency to bounce, nose over, ground loop, porpoise, or water loop.

(5) The landings may not require exceptional piloting skill or alertness.

(b) For landplanes and amphibians, the landing distance on land must be determined on a level, smooth, dry, hard-surfaced runway. In addition--

(1) The pressures on the wheel braking systems may not exceed those specified by the brake manufacturer;

(2) The brakes may not be used so as to cause excessive wear of brakes or tires; and

(3) Means other than wheel brakes may be used if that means--

(i) Is safe and reliable;

(ii) Is used so that consistent results can be expected in service; and

(iii) Is such that exceptional skill is not required to control the airplane.

(c) For seaplanes and amphibians, the landing distance on water must be determined on smooth water.

(d) For skiplanes, the landing distance on snow must be determined on smooth, dry, snow.

(e) The landing distance data must include correction factors for not more than 50 percent of the nominal wind components along the landing path opposite to the direction of landing, and not less than 150 percent of the nominal wind components along the landing path in the direction of landing.

(f) If any device is used that depends on the operation of any engine, and if the landing distance would be noticeably increased when a landing is made with that engine inoperative, the landing distance must be determined with that engine inoperative unless the use of compensating means will result in a landing distance not more than that with each engine operating.

[Doc. No. 5066, 29 FR 18291, Dec. 24, 1964, as amended by Amdt. 25-72, 55 FR 29774, July 20, 1990]

55 FR 29756, No. 140, July 20, 1990

SUMMARY: These amendments to the Federal Aviation Regulations (FAR) update

the standards for type certification of transport category airplanes for clarity and accuracy, and ensure that the standards are appropriate and practicable for the smaller transport category airplanes common to regional air carrier operation.

EFFECTIVE DATE: August 20, 1990.

Climb Performance

Introduction

Constraints on aircraft climb performance are also specified in the federal air regulations. These include a minimum landing climb gradient with all engines running, and minimum climb gradients with one engine inoperative during three take-off segments, an approach segment, and an enroute case.

These regulations are discussed in the section of FAR Part 25 included in these notes. They are summarized in the table below:

Required Climb Gradient

Number of Engines:	4	3	2
Flight Condition:			
First Take-Off Segment	0.5%	0.3%	0.0%
Second Take-Off Segment	3.0%	2.7%	2.4%
Final Take-Off Segment	1.7%	1.5%	1.2%
Enroute Climb	1.6%	1.4%	1.1%
Approach Segment	2.7%	2.4%	2.1%
Landing Segment	3.2%	3.2%	3.2%

The flight conditions are as follows:

First Take-Off Segment is with the critical engine inoperative, take-off thrust, landing gear extended, flaps in take-off position, $V = V_{10}$, and weight that exists at the time gear retraction is started (essentially the take-off weight).

Second Take-Off Segment is similar to first segment climb except that gear is up, $V = 1.2 V_s$, and the altitude is 400 feet above the ground.

Final Take-Off Segment also has one engine inoperative, but the others are operating at maximum continuous thrust rather than at take-off thrust. The altitude is that achieved when transition to enroute configuration is accomplished (flaps, slats, gear up) or 1500 feet (whichever is higher). Speed is $1.25 V_s$

at the weight at the end of the take-off segment.

Enroute Climb also requires one engine out, although there are requirements for two engine-out performance of 3 and 4 engine aircraft. One may choose a favorable speed, and an altitude that is sufficiently high to clear obstacles.

Approach Segment is again with one engine out and take-off thrust. Gear is up. Flaps are retracted a bit to increase stall speed by 10% above the stall speed with landing flap deflection. With this flap setting the airplane is flown at $V = 1.5 V_s$ at the landing weight.

Landing Segment is the only case with all engines operating. Gear is extended, flaps in landing position, $V = 1.3 V_s$ and thrust that is available 8 secs. after the throttle is moved from idle to take-off thrust position.

The second segment climb and, for two engine aircraft, the enroute climb are often the critical design requirements affecting the required engine thrust and wing aspect ratio.

Detailed requirements for climb are described in [FAR 25.115](#).

Estimating the Climb Gradient

Climb performance is specified in terms of the climb gradient, the ratio of climb rate to forward speed. For small angles of climb, the climb gradient and the flight path angle are essentially the same:

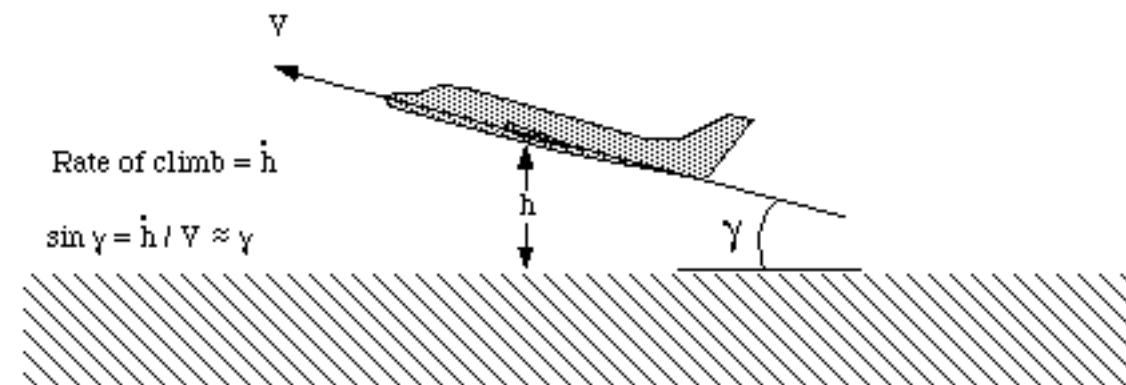

If the speed V is constant, the rate of change of potential energy must be equal to the product of V and the net force in the direction of motion:

$$W V \sin \gamma = (T - D) V \text{ or: } \gamma \approx (T - D) / W$$

When the aircraft is flown at a fixed Mach number or equivalent airspeed, the true airspeed changes. In this case, the total energy change is:

$$W/g V dV/dt + W V \sin \gamma = (T - D) V$$

$$\text{so, } \gamma \approx (T - D) / W - 1/g dV/dt$$

and, $dV/dt = dV/dh \cdot dh/dt = dV/dh \cdot V \sin \gamma$

After some algebra:

$$\gamma \approx [(T - D) / W] / (1 + V/g \cdot dV/dh)$$

The value of dV/dh depends on the type of operation as shown below:

Climb Operation	Altitude	V/g dV/dh (approx.)
Constant V_{true}	All	0
Constant V_{equiv}	Above 36,089 ft	$0.7 M^2$
Constant V_{equiv}	Below 36,089 ft	$0.567 M^2$
Constant M	Above 36,089 ft	0
Constant M	Below 36,089 ft	$-0.133 M^2$

Engine-out Climb Performance

In computing FAR 25 climb performance, the effects of one engine inoperative must include not only a decrease in thrust, but an increase in drag due to:

- 1) windmilling drag of inoperative engine or windmilling or feathered drag of propeller. Modern propellers on larger aircraft would always be equipped with automatic feathering provisions.
- 2) rudder and aileron drag associated with counteracting asymmetric thrust.

At low speeds, the windmilling drag of a high bypass ratio turbofan may be estimated empirically by the expression:

$$D_{windmill} = .0044 p A_c$$

where: p is the ambient static pressure, and A_c is the inlet area.

The second component of the drag increment may be estimated by computing the induced drag of the vertical tail when it is carrying the lift needed to trim the asymmetric yawing moment due to the failed engine:

$$\Delta D_{trim} = \frac{L_v^2}{q \pi h_v^2} = \frac{y_{engine}^2 (T + \Delta D_{windmill})^2}{q \pi h_v^2 l_v^2}$$

where:

L_v is the trimming load on the vertical tail

h_v is the vertical tail height

y_{engine} is the distance from fuselage centerline to critical engine

T is the take-off thrust for the critical engine

l_v is the vertical tail length (distance from c.g. to vertical tail a.c.)

The total drag increment is the sum of the windmilling term and the trim drag.

These climb gradients are determined for all applicable weights, altitudes, and temperatures. From this data, the maximum permissible weight for a given condition are established.

Operational Climb

Normal climb to cruise altitude is carried out at the speed for best overall economy (high speed climb) which is considerably faster than the speed for maximum rate of climb, which, in turn, is much faster than the speed for maximum climb gradient. If fuel quantity is limiting, climb may be performed at the speed for best fuel economy (long range climb speed), a speed between the best overall economy climb speed and the best gradient climb speed. Speed schedules are selected to be easily followed by the pilot with available instrumentation. Recent introduction of automatic flight directors, makes this task easier. The computed climb rates are integrated to produce time, fuel, and distance to climb to any altitude.

For approximate calculations, the additional fuel to climb to altitude (as compared with cruising the same distance at the cruise altitude) can be approximated by adding an increment to the total cruise fuel. This increment has been determined for a wide range of weights for the DC-9-30, the DC-8-62, and the DC-10-10. The results, expressed as a percentage of take-off weight are summarized in the following figure.

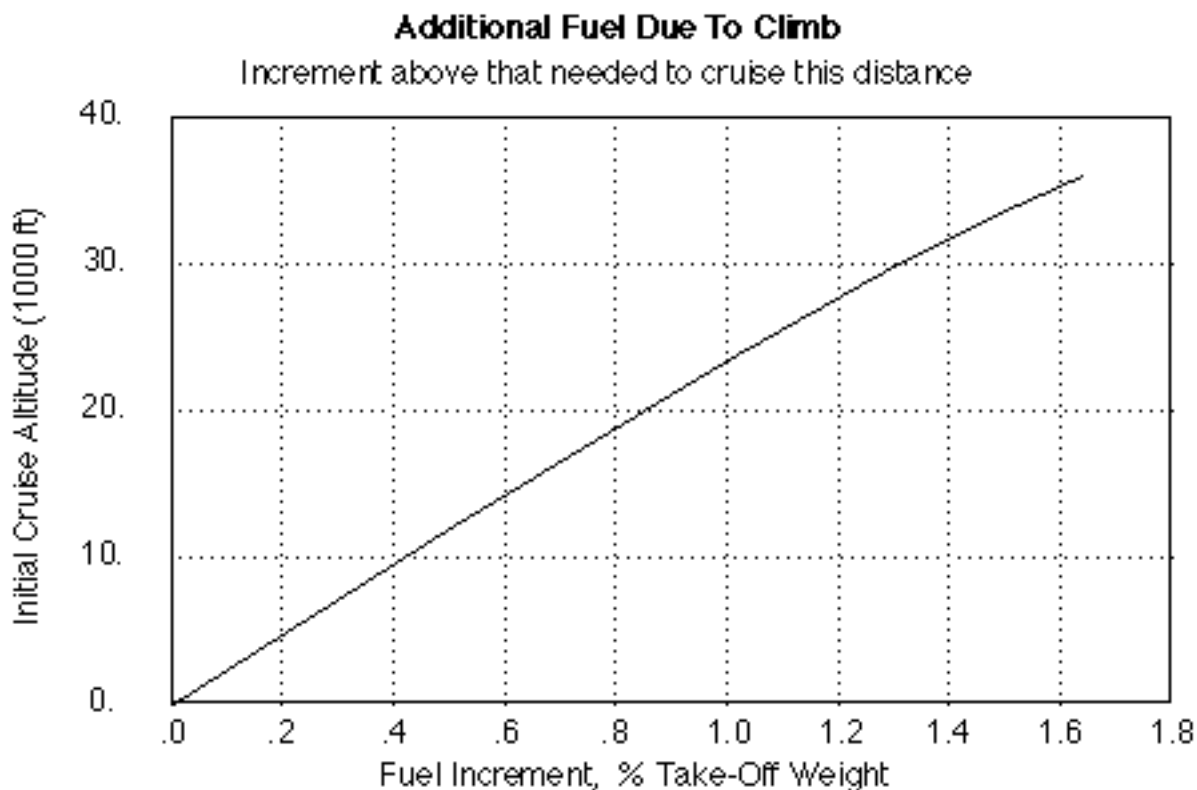

For different aircraft such as SST's we might think more fundamentally about the cause of this fuel

increment. With a rough estimate of the overall propulsion efficiency, we can express the extra fuel used in terms of the change in kinetic and potential energy. The net result, expressed as a percentage of take-off weight, is:

$$W_{\text{climb_fuel_inc}} / W_{\text{to}} (\%) = h(\text{kft}) / 31.6 + [V(\text{kts}) / 844]^2$$

This agrees with the plot above, indicating a 1.3% increment for flight at $M = .8$ and 30,000 ft, while for an SST that climbs to 60,000 ft and Mach 2.4, the increment is over 4.5%.

Cruise Performance and Range

Introduction

The calculation of aircraft range requires that we describe the entire "mission" or flight profile. A typical mission is illustrated below. Altitude is shown as the vertical coordinate and distance on the horizontal axis. Note that the altitude is greatly exaggerated: even on a short trip, the maximum altitude is only 1% to 2% of the distance flown.

The mission profile consists of two portions: the nominal mission and the reserves. Each of these is divided into several segments.

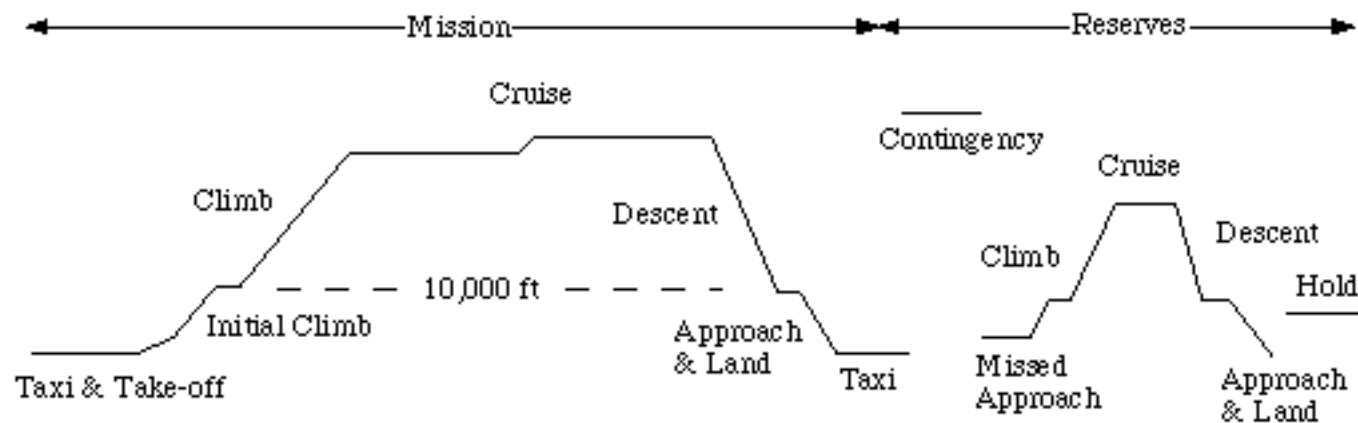

Taxi and take-off

A certain period of time is assumed for taxi and take-off. This time varies depending on traffic and airport layout, but a period of about 15 minutes is a reasonable average, used in cost estimates. The take-off segment also includes acceleration to the initial climb speed.

Initial Climb and Maneuver

The initial climb and air maneuvering involves airport-specific noise alleviation procedures and is constrained by other regulations such as a 250 kt CAS speed limit below 10,000 ft. in the U.S. and some other countries. This segment also involves acceleration to the enroute climb speed.

Climb

The climb segment of the mission is discussed in the previous section of these notes. Detailed calculations of time and fuel burned during climb may include several climb segments flown at different speeds. Climb computations for supersonic aircraft are especially important, with several subsonic and supersonic segments computed separately. For very short range missions the optimum cruise altitude is not reached and the climb may constitute half of the flight.

Cruise

One cannot continue climbing for long because as the altitude increases at a given speed the C_L increases. Speeding up would reduce C_L , but this is limited by Mach number constraints or engine power. Thus, there is a best altitude for cruise and this optimum altitude increases as the aircraft weight decreases (as fuel is burned). For long range missions, the initial and final cruise altitudes are quite different since the airplane weight changes substantially.

We could compute the altitude that leads to lowest drag at a given Mach number, but the optimum altitude is usually a bit lower since it results in higher true speeds, smaller engines, reduced pressure loads on the fuselage, and more margin against buffet. Thus, we will consider both initial and final cruise altitudes as design variables in the aircraft optimization. Except in a few lightly-travelled regions, variable altitude, or climbing cruise is not practical from a traffic control standpoint. Thus the true optimum is not generally attainable. In the U.S. ATC rules specify that aircraft be flown at specific flight altitudes so that the aircraft must cruise at constant altitude, and request clearance to climb to the next highest available altitude when sufficient fuel is consumed. This leads to "step cruise" profiles shown on the previous page, with 1 to 3 steps of 4000 ft in altitude due to airway requirements. Such stepped profiles lead to reductions in cruise range by 1%-2% if the altitudes are chosen to be optimal for the weight at the beginning of the step.

Descent, Approach, and Landing

Like the climb segment, the descent is performed according to a specified airspeed schedule with speed limit restrictions below 10,000 ft and extra fuel associated with maneuvers on approach.

Reserves

Reserve fuel is carried to allow for deviations from the original flight plan, including a requirement for diversion to an alternate airport when the planned destination is unavailable. The FAA specifies a minimum amount of reserve fuel as described below, but many airlines have additional requirements that result in reserves usually being somewhat higher than the FAA minimums. The FAR's establish different requirements for domestic and international flights as shown below.

There are also other "reserve" requirements such as those associated with "ETOPS" (extended twin engine operations). ETOPS rules currently require that the airplane be capable of flying with one engine inoperative to the nearest "suitable" airport. Some operators are certified for 180 minute ETOPS. Some are allowed 120 minutes, some 90, some only 75. Some aren't allowed to fly ETOPS under any circumstances. (Typically this is an economic decision made by the airline - not a reflection of relative safety - because of the onerous bookkeeping requirements.)

Domestic Reserves:

1. Climb from sea level to cruise altitude
2. Cruise to alternate airport at best speed and altitude (typ. 250 n.mi.)
3. Descend to sea level
4. Cruise for 45 minutes at long range cruise speed and altitude

International Reserves:

1. Fuel to fly 10% of planned block time at long range cruise speed
2. Climb from sea level to cruise altitude
3. Cruise to alternate
4. Descend to 1500 ft and hold for 30 minutes
5. Descend to sea level

Estimating the Aircraft Range

For the purposes of this course, we compute an equivalent still-air range (no wind) using a simplified mission profile.

The fuel required for warm-up, taxi, take-off, approach, and landing segments is sometimes taken as a single item called maneuver fuel. For our purposes, we estimate this as 0.7% of the take-off weight.

The fuel consumed in the climb segment is estimated in the previous section as a certain percentage of take-off weight above that needed to cruise the same distance at initial cruise altitude.

The descent segment of the mission requires slightly less fuel than would be required to cruise the same distance at the final cruise speed and altitude, so in the simplified computation the cruise extends to the destination airport and the mission is completed at the final cruise altitude.

The simplified mission is shown in the figure that follows.

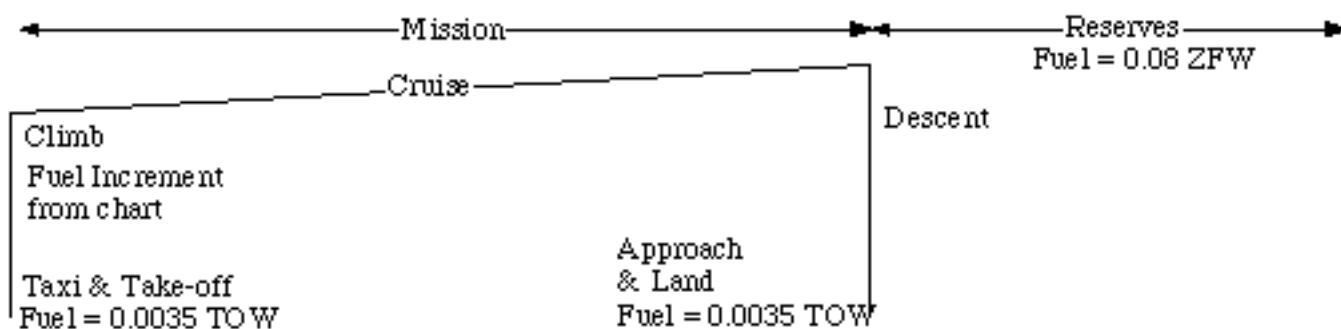

In order to compute the cruise range, we estimate the weight at the beginning and end of the cruise segment:

$$W_i = W_{\text{tow}} - .5 W_{\text{maneuver}} - W_{\text{climb}}$$

$$W_f = W_{\text{zfw}} + W_{\text{reserves}} + .5 W_{\text{maneuver}}$$

Where:

W_{maneuver} is estimated (roughly) as 0.7% of the take-off weight

W_{reserves} is estimated even more roughly as 8% of the zero fuel weight

and W_{climb} is estimated from the plot in the climb section of these notes.

The difference between initial and final cruise weights is the amount of fuel available for cruise. This is related to the cruise range as follows.

The specific range is the distance flown per unit weight of fuel burned, often in n.mi. / lb. It can be related directly to the engine specific fuel consumption:

$$\text{Specific Range} = V / cT$$

where V is the true speed, c is the thrust specific fuel consumption, and T is the thrust.

In level flight (or approximately when the climb angle is very small):

$$T = D = W / (L/D),$$

$$\text{so, Specific Range} = V/c L/D 1/W$$

$V/c L/D$ is sometimes called the range factor. It is related to the aerodynamic (L/D) and propulsion system (V/c) efficiencies.

The cruise range is then computed by integrating the specific range:

$$R = \int_{W_i}^{W_f} \frac{V}{c} \frac{L}{D} \frac{1}{W} dW$$

If the airplane is flown at a constant angle of attack (constant C_L) and M_{div} in the isothermal atmosphere (above 36,089 ft) where the speed of sound is constant, then V , L/D , and c are nearly constant and:

$$R = \frac{V}{c} \frac{L}{D} \int_{W_i}^{W_f} \frac{dW}{W} = \frac{V}{c} \frac{L}{D} \ln \frac{W_i}{W_f}$$

This is known as the Breguet Range Equation. When the altitude variation is such that L/D , V , or c is not constant, the integral may be evaluated numerically.

When the value of brake power specific fuel consumption is assumed constant (propeller aircraft), the range equation becomes:

$$R = \frac{\eta}{BSFC} \frac{L}{D} \ln \frac{W_f}{W_i}$$

where η is the propeller efficiency and BSFC is the power specific fuel consumption in consistent units.

Range / Payload Diagram

An aircraft does not have a single number that represents its range. Even the maximum range is subject to interpretation, since the maximum range is generally not very useful as it is achieved with no payload. To represent the available trade-off between payload and range, a range-payload diagram may be constructed as shown in the figure below.

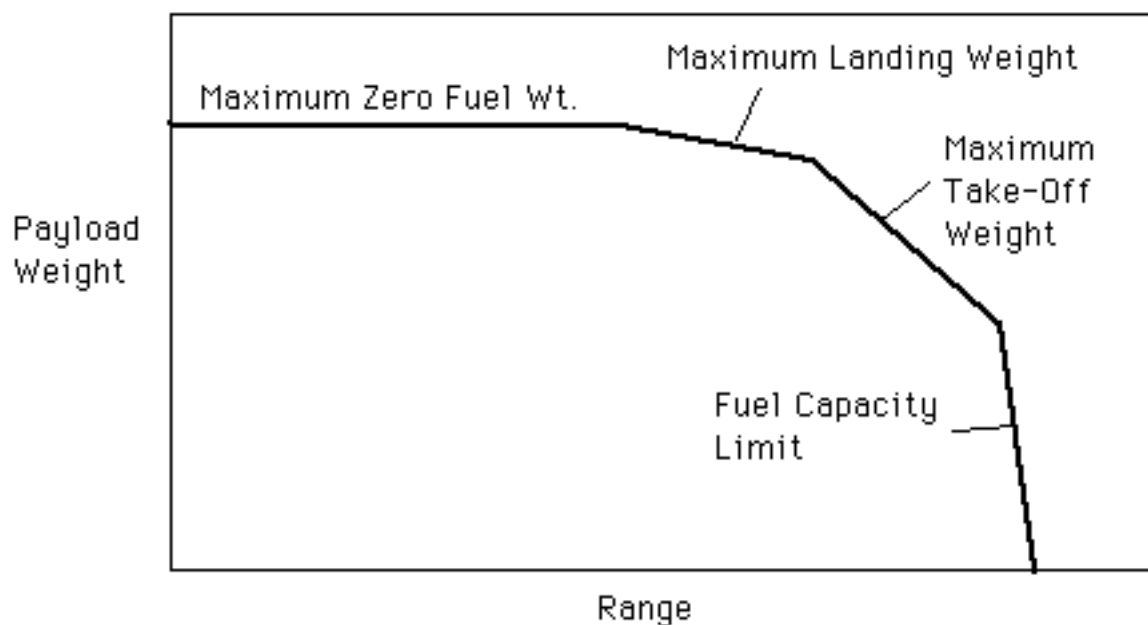

At the maximum payload weight is often constrained by the aircraft structure, which has been designed to handle a certain maximum zero fuel weight. (Sometimes the maximum payload weight is limited by volume, but this is rather rare. It has been noted that the MD-11 would exceed its maximum zero fuel weight if the fuselage were filled with ping pong balls.)

So, the airplane take-off weight can be increased from the zero fuel weight by adding fuel with a corresponding increase in range. This is the initial flat portion of the payload-range diagram.

At some point, the airplane could reach a limit on maximum landing weight. This usually happens only when the required reserve fuel is very large. Usually we can increase the weight until the airplane reaches its maximum take-off weight, with the full payload.

If we want to continue to add fuel (and range) from this point on, we must trade payload for fuel so as not to exceed the maximum take-off weight.

At some point, the fuel tanks will be full. We could increase the range further only by reducing the payload weight and saving on drag with a fixed fuel load. This is the final very steep portion of the payload range diagram.

Usually we are most interested in the range with maximum take-off weight and here we will focus on the range of the aircraft with a full compliment of passengers and baggage. This point is somewhere on the portion of the curve labeled maximum take-off weight, but often at a point considerably lower than that associated with maximum zero fuel weight (since the maximum zero fuel weight may be chosen to accommodate revenue cargo on shorter routes and to provide some growth capability.)

Take-Off Field Length Computation



Inputs

The following speeds are of importance in the take-off field length calculation:

V_{mu} Minimum Unstick Speed. Minimum airspeed at which airplane can safely lift off ground and continue take-off.

V_{mc} Minimum Control Speed. Minimum airspeed at which when critical engine is made inoperative, it is still possible to recover control of the airplane and maintain straight flight.

V_{mcg} Minimum control speed on the ground. At this speed the aircraft must be able to continue a straight path down the runway with a failed engine, without relying on nose gear reactions.

V_1 Decision speed, a short time after critical engine failure speed. Above this speed, aerodynamic controls alone must be adequate to proceed safely with takeoff.

V_R Rotation Speed. Must be greater than V_1 and greater than $1.05 V_{\text{mc}}$

V₁₀ Lift-off Speed. Must be greater than 1.1 V_{mu} with all engines, or 1.05 V_{mu} with engine out.

V₂ Take-off climb speed is the demonstrated airspeed at the 35 ft height. Must be greater than 1.1 V_{mc} and 1.2 V_s, the stalling speed in the take-off configuration.

Aircraft Performance FARs

- [Take-off](#)
- [Landing](#)
- [Climb](#)

I. Kroo 4/20/96

Sec. 25.115 Takeoff flight path.

(a) The takeoff flight path begins 35 feet above the takeoff surface at the end of the takeoff distance determined in accordance with Sec. 25.113(a).

(b) The net takeoff flight path data must be determined so that they represent the actual takeoff flight paths (determined in accordance with Sec. 25.111 and with paragraph (a) of this section) reduced at each point by a gradient of climb equal to--

- (1) 0.8 percent for two-engine airplanes;
- (2) 0.9 percent for three-engine airplanes; and
- (3) 1.0 percent for four-engine airplanes.

(c) The prescribed reduction in climb gradient may be applied as an equivalent reduction in acceleration along that part of the takeoff flight path at which the airplane is accelerated in level flight.

Sec. 25.117 Climb: general.

Compliance with the requirements of Secs. 25.119 and 25.121 must be shown at each weight, altitude, and ambient temperature within the operational limits established for the airplane and with the most unfavorable center of gravity for each configuration.

Sec. 25.119 Landing climb: All-engine-operating.

In the landing configuration, the steady gradient of climb may not be less than 3.2 percent, with--

(a) The engines at the power or thrust that is available eight seconds after initiation of movement of the power or thrust controls from the minimum flight idle to the takeoff position; and

(b) A climb speed of not more than 1.3 VS.

Sec. 25.121 Climb: One-engine-inoperative.

(a) Takeoff; landing gear extended. In the critical takeoff configuration existing along the flight path (between the points at which the airplane reaches VLOF and at which the landing gear is fully retracted) and in the configuration used in Sec. 25.111 but without ground effect, the steady gradient of climb must be positive for two-engine airplanes, and not less than 0.3 percent for three-engine airplanes or 0.5 percent for four-engine airplanes, at VLOF and with--

(1) The critical engine inoperative and the remaining engines at the power or thrust available when retraction of the landing gear is begun in accordance with Sec. 25.111 unless there is a more critical power operating condition existing later along the flight path but before the point at which

the landing gear is fully retracted; and

(2) The weight equal to the weight existing when retraction of the landing gear is begun, determined under Sec. 25.111.

(b) Takeoff; landing gear retracted. In the takeoff configuration existing at the point of the flight path at which the landing gear is fully retracted, and in the configuration used in Sec. 25.111 but without ground effect, the steady gradient of climb may not be less than 2.4 percent for two-engine airplanes, 2.7 percent for three-engine airplanes, and 3.0 percent for four-engine airplanes, at V_2 and with--

(1) The critical engine inoperative, the remaining engines at the takeoff power or thrust available at the time the landing gear is fully retracted, determined under Sec. 25.111, unless there is a more critical power operating condition existing later along the flight path but before the point where the airplane reaches a height of 400 feet above the takeoff surface; and

(2) The weight equal to the weight existing when the airplane's landing gear is fully retracted, determined under Sec. 25.111.

(c) Final takeoff. In the en route configuration at the end of the takeoff path determined in accordance with Sec. 25.111, the steady gradient of climb may not be less than 1.2 percent for two-engine airplanes, 1.5 percent for three-engine airplanes, and 1.7 percent for four-engine airplanes, at not less than 1.25 VS and with--

(1) The critical engine inoperative and the remaining engines at the available maximum continuous power or thrust; and

(2) The weight equal to the weight existing at the end of the takeoff path, determined under Sec. 25.111.

(d) Approach. In the approach configuration corresponding to the normal all-engines-operating procedure in which VS for this configuration does not exceed 110 percent of the VS for the related landing configuration, the steady gradient of climb may not be less than 2.1 percent for two-engine airplanes, 2.4 percent for three-engine airplanes, and 2.7 percent for four-engine airplanes, with--

(1) The critical engine inoperative, the remaining engines at the available takeoff power or thrust;

(2) The maximum landing weight; and

(3) A climb speed established in connection with normal landing procedures, but not exceeding 1.5 VS.

Sec. 25.123 En route flight paths.

(a) For the en route configuration, the flight paths prescribed in paragraphs (b) and (c) of this section must be determined at each weight, altitude, and ambient temperature, within the operating limits established for the airplane. The variation of weight along the flight path, accounting for the progressive consumption of fuel and oil by the operating engines, may be included in the computation. The flight paths must be determined at any selected speed, with--

(1) The most unfavorable center of gravity;

(2) The critical engines inoperative;

(3) The remaining engines at the available maximum continuous power or thrust; and

(4) The means for controlling the engine-cooling air supply in the position that provides adequate cooling in the hot-day condition.

(b) The one-engine-inoperative net flight path data must represent the actual climb performance diminished by a gradient of climb of 1.1 percent for two-engine airplanes, 1.4 percent for three-engine airplanes, and 1.6 percent for four-engine airplanes.

(c) For three- or four-engine airplanes, the two-engine-inoperative net flight path data must represent the actual climb performance diminished by a gradient of climb of 0.3 percent for three-engine airplanes and 0.5 percent for four-engine airplanes.

Noise

Introduction

Aircraft noise is hardly a new subject as evidenced by the following note received by a predecessor of United Airlines in about 1927.

FROM SCRAPBOOK OF LEON CUDDEBACK
CHIEF PILOT OF VARNEY AIRLINES FOUNDED IN 1926

*Dear Aviators One and All
Please have some enough to
stay off from the very pickers as
the pickers get the head ache and
are unable to pick berries on the
count of your God Damned racket
By
Berrie Raisers of Ada County*

Although internal noise was the major preoccupation of aircraft acoustic engineers for many years and still is important, the noise produced by the aircraft engine and experienced on the ground has become a dominant factor in the acceptability of the airplane. With the development of high bypass ratio engines, noise due to other sources has become important as well.

Internal noise is treated by placing the engines to minimize the noise directly radiated to the cabin, (e.g. using the wing as a shield) and by providing insulating material over the entire surface of the flight and passenger compartments. If the engines are mounted on the fuselage, vibration isolation is an important feature. In the late 1980's when prop-fans were being developed, internal noise become an important consideration again. It was, at one point, estimated that 2000 lbs of additional acoustic insulation would be required to reduce cabin noise levels to those of conventional jets if prop-fans were placed on the aircraft wings. This is one reason why many prop-fan aircraft were designed as aft-mounted pusher configurations.

External noise is affected by the location of the source and observer, the engine thrust, and a number of factors that influence the overall configuration design. These will be discussed in detail later in this chapter, but first we must understand the origins of noise and its measurement.

The Nature of Noise

A sound wave carries with it a certain energy in the direction of propagation. The sound becomes audible because of energy which originates at the source of the sound vibrations and which is transported by the sound waves. The changes in air pressure which reach the eardrum set it vibrating; the greater these changes, the louder is the sound.

The intensity of sound, I , is the quantity of energy transferred by a sound wave in 1 sec through an area of 1 cm. For a plane sine wave:

$$I = p^2 / 2 \rho c$$

where:

p = the amplitude of the varying acoustic excess pressure

ρ = air density

c = speed of sound

I is usually expressed in ergs per cm^2 per sec. (mW/m^2)

The human ear responds to a frequency range of about 10 octaves. It responds to air vibrations whose amplitude is hardly more than molecular size; it also responds without damage to sounds of intensity 10^{13} to 10^{14} times greater without damage.

The response of the ear is not proportional to the intensity, however. It is more nearly proportional to the logarithm of the intensity. If sound intensity is increased in steps of what seem to be equal increments of loudness, we find that the intensities form a sequence of the sort 1, 2, 4, 8, 16, ... or 1, 10, 100, 1000 not 1, 2, 3, 4, ... or 1, 10, 19, 28, Since the ear responds differently to different frequencies, the logarithmic relation of intensity to loudness is not generally perfect, but it is easier to handle than the enormous numbers involved in the audible intensity range. Therefore, the intensity level of sound is defined in decibels as 10 times the logarithm of the ratio of the intensity of a sound, I , to a reference level defined as 10^{-9} erg/cm²/sec.

Thus: Sound intensity level (SPL), decibels = $10 \log_{10} I / 10^{-9}$

The response of the ear is not exactly proportional to the decibel scale. In addition to the physical quantities, intensity and frequency, the psycho-physiological quantities of loudness and pitch must be considered. The loudness of a sound depends both on intensity level and frequency; pitch depends chiefly on frequency but to some extent on intensity. Contours of equal loudness for the average person are plotted in the following figure from Ref. 2. The actual contour values are the values of SPL at 1 kHz.

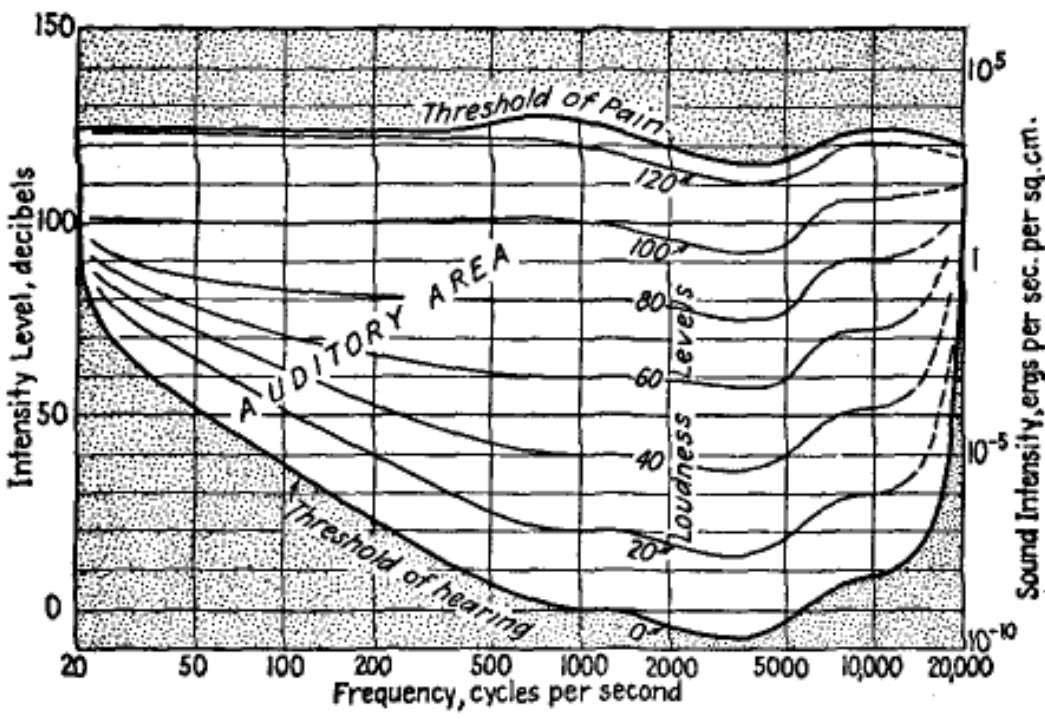

Contours of equal loudness, plotted against intensity and frequency for the average ear.

The db(A) Scale

In an attempt to develop a noise measuring scale more responsive to these characteristics of the ear, the "A" scale was defined to weight noise at frequencies above 1000 Hz more heavily. Noise measured on this scale is given in units of db(A).

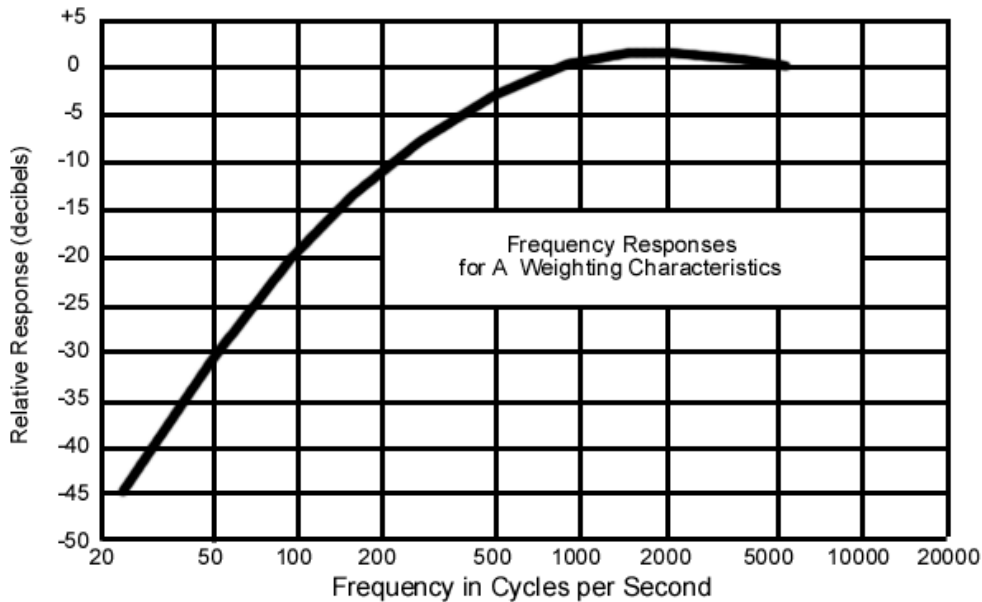

Frequency response weighting for the "A" scale. (From Peterson and Gross, 1967, p.9).

The Perceived Noise Level Scale PNdb and EPNdb

The scale most often used for aircraft noise measurement is the Perceived Noise Level (PNL) scale. The scale requires that the SPL be measured in each of nine contiguous frequency ranges and combined according to a special prescription, not too different from the A-weighting method, to provide a noise indication level. The units are PNdb.

The effective perceived noise level, EPNL, accounts for duration and presence of discrete frequency tones. It involves a correction factor that adds to the PNL when there are discrete tones in the noise spectrum. It also includes a correction obtained by integrating the PNL over a 10 second time interval. (Details are given in the full text of FAR Part 36.)

The effective perceived noise level correlates with people's perceived noisiness as shown in the figures below.

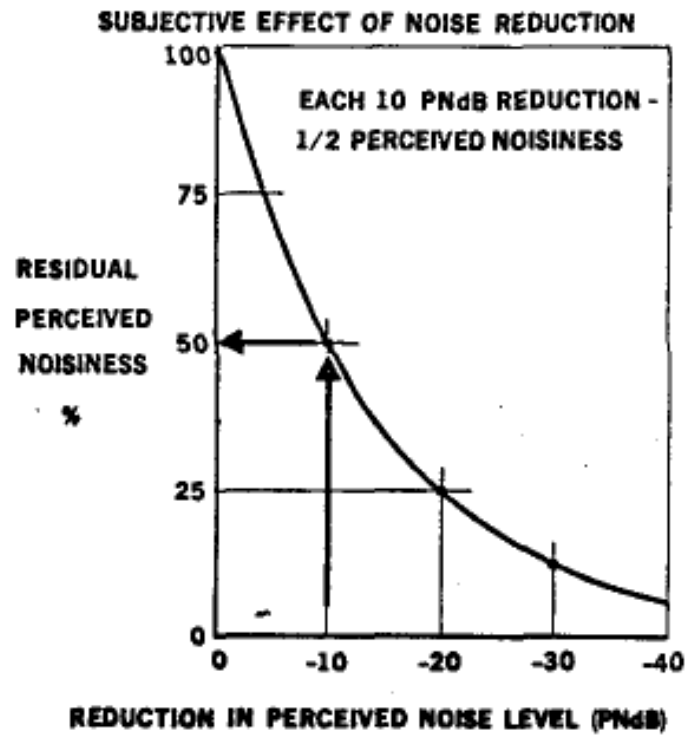
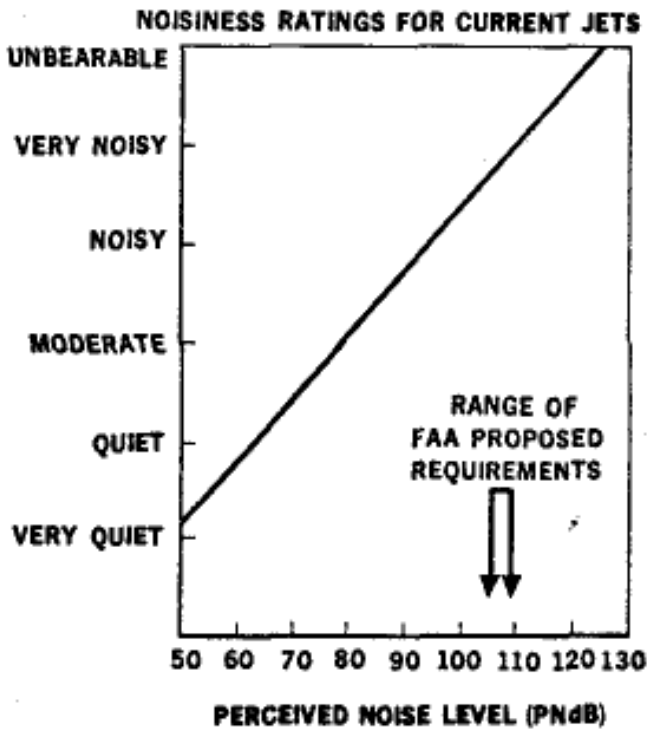

Subjective Reactions to Various Noise Levels

The fact that people's perception of noise varies logarithmically with sound intensity results in some interesting relations. Note that as intensity is reduced by 50% the SPL changes by $10 \log I_1/I_2 = -3\text{db}$. From the plot above this reduction would be only barely perceptible. This is why noise reduction is a challenge. To make something seem about half as noisy requires a reduction in SPL by about 10 db. This is a reduction in I of about 90%!

People's reactions also depend on how often such noises occur and a variety of methods for averaging noisiness have been used. Sound exposure levels (SEL), noise exposure forecasts (NEF), and Day-Night-Levels all involve some kind of averaging of multiple noise events, usually with higher weightings (e.g. 10-20 times) for night flights. These are intended to capture the community response in a statistical way. (See figure below.)

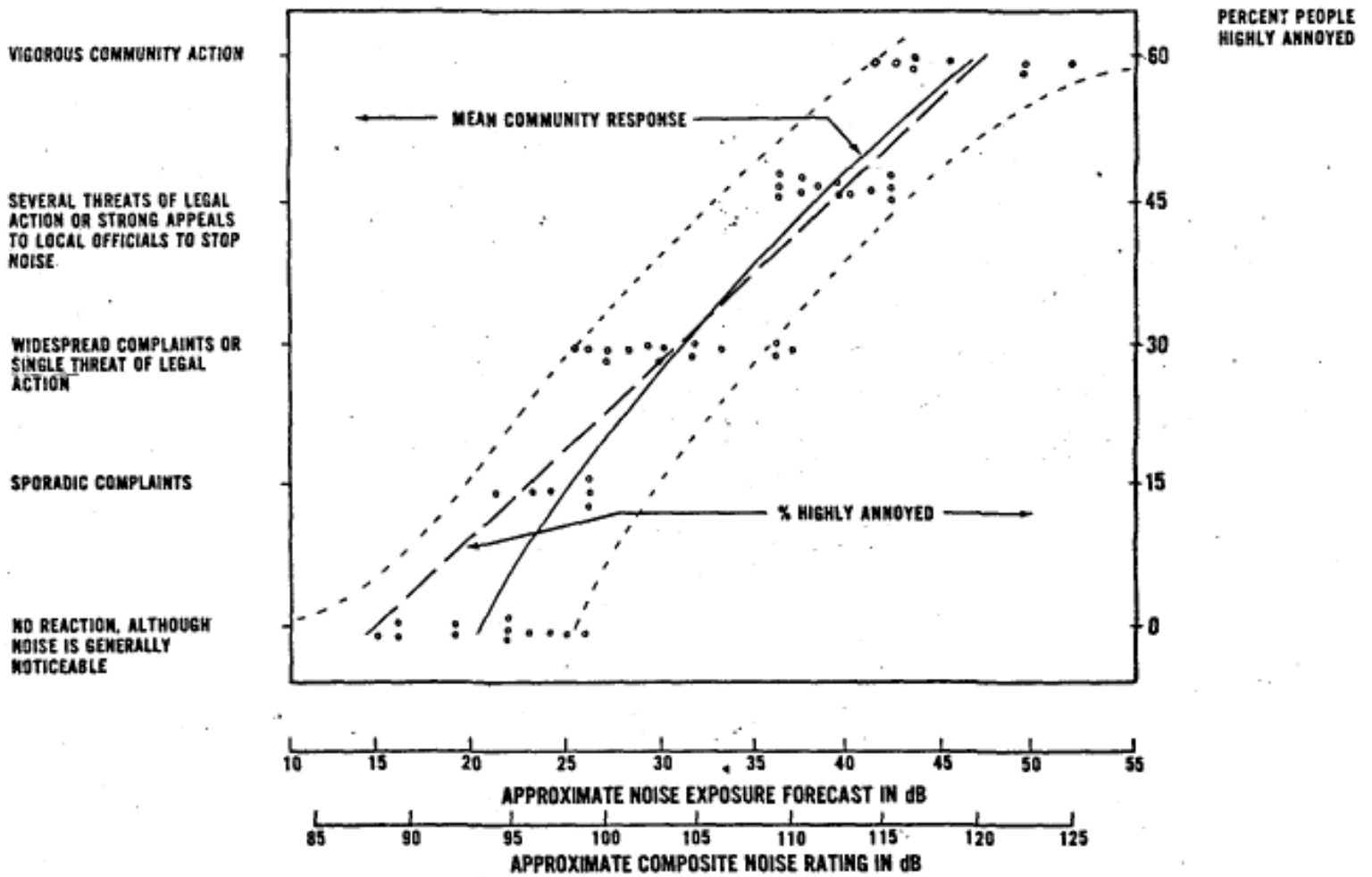

Community Response to Different Noise Levels

Footprints

The U.S. Environmental Protection Agency (EPA) uses a Day-Night Average A-Weighted Sound Level metric known as DNL as a method for predicting the effects on a population of the long term exposure to environmental noise. The DNL metric is legislated to be the single system for measuring aircraft noise impact and for determining land use compatibility.

Noise maps typically depict the DNL 65dB contour as this is identified by federal guidelines as the threshold level of aviation and community noise that is "significant". In general, most land uses are considered to be compatible with DNLs less than 65 dB.

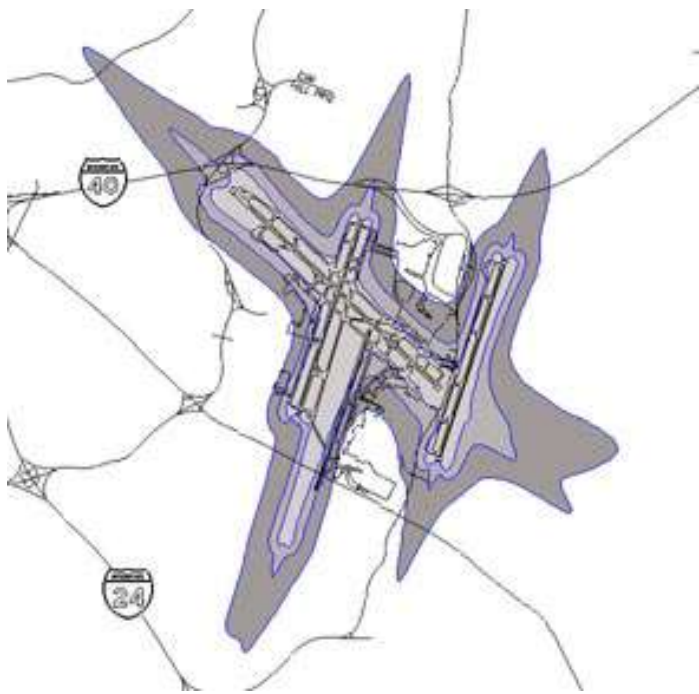

Sample of Estimated Noise Footprints Atlanta Airport in Jan. 2000

Contours of constant DNL or EPNdB are often plotted to determine the areas affected at a given levels. Different aircraft may have very different footprints, this is especially obvious when comparing 2 vs. 4 engine aircraft, because of different climb rates.

Sources of Noise

Aircraft noise is generally divided into two sources: that due to the engines, and that associated with the airframe itself. As higher bypass ratio engines have become more common and aircraft have become larger, interest in airframe-related noise has grown, but engine noise still accounts for most of the aircraft external noise. The relative importance of various noise sources is shown in the figure below.

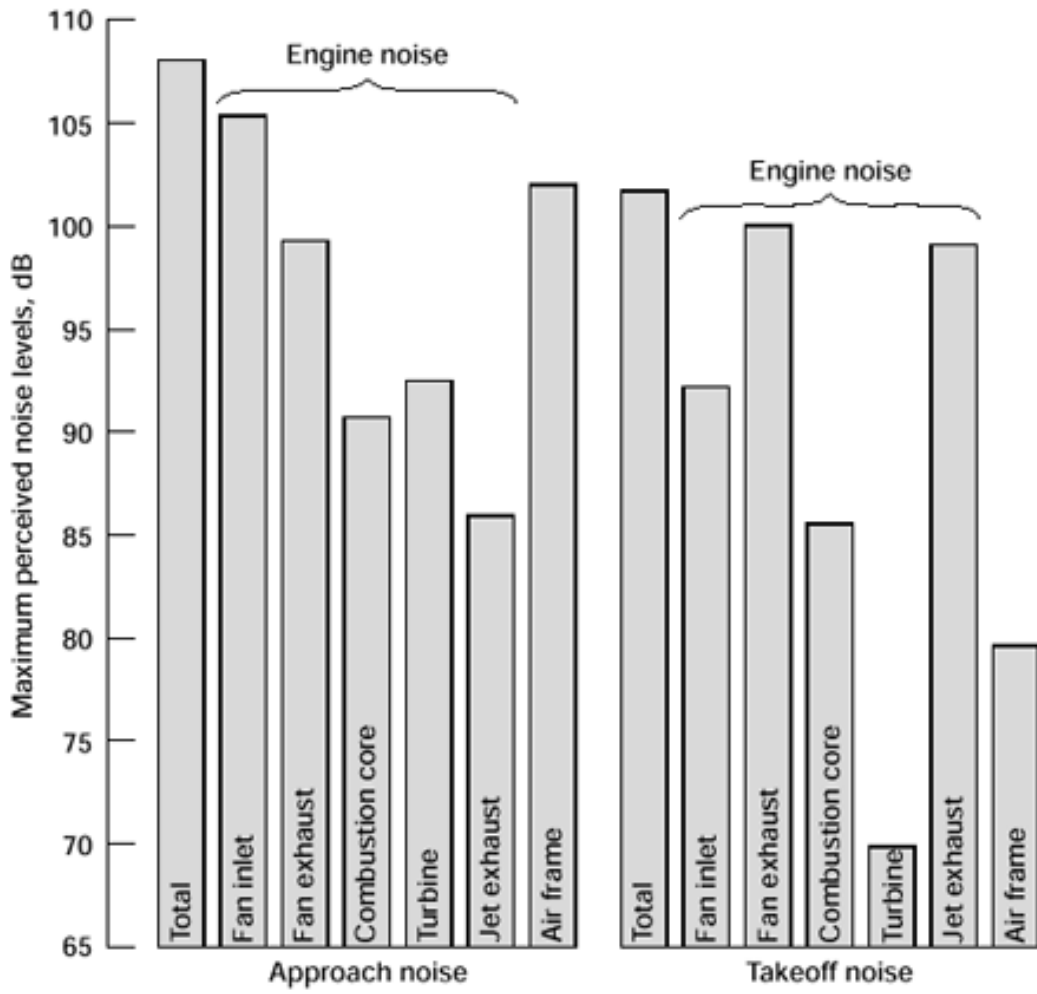

Propulsion-Related Noise Sources

Engine noise includes that generated at the fan inlet and exit, the combustor core, the turbine, and that caused by jet mixing. While jet noise, caused by the turbulent mixing of the high speed exhaust with the ambient air, is a broad band noise source, with most of the energy directed aft of the engine at a 45 degree angle from the engine axis, the turbomachinery noise often includes discrete tones associated with blade passage frequencies and their harmonics.

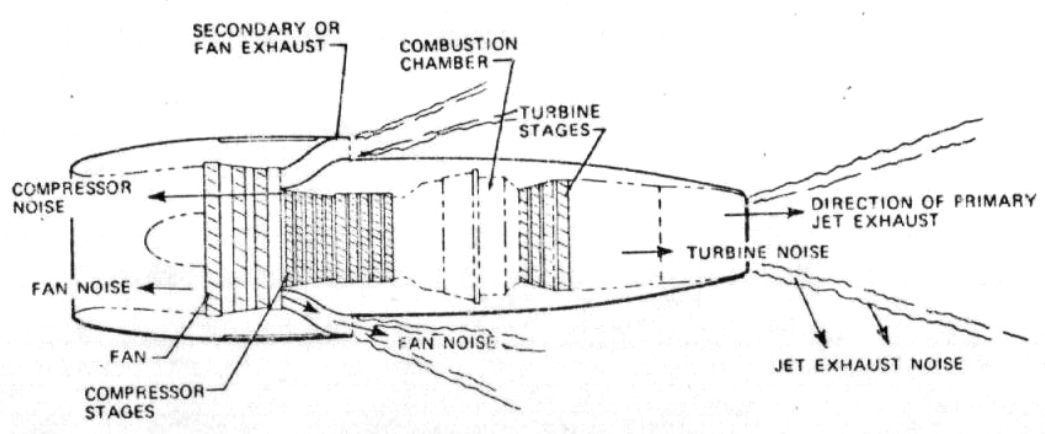

Jet noise levels vary as the sixth to eighth power of the jet exhaust velocity as shown in the figure below. Early turbojet engines had exhaust velocities of nearly 2000 ft/sec and noise suppressors were used to try to obtain better mixing and

lower the noise associated with the strong shear. Such suppressors were effective in reducing the low frequency noise, but often not the high frequencies and added weight and cost to the design.

EXHAUST NOISE LEVEL VS JET RELATIVE VELOCITY

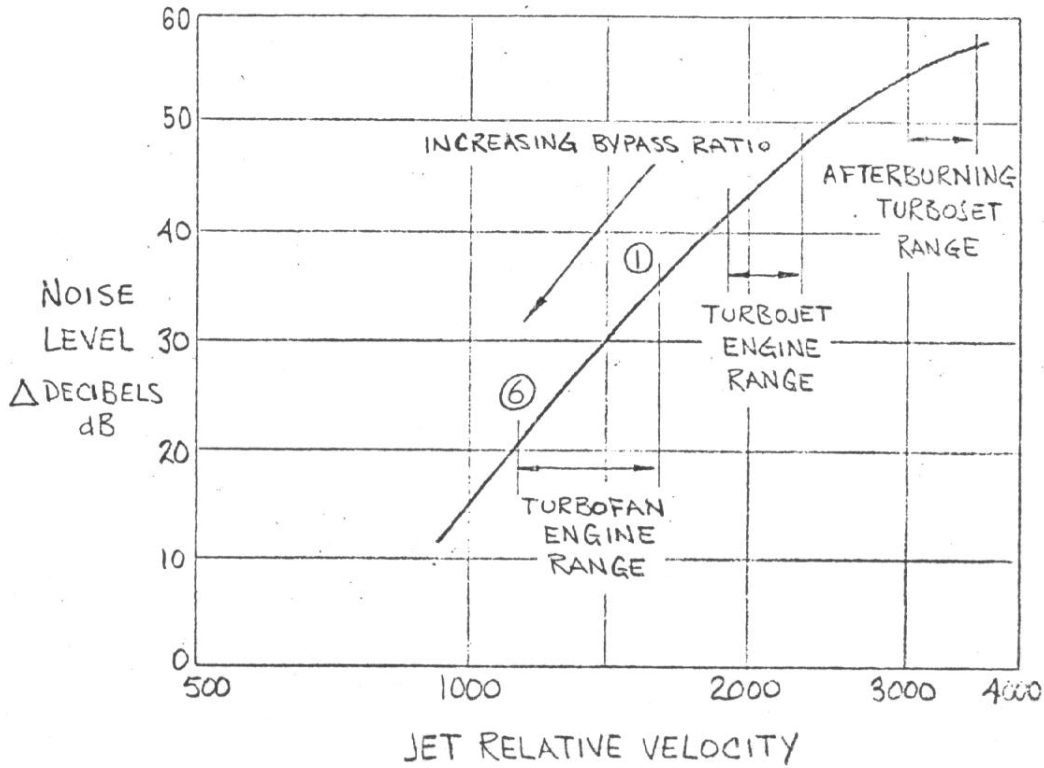

The jet velocity was reduced considerably as the bypass ratio increased. This is indicated by the figure below that applies to older engines, but is still representative of the trend observed for larger modern engines.

TURBOFAN JET VELOCITY 100 KTS TAS

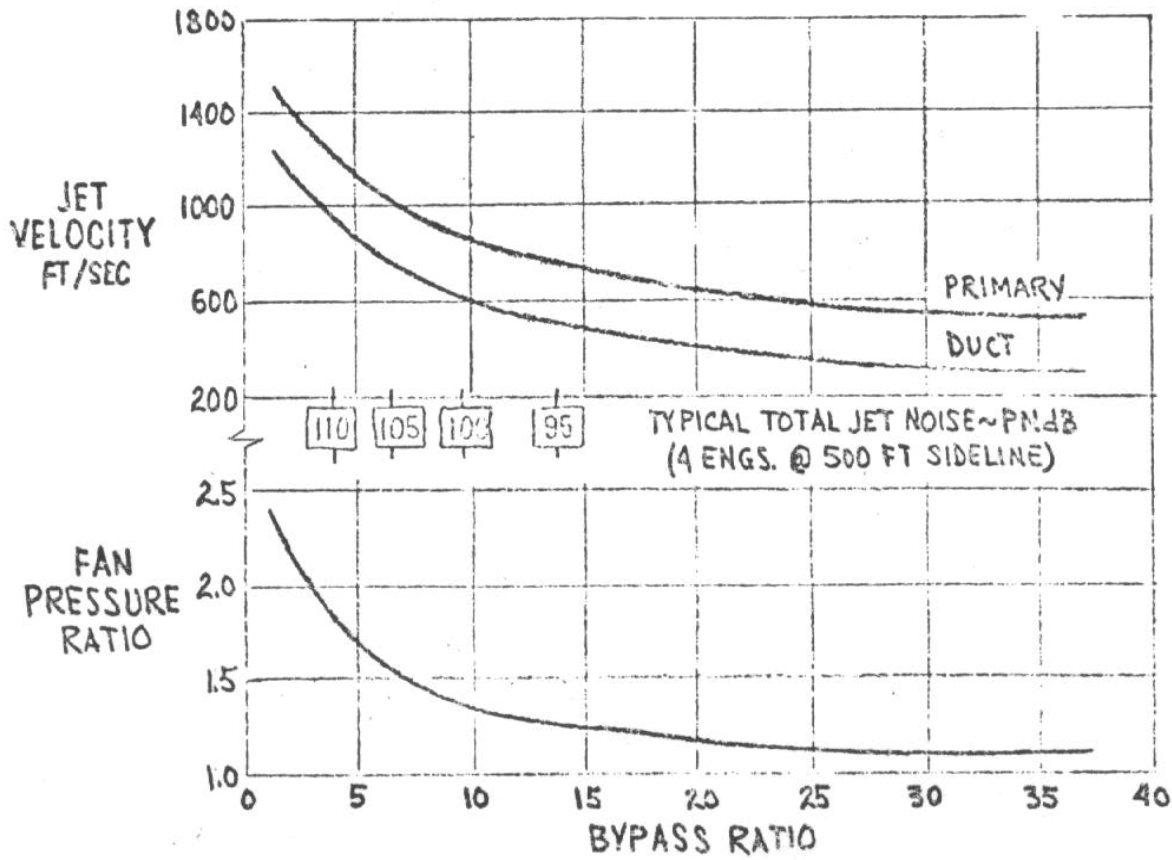

The net result is a substantial reduction in the noise due to jet mixing. At the same time, though, the larger fan noise become more significant as seen from the figure below.

Relative Perceived Noise Level vs. Bypass Ratio

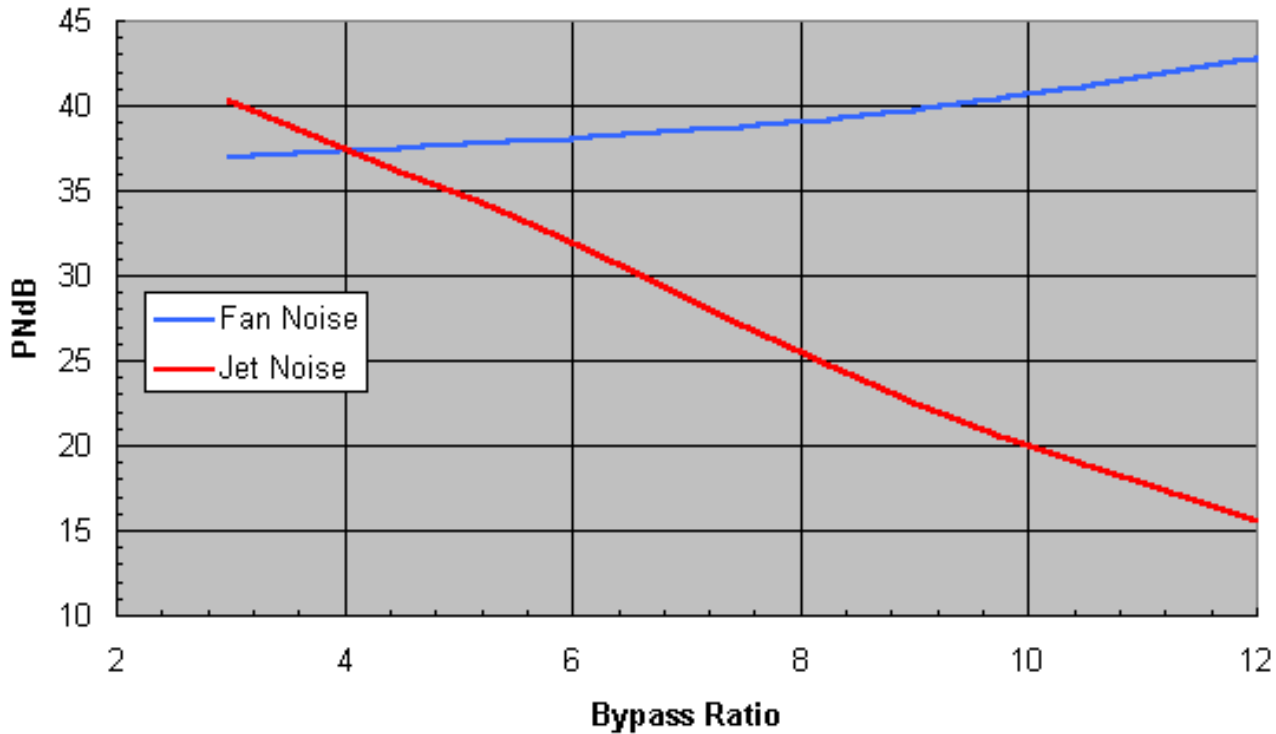

Computational aerodynamics is getting to the point of predicting such effects in a practical way, but it is a very complex problem, involving internal unsteady flows and propagation estimates.

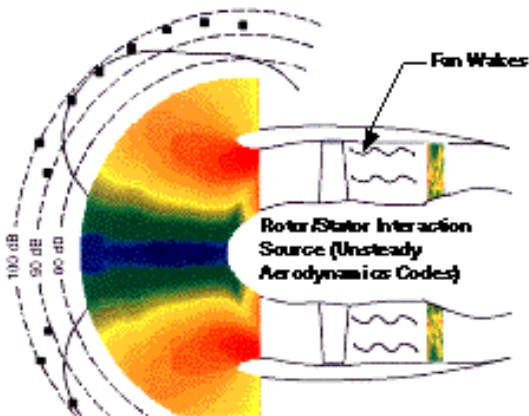

Without such CFD tools, one can still estimate the effects of engine thrust levels, separation distances, and number of engines by scaling experimental results according to the fundamental physics of the problem as described in the following sections.

Non-propulsive noise

In addition to the engine noise, the shear of the boundary layer and unsteady vortex shedding from landing gear, landing gear doors, and other separated flows as well as flap edge flows contribute a significant part of the acoustic energy, especially for large aircraft on approach.

WING UNSTEADY
AERODYNAMIC FORCES,
MODIFIED BY FLAPS,
SLATS, FAIRINGS, ETC.

BOUNDARY LAYER FLOW
OVER THE ENTIRE AIRFRAME

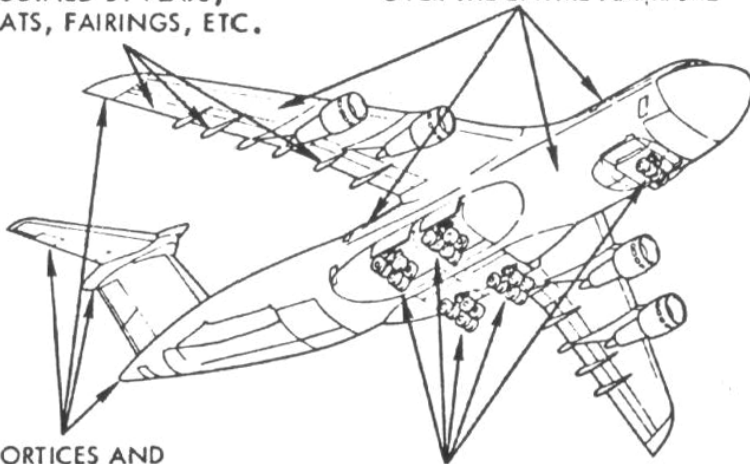

VORTICES AND
WAKES TRAILING
FROM WING,
FUSELAGE AND
EMPENNAGE

FLOW AROUND
LANDING GEAR,
WHEEL WELLS,
DOORS

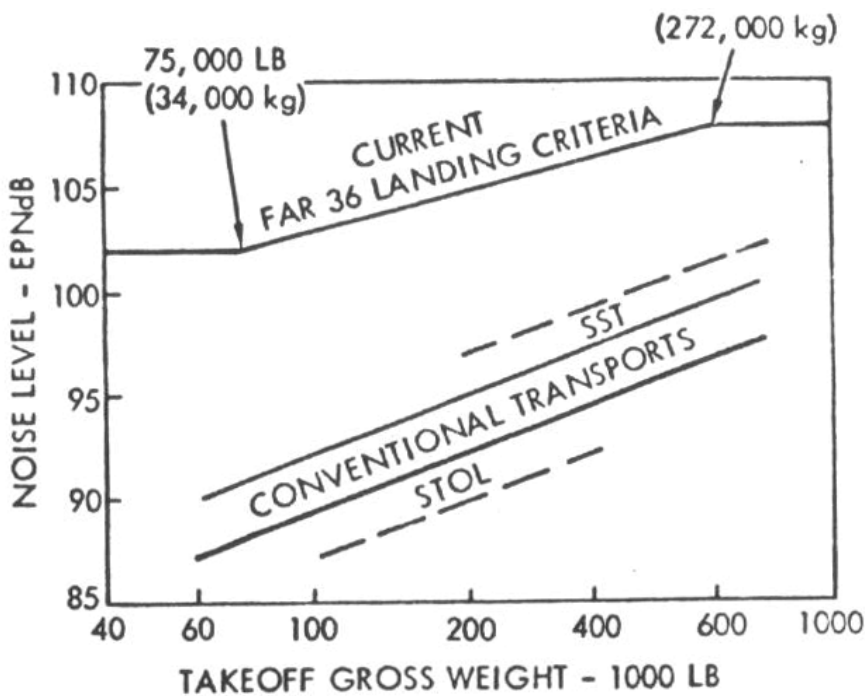

The figure on the right shows that these noise sources were still well below the requirement, but the figure was drawn in 1974. Stage 3 noise regulations now make airframe noise a significant issue.

Noise Reduction

With substantially more stringent noise regulations and a desire to reduce community environmental impact, engine companies, aircraft manufacturers, and government agencies have continued to look for ways to reduce aircraft noise.

NASA work as part of their advanced subsonic technology program includes the objective of 10 decibel (dB) community noise reduction relative to 1992 production technology. This includes:

- 6 dB engine noise reduction
- 50% improvement in nacelle liner efficiency
- 4 dB airframe noise reduction
- Community noise impact minimization through operations
- 6 dB interior noise reduction

To accomplish this, engineers are developing higher bypass ratio engines to reduce exhaust velocities, continuing to improve nacelle treatments, and operating the aircraft with take-off power cutbacks and 2-segment approaches.

757/PW2037 Installation

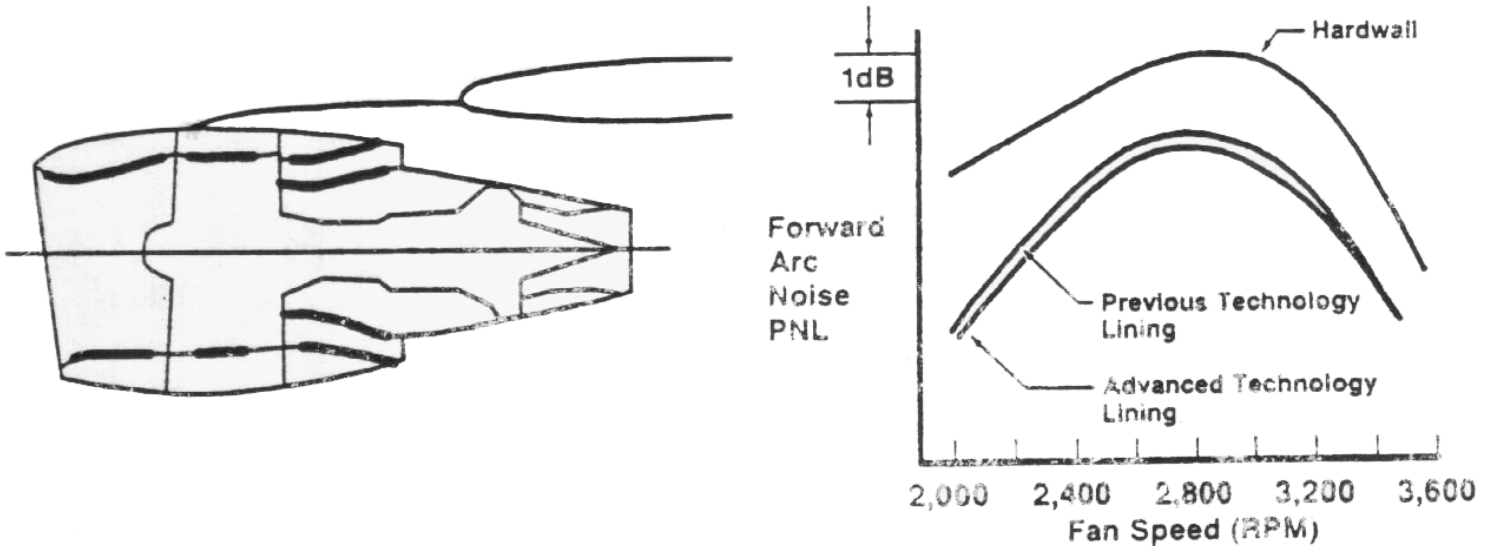

The picture below shows a large acoustic test facility used by NASA Lewis as part of their work on engine noise reduction.

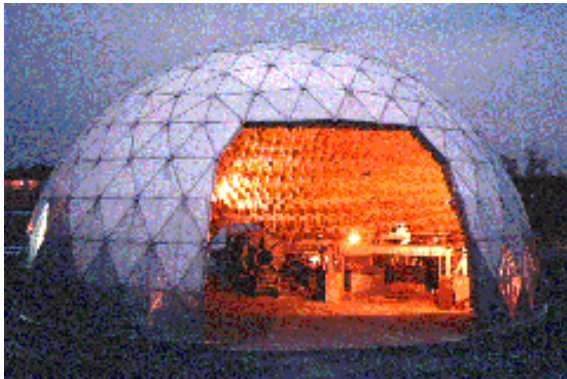

The Regulations

Noise regulations in FAR Part 36 Stage 3 include restrictions on noise in 3 conditions. The take-off noise is defined as the noise measured at a distance of 21,325 ft (6500 m) from the start of the take-off roll, directly under the airplane. The sideline noise is measured 1476 ft (450 m) from the runway centerline at a point where the noise level after liftoff is greatest. The approach noise is also measured under the airplane when it is at a distance of 6562 ft (2000 m) from the runway threshold. For each of these conditions the maximum noise level is a function of maximum takeoff gross weight, and for the take-off case the limits depend also on the number of engines. The figures below summarize the requirements.

**NOISE CERTIFICATION REQUIREMENTS - JET AND TRANSPORT AIRPLANES
TAKEOFF**

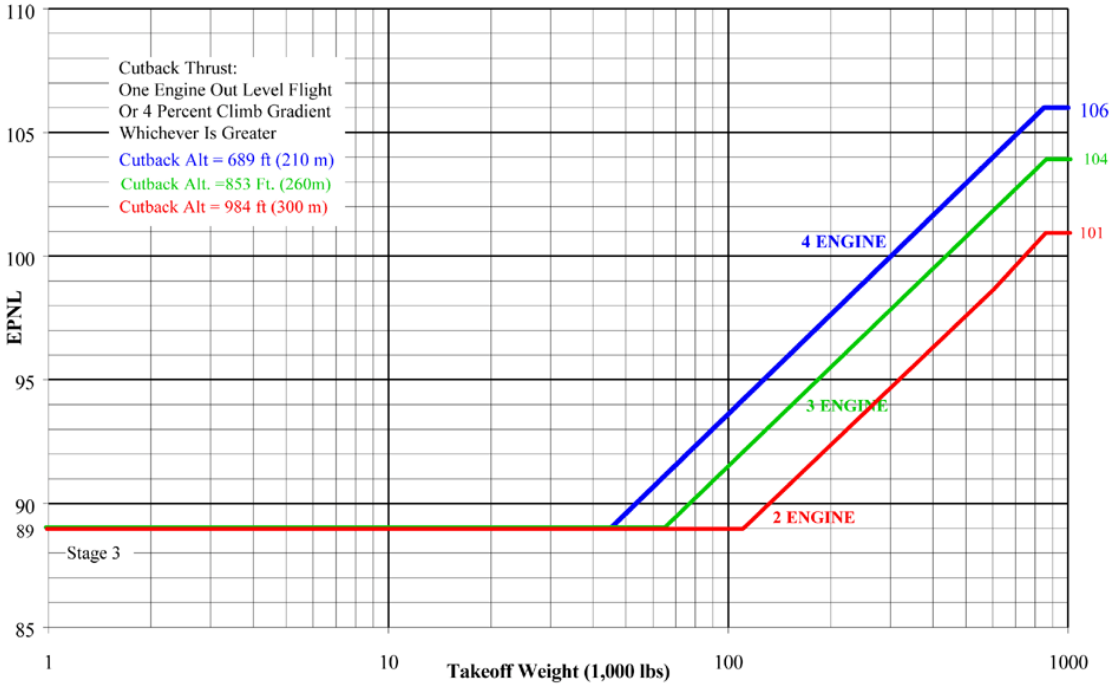

**NOISE CERTIFICATION REQUIREMENTS - JET AND TRANSPORT AIRPLANES
SIDELINE**

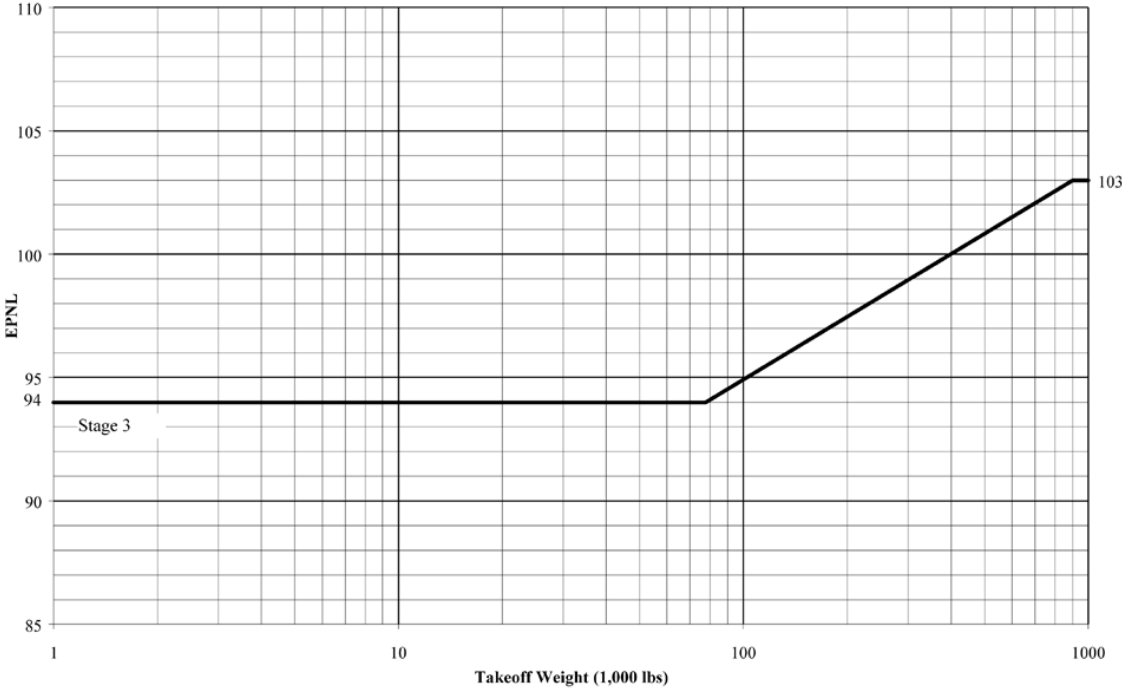

NOISE CERTIFICATION REQUIREMENTS - JET AND TRANSPORT AIRPLANES
APPROACH

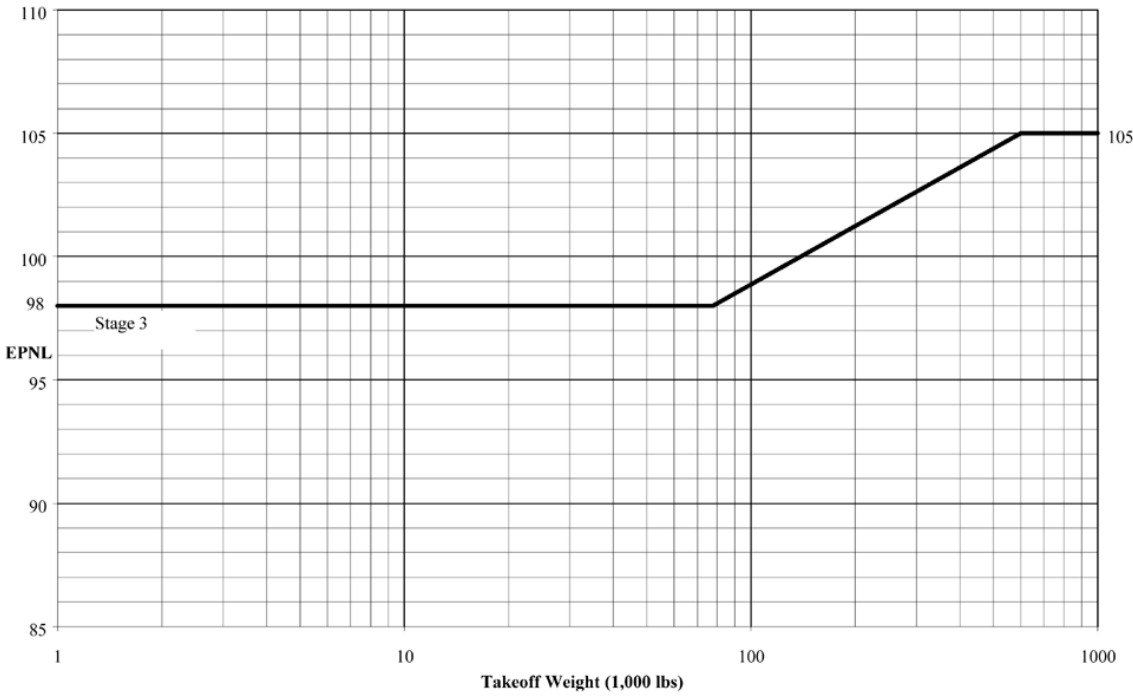

Estimating Aircraft Noise for Advanced Design

We start with a measurement of the noise due to a known engine at a known distance away. For example, a 25,000 lb (sea level static take-off thrust) turbofan engine with a bypass ratio of 6 produces a noise of about 101 PNdb at a distance of 1000 ft. This assumes some level of noise suppression (about 5PNdb). We might also infer a baseline engine noise from measured data such as that provided by GE and shown below:

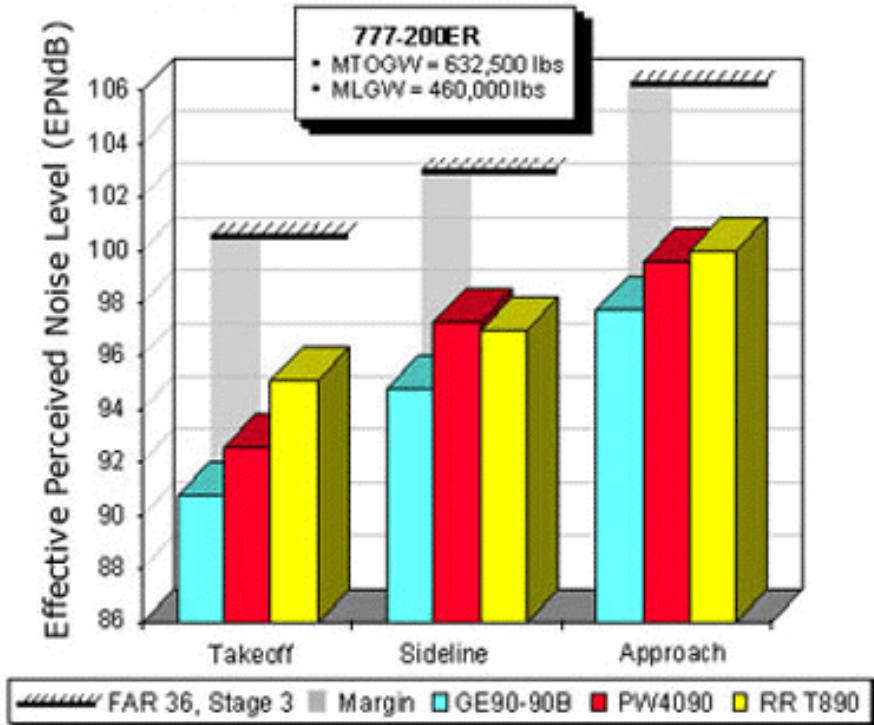

Noise Comparison

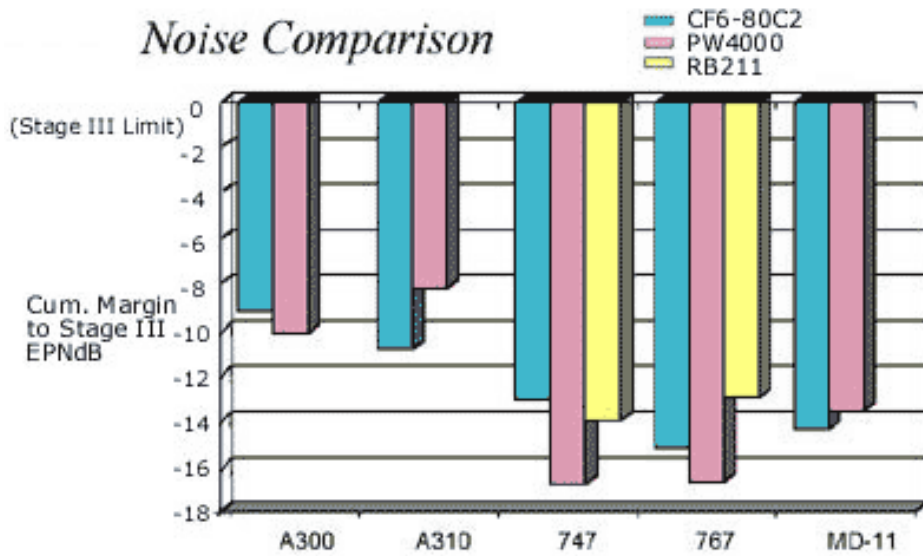

GE data based on no delayed cutbacks. Delayed cutbacks could improve GE 767 and 747 level by approx. 1.5dB

CF6-80C2 has Excellent Cumulative Stage 3 Margins

Examples of measured noise data form reference (from GE)

We are interested in the effect of design changes on the noise, so starting from the reference value, we make corrections for thrust level, distance, ground attenuation, and noise duration. These effects are shown in the plots below and further described by an example computation that follows.

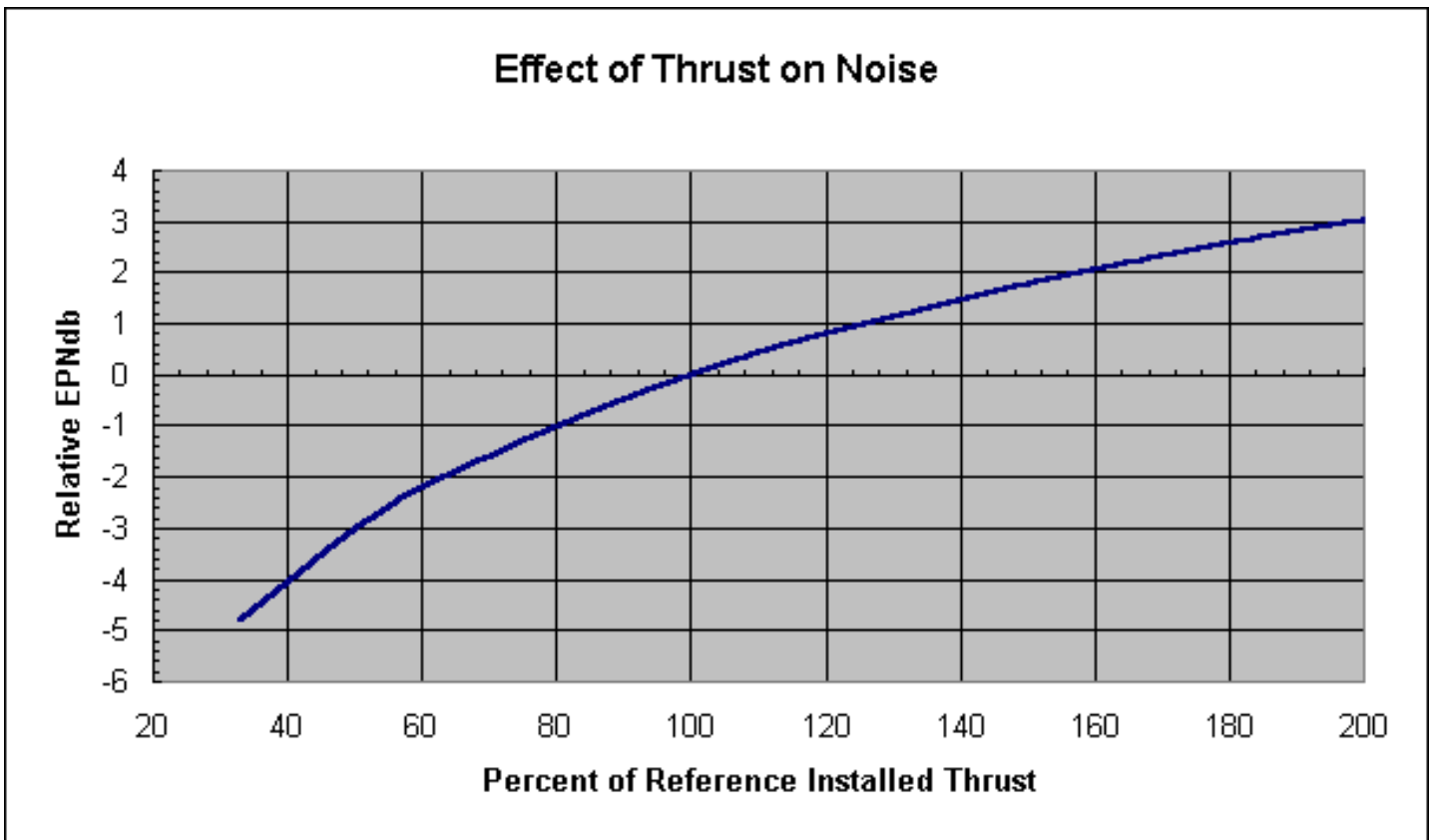

The effect of thrust level on noise is obtained by simply scaling the sound intensity (I) by the ratio of thrust to reference thrust. This correction is applied to scale the engine size or the number of engines. This means that if the engine

technology is similar, reducing the installed thrust by 50% will lead to a noise reduction of about 3db. ($10 \log (1/2) = -3$)

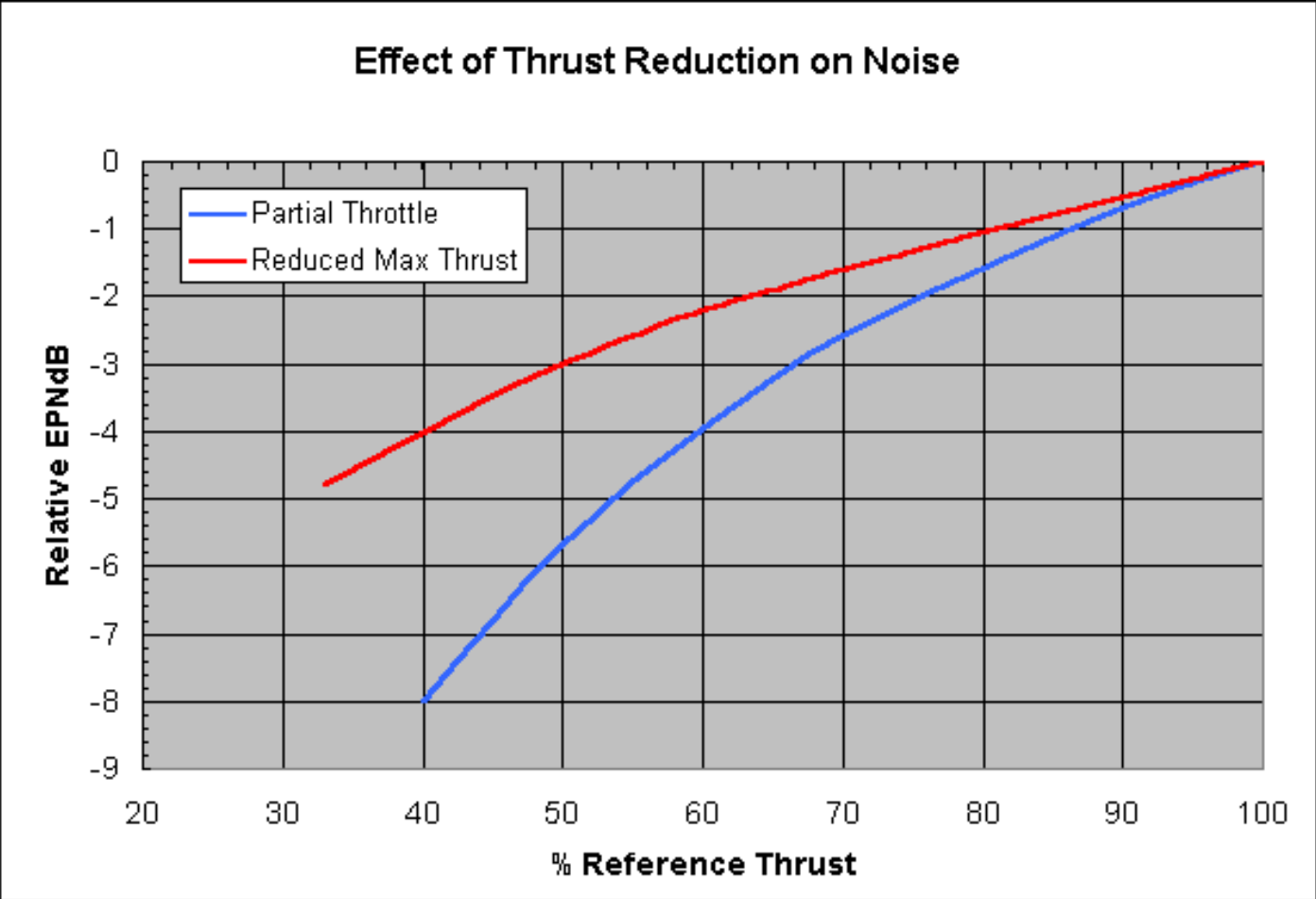

If thrust is reduced, not by scaling the engines, but by reducing the throttle setting, the noise is reduced much more because the fan tip speeds and exhaust velocity are reduced.

Effect of Distance on Noise

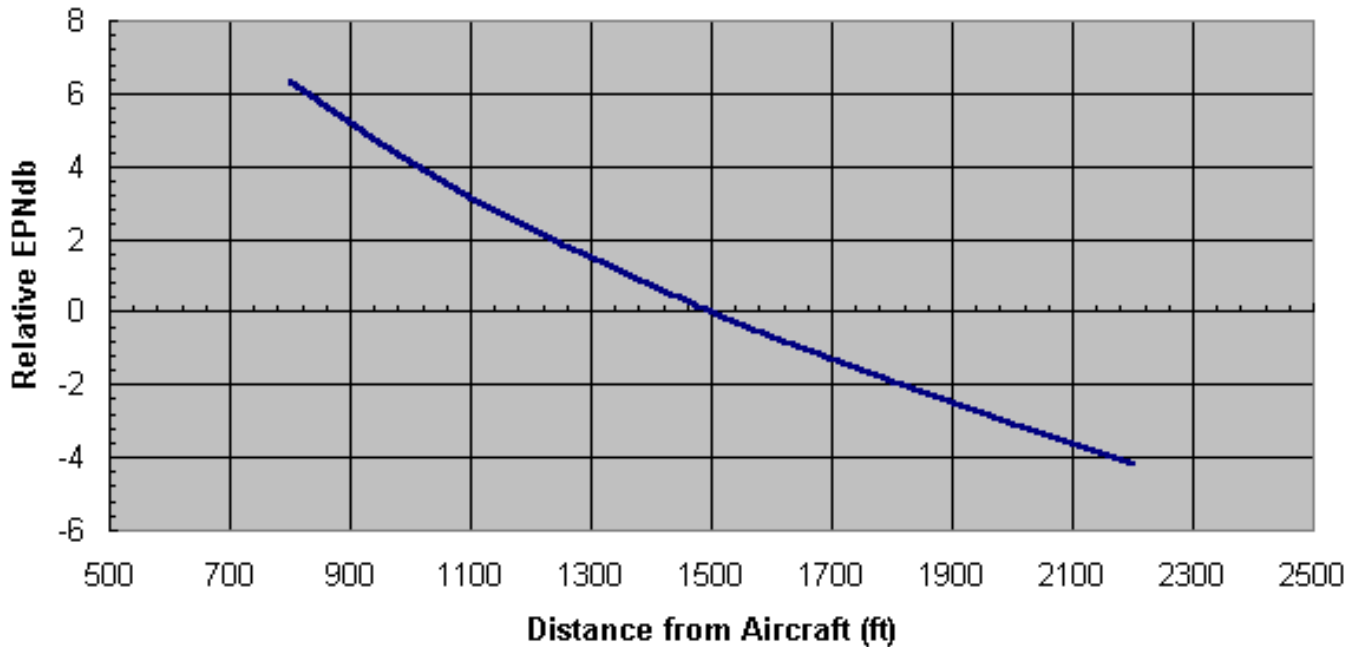

The sound intensity varies roughly as the inverse square of the distance from the source. This means that for each doubling of the distance, we expect a 6db reduction in the noise level. However, atmospheric attenuation adds about 1.2 db of reduction per 1000 ft so that increasing the distance from 1000 ft to 2000 ft results in about 7.2db attenuation. Both of these effects are included in the above plot. The presence of various obstacles and absorbing material near the ground is sometimes taken into account by adding 25% to the actual distance and considering this an effective distance.

To obtain EPNdb we typically reduce the PNdb level by about 4db for the take-off and sideline calculations and by about 5db on approach. (This reflects typical tone and duration corrections under these conditions.)

Finally we add the airframe noise which is very difficult to estimate, but which we take here to be related to the log of the aircraft weight: Airframe Noise (db) = 40 + 10 log W, where W is the aircraft weight in lbs. This fit is based on some simple scaling rules suggested by energy considerations and some empirical data from NASA and Lockheed measurements. It is very rough and applicable only on approach, but usually is not the major part of the noise contribution.

Example Computations (DC-10)

Take-off:

```

Base = 101 PNdb, 25,000 lb thrust, 1 engine, 1000ft
      + 4.8 for 3 engines
      + 1.9 for 40,000 lb SLS thrust engines
      - 4.0 for 1500 ft altitude at 6500m from start of take-off
      - 4.0 correction to EPNdb on take-off
  
```

 Total: 99.7 EPNdb (Flight measurement shows 98 db)

Sideline:

Base = 101 PNdb, 25,000 lb thrust, 1 engine, 1000ft
+ 4.8 for 3 engines
+ 1.9 for 40,000 lb SLS thrust engines
- 6.5 for 1476 ft (450m) from centerline (effective distance = $1476 * 1.25 = 1845$ ft)
- 4.0 correction to EPNdb on take-off

Total: 97.2 EPNdb (Flight measurement shows 96 db)

Approach:

Base = 101 PNdb, 25,000 lb thrust, 1 engine, 1000ft
+ 4.8 for 3 engines
+ 1.9 for 40,000 lb SLS thrust engines
+ 9.1 for 370 ft altitude at 6562 ft (2000m) from runway
- 7.0 correction for 45% throttle
- 5.0 correction to EPNdb on approach
Engine subtotal: 104.8 db
Airframe: 94.8 db at a landing weight of 300,000 lbs

Total (add I's): 105.2 EPNdb (Flight measurement shows 106 db)

Operating Costs (based on a summary by R.S. Shevell)

The figure of merit used to evaluate competitive airplane designs is always based on a cost-benefit analysis. The minimum cost per unit of work performed must be the criterion, here the work is performed equally well by the competing designs. If one design excels in some aspect of its performance, i.e., goes faster, lands in a shorter field, makes less noise, provides more comfort, then a higher cost per unit of work *may* be justified. How much higher cost can be justified is always a difficult question and often involves a broader economic study of the system, e.g., costs of longer runways, or psycho-logical and semi-economic judgments such as the value of a wider seat or greater speed. Even military aircraft can be judged on a cost effectiveness basis such as the total cost of delivering X troops to a location Y miles away.

The usual method of comparing the cost effectiveness of commercial aircraft is the direct operating cost, D.O.C.. Equations for estimating the comparative direct operating costs have been generated by the Air Transportation Association of America, ATA. First developed in 1944 from a paper published by Mentzer and Nourse of United Air Lines in 1940, these equations have been periodically revised in form and constants by the ATA to match current statistical cost data. The most recent issue was published in 1967 and is attached to these notes.

Direct operating costs can be expressed in terms of \$/hour, \$/mile, ¢/seat-mile or for cargo aircraft, ¢/ton-mile. Costs in terms of \$/mile indicate the maximum loss to an operator with an empty airplane, while costs per unit productivity such as ¢/seat-mile, or ¢/ton-mile are indicative of the fare that must be charged with reasonable load factors. Current practice usually bases costs on nautical miles although some people still like statute miles. It makes the D.O.C. look smaller. Figure 1 shows how aircraft DOC has changed with time in constant \$ terms, illustrating the remarkable reduction in cost during the history of commercial flight.

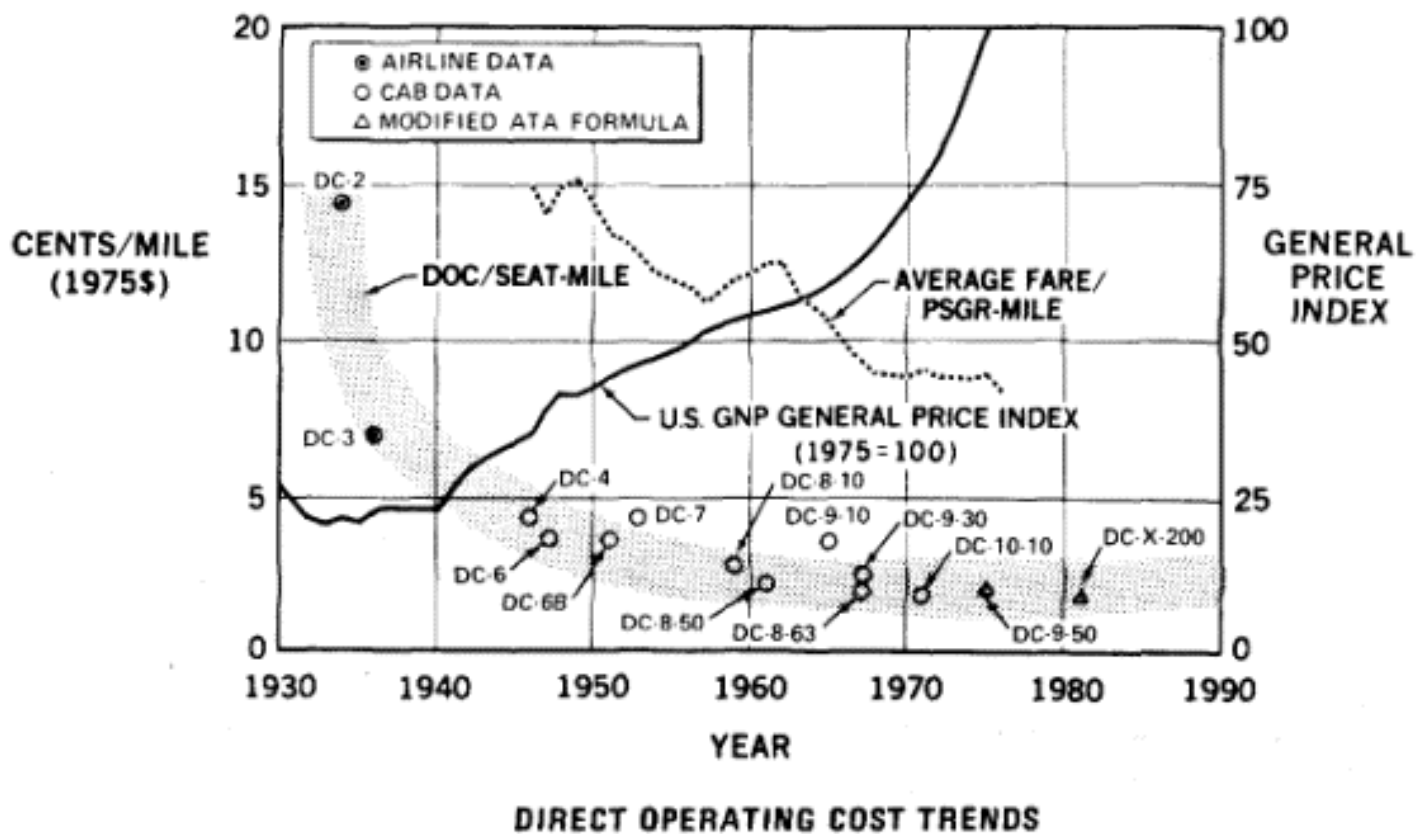

Figure 1.

Direct operating costs are extremely useful for comparative analysis. Since the actual cost varies with accounting practice and with every change in fuel costs, labor contracts or parts price, obviously a perfectly precise D.O.C. method would have constants that changed with route, airline, and the time of day. The ATA method is based on the average of many airlines and can be expected to give a reasonable estimate of the average D.O.C. for the time period on which the statistical studies were based. Constants such as fuel cost per gallon and labor rate per hour can be adjusted for later periods or special circumstances. Regardless of the accuracy of the D.O.C. value, however, the equations can be expected to give a good comparison between different airplanes designed to the same state of the art. Figures 2 and 3 show how the price of gasoline and the average consumer price index have changed over the last many years as well.

California Regular Unleaded Gasoline
Price per Gallon 1970 to 1999

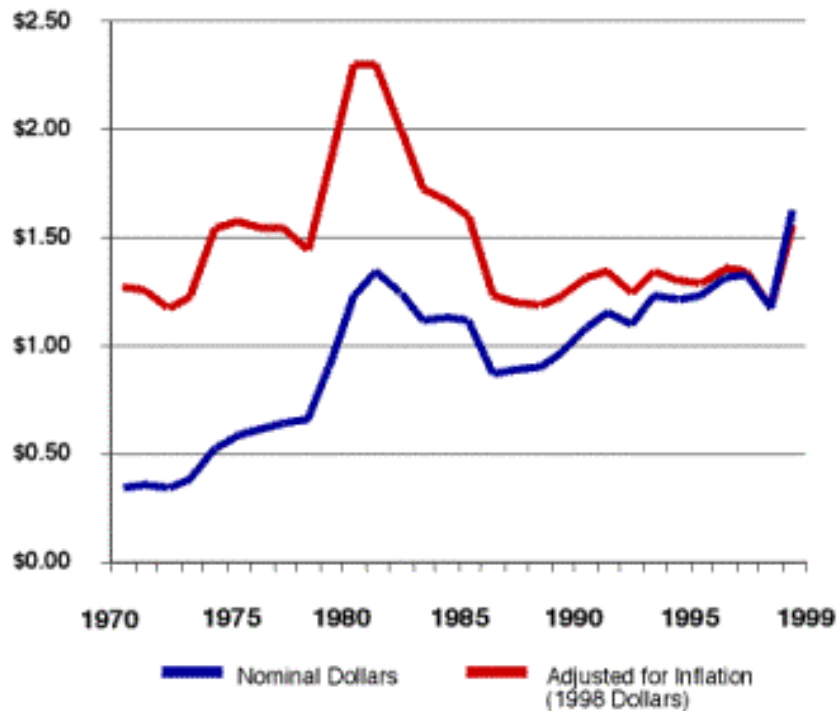

Figure 2.

Urban Consumer Index, US City Avg.

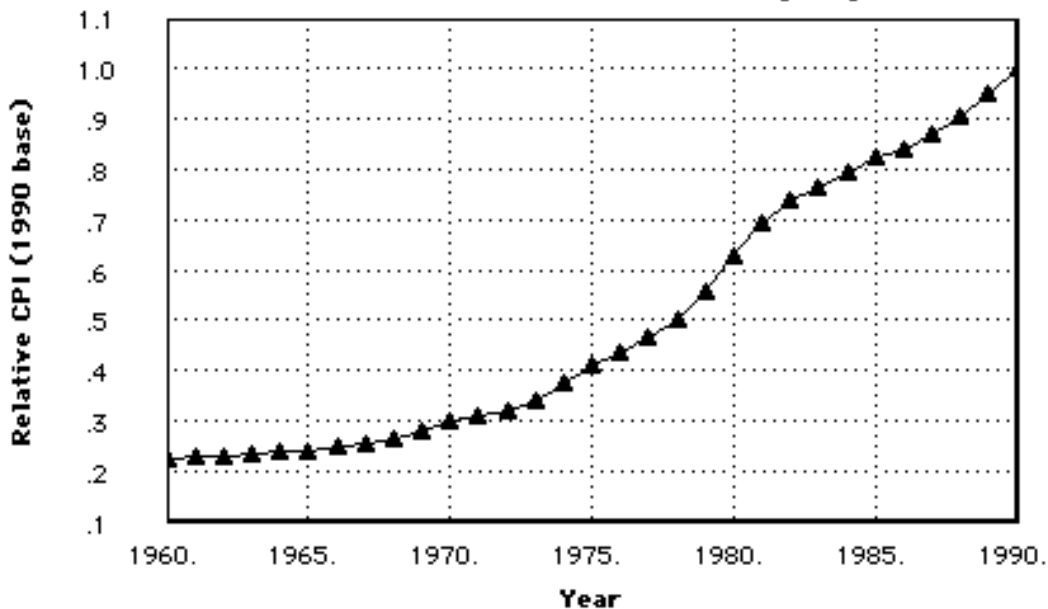

Figure 3.

The most intangible terms in the ATA equations are the maintenance quantities, specifically the labor man-hours per flight hour and per flight cycle for airframe and engines. The ATA values are based on experience but a new design can be better or worse than that experience. Because of the importance of these costs, a major

engineering effort is applied to detail design to optimize accessibility, easy replacement, and selection of reliable components.

If a new design shows genuine improvement in maintenance characteristics, the maintenance costs may be estimated separately. Sound justification for the reduction in such costs from previous models – which presumably match the statistical equations – must be presented or the lowered costs estimates will have an impact limited to the consumption of ink on the pages of a 4-color brochure.

Examples of justified modification of the ATA equations by aircraft manufacturers are

- 1) Maximum engine parts replacement cost per hour is guaranteed by the engine manufacturer. Then this value may be safely used in lieu of the equation.
- 2) The design uses significantly lower numbers of components than previous designs, e.g., fewer actuators, fewer valves, fewer switches – and the components selected have proven records of reliability.

Although aircraft manufacturers usually use the ATA equations, or slight modifications thereof, to make cost comparisons, airlines almost always generate their own equations based on each airline's individual cost experience. In spite of the differences that inevitably arise in these cost studies, the percentage each major cost item bears to the total cost is quite similar.

Figure 4 illustrates the relative importance of crew, maintenance, depreciation, insurance, and fuel costs by several methods for various airplanes. The method labeled "1966 ATA" was a preliminary and somewhat different form of the method issued in December, 1967. The data shown used engine manufacturer's material guarantees. The 1967 ATA data shown have DC-10 and 747 maintenance costs reduced by approximately 20% due to design improvements. The European airline data use the airline's own methods, the details of which are unknown. In spite of the diverse approaches, crew costs vary from 22% of the total at 100,000 lb take-off weight to 11% at 700,000 lb. ($\pm \sim 1\%$), maintenance costs are about 27% of the total ($\pm \sim 4\%$), depreciation varies from 22% for the small aircraft to 32% at 700,000 lb ($\pm 2\%$), insurance is 6.5% ($\pm 1\%$), and fuel is about 22% of the cost ($\pm 2\%$) with the

higher overseas fuel cost showing up in the European airline data.

CREW

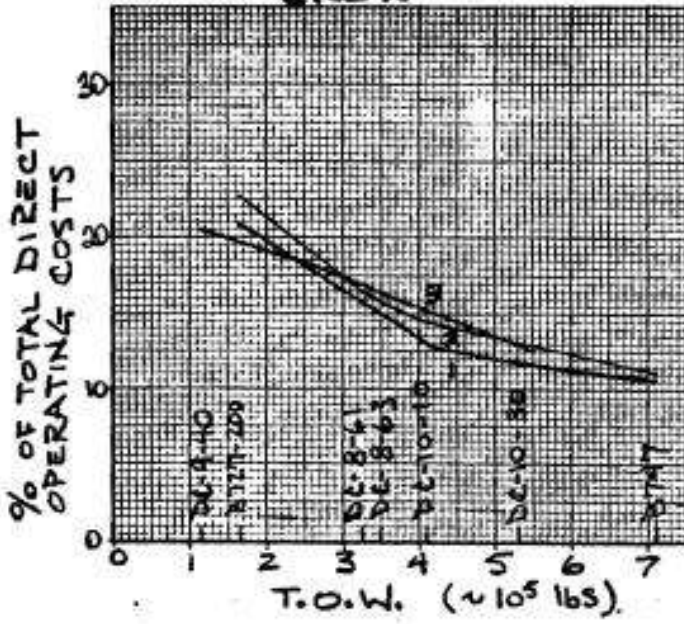

INSURANCE

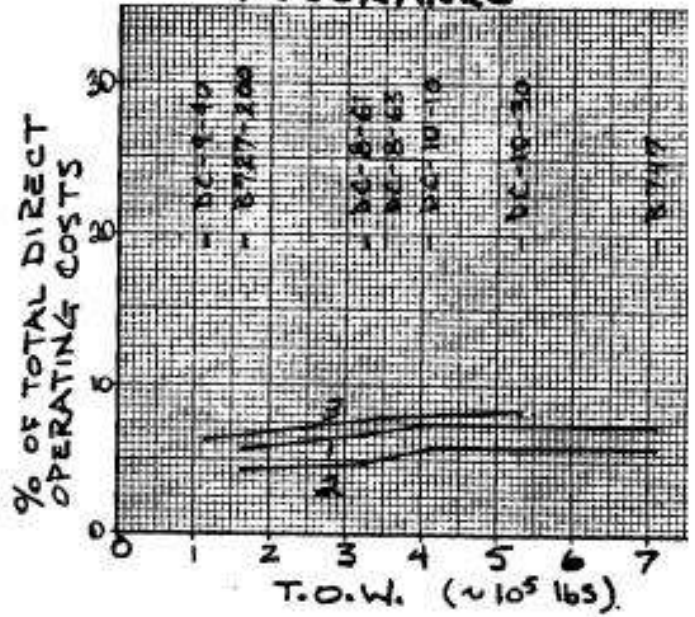

DEPRECIATION

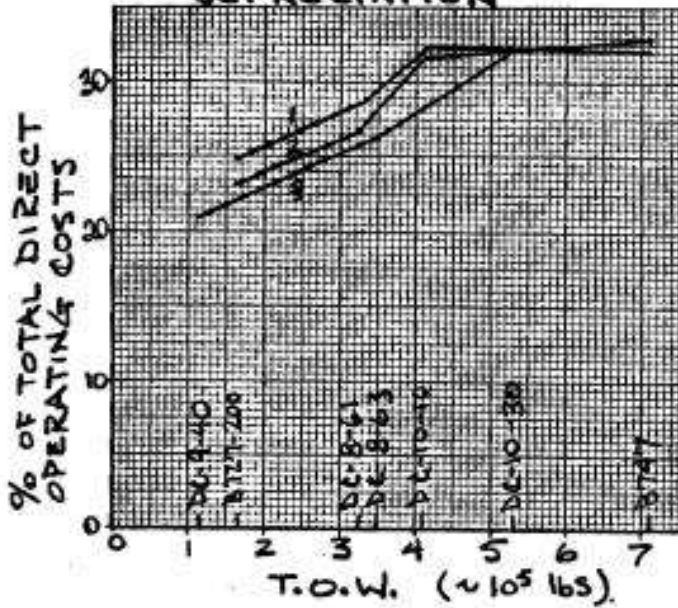

FUEL

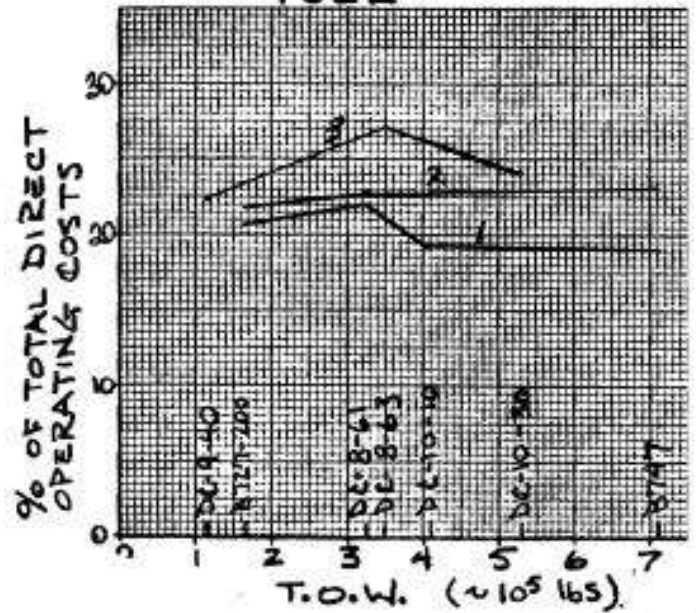

Figure 4.

DATA SOURCE & METHOD

1. Based on 1966 ATA equations except engine manufacturers material guarantee
2. 1967 ATA cost method except DC-IC maintenance costs based on new Douglas estimates. 747 given equal % advantage over ATA
3. Major European airline, internally generated method

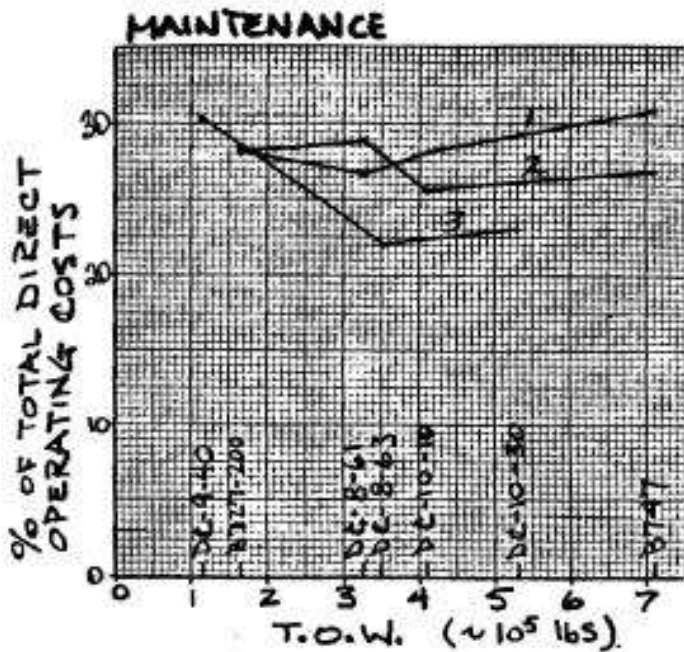

Figure 5 shows the primary parameters affecting D.O.C. as determined from analyzing the 1967 ATA equations. Relatively few variables are involved and it may be seen that many of these are interrelated. For example 'no. total engines' is used to obtain either total thrust of all engines, or total engine cost -- which is itself, a rough

function of total thrust. As shown in Figure 3, the cost per engine is a non-linear function of engine thrust so that 4 small engines cost more than 2 engines with the same total thrust. When aircraft being compared have the same number of engines this problem is eliminated.

PRIMARY AIRPLANE PARAMETERS AFFECTING DIRECT OPERATING COSTS

Primary Airplane Parameters

Cost Item (\$/mile)	Block Speed	Take-off Weight	Airframe Weight	Total Cost	Airframe Cost	No. of Engines	Thrust Per Engine	Cost Per Engine	Fuel Burned (lb/trip)
Crew Cost		X	X						
Maintenance									
Airframe		X		X		X			
Engine		X					X	X	X
Depreciation (1)	X			X		X		X	
Insurance (2)		X			X				
Fuel									X

- (1) Utilization and depreciation period also play an important role here.
- (2) Utilization is important in insurance cost.

FIGURE 5.

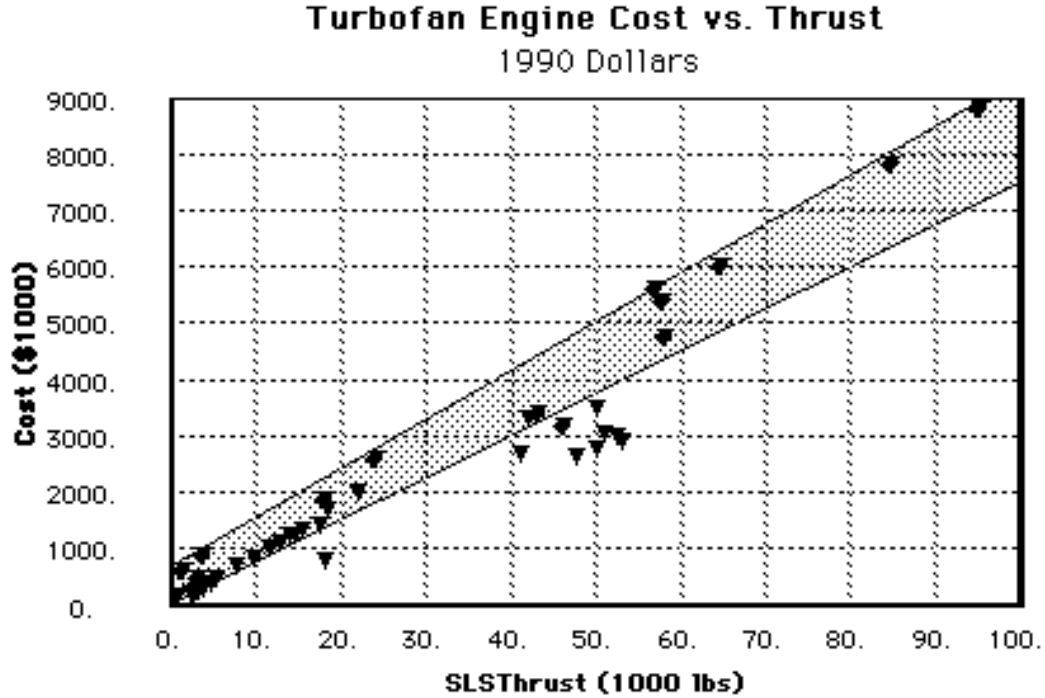

Figure 6.

Airframe cost is directly dependent upon airframe weight, for equal ‘state of the art’ cases, and total cost is the sum of airframe cost and engine cost. Take-off weight is the sum of payload (assumed the same for all designs being compared) engine weight, airframe weight and fuel. Thus DOC. depends upon total thrust, airframe weight and fuel burned, and since these three items are the variables in take-off weight, a minimum take-off weight is a good ‘first’ guess criterion for minimum D.O.C.. Of course, the effect on D.O.C. of the interplay between smaller engines and larger airframe (wing area), or vice versa, to achieve the same mission at a given take-off weight cannot be seen without a detailed D.O.C. study. With a given set of engines, the least take-off weight will be very close to the minimum D.O.C., and even with variable engine configurations, a minimum take-off weight selection will usually come close to the most efficient configuration selection. For modern turbine powered transport aircraft, an estimate of airframe cost at \$500 per pound of airframe weight is reasonable.

The exact impact of changes in individual airplane parameters on direct operating cost depends, of course, on the base case with which we start the analysis. The order of magnitude of the D.O.C. sensitivity factors is usually quite similar for different aircraft, however, so a good impression of the effect of design changes on D.O.C. can be obtained from the following table (Fig. 7) developed for the DC-10-10 trijet.

DIRECT OPERATING COST SENSITIVITY FACTORS
(Based on DC-10-10, 1967 ATA Method)

	10%. INCREASE IN:	% CHANGE IN
DOC	Airplane Total Cost (<i>I</i>)	5.0
	Airframe Cost	3.8
	Engine Cost	
1.1	Airframe Weight 0.9	
	Block Fuel	2.0
	Utilization	-3.2
	Flight Time	7.3
	Insurance Rate	0.7
	Depreciation Period	-2.9
	Engine Thrust	0.4

(1) Both airframe and engine costs increased 10%.

Figure 7.

Figure 7 is based on pre-1973 fuel costs so that an updated set of sensitivity factors would show a higher % change in DOC due to 10% increase in fuel cost and a lower effect on DOC of other variables. In 1977 the fuel % change in DOC would be about 3.2 to 3.7 instead of 2.0.

Although direct operating cost as defined in the usual ATA derived method does not including landing fees, landing fees are an airplane related cost. Figure 5 shows a breakdown of direct operating costs in percentages for a proposed future airplane. The relative costs are shown for several fuel prices. The basic chart includes landing fees and shows them to be 11 to 12% of total direct costs. The figures in parentheses give the data for the usual direct costs without landing fees. For fuel prices ranging from 15¢/gal to 60¢/gal the percentage of DOC attributable to fuel varies from 23% to 54%.

	FUEL PRICE			
	15¢/GAL	30¢/GAL	45¢/GAL	60¢/GAL
Fuel	20%	33%	43%	50%
Depreciation	26%	22%	19%	17%
Insurance	7%	6%	5%	4%
Cockpit Crew	15%	12%	11%	9%
Maintenance	19%	16%	13%	12%
Landing Fees	13%	11%	9%	8%
	-----	-----	-----	-----
	100%	100%	100%	100%

NOTE: BASED ON DC-10 TWIN 500 N Mi RANGE

Figure 8.

It is common to estimate aircraft manufacturing cost in terms of \$ /lb. of airframe weight empty plus the engine cost. Actually each portion of the airframe has a different cost per pound. The table in Figure 9 shows the distribution of airplane costs between basic structure and the various aircraft systems as percentages of total

airplane cost for a modern transport.

Basic Structure (Wing, Fuselage, Tail)	41.5%
Propulsion System including Engines	17.1%
Furnishings including Lighting	14.5%
Avionics (Communication and Navigation)	12.7%
Flight Control and Guidance Systems	5.3%
AC Power System	2.4%
Hydraulic and Auxiliary Power Systems	2.1%
Air Conditioning and Pressurization	1.9%
Landing Gear, Wheels, Tires, Brakes	1.7%
Miscellaneous Systems and Components	0.8%

Figure 9. Distribution of Airplane Manufacturing Costs

Direct Operating Costs are usually presented as curves of \$/n. mile vs. range, and ¢/seat/mile vs. range, as shown in Fig. 10 for the DC-8 series 60 family. The break points in the ¢/seat-n. mile curves are the maximum ranges for which the full passenger capacity can be carried.

DIRECT OPERATING COSTS
Passenger Models / 1967 ATA Method

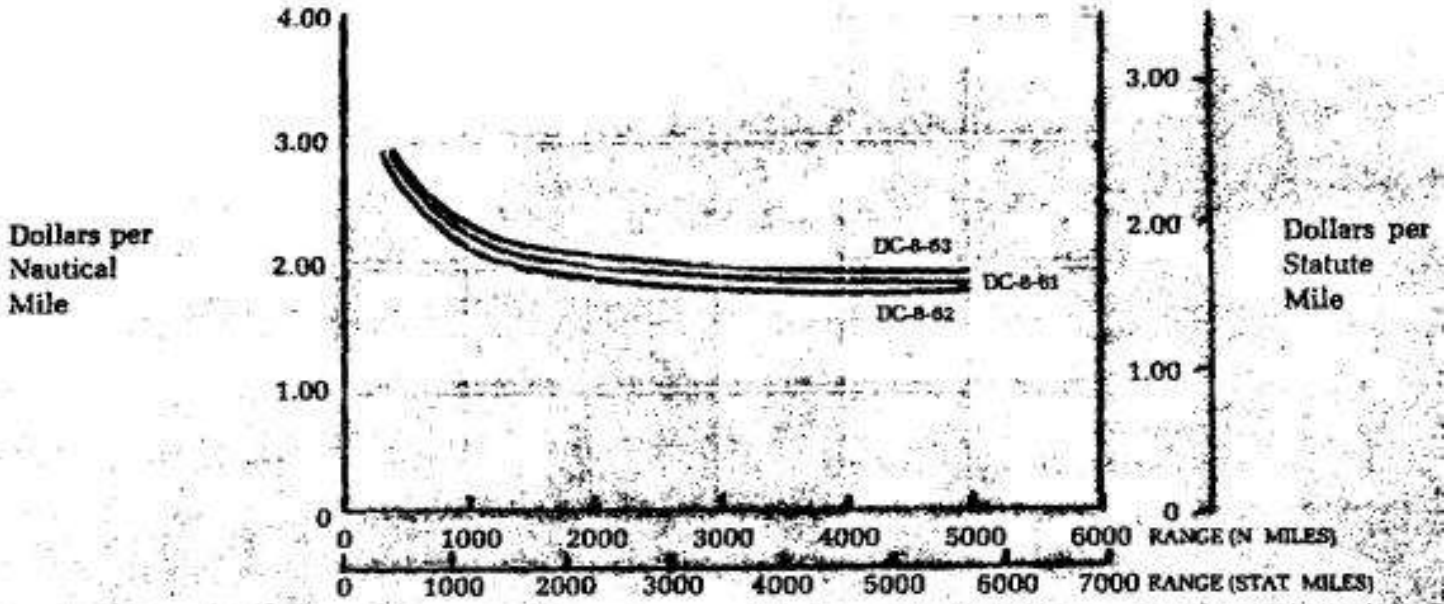

DIRECT OPERATING COSTS
Passenger Models / 1967 ATA Method

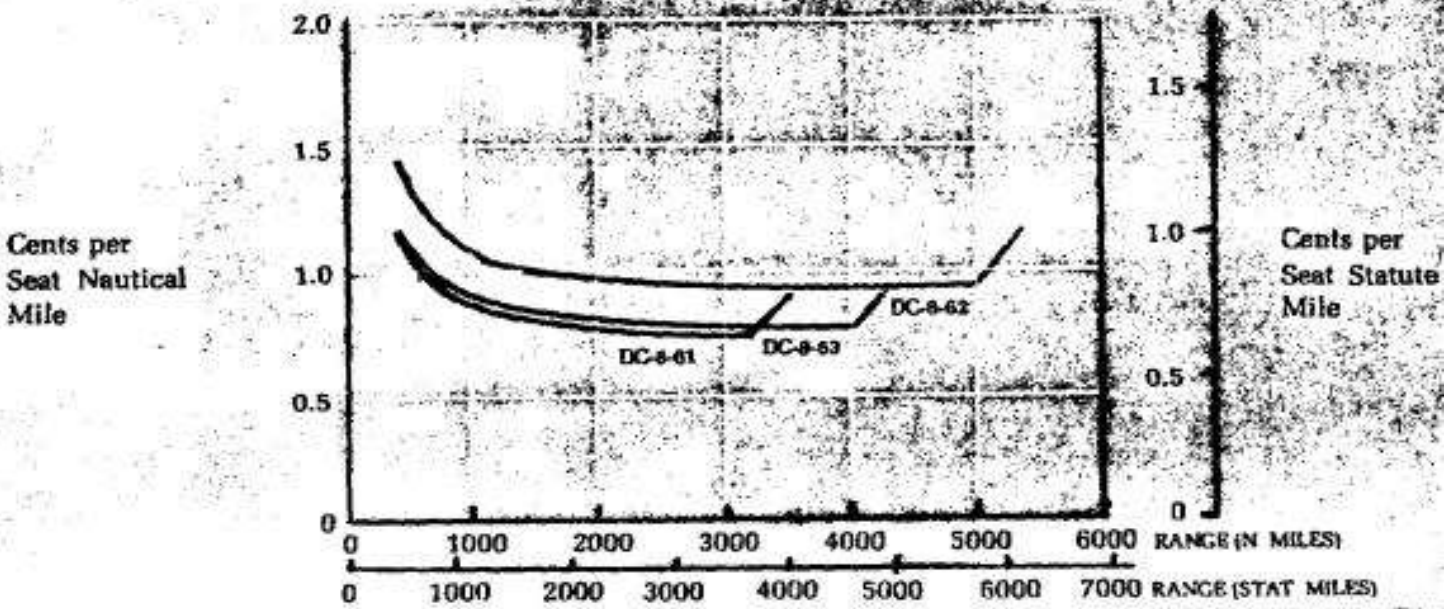

Figure 10.

Another example is shown in Fig. 11 where the \$/stat-mile is plotted for very different sized aircraft. The DC-10 shown is the domestic version, the DC-10-10. The corresponding ¢/seat stat-mile is shown in the table of Fig. 12. Although the DC-10-10 and B747 benefit in ¢/seat-mile from technology improvement, a significant part of the gain comes from larger size. This is emphasized in the \$/mile data. In the comparison between the DC-10 and the B747, the B747 fails to gain in seat-mile cost

even though it is much larger. This is partly because the improvement due to size flattens out between 300 and 400 passengers and partly because the B747 carries extra wing area and structure capable of much greater range than the DC-10-10. The overwater DC-10-30 with a range comparable to the B747 would show about the same ¢/seat-mile as the B-747. Figures 13 and 14 show similar results based on more recent data.

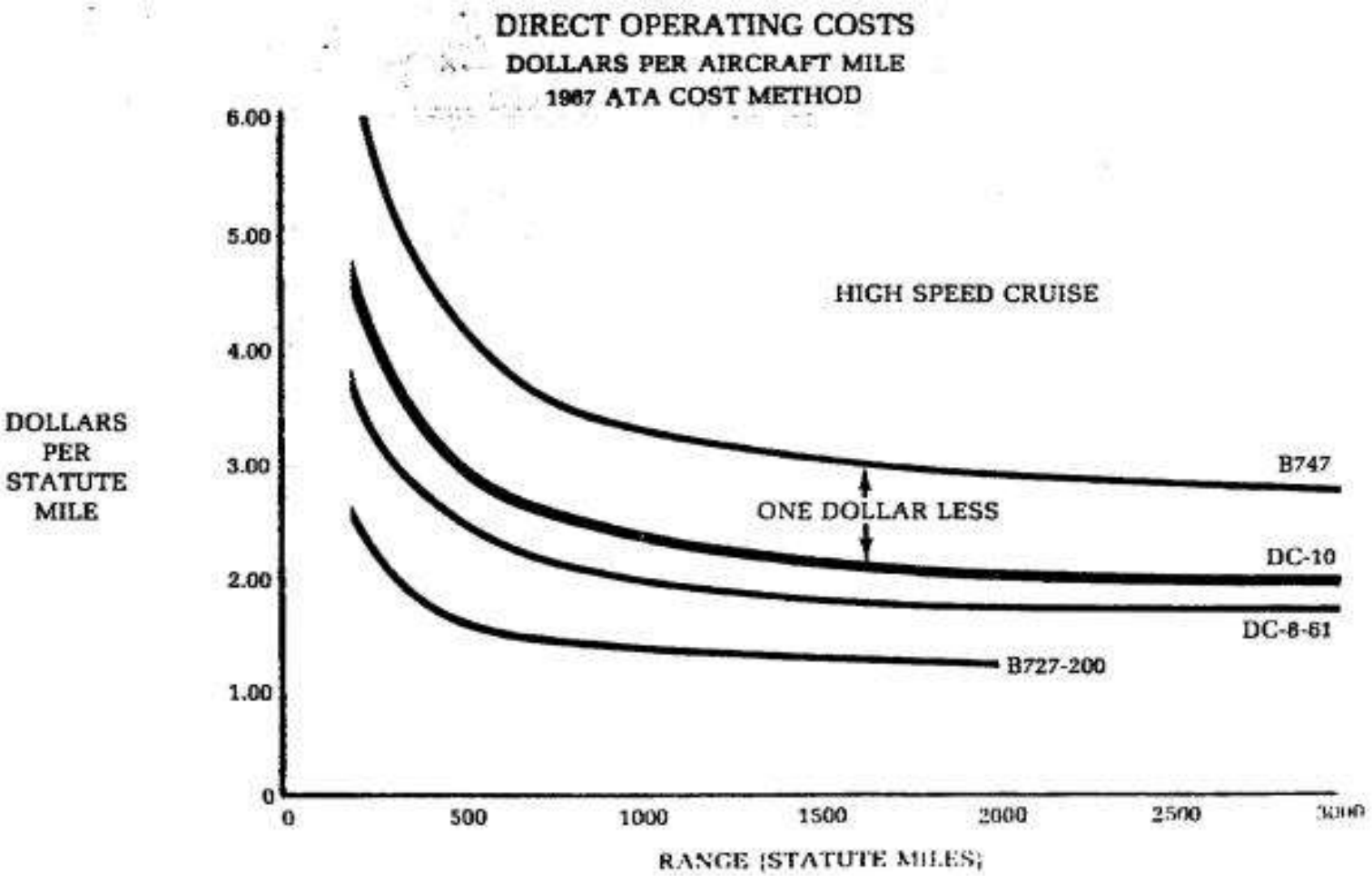

Figure 11.

Direct Operating Cost Comparison
In Year 2000 \$

Airplane (passengers)	DOC (ct/seat n.mi)	\$/n.mi.
MD-81 at 500 n.mi.	6.15	8.79
MD-11 at 3000 n.mi.	5.81	17.03
747-400 at 3000 n.mi.	5.43	22.58

Figure 12.

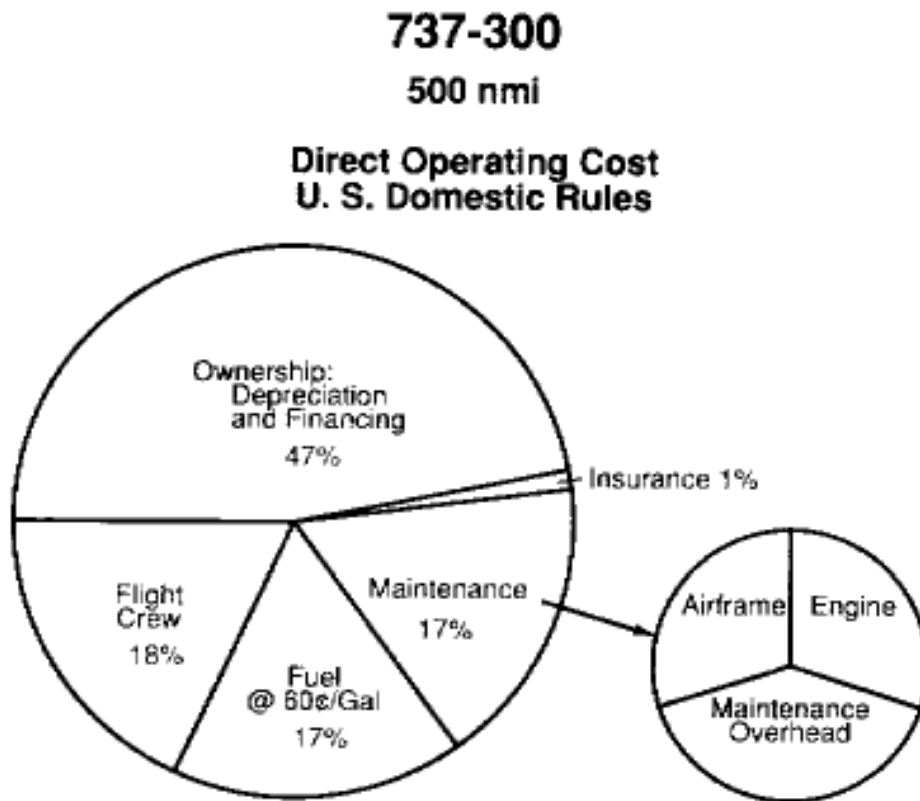

Figure 13.

737-300 Trip Cost

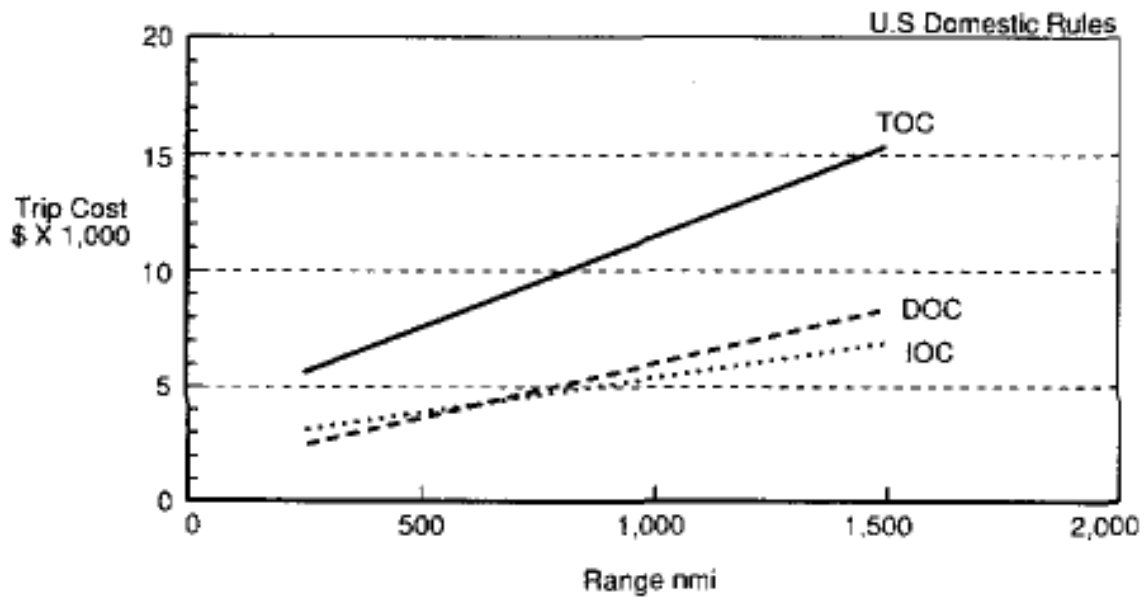

Figure 14.

INDIRECT OPERATING COSTS

Indirect operating costs (IOC) are those airline costs not directly connected with the actual flight of the aircraft. Indirect costs are just as real as other costs, but they are sometimes more difficult to separate and define. Indirect costs include the following:

- Aircraft Ground Handling
- Landing Fees
- Aircraft Service
- Cabin Attendants
- Food and Beverage
- Passenger Handling
- Reservations and Sales
- Baggage/Cargo handling
- Passenger Commissions
- Passenger Advertising
- Cargo Commission
- General and Administration

These costs are generally independent of the type of airplane, and thus are classified as indirect items. The actual value of each of these can only be estimated from statistics. A method of estimating the various factors has been developed by an Aircraft Industries Association Committee. Each term is based on maximum take-off weight, passenger capacity, enplaned passengers, or cargo carried, whichever is relevant to the particular term. For example the “Cabin Attendants” term is based on passenger capacity, while food and beverage, passenger handling, reservation, sales, commission and advertising are based on enplaned passengers. Since enplaned passengers enter into the equations, load factor influences the indirect costs.

Applying the IOC equations to the B-747, the DC-10, and a typical large twin engine airplane show very similar relationships between TOC and DOC for all three airplanes. The average of these relationships is shown in Fig.15 in the form of:

$$\frac{\text{TOTAL OPERATING COSTS (TOC)}}{\text{DIRECT OPERATING COSTS (DOC)}} = \frac{\text{IOC}}{\text{DOC}} + 1.0$$

TOC/DOC is shown to be a strong function of range, load factor and whether flights are domestic or international. TOC/DOC varies from about 1.7 for a domestic flight, 50% LF, and a range of 2200 nautical miles, to 2.1 for a domestic flight, 50% LF, and a range of 400 nautical miles. International flight values with 50% LF, vary from 1.9 at 4500 nautical miles to 2.5 at 1100 nautical miles.

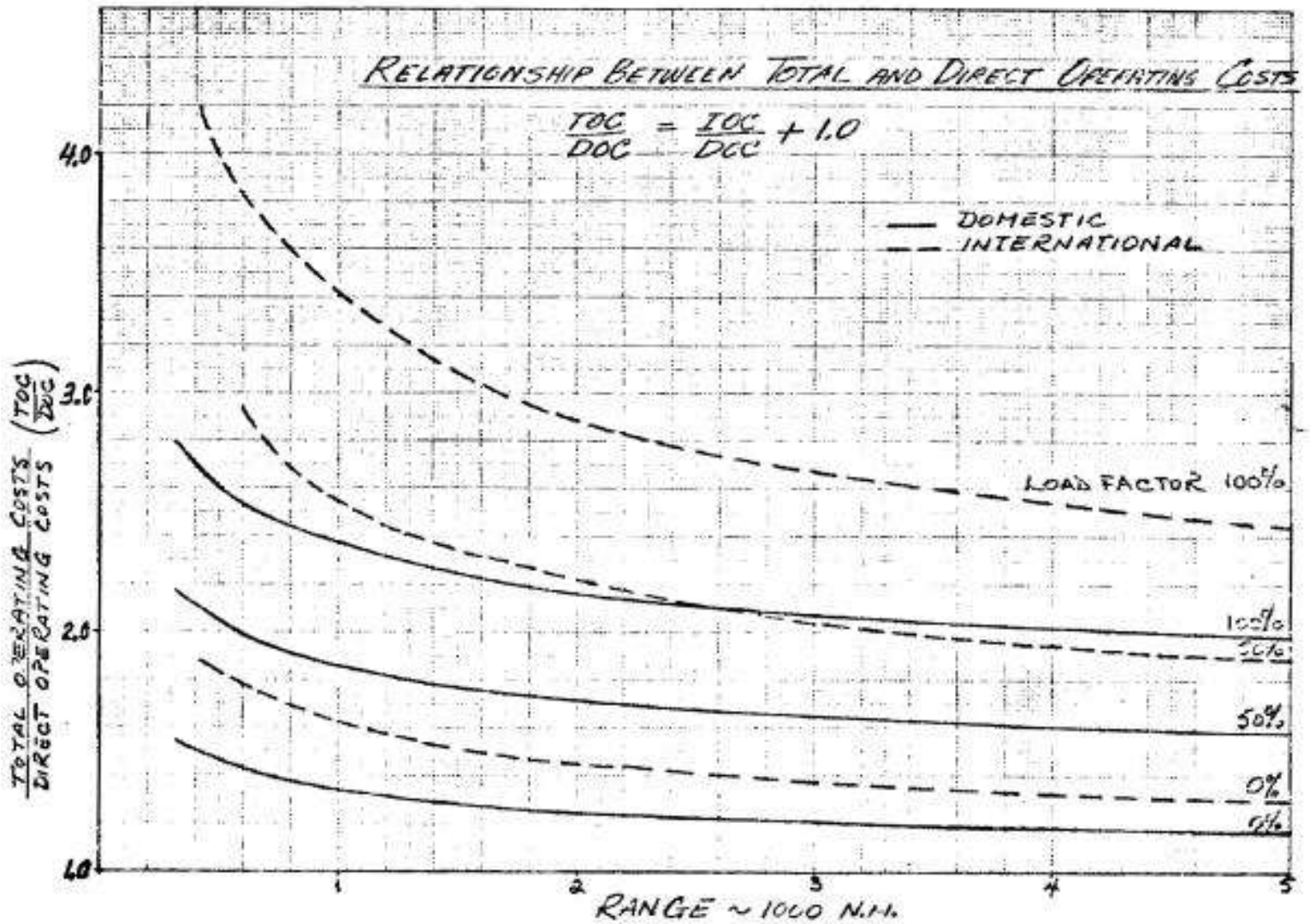

Figure 15.

The actual value of indirect costs may be estimated from an equation fitted to the results of the studies of the B-747, DC-10 and the large twin mentioned above. The equation agrees perfectly with the detailed method at 50% load factor and shows only a 1 to 2% difference at 100% load factor. The equation gives the indirect cost in \$/n. mile at a range of 1000 n. miles for domestic routes:

$$IOC_{1000 \text{ n.mi}} (\$/\text{n.mile}) = -.04 + .00129 W_g + .00119 N_p + .0127 N_p \text{ LF} \quad (\text{in 1968 } \$)$$

Where:

W_g = Maximum Take-off Weight (lb) / 1000

N_p = Passenger capacity

LF = Load factor

This equation is truly valid only for aircraft with cruise Mach numbers of about 0.85. However, speed differences of 10 to 20% will affect the IOC by only 2 to 4%. Higher block speeds reduce the IOC.

For other ranges the IOC is corrected by using the ratio of $IOC(\$/n.mi) / IOC_{1000nm}$ ($\$/n.mi$) from Figure 16. The latter is derived from the same data as Fig.15.

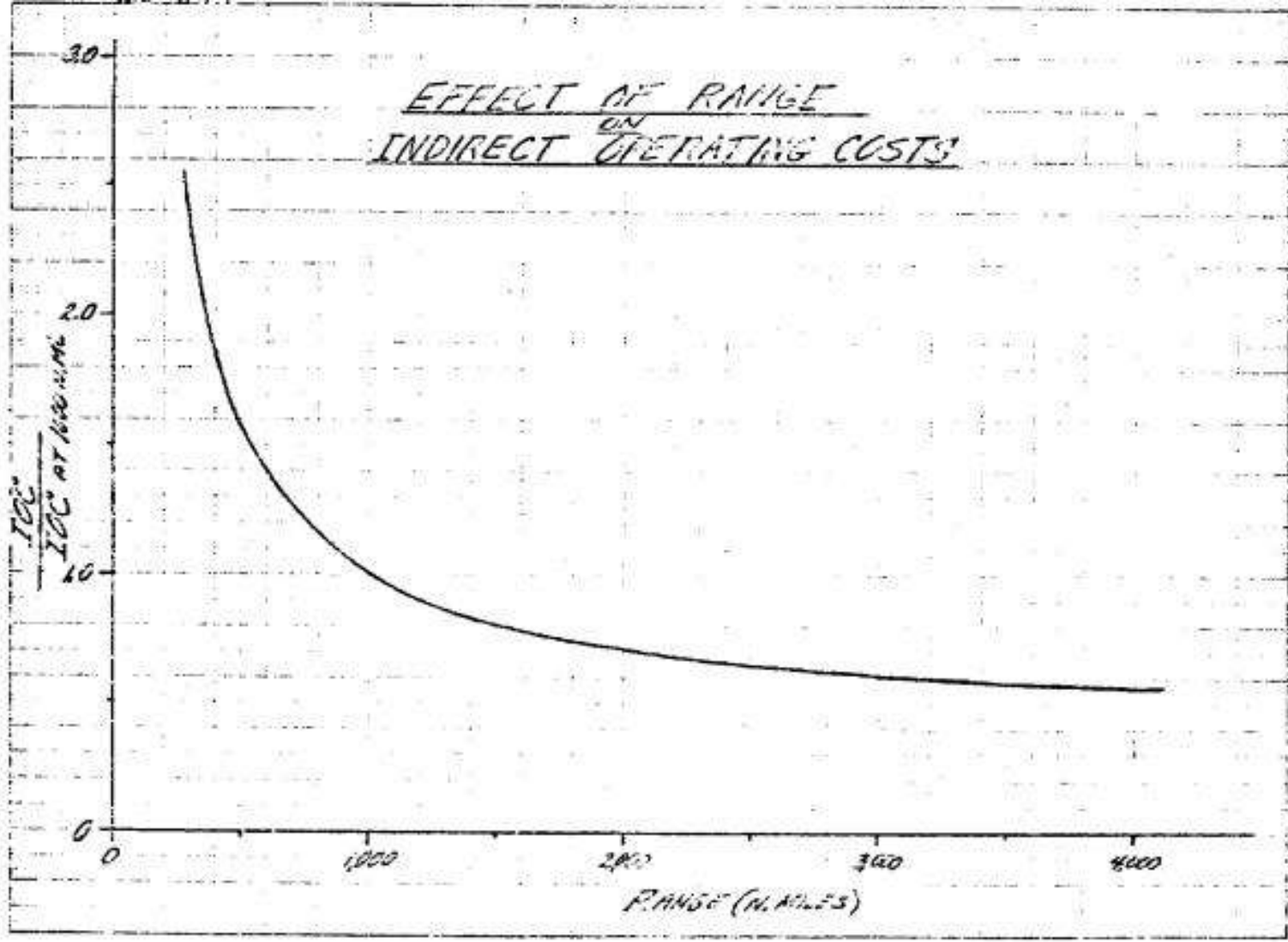

Figure 16.

Breakeven Load Factor

To break even at distance, d , with a yield of $\$y$ /passenger-mile, the revenue must equal the sum of the direct and indirect costs:

$$N * LF * d * y = DOC * N * d + N * LF * (\$/pass)_{\text{indirect}}$$

where DOC and $(\$/pass)_{\text{indirect}}$ are taken at distance, d ; N = number of pass. seats. LF is the breakeven load factor. Substituting:

$$LF_{\text{breakeven}} = d \text{ DOC} / [y d - (\$/pass)_{\text{indirect}}]$$

Total operating costs may be used in a complete airline system analysis in which each city-pair is studied to determine total traffic, required schedule frequency, load factors, total income, total costs and profit. Simpler presentations of the effect of costs may be shown in the form of passenger load required to pay the DOC as shown for the B707-320B and the B747 in Figure 17. Another type of analysis determines the break-even load factor, the load factor required to cover the total costs. Figure 18 shows this type of analysis for the DC-10, B747, DC-8-62, and the B727-200. All three of these economic analyses require establishing not only operating costs but also the yield, the average passenger fare per mile. The yield varies greatly with route and is generally different from the basic fare as airlines now determine fares based on the day of the week, when the ticket is purchased or whether the traveler will stray over a Saturday night.

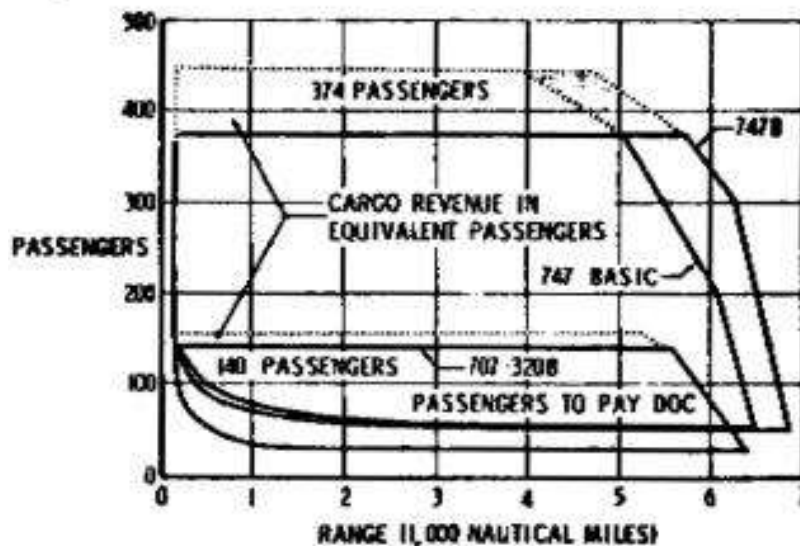
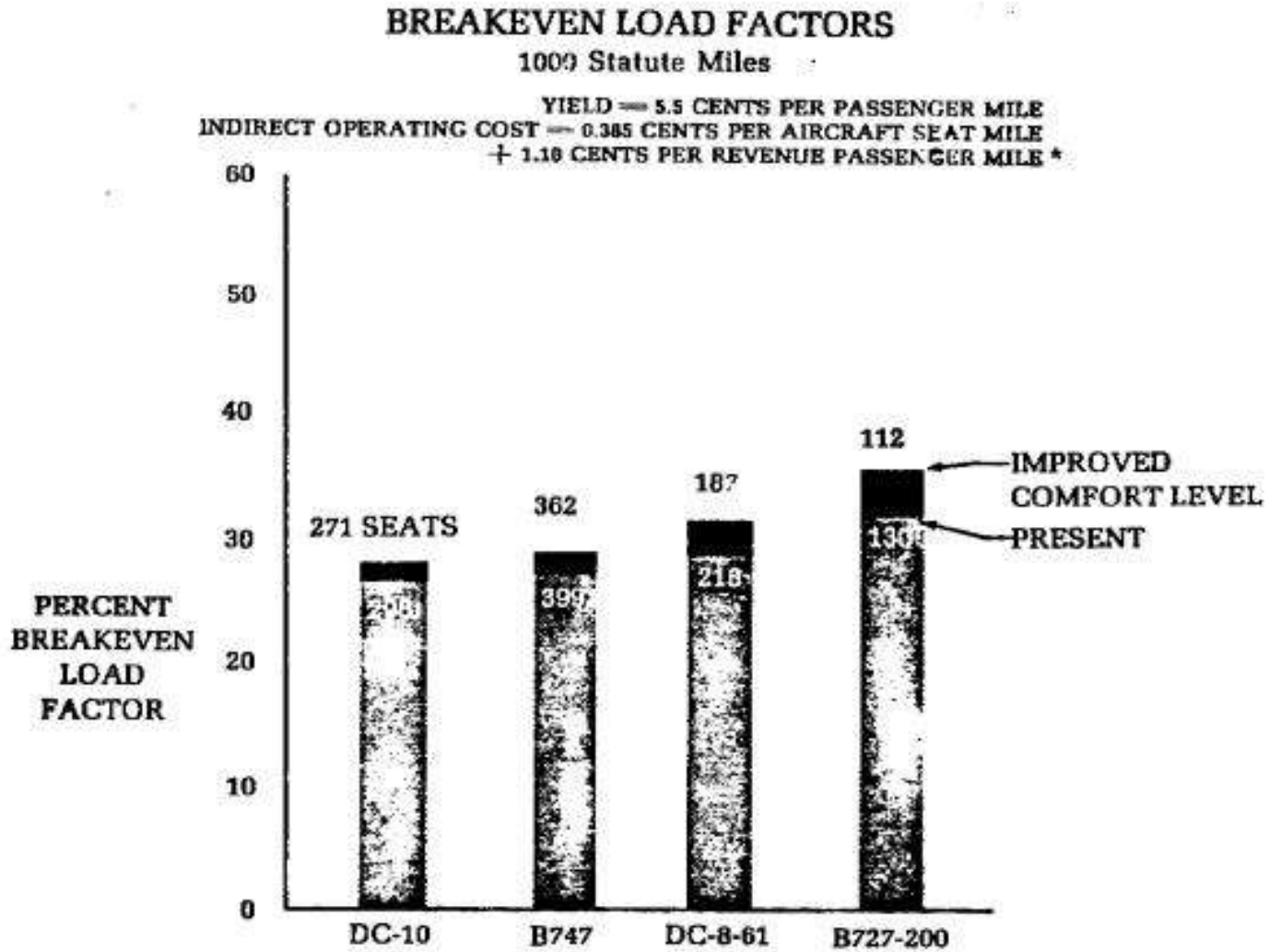

Figure 17.



*This formula reflects the average results at 1000 statute miles of four major U.S. domestic trunk carriers

Figure 18.

AIR TRANSPORT ASSOCIATION *of America*

**STANDARD METHOD OF ESTIMATING COMPARATIVE
DIRECT OPERATING COSTS OF
TURBINE POWERED TRANSPORT AIRPLANES**

December 1967

PREAMBLE

The following data represents a modification to the 1960 revision of the Air Transport Association Standard Method of Estimating Comparative Direct Operating Costs of Transport Airplanes.

Since it is doubtful that new transport airplanes will be powered by reciprocating engines and the overwhelming majority of the passenger miles are now being flown with turbine powered airplanes, this revision is confined to the turbine powered airplanes. It is considered that, with proper adjustment to the crew costs and the maintenance labor rates to account for the changing economic situation from 1960 to 1967, the 1960 revision is still valid for airplanes powered by reciprocating engines.

In addition to new methods of determining costs and new values for many of the basic parameters, the formula has been extrapolated to include the Supersonic Transport. The formula is not considered to be applicable to rotary wing or V/STOL aircraft.

PREFACE

The first universally recognized method for estimating direct operating costs of airplanes was published by the Air Transport Association of America in 1944. The method was developed from a paper, "Some Economic Aspects of Transport Airplanes," presented by Messrs. Mentzer and Nourse of United Air Lines, which appeared in the Journal of Aeronautical Sciences in April and May of 1940. The basis of this method was taken from statistical data obtained from airline operation of DC-S airplanes and was extrapolated to encompass the direct operating costs of larger airplanes which were then coming into the air transport picture.

In 1948 it was determined that the 1944 method of estimating direct operating costs fell short of its goal due to rising costs of labor, material, crew, and fuel and oil. Consequently, the Air Transport Association reviewed the statistical data which were then available, including four-engined as well as twin-engined airplane data, and in July 1949 published a revision to the 1944 method.

The ATA method was again revised in 1955 for the same reasons as above and also to introduce the turboprop and turbojet airplanes. The 1960 revision revised the predictions on turbine powered airplanes based on experience gained to that date.

The formula has again been revised to bring it up to date and an effort has been made to make it easier to use, yet at the same time more meaningful to its basic purpose – comparing airplanes. The formula has been extrapolated to include the Supersonic Transport.

This revision has been prepared with the assistance of an ATA working group consisting of representatives of the ATA member airlines and prime airframe and engine manufacturers. The assistance of this group is gratefully acknowledged.

INTRODUCTION

The objectives of a standardized method for the estimation of operating costs of an airplane are to provide a ready means for comparing the operating economics of competitive airplanes under a standard set of conditions, and to assist an airline operator and airplane manufacturer in assessing the economic suitability of an airplane for operation on a given route.

Any system evolved for these purposes must essentially be general in scope, and for simplicity will preferably employ standard formulae into which the values appropriate to the airplane under study are substituted. Clearly these formulae, seeking to give mathematical precision to complex economic problems, by their very nature can never attain this aim completely, but it can be closely approached by ensuring that the method quotes realistic universal averages.

Data derived from this report is intended to forecast a more or less airplane "lifetime average" cost and cannot necessarily be compared directly to actual cost data for an individual airline. These individual airline costs are dependent upon many things which the formula does not take into account. These would include, but not be limited to, fleet size, route structure, accounting procedures, etc. Particular care must be taken in comparing airline short term operating cost statistics to data derived from this report. Airline maintenance scheduling is such that heavy maintenance costs (overhaul) may not be included for a particular fleet during a short term period such as one year. In comparing data derived from this formula with actual reported data it should be noted that some carriers may capitalize certain costs. The capitalized cost would then be reported in depreciation or amortization cost figures. The formula is further based on the assumption that the carrier does its own work. Actual reported data may include work by outside agencies.

These formulae are designed to provide a basis of comparison between differing types of airplanes and should not be considered a reliable assessment of actual true value of the operating costs experienced on a given airplane. Where data are lacking, the user of this method should resort to the best information obtainable.

Operating costs fall into two categories – Direct and Indirect Cost, the latter dependent upon the particular service the operator is offering although in certain particulars, the Indirect Costs may also be dependent upon and be related to the airplane's characteristics. This method deals with only the direct operating costs with one exception. As maintenance burden is required to be reported to CAB as a Direct Cost, it is included in this formula. For data relating to estimation of Indirect Cost the following reference is provided:

"A Standard Method for Estimating Airline Indirect Operating Expense" Report (to be) published jointly by Boeing, Douglas and Lockheed.

DIRECT OPERATING COST EQUATION

The following pages present the detailed Direct Operating Cost Equation. The costs are calculated as a cost per airplane statute mile (Cam); however, can be converted as follows:

$$\text{Block Hour Cost} = \text{Cost/Mile} * V_b = \text{Cam} * V_b$$

$$\text{Flight Hour Cost} = \text{Cost/Mile} * V_b * t_b / t_f = \text{Cam} * V_b * t_b / t_f$$

Where
t_b = Block time (hours)
t_f = Flight time (hours)
V_b = Block speed (mi/hr)

BLOCK SPEED

For uniformity of computation of block speed, the following formula based upon a zero wind component shall be used:

$$V_b = D / (T_{gm} + T_{cl} + T_d + T_{cr} + T_{am})$$

Where

V_b = Block speed in mph

D = CAB trip distance in statute miles

T_{am} = Ground Maneuver time in hours including one minute for takeoff = .25 for all airplanes

T_{cl} = Time to climb including acceleration from takeoff speed to climb speed

T_d = Time to descend including deceleration to normal approach speed

T_{am} = Time for air maneuver shall be six minutes (No credit for distance) = .10 for all airplanes

T_{cr} = Time at cruise altitude (including traffic allowance)

$$= [(D + K_a + 20) - (D_c + D_d)] / V_{cr}$$

D_c = Distance to climb (statute miles) including distance to accelerate from takeoff speed to climb speed.

D_d = Distance to descend (statute miles) including distance to decelerate to normal approach speed.

V_{cr} = Average true airspeed in cruise (mph)

K_a = Airway distance increment $(7 + .015D)$ up to $D = 1400$ statute miles

= $.02D$ for D over 1400 statute miles

NOTES: 1. Climb and descent rates shall be such that 300 FPM cabin pressurization rate of change is not exceeded. In the transition from cruise to descent the cabin floor angle shall not change by more than 4 degrees nose down.

2. The true airspeed used should be the average speed attained during the cruising portion of the flight including the effect of step climbs, if used.

3. Zero wind and standard temperature shall be used for all performance.

RESERVE FUEL

Fuel reserve shall be the amount of fuel required to do the following: (These are in excess of minimum Federal Aviation Regulations and are representative of airline operational practices. This excess is not related to safety requirements).

Subsonic Airplanes

Domestic

- (1) Fly for 1:00 hour at normal cruise altitude at a fuel flow for end of cruise weight at the speed for 99% maximum range.
- (2) Exercise a missed approach and climbout at the destination airport, fly to and land at an alternate airport 200 nautical miles distant.

International

- (1) Fly for 10% of trip air time at normal cruise altitude at a fuel flow for end of cruise weight at the speed for 99% maximum range.
- (2) Exercise a missed approach and climbout at the destination airport, fly to an alternate airport 200 nautical miles distant.
- (3) Hold for :30 at alternate airport at 15,000 feet altitude.
- (4) Descend and land at alternate airport.

Supersonic Airplanes

Domestic and International

- (1) Fly 5% of trip air time at cruise altitude at supersonic cruise speed at a fuel flow for end of cruise weight.
- (2) Exercise a missed approach and climbout at the destination airport and fly to the alternate airport 200 nautical miles distant.
- (3) Hold :20 at 15,000 feet over the alternate airport.
- (4) Descend and land at the alternate airport.

Flight to Alternate Airport (All airplanes)

- (1) Power or thrust setting shall be 99% at maximum subsonic range.
- (2) Power setting for holding shall be for maximum endurance or the minimum speed for comfortable handling, whichever is greater.
- (3) Cruise altitude shall be the optimum for best range except that it shall not exceed the altitude where cruise distance equals climb plus descent distance.

BLOCK FUEL

Block fuel shall be computed from the following formula:

$$F_b = F_{gm} + F_{am} + F_{cl} + F_{cr} + F_d$$

Where F_b = Block fuel in lbs.

F_{gm} = Ground maneuver fuel based on fuel required to taxi at ground idle for the ground maneuver time of 14 minutes plus one minute at takeoff thrust or power.

F_{cl} = Fuel to climb to cruise altitude including that required for acceleration to climb speed.

F_{cr} = Fuel consumed at cruise altitude (including fuel consumed in 20 statute mile traffic allowance and allowance for airway distance increment K_a). Cruise altitude shall be optimum for minimum cost with the following limitations:

- (a) Cruise distance shall not be less than climb plus descent distance.
- (b) Cruise climb procedures shall not be used.
- (c) A maximum of two step-climbs may be used.

F_{am} = Six minutes at best cruise procedure consistent with airline practice (no credit for distance).

F_d = Fuel required to descend including deceleration to normal approach speed.

1. FLYING OPERATIONS

a. Flight Crew Costs (Figure 1)

These costs were derived from a review of several representative crew contracts. Based on this review, yearly rates of pay were arrived at which were used with welfare, training, travel expense, and crew utilization factors to produce the crew cost equations herein.

Domestic Subsonic Airplane with Two-man Crew

Turboprop

$$C_{am} = [.05 (TOGW_{max}/1000) + 63.0] / V_b$$

Turbojet

$$C_{am} = [.05 (TOGW_{max}/1000) + 100.0] / V_b$$

Domestic Subsonic Airplane with Three-man Crew

Turboprop

$$C_{am} = [.05 (TOGW_{max}/1000) + 98.0] / V_b$$

Turbojet

$$C_{am} = [.05 (TOGW_{max}/1000) + 135.0] / V_b$$

Domestic Supersonic Airplane with Three-man Crew

$$C_{am} = [.05 (TOGW_{max}/1000) + 180.0] / V_b$$

International Subsonic and Supersonic Airplane with Three-man Crew

Add 20.00 to term in brackets [] for domestic operation with three-man crew

Additional Crew Members (All Operations)

$$\text{Cam} = [35.00] / \text{Vb}$$

Where: TOGW_{max} = Maximum Certificated takeoff gross weight

b. Fuel and Oil –(Including 2% non-revenue flying)

It is assumed that the rate of consumption of oil will be .135 lbs/hr/eng.

Fuel and oil densities have been assumed as follows:

JP-4	grade of fuel	6.4 lbs/gal.
Kerosene	grade of fuel	6.7 lbs/gal.

NOTE: Turbine fuel standard BTU content of 18400 BTU/LB. is used in this report.

Synthetic jet oil 8.1 lbs/gal.

$$\text{Cam} = 1.02 * (\text{Fb} * \text{Cft} + \text{Ne} * .135 * \text{Cct} * \text{tb}) / \text{D}$$

Where: Fb = Block fuel in pounds (See page 4)

Cft = Cost of Fuel

Domestic = \$.01493/lb (\$.10/U.S. Gallon –Kerosene)

(\$.095/U.S. Gallon –JP-4)

International = \$.01642/lb

(\$.11/U.S. Gallon –Kerosene)

(\$.105/U.S. Gallon –JP-4)

Cct = Cost of oil for turbine engines = \$.926/lb (\$7.50/U.S. Gallon)

Ne = Number of engines installed

D = CAB trip distance (statute miles)

c. Hull Insurance Costs

During the initial introduction of a new type airplane such as the subsonic jets when first introduced and now the supersonic transport, the insurance rates are understandably high, but over the useful life of the airplane will average 2% per year.

The insured value rate is assumed to cover 100% of the initial price of the complete airplane

$$\text{Cam} = (\text{Rate/Dollar Value}) (\text{Airplane Cost}) / (\text{Utilization})$$

$$= \text{IRa} * \text{Ct} / (\text{U} * \text{Vb})$$

Where: IRa = 2%

Ct = Total airplane cost including engines (dollars)

2. DIRECT MAINTENANCE – FLIGHT EQUIPMENT

The term “maintenance” as presented in this method includes labor and material costs for inspection, servicing, and overhaul of the airframe and its accessories, engines, propellers, instruments, radio, etc. The formulae further include a 2% non-revenue flying factor.

There are two well established procedures being used for the maintenance of airplanes, namely periodic and progressive. The use of either of these procedures is dependent on the policy set forth by the individual airline, and in general, the costs will be approximately the same.

Close study of operating statistics shows that the average cost of maintenance may be fairly represented as functions of weight, thrust, price and/or flight cycles.

Maintenance burden will also be included in this section.

a. Labor — Airplane (Excluding engines only) (Figure 2)

$$C_{am} = (K_{FHa} * t_f + K_{FCa}) * RL * M^{1/2} / V_b * t_b$$

Where: $K_{FCa} = .05 * W_a / 1000 + 6 - 630 / (W_a/1000 + 120)$ = Labor manhours per flight cycle
 $K_{FHa} = .59 K_{FCa}$ = Labor manhours per flight hour
 RL = Labor Rate — \$/hr — \$4.00
 M = Cruise Mach Number (assume 1 for subsonic airplanes)
 W_a = Basic Empty Weight of the Airplane Less Engines—Lbs.

b. Material — Airplane (Excluding engines only)

$$C_{am} = (C_{FHa} * t_f + C_{FCa}) / (V_b * t_b)$$

Where:

$C_{FHa} = 3.08 C_a / 10^6$ = Material cost (\$/flight hour)
 $C_{FCa} = 6.24 C_a / 10^6$ = Material Cost (\$/flight cycle)
 C_a = Cost of complete airplane less engines (dollars)

c. Labor –Engine (includes bare engine, engine fuel control, thrust reverser, exhaust nozzle systems, and augmentor systems) (includes gear box, but does not include propeller on turboprop engines) (Figure 3)

$$C_{am} = (K_{FHe} * t_f + K_{FCe}) * RL / (V_b * t_b)$$

Where: $K_{FHe} = (0.6 + 0.027 T / 10^3) N_e$ = Labor manhours per flight hour (turbojet)
 $K_{FHe} = (0.65 + 0.03 T / 10^3) N_e$ = Labor manhours per flight hour (turboprop)
 $K_{FCe} = (0.3 + 0.03 T / 10^3) N_e$ = Labor manhours per flight cycle (jets and turboprop)

T = Maximum certificated takeoff thrust, including augmentation where applicable and at sea level, static, standard day conditions (Maximum takeoff equivalent shaft horsepower at sea level, static, standard day conditions for turboprop).

RL = Labor rate per man-hour \$4.00
 N_e = Number of engines

d. Material –Engine (includes bare engine, engine fuel control, thrust reverser, exhaust nozzle systems and augmentor systems) (includes gear box, but does not include propeller on turboprop engines)

$$C_{am} = (C_{FHe} * t_f + C_{FCe}) / (V_b * t_b)$$

Where: $CFHe = 2.5 Ne * (Ce / 10^5) = \text{Material Cost -- \$/Flight Hour (For Subsonic Airplanes)}$

$CFCe = 2.0 Ne * (Ce / 10^5) = \text{Material Cost -- \$/Flight Cycle (For Subsonic Airplanes)}$

$CFHe = 4.2 Ne * (Ce / 10^5) = \text{Material Cost -- \$/Flight Hour (For Supersonic Airplanes)}$

$CFCe = 2.9 Ne * (Ce / 10^5) = \text{Material Cost -- \$/Flight Cycle (For Supersonic Airplanes)}$

$Ne = \text{Number of engines}$

$Ce = \text{Cost of one engine}$

e. Maintenance Burden

This may be calculated at 1.8 times the direct airplane and engine labor cost.

3. DEPRECIATION — FLIGHT EQUIPMENT

The depreciation of the capital value of an airplane is dependent to a large degree on the individual airline and the world economic and competitive conditions as the airplane is maintained in a fully airworthy condition throughout its life. For the purposes of this formula, the depreciation periods in years (Da) and the residual value for the airplane and its components is as follows:

Complete Airplane Including Engines and All Spares		
	Depreciation Period (Da)	Residual Value
Subsonic Turbine Engine Airplane	12	0%
Supersonic Airplane	15	0%

NOTE: Financial accounting practice normally recognizes a residual value, however, the dollar amount is usually nominal.

a. Depreciation (Total Aircraft Including Spares)

$$Cam = (Ct + 0.10 (Ct - Ne Ce) + 0.40 Ne Ce) / (Da U Vb)$$

Where: $Ct = \text{Total airplane cost including engines (dollars)}$

$Ce = \text{Cost of one engine (dollars)}$

$Ne = \text{Number of engines}$

$Da = \text{Depreciation period (years)}$

$U = \text{Annual utilization — block hours/year (See Figure 4)}$

FIGURE 1: FLIGHT CREW COST-DOMESTIC
\$/BLOCK HOUR vs. TOGW_{max}/1000

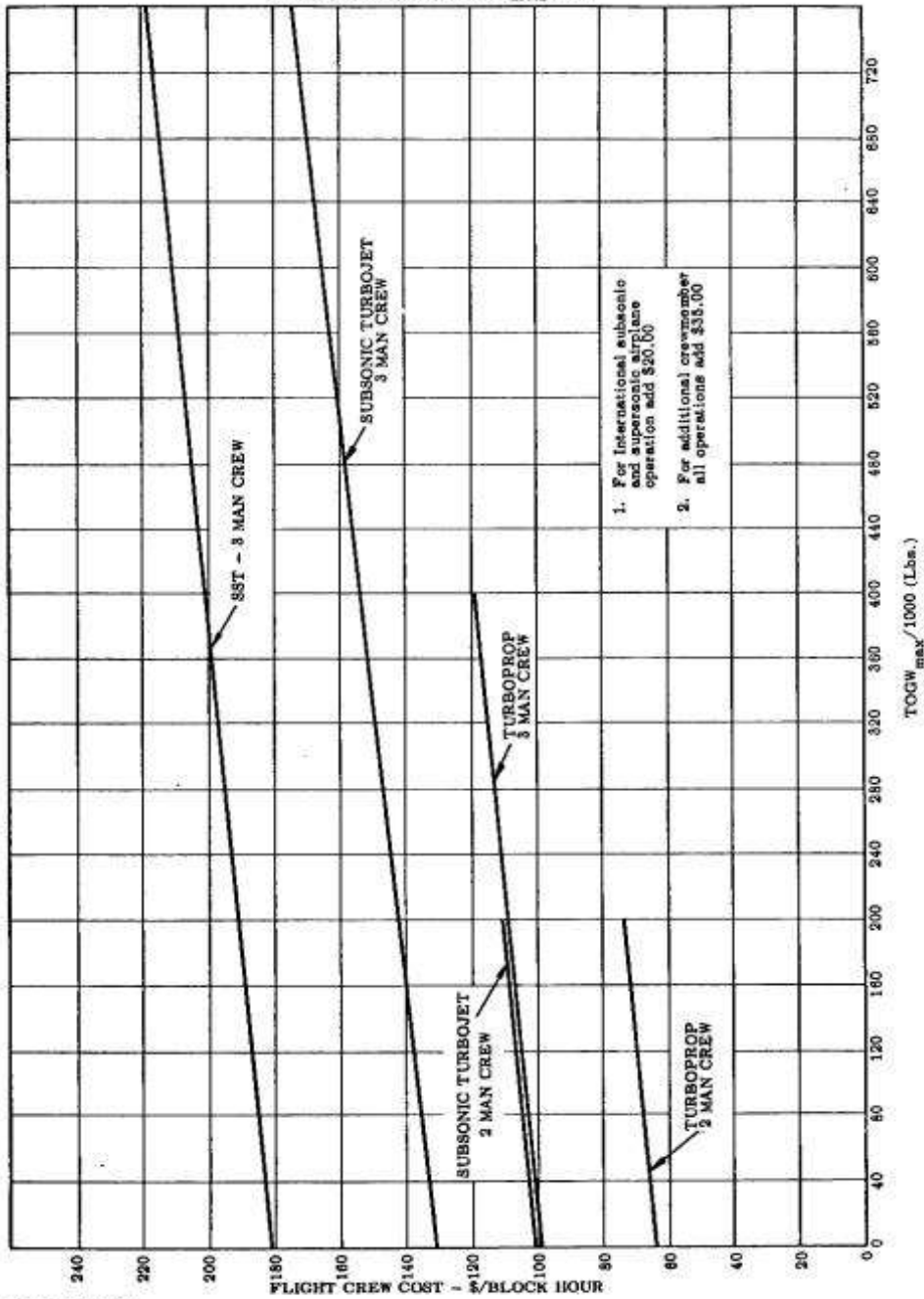

1. For international subsonic and turbo prop aircraft operation add \$20.00
2. For additional crewmember all operations add \$35.00

December 1967

FIGURE 2: AIRPLANE MAINTENANCE LABOR (EXCLUDING ENGINES ONLY)
 LABOR MANHOURS vs. W_B (BASIC EMPTY WEIGHT OF AIRPLANE LESS ENGINES)

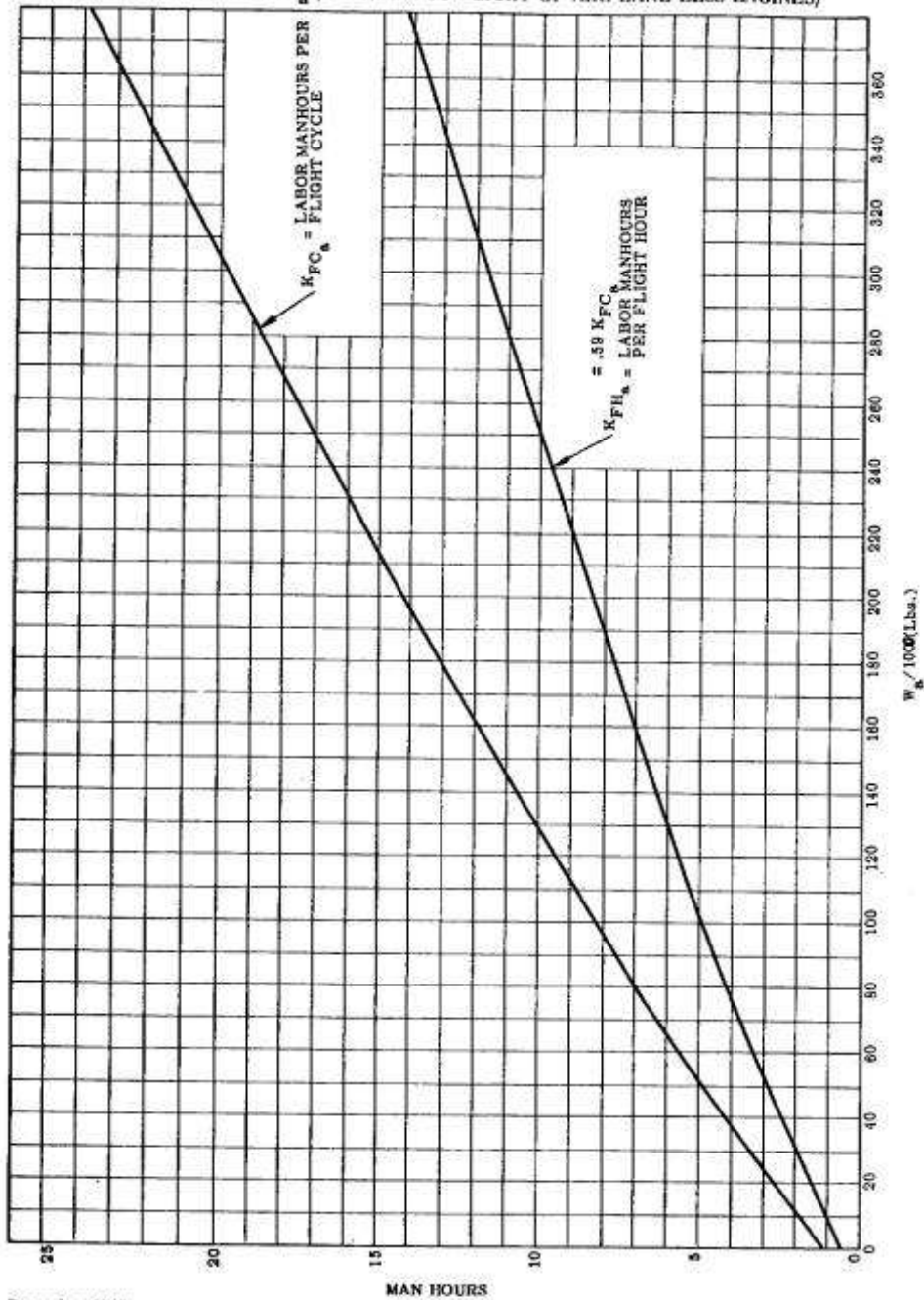

December 1967

XXV-28

FIGURE 3: ENGINE MAINTENANCE LABOR
MANHOURS VS. MAX. TAKEOFF THRUST

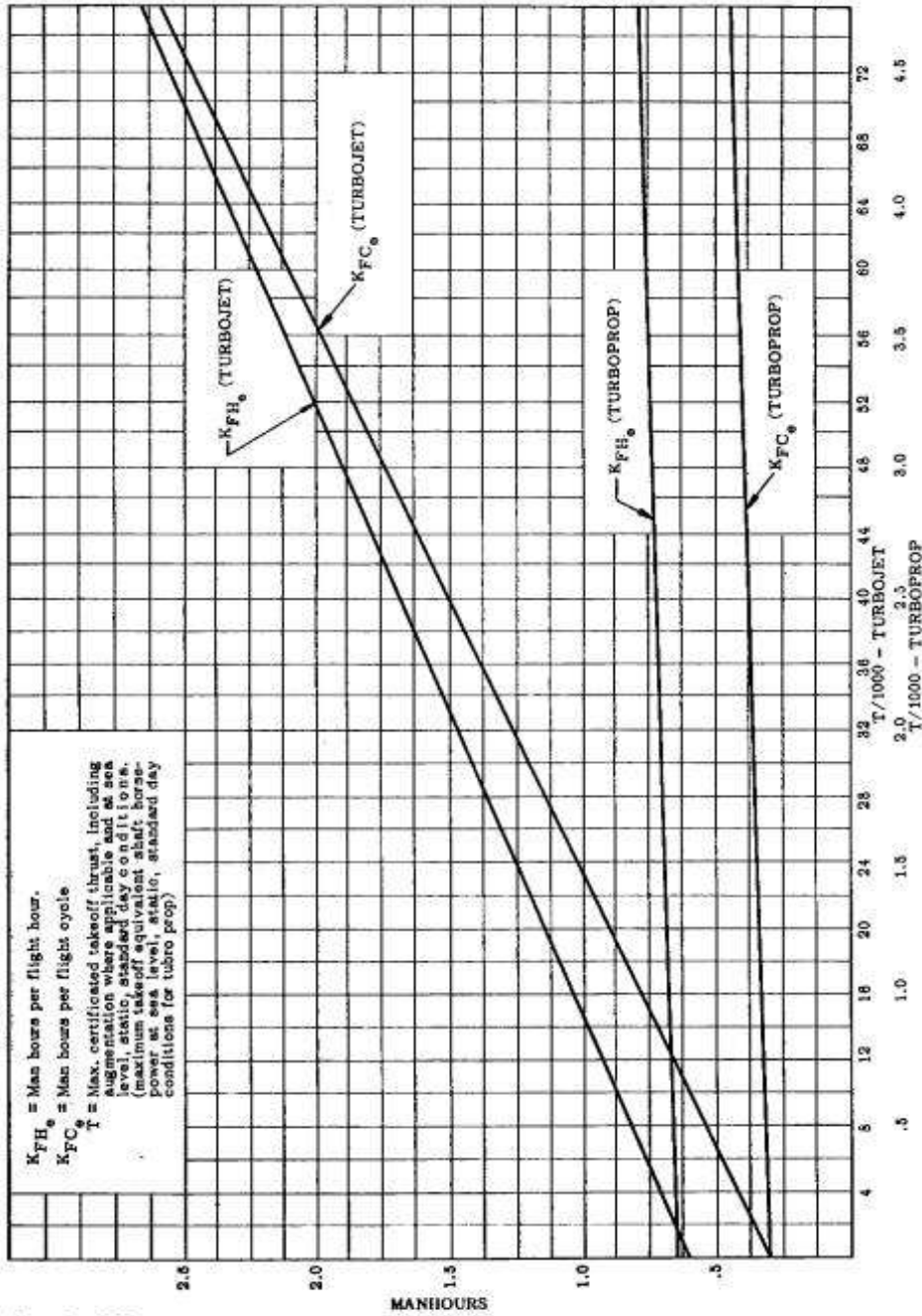

December 1967

XXV-29

FIGURE 4: ANNUAL UTILIZATION
BLOCK HOURS/YEAR vs. BLOCK TIME HOURS

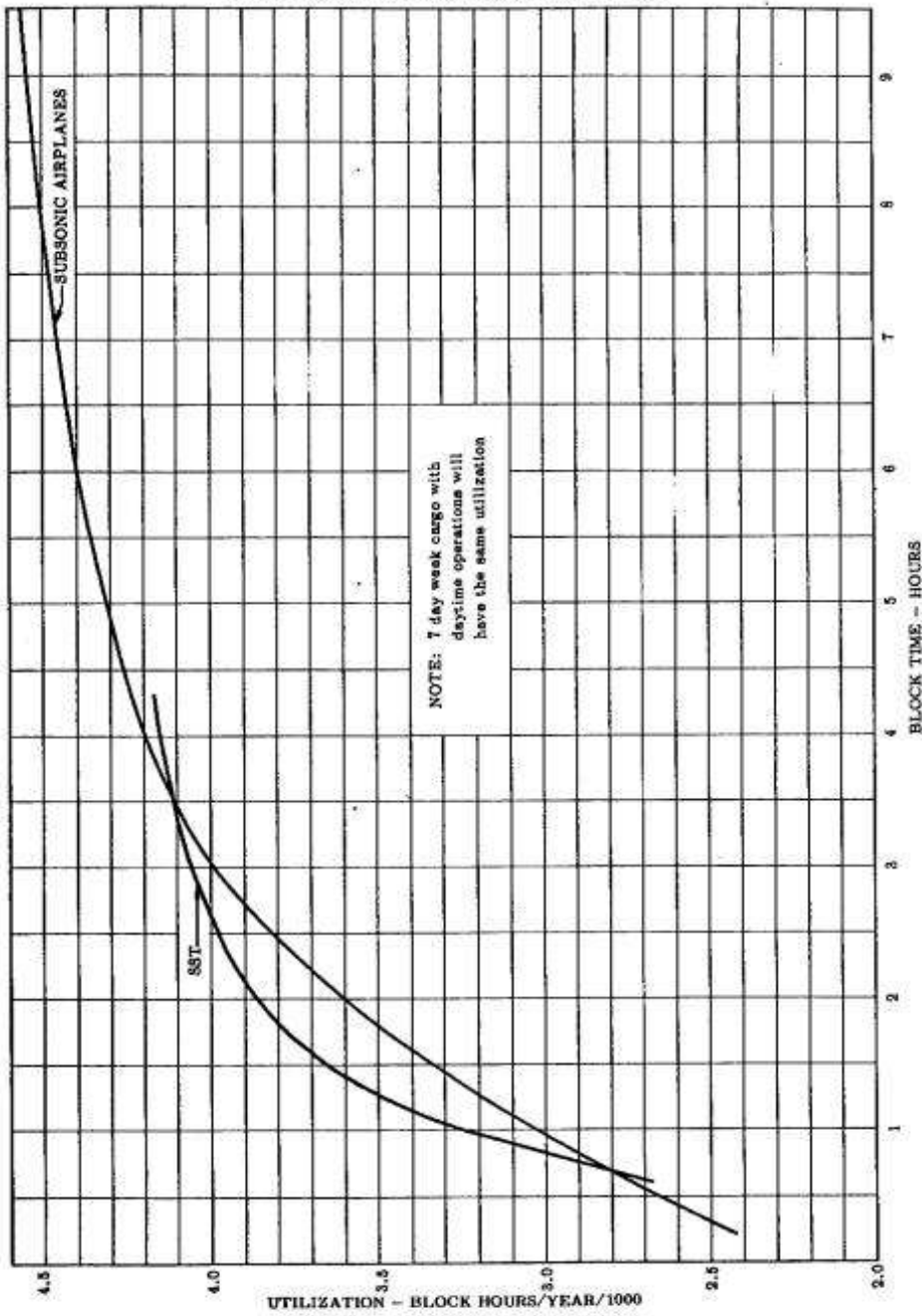

December 1967

XXV-30

1999 Airplane Prices

To the left is a range of 1999 prices for in-production airplanes. The difference between the high and low prices is a function of the configuration and special features options included in the airplane. Many options are available that significantly affect the price of the airplane: capability, interiors, avionics, fuel, and so forth.

The 1999 prices include the reset of our prices in July 1998, incorporation of optional features to basic, and escalation from 1998 to 1999.

*Note that the BBJ price is for a "green A/P" and excludes interior completion costs.

All prices are in U.S. dollars and are in millions.

Airplane Model	Price (millions \$)
717-200	31.5 - 35.5
737-300	40.0 - 46.5
737-400	44.0 - 51.5
737-500	34.5 - 41.0
737-600	36.0 - 44.0
737-700	41.5 - 49.0
737-800	51.0 - 57.5
737-900	53.5 - 61.0
747-400	167.5 - 187.0
747-400 Combi	177.5 - 197.0
757-200	65.5 - 73.0
757-300	73.5 - 81.0
767-200ER	89.0 - 100.0
767-300ER	105.0 - 117.0

767-400ER	115.0 - 127.0
777-200	137.0 - 154.0
777-200ER	144.0 - 164.0
777-300	160.5 - 184.5
MD-80	42.0 - 49.0
MD-90	49.0 - 56.5
MD-11	132.0 - 147.5
MD-11 Combi	144.5 - 162.0
Business Jets*	35.25*



[Search](#)

title: Consumer Price Index Data
 subtitle: from US Bureau of Labor Statistics

head:Year	Jan	Feb	Mar	Apr	May	Jun	
Jul	Aug	Sep	Oct	Nov	Dec	An Av	
1913	29.4	29.3	29.3	29.4	29.2	29.3	29.6
29.8	29.9	30.1	30.2	30.1	29.7		
1914	30.1	29.8	29.7	29.4	29.6	29.8	30.1
30.5	30.6	30.4	30.5	30.4	30.1		
1915	30.3	30.1	29.8	30.1	30.2	30.3	30.3
30.3	30.4	30.7	30.9	31.0	30.4		
1916	31.3	31.3	31.6	31.9	32.0	32.4	32.4
32.8	33.4	33.8	34.4	34.6	32.7		
1917	35.0	35.8	36.0	37.6	38.4	38.8	38.4
39.0	39.7	40.4	40.5	41.0	38.4		
1918	41.8	42.2	42.0	42.5	43.3	44.1	45.2
46.0	47.1	47.9	48.7	49.4	45.1		
1919	49.5	48.4	49.0	49.9	50.6	50.7	52.1
53.0	53.3	54.2	55.5	56.7	51.8		
1920	57.8	58.5	59.1	60.8	61.8	62.7	62.3
60.7	60.0	59.7	59.3	58.0	60.0		
1921	57.0	55.2	54.8	54.1	53.1	52.8	52.9
53.1	52.5	52.4	52.1	51.8	53.6		
1922	50.7	50.6	50.0	50.0	50.0	50.1	50.2
49.7	49.8	50.1	50.3	50.5	50.2		
1923	50.3	50.2	50.4	50.6	50.7	51.0	51.5
51.3	51.6	51.7	51.8	51.8	51.1		
1924	51.7	51.5	51.2	51.0	51.0	51.0	51.1
51.0	51.2	51.4	51.6	51.7	51.2		
1925	51.8	51.6	51.7	51.6	51.8	52.4	53.1
53.1	52.9	53.1	54.0	53.7	52.5		
1926	53.7	53.5	53.2	53.7	53.4	53.0	52.5
52.2	52.5	52.7	52.9	52.9	53.0		
1927	52.5	52.1	51.8	51.8	52.2	52.7	51.7
51.4	51.7	52.0	51.9	51.8	52.0		
1928	51.7	51.2	51.2	51.3	51.6	51.2	51.2
51.3	51.7	51.6	51.5	51.3	51.3		
1929	51.2	51.1	50.9	50.7	51.0	51.2	51.7
51.9	51.8	51.8	51.7	51.4	51.3		
1930	51.2	51.0	50.7	51.0	50.7	50.4	49.7
49.4	49.7	49.4	49.0	48.3	50.0		
1931	47.6	46.9	46.6	46.3	45.8	45.3	45.2
45.1	44.9	44.6	44.1	43.7	45.6		
1932	42.8	42.2	42.0	41.7	41.1	40.8	40.8
40.3	40.1	39.8	39.6	39.2	40.9		
1933	38.6	38.0	37.7	37.6	37.7	38.1	39.2
39.6	39.6	39.6	39.6	39.4	38.8		
1934	39.6	39.9	39.9	39.8	39.9	40.0	40.0
40.1	40.7	40.4	40.3	40.2	40.1		
1935	40.8	41.1	41.0	41.4	41.2	41.1	40.9
40.9	41.1	41.1	41.3	41.4	41.1		
1936	41.4	41.2	41.0	41.0	41.0	41.4	41.6
41.9	42.0	41.9	41.9	41.9	41.5		
1937	42.2	42.3	42.6	42.8	43.0	43.1	43.3

43.4	43.8	43.6	43.3	43.2	43.0		
1938	42.6	42.2	42.2	42.4	42.2	42.2	42.3
42.2	42.2	42.0	41.9	42.0	42.2		
1939	41.8	41.6	41.5	41.4	41.4	41.4	41.4
41.4	42.2	42.0	42.0	41.8	41.6		
1940	41.7	42.0	41.9	41.9	42.0	42.1	42.0
41.9	42.0	42.0	42.0	42.2	42.0		
1941	42.2	42.2	42.4	42.8	43.1	43.9	44.1
44.5	45.3	45.8	46.2	46.3	44.1		
1942	46.9	47.3	47.9	48.2	48.7	48.8	49.0
49.3	49.4	49.9	50.2	50.6	48.8		
1943	50.6	50.7	51.5	52.1	52.5	52.4	52.0
51.8	52.0	52.2	52.1	52.2	51.8		
1944	52.1	52.0	52.0	52.3	52.5	52.6	52.9
53.1	53.1	53.1	53.1	53.3	52.7		
1945	53.3	53.2	53.2	53.3	53.7	54.2	54.3
54.3	54.1	54.1	54.3	54.5	53.9		
1946	54.5	54.3	54.7	55.0	55.3	55.9	59.2
60.5	61.2	62.4	63.9	64.4	58.5		
1947	64.4	64.3	65.7	65.7	65.5	66.0	66.6
67.3	68.9	68.9	69.3	70.2	66.9		
1948	71.0	70.4	70.2	71.2	71.7	72.2	73.1
73.4	73.4	73.1	72.6	72.1	72.1		
1949	72.0	71.2	71.4	71.5	71.4	71.5	71.0
71.2	71.5	71.1	71.2	70.8	71.4		
1950	70.5	70.3	70.6	70.7	71.0	71.4	72.1
72.7	73.2	73.6	73.9	74.9	72.1		
1951	76.1	77.0	77.3	77.4	77.7	77.6	77.7
77.7	78.2	78.6	79.0	79.3	77.8		
1952	79.3	78.8	78.8	79.1	79.2	79.4	80.0
80.1	80.0	80.1	80.1	80.0	79.5		
1953	79.8	79.4	79.6	79.7	79.9	80.2	80.4
80.6	80.7	80.9	80.6	80.5	80.1		
1954	80.7	80.6	80.5	80.3	80.6	80.7	80.7
80.6	80.4	80.2	80.3	80.1	80.5		
1955	80.1	80.1	80.1	80.1	80.1	80.1	80.4
80.2	80.5	80.5	80.6	80.4	80.2		
1956	80.3	80.3	80.4	80.5	80.9	81.4	82.0
81.9	82.0	82.5	82.5	82.7	81.4		
1957	82.8	83.1	83.3	83.6	83.8	84.3	84.7
84.8	84.9	84.9	85.2	85.2	84.3		
1958	85.7	85.8	86.4	86.6	86.6	86.7	86.8
86.7	86.7	86.7	86.8	86.7	86.6		
1959	86.8	86.7	86.7	86.8	86.9	87.3	87.5
87.4	87.7	88.0	88.0	88.0	87.3		
1960	87.9	88.0	88.0	88.5	88.5	88.7	88.7
88.7	88.8	89.2	89.3	89.3	88.7		
1961	89.3	89.3	89.3	89.3	89.3	89.4	89.8
89.7	89.9	89.9	89.9	89.9	89.6		
1962	89.9	90.1	90.3	90.5	90.5	90.5	90.7
90.7	91.2	91.1	91.1	91.0	90.6		
1963	91.1	91.2	91.3	91.3	91.3	91.7	92.1

92.1	92.1	92.2	92.3	92.5	91.7		
1964	92.6	92.5	92.6	92.7	92.7	92.9	93.1
93.0	93.2	93.3	93.5	93.6	92.9		
1965	93.6	93.6	93.7	94.0	94.2	94.7	94.8
94.6	94.8	94.9	95.1	95.4	94.5		
1966	95.4	96.0	96.3	96.7	96.8	97.1	97.4
97.9	98.1	98.5	98.5	98.6	97.2		
1967	98.6	98.7	98.9	99.1	99.4	99.7	100.2
100.5	100.7	101.0	101.3	101.6	100.0		
1968	102.0	102.3	102.8	103.1	103.4	104.0	104.5
104.8	105.1	105.7	106.1	106.4	104.2		
1969	106.7	107.1	108.0	108.7	109.0	109.7	110.2
110.7	111.2	111.6	112.2	112.9	109.8		
1970	113.3	113.9	114.5	115.2	115.7	116.3	116.7
116.9	117.5	118.1	118.5	119.1	116.3		
1971	119.2	119.4	119.8	120.2	120.8	121.5	121.8
122.1	122.2	122.4	122.6	123.1	121.3		
1972	123.2	123.8	124.0	124.3	124.7	125.0	125.5
125.7	126.2	126.6	126.9	127.3	125.3		
1973	127.7	128.6	129.8	130.7	131.5	132.4	132.7
135.1	135.5	136.6	137.6	138.5	133.1		
1974	139.7	141.5	143.1	143.9	145.5	146.9	148.0
149.9	151.7	153.0	154.3	155.4	147.7		
1975	156.1	157.2	157.8	158.6	159.3	160.6	162.3
162.8	163.6	164.6	165.6	166.3	161.2		
1976	166.7	167.1	167.5	168.2	169.2	170.1	171.1
171.9	172.6	173.3	173.8	174.3	170.5		
1977	175.3	177.1	178.2	179.6	180.6	181.8	182.6
183.3	184.0	184.5	185.4	186.1	181.5		
1978	187.2	188.4	189.8	191.5	193.3	195.3	196.7
197.8	199.3	200.9	202.0	202.9	195.4		
1979	204.7	207.1	209.1	211.5	214.1	216.6	218.9
221.1	223.4	225.4	227.5	229.9	217.4		
1980	233.2	236.4	239.8	242.5	244.9	247.6	247.8
249.4	251.7	253.9	256.2	258.4	246.8		
1981	260.5	263.2	265.1	266.8	269.0	271.3	274.4
276.5	279.3	279.9	280.7	281.5	272.4		
1982	282.5	283.4	283.1	284.3	287.1	290.6	292.2
292.8	293.3	294.1	293.6	292.4	289.1		
1983	293.1	293.2	293.4	295.5	297.1	298.1	299.3
300.3	301.8	302.6	303.1	303.5	298.4		
1984	305.2	306.6	307.3	308.8	309.7	310.7	311.7
313.0	314.5	315.3	315.3	315.5	311.1		
1985	316.1	317.4	318.8	320.1	321.3	322.3	322.8
323.5	324.5	325.5	326.6	327.4	322.2		
1986	328.4	327.5	326.0	325.3	326.3	327.9	328.0
328.6	330.2	330.5	330.8	331.1	328.4		
1987	333.1	334.4	335.9	337.7	338.7	340.1	340.8
342.7	344.4	345.3	345.8	345.7	340.4		
1988	346.7	347.4	349.0	350.8	352.0	353.5	354.9
356.6	358.9	360.1	360.5	360.9	354.3		
1989	362.7	364.1	366.2	368.8	370.8	371.7	372.7
373.1	374.6	376.2	377.0	377.6	371.3		

1990	381.5	383.3	385.5	386.2	386.9	389.1	390.7
394.1	397.5	400.0	400.7	400.9	391.4		
1991	403.1	403.8	404.3	405.1	406.3	407.3	408.0
409.2	411.1	411.5	412.7	413.0	408.0		
1992	413.8	415.2	417.2	417.9	418.6	419.9	420.8
422.0	423.2	424.7	425.3	425.2	420.3		
1993	427.0	428.7	430.1	431.2	432.0	432.4	432.6
433.9	434.7	436.4	436.9	436.8	432.7		
1994	437.8	439.3	441.1	441.4	441.9	443.3	444.4
446.4	447.5	448.0	448.6	448.4	444.0		
1995	450.3	452.0	453.5	455.0	455.8	456.7	457.0
458.0	459.0	460.3	460.1	459.9	456.5		
1996	462.5	464.2	466.5	468.2	469.1	469.4	470.3
471.2	472.7	474.2	475.1	475.1	466.7		
1997	476.6	478.1	479.3	479.9	479.6	480.2	480.8
481.7	482.9	482.9	483.8	483.2	479.0		
1998	484.1	485.0	485.9	486.8	487.7	488.3	488.9
489.5	490.0	491.2	491.2	490.9	486.2		
1999	492.1	492.7	494.2	497.8			
end							

Optimization and Trade Studies



PASS: Program for Aircraft Synthesis Studies

This section contains java applets for analysis of transport aircraft. The system is based on Caffe, a Cooperative Applet Framework For Engineering. You may analyze the airplane or investigate the effects of changing various parameters.

As you enter various parameters in the different sections of this program, they are saved and passed to other pages. This section collects all of the information entered previously and computes the overall aircraft performance. Alternatively, you may view all of the inputs at once by going to the Summary of Project Inputs in the appendix. From this page you can reload or copy a complete description of your current design.

Start by looking at the effects of wing area and take-off weight changes to your design on the Performance Trade Studies page.

Several additional options are available at the links listed below:

- [Performance Trade Studies](#): the effect of wing area and take-off weight on performance.
- [Information on the variables](#) (a description, units, how they are computed)
- A simple [drawing](#) of your airplane.
- [Numerical optimization](#) lets you vary several parameters at once to find the best design.
- [A nicer 3-D view of the geometry](#) and an expert system that suggests what may be done to improve the design.

Parametric Studies

This program allows the designer to examine the effect of wing area and take-off weight on the computed performance parameters. Click the 'Compute' button to compute results. Please be prepared to wait up to 1-2 minutes for the plot to be constructed. Times vary widely. A 132 MHz Power Mac (604e) takes 60 secs to recompute the results using Netscape 4.04. A 180 MHz 603e Power Mac takes about 90 secs. Internet Explorer 4.0 for the Mac does not work with this page, while both IE4 and Netscape on Windows 95 work fine and require 4-6 seconds! A Sun SPARC-5 took about 5 minutes to recompute the results using Netscape 4.05.

Other pages:

- [Information on the variables](#) (a description, units, how they are computed)
- A simple [drawing](#) of your airplane.
- [Numerical optimization](#) lets you vary several parameters at once to find the best design.
- [A nicer 3-D view of the geometry](#) and an expert system that suggests what may be done to improve the design.

About the PASS variables...



PASS: Program for Aircraft Synthesis Studies

This document describes the input and output parameters for the PASS program, including the variable name, units, and a description of each variable.

Input Variables

1. **weight.maxto** (lbs) The design maximum take-off weight. For the cruise range computation, we assume the take-off weight is equal to this maximum value.
2. **sref** (ft²) The reference trapezoidal (trap) wing area.
3. **arw** () The wing aspect ratio based on the reference area.
4. **sweepw** (deg) The sweep of the trapezoidal wing quarter chord.
5. **tovercw** () The average wing thickness to chord ratio.
6. **taperw** () The ratio of tip chord to root chord for the trapezoidal reference wing.
7. **supercritical?** () Indicates peaky(0) or supercritical(1) section properties.
8. **lex** () Leading edge extension -- The additional wing chord added forward of the trap reference wing measured at the centerline, in units of trap root chord.
9. **tex** () Trailing edge extension -- The additional wing chord added aft of the trap reference wing measured at the centerline, in units of trap root chord.
10. **chordextspan** () The span of the leading and trailing edge extensions in units of semi-span (0.3 means the extra chord extends over 30% of the wing).
11. **wingdihedral** (deg) Wing dihedral angle.
12. **wingheight** () Wing height on fuselage (0 = low wing, 1 = high wing).
13. **wingxposition** () The location of the wing root leading edge on the fuselage. This applies the actual wing geometry, not the trapezoidal reference wing. The value is in units of fuselage length so 0.0 means the wing root at the centerline is at the fuselage nose and 1.0 means the wing root leading edge is at the very aft end of the fuselage.
14. **sh/sref** () The ratio of gross horizontal tail area to wing reference area.
15. **arh** () Horizontal tail aspect ratio.
16. **sweepht** (deg) Sweep of horizontal tail quarter chord.
17. **toverch** () Horizontal tail thickness to chord ratio.
18. **taperht** () Horizontal tail tip chord / root chord.
19. **dihedralht** (deg) Horizontal tail dihedral.

20. **ttail?** () 0 for low tail, 1 for T-Tail, or anything in-between.
21. **sv/sref** () Ratio of vertical tail area to wing reference area.
22. **arv** () Aspect ratio of vertical tail: height² / area
23. **sweepv** () Sweep of vertical tail quarter chord line.
24. **tovercv** () t/c of vertical tail.
25. **taperv** () Vertical tail taper ratio.
26. **#engines** () Total number of engines.
27. **#wingengines** () Number of engines on the wing.
28. **#tailengines** () Number of engines mounted on vertical tail.
29. **enginetype** () Engine type:
 1. high bypass ratio turbofan (uninstalled sls SFC = .326)
 2. low bypass ratio turbofan (uninstalled sls SFC = .59)
 3. advanced technology propfan (uninstalled sls SFC = .277)
 4. turboprop
 5. reserved
 6. SST engine with 40.5% cruise efficiency
 7. Advanced SST engine with 45% cruise efficiency, reduced lapse
30. **slsthurst** (lbs) Uninstalled sea level static take-off thrust for one engine.
31. **sfc/sfceref** () Ratio of actual sfc to reference engine sfc
32. **aircrafttype** () Type of aircraft or mission:
 1. Domestic short range, austere accommodations
 2. Domestic, med range, med comfort
 3. Long range, overwater
 4. Small Business Jet
 5. All cargo
 6. Commuter
 7. SST
33. **#passengers** () Actual number of passengers.
34. **#coachseats** () Number of seats in all-coach layout.
35. **#crew** () Number of flight crew members.
36. **#attendants** () Number of flight attendants.
37. **seatlayout1** () Distribution of seats and aisles written as an integer. 32 means 3 seats together, then an aisle, then 2 seats. 353 means a twin aisle airplane with 3 seats then an aisle, then 5 seats in the center, then another aisle, then another 3 seats.
38. **seatwidth** (in) Width of a seat including associated armrests.
39. **seatlayout2** () Seating layout for a second deck. Use 0 if single deck aircraft.
40. **aislewidth** (in) Width of an aisle.

41. **seatpitch** (in) Longitudinal seat pitch.
42. **fuseh/w** () Ratio of fuselage height to width.
43. **nosefineness** () Nose fineness ratio (Nose length / fuselage width)
44. **tailfineness** () Tailcone fineness ratio
45. **windshieldht** (ft) Height of windshield (use only for drawing program).
46. **pilotlength** (ft) Length of pilot station (also used in drawing)
47. **fwdspace** (ft) Extra space forward of seats in constant section (use negative value to place seats in tapering region of forward fuselage.
48. **aftspace** (ft) Extra space aft of seats in constant section (use negative value to place seats in tapering region of aft fuselage.
49. **altitude.inicr** (ft) Initial cruise altitude.
50. **altitude.finalcr** (ft) Final cruise altitude.
51. **altitude.cabin** (ft) Cabin pressure altitude.
52. **altitude.maxalt** (ft) Maximum design pressure altitude (at least 3000-5000ft above final cruise altitude).
53. **altitude.strdes** (ft) Altitude for loads analysis and structural sizing (typically 20,000 ft).
54. **machnumber.inicr** () Initial cruise Mach number -- Program sets final cruise Mach to this same value.
55. **fother** (ft²) Additional drag area associated with special items.
56. **fmarkup** () A markup factor to account for surface roughness or excess drag (typically 1.05-1.09).
57. **controlstype** () 1= aerodynamic, 2 = part power, 3 = fully powered controls.
58. **clhmax** () CLmax of horizontal tail.
59. **addclimbtime** (hr) Additional time required to climb (See climb notes).
60. **flapdeflection.to** (deg) Take-off flap deflection.
61. **flapdeflection.landing** (deg) Landing flap deflection.
62. **slatdeflection.to** (deg) Take-off slat deflection.
63. **slatdeflection.landing** (deg) Landing slat deflection.
64. **maxextrapayload** (lbs) The difference between maximum zero fuel weight and actual zero fuel weight. If this is set to 0, the aircraft is designed to carry only the specified weight of passengers, baggage, and cargo. Set this to a larger value and reduce the actual number of passengers to evaluate range at other than the full payload case. This may also be used to add growth capability to the design.
65. **wcargo** (lbs) Weight of cargo (in addition to baggage) actually carried on this mission.
66. **flapspan/b** () Ratio of flap span to total wing span.
67. **flapchord/c** () Ratio of flap chord to wing chord.
68. **yearstozero** (years) Depreciation period for economics analysis.
69. **fuel-\$pergal** (\$/gal) Current fuel price (use .60 to .80).
70. **oil-\$perlb** (\$/lb) Current price of oil (use about 10 \$/lb)
71. **insurerate** () Hull insurance rate in fraction of aircraft price per year (use .02)
72. **laborrate** (\$/hr) Current labor rate (varies but use 25 if no additional data is available).
73. **inflation** () Inflation factor from 1967 for use in correcting other ATA numbers (use about 5.0)
74. **ygear/fusewidth** () Ratio of gear track to fuselage width (1.6 typical)
75. **structwtfudge** () Structural weight correction factor to account for composites or other advanced

technology.

76. **wdryengine/slst** () Weight of the dry engine per unit of sea level static thrust.
77. **wother** (lbs) Weight of any additional items, not usually included in weight build-up.
78. **machnumber.strdes** () Mach number for the structural design conditions (maneuver and gust).
79. **dxengine1** (ft) The following allow for changes in the assumed engine locations. Engines are numbered left to right.
80. **dxengine2**
81. **dxengine3**
82. **dxengine4**
83. **dyengine1**
84. **dyengine2**
85. **dyengine3**
86. **dyengine4**
87. **dzengine1**
88. **dzengine2**
89. **dzengine3**
90. **dzengine4**
91. **arearulefactor** () Use 1.0 to simply add isolated component wave drags or .85 for nicely area-ruled fuselage.
92. **alphalimit** (deg) Maximum angle of attack limit at CLmax -- Use a large number except for SST designs.
93. **cgcontrol** () Used for SST's -- If set to 1, we assume fuel pumping so that the required tail load to trim is zero; if the value is 0, we compute the tail load required at the normally-computed cg position.
94. **x/ctransition** () Fraction of chord for wing and tail surfaces with laminar flow.
95. **range_required** (n.mi.) Required still air range with specified take-off weight and payload excluding reserves.
96. **tofl_required** (ft) FAA balanced field length at specified take-off weight.
97. **lfl_required** (ft) FAA landing field length at actual landing weight.
98. **altitude.vc** (ft) Altitude at which structural design at Mc is required (the knee of the placard). Assumed constant EAS from this altitude to sea level.

Computed Results

1. **ticketprice** (\$) Fare that would have to be charged to provide 10% net yield for given number of passengers.
2. **cruiserange** (n.mi.) Available still air range with reserves for given max takeoff weight.
3. **climb2grad** () Second segment climb gradient.
4. **tofieldln** (ft) FAR Balanced Take-off field length.
5. **landfieldln** (ft) FAR Landing field length
6. **doc** (cents/seat-st.mi) Direct operating cost.
7. **ioc** (\$/passenger) Indirect operating cost.

8. **d/t.initer** () Ratio of drag to thrust at initial cruise point. (Should be < .9 to permit some climb margin)
9. **d/t.finalcr** () Ratio of drag to thrust at final cruise point.
10. **l/d.initer** () Lift to drag ratio at initial cruise.
11. **l/d.finalcr** () Lift to drag ratio at final cruise.
12. **etotal.initer** () Span efficiency factor at initial cruise.
13. **einviscid.initer** () Inviscid span efficiency (includes tail trim drag)
14. **cd.initer** () Total CD at start of cruise.
15. **cdp.initer** () Parasite drag coefficient
16. **cdi.initer** () Induced drag coefficient.
17. **cdc.initer** () Compressibility drag coefficient. (Includes wave drag for SSTs)
18. **mdiv.initer** () Drag divergence Mach number
19. **nlimit** () Limit load factor.
20. **nult** () Ultimate load factor.
21. **clvertengout** () CL of the vertical tail to trim in second segment climb.
22. **minstability** () Computed minimum static margin.
23. **x/cgear** () Chordwise position (x/c) of landing gear on wing.
24. **clwmargin.climb** () Difference between CLmax and CL of the wing (should be > 0)
25. **clwmargin.initer** ()
26. **clwmargin.finalcr** ()
27. **clhmargin.to** () Difference between CLmax and CL of the tail.
28. **clhmargin.torot** () Difference between CLmax and CL of the tail during take-off rotation.
29. **clhmargin.climb** ()
30. **clhmargin.initer** ()
31. **clhmargin.finalcr** ()
32. **clhmargin.landing** ()
33. **machnumber.to** ()
34. **machnumber.landing** ()
35. **cltotal.initer** () Airplane lift coefficient.
36. **cltotal.finalcr** ()
37. **cltotal.to** ()
38. **cltotal.climb** ()
39. **cltotal.landing** ()
40. **airframecost** (\$) Estimated price of the airframe less engines.
41. **enginecost** (\$) Estimated cost of all of the engines.
42. **spanw** (ft) Wing span.
43. **arwgross** () Wing aspect ratio based on groww area.
44. **ftotal.initer** (ft²) Total equivalent flat plate parasite drag area
45. **fwing** (ft²)
46. **fhorizontal** (ft²)
47. **fvertical** (ft²)
48. **ffuselage** (ft²)
49. **fgaps** (ft²)
50. **fnacelles** (ft²)

51. **fnacellebase** (ft²)
52. **fpylons** (ft²)
53. **wwing** (lbs) Wing weight
54. **whorizontal** (lbs) Horizontal tail weight
55. **wvertical** (lbs)
56. **wrudder** (lbs)
57. **wsurfacecontrols** (lbs)
58. **wfuselage** (lbs)
59. **wgear** (lbs)
60. **whydro&pneumatic** (lbs)
61. **wapu** (lbs)
62. **winstruments** (lbs)
63. **welectrical** (lbs)
64. **welectronics** (lbs)
65. **wfurnishings** (lbs)
66. **waircondition** (lbs)
67. **wcrew** (lbs)
68. **wopitems** (lbs)
69. **wpassengers** (lbs)
70. **wbaggage** (lbs)
71. **wattendants** (lbs)
72. **wdryengine** (lbs)
73. **wnacelles&pylons** (lbs)
74. **wpayload** (lbs) Weight of the payload (pax, bags, cargo)
75. **wpropulsion** (lbs) Complete propulsion system weight.
76. **weight.maxzf** (lbs) Maximum zero fuel weight.
77. **weight.zf** (lbs) Actual zero fuel weight for this mission.
78. **weight.oe** (lbs) Operating empty weight.
79. **weight.empty** (lbs) Manufacturers empty weight
80. **weight.nopayload** (lbs) Weight with full fuel but no payload.
81. **wreserves** (lbs) Weight of reserve fuel.
82. **wfuel** (lbs) Total fuel weight.
83. **weight.climb** (lbs) Total aircraft weight in second segment climb.
84. **weight.initer** (lbs)
85. **weight.finalcr** (lbs)
86. **weight.landing** (lbs)
87. **climbfuelinc** (lbs) Computed climb fuel increment (see climb notes).
88. **tsfc.initer** (lb/hr/lb) Specific fuel consumption.
89. **thrustavail.initer** (lbs) Total available thrust.
90. **fuselength** (ft) Fuselage length.
91. **fusewidth** (ft) Fuselage Width
92. **cdwavevol.initer** () SST volume-dependent wave drag coefficient.
93. **cdwavelift.initer** () SST lift-dependent wave drag coefficient.

-
- Back to [PASS analysis page](#).
 - [A 2-D parametric study](#) of the effect of any two parameters on a third.
 - A simple [drawing](#) of your airplane.
 - [Numerical optimization](#) lets you vary several parameters at once to find the best design.
 - An expert system that suggests what may be done to improve the design.
-

PASS Aircraft Drawing



PASS: Program for Aircraft Synthesis Studies

This page provides a 3-D view of the airplane geometry.

- [Performance Trade Studies](#): The effect of weight and wing area on constraints.
 - [Information on the variables](#) (a description, units, how they are computed)
 - [Numerical optimization](#) lets you vary several parameters at once to find the best design.
-
-

PASS Aircraft Optimization

This page permits optimization of the aircraft subject to several constraints. See [notes on optimization](#) for additional information and some suggestions on the use of this code.

- [Performance Trade Studies](#)
 - [Information on the variables](#) (a description, units, how they are computed)
 - [Aircraft top view](#).
 - [3D View and expert system](#) that suggests what may be done to improve the design.
-

Optimization Notes

Analysis Results

The PASS analysis programs and optimizer include the analyses described in this text and mirror what you have done in problem sets, with a few minor exceptions. For the most part, if you see results that differ from your hand calculations, you should look back over your computations to see if you have overlooked something. The analyses here may differ from your calculations in the following ways:

- Inclusion of nacelle, pylon, tail drag
- Explicit computation of tail loads that may affect drag, C_{Lmax}
- Explicit computation of load factors for zero fuel weight case for fuselage weight calculation
- Computation of fuselage dimensions based on seating arrangement

If the performance results here differ from your by-hand calculations, try to trace back through the results to identify the source. For example, if you compute a range of 6000 n.mi. and the program says 3000, look at the contributors to range: sfc, zero fuel weight, L/D. You may find that your zero fuel weight is substantially lower than the value computed here and then look at component weights and find that you made an error in the wing weight estimate. Or you might find the L/D is much lower than you calculate and trace the difference to a very low $e_{inviscid}$, which may imply a very large tail load. This could be fixed by moving the wing, making a larger tail, or lengthening the fuselage.

Optimization

The optimization method used here is a gradient-free search method that is not very efficient, but is quite robust. Depending on the number of design variables selected, you may need to let the optimizer iterate for 200 or more iterations. It is often a good idea to restart the optimization after it has stopped to see that the design does not change. The values of each variable are stored after the optimization is complete so that if you then go to one of the drawing pages of the V-n diagram for example, and recompute the results on these pages, they should reflect the optimized design results. It is often a good idea to look at various properties of the final design on these pages that provide more detail than the summary pages.

Make sure that you choose values for the constraints that are appropriate for your airplane. There are default values that appear, but these may be totally inappropriate for your design. Check all of the inputs to make sure that your SST is not being designed with assumptions that make sense for a DC-9! You may want to specify constraint values that are somewhat more severe than you would like for your final design. This will assure that there is some margin and that your optimized design is not right up against the actual limits of several constraints simultaneously.

You must also make sure to choose design variables that are appropriate for the constraints that you impose. If you ask the optimizer to enforce a minimum stability constraint, but don't let it change the tail

size or wing position, you may find it changing other variables in unexpected ways. I have seen "optimized" wings with 45 degrees of sweep in order to satisfy a stability constraint the hard way. You should also start out by varying just a few of the design parameters and not imposing some of the constraints, just to get started and to make sure you understand what is changing and why. The optimizer slows down considerably as the number of variables is increased.

There are several parameters that are intentionally excluded from the optimization page. This does not mean that they are not important for your design. You may want to try changing some of these values and re-optimizing to examine the sensitivities of the optimized design to your selections. Parameters such as aft fineness ratio or tail aspect ratio can be important for short-coupled airplane designs to reduce trim drag; you may also want to experiment with some of your discrete choices such as seating layout, number of engines, tail configuration, etc..

Current Geometry

Appendices

A list of useful tables, references, and computational programs from various chapters and other sources is provided below.

- [Standard Atmosphere Properties](#)
- [Unit Converter](#)
- [Summary of Project Input Data](#)
- [Summary of Project Results](#)
- [Common Acronyms and Abbreviations](#)
- More to be added soon...

Atmospheric Model

The model used for computing atmospheric properties is based on the U.S. Standard Atmosphere 1972. It is valid to about 200,000 ft.

This applet does complex unit conversion based on the data provided in a editable file. You may view the file by clicking below, or create your own.

Show [conversion file](#).

```

! <xmp>
! Name Value      x10^n  Force   Length   Time     Temp
! length
ft      1.0            0      0       1         0         0
in      0.0833333     0      0       1         0         0
mi      5280.0         0      0       1         0         0
nmi     6076.1         0      0       1         0         0
m       3.280833      0      0       1         0         0
cm      3.280833     -2      0       1         0         0
mm      3.280833     -3      0       1         0         0
km      3.280833      3      0       1         0         0
yd      3.0           0      0       1         0         0
chain   66            0      0       1         0         0
league  18228.3       0      0       1         0         0
furlong 660           0      0       1         0         0
! area
acre    43560.        0      0       2         0         0
hectare 107641        0      0       2         0         0
! volume
gal     .13368        0      0       3         0         0
qt      .033421       0      0       3         0         0
pt      .016710       0      0       3         0         0
l       .035315       0      0       3         0         0
barrel  4.21092       0      0       3         0         0
cord    128           0      0       3         0         0
peck    .267368       0      0       3         0         0
bushel  1.069472     0      0       3         0         0
!time
sec     1.0           0      0       0         1         0
hr      3600.0        0      0       0         1         0
hour    3600.0        0      0       0         1         0
min     60.0          0      0       0         1         0
yr      3.1536000    7      0       0         1         0
year    3.1536000    7      0       0         1         0
day     8.64          4      0       0         1         0
week    6.04800      5      0       0         1         0
fortnight 12.09600    5      0       0         1         0
! speed
mph     1.46667      0      0       1         -1         0
kt      1.68781      0      0       1         -1         0
knot    1.68781      0      0       1         -1         0
! force
lb      1.0           0      1       0         0         0
oz      .0625         0      1       0         0         0
N       .22481        0      1       0         0         0
dyne    .22481       -5      1       0         0         0
poundal .031081       0      1       0         0         0
metricTon 2204.6       0      1       0         0         0
ton     2000          0      1       0         0         0
carat   .00004405    0      1       0         0         0
cuftH2O 62.366       0      1       0         0         0
! mass
kg      0.068522     0      1       -1        2         0
sl      1            0      1       -1        2         0
gram    0.068522    -3      1       -1        2         0
g       0.068522    -3      1       -1        2         0
mg      0.068522    -6      1       -1        2         0
! pressure
psi     0.006944     0      1       -2        0         0
Pa      2.08858     -2      1       -2        0         0
pascal  2.08858     -2      1       -2        0         0

```

atm	2116.22	0	1	-2	0	0
bar	2.08858	3	1	-2	0	0
inHg	70.727	0	1	-2	0	0
mmHg	2.7845	0	1	-2	0	0
torr	2.7845	0	1	-2	0	0
inH2O	5.2024	0	1	-2	0	0
centipoise	.002089	-2	1	-2	1	0
poise	.002089	0	1	-2	1	0
! temperature						
degK	1.8	0	0	0	0	1
degR	1.0	0	0	0	0	1
! energy						
J	0.73756	0	1	1	0	0
Joule	0.73756	0	1	1	0	0
cal	3.0880	0	1	1	0	0
BTU	778.17	0	1	1	0	0
erg	0.73756	-7	1	1	0	0
kWh	2656000	0	1	1	0	0
! power						
W	0.73756	0	1	1	-1	0
watt	0.73756	0	1	1	-1	0
kW	737.56	0	1	1	-1	0
hp	550	0	1	1	-1	0
! frequency						
rpm	.104720	0	0	0	-1	0
Hz	6.28319	0	0	0	-1	0
! angle						
degree	.017453	0	0	0	0	0
deg	.017453	0	0	0	0	0
rev	6.28319	0	0	0	0	0
cycle	6.28319	0	0	0	0	0
grad	.015708	0	0	0	0	0

Summary of Project Input Data

The field below displays the current values of all parameters defined in this project including many default values. You may copy these and save them as a document on your computer, then paste them back at another time.

Summary of Project Results

The field below displays selected results from the most recent analysis. You may copy these and save them as a document on your computer for future reference. This page is intended as a condensed summary. Please look at the individual pages (e.g. v-n diagram, component weight pages) with more detailed results.

Aviation Abbreviations

--From <http://gozips.uakron.edu/~evert/aircraft.abr>

A/FD	Airport/Facility Directory
AAS	Airport Advisory Service
ADF	Automatic Direction Finder
AGL	Above Ground Level
AIM	Airmans Information Manual
ALS	Approach Light System
ARSA	Airport Radar Service Area
ARSR	Air Routs Surveillance Radar
ASR	Airport Surveillance Radar
ATC	Air Traffic Control
ATIS	Auto Terminal Information Service
AWOS	Automated Weather Observing System
CAS	Calibrated Air Speed
CONSOL	Low or Medium Frequency Long Range Navigational Aid
CT	Control Tower
CTAF	Common Traffic Advisory Frequencies
CZ	Control Zone
DH	Decision Height
DME	Distance Measuring Equipment Compatible with TACAN
EAS	Equivalent Air Speed
ELT	Emergency Locator Transmitter
FAA	Federal Aviation Administration
FAR	Federal Aviation Regulations
FM	Fan Marker
FSS	Flight Service Station
GS	Glide Slope
HIRL	High Intensity Runway Light system
HIWAS	Hazardous Inflight Weather Advisory Service
IAS	Indicated Airspeed
ICAO	International Civil Aviation Organization
IFR	Instrument Flight Rules
ILS	Instrument Landing System
IM	Inner Marker
INT	Intersection
LDA	Localizer Directional Aid
LFR	Low Frequency Radio Range
LMM	Locator at Middle Marker (compass)
LOC	ILS Localizer
LOM	Compass Locator at Outer Marker
M	Mach Number
MAA	Maximum Authorized IFR Altitude
MALS	Medium intensity Approach Light System
MALSR	Medium intensity Approach Light System w/Runway Alignment lights
MCA	Minimum Crossing Altitude

MDA	Minimum Descent Altitude
MEA	Minimum Enroute IFR Altitude
MM	Middle Marker
MOA	Military Operation Area
MOCA	Minimum Obstruction Clearance Altitude
MRA	Minimum Reception Altitude
MSL	Mean Sea Level
MTR	Military Training Route
NAV/COM	Navigation Communications Radio
NAVAID	Navigational Aid
NDB	Non Directional Beacon (ADF)
NFCT	Non-Federal Control Tower
NO A/G	No Air to Ground Communications
NOAA	National Oceanic and Atmospheric Administration
NOPT	No Procedure Turn Required
NOTAM	Notice to Airmen Affecting Airport
OCSL	
OEI	One Engine Inoperative
OM	Outer Marker ILS
PAR	Precision Approach Radar
PCL	Pilot Controlled Lighting
RAIL	Runway Alignment Indicator Light System
RBN	Radio Beacon
RCLM	Runway Centerline Marking
RCLS	Runway Centerline Light System
REIL	Runway End Identification Lights
RFSS	Remote Flight Service Station
RR	Low or Medium Frequency Radio Range Station
RVR	Runway Visual Range as measured in the touchdown zone area
SALS	Short Approach Light System
SOB	Souls On Board
SSALS	Simplified Short Approach Light System
SSALSR	Simplified Short Approach Light System w/Runway alignment lights
TA	Transition Area
TACAN	Tactical Air Navigational Aid (UHF)
TAS	True Air Speed
TCA	Terminal Control Area
TCAS	Traffic Collision Avoidance System
TDZL	Touch Down Zone Lights
TRSA	Terminal Radar Service Area
TVOR	Terminal VHF Omnirange Station
TWEB	Transcribed Weather Broadcast
UNICOM	Aeronautical Advisory Communication
V1	Takeoff decision speed (formerly denoted as critical engine failure speed)
V2	Min minimum takeoff safety speed
V2	Takeoff safety speed
VA	Design Maneuvering Speed
VB	Design Speed for Maximum Gust Intensity
VC	Design Cruising Speed
VD	Design Diving Speed
VDF/MDF	Demonstrated Flight Diving Speed

VF Design Flap Speed
VFC/MFC Maximum Speed for Stability Characteristics
VFE Maximum Flap Extended Speed
VFR Visual Flight Rules
VH Maximum speed in level flight with maximum continuous power
VHF Very High Frequency
VLE Maximum landing gear extended speed
VLO Maximum landing gear operating speed
VLOF Lift-off Speed
VMC Minimum control speed with the critical engine inoperative
VMO/MMO Maximum operating limit speed
VMU Minimum unstick speed
VNE Never-exceed speed
VNO Maximum structural cruising speed
VOR VHF Omnidirectional Station
VOR-DME VHF Omnidirectional Range/Distance Measuring Equipment
VORTAC VHF Omnidirectional Range/Tactical Air Navigation
VR Rotation speed
VS Stalling speed or the minimum steady flight speed at which the airplane is controllable
VS0 Stalling speed or the minimum steady flight speed in the landing configuration
VS1 Stalling speed or the minimum steady flight speed obtained in a specific configuration
VTOL Vertical Take Off and Landing
VTOSS Takeoff Safety Speed for Category A Rotorcraft
VX Speed for best angle of climb
VY Speed for best rate of climb