

East African Railways and Harbours Magazine

50 CENTS
APRIL, 1956
VOL. 2—8

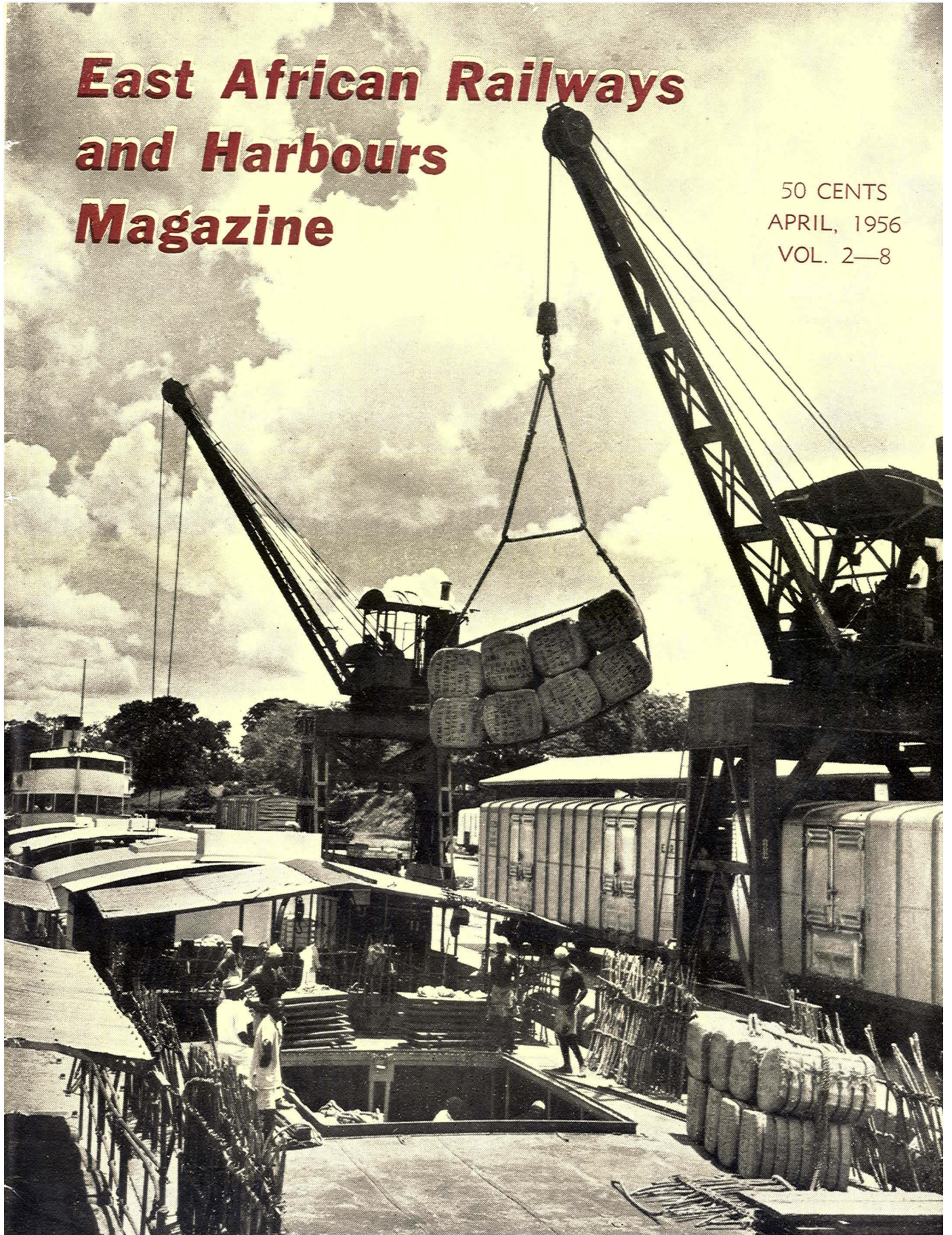

COVER PICTURE

The cover picture was taken at Namasagali Port 60 miles from the source of the Nile at the point where it first becomes navigable. With rail connection to the main Kenya-Uganda line at Mbulamuti, it is a base for steamships operating the Lakes Kioga and Kwania.

Discharging bales of cotton from the holds of lighters, tied up alongside the quay, are two four-ton steam cranes, whilst goods wagons can be seen ready to receive freight for onward transit. The funnel and bridge of the s.w.s. "Grant" can be seen astern of the lighters. Built in 1925, the s.w.s. "Grant" has a displacement of 228 tons carrying a total of 24 First Class and Second Class passengers.

DISTRICT

CORRESPONDENTS

Butiaba Mr. T. Maclachlan
Dar es Salaam Mr. K. L. Wilkinson
Iringa Mr. A. J. D. Davis
Kampala Mr. D. F. Muir
Kisumu Mr. M. G. Stoneham
Masindi Town Mr. B. A'anya
Mombasa Mr. A. P. Bendelow
Mtwara Mr. Pritam Singh
Nakuru Mr. L. B. Wiberly
Tabora Lt.-Col. R. N. Cooper
Tanga Mr. K. Harwood

E.A.R.&H.

Magazine

APRIL, 1956—Vol. 2—8

Contents

| | |
|-------------------------------------------------------------|---------|
| Editorial Notes | 255 |
| The Kilimanjaro Water Supply Scheme .. | 256 |
| Lake Salvage | 257 |
| River Boat Shuffle | 261 |
| East Africa's Expanding Industries— No. 2—Coffee | 265 |
| Uganda Railway Memories | 267 |
| News in Pictures | 270-271 |
| The "84" Class Locomotive | 272 |
| Miscellanea | 273 |
| Traffic News | 274 |
| Results of Working | 275 |
| Commedations and Criticisms | 276 |
| District Notes | 278 |
| Staff Notes | 280 |
| Recent Promotions | 284 |
| Sporting and Club News | 285 |
| Places and Faces | 288 |



Editorial Notes...

EAST AFRICAN RAILWAYS AND HARBOURS AND COST OF LIVING

SINCE the 1939-45 war the cost of living has in many countries become not only a common topic of conversation but also a serious problem. The reason for this is that, generally speaking, the cost of living has been continually rising and therefore there has been more or less continual pressure for higher wages and salaries. These, in turn, have tended to increase production costs and prices and therefore to cause further rises in the cost of living, with the inevitable result that there has been further pressure for higher wages and salaries and the cycle begins again. This is obviously not the whole story of what is sometimes known as the inflationary spiral, but it will suffice to show why people generally have become so interested in the cost of living.

As a result there have been many attempts to find out how the prices charged in the shops for commodities in common use are made up and what can be done to reduce them or at least keep them steady. The cost of distribution—which means largely the cost of transport—is often quoted as the principal reason why prices are high or vary enormously as between two countries or two places in the same country. It is very doubtful whether this is fair comment so far as the cost of transport is concerned, particularly bearing in mind the fact that without transport services to move goods to the places where they are needed, these goods might have little or no value, no matter how much it has cost to produce them.

East Africa has been no exception to the general rule and cost of living has figured prominently both in public discussions and private conversations for some time. Here, as elsewhere, the cost of transport has been given as one of the main reasons for the rising cost of living and, in an attempt to put this matter in perspective, the Administration has been publishing a series of advertisements to explain in simple words how little the cost of railway transport affects the cost of living.

Under such titles as "Cost of Living Causerie", "That Luxury Price Tag", "Eight Cents Change . . ." and "Tanganyika goes Shopping", examples of the current retail prices of a variety of everyday articles have been compared with the cost of moving them by rail to places as far afield as Mwanza, Kampala, Nairobi and Tabora from the ports

of Mombasa and Dar es Salaam or from local industrial and agricultural centres. Judging by comments made on these advertisements, most people in East Africa had inflated ideas of the cost of transporting goods by rail and few knew how reasonable railway rates and charges are. For instance, six items of groceries—ranging from a tin of Scotch herrings to a bottle of gin—purchased in Nairobi, 330 miles from their port of entry, Mombasa, are carried by rail for only 1.6 per cent of their retail price. Five cents on the herrings costing Sh. 1/75 and 35 cents on the gin selling at Sh. 27/50 cannot be considered excessive. Railway freight charges on articles produced in East Africa are no less reasonable—for example, the railway charge for moving a pound of butter 300 miles is barely 6 cents against a retail price in Nairobi of Sh. 3/85.

Another example taken has been a (necessarily) hypothetical car selling at a price of over £1,000 at a place 300 miles from the port where it was landed in East Africa. Most people would assume that quite a substantial proportion of this price is accounted for by the cost of transporting the car by rail from the port of entry, but in fact the proportion is only about 1 per cent, or less than the cost of driving the car over the same distance after taking into account the cost of petrol, oil and general depreciation. The same applies to humbler modes of propulsion. A bicycle in a crate is moved by rail from Dar es Salaam to Dodoma—289 miles—for a cost of Sh. 4/35 and any critic of railway rates is welcome to ride a bicycle over this distance for under Sh. 5.

Railway charges do not form an excessive percentage of retail prices, whether the goods are groceries, luxury cars, bicycles, clothing or essential agricultural equipment. In this last category an example of the freight costs on a tractor was given in an advertisement with the title "A Farmer in the Dell". Over 442 miles, equal to the distance from Mombasa to Nakuru, East African Railways and Harbours carry a tractor, in the Sh. 15,000 price range, for Sh. 136/50 or 0.9 per cent of its value. It is believed that this rate bears favourable comparison with any other mode of transport or any other railway system.

[Continued on page 275]

THE KILIMANJARO WATER SUPPLY SCHEME

The opening of the Kilimanjaro Water Supply Scheme on 26th March, brought festival to Sultan Hamud and rejoicing to the Masai and Wakamba.

Increasing traffic on the Mombasa-Nairobi section of the main Kenya-Uganda line necessitated the provision of additional water for locomotives for the section between Makindu, Simba and Kiu; these supplies have been furnished by the Kilimanjaro Water Supply Scheme which brings 500,000 gallons of water per day from the Ol' Turesh spring on the slopes of Kilimanjaro by a 65-mile pipeline to Nzai, near Sultan Hamud. A reservoir at Nzai, holding 3,000,000 gallons, feeds two pipelines, the one supplying Simba, the other Kima and Kiu. The scheme has taken two and a half years to complete and has cost £2,750,000.

The pipeline passes through Masai and Kamba tribal territory, and as a gesture of friendship, the Administration has provided six watering points along its length for the use of native cattle. The gift of these watering points at official handing-over ceremonies was received enthusiastically by members of the tribes concerned. Two "Tribal" class locomotives were also christened "Masai" and "Kamba" respectively.

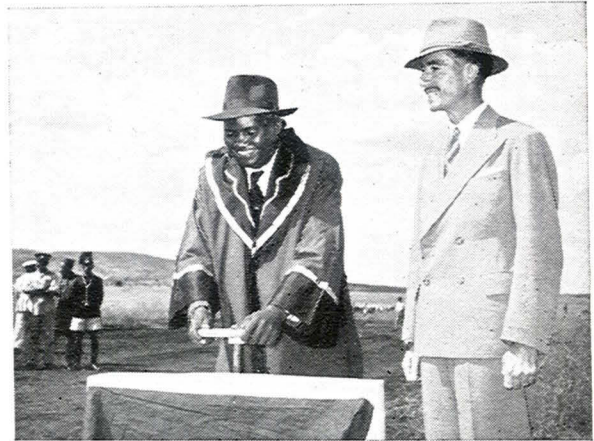

[Top right] Mr. P. H. Hicks, Assistant Chief Engineer, Construction, asks Mr. Joseph Mutiso, Chief of the Kangundo Location and President of Akamba Association, to turn on the tap which will fill the cattle troughs donated to the Wakamba.

[Right] Chief Mutengei ole Nchoonga, having taken over the water point donated to the Masai, displays a photograph of Mount Kilimanjaro presented to him as a souvenir to mark the occasion whilst Masai cattle drink from the troughs.

[Lower right] Before the two "Tribal" class locomotives, which are about to be christened "Masai" and "Kamba". Standing on the platform and reading from left to right are Mr. Colin Campbell, District Officer, Machakos; Mr. K. M. Cowley, Acting Provincial Commissioner, Southern Province; the Wakamba interpreter, Mr. Joseph Mutiso, President of the Akamba Association; Mr. A. F. Kirby, General Manager, East African Railways and Harbours; the Masai interpreter, Mr. Mopei ol Kedonyo, President of Kajiado Tribunal; and Mr. A. B. Simpson, District Commissioner, Kajiado.



LAKE SALVAGE



Salvaged from Kigoma Bay, the steamship "Graf von Goetzen," scuttled by the Germans in 1916, was reconditioned and rechristened the "Liamba". This account has been submitted by Mr. C. F. Laver, of Rainham, Kent. Mr. Laver was a shipwright diver who took part in the salvage and subsequent repair of the "Graf von Goetzen".

One of the Koenigsberg's 4.1-in. guns

THE GERMAN steamship *Graf von Goetzen*, which for a time proudly mounted on its fore-castle-deck one of the *Koenigsberg's* 4.1 guns, and served as a trooper during the war in East Africa, was scuttled by her captain when Kigoma was evacuated by the Germans on 26th July, 1916. She had been bombed by Belgian aircraft during the previous month, and probably still bears the scars on her starboard quarter. She sank in 11 fathoms on an alluvial flat just north of Bangue, striking the bottom heavily stern first and on her port side, wrecking the port propeller, tail-shaft and shaft-bracket, and crumpling her port quarter plating.

Subsequently the Belgians attempted to raise the wreck; it was lifted just clear of the bottom and taken into Kigoma Bay, where attempts to lift it higher from the bottom were ultimately abandoned. The wreck was then acquired for the Tanganyika Central Railway for the modest sum of £4,000, and in early December, 1922, a small salvage party assembled at Kigoma to get it afloat. In charge of the operation was Commander Kerr, late Royal Navy, and his deputy and paymaster was Commander Sharp, late Royal Navy—both then domiciled in Kenya Colony. The technical adviser was Mr. J. Shepherd, who had held the same office during operations on the sunken dock at Dar es Salaam. The European section of the party was completed by the addition of a ship's carpenter, a marine engineer—both ex Royal Navy—and four shipwright-divers.

The plan of salvage was drawn up in the face of two difficulties not usually experienced in salvage work: little was known concerning

the *Goetzen's* displacement, shape or condition; and the locality precluded the employment of anything in the nature of a salvage ship, or lifting lighter—the route to the lake led 780 miles over the mountains on a metre-gauge railway for one thing, and there was negligible rise-and-fall in the lake level for another. Nevertheless, a plan was prepared embodying the deceptively easy-looking method of raising by compressed air. To retain the air within the holds of the ship it was planned to extend the coamings of the hatches *downwards*. There was nothing very difficult likely to be met with in accomplishing this work; the difficulty in compressed-air salvage comes with the first movement of the ship—the imprisoned air rushes to whichever end or side starts to rise first, and makes it rise faster and faster, whilst the other end or side stays put. If the initial rise can be controlled by some counter measure, and limited to a rise of a few feet, the end or side which lags behind can receive an increased lift and be checked in turn; then the ship can be moved into shallower water and the process repeated.

The rise can be checked in two different ways. In the first, weights can be attached to the ship by wires slack enough to allow a fixed amount of rise, after which the weight attached to the rising end would be added to the dead-weight of that end of the ship and dragged up the beach with her. In the second, and the one Mr. Shepherd adopted, lifting pontoons are attached to each end, submerged at such a distance that when the end rises to the required height the pontoon emerges and thus reduces the lift. Two Vicker's collapsible pontoons were included in the equipment for this service, each designed to lift 50 tons.

The equipment at Kigoma included two specially constructed diving boats—rectangular box-like vessels with tapered ends—each rigged with a diving pump and gear for two divers shallow water, or one diver in depths over 33 feet up to 100 feet. There was also a motor-boat to act as tender to the diving boats and for kindred purposes. Ashore there was a steam-driven air-compressor linked to the wreck position by a two-inch main; and in reserve there was a six-inch motor-driven centrifugal salvage pump.

Within a week of arrival at Kigoma diving operations commenced on the wreck with a survey. The decks were found to be littered with the heavy wire hawsers used in the original attempt; and the mainmast had been bent down almost at right angles to clear the lifting lighter used. The hatch coamings were examined, and it was found to be a simple proposition to remove the coping-irons from their lower edges and to use the rivet holes for bolting on the extension plating—five-sixteenth mild steel plates, 10 ft. 6 in. by 4 ft. 6 in.

Diving routine was arranged so that in each diving boat one diver would be underwater three hours whilst the other acted as attendant; then without a break the first diver became the attendant whilst the other dived and endeavoured to complete the day's programme. The depth was great enough to require controlled decompression at the end of each dive—a short pause at 20 feet and a long one at 10 feet to avoid trouble from nitrogen bubbles in the blood and tissues; these stops were cut by the divers themselves to about half the times scheduled for salt-water diving at sea level, instead of increasing them to compensate for reduced atmospheric pressure. The reason for the cuts was initially the possibility that crocodiles might be tempted to sample a dangling leg after watching it waving around for half an hour; but it also gave another 15 minutes on the bottom, a ten per cent time bonus which was very acceptable where so much had to be accomplished.

The wire hawsers took up little diving time to clear, but the removal of the mainmast was a tougher proposition; its heel not only penetrated the deck, it also went down through the top of the twin shaft tunnel and was stepped on the vertical keel. The mast wedges in the deck were not at all so troublesome to extract as was anticipated; borers had been busy on

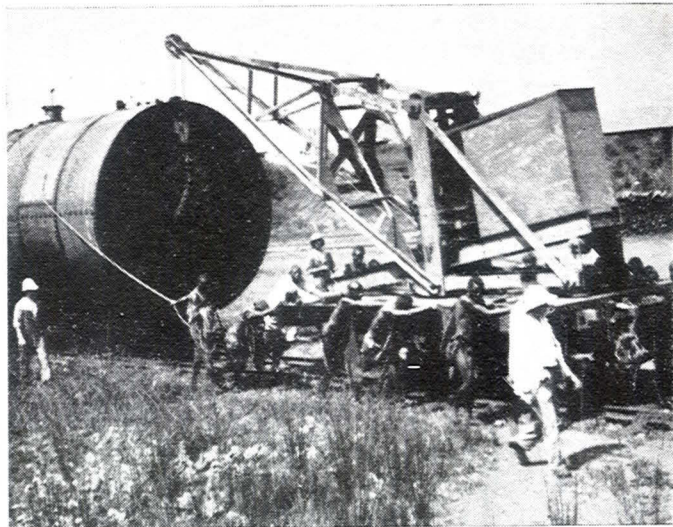

The tanks were not easy to transport on land.

them for a considerable time, honeycombing them with horizontal tunnels, and closely behind them followed ferocious-looking little fishes which ripped away the weakened wood to expose the borers. Some of the wedges had completely disappeared.

In the holds were a large number of empty oil drums, and some of these were secured to the mast, bungholes downwards, and compressed air fed into them until enough lift was built up to yank the mast from its housing.

After a few weeks the extension plates were completed and the air-compressor was started up to test the airtightness of the steel decks. The result was alarming; the decks, it appeared, had never been caulked, watertightness had been achieved by caulking the covering of teak decking. Like the mast wedges, these teak decks were partly destroyed by the combined operations of borer and fish; the air leaked up through them in numerous places. It was useless trying to stop the leaks from above the decks; they had to be stopped at source—on the underside of the steel deck plating—a most formidable prospect, and a very sticky problem for the technical adviser.

The first experiment at checking the leaks with tallow failed, due to the heat of the newly compressed air in the hold, the air escaped before it had time to cool down to the temperature of the surrounding water, which itself was about 80 degrees Fahrenheit, and the tallow fell away from the plating almost immediately. Ultimately, beeswax was found to be just the right substance for the purpose, and the divers had little difficulty in applying it to

the laps of plating in the total darkness which prevailed in the holds. But another difficulty immediately arose; they had no means of knowing where exactly the laps were leaking. The bubbles from a leak ran along between the steel deck and the covering wood deck, maybe appearing many yards away from the leak in the plating, and it was obviously impracticable for them to deal systematically with every joint in the decks whether leaking or not.

Eventually a solution was found which was both simple and effective: by running the compressor at top speed an airlock of about 8 in. could be maintained under the highest part of the deck; wax candles and a box of matches were taken down in a watertight box which was fitted with a valve to equalize the pressure for the purpose of opening the cover in the airlock, and after many abortive attempts, a candle was at last lighted, and from it others. They provided light and a ready means of locating leaks; the flame of a candle run along a lap would be sucked out through the first leak it met with, after which it was a matter of a minute or so to seal the leak with a pencil of beeswax.

The progressive reduction of leakage enabled a deeper airlock to be maintained without punishing the air-compressor so much, and there came a day when the holds were pronounced to be sufficiently airtight for requirements. The next business was the attachment of the two flexible pontoons, another straightforward job; but when the air was run into them they leaked as badly as the decks had done, and instead of taking their full lifts of 50 tons each, it was difficult to pump them up to half capacity.

Very little could be done about them; but it meant the acceptance of a heavy reduction of the checking forces when the ship began to lift. A trial lift was staged, and without hesitation the bow rose right to the surface, and as it did so the ship turned over on to her starboard side, with the bluff of her port bow steaming in the sun. After a while she was allowed to sink again to the bottom, and later was righted.

It was then decided to borrow water tanks from the Railway and to use them inverted as pontoons to make up for some of the deficiency resulting from the failure of the flexible pontoons. The technical adviser also

recommended that the centre of lift should be shifted further aft by making the bunkers airtight. About this time two of the divers became anxious to return to England, and were released from their contracts, after which Mr. Shepherd himself attended to the task of making the bunkers airtight, the ship's carpenter acting as his attendant.

When the substitute pontoons were all attached, the bunkers and the two boilers were blown, and another lift attempted. The result was little different to the first one. The root of the trouble probably lay in the heavy suction which had to be broken between the flat bottom of the ship and the clinging sand; by the time the ship was buoyant enough to break the suction she was too buoyant to be checked by the emergence of the pontoons. A bold decision was then taken to construct two cylindrical pontoons of steel, each with a lifting capacity of 70 tons.

Plates and angles were obtained from Dar es Salaam, and from them the two pontoons were built in the open air at the mouth of the cutting leading to the Point—probably the hottest spot in Kigoma, but the most convenient. The plant consisted of the salvage pneumatic drills and pistols; and a 6-in. hand-operated shearing machine and a charcoal-burning rivet-forge borrowed from the Railway. The plates and angles were bent cold to a radius of 5 ft. 7½ in. on an improvised press made up from a pair of wagon-lifting screw-jacks. The pontoons were properly riveted and caulked, and incorporated in the design two heavily proportioned sling-plates.

These pontoons were attached to the ship, but the suction forces were too great even for these giants, and the ship assumed her now too familiar posture with the bows seven or eight feet above water and the foremast horizontal and submerged. An endeavour was then made to float her on her side; air was pumped into the after hold until it began to escape through the shaft tunnel into the engine room. Pontoons were transferred to the stern, and use was made of every ounce of buoyancy that could be provided, but the stern stubbornly remained down in 11 fathoms. There was no question of suction in this position; it was simply the shift of the centre of lift due to the trim of the ship—the effect which defeats so many promising attempts in submarine salvage operations.

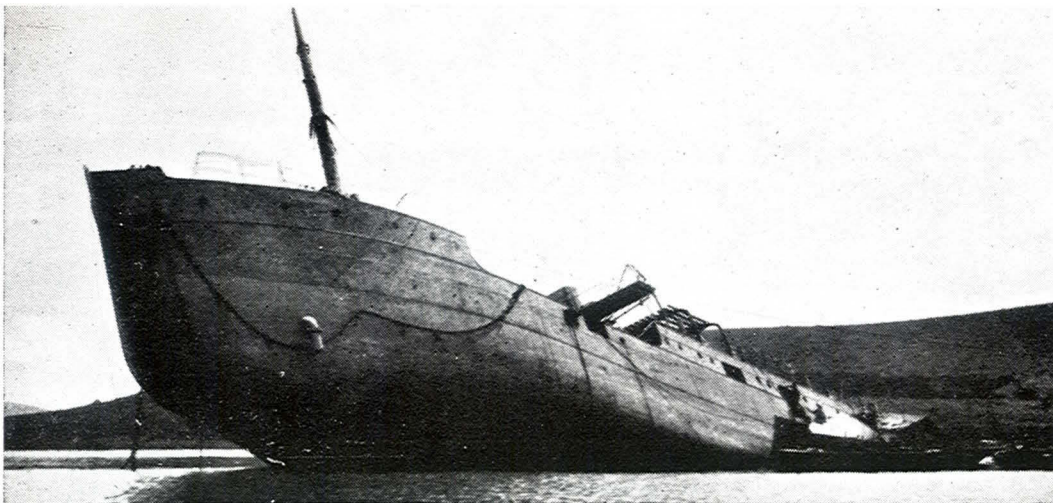

Forehold and engine room clear of the water. She surfaced like a submarine

Anxious discussion of the situation brought out the fact that unless more buoyancy could be obtained from the after hold, the salvage would have to be abandoned; and the only way to increase that buoyancy was to close the shaft-tunnel door to attempt to deepen the airlock in the after hold. Commander Kerr was most reluctant to allow a diver to enter the engine room with the ship in that condition, but eventually yielded to persuasion and the tunnel door proved sufficiently airtight to hold in the extra air. The air compressor ashore was driven as never before; but for an hour there was no visible response from the ship. The anxious watchers had one thing to cheer them; air was rushing into the ship and not much of it coming out again—the lifting forces were gathering strength. Then suddenly a shout went up from the crowd of spectators ashore, and with the water cascading from her port side she surfaced like a submarine, surrounded by a widening ring of foam from the air gushing from holds and pontoons. It was Sunday, 16th March, 1924.

There was no time lost in hauling the ship into shallower water where she was finally righted and floated. Most of the water trapped in her was pumped from her by the 6-in. salvage-pump—running towards the end on a magneto off a motor-cycle—but the last few hundred tons were pumped out by the ship's own donkey pump, running on compressed air. She was then berthed once again in the little basin containing the slipway, from which she had been launched, battered but a long way from beaten; she was destined to sail the waters of Lake Tanganyika for many long years under her new name—*Liemba*.

The reconditioning had to be carried out entirely afloat, and is believed to be unique in that respect, the ship having to be fitted with new shaft-brackets and new outer-bottom plating. The reconditioning party left England on 16th May, 1925, and the ship was re-christened on 16th May, 1927.

In a letter the author claims that the salvage of this ship was the most frustrating job with which he was ever associated and he always thinks of the present-day Liemba with great affection.

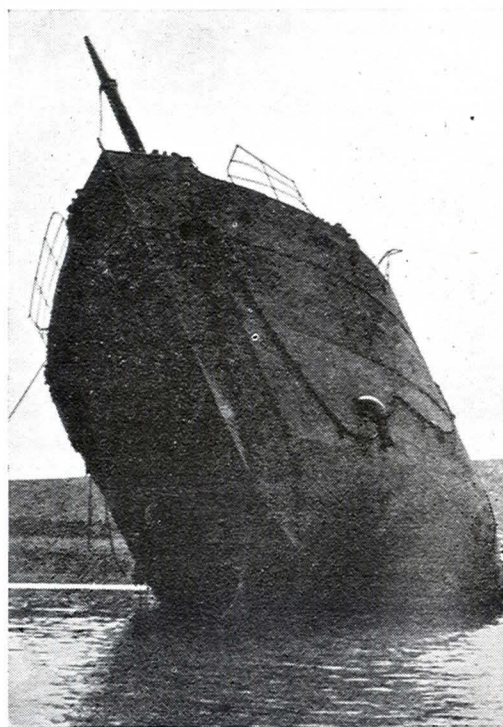

16th March, 1924

RIVER BOAT SHUFFLE

There are many people living in one of the three territories of East Africa who have yet to find out what goes on in the other two.



“WHAT did one know about Uganda?” “What was Uganda like?” “Why didn’t one know more about Uganda?” It was night and the motion of the Uganda “Mail” shortly after leaving Timboroa, the Commonwealth’s highest railway station on its way from Mombasa to Kampala, produced sparse moments of uneasy sleep punctuated by a medley of disquieting abstractions to which there seemed to be no satisfying answer. The day had passed happily through familiar country, viewed from an unfamiliar angle. Most Kenya settlers know the Rift Valley between Nairobi and Nakuru. They know its features very well, but they only know them as seen from the main road. Disturbing thoughts ran on—“How many have seen the Rift Valley from the window of a train? How many know what the hamlet of Kijabe looks like as seen from above instead of from below?” Proportionately not very many surely, for whilst it is customary for the settler to travel by train between Nairobi and Mombasa, he does not often do so between Nairobi and Nakuru. How many then have been as far up the line as Uganda? Why is Uganda scarcely mentioned during the normal course of conversation in Kenya? It was all very puzzling because the eyes of the early explorers had turned towards Uganda; the Imperial British East Africa Company had ambitions only as regards the development of Uganda. And the Railway? The Railway was originally built to link Uganda with the Indian Ocean. It was even called the Uganda Railway in the first instance. There was no mention of Kenya in those early days. Kenya had been discovered just incidentally—on the way to Uganda. And here was a Kenya settler, some sixty years later, pondering why he knew nothing about so close a neighbour as Uganda

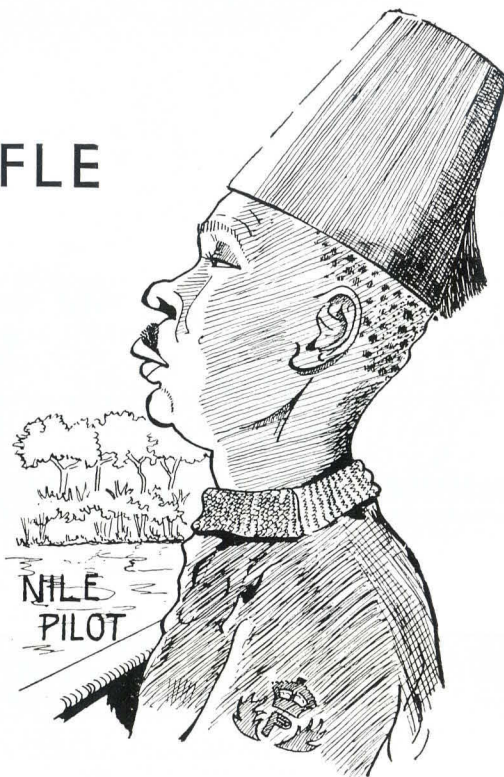

or even what to expect on arrival there, and further, being pretty certain that his was by no means an isolated case. Adventure lay ahead. Something new, a week’s trip by steamer, across Lake Kioga, across Lake Albert, up to the Sudan and return, something not seen before and if one had heard of the Great Lakes and of the river steamers, well . . . then one knew no more than that they existed. Sleep came at that juncture: one was getting just nowhere: fortunately though this was not the case with the train.

Morning was to provide that almost inevitable something which confronts every traveller in East Africa! Contrast. The first contrast was to be found in the speed of the train which seemed to be fairly hammering along over comparatively level ground. Having left the Rift Valley, the gradients and the curves had vanished. As a consequence more level ground brought a definite turn of speed. A further contrast was to be found in the countryside itself. It was tropical. A predominance of bush; little patches of cultivation; red earth; native huts and vegetation of

bright green. This was different from anything one had come across in Kenya. Maybe it could be compared with bits and pieces of country near the Coast, but it possessed an individuality of its own. . . . This was Uganda—almost another world, and that world seemed to start at the isolated station called Mbulamuti where the shelter and comfort of the Uganda Mail was forsaken for a humbler more ancient First Class carriage, on a local train, which tried to establish its importance by rattling fussily and noisily to Namasagali where the world of the rivers was to start.

Arrival at the world of the rivers produced an anti-climax for after 24 hours of hurry, rattle and movement, the other extreme is encountered at Namasagali where there is no hurry and rattle and precious little movement. There is green grass, the steamer, a quayside, a vast languid estuary and eight hours to wait until the steamer is due to sail. And the steamer! Pictures and photographs of the river steamers of the Inland Marine Services are not uncommon, yet the sight of the stern-wheeler *Grant* in actuality was almost unbelievable. A person who had travelled the waters of the Ganges or the Brahmaputra, however, would have seen similar craft, and, if the American motion pictures are not too misleading, then the stern-wheeler *Grant*, tied up alongside, would have passed unnoticed over the waters of the Mississippi in Louisiana, for to the eyes of the man-in-the-street here was a "Show Boat". She is flat-bottomed, has a square bow and stern, has hardly any free-board and her upper-works and decks rise high out of the water like a wedding cake whilst two paddle wheels are housed between decks aft.

Now to get the best out of a holiday spent upon these river steamers a passenger must acquire the spirit of the river steamer folk. The words "No hurry. Not to worry" would cover most of the daily activities aboard, for whilst undoubtedly a great deal is going on the whole time, the passenger does not get that impression. Life aboard is one of complete relaxation and there is no greater relaxation than time spent in watching other people do things quietly. River steamer life is a sort of family affair. The Engineer-in-Charge and his wife may both be aboard and the passengers are welcomed as something in the nature of guests. The deck arrangements on most of the river steamers do not vary much. Cabins

are very comfortable and shady and there is a neat little saloon and bar handy up forward. Here one may make the acquaintance of the ship's dog.

Part of a successful river steamer technique consists of knowing how to employ one's time whilst the steamer is loading and unloading at ports. Otherwise there may be intervals of boredom, for considerable periods are spent in port, and one of the longest of these idle periods occurs on the first day of embarkation at Namasagali. On this occasion the time passed happily enough between meals served in the saloon aboard the *Grant*. Namasagali is an enchanting, clean, lazy place where all seems to be smiles. A little township of shady avenues, red roads, bright open spaces; of brilliant green grass with well-kept and sturdily built bungalows set in shady gardens with asters, frangipani and shrubberies overlooking a glassy languid estuary. Egrets and cormorants skim over the surface of the water and everywhere there are Africans fishing.

The cult of pottering is a very pleasant one and not always unfruitful. Namasagali is a splendid place for this amongst attractive surroundings. Having exhausted the potentialities of the tiny cantonment, then the activities of the quayside and the railway sidings and workshops provide further excellent scope. Tied up alongside a quay by the workshops there was another stern-wheeler, the *Speke*. She was built in 1909, nearly half a century ago, but in outward appearance she is very much the same as river steamers built more recently. A Sikh foreman, who had been in Namasagali for 20 years, had lots of stories about the *Speke*. It was he who led the way to a mango tree surmounting a small hill. Beneath its shade, with iron wheels embedded in the ground, was the framework of an old, decrepit, lichen-covered pole-wagon. "There," said Inder Singh, the Sikh foreman, "there is the *gharri* that brought the *Speke's* boiler to Namasagali from Jinja, in 1909. There was no proper road in those days, so they say, and the boiler was drawn across country by a span of 16 oxen". Indeed it looked as though the pole-wagon had rested beneath the mango tree since that very day it arrived, 47 years ago.

Until one has seen one of these river steamers and its complement of lighters get under way one would discount any description of procedure. Freight, boxes, African

passengers plus their bicycles by the hundred, are carried, not on the steamer, but on lighters. The lighters instead of being towed in the normal fashion are lashed together to form a solid mass which is then nosed along by the bows of the steamer astern of them.

As the *Grant* cast off, the noise of African farewells drowned everything else. Thereafter, out in a more peaceful mid-stream, all that could be heard was a soothing "thump-thump" of the stern wheels as the *Grant* made her leisurely way down-stream through Lake Kioga towards Masindi Port with 16 hours of steaming ahead.

Whilst the sun went down over the broad stretches of a fickle, flowing stream that wound its way through green swamps of papyrus grass which were forever drifting, one realized that the African pilots at the wheel and on look-out had no easy task for the channel never took the same course two days running.

Masindi Port differs very little from other lakeside ports. It stands alone and isolated, having seemingly no connection with civilization. A shed, a few quaint wood-fuelled cranes, bales of cotton and other goods and that is all. To reach Nimule on the borders of the Sudan, it was to be a case of "River Boat Shuffle". A night stop at the Masindi Hotel, another road journey next day to Butiaba on Lake Albert, across the lake on a larger lake steamer, then another "Show Boat" at Pakwach for a further hundred miles of river down the Albert Nile.

After an uneventful journey over 30 miles of red roads in one of the East African Railways and Harbours Road Services buses through luxuriant bush country and threatening weather, Masindi town appeared as a veritable oasis. A night's stay in the hotel, which is run by a Goan manager, provides a pleasant interlude. D'Souza, known all over Uganda as "Juma", is a great local character, and is something in the nature of a martinet. He rules the affairs of this spotless hotel with a rod of iron spiced with spontaneous wit and geniality and woe-betide the guest who is not ready when the bell rings at 8 a.m. in the morning to announce the departure of the "Butiaba bus".

And so on to Butiaba. More red roads, bush and plantations, an old Georgian-looking planter's house and then the escarpment: the descent to the shores of Lake Albert with the trees and buildings of Butiaba on a flat promontory below, giving the impression that it stood on an island completely detached from the mainland. Beyond, the mountains. If you have ever seen the Mountains of Mourne bordering Carlingford Lough in Northern Ireland, you will understand that it is no exaggeration to compare them to the deep blues of the mountains of the Belgian Congo as they appear to merge with the western shores of Lake Albert.

Lake Albert is an inland sea. Storms and green seas rise upon it without warning and can become very nasty. These were not waters for a river steamer. Hardly surprising to find then that the twin-screw *Robert Coryndon*, which lay at Butiaba, was very much not a river steamer, but a lovely looking sea-going ship. The journey across the lake was delightful, as were the skipper's stories of the huge Nile perch which moved in its depths, for excellent fishing can be obtained from Butiaba. The Prince of Wales once took a very large fish here on a hook turned out for him in the local workshops.

It was evening before the *Robert Coryndon* entered port at Pakwach, but in the meantime there had been considerable excitement amongst the passengers for already some herds of elephant had been spotted as the *Robert Coryndon* left the lake and entered the Albert Nile. Not that the elephants were easily distinguishable at that distance, they looked like black specks—but the sight was enough to set the tongues wagging before the *Robert Coryndon* berthed beside a quayside which supported but a repetition of an almost unchanging river port scene, hundreds of shouting colourfully dressed Africans, seemingly happy, hundreds of bicycles, hundreds of bales of cotton and always fishermen sitting over their primitive home-made rods-cum-"nylon" lines everywhere.

Whilst on the last leg of this trip down the Nile from Pakwach to the Sudanese border aboard the *Lugard II*, another comfortable river steamer, one was to experience some of the trials of navigation encountered in these shallow-flowing waters. Floating islands of papyrus often make progress difficult. Sudden storms of rain bring visibility down to nothing



whilst gusts of wind striking the high upper-works of the river steamers and combining with the strength of the current, can blow both ship and lighters right into the river bank. None of these eventualities, however, seem to be regarded as anything approaching the nature of a crisis. They are accepted as an unavoidable part of river navigation. If the wind drives a river steamer aground, the skipper waits until the wind drops before trying to refloat his ship. If the visibility becomes bad, anchor is dropped until it clears, and if a floating island is struck, then the telegraph goes round to "Full Astern".

One African pilot aboard the *Lugard II*, who had sailed the Nile for 27 years, explained that whilst the river channels were for ever changing, he could tell where there was sufficient draught of navigable water by instinct. This is apparently perfectly true: these African pilots do rely on instinct to a very large extent.

But the journey past Obongi, past the cotton mills of Rhino Camp where we came across some white hunters, and by Laropi up to Nimule was peaceful, leisurely and uneventful. A few elephants here and there resting in the shade beneath the trees and some indignant stares from hippos as the steamer passed, and there was nothing much more except unending green with occasional hills.

A flag supporting blue, yellow and green stripes and fluttering at an insignificant mast-head at Nimule, a port which differed little in

pattern from any of the others, proclaimed that the *Lugard II* had arrived at journey's end in a foreign country; the Sudan; and then there were good-byes to fellow passengers who were to make the motor trip northward to Juba and thence on down the Nile to Khartoum, Cairo and thereafter Europe.

Whilst waiting for the lighters to be discharged and reloaded, Nimule provided yet another prize for the potterer. About a mile and a half inland on beyond a native market and down a narrow path through the Napier grass, there is a lonely unhandsome monument built of rough, quarried stone. It stands beneath a large tree and painted upon a tin plaque attached to its face are the words:—

SHEDERAT-EL-SOWAW

(The Traveller's Tree)

It's shade was enjoyed by—

- Giovani Miani Dec., 1857
- Samuel Baker Feb., 1865
- Emin Pasha Dec., 1875
- Winston Churchill Dec., 1907

How many Kenya settlers have also enjoyed the shade of this tree which is so easy to reach on a ten-day round trip from Nairobi, but which seems to be at the other end of 'the world'? Not many. Perhaps the bewitching blandishments of the Coast are too strong. But if it is a semblance of peace that you are after—well, there it is.

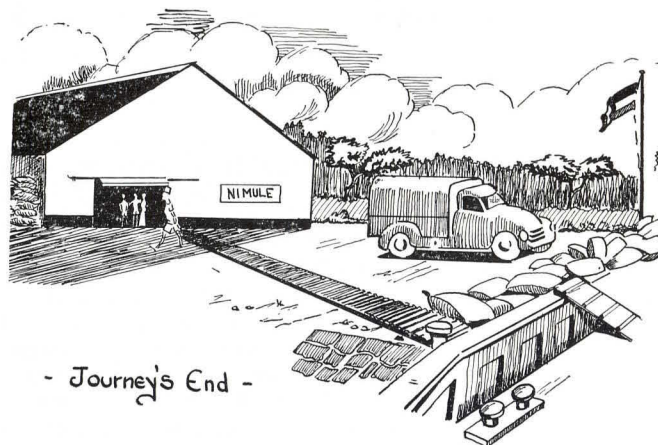

- Journey's End -

EAST AFRICA'S EXPANDING INDUSTRIES

No. 2 . . . Coffee

EAST Africa and coffee have had a close connection, commercially, for over half a century and East Africa's coffee industry is known the world over as being the source of some of the best quality coffee obtainable. The East African coffee industry has earned its reputation upon the merit of quality rather than quantity. The annual output of approximately 70,000 tons, valued for export at over £25,000,000, is small compared with the world output of some 2,735,000 tons. It is likely that East African coffee production will increase as it has continued to increase ever since the first modest attempt to grow Arabica coffee was made by a European near Nairobi, at the end of the last century. The demand for coffee is still on the increase.

History

The early history of coffee is obscure, but several stories are told about the first discovery of the stimulating effect of the coffee berry. The story told here, may or may not be true, but it is a nice story. A goatherd, in Abyssinia, complained to the abbot of a neighbouring monastery that his goats became frolicsome after eating the berries of the coffee tree. The abbot observed that this was so and decided to try the berries for himself. He, too, found that they made him feel exhilarated and accordingly he ordered that the berries be boiled and the liquid be drunk by his monks, who used to fall asleep over their religious devotions. Thereafter they found no difficulty in keeping awake, and the fame of the "wakeful monastery" and the powers of the coffee berry spread rapidly. After trial and error an orthodox method of preparing coffee was evolved.

It has never been determined whether coffee was first prepared as a drink in Abyssinia or Arabia. There is also a difference of opinion as to the derivation of the name "coffee". Some claim that it comes from the Arabic word *K'hawah*, while others maintain that the



name is taken from the word *Kaffa*, a province in Abyssinia. The cult of coffee-drinking whether it originated in Abyssinia or Arabia—neither country far distant from East Africa—started 600 years ago. The habit spread through Arabia to Syria and was thence brought to Europe by merchants who traded in the eastern Mediterranean. There is record that coffee was drunk in Venice in 1615, and it became a fashionable drink in Marseilles in 1644, thereafter spreading rapidly through France, England, Holland and Germany. Coffee-drinking was first introduced into England by a Cretan student at Oxford, Nathaniel Conopius, in 1637, and it seems to have followed that the first "coffee-house" was also opened at Oxford in 1650 by a man called Jacobus. The first "coffee-house" in London, however, was not opened until two years later when one was established in St. Michael's Alley, Cornhill. Thereafter coffee-houses all over England played a leading part in the social life of the country during the 17th and 18th centuries, but not always without opposition. Charles II endeavoured to close the coffee-houses on the ground that they had become centres of political agitation, but such an outcry followed that his closure only lasted 11 days. Coffee-houses were also closed in other countries because of the alleged political activities of their frequenters and the drinking of coffee since early days has several times been banned on religious grounds. On the



Claimed to be the first coffee crop picked in East Africa at St. Austin's Mission, Nairobi, 1902. Seen in the photograph from left to right are: the Rev. Father Tom Burke, Bro. Lucien, Bro. Timothy and Bro. Martial.

other hand the praises of coffee were many times sung and it is interesting to find that Bach composed *The Coffee Cantata* and that there is a statue in Vienna to Franz Kolschitzky, who spread the cult of coffee-drinking there. With a world-wide spread of coffee-drinking the demand for production increased through the centuries with the result that the coffee industry has become one of the greatest importance.

What is Coffee?

Botanically coffee is a genus of the *Rubiaceae* family of which there are some 25 species to be found the world over. Two of these species are to be found in East Africa, *Coffea Arabica* and *Coffea Robusta*. Arabica produces the more attractive drinking qualities, and fetches the higher price, whilst Robusta has the advantage of being the hardier, the more resistant to disease and the more capable of enduring changing climatic conditions. It can also be grown at lower altitudes. The husbandry of coffee is not easy; it needs the most careful attention involving repeated weeding, cultivation, manuring and pruning together with continual preventive measures against insect pests. It takes between four and five years for a coffee tree to reach maturity after which it may yield anything between $\frac{1}{2}$ lb. and 8 lb. of berries. The mature berry consists of two seeds contained in a delicate "silver skin" which in turn is enclosed by a "parchment" covering and surrounded by a yellowish pulp. Ordinarily, each of the two seeds are flat on one side and lie against one

another. To prepare the berries for market basically involves stripping off the outer layers of the berry to liberate the seeds or beans.

Processing

The coffee planter not only grows the coffee but also has to prepare the berries for curing in a factory. Two basic methods are used to prepare coffee for the market. One is the dry method most commonly used for Robusta, the other is the wet method normally used for Arabicas. The dry procedure involves spreading out the berries on a stone or brick drying-floor exposed to the sun's rays. The process takes two or three weeks.

The dry method is the more primitive one and has come to be regarded as less desirable than the wet method since it is thought that "washed" coffee is less likely to be sour. In the wet method, the berries are first placed in large tanks of water and the mature berries sink to the bottom. After soaking they are drawn off through pipes which tear the pulp and liberate the seeds. The pulp is removed and the seeds or beans are conveyed to another tank. Water percolates through the seeds again and fermentation takes place. This loosens the material surrounding the parchment-covered beans. The beans are then washed to remove all dirt and foreign matter and also to segregate the "floats"—the black beans of grading tests. After this the beans are dried on concrete floors by the heat of the sun or by mechanical driers. The coffee beans are then sent from the plantation to a coffee-curing factory where the shells are peeled off by machinery and where the beans are graded.

Conditions Required for Coffee Growing

One of the reasons why the coffee tree is difficult to cultivate is because it will only grow well in certain parts of the world where specific conditions prevail. The tree does not flourish in either high or low temperatures—it grows best in a mean temperature of 70 deg Fahrenheit—it must not be exposed to an annual rainfall of less than 40 inches or more than 70 inches; it requires and grows best on soil of volcanic origin, deep, rich, and well-drained. There are not many places in the world which can provide these exacting conditions and coffee-planting is confined to parts of South America, Colombia, Brazil, Venezuela, Peru, Ecuador, India, Mexico, the British West Indies and Haiti. Coffee is also grown in the three territories of East Africa, for there are districts in East Africa which furnish all the necessary climatic and agricultural requirements.

[Continued on page 277]

Uganda Railway Memories

PART I

Major Robert Foran, an early settler in British East Africa, gives his impressions of travel on the Uganda Railway at the beginning of the century and illustrates them with photographs taken before 1910.

"When Time, who steals our years away,
Shall steal our pleasure too,
The memory of the past will stay,
And half our joys renew."

—Thomas Moore: *Song*

FIFTY-TWO years ago I made my first journey over the old Uganda Railway between Mombasa and Nairobi—March 18/19, 1904. The railway had by then only been completed as far as the shores of the Victoria Lake reaching Kisumu on December 20, 1901, and the first rails had been laid across Mombasa Island in June of 1895. Thus, it was still in the stage of infancy. Those who now travel in luxury over the system of the East African Railways and Harbours can have little conception of what passengers experienced during those early pioneer times. The modern generation has been given little cause for complaint, though often voicing displeasure about absurdly trivial matters and I am often tempted, when perusing their effusions in the local Press, to speculate what they might have thought of the conditions prevailing during my early years in Kenya Colony.

In those days one journeyed through a veritable "Nature's Zoo"—a most apt description, too—between the Coast and Nairobi. The vast congregations of game have long been just a memory of the real old-timers, and can never again be revived. I remember that when the up-mixed train arrived at Makindu, where breakfast was taken in the Dak Bungalow, I counted no less than fifteen different species of wild animals quietly grazing within a radius of a hundred yards of the station: a troop of six giraffe, a solitary rhinoceros, two hyena, zebra, hartebeest, wildebeest, a jackal, Grant's and Thomson's gazelle, Grant's zebra, impala, and various others.

Anything was liable to happen, and passengers could not predict what novelties or adventures would be their lot on the mixed-train to the Highlands. From Makindu to Nairobi I travelled squatting on the roof of



V.I.P.'s were allowed to ride on a comfortable bench above the cow-catcher in front of the engine. Left to right—Ex-President Theodore Roosevelt, R. J. Cunninghame (White hunter), Major Edgar A. Mearno (American naturalist).

the coach, for this provided a perfect grandstand, though sparks from the woodfuel of the locomotive constantly burned holes in our clothing. That was the favourite place for travellers, but the V.I.P.'s were allowed to ride seated on a comfortable bench firmly secured above the cow-catcher in front of the engine. The stalls for the V.I.P.'s, and the gallery for the lesser fry!

Life was far more exciting for railway passengers, and no less so for station staffs, in those early times. There used to be a file of "comics" in the Traffic Manager's office from Asian station masters, which A. E. Cruickshank, then Traffic Manager, allowed me to copy. Here are some of them, culled from an old note-book:—

From Station Master, Simba.
To Traffic Manager, Nairobi.
March, 1902.

"Lion on platform. Please instruct driver and guard of down-mixed to proceed carefully without signal in yard. Guard also please advise passengers not alight from train and be cautious if coming office."

From Station Master, Tsavo.
To Traffic Manager, Nairobi.
May, 1901.

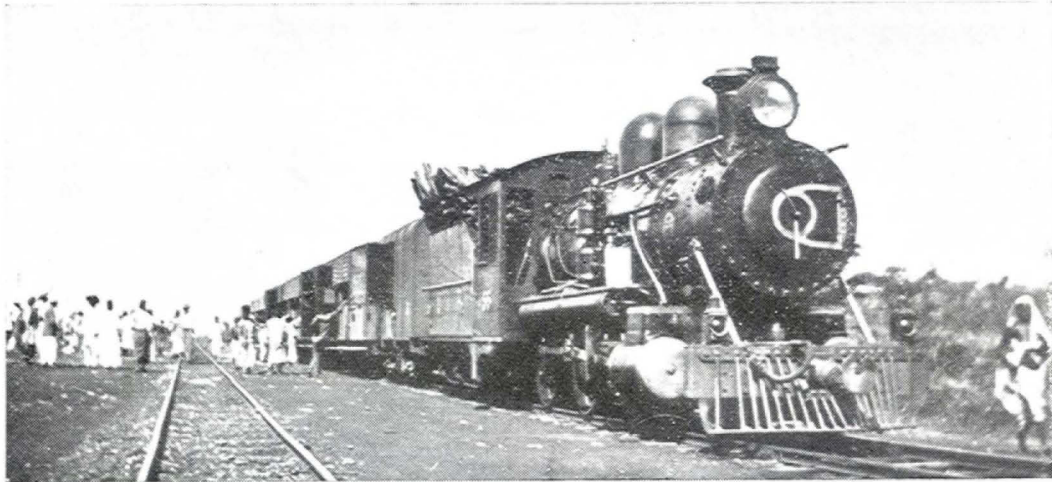

The Uganda Mail arrives at Athi River Station pulled by an American-type locomotive.

"Just a lion twice or thrice to break office and fencing doors, leaving office door on bell ringing half-hour. Myself and family, consisting two wives and three children, narrowly escaping danger of life. Now seeking safety in office. Kindly despatch rifle and one cartridge to aid on first incoming train so can deal with intruder."

From Station Master, Simba.
To Traffic Manager, Nairobi.
August, 1902.

"Two lions on platform. Train approaching and pointsman up water-tank. Lions not let down. I very nervously frightened and secure in office. Cannot dare give 'line clear' signal to on-coming train. Please arrange matter own personal satisfaction and dispose of two lions who great bane my existence."

From Station Master, Simba.
To Traffic Manager, Nairobi.
April, 1903.

"Please inform station master, Makindu, instruct driver up-mixed approach station with caution or beware serious troubles and life dangers. Four lions with consorts aggressively on platform and full charge my official functions. Regret impossible perform necessary duties. Please therefore arrange grave matter under report as said lions and consorts making fearful roars and acting savagely. Am in terror of own life."

At Machakos Road I was introduced to the European engine driver of the up-mixed, Sam Pike. He was a man of note in the new country, having been the first European driver

on the birth of the Uganda Railway and came from the Indian Railways to East Africa. Sam was a "character": also a very privileged person on the new railway. He could get away with almost anything. Sam would halt the train between two stations, walk down the line of coaches, and demand a drink. If this was not forthcoming promptly, he threatened to keep the train stalled until his thirst had been quenched. As no dining cars then existed and refreshments were only obtainable at tea rooms at various stations, all of them managed by the contracting firm of J. A. Nazareth & Co. of Nairobi, everyone wisely took with them a chop-box of foodstuff and supply of drinks. A bottle of beer or whisky was always produced and handed to Sam without further argument, for he was a man of few words and meant exactly what he said. When Sam's inner works had been suitably oiled, the train would proceed to the next station. When Sam wanted a drink, he wanted it; what is more, invariably he got it, too!

Sam Pike would also halt his train if some passenger shot a buck from the carriage while on the move, and wait patiently until the beast had been skinned and cut up. He would accept a choice joint of venison as his share of the spoils, and then sound the engine whistle to signal that the train was going onwards. Timetables did not worry drivers unduly during those carefree days: certainly not Sam Pike! A late arrival at Nairobi could be explained by a convenient hot-box having caused delay between stations. This worked satisfactorily. The hot-boxes on Sam Pike's trains occurred almost every journey. He was the type of man

whom some label a "rough diamond", but was immensely popular with everyone throughout the country.

On one occasion when I was travelling on the up-mixed from Nairobi to Kisumu, a fellow-passenger was a lady who had been the guest of the Cruickshanks in Nairobi and was now proceeding to Entebbe. On arrival at Kikuyu there was a long delay and I sought out the station master to learn what was wrong. He told me that, after the train left Nairobi, it had been discovered that the lady's trunk had been abandoned on the platform and had not been put on the train. An engine and guard's van was bringing the trunk to Kikuyu, and the mixed-train must await their arrival before proceeding.

On another journey in the same direction we arrived at Limuru and found the guard missing. The door of his van was swinging open. There happened to be a doctor on the train, so he and I boarded the engine to investigate, fearing a serious accident might have happened to him. We ran back along the line through the forest and suddenly saw the guard striding along the track, bawling songs at the top of his voice. He was quite unhurt. He explained that, having seen the door of a third class coach swinging open, he had tried to scramble his way along the train to close it but a sudden jolt when going round a curve had thrown him off the train. Once he had rejoined the up-mixed we proceeded.

The Asian station master at Naivasha was once faced with a problem, which could not

be solved by reference to the "books of words". The wife of the European Permanent Way Inspector had died and the bereaved husband wished to have her buried in Nairobi, so wired the Traffic Manager for permission to bring the coffin there on the first down-train. Permission was readily given. The station master had never before handled a coffin for transport on the railway, and the correct procedure greatly puzzled him. Finally, he telegraphed to the Traffic Manager: "Shall I charge Mrs. Smith goods or passenger rates?" The reply was: "No charge."

There was a young South African who came to me when I was in police charge of Nairobi with a tale of woe and asked for my help. He wanted to return to his home in South Africa and only had just enough money to pay for a second class passage from Mombasa to Durban. His available funds would not run to the payment of the railway fare between Nairobi and Mombasa. I offered him the necessary financial help, which the South African, Charlie Hobbs, politely declined. He wished to travel under his own steam. He dined with me and we plotted, the upshot of which was that I aided him in stowing himself that night in a covered steel goods wagon labelled for Mombasa. I had ascertained previously that it would be attached next day to the down-mixed. Hobbs must have had a hellish journey to Mombasa in that sealed wagon, and, indeed, he confirmed this fact in a brief note to me before sailing: "Arrived nearly suffocated, more dead than alive!" I can well believe it.



Naivasha Lake and Railway Station seen from the Rift Valley Hotel in 1907.



NEWS IN



Top left]

A consignment of over a hundred elephant tusks from Nimule being off-loaded from the s.s *Robert Coryndon* at Butiaba. This is the first consignment of ivory that has come up the Albert Nile for many years.

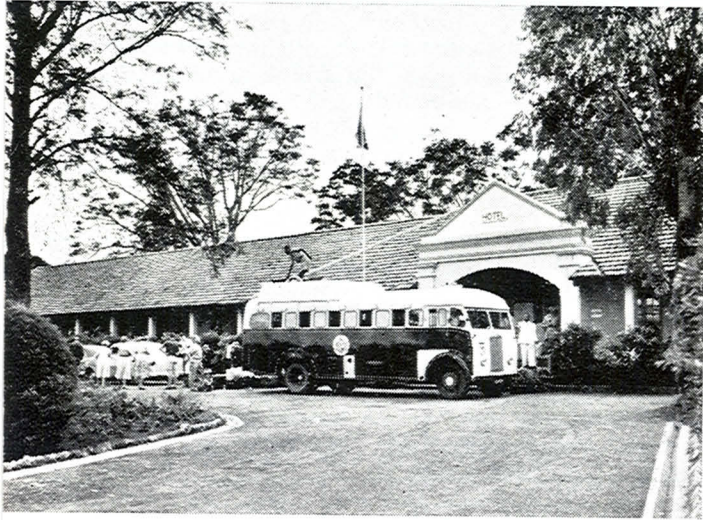

Left]

An East African Railways and Harbours Upper Class bus arrives at the Masindi Hotel from Masindi Port.

Lower Left]

A new block of six flats for East African Railways and Harbours European employees. These flats, which stand on the high ground overlooking No. 1 Berth at Kilindini, were designed by the Architect's Office of the Chief Engineer and were built by the District Engineer, Mombasa. The flats have been designed "one room thick", to give the maximum circulation of air to the rooms.

Below]

The last rail of the Western Uganda Extension is laid at Kasese terminus. This completes 208 miles of line from Kampala passing through most difficult country including swamps, valleys, broken hills and escarpment. Construction began in 1952.

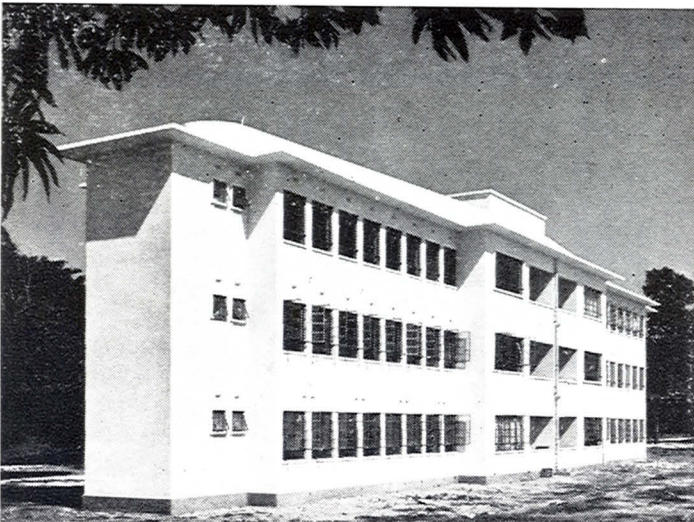

PICTURES



Top right]

On 7th May the restaurant car "Longonot" and one of the new aluminium First Class coaches, attached to the Mombasa-Nairobi Mail, were burnt right out. The fire was discovered between Simba and Emali stations. The coaches were uncoupled from the Mail at considerable risk.



Right]

Next morning. All that remained of the restaurant car and the First Class coach after the fire.

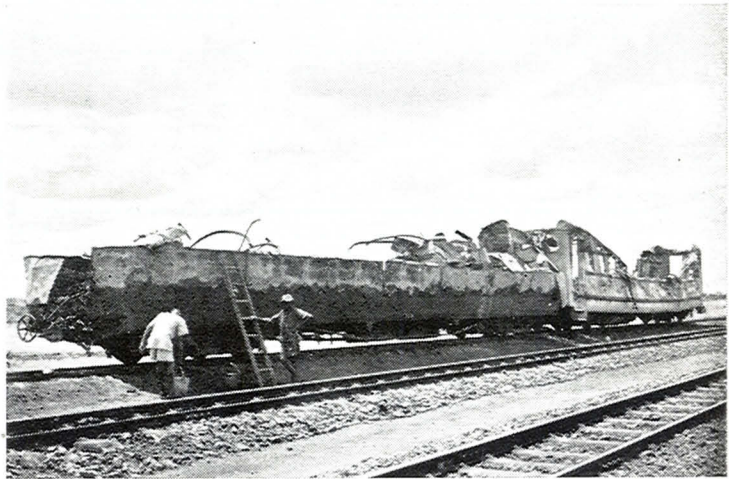

Lower right]

Two six-ton trailers for Scammell mechanical horses being converted in the District Mechanical Engineer's Workshops, Mombasa. These trailers are designed to carry cargo on pallets, and the floorboards incline towards the centre in order to keep the loads in place.

Below]

Mr. J. M. Fogarty (left), the Resident Engineer, Western Uganda Extension, shakes hands with Mr. A. A. Friedman, the Resident Engineer of the Kilembe Mine, as the last rail of the Western Uganda Extension is laid. The beneficial effect upon economic development in the districts through which the line passes is already being felt.

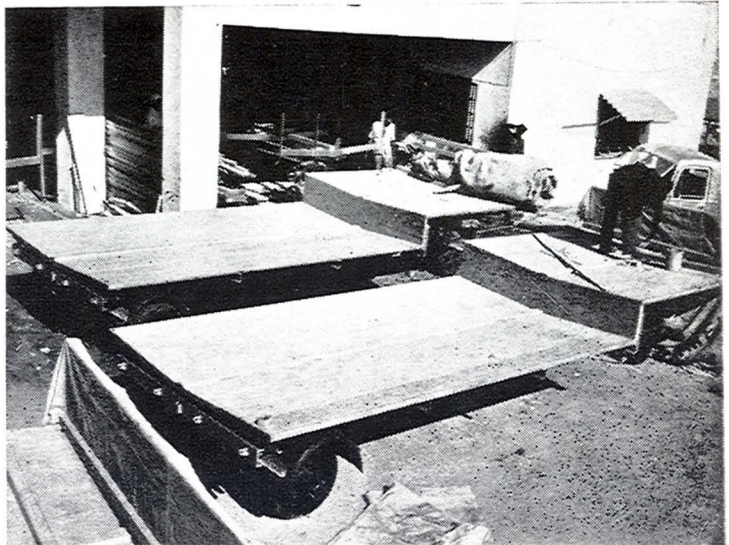
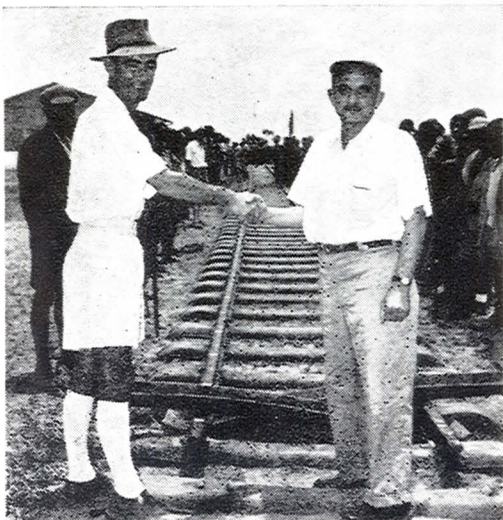



“84” CLASS 0-8-0 DIESEL-HYDRAULIC LOCOMOTIVES

THREE locomotives of this class have recently been put into service, two having arrived in January, 1956, and the third a month later. For the present they will be employed at the Port of Mombasa on heavy-shunting and transfer duties.

The locomotive is powered by a Paxman-type 12 R.P.HXL Series II, 12-cylinder 60° Vee 4-stroke compression ignition engine which develops 510 h.p. at 1,250 r.p.m. The drive is transmitted from the engine through a Voith-North British turbo transmission unit type L24V to the two-range final drive and reversing gearbox from which the jackshaft drives the side rods through balanced cranks. The low speed range of 0-20 m.p.h. is used primarily for heavy-shunting duties and for transfer work on lightweight track. The higher speed range of 0-35 m.p.h. is available for transfer and trip working where track conditions permit of speeds in excess of 20 m.p.h. All coupling rod crank pins

are equipped with British Timken tapered roller bearings. A deadman's control gear automatically applies the brakes and stops the engine, after a short period, if the driver's foot is removed from the treadle.

Manufacturers.—North British Locomotive Co., Ltd., Glasgow.

Gauge.—Metre (convertible to 3 ft. 6 in.).

Horse Power.—510 at 1,250 r.p.m. (sea level rating).

Transmission.—Hydraulic.

Total Weight.—Light, 49 tons 18 cwt. 1 qr.

Total Weight in Working Order.—52 tons.

Low Speed Range.—0-20 m.p.h.

High Speed Range.—0-35 m.p.h.

Tractive Effort—

Low range, 33,300 lb.

High range, 20,500 lb.

Fuel Capacity.—335 gallons.

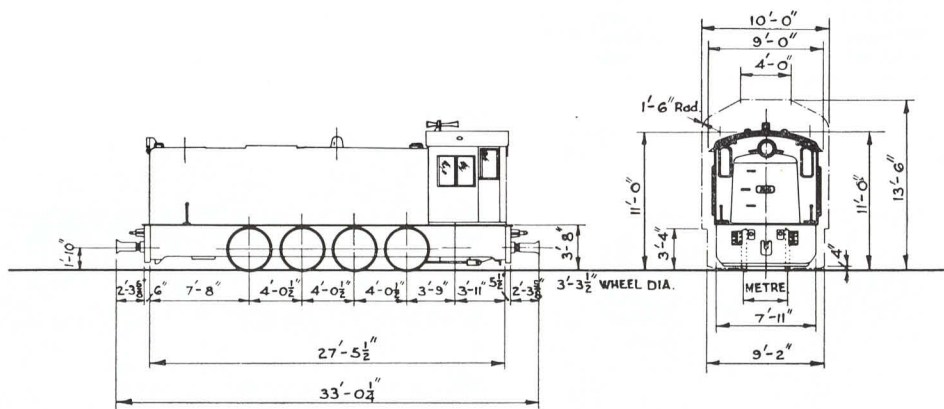

TONS TONS TONS TONS
WEIGHT IN WORKING ORDER. _____ 13 13 13 13

TOTAL WEIGHT IN WORKING ORDER. _____ 52 TONS

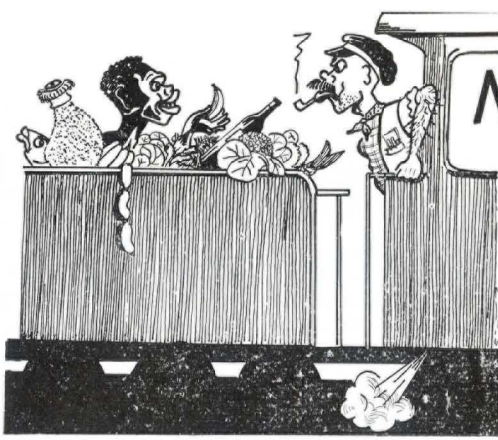

Miscellanea

RAILWAY LINE IS BEING PAVED WITH —GOLD AND SILVER—

The Tabora branch of the Tanganyika Central Railway line is being paved with gold and silver. Small quantities of the minerals are contained in the ballast now being supplied to the line, but they are too low in grade to pay for their extraction from rock. Quarrying for the ballast, may, however, reveal that deposits of payable ore are concealed in the mass of low-grade material. The quarry, Mahene Mine, at Km. 110, on the Tabora-Mwanza line, was worked for gold by Mr. A. S. Kerr in 1945 and 1946. The operations proved uneconomical in the face of mining costs and the mine was closed down and abandoned. Later the Canadian Exploration, Ltd., came to the conclusion that whilst there was evidence that a wide spread of gold mineralization, of copper and a possibility of the occurrence of payable ore, thorough exploration would be an extremely expensive matter. The property was abandoned. But last year a demand arose from the Railway Administration for crushed rock to ballast the Tabora Mwanza line. Canadian Exploration conceived the idea of reopening Mahene Mine for crushed rock over a large area, crushing this material and selling it to the E.A.R. & H. as ballast, with an eye to the chances of discovering and exposing a payable gold-ore body. A siding loop and a short spur line are now being built at the mine. The future of the Mahene gold-mine is in the lap of the gods, but should a metal mine emerge it will be fortunate in having established railway facilities, a mining plant and many other facilities.

[Extract from the "Sunday News", 29-4-56.]

Tender Conversion

Received by the Stores Superintendent:—

"I kindly request to whether you can admit me to one of tenders who are invited for local foodstuffs. I am seventeen years old and I have successfully completed Form II intermediate school."

Berth Birth

A letter addressed to the General Manager reads:—

"I have the honour to inform you that my daughter was born in the passenger train on at 12.30 hours near Mtito Andei. For your information I was travelling on the train from Nairobi as per ticket No. C 8863 and C 8863, birth No. 1109 C. It is believed that any child born in a train is legible for free journey for an indefinite period. Would you please confirm. I thank you very much in respect of the services rendered by your staff during the journey."

[Regrettably the General Manager was unable to comply with this request. The idea might become popular.]



Found in the bodywork of a restaurant car which was being stripped for rebuilding at Dar es Salaam. A third class weekly ticket from Glasgow to Motherwell and Flemington dated March, 1924, and a fish knife inscribed "U.R. Clement Hill". The lake steamer "Clement Hill" was placed in service in 1906 and was withdrawn from service in 1935. She was sunk at Luambo Island as a breakwater in 1936.

Traffic News

THE APPROXIMATE railway revenue for the period 1st January to 30th April, 1956, was £5,959,885 compared with £5,526,754 for the same period on 1955—an increase of 7.8 per cent. Of this total revenue £4,721,528 was derived from goods traffic, £181,734 from the water transport services, £179,142 from the road services and £75,452 from the Administration's hotels and catering services.

During the first four months of 1956, a total of 754,898 bill of lading tons of cargo was imported through Kilindini, an increase of 13.4 per cent over the corresponding figure for 1955. This considerable increase was possible in spite of a marked falling off in the tonnages offering for railing up-country during March and April—an indication that substantial in-roads are being made into the back-log of tonnage alleged to be waiting shipment from the United Kingdom to East Africa.

During the first quarter of 1956, 260,003 bill of lading tons were exported through Kilindini—about 600 tons less than during the first quarter of 1955. Although the actual tonnage shipped from Kilindini, therefore, fell slightly, traffic railed to Mombasa Island in the first four months of this year amounted to 271,525 tons compared with 258,750 tons during the first four months of 1955—an increase of almost 5 per cent. A record was set up in March when 79,449 tons were moved from up-country on the Kenya/Uganda section to the Coast. The previous highest tonnage recorded was 72,074 in July, 1955. Significant increases were involved in the movement of coffee, cotton, cottonseed, groundnuts, sisal and soda-ash. Corresponding railings up-country amounted to 462,422 tons, about 26,000 tons greater than the figure for the first four months of 1955.

The Port of Tanga has continued to work at a very high level. In February, 23,764 bill of lading tons were exported, an all-time record. Altogether, 62,527 bill of lading tons were exported during the first quarter of 1956 compared with 57,375 bill of lading tons during the same period of 1955. Imports in the same period amounted to 37,468 bill of lading tons. It is now evident that with the easing of the situation at Kilindini the high level of imports through Tanga which has persisted during the past 12 months will fall off very considerably. Total railings to Tanga up to 30th April amounted to 56,321 tons—nearly 10,000 tons

more than the corresponding 1955 figure. In very large measure this increase resulted from heavy movements of maize from the Northern Province. Railings up-country from Tanga during the first quarter of 1956 amounted to 22,950 tons.

On the Central Line, imports through Dar es Salaam have been at a lower level than in 1955, due principally to smaller importations of cement. Exports, however, show a marked increase. In the four months ending 30th April, 1956, railings to Dar es Salaam amounted to 82,350 tons, the principal increases being in respect of maize, lead ore and cattle cake. In line with the fall-off in imports, railings up-country from Dar es Salaam were lower than in the corresponding period of 1955.

In general, the railway has been able to meet all demands made on it and there is every indication that considerable increases in tonnage can be dealt with when these are offered for carriage.

In spite of the improved passenger services, both on the Kenya and Uganda section and on the Central Line, it is disappointing to record that overall our passenger traffic is less than it was during 1955, though on the Central Line there are signs that there may be some slight increase over the 1955 level. Earnings from this source during the first four months of this year were about £6,000 less than earnings for the same period in 1955.

In Tanganyika our road services have been faced with very heavy tonnages of maize to be moved to railhead, though this is now almost at an end. To meet the requirements of the Grain Storage Department it was necessary to hire a considerable number of lorries. In Uganda also our road services have been hard pressed to meet all the demands made on them, and it is encouraging to note the success which has attended the introduction of the goods service between Kampala and Masindi Town.

Once again the marine workshops at Kisumu are undertaking a major construction. The *Sybil* has been withdrawn from service for conversion to a passenger/cargo ship, and it is hoped that by September she will be operating a regular service between Mwanza and Bukoba. Both cabin class and third class passenger accommodation will be provided, and she should improve very considerably the service between these two important Tanganyika ports.

RESULTS OF WORKING

January-March, 1956

The tables show the approximate earnings and tonnages carried on the Administration's services during the first three months of the year. Corresponding figures for 1955 are shown for the purpose of comparison:—

| RAIL, ROAD AND MARINE SERVICES | | | | |
|--------------------------------|-------------|------------------|-----------|------------------|
| | TONNAGE | | REVENUE | |
| | 1955 | 1956 | 1955 | 1956 |
| | <i>Tons</i> | Tons | £ | £ |
| January-February | 844,629 | 921,261 | 2,720,584 | 2,980,953 |
| March | 468,690 | 504,386 | 1,427,073 | 1,553,196 |
| Total .. | 1,313,319 | 1,425,647 | 4,147,657 | 4,534,149 |

| HARBOURS | | | | |
|------------------|-------------|------------------|---------|------------------|
| | TONNAGE | | REVENUE | |
| | 1955 | 1956 | 1955 | 1956 |
| | <i>Tons</i> | Tons | £ | £ |
| January-February | 690,745 | 827,467 | 522,504 | 837,236 |
| March | 423,281 | 378,857 | 331,263 | 389,544 |
| Total .. | 1,114,026 | 1,206,324 | 853,767 | 1,226,780 |

Continued from page 255]

Editorial Notes—(Contd.)

The basis of all railway rates is the value, weight, bulkiness, liability to damage, or dangerous nature of the goods to be carried and these factors, coupled with the distance which the goods have to move, determine the price of transporting them. Some railway rates are higher than others, but in no case can they be considered excessive in relation to the retail price of the goods concerned. In addition, although the cost of most goods and services in East Africa has risen since 1947 by anything up to 300 per cent, the price of railway transport has only risen by an average of 40 per cent in the same period. The East African Railways and Harbours are obliged by their governing Act to pay their way and therefore they cannot afford to transport goods—or passengers—for nothing, but, after taking all

factors into account and particularly since the average distance for which they carry goods is over 370 miles, it would be fair to say that railway charges make little difference in these territories to the average man's cost of living.

It would be well to sound one note of caution. The cost of moving goods by railway is low so long as the railway has sufficient quantities of traffic to enable them to achieve the bulk movement which produces this low cost. If a railway loses any substantial proportion of its traffic to other forms of transport, the cost per ton of moving what remains will increase. If this were to happen in East Africa this increased cost would have to be passed on to the customer, since the East African Railways and Harbours must pay their way, though they do not operate on a profit-making basis. In such a situation the cost of railway transport might well become a significant factor in the cost of living.

Commendations & Criticisms

A letter to the General Manager from Mrs. Cooke reads:—

“I should like to thank you and your railway for all the kindness shown last night on the special *Uganda* boat train—I had left one of my father’s suitcases behind at our house in Nairobi and the operator, Nairobi, passed a message for me from Athi. The guard on the train took endless trouble to get a reply to reassure me at Konza, and the catering manager was most helpful—all a really wonderful service and we are very grateful. The suitcase came by air and is now delivered on board.”

* * *

The following letter addressed to the Station Master, Nairobi, came from the Rev. W. J. Picton, the Garrison Chaplain, Nanyuki:—

“As a family we have travelled in many countries, but in no country have we been so favourably impressed with the efficiency of its Railway service as we have been here.”

* * *

Extract from a letter written by Mr. P. S. Luker addressed from Tokyo, Japan:—

“I would like to thank you and your staff for giving me, through my sister, valuable information on transport available between Abercorn and Cairo.

I have been worried for months whether it would be possible for me to travel overland, by train and boat, between these places and your information has made a trip through Africa a plan rather than a hope. No other official department I have ever dealt with, as a journalist or private citizen, has ever shown so much consideration without profit to themselves.”

* * *

An extract from a letter received from Mrs. M. H. C. Topham of Naro Moru reads:—

“I should be very grateful if you could make some inquiry as to why no place was reserved for me on the train leaving Nanyuki for Nairobi yesterday, Thursday the 15th, when I joined it at Naro Moru yesterday morning. I bought my ticket about a week or ten days before and the Station Master at Naro Moru, at the time, and in

the presence of my husband and myself telephoned at once to the office at Nanyuki for a reservation, so that I knew he was not to blame in any way. Had it not been for the helpfulness and courtesy of the guard on the train, who could not have taken more trouble over the matter, I should have had a most uncomfortable journey. . . .”

Comment

The Station Master at Naro Moru telephoned Nanyuki but his call was misunderstood and taken to be an inquiry as to whether there would be room on the train for the passenger. The Station Master receiving such a call should have realized that a call of this nature was unlikely to be an inquiry and taken steps to ascertain whether a reservation was required. An apology has been given to Mrs. Topham. This complaint emphasizes the need for clarity in telephone conversations.

* * *

The following case which occurred towards the end of 1955 may be of interest as showing how essential it is for station staff to follow the simple instructions for dealing with consignments passing through their hands:—

On the 28th November, 1955, a large agricultural hay baler was consigned from Nairobi to Kipkabus. It was correctly loaded to Nakuru for transshipment but did not arrive at Kipkabus. After extensive inquiries were made by headquarter and district office staff and the Railway Police, the lost machine was discovered at Bukoba on 20th January, 1956.

Comment

The consignment had been marked in error as NRB/BKB instead of NRB/ KKB and had been on hand at Bukoba since 9th December, 1955. A considerable amount of time and energy spent on telephoning, telegraphing, writing letters and searching of stations and goods yards would have been avoided if—

- (a) the consignment had been marked correctly at Nairobi in the first place;
- (b) the transshipping staff at Nakuru had spotted the error which could have been done quite easily, as Kipkabus was written quite plainly on the machine;
- (c) the pier staff at Bukoba had reported the machine on hand immediately.

Continued from page 266]

Districts in East Africa where Coffee is Grown

Both Robusta and Arabica are planted in East Africa, but in very widely separated areas, where the climatic conditions are suitable. The localities in which the growth of coffee flourishes are as follow:—

Uganda.—Bugishu, Mengo, Toro, Kampala, Masaka.

Kenya.—Kabete, Kiambu, Ruiru, Thika, Solai, Subukia, the Trans Nzoia, Kisii, Meru and Embu.

Tanganyika.—Oldeani, Arusha, Moshi, Lushoto, Mbeya and Tukuyu.

Coffee is grown by European planters and Africans in all these territories.

The coffee industry in East Africa can be said to have started side by side with the Uganda Railway. Mr. John Patterson established the first coffee plantation in British East Africa in 1896; the plantation was near Nairobi. It was a gamble whether his venture would succeed, but he was under no doubt that if his crop materialized there would be a demand for it on the world market. The venture did succeed and except for a period during the trade recession of the 1930's, coffee has never looked back.

In 1943 Kenya exported 6,000 tons of coffee to a total value of £500,000; in 1952 the comparative figures were 17,000 tons and £7,123,000. Even allowing for the depreciated buying power of the pound, these figures are impressive and, as the African-grown coffee comes into production, they should be greatly exceeded. Coffee in 1953, contributed £6,713,000 to the total value of Kenya's exports, equal to 34.4 per cent.

In the early 1900's Arabica coffee was also introduced into German East Africa (Tanganyika) by a Roman Catholic Mission at Kilema, on the slopes of Kilimanjaro. It is of interest to note, however, that Robusta coffee was planted 250 years earlier in Bukoba by the Bunyoro invaders, who used it, not for drinking, but as an iron-ration. The Chagga, a tribe living in the Kilimanjaro district and particularly noted for their agricultural zeal, were quick to note the prosperity of the Kilema Mission plantations and started to plant coffee themselves. By 1916, the Chagga growers owned 14,000 trees and in 1925 they formed their own Native Coffee Planters' Association. This has now become the Kilimanjaro Native Coffee Union with head-

quarters at Moshi, which handles nearly two-thirds of the washed Arabica coffee produced in Tanganyika.

Although there has been indigenous Robusta coffee in Uganda for centuries, coffee first figured as an industry to a noticeable extent during the First World War. Arabica coffee is grown by both Africans and Europeans, but during the last 20 years, the latter have largely fallen out of production and the main Arabica crop is now limited to African production in Bugishu and in the south-western districts. On the other hand the Robusta industry has expanded rapidly. On many European estates, Robusta has taken the place of the original Arabica, whilst African production, especially in Buganda Province, has reached the status of a large industry.

In all three territories, coffee interests are looked after by representative organizations such as the Coffee Board of Kenya, the Coffee Board of Tanganyika, the Kilimanjaro Native Coffee Union, the Uganda Estate Coffee Producers' Association and the Uganda Coffee Industry Board. The Agricultural Departments of each of the three Governments concerned have all been closely connected with the welfare of the industry, providing, where necessary, financial aid, together with control, and research and experimental stations.

The growth of this industry can be measured by the tonnages carried by East African Railways and Harbours on the Kenya/Uganda, Tanga and Central lines over the last 30 years:—

| | | | | |
|------|----|----|----|---------------|
| 1925 | .. | .. | .. | 14,505 tons |
| 1930 | .. | .. | .. | 22,589 tons |
| 1940 | .. | .. | .. | 52,496 tons |
| 1950 | .. | .. | .. | 73,046 tons |
| 1055 | .. | .. | .. | 187,000 tons* |

Such an increase is truly remarkable especially during the last five years. If world demand does not change, there is every indication that the coffee industry of East Africa will continue to expand.

**The figures include coffee grown in the Belgian Congo and carried on the Central Line, Tanganyika. This amounted to approximately 18,000 tons during 1955.*

ERRATUM

It is regretted that a factual error appeared on page 233 of February's issue of the magazine, in the article "Mombasa, the History and Development". Column two, line nine, should have read:—"However, as capital became available a contract was placed in 1953 for the construction of two new berths founded on screw cylinders. These two new berths were to be in the same line and to the northward of Nos. 7 and 8 berths".

District Notes

Dar es Salaam

The new lighter-towing tug *Kiroboto*, which was designed and built in Dar es Salaam dockyard, was launched on 15th March by Mrs. Bobby Fisher, wife of the late Commander H. I. Fisher, in the presence of Mr. C. W. Leverett, Regional Representative, Dar es Salaam. The *Kiroboto* is the first of two of this particular class of tug; it is larger and of greater horsepower than any previously built in Dar es Salaam, and should prove a valuable addition to the East African Railways and Harbours towing fleet. After launching, the tug proceeded to Tanga under its own power, no trouble being experienced throughout the voyage. The tug handled well, vibration was negligible, and both the main engine and auxiliaries gave most satisfactory results. This craft building programme, employing local labour throughout and working under European supervision, began under the direction of Mr. G. Crawford, Dockyard Superintendent, who was later transferred to Mombasa. Mr. Crawford had the satisfaction of seeing the *Kiroboto* completed and in service whilst he was on his way to the United Kingdom on vacation leave, pending retirement.

The *Kiroboto*, which in Swahili means a "flea", is 47 ft. 6 in. in overall length with a beam overall of 12 ft. 8 in. and a mean draught of 4 ft. 7 in. On trial, a speed of 8.2 knots was obtained with engine revolutions set at 900 per minute.

Namasagali

Beneath a mango tree, upon a small mound, near the Marine Workshops at Namasagali, are the remains of a somewhat prehistoric-looking

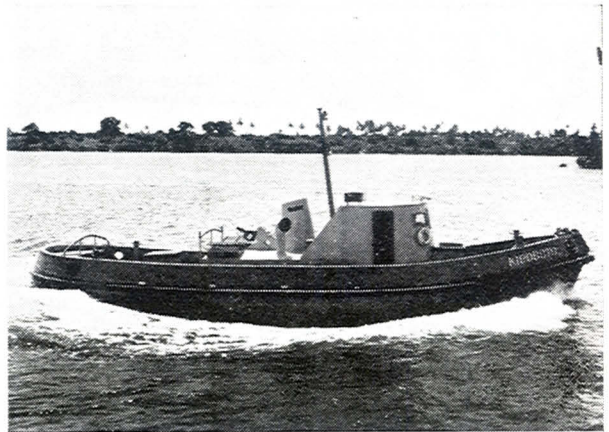

vehicle. At first sight it looks like the counterpart of Kim's gun at Lahore, made famous by Rudyard Kipling. Closer inspection reveals that it is not a gun but is what is left of a four-wheeled conveyance with a broken perch, for the front wheels have become separated from the chassis. In fact this is the pole-wagon which brought the s.w. *Speke's* boiler from Jinja to Namasagali in 1909. According to the story told of that journey over bare bush tracks, the pole-wagon was drawn by a span of 16 oxen or mules. The name Hornsey and Sons Ltd., Grantham, England, can be clearly seen upon the hubs of the wheels. Six inches of earth covers the lower portion of the wheel rims and the wheels must have been fast for many years. Maybe the pole-wagon stands on exactly the same spot where it was left after the journey from Jinja in 1909.

West Nile

Passenger services to and from the West Nile District, as far as Rhino Camp, have been doubled. Since 20th March, there has been a weekly service instead of a fortnightly one via Namasagali, Masindi Port and Butiaba. Third class passenger traffic has increased considerably since the beginning of the year and the need for a weekly service has become very apparent during the last few months. Most of the traffic is made up of immigrant labourers from the West Nile, travelling from the sugar estates at Lugazi and Kakira.

The new weekly services will spread the flow of passenger traffic more evenly and will afford improved transport facilities. Additional services on Lake Kioga by the s.w. *Stanley* to Kachung were also introduced to expedite the movement of cotton from ginneries in that area.

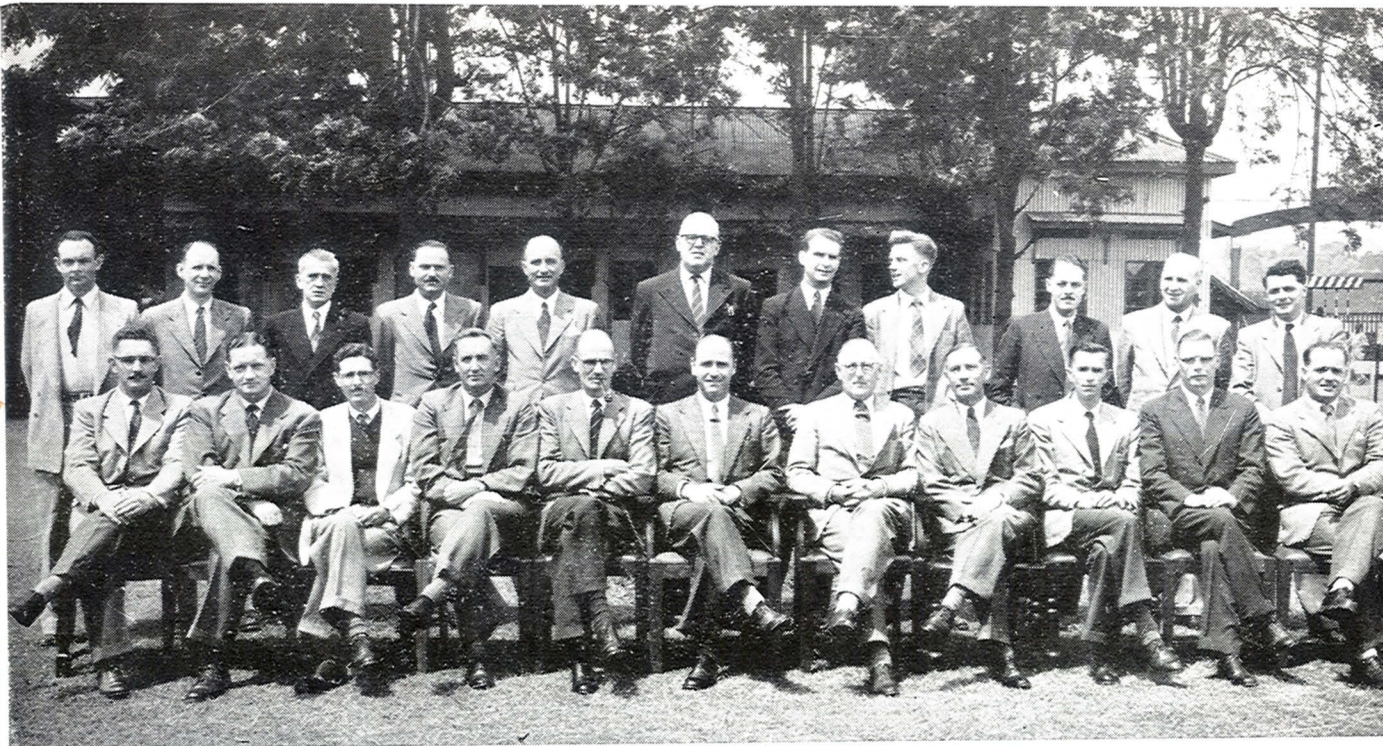

Mechanical Department—District Officers Conference, 1956

Standing, left to right—D. M. S. Fairweather, Acting Asst. W.M. (Nairobi); A. G. Brown, A.M.E. (P.) (Nairobi); W. R. Craig, A.M.P.S. (O.) (Nairobi); B. C. Farmer, D.M.P.S. (Nairobi); A. G. Cowley, W.M. (Nairobi); G. H. Walmsley, Works Acct. (Nairobi); J. E. Fuller, A.M.P.S. (M.) (Nairobi); E. Horner, A.M.P.S. (Eldoret); P. D. Swan, A.M.P.S. (C. & W.) (Nairobi); G. D. Sinclair, E.E. (Nairobi); F. J. Hickson, Adm. Asst. (Nairobi).

Sitting, left to right—A. Towle, D.M.E. (Mombasa); J. W. Lee, D.M.P.S. (Eldoret); J. P. R. McCrindle, S.M.E. (M.P.) (Nairobi); H. B. Marshall, A.C.M.E. (M.P.) (Nairobi); N. F. Stevens, A.C.M.E. (W.) (Nairobi); J. Hudson, C.M.E. (Nairobi); W. E. Bulman, A.C.M.E. (T.) (Nairobi); S. G. Hudson, Acting D.M.E. (Dar es Salaam); F. J. Kent, D.M.P.S. (Tabora); J. Hull, Acting W.M. (Dar es Salaam); J. Stewart, Acting D.M.E. (Tanga).

The following officers have service with home railways as indicated:—

A. G. Brown, L.N.E.R.
W. R. Craig, L.N.E.R.
B. C. Farmer, L.M.S.R.
A. G. Cowley, L.N.E.R.
J. E. Fuller, L.N.E.R.
E. Horner, L.M.S.R.
F. J. Hickson, L.N.E.R.
A. Towle, L.M.S.R.
J. W. Lee, L.M.S.R.

J. P. R. McCrindle, L.M.S.R.
H. B. Marshall, L.M.S.R.
N. F. Stevens, L.M.S.R.
J. Hudson, L.M.S.R.
W. E. Bulman, G.W.R.
S. G. Hudson, L.N.E.R.
F. J. Kent, L.M.S.R.
J. Hull, L.M.S.R.

STAFF NOTES

★ ★ ★

MMR. JAMES MASTER, M.B.E., Assistant Superintendent (Hotels and Catering), went on overseas leave pending retirement in March, having completed 27 years' service in the Administration's catering services. Mr. Master had held the senior executive post in the catering services since July, 1922. A more vigorous officer, always determined to achieve the impossible in feeding the many thousands of travellers by the Administration's services, would be hard to find. No task, however formidable, daunted him, and he will always be remembered for the energetic and courteous manner in which he invariably insisted upon and achieved the highest standards of efficient public catering service.

Mr. Master entered the public catering business at the end of the 1914-18 War, in which he was injured whilst serving as a test pilot in the Royal Air Force. His catering career began with the Irish Pullman cars and in 1929 he joined the Catering Department of the East African Railways and Harbours. The turnover of these services has trebled over the period of Mr. Master's term of office and the results which have been achieved under his direction, often in the face of serious food and staff shortages, command the highest of praise.

Heavy movements of troops, for whom catering services had to be provided at short notice and awkward hours, were a severe strain on the Administration's limited catering organization during the Second World War, but thanks to Mr. Master's competent resourcefulness the demands were at all times adequately met.

Upon the amalgamation of the Kenya and Uganda and Tanganyika Railways in 1948, Mr. Master was faced with the task of introducing the Administration's departmental catering services into Tanganyika in place of private contract catering arrangements, and he was also responsible for the development of the Administration's railway hotels at Dodoma and Tabora, and, more recently, Iringa. This reorganization of the Railway catering services in Tanganyika was indeed an arduous undertaking in view of the most serious losses of experienced catering staff caused by the Emergency operations in Kenya.

The problem of serving thousands of different types of meals from widely scattered mobile and stationary catering units to the many peoples of diverse tastes in East Africa is in the best of circumstances an exacting task and calls for tremendous attention to detailed planning, constant and close supervision and great patience. Mr. Master has carried this burden confidently and efficiently at all times over a long period, and his wide experience and invaluable services will be missed.

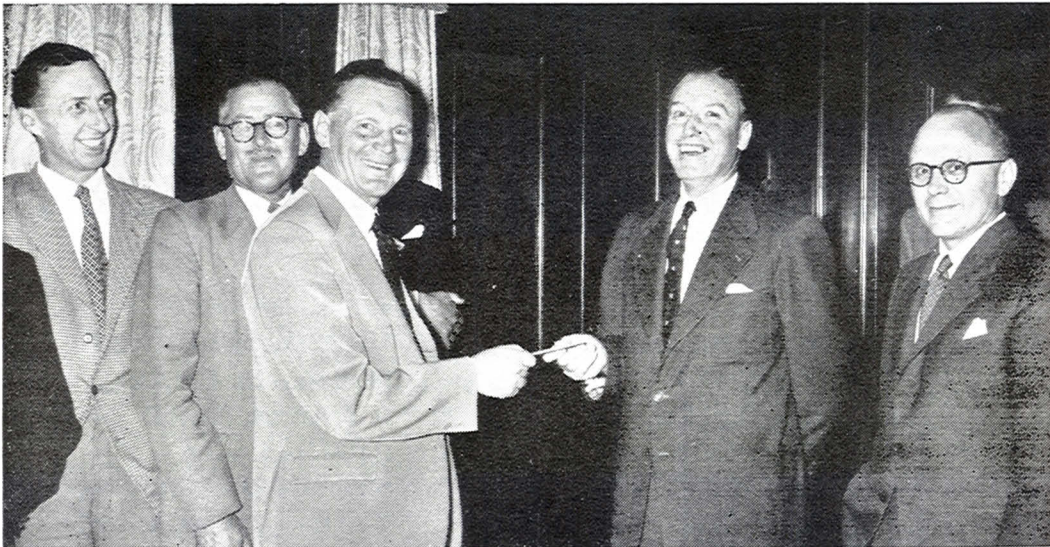

Mr. A. J. R. Master, Assistant Superintendent (Hotels and Catering), is presented with a cheque on his retirement by Mr. A. F. Kirby, the General Manager, East African Railways and Harbours, at a ceremony held on 27th March. In the group are (left to right): Mr. J. M. Kesson, Assistant Chief Engineer, Mr. W. E. Bulman, Assistant Chief Mechanical Engineer, Mr. A. F. Kirby, Mr. A. J. R. Master and Mr. C. T. Hutson, Chief Commercial Superintendent.

In his spare time, Mr. Master was an indefatigable and versatile producer of many theatrical works ranging from straight plays to musical comedy, including many broadcast programmes and colourful pageants of East African interest; but above all, his deepest theatrical interest has been in the presentation of Shakespeare's plays to the public of East Africa, for which he was fittingly rewarded by being made a governor of the Shakespeare Memorial Theatre, Stratford-on-Avon. Mr. Master is a Fellow of the Royal Society of Arts and he was for a long period from its inception president of the Nairobi Musical Society.

Mr. Master on his retirement was presented with two cheques with which to purchase gifts of his own selection. The first of these presentations was made by the General Manager, Mr. A. F. Kirby, on behalf of his Railway colleagues, and the second by Mr. C. T. Hutson, the Chief Commercial Superintendent, on behalf of the Railway Catering Section. The Railway Club, with which Mr. Master had been closely connected throughout his service in East Africa—in sporting circles and as president and producer of the Railway



A reproduction of a pencil sketch of Her Majesty the Queen, drawn by Mr. Jagir Singh Roa, who is an Artisan in the Engineer's Department (N.E.D.). The original drawing is 2 ft. 3 in. x 1 ft. 9 in. Mr. Jagir Singh Rao entered the service on 1st January, 1938, as a mason at Eldoret.



Mr. A. G. Cowley, Works Manager of the Chief Engineer's Department, presents a clock to Mr. Imdad Ali on his retirement.

Players—held a farewell sundowner party in his honour, at which the president of the club, Mr. A. F. Kirby, presented him with an onyx desk set to go with the desk and chairs which he will purchase with the gifts from his colleagues and the Railway Catering Section.

C. T. H.

* * *

Mr. Imdad Ali, who left Bombay to come to Kenya on 17th May, 1922, has retired after 34 years' service with the Administration. When Mr. Imdad Ali, who retired as a Chargehand Grade II, first reported for service at Nairobi, five or six Europeans only were employed in the Nairobi Workshops. Mr. Imdad Ali has five sons, two of whom are studying in Karachi, whilst one is employed in the Pakistan Foreign Ministry's Office. His two other sons and two daughters are with him in Kenya. Mr. Imdad Ali, whilst intending to settle down in Pakistan, hopes to return to Kenya on occasional visits.

* * *

Born in 1892, Mr. Pauze Mwanchao, Shunter Grade XI at Tanga, in the Chief Mechanical Engineer's Department, has retired after 28 years' service. Mr. Pauze Mwanchao is a married man with a family.

Mr. Panda Luhinda, Artisan Grade IX, has retired after 28 years' service. He joined the Tanganyika Railways in 1927 and has been stationed at Tabora during the whole period of his service with the two administrations. He is married.



Mr. W. T. Jones

Mr. William Thomas Jones, who has been seconded to the General Manager's Office as Senior Trainer of the "Training Within Industry" scheme was brought to Kenya in 1924 by his father, who left the Great Western Railway during that year, to join the Uganda Railway. Mr. Jones having first attended the

Below]

Mr. E. R. Muga, of the Mechanical Engineer's Department, photographed with one of his sons, Mr. I. Abonyo, who is a Welfare Assistant in the Administration.

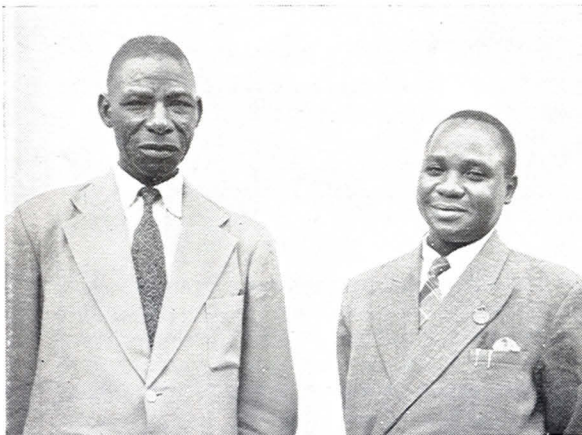

Nakuru Government School, became a founder pupil of the Prince of Wales School, Nairobi, and later, in 1932, joined the Kenya Uganda Railway as an apprentice. On completion of his apprenticeship, Mr. Jones was sent to Messrs. Beyer Peacock's, in Manchester, for a two-year "improvers' course". Since 1955 he has held the appointment of Workshops Instructor.

* * *

Mr. E. R. Muga, of the Mechanical Department, has retired after 33 years' service. During his service he has been Supervisor of Apprentice Boys, an Assistant Hostel Superintendent, a Cook in charge of the European Running Room at Kisumu and an artisan. He has resigned from the appointment of Artisan Grade X in the Chief Mechanical Engineer's Workshop, Nairobi, with happy recollections of East African Railways and Harbours.

* * *

For some time past, East African Railways and Harbours have sponsored a scheme whereby European and Asian schoolboys are given holiday employment by working for the Administration, and earning a nominal salary. The salient idea of the scheme is to

Below]

Brian Eve, of the Prince of Wales School, Nairobi, at work in the Civil Engineer's Drawing Office, where he has been under instruction during the Holiday Employment Scheme for Schoolboys. Brian Eve's father is Mr. E. C. Eve, Establishment Officer in the General Manager's Office.

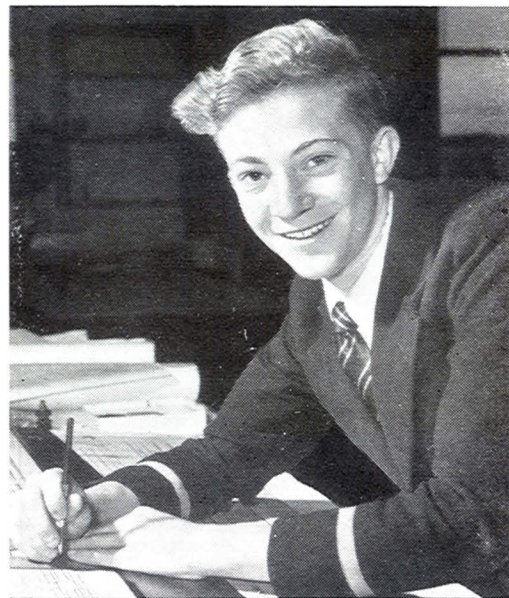

encourage boys who are seeking a career to join the Railway and Harbours Administration. It gives the Administration the chance of weighing up a boy's potentialities and also of assessing his worth as a potential employee.

It is the opinion of many East African Railways and Harbours employees that an aptitude for railway work is born rather than made and this aptitude is liable to show in students almost from the very start. There are openings for the future in all of the Railways and Harbours Departments whether it be Commercial, Operating, Civil Engineering, Accounts, Stores or Mechanical Engineering. A boy who has made the grade during holiday employment, and who wishes to be employed by the Administration on finishing school, will be taken in on his merits and he will have the advantage of starting a job already knowing something about it and also knowing what to expect.

The scheme has recently expanded and 14 African students from the Makerere College, Uganda, are spending their long vacations with East African Railways and Harbours.

After 26 years of loyal and faithful service Mr. Hamisi Salahe has retired at the age of 54 years from the Administration. He was employed at the time of his retirement as an Artizan Grade D in the Stores Department at Tanga.

* * *

Mr. Ishwerbhai K. Patel, Station Clerk Grade V, is going on leave pending retirement on 30th April.

Mr. Patel, who was born in 1899, has had 36 years' service and has been stationed at many places along the line. Before being transferred to Nakuru in 1951, he was serving at the Kisumu Pier Goods Shed.

* * *

Mr. Mubiru Yosia, Clerk Grade XI in the Chief Commercial Superintendent's Department, who joined the Administration on 1st May, 1921, has retired after 34 years' service.

Mr. Mubiru has been employed for most of his service at Buwaya Pier and Kampala. In April, 1953, he was posted to the Kampala Goods Shed.



A group of the Chief Mechanical Engineer's staff on the occasion of a presentation to Mr. K. N. Dutt, Chief Clerk of the Material Control Office, who has retired after over 28 years' service. A radio, a cigarette case and a pen and pencil set were presented to Mr. Dutt by Mr. A. G. Cowley, the Works Manager.

Front row, sitting (left to right)—Messrs. K. Din, R. Tayler, D. Hess, J. Macaulay, J. Mitchel, D. Bolland, D. Fairweather, A. G. Cowley, K. N. Dutt (to whom the presentation was made), A. Brown, J. Thomas, A. Shah, P. MacBrearty, H. Kirby.

First row, standing—Messrs. A. Sampson, F. Okongo, R. Wandera, O. Silvester, D. Zadock, W. P. Burn, A. De Souza, M. Lall, A. S. Mir, V. Pall, A. Ditta, A. Hassis, E. G. Opondo, M. S. Malik, B. A. Bhatti, P. Singh, P. Owundu, L. Odera.

Second row, standing—Messrs. S. Lukini, D. Wanyoki, R. Marlingi, P. Otio, O. Jebenia, L. Manyasi, G. Osari, M. Maredo, A. Hassan, D. K. Dey, A. Ibrahim, P. Gdiambo, R. P. Reddi, M. Lall, B. Singh, Bhagat Singh, C. Odiambo, H. Okelo, J. Odiero, D. Oyugi, K. Mutende, K. Pews, B. Wanyama.

RECENT PROMOTIONS

General Manager's Department

J. P. Lovegrove, Nairobi, to Executive, Div. "C".
Mrs. Rapley, Nairobi, to Clerk, Grade IV.
Mohamed Amin, to Instructor (T.W.I.), Grade IV.

Accounts Department

Mohamed Singh, Nairobi, to Clerk, Grade VIII.
Kewal Krishan Prashar, Nairobi, to Clerk, Grade VIII.

Port Department

J. Murray, Mombasa, to Foreman, Grade I.
G. McLarnon, Dar es Salaam, to Foreman, Grade I.
F. C. Aspinwall, Dar es Salaam, to Foreman, Grade II.
W. S. Thomas, Mombasa, to Foreman, Grade III.
Miss K. H. Crawford, Dar es Salaam, to Stenographer I.
R. M. Child, Mombasa, to Clerk, Grade IV.
L. E. D'Souza, Mombasa, to Clerk, Grade VI.
Roque D'Mello, Mombasa, to Clerk, Grade VI.

Stores Department

N. N. Vaid, Nairobi, to Clerk/Storekeeper, Grade VIII.
Hardyal Singh, Nairobi, to Clerk/Storekeeper, Grade VIII.
William Orwa, Nairobi, to Clerk/Storekeeper, Grade XI.
Nyambok Omach, Nairobi, to Clerk/Storekeeper, Grade XI.
Jairo Andiego, Nairobi, to Clerk/Storekeeper, Grade XI.

Mechanical Department

J. E. Roane, Mtwara, to Inspector, Div. I, Grade I.
P. L. Malan, Shop 009, Nairobi, to Foreman, Div. I, Grade I.
V. H. D. A. Brooks, Shop 007, Nairobi, to Foreman, Div. I, Grade I.
M. M. White, Shop 007, Nairobi, to Foreman I, Grade II.
Raj Singh, Tabora, to Chargehand, Grade V.
G. F. Fernandes, Kampala, to Leading Artisan, Grade VI.
Stephen Zambetakis, Tabora, to Leading Artisan, Grade VI.
Rattan Singh, Tabora, to Artisan II, Grade VII.
Ahmed Mohd Arat, Dar es Salaam, to Artisan II, Grade VII.
Simion P. Fikion, Dodoma, to Artisan II, Grade VII.
Nirmal Singh, Shop 003, Nairobi, to Artisan II, Grade VIII.
Mohd Hussein, Morogoro, to Artisan II, Grade VIII.
Hassanali Ismail, Dodoma, to Artisan II, Grade VIII.
Adam Shamsheychi, Dar es Salaam, to Artisan II, Grade VIII.
Dharam Pall, Dar es Salaam, to Artisan II, Grade VIII.
Paul Majaliwa, Dar es Salaam, to Artisan III, Grade IX.
N. Rombo, C.X.R., Kisumu, to Artisan IV, Grade X.
W. Mukuya, C.X.R., Eldoret, to Artisan V, Grade XI.
A. Samson, Kampala, to Artisan V, Grade XI.
Asmani Hamidi, Dar es Salaam, to Artisan V, Grade XI.
Miss V. Lay, District Motive Power Superintendent, Nairobi, to Stenographer I.
C. W. Dalgairns, Nairobi, to Div. I, Junior Prob. Draughtsman.
Jashrat Anya, Dar es Salaam, to Clerk, Div. II, Grade VI.
D. K. Dey, Nairobi, to Clerk, Div. II, Grade VIII.
Raphel Chulu, Dar es Salaam, to Clerk, Div. III, Grade XI.
Phillip Mayaka, Dar es Salaam, to Clerk, Div. III, Grade XI.
D. P. Sharma, Mombasa, to Driver I, Grade V.
Mukuzi, Voi, to Driver III, Grade VII.
Mohd Yusuf, Eldoret, to Driver IV, Grade VIII.
Ngunu, Mombasa, to Driver I, Grade IX.
Okumu, Mombasa, to Driver V, Grade IX.
Malebe, Mombasa, to Driver V, Grade IX.
K. Siobie, Kampala, to Driver V, Grade IX.
Webuye, Jinja, to Driver V, Grade IX.
Hamisi Alii, Mwanza, to Driver V, Grade IX.
A. Olale, Kilindini Harbour, to Crane Driver, Div. III, Grade X.
Knsimba, Kilindini Harbour, to Crane Driver, Div. III, Grade X.
Onyimbo, Kilindini Harbour, to Crane Driver, Div. III, Grade X.

Engineering Department

N. R. Pickering, Nairobi, to Inspector (Godown Areas), Grade II.
Mohamed Khan, Sultan Hamud, to P.W.I., Grade III.
S. D. B. Patel, Namaganda, to P.W.I., Grade III.
K. C. Rajp Shinyanga, to P.W.I., Grade III.
Hansraj Kala, Dar es Salaam, to Chargehand, Grade V.
Prem Nath Sood, Nairobi, to Tracer, Grade VII.
S. J. Alvarez, Nairobi, Tracer, Grade VIII.
M. A. Latif, Nairobi, to Tracer, Grade VIII.
Ram Singh Mehanga Singh, Nairobi, to Artisan, Grade VIII.
Ambaram Vallabh, Nairobi, to Artisan, Grade VIII.
Charan Singh Amar Singh, Nakuru, to Artisan, Grade VIII.
Vithal Visram, Dar es Salaam, Artisan, Grade VIII.
Naran Jiwa Mandora, Dodoma, to Artisan, Grade VIII.
Juma Bilali, Dodoma, to Artisan, Grade IX.
Salim Ali, Dodoma, to Artisan, Grade IX.
Sadok Nyasio, Nakuru, to Artisan, Grade IX.

L. G. Gichuhi, Nairobi, to Clerk, Grade IX.
Yusuf Mohamed, Mombasa, to Clerk, Grade IX.
R. M. Makoji, Mombasa, to Clerk, Grade X.
Henry Obunde, Mombasa, to Clerk, Grade X.
Benjamin Karanja, Nairobi, to Clerk, Grade X.
C. M. P. Hinjusun, Sultan Hamud, to Clerk, Grade X.
M. H. Salch, Tanga, to Clerk, Grade X.
D. Mbwana, Tanga, to Clerk, Grade X.
Soud Othman, Dar es Salaam, to Clerk, Grade X.
John Elunguta, Tororo, to Clerk, Grade X.
W. A. Rashidi, Mtwara, to Clerk, Grade X.
Jumbe Mwarabu, Tanga, to Artisan, Grade X.
Waziri Ali, Mombasa, to Artisan, Grade X.
K. G. Kinuthia, Nairobi, to Clerk, Grade XI.
Enesti Oyak Onek, Nairobi, to Artisan, Grade XI.
Jonathan Mwachanya, Nairobi, to Artisan, Grade XI.
Johana Omina, Nakuru, to Artisan, Grade XI.
Ali Ramadhani, Tanga, to Artisan, Grade XI.
Juma Pembe, Dodoma, Artisan, Grade XI.
Matata Ali, Tabora, to Tracer, Grade XI.
Ongadi Obade, Tsavo, to Stationary Engine Driver, Grade XI.
Thabithi Alii, Dar es Salaam, to Motor Driver, Grade XI.
Farasco Ekesa, Eldoret, Motor Driver, Div. III, Junior.
Titus Kazinza, Mwanza, to Clerk, Div. III, Junior.
Mwangi Muhaicha, Nakuru, to Clerk, Div. III, Junior.
Peter Chengo, Mombasa, to Clerk, Div. III, Junior.

Commercial and Operating Departments

F. J. L. H. Stone, Nairobi, to Yard Master, Executive Div. "B".
J. L. Jacklin, Kilindini, to Yard Master, Executive, Div. "C".
J. P. M. Armstrong, Nairobi, to Catering Inspector, Div. I, Grade I.
B. Franzal, Dar es Salaam, to Catering Inspector, Div. I, Grade I.
D. D. Mayor, B.E.M., Kampala, to Traffic Inspector, Div. I, Grade I.
R. Pearson, Kilindini, to Deputy Yard Master, Div. I, Grade I.
R. P. Clarke, Kampala, to Traffic Inspector, Div. I, Grade I.
J. Shaw, Kilindini, to Deputy Yard Master, Div. I, Grade I.
E. Hopper, Nairobi Yard, to Deputy Yard Master, Div. I, Grade I.
G. H. Nicoll, Kampala, to Traffic Inspector, Div. I, Grade I.
J. H. Fairless, Mombasa, to Yard Master, Div. I, Grade I.
C. N. Watkins, Nairobi Yard, to Deputy Yard Master, Div. I, Grade I.
D. H. Pickering, Kilindini, to Assistant Yard Master, Div. I, Grade II.
E. H. Jones, Nairobi Yard, to Assistant Yard Master, Div. I, Grade II.
J. I. Sutton, Tabora, to Traffic Inspector, Div. I, Grade II.
T. J. Bird, Nairobi Yard, to Assistant Goods Agent, Div. I, Grade II.
T. W. Marsden, Nairobi, to Clerk, Div. I, Grade II.
H. J. Cave, Nairobi, to Assistant Yard Master, Div. I, Grade II.
J. A. Elkins, Nakuru, to Station Master, Div. I, Grade II.
K. Harwood, Tanga, to Clerk, Div. I, Grade II.
L. R. Mitchell, Dar es Salaam, to Station Master, Div. I, Grade II.
D. F. Muir, Kampala, to Clerk, Div. I, Grade II.
S. Pritchard, Dodoma, to Traffic Inspector, Div. I, Grade II.
G. W. Creese, Kilindini, to Assistant Yard Master, Div. I, Grade II.
J. Longford, Nairobi, to Clerk, Div. I, Grade II.
F. Wild, Kilindini, to Assistant Yard Master, Div. I, Grade II.
D. Severn, Nairobi, to Assistant Yard Master, Div. I, Grade II.
A. H. Samuel, Nairobi, to Controller (T. or M.P.), Div. I, Grade II.
A. B. Salt, Nairobi, to Catering Inspector, Div. I, Grade III.
S. R. Goldsmith, Dar es Salaam, to Clerk, Div. I, Grade III.
A. Kidd, Kampala, to Clerk, Div. I, Grade III.
G. Forte, Vacation leave, to Clerk, Div. I, Grade III.
Sarwan Singh, Nairobi, to Yard Foreman, Div. I, Grade III.
Kartar Singh, Nairobi, to Yard Foreman, Div. I, Grade III.
L. W. Morris, Nairobi, to Goods Shed Foreman, Div. I, Grade III.
G. A. Merry, Nairobi, to Goods Shed Foreman, Div. I, Grade III.
H. H. Acharya, Namasagali, to Station Master, Div. I, Grade III.

It is regretted that all the promotions that were received from the Commercial and Operating Departments have not been included. These will be printed in the next issue.

Sporting & Club News

Nairobi Railway Club

The long-awaited extensions to the club building are well under way and the new bar-lounge should be ready by July. There is a very pleasant view from this high vantage point over the Railway Golf Course and across the club playing grounds towards the Parliament buildings, and the extensions will include an open covered terrace for watching sports and games. When the left wing is completed, a flat for the secretary/manager will occupy the right wing.

Soccer takes top place in outside activities at present and the Railway Club is taking a prominent part in establishing the new European Soccer League at Nairobi, with several club members on the League Executive. Railway teams have entered for the Dobbie League and the Judge League. Mr. Cyril Manning, the club soccer secretary, is

keen to form a Railway Juniors team of schoolboys who are day scholars, to play some of the primary school teams. Over 30 youngsters, including one enthusiastic girl, attend the weekly practice on the club ground.

The club was honoured to have Mr. Stanley Matthews as a sun-downer held at the club during his successful tour of East Africa.

Several of our members did well at the Parklands Tennis Tournament during May, including Mr. Percy Byers and Mr. Clive Wharton who reached the final of the Men's Handicap Doubles.

A new departure in the club's monthly programme is a series of classical musical concerts which are enjoyable and much appreciated.

The Railway Players are getting ready to take part in the annual Kenya Drama Festival.

Below]

The Railway Mixed Hockey Team which has retained the May Knock-out Competition Shield for the year 1956. In an exciting final, this team beat the Impala "A" team on the latter's ground by three goals to two

**Back Row—P. Vaughan, A. Hawkins, P. Coulson, N. Deckar, A. Lacey.
Front Row—J. Goodall, K. O'Shea, D. Mathews, J. Clarke, J. Marsh.**

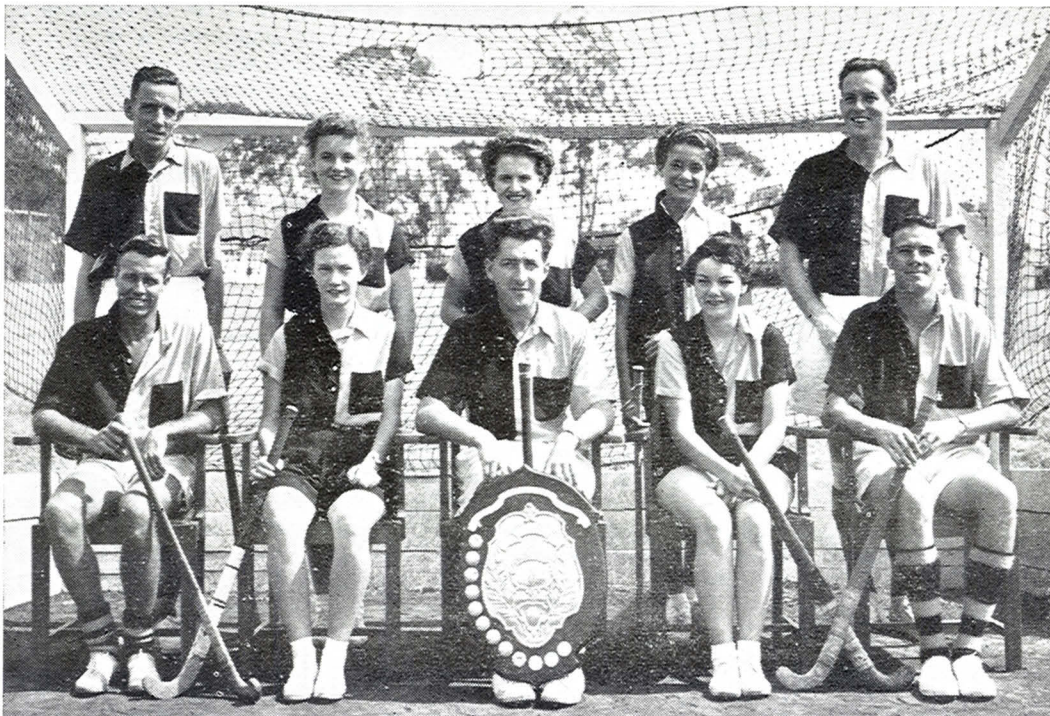

Fourteenth Railway Athletic Meeting

INTEREST in the Fourteenth Railway Athletic Meeting is steadily growing. The meeting to be held at the Nairobi Railway Club on the 21st and 22nd July, is promising to be the best ever and new records will no doubt be set up in both the Railway and open events.

Competition for the "Rhodes" Departmental Challenge Shield will be keener this year as strength has been added to two previous departmental teams. It has been decided to join the Stores and Accounts teams and the Ports team is to be reinforced for the first time by competitors from the Landing and Shipping Company.

It has been thought advisable to give districts and departments guidance as to the standards below which no competitor will be allowed to enter for the various track and field events. The standards, detailed below, are not high, but should ensure that all competitors are in training and able to put up a reasonable showing in the track heats and field eliminations.

| Event | Standard |
|---------------------------|-----------------|
| 100 yds. | 11.5 secs. |
| 100 yds. (apprentices) .. | 11.5 secs. |
| 120 yds. hurdles | 21.0 secs. |
| 220 yds. | 26.0 secs. |
| 440 yds. | 58.0 secs. |
| 880 yds. | 2 min. 15 secs. |
| One mile | 5 min. 10 secs. |
| High jump | 5 ft. |
| Long jump | 17 ft. |
| Hop, step and jump | 35 ft. |
| Discus | 70 ft. |
| Shot | 28 ft. |
| Javelin | 100 ft. |

East African Railways and Harbours will be represented at the Olympic Games,



Miss P. Northrop

which are being held at Melbourne, Australia, between 22nd November and 10th December this year by Miss Peggy Northrop.

Miss Northrop, who is on the General Manager's staff, has achieved, in recent weeks of training in Nairobi, what is the equivalent of the 100 metres in 68 seconds at sea level. This brings her time within the standard required for entry. She is now concentrating on the 400 metres and intends to compete in both events at Melbourne.

Miss Northrop, who is 21 and Kenya born, swam for the Mermaids Club in the English National Championships of 1954, and brought back the Gold Medal.

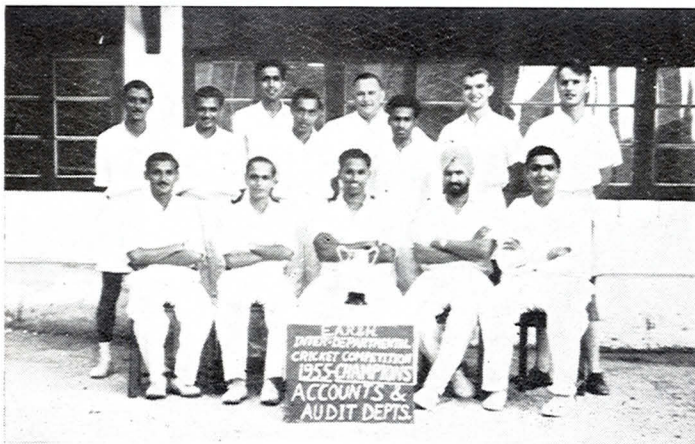

Erratum.—It is regretted that in the February issue of the Magazine the names of the Dar es Salaam Accounts/Audit XI appeared beneath a photograph of the Railway Asian XI, winners of the Sethi Challenge Cup. To the left is the correct photograph of the Accounts/Audit XI, winners of the Kassum Brothers Cup, Dar es Salaam. Sitting, left to right: J. Vaghela, A. Mascarenhas, A. D'Costa (Captain), Tarlochan Singh, N. Karmali. Standing, left to right: F. Giga, G. A. Patel, C. J. Bhatt, J. D'Souza, C. L. Duly, N. Nair, N. L. Allott, A. Dalby.



Above]

The Stores Department Team, winners of the "Dalton" Cup in the 1955 Inter-Departmental Football Competition, with their supporters. Sitting, from left to right: W. J. Lardner (Stores Superintendent), S. Osiaka, A. Obara, N. Omach (Captain), W. Mwamba, J. Majera, G. Oko, M. Barreto. Standing, from left to right: Wandhala, F. Shimwaka, J. Onyango, Malika, M. Wandera, J. Wandera, K. Madhunde, S. Obamba and J. Ameyo.



Right]

Nyambok Omach, Captain of the Stores Department Team, receiving the "Dalton" Cup from the Principal Welfare Officer, Mr. I. L. Robinson.

Below]

Police Team, runners-up of the "Dalton" Cup. Sitting, from left to right: S. Mwalo, W. Kamula, P. Onyancha (Captain), J. Shigali, L. Techera. Standing, from left to right: F. Munwango, E. K. Otieno, S. Coutinho, P. Manyoni, A. Okwayo and J. D. Mitchell.





Places and Faces

THE NAMASAGALI STORES

The Namasagali Stores is of great importance as a depôt of supply. The picturesque little township of Namasagali is situated at the connecting centre between a Lake Service terminal on Lake Kioga and the railhead of a branch line from Mbulamuti Junction on the main Kenya/Uganda line. The Namasagali Stores is responsible for maintaining the supply of general and catering stores, together with rations for the East African Railways and Harbours' staff over a vast area throughout districts of Uganda which include Masindi Port, Masindi Town, Butiaba, Murchison Falls, Pakwach and Nimule. The river steamers *Speke*, *Stanley* and *Grant* are also provisioned through the Namasagali Stores. Inwards and outwards tonnages handled by this depôt during 1955 amounted to 9,100, including fuel oil for the river steamers on Lake Kioga and Lake Albert.

To the left and right: Members of the Namasagali Stores staff are pictured:

- | | |
|-----------------------------------------------|-----------------------------------------------|
| (1) Stores Clerk Kamal Dev Punja. | (2) Clerk/Store- keeper John Omolo. |
| (3) Clerk/Store- keeper Benjamin Omuga. | (4) Clerk/Store- keeper Selestinu Ayoo. |
| (5) Porter Haliwa. | (6) Headman Ofuwa Owuor. |

Headman Ofuwa Owuor has the longest service with 30 years, whilst Porter Haliwa has served for 28 years. Clerk Kamal Dev Punja is at present on leave in India.

