

**NATO JOINT
MILITARY SYMBOLOGY
APP-6(C)**

(INTENTIONALLY BLANK)

APP-6(C)

NATO JOINT MILITARY SYMBOLOGY

MAY 2011

(INTENTIONALLY BLANK)

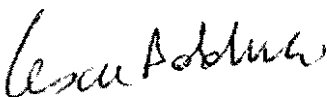

NORTH ATLANTIC TREATY ORGANISATION

NATO STANDARDIZATION AGENCY (NSA)

NATO LETTER OF PROMULGATION

24 May 2011

1. APP-6(C) – NATO JOINT MILITARY SYMBOLOGY is a NATO UNCLASSIFIED publication. The agreement of NATO nations to use this publication is recorded in STANAG 2019.
2. APP-6(C) is effective on receipt. It supercedes APP-6(B), which shall be destroyed in accordance with the local procedure for the destruction of documents.


 Cihangir AKSIT, TUR Civ
Director, NATO Standardization Agency

(INTENTIONALLY BLANK)

NATIONAL LETTER OF PROMULGATION

(INTENTIONALLY BLANK)

(INTENTIONALLY BLANK)

RECORD OF RESERVATIONS BY NATIONS

CHAPTER	RECORD OF RESERVATIONS BY NATIONS
General	DEU, GRC, USA

RECORD OF SPECIFIC RESERVATIONS

NATION	SPECIFIC RESERVATIONS
DEU	DEU will implement STANAG 2019 (EDITION 6) - AAP-6(C) initially for manual use only, automated systems will follow on a case by case basis.
GRC	Hellenic Navy will implement APP-6(C) in the operating planning - analysis framework by inserting the related symbols manually. The electronic format of APP-6(C) will be applied as a standard for the future acquisition of Automated Command and Control Support Systems on a case by case basis and in such way to avoid possible screen clutter.
	<p>The United States (USA) does not subscribe to the language in Table 3-3 which reads: “A unit in which infantry and armour units are assigned together to achieve a combined arms effect.”</p> <p>Rationale. US ratification is contingent upon higher lever AJP approved terminology and MCM-0041-2010, “MC Position on the Use of Effects in Operations”; effects are created or generated to support achievement of objectives. Effects and objectives are not interchangeable terms. Text should read: “A unit in which infantry and armour units are assigned together to create a combined arms effect.”</p> <p>The USA does not subscribe to the language in paragraph 0701 which reads: “Ultimately, the joint force commander and his forces must be capable of accomplishing their mission, either directly or indirectly, by the application of physical or psychological effects, and be able to sustain such operations for as long as is necessary to achieve operational objectives.”</p> <p>Rationale. US ratification is contingent upon higher lever AJP approved terminology and MCM-0041-2010, “MC Position on the Use of Effects in Operations”; effects are the result of the employment of capabilities. Effects are not something that is applied. Text should read: “Ultimately, the joint force commander and his forces must be capable of accomplishing their mission, either directly or indirectly, by the employment of capabilities to create physical or psychological effects, and be able to sustain such operations for as long as is necessary to achieve operational objectives.”</p>

PREFACE

0001. This standard provides common operational symbology along with details on its display and plotting to ensure the compatibility and, to the greatest extent possible, the interoperability of North Atlantic Treaty Organization (NATO) command and control systems, operations, and training and is intended to be equally applicable to operations conducted by a coalition of NATO, partners, non-NATO nations or other organisations.
0002. This new edition reflects a baseline of agreed changes, provides additional symbols, and reflects the harmonization initialised with all services.
0003. Allied Procedural Publication (APP)-6(C) focuses on the building block nature of military symbols. It contains figures and tables that provide the user with standard frames, icons, modifiers, and amplifiers using colour, graphic and alphanumeric representations along with guidelines for their use. Each of the symbols shown is a reflection of NATO doctrine.
0004. APP-6(C) is designed to be flexible enough to accommodate further change, development and input from the operators and users. Changes to these symbols and the addition of new symbol sets will be worked through NATO procedures.

(INTENTIONALLY BLANK)

NATO JOINT MILIARY SYMBOLOGY

CONTENTS

Chapter 1	Military Symbols	1-1
	Introduction	1-1
	Detailed Requirements	1-4
	Technical Specifications	1-12
Chapter 2	Air Symbols	2-1
	Building Air Symbols	2-2
	Icons	2-6
	Modifiers	2-14
	Missiles	2-24
Chapter 3	Land Symbols	3-1
	Introduction	3-1
	Land Unit, Individual, and Organization Symbols	3-2
	Land Equipment Symbols	3-60
	Land Installation Symbols	3-81
Chapter 4	Maritime Symbols	4-1
	Surface Symbols	4-2
	Subsurface Symbols	4-30
Chapter 5	Space Symbols	5-1
	Building Space Symbols	5-2
	Icons	5-6
	Modifiers	5-11
Chapter 6	Stability Activities and Civil Support Activities Symbols	6-1
Chapter 7	Control Measure Symbols	7-1
	Command and Control	7-5
	Manoeuvre	7-25
	Airspace	7-71
	Maritime	7-91
	Deception	7-131
	Fires	7-133

	Force Protection	7-158
	Sustainment	7-208
	Intelligence	7-233
	Abbreviations and Acronyms	7-234
	Appendix A: Mission Tasks and Mission Task Verbs	7-A-1
Chapter 8	Meteorological Symbols	8-1
	Introduction	8-1
	Weather Symbols	8-2
Annex A	Symbol Identification Codes	A-1
Annex B	Comparative Formations/Unit Designations	B-1
Lexicon		L-1
	Acronyms and Abbreviations	L-1
	Terms and Definitions	L-5
Reference Publications		R-1

CHAPTER 1

MILITARY SYMBOLS

SECTION I - INTRODUCTION

Scope

0101. This publication provides a standardized, structured set of graphical symbols for the display of information in military systems and applications. A standard method for symbol construction is provided using common building blocks which shall be used to create current symbol sets as well as for creating sets that may be needed in future 1.

Purpose

0102. In command and control of military operations, the reality of the displayed operational picture, its correct assessment and the decision-making speed are decisive factors. In joint military operations, it is imperative to have a common language clearly understood among all users. Graphical representation of objects, commands, movements and additional information (including alphanumeric text and colours) are observed and readily understood faster than merely text alone. This is valid even more for a user population with a widely different background of language, component, knowledge and experience. A common standard of joint military symbols is therefore an important element to enhance efficiency and contribute to success in joint operations.

0103. The purpose of this publication is to establish a common standard for the design, development and use of symbols depicting joint military activities. The publication aims to provide a standard visual portrayal for all command and control (C2) symbols and control measure symbols.

Applicability

0104. Allied Procedural Publication (APP)-6(C) applies to electronic/automated and hand-drawn graphic displays, both multi-coloured and monochrome. It shall be applied to mapping/charting as well as to engineering and design of system symbols.

0105. APP-6(C) shall be used by all North Atlantic Treaty Organization (NATO) forces involved in operations, for system development, and training. It aims to serve as the basic standard building set for future NATO implementations of symbol sets used in manual applications and electronic display systems. Any nation that wishes to work with NATO is invited to use the same standard.

Content

0106. This publication provides building blocks for the standard composition of symbols. This includes frame, icon, amplifier and modifier using colour, graphic and alphanumeric representations. It gives detailed standards and requirements for symbol construction and composition with a certain degree of flexibility for special user’s needs.

0107. The symbol set encompasses the graphic representation of units, equipment, installations, and other elements and activities relevant to joint military operations. It contains the building blocks for joint military symbols from the domains air (chapter 2), land (chapter 3), sea/maritime (chapter 4), space (chapter 5) and the display of stability activities and civil support activities (chapter 6).

0108. In addition APP-6(C) contains listed standardized symbols and figures for control measures (chapter 7) and an International Standardization Organization (ISO) meteorological symbol set (chapter 8).

Dimensions of Joint Military Symbology

0109. Figure 1-1 shows the joint military symbol sets generated to support planning and conduct of joint operations. Each set of symbols for air, land, maritime, space, stability and civil support activities, control measures, and meteorology is graphically represented down to the lowest level in each of the associated chapters.

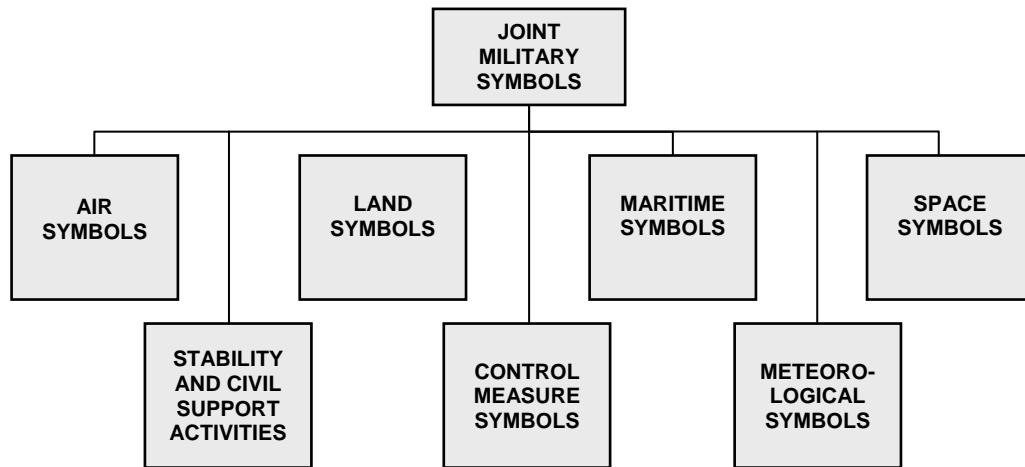


Figure 1-1. Joint Military Symbology Dimensions.

Objective

0110. One purpose of graphical joint military symbols is to convey information about the object being depicted. Military objects are understood to be physical objects e.g. units, equipment, installations and meteorological occurrences or non-physical entities e.g.

¹ The building block approach does not apply to the symbol sets in Chapter 3 - Section II “Land Equipment Symbols”, Chapter 7 “Control Measure Symbols”, and Chapter 8 “Meteorological Symbols”.

planning, control measures, or anticipated locations with temporarily assigned characteristics or temporary validity. Additionally, symbols are also used to convey activities and operations for stability and civil support activities.

0111. While the focus of this publication is the display of symbols in modern multi-chromatic electronic systems, all symbols must be usable in monochromatic systems and as hand-drawn symbols. The need to reduce information cluttering a screen underlines the requirement of symbol display options with the possibility of reducing size and displayed information of symbols.

0112. The engineering and design of symbols and the composition of their building blocks must take into account considerations of human factors, such as symbol recognition and legibility across a variety of illumination conditions, map backgrounds, symbol size, display types, and under mental and physical fatigue.

SECTION II - DETAILED REQUIREMENTS

0113. Icon-based symbols represent units, equipment, installations, and activities from all dimensions, and meteorological occurrences. An icon-based symbol is a composition of a frame, fill, icon, modifiers, and amplifiers. These elements are located within and around a virtual octagon. The placement of the various elements is explained in the following paragraphs.

0114. The components of an icon-based symbol provide information about the standard identity, battle dimension, status, and mission of an operational object.

a. **Frame.** The frame is the border of a symbol. It does not include associated information inside or outside of the border. The frame serves as the base to which other symbol components are added. Though sometimes optional, in most cases a frame surrounds an icon. When a frame is included in a symbol, its shape shall indicate the standard identity, dimension, and status of the object being represented. Table 1-1 provides the frame shapes. A frame can be black or white depending on display background, or it can be coloured, using the default colours in Table 1-4, to provide enhanced presentation information about standard identity.

(1) **Standard identity.** In imagery interpretation, identity is the discrimination between objects within a particular type or class (AAP-6). Standard identity reflects the relationship between the viewer and the operational object being monitored. The standard identity categories are unknown, assumed friend, friend, neutral, suspect, and hostile. In the realm of surface operation symbols, a circle or rectangle frame is to denote friend or assumed friend standard identity, a diamond frame to denote hostile or suspect standard identity, a square frame to denote neutral standard identity, and a quatrefoil frame to denote unknown and pending standard identity. The symbols for air, space, and subsurface objects adhere to this logic, but with “open” frames (see Table 1-1).

(2) **Dimension.** A dimension defines the primary mission area for the object within the operational environment. An object can have a mission area above the earth's surface (i.e., in the air or outer space), on the earth's surface, or below the earth's surface. If the mission area of an object is on the earth's surface, it can be either on land or sea. The land dimension includes those mission areas on the land surface or close to the surface (e.g., land mines and underground shelters), whereas the sea surface dimension includes only those objects whose mission area is on the sea surface. The subsurface dimension includes those objects whose mission area is below the sea surface (e.g., submarines and sea mines). To clarify which dimension should be used for a given object, maritime surface units shall be depicted in the sea surface dimension. Aircraft, regardless of service ownership, shall be depicted in the air dimension while air facilities shall be depicted as land installations. Ground equipment shall be depicted in the land dimension. Likewise, a landing craft whose primary mission is ferrying personnel or equipment to and from shore are represented in the sea surface dimension. However, a landing craft whose primary mission is to fight on land is a ground asset and is represented in the land dimension.

Table 1-1. Standard identities and dimensions.

Standard Identity	Units / Entities					Equip-ment	Instal-lations	Activity
	Air	Space	Land	Sea Surface	Sea Sub-surface			
Pending ²								
Unknown								
Suspect								
Hostile								
Neutral								
Assumed Friend								
Friend								

As shown in Table 1-1., a closed frame shall be used to denote the land and sea surface dimension, a frame open at the bottom to denote the air/space dimension, and a frame open at the top to denote the subsurface dimension. A solid line is used to denote the certainty of identification of standard identity and shall identify the symbol as friend, hostile, neutral and unknown.

² The term “pending” is not recognized as a standard identity within STANAG 1241; it is depicted as a status.

A black and white dotted line (one dot black and one dot white in an alternating pattern) denotes the uncertainty of identification of standard identity and shall identify the symbol as assumed friend, suspect, or pending. Figure 1-2 shows the display of black and white dotted lines on various backgrounds.

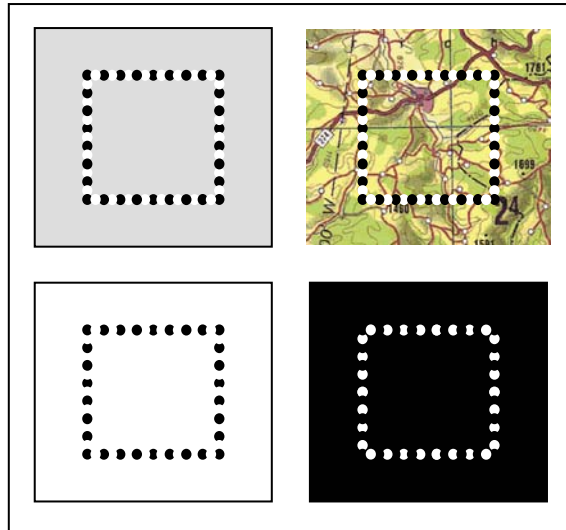


Figure 1-2. Examples of Black and White Dotted Lines on Various Backgrounds.

(3) **Status.** The parameter “status” contains the information, whether an operational object exists at the location identified (status is “present” or “confirmed”), will in the future reside at that location (status is "planned" or “anticipated”) or is thought to reside at that location (suspected). The symbol frame will be a solid line when indicating a present status and a dashed line when indicating anticipated, planned, or suspected status (see Table 1-2). When the standard identity of the frame is uncertain as is the case for assumed friend, suspect, or pending, the status will not be displayed. Additionally, the status cannot be shown when the symbol is unframed or is displayed as a dot.

Table 1-2. Present and planned status.

Dimension \ Status	Air	Space	Land	Sea Surface	Sea Sub-surface	Equipment	Installations	Activity
Present or Confirmed Position (P)								
Anticipated, Planned or Suspected Position (A)								

- b. **Colour/Fill.** The fill is the interior area within a symbol. In framed symbols, colour shall provide a redundant clue with regard to standard identity. If colour is not used, the fill is transparent. In unframed symbols, colour shall be the sole indicator of standard identity, excluding text amplifiers. Table 1-4 defines the default colours that shall be used to designate standard identity when coloured symbols are either hand drawn or displayed electronically.
- c. **Icon.** The icon is the innermost part of a symbol which provides an abstract pictorial or alphanumeric representation of units, equipment, installations, activities, or operations. This publication distinguishes between icons that must be framed or unframed and icons where framing is optional.
- d. **Modifiers.** A modifier provides an abstract pictorial or alphanumeric representation that is displayed in conjunction with an icon. The modifier provides additional information about the icon (i.e., unit, equipment, installation, or activity) being displayed. Modifiers conform to the bounding octagon and are placed either above or below the icon. This publication defines various types of modifiers and indicates where each is to be placed in relation to the icon within the symbol.
- e. **Amplifiers.** An amplifier provides additional information about the symbol being portrayed and is displayed outside the frame. The available amplifier fields are presented around the friendly land unit symbol frame in Figure 1-3. The amplifier field descriptions will vary with domain and will be detailed within the respective chapters. The default placement of amplifiers in fields around symbols is shown in each of the dimension chapters, in Chapter 6 for stability and civil support activities, and in Chapter 7 for control measure symbols. Not all amplifiers are applicable to all symbols. However, when any amplifier is displayed, it shall be defined in accordance with the appropriate standard identity or control measure symbol. It is recommended that for the purposes of de-cluttering the display only essential amplifiers are used.

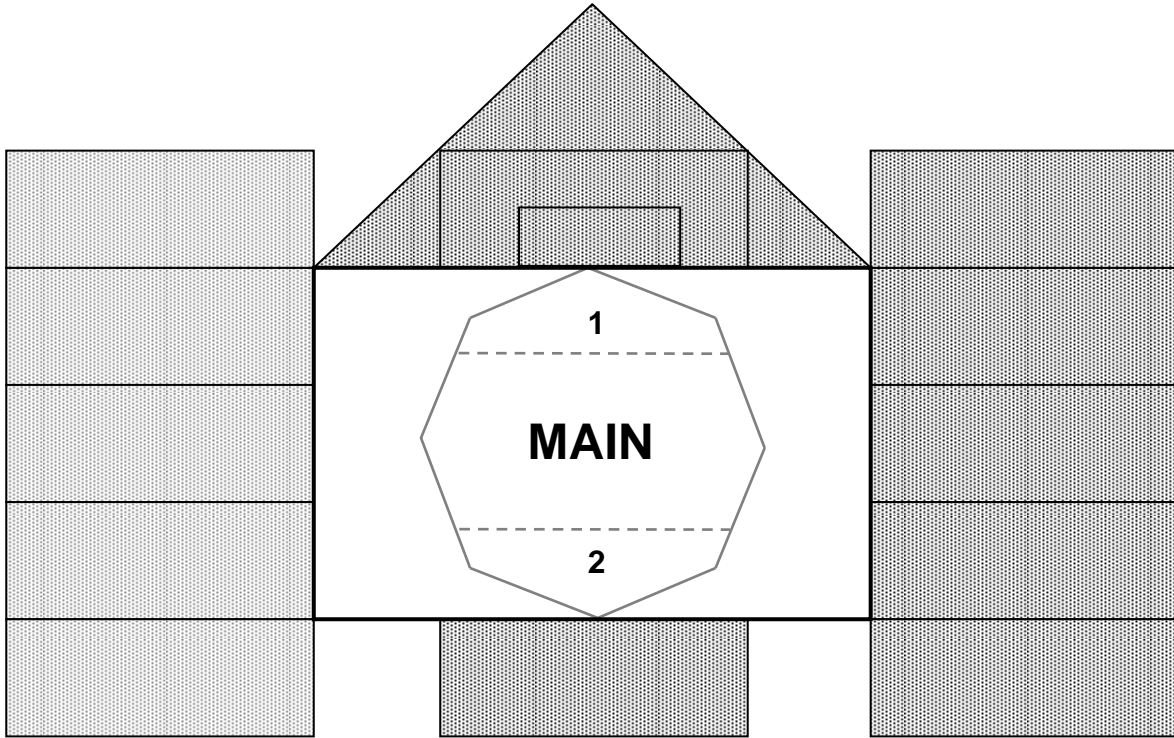


Figure 1-3. Standard amplifier fields.

f. **Additional Amplifiers.** Position, direction and speed can be depicted with additional amplifiers shown in figure 1-4. The headquarters staff indicator should extend a distance of one octagon height below the bottom of the frame. The length of the lines in direction of the movement indicator should be the same as the height of the octagon. The speed leader starts from the centre of the symbol and points in the direction of movement. The length of speed leader corresponds to the speed of the depicted symbol.

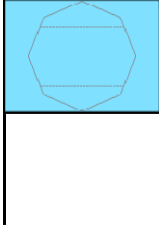
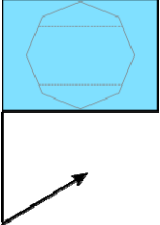
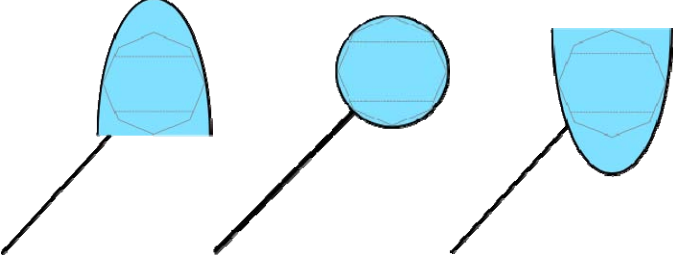
Position	Direction & Movement	Speed Leader
		

Figure 1-4. Additional amplifiers.

Location of Icons and Modifiers inside the Octagon for Unit Symbols

0115. The purpose of icon, modifier, and amplifier placement is to standardize the location of information that graphically describes a unit and provides additional information on capabilities, status, location, etc. Figure 1-5 shows the composition and placement of an icon, its modifiers and amplifiers around a hostile land or sea surface frame. The placement of icons, modifiers, and amplifier information is the same regardless of frame shape or standard identity.

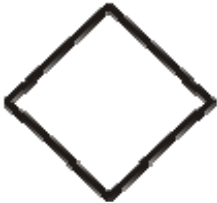


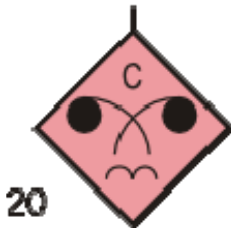



Frame		Fill		Icon	
					
					
					
Graphic		Text		Graphic	
Modifiers		Amplifiers			
				20	

Figure 1-5. Icon based symbol components.

0116. The octagon serves as the spatial reference for placement of icons and modifiers within the frame of a symbol. It is divided into sectors. The three sectors specify where icons and modifiers are positioned and how much space is available for sizing of icons and modifiers. Figure 1-6 provides examples showing the sectors for each of the frame shape types.




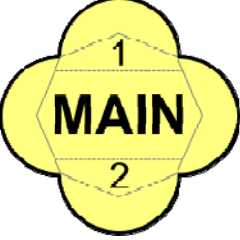
FRIENDLY	HOSTILE
	
NEUTRAL	UNKNOWN
	

Figure 1-6. Location of Icons and Modifiers.

0117. In general, icons should not be so large as to exceed the dimensions of the main sector of the octagon or touch the interior border of the frame. However, there are exceptions to this size rule. In those cases the icons will occupy the entire frame and must, therefore, exceed the dimensions of the main sector of the octagon and touch the interior border of the frame. These are called full frame icons (examples see Figure 1-7). Full frame icons occur only in the land domain (see Chapter 3).

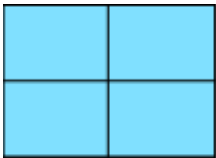
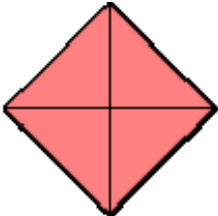
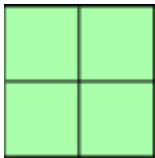
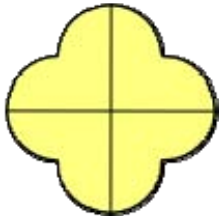
Friendly	Hostile	Neutral	Unknown
			
Medical	Medical	Medical	Medical

Figure 1-7. Examples for Full Frame Icons.

Control measure symbols

0118. Control measures are directives given to assign responsibilities, coordinate fires and manoeuvre, and control operations. They may be boundaries, special area designations, and other unique markings related to operational environment geometry and necessary for planning and management of operations. Control measure symbols represent control measures that can be portrayed graphically and provide operational information that cannot be displayed via icon-based symbols alone. They can be displayed as points, lines, areas or tactical mission tasks (Appendix 1). Control measure symbols can be combined with other symbols, icons and modifiers to display operational information. They do not follow the same building rules as the icon based symbols but will be built in accordance with the rules related to the individual domain symbol sets. The control measure symbols for monochrome systems will be black or white, depending on display background. For colour systems, control measures can be black, blue (friendly), red (hostile), green (obstacles), or yellow (chemical, biological, radiological, nuclear (CBRN) contaminated area fill). Description, placement and further details of control measure symbols are addressed in Chapter 7.

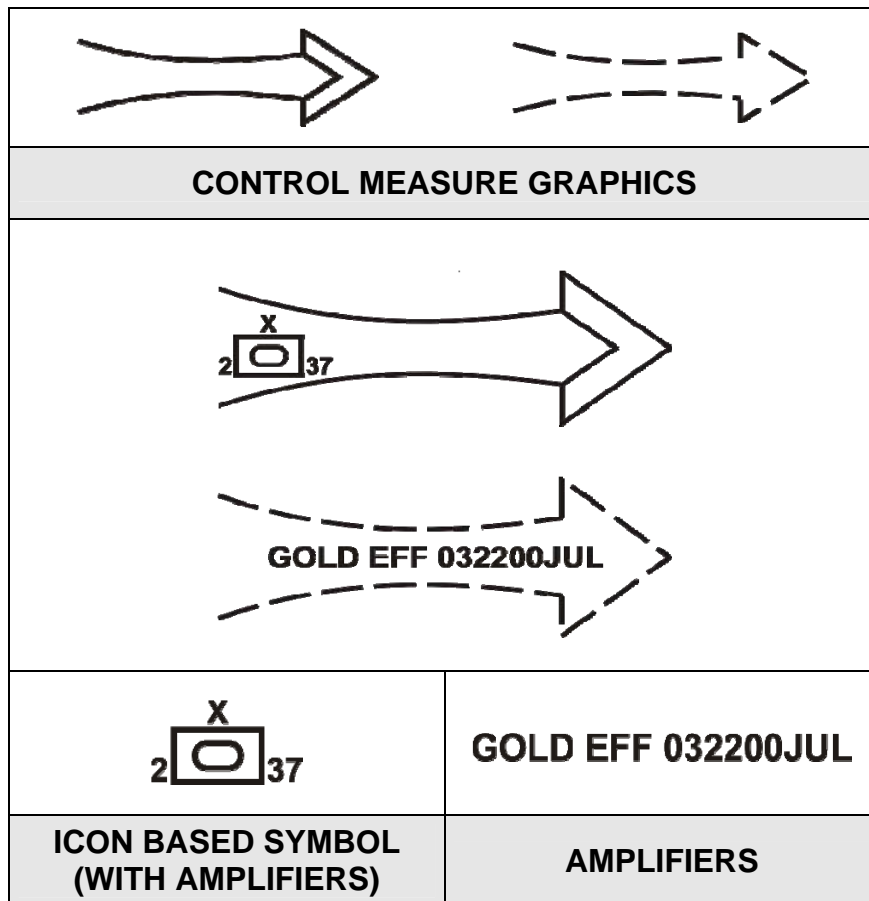


Figure 1-8. Control measure symbol components.

SECTION III - TECHNICAL SPECIFICATIONS

Scope

0119. This section provides additional technical specifications concerning the composition of symbols. These are intended to present guidance for an effective implementation of both icon based symbols and control measure symbols.

Technical Specification

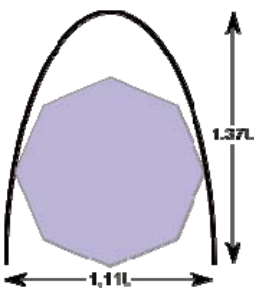
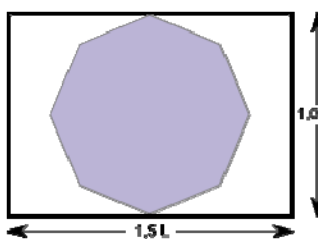
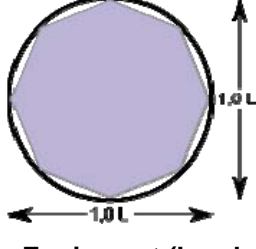
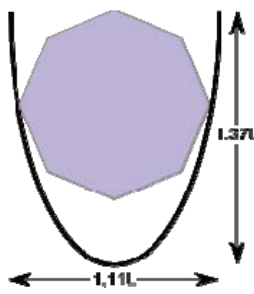
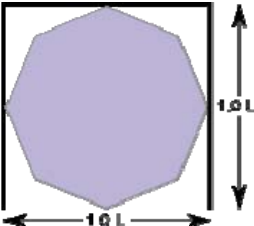
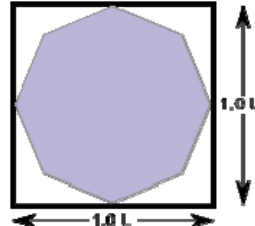
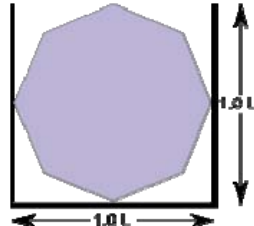
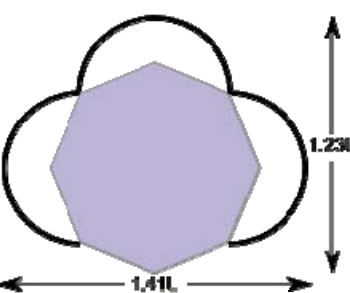
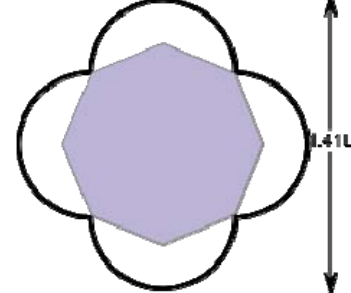
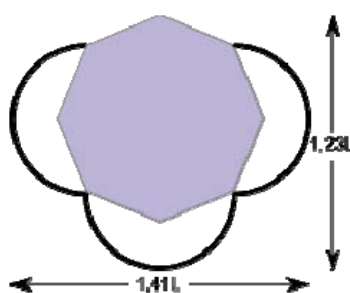
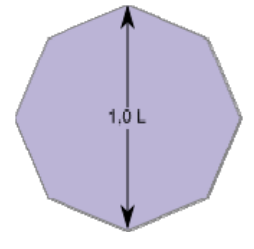
0120. The relative size of each symbol and symbol component shall be consistent within a given implementation. Each of these sizes can be related to length “L” as shown in Table 1-3.

0121. The frame seize shall be determined in relation to an octagon defining the outer boundary for all icons. “L” is the default length and height of the octagon. Frame length and height may vary from 1.0L to 1.5L, depending on the particular shape, as shown in Table 1-3. The minimum diameter of a dot should be 0.15L. In general, icons must not be so large as to touch the interior border of the frame. Only full frame icons are an exception to this sizing rule. They occupy the entire symbol and must therefore touch the interior border of the frame. The dimensions of unframed icons should be the same as framed icons.

Table 1-3. Relative Symbol Frame Sizes.

Air and Space	Surface Frames (units, equipment and installations)	Subsurface frames

Table 1-3. Relative Symbol Frame Sizes.

Air and Space	Surface Frames (units, equipment, installations and Maritime domain symbols)		Subsurface frames
	 <p>Units and installations</p>	 <p>Equipment (Land and Maritime)</p>	
			
			
	<p>Regular octagon forms the basis of frame sizing.</p>		

Placement of multiple icons

0122. Some military unit symbols are complex and include full frame and main icons overlaid onto each other. Some complex symbols require the main icon to be reduced in size so that it will be visible (see chapter 3).

Relative Sector Dimensions

0123. Figure 1-9 shows relative dimensions for the sectors in the building octagon for maximum view ability.

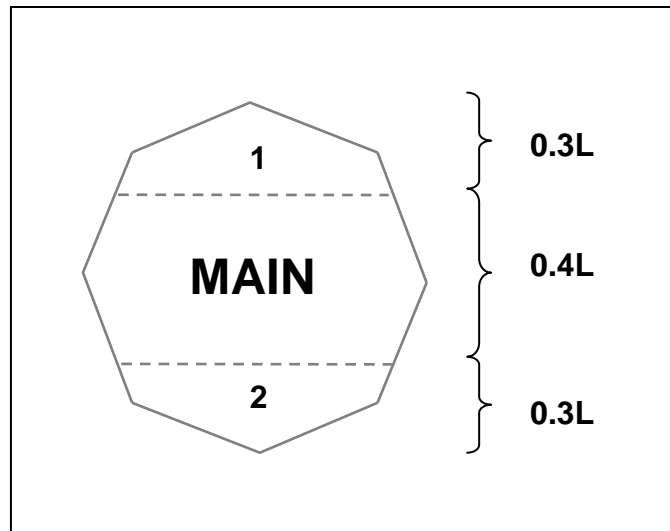


Figure 1-9. Relative Sector Dimensions.

Adding temporary features to standard symbols

0124. The building block approach included in this standard provides a logical structure from which to define a set of design rules for the construction of symbols. A single graphic feature or attribute was selected to represent each type of object in the operational environment, with the same feature included in the symbol whenever that type of object is represented. For example, whenever a helicopter unit is rendered, its icon is a "rotary wing" graphic. The approach taken in this standard differs from the concept of icons as composites of graphic "primitives" in that the placement of a given feature may vary as needed to maximize legibility when the icon is displayed within a frame. When implementations require temporary extensions to the symbol provided in this standard, the following display rules apply:

- a. Implementations shall not modify the frame shapes defined in this standard that indicates standard identity, dimension, and status.
- b. Implementations shall use the default frame colours defined in this standard to indicate standard identity. If differentiation is needed within a standard identity category, additional colours should be used (i.e., for the frame or colour fill) within that category, but the default colours for the other standard identities should not be changed. Hardware permitting and unless specifically prohibited by system specification for operational reasons, implementation of this standard should provide for operator control of colour to the individual icon level. The intent is maximum operational flexibility in those situations, where the basic default colours are not sufficient for ready discrimination (i.e. multiple hostiles which must be differentiated from each other) and

to assign a specific colour to a special interest target without reference to its standard identity. However, different shades or hues of a colour for different hostile formations, units, and threat rankings are not an option.

Line Width

0125. Because the symbol frame indicates both the standard identity and dimension of an object, it is critical that line width is sufficient to ensure frame legibility and discriminability at normal viewing distance. The optimum line width may differ depending on frame size and be affected by whether the frame is filled or unfilled and displayed in colour or black/white. Usability testing should be performed to identify the optimum rendering for a given implementation.

Colour

0126. It is important that implementations maximize the contrast between symbols and the display background in order to provide optimum discriminability. This contrast can be provided by using high contrast colour for the frame, icon, and modifiers depending on the background. Implementers should select specific values (e.g., in Commission Internationale de l’Eclairage [CIE] or red, green, blue [RGB] terms) for the default colours in Table 1-4 based on considerations such as operational requirements, hardware configuration, display background, and viewing conditions (e.g., ambient light). All components of a symbol with the exception of the frame fill should be the same colour (e.g., black, white, or one of the default colours indicating standard identity). Implementers should conduct sufficient usability testing to ensure effective operator performance when using the symbols. While colour coding shall be the same throughout an implementation, colour saturation may need to vary depending on the display option(s) selected. For example, to ensure optimum symbol discriminability, different shades of red may be needed in a frame-only symbol as compared to the colour fill in a symbol with a black frame and icon.

Table 1-4. Default colours.

Description	Hand-Drawn	Computer Generated	
		ICON (RGB Value)	FILL (RGB Value)
Friend, Assumed Friend	Blue	Cyan (0, 255, 255)	Crystal Blue (128, 224, 255)
Unknown, Pending	Yellow	Yellow (255, 255, 0)	Light Yellow (255, 255, 128)
Neutral	Green	Neon Green (0, 255, 0)	Bamboo Green (170, 255, 170)
Hostile, Suspect, Joker, Faker	Red	Red (255, 0, 0)	Salmon (255, 128, 128)
Boundaries, lines, areas, text, icons, and frames	Black	Black (0, 0, 0)	Black (0, 0, 0)
(See note)	White	White (255, 255, 255)	Off-White (6% Grey) (239, 239, 239)

Note: A high contrast colour should be used as the default colour depending on the background for boundaries, lines, areas, text, icons, and frames.

CHAPTER 2

AIR SYMBOLS

Scope

0201. This chapter covers symbols for air assets and their activities. Air installations and headquarters are covered in Chapter 3 “Land Symbols”, while airspace coordination and planning is part of Chapter 7 “Control Measures Symbols”.

Characteristics of Symbols for Air Operations

0202. Air assets use the third dimension in order to create effects that contribute to the achievement of joint force commander objectives. Reach, speed and manoeuvrability are some of their inherent capabilities.

0203. For this reason, in order to depict in near real time large areas with fast moving airspace users manoeuvring within all three dimensions, specific requirements for the air picture production have to be met:

- a. The picture has to be updated near real time.
- b. Vectors have to be provided in order to help to anticipate movement of own, neutral and hostile objects.
- c. Wherever known, relevant data like “aircraft type,” “call sign,” “mission,” “origin,” “destination” etc. have to be affiliated to the objects without cluttering the display.
- d. Objects may overlap on the display but must still be recognisable to controllers.
- e. The display contains a multitude of non-military moving objects (civil aircraft); airspace control and de-confliction means; fire support coordination means; and installations (e.g. airfields).

SECTION I – BUILDING AIR SYMBOLS

General

0204. This section establishes a single standard for developing air symbols. It includes a variety of air related icons, modifiers, and amplifiers for building symbols. However, no attempt to depict all possible air symbols has been made. Rather, a standard method for constructing these symbols is presented. Once the user is familiar with the prescribed system, any desired unit can be depicted using the logical sequence provided in this chapter. The symbols shown in this chapter are adequate for depicting all air standard identities defined in STANAG 1241. When representing not yet defined units, select the most appropriate symbol combination contained herein. Avoid using any symbols, or combinations and modifications of symbols that differ from those laid down in this publication. If, after searching icons and modifiers given in this publication, it is necessary to create a new symbol, explain the symbol in an accompanying legend.

Composition of Air Symbols

0205. An air symbol is composed of a frame, colour (fill), icon, modifiers, and amplifiers (not shown) (Figure 2-1). (See Table 2-1 for the steps used to build air symbols.)

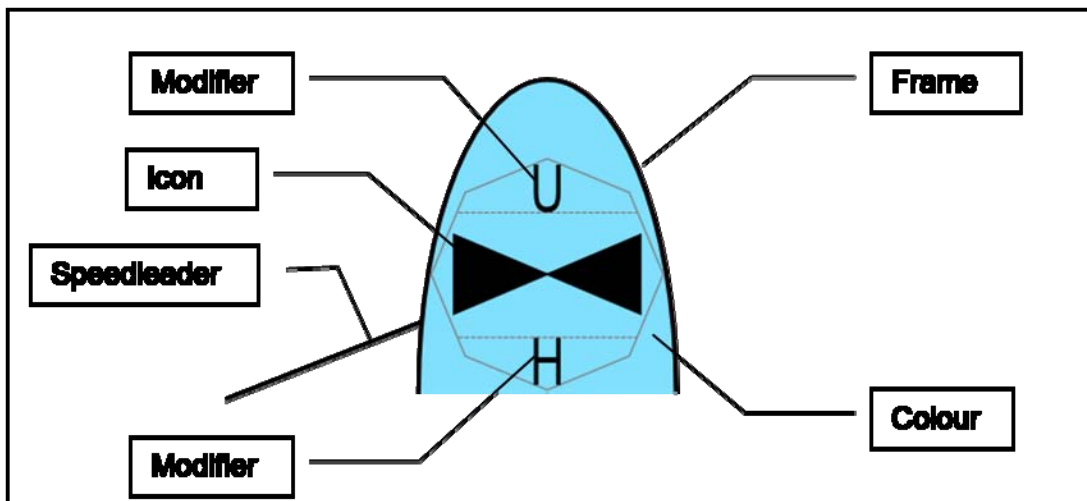
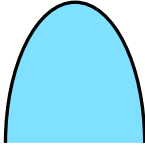


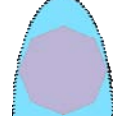
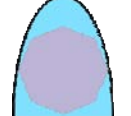
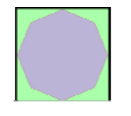
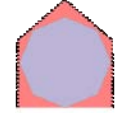

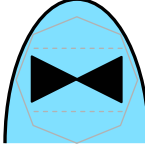
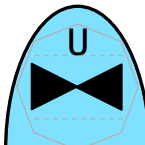
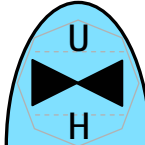


Figure 2-1. Air Symbol Composition.

Table 2-1. Air Symbol Composition Process.							
Step No.	Step				Examples		
Step 1	Choose the frame according to standard identity.						
Air Standard Identities and Frame Shapes							
	Pending	Unknown	Assumed Friend	Friend	Neutral	Suspect	Hostile
Sea Sub-surface							
Step 2	Choose and add main sector icon.						
Step 3	Choose and add a modifier in either sector 1 or sector 2 if applicable or deemed necessary for visualization.						
Step 4	Choose and add a second modifier if applicable and/or deemed necessary for visual representation. NOTE: only one modifier is permitted per modifier position						

Amplifier Fields

0206. On the tactical display, information about a displayed object is conveyed by the symbol via frame shape, icon/letter and colour coding. There may be, however, additional information that cannot be conveyed by graphical means, but by written (alphanumeric) information only.

0207. This information can be displayed either in secondary information fields outside the tactical screen, a method that forces the operator to a constant shift of focus and will not be considered further in this text, or by use of amplifier fields.

0208. The purpose of the amplifier fields described in this section is to standardize the display of additional alphanumeric information, i.e. on identity, location and movement, capabilities. Figure 2-2 shows the placement of amplifier fields around an air symbol frame. The placement of the label is the same regardless of frame shape or affiliation.

0209. In comparison to amplifier fields for land symbols, air amplifier fields –constitute a reduction in the amount of information displayed

0210. In the default mode, the label is not shown. It is the user’s task to define and call up for display the information considered to be necessary. Additionally, the user must be enabled to suppress the filled and displayed label to reduce screen clutter and call it up again as considered appropriate to the tactical situation. Table 2-2 provides a list of amplifier field content for air symbols and Table 2-3 provides a list of amplifier field content for weapons (missiles) in flight symbols.

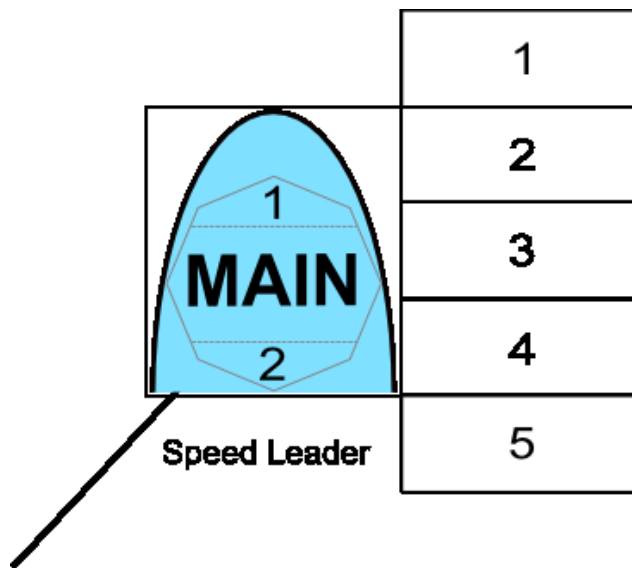


Figure 2-2. Air Symbol Amplifier Fields.

Table 2-2. Contents of Labels for Air Symbols (Example).			
<i>Field</i>	<i>Field Title</i>	<i>Description (Alternatives)</i>	<i>Prefix (when applicable)</i>
1	Track Number	System Track Number	TN
2	Call sign	a) Airframe number b) Mission call sign	
3	Position and Movement, 3 rd Dimension Info	Course [degrees]/Speed [knots] or Bearing [degrees]/Distance [nautical miles] Height [feet/flight level]	C/S B/D
4	Nation	Nations Name: A 3-letter code indicating the object's country of origin (STANAG 1059)	
5	Additional Information	For friendly units - Sensor or Weapon load, endurance, etc. For other Units - Credibility of Information	

Table 2-3. Contents of Labels for Weapons in Flight (Example).			
<i>Field</i>	<i>Field Title</i>	<i>Description (Alternatives)</i>	<i>Prefix (when applicable)</i>
1	Track Number	System Track Number	TN
2	Name	Weapon Type/Name	
3	Position and Movement, 3 rd Dimension Info	Course [degrees] /Speed [knots] or Bearing [degrees] / Distance [nautical miles] Height [feet/flight level]	C/S B/D
4	Nation	Nations Name: A 3-letter code indicating the object's country of origin (STANAG 1059)	
5	Additional Information	Threat Ranking	

SECTION II –ICONS

0211. Icons in the main sector (Figure 2.2) normally reflect the main function of the symbol, but in some cases can also reflect modifying information as well. Table 2-4 below shows the icons for use in air symbols in the main sector of the symbol.

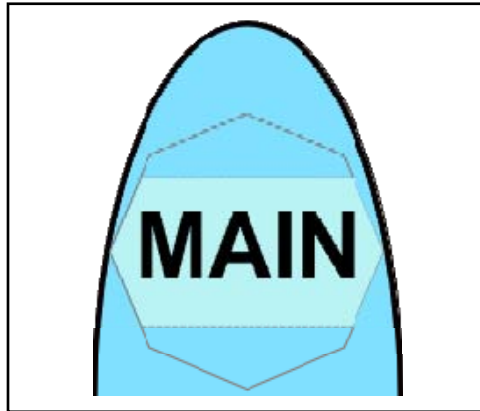


Figure 2-3. Main Sector Icons.



Table 2-4. Air Main Sector Icons.			
FUNCTION	ICON	LOCATION	REMARKS
MILITARY	MIL		None
CIVILIAN	CIV		None


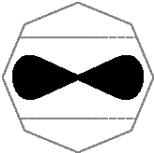

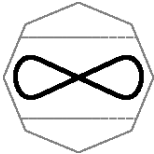

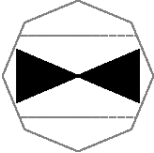

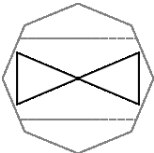


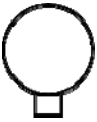
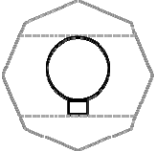


Table 2-4. Air Main Sector Icons.			
FUNCTION	ICON	LOCATION	REMARKS
MILITARY FIXED WING			None
CIVILIAN FIXED WING			None
MILITARY ROTARY WING			None
CIVILIAN ROTARY WING			None
MILITARY BALLOON			None
CIVILIAN BALLOON			None
MILITARY AIRSHIP			None


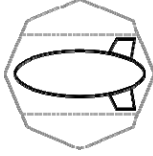





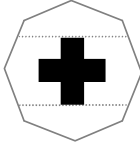

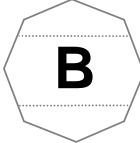
Table 2-4. Air Main Sector Icons.			
FUNCTION	ICON	LOCATION	REMARKS
CIVILIAN AIRSHIP			None
UNMANNED AERIAL VEHICLE			None
AIR DECOY			None
MEDICAL EVACUATION			None
ATTACK/STRIKE	A		None
BOMBER	B		None

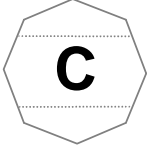

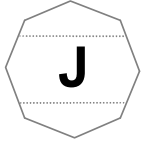
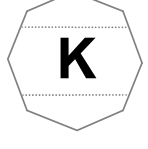

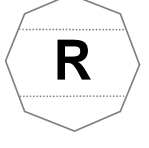
Table 2-4. Air Main Sector Icons.			
FUNCTION	ICON	LOCATION	REMARKS
CARGO	C		None
FIGHTER	F		None
JAMMER / ELECTRONIC COUNTER- MEASURES	J		None
TANKER	K		None
PATROL	P		None
RECONNAISSANCE	R		None

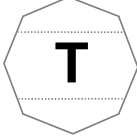





Table 2-4. Air Main Sector Icons.			
FUNCTION	ICON	LOCATION	REMARKS
TRAINER	T		None
UTILITY	U		None
VSTOL	V		None
AIRBORNE COMMAND POST	ACP		None
AIRBORNE EARLY WARNING	AEW		None
ANTISURFACE WARFARE	ASUW		None







Table 2-4. Air Main Sector Icons.			
FUNCTION	ICON	LOCATION	REMARKS
ANTISUBMARINE WARFARE	ASW		None
COMMUNICATIONS	COM		None
COMBAT SEARCH AND RESCUE	CSAR		None
ELECTRONIC SUPPORT MEASURES	ESM		None
GOVERNMENT	GOV		None
MINE COUNTERMEASURES	MCM		None









Table 2-4. Air Main Sector Icons.			
FUNCTION	ICON	LOCATION	REMARKS
PERSONNEL RECOVERY	PR		None
PASSENGER	PX		None
SEARCH AND RESCUE	SAR		None
SUPPRESSION OF ENEMY AIR DEFENCE	SEAD		None
SPECIAL OPERATIONS FORCES	SOF		None
ULTRA LIGHT	UL		None

Table 2-4. Air Main Sector Icons.			
FUNCTION	ICON	LOCATION	REMARKS
RECONNAISSANCE	R		None
VIP	VIP		None

SECTION III – MODIFIERS

0212. Modifiers display additional information regarding the icon. Sector 1 modifiers are placed above the icon (Figure 2-4) and denote aircraft type or mission area (see Table 2-5). Table 2-6 shows sector 1 modifiers for air symbols.

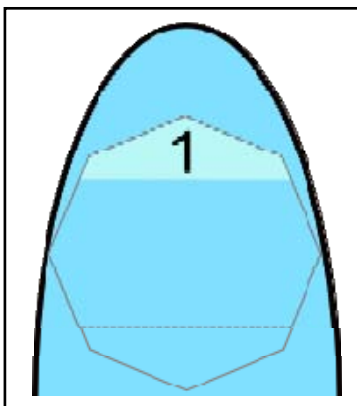


Figure 2-4. Sector 1 Modifier Placement.

Table 2-5. Air Sector 1 Modifier Description.		
<i>MODIFIER</i>	<i>NAME</i>	<i>DESCRIPTION</i>
A	Attack	Aircraft Type
B	Bomber	Aircraft Type
C	Cargo	Aircraft Type
F	Fighter	Aircraft Type
I	Interceptor	Mission Area
K	Tanker	Aircraft Type
U	Utility	Aircraft Type
V	VSTOL	Aircraft Type
PX	Passenger	Aircraft Type
UL	Ultra-Light	Aircraft Type
ACP	Airborne Command Post	Aircraft Type
ASUW	Antisurface Warfare	Mission Area
AEW	Airborne Early Warning	Aircraft Type
GOV	Government	Aircraft Type
+	MEDEVAC	Mission Area

Table 2-5. Air Sector 1 Modifier Description.		
<i>MODIFIER</i>	<i>NAME</i>	<i>DESCRIPTION</i>
E	Escort	Mission Area
IC	Intensive Care	Mission Area
J	Jammer / Electronic Counter-Measures	Mission Area
P	Patrol	Mission Area
R	Reconnaissance	Mission Area
T	Trainer	Mission Area
PH	Photographic (Reconnaissance)	Mission Area
PR	Personnel Recovery	Mission Area
ASW	Antisubmarine Warfare	Mission Area
COM	Communications	Mission Area
ESM	Electronic Surveillance Measures	Mission Area
MCM	Mine Countermeasures	Mission Area
SAR	Search and Rescue	Mission Area
SOF	Special Operations Forces	Mission Area
SUW	Surface Warfare	Mission Area
VIP	VIP Transport	Mission Area
CSAR	Combat Search and Rescue	Mission Area
SEAD	Suppression of Enemy Air Defences	Mission Area

Table 2-6. Air Sector 1 Modifiers.

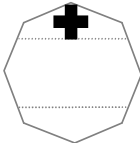
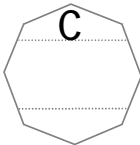
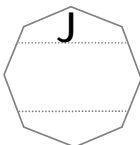
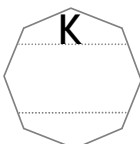
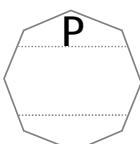
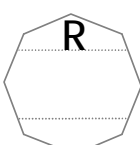
DESCRIPTION	ICON	LOCATION	REMARKS
MEDICAL EVACUATION	+		None
CARGO	C		Only in conjunction with air symbols.
ELECTRONIC COUNTER-MEASURES / JAMMER	J		None
TANKER	K		Only in conjunction with air symbols.
PATROL	P		Only in conjunction with air symbols.
RECONNAISSANCE	R		Only in conjunction with air symbols.

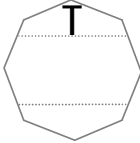
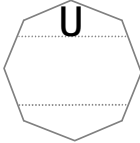

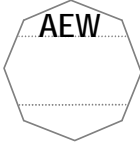

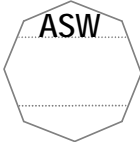
Table 2-6. Air Sector 1 Modifiers.			
DESCRIPTION	ICON	LOCATION	REMARKS
TRAINER	T		None
UTILITY	U		None
AIRBORNE COMMAND POST	ACP		None
AIRBORNE EARLY WARNING	AEW		None
ANTISURFACE WARFARE	ASUW		None
ANTISUBMARINE WARFARE	ASW		None

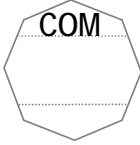

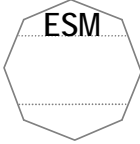
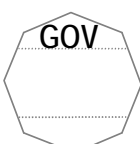
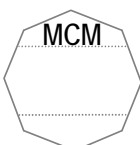
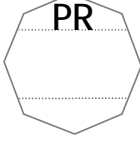
Table 2-6. Air Sector 1 Modifiers.			
DESCRIPTION	ICON	LOCATION	REMARKS
COMMUNICATIONS	COM		None
COMBAT SEARCH AND RESCUE	CSAR		None
ELECTRONIC SUPPORT MEASURES	ESM		None
GOVERNMENT FLIGHT	GOV		None
MINE COUNTERMEASURES	MCM		None
PERSONAL RECOVERY	PR		None

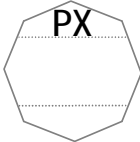


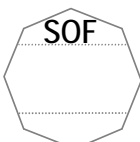
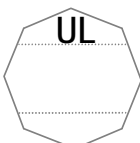


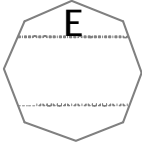
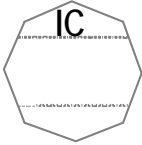
Table 2-6. Air Sector 1 Modifiers.			
DESCRIPTION	ICON	LOCATION	REMARKS
PASSENGER PLANE	PX		None
SEARCH AND RESCUE	SAR		None
SUPPRESSION OF ENEMY AIR DEFENCES	SEAD		None
SPECIAL OPERATIONS FORCES	SOF		None
ULTRA LIGHT	UL		None
PHOTOGRAPHIC	PH		None

Table 2-6. Air Sector 1 Modifiers.			
DESCRIPTION	ICON	LOCATION	REMARKS
VIP	VIP		None
ESCORT	E		None
INTENSIVE CARE	IC		None

0213. Sector 2 modifiers are placed below the icon (Figure 2-5) and denote cargo, transport, or refuelling capacity (see Table 2-7). Table 2-8 shows sector 2 modifiers for air symbols.

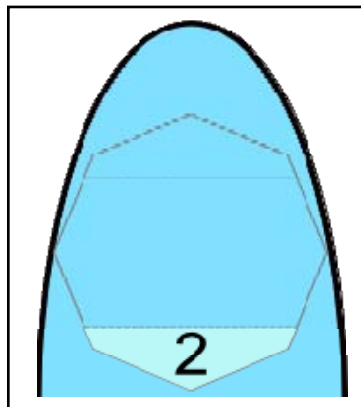


Figure 2-5. Sector 2 Modifier Placement.

Table 2-7. Air Sector 2 Modifier Description.		
<i>MODIFIER</i>	<i>NAME</i>	<i>DESCRIPTION</i>
H	Heavy	Cargo/Transport Capacity
M	Medium	Cargo/Transport Capacity
L	Light	Cargo/Transport Capacity
B	Boom-Only	Re-Fuelling Capability
D	Drogue-Only	Re-Fuelling Capability
B/D	Boom and Drogue	Re-Fuelling Capability
CR	Close Range	Range Capability
SR	Short Range	Range Capability
MR	Medium Range	Range Capability
LR	Long Range	Range Capability

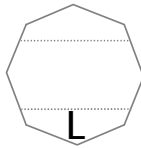
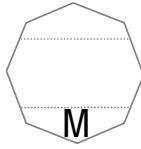
Table 2-8. Air Sector 2 Modifiers.			
DESCRIPTION	ICON	LOCATION	REMARKS
LIGHT	L		None
MEDIUM	M		None

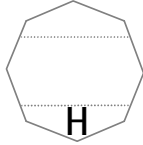
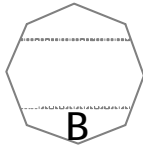
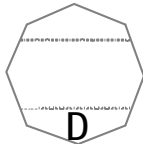

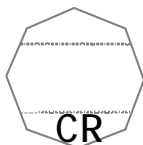

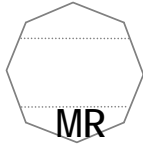
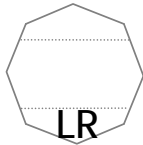
Table 2-8. Air Sector 2 Modifiers.			
DESCRIPTION	ICON	LOCATION	REMARKS
HEAVY	H		None
BOOM-ONLY	B		Use with tankers only
DROGUE-ONLY	D		Use with tankers only
BOOM AND DROGUE	B/D		Use with tankers only
CLOSE RANGE	CR		None

Table 2-8. Air Sector 2 Modifiers.			
DESCRIPTION	ICON	LOCATION	REMARKS
SHORT RANGE	SR		None
MEDIUM RANGE	MR		None
LONG RANGE	LR		None

SECTION IV – MISSILES

0214. The bounding octagon for missile follows a format similar to the standard format for symbols, however it is turned 90 degrees to the right so that the missile is vertical and the modifiers are on the left (sector 1) and right (sector 2). There is only one icon for missiles and it is as shown in Figure 2-6.

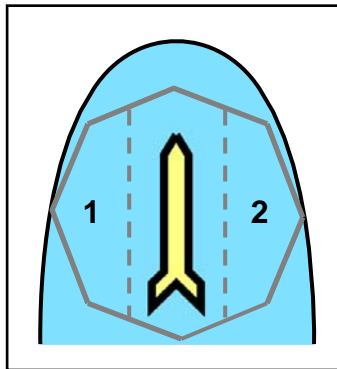


Figure 2-6. Missile Main Icon and Modifier Placement.

Missile Sector 1 and 2 Modifiers

0215. Missile Sector 1 modifiers are used to denote either launch origin or missile type. Table 2-9 lists Missile Sector 1 modifiers.

Table 2-9. Missile Sector 1 Modifiers.		
<i>MODIFIER</i>	<i>NAME</i>	<i>DESCRIPTION</i>
A	Air	Launch Origin
S	Surface	Launch Origin
SU	Subsurface	Launch Origin
SP	Space	Launch Origin
AB	Anti-Ballistic	Missile Type
B	Ballistic	Missile Type
C	Cruise	Missile Type

0216. Missile sector 2 modifiers are placed to the right of the missile icon and denote projected missile destination or missile type. Table 2-10 below lists the missile sector 2 modifiers.

Table 2-10. Missile Sector 2 Modifiers.		
<i>MODIFIER</i>	<i>NAME</i>	<i>DESCRIPTION</i>
A	Air	Missile Destination
S	Surface	Missile Destination
SU	Subsurface	Missile Destination
SP	Space	Missile Destination
L	Launched	Missile Type
M	Missile	Missile Type

(INTENTIONALLY BLANK)

CHAPTER 3

LAND SYMBOLS

SECTION I - INTRODUCTION

Purpose

0301. This chapter addresses land military symbols that support units, individuals and organizations (Section II), equipment (Section III), and installations (Section IV). See figure 3-1. The tables in this chapter present the icons, modifiers, and amplifiers for land forces.

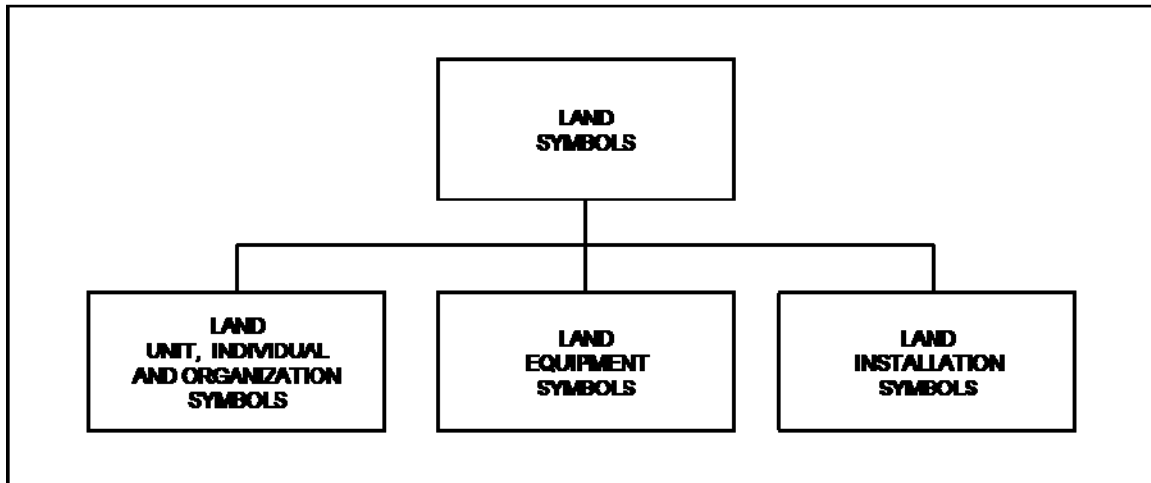


Figure 3-1. Hierarchy of Land Symbols.

Scope

0302. This chapter is divided into three sections. Section I provides the basics for building land unit, individual, and organization symbols. Section II provides the basics for building land equipment symbols. Section III provides the basics for building land installation symbols.

As stated in Chapter 1, there are basic elements in the building of military symbols that are common to all environments. This chapter elaborates on those common elements.

These land symbols are based on a hand drawn system that has been in use for many years. As this system has been further developed for use for computer generated graphics, the number of departures from standard rules has become apparent to users. The user should be aware of this fact when using this system.

Section II - Land Unit, Individual, and Organization Symbols

General

0303. This section establishes a single standard for developing land unit, individual, and organization symbols. A unit is a military element whose structure is prescribed by a competent authority. Individuals and organizations are civilian based. This section includes a wide variety of icons, modifiers, and amplifiers for building a wide variety of symbols. However, no attempt has been made to depict all possible combinations. Rather, a standard method for constructing symbols is presented. Once the user is familiar with the prescribed system, any desired symbol can be developed using the logical sequence provided in this chapter. The symbols shown in this chapter are adequate for depicting all standard identities for units, individuals, and organizations. When representing unorthodox units, individuals, and organizations, select the most appropriate symbol contained herein. Avoid using any symbols or combinations and modifications of symbols that differ from those in this publication. If, after searching doctrinal icons and modifiers, it is necessary to create a new symbol, explain the symbol in an accompanying legend. Computer-generated systems may have difficulty in passing non-standard symbols.

Composition of Unit, Individual, and Organization Symbols

0304. A unit, individual, or organization symbol is composed of a frame, colour (fill), icon, modifier, and amplifiers (figure 3-2). (See table 3-1 for the steps used to build unit symbols.)

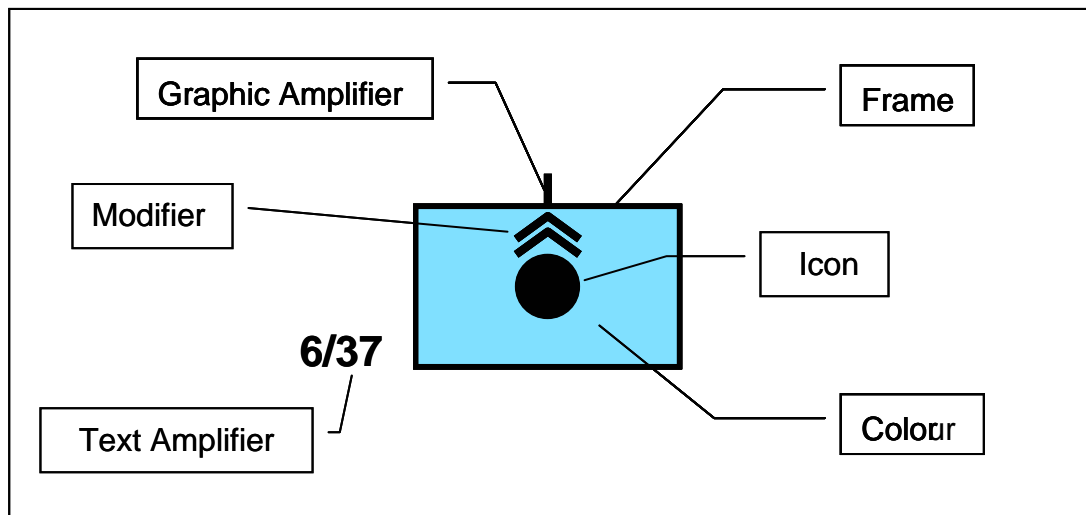
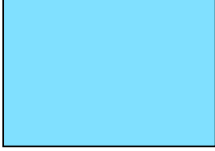

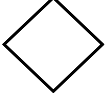

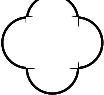



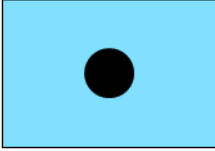




Figure 3-2. Land Unit, Individual, and Organization Symbol Composition.

Table 3-1. Building Unit, Individual, and Organization Symbols.

<i>Step No.</i>	<i>Step</i>	<i>Example</i>					
Step 1.	Choose the frame according to standard identity.						
Land Unit Frame Shapes and Standard Identity							
STANDARD IDENTITY	FRIENDLY	HOSTILE	NEUTRAL	UNKNOWN	ASSUMED FRIEND	SUSPECT	PENDING
FRAME							
Step 2.	Choose and add main sector icon.						
Step 3.	Choose and add a modifier in either sector 1 or sector 2 if applicable or deemed necessary for visualization.						
Step 4.	Choose and add a modifier in either sector 1 or sector 2 if applicable or deemed necessary for visualization. NOTE: Only one modifier is permitted per modifier position.						

Land Unit Icon, Modifier, and Amplifier Fields

0305. The purpose of icon, modifier, and amplifier fields is to standardize the location of information that graphically describes a unit, individual, and organization and provides additional information on capabilities, status, location, etc. Figure 3-3 shows the placement of unit icon, modifier, and amplifier fields around the friendly land unit symbol frame. The placement of unit icon, modifier, and amplifier information fields is the same regardless of frame shape or affiliation. See Paragraphs 0113-0115 in Chapter 1 for a fuller discussion of icons, modifiers, and amplifiers.

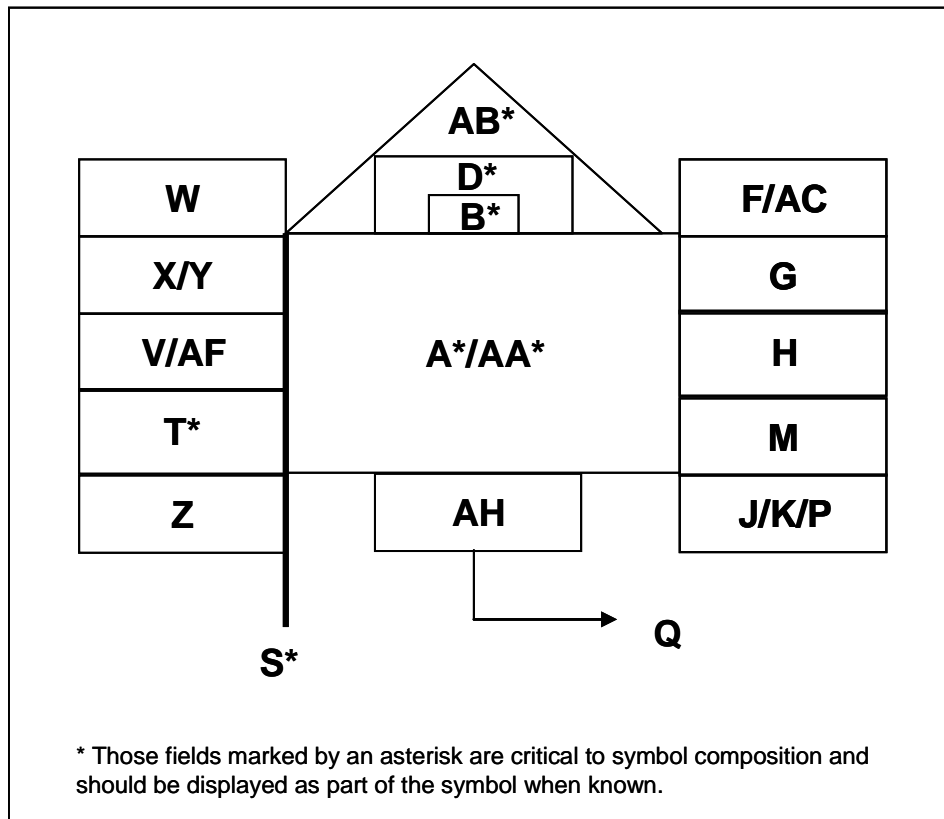


Figure 3-3. Land Unit, Individual, and Organization Icon, Modifier, and Amplifier Fields.

Location of Icons and Modifiers inside the Octagon for Land Unit, Individual, and Organization Symbols

0306. For land unit symbols, the octagon as described in Chapter 1, paragraph 0116 serves as the foundation for placement of icons and modifiers. The octagon is divided into sectors. The three sectors specify where icons and modifiers are positioned and how much space is available for sizing of icons and modifiers. Figure 3-4 provides examples showing the sectors for each of the frame shape types. The lettering size for text icons and modifiers will vary based on the number of letters used.

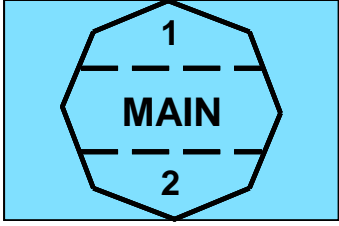
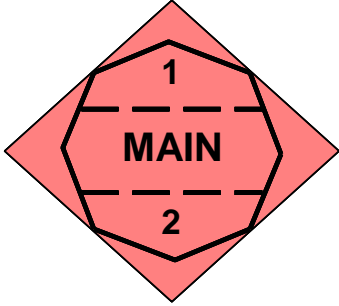
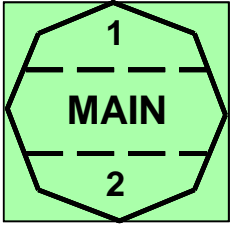
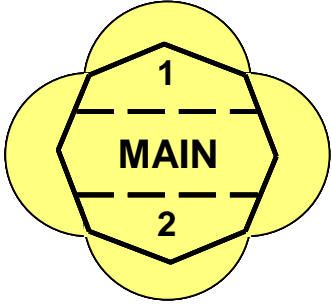
FRIENDLY	HOSTILE
	
NEUTRAL	UNKNOWN
	

Figure 3-4. Location of Icons and Modifiers.

In general, icons should not be so large as to exceed the dimensions of the main sector of the octagon or touch the interior border of the frame. However, there are exceptions to this size rule. In those cases the icons will occupy the entire frame and must, therefore, exceed the dimensions of the main sector of the octagon and touch the interior border of the frame (see figure 3-5). These are called full frame icons.

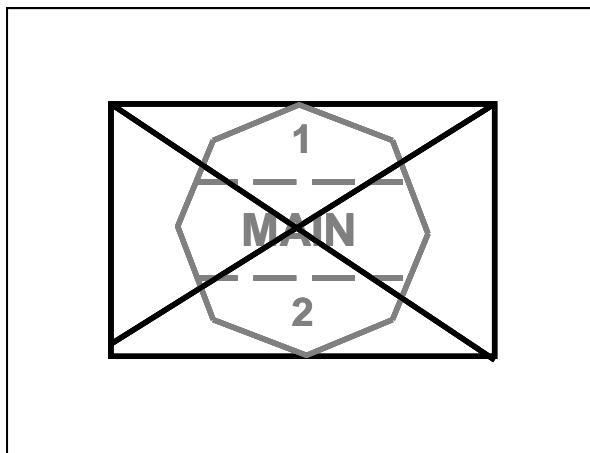


Figure 3-5. Icon Placement for Full Frame Icons.

Icon, Modifier, and Amplifier Fields

0307. See paragraph 114 in Chapter 1 for a description of and more information on amplifiers. Table 3-2 provides a description of each of the unit symbol amplifying information fields as shown in figure 3-2. See Annex A (TBD) for examples of unit symbols with multiple fields that are filled in.

Table 3-2. Description of Icon, Modifier, and Amplifier Fields for Unit Symbols.			
<i>Field</i>	<i>Field Title</i>	<i>Description</i>	<i>Text/Graphic</i>
A	Icon(s)	Basic branch or functional symbol which can include capability modifiers.	Both
B	Echelon	A symbol modifier that denotes the size of a unit .	Both
D	Task Force	A symbol placed over the echelon indicator to denote a task-organized unit.	Graphic
F	Reinforced or Detached	Indicates whether a unit is reinforced (+), reduced (-), or reinforced and reduced (±).	Text
G	Staff Comments	Free text. Can be used by staff for information required by commander.	Text
H	Additional Information	Free text.	Text
J	Evaluation Rating	Degree of confidence that may be placed on the information represented by the symbol. It is shown as one letter and one number made up of Reliability of Source and Credibility of Information. (STANAG 2511). <u>Reliability of Source:</u> A. Completely reliable B. Usually reliable C. Fairly reliable D. Not usually reliable E. Unreliable F. Reliability cannot be judged. <u>Credibility of Information:</u> 1. Confirmed by other sources 2. Probably true 3. Possibly true 4. Doubtful 5. Improbable 6. Truth cannot be judged.	Text
K	Combat Effectiveness	Effectiveness of unit or equipment displayed. 1. Fully operational 2. Substantially operational 3. Marginally operational 4. Not operational	Text
M	Higher Formation	Number or title of higher echelon command of unit being displayed. ¹	Text

Table 3-2. Description of Icon, Modifier, and Amplifier Fields for Unit Symbols.			
<i>Field</i>	<i>Field Title</i>	<i>Description</i>	<i>Text/Graphic</i>
P	Identification, Friend-or-Foe (IFF)/Selective Identification Feature (SIF)	Identification modes and codes.	Text
Q	Direction of Movement Arrow/Offset Location Indicator	With arrow, it denotes the direction symbol is moving or will move. Without arrow, it is used to denote precise location or to declutter, except headquarters.	Graphic
S	Headquarters Staff Indicator/Offset Location Indicator	Identifies unit symbol as a headquarters or used to indicate precise location or to declutter.	Graphic
T	Unique Designation	An alphanumeric designator that uniquely identifies a particular unit (designation).	Text
V	Type of Equipment	Identifies unique designation (such as M-2 for infantry fighting vehicle).	Text
W	Date-Time Group	An alphanumeric designator for displaying a date-time group (DDHHMMSSZMONYY) or "O/O" for on order. The date-time group is composed of a group of six numeric digits with a time zone suffix and the standardized three-letter abbreviation for the month followed by two digits. The first pair of digits represents the day; the second pair, the hour; the third pair, the minutes. The last two digits of the year are after the month. For automated systems, two digits may be added before the time zone suffix and after the minutes to designate seconds.	Text
X	Altitude/Depth	Altitude as displayed on the global positioning system (GPS).	Text
Y	Location	Latitude and longitude; grid coordinates.	Text
Z	Speed	Displays speed in nautical miles per hour or kilometres per hour.	Text
AA	Named Headquarters C2	This field applies to named commands such as SHAPE, SACLANT, ARRC, ISAF or joint, multinational, or coalition commands such as CJTF, JTF, MJTF.	Text
AB	Feint or Dummy Indicator	Indicates that it is a dummy or a feint for deception purposes.	Graphic
AC	Country Indicator	A three-letter code that indicates the country of origin of the unit (STANAG 1059). In stability activities, this field can be used for factions or groups.	Text
AF	Common Identifier	Example: Paladin for the M109A6 howitzer or Leopard for the KPz-70 tank. (Use NATO code name for hostile common identifiers.)	Text
AH	Headquarters Element	Indicates what type of element of a headquarters is being represented, such as TOC, MAIN.	Text

Unit Main Sector Icons

0308. Icons in the main sector (figure 3-6) normally reflect the main function of the symbol, but in some cases can also reflect modifying information (e.g., armoured engineers). Table 3-3 below shows the icons for use in land unit symbols in the main sector of the A field of the symbol. In most cases, the dimensions of the icon will be sized to occupy as much area in the main sector as is available. However, in some cases the icon may be reduced to allow more room for modifiers for better recognition or to allow for one icon to modify another (e.g., armoured/self-propelled artillery).

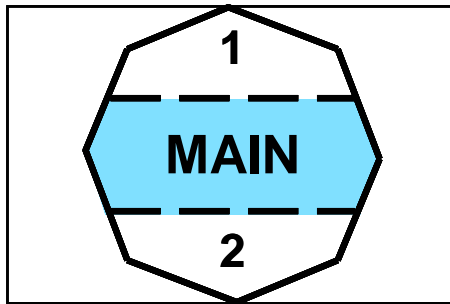


Figure 3-6. Main Sector Icons.

Table 3-3. Main Sector Icons.			
<i>FUNCTION</i> <i>Note: AAP-6 definitions are included for clarification when existing.</i>	<i>ICON</i>	<i>LOCATION</i>	<i>REMARKS</i>
ADMINISTRATIVE	ADM		None
AIR TRAFFIC SERVICES / AIRFIELD OPERATIONS			None
AIRPORT OF DEBARKATION (APOD)/ AIRPORT OF EMBARKATION (APOE)			The transportation and runway icons together represent the APOD / APOE icon. This is a transportation unit.
AMMUNITION			See also Table 3-4. Full Frame Icons under Classes of Supply – Class V













Table 3-3. Main Sector Icons.			
FUNCTION <i>Note: AAP-6 definitions are included for clarification when existing.</i>	ICON	LOCATION	REMARKS
ARMOUR/ ARMOURED/ MECHANISED/ SELF-PROPELLED/ TRACKED			None
AVIATION ROTARY WING/ARMY AVIATION			None
AVIATION FIXED WING			None
AVIATION COMPOSITE FIXED WING AND ROTARY WING			None
BAND	BAND		None
CHEMICAL BIOLOGICAL RADIOLOGICAL NUCLEAR (CBRN) DEFENCE			None
CIVIL AFFAIRS	CA		None











Table 3-3. Main Sector Icons.			
FUNCTION <i>Note: AAP-6 definitions are included for clarification when existing.</i>	ICON	LOCATION	REMARKS
CIVIL-MILITARY-COOPERATION			None
COMBAT	CBT		None
COMBAT SERVICE SUPPORT The support provided to combat forces, primarily in the fields of administration and logistics.	CSS		None
COMBAT SUPPORT (MANOEUVRE ENHANCEMENT) Integrates the complementary and reinforcing capabilities of the force protection, manoeuvre and fires, and sustainment joint functions, tasks, and systems to enhance freedom of action into a single unit.			None
COMBINED ARMS A unit in which infantry and armour units are assigned together to create a combined arms effect.			None
COUNTER-INTELLIGENCE	CI		None
CRIMINAL INVESTIGATION DIVISION	CID		None

Table 3-3. Main Sector Icons.










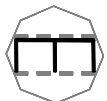

FUNCTION <i>Note: AAP-6 definitions are included for clarification when existing.</i>	ICON	LOCATION	REMARKS
DIVING			None
DOG	DOG		None
DRILLING			None
ELECTRONIC RANGING			None
ELECTRONIC WARFARE Military action to exploit the electromagnetic spectrum encompassing: the search for, interception and identification of electromagnetic emissions, the employment of electromagnetic energy, including directed energy, to reduce or prevent hostile use of the electromagnetic spectrum, and actions to ensure its effective use by friendly forces.	EW		Increased spacing between and reduced size on letters with modifiers for direction finding, intercept and jamming
ENGINEER			Reduced when used as an icon with the armoured modifier.  Armoured Engineer

Table 3-3. Main Sector Icons.













<p>FUNCTION <i>Note: AAP-6 definitions are included for clarification when existing.</i></p>	<p>ICON</p>	<p>LOCATION</p>	<p>REMARKS</p>
<p>EXPLOSIVE ORDNANCE DISPOSAL The detection, identification, onsite evaluation, rendering safe, recovery and final disposal of unexploded explosives ordnance. It may also include explosives ordnance which has become hazardous by damage or deterioration.</p>	<p>EOD</p>		<p>None</p>
<p>FIELD ARTILLERY Note: US also uses for Fires.</p>			<p>Reduced when used as an icon with the self-propelled modifier.</p>  <p>Self-Propelled Field Artillery</p>
<p>FIELD ARTILLERY OBSERVER</p>			<p>The reduced field artillery and reconnaissance and observation post icons together represent the field artillery observer icon.</p>
<p>FIELD CAMP CONSTRUCTION</p>	<p>CAMP</p> 	<p>CAMP</p> 	<p>The engineer and camp icon together represent the field camp icon.</p>
<p>FINANCE</p>			<p>None</p>
<p>FIRE PROTECTION/ FIRE FIGHTING</p>			<p>None</p>







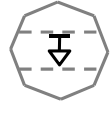


Table 3-3. Main Sector Icons.			
<i>FUNCTION</i> <i>Note: AAP-6 definitions are included for clarification when existing.</i>	<i>ICON</i>	<i>LOCATION</i>	<i>REMARKS</i>
GEOSPATIAL SUPPORT/ GEOSPATIAL INFORMATION SUPPORT	GEO		None
INFORMATION OPERATIONS	IO		None
INTERROGATION	IPW		None
JOINT FIRE SUPPORT	JFS		None
JUDGE ADVOCATE GENERAL	JAG		None
LABOUR			None
LAUNDRY/BATH			None

Table 3-3. Main Sector Icons.











FUNCTION <i>Note: AAP-6 definitions are included for clarification when existing.</i>	ICON	LOCATION	REMARKS
LIAISON That contact or intercommunication maintained between elements of military forces to ensure mutual understanding and unity of purpose and action.	LO		None
MAINTENANCE All actions taken to retain equipment in or to restore it to a specified condition, including inspection, testing, servicing, classification as to serviceability, repair, rebuilding and reclamation.			None
MATERIEL	MAT		Must be used in conjunction with the supply icon. 
METEOROLOGICAL	MET		None
MILITARY INTELLIGENCE	MI		None
MILITARY POLICE	MP		None
MINE In land mine warfare, an explosive ammunition designed to be placed under, on or near the ground or other surface area and to be actuated by the presence, proximity or contact of a person, land vehicle, aircraft or boat, including landing craft.			None

Table 3-3. Main Sector Icons.











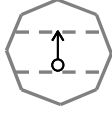
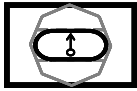


FUNCTION <i>Note: AAP-6 definitions are included for clarification when existing.</i>	ICON	LOCATION	REMARKS
MINE CLEARING/ COUNTERMINE			Main and 1
MINE LAUNCHING/ MINE LAUNCHER			Main and 2
MINE LAYING/ MINE LAYER			Main and 1
MISSILE			None
MORALE, WELFARE, AND RECREATION	<p>MWR</p>		None
MORTAR			<p>Reduced when used as an icon with the tracked modifier.</p>  <p>Tracked Mortar</p>
MORTUARY AFFAIRS/ GRAVES REGISTRATION			None

Table 3-3. Main Sector Icons.














FUNCTION <i>Note: AAP-6 definitions are included for clarification when existing.</i>	ICON	LOCATION	REMARKS
NAVAL			None
OBSERVER/ OBSERVATION			None
ORDNANCE			None
PERSONNEL SERVICES	PS		None
PETROLEUM OIL LUBRICANTS A broad term that includes all petroleum and associated products used by the Armed Forces.			See also Table 3-4. Full Frame Icons under Classes of Supply – Class III
PIPELINE			None
POSTAL			None

Table 3-3. Main Sector Icons.












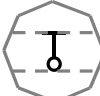

FUNCTION <i>Note: AAP-6 definitions are included for clarification when existing.</i>	ICON	LOCATION	REMARKS
PUBLIC AFFAIRS (PUBLIC INFORMATION)	PA		None
PSYCHOLOGICAL OPERATIONS Planned psychological activities designed to influence attitudes and behaviour affecting the achievement of political and military objectives.			None
QUARTERMASTER			None
RADAR			None
RADIO			Normally used in conjunction with signal icon.  Signal Radio
RADIO RELAY			Normally used in conjunction with signal icon.  Signal Radio Relay

Table 3-3. Main Sector Icons.




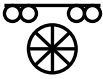







<i>FUNCTION</i> <i>Note: AAP-6 definitions are included for clarification when existing.</i>	<i>ICON</i>	<i>LOCATION</i>	<i>REMARKS</i>
RADIO TELETYPE CENTRE			Normally used in conjunction with signal icon.  Signal Radio Teletype Centre
RAILHEAD A point on a railway where loads are transferred between trains and other means of transport.			The transportation and railroad icons together represent the railhead icon. This is a transportation unit.
RELIGIOUS SUPPORT	REL		None
REPLACEMENT HOLDING UNIT	RHU		None
SEA-AIR-LAND	SEAL		None
SEAPORT OF DEBARKATION (SPOD)/SEAPORT OF EMBARKATION (SPOE)			The transportation and naval icons together represent the SPOD/SPOE icon. This is a transportation unit.
SECURITY	SEC		None

Table 3-3. Main Sector Icons.












FUNCTION <i>Note: AAP-6 definitions are included for clarification when existing.</i>	ICON	LOCATION	REMARKS
SECURITY POLICE (AIR)			SP and fixed wing aviation icons together represent the security police (air) icon.
SENSOR			None
SHORE PATROL	SP		None
SNIPER			None
SPECIAL FORCES Specially designated, organized, trained and equipped forces using operational techniques and modes of employment not standard to conventional forces. (APP-6) Note: These are land units.	SF		None
SPECIAL OPERATIONS FORCES	SOF		None
SURVEILLANCE The systematic observation of aerospace, surface or subsurface areas, places, persons, or things, by visual, aural, electronic, photographic, or other means.			None

Table 3-3. Main Sector Icons.



















FUNCTION <i>Note: AAP-6 definitions are included for clarification when existing.</i>	ICON	LOCATION	REMARKS
SURVEY			Can be used as a sector 1 modifier.
SUSTAINMENT The provision of personnel, logistics and other support required to maintain and prolong operations until successful mission accomplishment. (AJP-3)	SUST		None
TACTICAL SATELLITE			Normally used in conjunction with signal icon.  Signal Tactical Satellite
TOPOGRAPHIC			None
TRANSPORTATION			None
UNMANNED SYSTEMS			None
VIDEO IMAGERY (COMBAT CAMERA)			None

Table 3-3. Main Sector Icons.			
<i>FUNCTION</i> <i>Note: AAP-6 definitions are included for clarification when existing.</i>	<i>ICON</i>	<i>LOCATION</i>	<i>REMARKS</i>
WATER			None
WATER PURIFICATION			None

Full Frame Icons

0309. As with main sector icons, full frame icons (figure 3-7) normally reflect the main function of the symbol, but in some cases can also reflect modifying information as well e.g., air and naval gunfire liaison company). Table 3-4 below shows the full frame icons for use in land unit symbols. The diagonal lines used for full frames icons such as infantry, reconnaissance, signal, etc. will be angled to conform to the shape of the frame.

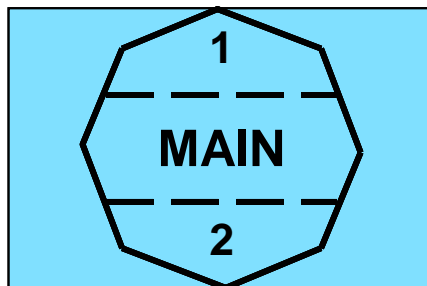


Figure 3-7. Full frame icons.


Table 3-4. Full Frame Icons.			
<i>FUNCTION</i>	<i>ICON</i>	<i>LOCATION</i>	<i>REMARKS</i>
<i>Friendly</i>	<i>Hostile</i>	<i>Neutral</i>	<i>Unknown</i>
AIR ASSAULT WITH ORGANIC LIFT			None

Table 3-4. Full Frame Icons.




















<i>FUNCTION</i>	<i>ICON</i>	<i>LOCATION</i>	<i>REMARKS</i>
<i>Friendly</i>	<i>Hostile</i>	<i>Neutral</i>	<i>Unknown</i>
			
AIR DEFENCE			None
			
AIR AND NAVAL GUNFIRE LIAISON COMPANY (ANGLICO)			The reconnaissance, field artillery, rotary wing aviation, and naval icons represent the ANGLICO icon.
			
AMPHIBIOUS			None
			

Table 3-4. Full Frame Icons.



















<i>FUNCTION</i>	<i>ICON</i>	<i>LOCATION</i>	<i>REMARKS</i>
<i>Friendly</i>	<i>Hostile</i>	<i>Neutral</i>	<i>Unknown</i>
ANALYSIS			Normally used in conjunction with the electronic warfare icon. Increased spacing between letters. 
			
ANTITANK/ ANTIARMOUR			None
			
BROADCAST TRANSMITTER ANTENNA			Can be used in conjunction with the psychological operations icon.  Psychological Operations Broadcast
			
CORPS SUPPORT			None

Table 3-4. Full Frame Icons.




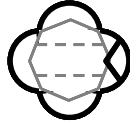








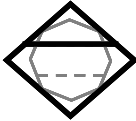

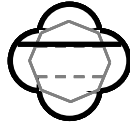
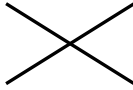



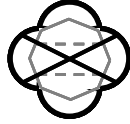
<i>FUNCTION</i>	<i>ICON</i>	<i>LOCATION</i>	<i>REMARKS</i>
<i>Friendly</i>	<i>Hostile</i>	<i>Neutral</i>	<i>Unknown</i>
			
DIRECTION FINDING			Normally used in conjunction with the electronic warfare icon.  Electronic Warfare Direction Finding
			
HEADQUARTERS OR HEADQUARTERS ELEMENT			None
			
INFANTRY			None
			

Table 3-4. Full Frame Icons.














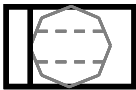
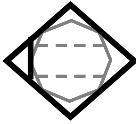

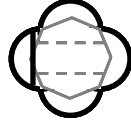
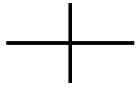
<i>FUNCTION</i>	<i>ICON</i>	<i>LOCATION</i>	<i>REMARKS</i>
<i>Friendly</i>	<i>Hostile</i>	<i>Neutral</i>	<i>Unknown</i>
INTERCEPT (SEARCH AND RECORDING)			Normally used in conjunction with the electronic warfare icon  Electronic Warfare Intercept
			
JAMMING			Normally used in conjunction with the electronic warfare icon  Electronic Warfare Jamming
			
MAIN GUN SYSTEM			None
			
MEDICAL			None

Table 3-4. Full Frame Icons.




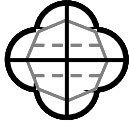
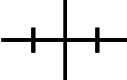
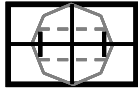


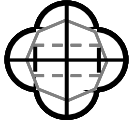




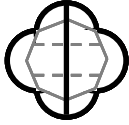

<i>FUNCTION</i>	<i>ICON</i>	<i>LOCATION</i>	<i>REMARKS</i>
<i>Friendly</i>	<i>Hostile</i>	<i>Neutral</i>	<i>Unknown</i>
			
MEDICAL TREATMENT FACILITY			None
			
MOTORIZED A unit equipped with complete motor transportation that enables all of its personnel, weapons, and equipment to be moved at the same time without assistance from other sources.			None
			
RECONNAISSANCE A mission undertaken to obtain, by visual observation or other detection methods, information about the activities and resources of an enemy or potential enemy, or to secure data concerning the meteorological, hydrographical, or geographic characteristics of a particular area. Note: Also referred to as cavalry and scout.			None

Table 3-4. Full Frame Icons.

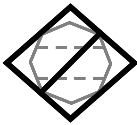

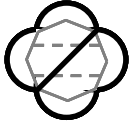










<i>FUNCTION</i>	<i>ICON</i>	<i>LOCATION</i>	<i>REMARKS</i>
<i>Friendly</i>	<i>Hostile</i>	<i>Neutral</i>	<i>Unknown</i>
			
SEARCH (RECONNAISSANCE)			Normally used in conjunction with the electronic warfare icon  Electronic Warfare Search
			
SIGNAL			None
			
SUPPLY			When used with Headquarters, also referred to as Service as in Headquarters and Service None

Table 3-4. Full Frame Icons.


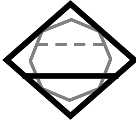

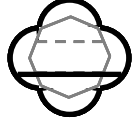










<i>FUNCTION</i>	<i>ICON</i>	<i>LOCATION</i>	<i>REMARKS</i>
<i>Friendly</i>	<i>Hostile</i>	<i>Neutral</i>	<i>Unknown</i>
			
NATO CLASSES OF SUPPLY	Note: These icons are also used in creating supply points. See Chapter 5, Control Measure Symbols.	Note: Use the same positioning for the supply icon as shown in the examples for supply.	Classes of Supply require the use of the supply icon in conjunction with the each different class and subclass type icons.
CLASS I Those items which are consumed by personnel or animals at the approximately uniform rate, irrespective of local changes in combat or terrain conditions.			Class I icon requires the use of the supply icon in conjunction with the Roman numeral I icon to represent all of Class I.
CLASS II Supplies for which allowances are established by tables of organisation and equipment.			Class II icon requires the use of the supply icon in conjunction with the Roman numeral II icon to represent all of Class II.
CLASS III PETROLEUM, OIL AND LUBRICANTS (POL) Fuels and lubricants for all purposes, except for operating aircraft or for use in weapons such as flame throwers.			Class III icon requires the use of the supply icon in conjunction with the POL icon.
CLASS IV Supplies for which initial issue allowances are not prescribed by approved issue tables. Normally such supplies include fortification and construction materials, as well as additional quantities of items identical to those authorized for initial issue (Class II), such as additional vehicles.			Class IV icon requires the use of the supply icon in conjunction with the Roman numeral IV icon to represent all of Class IV.
CLASS V AMMUNITION Ammunition, explosives and chemical agents of all types.			Class V icon requires the use of the supply icon in conjunction with the ammunition icon.





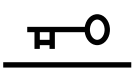











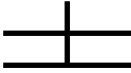







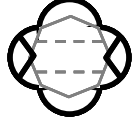
Table 3-4. Full Frame Icons.			
<i>FUNCTION</i>	<i>ICON</i>	<i>LOCATION</i>	<i>REMARKS</i>
<i>Friendly</i>	<i>Hostile</i>	<i>Neutral</i>	<i>Unknown</i>
MULTIPLE CLASSES OF SUPPLY	I&IV _____		The Multiple Classes of Supply icon requires the use of the supply icon in conjunction with the Roman numeral representation of classes of supply icons.
ALL CLASSES OF SUPPLY	ALL _____		The All Classes of Supply icon requires the use of the supply icon in conjunction with the all icon.
US CLASSES OF SUPPLY			
Note: See STANAG 2961, <i>Classes of Supply of NATO Land Forces</i> . It includes other systems for designating classes of supply to include a comparison with US classes (shown below).			
CLASS I (NATO CLASS I) SUBSISTENCE			Class I subsistence icon requires the use of the supply icon in conjunction with the subsistence icon.
CLASS II (NATO CLASS II) CLOTHING AND EQUIPMENT			Class II clothing and equipment icon requires the use of the supply icon in conjunction with the quartermaster icon.
CLASS III (NATO CLASS III) PETROLEUM, OIL AND LUBRICANTS (POL)			Class III icon requires the use of the supply icon in conjunction with the POL icon.
CLASS IV (NATO CLASS IV) CONSTRUCTION MATERIAL			Class IV construction material icon requires the use of the supply icon in conjunction with the engineer icon.
CLASS V (NATO CLASS V) AMMUNITION			Class V icon requires the use of the supply icon in conjunction with the ammunition icon.

Table 3-4. Full Frame Icons.

<i>FUNCTION</i>	<i>ICON</i>	<i>LOCATION</i>	<i>REMARKS</i>
<i>Friendly</i>	<i>Hostile</i>	<i>Neutral</i>	<i>Unknown</i>
CLASS VI (NATO CLASS I) PERSONAL DEMAND			Class I personal demand icon requires the use of the supply icon in conjunction with the personal demand icon.
CLASS VII (NATO CLASS II) MAJOR END			Class II major end items icon requires the use of the supply icon in conjunction with the major end items icon.
CLASS VIII (NATO CLASS II) MEDICAL			Class II medical icon requires the use of the supply icon in conjunction with the medical icon.
CLASS IX (NATO CLASS II) REPAIR PARTS			Class II repair parts icon requires the use of the supply icon in conjunction with the repair parts icon.
CLASS X (NATO CLASS IV) NON-STANDARD ITEMS	CA		Class IV non-standard items icon requires the use of the supply icon in conjunction with the civil affairs icon.
THEATRE/ECHELONS ABOVE CORPS SUPPORT			None
			

Sector 1 Modifiers

0310. Sector 1 modifiers (Figure 3-8) depict additional information pertaining to the icon. Table 3-5 shows the modifiers for use in land unit symbols in sector 1 of the A field of the symbol.

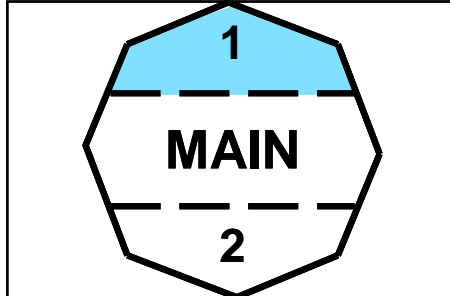


Figure 3-8. Sector 1 Modifiers Placement.

Table 3-5. Sector 1 Modifiers.			
<i>FUNCTION</i>	<i>ICON</i>	<i>LOCATION</i>	<i>REMARKS</i>
AIRMOBILE/AIR ASSAULT (US ONLY)	∨		None
AREA	AREA		None
ATTACK	A		Normally used with aviation. Attack Aviation
BIOLOGICAL	B		Normally used with CBRN defence icon. Biological CBRN Defence












Table 3-5. Sector 1 Modifiers.			
<i>FUNCTION</i>	<i>ICON</i>	<i>LOCATION</i>	<i>REMARKS</i>
BORDER	BOR		None
BRIDGING			Normally used with engineer icon.  Engineer Bridging
CHEMICAL	C		Normally used with CBRN defence icon.  Chemical CBRN Defence
CLOSE PROTECTION A unit that provides additional protection to important personnel.	CLP		None
COMBAT	CBT		None
COMMAND AND CONTROL	C2		None
COMMUNICATIONS CONTINGENCY PACKAGE	CCP		Must be used in conjunction with the signal icon.  Signal Communications Contingency Package










Table 3-5. Sector 1 Modifiers.			
<i>FUNCTION</i>	<i>ICON</i>	<i>LOCATION</i>	<i>REMARKS</i>
CONSTRUCTION	CONST		None
CROSS CULTURAL COMMUNICATION	CCC		Normally used in conjunction with psychological operations.
CROWD AND RIOT CONTROL	CRC		Always used with military police icon.  Military Police Crowd and Riot Control
DECONTAMINATION The process of making any person, object, or area safe by absorbing, destroying, neutralizing, making harmless, or removing, chemical or biological agents, or by removing radioactive material clinging to or around it.	D		None
DETENTION	DET		None
DIRECT COMMUNICATIONS			Normally used in conjunction with psychological operations icon.  Direct Communication Psychological Operations











Table 3-5. Sector 1 Modifiers.			
<i>FUNCTION</i>	<i>ICON</i>	<i>LOCATION</i>	<i>REMARKS</i>
DIVING			None
DIVISION	XX		None
DOG	DOG		 Military Police Dog
DRILLING			None
ELECTRO-OPTICAL	EO		None
ENHANCED	ENH		None
EXPLOSIVE ORDNANCE DISPOSAL	EOD		None






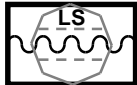





Table 3-5. Sector 1 Modifiers.			
<i>FUNCTION</i>	<i>ICON</i>	<i>LOCATION</i>	<i>REMARKS</i>
FIRE DIRECTION CENTRE That element of a command post, consisting of gunnery and communication personnel and equipment, by means of which the commander exercises fire direction and/or fire control.	FDC		None
FORCE	F		None
FORWARD	FWD		None
GROUND STATION MODULE	GSM		None
LANDING SUPPORT	LS		Must be used in conjunction with the amphibious icon.  Landing Support
LARGE EXTENSION NODE	LEN		Must be used in conjunction with the signal icon.  Signal Large Extension Node
MAINTENANCE			 Aviation Maintenance













Table 3-5. Sector 1 Modifiers.			
<i>FUNCTION</i>	<i>ICON</i>	<i>LOCATION</i>	<i>REMARKS</i>
METEOROLOGICAL	MET		 Field Artillery Meteorological
MINE COUNTERMEASURE	MCM		None
MISSILE			 Missile Maintenance
(MOBILE) ADVISOR AND SUPPORT			None
MOBILE SUBSCRIBER EQUIPMENT	MSE		Must be used in conjunction with the signal icon.  Signal Mobile Subscriber Equipment
MOBILITY SUPPORT	MS		None
MOVEMENT CONTROL CENTRE An organization responsible for planning, routing, scheduling, and control of personnel and cargo movements over lines of communications.	MCC		None















Table 3-5. Sector 1 Modifiers.			
<i>FUNCTION</i>	<i>ICON</i>	<i>LOCATION</i>	<i>REMARKS</i>
MULTINATIONAL	MN		None
MULTINATIONAL SPECIALIZED UNIT	MSU		None
MULTIPLE ROCKET LAUNCHER			Must be used in conjunction with the field artillery icon.  Multiple Rocket Launcher Field Artillery
NATO MEDICAL ROLES Note: See AJP-4.10 for an explanation of these roles.	1		Always used in conjunction with the medical treatment facility icon.  NATO Role 1 Medical Treatment Facility
	3		
NAVAL			 Naval Engineer
NODE CENTRE	NC		Must be used in conjunction with the signal icon.  Signal Node Centre
NUCLEAR	N		Normally used with CBRN defence icon.  Nuclear CBRN Defence














Table 3-5. Sector 1 Modifiers.			
<i>FUNCTION</i>	<i>ICON</i>	<i>LOCATION</i>	<i>REMARKS</i>
OPERATIONS	OPS		None
RADAR			 Field Artillery Radar
RADIOLOGICAL	RAD		Normally used with CBRN Defence.  Radiological CBRN Defence
SEARCH AND RESCUE The use of aircraft, surface craft, submarines, specialized rescue teams and equipment to search for and rescue personnel in distress on land or at sea.	SAR		None
SECURITY	SEC		None
SENSOR			 Military Intelligence Sensor
SENSOR CONTROL MODULE (SCM)	SCM		Normally used in conjunction with the military intelligence icon and sensor modifier.  Military Intelligence Sensor Control Module



















Table 3-5. Sector 1 Modifiers.			
<i>FUNCTION</i>	<i>ICON</i>	<i>LOCATION</i>	<i>REMARKS</i>
<p>SIGNALS INTELLIGENCE The generic term used to describe communications intelligence and electronic intelligence when there is no requirement to differentiate between these two types of intelligence, or to represent fusion of the two.</p>			<p>Normally used in conjunction with military intelligence icon.</p>  <p>Military Intelligence Signals Intelligence</p>
<p>SINGLE SHELTER SWITCH</p>	SSS		<p>Normally used in conjunction with the signal icon.</p>  <p>Signal Single Shelter Switch</p>
<p>SINGLE ROCKET LAUNCHER</p>			<p>Must be used in conjunction with the field artillery icon.</p>  <p>Single Rocket Launcher Field Artillery</p>
<p>SMOKE</p>	S		None
<p>SNIPER</p>			 <p>Infantry Sniper</p>
<p>SOUND RANGING</p>	SDR		<p>Normally used in conjunction with the sensor icon.</p>  <p>Sound Ranging Sensor</p>

Table 3-5. Sector 1 Modifiers.			
<i>FUNCTION</i>	<i>ICON</i>	<i>LOCATION</i>	<i>REMARKS</i>
SPECIAL WEAPONS AND TACTICS	SWAT		Normally used in conjunction with the military police icon.  Military Police Special Weapons and Tactics
SURVEY			 Field Artillery Survey
TACTICAL EXPLOITATION	TE		None
TARGET ACQUISITION The detection, identification, and location of a target in sufficient detail to permit the effective employment of weapons.	TA		None
TOPOGRAPHIC			None
UTILITY	U		None
VIDEO IMAGERY (COMBAT CAMERA)			 Signal Combat Camera

Sector 2 Modifiers

0311. Icons in sector 2 (figure 3-9) show modifying information. Table 3-6 shows the icons for use in land unit symbols in sector 2 of the A field of the symbol.

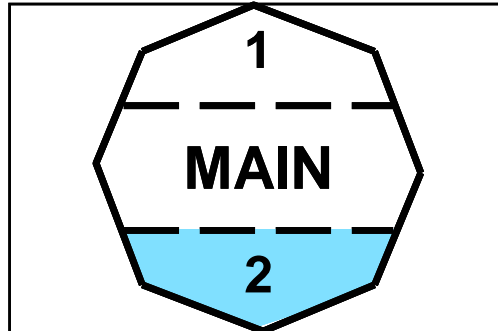


Figure 3-9. Location of Sector 2 Icons.

Table 3-6. Sector 2 Modifiers.			
<i>FUNCTION</i>	<i>ICON</i>	<i>LOCATION</i>	<i>REMARKS</i>
AIRBORNE Adjective used to describe troops specially trained to carry out operations, either dropped by parachute or air landing, following an air movement.	☪		None
ARCTIC	⌋		None
BATTLE DAMAGE REPAIR Essential repair, which may be improvised, carried out rapidly in a battle environment in order to return damaged or disabled equipment to temporary service.	BDR		Must be used in conjunction with the maintenance icon. Battle Damage Repair Maintenance
BICYCLE EQUIPPED	○		None














Table 3-6. Sector 2 Modifiers.			
<i>FUNCTION</i>	<i>ICON</i>	<i>LOCATION</i>	<i>REMARKS</i>
CASUALTY STAGING	CS		Always used in conjunction with the medical icon and is offset to the right of the centre line.  Medical Casualty Staging Unit
CLEARING	CLR		Normally used in conjunction with the mine icon.  Mine Clearing
CLOSE RANGE	CR		Normally used in conjunction with UAV icon.  Close Range Unattended Aerial Vehicle
CONTROL			Normally used in conjunction with the unmanned systems icon.  UAV Control
DECONTAMINATION	D		Used as a sector 2 modifier when C, B, R, or N is used as a sector 1 modifier.  Chemical Decontamination
DEMOLITION.	DEM		Normally used in conjunction with the Engineer icon  Engineer Demolition












Table 3-6. Sector 2 Modifiers.			
<i>FUNCTION</i>	<i>ICON</i>	<i>LOCATION</i>	<i>REMARKS</i>
DENTAL	D		<p>Normally used in conjunction with the medical icon and is offset to the right of the centre line.</p>  <p>Dental Medical</p>
DIGITAL	DIG		<p>Normally used in conjunction with signal icon.</p>  <p>Signal Digital</p>
ENHANCED POSITION LOCATION REPORTING SYSTEM (EPLRS)			<p>Must be used in conjunction with the signal icon.</p>  <p>Signal Enhanced Position Location Reporting System</p>
EQUIPMENT All non-expendable items needed to outfit/equip an individual or organization.	E		<p>Normally used in conjunction with the CBRN icon and decontamination modifier.</p>  <p>CBRN Equipment Decontamination</p>
HEAVY	H		None
HIGH ALTITUDE	HA		See multiple altitudes.

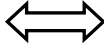










Table 3-6. Sector 2 Modifiers.			
<i>FUNCTION</i>	<i>ICON</i>	<i>LOCATION</i>	<i>REMARKS</i>
INTERMODAL			Normally used in conjunction with transportation icon.  Intermodal Transportation
INTENSIVE CARE	IC		Normally used in conjunction with the medical icon and is offset to the right of the centre line.  Medical Intensive Care
LIGHT	L		None
LABORATORY	LAB		None
LAUNCHER			Normally used in conjunction with the unmanned systems icon.  UAV Launcher
LONG RANGE	LR		None







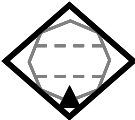

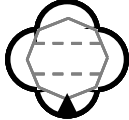

Table 3-6. Sector 2 Modifiers.			
<i>FUNCTION</i>	<i>ICON</i>	<i>LOCATION</i>	<i>REMARKS</i>
LOW ALTITUDE	LA		See multiple altitudes.
MEDIUM	M		None
MEDIUM ALTITUDE	MA		See multiple altitudes.
MEDIUM RANGE	MR		None
MOUNTAIN			Base must touch or be near the bottom of the frame (see below).
			
MULTIPLE ALTITUDES	H/MA		The Multiple Altitudes icon uses the combination of altitudes icons. Note: This example represents high to medium altitude.













Table 3-6. Sector 2 Modifiers.			
<i>FUNCTION</i>	<i>ICON</i>	<i>LOCATION</i>	<i>REMARKS</i>
MULTI-CHANNEL	MC		Normally used in conjunction with signal icon.  Signal Multi-channel
OPTICAL (FLASH)	OPT		Normally used in conjunction with the field artillery icon and target acquisition modifier.  Field Artillery Optical (Flash) Target Acquisition
PACK ANIMAL			None
PATIENT EVACUATION COORDINATION	PEC		Normally used in conjunction with the medical icon and is offset to the right of the centre line.  Medical Patient Evacuation Coordination
PREVENTIVE MAINTENANCE	PM		Must be used in conjunction with the maintenance icon.  Preventive Maintenance
PSYCHOLOGICAL	P		Normally used in conjunction with the medical icon and is offset to the right of the centre line.  Psychological Medical

Table 3-6. Sector 2 Modifiers.			
<i>FUNCTION</i>	<i>ICON</i>	<i>LOCATION</i>	<i>REMARKS</i>
RADIO RELAY LINE OF SIGHT			Normally used in conjunction with signal icon. Signal Line of Sight Radio Relay
RAILROAD			None
RECOVERY (UNMANNED SYSTEMS) In air operations, that phase of a mission which involves the return of an aircraft to a base.			Normally used in conjunction with the unmanned systems icon. UAV Recovery
RECOVERY (MAINTENANCE) In battlefield maintenance, the extrication of an abandoned, disabled or immobilized vehicle and, if necessary, its removal to a maintenance point.			None
RESCUE COORDINATION CENTRE.	RCC		Normally used in conjunction with the medical icon and is offset to the right of the centre line. Medical Rescue Coordination Centre
RIVERINE			None
SINGLE CHANNEL	SC		Normally used in conjunction with signal icon. Single Channel
















Table 3-6. Sector 2 Modifiers.			
<i>FUNCTION</i>	<i>ICON</i>	<i>LOCATION</i>	<i>REMARKS</i>
SKI			None
SHORT RANGE	SR		None
STRATEGIC	STR		None
SUPPORT	SPT		None
TACTICAL	TAC		None
TOWED			None
TROOP	T		<p>Normally used in conjunction with the CBRN icon and decontamination modifier.</p>  <p>CBRN Troop Decontamination</p>

Table 3-6. Sector 2 Modifiers.			
<i>FUNCTION</i>	<i>ICON</i>	<i>LOCATION</i>	<i>REMARKS</i>
VERTICAL OR SHORT TAKE-OFF AND LANDING (VSTOL)	VSTOL		Normally used in conjunction with fixed wing aviation or rotary wing aviation.  Rotary Wing Aviation Vertical Short Takeoff and Landing
VETERINARY	V		Normally used in conjunction with the medical icon and is offset to the right of the centre line.  Veterinary Medical
WHEELED	OOO		None


Echelon Amplifiers (Field B)

0312. Echelons are separate levels of command. As compared to a regiment, a division is a higher echelon and a battalion is a lower echelon. Table 3-7 shows the amplifiers for echelons. Annex B provides comparative unit/formation designations for the NATO nations land forces.

Table 3-7. Field B: Echelon.	
<i>Echelon</i>	<i>Symbol</i>
Team ¹ /Crew	∅
Squad ²	•
Section ³	••
Platoon ⁴ /Detachment	•••
Company ⁵	
Battalion ⁶	
Regiment ⁷ /Group ⁸	
Brigade ⁹	X
Division ¹⁰	XX
Corps ¹¹	XXX
Army ¹²	XXXX
Army Group ¹³	XXXXX
Theatre ¹⁴	XXXXXX
<p>Notes:</p> <p>¹Team: The smallest formation.</p> <p>²Squad: A formation larger than a team, but smaller than a section.</p> <p>³Section: A formation larger than a squad, but smaller than a platoon.</p> <p>⁴Platoon: A formation larger than a section, but smaller than a company.</p> <p>⁵Company: A formation larger than a platoon, but smaller than a battalion. A unit consisting of two or more platoons, usually of the same type, with a headquarters and a limited capacity for self-support.</p> <p>⁶Battalion: A formation larger than a company, but smaller than a regiment. A unit consisting of two or more company-, battery-, or troop-sized units and a headquarters.</p> <p>⁷Regiment: A formation larger than a battalion, but smaller than a brigade.</p> <p>⁸Group: A flexible administrative and tactical unit composed of either two or more battalions or two or more squadrons. The term also applies to combat support or combat service support units.</p> <p>⁹Brigade: A formation larger than a regiment, but smaller than a division.</p> <p>¹⁰Division: A major administrative and tactical unit/formation which combines in itself the necessary arms and services required for sustained combat, larger than a regiment/brigade and smaller than a corps.</p> <p>¹²Army Corps: A formation larger than a division but smaller than an army or army group. It usually consists of two or more divisions together with supporting arms and services..</p> <p>¹²Army: A formation larger than an army corps, but smaller than an army group. It usually consists of two or more army corps.</p> <p>¹³Army Group: The largest formation of land forces, normally comprising two or more armies or army corps under a designated commander.</p> <p>¹⁴Theatre: A theatre is a broad geographical area defined by the SACEUR, which includes and surrounds the JOA, where strategic and operational activity may take place in support of the JFC mission. (AJP-3).</p>	


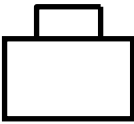
A Command as an Echelon (Field B)

0313. There is also a separate echelon known as a command. A command is a unit or units, an organization, or an area under the command of one individual. It does not correspond to any of the other echelons. It is designated by using ++ as its echelon symbol (see Table 3-8).

Table 3-8. Command as an Echelon.			
<i>FUNCTION</i>	<i>ICON</i>	<i>LOCATION</i>	<i>REMARKS</i>
COMMAND	++	<div style="text-align: center;"> ++  </div>	None




Task Force Amplifier (Field D)

0314. A task force is a temporary grouping of units, under one commander, formed for carrying out a specific operation or mission or a semi-permanent organization of units, under one commander, formed for the purpose of carrying out a continuing specified task (see Table 3-9).

Table 3-9. Task Force.			
<i>FUNCTION</i>	<i>ICON</i>	<i>LOCATION</i>	<i>REMARKS</i>
TASK FORCE			None



Reinforced, Reduced, or Reinforced and Reduced Amplifiers (Field F)


0315. These icons are used at division and below levels. The reinforced icon + indicates that the capability of one unit has been augmented by the capability of another unit. The reduced icon – indicates that the capability of a unit has been reduced by the detachment of one or more of its units. If a unit has been both reinforced and reduced, then the ± icon is used (see table 3-10).

Table 3-10. Reinforced, Reduced, or Reinforced and Reduced.			
<i>FUNCTION</i>	<i>ICON</i>	<i>LOCATION</i>	<i>REMARKS</i>
REINFORCED	+		None
REDUCED	-		None
REINFORCED AND REDUCED	±		None

Named Command and Control Headquarters (Field AA)

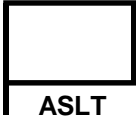
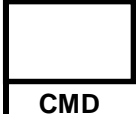



0316. These are headquarters that are designated by a name, such as Allied Command Operations, Allied Command Transformation, etc (see table 3-11).

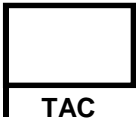
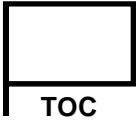
Table 3-11. Named Command and Control Headquarters.			
<i>FUNCTION</i>	<i>ICON</i>	<i>LOCATION</i>	<i>REMARKS</i>
ALLIED COMMAND EUROPE RAPID REACTION CORPS	ARRC		None
INTERNATIONAL SECURITY ASSISTANCE FORCE	ISAF		None

MULTINATIONAL	MN		None
---------------	-----------	--	------

Headquarters Elements (Field AH)

0317. These are examples of named headquarters elements (see table 3-12).

Table 3-12. Field AH: Headquarters Element.			
<i>FUNCTION</i>	<i>AMPLIFIER</i>	<i>LOCATION</i>	<i>REMARKS</i>
ASSAULT COMMAND POST	ASLT		None
COMMAND GROUP	CMD		None
FORWARD COMMAND POST	FWD		None
MAIN COMMAND POST	MAIN		None
REAR COMMAND POST	REAR		None

TACTICAL COMMAND POST	TAC		None
TACTICAL OPERATIONS CENTRE	TOC		None

Locating Unit Symbols

0318. The centre of mass of the unit symbol indicates the general vicinity of the centre of mass of the unit. To indicate precise location or reduce clutter in an area with multiple units, a line (without an arrow) extends from the centre of the bottom of the frame to the unit location displayed as field Q. The line may be extended or bent as required. If a group of units (or installations) other than a headquarters is at one location, the grouping of the symbols may be enclosed with a bracket and the exact location indicated by a line from the centre of the bracket (see figure 3-10).

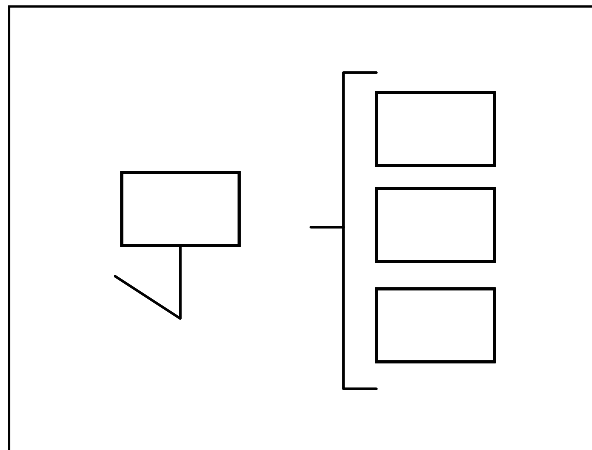


Figure 3-10. Offset and Multiple Unit Locations.

Headquarters unit symbols include a staff or line drawn from the bottom left hand corner displayed as field "S." This staff may be bent or extended as required to indicate unit location. If several headquarters are at one location, more than one headquarters can be on a single staff. The highest echelon headquarters is placed on top, followed by the next levels in descending order (see figure 3-11).

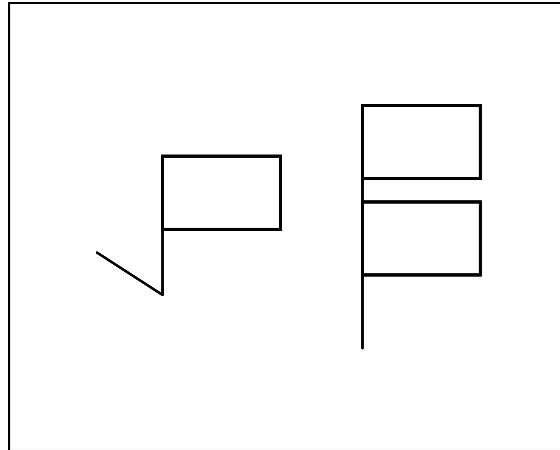


Figure 3-11. Offset Headquarters and Multiple Headquarters Locations.

Individual and Organization Main Sector Icons

0319. These icons represent non-military individuals and organizations. Icons in the main sector (figure 3-6 on page 3-9) normally reflect the main function of the symbol, but in some cases can also reflect modifying information as well. Table 3-13 below shows the icons for use in land individual and organization symbols in the main sector of the A field of the symbol. In most cases, the dimensions of the icon will be sized to occupy as much area in the main sector as is available. However, in some cases the icon may be reduced to allow more room for modifiers for better recognition or to allow for one icon to modify another.


















Table 3-13. Main Sector Icons.			
<i>FUNCTION</i>	<i>ICON</i>	<i>LOCATION</i>	<i>REMARKS</i>
CIVILIAN POLICE			None
ENVIRONMENTAL PROTECTION			None
GOVERNMENT ORGANIZATION	GO		None

Table 3-13. Main Sector Icons.			
<i>FUNCTION</i>	<i>ICON</i>	<i>LOCATION</i>	<i>REMARKS</i>
INTERNAL SECURITY FORCE	ISF		None
INDIVIDUAL			None
ORGANIZATION OR GROUP			None
KILLING VICTIM			None
KILLING VICTIMS			None
VICTIM OF AN ATTEMPTED CRIME			None
SPY	SPY		None

Sector 1 Modifiers

0320. Modifiers in sector 1 (figure 3-8 on page 3-36) show additional information pertaining to the icon. Table 3-14 shows the modifiers for use in land individuals and organization symbols in sector 1 of the A field of the symbol.













Table 3-14. Sector 1 Modifiers.			
<i>FUNCTION</i>	<i>ICON</i>	<i>LOCATION</i>	<i>REMARKS</i>
Types of Killing Victims - Always used with a killing victim or killing victims icon.			
ASSASSINATION	AS		 Assassination Victim
EXECUTION (WRONGFUL KILLING)	EX		 Execution (Wrongful Killing) Victim
MURDER VICTIMS	MU		 Murder Victims
Criminal Activities Victims – Always used with individual icon or organization icon.			
HIJACKING	H		 Hijacking Victim
KIDNAPPING	K		 Kidnapping Victim
PIRACY	PI		 Piracy Victims
























Table 3-14. Sector 1 Modifiers.			
<i>FUNCTION</i>	<i>ICON</i>	<i>LOCATION</i>	<i>REMARKS</i>
RAPE	RA		 Rape Victim
The following modifiers are normally used in conjunction with either an individual or organization icon.			
DISPLACED PERSON(S), REFUGEE(S) AND EVACUEE(S)	DPRE		 Displaced Persons, Refugees and Evacuees
FOREIGN FIGHTER(S)	FF		 Foreign Fighter
GANG MEMBER OR GANG	GANG		 Gang
GOVERNMENT ORGANIZATION	GO		None
LEADER OR LEADERSHIP	LDR		Can be used as a sector 2 modifier when used with a sector 1 modifier.  Terrorist Leader
NON-GOVERNMENTAL ORGANIZATION MEMBER OR NON-GOVERNMENTAL ORGANIZATION	NGO		 Non-governmental Organization

Table 3-14. Sector 1 Modifiers.			
<i>FUNCTION</i>	<i>ICON</i>	<i>LOCATION</i>	<i>REMARKS</i>
COERCED/ IMPRESSED RECRUIT	C		 Coerced Recruitment of an Organization
WILLING RECRUIT	W		 Willing Recruit
RELIGIOUS OR RELIGIOUS ORGANIZATION	REL		 Religious Organization
TARGETED INDIVIDUAL OR ORGANIZATION	TGT		 Targeted Individual
TERRORIST OR TERRORIST ORGANIZATION	TER		 Terrorist Organization

Sectors 2 Modifiers

0321. Sector 2 modifiers also depict additional information regarding a symbol's icon. Currently, there are no sector 2 modifiers.

SECTION III

LAND EQUIPMENT SYMBOLS

General

0322. This section establishes a single standard for developing land equipment symbols. Equipment is all non-expendable items that are needed to outfit or equip an individual or organization. This section provides a wide selection of land equipment icons with a standard method for constructing land equipment symbols. Once the user is familiar with the prescribed system, any land equipment symbol can be developed using the logical sequence provided in this chapter. The symbols shown in this chapter are adequate for depicting hostile units. Avoid using any symbol that differs from those in this publication. If, after searching doctrinal icons, it is necessary to create a new symbol, explain the symbol in an accompanying legend. Computer-generated systems may have difficulty in passing non-standard symbols.

Composition of Equipment Symbols

0323. A land equipment symbol is normally composed of a frame which is optional, colour (fill), equipment icon, modifier, and text or graphic amplifiers (see figure 3-12). (See table 3-15 for the steps used to build equipment symbols.) Icons and modifiers for equipment are displayed differently for weapons systems and vehicles. Most of the icons fill the entire frame and their size modifier is part of the icon, normally located in the main sector. The mobility is shown outside the frame as a graphic amplifier. However, there are also icons that follow the normal pattern established in chapter 1. A non-standard symbol is used for the building section to show a similar pattern for development while showing the variation of this legacy system.

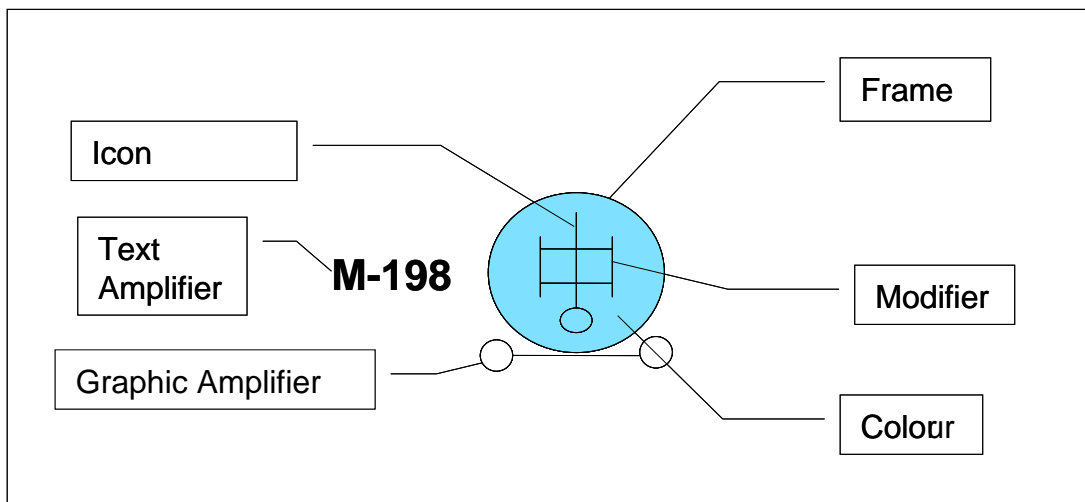
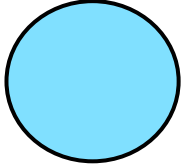
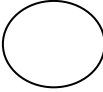
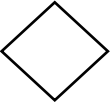

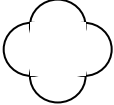



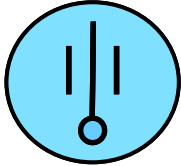
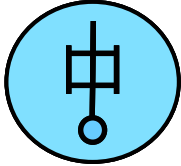
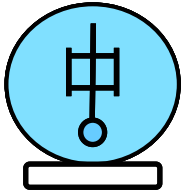


Figure 3-12. Land Equipment Symbol Composition.

Table 3-15. Building Equipment Symbols with Frames.

<i>Step No.</i>	<i>Step</i>	<i>Example</i>					
Step 1.	Choose frame according to standard identity.						
Land Equipment Frame Shapes and Standard Identity							
STANDARD IDENTITY	FRIENDLY	HOSTILE	NEUTRAL	UNKNOWN	ASSUMED FRIEND	SUSPECT	PENDING
FRAME							
Step 2.	Choose and add main sector icon.						
Step 3.	Choose and add a modifier.						
Step 4.	Choose and add a graphic mobility amplifier.						

Land Equipment Icon, Modifier, and Amplifier Fields

0324. Figure 3-13 shows the placement of equipment labelling fields around the friendly land equipment symbol frame. The placement of equipment symbol modifier fields is the same regardless of frame shape or standard identity.

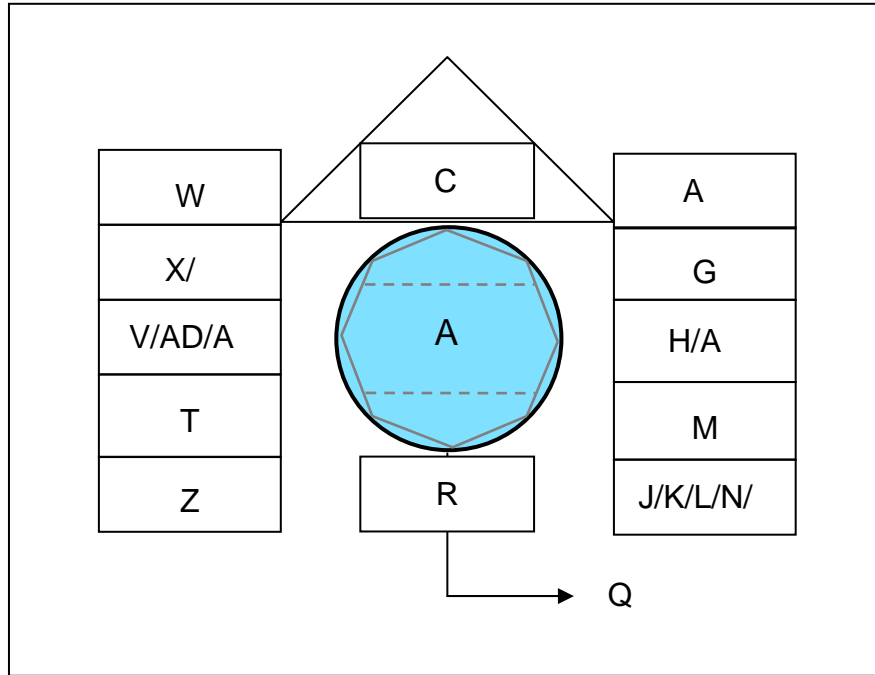


Figure 3-13. Land Equipment Icon and Modifier and Amplifier Fields.

0325. Table 3-16 provides a description of each of the equipment symbol fields as shown in figure 3-13.

Table 3-16. Description of Icon, Modifier, and Amplifier Fields for Land Equipment Symbols.			
<i>Field</i>	<i>Field Title</i>	<i>Description</i>	<i>Text/Graphic</i>
A	Icon	Basic equipment symbol that can include size or capacity modifiers.	Both
C	Quantity	Identifies the number of items present.	Text
G	Staff Comments	Free text. Can be used by staff for information required by commander.	Text
H	Additional Information	Free text. Additional information not covered by other fields.	Text

Table 3-16. Description of Icon, Modifier, and Amplifier Fields for Land Equipment Symbols.			
<i>Field</i>	<i>Field Title</i>	<i>Description</i>	<i>Text/Graphic</i>
J	Evaluation Rating	<p>Degree of confidence that may be placed on the information represented by the symbol. It is shown as one letter and one number made up of Reliability of Source and Credibility of Information.</p> <p>Reliability of Source:</p> <p>A. Completely reliable B. Usually reliable C. Fairly reliable D. Not usually reliable E. Unreliable F. Reliability cannot be judged.</p> <p>Credibility of Information:</p> <p>1. Confirmed by other sources 2. Probably true 3. Possibly true 4. Doubtful 5. Improbable 6. Truth cannot be judged.</p>	Text
K	Combat Effectiveness	<p>Effectiveness of unit or equipment displayed.</p> <p>1. Fully Operational 2. Substantially Operational 3. Marginally Operational 4. Not Operational</p>	Text
L	Signature Equipment	Identifies a detectable electronic signature "!" for hostile equipment.	Text
M	Higher Formation	Number or title of higher echelon command of equipment being displayed.	Text
P	Identification, Friend-or-Foe (IFF)/Selective Identification Feature (SIF)	IFF/SIF identification modes and codes.	Text
Q	Direction of Movement Arrow/Offset Location Indicator	With arrow, it denotes the direction symbol is moving or will move. Without arrow, it is used to denote precise location or to declutter.	Graphic
R	Mobility Indicator	Pictorial representation of the mobility of the symbol.	Graphic
T	Unique Designation	An alphanumeric designator that uniquely identifies a particular model of equipment (number).	Text

Table 3-16. Description of Icon, Modifier, and Amplifier Fields for Land Equipment Symbols.			
<i>Field</i>	<i>Field Title</i>	<i>Description</i>	<i>Text/Graphic</i>
V	Type of Equipment	Identifies unique designation (such as AH-64 for attack helicopter).	Text
W	Date-Time Group	An alphanumeric designator for displaying a date-time group (DDHHMMSSZMONYY) or "O/O" for on order. The date-time group is composed of a group of six numeric digits with a time zone suffix and the standardized three-letter abbreviation for the month, followed by two digits. The first pair of digits represents the day; the second pair, the hour; the third pair, the minutes. The last two digits of the year are after the month. For automated systems, two digits may be added before the time zone suffix and after the minutes to designate seconds.	Text
X	Altitude/Depth	Height in feet of equipment or structure on the ground.	Text
Y	Location	Latitude and longitude; grid coordinates.	Text
Z	Speed	Displays speed in nautical miles per hour or kilometres per hour.	Text
AB	Dummy Indicator	Indicates that the equipment is a dummy.	Graphic
AC	Country Indicator	A two or three-letter code that indicates the country of origin of the unit. This field can be used also for factions or groups in crisis response operations. (Names of factions, groups, must be spelled out.) STANAG 1059	Text
AD	Platform Type	Electronic intelligence notation (ELNOT) or communications intelligence notation (CENOT)	Text
AE	Equipment Teardown Time	Equipment teardown time in minutes.	Text
AF	Common Identifier	Example: Patriot for air defence missile launcher.	Text

Location of Icons and Modifiers inside the Octagon (Field A) for Land Unit Symbols

0326. Most current land weapons and vehicle equipment symbols are full frame icons. See figure 3-14.

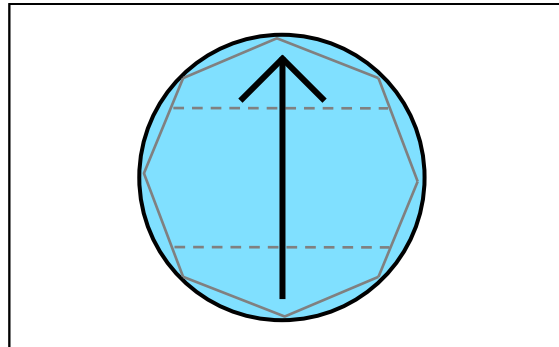


Figure 3-14. Icon Placement for Full Frame Icons.

However, it is the future intention that land equipment symbols use the octagon as described in chapter 1 in paragraph 0120 as the foundation for placement of icons and modifiers. Those icons and modifiers will not extend outside the boundaries of the octagon. See figure 3-15.

FRIENDLY	HOSTILE
<p>A light blue octagon with a black outline. The word "MAIN" is centered in the middle. Above it is a dashed line labeled "1", and below it is another dashed line labeled "2".</p>	<p>A red diamond with a black outline. Inside is a black octagon. The word "MAIN" is centered in the middle of the octagon. Above it is a dashed line labeled "1", and below it is another dashed line labeled "2".</p>
NEUTRAL	UNKNOWN
<p>A light green square with a black outline. Inside is a black octagon. The word "MAIN" is centered in the middle of the octagon. Above it is a dashed line labeled "1", and below it is another dashed line labeled "2".</p>	<p>A yellow four-lobed shape with a black outline. Inside is a black octagon. The word "MAIN" is centered in the middle of the octagon. Above it is a dashed line labeled "1", and below it is another dashed line labeled "2".</p>

Figure 3-15. Location of Icons and Modifiers for Land Equipment Symbols.

Equipment Types

0327. Table 3-17 provides the equipment types to be used in Field A of equipment symbols. Most equipment icons are full frame icons. However, there are exceptions to full frame equipment icons and those will be in the main sector (figure 3-16). Friendly frames (circles) are used in table 3-17 simply to illustrate the framed location of equipment icons. The frame shape appropriate to the equipment being displayed would normally be used in practice.

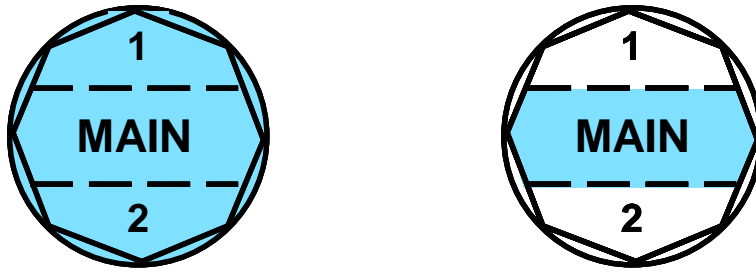


Figure 3-16. Full Frame Icons and Main Sector Icons.

Table 3-17. Equipment Types.			
<i>EQUIPMENT TYPE</i>	<i>ICON/ICON WITH MODIFIER</i>	<i>LOCATION</i>	<i>REMARKS</i>
Weapons Systems			
WEAPON SYSTEM Note: The use of the shaft indicates a weapons system.			
Rifles			
RIFLE	↑	⊕	None
SINGLE SHOT RIFLE	⤴	⊕	None
SEMIAUTOMATIC RIFLE	⤴	⊕	None



















Table 3-17. Equipment Types.			
<i>EQUIPMENT TYPE</i>	<i>ICON/ICON WITH MODIFIER</i>	<i>LOCATION</i>	<i>REMARKS</i>
AUTOMATIC RIFLE			None
Machine Guns			
MACHINE GUN			None
LIGHT MACHINE GUN			None
MEDIUM MACHINE GUN			None
HEAVY MACHINE GUN			None
Grenade Launcher			
GRENADE LAUNCHER Note: The use of the circle in the centre of the shaft indicates a grenade launcher system.			None
LIGHT GRENADE LAUNCHER			Size indicator is placed on bottom half of shaft.
MEDIUM GRENADE LAUNCHER			Size indicator is placed on bottom half of shaft.
HEAVY GRENADE LAUNCHER			Size indicator is placed on bottom half of shaft.















Table 3-17. Equipment Types.			
<i>EQUIPMENT TYPE</i>	<i>ICON/ICON WITH MODIFIER</i>	<i>LOCATION</i>	<i>REMARKS</i>
Flame Thrower			
FLAME THROWER			Uses the standard system of size/range modifiers and placement rules.
Gun			
AIR DEFENCE GUN Note: The used of the closed radar dome at the base of the shaft indicates that the weapons system is primarily for air defence.			Uses the standard system of size/range modifiers and placement rules.
ANTITANK GUN Note: The use of the upside down V at the base of the shaft indicates the weapon system is primarily antitank.			Uses the standard system of size/range modifiers and placement rules.
DIRECT FIRE GUN			Uses the standard system of size/range modifiers and placement rules.
RECOILLESS GUN			Uses the standard system of size/range modifiers and placement rules.
Howitzer			
HOWITZER Note: The circle at the base of the shaft indicates a high trajectory indirect fire weapons system. In addition, the use of the parallel lines on both sides of the shaft indicates a howitzer.			Uses the standard system of size/range modifiers and placement rules.
Missile Launcher			
MISSILE LAUNCHER Note: The use of the dome covering the entire shaft indicates a missile launcher.			Uses the standard system of size/range modifiers and placement rules.













Table 3-17. Equipment Types.			
<i>EQUIPMENT TYPE</i>	<i>ICON/ICON WITH MODIFIER</i>	<i>LOCATION</i>	<i>REMARKS</i>
AIR DEFENCE MISSILE LAUNCHER SURFACE-TO-AIR (SAM) Note: The use of the closed radar dome at the base of the shaft indicates that the weapons system is primarily for air defence.			Uses the standard system of size/range modifiers and placement rules.
ANTITANK MISSILE LAUNCHER Note: The use of the upside down V at the base of the shaft indicates the weapon system is primarily antitank.			Uses the standard system of size/range modifiers and placement rules.
SURFACE-TO-SURFACE MISSILE LAUNCHER Note: The use of the line at the base of the shaft indicates that the weapons system is primarily for surface-to-surface.			Uses the standard system of size/range (short, medium, and long range) modifiers and placement rules.
Mortar			
MORTAR Note: the circle at the base of the shaft indicates a high trajectory indirect fire weapons system or mortar.			Uses the standard system of size/range modifiers and placement rules.
Rocket Launcher			
SINGLE ROCKET LAUNCHER			Uses the standard system of size/range modifiers and placement rules.
MULTIPLE ROCKET LAUNCHER			Uses the standard system of size/range modifiers and placement rules.

Table 3-17. Equipment Types.			
<i>EQUIPMENT TYPE</i>	<i>ICON/ICON WITH MODIFIER</i>	<i>LOCATION</i>	<i>REMARKS</i>
ANTITANK ROCKET LAUNCHER Note: The use of the upside down V at the base of the shaft indicates the weapon system is primarily antitank.			Uses the standard system of size/range modifiers and placement rules.
Non-Lethal Weapon			
NON-LETHAL WEAPON			Non-Lethal Grenade Launcher
TASER			None
WATER CANNON			None
Vehicle			
A self-propelled, boosted, or towed conveyance for transporting a burden on land, sea or through air or space.			
Armoured Vehicles			
ARMOURED FIGHTING VEHICLE (AFV)			None
ARMOURED FIGHTING VEHICLE (AFV) COMMAND AND CONTROL			None
ARMOURED PERSONNEL CARRIER (APC)			None

















Table 3-17. Equipment Types.			
<i>EQUIPMENT TYPE</i>	<i>ICON/ICON WITH MODIFIER</i>	<i>LOCATION</i>	<i>REMARKS</i>
AMPHIBIOUS ARMOURED PERSONNEL CARRIER (APC)			None
ARMOURED MEDICAL PERSONNEL CARRIER			None
ARMOURED PROTECTED VEHICLE Note: Use the same icon as used for armoured.			None
ARMOURED PROTECTED VEHICLE WITH LIMITED CROSS COUNTRY MOBILITY			None
ARMOURED PROTECTED RECOVERY VEHICLE			None
MEDICAL EVACUATION ARMOURED PROTECTED VEHICLE			None
TANK			Size indicator is placed vertically on the icon instead of horizontally.
LIGHT TANK			Size indicator is placed vertically on the icon instead of horizontally.

















Table 3-17. Equipment Types.			
<i>EQUIPMENT TYPE</i>	<i>ICON/ICON WITH MODIFIER</i>	<i>LOCATION</i>	<i>REMARKS</i>
MEDIUM TANK			Size indicator is placed vertically on the icon instead of horizontally.
HEAVY TANK			Size indicator is placed vertically on the icon instead of horizontally.
TANK RECOVERY VEHICLE			
Engineer Vehicles and Equipment			
BRIDGE Note: Uses the same icon as used for the control measure symbol.			None
BRIDGE MOUNTED ON UTILITY VEHICLE			None
FIXED BRIDGE			None
FLOATING BRIDGE			None
FOLDING GIRDER BRIDGE			None



















Table 3-17. Equipment Types.			
<i>EQUIPMENT TYPE</i>	<i>ICON/ICON WITH MODIFIER</i>	<i>LOCATION</i>	<i>REMARKS</i>
HOLLOW DECK BRIDGE			None
DRILL Note: Uses the same icon as used for the drilling unit symbol.			None
DRILL MOUNTED ON VEHICLE			None
EARTHMOVER			None
MULTIFUNCTIONAL EARTHMOVER/DIGGER			None
MINE CLEARING EQUIPMENT			None
MINE CLEARING VEHICLE			None
MINE LAYING EQUIPMENT			None
MINE LAYING VEHICLE			None

















Table 3-17. Equipment Types.			
<i>EQUIPMENT TYPE</i>	<i>ICON/ICON WITH MODIFIER</i>	<i>LOCATION</i>	<i>REMARKS</i>
Utility Vehicle Multi-purpose vehicle capable of moving troops but may be used in command and control, logistics, casualty evacuation or other roles.			
UTILITY VEHICLE			None
MEDICAL VEHICLE			None
MEDICAL EVACUATION			None
MOBILE EMERGENCY PHYSICIAN			None
BUS			None
LIMITED CROSS-COUNTRY TRUCK			None
CROSS-COUNTRY TRUCK			None
SEMI-TRAILER TRUCK			None















Table 3-17. Equipment Types.			
<i>EQUIPMENT TYPE</i>	<i>ICON/ICON WITH MODIFIER</i>	<i>LOCATION</i>	<i>REMARKS</i>
POL VEHICLE			None
WATER VEHICLE			None
Train			
TRAIN LOCOMOTIVE			None
RAILCAR			None
Other			
CBRN EQUIPMENT Note: Uses the same icon as used for the CBRN unit symbol.			None
COMPUTER SYSTEM			None
LASER			None
Land Mine			
In land mine warfare, an explosive ammunition designed to be placed under, on or near the ground or other surface area and to be actuated by the presence, proximity or contact of a person, land vehicle, aircraft or boat, including landing craft.			






















Table 3-17. Equipment Types.			
<i>EQUIPMENT TYPE</i>	<i>ICON/ICON WITH MODIFIER</i>	<i>LOCATION</i>	<i>REMARKS</i>
LAND MINE (UNSPECIFIED) Note: Uses the same icon as used for the control measure symbol.			None
ANTIPERSONNEL LAND MINE In land mine warfare, a mine designed to be exploded by the presence, proximity or contact of a person and that will incapacitate, wound or kill one or more persons. (AAP-19)			Note: Uses the same icon as used for the control measure symbol. Note: Uses the same icon as used for the control measure symbol.
ANTITANK LAND MINE A mine designed to immobilize or destroy a tank. (AAP-19)			Note: Uses the same icon as used for the control measure symbol.
IMPROVISED EXPLOSIVE DEVICE (IED) A device placed or fabricated in an improvised manner incorporating destructive, lethal, noxious, pyrotechnic or incendiary chemicals and designed to destroy, incapacitate, harass or distract. It may incorporate military stores, but is normally devised from non-military components.	IED		None
Sensor Equipment which detects, and may indicate, and/or record objects and activities by means of energy or particles emitted, reflected, or modified by objects.			
SENSOR			None
SENSOR EMPLACED			None

Table 3-17. Equipment Types.			
<i>EQUIPMENT TYPE</i>	<i>ICON/ICON WITH MODIFIER</i>	<i>LOCATION</i>	<i>REMARKS</i>
RADAR			None
Other			
ANTENNAE			None
GENERATOR SET	G		None
PSYCHOLOGICAL OPERATIONS EQUIPMENT			None
BOMB	BOMB		None
BOOBY TRAP A device designed, constructed or adapted to kill or injure, which functions when a person disturbs or approaches an apparently harmless object or performs an apparently safe act. (AAP-6)			None

Sector 1 and 2 Modifiers

0328. Sector 1 and Sector 2 modifiers have been designated to portray additional information regarding a symbol's icon. Currently, there are no specific sector 1 or 2 modifiers for equipment systems.

Mobility Indicator Amplifiers

0329. Table 3-18 provides mobility indicator amplifiers for the equipment types for Field R for equipment symbols.


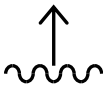


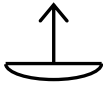


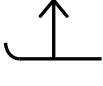




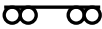
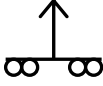
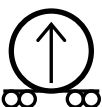

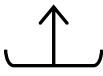


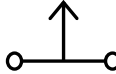
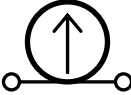

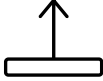


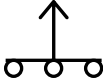


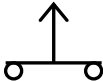


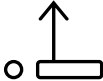

Table 3-18. Mobility Indicator (Field R).			
<i>MOBILITY TYPE</i>	<i>ICON</i>	<i>LOCATION (UNFRAMED)</i>	<i>LOCATION (FRAMED)</i>
AMPHIBIOUS			
BARGE			
OVER-SNOW (PRIME MOVER)			
PACK ANIMAL(S)			
RAILWAY			
SLED			
TOWED			

Table 3-18. Mobility Indicator (Field R).			
<i>MOBILITY TYPE</i>	<i>ICON</i>	<i>LOCATION (UNFRAMED)</i>	<i>LOCATION (FRAMED)</i>
TRACKED			
WHEELED (CROSS COUNTRY)			
WHEELED (LIMITED MOBILITY)			
WHEELED AND TRACKED			

Equipment Size or Range Indicators

0330. In building equipment symbols, horizontal or vertical lines are added for size or range indicators. If an equipment symbol has no lines, it is a basic equipment symbol. Adding one line designates it as light or short-range. Adding two lines designates it as medium or medium-range. Finally, adding three lines designates it as heavy or long-range. If a system is designated as greater than heavy or long-range, heavy or long-range indicators will be used. (See table 3-19.)

Table 3-19. Examples of Size and Range Indicators by Equipment Systems.				
<i>SYSTEM</i>	<i>STANDARD WEIGHT/RANGE/CALIBRE</i>	<i>LIGHT/SHORT</i>	<i>MEDIUM/MEDIUM (INTERMEDIATE)</i>	<i>HEAVY/LONG</i>
CANNON ARTILLERY	Calibre and Maximum Range ¹	120 mm or less	Greater than 120 mm but not greater than 160 mm	Greater than 160 mm but not greater than 210 mm
MORTAR	Calibre	60 mm or less	Greater than 60 mm but less than 107 mm	107 mm or larger
SEMI TRAILERS	Cargo Capacity	Less than 12 tons	Between 12 tons and 40 tons	Greater than 40 tons
UTILITY HELICOPTERS	Weight	Less than 4,000 lbs	Between 4,000 lbs and 10,000 lbs	Greater than 10,000 lbs
	Range	Less than 240 nautical miles	Between 240 and 320 nautical miles	Greater than 320 nautical miles
WATER-CRAFT (ARMY)	Capacity	Less than 300 tons	Between 300 tons and 1,700 tons	Greater than 1,700 tons
¹ Cannon artillery has a very heavy category: greater than 210 mm, but there is no modifier.				

Section IV

Land Installation Symbols

General

0331. Installations are sites that incorporate permanent, semi-permanent, and temporary structures. This chapter establishes a single standard system for the development of a variety of installation symbols. Avoid using any symbols, or combinations and modifications of symbols, different from those in this publication. If, after searching the doctrinal symbols and modifiers in this publication, a new symbol must be created, explain it in an accompanying legend.

Composition of Installation Symbols

0332. An installation symbol is composed of a frame, colour (fill), installation icon, text or graphic modifiers (figure 3-17), and text or graphic amplifiers. (See table 3-20 for the steps used to build installation symbols.)

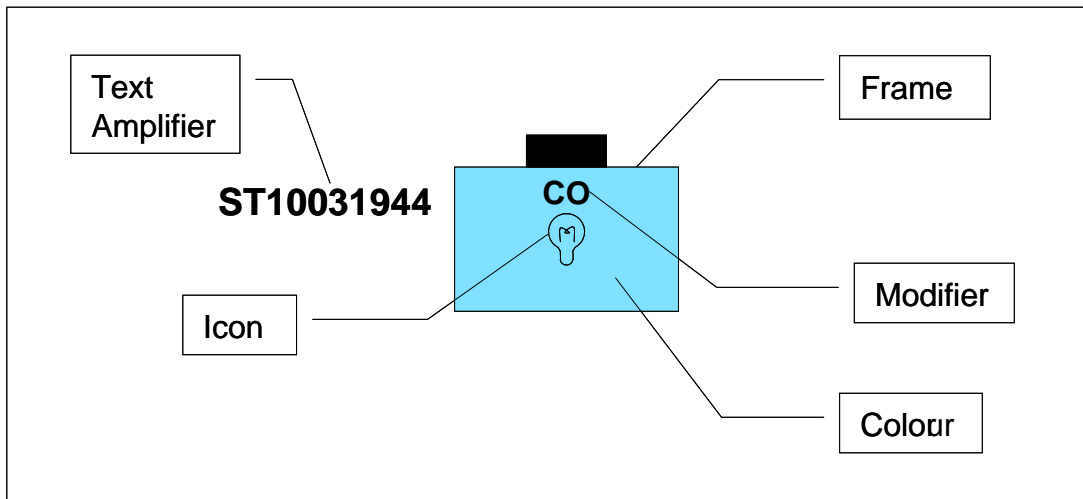

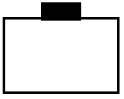
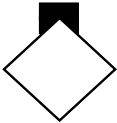




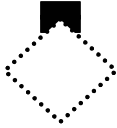
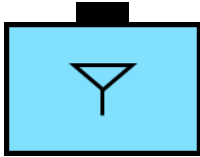
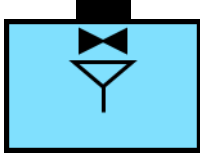


Figure 3-17. Installation Symbol Composition.

Table 3-20. Building Installation Symbols.

<i>Step #</i>	<i>Step</i>	<i>Example</i>					
Step 1.	Choose the frame according to standard identity.						
Land Installation Frame Shapes and Standard Identity							
STANDARD IDENTITY	FRIENDLY	HOSTILE	NEUTRAL	UNKNOWN	PENDING	ASSUMED FRIEND	SUSPECT
FRAME							
Steps 2	Choose and add main sector icon.						
Step 3.	Choose and add a modifier in either sector 1 or sector 2 if applicable or deemed necessary for visualization.						
Step 4.	Choose and add a second modifier in either sector 1 or sector 2 if applicable or deemed necessary for visualization. NOTE: Only one modifier is permitted per modifier position.	There are no specific sector 2 modifiers at this time.					

Land Installation Symbol Fields

0333. Figure 3-18 shows the placement of installation symbol icons, modifiers, and amplifiers in and around the friendly land installation symbol frame. The placement of installation symbol icons, modifiers, and amplifiers is the same regardless of frame shape or affiliation.

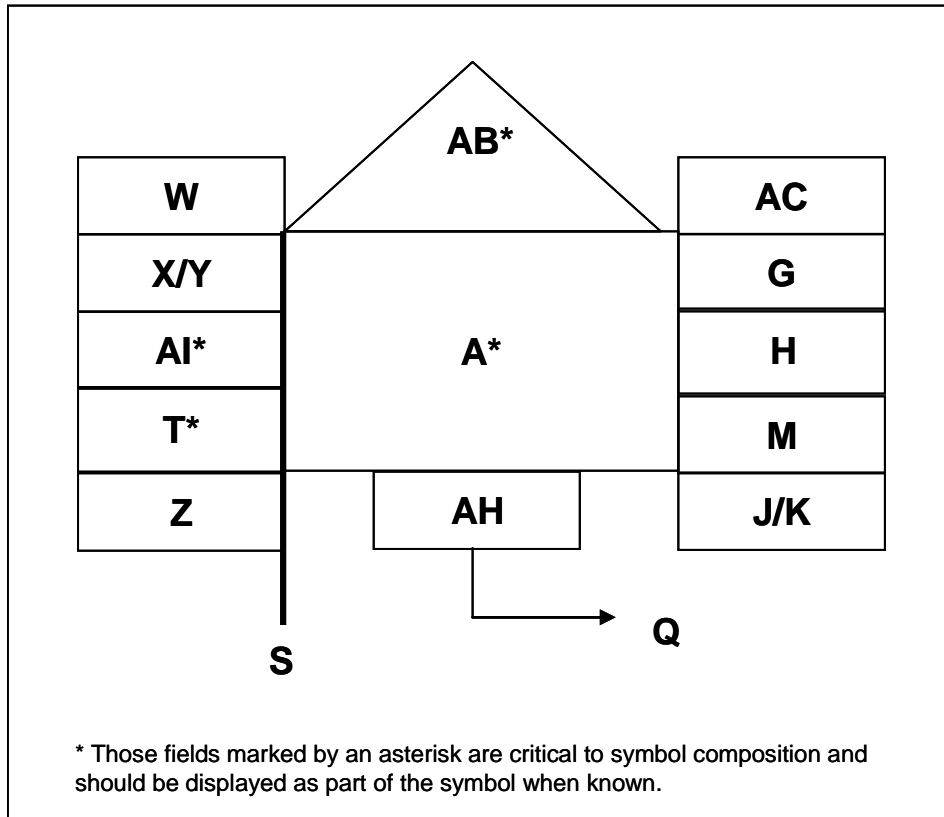


Figure 3-18. Land Installation Icon, Modifier, and Amplifier Fields.

Location of Icons and Modifiers inside the Octagon (Field A) for Land Installation Symbols

0334. For land installation symbols, the octagon as described in Chapter 1 in paragraph 0116 serves as the foundation for placement of icons and modifiers. The octagon is divided into sectors. The three sectors specify where icons and modifiers are positioned and how much space is available for sizing of icons and modifiers. Figure 3-19 provides examples showing the sectors for each of the frame shape types. The lettering size for text icons and modifiers will vary based on the number of letters used.

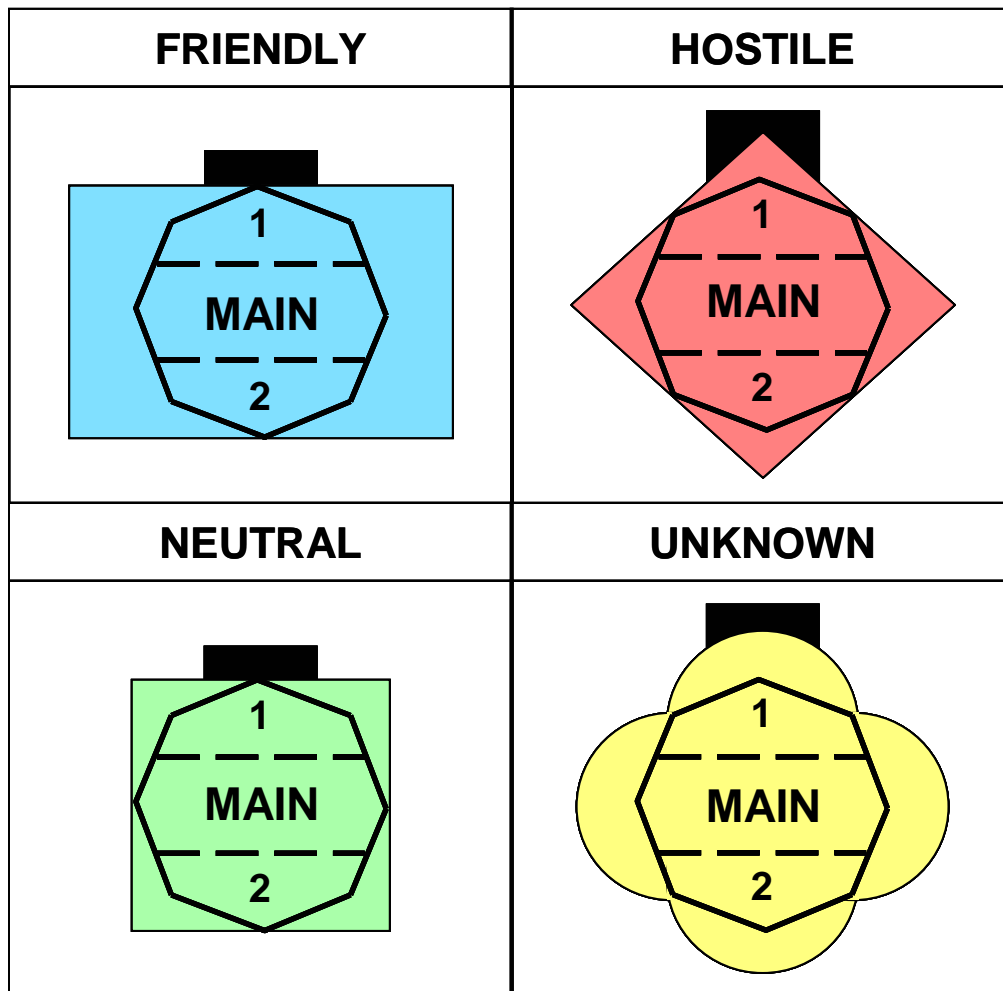


Figure 3-19. Location of Icons and Modifiers.

In general, icons should not be so large as to exceed the dimensions of the main sector of the octagon or touch the interior border of the frame. However, there are exceptions to this size rule. In those cases the icons will occupy the entire frame and must, therefore, exceed the dimensions of the main sector of the octagon and touch the interior border of the frame (see figure 3-20). These are called full frame icons.

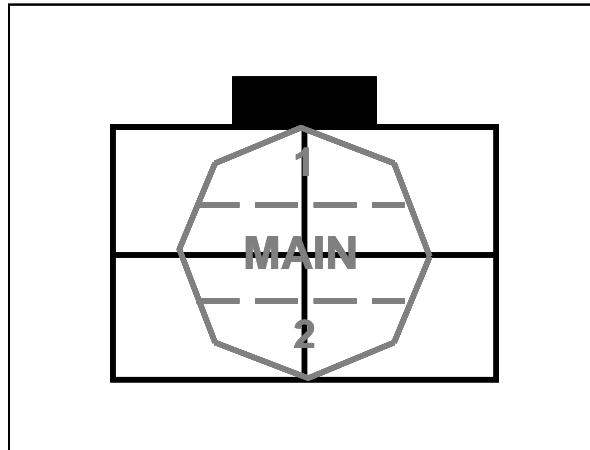


Figure 3-20. Icon Placement for Full Frame Icons.

Icon, Modifier, and Amplifier Fields

0335. See paragraph 114 in chapter 1 for a description of and more information on amplifiers. Table 3-21 provides a description of each of the installation symbol icon, modifier, and amplifier fields as shown in figure 3-18.

Table 3-21. Description of Icon, Modifier, and Amplifier Fields for Installation Symbols.			
<i>Field</i>	<i>Field Title</i>	<i>Description</i>	<i>Text/Graphic</i>
A	Symbol	Basic installation symbol that includes an icon and can include capability modifiers.	Both
G	Staff Comments	Free text. Can be used by staff for information required by commander.	Text
H	Additional Information	Free text. For installations, this field is used to describe the specific nature of the installation, such as production, processing, or storage.	Text

Table 3-21. Description of Icon, Modifier, and Amplifier Fields for Installation Symbols.			
<i>Field</i>	<i>Field Title</i>	<i>Description</i>	<i>Text/Graphic</i>
J	Evaluation Rating	<p>Degree of confidence that may be placed on the information represented by the symbol. It is shown as one letter and one number made up of Reliability of Source and Credibility of Information.</p> <p>Reliability of Source:</p> <p>A. Completely reliable B. Usually reliable C. Fairly reliable D. Not usually reliable E. Unreliable F. Reliability cannot be judged</p> <p>Credibility of Information:</p> <p>1. Confirmed by other sources 2. Probably true 3. Possibly true 4. Doubtful 5. Improbable 6. Truth cannot be judged</p>	Text
K	Capacity of Installation	Capacity of installation displayed.	Text
M	Higher Formation	Number or title of parent organization.	Text
Q	Offset Location Indicator	Used to denote precise location of installation or to declutter multiple installation locations.	Graphic
S	Headquarters Staff Indicator/Offset Location Indicator	Used to indicate precise location of headquarters or to declutter multiple headquarters locations.	Graphic
T	Unique Designation	An alphanumeric designator that uniquely identifies a particular installation (name).	Text

Table 3-21. Description of Icon, Modifier, and Amplifier Fields for Installation Symbols.			
<i>Field</i>	<i>Field Title</i>	<i>Description</i>	<i>Text/Graphic</i>
W	Date-Time Group	An alphanumeric designator for displaying a date-time group (DDHHMMSSZMONYY) or "O/O" for on order. The date-time group is composed of a group of six numeric digits with a time zone suffix and the standardized three-letter abbreviation for the month followed by two digits. The first pair of digits represents the day; the second pair, the hour; the third pair, the minutes. The last two digits of the year are after the month. For automated systems, two digits may be added before the time zone suffix and after the minutes to designate seconds.	Text
X	Altitude/Depth	Height in feet of equipment or structure on the ground.	Text
Y	Location	Latitude and longitude or grid coordinates.	Text
Z	Speed	Displays speed in nautical miles per hour or kilometres per hour.	Text
AB	Feint or Dummy Indicator	Indicates that it is a dummy for deception purposes.	Graphic
AC	Country Indicator	A three-letter code that indicates the country of the owner of the installation. This field can be used also for factions or groups in stability activities.	Text
AI	Installation Composition	Indicates the component type of the installation: Development Research Production Service Storage Utility.	Text

Installation Icons

0336. Table 3-22 provides installation icons for use in land unit symbols in the A area of the symbol. Those icons that appear in the unit and equipment sections of this chapter can be used to create installation symbols.

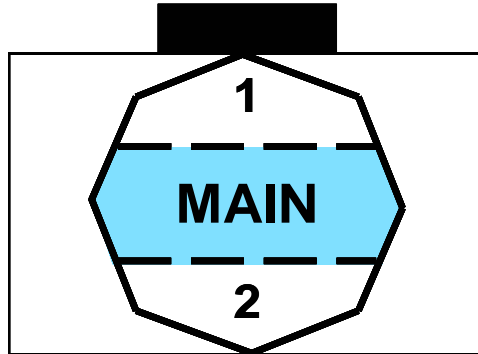


Figure 3-21. Main Sector Icons.

Table 3-22. Installation Icons.			
<i>FUNCTION</i>	<i>ICON/MODIFIER</i>	<i>LOCATION</i>	<i>REMARKS</i>
Airport/Air Base Note: Uses the same icon as used for the APOD/APOE unit symbol.			The transportation and runway icons together represent the airport/air base icon. This is an exception to the general construction rules.
Ammunition Cache			The horizontal line must touch the edge of the frame. This is an exception to the general construction rules.
Black List Location	BLK		None












Table 3-22. Installation Icons.			
<i>FUNCTION</i>	<i>ICON/MODIFIER</i>	<i>LOCATION</i>	<i>REMARKS</i>
Broadcast Transmitter Antenna			None
Chemical Biological Radiological Nuclear (CBRN) Note: Uses the same icon as used for the CBRN unit symbol.			Normally used with CBRN defence icon.
Electric Power			None
Food Distribution			The horizontal line must touch the edge of the frame. This is an exception to the general construction rules.
Grey List Location	GRAY		None
Mass Grave Site			None

Table 3-22. Installation Icons.			
<i>FUNCTION</i>	<i>ICON/MODIFIER</i>	<i>LOCATION</i>	<i>REMARKS</i>
Medical Note: Uses the same icon as used for the medical unit symbol.			The medical icon is a full frame icon. It must touch the frame edge. This is an exception to the general construction rules.
Medical Treatment Facility (Hospital) Note: Uses the same icon as used for the medical treatment facility symbol.			The medical treatment facility (hospital) icon is a full frame icon. It must touch the frame edge. This is an exception to the general construction rules.
Mine			None
Nuclear(Non-CBRN) Commercial facility that processes nuclear material.			Can be reduced and used as a modifier. Nuclear Electric Power
Printed Media			None
Railhead/Railroad Station Note: Uses the same icon as used for the railhead unit symbol.			The transportation and railhead icons together represent the railhead/railroad station icon. This is an exception to the general construction rules.













Table 3-22. Installation Icons.			
<i>FUNCTION</i>	<i>ICON/MODIFIER</i>	<i>LOCATION</i>	<i>REMARKS</i>
Safe House	SAFE		None
Sea Port/Naval Base Note: Uses the same icon as used for the SPOD/SPOE unit symbol.			The transportation and naval icons together represent the sea port/naval base icon. This is an exception to the general construction rules.
Ship Yard Building and Repair Facilities.	YRD 	Main and 1 	The naval and yard icons together represent the ship yard icon. This is an exception to the general construction rules.
Telecommunications Civilian			None
Water Note: Uses the same icon as used for the water unit symbol.			None
Water Treatment Note: Uses the same icon as used for the water purification unit symbol.	PURE 		None

Table 3-22. Installation Icons.			
<i>FUNCTION</i>	<i>ICON/MODIFIER</i>	<i>LOCATION</i>	<i>REMARKS</i>
White List Location	WHT		None

Sector 1 Modifiers

0337. Sector 1 modifiers (figure 3-22) provide additional information regarding the symbol's icon. Table 3-23 shows the modifiers for use in installation symbols in sector 1 of the field A of the symbol.

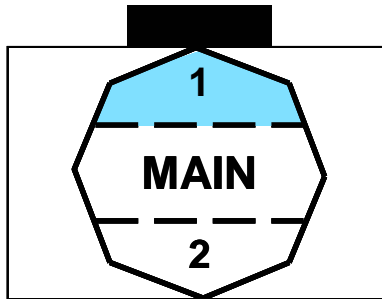


Figure 3-22. Sector 1 Icons.



Table 3-23. Installation Modifiers			
<i>FUNCTION</i>	<i>ICON / MODIFIER</i>	<i>LOCATION</i>	<i>REMARKS</i>
Chemical Biological Radiological Nuclear (CBRN)			
Biological Note: Uses the same modifier as used for unit symbols.	B		Normally used with CBRN defence icon.  CBRN Biological



















Table 3-23. Installation Modifiers			
<i>FUNCTION</i>	<i>ICON / MODIFIER</i>	<i>LOCATION</i>	<i>REMARKS</i>
Chemical Note: Uses the same modifier as used for unit symbols.	C		Normally used with CBRN defence icon.  CBRN Chemical
Nuclear Note: Uses the same modifier as used for unit symbols.	N		Normally used with CBRN defence icon.  CBRN Nuclear
Electric Power			
Electric Power Coal	CO		Normally used with electric power icon.  Coal Electric Power
Electric Power Geothermal	GT		Normally used with electric power icon.  Geothermal Electric Power
Electric Power Hydroelectric	HY		Normally used with electric power icon.  Hydroelectric Electric Power

Table 3-23. Installation Modifiers			
<i>FUNCTION</i>	<i>ICON / MODIFIER</i>	<i>LOCATION</i>	<i>REMARKS</i>
Electric Power Natural Gas	NG		Normally used with electric power icon.  Natural Gas Electric Power
Electric Power Petroleum Note: Uses the same icon as used for the POL unit symbol.			Can be used with electric power icon.  Petroleum Electric Power
Telecommunications			
Telecommunications Civilian Radio	R		None
Telecommunications Civilian Telephone	T		None
Telecommunications Civilian Television	TV		None

Sector 2 Modifiers

0338. Sector 2 modifiers can also provide additional information pertaining the symbol's icon. There are no specific sector 2 modifiers at this time.

CHAPTER 4

MARITIME SYMBOLS

Scope

0401. This chapter covers symbols for operations in the maritime domain.

Characteristics of Symbols for in the Maritime Domain

0402. The maritime domain is composed of the sea surface and subsurface battle dimensions.

0403. In the maritime domain, a ship is both a unit and equipment and is normally represented by a surface or subsurface icon with equipment frame. Non-manned equipment exists at the surface and in the subsurface dimension in stationary or moving sensor carriers (autonomous underwater vehicles [AUV]) or stationary or moving weapons (mines and torpedoes).

0404. The surface dimension contains a multitude of non-military ships and stationary objects (e.g. oil rigs), which are the primary objects of military operations (protect, control, deny, access, and destroy).

Content and Structure

0405. This chapter provides the basics for building maritime symbols. The chapter is divided into two sections. Section I covers sea surface symbols and Section II sea subsurface symbols. Each section contains both military and non-military, civilian symbols.

0406. The symbols mentioned above are, accordingly, subdivided into:

- a. units, equipment and objects in maritime surface warfare,
- b. units, equipment and objects in maritime subsurface warfare.

0407. Maritime control measure symbols (points, lines, areas, commands, standard positions, emergencies, hazards and sonobuoys) are shown in Chapter 7.

Further Developments

0408. This chapter establishes a single standard for maritime domain symbols. It includes a variety of icons and modifiers. In order to ensure that all icons and modifiers shown here can be depicted in all standard identities, they must fit into the boundaries of the octagon presented in Figure 4-2 and adhere to the rules provided in Chapter 1.

SECTION I – SEA SURFACE SYMBOLS

Symbol Subset Structure

0409. The units, equipment, and objects of maritime surface operations as described in paragraph 0403 and 0404 are further subdivided in:

- a. military surface objects (units), consisting of:
 - surface warfare (line ships) units
 - amphibious warfare units
 - mine warfare units
 - task organization units
 - military non-combatants /auxiliaries and service craft
- b. non-military objects (ships, boats and installations)

Composition of Sea Surface Symbols

0410. A sea surface symbol is composed of a frame, colour (fill), functional icons (pictogram and/or letters), modifiers and amplifiers (i.e., labels) (Figure 4-1). Table 4-1 depicts the sea surface symbol composition process.

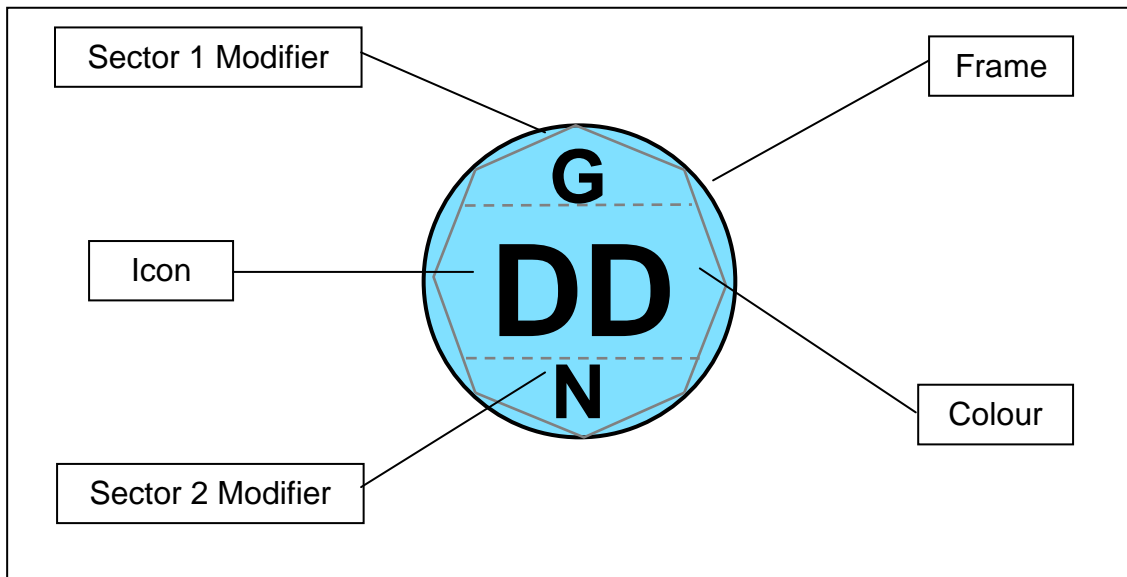
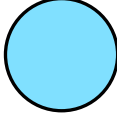
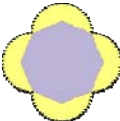












Figure 4-1. Sea Surface Symbol Composition.

Table 4-1. Sea Surface Symbol Composition Process.							
<i>Step No.</i>	<i>Step</i>				<i>Examples</i>		
Step 1	Choose frame according to standard identity						
Maritime Standard Identities and Frame Shapes							
	Pending	Unknown	Assumed Friend	Friend	Neutral	Suspect	Hostile
Sea Surface							
Step 2	Choose and add main sector icon						
Step 3	Choose and add a modifier in either sector 1 or sector 2 position if applicable or deemed necessary for visualization.				 		
Step 4	Choose and add a second modifier (if applicable and/or deemed necessary for visual representation. NOTE: only one modifier is permitted per modifier position						

Icons and Modifiers

0412. All icons shall be placed within the “MAIN” sector of the bounding octagon. Icons may be re-sized accordingly due to the presence or absence of modifiers in order to optimise legibility. Icons may be single icons or compound icons.

0413. Modifiers may be placed above (octagon sector 1) and below (octagon sector 2) of the icon (see Figure 4-2). Only one modifier may be placed within sector 1 or 2 at a given time. Multiple modifiers in the same position are prohibited due to legibility concerns.

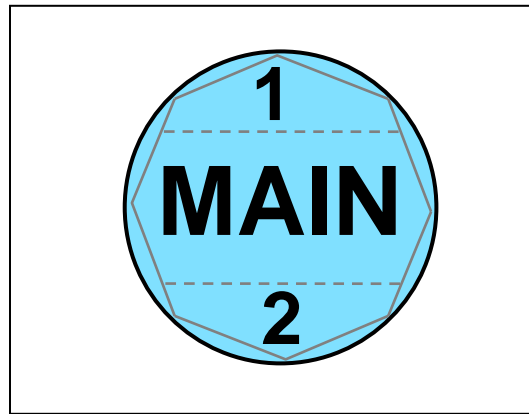


Figure 4-2. Icon and Modifier sectors for Sea Surface Symbols.

Sea Surface Sector 1 Modifiers are used to denote 1) mission area, 2) weapons capability, or 3) asset capability of a given icon. Table 4-2 lists sea surface sector 1 modifiers. The respective icons are shown in table 4-8.

Table 4-2. Sea Surface Sector 1 Modifiers.		
Modifier	Name	Type
AAW	Anti-air Warfare	Mission Area
ASW	Antisubmarine Warfare	Mission Area
E	Escort	Mission Area
EW	Electronic Warfare	Mission Area
ISR	Intelligence, Surveillance, Reconnaissance	Mission Area
MCM	Mine Countermeasures	Mission Area
MD	Missile Defence	Mission Area
ME	Medical (Facilities Role 2+)	Mission Area
MW	Mine Warfare	Mission Area
RMV	Remote Multi-Mission Vehicle	Mission Area
SOF	Special Operations Force	Mission Area

SUW	Surface Warfare	Mission Area
B	Ballistic Missile	Weapons Capability
G	Guided Missile	Weapons Capability
M	Other Guided Missile (Point Defence)	Weapons Capability
T	Torpedo	Weapons Capability
∨	Drone-Equipped	Asset Capability
H	Helicopter-Equipped/VSTOL	Asset Capability

Sea surface sector 2 modifiers are used to denote 1) ship propulsion, 2) ship mobility, 3) ship capacity, 4) cargo capacity, or 5) USV control of a given icon. Table 4-3 lists sea surface sector 2 modifiers. The respective icons are shown in table 4-9.

Table 4-3. Sea Surface Sector 2 Modifiers.		
Modifier	Name	Type
N	Nuclear Powered	Ship Propulsion
H	Heavy	Ship Capacity
L	Light	Ship Capacity
M	Medium	Ship Capacity
D	Dock	Cargo Capacity
LOG	Logistics	Cargo Capacity
T	Tank	Cargo Capacity
V	Vehicle	Cargo Capacity
F	Fast	Ship Mobility
J	Air-Cushioned	Ship Mobility
AC	Air-Cushioned (USA only)	Ship Mobility
K	Hydrofoil	Ship Mobility
AUT	Autonomous Control	USV Control
RP	Remotely Piloted	USV Control
EXP	Expendable	USV Control

Amplifiers

0414. On the tactical display, information about a displayed object is conveyed by the symbol via frame shape, icon/letter and colour coding. There may be, however, additional and varying information that cannot be conveyed by graphical means, but by written (alphanumeric) information only.

This information may be displayed either in secondary information fields outside the tactical screen, a method that forces the operator to a constant shift of focus and will not be considered further in this text, or by use of amplifiers in the form of symbol labels.

The purpose of the amplifiers described in this section is to standardize the display of additional alphanumerical information on identity, movement and location, capabilities, etc. Figure 4-3 shows the placement of amplifiers with a symbol frame. The placement of the amplifier is the same regardless of frame shape or standard identity.

Maritime domain symbol amplifiers require a reduced amount of information to be displayed in one position relative to the symbol as compared to Land Symbols (see Chapter 3). Maritime amplifiers shall be placed to the immediate right of the symbol as opposed to separate positions surrounding it.

A set of amplifiers for sea surface symbols, including object name, position, speed, and time, shall be displayed in the five standard amplifier scheme fields (see Ch. 1, Figure 1.4) to the right of the symbol as given in Figure 4-3. The position of the standard information fields differs from those used for symbols in land domain.

In the default mode, the amplifier is not shown. It is the user's task to define and call up for display the information considered to be necessary. Additionally, the user must be enabled to suppress the amplifier to reduce screen clutter and call it up again as considered appropriate to the tactical situation.

The speed leader is a dynamic amplifier that depicts the speed and direction of movement (course) and originates from the centre of the object. The length of the speed leader corresponds to the speed of the object.

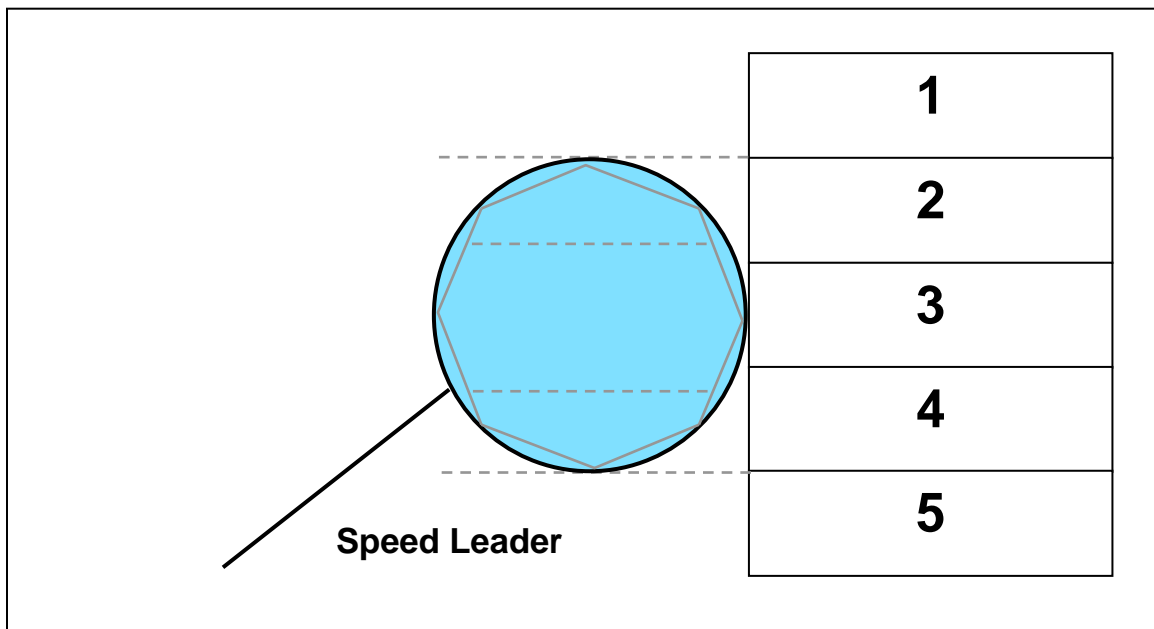


Figure 4-3. Sea Surface symbol amplifier fields.

Table 4-4 provides the possibilities of information display for military and non-military surface objects by amplifiers.

Table 4-4. Contents of Amplifiers for Sea Surface Symbols.			
<i>Field</i>	<i>Field Title</i>	<i>Description (Alternatives)</i>	<i>Prefix (when applicable)</i>
1	Track Number	System Track Number	TN
2	Name	Ships Name, Hull Number or Task Organization Designator (military only), Mission / International call sign	-
3	Position Movement (if speed leader is suppressed) DTG	Course [degrees] /Speed [knots] and/or Bearing [degrees] / Distance [nautical miles] Date-Time Group	- B/D
4	Identification	Country of origin (STANAG 1059 - 3-letter code) or Organization (e.g. UN, NATO, EU) Any other information (e.g. IFF / AIS)	-
5	Additional Information	For friendly units: - Sensor or weapon load, endurance, etc. For other units: - Credibility of information	-

Sea Surface Icons

0415. Table 4-5 (Military Ships), Table 4-6 (Civilian Vessels), and Table 4-7 (Own Ship) provide the sea surface icon subset.

The 2- and 3-letter codes used in the military sea surface icons (Table 4-5) are in accordance with STANAG 1166 (Edition 7).

Non-military, civilian sea surface icons (Table 4-6) are displayed with an standard identity colour frame, but a white symbol icon to differentiate from military units. The single letter codes used within the merchant ship icons are derived from the STANAG 1166 as the 3rd letter specifying the type of the merchant ship. For other types of non-military surface vessels, the icons/letter codes of the symbol were chosen without STANAG reference. In order to enable the operator to “de-clutter” a large display,

civilian symbols may be displayed in reduced-size symbols without a frame but with their standard identity colour.

The symbols of Tables 4-5 through 4-7 are shown in the bounding octagon.
 The singular own ship symbol (Table 4-7) is necessary in order to display the own position in an off-centre display mode.

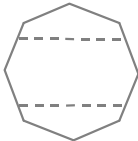







Table 4-5. Military Sea Surface Icons.			
<i>DESCRIPTION</i>	<i>ICON</i>	<i>LOCATION : MAIN</i>	<i>REMARKS</i>
SEA SURFACE TRACK	None		None
MILITARY	MIL		None
COMBATANT			None
SURFACE COMBATANT, LINE			None
CARRIER			None








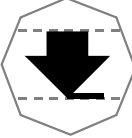
Table 4-5. Military Sea Surface Icons.			
<i>DESCRIPTION</i>	<i>ICON</i>	<i>LOCATION : MAIN</i>	<i>REMARKS</i>
BATTLESHIP	BB		None
CRUISER, GUIDED MISSILE	CG		None
DESTROYER	DD		None
FRIGATE	FF		None
CORVETTE	FS		None
LITTORAL COMBATANT SHIP	LCS		None
AMPHIBIOUS WARFARE SHIP			None








Table 4-5. Military Sea Surface Icons.			
<i>DESCRIPTION</i>	<i>ICON</i>	<i>LOCATION : MAIN</i>	<i>REMARKS</i>
AMPHIBIOUS FORCE FLAGSHIP / AMPHIBIOUS COMMAND SHIP	LCC		None
AMPHIBIOUS ASSAULT, NON- SPECIFIED	LA		None
AMPHIBIOUS ASSAULT SHIP, GENERAL	LHA		None
AMPHIBIOUS ASSAULT SHIP, MULTI-PURPOSE	LHD		None
AMPHIBIOUS TRANSPORT, DOCK	LPD		None
AMPHIBIOUS ASSAULT SHIP, HELICOPTER	LPH		None
LANDING SHIP	LS		None









Table 4-5. Military Sea Surface Icons.			
<i>DESCRIPTION</i>	<i>ICON</i>	<i>LOCATION : MAIN</i>	<i>REMARKS</i>
LANDING CRAFT	LC		None
MINE WARFARE VESSEL			None
MINELAYER	ML		None
MINESWEEPER	MS		None
MINESWEEPER, DRONE	MSD		None
MINEHUNTER	MH		None
MINE COUNTER MEASURE SUPPORT SHIP	MCS		None










Table 4-5. Military Sea Surface Icons.			
<i>DESCRIPTION</i>	<i>ICON</i>	<i>LOCATION : MAIN</i>	<i>REMARKS</i>
MINE COUNTERMEASURES	MCM		None
SEA SURFACE DECOY	◀◀◀		None
PATROL	▼		None
PATROL CRAFT, SUBMARINE CHASER / ESCORT, GENERAL	PC		None
PATROL SHIP, GENERAL	PG		None
MILITARY SPEEDBOAT			None
MILITARY SPEEDBOAT, RIGID-HULL INFLATABLE BOAT			None






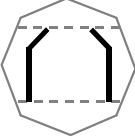






Table 4-5. Military Sea Surface Icons.			
<i>DESCRIPTION</i>	<i>ICON</i>	<i>LOCATION : MAIN</i>	<i>REMARKS</i>
MILITARY JETSKI			None
UNMANNED SURFACE WATER VEHICLE			None
NAVY TASK ORGANIZATION UNIT, UNSPECIFIED			None
NAVY TASK FORCE			None
NAVY TASK GROUP			None
NAVY TASK UNIT			None





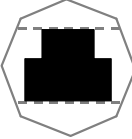




Table 4-5. Military Sea Surface Icons.			
<i>DESCRIPTION</i>	<i>ICON</i>	<i>LOCATION : MAIN</i>	<i>REMARKS</i>
NAVY TASK ELEMENT	(TE)		None
CONVOY			None
NONCOMBATANT			None
AUXILIARY SHIP, GENERAL	AA		None
AMMUNITION SHIP (UNDERWAY REPLENISHMENT CAPABLE)	AE		None
STORES SHIP, NAVAL (DRY GOODS)	AF		None
AUXILIARY FLAG OR COMMAND SHIP	AGF		None

Table 4-5. Military Sea Surface Icons.			
<i>DESCRIPTION</i>	<i>ICON</i>	<i>LOCATION : MAIN</i>	<i>REMARKS</i>
INTELLIGENCE COLLECTOR	AGI		None
OCEAN RESEARCH SHIP	AGO		None
SURVEY SHIP	AGS		None
HOSPITAL SHIP	AH		None
CARGO SHIP, NAVAL	AK		None
COMBAT SUPPORT SHIP, FAST	AOE		None
OILER, REPLENISHMENT	AOR		None







Table 4-5. Military Sea Surface Icons.			
<i>DESCRIPTION</i>	<i>ICON</i>	<i>LOCATION : MAIN</i>	<i>REMARKS</i>
REPAIR SHIP	AR		None
SUBMARINE TENDER	AS		None
TUG, OCEAN GOING	AT		None
SERVICE CRAFT, YARD, GENERAL	YY		None
BARGE, NOT SELF-PROPELLED	YB		None
BARGE, SELF-PROPELLED	YS		None



Table 4-5. Military Sea Surface Icons.			
<i>DESCRIPTION</i>	<i>ICON</i>	<i>LOCATION : MAIN</i>	<i>REMARKS</i>
TUG, HARBOUR	YT		None
LAUNCH	YFT		None












Table 4-6. Non-Military Surface Icons.			
<i>DESCRIPTION</i>	<i>ICON</i>	<i>LOCATION : MAIN</i>	<i>REMARKS</i>
CIVILIAN	CIV		None
MERCHANT SHIP, GENERAL			None
CARGO, GENERAL			None
CONTAINER SHIP			None
DREDGE			None
ROLL ON-ROLL OFF			None

Table 4-6. Non-Military Surface Icons.






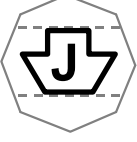






<i>DESCRIPTION</i>	<i>ICON</i>	<i>LOCATION : MAIN</i>	<i>REMARKS</i>
FERRY			None
HEAVY LIFT			None
HOVERCRAFT			None
MERCHANT SHIP, LASH CARRIER (WITH BARGES)			None
OILER/TANKER			None
PASSENGER SHIP			None

Table 4-6. Non-Military Surface Icons.













<i>DESCRIPTION</i>	<i>ICON</i>	<i>LOCATION : MAIN</i>	<i>REMARKS</i>
TUG, OCEAN GOING			None
TOW			None
TRANSPORT SHIP, HAZARDOUS MATERIAL			None
JUNK/DHOW			None
BARGE, NOT SELF-PROPELLED			None
FISHING VESSEL			None













Table 4-6. Non-Military Surface Icons.			
<i>DESCRIPTION</i>	<i>ICON</i>	<i>LOCATION : MAIN</i>	<i>REMARKS</i>
DRIFTER			None
TRAWLER			None
LAW ENFORCEMENT VESSEL WPB (COASTGUARD) VPB (POLICE) ZPB (CUSTOMS)			None
LEISURE CRAFT, SAILING BOAT			None
LEISURE CRAFT, MOTORIZED			None
LEISURE CRAFT, MOTORIZED, RIGID-HULL INFLATABLE BOAT			None








Table 4-6. Non-Military Surface Icons.			
<i>DESCRIPTION</i>	<i>ICON</i>	<i>LOCATION : MAIN</i>	<i>REMARKS</i>
LEISURE CRAFT, MOTORIZED, SPEEDBOAT			None
LEISURE CRAFT, JETSKI			None
UNMANNED SURFACE WATER VEHICLE (USV)			None

Table 4-7. Own Ship.	
<i>DESCRIPTION</i>	<i>ICON</i>
OWN SHIP	

Sea Surface Modifiers

0416. Table 4-8 shows sea surface sector 1 modifiers and illustrates their placement within the bounding octagon.

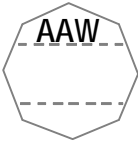
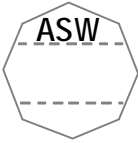
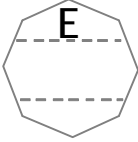
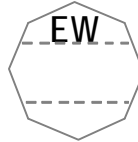
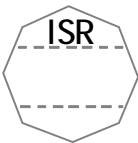
Table 4-8. Sea Surface Sector 1 Modifiers.			
FUNCTION	MODIFIER	LOCATION:	REMARKS
ANTI-AIR WARFARE	AAW		None
ANTISUBMARINE WARFARE	ASW		None
ESCORT	E		None
ELECTRONIC WARFARE	EW		None
INTELLIGENCE, SURVEILLANCE, RECONNAISSANCE	ISR		None



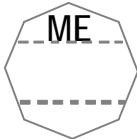



Table 4-8. Sea Surface Sector 1 Modifiers.			
<i>FUNCTION</i>	<i>MODIFIER</i>	<i>LOCATION:</i>	<i>REMARKS</i>
MINE COUNTER MEASURES	MCM		None
MISSILE DEFENCE	MD		None
MEDICAL (FACILITIES ROLE 2)	ME		None
MINE WARFARE	MW		None
REMOTE MULTI-MISSION VEHICLHLE	RMV		None
SPECIAL OPERATIONS FORCE	SOF		None

Table 4-8. Sea Surface Sector 1 Modifiers.


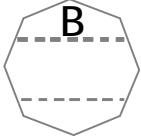
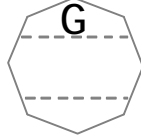
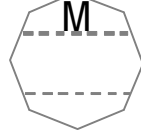
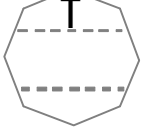

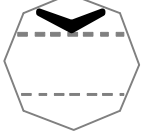
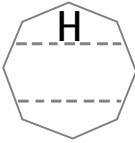
<i>FUNCTION</i>	<i>MODIFIER</i>	<i>LOCATION:</i>	<i>REMARKS</i>
SURFACE WARFARE	SUW		None
BALLISTIC MISSILE	B		None
GUIDED MISSILE	G		None
OTHER GUIDED MISSILE (POINT DEFENCE)	M		None
TORPEDO	T		None
DRONE-EQUIPPED			None

Table 4-8. Sea Surface Sector 1 Modifiers.			
<i>FUNCTION</i>	<i>MODIFIER</i>	<i>LOCATION:</i>	<i>REMARKS</i>
HELICOPTER-EQUIPPED / VERTICAL SHORT TAKE-OFF AND LANDING (VSTOL)	H		None

0417. Table 4-9 lists sea surface sector 2 modifiers and illustrates their placement within the bounding octagon.

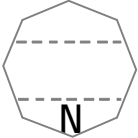
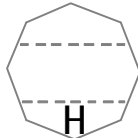
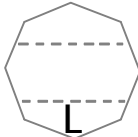
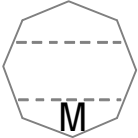
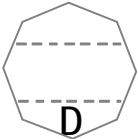
Table 4-9. Sea Surface Sector 2 Modifiers.			
<i>FUNCTION</i>	<i>MODIFIER</i>	<i>LOCATION:</i>	<i>REMARKS</i>
NUCLEAR POWERED	N		None
HEAVY	H		None
LIGHT	L		None
MEDIUM	M		None
DOCK	D		None


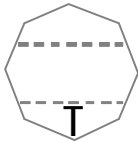
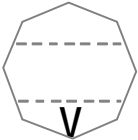

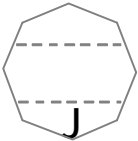

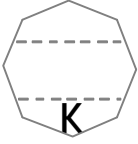



Table 4-9. Sea Surface Sector 2 Modifiers.			
<i>FUNCTION</i>	<i>MODIFIER</i>	<i>LOCATION:</i>	<i>REMARKS</i>
LOGISTICS	LOG		None
TANK	T		Only in conjunction with amphibious warfare or landing ship symbols.
VEHICLE	V		Only in conjunction with amphibious warfare or landing ship symbols.
FAST	F		None
AIR-CUSHIONED	J		None
AIR-CUSHIONED (USA ONLY)	AC		None

Table 4-9. Sea Surface Sector 2 Modifiers.			
<i>FUNCTION</i>	<i>MODIFIER</i>	<i>LOCATION:</i>	<i>REMARKS</i>
HYDROFOIL	K		None
AUTONOMOUS CONTROL	AUT		None
REMOTELY PILOTED	RP		None
EXPENDABLE	EXP		None

SECTION II – SEA SUBSURFACE SYMBOLS

Symbol Subset Structure

0416. The units, equipment, and objects of sea subsurface operations as mentioned in paragraph 0403 are further subdivided in

- a. military sea subsurface objects (units)
 - submarines
 - non-stationary sensors (i.e., AUV)
 - non-stationary weapons (torpedoes) and decoys
 - stationary weapons (mines) with an additional display mode
 - others (e.g., diver)
- b. non-military sea subsurface objects.

Composition of Sea Subsurface Symbols

0417. A unit symbol is composed of a frame (in this case the subsurface frame), colour (fill), icon (pictogram and/ or letters) and amplifiers. Figure 4-4 shows an example without amplifiers. However, in the area of mine warfare, the status of “OPERATIONAL/NEUTRALIZED” is displayed by a second icon within the symbol. This is shown in Table 4-17.

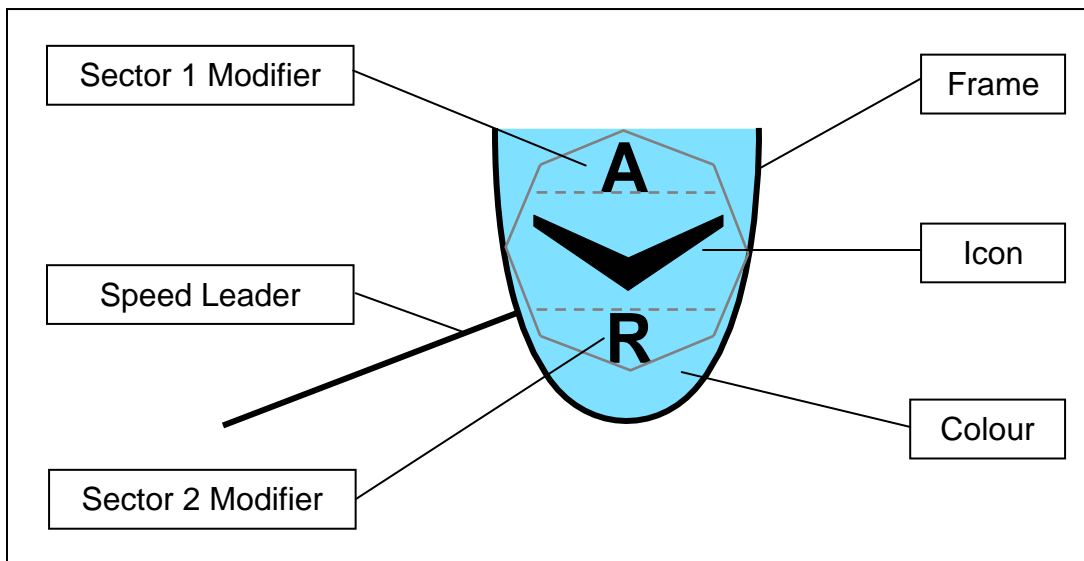
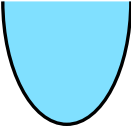







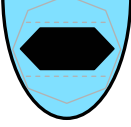
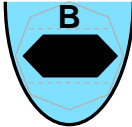
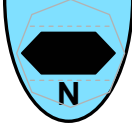
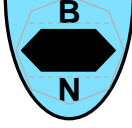


Figure 4-4. Sea Subsurface Symbol.

The process for sea subsurface symbol composition is shown in Table 4-10.

Table 4-10. Sea Subsurface Symbol Composition Process.							
<i>Step No.</i>	<i>Step</i>				<i>Examples</i>		
Step 1	Choose frame according to standard identity						
Maritime Standard Identities and Frame Shapes							
	Pending	Unknown	Assumed Friend	Friend	Neutral	Suspect	Hostile
Sea Sub-surface							
Step 2	Choose and add functional icon						
Step 3	Choose and add a modifier in either sector 1 or sector 2 position if applicable or deemed necessary for visualization.				 		
Step 4	Choose and add a second modifier (if applicable and/or deemed necessary for visual representation. NOTE: only one modifier is permitted per modifier position						

Modifiers

0418. Modifiers may be placed above (sector 1) and below (sector 2) of the icon (see Figure 4-5). Only one modifier may be placed within sector 1 or 2 at a given time. Multiple modifiers in the same sector are prohibited.

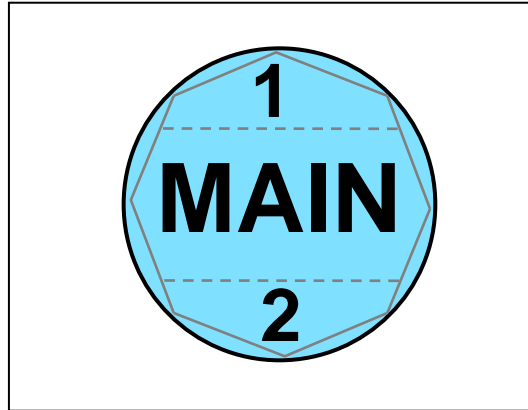


Figure 4-5. Icon and Modifier sectors for Sea Subsurface Symbols.

Sea subsurface sector 1 modifiers denote 1) mission area, 2) weapons capability, 3) asset capability, or 4) submarine classification for a given icon. Table 4-11 depicts sea subsurface sector 1 modifiers. The respective icons are shown in table 4-19.

Table 4-11. Sea Subsurface Sector 1 Modifiers.		
Modifier	Name	Description
ASW	Anti-Submarine Warfare	Mission Area
AUX	Auxiliary	Mission Area
C2	Command and Control	Mission Area
ISR	Intelligence, Surveillance, Reconnaissance	Mission Area
MCM	Mine Countermeasures	Mission Area
MW	Mine Warfare	Mission Area
SUW	Surface Warfare	Mission Area
A	Attack	Weapons Capability
B	Ballistic Missile	Weapons Capability
G	Guided Missile	Weapons Capability
M	Other Guided Missile (Point Defence)	Weapons Capability
SOF	Special Operations Force	Asset Capability
P1	Possible Submarine – Low 1	Submarine Classification
P2	Possible Submarine – Low 2	Submarine Classification
P3	Possible Submarine – High 3	Submarine Classification
P4	Possible Submarine – High 4	Submarine Classification

PB	Probable Submarine	Submarine Classification
CT	Certain Submarine	Submarine Classification

Sea subsurface sector 2 modifiers depict 1) ship propulsion or 2) unmanned underwater vehicle (UUV) control. Table 4-12 lists sea subsurface sector 2 modifiers. The respective icons are shown in table 4-20.

Table 4-12. Sea Subsurface Sector 2 Modifiers.		
Modifier	Name	Description
AI	Air Independent Propulsion	Ship Propulsion
D	Diesel Propulsion	Ship Propulsion
D1	Diesel – Type 1	Ship Propulsion
D2	Diesel – Type 2	Ship Propulsion
D3	Diesel – Type 3	Ship Propulsion
N	Nuclear Powered	Ship Propulsion
N1	Nuclear – Type 1	Ship Propulsion
N2	Nuclear – Type 2	Ship Propulsion
N3	Nuclear – Type 3	Ship Propulsion
N4	Nuclear – Type 4	Ship Propulsion
N5	Nuclear – Type 5	Ship Propulsion
N6	Nuclear – Type 6	Ship Propulsion
N7	Nuclear – Type 7	Ship Propulsion
AUT	Autonomous Control	UUV Control
RP	Remotely Piloted	UUV Control
EXP	Expendable	UUV Control

Amplifiers

0419. On the tactical display, information about a displayed object is conveyed by the symbol via frame shape, icon/letter and colour coding. There may be, however, additional and varying information that cannot be conveyed by graphical means, but by written (alphanumeric) information. This information may be displayed either in secondary information fields outside the tactical screen, a method that forces the operator to a constant shift of focus and will not be considered further in this text, or by use of amplifiers in the form of symbol labels.

The purpose of the amplifiers described in this section is to standardize the display of additional alphanumeric information on identity, movement and location, capabilities, etc. Figure 4-6 shows the placement of amplifiers with a symbol frame. The placement of the amplifier is the same regardless of frame shape or standard identity.

Maritime domain symbol amplifiers require a reduced amount of information to be displayed in one position relative to the symbol as compared to Land Symbols (see Chapter 3). Maritime amplifiers shall be placed to the immediate right of the symbol as opposed to separate positions surrounding it.

A set of amplifiers for sea subsurface symbols, including object name, position, speed, and time, shall be displayed in the five standard amplifier scheme fields (see chapter. 1, Figure 1.4) to the right of the symbol as given in Figure 4-6. The position of the standard information fields differs from those used for symbols in land and air domains.

In the default mode, the amplifier is not shown. It is the user’s task to define and call up for display the information considered to be necessary. Additionally, the user must be enabled to suppress the amplifier to reduce screen clutter and call it up again as considered appropriate to the tactical situation.

The speed leader is a dynamic amplifier that depicts the speed and direction of movement (course) and originates from the centre of the object. The length of the speed leader corresponds to the speed of the object.

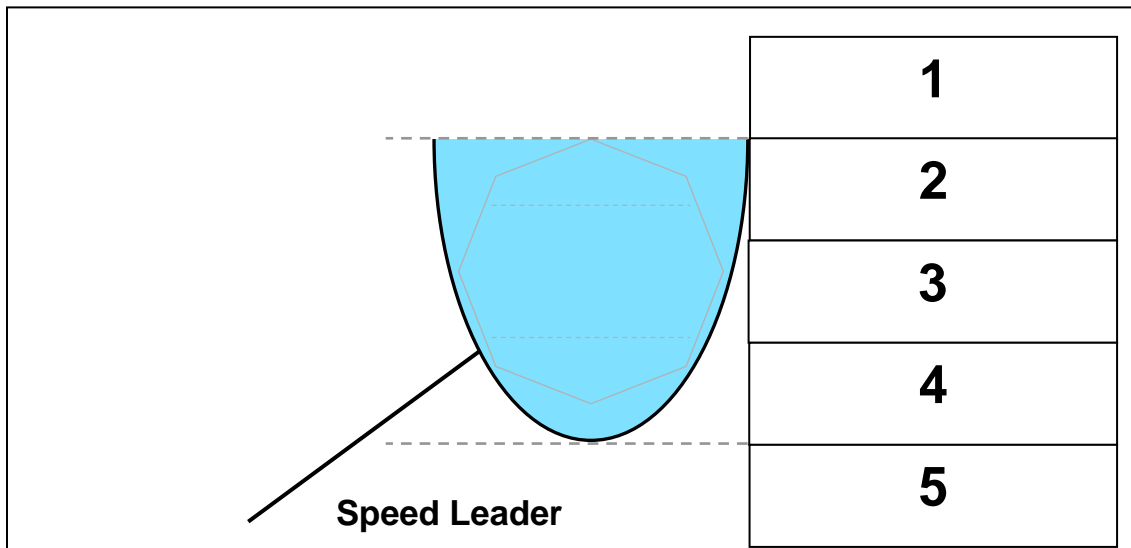


Figure 4-6. Sea Subsurface symbol amplifier fields.

Table 4-13 provides the possibilities of information display for military and non-military sea subsurface symbols by amplifiers.

Table 4-13. Contents of Amplifiers for Military and Non-military Sea Subsurface Symbols.			
<i>Field</i>	<i>Field Title</i>	<i>Description (Alternatives)</i>	<i>Prefix (when applicable)</i>
1	Track Number	System Track Number	TN
2	Name	Ships Name, Hull Number or Task Organization Designator (military only), Mission / International call sign	-
3	Position Movement (if speed leader is suppressed) DEPTH DTG	Course [degrees] /Speed [knots] and/or Bearing [degrees] / Distance [nautical miles] DEPTH [feet/meters]=] Date Time Group	- B/D
4	Identification	Country of origin (STANAG 1059 - 3-letter code) or Organization (e.g. UN, NATO, EU) Any other information (e.g. IFF / AIS)	-
5	Additional Information	For friendly units: - Sensor or weapon load, endurance, etc. For other units: - Credibility of information For submarine contacts: - Classification - NONSUB - POSSUB LOW 1 or 2 - POSSUB HIGH 3 or 4 - PROBSUB - CERTSUB	-

Sea Subsurface Icons

0420. Table 4-14 (Military), Table 4-15 (Civilian), Table 4-16 (Weapon), Table 4-17 (Mine), and Table 4-18 (Seabed Installations) provide the subsurface symbol subset.



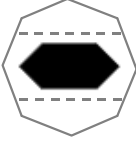






Table 4-14. Military Sea Subsurface Icons.			
<i>DESCRIPTION</i>	<i>ICON</i>	<i>LOCATION : MAIN</i>	<i>REMARKS</i>
MILITARY	MIL		None
SUBMARINE			None
SUBMARINE, SURFACED			None
SUBMARINE, BOTTOMED			None
SUBMARINE, SNORKELING			None


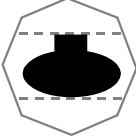





Table 4-14. Military Sea Subsurface Icons.			
<i>DESCRIPTION</i>	<i>ICON</i>	<i>LOCATION : MAIN</i>	<i>REMARKS</i>
OTHER SUBMERSIBLE			None
AUTONOMOUS UNDERWATER VEHICLE/ UNMANNED UNDERWATER VEHICLE (AUV/UUV)			None
NON-SUBMARINE	NON SUB		None
DIVER, MILITARY			None



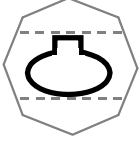




Table 4-15. Non-Military Sea Subsurface Icons.			
<i>DESCRIPTION</i>	<i>ICON</i>	<i>LOCATION : MAIN</i>	<i>REMARKS</i>
CIVILIAN	CIV		None
SUBMERSIBLE, CIVILIAN			None
AUTONOMOUS UNDERWATER VEHICLE/ UNMANNED UNDERWATER VEHICLE (AUV/UUV), CIVILIAN			None
DIVER, CIVILIAN			None



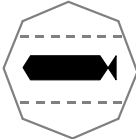







Table 4-16. Sea Subsurface Weapon Icons.			
<i>DESCRIPTION</i>	<i>ICON</i>	<i>LOCATION : MAIN</i>	<i>REMARKS</i>
UNDERWATER WEAPON	WPN		None
TORPEDO			None
IMPROVISED EXPLOSIVE DEVICE (IED)	IED		None
UNDERWATER DECOY			None
SEA MINE DECOY			None
SEA MINE DECOY, BOTTOM/GROUND			None











Table 4-16. Sea Subsurface Weapon Icons.			
<i>DESCRIPTION</i>	<i>ICON</i>	<i>LOCATION : MAIN</i>	<i>REMARKS</i>
SEA MINE DECOY, MOORED			None

Table 4-17. Sea Subsurface Mine Icons.			
<i>DESCRIPTION</i>	<i>Mine (Operational)</i>	<i>Mine (Neutralized)</i>	<i>REMARKS</i>
SEA MINE			Displayed with or without frame as Compound Icon
SEA MINE (BOTTOM/ GROUND)			See above
SEA MINE (MOORED)			See above
SEA MINE (FLOATING)			See above



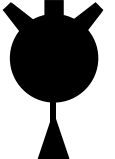



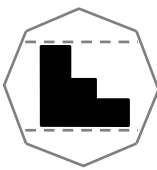

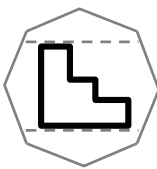
SEA MINE (IN OTHER POSITION)			See above
SEA MINE (RISING)			See above
UNEXPLODED EXPLOSIVE ORDNANCE			Displayed with frame

Table 4-18. Sea Subsurface Installations.

<i>DESCRIPTION</i>	<i>ICON</i>	<i>LOCATION : MAIN</i>	<i>REMARKS</i>
SEABED INSTALLATION, MAN-MADE, MILITARY			None
SEABED INSTALLATION, MAN-MADE, NON-MILITARY			None

Sea Subsurface Modifiers

0421. Table 4-19 lists sea subsurface sector 1 modifiers and illustrates their placement within the bounding octagon.



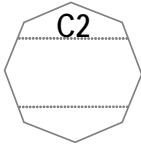
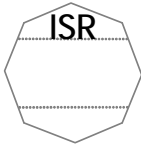

Table 4-19. Sea Subsurface Sector 1 Modifiers.			
<i>FUNCTION</i>	<i>MODIFIER</i>	<i>LOCATION:</i>	<i>REMARKS</i>
ANTISUBMARINE WARFARE	ASW		None
AUXILIARY	AUX		None
COMMAND AND CONTROL	C2		None
INTELLIGENCE, SURVEILLANCE, RECONNAISSANCE	ISR		None
MINE COUNTERMEASURES	MCM		None


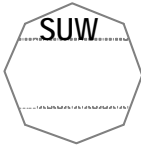
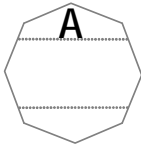
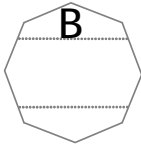
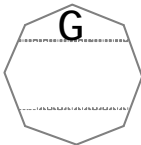
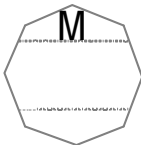
Table 4-19. Sea Subsurface Sector 1 Modifiers.			
<i>FUNCTION</i>	<i>MODIFIER</i>	<i>LOCATION:</i>	<i>REMARKS</i>
MINE WARFARE	MW		None
SURFACE WARFARE	SUW		None
ATTACK	A		None
BALLISTIC MISSILE	B		None
GUIDED MISSILE	G		None
OTHER GUIDED MISSILES (POINT DEFENCE)	M		None


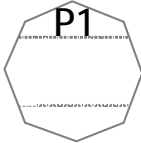
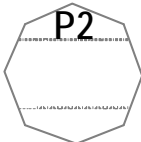
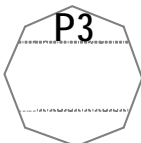

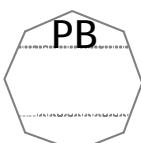

Table 4-19. Sea Subsurface Sector 1 Modifiers.			
<i>FUNCTION</i>	<i>MODIFIER</i>	<i>LOCATION:</i>	<i>REMARKS</i>
SPECIAL OPERATIONS FORCE	SOF		None
POSSIBLE SUBMARINE - LOW 1	P1		None
POSSIBLE SUBMARINE - LOW 2	P2		None
POSSIBLE SUBMARINE - HIGH 3	P3		None
POSSIBLE SUBMARINE - HIGH 4	P4		None
PROBABLE SUBMARINE	PB		None

Table 4-19. Sea Subsurface Sector 1 Modifiers.			
<i>FUNCTION</i>	<i>MODIFIER</i>	<i>LOCATION:</i>	<i>REMARKS</i>
CERTAIN SUBMARINE	CT		None

0422. Table 4-20 lists subsurface sector 2 modifiers and illustrates their placement within the bounding octagon.

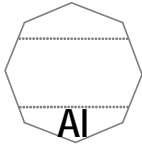
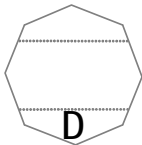
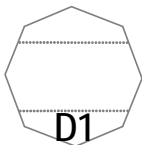
Table 4-20. Sea Subsurface Sector 2 Modifiers.			
<i>FUNCTION</i>	<i>MODIFIER</i>	<i>LOCATION:</i>	<i>REMARKS</i>
AIR INDEPENDENT PROPULSION	AI		None
DIESEL PROPULSION	D		None
DIESEL - TYPE 1	D1		None

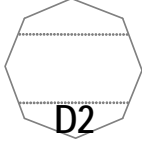
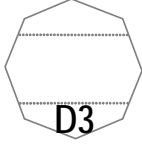
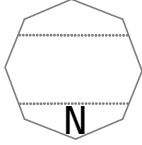



Table 4-20. Sea Subsurface Sector 2 Modifiers.			
<i>FUNCTION</i>	<i>MODIFIER</i>	<i>LOCATION:</i>	<i>REMARKS</i>
DIESEL - TYPE 2	D2		None
DIESEL - TYPE 3	D3		None
NUCLEAR POWERED	N		None
NUCLEAR - TYPE 1	N1		None
NUCLEAR - TYPE 2	N2		None
NUCLEAR - TYPE 3	N3		None



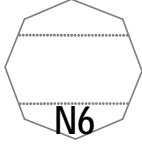




Table 4-20. Sea Subsurface Sector 2 Modifiers.			
<i>FUNCTION</i>	<i>MODIFIER</i>	<i>LOCATION:</i>	<i>REMARKS</i>
NUCLEAR - TYPE 4	N4		None
NUCLEAR - TYPE 5	N5		None
NUCLEAR - TYPE 6	N6		None
NUCLEAR - TYPE 7	N7		None
AUTONOMOUS CONTROL	AUT		None
REMOTELY PILOTED	RP		None

Table 4-20. Sea Subsurface Sector 2 Modifiers.			
<i>FUNCTION</i>	<i>MODIFIER</i>	<i>LOCATION:</i>	<i>REMARKS</i>
EXPENDABLE	EXP		None

CHAPTER 5

SPACE SYMBOLS

Scope

0501. This chapter covers symbols for space assets, related activities and other relevant objects (debris) within earth orbit. Space-related ground installations are covered in Chapter 3 “Land Symbols”.

Characteristics of Symbols for Space Operations

0502. Security and military operations are dependent on space capabilities for command and control (C2), communications, situation awareness, and intelligence, surveillance and reconnaissance (ISR). Because of meteorological satellites, forces no longer have to wonder how weather will impact future operations. The global positioning system (GPS) provides precise position, navigation and timing information to expeditionary and mobile forces. Additionally, satellites provide missile warning and tracking information. Space systems enable friendly force tracking for shared situational awareness, enable precision engagement for time sensitive targets, and shorten the joint air tasking cycle. The persistence (always on orbit), perspective (high altitude), penetration (no over flight restrictions), and presence (ability to provide combat support without being physically located with forward forces) of space systems provide forces beyond line of sight secure communications. In order to depict in near-real time large areas with fast moving space users manoeuvring within all three dimensions, specific requirements for the space picture production have to be met:

- a. The picture has to be updated in near real-time.
- b. Vectors have to be provided in order to help to anticipate movement of own, neutral and hostile objects.
- c. Wherever known, relevant data like “type”, “mission”, “operator”, “capabilities” etc. have to be affiliated to the objects without cluttering the display.
- d. Objects may overlap on the display but must still be recognisable to controllers.
- e. Depending on the scenario, the display may contain a multitude of moving objects (debris).

SECTION I - BUILDING SPACE SYMBOLS

General

0503. This section establishes a single standard for developing space symbols. It includes a variety of space related icons, modifiers, and amplifiers for building symbols. However, no attempt to depict all possible space symbols has been made. Rather, a standard method for constructing these symbols is presented. Once the user is familiar with the prescribed system, a symbol for any conceivable object can be created using the logical sequence provided in this chapter. The symbols shown in this chapter are adequate for depicting all standard identities. When representing not yet defined objects, the most appropriate symbol combination contained herein shall be selected. Any symbols, or combinations and modifications of symbols that differ from those laid down in this publication should be avoided. If, after searching icons and modifiers given in this publication, it is necessary to create a new symbol, the symbol shall be explained in an accompanying legend. Automated systems may have difficulty in passing non-standard symbols.

Composition of Space Symbols

0504. A space symbol is composed of a frame, colour (fill), functional icon (main icon), and modifiers (secondary icons) (figure 5-1).

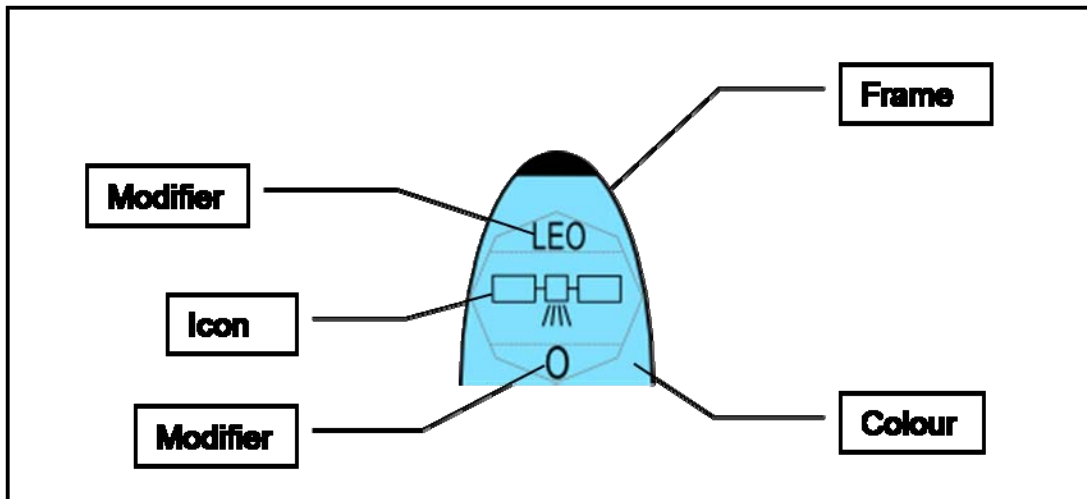
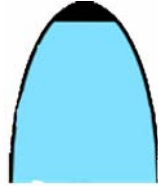
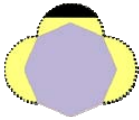


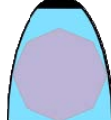
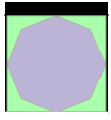
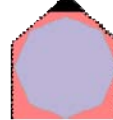

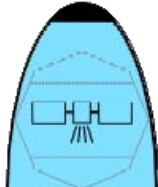
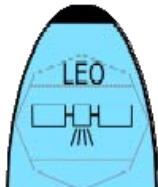
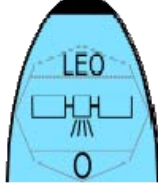


Figure 5-1. Space Symbol Composition.

See table 5-1 for the steps used to build space symbols.

Table 5-1. Building Unit Symbols.							
Step #	Step			Example			
Step 1.	Choose the frame according to standard identity.						
Affiliations and Frame Shapes							
Affiliation	Pending	Unknown	Assumed Friend	Friend	Neutral	Suspect	Hostile
Frame							
Step 2.	Choose and add main sector icon.						
Step 3.	Choose and add a modifier in either sector 1 or sector 2 if applicable or deemed necessary for visualization.						
Step 4.	Choose and add a modifier in either sector 1 or sector 2 if applicable or deemed necessary for visualization. NOTE: Only one modifier is permitted per modifier position.						

Amplifier Fields

0505. On the tactical display, information about a displayed object is conveyed by the symbol via frame shape, icon/letter and colour coding. There may be, however, additional information that cannot be conveyed by graphical means, but by written (alphanumerical) information only.

0506. This information can be displayed either in secondary information fields outside the tactical screen, a method that forces the operator to a constant shift of focus and will not be considered further in this text, or by use of amplifier fields.

0507. The purpose of the amplifier fields described in this section is to standardize the display of additional alphanumerical information, i.e. on identity, location and movement, capabilities. Figure 5-2 shows the placement of amplifier fields around a space symbol frame. The placement of the label is the same regardless of frame shape or affiliation.

0508. Space amplifier fields are to be displayed in one position relative to the symbol, its right side and not in different and separate positions all around it. Track number, name, position, and nation are considered essential information and displayed in fields 1 through 5 to the right of the symbol.

0509. In the default mode, the label is not shown. It is the user's task to define and call up for display the information considered to be necessary. Additionally, the user must be enabled to suppress the filled and displayed label to reduce screen clutter and call it up again as considered appropriate to the tactical situation. Table 5-2 lists the contents and descriptions for the space amplifier fields.

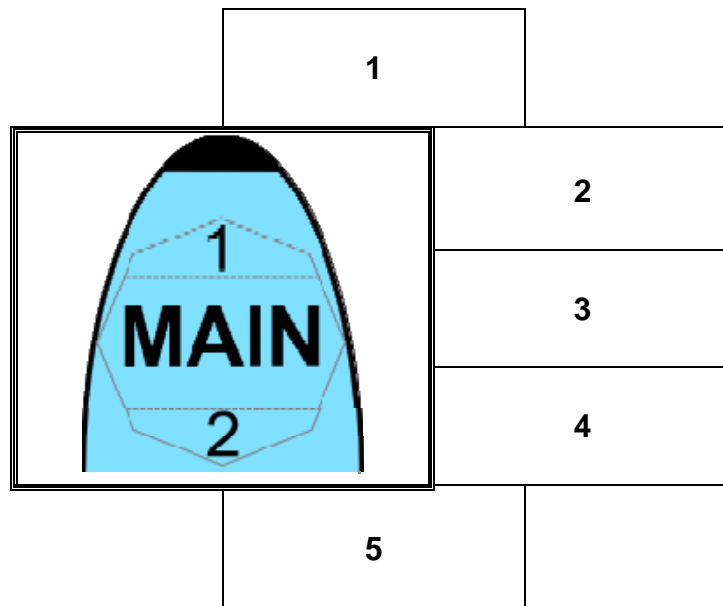


Figure 5-2. Symbol Amplifier Fields.

Table 5-2. Contents of Labels for Space Symbols (Example).

<i>Field</i>	<i>Field Title</i>	<i>Description (Alternatives)</i>	<i>Prefix (when applicable)</i>
1	SSTNUM	Space System Track Number	SSTN
2	SSNAME	a) Space System Name b) Mission call sign	
3	Position and Orbit, 3 rd Dimension Info	Georef Position [degrees]/Inclination] or Trajectory Height [feet/orbit]	
4	Nation	Nations Name: A 3-letter code indicating the object's country of origin (STANAG 1059)	
5	Additional Information	For FRIENDLY units - Sensor or Weapon load, specific orbit, footprint etc. For other Units - Credibility of Information	

SECTION II - ICONS

0510. Icons in the main sector reflect the main function or capability to be depicted by a symbol, Table 5-4 below shows the icons for use in space symbols in the main sector of the symbol.

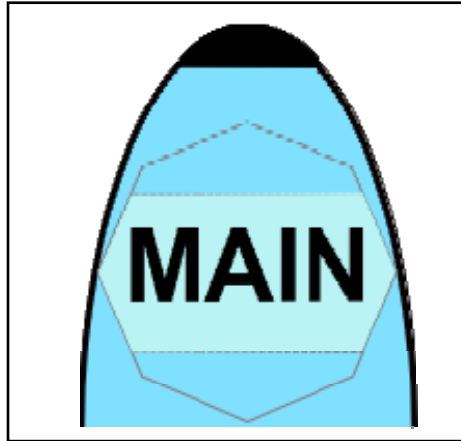


Figure 5-3. Main Sector Icons Placement.




Table 5-4. Main Sector Icons.			
<i>FUNCTION</i>	<i>ICON</i>	<i>LOCATION</i>	<i>REMARKS</i>
SPACE VEHICLE	SV		None
RE-ENTRY VEHICLE	RV		None
PLANET LANDER	PL		None














Table 5-4. Main Sector Icons.			
<i>FUNCTION</i>	<i>ICON</i>	<i>LOCATION</i>	<i>REMARKS</i>
ORBITER SHUTTLE MILITARY			None
ORBITER SHUTTLE CIVILIAN			None
MILITARY CAPSULE			None
CIVILIAN CAPSULE			None
SATELLITE, GENERAL	SAT		None
MILITARY SATELLITE			None
CIVIL SATELLITE		Main 	None


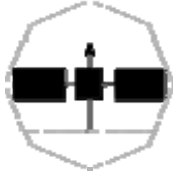


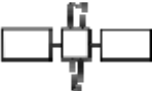









Table 5-4. Main Sector Icons.			
<i>FUNCTION</i>	<i>ICON</i>	<i>LOCATION</i>	<i>REMARKS</i>
ANTI-SATELLITE WEAPON			None
ASTRONOMICAL SATELLITE MILITARY			None
ASTRONOMICAL SATELLITE CIVIL			None
BIOSATELLITE MILITARY			None
BIOSATELLITE CIVIL			None
COMMUNICATIONS SATELLITE MILITARY			None
COMMUNICATIONS SATELLITE CIVIL		Main 	None

Table 5-4. Main Sector Icons.





















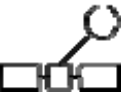





<i>FUNCTION</i>	<i>ICON</i>	<i>LOCATION</i>	<i>REMARKS</i>
EARTH OBSERVATION SATELLITE			None
EARTH OBSERVATION SATELLITE			None
MINIATURIZED SATELLITE MILITARY			None
MINIATURIZED SATELLITE CIVIL			None
NAVIGATIONAL SATELLITE MILITARY			None
NAVIGATIONAL SATELLITE CIVIL			None
RECONNAISSANCE SATELLITE			None

Table 5-4. Main Sector Icons.

<i>FUNCTION</i>	<i>ICON</i>	<i>LOCATION</i>	<i>REMARKS</i>
SPACE STATION MILITARY			None
SPACE STATION CIVIL			None
TETHER SATELLITE MILITARY			None
TETHER SATELLITE CIVIL			None
WEATHER SATELLITE MILITARY			None
WEATHER SATELLITE CIVIL			None

SECTION III – SECTOR MODIFIERS

0511. Modifiers in sector 1 (Figure 5-4) and sector 2 (Figure 5-5) show modifying information. Specifically, sector 1 space modifiers denote orbit; whereas, sector 2 space modifiers denote sensors. Tables 5-5 and 5-6 show the icons for use in space symbols in sector 1 and 2.

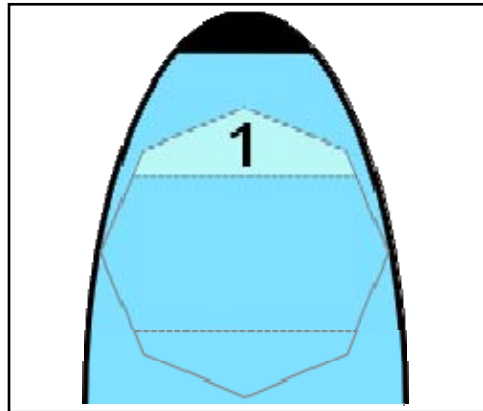


Figure 5-4. Sector 1 Modifier Placement.







Table 5-5. Sector 1 Modifier (Type of Orbit).			
<i>FUNCTION</i>	<i>ICON</i>	<i>LOCATION</i>	<i>REMARKS</i>
LOW EARTH ORBIT (LEO)	LEO		None
MEDIUM EARTH ORBIT (MEO)	MEO		None
HIGH EARTH ORBIT (HEO)	HEO		None

Table 5-5. Sector 1 Modifier (Type of Orbit).			
<i>FUNCTION</i>	<i>ICON</i>	<i>LOCATION</i>	<i>REMARKS</i>
GEOSYNCHRONOUS ORBIT (GSO)	GSO		None
GEOSTATIONARY ORBIT (GO)	GO		None
MOLNIYA ORBIT (MO)	MO		None

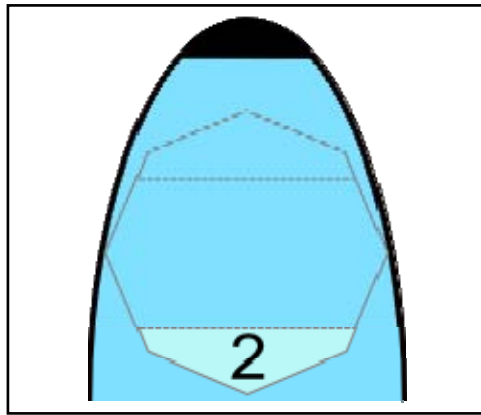


Figure 5-5. Sector 2 Modifier Placement.











Table 5-6. Sector 2 Modifiers (Type of Sensors).			
<i>FUNCTION</i>	<i>ICON</i>	<i>LOCATION</i>	<i>REMARKS</i>
OPTICAL	O		Only used with satellite.
INFRA-RED	IR		Only used with satellite.
RADAR	R		Only used with satellite.
SIGINT	SI		Only used with satellite.

Table 5-7. Hazards (Space Debris)		
FUNCTION	LOCATION	REMARKS
MAN MADE SPACE DEBRIS SMALL		None
MAN MADE SPACE DEBRIS MEDIUM		None
MAN MADE SPACE DEBRIS BIG		None
NATURAL SPACE DEBRIS SMALL		None
NATURAL SPACE DEBRIS MEDIUM		None
NATURAL SPACE DEBRIS BIG		None

CHAPTER 6

STABILITY AND CIVIL SUPPORT ACTIVITIES SYMBOLS

General

0601. Alliance security interests can be affected by risks of a wide nature, including acts of terrorism, sabotage and organized crime, and by the disruption of the flow of vital resources. Additionally, the uncontrolled movement of large numbers of people, particularly because of armed conflicts, can also pose problems for security and stability affecting the Alliance. The joint force commander therefore requires a set of symbols that provide the capability to depict stability activities and civil support activities across the continuum of operations. This set of symbols, as with the other sets in this publication, is built upon the basics as described in Chapter 1.

Composition of an Activity Symbol

0602. An activity symbol is composed of a frame, colour (fill), activity functional icon, modifiers (secondary icons), and text/graphic amplifiers (figure 6-1).

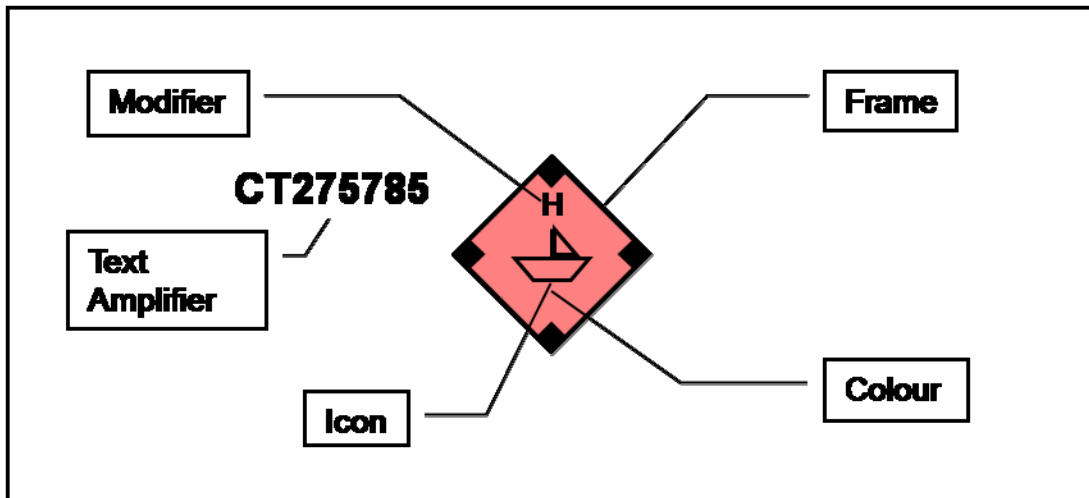







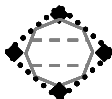





Figure 6-1. Activity Symbol Composition.

Building an Activity Symbol

0603. Table 6-1 provides the steps for building an activity symbol. Once the user is familiar with the system in Table 6-1, any desired symbol can be developed using this logical sequence.

Table 6-1. Building An Activity, Location, or Non-military Organization Symbol.								
<i>Step #</i>	<i>Step</i>	<i>Example</i>						
Step 1.	Choose the frame according to standard identity.							
Activity Symbol Frame Shapes and Affiliation								
	STANDARD IDENTITY	FRIENDLY	HOSTILE	NEUTRAL	UNKNOWN	ASSUMED FRIEND	SUSPECT	PENDING
FRAME								
Steps 2.	Choose and add main sector icon.							
Step 3.	Choose and add a modifier in either sector 1 or sector 2 if applicable or deemed necessary for visualization.							
Step 4.	Choose and add a modifier in either sector 1 or sector 2 if applicable or deemed necessary for visualization. NOTE: Only one modifier is permitted per modifier position.	There are no specific sector 2 modifiers at this time.						

Activity Icon, Modifier, and Amplifier Fields

0604. The purpose of activity icon, modifier, and amplifier fields is to standardize the location of information that graphically describes a stability and civil support activity and provides additional information on capabilities, status, location, etc. Figure 6-2 shows the placement of the activity icon, modifier, and amplifier fields around the friendly activity symbol frame. The placement of activity icon, modifier, and amplifier information fields is the same regardless of frame shape or affiliation.

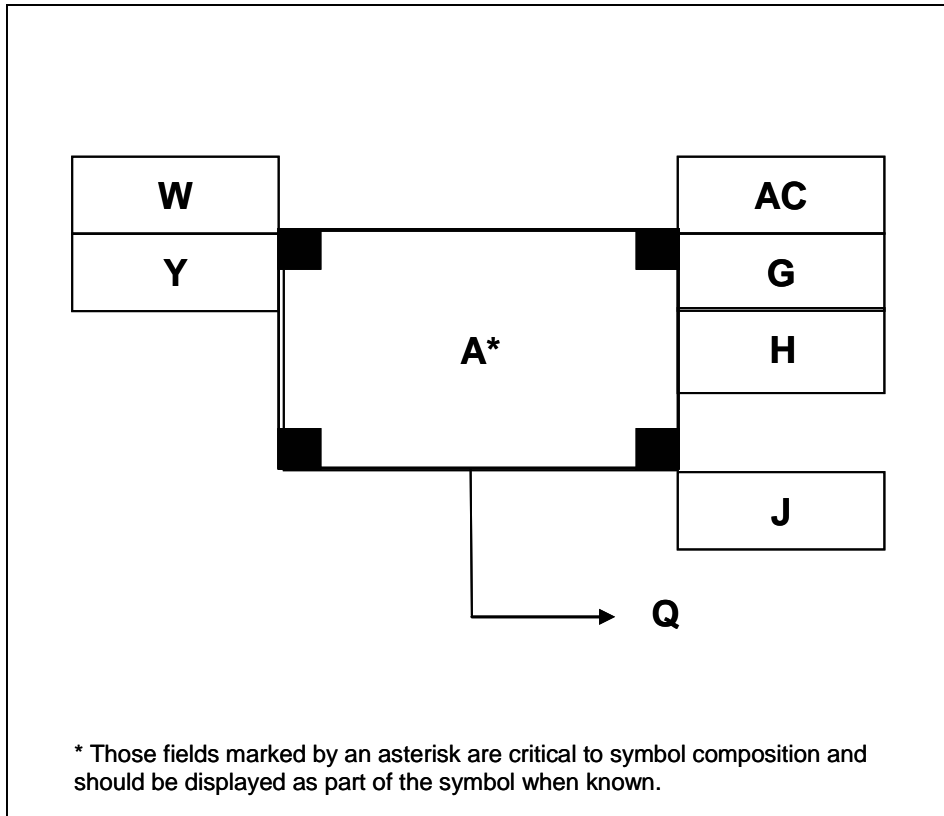


Figure 6-2. Activity Icon, Modifier, and Amplifier Fields.

Location of Icons and Modifiers inside the Octagon for Activity Symbols

0605. For activity symbols, the octagon is as described in Chapter 1 in paragraph 0120a. It serves as the foundation for placement of icons and modifiers. The octagon is divided into sectors. The three sectors specify where icons and modifiers are positioned and how much space is available for sizing of icons and modifiers. Table 6-2 provides examples showing the sectors for each of the frame shape types. The lettering size for text icons and modifiers will vary based on the number of letters used.

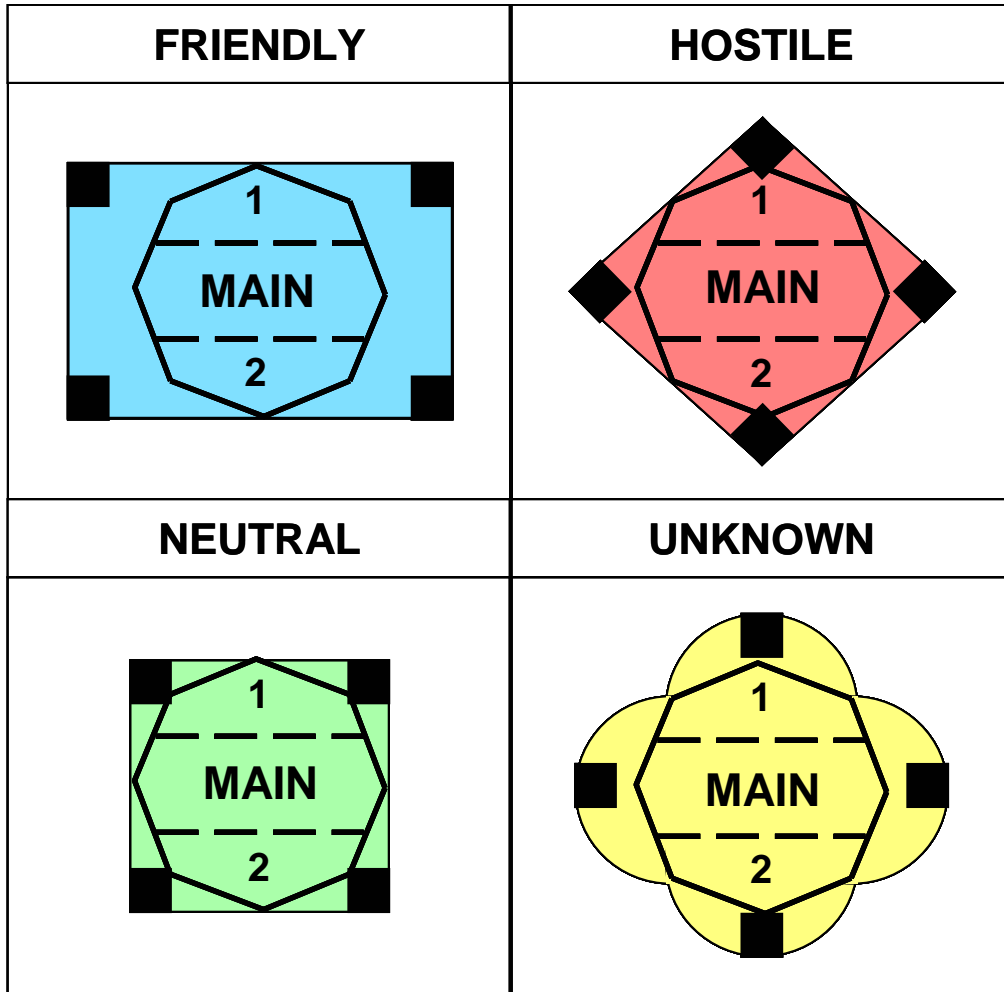


Figure 6-3. Locations of Icons and Modifiers.

In general, icons should not be so large as to exceed the dimensions of the main sector of the octagon or touch the interior border of the frame. However, there are exceptions to this size rule. In those cases the icons will occupy the entire frame and must, therefore, exceed the dimensions of the main sector of the octagon and touch the interior border of the frame (see Chapter 3). These are called full frame icons.

Icon, Modifier, and Amplifier Fields

0606. See paragraph 114 in Chapter 1 for a description of and more information on amplifiers. Table 6-2 provides a description of each of the unit symbol amplifying information fields as shown in Figure 6-3.

Table 6-2. Description of Icon, Modifier, and Amplifier Fields for Activity Symbols.			
<i>Field</i>	<i>Field Title</i>	<i>Description</i>	<i>Text/Graphic</i>
A	Symbol	Symbol contains an icon in the “Main” sector of the bounding octagon and may contain a modifier in sector 1, sector 2, or both.	Either
G	Staff Comments	Free text. Can be used by staff for information required by commander.	Text
H	Additional Information	Free text.	Text
J	Evaluation Rating	Degree of confidence that may be placed on the information represented by the symbol. It is shown as one letter and one number made up of Reliability of Source and Credibility of Information. (STANAG 2511). <u>Reliability of Source:</u> A. Completely reliable B. Usually reliable C. Fairly reliable D. Not usually reliable E. Unreliable F. Reliability cannot be judged. <u>Credibility of Information:</u> 1. Confirmed by other sources 2. Probably true 3. Possibly true 4. Doubtful 5. Improbable 6. Truth cannot be judged.	Text
Q	Offset Location Indicator	It is used to denote precise location.	Graphic
W	Date-Time Group	An alphanumeric designator for displaying a date-time group (DDHHMMSSZMONYY) or “O/O” for on order. The date-time group is composed of a group of six numeric digits with a time zone suffix and the standardized three-letter abbreviation for the month followed by two digits. The first pair of digits represents the day; the second pair, the hour; the third pair, the minutes. The last two digits of the year are after the month. For automated systems, two digits may be added before the time zone suffix and after the minutes to designate seconds.	Text
AC	Country Indicator	A three-letter code that indicates the country of origin of the organization (STANAG 1059). In stability activities, this field can be used for factions or groups.	Text

Main Sector Icons

0607. Icons in the main sector (Figure 6-4) normally reflect the main function of the symbol, but in some cases can also reflect modifying information as well. Table 6-3 below shows the icons for use in activity symbols in the main sector of the A field of the symbol. The use of icons from chapters 2, 3, and 4 is also permissible in building activity symbols.

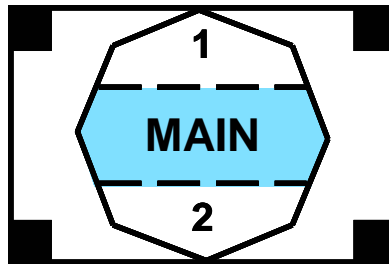


Figure 6-4. Main Sector Icons.

Table 6-3. Main Sector Icons.			
<i>FUNCTION</i>	<i>ICON</i>	<i>LOCATION:</i>	<i>REMARKS</i>
Arrest			None
Arson/Fire	FIRE		None
Attempted Criminal Activity			None
Demonstration	MASS		None
Drive-by Shooting			None





















Table 6-3. Main Sector Icons.			
FUNCTION	ICON	LOCATION:	REMARKS
Drug Related Activities	DRUG		Reduced when used as a modifier for an icon.  Drug Arrest
Explosion			Modifiers are placed inside the icon in the main sector.  IED Explosion
Extortion	\$		None
	€		
Extortion	£		None
	¥		
Graffiti			None
Killing			None
Patrolling			None
Poisoning			None

Table 6-3. Main Sector Icons.			
<i>FUNCTION</i>	<i>ICON</i>	<i>LOCATION:</i>	<i>REMARKS</i>
Radio and Television Psychological Operations			None
Riot	RIOT		None
Searching			None

Sector 1 Modifiers

0608. Sector 1 modifiers (Figure 6-5) provide additional information regarding the icon within the symbol. Table 6-4 shows the modifiers for use in activity, location, or non-military organization symbols in sector 1 of the A field of the symbol.

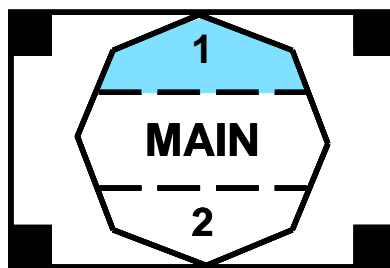


Figure 6-5. Sector 1 Modifier Placement.



















Table 6-4. Sector 1 Modifier.			
<i>FUNCTION</i>	<i>ICON</i>	<i>LOCATION</i>	<i>REMARKS</i>
Criminal Related Activities			
Assassination	AS		Normally used in conjunction with individual and attempted criminal activity icon.  Assassinated Individual
Execution (Wrongful Killing)	EX		Normally used in conjunction with individual and attempted criminal activity icon.  Executed Individual
Hijacking/Hijacked	H		Normally used in conjunction with civilian equipment systems.  Automobile Hijacking
House-to-House			None
Kidnapping	K		Normally used in conjunction with individual and attempted criminal activity icon.  Attempted Kidnapping
Murder	MU		Normally used in conjunction with individual and attempted criminal activity icon.  Murdered Individual

Table 6-4. Sector 1 Modifier.			
<i>FUNCTION</i>	<i>ICON</i>	<i>LOCATION</i>	<i>REMARKS</i>
Piracy	PI		Normally used in conjunction with equipment icons.  Pleasure Craft Piracy
Rape	RA		Normally used in conjunction with individual and attempted criminal activity icon.  Rape
Written Psychological Operations			None

Sectors 2 Icons

0609. Sector 2 modifiers may also provide additional information regarding the icon. Presently, there are no specific sector 2 modifiers.

CHAPTER 7

CONTROL MEASURE SYMBOLS

General

0701. Ultimately, the joint force commander and his forces must be capable of accomplishing their mission, either directly or indirectly, by the employment of capabilities to create physical or psychological effects, and be able to sustain such operations for as long as is necessary to achieve operational objectives. The principal method by which this capability is delivered is through the combination of joint operational capabilities and a range of mechanisms and control measures.

This chapter establishes a standard system for the development and use of control measure symbols. Within this standard system there are series of control measure symbols that follow standard formats and there are control measure symbols that follow stand alone formats. This chapter provides rules for automated and hand-drawn symbols and examples for all control measure symbols. These control measure symbols are the standard for all command and control systems and simulations, including those used in live, virtual, and constructive environments. For many control measure symbols, there is a corresponding definition provided in this section. These definitions are provided to help add clarity in using these symbols. For ease of understanding and use the control measure symbols have been broken down into groups that correspond to the joint functions of command and control to include joint targeting, manoeuvre and fires, intelligence, force protection, sustainment, and deception under information operations.

Colouring

0702. All friendly graphic control measures will be shown in black or blue when drawn manually or on a colour computer-generated display. Hostile graphic control measures will be shown in red. If red is not available, they will be drawn in black with the abbreviation “ENY” placed on the graphic in at least two places. All obstacles as shown in this chapter, friendly, hostile, neutral, unknown or factional, will be drawn using the colour green. If the colour green is not available obstacles should be drawn using black. The colour yellow will be used for the cross-

hatching for CBRN contaminated areas. NOTE: The use of green and yellow for obstacles and CBRN is in contradiction to the standard identities.

Labelling

0703. Make all text labelling in upper case letters. The reader should be able to read the labels for all text labels of modifier or amplifier fields for control measures symbols when the bottom of the overlay is closest to the reader. Labelling written on an angle should be readable to the viewer so they do not have to turn their head.

Command and Control

Boundaries

0704. In land warfare, a boundary is a line by which areas of responsibility between adjacent units/formations are defined. For boundaries, all field labels are displayed perpendicular to the boundary line. Figure 6-1 below provides the orientation of field labels for horizontal (east/west) and vertical (north/south) boundaries. The graphic for the highest echelon (Field B) unit on lateral boundaries is used for the boundary line. The graphic for the lower echelon (Field B) unit on a rear or forward boundary is used for the boundary line. (See Table 7-2) When units of the same echelon are adjacent to each other, the abbreviated echelon designator (Field T) can be omitted from the alphanumeric designator. Tables 7-20 and 7-21 at the end of the chapter provide a list of abbreviations and acronyms to be used for Field T. For all boundaries, use Arabic numerals to show the numbers of units, except for a corps boundary, use Roman numerals to show the number of corps. When the boundary is between units of different countries, the three-letter country code (Field AH) is shown in parenthesis behind or below the unit designation.

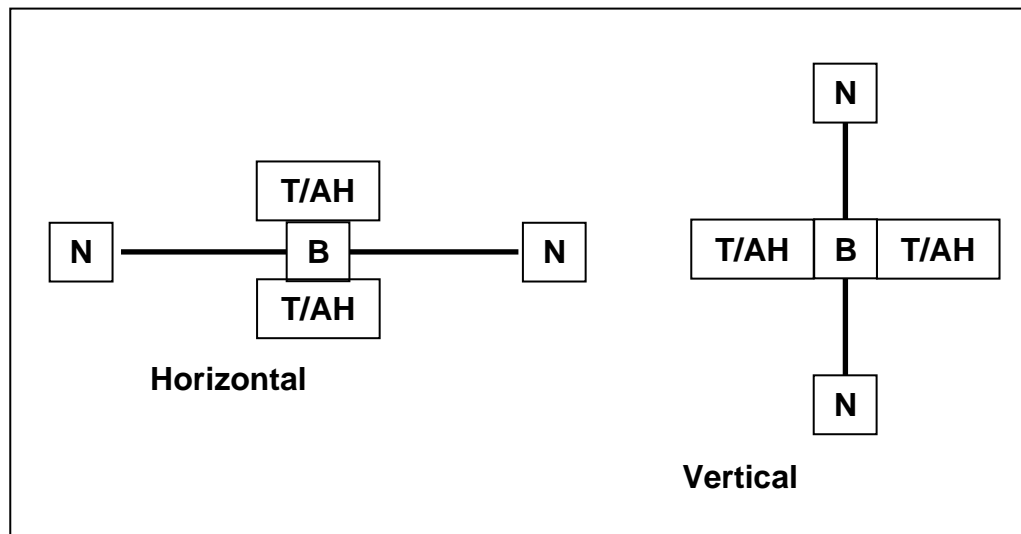


Figure 7-1. Orientation of Boundary Lines.

Table 7-1. Boundaries.			
<i>CONTROL MEASURE</i>	<i>TEMPLATE</i>	<i>DRAW RULES</i>	<i>EXAMPLE</i>
Friendly Present Boundary		<p><u>Anchor Points.</u> This graphic requires at least two points, points 1 and 2, to define the line. Additional points can be defined to extend and shape the line.</p> <p><u>Size/Shape.</u> The first and last anchor points determine the length of the line. The line segment between each pair of anchor points will repeat all information associated with the line segment between points 1 and 2.</p> <p><u>Orientation.</u> Orientation is determined by the anchor points.</p>	<p>2ID (USA)</p> <p>————— XX —————</p> <p>52ID (GBR)</p>
Friendly Planned or On Order Boundary			<p>1ID (CAN)</p> <p>- - - - - XX - - - - -</p> <p>2AD (FRA)</p>
Enemy Known Boundary	<p>Monochrome</p>		<p>12IN</p> <p>ENY ——— ——— ENY</p> <p>7IN</p>

Table 7-1. Boundaries.			
<i>CONTROL MEASURE</i>	<i>TEMPLATE</i>	<i>DRAW RULES</i>	<i>EXAMPLE</i>
	<p>Colour</p>		<p style="text-align: center;">1AAB</p> <p style="text-align: center;">----- X -----</p> <p style="text-align: center;">3ARBN</p>
Enemy Suspected or Templated Boundary			<p style="text-align: center;">211AR</p> <p style="text-align: center;">ENY----- II -----ENY</p> <p style="text-align: center;">12ARCOY</p>
			<p style="text-align: center;">3ABB</p> <p style="text-align: center;">----- X -----</p> <p style="text-align: center;">8ABR</p>

Table 7-2. Lateral, Forward, and Rear Boundaries.	
<i>BOUNDARY TYPE</i>	<i>EXAMPLE</i>
<p>Lateral Boundary Control measure that defines the left or right limit of a unit's operational area. Together with the rear and forward boundaries and a coordinating altitude, lateral boundaries define the area of operations for a commander.</p>	<p><i>Note: The symbols that have been coloured grey are used to help explain how the control measure is used, but they are not a part of the control measure.</i></p>

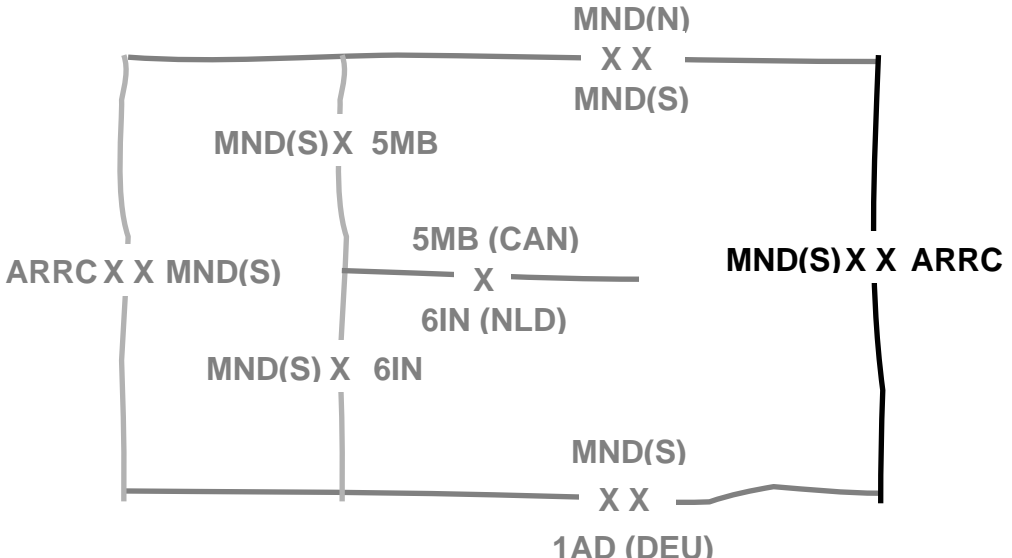
<p align="center">Table 7-2. Lateral, Forward, and Rear Boundaries.</p>	
<p><i>BOUNDARY TYPE</i></p>	<p align="center"><i>EXAMPLE</i></p> <p><i>Note: The symbols that have been coloured grey are used to help explain how the control measure is used, but they are not a part of the control measure.</i></p>
<p>Forward Boundary The farthest limit, in the direction of the enemy, of an organization's responsibility.</p>	 <p>The diagram illustrates a forward boundary with several key elements and their relationships:</p> <ul style="list-style-type: none"> Top Center: MND(S) X 5MB Top Right: MND(N) X X, MND(S) Center: 5MB (CAN) X, 6IN (NLD) Bottom Center: MND(S) X 6IN Bottom Right: MND(S) X X, 1AD (DEU) Left Side: ARRC X X MND(S) Right Side: MND(S) X X ARRC <p>Grey 'X' symbols indicate specific control measure usage points between these elements.</p>

Table 7-2. Lateral, Forward, and Rear Boundaries.	
<i>BOUNDARY TYPE</i>	<i>EXAMPLE</i>
<p>Rear Boundary Line that defines the rear area of operations assigned to a particular unit. The area behind the rear boundary belongs to the next higher commander and positioning of elements behind it must be coordinated with that commander.</p>	

Points

0705. In a number of tables (sustainment, CBRN decontamination, and special C2) that follow there are point control measure symbols that follow a specific format as shown in Figure 7-2 below. Supply points follow this same format with a modification to the symbol. Supply points use the same icon used for supply units. The supply icon is placed toward the bottom of the box as shown in Figure 7-2 below. This is format for use only with these types of points, as there are other points (contact, coordination, decision, targets, etc.) as displayed throughout this section on land control measure symbols that are formatted differently. In building points, the type of point is abbreviated and positioned inside the top part of the point symbol in field A. For supply symbols this may be a graphic depiction. In addition, below the abbreviation of the point name, the designation of the unit servicing that point can be included in field T. To differentiate points, the point is numbered, lettered, or a combination. The number, letter or combination is placed on the outside of the symbol on the right side at the top in field T. On the outside of the point on the left side at the top and middle, date-time groups can be associated with the point. On the outside of the point at the top, additional information can be provided in field H. Point symbols cannot be rotated and therefore text will not be written on an angle.

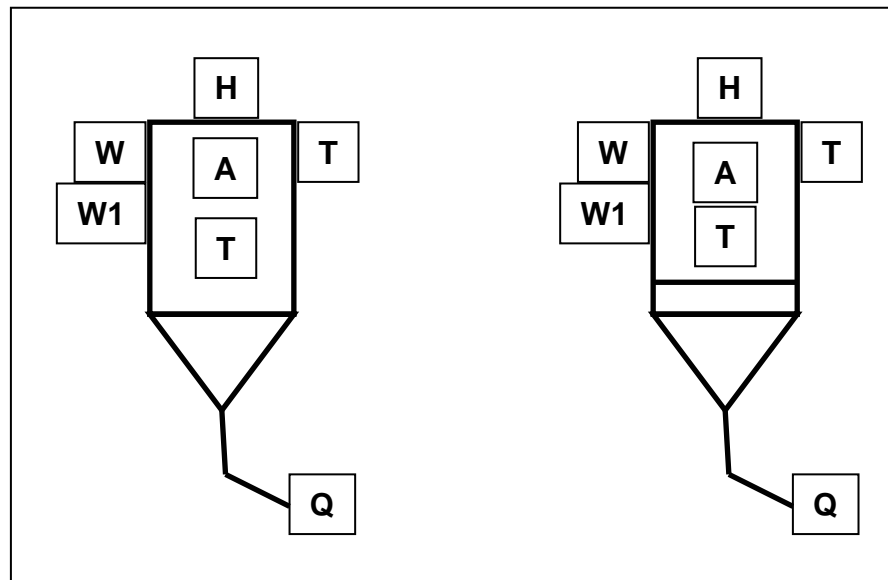


Figure 7-2. Template for Point and Supply Point Control Measure Symbols.

Lines

0706. In the tables that follow there are line control measure symbols that follow a specific format as shown in Figure 7-3 below. Most lines are also named as a phase line for easy reference for use in orders and during transmissions. A phase line will be marked as PL with the name in the T field. Other lines that have a specific purpose and are also named as phase lines should have the primary purpose in the T1 field (such as restrictive fire line “RFL”) labelled on top of the line at both ends of the line inside the lateral boundaries or as often as necessary for clarity. The T2 field is used for fire support coordination measures to show the designation of the controlling headquarters. The use of phase lines to mark line control measure symbols is not mandatory.

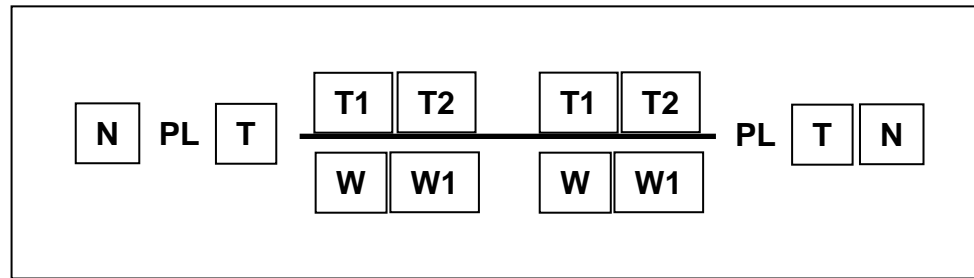


Figure 7-3. Template for Line Control Measure Symbols.

Areas

0707. In the tables that follow there are area control measure symbols that follow a specific format as shown in Figure 7-4. Areas will normally be marked with the abbreviation for the type of area in the A field followed by a name in the T field. This labelling should be in the centre of the area unless the area is too small or the labelling would interfere with the locating of units. Not all fields are required for each area, some areas may use only one field, while other will use several.

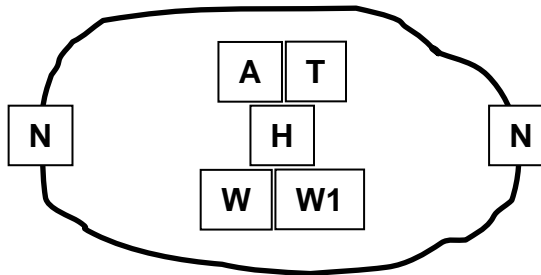


Figure 7-4. Template for Area Control Measure Symbols.

Area of Operations

0708. An area of operations is an operational area defined by a joint commander for land or maritime forces to conduct military activities. Normally, an area of operations does not encompass the entire joint operations area of the joint commander, but is sufficient in size for the joint force component commander to accomplish assigned missions and protect forces. Operational area is an overarching term encompassing more descriptive terms for geographic areas in which military operations are conducted. Operational areas include, but are not limited to, such descriptors as area of responsibility, theatre of war, theatre of operations, joint operations area, amphibious objective area, joint special operations area, and area of operations.

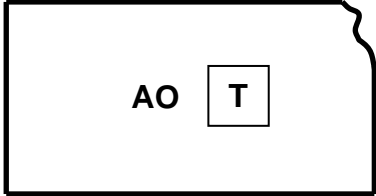

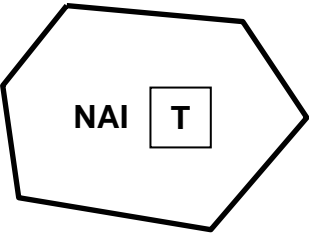
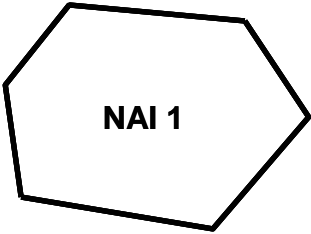
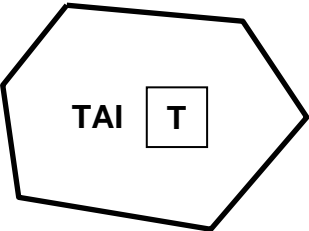

Table 7-3. Area of Operations.			
<i>CONTROL MEASURE</i>	<i>TEMPLATE</i>	<i>DRAW RULES</i>	<i>EXAMPLE</i> <i>Note: The symbols that have been coloured grey are used to help explain how the control measure is used, but they are not a part of the control measure.</i>
Area of Operations		<p><u>Anchor Points.</u> This graphic requires at least three anchor points to define the boundary of the area. Add as many points as necessary to accurately reflect the area's size and shape.</p> <p><u>Size/Shape.</u> Determined</p>	

Table 7-3. Area of Operations.			
<i>CONTROL MEASURE</i>	<i>TEMPLATE</i>	<i>DRAW RULES</i>	<i>EXAMPLE</i> <i>Note: The symbols that have been coloured grey are used to help explain how the control measure is used, but they are not a part of the control measure.</i>
<p>Named Area of Interest A geographical area where information is gathered to satisfy specific intelligence requirements. (AAP-6)</p>		<p>by the anchor points. The information fields should be moveable and scalable as a block within the area. <u>Orientation</u>. Not applicable.</p>	
<p>Target Area of Interest The geographical area where high-value targets can be acquired and engaged by friendly forces.</p>			

Command and Control Measure Symbols

0709. These symbols are used in the exercise of authority and direction by a properly designated commander over assigned and attached forces in the accomplishment of the mission.

Table 7-4. Command and Control Measure Symbols.			
<i>CONTROL MEASURE</i>	<i>TEMPLATE</i>	<i>DRAW RULES</i>	<i>EXAMPLE</i>
			<i>Note: The symbols that have been coloured grey are used to help explain how the control measure is used, but they are not a part of the control measure.</i>
Points			
Unspecified Control Point		<p><u>Anchor Points.</u> This graphic requires one anchor point. The point defines the tip of the inverted cone.</p> <p><u>Size/Shape.</u> Static.</p> <p><u>Orientation.</u> The graphic will typically be oriented upright, as shown in the example to the right.</p>	Examples follow.

Table 7-4. Command and Control Measure Symbols.			
<i>CONTROL MEASURE</i>	<i>TEMPLATE</i>	<i>DRAW RULES</i>	<i>EXAMPLE</i> <i>Note: The symbols that have been coloured grey are used to help explain how the control measure is used, but they are not a part of the control measure.</i>
Amnesty Point			<p>WEAPONS</p> <p>080700ZMAY08- 120700ZMAY08</p>

Table 7-4. Command and Control Measure Symbols.			
<i>CONTROL MEASURE</i>	<i>TEMPLATE</i>	<i>DRAW RULES</i>	<i>EXAMPLE</i>
<p>Checkpoint A predetermined point on the surface of the earth used as a means of controlling movement, a registration target for fire adjustment, or reference for location. (AAP-6)</p>	<p style="text-align: center;">ANCHOR POINT</p>		<p style="text-align: center;"> </p>
<p>Centre of Main Effort</p>	<p style="text-align: center;">CENTRE POINT</p>	<p><u>Anchor Points.</u> This graphic requires one anchor point. The centre point defines the centre of the symbol. <u>Size/Shape.</u> Static. <u>Orientation.</u> The graphic is typically centred over the desired location. Note: For the Centre of Main effort, the symbol can be rotated so that the lines at the top of the symbol are oriented toward the point of main effort.</p>	

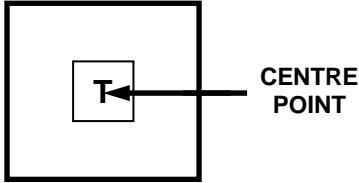
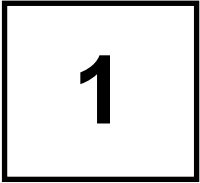
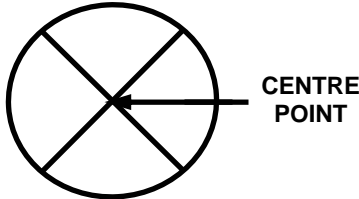
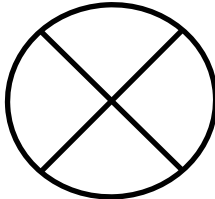
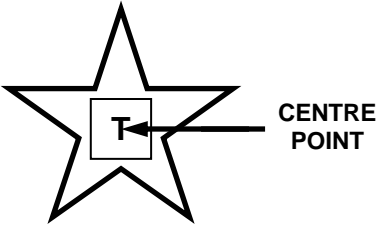

Table 7-4. Command and Control Measure Symbols.			
CONTROL MEASURE	TEMPLATE	DRAW RULES	EXAMPLE
<p>Contact Point In land warfare, a point on the terrain, easily identifiable, where two or more units are required to make contact. (AAP-6)</p>			
<p>Coordinating Point Designated point at which, in all types of combat, adjacent units/formations must make contact for purposes of control and coordination. (AAP-6)</p>			
<p>Decision Point A point in space and time, identified during the planning process, where it is anticipated that the commander must make a decision concerning a specific course of action.</p>			

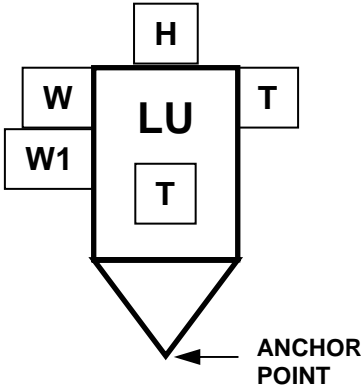
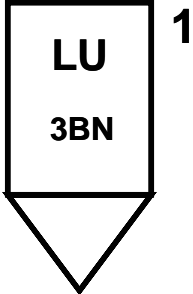
Table 7-4. Command and Control Measure Symbols.			
<i>CONTROL MEASURE</i>	<i>TEMPLATE</i>	<i>DRAW RULES</i>	<i>EXAMPLE</i>
<p>Linkup Point A point where two infiltrating elements in the same or different infiltration lanes are scheduled to meet to consolidate before proceeding with their missions.</p>	 <p>The diagram shows a central inverted triangle with a square box at its top vertex. Inside the triangle is a square box containing the letters 'LU' and another square box containing the letter 'T'. To the left of the triangle, there are two square boxes: one containing 'W' and one containing 'W1'. To the right of the triangle, there is one square box containing the letter 'T'. An arrow points to the bottom vertex of the triangle, labeled 'ANCHOR POINT'.</p>	<p><u>Anchor Points.</u> This graphic requires one anchor point. The point defines the tip of the inverted cone. <u>Size/Shape.</u> Static. <u>Orientation.</u> The graphic will typically be oriented upright, as shown in the example to the right, but will be rotated in 90 degree increments .</p>	 <p>The diagram shows a square box containing the letters 'LU' and '3BN' stacked vertically. To the right of the box is a superscript '1'. Below the box is an inverted triangle pointing downwards.</p>

Table 7-4. Command and Control Measure Symbols.			
<i>CONTROL MEASURE</i>	<i>TEMPLATE</i>	<i>DRAW RULES</i>	<i>EXAMPLE</i>
<p>Passage Point A specifically designated place where the passing units will pass through the stationary unit.</p>			<p><i>Note: The symbols that have been coloured grey are used to help explain how the control measure is used, but they are not a part of the control measure.</i></p> <p>120700ZMAY08- 120900ZMAY08</p>
<p>Point of Interest</p>			

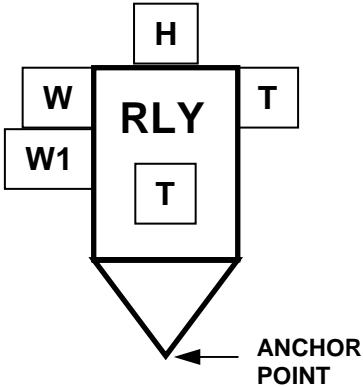
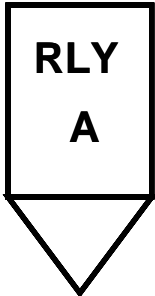
Table 7-4. Command and Control Measure Symbols.			
<i>CONTROL MEASURE</i>	<i>TEMPLATE</i>	<i>DRAW RULES</i>	<i>EXAMPLE</i>
<p>Rally Point An easily identifiable point on the ground at which units can reassemble and reorganize if they become dispersed.</p>	 <p>The diagram shows a central shield-shaped symbol with a downward-pointing triangle at the bottom. The shield contains the letters 'RLY' and a smaller box containing 'T'. Surrounding the shield are several boxes: 'H' above, 'W' to the left, 'W1' to the left of 'W', and 'T' to the right. An arrow points to the bottom vertex of the triangle with the label 'ANCHOR POINT'.</p>		<p><i>Note: The symbols that have been coloured grey are used to help explain how the control measure is used, but they are not a part of the control measure.</i></p> <div style="text-align: center;">  <p>The diagram shows a shield-shaped symbol with a downward-pointing triangle at the bottom. Inside the shield, the letters 'RLY' are positioned above the letter 'A'.</p> </div>

Table 7-4. Command and Control Measure Symbols.			
<i>CONTROL MEASURE</i>	<i>TEMPLATE</i>	<i>DRAW RULES</i>	<i>EXAMPLE</i>
<p>Release Point In road movements, a well defined point on a route at which the elements composing a column return under the authority of their respective commanders, each one of these elements continuing its movement towards its own appropriate destination. (AAP-6)</p>			

Table 7-4. Command and Control Measure Symbols.			
<i>CONTROL MEASURE</i>	<i>TEMPLATE</i>	<i>DRAW RULES</i>	<i>EXAMPLE</i>
<p>Start Point A well defined point on a route at which a movement of vehicles begins to be under the control of the commander of this movement. It is at this point that the column is formed by the successive passing, at an appointed time, of each of the elements composing the column. In addition to the principal start point of a column there may be secondary start points for its different elements. (AAP-6)</p>			<p><i>Note: The symbols that have been coloured grey are used to help explain how the control measure is used, but they are not a part of the control measure.</i></p> <p style="text-align: center;">060630ZJUN07</p> <div style="text-align: center;"> </div>

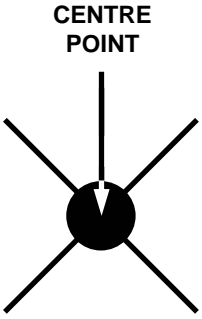
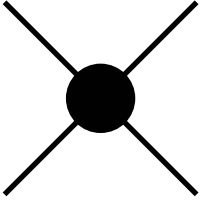
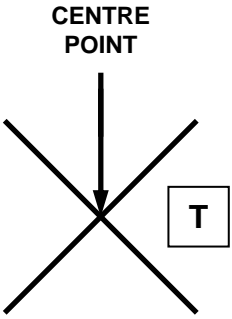
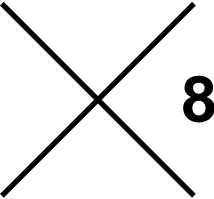
Table 7-4. Command and Control Measure Symbols.			
CONTROL MEASURE	TEMPLATE	DRAW RULES	EXAMPLE
Special Point	<p style="text-align: center;">CENTRE POINT</p> 		
<p>Waypoint A designated point or series of points loaded and stored in a global positioning system or other electronic navigational aid system to facilitate movement.</p>	<p style="text-align: center;">CENTRE POINT</p> 	<p><u>Anchor Points.</u> This graphic requires one anchor point. The centre point defines the centre of the symbol. <u>Size/Shape.</u> Static. <u>Orientation.</u> The graphic is typically centred over the desired location.</p>	

Table 7-4. Command and Control Measure Symbols.			
CONTROL MEASURE	TEMPLATE	DRAW RULES	EXAMPLE
Lines			
Light Line A designated line forward of which vehicles are required to use black-out lights at night. (AAP-6)			
Areas			
Airfield Zone	<p>Note: The Field "H" for this symbol includes type of airfield, length of runway and other pertinent information.</p>	<p><u>Anchor Points.</u> This graphic requires at least three anchor points to define the boundary of the area. Add as many points as necessary to accurately reflect the area's size and shape.</p> <p><u>Size/Shape.</u> Determined by the anchor points.</p> <p><u>Orientation.</u> Not applicable.</p>	

Manoeuvre

Manoeuvre Control Measure Symbols

0710. Manoeuvre is the employment of forces on the battlefield through movement in combination with fire, or fire potential, to achieve a position of advantage in respect to the enemy in order to accomplish the mission.

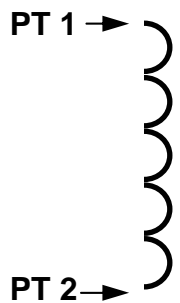
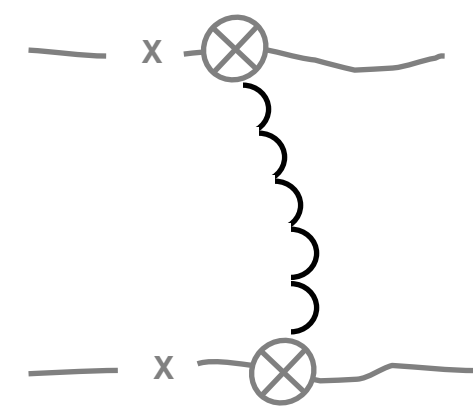
Table 7-5. Manoeuvre Control Measure Symbols.			
<i>CONTROL MEASURE</i>	<i>TEMPLATE</i>	<i>DRAW RULES</i>	<i>EXAMPLE</i>
<p>Forward Line of Troops</p> <p>A line which indicates the most forward positions of forces in any kind of military operation at a specific time.</p>			
Friendly Present		<p>Anchor Points. This graphic requires at least two points, points 1 and 2, to define the line. Additional points can be defined to extend the line.</p> <p>Size/Shape. The first and last anchor points determine the length of the line. The end-of line information will typically be posted at the ends of the line as it is displayed on the screen.</p> <p>Orientation. Orientation is determined by the order in which the anchor points are entered.</p>	

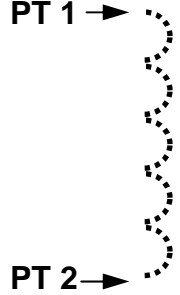
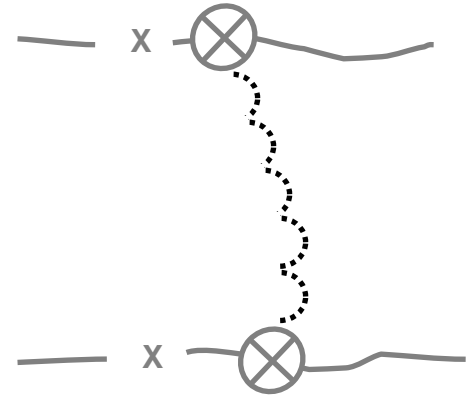
Table 7-5. Manoeuvre Control Measure Symbols.			
<i>CONTROL MEASURE</i>	<i>TEMPLATE</i>	<i>DRAW RULES</i>	<i>EXAMPLE</i> <i>Note: The symbols that have been coloured grey are used to help explain how the control measure is used, but they are not a part of the control measure.</i>
Friendly Planned or On Order	<p>PT 1 →</p>  <p>PT 2 →</p>		

Table 7-5. Manoeuvre Control Measure Symbols.			
CONTROL MEASURE	TEMPLATE	DRAW RULES	EXAMPLE
Enemy Known			

Table 7-5. Manoeuvre Control Measure Symbols.			
<i>CONTROL MEASURE</i>	<i>TEMPLATE</i>	<i>DRAW RULES</i>	<i>EXAMPLE</i>
Enemy Suspected or Templated			<p><i>Note: The symbols that have been coloured grey are used to help explain how the control measure is used, but they are not a part of the control measure.</i></p>

Table 7-5. Manoeuvre Control Measure Symbols.			
<i>CONTROL MEASURE</i>	<i>TEMPLATE</i>	<i>DRAW RULES</i>	<i>EXAMPLE</i>
<p>Line of Contact A general trace delineating the locations where two opposing forces are engaged.</p>	<p>The line of contact symbol is created when both the friendly and enemy forward line of troops symbols are displayed.</p>		<p><i>Note: The symbols that have been coloured grey are used to help explain how the control measure is used, but they are not a part of the control measure.</i></p>
<p>Phase Line A line utilized for control and coordination of military operations, usually a terrain feature extending across the zone of action. (AAP-6)</p>		<p>Anchor Points. This graphic requires at least two points, points 1 and 2, to define the line. Additional points can be defined to extend the line. Size/Shape. The first and last anchor points determine the length of the line. The end-of line information will typically be posted at the ends of the line as it is displayed on the screen. Orientation. Orientation is determined by the anchor points.</p>	

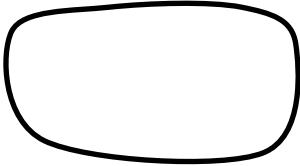
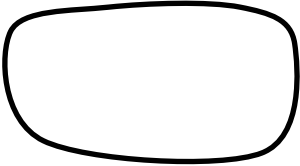
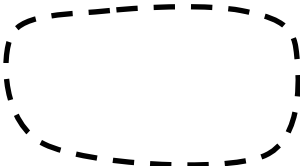
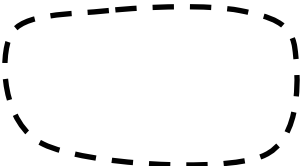
Table 7-5. Manoeuvre Control Measure Symbols.			
<i>CONTROL MEASURE</i>	<i>TEMPLATE</i>	<i>DRAW RULES</i>	<i>EXAMPLE</i> <i>Note: The symbols that have been coloured grey are used to help explain how the control measure is used, but they are not a part of the control measure.</i>
Areas			
Friendly Area		<u>Anchor Points.</u> This graphic requires at least three anchor points to define the boundary of the area. Add as many points as necessary to accurately reflect the area's size and shape. <u>Size/Shape.</u> Determined by the anchor points. The information field should be moveable within the area. <u>Orientation.</u> Not applicable.	
Friendly Planned or On Order Area			

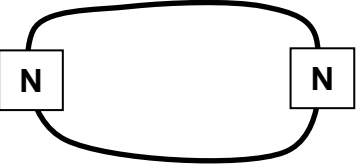
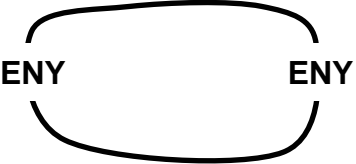
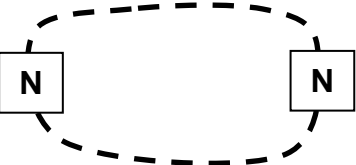
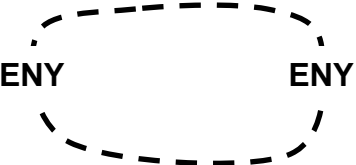
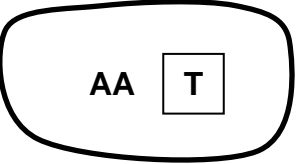

Table 7-5. Manoeuvre Control Measure Symbols.			
CONTROL MEASURE	TEMPLATE	DRAW RULES	EXAMPLE <i>Note: The symbols that have been coloured grey are used to help explain how the control measure is used, but they are not a part of the control measure.</i>
Enemy Known or Confirmed Area			
Enemy Suspected Area			
Assembly Area (AA) An area in which a command is assembled preparatory to further action.		<u>Anchor Points.</u> This graphic requires at least three anchor points to define the boundary of the area. Add as many points as necessary to accurately reflect the area's size and shape. <u>Size/Shape.</u> Determined by the anchor points. The	

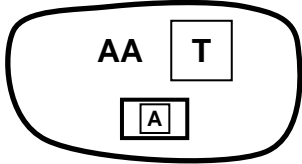
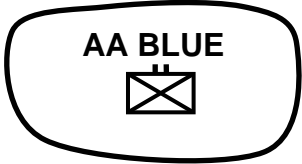
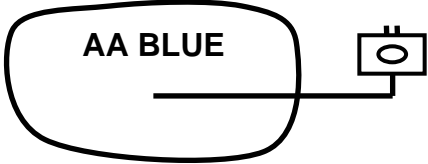
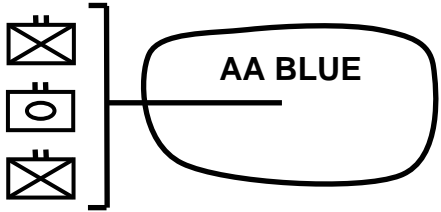
Table 7-5. Manoeuvre Control Measure Symbols.			
<i>CONTROL MEASURE</i>	<i>TEMPLATE</i>	<i>DRAW RULES</i>	<i>EXAMPLE</i>
Occupied Assembly Area		information field should be moveable within the area. <u>Orientation</u> . Not applicable.	
Occupied Assembly Area with Offset Unit			
Occupied Assembly Area with Offset Units			

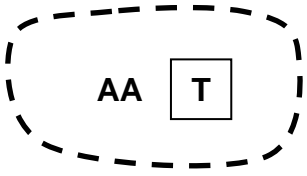

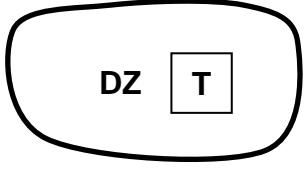

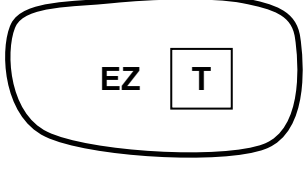

Table 7-5. Manoeuvre Control Measure Symbols.			
CONTROL MEASURE	TEMPLATE	DRAW RULES	EXAMPLE <i>Note: The symbols that have been coloured grey are used to help explain how the control measure is used, but they are not a part of the control measure.</i>
Proposed or On Order Assembly Area			
Drop Zone (DZ) A specified area upon which airborne troops, equipment, or supplies are airdropped. (AAP-6)		Anchor Points. This graphic requires at least three anchor points to define the boundary of the area. Add as many points as necessary to accurately reflect the area's size and shape. Size/Shape. Determined by the anchor points. The information field should be moveable within the area. Orientation. Not applicable.	
Extraction Zone (EZ) A specified drop zone used for the delivery of supplies and/or equipment by means of an extraction technique from an aircraft flying very close to the ground. (AAP-6)			

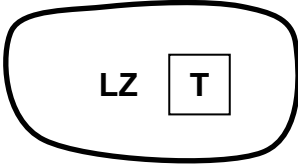

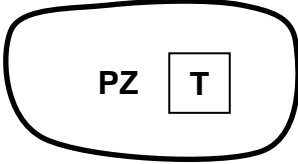

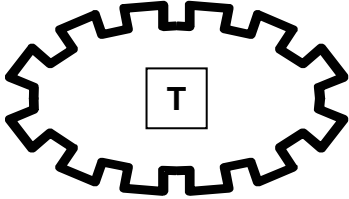

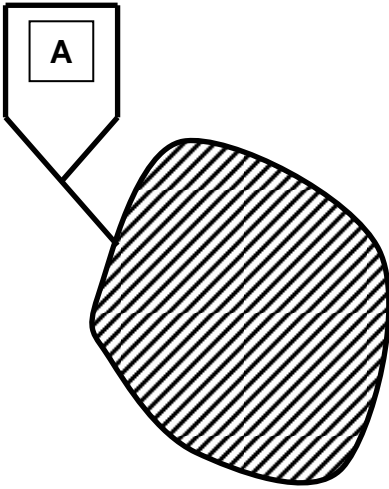
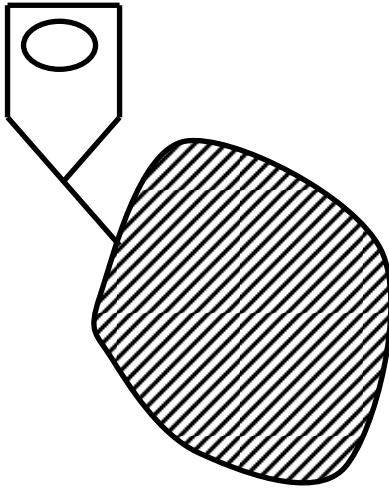
Table 7-5. Manoeuvre Control Measure Symbols.			
CONTROL MEASURE	TEMPLATE	DRAW RULES	EXAMPLE <i>Note: The symbols that have been coloured grey are used to help explain how the control measure is used, but they are not a part of the control measure.</i>
Landing Zone (LZ) A specified zone used for the landing of aircraft on land, water or deck. (AAP-6)			
Pickup Zone (PZ) A geographic area used to pick up troops or equipment by helicopter.			
Fortified Area		Anchor Points. This graphic requires at least three anchor points to define the boundary of the area. Add as many points as necessary to accurately reflect the area's size and shape. 2. Size/Shape. Determined by the anchor points. 3. Orientation. Not applicable.	

Table 7-5. Manoeuvre Control Measure Symbols.			
<i>CONTROL MEASURE</i>	<i>TEMPLATE</i>	<i>DRAW RULES</i>	<i>EXAMPLE</i>
Limited Access Area		<p><u>Anchor Points.</u> The area graphic requires at least three anchor points to define the boundary of the area. Add as many points as necessary to accurately reflect the area's size and shape. The LAA point symbol requires one anchor point and is connected to the area graphic with a straight line.</p> <p><u>Size/Shape.</u> Determined by the anchor points. The information field should be moveable within the area.</p> <p><u>Orientation.</u> The LAA point symbol will be oriented upright, as shown in the example to the right,</p>	<p><i>Note: The symbols that have been coloured grey are used to help explain how the control measure is used, but they are not a part of the control measure.</i></p> 

Defensive Manoeuvre

0711. Defensive operations defeat an enemy attack, buy time, economize forces, or develop conditions favourable for offensive operations.

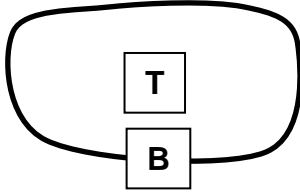
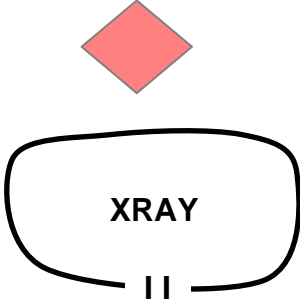
Table 7-6. Defensive Control Measure Symbols.			
CONTROL MEASURE	TEMPLATE	DRAW RULES	EXAMPLE
<i>Note: The symbols that have been coloured grey are used to help explain how the control measure is used, but they are not a part of the control measure.</i>			
Areas			
<p>Battle Position A defensive location oriented on a likely enemy avenue of approach.</p>		<p>Anchor Points. This graphic requires at least three anchor points to define the boundary of the area. Add as many points as necessary to accurately reflect the area's size and shape.</p> <p>Size/Shape. Determined by the anchor points. The information field should be moveable and scalable within the area.</p> <p>Orientation. The side opposite Field B (Echelon) faces toward the hostile force.</p>	

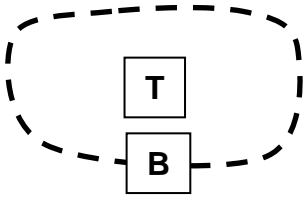
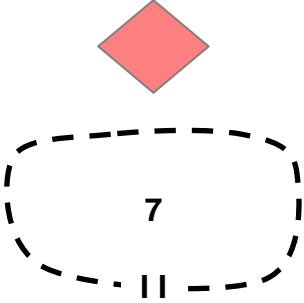
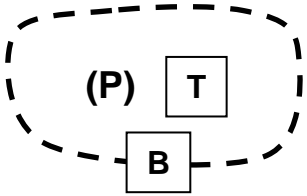
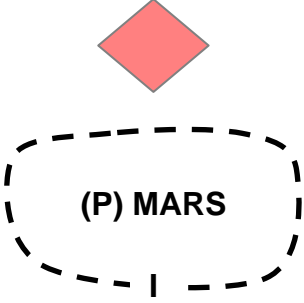
Table 7-6. Defensive Control Measure Symbols.			
CONTROL MEASURE	TEMPLATE	DRAW RULES	EXAMPLE <i>Note: The symbols that have been coloured grey are used to help explain how the control measure is used, but they are not a part of the control measure.</i>
Battle Position Planned			
Battle Position Prepared (P) but not Occupied			

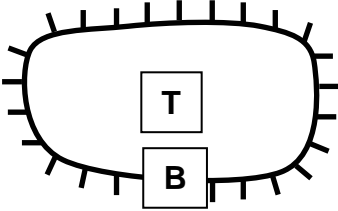
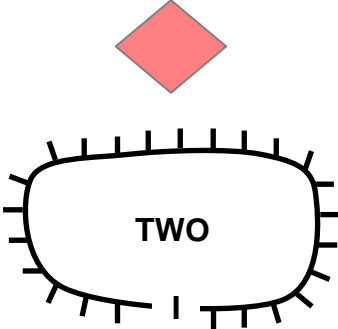
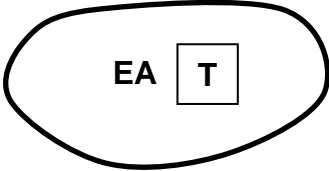
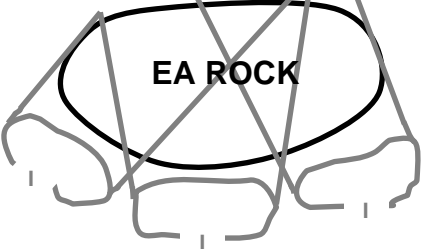
Table 7-6. Defensive Control Measure Symbols.			
<i>CONTROL MEASURE</i>	<i>TEMPLATE</i>	<i>DRAW RULES</i>	<i>EXAMPLE</i>
<p>Strong Point A key point in a defensive position, usually strongly fortified and heavily armed with automatic weapons, around which other positions are grouped for its protection. (AAP-6)</p>			<p><i>Note: The symbols that have been coloured grey are used to help explain how the control measure is used, but they are not a part of the control measure.</i></p> 
<p>Engagement Area (EA) An area where the commander intends to contain and destroy an enemy force with the massed effects of all available weapons and supporting systems.</p>		<p><u>Anchor Points.</u> This graphic requires at least three anchor points to define the boundary of the area. Add as many points as necessary to accurately reflect the area's size and shape.</p> <p><u>Size/Shape.</u> Determined by the anchor points. The information field should be moveable within the area.</p> <p><u>Orientation.</u> Not applicable.</p>	

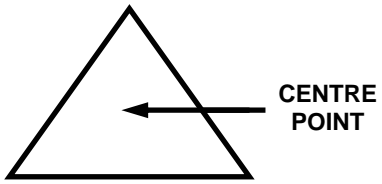
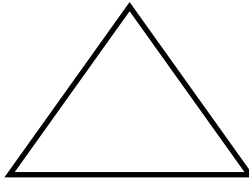
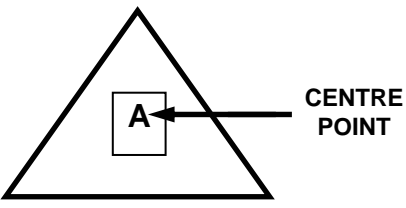
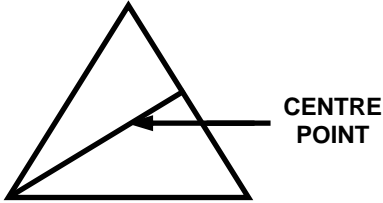
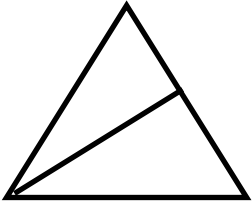
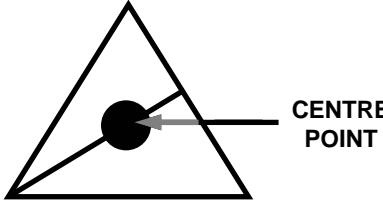
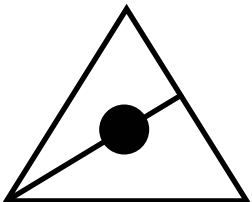
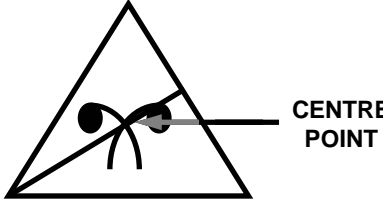
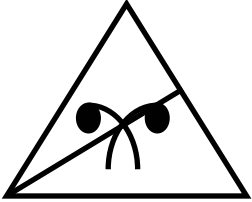
Table 7-6. Defensive Control Measure Symbols.			
<i>CONTROL MEASURE</i>	<i>TEMPLATE</i>	<i>DRAW RULES</i>	<i>EXAMPLE</i>
Observation Post /Outpost			
A position from which military observations are made, or fire directed and adjusted, and which possesses appropriate communications; may be airborne.			
Observation Post /Outpost (Unspecified)		<p><u>Anchor Points.</u> This graphic requires one anchor point. The centre point defines the centre of the graphic.</p> <p><u>Size/Shape.</u> Static.</p> <p><u>Orientation.</u> The graphic is typically centred over the desired location.</p>	
Observation Post /Outpost (Specified)			Examples follow.

Table 7-6. Defensive Control Measure Symbols.			
CONTROL MEASURE	TEMPLATE	DRAW RULES	EXAMPLE
Reconnaissance Outpost			
Forward Observer Outpost			
CBRN Observation Outpost			

7-40



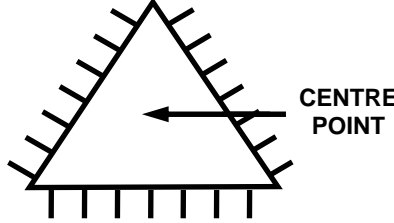
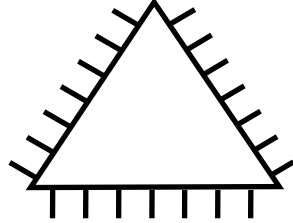
Table 7-6. Defensive Control Measure Symbols.			
<i>CONTROL MEASURE</i>	<i>TEMPLATE</i>	<i>DRAW RULES</i>	<i>EXAMPLE</i> <i>Note: The symbols that have been coloured grey are used to help explain how the control measure is used, but they are not a part of the control measure.</i>
Sensor Outpost/Listening Post			
Combat Outpost			

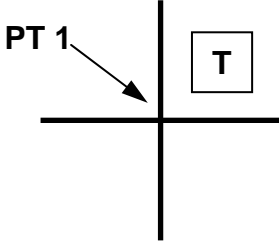
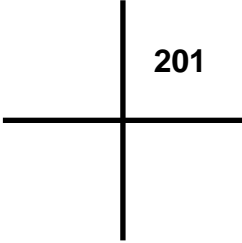
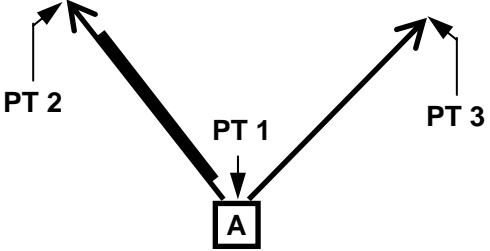
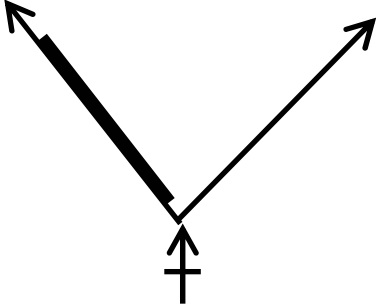
Table 7-6. Defensive Control Measure Symbols.			
<i>CONTROL MEASURE</i>	<i>TEMPLATE</i>	<i>DRAW RULES</i>	<i>EXAMPLE</i>
<p>Target Reference Point An easily recognizable point on the ground (either natural or manmade) used to initiate, distribute, and control fires. Target reference points (TRPs) can also designate the centre of an area where the commander plans to distribute or converge the fires of all his weapons rapidly. They are used by task force and below, and can further delineate sectors of fire within an engagement area. TRPs are designated using the standard target symbol and numbers issued by the fire support officer. Once designated, TRPs also constitute indirect fire targets.</p>		<p><u>Anchor Points.</u> This graphic requires one anchor point. The centre point defines the centre of the graphic. <u>Size/Shape.</u> Static. <u>Orientation.</u> The graphic is typically centred over the desired location.</p>	

Table 7-6. Defensive Control Measure Symbols.			
<i>CONTROL MEASURE</i>	<i>TEMPLATE</i>	<i>DRAW RULES</i>	<i>EXAMPLE</i>
<p>Forward Edge of the Battle Area The foremost limits of a series of areas in which ground combat units are deployed, excluding the areas in which the covering or screening forces are operating, designated to coordinate fire support, the positioning of forces or the manoeuvre of units. (AAP-6)</p>		<p>Anchor Points. This graphic requires at least two points, points 1 and 2, to define the line. Additional points can be defined to extend the line. Size/Shape. The first and last anchor points determine the length of the line. The end-of line information will typically be posted at the ends of the line as it is displayed on the screen. Orientation. Orientation is determined by the order in which the anchor points are entered.</p>	<p><i>Note: The symbols that have been coloured grey are used to help explain how the control measure is used, but they are not a part of the control measure.</i></p>
<p>Proposed or On Order Forward Edge of the Battle Area</p>			

Table 7-6. Defensive Control Measure Symbols.			
<i>CONTROL MEASURE</i>	<i>TEMPLATE</i>	<i>DRAW RULES</i>	<i>EXAMPLE</i>
Principal Direction of Fire		<p><u>Anchor Points.</u> This symbol requires three anchor points. Point 1 defines the vertex of the graphic. Points 2 and 3 define the tips of the arrowheads.</p> <p><u>Size/Shape.</u> The length and orientation of the arrows can vary independently.</p> <p><u>Orientation.</u> Orientation is determined by the anchor points. The arrowheads may touch other graphics that define the limits of the task. The tactical symbol indicator is centred over point 1.</p>	<p><i>Note: The symbols that have been coloured grey are used to help explain how the control measure is used, but they are not a part of the control measure.</i></p> 

Offensive Manoeuvre

0712. Offensive operations aim at destroying or defeating an enemy.

Table 7-7. Offensive Control Measure Symbols.			
<i>CONTROL MEASURE</i>	<i>TEMPLATE</i>	<i>DRAW RULES</i>	<i>EXAMPLE</i>
Axis of Advance			
A line of advance assigned for purposes of control; often a road or a group of roads, or a designated series of locations, extending in the direction of the enemy.			
Friendly Airborne/Aviation		<p>Anchor Points. The graphic requires N anchor points, where N is between 3 and 50. Point 1 defines the tip of the arrowhead. Point N-1 defines the rear of the symbol. Point N defines the back of the arrowhead. Anchor points are numbered sequentially beginning with point number one (1), in increments of one (1).</p> <p>2. Size/Shape. Points 1 through N-1 and 2 determine the graphic's centreline and Point N determines the width. The crossover point on the graphic shall occur between Points 1 and 2.</p> <p>3. Orientation. The arrowhead typically points toward enemy forces.</p>	<p>Airborne</p>

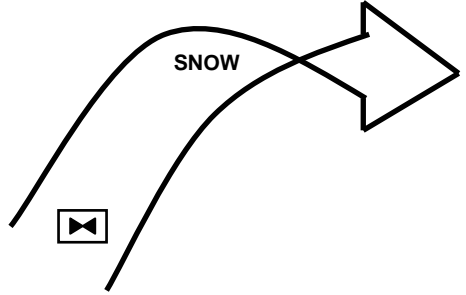
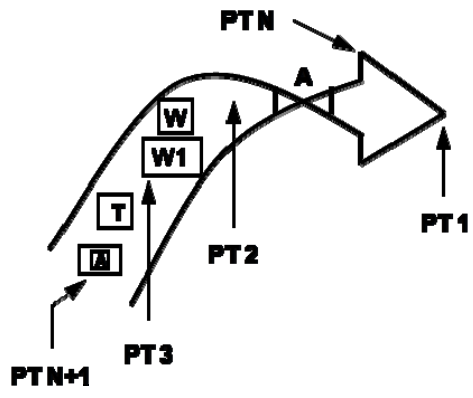
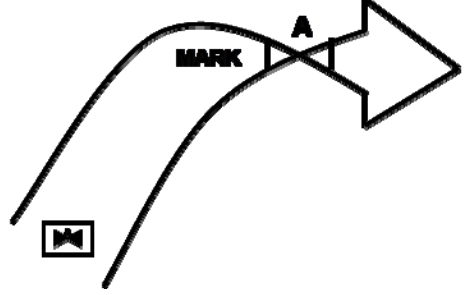
Table 7-7. Offensive Control Measure Symbols.			
<i>CONTROL MEASURE</i>	<i>TEMPLATE</i>	<i>DRAW RULES</i>	<i>EXAMPLE</i>
			<p><i>Note: The symbols that have been coloured grey are used to help explain how the control measure is used, but they are not a part of the control measure.</i></p> <p>Aviation</p> 
Attack Helicopter			

Table 7-7. Offensive Control Measure Symbols.			
<i>CONTROL MEASURE</i>	<i>TEMPLATE</i>	<i>DRAW RULES</i>	<i>EXAMPLE</i>
<p>Main Attack The principal attack or effort into which the commander throws the full weight of the offensive power at his disposal. (AAP-6)</p>		<p><u>Anchor Points.</u> The graphic requires N anchor points, where N is between 3 and 50. Point 1 defines the tip of the arrowhead. Point N-1 defines the rear of the symbol. Point N defines the back of the arrowhead. Anchor points are numbered sequentially beginning with point number one (1), in increments of one (1). <u>Size/Shape.</u> Points 1 through N-1 and 2 determine the graphic's centreline and Point N</p>	<p><i>Note: The symbols that have been coloured grey are used to help explain how the control measure is used, but they are not a part of the control measure.</i></p>

Table 7-7. Offensive Control Measure Symbols.			
<i>CONTROL MEASURE</i>	<i>TEMPLATE</i>	<i>DRAW RULES</i>	<i>EXAMPLE</i>
<p>Supporting Attack An offensive operation carried out in conjunction with a main attack and designed to achieve one or more of the following: a. deceive the enemy; b. destroy or pin down enemy forces which could interfere with the main attack; c. control ground whose occupation by the enemy will hinder the main attack; or d. force the enemy to commit reserves prematurely or in an indecisive area. (AAP-6)</p>	<p>The template diagram shows a curved arrow pointing to the right. The arrowhead is at the top right. Along the curve, there are several points labeled PT N, PT 2, PT 1, PT 3, and PT N+1. There are also several boxes: a box labeled 'T' near PT 2, a box labeled 'W' and 'W1' near PT 1, and a box labeled 'A' near PT N+1. Arrows point from the labels to their respective symbols.</p>	<p>determines the width. Orientation. The arrowhead typically points toward enemy forces.</p>	<p>The example diagram shows a curved arrow pointing to the right, similar to the template. The arrowhead is at the top right. The word 'DAVID' is written inside the arrow. To the left of the arrow, there is a box with an 'X' inside.</p>

Table 7-7. Offensive Control Measure Symbols.			
<i>CONTROL MEASURE</i>	<i>TEMPLATE</i>	<i>DRAW RULES</i>	<i>EXAMPLE</i>
Supporting Attack Planned or On Order			<p><i>Note: The symbols that have been coloured grey are used to help explain how the control measure is used, but they are not a part of the control measure.</i></p>

Table 7-7. Offensive Control Measure Symbols.			
<i>CONTROL MEASURE</i>	<i>TEMPLATE</i>	<i>DRAW RULES</i>	<i>EXAMPLE</i>
Axis of Advance for a Feint			<p><i>Note: The symbols that have been coloured grey are used to help explain how the control measure is used, but they are not a part of the control measure.</i></p>

Table 7-7. Offensive Control Measure Symbols.			
<i>CONTROL MEASURE</i>	<i>TEMPLATE</i>	<i>DRAW RULES</i>	<i>EXAMPLE</i>
Enemy Confirmed	<p>The template diagram shows a path starting from a point labeled PT N+1, moving to a diamond symbol containing the letter 'A'. From there, the path goes to PT 3, then to PT 2, and finally to PT N. There are two curved arrows originating from the path, one above and one below, both pointing towards the right. A box labeled 'N' is placed on the path between PT 3 and PT 2.</p>		<p><i>Note: The symbols that have been coloured grey are used to help explain how the control measure is used, but they are not a part of the control measure.</i></p> <p>The example diagram shows the same path and symbols as the template, but the path, the diamond symbol, and the box labeled 'N' are highlighted in grey. The curved arrows are also highlighted in grey. The labels PT N+1, PT 3, PT 2, and PT N are not highlighted.</p>

Table 7-7. Offensive Control Measure Symbols.			
<i>CONTROL MEASURE</i>	<i>TEMPLATE</i>	<i>DRAW RULES</i>	<i>EXAMPLE</i>
Enemy Templated or Suspected			<p><i>Note: The symbols that have been coloured grey are used to help explain how the control measure is used, but they are not a part of the control measure.</i></p>
Direction of Attack			
A specific direction or route that the main attack or centre of mass of the unit will follow.			
Friendly Aviation		<p>Anchor Points. This graphic requires at least two points, points 1 and 2, to define the line. Additional points can be defined to extend and shape the line.</p> <p>Size/Shape. The first and last anchor points determine the length of the line.</p>	

Table 7-7. Offensive Control Measure Symbols.			
<i>CONTROL MEASURE</i>	<i>TEMPLATE</i>	<i>DRAW RULES</i>	<i>EXAMPLE</i>
Friendly Direction of Main Attack		Orientation. Orientation is determined by the anchor points.	
Friendly Direction of Supporting Attack			
Friendly Ground Axis Planned or On Order with Effective Date and Time (if known)			

Table 7-7. Offensive Control Measure Symbols.			
<i>CONTROL MEASURE</i>	<i>TEMPLATE</i>	<i>DRAW RULES</i>	<i>EXAMPLE</i>
Direction of Attack for a Feint			<p><i>Note: The symbols that have been coloured grey are used to help explain how the control measure is used, but they are not a part of the control measure.</i></p>
Enemy Confirmed			
Enemy Templated or Suspected			

Table 7-7. Offensive Control Measure Symbols.			
<i>CONTROL MEASURE</i>	<i>TEMPLATE</i>	<i>DRAW RULES</i>	<i>EXAMPLE</i>
Lines			
<p>Final Coordination Line A line close to the enemy position used to coordinate the lifting or shifting of supporting fires with the final deployment of manoeuvre elements.</p>		<p><u>Anchor Points.</u> This graphic requires at least two points, points 1 and 2, to define the line. Additional points can be defined to extend the line. <u>Size/Shape.</u> The first and last anchor points determine the length of the line. The end-of line information will typically be posted at the ends of the line as it is displayed on the screen. <u>Orientation.</u> Orientation is determined by the anchor points.</p>	

Table 7-7. Offensive Control Measure Symbols.			
<i>CONTROL MEASURE</i>	<i>TEMPLATE</i>	<i>DRAW RULES</i>	<i>EXAMPLE</i>
<p>Infiltration Lane A control measure that coordinates forward and lateral movement of infiltrating units and fixes fire planning responsibilities.</p>	<p>The template shows two parallel, slightly curved lines representing the boundaries of an infiltration lane. Three anchor points are marked: PT 1 at the left end of the lower line, PT 2 at the right end of the lower line, and PT 3 at the top center between the two lines. A small square box labeled 'T' is positioned in the center between the two lines.</p>	<p><u>Anchor Points.</u> This graphic requires three anchor points. Points 1 and 2 define the endpoints of the infiltration lane, and point 3 defines one side of the lane.</p> <p><u>Size/Shape.</u> Points 1 and 2 determine the centreline of the graphic, and point 3 determines the width of the infiltration lane. The rest of the graphic stays proportional to the length of the centreline.</p> <p><u>Orientation.</u> Orientation is determined by points 1 and 2.</p>	<p>The example shows the final symbol for an infiltration lane. It consists of two parallel lines with a grey zigzag symbol (representing a minefield) crossing them. The word 'GREEN' is written in bold black letters in the center between the two lines.</p>

Table 7-7. Offensive Control Measure Symbols.			
<i>CONTROL MEASURE</i>	<i>TEMPLATE</i>	<i>DRAW RULES</i>	<i>EXAMPLE</i>
<p>Limit of Advance An easily recognized terrain feature beyond which attacking elements will not advance.</p>		<p><u>Anchor Points.</u> This graphic requires at least two points, points 1 and 2, to define the line. Additional points can be defined to extend the line. <u>Size/Shape.</u> The first and last anchor points determine the length of the line. The end-of line information will typically be posted at the ends of the line as it is displayed on the screen. <u>Orientation.</u> Orientation is determined by the anchor points.</p>	<p><i>Note: The symbols that have been coloured grey are used to help explain how the control measure is used, but they are not a part of the control measure.</i></p>

Table 7-7. Offensive Control Measure Symbols.			
<i>CONTROL MEASURE</i>	<i>TEMPLATE</i>	<i>DRAW RULES</i>	<i>EXAMPLE</i>
<p>Line of Departure In land warfare, a line designated to coordinate the departure of attack elements. (AAP-6) In amphibious warfare, a suitably marked offshore coordinating line to assist assault craft to land on designated beaches at scheduled times. (AAP-6)</p>			<p><i>Note: The symbols that have been coloured grey are used to help explain how the control measure is used, but they are not a part of the control measure.</i></p>
<p>Line of Departure/Line of Contact The designation of forward friendly positions as the line of departure when opposing forces are in contact.</p>			

Table 7-7. Offensive Control Measure Symbols.			
<i>CONTROL MEASURE</i>	<i>TEMPLATE</i>	<i>DRAW RULES</i>	<i>EXAMPLE</i>
<p>Probable Line of Deployment A line selected on the ground, usually the last covered and concealed position prior to the objective and forward of the line of departure, where attacking units deploy prior to beginning an assault; it is generally used under conditions of limited visibility.</p>			<p><i>Note: The symbols that have been coloured grey are used to help explain how the control measure is used, but they are not a part of the control measure.</i></p>
Areas			
<p>Assault Position That position between the line of departure and the objective in an attack from which forces assault the objective. Ideally, it is the last covered and concealed position before reaching the objective</p>		<p><u>Anchor Points.</u> This graphic requires at least three anchor points to define the boundary of the area. Add as many points as necessary to accurately reflect the area's size and shape. <u>Size/Shape.</u> Determined by the anchor points. The information field should be moveable within the area. <u>Orientation.</u> Not applicable.</p>	

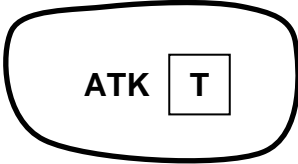

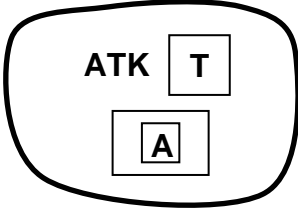

Table 7-7. Offensive Control Measure Symbols.			
CONTROL MEASURE	TEMPLATE	DRAW RULES	EXAMPLE <i>Note: The symbols that have been coloured grey are used to help explain how the control measure is used, but they are not a part of the control measure.</i>
Attack Position The last position occupied by the assault echelon before crossing the start line/line of departure. (AAP-6)			
Friendly Occupied Note: Only used if a unit must stop in the attack position. Offset indicator may also be used.			

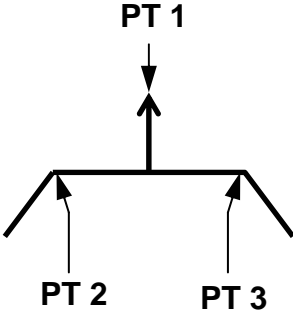
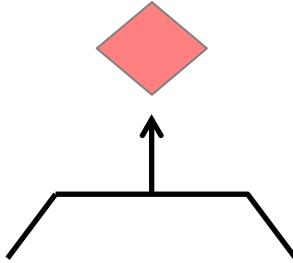
Table 7-7. Offensive Control Measure Symbols.			
<i>CONTROL MEASURE</i>	<i>TEMPLATE</i>	<i>DRAW RULES</i>	<i>EXAMPLE</i>
Attack By Fire Position		<p><u>Anchor Points.</u> This graphic requires three anchor points. Point 1 is the tip of the arrowhead. Points 2 and 3 define the endpoints of the straight line on the back side of the graphic.</p> <p><u>Size/Shape.</u> Points 2 and 3 determine the length of the straight line on the back side of the graphic. The rear of the arrow should connect to the midpoint of the line between points 2 and 3.</p> <p><u>Orientation.</u> Orientation is determined by the anchor points. The back side of the graphic encompasses the firing position, while the arrowhead typically points at the target .</p>	<p><i>Note: The symbols that have been coloured grey are used to help explain how the control measure is used, but they are not a part of the control measure.</i></p> 

Table 7-7. Offensive Control Measure Symbols.			
<i>CONTROL MEASURE</i>	<i>TEMPLATE</i>	<i>DRAW RULES</i>	<i>EXAMPLE</i>
Support by Fire Position		<p><u>Anchor Points.</u> This graphic requires four anchor points. Points 1 and 2 define the endpoints of the straight line on the back side of the graphic. Points 3 and 4 define the tips of the arrowheads.</p> <p><u>Size/Shape.</u> Points 1 and 2 determine the length of the straight line on the back side of the graphic. The rear of the arrows should connect to points 1 and 2.</p> <p><u>Orientation.</u> Orientation is determined by the anchor points. The back side of the graphic encompasses the firing position, while the arrowheads typically indicate the arc of coverage that the firing position is meant to support.</p>	<p><i>Note: The symbols that have been coloured grey are used to help explain how the control measure is used, but they are not a part of the control measure.</i></p>

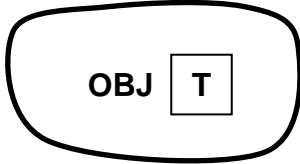
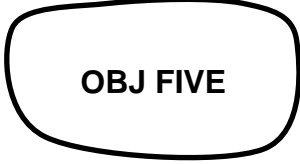
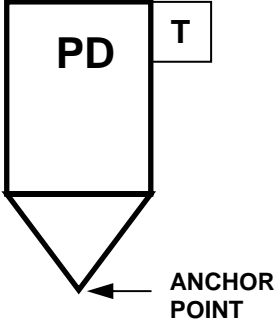
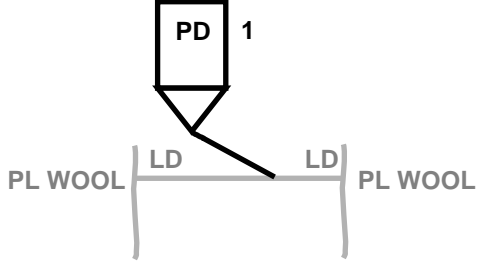
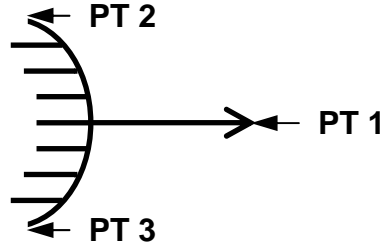
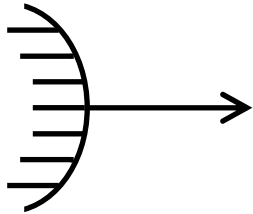
Table 7-7. Offensive Control Measure Symbols.			
CONTROL MEASURE	TEMPLATE	DRAW RULES	EXAMPLE
			<i>Note: The symbols that have been coloured grey are used to help explain how the control measure is used, but they are not a part of the control measure.</i>
<p>Objective Objective Area – A defined geographical area within which is located an objective to be captured or reached by the military forces. This area is defined by competent authority for purposes of command and control. (AAP-6)</p>		<p>Anchor Points. This graphic requires at least three anchor points to define the boundary of the area. Add as many points as necessary to accurately reflect the area's size and shape. Size/Shape. Determined by the anchor points. The information field should be moveable within the area. Orientation. Not applicable.</p>	
Points			
<p>Point of Departure A specific place where a unit will cross the line of departure.</p>		<p>Anchor Points. This graphic requires one anchor point. The point defines the tip of the inverted cone. Size/Shape. Static. Orientation. The graphic will typically be oriented upright, as shown in the example to the right.</p>	

Table 7-7. Offensive Control Measure Symbols.			
<i>CONTROL MEASURE</i>	<i>TEMPLATE</i>	<i>DRAW RULES</i>	<i>EXAMPLE</i>
<p>Ambush A surprise attack by fire from concealed positions on a moving or temporarily halted enemy.</p>		<p>Anchor Points. This graphic requires three anchor points. Point 1 is the tip of the arrowhead. Points 2 and 3 define the endpoints of the curved line on the back side of the graphic.</p> <p>2. Size/Shape. Points 2 and 3 determine the length of the curved line on the back side of the graphic. The rear of the arrow should connect to the midpoint of the line between points 2 and 3.</p> <p>3. Orientation. Orientation is determined by the anchor points. The back side of the graphic encompasses the ambush position with the arrowhead shaft positioned at the centre of mass, while the arrowhead points in the direction of fire.</p>	<p><i>Note: The symbols that have been coloured grey are used to help explain how the control measure is used, but they are not a part of the control measure.</i></p> 

Manoeuvre

0713. Manoeuvre is the employment of forces on the battlefield through movement in combination with fire, or fire potential, to achieve a position of advantage in respect to the enemy in order to accomplish the mission.

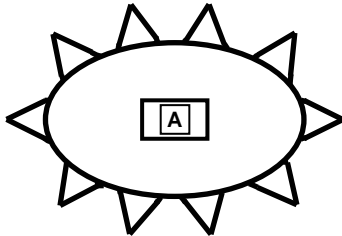
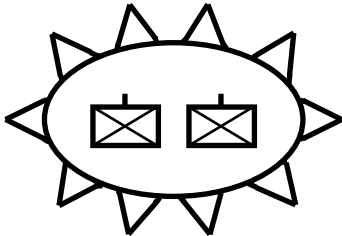
Table 7-8. Manoeuvre Control Measure Symbols.			
<i>CONTROL MEASURE</i>	<i>TEMPLATE</i>	<i>DRAW RULES</i>	<i>EXAMPLE</i>
<p><i>Note: The symbols that have been coloured grey are used to help explain how the control measure is used, but they are not a part of the control measure.</i></p>			
Areas			
Encirclement			
The loss of freedom of manoeuvre resulting from enemy control of all ground routes of evacuation and reinforcement.			
Friendly		<p><u>Anchor Points.</u> This graphic requires at least three anchor points to define the boundary of the area. Add as many points as necessary to accurately reflect the area's size and shape.</p> <p><u>Size/Shape.</u> Determined by the anchor points.</p> <p><u>Orientation.</u> Not applicable.</p>	

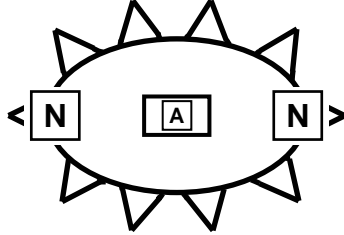
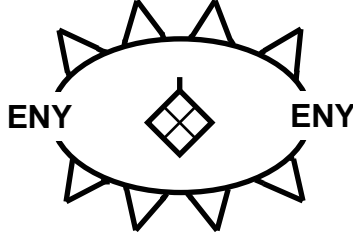
Table 7-8. Manoeuvre Control Measure Symbols.			
<i>CONTROL MEASURE</i>	<i>TEMPLATE</i>	<i>DRAW RULES</i>	<i>EXAMPLE</i> <i>Note: The symbols that have been coloured grey are used to help explain how the control measure is used, but they are not a part of the control measure.</i>
Enemy			

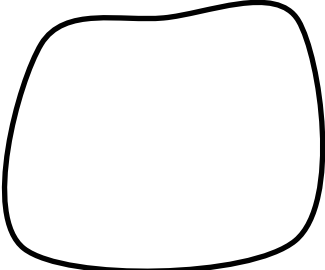
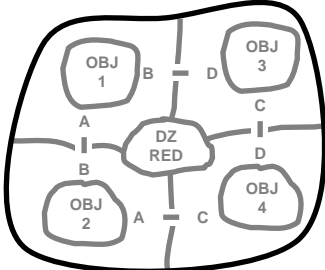
Table 7-8. Manoeuvre Control Measure Symbols.			
<i>CONTROL MEASURE</i>	<i>TEMPLATE</i>	<i>DRAW RULES</i>	<i>EXAMPLE</i>
Lines			
<p>Airhead Line A line denoting the limits of the objective area for an airborne assault.</p> <p>Airhead A designated area in a hostile or threatened territory which, when seized and held, ensures the continuous air landing of troops and materiel and provides the manoeuvre space necessary for projected operations. Normally it is the area seized in the assault phase of an airborne operation. (AAP-6)</p>	 <p style="text-align: center;">AIRHEAD LINE</p>	<p><u>Anchor Points.</u> This graphic requires at least three anchor points to define the boundary of the area. Add as many points as necessary to accurately reflect the area's size and shape.</p> <p><u>Size/Shape.</u> Determined by the anchor points.</p> <p><u>Orientation.</u> Not applicable.</p>	 <p style="text-align: center;">AIRHEAD LINE</p>

Table 7-8. Manoeuvre Control Measure Symbols.			
<i>CONTROL MEASURE</i>	<i>TEMPLATE</i>	<i>DRAW RULES</i>	<i>EXAMPLE</i>
<p>Bridgehead Line (BL) The limit of the objective area in the development of the bridgehead. (AAP-6)</p>		<p><u>Anchor Points.</u> This graphic requires at least two points, points 1 and 2, to define the line. Additional points can be defined to extend the line . <u>Size/Shape.</u> The first and last anchor points determine the length of the line. The end-of line information will typically be posted as it is displayed In the template. <u>Orientation.</u> Orientation is determined by the anchor points.</p>	

Table 7-8. Manoeuvre Control Measure Symbols.			
<i>CONTROL MEASURE</i>	<i>TEMPLATE</i>	<i>DRAW RULES</i>	<i>EXAMPLE</i>
<p>Holding Line (HL) In retrograde river crossing operations, the outer limit of the area established between the enemy and the water obstacle to preclude direct and observed indirect fires into the crossings.</p>			<p><i>Note: The symbols that have been coloured grey are used to help explain how the control measure is used, but they are not a part of the control measure.</i></p>

Table 7-8. Manoeuvre Control Measure Symbols.			
<i>CONTROL MEASURE</i>	<i>TEMPLATE</i>	<i>DRAW RULES</i>	<i>EXAMPLE</i>
<p>Release Line Phase line used in river crossing operations that delineates a change in the headquarters controlling movement.</p>			<p><i>Note: The symbols that have been coloured grey are used to help explain how the control measure is used, but they are not a part of the control measure.</i></p>

Airspace

Airspace Control Measures (Means)

0714. Airspace control measures (means) are control measures used by NATO to segregate, control and/or reserve airspace for allied operations. Airspace control means are used to enhance the effectiveness of accomplishing the joint force commander's objectives; to prevent mutual interference; to facilitate air defence identification; to prevent fratricide; and to help in safely accommodating the flow of all air traffic in the area of operations. In general terms, airspace control means can be broken down into the following groups: points, lines, air corridors and routes, and areas.

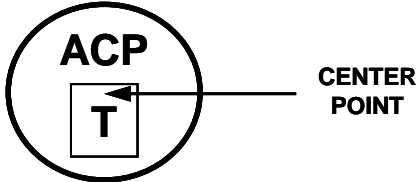

Table 7-9. Airspace Control Means.			
<i>CONTROL MEASURE</i>	<i>TEMPLATE</i>	<i>DRAW RULES</i>	<i>EXAMPLE</i>
Points			
Air Control Point		<p><u>Anchor Points.</u> This graphic requires one anchor point. The centre point defines the centre of the graphic.</p> <p><u>Size/Shape.</u> Static.</p> <p><u>Orientation.</u> The graphic is typically centred over the desired location.</p>	

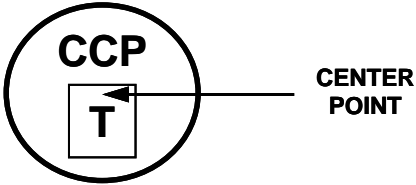
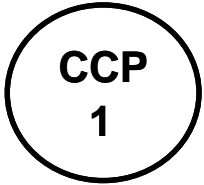
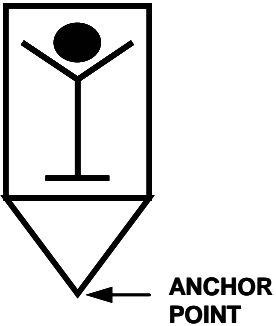
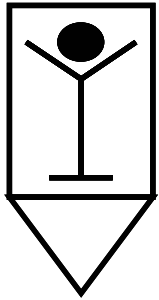
Table 7-9. Airspace Control Means.			
<i>CONTROL MEASURE</i>	<i>TEMPLATE</i>	<i>DRAW RULES</i>	<i>EXAMPLE</i>
Communications Check Point			
Downed Aircrew Pick-Up Point		<p><u>Anchor Points.</u> This graphic requires one anchor point. The point defines the tip of the inverted cone.</p> <p><u>Size/Shape.</u> Static.</p> <p><u>Orientation.</u> The graphic will typically be oriented upright, as shown in the example to the right.</p>	

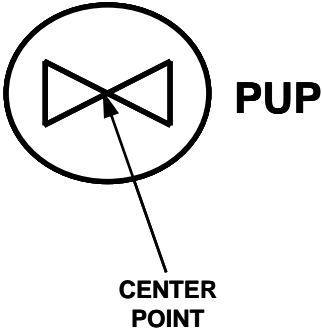
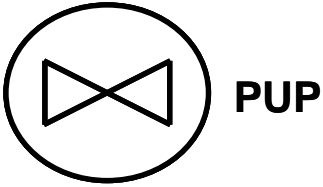


Table 7-9. Airspace Control Means.			
CONTROL MEASURE	TEMPLATE	DRAW RULES	EXAMPLE
<p>Pop-Up Point (PUP) The location at which aircraft quickly gain altitude for target acquisition and engagement.</p>		<p>Anchor Points. This graphic requires one anchor point. The centre point defines the centre of the graphic. Size/Shape. Static. Orientation. The graphic is typically centred over the desired location.</p>	<p><i>Note: The symbols that have been coloured grey are used to help explain how the control measure is used, but they are not a part of the control measure.</i></p> 
Lines			
<p>Identification, Friend-or-Foe (IFF) Off Line Line demarking where friendly aircraft en-route to targets stop emitting an IFF signal. (AJP-3.5.5)</p>		<p>Anchor Points. This graphic requires at least two points, points 1 and 2, to define the line. Additional points can be defined to extend the line. Size/Shape. The first and last anchor points determine the length of the</p>	

Table 7-9. Airspace Control Means.			
<i>CONTROL MEASURE</i>	<i>TEMPLATE</i>	<i>DRAW RULES</i>	<i>EXAMPLE</i>
<p>Identification, Friend-or-Foe (IFF) On Line Line demarking where friendly aircraft returning to friendly territory start emitting an IFF signal. (AJP-3.5.5)</p>		<p>line. <u>Orientation</u>. Orientation is determined by the anchor points.</p>	

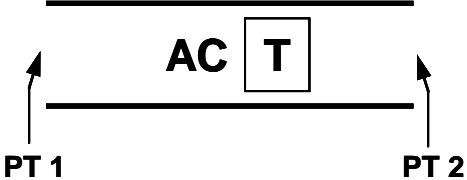

Table 7-9. Airspace Control Means.			
<i>CONTROL MEASURE</i>	<i>TEMPLATE</i>	<i>DRAW RULES</i>	<i>EXAMPLE</i>
Corridors (Areas)			
<p>Air Corridor A restricted air route of travel specified for use by friendly aircraft and established for the purpose of preventing friendly aircraft from being fired on by friendly forces. (AAP-6)</p>	<p>NAME: T WIDTH: H MIN ALT: X MAX ALT: X1 DTG START: W DTG END: W1</p> 	<p><u>Anchor Points.</u> This graphic may contain multiple segments. Each segment requires 2 anchor points. Point numbers that define the trace of the segment are sequential beginning with point 1, in increments of 1, up to a max of 99 points. Each anchor point defines the endpoint of a segment's centreline. The anchor points are Air Control Points (ACP), Communications Checkpoints (CCP) or both.</p> <p><u>Size/Shape.</u> Points 1 and 2 determine the length of a segment. The information field inside each segment should be moveable and scalable within each segment. The information box outside the graphic should be placed between points 1 and 2 in such a way it does not obscure the graphic.</p> <p><u>Orientation.</u> The anchor points determine orientation.</p>	<p>NAME: GOLD WIDTH: 400M MIN ALT: 500M MAX ALT: 4000M DTG START: 240700ZMAY08 DTG END: 280700ZMAY08</p> 

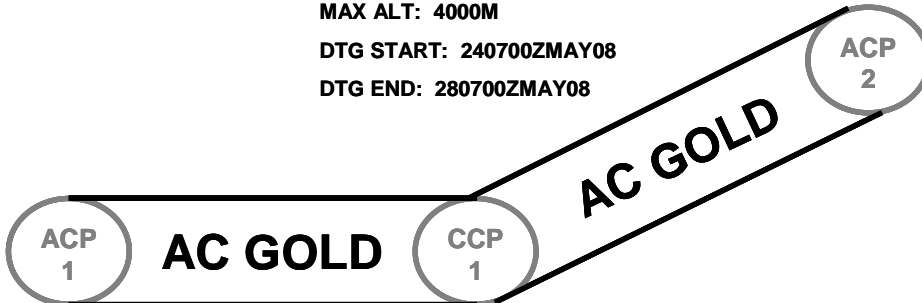
Table 7-9. Airspace Control Means.			
<i>CONTROL MEASURE</i>	<i>TEMPLATE</i>	<i>DRAW RULES</i>	<i>EXAMPLE</i>
Air Corridor with Multiple Segments		<p>NAME: GOLD WIDTH: 400M MIN ALT: 500M MAX ALT: 4000M DTG START: 240700ZMAY08 DTG END: 280700ZMAY08</p>	<p><i>Note: The symbols that have been coloured grey are used to help explain how the control measure is used, but they are not a part of the control measure.</i></p> 



Table 7-9. Airspace Control Means.			
<i>CONTROL MEASURE</i>	<i>TEMPLATE</i>	<i>DRAW RULES</i>	<i>EXAMPLE</i>
<p>Low-Level Transit Route A temporary corridor of defined dimensions established in the forward area to minimize the risk to friendly aircraft from friendly air defences or surface forces.</p>	<p> NAME: T WIDTH: H MIN ALT: X MAX ALT: X1 DTG START: W DTG END: W1 </p> 		<p> NAME: COBRA WIDTH: 100M MIN ALT: 50M MAX ALT: 1000M DTG START: 090700Z0CT08 DTG END: 091700Z0CT08 </p> 



Table 7-9. Airspace Control Means.			
<i>CONTROL MEASURE</i>	<i>TEMPLATE</i>	<i>DRAW RULES</i>	<i>EXAMPLE</i>
<p>Minimum-Risk Route A temporary route of defined dimensions recommended for use by fixed-wing platforms to route them between transit routes and the rear of the forward area and their operations areas. (AJP-3.3.5)</p>	<p> NAME: T WIDTH: H MIN ALT: X MAX ALT: X1 DTG START: W DTG END: W1 </p> 		<p> NAME: RED WIDTH: 500M MIN ALT: 1000M MAX ALT: 7000M DTG START: 110200ZSEP08 DTG END: 140300ZSEP08 </p> 

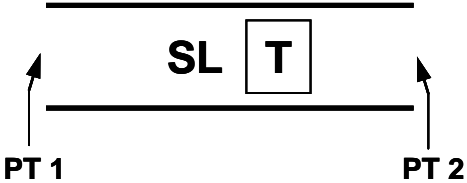

Table 7-9. Airspace Control Means.			
<i>CONTROL MEASURE</i>	<i>TEMPLATE</i>	<i>DRAW RULES</i>	<i>EXAMPLE</i>
<p>Safe Lane A bi-directional lane connecting an airbase, landing site and/or base defence zone to adjacent routes/corridors. Safe lanes may also be used to connect adjacent activated routes/corridors. (AJP-3.3.5)</p>	<p> NAME: T WIDTH: H MIN ALT: X MAX ALT: X1 DTG START: W DTG END: W1 </p> 		<p> NAME: LION WIDTH: 200M MIN ALT: 200M MAX ALT: 1000M DTG START: 240730ZFEB08 DTG END: 280900ZFEB08 </p> 



Table 7-9. Airspace Control Means.			
<i>CONTROL MEASURE</i>	<i>TEMPLATE</i>	<i>DRAW RULES</i>	<i>EXAMPLE</i>
<p>Standard Use Army Aircraft Flight Route (SAAFR) Route established below the coordination level to facilitate movement of army aviation assets in the forward area in direct support of ground operations. (AJP-3.3.5)</p>	<p>NAME: T WIDTH: H MIN ALT: X MAX ALT: X1 DTG START: W DTG END: W1</p> 	<p><u>Anchor Points.</u> This graphic may contain multiple segments. Each segment requires 2 anchor points. Each anchor point defines the endpoint of a segment's centreline. The anchor points are Air Control Points, Communications Check Points or a combination of the two. <u>Size/Shape.</u> Points 1 and 2 determine the length and width of the graphic. The information fields associated with each segment should be moveable and scalable within each segment. <u>Orientation.</u> The anchor points determine orientation.</p>	<p>NAME: BLUE WIDTH: 200M MIN ALT: 50M MAX ALT: 1000M DTG START: 260930ZMAY08 DTG END: 280700ZMAY08</p> 

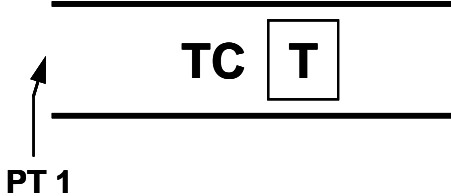

Table 7-9. Airspace Control Means.			
CONTROL MEASURE	TEMPLATE	DRAW RULES	EXAMPLE
<p>Transit Corridors Bi-directional and established to route aircraft through air defences, in the rear area where appropriate, with minimum risk.</p>	<p> NAME: T WIDTH: H MIN ALT: X MAX ALT: X1 DTG START: W DTG END: W1 </p> 		<p> NAME: KING WIDTH: 300M MIN ALT: 700M MAX ALT: 2000M DTG START: 260700ZMAR08 DTG END: 280700ZMAR08 </p> 



Table 7-9. Airspace Control Means.			
<i>CONTROL MEASURE</i>	<i>TEMPLATE</i>	<i>DRAW RULES</i>	<i>EXAMPLE</i>
<p>Unmanned Aerial Vehicle Route Airspace created specifically for unmanned aerial vehicle operations. (AJP-3.3.5)</p>	<p> NAME: T WIDTH: H MIN ALT: X MAX ALT: X1 DTG START: W DTG END: W1 </p> 		<p> NAME: DRAGON WIDTH: 400M MIN ALT: 500M MAX ALT: 4000M DTG START: 200700ZMAY08 DTG END: 210700ZMAY08 </p> 

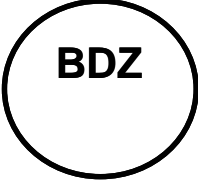

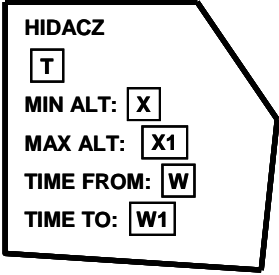
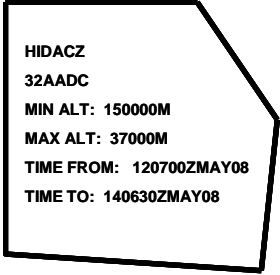
Table 7-9. Airspace Control Means.			
<i>CONTROL MEASURE</i>	<i>TEMPLATE</i>	<i>DRAW RULES</i>	<i>EXAMPLE</i>
Areas (Zones)			
<p>Base Defence Zone A zone established around airbases to enhance the effectiveness of local ground based air defence systems. (AJP 3.3.5)</p>		<p><u>Anchor Points.</u> This graphic requires at least three anchor points to define the boundary of the area. Add as many points as necessary to accurately reflect the area's size and shape. <u>Size/Shape.</u> Determined by the anchor points. The information fields should be moveable and scalable as a block within the area. <u>Orientation.</u> Not applicable.</p>	
<p>High-Density Airspace Control Zone Airspace of defined dimensions, designated by the airspace control authority, in which there is a concentrated employment of numerous and varied weapons/airspace users. (AAP-6)</p>		<p><u>Anchor Points.</u> This graphic requires at least three anchor points to define the boundary of the area. Add as many points as necessary to accurately reflect the area's size and shape. <u>Size/Shape.</u> Determined by the anchor points. The information fields should be moveable and scalable as a block within the area. <u>Orientation.</u> Not applicable.</p>	
Restricted Operations Zones			

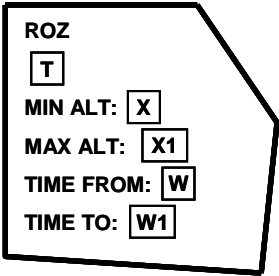
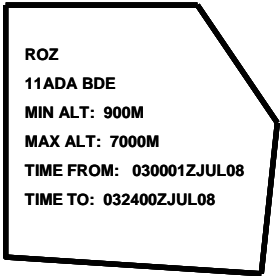
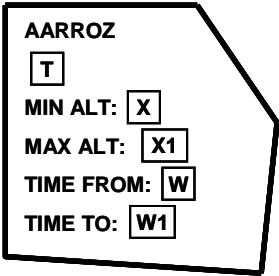

Table 7-9. Airspace Control Means.			
<i>CONTROL MEASURE</i>	<i>TEMPLATE</i>	<i>DRAW RULES</i>	<i>EXAMPLE</i>
<p>Restricted Operating Zone (ROZ) Airspace of defined dimensions, designated by the airspace control authority, in response to specific operational situations/requirements within which the operation of one or more airspace users is restricted. (AAP-6) Note: This is the definition for restricted operations area.</p>	 <p>ROZ T MIN ALT: X MAX ALT: X1 TIME FROM: W TIME TO: W1</p>	<p><u>Anchor Points.</u> This graphic requires at least three anchor points to define the boundary of the area. Add as many points as necessary to accurately reflect the area's size and shape. <u>Size/Shape.</u> Determined by the anchor points. The information fields should be moveable and scalable as a block within the area. <u>Orientation.</u> Not applicable.</p>	 <p>ROZ 11ADA BDE MIN ALT: 900M MAX ALT: 7000M TIME FROM: 030001ZJUL08 TIME TO: 032400ZJUL08</p>
<p>Air-to-Air Restricted Operations Zone (AARROZ)</p>	 <p>AARROZ T MIN ALT: X MAX ALT: X1 TIME FROM: W TIME TO: W1</p>		 <p>AARROZ ISAF MIN ALT: 100M MAX ALT: 27000M TIME FROM: 210030ZNOV07 TIME TO: 300029ZNOV07</p>

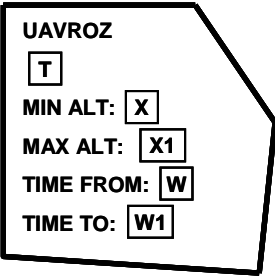

Table 7-9. Airspace Control Means.			
<i>CONTROL MEASURE</i>	<i>TEMPLATE</i>	<i>DRAW RULES</i>	<i>EXAMPLE</i>
Unmanned Aerial Vehicle Restricted Operations Zone (UAVROZ)	 <p>UAVROZ T MIN ALT: X MAX ALT: X1 TIME FROM: W TIME TO: W1</p>		<p style="text-align: center;"><i>Note: The symbols that have been coloured grey are used to help explain how the control measure is used, but they are not a part of the control measure.</i></p>  <p>UAVROZ MND(N) MIN ALT: 25M MAX ALT: 2000M TIME FROM: 190500ZDEC07 TIME TO: 262400ZDEC07</p>

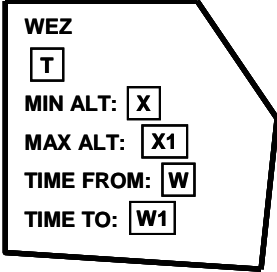

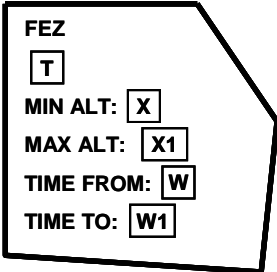
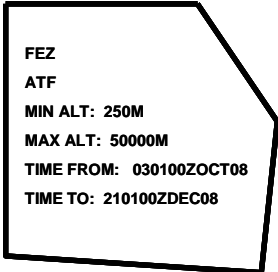
Table 7-9. Airspace Control Means.			
<i>CONTROL MEASURE</i>	<i>TEMPLATE</i>	<i>DRAW RULES</i>	<i>EXAMPLE</i>
Weapons Engagement Zones			
<p>Weapon Engagement Zone In air defence, airspace of defined dimensions within which the responsibility for engagement normally rests with a particular weapon system. (AAP-6) Note: Includes FEZ, JEZ, MEZ (LOMEZ and HIMEZ), SHORADEZ.</p>	 <p>WEZ T MIN ALT: X MAX ALT: X1 TIME FROM: W TIME TO: W1</p>	<p><u>Anchor Points.</u> This graphic requires at least three anchor points to define the boundary of the area. Add as many points as necessary to accurately reflect the area's size and shape. <u>Size/Shape.</u> Determined by the anchor points. The information fields should be moveable and scalable as a block within the area. <u>Orientation.</u> Not applicable.</p>	 <p>WEZ 21 ADA BN MIN ALT: 100M MAX ALT: 34000M TIME FROM: 040030ZJAN08 TIME TO: 040029ZJAN08</p>
<p>Fighter Engagement Zone In air defence, airspace of defined dimensions within which the responsibility for engagement normally rests with a particular weapon system. (AAP-6)</p>	 <p>FEZ T MIN ALT: X MAX ALT: X1 TIME FROM: W TIME TO: W1</p>		 <p>FEZ ATF MIN ALT: 250M MAX ALT: 50000M TIME FROM: 030100ZOCT08 TIME TO: 210100ZDEC08</p>

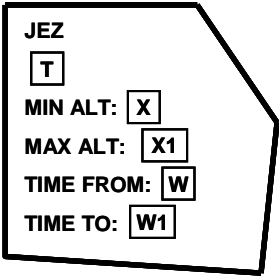
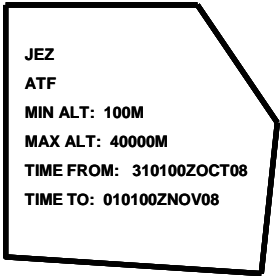
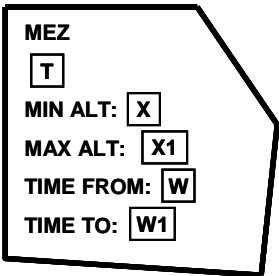
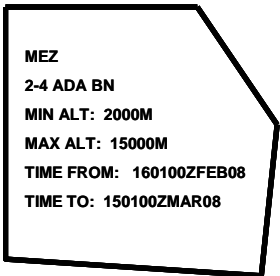
Table 7-9. Airspace Control Means.			
CONTROL MEASURE	TEMPLATE	DRAW RULES	EXAMPLE <i>Note: The symbols that have been coloured grey are used to help explain how the control measure is used, but they are not a part of the control measure.</i>
Joint Engagement Zone (JEZ)	 <p>JEZ T MIN ALT: X MAX ALT: X1 TIME FROM: W TIME TO: W1</p>		 <p>JEZ ATF MIN ALT: 100M MAX ALT: 40000M TIME FROM: 310100Z0CT08 TIME TO: 010100ZNOV08</p>
Missile Engagement Zone (MEZ) In air defence, airspace of defined dimensions within which the responsibility for engagement normally rests with a particular weapon system. (AAP-6)	 <p>MEZ T MIN ALT: X MAX ALT: X1 TIME FROM: W TIME TO: W1</p>		 <p>MEZ 2-4 ADA BN MIN ALT: 2000M MAX ALT: 15000M TIME FROM: 160100ZFEB08 TIME TO: 150100ZMAR08</p>

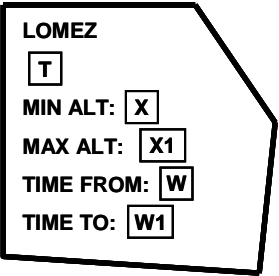
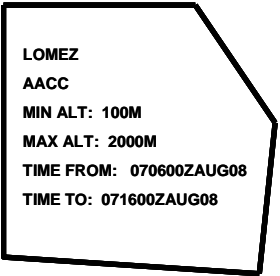
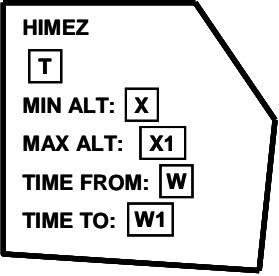

Table 7-9. Airspace Control Means.			
<i>CONTROL MEASURE</i>	<i>TEMPLATE</i>	<i>DRAW RULES</i>	<i>EXAMPLE</i>
Low (Altitude) Missile Engagement Zone (LOMEZ)	 <p>LOMEZ T MIN ALT: X MAX ALT: X1 TIME FROM: W TIME TO: W1</p>		<p><i>Note: The symbols that have been coloured grey are used to help explain how the control measure is used, but they are not a part of the control measure.</i></p>  <p>LOMEZ AACC MIN ALT: 100M MAX ALT: 2000M TIME FROM: 070600ZAUG08 TIME TO: 071600ZAUG08</p>
High (Altitude) Missile Engagement Zone (HIMEZ)	 <p>HIMEZ T MIN ALT: X MAX ALT: X1 TIME FROM: W TIME TO: W1</p>		 <p>HIMEZ AACC MIN ALT: 20000M MAX ALT: 50000M TIME FROM: 070600ZAUG08 TIME TO: 071600ZAUG08</p>

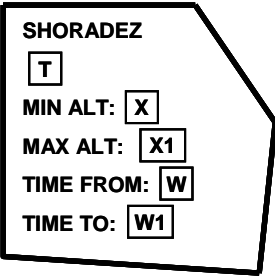
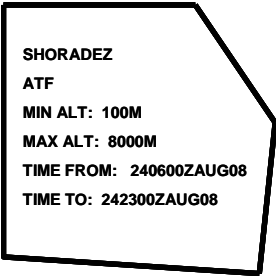
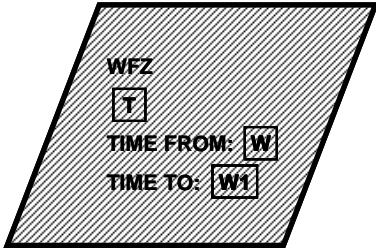
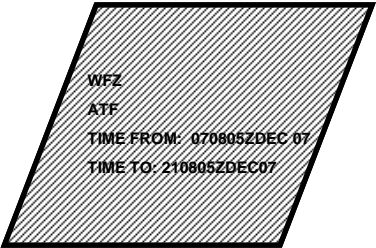
Table 7-9. Airspace Control Means.			
<i>CONTROL MEASURE</i>	<i>TEMPLATE</i>	<i>DRAW RULES</i>	<i>EXAMPLE</i>
<p>Short Range Air Defence Engagement Zone (SHORADEZ)</p> <p>In air defence, airspace of defined dimensions within which the responsibility for engagement normally rests with a particular weapon system. (AAP-6)</p> <p>Note: Replaces Forward Area Air Defence Engagement Zone (FAADEZ)</p>	 <p>SHORADEZ T MIN ALT: X MAX ALT: X1 TIME FROM: W TIME TO: W1</p>		<p><i>Note: The symbols that have been coloured grey are used to help explain how the control measure is used, but they are not a part of the control measure.</i></p> <div style="text-align: center;">  <p>SHORADEZ ATF MIN ALT: 100M MAX ALT: 8000M TIME FROM: 240600ZAUG08 TIME TO: 242300ZAUG08</p> </div>

Table 7-9. Airspace Control Means.			
<i>CONTROL MEASURE</i>	<i>TEMPLATE</i>	<i>DRAW RULES</i>	<i>EXAMPLE</i>
<p>Weapons Free Zone An air defence zone established around key assets or facilities other than airbases which merit special protection by ground based air defence assets where weapons may be fired at any target not positively identified as friendly. (AJP-3.3.5)</p>		<p><u>Anchor Points.</u> This graphic requires at least three anchor points to define the boundary of the area. Add as many points as necessary to accurately reflect the area's size and shape. <u>Size/Shape.</u> Determined by the anchor points. The information fields should be moveable and scalable as a block within the area. <u>Orientation.</u> Not applicable. Note: Upward diagonal lines are part of the fill.</p>	

Maritime

Maritime Control Measures

0715. Maritime control measures are used by NATO to help the maritime component commander and his subordinate commanders to direct action by establishing responsibilities and to prevent ships, units, or aircraft from impeding one another and to impose necessary coordination. They aid the cooperation among forces without imposing needless restrictions on their freedom of action. In general terms, maritime control measures can be broken down into the following groups: points, lines, and areas.

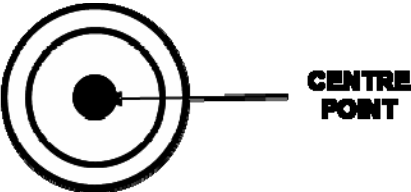
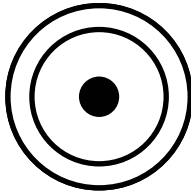
Table 7-10. Maritime Control Measures.			
<i>CONTROL MEASURE</i>	<i>TEMPLATE</i>	<i>DRAW RULES</i>	<i>EXAMPLE</i> <i>Note: The symbols that have been coloured grey are used to help explain how the control measure is used, but they are not a part of the control measure.</i>
Points			
Weapons			
Aim Point		<p><u>Anchor Points.</u> This graphic requires one anchor point. The centre point defines the centre of the graphic.</p> <p><u>Size/Shape.</u> Static.</p> <p><u>Orientation.</u> The graphic is typically centred over the desired location.</p>	

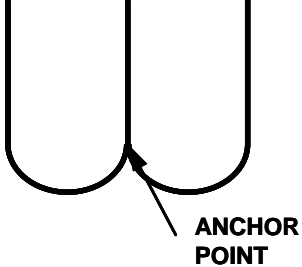
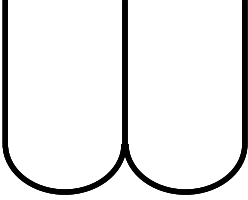
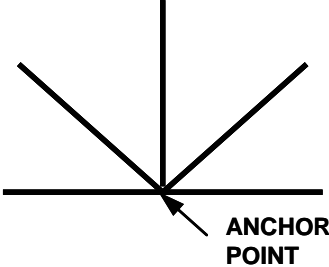
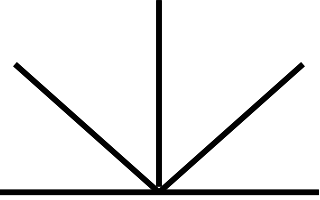
Table 7-10. Maritime Control Measures.			
<i>CONTROL MEASURE</i>	<i>TEMPLATE</i>	<i>DRAW RULES</i>	<i>EXAMPLE</i>
Drop Point		<p><u>Anchor Points.</u> This graphic requires one anchor point. The point defines the bottom of the central vertical line in the graphic where the curved and vertical lines meet.</p> <p><u>Size/Shape.</u> Static.</p> <p><u>Orientation.</u> The graphic will typically be oriented upright (as shown in the example to the right).</p>	
Entry Point		<p><u>Anchor Points.</u> This graphic requires one anchor point. The point defines the point where all the lines meet.</p> <p><u>Size/Shape.</u> Static.</p> <p><u>Orientation.</u> The graphic will typically be oriented upright (as shown in the example to the right).</p>	

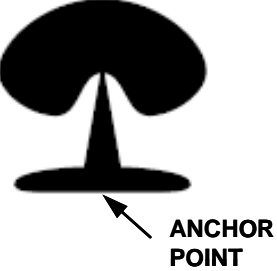


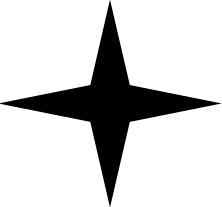
Table 7-10. Maritime Control Measures.			
<i>CONTROL MEASURE</i>	<i>TEMPLATE</i>	<i>DRAW RULES</i>	<i>EXAMPLE</i>
Ground Zero		<p><u>Anchor Points.</u> This graphic requires one anchor point. The anchor point defines the midpoint of the graphic's base.</p> <p><u>Size/Shape.</u> Static.</p> <p><u>Orientation.</u> The graphic will typically be oriented upright (as shown in the example to the right).</p>	<p><i>Note: The symbols that have been coloured grey are used to help explain how the control measure is used, but they are not a part of the control measure.</i></p> 
Impact Point		<p><u>Anchor Points.</u> This graphic requires one anchor point. The centre point defines the centre of the graphic.</p> <p><u>Size/Shape.</u> Static.</p> <p><u>Orientation.</u> The graphic is typically centred over the desired location.</p>	


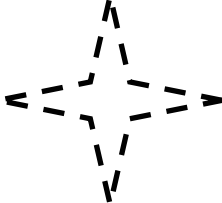
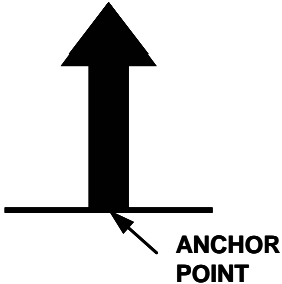
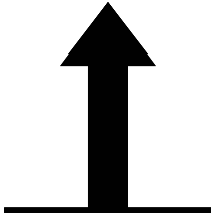
Table 7-10. Maritime Control Measures.			
<i>CONTROL MEASURE</i>	<i>TEMPLATE</i>	<i>DRAW RULES</i>	<i>EXAMPLE</i>
Predicted Impact Point			
Missile Detection Point		<p><u>Anchor Points.</u> This graphic requires one anchor point. The anchor point defines the midpoint of the graphic's base.</p> <p><u>Size/Shape.</u> Static.</p> <p><u>Orientation.</u> T The graphic will typically be oriented upright (as shown in the example to the right).</p>	

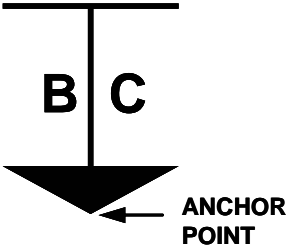
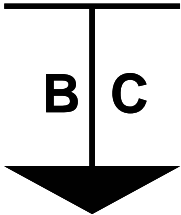
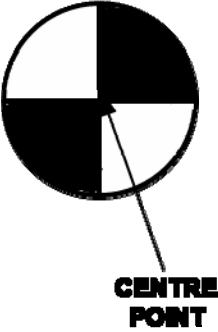
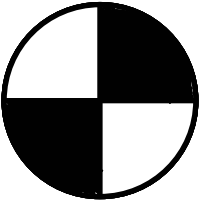
Table 7-10. Maritime Control Measures.			
<i>CONTROL MEASURE</i>	<i>TEMPLATE</i>	<i>DRAW RULES</i>	<i>EXAMPLE</i>
Sub-Surface Warfare			
Brief Contact		<p><u>Anchor Points.</u> This graphic requires one anchor point. The point defines the tip of the arrowhead.</p> <p><u>Size/Shape.</u> Static.</p> <p><u>Orientation.</u> The graphic will typically be oriented upright (as shown in the example to the right).</p>	
Datum		<p><u>Anchor Points.</u> This graphic requires one anchor point. The point defines the centre of the graphic.</p> <p><u>Size/Shape.</u> Static.</p> <p><u>Orientation.</u> The graphic will be oriented as shown in the example to the right, and will be centred over the datum.</p>	

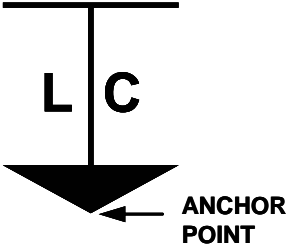
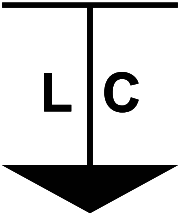
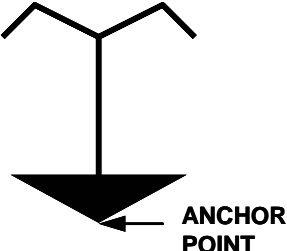
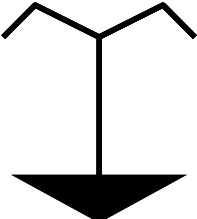
Table 7-10. Maritime Control Measures.			
<i>CONTROL MEASURE</i>	<i>TEMPLATE</i>	<i>DRAW RULES</i>	<i>EXAMPLE</i>
Lost Contact		<p><u>Anchor Points.</u> This graphic requires one anchor point. The point defines the tip of the arrowhead.</p> <p><u>Size/Shape.</u> Static.</p> <p><u>Orientation.</u> The graphic will typically be oriented upright (as shown in the example to the right).</p>	
Sinker			

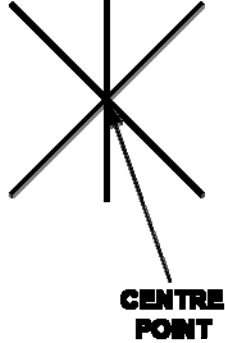
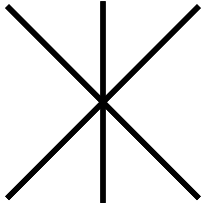
Table 7-10. Maritime Control Measures.			
<i>CONTROL MEASURE</i>	<i>TEMPLATE</i>	<i>DRAW RULES</i>	<i>EXAMPLE</i>
Fix			
Acoustic Fix		<p><u>Anchor Points.</u> This graphic requires one anchor point. The centre point defines the centre of the graphic.</p> <p><u>Size/Shape.</u> Static.</p> <p><u>Orientation.</u> The graphic is typically centred over the desired location.</p>	

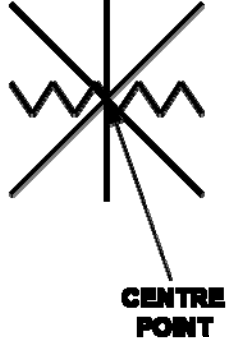
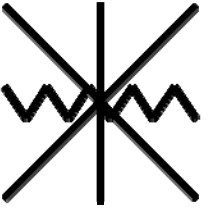
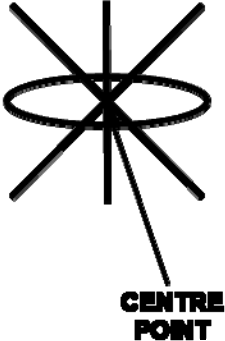
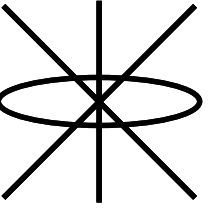
Table 7-10. Maritime Control Measures.			
<i>CONTROL MEASURE</i>	<i>TEMPLATE</i>	<i>DRAW RULES</i>	<i>EXAMPLE</i>
Electromagnetic Fix			
Optical Fix			
Formation		<u>Anchor Points</u> . This graphic requires one	

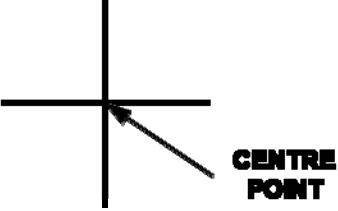
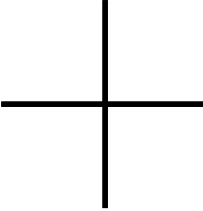
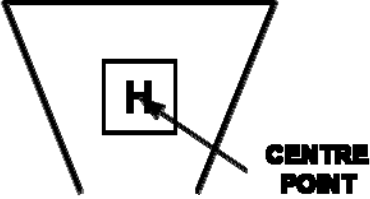
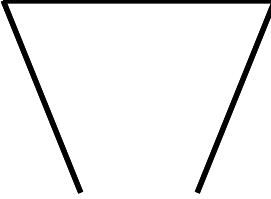
Table 7-10. Maritime Control Measures.			
<i>CONTROL MEASURE</i>	<i>TEMPLATE</i>		<i>DRAW RULES</i>
<i>CONTROL MEASURE</i>	<i>TEMPLATE</i>		<i>EXAMPLE</i>
			<p>anchor point. The centre point defines the centre of the graphic, where the two lines intersect.</p> <p><u>Size/Shape.</u> Static.</p> <p><u>Orientation.</u> The graphic is typically centred over the desired location.</p>
			
Harbour			
Harbour			<p><u>Anchor Points.</u> This graphic requires one anchor point. The centre point defines the centre of the graphic.</p> <p><u>Size/Shape.</u> Static. The graphic's corners form a 70- degree angle.</p> <p><u>Orientation.</u> The graphic is typically centred over the desired location. A user can use this graphic to define a new type of point if the selection that follows is not sufficient.</p>
			
Harbour Entrance Point	A	Q	Must be used in conjunction with the harbour control measure symbol.

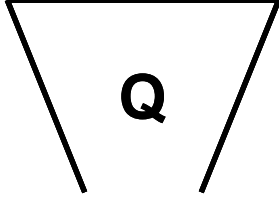
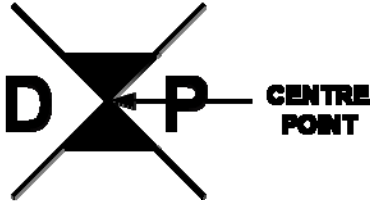
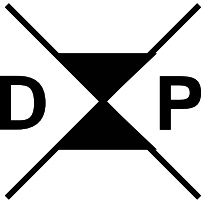
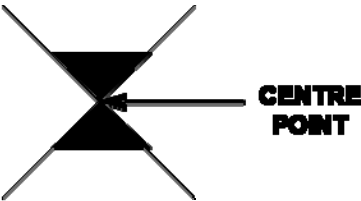
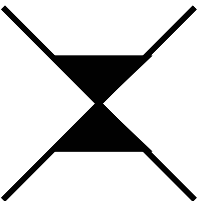
Table 7-10. Maritime Control Measures.			
<i>CONTROL MEASURE</i>	<i>TEMPLATE</i>		<i>DRAW RULES</i>
<i>CONTROL MEASURE</i>	<i>TEMPLATE</i>	<i>DRAW RULES</i>	<i>EXAMPLE</i>
	X	Y	
Search			
Dip Position		<p><u>Anchor Points.</u> This graphic requires one anchor point. The centre point defines the centre of the graphic.</p> <p><u>Size/Shape.</u> Static.</p> <p><u>Orientation.</u> The graphic is typically centred over the desired location.</p>	
Search			

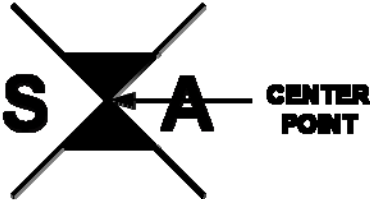
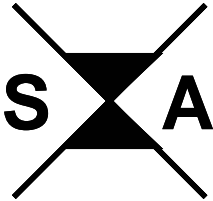
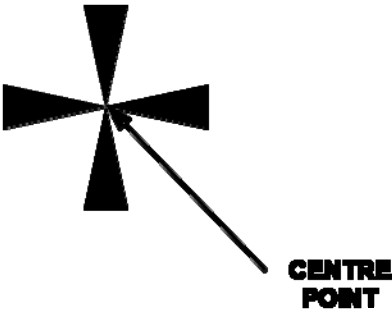
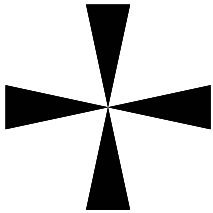
Table 7-10. Maritime Control Measures.			
<i>CONTROL MEASURE</i>	<i>TEMPLATE</i>	<i>DRAW RULES</i>	<i>EXAMPLE</i> <i>Note: The symbols that have been coloured grey are used to help explain how the control measure is used, but they are not a part of the control measure.</i>
Search Area			
Search Centre			


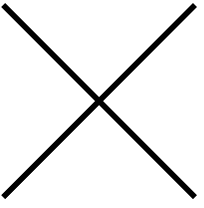
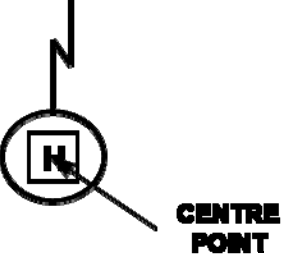
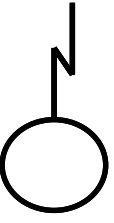
Table 7-10. Maritime Control Measures.			
<i>CONTROL MEASURE</i>	<i>TEMPLATE</i>	<i>DRAW RULES</i>	<i>EXAMPLE</i>
<p>Navigational Reference Point</p>			
Sonobouys			
<p>Sonobouy</p>		<p>Anchor Points. This graphic requires one anchor point. The point defines the centre of the circle.</p> <p><u>Size/Shape.</u> Static. The diameter of the circle should be 1/2 the height of the graphic.</p> <p><u>Orientation.</u> The graphic's centre point is typically centred over the desired location. The graphic will be oriented upright, as shown in the example.</p>	
<p>Ambient Noise Sonobouy</p>			

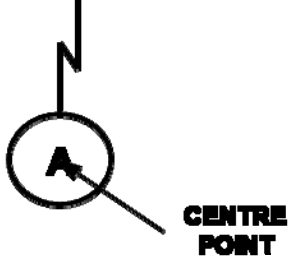
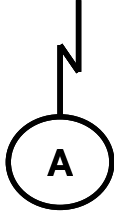
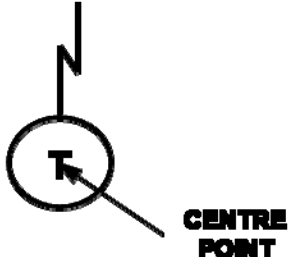
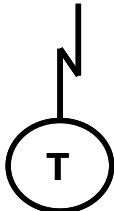
Table 7-10. Maritime Control Measures.			
<i>CONTROL MEASURE</i>	<i>TEMPLATE</i>	<i>DRAW RULES</i>	<i>EXAMPLE</i> <i>Note: The symbols that have been coloured grey are used to help explain how the control measure is used, but they are not a part of the control measure.</i>
			
Air Transportable Communication (ATAC)			

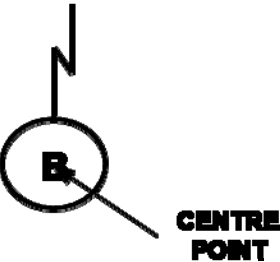
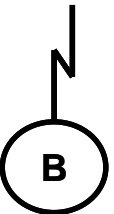
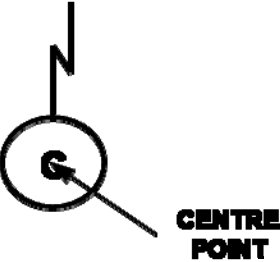
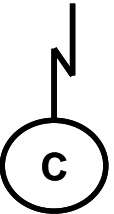
Table 7-10. Maritime Control Measures.			
<i>CONTROL MEASURE</i>	<i>TEMPLATE</i>	<i>DRAW RULES</i>	<i>EXAMPLE</i> <i>Note: The symbols that have been coloured grey are used to help explain how the control measure is used, but they are not a part of the control measure.</i>
Bathlythermo-graph Transmitting Sonobouy			
Command Active Sonobouy Directional Command Active Sonobouy System			

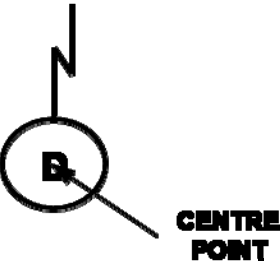
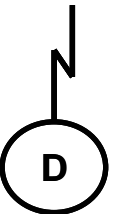
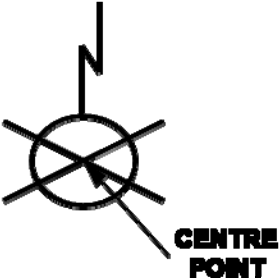
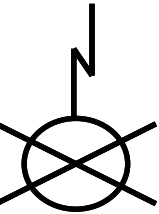
Table 7-10. Maritime Control Measures.			
<i>CONTROL MEASURE</i>	<i>TEMPLATE</i>	<i>DRAW RULES</i>	<i>EXAMPLE</i> <i>Note: The symbols that have been coloured grey are used to help explain how the control measure is used, but they are not a part of the control measure.</i>
Digital Frequency Analysing and Recording (DIRAR)			
Expired Sonobouy			

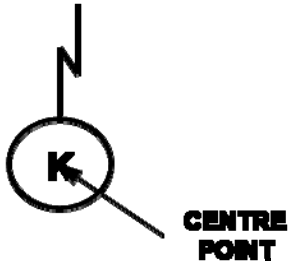
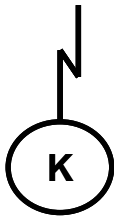
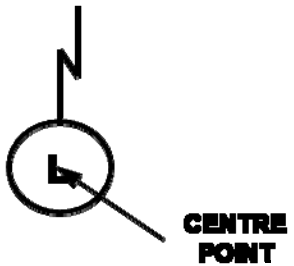
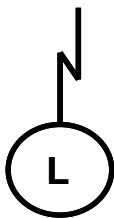
Table 7-10. Maritime Control Measures.			
CONTROL MEASURE	TEMPLATE	DRAW RULES	EXAMPLE <i>Note: The symbols that have been coloured grey are used to help explain how the control measure is used, but they are not a part of the control measure.</i>
Kingpin Sonobouy			
Low Frequency Analysing and Recording Sonobouy			
Pattern Sonobouy			

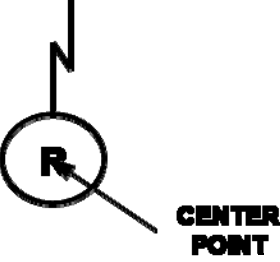
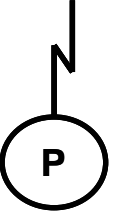
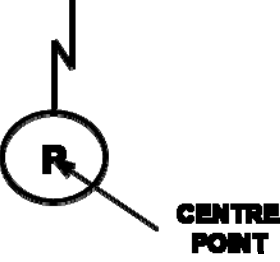
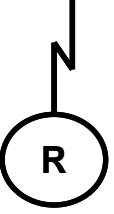
Table 7-10. Maritime Control Measures.			
<i>CONTROL MEASURE</i>	<i>TEMPLATE</i>	<i>DRAW RULES</i>	<i>EXAMPLE</i> <i>Note: The symbols that have been coloured grey are used to help explain how the control measure is used, but they are not a part of the control measure.</i>
			
Range Only Sonobouy			

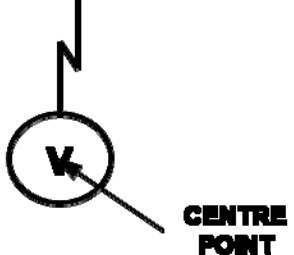
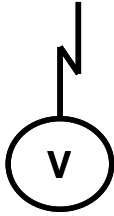
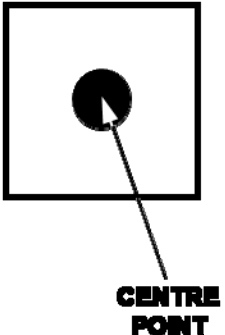
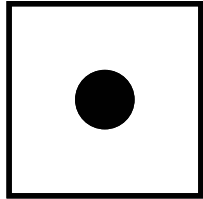
Table 7-10. Maritime Control Measures.			
CONTROL MEASURE	TEMPLATE	DRAW RULES	EXAMPLE
Vertical Line Array Directional Frequency Analysis and Recording (DIFAR) Sonobouy			
Reference Points			
Reference Point		<p><u>Anchor Points.</u> This graphic requires one anchor point. The centre point defines the centre of the graphic.</p> <p><u>Size/Shape.</u> Static.</p> <p><u>Orientation.</u> The graphic is typically centred over the desired location.</p>	

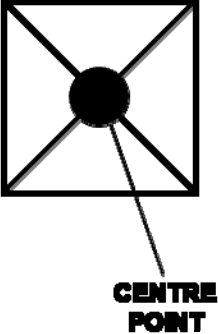
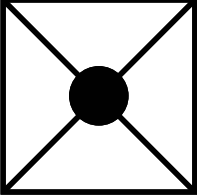
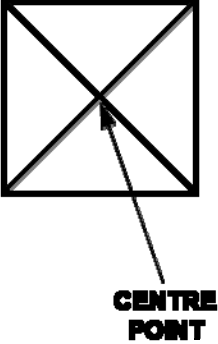
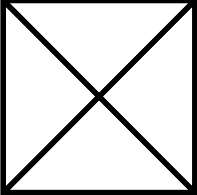
Table 7-10. Maritime Control Measures.			
<i>CONTROL MEASURE</i>	<i>TEMPLATE</i>	<i>DRAW RULES</i>	<i>EXAMPLE</i> <i>Note: The symbols that have been coloured grey are used to help explain how the control measure is used, but they are not a part of the control measure.</i>
Special Point	 <p>CENTRE POINT</p>		
Navigational Reference Point	 <p>CENTRE POINT</p>		

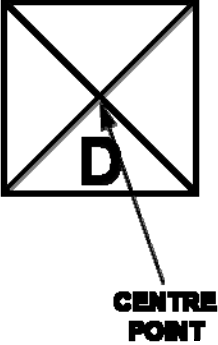
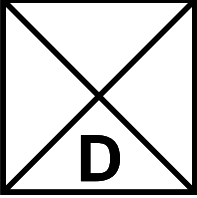
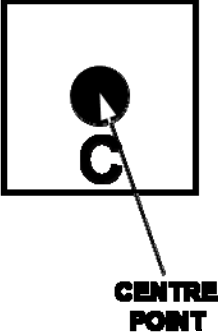
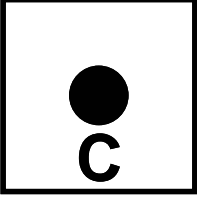
Table 7-10. Maritime Control Measures.			
<i>CONTROL MEASURE</i>	<i>TEMPLATE</i>	<i>DRAW RULES</i>	<i>EXAMPLE</i> <i>Note: The symbols that have been coloured grey are used to help explain how the control measure is used, but they are not a part of the control measure.</i>
Data Link Reference Point			
Corridor Tab Point			

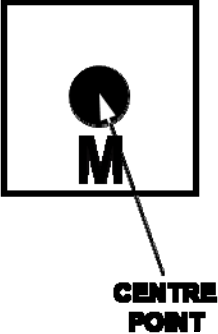
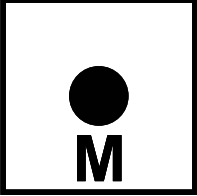
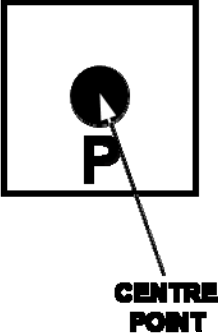
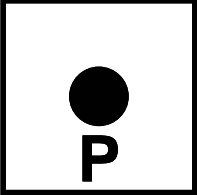
Table 7-10. Maritime Control Measures.			
<i>CONTROL MEASURE</i>	<i>TEMPLATE</i>	<i>DRAW RULES</i>	<i>EXAMPLE</i> <i>Note: The symbols that have been coloured grey are used to help explain how the control measure is used, but they are not a part of the control measure.</i>
Marshall Point			
Position and Intended Movement (PIM)			

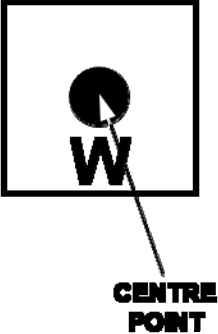
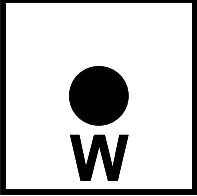
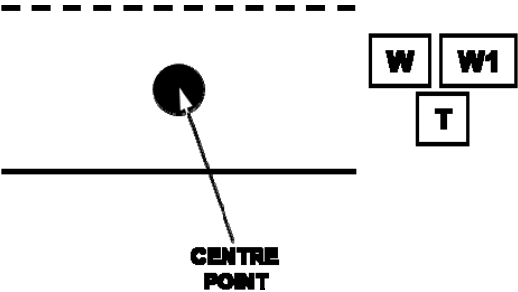
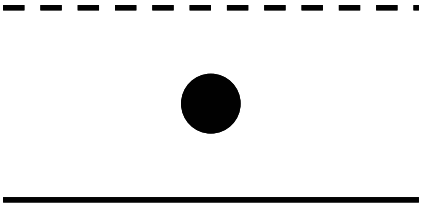
Table 7-10. Maritime Control Measures.			
<i>CONTROL MEASURE</i>	<i>TEMPLATE</i>	<i>DRAW RULES</i>	<i>EXAMPLE</i>
Waypoint			
Subsurface Stations			
General Subsurface Station		<p><u>Anchor Points.</u> This graphic requires one anchor point. The centre point defines the centre of the graphic.</p> <p><u>Size/Shape.</u> Static.</p> <p><u>Orientation.</u> The graphic is typically centred over the desired location.</p>	

Table 7-10. Maritime Control Measures.			
CONTROL MEASURE	TEMPLATE	DRAW RULES	EXAMPLE <i>Note: The symbols that have been coloured grey are used to help explain how the control measure is used, but they are not a part of the control measure.</i>
Submarine Subsurface Station			
Submarine Antisubmarine Warfare Subsurface Station			

Table 7-10. Maritime Control Measures.			
CONTROL MEASURE	TEMPLATE	DRAW RULES	EXAMPLE <i>Note: The symbols that have been coloured grey are used to help explain how the control measure is used, but they are not a part of the control measure.</i>
Unmanned Underwater Vehicle Subsurface Station			
Antisubmarine Warfare (ASW) Unmanned Underwater Vehicle Subsurface Station			

Table 7-10. Maritime Control Measures.			
<i>CONTROL MEASURE</i>	<i>TEMPLATE</i>	<i>DRAW RULES</i>	<i>EXAMPLE</i>
Mine Warfare Unmanned Underwater Vehicle Subsurface Station			
Surface Warfare Unmanned Underwater Vehicle Subsurface Station			

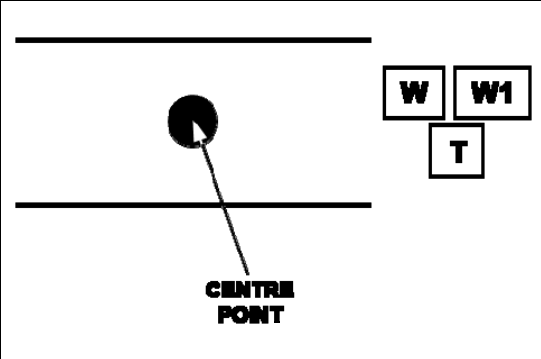
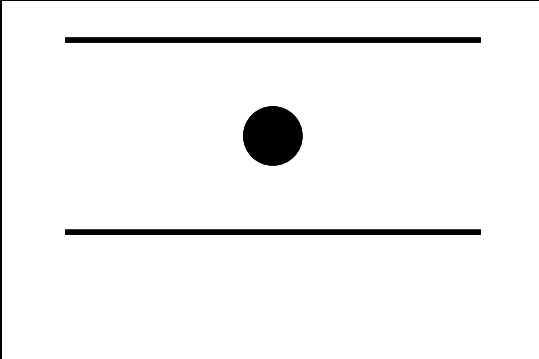
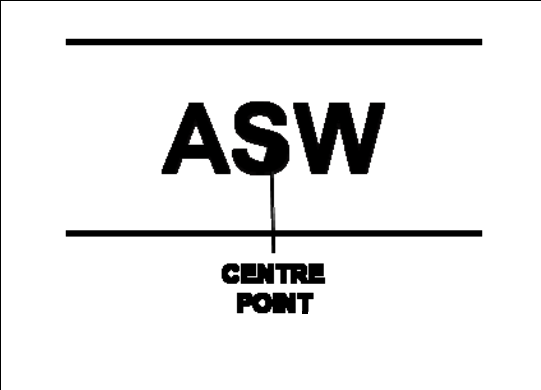
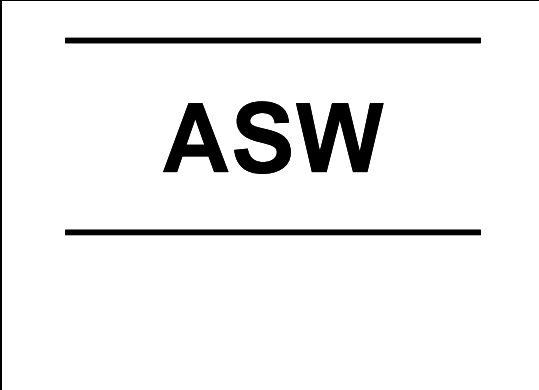
Table 7-10. Maritime Control Measures.			
<i>CONTROL MEASURE</i>	<i>TEMPLATE</i>	<i>DRAW RULES</i>	<i>EXAMPLE</i>
Surface Stations			
General Surface Station		<p><u>Anchor Points.</u> This graphic requires one anchor point. The centre point defines the centre of the graphic.</p> <p><u>Size/Shape.</u> Static.</p> <p><u>Orientation.</u> The graphic is typically centred over the desired location.</p>	
Antisubmarine Warfare (ASW) Surface Station			

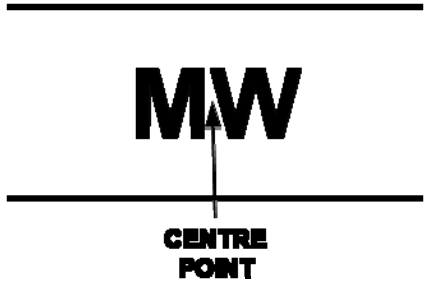

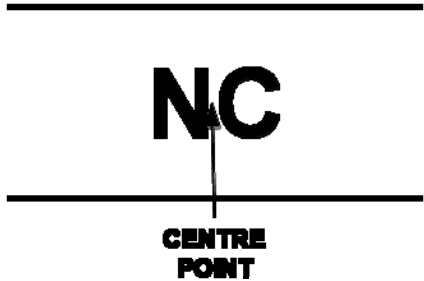

Table 7-10. Maritime Control Measures.			
<i>CONTROL MEASURE</i>	<i>TEMPLATE</i>	<i>DRAW RULES</i>	<i>EXAMPLE</i> <i>Note: The symbols that have been coloured grey are used to help explain how the control measure is used, but they are not a part of the control measure.</i>
Mine Warfare Surface Station			
Non-Combatant Surface Station			

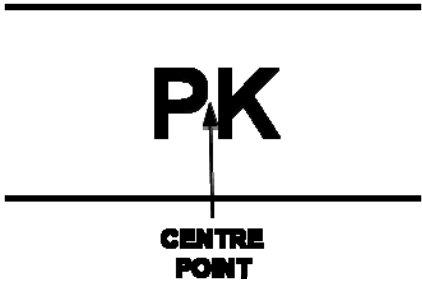
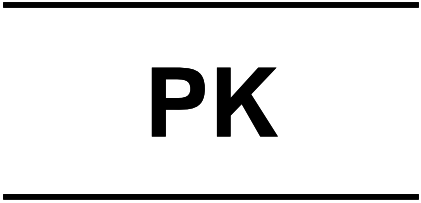

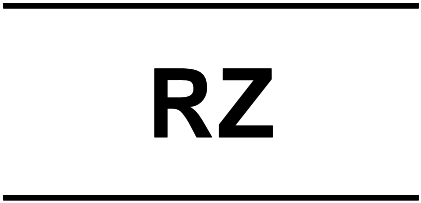
Table 7-10. Maritime Control Measures.			
CONTROL MEASURE	TEMPLATE	DRAW RULES	EXAMPLE <i>Note: The symbols that have been coloured grey are used to help explain how the control measure is used, but they are not a part of the control measure.</i>
Picket Surface Station			
Rendezvous Surface Station			

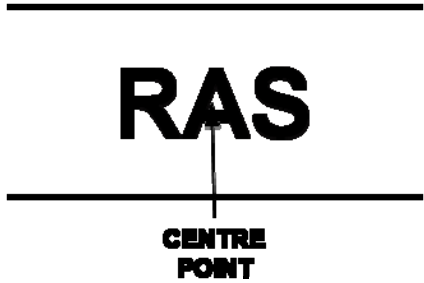

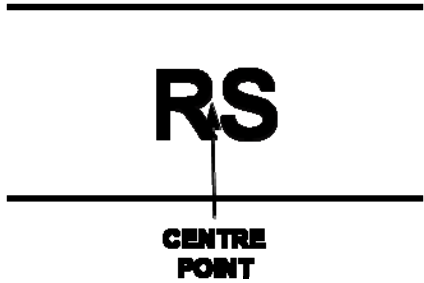
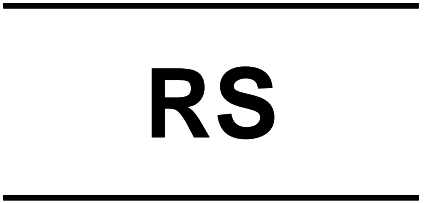
Table 7-10. Maritime Control Measures.			
<i>CONTROL MEASURE</i>	<i>TEMPLATE</i>	<i>DRAW RULES</i>	<i>EXAMPLE</i> <i>Note: The symbols that have been coloured grey are used to help explain how the control measure is used, but they are not a part of the control measure.</i>
Replenishment at Sea Surface Station			
Rescue Surface Station			

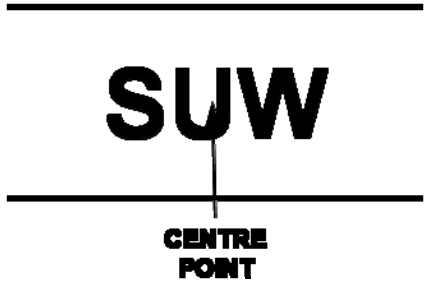
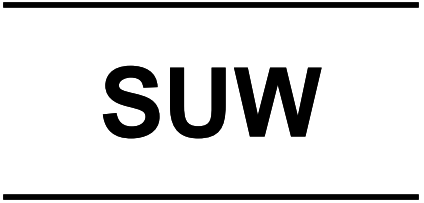
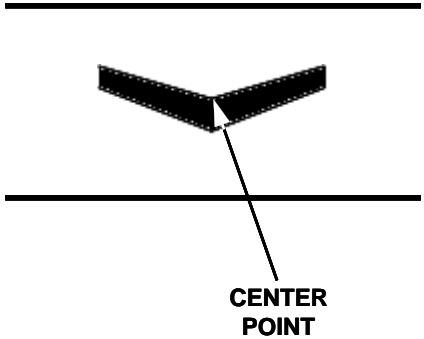
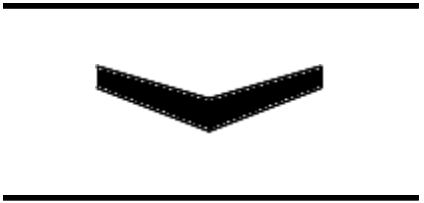
Table 7-10. Maritime Control Measures.			
CONTROL MEASURE	TEMPLATE	DRAW RULES	EXAMPLE <i>Note: The symbols that have been coloured grey are used to help explain how the control measure is used, but they are not a part of the control measure.</i>
Surface Warfare Surface Station			
Unmanned Underwater Vehicle Surface Station			

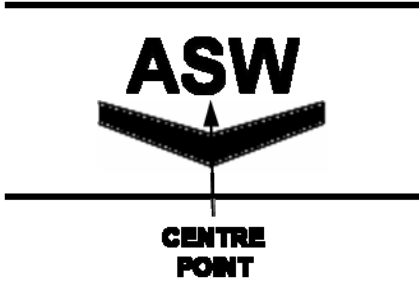
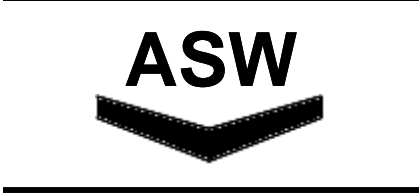
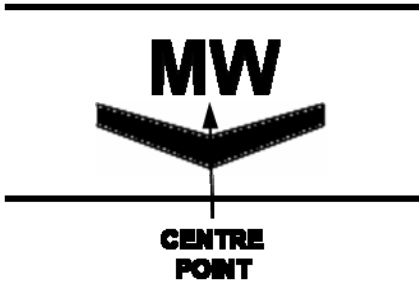

Table 7-10. Maritime Control Measures.			
CONTROL MEASURE	TEMPLATE	DRAW RULES	EXAMPLE <i>Note: The symbols that have been coloured grey are used to help explain how the control measure is used, but they are not a part of the control measure.</i>
Antisubmarine Warfare (ASW) Unmanned Underwater Vehicle Surface Station	 <p>The template diagram for ASW consists of two horizontal lines. Between them is a downward-pointing chevron shape. Inside the chevron is an upward-pointing arrow. Below the chevron, the text "CENTRE POINT" is written in bold, centered.</p>		 <p>The example diagram for ASW shows the same two horizontal lines and downward-pointing chevron shape. The chevron and the text "ASW" above it are shaded grey.</p>
Mine Warfare Unmanned Underwater Vehicle Surface Station	 <p>The template diagram for MW consists of two horizontal lines. Between them is a downward-pointing chevron shape. Inside the chevron is an upward-pointing arrow. Below the chevron, the text "CENTRE POINT" is written in bold, centered.</p>		 <p>The example diagram for MW shows the same two horizontal lines and downward-pointing chevron shape. The chevron and the text "MW" above it are shaded grey.</p>

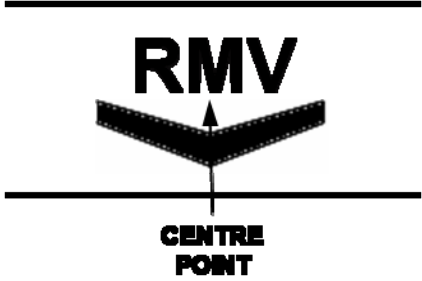

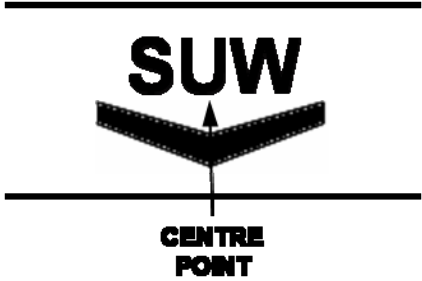
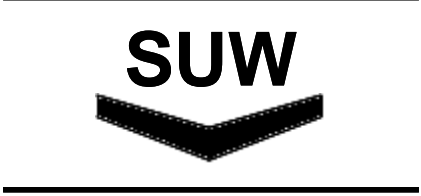
Table 7-10. Maritime Control Measures.			
CONTROL MEASURE	TEMPLATE	DRAW RULES	EXAMPLE <i>Note: The symbols that have been coloured grey are used to help explain how the control measure is used, but they are not a part of the control measure.</i>
Remote Multi-Mission Vehicle Unmanned Underwater Vehicle Surface Station			
Surface Warfare Unmanned Underwater Vehicle Surface Station			

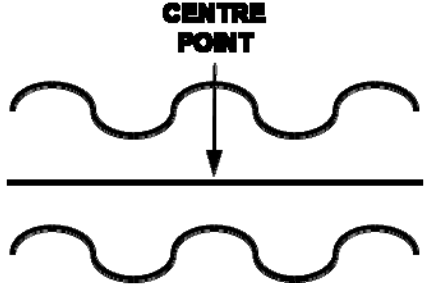
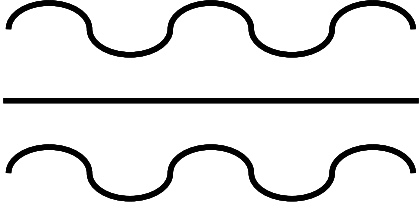
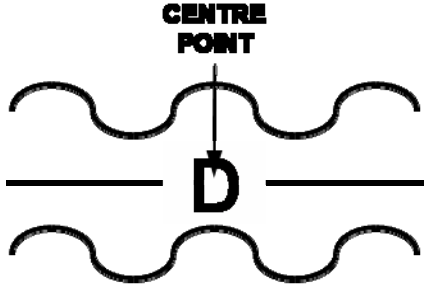
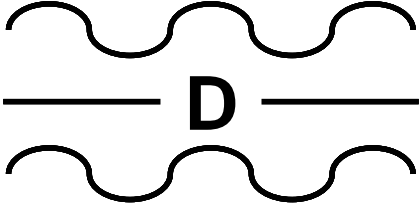
Table 7-10. Maritime Control Measures.			
<i>CONTROL MEASURE</i>	<i>TEMPLATE</i>	<i>DRAW RULES</i>	<i>EXAMPLE</i>
Routes			
General Route		<p><u>Anchor Points.</u> This graphic requires one anchor point. The centre point defines the centre of the graphic's straight line.</p> <p><u>Size/Shape.</u> Static.</p> <p><u>Orientation.</u> The graphic is typically centred over the desired location.</p>	
Diversion			

Table 7-10. Maritime Control Measures.			
CONTROL MEASURE	TEMPLATE	DRAW RULES	EXAMPLE <i>Note: The symbols that have been coloured grey are used to help explain how the control measure is used, but they are not a part of the control measure.</i>
Position and Intended Movement (PIM)			
Picket			

Table 7-10. Maritime Control Measures.			
<i>CONTROL MEASURE</i>	<i>TEMPLATE</i>	<i>DRAW RULES</i>	<i>EXAMPLE</i> <i>Note: The symbols that have been coloured grey are used to help explain how the control measure is used, but they are not a part of the control measure.</i>
Point R			
Rendezvous			

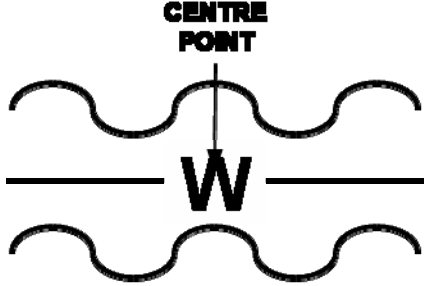
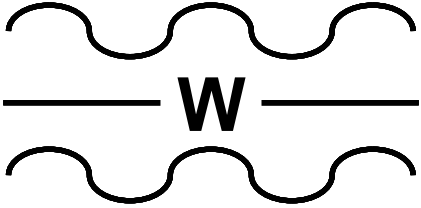
Table 7-10. Maritime Control Measures.			
<i>CONTROL MEASURE</i>	<i>TEMPLATE</i>	<i>DRAW RULES</i>	<i>EXAMPLE</i> <i>Note: The symbols that have been coloured grey are used to help explain how the control measure is used, but they are not a part of the control measure.</i>
Waypoint	 <p>The template diagram shows a central bold letter 'W' with a vertical line extending upwards from its top to the words 'CENTRE POINT' in bold. The 'W' is flanked by two horizontal lines. Above and below these horizontal lines are two wavy lines, each consisting of three rounded humps.</p>		 <p>The example diagram shows the same 'W' symbol as in the template, but with the wavy lines and horizontal lines drawn in a grey color. The 'W' itself is black.</p>
Emergency			

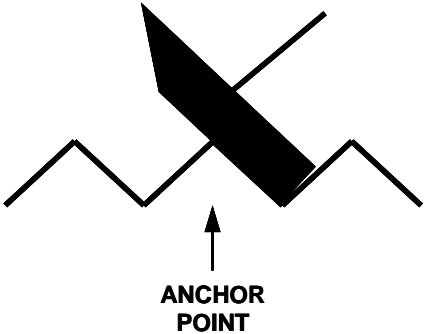
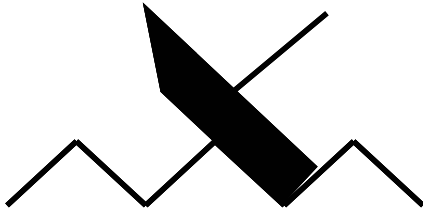
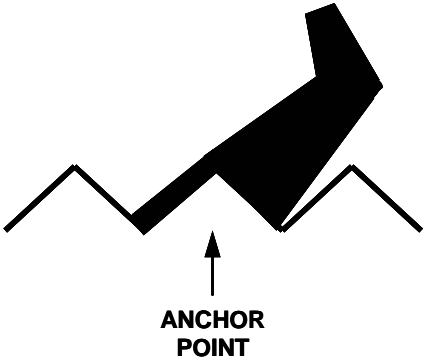
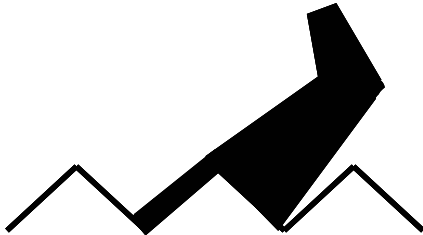
Table 7-10. Maritime Control Measures.			
CONTROL MEASURE	TEMPLATE	DRAW RULES	EXAMPLE
Distressed Vessel		<p><u>Anchor Points.</u> This graphic requires one anchor point. The anchor point defines the midpoint of the graphic's base.</p> <p><u>Size/Shape.</u> Static.</p> <p><u>Orientation.</u> The graphic will typically be oriented upright, as shown in the example to the right.</p>	
Ditched Aircraft/ Downed Aircraft			

Table 7-10. Maritime Control Measures.			
<i>CONTROL MEASURE</i>	<i>TEMPLATE</i>	<i>DRAW RULES</i>	<i>EXAMPLE</i> <i>Note: The symbols that have been coloured grey are used to help explain how the control measure is used, but they are not a part of the control measure.</i>
Person In Water/Bailout			

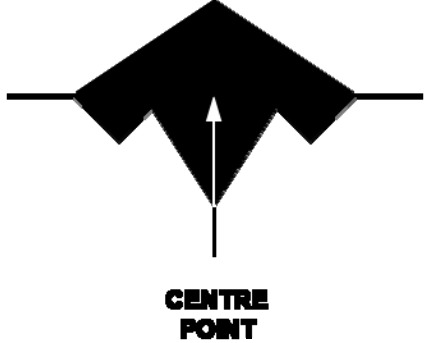
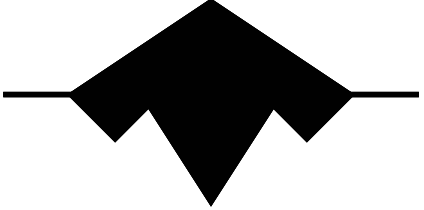
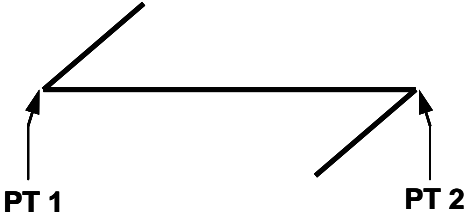
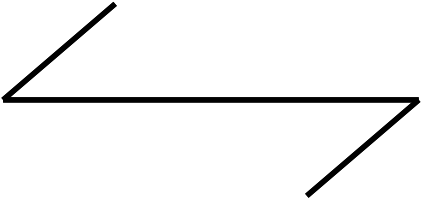
Table 7-10. Maritime Control Measures.			
<i>CONTROL MEASURE</i>	<i>TEMPLATE</i>	<i>DRAW RULES</i>	<i>EXAMPLE</i>
Hazards			
Iceberg		<p><u>Anchor Points.</u> This graphic requires one anchor point. The centre point defines centre of the graphic.</p> <p><u>Size/Shape.</u> Static.</p> <p><u>Orientation.</u> The graphic is typically centred over the desired location.</p>	
Navigational		<p><u>Anchor Points.</u> This graphic requires two anchor points. Points 1 and 2 define the corner points of the graphic.</p> <p><u>Size/Shape.</u> The graphic varies only in length.</p> <p><u>Orientation.</u> Orientation is determined by the anchor points.</p>	

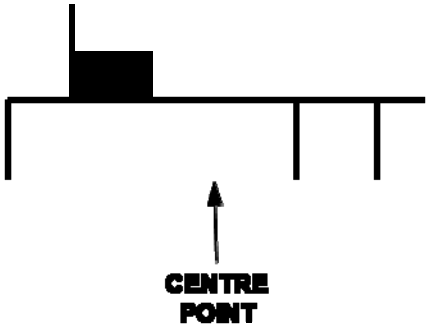
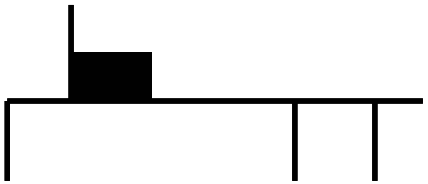

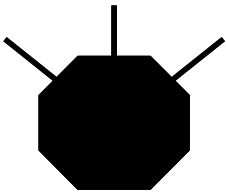
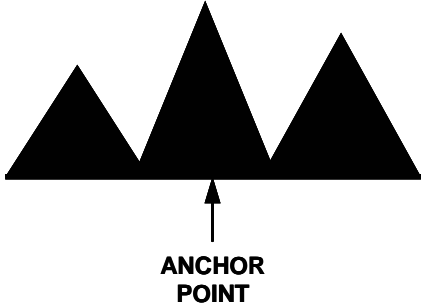
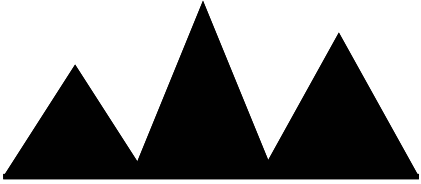
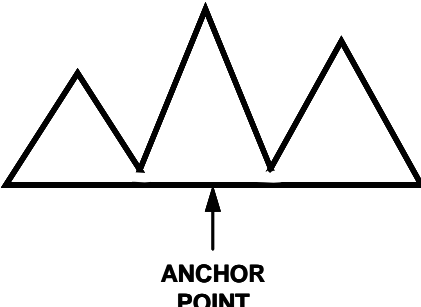
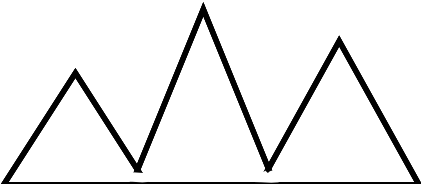
Table 7-10. Maritime Control Measures.			
<i>CONTROL MEASURE</i>	<i>TEMPLATE</i>	<i>DRAW RULES</i>	<i>EXAMPLE</i>
Oil Rig		<p><u>Anchor Points.</u> This graphic requires one anchor point. The centre point defines centre of the graphic.</p> <p><u>Size/Shape.</u> Static.</p> <p><u>Orientation.</u> The graphic is typically centred over the desired location.</p>	<p><i>Note: The symbols that have been coloured grey are used to help explain how the control measure is used, but they are not a part of the control measure.</i></p> 
Sea Mine-Like		<p><u>Anchor Points.</u> This graphic requires one anchor point. The centre point is the centre of the octagon.</p> <p><u>Size/Shape.</u> Static.</p> <p><u>Orientation.</u> The graphic's centre point is typically centred over the desired location. The graphic will typically be oriented upright, as shown in the example to the right, but can be rotated in 90 degree increments.</p>	

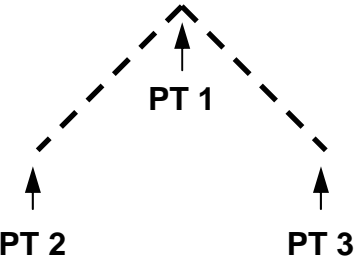
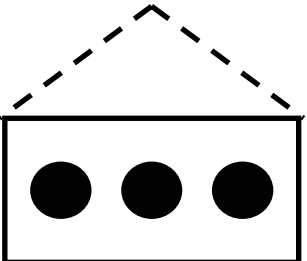
Table 7-10. Maritime Control Measures.			
<i>CONTROL MEASURE</i>	<i>TEMPLATE</i>	<i>DRAW RULES</i>	<i>EXAMPLE</i>
Sea Subsurface Returns			
Bottom Return/ Non-Mine, Mine- Like Bottom Object (NOMBO)		<p><u>Anchor Points.</u> This graphic requires one anchor point. The anchor point defines the midpoint of the graphic's base.</p> <p><u>Size/Shape.</u> Static.</p> <p><u>Orientation.</u> The graphic will typically be oriented upright, as shown in the example to the right, but can be rotated in 90 degree increments.</p>	
Bottom Return/ Non-Mine, Mine- Like Bottom Object (NOMBO)/ Installation/ Manmade			

Deception

Deception Control Measures

0716. Deception control measures are designed to mislead the enemy by manipulation, distortion, or falsification of evidence to induce him to react in a manner prejudicial to his interests.

Table 7-11. Deception Control Measure Symbols.			
<i>CONTROL MEASURE</i>	<i>TEMPLATE</i>	<i>DRAW RULES</i>	<i>EXAMPLE</i>
<p>Decoy/Dummy An imitation of a person, object or phenomenon, which is intended to deceive hostile surveillance or detection systems or mislead the adversary. (AAP-6)</p>		<p><u>Anchor Points.</u> This graphic requires 3 anchor points. Point 1 defines the vertex of the graphic, and points 2 and 3 define its endpoints.</p> <p><u>Size/Shape.</u> Points 1, 2, and 3 determine the length of the lines connecting them. The line defined by points 1 and 2 is typically the same length as the line between points 2 and 3.</p> <p><u>Orientation.</u> Orientation is determined by the anchor points.</p>	<p><i>Note: The symbols that have been coloured grey are used to help explain how the control measure is used, but they are not a part of the control measure.</i></p>

<p>Decoy/Dummy and Feint In military deception, an offensive action involving contact with the adversary conducted for the purpose of deceiving the adversary as to the location and/or time of the actual main offensive action.</p>		<p>Note: Anchor points are determined by the relationship between the control measure symbol being modified and the decoy/dummy or feint control measure symbol modifying it. See the specific control measure being modified for anchor points.</p>	
<p>Axis of Advance for a Feint</p>	<p>See Axis of Advance under Manoeuvre Control Measures (Page 7-47)</p>		
<p>Direction of Attack for a Feint</p>	<p>See Direction of Attack under Manoeuvre Control Measures (Page 7-51)</p>		
<p>Decoy Mined Area</p>	<p>See Decoy Mined Area under Obstacles (Page 7-168)</p>		
<p>Dummy Minefield</p>	<p>See Decoy Mined Minefield under Obstacles (Page 7-169)</p>		

Fires

Fire Support Coordination Measures

0717. Fire support coordination measures are measures employed by land or amphibious commanders to facilitate the rapid engagement of targets and simultaneously provide safeguards for friendly forces. Fire support control measures should be labelled with the abbreviation of the control measure, the controlling headquarters (Field T), and the effective times (Field W/W1). For lines this labelling should be on both ends of the line and repeated as often as necessary for clarity along any line that passes through many boundaries.

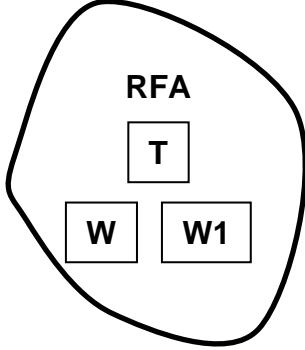

Table 7-12. Fire Support Coordination Measures.			
<i>CONTROL MEASURE</i>	<i>TEMPLATE</i>	<i>DRAW RULES</i>	<i>EXAMPLE</i>
			<i>Note: The symbols that have been coloured grey are used to help explain how the control measure is used, but they are not a part of the control measure.</i>
Lines			
<p>Fire Support Coordination Line (FSCL)</p> <p>Note: Because of the length of the FSCL definition it is included in the glossary.</p>		<p><u>Anchor Points.</u> This graphic requires at least two points, points 1 and 2, to define the line. Additional points can be defined to extend the line.</p> <p><u>Size/Shape.</u> The first and last anchor points determine the length of the line. The end-of line information will typically be</p>	

Table 7-12. Fire Support Coordination Measures.			
<i>CONTROL MEASURE</i>	<i>TEMPLATE</i>	<i>DRAW RULES</i>	<i>EXAMPLE</i>
<p>Fire Support Safety Line (FSSL) A line short of which indirect fire systems do not fire except on request or approval of the commander who established the line, but beyond which they may fire at any time without danger to friendly troops. (AartyP-5)</p>		<p>posted at the ends of the line as it is shown in the example. Orientation. Orientation is determined by the anchor points.</p>	
<p>No Fire Line</p>			

Table 7-12. Fire Support Coordination Measures.			
<i>CONTROL MEASURE</i>	<i>TEMPLATE</i>	<i>DRAW RULES</i>	<i>EXAMPLE</i>
<p>Restrictive Fire Line A line established between converging friendly forces (one or both may be moving) that prohibits all fire or effects from fires across the line without coordination with the affected force. (AartyP-5)</p>	<p>The template shows a horizontal line with arrows at both ends pointing towards 'PT 1' and 'PT 2'. Above the line are two 'RFL' symbols and two 'T' symbols. Below the line are two boxes labeled 'W' and 'W1' on the left, and two boxes labeled 'W' and 'W1' on the right.</p>		<p><i>Note: The symbols that have been coloured grey are used to help explain how the control measure is used, but they are not a part of the control measure.</i></p> <p>The example diagram shows a horizontal line with 'RFL 23ID' on both sides. Below the line are two boxes with the code '110800ZMAY98-041200MAY08'. Above the line are two boxes labeled '3' and '1', each containing a circle with an 'X'. Below the line are two boxes labeled '2' and '23', each containing a square with an 'X'. Vertical lines labeled 'PL RED' and 'XX' are on the far left and right. A large arrow points upwards from the bottom center.</p>

Table 7-12. Fire Support Coordination Measures.			
<i>CONTROL MEASURE</i>	<i>TEMPLATE</i>	<i>DRAW RULES</i>	<i>EXAMPLE</i>
Areas			
<p>Airspace Coordination Area (ACA) A restricted area or route of travel specified for use by friendly aircraft and established for the purpose of preventing friendly aircraft from being fired on by friendly forces. (AartyP-5)</p>		<p><u>Anchor Points.</u> This graphic requires at least three anchor points to define the boundary of the area. Add as many points as necessary to accurately reflect the area's size and shape.</p> <p><u>Size/Shape.</u> Determined by the anchor points. The information fields should be movable and scalable as a block within the area. Field W1 is optional.</p> <p><u>Orientation.</u> Not applicable.</p>	

Table 7-12. Fire Support Coordination Measures.			
CONTROL MEASURE	TEMPLATE	DRAW RULES	EXAMPLE
<p>Free Fire Area (FFA) A specific designated area into which any weapon system may fire without additional co-ordination with the establishing headquarters.</p>			<p>Note: The symbols that have been coloured grey are used to help explain how the control measure is used, but they are not a part of the control measure.</p>
<p>No Fire Area (NFA) An area into which no fires or the effects of fires are allowed.</p>			

Table 7-12. Fire Support Coordination Measures.			
CONTROL MEASURE	TEMPLATE	DRAW RULES	EXAMPLE <i>Note: The symbols that have been coloured grey are used to help explain how the control measure is used, but they are not a part of the control measure.</i>
<p>Restricted Fire Area (RFA) An area in which specific restrictions are imposed and in which fires that exceed those restrictions are not delivered without co-ordination with the establishing headquarters. (AartyP-5)</p>			

Targets

0718. A target is the object of a particular action, for example a geographic area, a complex, an installation, a force, equipment, an individual, a group or a system, planned for capture, exploitation, neutralization or destruction by military forces.

Table 7-13. Target Control Measure Symbols.			
CONTROL MEASURE	TEMPLATE	DRAW RULES	EXAMPLE
Point Targets			
<p>Point or Single Target A target which requires the accurate placement of bombs or fire. (AAP-6) Note: Guidance on building target numbers is found in AArtyP-1.</p>		<p><u>Anchor Points.</u> This graphic requires one anchor point. The centre point defines the centre of the graphic. <u>Size/Shape.</u> Static. <u>Orientation.</u> The graphic is typically centred over the desired location.</p>	
<p>Nuclear Target Note: The point at the centre of the target represents the desired ground zero.</p>			

Table 7-13. Target Control Measure Symbols.			
<i>CONTROL MEASURE</i>	<i>TEMPLATE</i>	<i>DRAW RULES</i>	<i>EXAMPLE</i>
Linear Targets			
Linear Target		<p><u>Anchor Points.</u> This graphic requires at least two anchor points, points 1 and 2, to define the line. Additional points can be defined to extend the line.</p> <p><u>Size/Shape.</u> The first and last anchor points determine the length of the line. The line segment between each pair of anchor points will repeat all information associated with the line segment between points 1 and 2.</p> <p><u>Orientation.</u> Orientation is determined by the anchor points.</p>	
Linear Smoke Target			

Table 7-13. Target Control Measure Symbols.			
CONTROL MEASURE	TEMPLATE	DRAW RULES	EXAMPLE
			<i>Note: The symbols that have been coloured grey are used to help explain how the control measure is used, but they are not a part of the control measure.</i>
Final Protective Fire (FPF) An immediately available prearranged barrier of fire designed to impede enemy movement across defensive lines or areas. (AAP-6)			
Area Targets			
Circular Target		<u>Anchor Points.</u> This graphic requires one (1) anchor point. Point 1 defines the centre point of the graphic. <u>Size/Shape.</u> Size: The radius, defined in meters, determines the size of the Circular Target. Shape: Circle. The information fields should be movable and scaleable within the circle. <u>Orientation.</u> Not applicable.	

Table 7-13. Target Control Measure Symbols.			
<i>CONTROL MEASURE</i>	<i>TEMPLATE</i>	<i>DRAW RULES</i>	<i>EXAMPLE</i>
Rectangular Target		<p><u>Anchor Points.</u> This graphic requires one (1) anchor point to define the centre of the area.</p> <p><u>Size/Shape.</u> Size is determined by the anchor point, the target length (in meters), and target width (in meters). A rectangular target is wider and longer than 200 meters. The information fields should be moveable and scaleable within the area.</p> <p>Shape: Rectangle.</p> <p><u>Orientation.</u> As determined by the Target Attitude (in mils).</p>	<p><i>Note: The symbols that have been coloured grey are used to help explain how the control measure is used, but they are not a part of the control measure.</i></p>
Irregular Target		<p><u>Anchor Points.</u> This graphic requires at least three anchor points to define the boundary of the area. Add as many points as necessary to accurately reflect the area's size and shape.</p> <p><u>Size/Shape.</u> Determined by the anchor points. The information field should be moveable within the area.</p> <p><u>Orientation.</u> Not applicable.</p>	

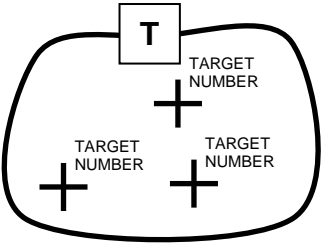
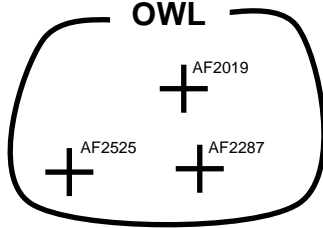
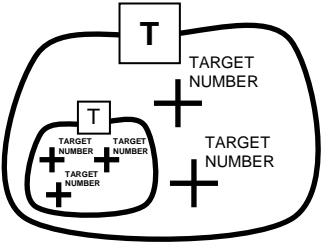
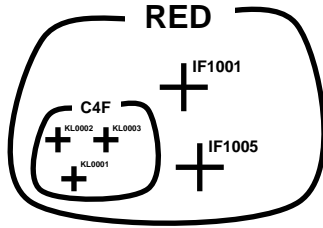
Table 7-13. Target Control Measure Symbols.			
<i>CONTROL MEASURE</i>	<i>TEMPLATE</i>	<i>DRAW RULES</i>	<i>EXAMPLE</i>
			<i>Note: The symbols that have been coloured grey are used to help explain how the control measure is used, but they are not a part of the control measure.</i>
<p>Series of Targets In artillery and naval fire support, a number of targets and/or group(s) of targets planned to support a manoeuvre phase. A series of targets may be indicated by a nickname. (AAP-6)</p>	<p>Point Targets</p> 	<p>Anchor Points. This graphic requires at least three anchor points to define the boundary of the area. Add as many points as necessary to accurately reflect the area's size and shape. Size/Shape. Determined by the anchor points. Orientation. Not applicable. The area will encompass two or more fire support graphics (point/single target, nuclear target, circular target, rectangular target, or area target). The naming convention determines whether the area describes a series or group of targets.</p>	
	<p>Targets and Groups of Targets</p> 		

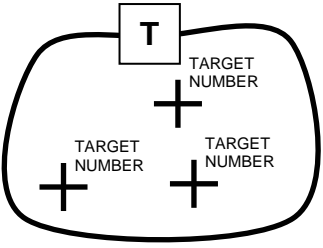
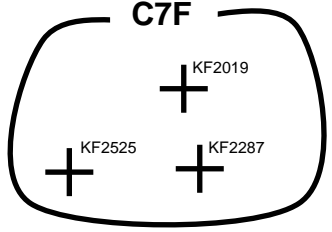
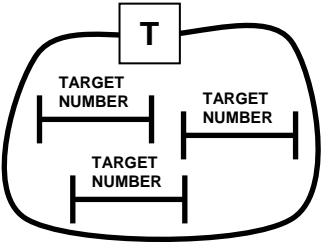
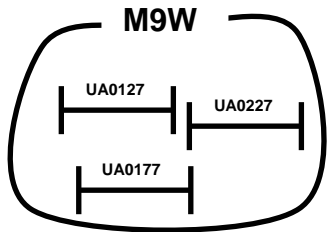
Table 7-13. Target Control Measure Symbols.			
<i>CONTROL MEASURE</i>	<i>TEMPLATE</i>	<i>DRAW RULES</i>	<i>EXAMPLE</i>
<p>Group of Targets Two or more targets on which fire is desired simultaneously. A group of targets is designated by a letter/number combination or a nickname. (AAP-6)</p>	<p>Point Targets</p> 		<p>C7F</p> 
	<p>Linear Targets</p> 		<p>M9W</p> 

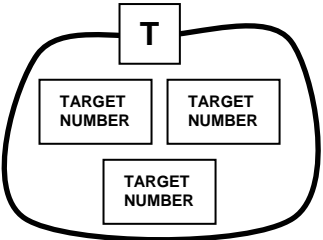
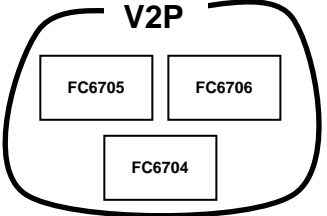


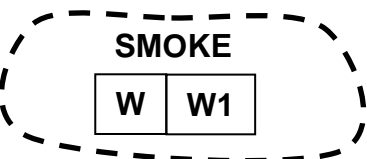
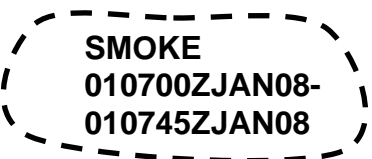
Table 7-13. Target Control Measure Symbols.			
CONTROL MEASURE	TEMPLATE	DRAW RULES	EXAMPLE
	<p>Area Targets</p> 		<p><i>Note: The symbols that have been coloured grey are used to help explain how the control measure is used, but they are not a part of the control measure.</i></p> 
Smoke		<p><u>Anchor Points.</u> This graphic requires at least three anchor points to define the boundary of the area. Add as many points as necessary to accurately reflect the area's size and shape.</p> <p><u>Size/Shape.</u> Determined by the anchor points. The information field should be moveable within the area.</p> <p><u>Orientation.</u> Not applicable.</p>	
Smoke Planned or On Order			



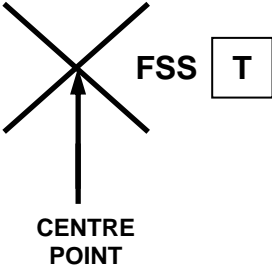

Table 7-13. Target Control Measure Symbols.			
CONTROL MEASURE	TEMPLATE	DRAW RULES	EXAMPLE
			<i>Note: The symbols that have been coloured grey are used to help explain how the control measure is used, but they are not a part of the control measure.</i>
Bomb Area			
Naval Gunfire			
Fire Support Station An exact location at sea within a fire support area from which a fire support ship delivers fire.		<u>Anchor Points.</u> This graphic requires one anchor point. The centre point defines the centre of the symbol. <u>Size/Shape.</u> Static. <u>Orientation.</u> The graphic is typically centred over the desired location.	

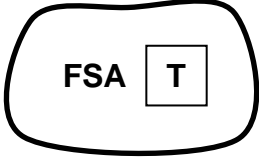

Table 7-13. Target Control Measure Symbols.			
<i>CONTROL MEASURE</i>	<i>TEMPLATE</i>	<i>DRAW RULES</i>	<i>EXAMPLE</i> <i>Note: The symbols that have been coloured grey are used to help explain how the control measure is used, but they are not a part of the control measure.</i>
<p>Fire Support Area An appropriate manoeuvre area assigned to fire support ships from which to deliver gun-fire support of an amphibious operation. (AAP-6)</p>		<p><u>Anchor Points.</u> This graphic requires at least three anchor points to define the boundary of the area. Add as many points as necessary to accurately reflect the area's size and shape. <u>Size/Shape.</u> Determined by the anchor points. The information fields should be moveable and scalable as a block within the area. <u>Orientation.</u> Not applicable.</p>	

Table 7-13. Target Control Measure Symbols.			
<i>CONTROL MEASURE</i>	<i>TEMPLATE</i>	<i>DRAW RULES</i>	<i>EXAMPLE</i>
Field Artillery			
Firing Point		<p><u>Anchor Points.</u> This graphic requires one anchor point. The point defines the tip of the inverted cone.</p> <p><u>Size/Shape.</u> Static.</p> <p><u>Orientation.</u> The graphic will typically be oriented upright, as shown in the example to the right.</p>	

Table 7-13. Target Control Measure Symbols.			
<i>CONTROL MEASURE</i>	<i>TEMPLATE</i>	<i>DRAW RULES</i>	<i>EXAMPLE</i>
Hide Point			

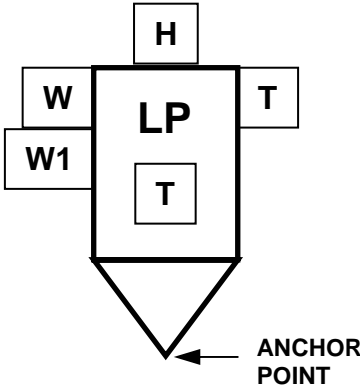
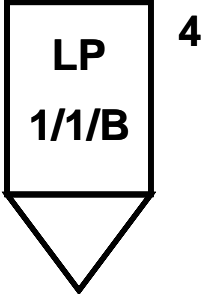
Table 7-13. Target Control Measure Symbols.			
<i>CONTROL MEASURE</i>	<i>TEMPLATE</i>	<i>DRAW RULES</i>	<i>EXAMPLE</i>
Launch Point	 <p>The diagram shows a central rectangle containing the letters 'LP' and a smaller rectangle below it containing the letter 'T'. Above the rectangle is a box with 'H', to the left is a box with 'W', and to the right is a box with 'T'. Further to the left is a box with 'W1'. Below the rectangle is a downward-pointing triangle. An arrow points to the bottom vertex of this triangle with the label 'ANCHOR POINT'.</p>		 <p>The diagram shows a downward-pointing arrowhead shape. Inside the rectangular part of the arrowhead, the letters 'LP' are at the top and '1/1/B' is below them. To the right of the arrowhead is the number '4'.</p>

Table 7-13. Target Control Measure Symbols.			
<i>CONTROL MEASURE</i>	<i>TEMPLATE</i>	<i>DRAW RULES</i>	<i>EXAMPLE</i>
Reload Point			<p>120700ZJUN08- 140700ZJUN08</p>

Table 7-13. Target Control Measure Symbols.			
<i>CONTROL MEASURE</i>	<i>TEMPLATE</i>	<i>DRAW RULES</i>	<i>EXAMPLE</i>
<p>Survey Control Point</p>			
<p>Position Area for Artillery An area assigned to an artillery unit where individual artillery systems can maneuver to increase their survivability.</p>		<p><u>Anchor Points.</u> This graphic requires two anchor points. Point 1 and 2 define the opposite corners of this four-sided figure. <u>Size/Shape.</u> Determined by the anchor points. <u>Orientation.</u> Not applicable.</p>	

Target Acquisition

0719. Target acquisition is the detection, identification, and location of a target in sufficient detail to permit the effective employment of weapons.

Table 7-14. Target Acquisition Control Measure Symbols.			
<i>CONTROL MEASURE</i>	<i>TEMPLATE</i>	<i>DRAW RULES</i>	<i>EXAMPLE</i> <i>Note: The symbols that have been coloured grey are used to help explain how the control measure is used, but they are not a part of the control measure.</i>
Artillery Target Intelligence Zone An area in enemy territory that the commander wishes to monitor closely.			
Call For Fire Zone A search area from which the commander wants to attack hostile firing systems.			

Table 7-14. Target Acquisition Control Measure Symbols.			
<i>CONTROL MEASURE</i>	<i>TEMPLATE</i>	<i>DRAW RULES</i>	<i>EXAMPLE</i> <i>Note: The symbols that have been coloured grey are used to help explain how the control measure is used, but they are not a part of the control measure.</i>
<p>Censor Zone An area from which radar is prohibited from reporting acquisitions. (Normally placed around friendly weapons systems and is most often used in non-linear or cross forward line of own troop activities.)</p>			
<p>Critical Friendly Zone An area, usually a friendly unit or location, that the manoeuvre commander designates as critical to the protection of an asset whose loss would seriously jeopardize the mission.</p>			

Table 7-14. Target Acquisition Control Measure Symbols.			
CONTROL MEASURE	TEMPLATE	DRAW RULES	EXAMPLE <i>Note: The symbols that have been coloured grey are used to help explain how the control measure is used, but they are not a part of the control measure.</i>
Dead Space Area An area where hostile weapons cannot be detected.			
Sensor Zone			
Target Build-up Area			

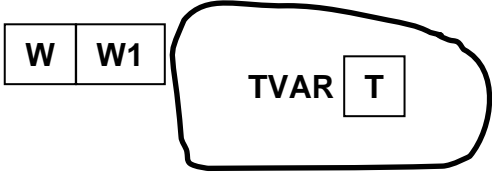
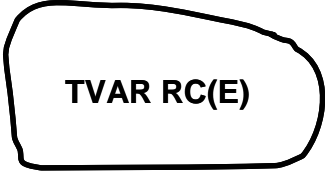
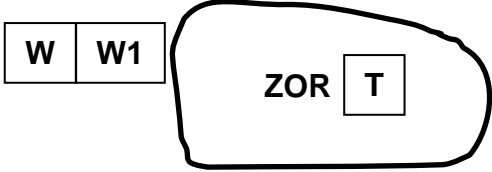
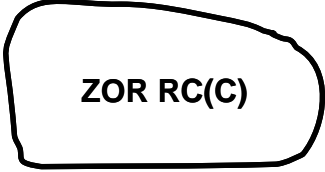
Table 7-14. Target Acquisition Control Measure Symbols.			
CONTROL MEASURE	TEMPLATE	DRAW RULES	EXAMPLE <i>Note: The symbols that have been coloured grey are used to help explain how the control measure is used, but they are not a part of the control measure.</i>
Target Value Area			
Zone of Responsibility			

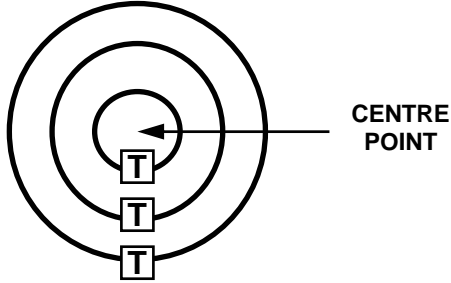
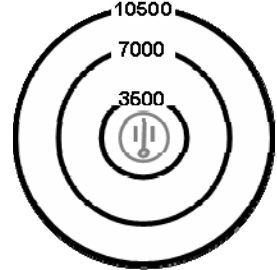
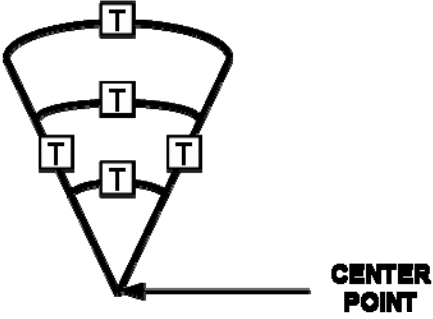
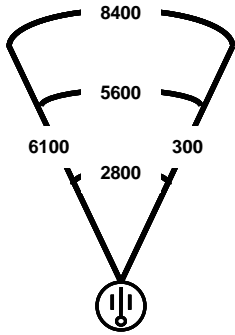
Table 7-14. Target Acquisition Control Measure Symbols.			
<i>CONTROL MEASURE</i>	<i>TEMPLATE</i>	<i>DRAW RULES</i>	<i>EXAMPLE</i>
Weapons/Radar Range Fan			
Circular		<p><u>Anchor Points.</u> This graphic requires one anchor point that defines an object at a dynamic grid location. This coordinate, which pinpoints the current physical location of a specific unit, weapon or acquisition system, may change with the movement of the object. The symbol for that object is located at the anchor point.</p> <p><u>Size/Shape.</u> Shapes are concentric circles. Size is defined by the minimum and maximum ranges (as many as required) measured from the anchor point. All units in meters.</p> <p><u>Orientation.</u> The centre point is typically centred over the known location of a weapon or target acquisition system. The orientation of the Circular Range Fan is the direction of engagement. The orientation may change as the object moves or changes.</p>	<p><i>Note: The symbols that have been coloured grey are used to help explain how the control measure is used, but they are not a part of the control measure.</i></p> 

Table 7-14. Target Acquisition Control Measure Symbols.			
<i>CONTROL MEASURE</i>	<i>TEMPLATE</i>	<i>DRAW RULES</i>	<i>EXAMPLE</i>
Sector		<p><u>Anchor Points.</u> This graphic requires one anchor point that defines an object at a dynamic grid location. This coordinate, which pinpoints the current physical location of a specific unit, weapon or acquisition system, may change with the movement of the object. The symbol for that object is located at the anchor point.</p> <p><u>Size/Shape.</u> Determined from the anchor point with a single azimuth that denotes Sector Centre. The maximum left and right limits of the sector are measured from the sector centreline. Multiple ranges and/or maximum left and right limits of the sector, as well as height, may be entered, as required, to define the sector. All ranges in meters.</p> <p><u>Orientation.</u> The centre point is typically centred over the known location of a weapon or target acquisition system. The orientation may change as the object moves or changes.</p>	<p><i>Note: The symbols that have been coloured grey are used to help explain how the control measure is used, but they are not a part of the control measure.</i></p> 

Force Protection

Obstacles

0720. An obstacle is a natural or man-made restriction to movement which will impose delay and which will normally require specific equipment or munitions to overcome. (AAP-19)

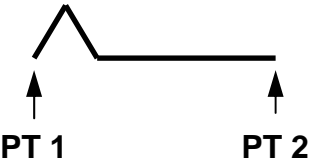

Table 7-15. Obstacle Control Measure Symbols.			
<i>CONTROL MEASURE</i>	<i>TEMPLATE</i>	<i>DRAW RULES</i>	<i>EXAMPLE</i>
<p>Abatis An obstacle constructed by the felling and interlacing of trees across a route. (AAP-19)</p>		<p><u>Anchor Points.</u> This graphic requires at least two anchor points, points 1 and 2, to define the line. Additional points can be defined to extend the line.</p> <p><u>Size/Shape.</u> The first and last anchor points determine the length of the line. The size of the tooth does not change.</p> <p><u>Orientation.</u> Orientation is determined by the anchor points.</p>	<p><i>Note: The symbols that have been coloured grey are used to help explain how the control measure is used, but they are not a part of the control measure.</i></p> 

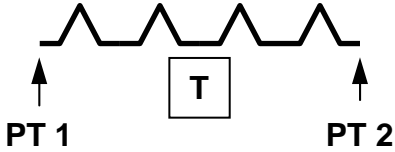

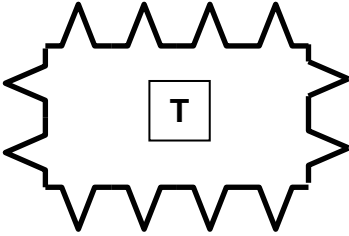
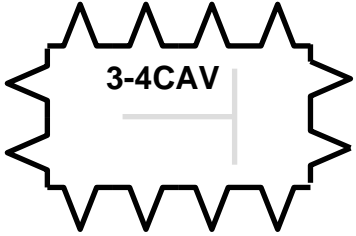
Table 7-15. Obstacle Control Measure Symbols.			
CONTROL MEASURE	TEMPLATE	DRAW RULES	EXAMPLE
<p>Obstacle Line A conceptual control measure used at battalion or brigade level to show placement intent without specifying a particular type of linear obstacle.</p>		<p>Anchor Points. This graphic requires at least two anchor points, points 1 and 2, to define the line. Additional points can be defined to extend the line. Size/Shape. The first and last anchor points determine the length of the line. Orientation. Orientation is determined by the anchor points.</p>	<p><i>Note: The symbols that have been coloured grey are used to help explain how the control measure is used, but they are not a part of the control measure.</i></p> 
<p>Obstacle Belt An area designated at brigade level in which barrier operations are focused. (AAP-19)</p>		<p>Anchor Points. This graphic requires at least three anchor points to define the boundary of the area. Add as many points as necessary to accurately reflect the area's size and shape. Size/Shape. Determined by the anchor points. The information fields should</p>	

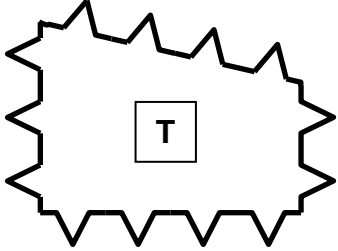
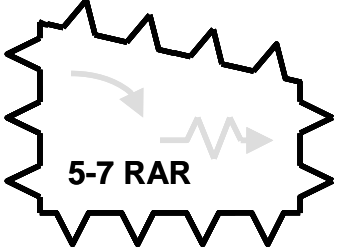
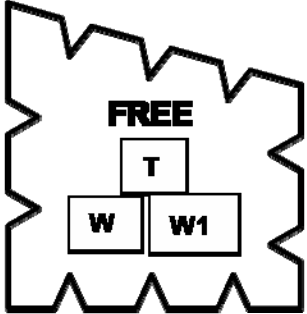

Table 7-15. Obstacle Control Measure Symbols.			
<i>CONTROL MEASURE</i>	<i>TEMPLATE</i>	<i>DRAW RULES</i>	<i>EXAMPLE</i>
<p>Obstacle Zone An area designated at corps or division level in which barrier operations are focused. It may be subdivided, below division, into a number of obstacle belts. (AAP-19)</p>		<p>be moveable within the area. <u>Orientation</u>. Not applicable.</p>	
<p>Obstacle Free Zone</p>			

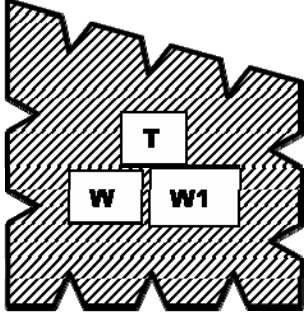

Table 7-15. Obstacle Control Measure Symbols.			
<i>CONTROL MEASURE</i>	<i>TEMPLATE</i>	<i>DRAW RULES</i>	<i>EXAMPLE</i> <i>Note: The symbols that have been coloured grey are used to help explain how the control measure is used, but they are not a part of the control measure.</i>
Obstacle Restricted Zone			

Table 7-15. Obstacle Control Measure Symbols.			
<i>CONTROL MEASURE</i>	<i>TEMPLATE</i>	<i>DRAW RULES</i>	<i>EXAMPLE</i>
Antitank Obstacles			
Antitank Ditch			
A ditch which is impassable to vehicles unaided. It may be prepared using machinery or explosives.			
Antitank Ditch – Under Construction		<p><u>Anchor Points.</u> This graphic requires at least two anchor points, points 1 and 2, to define the line. Additional points can be defined to extend the line.</p> <p><u>Size/Shape.</u> The first and last anchor points determine the length of the line.</p> <p><u>Orientation.</u> Orientation is determined by the anchor points. The teeth point toward enemy forces.</p>	

Table 7-15. Obstacle Control Measure Symbols.			
<i>CONTROL MEASURE</i>	<i>TEMPLATE</i>	<i>DRAW RULES</i>	<i>EXAMPLE</i>
Antitank Ditch – Completed			<p><i>Note: The symbols that have been coloured grey are used to help explain how the control measure is used, but they are not a part of the control measure.</i></p>
Obstacle Effects			
<p>Block An obstacle effect that integrates fire planning and obstacle effort to stop an attacker along a specific avenue of approach or to prevent him from passing through an engagement area.</p>	<p>The horizontal line is the limit of the enemy advance. The vertical line indicates where obstacles tie in to terrain that is untraffickable.</p>	<p><u>Anchor Points:</u> The graphic requires three anchor points. They define the endpoints of the symbol's vertical lines. <u>Size/Shape:</u> The anchor points determine the length of the horizontal and vertical lines. <u>Orientation:</u> The horizontal line's orientation must be selected. The vertical line faces away from the enemy with the horizontal line projecting toward from the enemy.</p>	

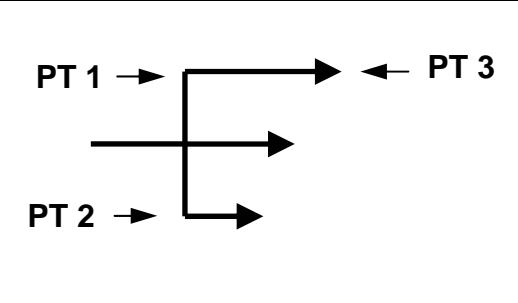
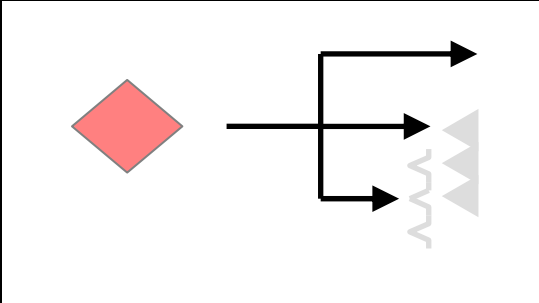
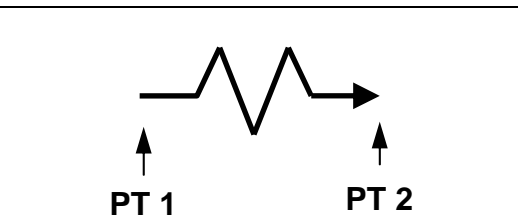
Table 7-15. Obstacle Control Measure Symbols.			
<i>CONTROL MEASURE</i>	<i>TEMPLATE</i>	<i>DRAW RULES</i>	<i>EXAMPLE</i>
			<i>Note: The symbols that have been coloured grey are used to help explain how the control measure is used, but they are not a part of the control measure.</i>
<p>Disrupt An obstacle effect that focuses fire planning and obstacle effort to cause the enemy to break up his formation and tempo, interrupt his timetable, commit breaching assets prematurely, and attack in a piecemeal effort.</p>	 <p>Short arrow indicates where enemy is disrupted by obstacles. Longer arrows indicates where movement is allowed and enemy is attacked by fires.</p>	<p><u>Anchor Points:</u> This graphic requires three anchor points. Points 1 and 2 define the end points of the graphic's vertical line. Point 3 defines the tip of the longest arrow. <u>Size/Shape:</u> Points 1 and 2 determine the height of the graphic and point 3 determines its length. The spacing between the graphic's arrows will stay proportional to the graphic's vertical line. The length of the short arrows will remain in proportion to the length of the longest arrow. <u>Orientation:</u> The arrows point away from enemy forces.</p>	
<p>Fix An obstacle effect that focuses fire planning and obstacle effort to slow an attacker's movement within a specified area,</p>		<p><u>Anchor Points:</u> This graphic requires 2 anchor points. Point 1 defines the tip of the arrowhead, and point 2 defines the rear of the graphic. <u>Size/Shape:</u> Points 1 and 2 determine the length of the</p>	

Table 7-15. Obstacle Control Measure Symbols.			
<i>CONTROL MEASURE</i>	<i>TEMPLATE</i>	<i>DRAW RULES</i>	<i>EXAMPLE</i>
normally an engagement area.	From the tip of the arrow to the back of the irregular part of the graphic indicates where enemy advance is slowed by obstacles.	graphic, which varies only in length. <u>Orientation:</u> The arrow points away from enemy forces with the tip of the arrowhead indicating the location of the action.	<i>Note: The symbols that have been coloured grey are used to help explain how the control measure is used, but they are not a part of the control measure.</i>
Turn An obstacle effect that integrates fire planning and obstacle effort to drive an enemy formation from one avenue of approach to an adjacent avenue of approach or into an engagement area.		<u>Anchor Points:</u> This symbol requires two anchor points. Point 1 defines the rear of the graphic. Point 2 defines the tip of the arrowhead. Point 3 defines the 90 degree arc. <u>Size/Shape:</u> Points 1 and 2 are connected by a 90 degree arc. Point 3 indicates on which side of the line the arc is placed. <u>Orientation:</u> The rear of the graphic identifies the enemy's location and the arrow points in the direction the obstacle should force the enemy to turn.	
	Direction of the arrow indicates the desired direction of turn.		

Table 7-15. Obstacle Control Measure Symbols.			
<i>CONTROL MEASURE</i>	<i>TEMPLATE</i>	<i>DRAW RULES</i>	<i>EXAMPLE</i>
Wire Obstacles			
Unspecified		<p><u>Anchor Points.</u> This graphic requires at least two anchor points, points 1 and 2, to define the line. Additional points can be defined to extend the line.</p> <p><u>Size/Shape.</u> The first and last anchor points determine the length of the line.</p> <p><u>Orientation.</u> Orientation is determined by the anchor points.</p>	
Single Fence			
Double Fence			

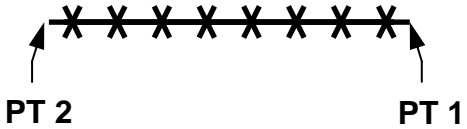
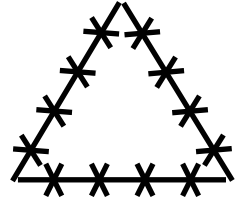
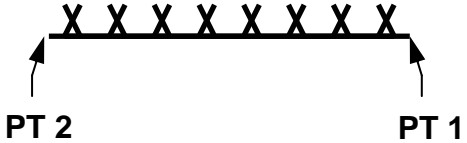
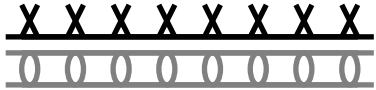
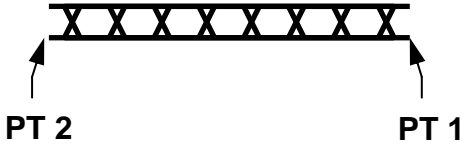
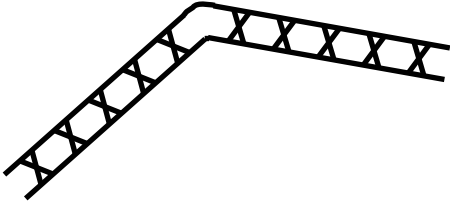
Table 7-15. Obstacle Control Measure Symbols.			
<i>CONTROL MEASURE</i>	<i>TEMPLATE</i>	<i>DRAW RULES</i>	<i>EXAMPLE</i>
Double Apron Fence			<p><i>Note: The symbols that have been coloured grey are used to help explain how the control measure is used, but they are not a part of the control measure.</i></p> 
Low Wire Fence			
High Wire Fence			

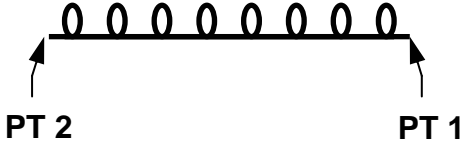
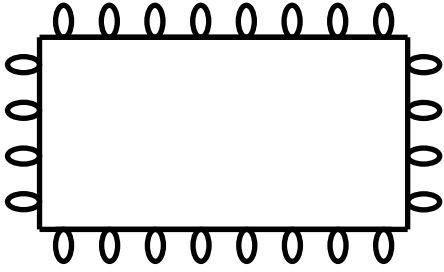
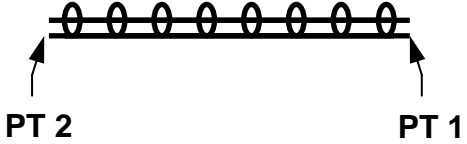

Table 7-15. Obstacle Control Measure Symbols.			
<i>CONTROL MEASURE</i>	<i>TEMPLATE</i>	<i>DRAW RULES</i>	<i>EXAMPLE</i>
Single Concertina			<p><i>Note: The symbols that have been coloured grey are used to help explain how the control measure is used, but they are not a part of the control measure.</i></p> 
Double Strand Concertina			

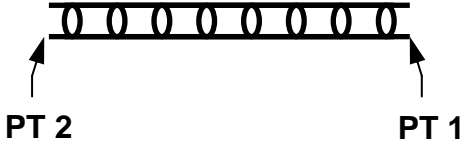
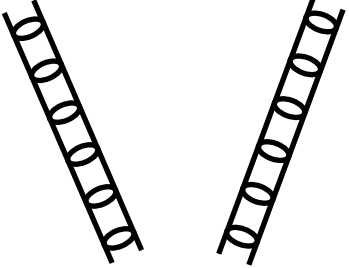
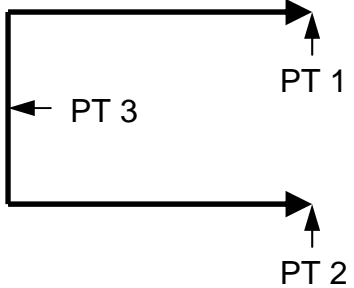

Table 7-15. Obstacle Control Measure Symbols.			
<i>CONTROL MEASURE</i>	<i>TEMPLATE</i>	<i>DRAW RULES</i>	<i>EXAMPLE</i>
Triple Strand Concertina			<p><i>Note: The symbols that have been coloured grey are used to help explain how the control measure is used, but they are not a part of the control measure.</i></p> 
Obstacle Bypass			
Obstacle Bypass Easy		<p><u>Anchor Points.</u> This graphic requires three anchor points. Points 1 and 2 define the tips of the arrowheads and point 3 defines the rear of the graphic.</p> <p><u>Size/Shape.</u> Points 1 and 2 determine the graphic's height and point 3 determines its length. The vertical line at the rear of the graphic will be the</p>	

Table 7-15. Obstacle Control Measure Symbols.			
<i>CONTROL MEASURE</i>	<i>TEMPLATE</i>	<i>DRAW RULES</i>	<i>EXAMPLE</i>
Obstacle Bypass Difficult		<p>same length as the opening. <u>Orientation.</u> The opening typically faces enemy forces.</p>	

Table 7-15. Obstacle Control Measure Symbols.			
<i>CONTROL MEASURE</i>	<i>TEMPLATE</i>	<i>DRAW RULES</i>	<i>EXAMPLE</i>
Obstacle Bypass Impossible		<p><u>Anchor Points.</u> This graphic requires three anchor points. Points 1 and 2 define the tips of the arrowheads and point 3 defines the rear of the graphic.</p> <p><u>Size/Shape.</u> Points 1 and 2 determine the graphic's height and point 3 determines its length. The vertical line at the rear of the graphic will be the same length as the opening, and the gap will be at the line's midpoint.</p> <p><u>Orientation.</u> The opening typically faces enemy forces.</p>	<p><i>Note: The symbols that have been coloured grey are used to help explain how the control measure is used, but they are not a part of the control measure.</i></p>

Table 7-15. Obstacle Control Measure Symbols.			
<i>CONTROL MEASURE</i>	<i>TEMPLATE</i>	<i>DRAW RULES</i>	<i>EXAMPLE</i>
Land Mines			
<p>In land mine warfare, an explosive ammunition designed to be placed under, on or near the ground or other surface area and to be actuated by the presence, proximity or contact of a person, land vehicle, aircraft or boat, including landing craft. (AAP-6)</p>			
<p>Antipersonnel Mine In land mine warfare, a mine designed to be exploded by the presence, proximity or contact of a person and that will incapacitate, wound or kill one or more persons. (AAP-19)</p>		<p><u>Anchor Points.</u> This graphic requires one anchor point. The centre point defines the centre of the circle. <u>Size/Shape.</u> Static. <u>Orientation.</u> The graphic is typically centred over the desired location.</p>	
<p>Antipersonnel Mine with Directional Effects</p>			

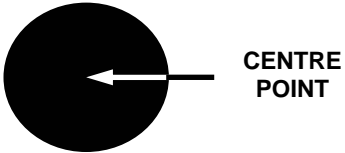
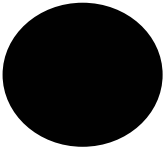
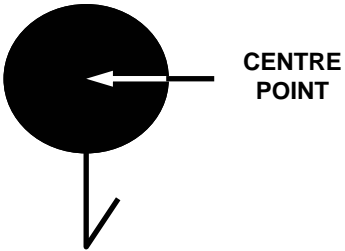
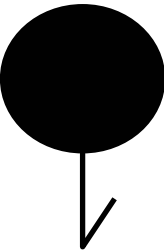
Table 7-15. Obstacle Control Measure Symbols.			
<i>CONTROL MEASURE</i>	<i>TEMPLATE</i>	<i>DRAW RULES</i>	<i>EXAMPLE</i> <i>Note: The symbols that have been coloured grey are used to help explain how the control measure is used, but they are not a part of the control measure.</i>
Antitank Mine A mine designed to immobilize or destroy a tank. (AAP-19)			
Antitank Mine with Antihandling Device A device intended to protect a mine and which is part of, linked to, attached to or placed under the mine and which activates when an attempt is made to tamper with or otherwise intentionally disturb the mine. (AAP-19)			

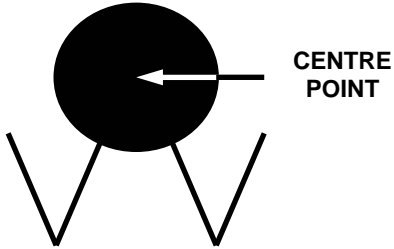
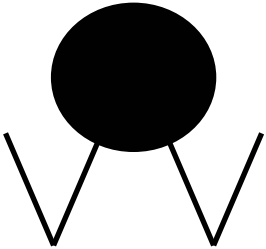
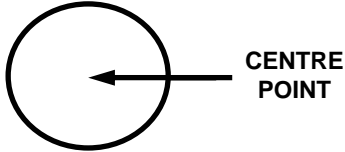
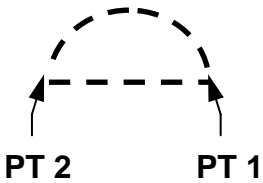

Table 7-15. Obstacle Control Measure Symbols.			
<i>CONTROL MEASURE</i>	<i>TEMPLATE</i>	<i>DRAW RULES</i>	<i>EXAMPLE</i>
<p>Wide Area Antitank Mine An antitank mine that detects and acquires targets then launches a subammunition that attacks the top of the targets.</p>			
	<p>Unspecified Mine</p>		
<p>Mine Cluster</p>		<p><u>Anchor Points.</u> This graphic requires at least two anchor points. Points 1 and 2 define the corners of the graphic. <u>Size/Shape.</u> Points 1 and 2 determine the length of the straight line. The radius of the semicircle is ½ the length of the straight line. <u>Orientation.</u> Not applicable.</p>	

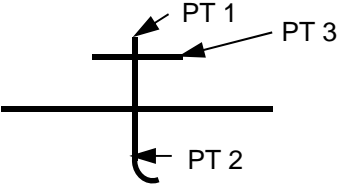
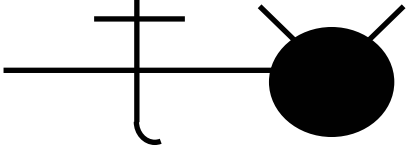
Table 7-15. Obstacle Control Measure Symbols.			
<i>CONTROL MEASURE</i>	<i>TEMPLATE</i>	<i>DRAW RULES</i>	<i>EXAMPLE</i>
Trip Wire		<p><u>Anchor Points.</u> This graphic requires three anchor points. Points 1 and 2 define the vertical straight line portion of the graphic. Point 3 defines an end of the horizontal line.</p> <p><u>Size/Shape.</u> Points 1 and 2 determine the length of the vertical, straight-line portion of the graphic and point 3 determines its width. The distance between the line connecting points 1 and 2, and point 3 is the radius of the 90 degree arc at the bottom of the graphic.</p> <p><u>Orientation.</u> Orientation is determined by the anchor points.</p>	<p><i>Note: The symbols that have been coloured grey are used to help explain how the control measure is used, but they are not a part of the control measure.</i></p> 

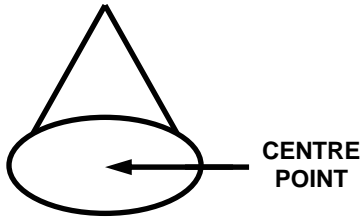
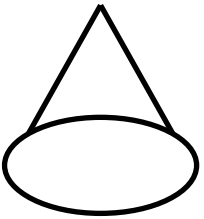
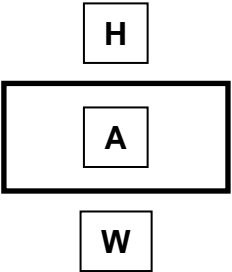
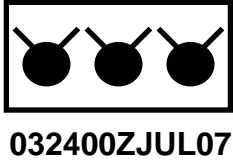
Table 7-15. Obstacle Control Measure Symbols.			
<i>CONTROL MEASURE</i>	<i>TEMPLATE</i>	<i>DRAW RULES</i>	<i>EXAMPLE</i>
<p>Booby Trap A device designed, constructed or adapted to kill or injure, which functions when a person disturbs or approaches an apparently harmless object or performs an apparently safe act. (AAP-6)</p>		<p><u>Anchor Points.</u> This graphic requires one anchor point. The centre point defines the centre of the circle. <u>Size/Shape.</u> Static. <u>Orientation.</u> The graphic is typically centred over the desired location.</p>	
Minefield			
In land mine warfare, a defined area in which mines have been emplaced. (AAP-6)			
<p>Completed Minefield</p>		<p><u>Anchor Points.</u> This graphic requires one anchor point. The centre point defines the centre of the graphic. <u>Size/Shape.</u> Static. The A field (graphics) will be filled with the type of mine(s) contained in the minefield (see mine types listed in this appendix). If only scatterable mines are</p>	<p style="text-align: center;">+S</p> 

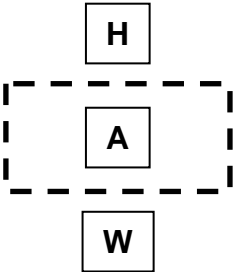
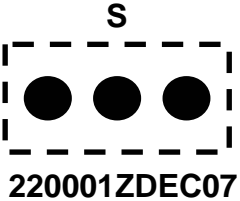
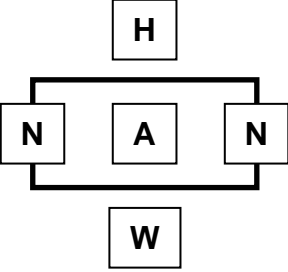

Table 7-15. Obstacle Control Measure Symbols.			
<i>CONTROL MEASURE</i>	<i>TEMPLATE</i>	<i>DRAW RULES</i>	<i>EXAMPLE</i>
Planned Minefield		<p>within the minefield, the H field will be filled with an "S" or a "+S" will be used if there is a mix of scatterable and other mines as appropriate, and a self-destruct time will be posted in the W field for the scatterable mines.</p> <p><u>Orientation.</u> The graphic's centre point is typically centred over the desired location. If an offset location indicator is used with this graphic, the indicator will point to the centre of mass of the minefield.</p>	<p style="text-align: center;">S</p> 
Known Enemy Minefield		<p>within the minefield, the H field will be filled with an "S" or a "+S" will be used if there is a mix of scatterable and other mines as appropriate, and a self-destruct time will be posted in the W field for the scatterable mines.</p> <p><u>Orientation.</u> The graphic's centre point is typically centred over the desired location. If an offset location indicator is used with this graphic, the indicator will point to the centre of mass of the minefield.</p>	

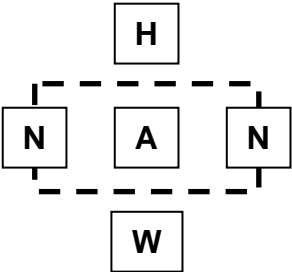
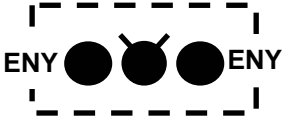
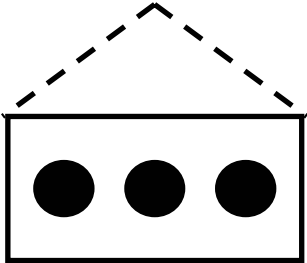
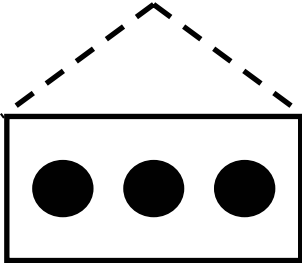
Table 7-15. Obstacle Control Measure Symbols.			
<i>CONTROL MEASURE</i>	<i>TEMPLATE</i>	<i>DRAW RULES</i>	<i>EXAMPLE</i>
Suspected or Templated Enemy Minefield			<p><i>Note: The symbols that have been coloured grey are used to help explain how the control measure is used, but they are not a part of the control measure.</i></p> 
Dummy Minefield			

Table 7-15. Obstacle Control Measure Symbols.			
<i>CONTROL MEASURE</i>	<i>TEMPLATE</i>	<i>DRAW RULES</i>	<i>EXAMPLE</i>
<p>Mined Area An area which is dangerous because of the presence or suspected presence of mines. (AAP-6)</p>		<p>Anchor Points. This graphic requires at least three anchor points to define the boundary of the area.</p> <p>Size/Shape. Determined by the anchor points. The graphic will be filled with the type of mine(s) contained in the minefield (see mine types listed in this appendix). If scatterable mines are within the minefield, the H field will be filled with an "S" or a "+S" as appropriate, and a self-destruct time will be posted in the W field.</p> <p>Orientation. Not applicable.</p>	
<p>Decoy Mined Area</p>			

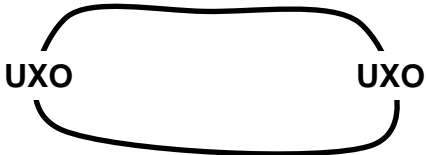
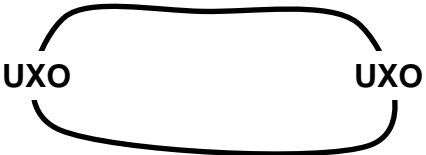
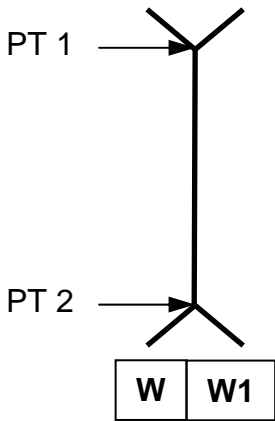
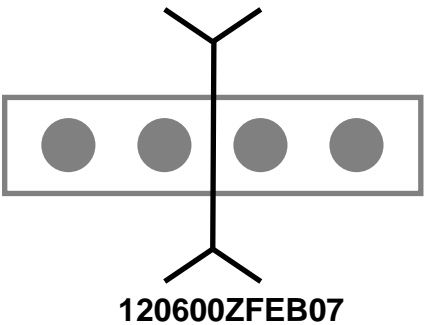
Table 7-15. Obstacle Control Measure Symbols.			
<i>CONTROL MEASURE</i>	<i>TEMPLATE</i>	<i>DRAW RULES</i>	<i>EXAMPLE</i>
<p>Unexploded Explosive Ordnance (UXO) Area</p>		<p><u>Anchor Points.</u> This graphic requires at least three anchor points to define the boundary of the area. Add as many points as necessary to accurately reflect the area's size and shape.</p> <p><u>Size/Shape.</u> Determined by the anchor points.</p> <p><u>Orientation.</u> Not applicable.</p>	<p><i>Note: The symbols that have been coloured grey are used to help explain how the control measure is used, but they are not a part of the control measure.</i></p> 
<p>Lane A route through an enemy or friendly obstacle that provides a passing force safe passage.</p>		<p><u>Anchor Points.</u> This graphic requires two anchor points. Points 1 and 2 define the tips of the arrowheads.</p> <p><u>Size/Shape.</u> Points 1 and 2 determine the length of the graphic, which varies only in length. The lines of the arrowhead will form an acute angle.</p> <p><u>Orientation.</u> Orientation is determined by the anchor points.</p>	 <p>120600ZFEB07</p>

Table 7-15. Obstacle Control Measure Symbols.			
<i>CONTROL MEASURE</i>	<i>TEMPLATE</i>	<i>DRAW RULES</i>	<i>EXAMPLE</i>
<p>Gap An area within a minefield or obstacle belt, free of live mines or obstacles, whose width and direction will allow a friendly force to pass through in tactical formation.</p>		<p><u>Anchor Points.</u> This graphic requires four points. Points 1 and 2 define one side of the gap and points 3 and 4 define the opposite side of the gap. <u>Size/Shape.</u> Determined by the anchor points. <u>Orientation.</u> Not applicable.</p>	<p><i>Note: The symbols that have been coloured grey are used to help explain how the control measure is used, but they are not a part of the control measure.</i></p>

Table 7-15. Obstacle Control Measure Symbols.			
<i>CONTROL MEASURE</i>	<i>TEMPLATE</i>	<i>DRAW RULES</i>	<i>EXAMPLE</i>
<p>Roadblocks, Craters, and Blown Bridges</p> <p>Crater obstacle – An obstacle consisting of one or more craters, created normally in a roadway using demolitions.</p>			
Planned		<p><u>Anchor Points.</u> This graphic requires three anchor points. Points 1 and 2 define the endpoints of the graphic, and point 3 defines the location of one side of the graphic.</p> <p><u>Size/Shape.</u> Points 1 and 2 determine the centreline of the graphic, and point 3 determines its width.</p> <p><u>Orientation.</u> Orientation is determined by the anchor points.</p>	
Explosives, State of Readiness 1 (Safe)			

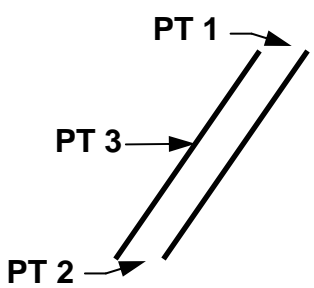
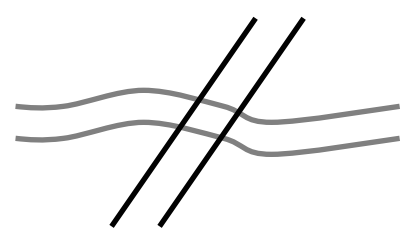
Table 7-15. Obstacle Control Measure Symbols.			
<i>CONTROL MEASURE</i>	<i>TEMPLATE</i>	<i>DRAW RULES</i>	<i>EXAMPLE</i> <i>Note: The symbols that have been coloured grey are used to help explain how the control measure is used, but they are not a part of the control measure.</i>
Explosives, State of Readiness 2 (armed but passable)			

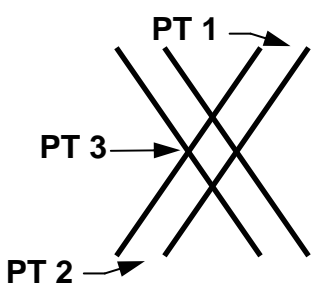
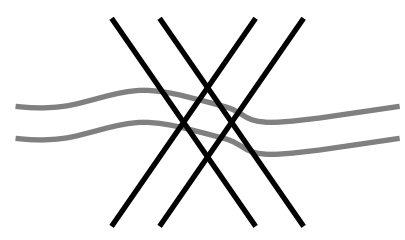
Table 7-15. Obstacle Control Measure Symbols.			
<i>CONTROL MEASURE</i>	<i>TEMPLATE</i>	<i>DRAW RULES</i>	<i>EXAMPLE</i>
Roadblock Complete (Executed)		<p><u>Anchor Points.</u> This graphic requires three anchor points. Points 1 and 2 define the endpoints of the graphic, and point 3 defines the location of one side of the graphic.</p> <p><u>Size/Shape.</u> Points 1 and 2 determine the centreline of one set of the graphic's parallel lines, and point 3 determines their width. The additional set of parallel lines stays proportional to the first set, and crosses the first set at the centre point of the overall graphic.</p> <p><u>Orientation.</u> Orientation is determined by the anchor points.</p>	<p><i>Note: The symbols that have been coloured grey are used to help explain how the control measure is used, but they are not a part of the control measure.</i></p> 

Table 7-15. Obstacle Control Measure Symbols.			
<i>CONTROL MEASURE</i>	<i>TEMPLATE</i>	<i>DRAW RULES</i>	<i>EXAMPLE</i>
Water Crossing Site			
The location of a single bridge or rafting site, or in an initial assault a site for the crossing of assault boats or for the swimming or fording of vehicles on a broad front.			
Assault Crossing		<p><u>Anchor Points.</u> This graphic requires four points. Points 1 and 2 define one side of the assault crossing site and points 3 and 4 define the opposite side of the assault crossing site.</p> <p><u>Size/Shape.</u> Determined by the anchor points.</p> <p><u>Orientation.</u> Not applicable.</p>	

Table 7-15. Obstacle Control Measure Symbols.			
<i>CONTROL MEASURE</i>	<i>TEMPLATE</i>	<i>DRAW RULES</i>	<i>EXAMPLE</i>
Bridge		<p><u>Anchor Points.</u> This graphic requires three anchor points. Points 1 and 2 define the endpoints of the first line. Point 3 defines the location of the parallel line.</p> <p><u>Size/Shape.</u> Points 1 and 2 determine the length of the graphic. Point 3 determines its width.</p>	<p><i>Note: The symbols that have been coloured grey are used to help explain how the control measure is used, but they are not a part of the control measure.</i></p>
Ferry		<p><u>Anchor Points.</u> This graphic requires two anchor points. Points 1 and 2 define the tips of the arrowheads.</p> <p><u>Size/Shape.</u> Points 1 and 2 determine the length of the graphic, which varies only in length. The arrowheads will be filled-in versions of a common arrowhead.</p> <p><u>Orientation.</u> Orientation is determined by the anchor points.</p>	

Table 7-15. Obstacle Control Measure Symbols.			
<i>CONTROL MEASURE</i>	<i>TEMPLATE</i>	<i>DRAW RULES</i>	<i>EXAMPLE</i>
Ford Easy		<p><u>Anchor Points.</u> This graphic requires three anchor points. Points 1 and 2 define the endpoints of the first line. Point 3 defines the location of the parallel line.</p> <p><u>Size/Shape.</u> Points 1 and 2 determine the length of the graphic. Point 3 determines its width.</p> <p><u>Orientation.</u> Orientation is determined by the anchor points.</p>	<p><i>Note: The symbols that have been coloured grey are used to help explain how the control measure is used, but they are not a part of the control measure.</i></p>
Ford Difficult		<p><u>Anchor Points.</u> This graphic requires three anchor points. Points 1 and 2 define the endpoints of the first line. Point 3 defines the location of the parallel line.</p> <p><u>Size/Shape.</u> Points 1 and 2 determine the length of the graphic. Point 3 determines its width.</p> <p><u>Orientation.</u> Orientation is determined by the anchor points.</p>	

Table 7-15. Obstacle Control Measure Symbols.			
<i>CONTROL MEASURE</i>	<i>TEMPLATE</i>	<i>DRAW RULES</i>	<i>EXAMPLE</i>
Raft Site		<p><u>Anchor Points.</u> This graphic requires two anchor points. Points 1 and 2 define the tips of the arrowheads.</p> <p><u>Size/Shape.</u> Points 1 and 2 determine the length of the graphic, which varies only in length. The lines of the arrowhead will form an acute angle.</p> <p><u>Orientation.</u> Orientation is determined by the anchor points.</p>	
<p>Engineer Regulating Point Checkpoint to ensure that vehicles do not exceed the capacity of the crossing means and to give drivers final instructions on site-specific procedures and information, such as speed and vehicle interval.</p>		<p><u>Anchor Points.</u> This graphic requires one anchor point. The point defines the tip of the inverted cone.</p> <p><u>Size/Shape.</u> Static.</p> <p><u>Orientation.</u> The graphic will typically be oriented upright, as shown in the example to the right.</p>	

Field Fortification Obstacle Control Measures

0721. A field fortification is an emplacement or shelter of a temporary nature which can be constructed with reasonable facility by units requiring no more than minor engineer supervisory and equipment participation. (AAP-6)



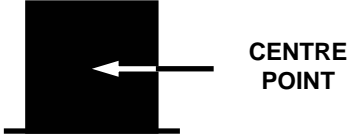

Table 7-16. Field Fortification Control Measure Symbols.			
<i>CONTROL MEASURE</i>	<i>TEMPLATE</i>	<i>DRAW RULES</i>	<i>EXAMPLE</i> <i>Note: The symbols that have been coloured grey are used to help explain how the control measure is used, but they are not a part of the control measure.</i>
Points			
Shelter		<p><u>Anchor Points.</u> This graphic requires one anchor point. The centre point defines the centre of the circle.</p> <p><u>Size/Shape.</u> Static.</p> <p><u>Orientation.</u> The graphic is typically centred over the desired location.</p>	
Above Ground Shelter			

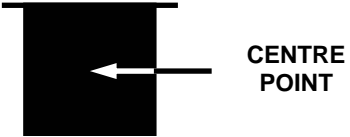

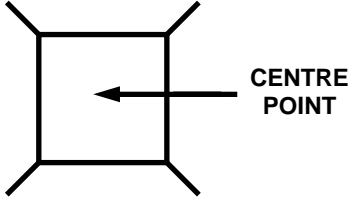
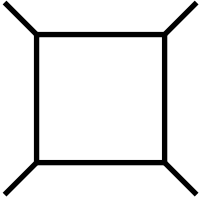

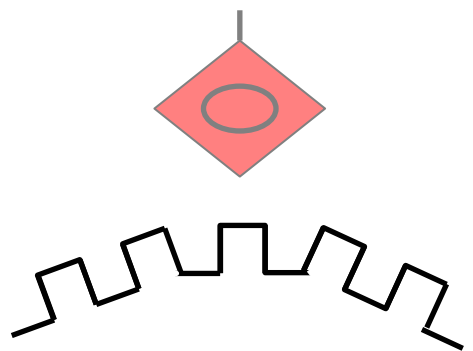
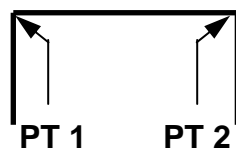

Table 7-16. Field Fortification Control Measure Symbols.			
<i>CONTROL MEASURE</i>	<i>TEMPLATE</i>	<i>DRAW RULES</i>	<i>EXAMPLE</i> <i>Note: The symbols that have been coloured grey are used to help explain how the control measure is used, but they are not a part of the control measure.</i>
Below Ground Shelter			
Fort			

Table 7-16. Field Fortification Control Measure Symbols.			
<i>CONTROL MEASURE</i>	<i>TEMPLATE</i>	<i>DRAW RULES</i>	<i>EXAMPLE</i>
Fortified Line		<p><u>Anchor Points.</u> This graphic requires at least two anchor points, points 1 and 2, to define the line. Additional points can be defined to extend the line.</p> <p><u>Size/Shape.</u> The first and last anchor points determine the length of the line.</p> <p><u>Orientation.</u> Orientation is determined by the anchor points. The ramparts typically point toward enemy forces.</p>	<p><i>Note: The symbols that have been coloured grey are used to help explain how the control measure is used, but they are not a part of the control measure.</i></p> 
Fortified Position		<p><u>Anchor Points.</u> This graphic requires two anchor points. Points 1 and 2 define the corners on the front of the graphic.</p> <p><u>Size/Shape.</u> Points 1 and 2 determine the length of the graphic, which varies only in length.</p> <p><u>Orientation.</u> Orientation is determined by the anchor points. The graphic typically faces enemy forces.</p>	

NATO UNCLASSIFIED

APP-6(C)

7-194

NATO UNCLASSIFIED

ORIGINAL

Chemical, Biological, Radiological and Nuclear Attacks and Events

0722. These control measure symbols depict those conditions found in an area resulting from immediate or persisting effects of chemical, biological, radiological or nuclear attacks or events (release other than attack).

Table 7-17. CBRN Defence Control Measure Symbols.			
<i>CONTROL MEASURE</i>	<i>TEMPLATE</i>	<i>DRAW RULES</i>	<i>EXAMPLE</i>
Chemical		<p><u>Anchor Points.</u> This graphic requires one anchor point. The anchor point defines the midpoint of the graphic's base.</p> <p><u>Size/Shape.</u> Static.</p> <p><u>Orientation.</u> The graphic will typically be oriented upright, as shown in the example to the right, but can be rotated in 90 degree increments.</p>	<p><i>Note: The symbols that have been coloured grey are used to help explain how the control measure is used, but they are not a part of the control measure.</i></p>

Table 7-17. CBRN Defence Control Measure Symbols.			
<i>CONTROL MEASURE</i>	<i>TEMPLATE</i>	<i>DRAW RULES</i>	<i>EXAMPLE</i>
Biological			<p style="text-align: center;"><i>Note: The symbols that have been coloured grey are used to help explain how the control measure is used, but they are not a part of the control measure.</i></p> <div style="text-align: center;"> <p>1</p> <p>211400ZNOV07 ANTHRAX</p> <p>LETTER ENY</p> <p>DT03071952</p> </div>

Table 7-17. CBRN Defence Control Measure Symbols.			
<i>CONTROL MEASURE</i>	<i>TEMPLATE</i>	<i>DRAW RULES</i>	<i>EXAMPLE</i>
Nuclear			<p><i>Note: The symbols that have been coloured grey are used to help explain how the control measure is used, but they are not a part of the control measure.</i></p>

Table 7-17. CBRN Defence Control Measure Symbols.			
<i>CONTROL MEASURE</i>	<i>TEMPLATE</i>	<i>DRAW RULES</i>	<i>EXAMPLE</i>
Nuclear Fallout Producing			<p style="text-align: center;"><i>Note: The symbols that have been coloured grey are used to help explain how the control measure is used, but they are not a part of the control measure.</i></p> <div style="text-align: center;"> <p>1</p> </div>

Table 7-17. CBRN Defence Control Measure Symbols.			
<i>CONTROL MEASURE</i>	<i>TEMPLATE</i>	<i>DRAW RULES</i>	<i>EXAMPLE</i>
<i>Note: The symbols that have been coloured grey are used to help explain how the control measure is used, but they are not a part of the control measure.</i>			
Decontamination Points/Sites			
General Decontamination Point/Site		<p><u>Anchor Points.</u> This graphic requires one anchor point. The point defines the tip of the inverted cone.</p> <p><u>Size/Shape.</u> Static.</p> <p><u>Orientation.</u> The graphic will typically be oriented upright, as shown in the example to the right.</p>	

Table 7-17. CBRN Defence Control Measure Symbols.			
<i>CONTROL MEASURE</i>	<i>TEMPLATE</i>	<i>DRAW RULES</i>	<i>EXAMPLE</i> <i>Note: The symbols that have been coloured grey are used to help explain how the control measure is used, but they are not a part of the control measure.</i>
Alternate Decontamination Point/Site			

Table 7-17. CBRN Defence Control Measure Symbols.			
<i>CONTROL MEASURE</i>	<i>TEMPLATE</i>	<i>DRAW RULES</i>	<i>EXAMPLE</i>
Equipment Decontamination Point/Site			<p>WHEELED</p>

Table 7-17. CBRN Defence Control Measure Symbols.			
<i>CONTROL MEASURE</i>	<i>TEMPLATE</i>	<i>DRAW RULES</i>	<i>EXAMPLE</i>
Troop Decontamination Point/Site			<p style="text-align: center;"><i>Note: The symbols that have been coloured grey are used to help explain how the control measure is used, but they are not a part of the control measure.</i></p> <div style="text-align: center;"> </div>

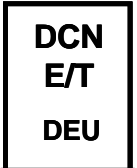
Table 7-17. CBRN Defence Control Measure Symbols.			
<i>CONTROL MEASURE</i>	<i>TEMPLATE</i>	<i>DRAW RULES</i>	<i>EXAMPLE</i>
Equipment/Troop Decontamination Point/Site			<p><i>Note: The symbols that have been coloured grey are used to help explain how the control measure is used, but they are not a part of the control measure.</i></p> <p>CONTRACTOR OPERATED</p> <p>210700ZAPR08  MND(S) 071800ZMAY08</p>

Table 7-17. CBRN Defence Control Measure Symbols.			
<i>CONTROL MEASURE</i>	<i>TEMPLATE</i>	<i>DRAW RULES</i>	<i>EXAMPLE</i> <i>Note: The symbols that have been coloured grey are used to help explain how the control measure is used, but they are not a part of the control measure.</i>
Operational Decontamination Point/Site			

Table 7-17. CBRN Defence Control Measure Symbols.			
<i>CONTROL MEASURE</i>	<i>TEMPLATE</i>	<i>DRAW RULES</i>	<i>EXAMPLE</i> <i>Note: The symbols that have been coloured grey are used to help explain how the control measure is used, but they are not a part of the control measure.</i>
Thorough Decontamination Point/Site			<p>MEDICAL</p>

Table 7-17. CBRN Defence Control Measure Symbols.			
<i>CONTROL MEASURE</i>	<i>TEMPLATE</i>	<i>DRAW RULES</i>	<i>EXAMPLE</i>
Main Equipment Decontamination Point/Site			
Forward Troop Decontamination Point/Site			

Table 7-17. CBRN Defence Control Measure Symbols.			
<i>CONTROL MEASURE</i>	<i>TEMPLATE</i>	<i>DRAW RULES</i>	<i>EXAMPLE</i>
Wounded Personnel Decontamination Site			<p><i>Note: The symbols that have been coloured grey are used to help explain how the control measure is used, but they are not a part of the control measure.</i></p>
Contaminated Areas			
Biologically Contaminated Area		<p><u>Anchor Points.</u> This graphic requires at least three anchor points to define the boundary of the area. Add as many points as necessary to accurately reflect the area's size and shape.</p> <p><u>Size/Shape.</u> Determined by the anchor points. The graphic should be moveable within the area.</p> <p><u>Orientation.</u> Not applicable.</p>	

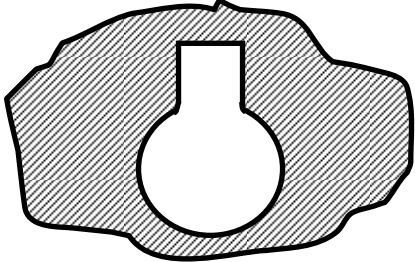
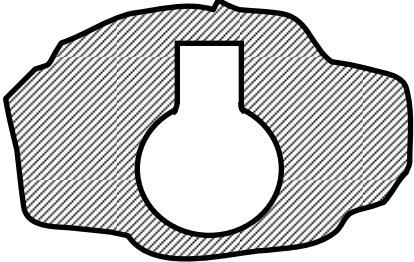
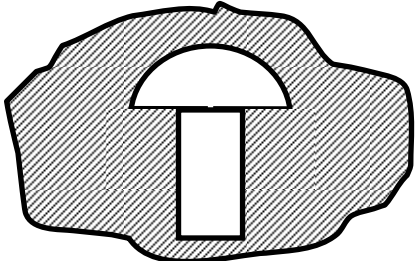
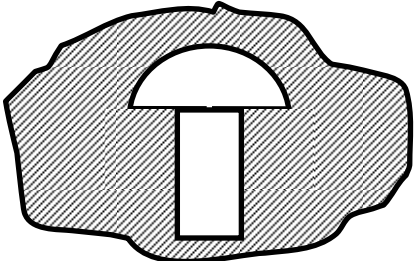
Table 7-17. CBRN Defence Control Measure Symbols.			
<i>CONTROL MEASURE</i>	<i>TEMPLATE</i>	<i>DRAW RULES</i>	<i>EXAMPLE</i> <i>Note: The symbols that have been coloured grey are used to help explain how the control measure is used, but they are not a part of the control measure.</i>
Chemical Contaminated Area			
Radioactive Contaminated Area			

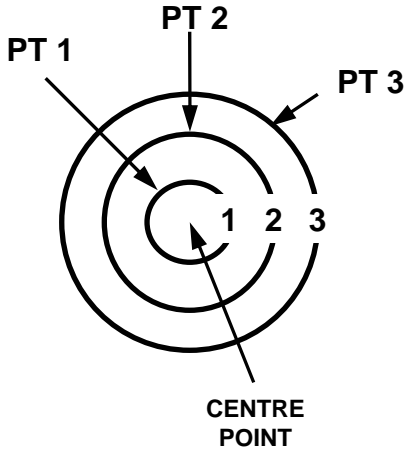
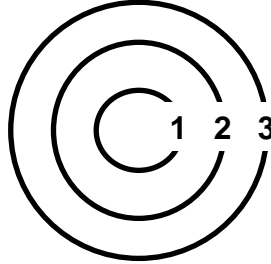
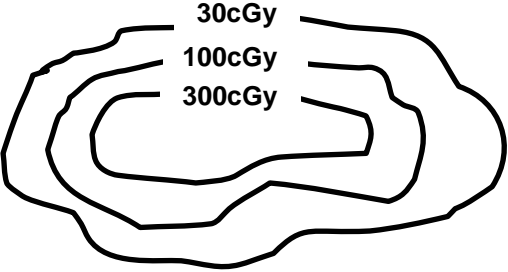
Table 7-17. CBRN Defence Control Measure Symbols.			
<i>CONTROL MEASURE</i>	<i>TEMPLATE</i>	<i>DRAW RULES</i>	<i>EXAMPLE</i>
Minimum Safe Distance Zone	 <p>The template diagram shows three concentric circles. The innermost circle is labeled '1', the middle circle is labeled '2', and the outermost circle is labeled '3'. A central point is labeled 'CENTRE POINT'. Three anchor points are labeled 'PT 1', 'PT 2', and 'PT 3'. Arrows point from these labels to their respective points on the circles.</p>	<p><u>Anchor Points.</u> This graphic requires four anchor points. The centre point defines the centre of the graphic. Points 1, 2, and 3 define the radii of circles 1, 2, and 3.</p> <p><u>Size/Shape.</u> As defined by the operator.</p> <p><u>Orientation.</u> The centre point is typically centred over the known/suspected source location of an NBC event.</p>	<p><i>Note: The symbols that have been coloured grey are used to help explain how the control measure is used, but they are not a part of the control measure.</i></p>  <p>The example diagram shows three concentric circles. The innermost circle is labeled '1', the middle circle is labeled '2', and the outermost circle is labeled '3'.</p>

Table 7-17. CBRN Defence Control Measure Symbols.			
<i>CONTROL MEASURE</i>	<i>TEMPLATE</i>	<i>DRAW RULES</i>	<i>EXAMPLE</i>
<p>Radiation Dose Rate Contour Line A line on a map, diagram or overlay joining all points at which the radiation dose rate at a given time is the same.</p>		<p><u>Anchor Points.</u> This graphic requires at least three anchor points to define the boundary of the area. Add as many points as necessary to accurately reflect the area's size and shape. <u>Size/Shape.</u> Determined by the anchor points. <u>Orientation.</u> Not applicable.</p>	<p><i>Note: The symbols that have been coloured grey are used to help explain how the control measure is used, but they are not a part of the control measure.</i></p>  <p>The diagram shows three nested, irregular contour lines. The innermost line is labeled '300cGy', the middle line is labeled '100cGy', and the outermost line is labeled '30cGy'. Each line is drawn with several anchor points connected by straight segments to define its irregular shape.</p>

Sustainment

Sustainment Control Measures

0723. Sustainment is the provision of logistics and personnel services required to maintain and prolong operations until successful mission accomplishment.

Table 7-18. Sustainment Point Control Measure Symbols			
CONTROL MEASURE	TEMPLATE	DRAW RULES	EXAMPLE
Points			
<p>Ambulance Exchange Point A location where a patient is transferred from one ambulance to another en route to a medical treatment facility. This may be an established point in an ambulance shuttle system or it may be designated independently.</p>		<p><u>Anchor Points.</u> This graphic requires one anchor point. The point defines the tip of the inverted cone. <u>Size/Shape.</u> Static. <u>Orientation.</u> The graphic will typically be oriented upright, as shown in the example to the right,</p>	

Table 7-18. Sustainment Point Control Measure Symbols			
CONTROL MEASURE	TEMPLATE	DRAW RULES	EXAMPLE
<p>Ammunition Supply Point An area designated to receive, store, reconfigure, and issue Class V material.</p>			
<p>Ammunition Transfer Point A designated temporary site from which Class V material is transferred to unit vehicles.</p>			

Table 7-18. Sustainment Point Control Measure Symbols			
CONTROL MEASURE	TEMPLATE	DRAW RULES	EXAMPLE
Cannibalisation Point			
Casualty Collection Point A specific location where casualties are assembled to be transported to a medical treatment facility, for example, a company aid post.			

Table 7-18. Sustainment Point Control Measure Symbols			
CONTROL MEASURE	TEMPLATE	DRAW RULES	EXAMPLE
<p>Civilian Collection Point A specific location where civilians are assembled to be transported to another location.</p>			<p>Note: The symbols that have been coloured grey are used to help explain how the control measure is used, but they are not a part of the control measure.</p>
<p>Detainee Collection Point A specific location where detainees are assembled to be transported to another location.</p>			

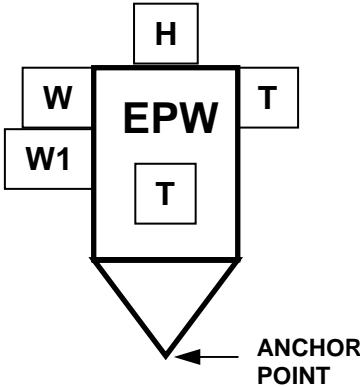
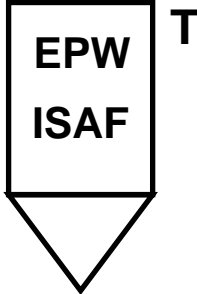
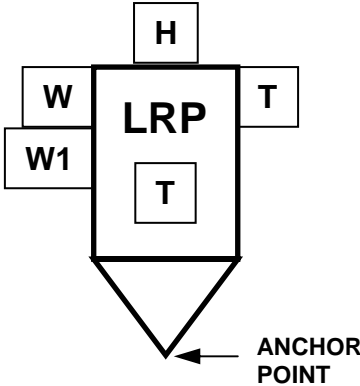
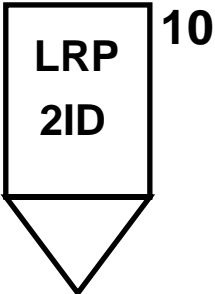
Table 7-18. Sustainment Point Control Measure Symbols			
CONTROL MEASURE	TEMPLATE	DRAW RULES	EXAMPLE
<p>Enemy Prisoner of War (EPW) Collection Point A specific location where enemy prisoners of war are assembled to be transported to another location.</p>	 <p>The diagram shows a central rectangle containing the text 'EPW' and a smaller rectangle below it containing the letter 'T'. Above the rectangle is a box with 'H', to the left are boxes with 'W' and 'W1', and to the right is a box with 'T'. Below the rectangle is a downward-pointing triangle with an arrow pointing to its vertex labeled 'ANCHOR POINT'.</p>		<p><i>Note: The symbols that have been coloured grey are used to help explain how the control measure is used, but they are not a part of the control measure.</i></p>  <p>The example shows a downward-pointing triangle with a rectangular box inside. The box contains the text 'EPW' and 'ISAF' stacked vertically. A small 'T' is positioned to the right of the top of the box.</p>
<p>Logistics Release Point (LRP)</p>	 <p>The diagram shows a central rectangle containing the text 'LRP' and a smaller rectangle below it containing the letter 'T'. Above the rectangle is a box with 'H', to the left are boxes with 'W' and 'W1', and to the right is a box with 'T'. Below the rectangle is a downward-pointing triangle with an arrow pointing to its vertex labeled 'ANCHOR POINT'.</p>		 <p>The example shows a downward-pointing triangle with a rectangular box inside. The box contains the text 'LRP' and '2ID' stacked vertically. A '10' is positioned to the right of the top of the box.</p>

Table 7-18. Sustainment Point Control Measure Symbols			
<i>CONTROL MEASURE</i>	<i>TEMPLATE</i>	<i>DRAW RULES</i>	<i>EXAMPLE</i>
<p>Maintenance Collection Point (MCP) A point established to collect equipment awaiting repair, controlled exchange, cannibalisation, or evacuation. It may be operated by the user or by the direct support maintenance units.</p>			
<p>Rearm, Refuel, and Resupply Point (R3P) A designated point through which a unit passes where it receives fuel, ammunition, and other necessary supplies to continue operations.</p>			

Table 7-18. Sustainment Point Control Measure Symbols			
CONTROL MEASURE	TEMPLATE	DRAW RULES	EXAMPLE
<p>Refuel On the Move (ROM) Point An area established to ensure that fuel tanks on combat and fuel servicing vehicles are full before they arrive in the unit's tactical assembly area.</p>			<p>ROM PPLI</p>
<p>Traffic Control Post (TCP) Manned post used to preclude interruption of traffic flow or movement along designated routes.</p>			<p>MSR1</p> <p>RC(N)</p>

Table 7-18. Sustainment Point Control Measure Symbols			
CONTROL MEASURE	TEMPLATE	DRAW RULES	EXAMPLE
<p>Trailer Transfer Point (TTP) A location where trailers are transferred from one carrier to another while en route.</p>			<p><i>Note: The symbols that have been coloured grey are used to help explain how the control measure is used, but they are not a part of the control measure.</i></p>

Table 7-18. Sustainment Point Control Measure Symbols			
<i>CONTROL MEASURE</i>	<i>TEMPLATE</i>	<i>DRAW RULES</i>	<i>EXAMPLE</i>
<p>Unit Maintenance Collection Point (UMCP) A location or series of locations, operated by a battalion maintenance platoon, that is the nearest point to the combat unit to which equipment can be recovered, and where limited parts are available, and some repairs can be performed.</p>			<p><i>Note: The symbols that have been coloured grey are used to help explain how the control measure is used, but they are not a part of the control measure.</i></p> <div style="text-align: center;"> </div>

Supply Points

0724. A supply point is any point where supplies are issued in detail. Supply points follow the format as shown above with a modification to the symbol. As with the symbol for supply units, there is an additional line placed toward the bottom of the box. In building points, the name/type of the point is abbreviated and positioned inside the top part of the point symbol in field “A”. For some supply symbols this may be a graphic icon. STANAG 2961 provides comparison charts for NATO and NATO nation classes of supply.

Table 7-19. Supply Point Control Measure Symbols.			
<i>CONTROL MEASURE</i>	<i>TEMPLATE</i>	<i>DRAW RULES</i>	<i>EXAMPLE</i>
General Supply Point		<p><u>Anchor Points.</u> This graphic requires one anchor point. The point defines the tip of the inverted cone.</p> <p><u>Size/Shape.</u> Static.</p> <p><u>Orientation.</u> The graphic will typically be oriented upright, as shown in the examples to the right,</p>	<p><i>Note: The symbols that have been coloured grey are used to help explain how the control measure is used, but they are not a part of the control measure.</i></p>

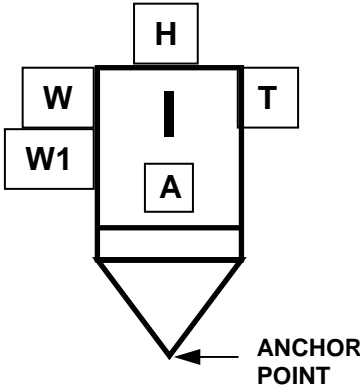
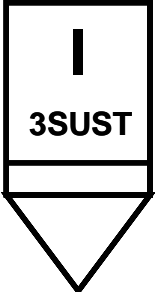
Table 7-19. Supply Point Control Measure Symbols.			
<i>CONTROL MEASURE</i>	<i>TEMPLATE</i>	<i>DRAW RULES</i>	<i>EXAMPLE</i>
<p>Class I Those items which are consumed by personnel or animals at the approximately uniform rate, irrespective of local changes in combat or terrain conditions. (STANAG 2961)</p>	 <p>The diagram shows a template for a Class I supply point symbol. It consists of a central vertical rectangle with a downward-pointing triangle at the bottom. The rectangle is divided into three horizontal sections. The top section contains a vertical bar with the letter 'I' inside. The middle section contains a horizontal bar with the letter 'A' inside. The bottom section is empty. To the left of the rectangle, there are two boxes: the top one contains 'W' and the bottom one contains 'W1'. To the right of the rectangle, there is a box containing 'T'. Above the rectangle, there is a box containing 'H'. Below the triangle, there is an arrow pointing to the bottom vertex, labeled 'ANCHOR POINT'.</p>		<p><i>Note: The symbols that have been coloured grey are used to help explain how the control measure is used, but they are not a part of the control measure.</i></p> <div style="text-align: center;">  <p>The example shows a Class I supply point symbol. It is a vertical rectangle with a downward-pointing triangle at the bottom. The rectangle is divided into three horizontal sections. The top section contains a vertical bar with the letter 'I' inside. The middle section contains the text '3SUST'. The bottom section is empty. To the right of the symbol, there is a large number '2'.</p> </div>

Table 7-19. Supply Point Control Measure Symbols.			
<i>CONTROL MEASURE</i>	<i>TEMPLATE</i>	<i>DRAW RULES</i>	<i>EXAMPLE</i>
<p>Class II Supplies for which allowances are established by tables of organization and equipment. (STANAG 2961)</p>			<p><i>Note: The symbols that have been coloured grey are used to help explain how the control measure is used, but they are not a part of the control measure.</i></p> <div style="text-align: center;"> </div>

Table 7-19. Supply Point Control Measure Symbols.			
<i>CONTROL MEASURE</i>	<i>TEMPLATE</i>	<i>DRAW RULES</i>	<i>EXAMPLE</i>
<p>Class III Fuels and lubricants for all purposes, except for operating aircraft or for use in weapons such as flame throwers. (STANAG 2961)</p>			<p><i>Note: The symbols that have been coloured grey are used to help explain how the control measure is used, but they are not a part of the control measure.</i></p> <div style="text-align: center;"> </div>

Table 7-19. Supply Point Control Measure Symbols.			
<i>CONTROL MEASURE</i>	<i>TEMPLATE</i>	<i>DRAW RULES</i>	<i>EXAMPLE</i>
<p>Class IV Supplies for which initial issue allowances are not prescribed by approved issue tables. (STANAG 2961)</p>			<p><i>Note: The symbols that have been coloured grey are used to help explain how the control measure is used, but they are not a part of the control measure.</i></p> <div style="text-align: center;"> </div>

Table 7-19. Supply Point Control Measure Symbols.			
<i>CONTROL MEASURE</i>	<i>TEMPLATE</i>	<i>DRAW RULES</i>	<i>EXAMPLE</i>
<p>Class V Ammunition, explosives and chemical agents of all types. (STANAG 2961)</p>			<p><i>Note: The symbols that have been coloured grey are used to help explain how the control measure is used, but they are not a part of the control measure.</i></p> <div style="text-align: center;"> <p>>20MM</p> </div>

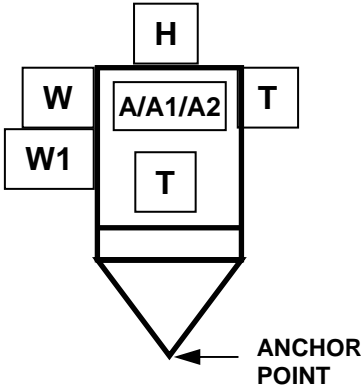
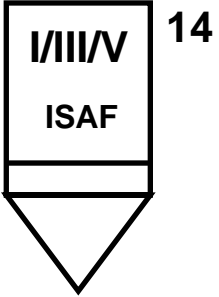
Table 7-19. Supply Point Control Measure Symbols.			
<i>CONTROL MEASURE</i>	<i>TEMPLATE</i>	<i>DRAW RULES</i>	<i>EXAMPLE</i>
<p>Multiple Supply Class Point Note: Use supply class numbers (I, II, III, IV and V) for A field or ALL for all classes of supply.</p>	 <p>The diagram shows a template for a supply point control measure symbol. It consists of a central vertical rectangle with a downward-pointing triangle at the bottom. The rectangle is divided into several sections. At the top is a small box containing the letter 'H'. Below this is a larger box containing 'A/A1/A2'. To the left of this box are two smaller boxes, one containing 'W' and one containing 'W1'. To the right is a box containing 'T'. Below the 'A/A1/A2' box is another box containing 'T'. Below the 'T' box is a horizontal line. Below the horizontal line is another horizontal line. Below the second horizontal line is the downward-pointing triangle. An arrow points to the bottom vertex of the triangle, labeled 'ANCHOR POINT'.</p>		 <p>The diagram shows an example of a supply point control measure symbol. It is a downward-pointing triangle with a rectangular box inside. The box is divided into two sections. The top section contains the Roman numeral 'I/III/V' followed by the number '14'. The bottom section contains the text 'ISAF'. Below the box is a horizontal line, and below that is the downward-pointing triangle.</p>

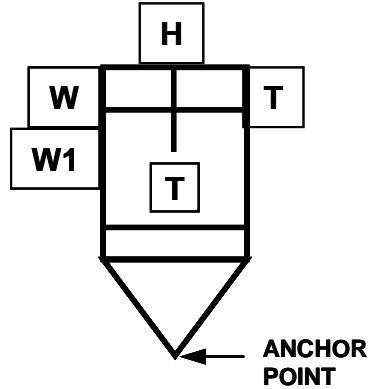
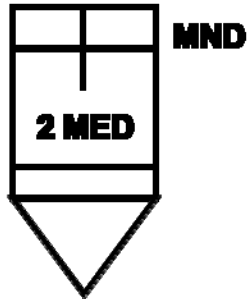
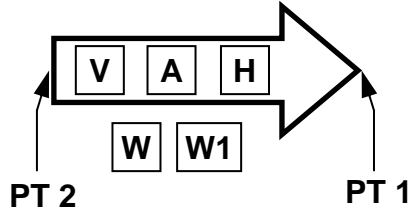
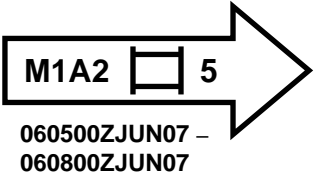
Table 7-19. Supply Point Control Measure Symbols.			
<i>CONTROL MEASURE</i>	<i>TEMPLATE</i>	<i>DRAW RULES</i>	<i>EXAMPLE</i>
Medical Supply Point	 <p>The diagram shows a shield-shaped template with a vertical line through the center. At the top is a box labeled 'H'. Below it, on the left and right sides, are boxes labeled 'W' and 'T' respectively. Further down, on the left side, is a box labeled 'W1'. In the center of the shield is a box labeled 'T'. At the bottom point of the shield, an arrow points to the label 'ANCHOR POINT'.</p>		<p><i>Note: The symbols that have been coloured grey are used to help explain how the control measure is used, but they are not a part of the control measure.</i></p>  <p>The diagram shows a shield-shaped symbol with a vertical line through the center. The top section is a rectangle with a horizontal line across it. Below this is a larger rectangle containing the text '2 MED'. The bottom section is a triangle pointing downwards. To the right of the shield is the label 'MND'.</p>
Convoy			
A group of vehicles organized for the purpose of control and orderly movement with or without escort protection. (AAP-6)			
Moving	 <p>The diagram shows a horizontal arrow pointing to the right. Inside the arrow's shaft are three boxes labeled 'V', 'A', and 'H' from left to right. Below the arrow, there are two boxes labeled 'W' and 'W1'. At the tail of the arrow, an arrow points to the label 'PT 2'. At the tip of the arrowhead, an arrow points to the label 'PT 1'.</p>	<p><u>Anchor Points.</u> This graphic requires two anchor points. Point 1 defines the tip of the arrowhead, and point 2 defines the rear of the graphic.</p> <p><u>Size/Shape.</u> Points 1 and 2 determine the length of the</p>	 <p>The diagram shows a horizontal arrow pointing to the right. Inside the arrow's shaft are three boxes labeled 'M1A2', a small square, and '5'. Below the arrow is the text '060500ZJUN07 - 060800ZJUN07'.</p>

Table 7-19. Supply Point Control Measure Symbols.			
<i>CONTROL MEASURE</i>	<i>TEMPLATE</i>	<i>DRAW RULES</i>	<i>EXAMPLE</i>
Halted		<p>graphic, which varies only in length. <u>Orientation.</u> The arrow points in the direction the convoy is moving.</p>	
Supply Route			
<p>Main Supply Route (MSR) The route or routes designated within an area of operations upon which the bulk of traffic flows in support of military operations. (AAP-6)</p>		<p><u>Anchor Points.</u> This graphic requires at least two anchor points, points 1 and 2, to define the line. Additional points can be defined to extend the line. <u>Size/Shape.</u> The first and last anchor points determine the length of the line. The line segment</p>	<p>MSR CAMEL</p>

Table 7-19. Supply Point Control Measure Symbols.			
CONTROL MEASURE	TEMPLATE	DRAW RULES	EXAMPLE
<p>Alternate Supply Route (ASR) A route or routes designated within an area of operations to provide for the movement of traffic when main supply routes become disabled or congested.</p>		<p>between each pair of anchor points will repeat all information associated with the line segment between points 1 and 2. <u>Orientation</u>. Orientation is determined by the anchor points.</p>	<p>ASR DONKEY</p>
	<p>One Way Traffic</p>		

Table 7-19. Supply Point Control Measure Symbols.			
<i>CONTROL MEASURE</i>	<i>TEMPLATE</i>	<i>DRAW RULES</i>	<i>EXAMPLE</i> <i>Note: The symbols that have been coloured grey are used to help explain how the control measure is used, but they are not a part of the control measure.</i>
Two Way Traffic			
Alternating Traffic			





Table 7-19. Supply Point Control Measure Symbols.			
<i>CONTROL MEASURE</i>	<i>TEMPLATE</i>	<i>DRAW RULES</i>	<i>EXAMPLE</i> <i>Note: The symbols that have been coloured grey are used to help explain how the control measure is used, but they are not a part of the control measure.</i>
Areas			
Detainee Holding Area		<u>Anchor Points.</u> This graphic requires at least three anchor points to define the boundary of the area. Add as many points as necessary to accurately reflect the area's size and shape. <u>Size/Shape.</u> Determined by the anchor points. <u>Orientation.</u> Not applicable.	
Enemy Prisoner of War Holding Area			

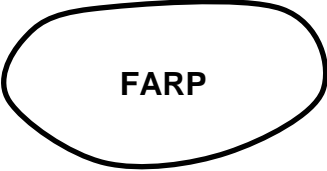

Table 7-19. Supply Point Control Measure Symbols.			
<i>CONTROL MEASURE</i>	<i>TEMPLATE</i>	<i>DRAW RULES</i>	<i>EXAMPLE</i> <i>Note: The symbols that have been coloured grey are used to help explain how the control measure is used, but they are not a part of the control measure.</i>
<p>Forward Arming and Refueling Point (FARP) A temporary facility — organized, equipped, and deployed by an aviation commander, and normally located in the main battle area closer to the area where operations are being conducted than the aviation unit's combat service area — to provide fuel and ammunition necessary for the employment of aviation maneuver units in combat. The forward arming and refueling point permits combat aircraft to rapidly refuel and rearm simultaneously.</p>			

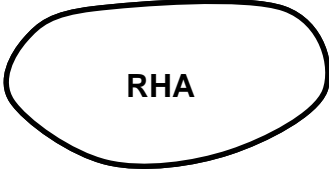
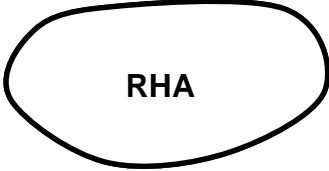
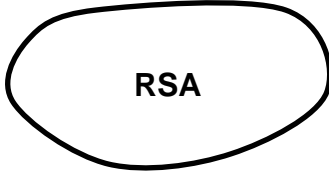
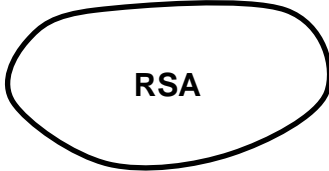
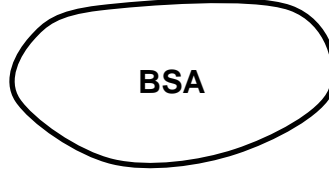
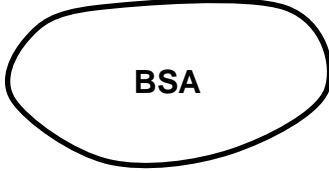
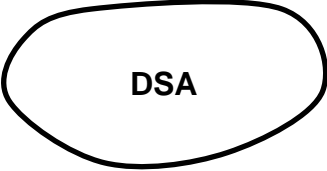
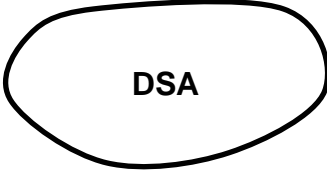
Table 7-19. Supply Point Control Measure Symbols.			
CONTROL MEASURE	TEMPLATE	DRAW RULES	EXAMPLE <i>Note: The symbols that have been coloured grey are used to help explain how the control measure is used, but they are not a part of the control measure.</i>
Refugee Holding Area			
Support Area			
Regimental Support Area		<u>Anchor Points.</u> This graphic requires at least three anchor points to define the boundary of the area. Add as many points as necessary to accurately reflect the area's size and shape. <u>Size/Shape.</u> Determined by the anchor points. <u>Orientation.</u> Not applicable.	
Brigade Support Area (BSA) A designated area in which combat service support elements from division support command and corps support command provide logistic support to a brigade.			

Table 7-19. Supply Point Control Measure Symbols.			
<i>CONTROL MEASURE</i>	<i>TEMPLATE</i>	<i>DRAW RULES</i>	<i>EXAMPLE</i> <i>Note: The symbols that have been coloured grey are used to help explain how the control measure is used, but they are not a part of the control measure.</i>
Division Support Area An area normally located in the division rear and often positioned near air-landing facilities along the main supply route.			

Intelligence

Intelligence Control Measures

0724. These control measure symbols support the planning, execution and support the acquisition of timely, tailored and accurate intelligence in relation with the commander's mission.

Table 7-20. Intelligence Control Measure Symbols.			
<i>CONTROL MEASURE</i>	<i>TEMPLATE</i>	<i>DRAW RULES</i>	<i>EXAMPLE</i>
Intelligence Coordination Line (ICL)		<p><u>Anchor Points.</u> This graphic requires at least two points, points 1 and 2, to define the line. Additional points can be defined to extend the line.</p> <p><u>Size/Shape.</u> The first and last anchor points determine the length of the line. The end-of line information will typically be posted at the ends of the line as it is displayed on the screen.</p> <p><u>Orientation.</u> Orientation is determined by the anchor points.</p>	<p><i>Note: The symbols that have been coloured grey are used to help explain how the control measure is used, but they are not a part of the control measure.</i></p>

Abbreviations and Acronyms

Abbreviations and Acronyms for Use with Control Measure Symbols

0725. Table 7-21 provides a list of abbreviations and acronyms for echelons and functional organizations to be used with boundaries.

Table 7-21. Abbreviations and Acronyms for Use With Boundaries		
<i>ECHELON</i>	<i>ABBREVIATION /ACRONYM</i>	<i>EXAMPLES</i> <i>Note: Any Unit identification can be followed by a 3 letter country code in parenthesis.</i>
Army Group	AG (AAP-15)	1AG
Army	A (AAP-15)	3A
Corps	Does not require an abbreviation. Corps are the only echelon to use Roman numerals.	II
Marine Expeditionary Force	MEF (AAP-15)	III MEF (Use Roman numerals)
Marine Air-Ground Task Force	MAGTF (AAP-15)	4MAGTF
Division	DIV (AAP-15)	1DIV
• Air Assault Division	• AAD	101AAD
• Airborne Division	• ABD (AAP-15)	6ABD

Table 7-21. Abbreviations and Acronyms for Use With Boundaries		
• Armoured Division	• AD (AAP-15)	2AD
• Cavalry Division	• CD	1CD
• Infantry Division	• ID (AAP-15)	52ID
• Marine Division	• MARD	1MARD
• Mechanized Division	• MD (AAP-15)	4MD
• Mountain Division	• MTND	10MTND
• Multinational Division	• MND (AAP-15)	1MND or MND(S) Note: Multinational divisions may use geographical references in parenthesis.
Brigade	BDE (AAP-15)	2BDE
• Air Assault Brigade	• AAB (AAP-15)	8AAB
• Airborne Brigade	• ABB (AAP-15)	3ABB
• Marine Expeditionary Brigade	• MEB (AAP-15)	6MEB
• Multinational Brigade	• MNB (AAP-15)	2MNB
• Naval Infantry Brigade	• NIB (AAP-15)	4NIB
Regiment	REGT (AAP-15)	21REGT
• Airborne Regiment	• ABR (AAP-15)	901ABR
Marine Expeditionary Unit	MEU (AAP-15)	3MEU
Group	GP	41GP
• Battle Group	• BG (AAP-15)	5BG
Battalion	BN (AAP-15)	7BN

Table 7-21. Abbreviations and Acronyms for Use With Boundaries		
Company	COY (AAP-15)	ACoy or 2COY
Platoon	PLT	2PLT
Team	TM	BTM

0726. Table 7-21 provides a list of abbreviations and acronyms for unit functions to be used with control measures. The asterisk behind the abbreviation indicates that it is in AAP-15.

Table 7-22. Abbreviation and Acronyms used in Control Measure Symbols for Unit Functions	
Function	Abbreviation /Acronyms
Air Defence	ADA*
Antitank/Anti armour	AT*
Armour	AR*
Aviation	AVN*
Chemical Biological Radiological Nuclear (CBRN)	CB
Civil Affairs	CA*
Combined Arms	CAR
Counterintelligence	CI*
Electronic Warfare	EW*
Engineer	EN

Table 7-22. Abbreviation and Acronyms used in Control Measure Symbols for Unit Functions	
Function	Abbreviation /Acronyms
Explosive Ordnance Disposal	EOD*
Field Artillery	FA*
Infantry	IN
Logistics	LOG*
Maintenance	MNT
Medical	MED*
Military Intelligence	MI*
Military Police	MP*
Naval	NAV
Ordnance	ORD
Quartermaster	QM
Reconnaissance	REC
Signal	SIG
Special Forces/	SF
Special Operations Force	SOF
Surveillance	SUR
Sustainment	SUST
Transportation	TPT

NATO UNCLASSIFIED

APP-6(C)

(INTENTIONALLY BLANK)

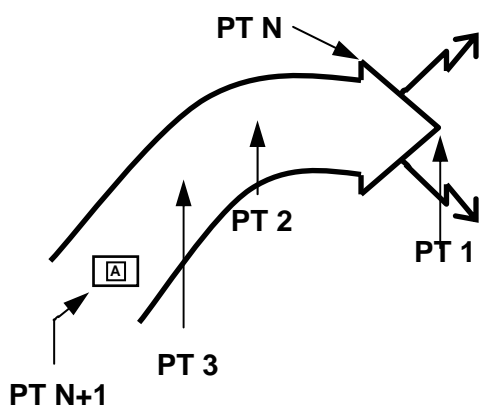
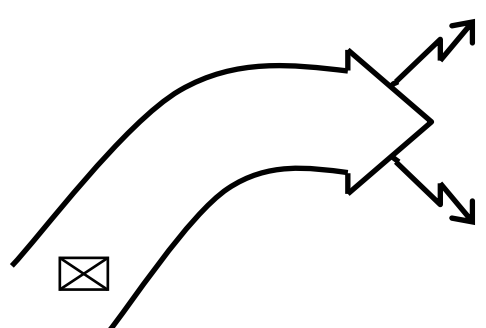
7-240

NATO UNCLASSIFIED

ORIGINAL

APPENDIX A TO CHAPTER 7, CONTROL MEASURE SYMBOLS: MISSION TASKS AND MISSION TASK VERBS

The tactical mission task and mission task verb symbols in Appendix A to Chapter 7 are the graphical representations of many of the tactical mission task verbs. Not all tactical mission tasks and mission task verbs have an associated symbol. Tactical mission task and mission task verb symbols are for use in course of action sketches, synchronization matrices, and manoeuvre sketches. They do not replace any part of the operation order. The tactical mission task verb symbols should be scaled to fit the map scale and size of unit for which they are being used. The examples shown here are for illustration purposes only. (This Annex supports Edition 1 of STANAG 2287.)

Table 7-A-1. Mission Tasks and Mission Task Verbs Symbols			
CONTROL MEASURE	TEMPLATE	DRAW RULES	EXAMPLE
<p>Advance To Contact (MTV) An offensive operation designed to gain or re-establish contact with the enemy. (AAP-6)</p>		<p><u>Anchor Points.</u> The graphic requires N anchor points, where N is between 3 and 50. Point 1 defines the tip of the arrowhead. Point N-1 defines the rear of the symbol. Point N defines the back of the arrowhead. Anchor points are numbered sequentially beginning with point number one (1), in increments of one (1). <u>Size/Shape.</u> Points 1 through N-1 and 2 determine the graphic's centreline and Point N determines the width.</p>	<p><i>Note: The symbols that have been colored gray are used to help explain how the control measure is used, but they are not a part of the control measure.</i></p> 

7-A-1

Table 7-A-1. Mission Tasks and Mission Task Verbs Symbols

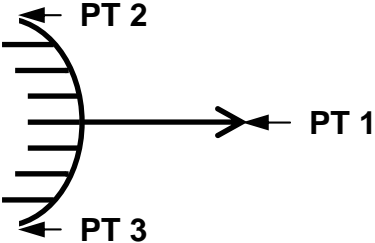
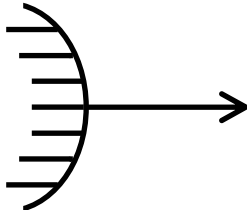
CONTROL MEASURE	TEMPLATE	DRAW RULES	EXAMPLE <i>Note: The symbols that have been colored gray are used to help explain how the control measure is used, but they are not a part of the control measure.</i>
<p>Ambush (MTV) A surprise attack by fire from concealed positions on a moving or temporarily halted enemy.</p>		<p>Orientation. The arrowhead typically points toward enemy forces.</p> <p>Anchor Points. This graphic requires three anchor points. Point 1 is the tip of the arrowhead. Points 2 and 3 define the endpoints of the curved line on the back side of the graphic.</p> <p>2. Size/Shape. Points 2 and 3 determine the length of the curved line on the back side of the graphic. The rear of the arrow should connect to the midpoint of the line between points 2 and 3.</p> <p>3. Orientation. Orientation is determined by the anchor points. The back side of the graphic encompasses the ambush position with the arrowhead shaft positioned at the centre of mass, while the arrowhead points in the direction of fire.</p>	

Table 7-A-1. Mission Tasks and Mission Task Verbs Symbols

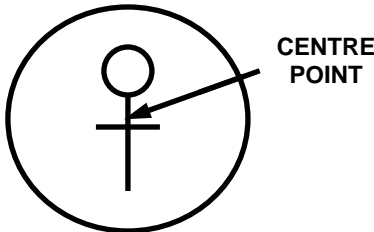
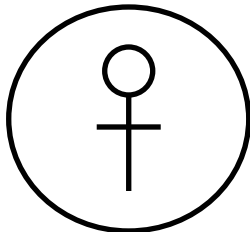
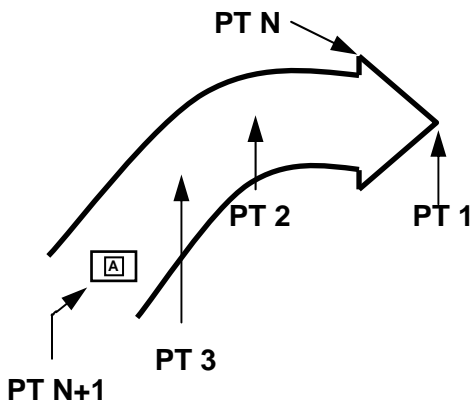
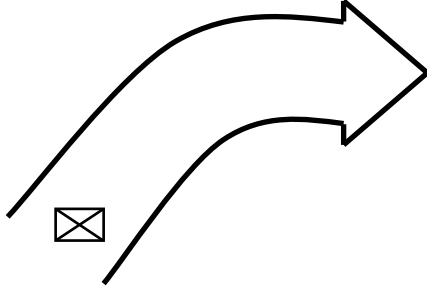
CONTROL MEASURE	TEMPLATE	DRAW RULES	EXAMPLE <i>Note: The symbols that have been colored gray are used to help explain how the control measure is used, but they are not a part of the control measure.</i>
<p>Arrest (MTV) To seize and hold a person under the authority of the law. (STANAG 2287)</p>		<p><u>Anchor Points.</u> This graphic requires one anchor point. The centre point defines the centre of the symbol. <u>Size/Shape.</u> Static. <u>Orientation.</u> The graphic is typically centered over the desired location.</p>	
<p>Attack (MTV) Take offensive action against a specified objective. (STANAG 2287)</p>		<p><u>Anchor Points.</u> The graphic requires N anchor points, where N is between 3 and 50. Point 1 defines the tip of the arrowhead. Point N-1 defines the rear of the symbol. Point N defines the back of the arrowhead. Anchor points are numbered sequentially beginning with point number one (1), in increments of one (1). <u>Size/Shape.</u> Points 1 through N-1 and 2 determine the graphic's centreline and Point N determines the width. <u>Orientation.</u> The arrowhead typically points toward enemy forces.</p>	

Table 7-A-1. Mission Tasks and Mission Task Verbs Symbols

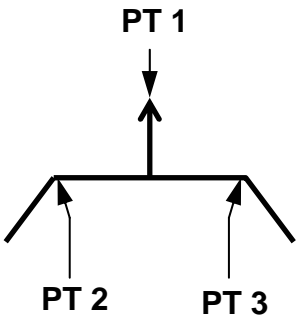
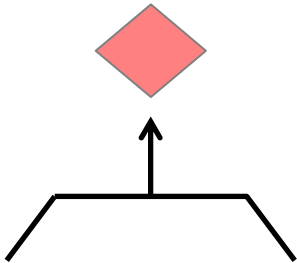
CONTROL MEASURE	TEMPLATE	DRAW RULES	EXAMPLE <i>Note: The symbols that have been colored gray are used to help explain how the control measure is used, but they are not a part of the control measure.</i>
<p>Attack By Fire (MTV) Engage an enemy with direct fires, supported by indirect fires, without closing with him. (STANAG 2287)</p>		<p>Anchor Points. This graphic requires three anchor points. Point 1 is the tip of the arrowhead. Points 2 and 3 define the endpoints of the straight line on the back side of the graphic.</p> <p>Size/Shape. Points 2 and 3 determine the length of the straight line on the back side of the graphic. The rear of the arrow should connect to the midpoint of the line between points 2 and 3.</p> <p>Orientation. Orientation is determined by the anchor points. The back side of the graphic encompasses the firing position, while the arrowhead typically points at the target .</p>	

Table 7-A-1. Mission Tasks and Mission Task Verbs Symbols

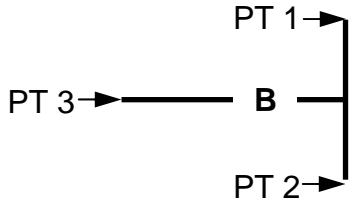
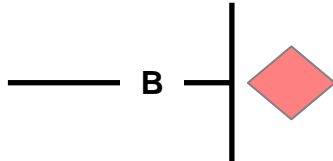
CONTROL MEASURE	TEMPLATE	DRAW RULES	EXAMPLE <i>Note: The symbols that have been colored gray are used to help explain how the control measure is used, but they are not a part of the control measure.</i>
<p>Block (MT/MTV) Deny enemy access to a given area, or to prevent his advance in a particular direction. (STANAG 2287)</p>		<p><u>Anchor Points.</u> This graphic requires three anchor points. Points 1 and 2 define the endpoints of the graphic's vertical line. Point 3 defines the the endpoint of the graphic's horizontal line.</p> <p><u>Size/Shape.</u> Points 1 and 2 determine the length of the vertical line. Points 2 and 3 determine the length of the horizontal line, which will project perpendicularly from the midpoint of the vertical line.</p> <p><u>Orientation.</u> The head of the "T" faces enemy forces.</p>	

Table 7-A-1. Mission Tasks and Mission Task Verbs Symbols

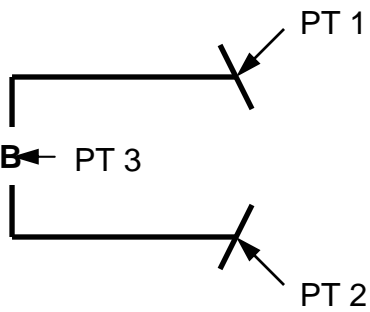
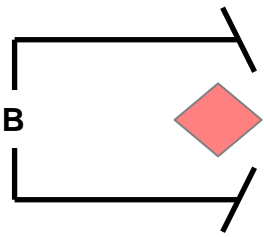
CONTROL MEASURE	TEMPLATE	DRAW RULES	EXAMPLE <i>Note: The symbols that have been colored gray are used to help explain how the control measure is used, but they are not a part of the control measure.</i>
<p>Breach (MT/MTV) Break through or secure passage through an enemy defence, obstacle, or fortification. (STANAG 2287)</p>		<p>Anchor Points. This graphic requires three anchor points. Points 1 and 2 define the endpoints of the graphic's opening and point 3 defines the rear of the graphic. Size/Shape. Points 1 and 2 determine the graphic's height and point 3 determines its length. The vertical line at the rear of the graphic will be the same height as the opening. Orientation. The opening defines the span of the breach and faces enemy forces.</p>	

Table 7-A-1. Mission Tasks and Mission Task Verbs Symbols

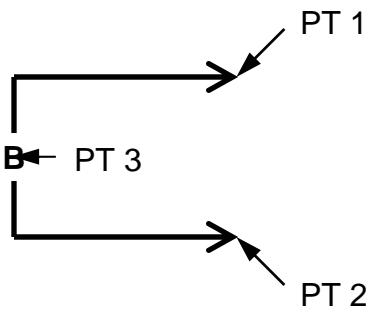
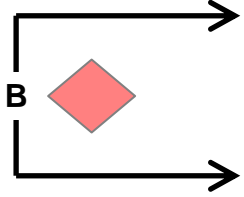
CONTROL MEASURE	TEMPLATE	DRAW RULES	EXAMPLE <i>Note: The symbols that have been colored gray are used to help explain how the control measure is used, but they are not a part of the control measure.</i>
<p>Bypass (MT/MTV) Manoeuvre around an obstacle, position, or enemy force to maintain the momentum of advance. (STANAG 2287)</p>		<p>Anchor Points. This graphic requires three anchor points. Points 1 and 2 define the endpoints of the graphic's opening and point 3 defines the rear of the graphic. Size/Shape. Points 1 and 2 determine the graphic's height and point 3 determines its length. The vertical line at the rear of the graphic will be the same height as the opening. Orientation. The opening defines the span of the bypass and faces enemy forces.</p>	

Table 7-A-1. Mission Tasks and Mission Task Verbs Symbols

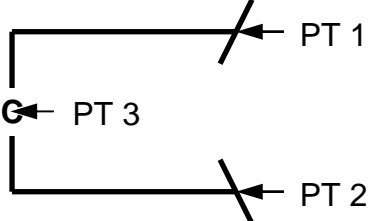
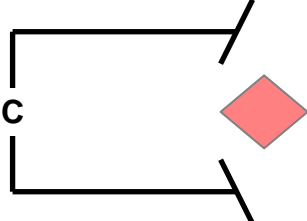
CONTROL MEASURE	TEMPLATE	DRAW RULES	EXAMPLE <i>Note: The symbols that have been colored gray are used to help explain how the control measure is used, but they are not a part of the control measure.</i>
<p>Canalize (MT/MTV) Restrict enemy movement to a narrow zone. (STANAG 2287)</p>		<p>Anchor Points. This graphic requires three anchor points. Points 1 and 2 define the endpoints of the graphic's opening and point 3 defines the rear of the graphic.</p> <p>Size/Shape. Points 1 and 2 determine the graphic's height and point 3 determines its length. The vertical line at the rear of the graphic will be the same height as the opening.</p> <p>Orientation. The opening defines the span of the canalization and faces enemy forces.</p>	

Table 7-A-1. Mission Tasks and Mission Task Verbs Symbols

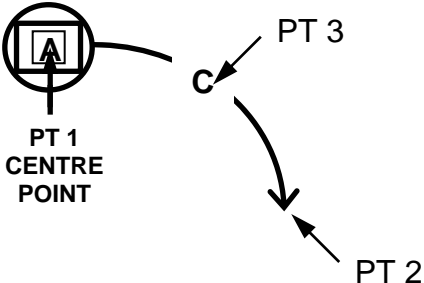
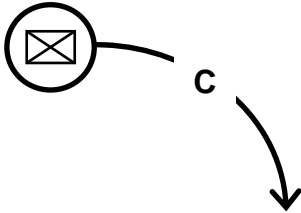
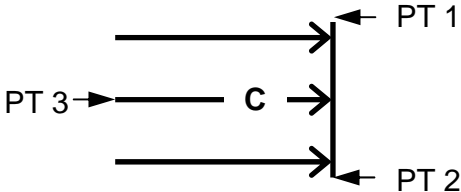
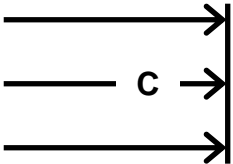
CONTROL MEASURE	TEMPLATE	DRAW RULES	EXAMPLE <i>Note: The symbols that have been colored gray are used to help explain how the control measure is used, but they are not a part of the control measure.</i>
<p>Capture (MTV) Gain possession of specified enemy personnel, materiel or information. (STANAG 2287)</p>		<p>Anchor Points. This symbol requires two anchor points. Point 1 defines the centre point of the circle. Point 2 defines the tip of the arrowhead. Point 3 defines the 90 degree arc. Size/Shape. Points 1 and 2 are connected by a 90 degree arc. The circle will at least be large enough to accommodate a unit symbol. Point 3 indicates on which side of the line the arc is placed. Orientation. The arrowhead identifies the location of the object to be captured, and the circle identifies the unit(s) assigned the task.</p>	
<p>Clear (MT/MTV) Remove all enemy forces and eliminate organized resistance in an assigned area.</p>		<p>Anchor Points. This graphic requires three anchor points. Points 1 and 2 define the endpoints of the graphic's vertical line and point 3 defines the rear of the graphic. Size/Shape. Points 1 and 2 determine the graphic's height and point 3 determines its length. The spacing between the graphic's arrows will stay proportional to the graphic's height. The tip of</p>	

Table 7-A-1. Mission Tasks and Mission Task Verbs Symbols

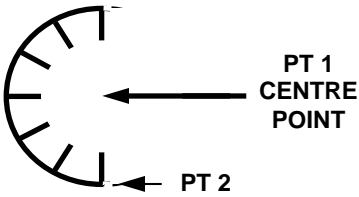
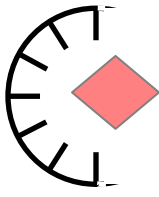
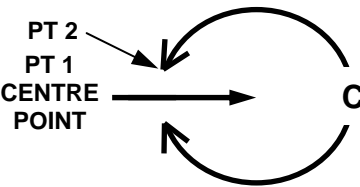
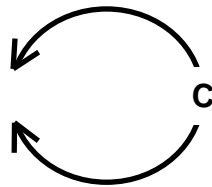
CONTROL MEASURE	TEMPLATE	DRAW RULES	EXAMPLE <i>Note: The symbols that have been colored gray are used to help explain how the control measure is used, but they are not a part of the control measure.</i>
		the middle arrowhead will be at the midpoint of the vertical line. 3. Orientation. The arrows point toward enemy forces.	
Contain (MT/MTV) Restrict the freedom of manoeuvre of an enemy force to a specified area. (STANAG 2287)		Anchor Points. This graphic requires two anchor points. Point 1 defines the centre point of the graphic and point 2 defines the graphic's start point of the semicircle and radius. Size/Shape. The radius will be long enough for the graphic to encompass the area where enemy forces are to be contained. Orientation. The opening typically faces enemy forces.	
Control (MTV) Maintain physical influence over a specified area to prevent its use by an enemy. (STANAG 2287)		Anchor Points. This graphic requires two anchor points. Point 1 defines the centre point of the graphic and point 2 defines the graphic's start point and radius. Size/Shape. The radius will be long enough for the graphic to encompass the area being isolated. The opening will be a 30 degree arc of the circle. Orientation. The opening will be on the friendly side	

Table 7-A-1. Mission Tasks and Mission Task Verbs Symbols

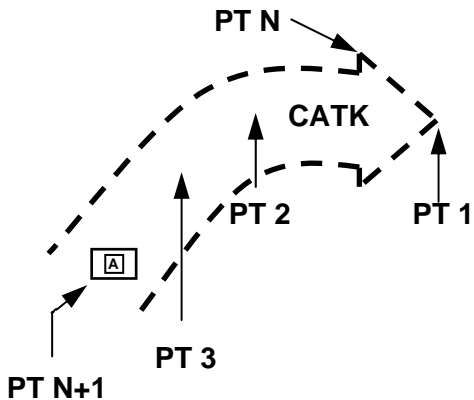
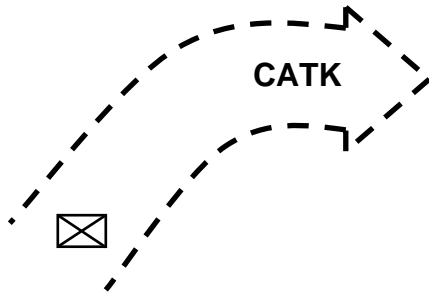
CONTROL MEASURE	TEMPLATE	DRAW RULES	EXAMPLE <i>Note: The symbols that have been colored gray are used to help explain how the control measure is used, but they are not a part of the control measure.</i>
		of the graphic.	
<p>Counterattack (MT/MTV) Attack against an enemy attacking force. (STANAG 2287)</p>		<p><u>Anchor Points.</u> The graphic requires N anchor points, where N is between 3 and 50. Point 1 defines the tip of the arrowhead. Point N-1 defines the rear of the symbol. Point N defines the back of the arrowhead. Anchor points are numbered sequentially beginning with point number one (1), in increments of one (1). <u>Size/Shape.</u> Points 1 through N-1 and 2 determine the graphic's centreline and Point N determines the width. <u>Orientation.</u> The arrowhead points toward enemy forces.</p>	

Table 7-A-1. Mission Tasks and Mission Task Verbs Symbols

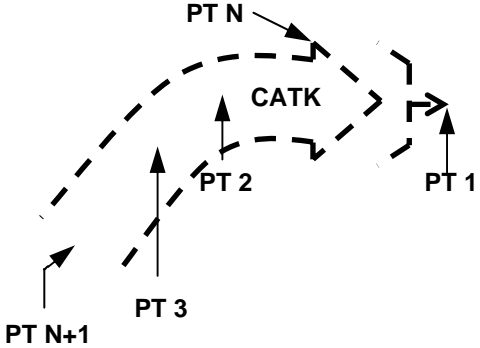
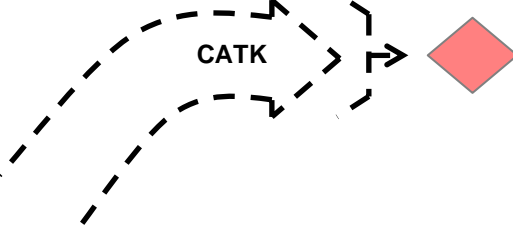
CONTROL MEASURE	TEMPLATE	DRAW RULES	EXAMPLE <i>Note: The symbols that have been colored gray are used to help explain how the control measure is used, but they are not a part of the control measure.</i>
<p>Counterattack By Fire (MT) Attack against an enemy attacking force using fires. NOTE: This is a method of counterattack.</p>		<p>Anchor Points. The graphic requires N anchor points, where N is between 3 and 50. Point 1 defines the tip of the arrowhead of the fire portion of the symbol. Point N-1 defines the rear of the symbol. Point N defines the back of the arrowhead. Anchor points are numbered sequentially beginning with point number one (1), in increments of one (1).</p> <p>Size/Shape. Points 1 through N-1 and 2 determine the graphic's centreline and Point N determines the width.</p> <p>Orientation. The arrowhead points toward enemy forces.</p>	

Table 7-A-1. Mission Tasks and Mission Task Verbs Symbols

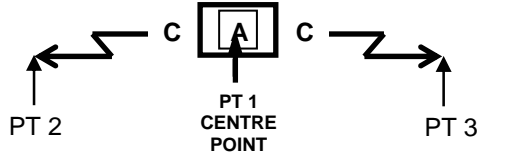
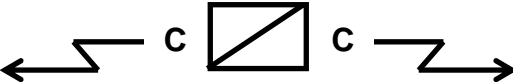
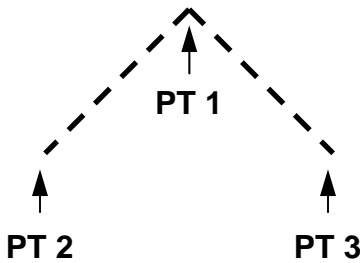
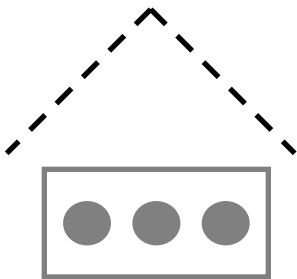
CONTROL MEASURE	TEMPLATE	DRAW RULES	EXAMPLE <i>Note: The symbols that have been colored gray are used to help explain how the control measure is used, but they are not a part of the control measure.</i>
<p>Cover (MT/MTV) Provide security for the main force by intercepting, engaging, delaying, disorganizing, deceiving the enemy, while also observing and reporting information, before he can attack, observe or defend. Operate independently of main force. (STANAG 2287)</p>		<p>Anchor Points. This symbol requires three anchor points. Point 1 defines the vertex of the graphic. Points 2 and 3 define the tips of the arrowheads. Size/Shape. Points 1 and 2 and points 1 and 3 determine the length of the arrows. The length and orientation of the arrows can vary independently. Orientation. Orientation is determined by the anchor points. The arrowheads may touch other graphics that define the limits of the task. The unit symbol is centred over point 1.</p>	
<p>Conduct Deception (MTV) Those measures designed to mislead the enemy by manipulation, distortion, or falsification of evidence to induce him to react in a manner prejudicial to his interests. (AAP-6)</p>		<p>Anchor Points. This graphic requires 3 anchor points. Point 1 defines the vertex of the graphic, and points 2 and 3 define its endpoints. Size/Shape. Points 1, 2, and 3 determine the length of the lines connecting them. The line defined by points 1 and 2 is typically the same length as the line between points 2 and 3. Orientation. Orientation is determined by the anchor points.</p>	

Table 7-A-1. Mission Tasks and Mission Task Verbs Symbols

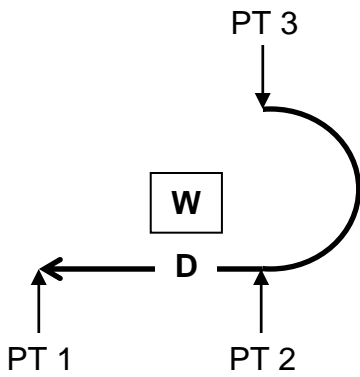
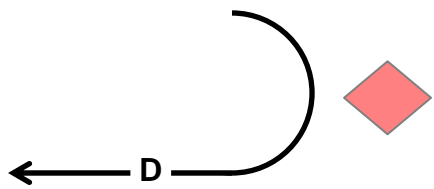
CONTROL MEASURE	TEMPLATE	DRAW RULES	EXAMPLE <i>Note: The symbols that have been colored gray are used to help explain how the control measure is used, but they are not a part of the control measure.</i>
<p>Delay (MT/MTV) Prevent an enemy force arriving at a specified location either: for a specified length of time; or until a specified time or event. Measure: enemy slowed to comply with time/space criteria.</p>		<p>Anchor Points. This graphic requires three anchor points. Point 1 defines the tip of the arrowhead. Point 2 defines the end of the straight line portion of the graphic. Point 3 defines the diameter and orientation of the 180 degree circular arc.</p> <p>Size/Shape. Points 1 and 2 determine the length of the straight line portion of the symbol. Point 3 defines which side of the line the arc is on and the diameter of the arc.</p> <p>Orientation. The arrow points in the direction of the action. The tip of the arrowhead may indicate the location where the action is to conclude. The unit's current location is typically represented at the base of the arc. The 180 degree circular arc is always perpendicular to the line.</p>	

Table 7-A-1. Mission Tasks and Mission Task Verbs Symbols

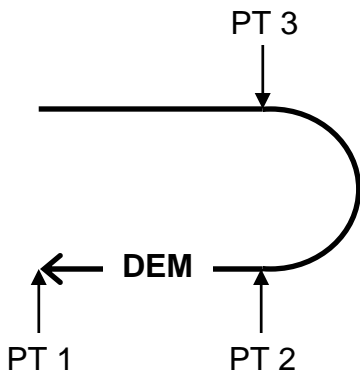
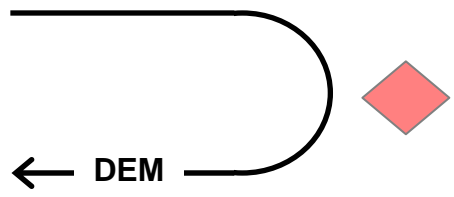
CONTROL MEASURE	TEMPLATE	DRAW RULES	EXAMPLE <i>Note: The symbols that have been colored gray are used to help explain how the control measure is used, but they are not a part of the control measure.</i>
<p>Demonstrate (MTV) Deceive the enemy by making a show of force without seeking contact. (STANAG 2287)</p>		<p>Anchor Points. This graphic requires three anchor points. Point 1 defines the tip of the arrowhead. Point 2 defines the end of the straight line portion of the graphic. Point 3 defines the diameter and orientation of the 180 degree circular arc.</p> <p>Size/Shape. Points 1 and 2 determine the length of both straight line portions of the symbol. Point 3 defines which side of the line the arc is on and the diameter of the arc.</p> <p>Orientation. The arrow points in the direction of the action. The tip of the arrowhead may indicate the location where the action is to conclude. The unit's current location is typically represented at the base of the symbol. The 180 degree circular arc is always perpendicular to the line.</p>	

Table 7-A-1. Mission Tasks and Mission Task Verbs Symbols

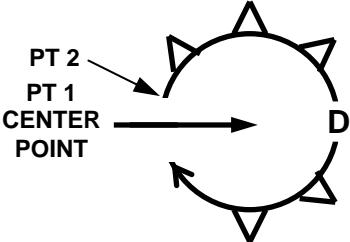
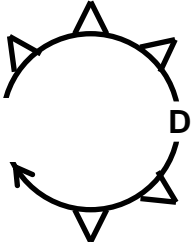
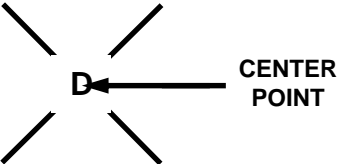
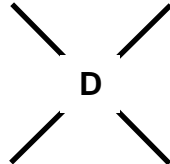
CONTROL MEASURE	TEMPLATE	DRAW RULES	EXAMPLE <i>Note: The symbols that have been colored gray are used to help explain how the control measure is used, but they are not a part of the control measure.</i>
<p>Deny (MTV) Prevent enemy use of a specified thing. (STANAG 2287)</p>	 <p>The diagram shows a circle with a 30-degree arc removed from its right side. The center of the circle is labeled 'CENTER POINT' with an arrow pointing to it. Two points on the circle's circumference are labeled 'PT 1' and 'PT 2' with arrows pointing to them. A letter 'D' is placed at the end of the arc on the right side of the circle.</p>	<p><u>Anchor Points.</u> This graphic requires two anchor points. Point 1 defines the centre point of the graphic and point 2 defines the graphic's start point and radius. <u>Size/Shape.</u> The radius will be long enough for the graphic to encompass the area being denied. The opening will be a 30 degree arc of the circle. <u>Orientation.</u> The opening will be on the friendly side of the graphic.</p>	 <p>The diagram shows a circle with a 30-degree arc removed from its right side. A letter 'D' is placed at the end of the arc on the right side of the circle.</p>
<p>Destroy (MT/MTV) Damage an object or an enemy force so that it is rendered useless to the enemy until reconstituted. (STANAG 2287)</p>	 <p>The diagram shows a central letter 'D' with four lines radiating outwards from it. An arrow points from the text 'CENTER POINT' to the 'D'.</p>	<p><u>Anchor Points.</u> This graphic requires one anchor point. The centre point defines centre of the graphic. <u>Size/Shape.</u> Static. <u>Orientation.</u> The graphic is typically centered over the desired location.</p>	 <p>The diagram shows a central letter 'D' with four lines radiating outwards from it.</p>

Table 7-A-1. Mission Tasks and Mission Task Verbs Symbols

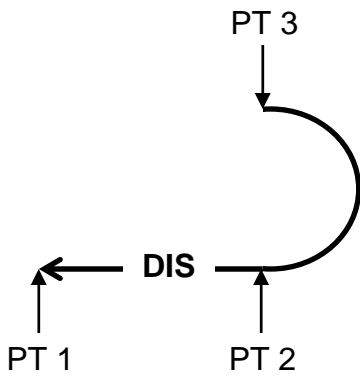
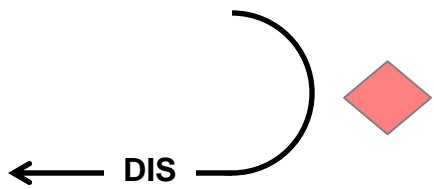
CONTROL MEASURE	TEMPLATE	DRAW RULES	EXAMPLE <i>Note: The symbols that have been colored gray are used to help explain how the control measure is used, but they are not a part of the control measure.</i>
Disengage (MTV)		<p>Anchor Points. This graphic requires three anchor points. Point 1 defines the tip of the arrowhead. Point 2 defines the end of the straight line portion of the graphic. Point 3 defines the diameter and orientation of the 180 degree circular arc.</p> <p>Size/Shape. Points 1 and 2 determine the length of the straight line portion of the symbol. Point 3 defines which side of the line the arc is on and the diameter of the arc.</p> <p>Orientation. The arrow points in the direction of the action. The tip of the arrowhead may indicate the location where the action is to conclude. The unit's current location is typically represented at the base of the arc. The 180 degree circular arc is always perpendicular to the line.</p>	

Table 7-A-1. Mission Tasks and Mission Task Verbs Symbols

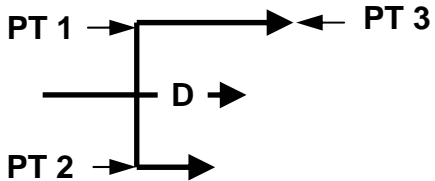
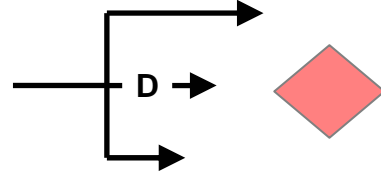
CONTROL MEASURE	TEMPLATE	DRAW RULES	EXAMPLE <i>Note: The symbols that have been colored gray are used to help explain how the control measure is used, but they are not a part of the control measure.</i>
<p>Disrupt (MT/MTV) Break apart an enemy's formation and tempo, interrupt the enemy timetable, cause premature and/or piecemeal commitment of forces.</p>		<p><u>Anchor Points.</u> This graphic requires three anchor points. Points 1 and 2 define the end points of the graphic's vertical line. Point 3 defines the tip of the longest arrow. <u>Size/Shape.</u> Points 1 and 2 determine the height of the graphic and point 3 determines its length. The spacing between the graphic's arrows will stay proportional to the graphic's vertical line. The length of the short arrows will remain in proportion to the length of the longest arrow. The arrows are perpendicular to the baseline (vertical line) and parallel to each other. <u>Orientation.</u> The arrows typically point toward enemy forces.</p>	

Table 7-A-1. Mission Tasks and Mission Task Verbs Symbols

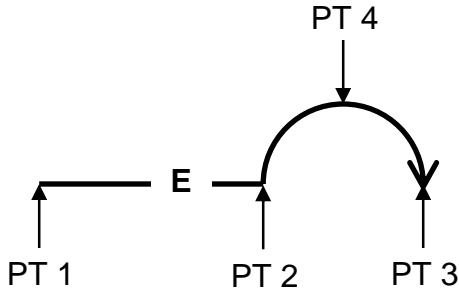

CONTROL MEASURE	TEMPLATE	DRAW RULES	EXAMPLE <i>Note: The symbols that have been colored gray are used to help explain how the control measure is used, but they are not a part of the control measure.</i>
<p>Envelop (MTV) Pass around or over the enemy's defensive position to secure objectives to enemy's rear.</p>		<p>Anchor Points. This graphic requires four anchor points. Point 1 defines the beginning of the straight line. Point 2 defines the end of the straight line portion of the graphic. Point 3 defines the diameter. Point 4 defines the orientation of the 180 degree circular arc.</p> <p>Size/Shape. Points 1 and 2 determine the length of the straight line portion of the symbol. Point 3 defines the diameter of the arc. Point 4 defines which side of the line the arc is on.</p> <p>Orientation. The arrow points in the direction of the action. The tip of the arrowhead may indicate the location where the action is to conclude. The unit's current location is typically represented at the beginning of the straight line. The 180 degree circular arc is always parallel to the line.</p>	

Table 7-A-1. Mission Tasks and Mission Task Verbs Symbols

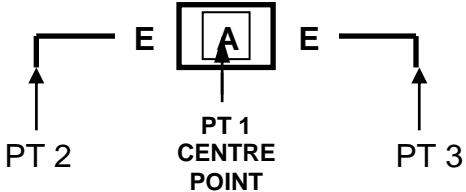
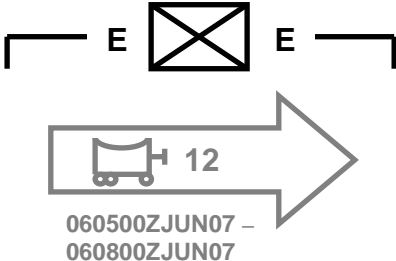
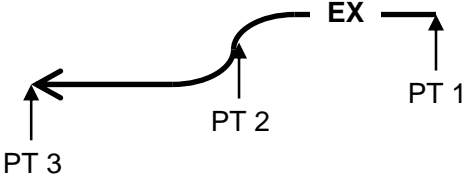

CONTROL MEASURE	TEMPLATE	DRAW RULES	EXAMPLE <i>Note: The symbols that have been colored gray are used to help explain how the control measure is used, but they are not a part of the control measure.</i>
<p>Escort (MTV) Accompany and protect. (STANAG 2287) Note: Symbol is normally used in conjunction with convoy symbol.</p>		<p><u>Anchor Points.</u> This graphic requires three anchor points. Point 1 defines the centre of the graphic. Point 2 and Point 3 defines the length of the escort. <u>Size/Shape.</u> Points 2 and 3 determine the length of the symbol. <u>Orientation.</u> The escort symbol appears above the convoy or escorted unit symbol.</p>	
<p>Exfiltrate (MTV) Withdraw through or around enemy positions without detection. (STANAG 2287)</p>		<p><u>Anchor Points.</u> This graphic requires three anchor points. Point 1 defines the end of the straight line portion of the graphic. Point 2 defines the centre of the two 90 degree circular arcs. Point 3 defines the tip of the arrowhead. <u>Size/Shape.</u> Points 1 and 3 determine the length of the symbol. <u>Orientation.</u> The arrow points in the direction of friendly forces. The tip of the arrowhead may indicate the location where the action is to conclude.</p>	

Table 7-A-1. Mission Tasks and Mission Task Verbs Symbols

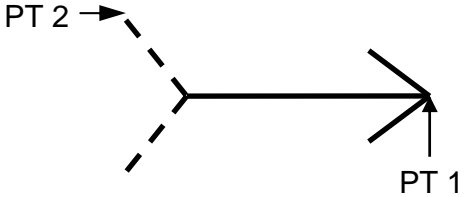
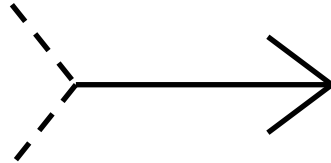
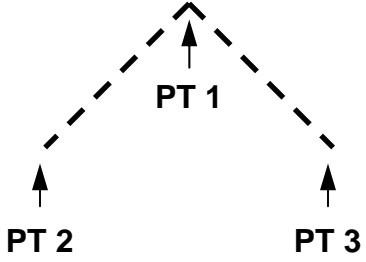
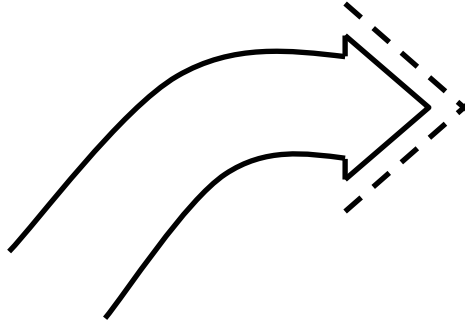
CONTROL MEASURE	TEMPLATE	DRAW RULES	EXAMPLE <i>Note: The symbols that have been colored gray are used to help explain how the control measure is used, but they are not a part of the control measure.</i>
<p>Conduct Exploitation (MTV) An offensive operation that usually follows a successful attack and is designed to disorganize the enemy in depth. AAP-6)</p>		<p>Anchor Points. This graphic requires two anchor points. Point 1 defines the tip of the arrowhead. Point 2 defines the end of the symbol. Size/Shape. Points 1 and 2 determine the length of the symbol. Point 2 determines the width of the 30 and 150 degree lines that form the base. Orientation. The arrow points in the direction of the action. The tip of the arrowhead may indicate the location where the action is to conclude. The unit's projected location would be at the base of the symbol.</p>	
<p>Feint (MTV) Deceive the enemy by seeking contact but avoiding a decisive engagement.</p>		<p>Anchor Points. This graphic requires 3 anchor points. Point 1 defines the vertex of the graphic, and points 2 and 3 define its endpoints. Size/Shape. Points 1, 2, and 3 determine the length of the lines connecting them. The line defined by points 1 and 2 is typically the same length as the line between points 2 and 3. Orientation. Orientation is determined by the anchor</p>	

Table 7-A-1. Mission Tasks and Mission Task Verbs Symbols


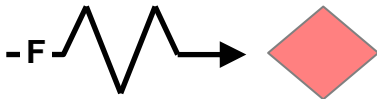
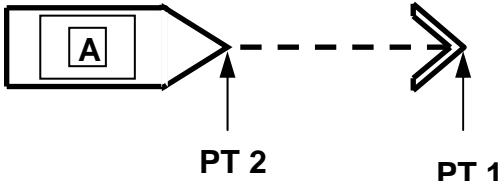
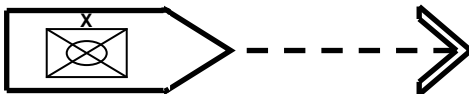
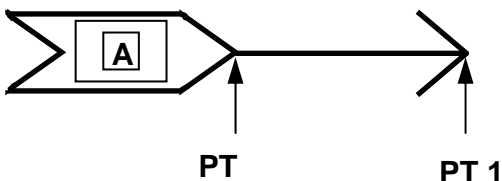
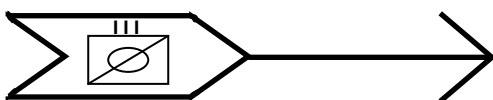
CONTROL MEASURE	TEMPLATE	DRAW RULES	EXAMPLE <i>Note: The symbols that have been colored gray are used to help explain how the control measure is used, but they are not a part of the control measure.</i>
<p>Fix (MT/MTV) Prevent an enemy from moving any part of his forces from a specified location for a specified period of time.</p>		<p>points. Anchor Points: This graphic requires 2 anchor points. Point 1 defines the tip of the arrowhead, and point 2 defines the rear of the graphic. Size/Shape: Points 1 and 2 determine the length of the graphic, which varies only in length. Orientation: The arrow points toward the enemy forces.</p>	
<p>Follow and Assume (MT/MTV) Follow a force conducting an offensive operation, and be prepared to continue the mission if the lead force is fixed, or otherwise unable to continue.</p>		<p>Anchor Points: This graphic requires at least two points, points 1 and 2, to define the line. Additional points can be defined to extend and shape the line. Size/Shape: The first and last anchor points determine the length of the line. The graphic at the end of the line will contain the symbol of the unit that follows and assumes or follows and supports Orientation: Orientation is determined by the anchor points.</p>	
<p>Follow and Support (MT/MTV) Follow and support a lead force conducting an offensive operation.</p>		<p>Anchor Points: This graphic requires at least two points, points 1 and 2, to define the line. Additional points can be defined to extend and shape the line. Size/Shape: The first and last anchor points determine the length of the line. The graphic at the end of the line will contain the symbol of the unit that follows and assumes or follows and supports Orientation: Orientation is determined by the anchor points.</p>	

Table 7-A-1. Mission Tasks and Mission Task Verbs Symbols

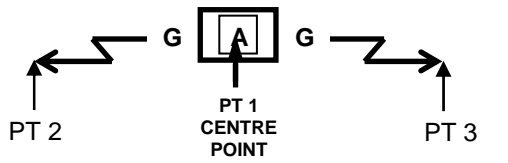

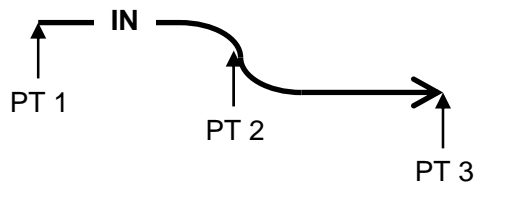
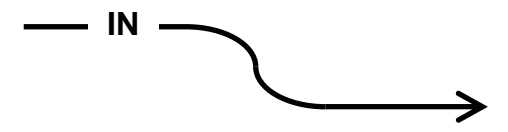
CONTROL MEASURE	TEMPLATE	DRAW RULES	EXAMPLE <i>Note: The symbols that have been colored gray are used to help explain how the control measure is used, but they are not a part of the control measure.</i>
<p>Guard (MT/MTV) Protect the main force by fighting to gain time, while also observing and reporting information. Operate within fire support range of main force. (STANAG 2287)</p>	 <p>The diagram shows a central square with a smaller square inside it, labeled 'A'. Below 'A' is 'PT 1 CENTRE POINT'. To the left is 'PT 2' and to the right is 'PT 3'. Two jagged arrows point outwards from the central square, one to the left and one to the right, each labeled 'G'.</p>	<p>Anchor Points. This symbol requires three anchor points. Point 1 defines the vertex of the graphic. Points 2 and 3 define the tips of the arrowheads. Size/Shape. Points 1 and 2 and points 1 and 3 determine the length of the arrows. The length and orientation of the arrows can vary independently. Orientation. Orientation is determined by the anchor points. The arrowheads may touch other graphics that define the limits of the task. The unit symbol is centred over point 1.</p>	 <p>The diagram shows the Guard symbol with a diagonal slash through the central square. The jagged arrows are oriented horizontally, pointing left and right.</p>
<p>Infiltrate (MTV)</p>	 <p>The diagram shows a horizontal line starting at 'PT 1', curving downwards at 'PT 2', and ending in an arrowhead at 'PT 3'. The label 'IN' is placed above the straight portion of the line.</p>	<p>Anchor Points. This graphic requires three anchor points. Point 1 defines the end of the straight line portion of the graphic. Point 2 defines the centre of the two 90 degree circular arcs. Point 3 defines the tip of the arrowhead. Size/Shape. Points 1 and 3 determine the length of the of the symbol. Orientation. The arrow points in the direction of enemy forces. The tip of the arrowhead may</p>	 <p>The diagram shows the Infiltrate symbol with a horizontal line on the left, a curved section, and an arrowhead pointing right. The label 'IN' is placed above the straight portion.</p>

Table 7-A-1. Mission Tasks and Mission Task Verbs Symbols

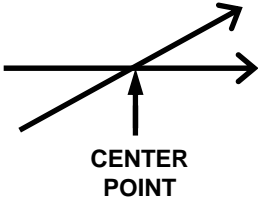
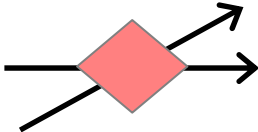
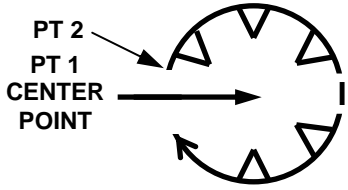
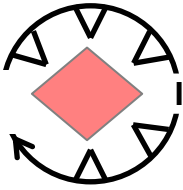
CONTROL MEASURE	TEMPLATE	DRAW RULES	EXAMPLE <i>Note: The symbols that have been colored gray are used to help explain how the control measure is used, but they are not a part of the control measure.</i>
<p>Interdict (MT/MTV) Keep an enemy force out of range so that it cannot be used effectively against a friendly force. (STANAG 2287)</p>		<p>indicate the location where the action is to conclude.</p> <p><u>Anchor Points.</u> This graphic requires one anchor point. The centre point defines centre of the graphic.</p> <p><u>Size/Shape.</u> Static.</p> <p><u>Orientation.</u> The graphic is typically centered over the desired location.</p>	
<p>Isolate (MT/MTV) Seal off an enemy force from its sources of support, to deny it freedom of movement, and prevent it from having contact with other enemy forces. (STANAG 2287)</p>		<p><u>Anchor Points.</u> This graphic requires two anchor points. Point 1 defines the centre point of the graphic and point 2 defines the graphic's start point and radius.</p> <p><u>Size/Shape.</u> The radius will be long enough for the graphic to encompass the area being isolated. The opening will be a 30 degree arc of the circle.</p> <p><u>Orientation.</u> The opening will be on the friendly side of the graphic.</p>	

Table 7-A-1. Mission Tasks and Mission Task Verbs Symbols

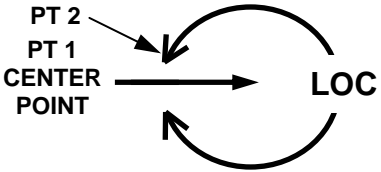
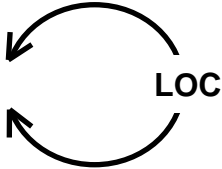
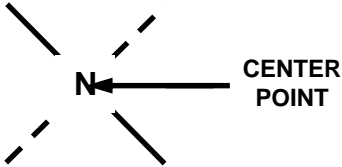
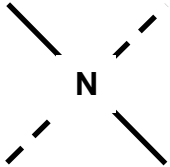
CONTROL MEASURE	TEMPLATE	DRAW RULES	EXAMPLE <i>Note: The symbols that have been colored gray are used to help explain how the control measure is used, but they are not a part of the control measure.</i>
<p>Locate (MTV) Determine the position of a specified thing. (STANAG 2287)</p>		<p>Anchor Points. This graphic requires two anchor points. Point 1 defines the centre point of the graphic and point 2 defines the graphic's start point and radius. Size/Shape. The radius will be long enough for the graphic to encompass the area being searched. The opening will be a 30 degree arc of the circle. Orientation. The opening will be on the friendly side of the graphic.</p>	
<p>Neutralize (MT/MTV) Render an enemy element temporarily incapable of interfering with the operation. (STANAG 2287)</p>		<p>Anchor Points. This graphic requires one anchor point. The centre point defines centre of the graphic. Size/Shape. Static. Orientation. The graphic is typically centered over the desired location.</p>	

Table 7-A-1. Mission Tasks and Mission Task Verbs Symbols

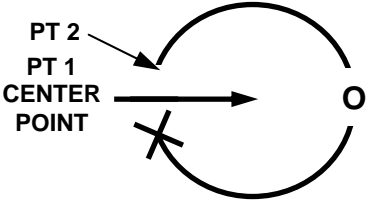
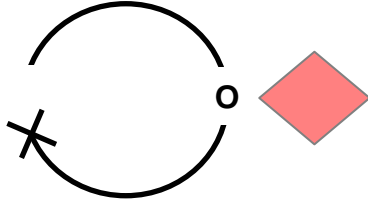
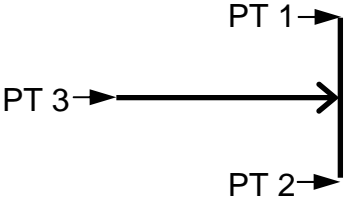
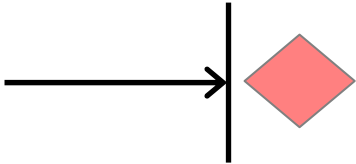
CONTROL MEASURE	TEMPLATE	DRAW RULES	EXAMPLE <i>Note: The symbols that have been colored gray are used to help explain how the control measure is used, but they are not a part of the control measure.</i>
<p>Occupy (MT/MTV) Position a unit in a specified area without enemy opposition. (STANAG 2287)</p>		<p>Anchor Points. This graphic requires two anchor points. Point 1 defines the centre point of the graphic and point 2 defines the graphic's start point and radius. Size/Shape. The radius will be long enough for the graphic to encompass the area being isolated. The opening will be a 30 degree arc of the circle. Orientation. The opening will be on the friendly side of the graphic.</p>	
<p>Penetrate (MT/MTV) Break through enemy defence and disrupt the defensive system. (STANAG 2287)</p>		<p>Anchor Points. This graphic requires three anchor points. Points 1 and 2 define the endpoints of the graphic's vertical line. Point 3 defines the rear of the graphic. Size/Shape. Points 1 and 2 determine the height of the graphic and point 3 determines its length. The arrow will project perpendicularly from the midpoint of the vertical line. Orientation. The arrow points toward enemy forces.</p>	

Table 7-A-1. Mission Tasks and Mission Task Verbs Symbols

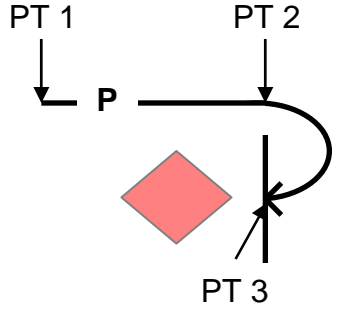
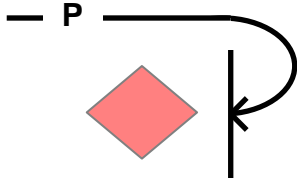
CONTROL MEASURE	TEMPLATE	DRAW RULES	EXAMPLE <i>Note: The symbols that have been colored gray are used to help explain how the control measure is used, but they are not a part of the control measure.</i>
<p>Pursue (MTV) Catch or cut off a hostile force attempting to escape, with the aim of destroying it. (STANAG 2287) Note: Pursuit - An offensive operation designed to catch or cut off a hostile force attempting to escape, with the aim of destroying it. (AAP-6)</p>		<p>Anchor Points. This graphic requires three anchor points. Point 1 defines the beginning of the straight line. Point 2 defines the end of the straight line portion of the graphic. Point 3 defines the diameter and orientation of the 180 degree circular arc and the tip of the arrowhead.</p> <p>Size/Shape. Points 1 and 2 determine the length of the straight line portion of the symbol. Point 3 defines which side of the line the arc is on and the diameter of the arc.</p> <p>Orientation. The arrow points in the direction of the action. The unit's current location is typically represented at the base of the line. The 180 degree circular arc is always perpendicular to the line.</p>	

Table 7-A-1. Mission Tasks and Mission Task Verbs Symbols

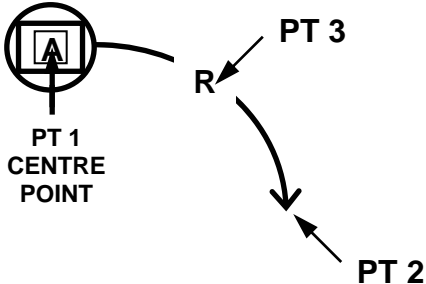
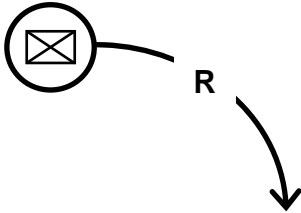
CONTROL MEASURE	TEMPLATE	DRAW RULES	EXAMPLE <i>Note: The symbols that have been colored gray are used to help explain how the control measure is used, but they are not a part of the control measure.</i>
<p>Recover (MTV) Extract a friendly force element or materiel from a location not under friendly control, with or without force. (STANAG 2287)</p>		<p>Anchor Points. This symbol requires two anchor points. Point 1 defines the centre point of the circle. Point 2 defines the tip of the arrowhead. Point 3 defines the 90 degree arc. Size/Shape. Points 1 and 2 are connected by a 90 degree arc. The circle will at least be large enough to accommodate a unit symbol. Point 3 indicates on which side of the line the arc is placed. Orientation. The arrowhead identifies the location of the element or material to be recovered, and the circle identifies the unit(s) assigned the task.</p>	

Table 7-A-1. Mission Tasks and Mission Task Verbs Symbols

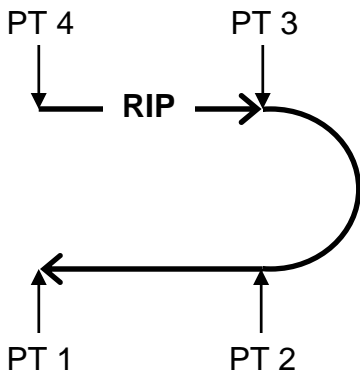
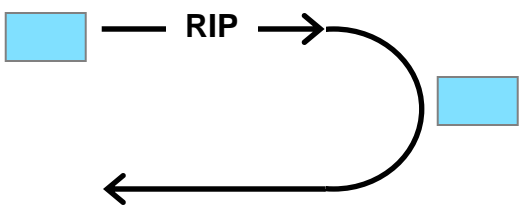
CONTROL MEASURE	TEMPLATE	DRAW RULES	EXAMPLE <i>Note: The symbols that have been colored gray are used to help explain how the control measure is used, but they are not a part of the control measure.</i>
<p>Relief In Place (MT/MTV) An operation in which, by direction of higher authority, all or part of a unit is replaced in an area by the incoming unit. The responsibilities of the replaced elements for the mission and the assigned zone of operations are transferred to the incoming unit. The incoming unit continues the operation as ordered.</p>		<p>Anchor Points. This graphic requires four anchor points. Point 1 defines the tip of the first arrowhead. Point 2 defines the end of the straight line portion of the first arrow. Point 3 defines the tip of the second arrowhead. Point 4 defines the end of the second arrow.</p> <p>Size/Shape. Points 1 and 2, and points 3 and 4 determine the length of each arrow. Points 2 and 3 shall be connected by a smooth, curved line.</p> <p>Orientation. Determined by the anchor points. The unit being relieved is typically located at the base of the curve, and the unit performing the relief is typically located at the end of the symbol. The arrowhead typically points to the location the relieved unit should move to.</p>	

Table 7-A-1. Mission Tasks and Mission Task Verbs Symbols

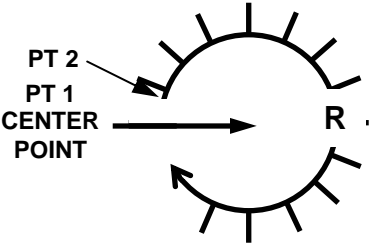
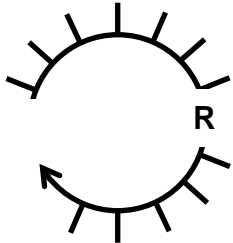
CONTROL MEASURE	TEMPLATE	DRAW RULES	EXAMPLE <i>Note: The symbols that have been colored gray are used to help explain how the control measure is used, but they are not a part of the control measure.</i>
<p>Retain (MT/MTV) Keep possession of a terrain feature to ensure it is free of enemy occupation or use. (STANAG 2287)</p>		<p><u>Anchor Points.</u> This graphic requires two anchor points. Point 1 defines the centre point of the graphic and point 2 defines the graphic's start point and radius. <u>Size/Shape.</u> The radius will be long enough for the graphic to encompass the area being retained. The opening will be a 30 degree arc of the circle. <u>Orientation.</u> The opening will be on the friendly side of the graphic.</p>	

Table 7-A-1. Mission Tasks and Mission Task Verbs Symbols

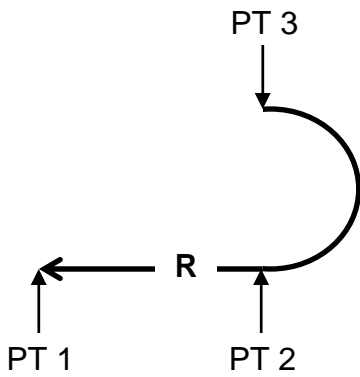
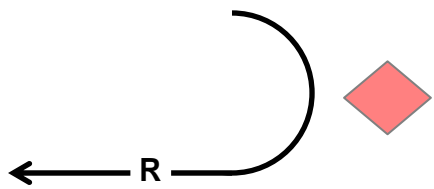
CONTROL MEASURE	TEMPLATE	DRAW RULES	EXAMPLE <i>Note: The symbols that have been colored gray are used to help explain how the control measure is used, but they are not a part of the control measure.</i>
<p>Retire (MTV) Move a force, out of contact, away from the enemy. (STANAG 2287)</p> <p>Retirement (MT) An operation in which a force out of contact moves away from the enemy. (AAP-6)</p>		<p>Anchor Points. This graphic requires three anchor points. Point 1 defines the tip of the arrowhead. Point 2 defines the end of the straight line portion of the graphic. Point 3 defines the diameter and orientation of the 180 degree circular arc.</p> <p>Size/Shape. Points 1 and 2 determine the length of the straight line portion of the symbol. Point 3 defines which side of the line the arc is on and the diameter of the arc.</p> <p>Orientation. The arrow points in the direction of the action. The tip of the arrowhead may indicate the location where the action is to conclude. The unit's current location is typically represented at the base of the arc. The 180 degree circular arc is always perpendicular to the line.</p>	

Table 7-A-1. Mission Tasks and Mission Task Verbs Symbols

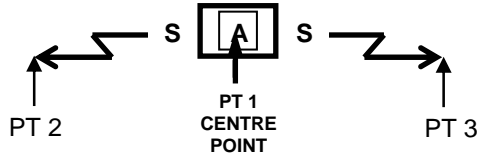
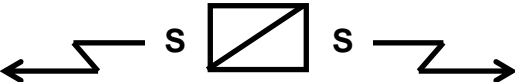
CONTROL MEASURE	TEMPLATE	DRAW RULES	EXAMPLE <i>Note: The symbols that have been colored gray are used to help explain how the control measure is used, but they are not a part of the control measure.</i>
<p>Screen (MT/MTV) Observe, identify, and report information on threats to the main force. Only fight in self-protection. (STANAG 2287)</p>	 <p>The template diagram shows a central square containing the letter 'A'. Below the square is an upward-pointing arrow labeled 'PT 1 CENTRE POINT'. To the left and right of the square are two more upward-pointing arrows labeled 'PT 2' and 'PT 3' respectively. A zigzag line connects PT 2 to the left side of the square, and another zigzag line connects PT 3 to the right side of the square. The letter 'S' is placed between the square and each zigzag line.</p>	<p><u>Anchor Points.</u> This symbol requires three anchor points. Point 1 defines the vertex of the graphic. Points 2 and 3 define the tips of the arrowheads. <u>Size/Shape.</u> Points 1 and 2 and points 1 and 3 determine the length of the arrows. The length and orientation of the arrows can vary independently. <u>Orientation.</u> Orientation is determined by the anchor points. The arrowheads may touch other graphics that define the limits of the task. The unit symbol is centered over point 1.</p>	 <p>The example diagram shows a square with a diagonal line from the top-left to the bottom-right. It has the same anchor point structure as the template: PT 1 (Centre Point) below the square, and PT 2 and PT 3 to the left and right. Zigzag lines connect PT 2 and PT 3 to the square, with 'S' symbols between them.</p>

Table 7-A-1. Mission Tasks and Mission Task Verbs Symbols

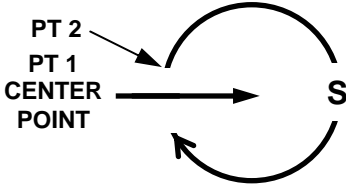
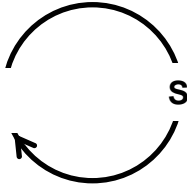
CONTROL MEASURE	TEMPLATE	DRAW RULES	EXAMPLE <i>Note: The symbols that have been colored gray are used to help explain how the control measure is used, but they are not a part of the control measure.</i>
<p>Secure (MTV) Gain possession of a position or terrain feature, with or without force, and to make such disposition as will prevent its destruction or loss to enemy action. (STANAG 2287)</p> <p>Secure (MT) In an operational context, to gain possession of a position or terrain feature, with or without force, and to make such disposition as will prevent, as far as possible, its destruction or loss by enemy action. (AAP-6)</p>		<p>Anchor Points. This graphic requires two anchor points. Point 1 defines the centre point of the graphic and point 2 defines the graphic's start point and radius.</p> <p>Size/Shape. The radius will be long enough for the graphic to encompass the area being secured. The opening will be a 30 degree arc of the circle.</p> <p>Orientation. The opening will be on the friendly side of the graphic.</p>	

Table 7-A-1. Mission Tasks and Mission Task Verbs Symbols

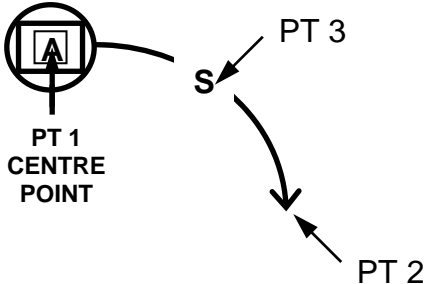
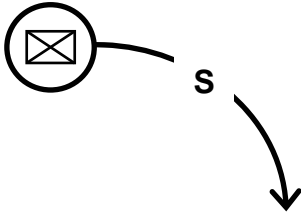
CONTROL MEASURE	TEMPLATE	DRAW RULES	EXAMPLE <i>Note: The symbols that have been colored gray are used to help explain how the control measure is used, but they are not a part of the control measure.</i>
<p>Seize (MT/MTV) Clear a designated area and obtain control of it. (STANAG 2287)</p>		<p>Anchor Points. This symbol requires two anchor points. Point 1 defines the centre point of the circle. Point 2 defines the tip of the arrowhead. Point 3 defines the 90 degree arc. Size/Shape. Points 1 and 2 are connected by a 90 degree arc. The circle will at least be large enough to accommodate a unit symbol. Point 3 indicates on which side of the line the arc is placed. Orientation. The arrowhead identifies the location to be seized, and the circle identifies the unit(s) assigned the task.</p>	

Table 7-A-1. Mission Tasks and Mission Task Verbs Symbols

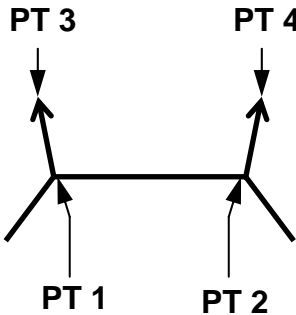
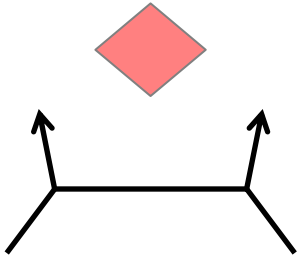
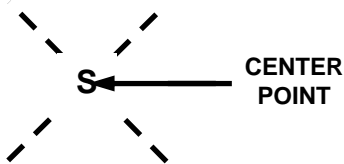
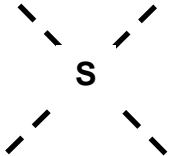
CONTROL MEASURE	TEMPLATE	DRAW RULES	EXAMPLE <i>Note: The symbols that have been colored gray are used to help explain how the control measure is used, but they are not a part of the control measure.</i>
<p>Support By Fire (MTV) Engage the enemy by direct fire in support of another manoeuvring force. (STANAG 2287)</p>		<p>Anchor Points. This graphic requires four anchor points. Points 1 and 2 define the endpoints of the straight line on the back side of the graphic. Points 3 and 4 define the tips of the arrowheads. Size/Shape. Points 1 and 2 determine the length of the straight line on the back side of the graphic. The rear of the arrows should connect to points 1 and 2. Orientation. Orientation is determined by the anchor points. The back side of the graphic encompasses the firing position, while the arrowheads typically indicate the arc of coverage that the firing position is meant to support.</p>	
<p>Suppress (MTV) Temporarily degrade an enemy capability to enable a friendly action. (STANAG 2287)</p>		<p>Anchor Points. This graphic requires one anchor point. The centre point defines centre of the graphic. Size/Shape. Static. Orientation. The graphic is typically centered over the desired location.</p>	

Table 7-A-1. Mission Tasks and Mission Task Verbs Symbols

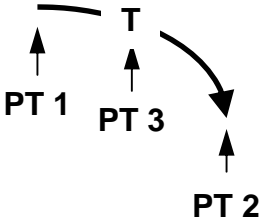
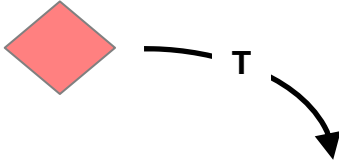
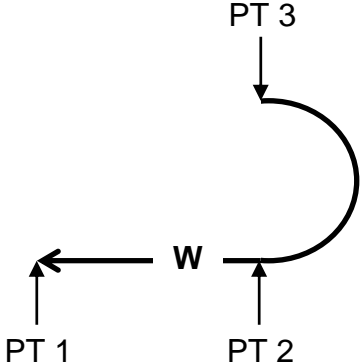
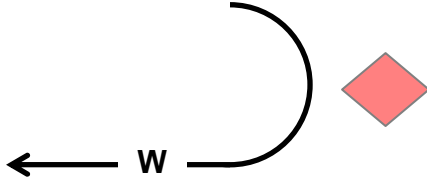
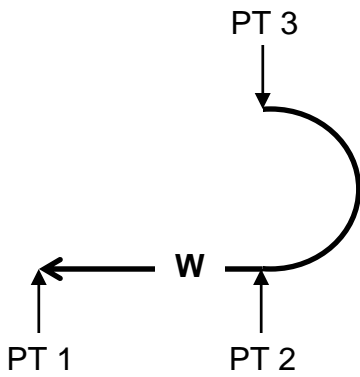
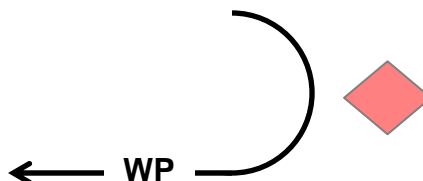
CONTROL MEASURE	TEMPLATE	DRAW RULES	EXAMPLE <i>Note: The symbols that have been colored gray are used to help explain how the control measure is used, but they are not a part of the control measure.</i>
<p>Turn (MTV) Force an enemy from one direction of advance to another. (STANAG 2287)</p>		<p><u>Anchor Points:</u> This symbol requires two anchor points. Point 1 defines the rear of the graphic. Point 2 defines the tip of the arrowhead. Point 3 defines the 90 degree arc. <u>Size/Shape:</u> Points 1 and 2 are connected by a 90 degree arc. Point 3 indicates on which side of the line the arc is placed. <u>Orientation:</u> The rear of the graphic identifies the enemy's location and the arrow points in the direction the obstacle should force the enemy to turn.</p>	
<p>Withdraw (MT/MTV) Disengage from the enemy and move in a direction away from the enemy. (STANAG 2287)</p>		<p><u>Anchor Points:</u> This graphic requires three anchor points. Point 1 defines the tip of the arrowhead. Point 2 defines the end of the straight line portion of the graphic. Point 3 defines the diameter and orientation of the 180 degree circular arc. <u>Size/Shape:</u> Points 1 and 2 determine the length of the straight line portion of the symbol. Point 3 defines</p>	

Table 7-A-1. Mission Tasks and Mission Task Verbs Symbols

CONTROL MEASURE	TEMPLATE	DRAW RULES	EXAMPLE <i>Note: The symbols that have been colored gray are used to help explain how the control measure is used, but they are not a part of the control measure.</i>
<p>Withdraw Under Pressure (MT) Disengage from the enemy while under pressure and move in a direction away from the enemy. NOTE: This is a method of withdrawal.</p>		<p>which side of the line the arc is on and the diameter of the arc. <u>Orientation.</u> The arrow points in the direction of the action. The tip of the arrowhead may indicate the location where the action is to conclude. The unit's current location is typically represented at the base of the arc. The 180 degree circular arc is always perpendicular to the line.</p>	

NATO UNCLASSIFIED

APP-6(C)

(INTENTIONALLY BLANK)

7-A-38

NATO UNCLASSIFIED

ORIGINAL

CHAPTER 8

METEOROLOGICAL SYMBOLS

SECTION I - INTRODUCTION

Scope

0801. This chapter contains a structured set of symbols and graphics for the display of meteorological information.

Purpose

0802. For military operations, it is important to consider meteorological impacts as part of the environmental conditions. All meteorological parameters are strictly related to both time and space, and they could represent observations or forecasts. Therefore, it is recommended to display these sets in a separate layer.

0803. A meteorological symbol that displays an observation is always referred to a three-dimensional geographic point or to the vicinity of that point.

0804. A meteorological symbol that represents a weather prediction is often referred to a wider area which has to be delimited in a well-defined manner.

Content

0805. The set of meteorological symbols and graphics is based on approved symbols and icons from the World Meteorological Organization (WMO).

SECTION II – WEATHER SYMBOLOGY





Table 8-1. Weather Graphics.	
<i>DESCRIPTION</i>	<i>WEATHER GRAPHIC</i>
Pressure Systems	
<p>Low Pressure Centre</p> <p>1. An area of low atmospheric pressure which has a closed circulation that is cyclonic, i.e., as viewed from above, the circulation is counter-clockwise in the Northern Hemisphere, clockwise in the Southern Hemisphere, or undefined at the Equator. Because cyclonic circulation and relatively low atmospheric pressure usually coexist, in common practice, the terms “cyclone” and “low” are used interchangeably. Also, because cyclones often are accompanied by inclement (sometimes destructive) weather, they are frequently referred to simply as storms. 2. Frequently misused to denote a tornado. 3. In the Indian Ocean, a tropical cyclone of hurricane or typhoon force.</p>	
<p>High Pressure Centre</p> <p>An area of high atmospheric pressure which has a closed circulation that is anti-cyclonic, i.e., as viewed from above, the circulation is clockwise in the Northern Hemisphere, counter-clockwise in the southern Hemisphere, or undefined at the Equator.</p>	
Frontal Systems	
<p>Cold Front</p> <p>A zone separating two air masses, of which the cooler, denser mass is advancing and replacing the warmer.</p>	
<p>Upper Cold Front</p> <p>Occurs when discontinuity at the forward edge of an advancing cold air mass is displacing warmer air in its path and the two air masses intersect above ground level.</p>	





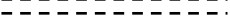
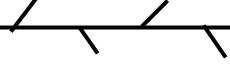
Table 8-1. Weather Graphics.	
<i>DESCRIPTION</i>	<i>WEATHER GRAPHIC</i>
<p>Warm Front</p> <p>The discontinuity at the forward edge of an advancing warm air mass that is displacing cooler air in its path.</p>	
<p>Upper Warm Front</p> <p>Occurs when discontinuity at the forward edge of an advancing warm air mass is displacing cooler air in its path and the two air masses intersect above ground level.</p>	
<p>Occluded Front</p> <p>The line along which a cold front has overtaken a warm front at ground level.</p>	
<p>Stationary Front</p> <p>A situation in which the surface position of a front does not move; the flow on either side of such a boundary is nearly parallel to the position of the front.</p>	
Lines	
<p>Trough Line</p> <p>An elongated region of low atmospheric pressure.</p>	
<p>Convergence Line</p> <p>A line along which the wind direction changes.</p>	


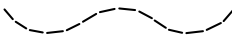
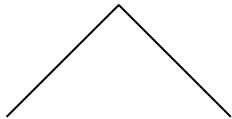
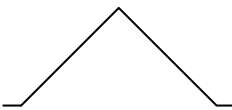


Table 8-1. Weather Graphics.	
<i>DESCRIPTION</i>	<i>WEATHER GRAPHIC</i>
<p>Ridge Line</p> <p>An elongated region of high atmospheric pressure.</p>	
<p>Squall Line</p> <p>A line of high winds and thunderstorms in convectively unstable air, an instability line (of non-frontal nature); it may be generated by a cold front. Such a line may be some hundreds of miles in length and is sometimes called a “pseudo front.” It is associated with line thunderstorms, shear line of which are the squall lines, accompanied by strong gusts, hail, rain, and sometimes tornadoes but well in advance of the cold front (if present).</p>	
<p style="text-align: center;">Turbulence</p> <p>Turbulence is a transitory atmospheric condition which has varying effects on aircraft operations. It is a serious hazard to pilots that may occur without warning.</p>	
<p>Light Turbulence</p> <p>Description is dependent on associated aircraft type.</p>	
<p>Moderate Turbulence</p> <p>Description is dependent on associated aircraft type.</p>	
<p>Severe Turbulence</p> <p>Description is dependent on associated aircraft type.</p>	
<p>Extreme Turbulence</p> <p>Description is dependent on associated aircraft type.</p>	

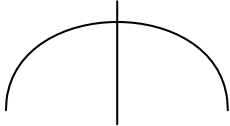
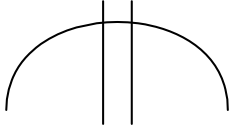
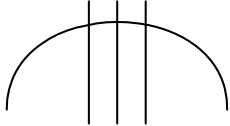
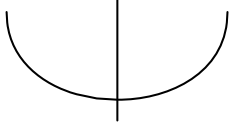
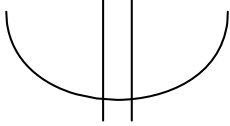
Table 8-1. Weather Graphics.	
<i>DESCRIPTION</i>	<i>WEATHER GRAPHIC</i>
Clear Icing Glossy, clear, or translucent ice formed by the relatively slow freezing of large super cooled droplets. The droplets spread out over the airframe surface before completely freezing.	
Light Clear Icing Description is dependent on associated aircraft type.	
Moderate Clear Icing Description is dependent on associated aircraft type.	
Severe Clear Icing Description is dependent on associated aircraft type.	
Rime Icing Rough, milky opaque ice formed by the instantaneous freezing of small super cooled droplets which trap air within the ice as they strike the aircraft.	
Light Rime Icing Description is dependent on associated aircraft type.	
Moderate Rime Icing Description is dependent on associated aircraft type.	

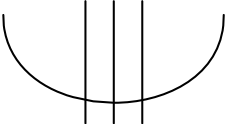
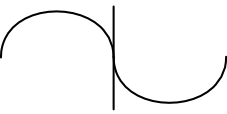
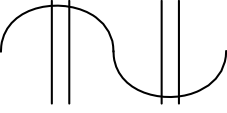
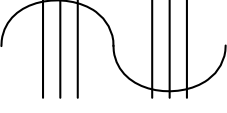
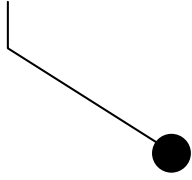

Table 8-1. Weather Graphics.	
<i>DESCRIPTION</i>	<i>WEATHER GRAPHIC</i>
<p>Severe Rime Icing</p> <p>Description is dependent on associated aircraft type.</p>	
<p style="text-align: center;">Mixed Icing</p> <p>A hard rough conglomerate of ice which can cause very rough accumulation and severe loss of lift.</p>	
<p>Light Mixed Icing</p> <p>Description is dependent on associated aircraft type.</p>	
<p>Moderate Mixed Icing</p> <p>Description is dependent on associated aircraft type.</p>	
<p>Severe Mixed Icing</p> <p>Description is dependent on associated aircraft type.</p>	
<p>Wind Barb</p> <p>Used, in different variations, to represent wind speeds.</p>	
<p>Jet Stream</p> <p>A narrow belt of strong winds, with speeds of 50 to 200 knots, in the upper troposphere. In the northern Hemisphere these winds usually have a westerly component.</p>	



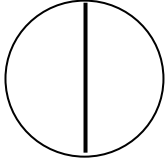
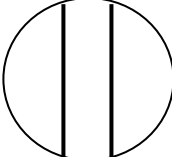
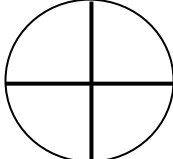
Table 8-1. Weather Graphics.	
<i>DESCRIPTION</i>	<i>WEATHER GRAPHIC</i>
Flight Rules	
<p>Instrument Ceiling</p> <p>Evaluation of ceiling height by cloud measuring equipment.</p>	
<p>Visual Ceiling</p> <p>The height above the earth's surface of the lowest (thin or opaque) layer reported as broken (5-7 oktas) or overcast (8 oktas), or the vertical visibility into an indefinite ceiling.</p>	
Coverage Symbols	
<p>Clear Sky (SKC)</p> <p>The absence of layers of clouds or other obscuring phenomena.</p>	SKC
<p>Scattered Sky (SCT)</p> <p>A summation sky cover of one-eighth through four-eighths.</p>	
<p>Broken Sky (BKN)</p> <p>A summation sky cover of five-eighths through seven-eighths.</p>	
<p>Overcast (OVC)</p> <p>A summation sky cover of eight-eighths</p>	

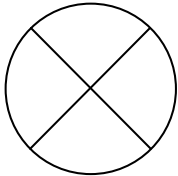
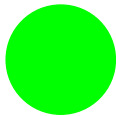
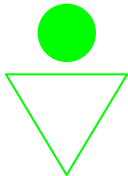
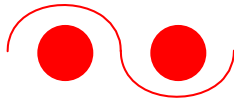


Table 8-1. Weather Graphics.	
<i>DESCRIPTION</i>	<i>WEATHER GRAPHIC</i>
<p>Sky Obscured or Partially Obscured</p> <p>1. Obscured - A condition in which surface-based obscuring phenomena (e.g., fog, rain, or snow) are hiding eight-eighths of the sky or higher layers. The terms “obscuration” and “indefinite ceiling” may also be used in relation to this sky condition.</p> <p>2. Partially Obscured - A condition in which surface-based obscuring phenomena are hiding at least one-eighth, but less than eight-eighths, of the sky or higher layers. The term “partial obscuration” may also be used in relation to this sky condition.</p>	
Precipitation	
<p>Rain (RA)</p> <p>Precipitation, either in the form of drops larger than 0.02 inch (0.5 mm), or smaller drops, which in contrast to drizzle, are widely separated.</p>	
<p>Rain Shower (SHRA)</p> <p>The rain changes intensity or starts and stops abruptly. These showers fall exclusively from cumuliform clouds.</p>	
<p>Freezing Rain (FZRA)</p> <p>Rain that freezes on impact with the ground, with objects in flight, or with objects on the ground. Produces glaze (clear) ice.</p>	
<p>Drizzle (DZ)</p> <p>Fairly uniform precipitation composed exclusively of fine drops (diameter less than 0.02 inch or 0.5 mm) very close together. Drizzle appears to float while following air currents; although, unlike fog droplets, drizzle falls to the ground. It usually falls from low stratus clouds and is frequently accompanied by low visibility and fog.</p>	
<p>Freezing Drizzle (FZDZ)</p> <p>Drizzle which freezes upon impact with the ground, with objects in flight, or with objects on the ground. Produces glaze (clear) ice.</p>	

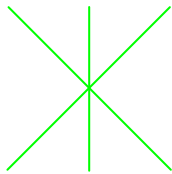
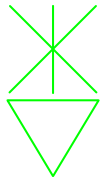
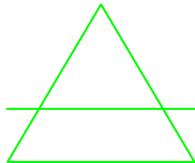
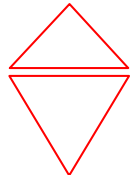
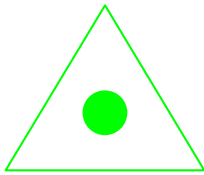

Table 8-1. Weather Graphics.	
<i>DESCRIPTION</i>	<i>WEATHER GRAPHIC</i>
<p>Snow (SN)</p> <p>Precipitation of snow crystals, mostly branched in the form of six-pointed stars, many times clustered to form snowflakes.</p>	
<p>Snow Showers (SHSN)</p> <p>Snow changes intensity or starts and stops abruptly. These showers fall exclusively from cumuliform clouds.</p>	
<p>Snow Grains (SG)</p> <p>Precipitation of very small, white, opaque particles of ice; the solid equivalent of drizzle. The grains are fairly flat or elongated. Diameters are generally less than .04 inch (1mm). When the grains hit hard ground, they do not bounce or shatter. They usually fall in very small quantities from stratus clouds (or occasionally from fog).</p>	
<p>Hail (SHGS)</p> <p>Precipitation in the form of small balls or other pieces of ice falling separately or frozen together in irregular lumps. Hailstones consist of alternate opaque and clear layers of ice in most cases. Hail is normally associated with thunderstorms and surface temperatures above freezing.</p>	
<p>Ice Pellets (PL)</p> <p>Precipitation of transparent or translucent pellets of ice, which are round or irregular, rarely conical, and have a diameter of 0.2 inch (5 mm) or less. The pellets usually rebound when striking hard ground and make a sound on impact. They are two main types. Hard grains of ice consisting of frozen raindrops or melted and refrozen snowflakes and pellets of snow encased in a thin layer of ice formed from the freezing, either of droplets intercepted by the pellets or of water resulting from the partial melting of the pellets.</p>	
<p>Ice Crystals (IC)</p> <p>A fall of unbranched (snow crystals are branched) ice crystals in the form of needles, columns, or plates. They are termed "ice prisms" in Synoptic observations. Ice crystals are often so tiny they seem to be suspended in the air. They may fall from a cloud or from clear air. The crystals are visible mainly when they glitter in the sunshine or other bright light (diamond dust), thus producing a luminous pillar or other optical phenomena. This hydrometeor (rarely more than the lightest precipitation), which is frequent in polar regions, occurs only at very low temperatures in stable air masses.</p>	

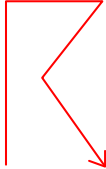
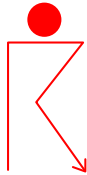
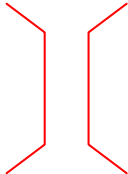
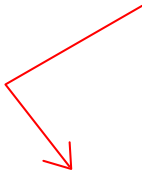
Table 8-1. Weather Graphics.	
<i>DESCRIPTION</i>	<i>WEATHER GRAPHIC</i>
Storms	
<p>Thunderstorm (TS)</p> <p>A local storm produced by a cumulonimbus cloud accompanied by strong, gusty winds; vertical currents at higher levels; and heavy precipitation with lightning and/or thunder. It is usually a few miles in both horizontal and vertical dimensions, extending from the ground up to 20,000, 40,000, or even 60,000 feet in the most vigorous examples.</p>	
<p>Thunderstorm (TS) and Rain (RA)</p> <p>A local storm produced by a cumulonimbus cloud accompanied by lightning and/or thunder and precipitation, either in the form of drops larger than 0.02 inch (0.5 mm) or smaller drops, which in contrast to drizzle, are widely separated.</p>	
<p>Funnel Cloud (FC) / Tornado / Waterspout</p> <p>1. Funnel Cloud (FC) - A violent, rotating column of air which does not touch the ground, usually appended to a cumulonimbus cloud. Also called a tuba.</p> <p>2. Tornado - (+FC) - A violent, rotating column of air touching the ground; funnel cloud touching the ground. A tornado nearly always starts as a funnel cloud (FC) and is accompanied by a loud, roaring noise.</p> <p>3. Waterspout (+FC) - A violent, rotating column of air that forms over a body of water, such as a bay, gulf, or lake and touches the water surface; a tornado or funnel cloud that touches a body of water.</p>	
<p>Lightning (LTG)</p> <p>A luminous manifestation accompanying a sudden electrical discharge which takes place from or inside a cloud or, less often, from high structures on the ground or from mountains.</p>	
Storm Systems	



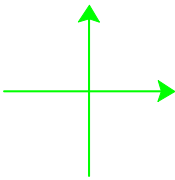

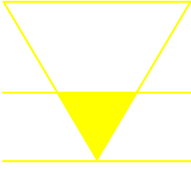
Table 8-1. Weather Graphics.	
<i>DESCRIPTION</i>	<i>WEATHER GRAPHIC</i>
<p>Tropical Storm</p> <p>A tropical cyclone having winds ranging from approximately 48 to 121 kilometres or 30 to 75 miles per hour.</p>	
<p>Hurricane</p> <p>Tropical cyclones, especially in the West Indies, in which the wind velocity equals or exceeds 64 knots (73 mph).</p>	
Obstructions To Visibility	
<p>Blowing Snow (BLSN)</p> <p>Snow particles raised and stirred violently by the wind to moderate or great heights. Prevailing visibility is reduced to less than 7 miles (9,999 meters) and the sky may become obscured when the particles are raised to great heights.</p>	
<p>Fog (FG)</p> <p>A visible aggregate of minute water particles (droplets) which are based on the Earth's surface, extends vertically, and reduces horizontal visibility to less than 5/8 mile (1,000 meters). When fog is further described by the descriptors BC, MI, or PR, the prevailing visibility may be equal to or greater than 5/8 mile (1,000 meters). Unlike drizzle, FG does not fall to the ground.</p>	
<p>Freezing Fog (FZFG)</p> <p>A suspension of numerous minute ice crystals in the air, or water droplets at temperatures below 0 degrees Celsius, based at the Earth's surface and extending vertically to greater than 6 feet (1.8 meters). FZFG reduces prevailing visibility to less than 5/8 mile (1000 meters) and, unlike drizzle, does not fall to the ground. The water droplets may freeze upon contact with exposed objects to form a coating of rime or glaze, and it can occur even though the air temperature is above freezing. The water droplets may freeze upon contact with exposed objects to form a coating of rime or glaze. Also called Ice Fog.</p>	






Table 8-1. Weather Graphics.	
<i>DESCRIPTION</i>	<i>WEATHER GRAPHIC</i>
<p style="text-align: center;">Dust or Sand Storm</p> <p>1. <u>Duststorm (DS)</u>. An unusual, frequently severe weather condition characterized by strong winds and dust-filled air over an extensive area. Report a duststorm if the prevailing visibility is reduced to less than 5/8 miles (1,000 meters) but not less than 5/16 miles (500 meters). Report a heavy (severe) duststorm (+DS) if the visibility is reduced to less than 5/16 miles (500 meters).</p> <p>2. <u>Sandstorm (SS)</u>. Particles of sand ranging in diameter from 0.008 inches to 1 millimetres carried aloft by a strong wind. The sand particles are mostly confined to the lowest ten feet and rarely rise more than fifty feet above the ground. A sandstorm is reported if the prevailing visibility is reduced to less than 5/8 miles (1,000 meters) but not less than 5/16 miles (500 meters). Report a heavy (severe) sandstorm (+SS) if the visibility is reduced to less than 5/16 miles (500 meters).</p>	
<p>Dust Devil</p> <p>Well-developed dust/sand whirls (PO). An ensemble of particles of dust or sand, sometimes accompanied by small litter, raised from the ground in the form of a whirling column of varying height with a small diameter and an approximately vertical axis. Reported regardless of the visibility.</p>	
<p>Smoke (FU)</p> <p>A suspension in the air of small particles produced by combustion. A transition to haze may occur when smoke particles have travelled great distances (25 to 100 miles or 40 to 160 kilometres or more) and when the larger particles have settled out and the remaining particles have become widely scattered through the atmosphere. When viewed through smoke, the disk of the sun at sunrise and sunset appears very red. The disk may have an orange tinge when the sun is above the horizon. Evenly distributed smoke from distant sources generally has a light greyish or bluish appearance.</p>	
<p>Haze (HZ)</p> <p>A suspension in the air of extremely small, dry particles invisible to the naked eye and sufficiently numerous to give the air an opalescent appearance. This phenomenon resembles a uniform veil over the landscape and subdues all colours. Dark objects viewed through this veil tend to have a bluish tinge while bright objects, such as the sun or distant lights, tend to have a dirty yellow or reddish hue. When haze is present and the sun is well above the horizon, its light may have a peculiar silvery tinge. Haze particles may be composed of a variety of substances; e.g., dust, salt, residue from distant fires or volcanoes, pollen, etc., which generally are well diffused through the atmosphere.</p>	

Table 8-1. Weather Graphics.	
<i>DESCRIPTION</i>	<i>WEATHER GRAPHIC</i>
Blowing Dust or Sand Dust or sand raised by the wind to a height of 6 feet (1.8 meters) or more.	

(INTENTIONALLY BLANK)

ANNEX A

SYMBOL IDENTIFICATION CODES

Purpose

A001. When published this annex will outline the procedures for determining symbol identification codes (SIDC) for symbols in APP-6(C). It will be published at a later date. Countries that use SIDCs should continue to use the codes in APP-6(B) until this annex is published.

Symbol Identification Codes

A002. A symbol identification code is an alphanumeric code based on a database structure that provides the minimum elements required to construct the basic icon and/or a complete symbol.

(INTENTIONALLY BLANK)

ANNEX B

COMPARATIVE FORMATION/UNIT DESIGNATIONS

General

B001. The data given in this Annex has been provided by each nation. The designations assigned by the various nations to their formations/units are shown against the agreed size symbols listed in Table II in Chapter 2 of this document. If a nation has no formation unit of the size indicated by the symbol, no designation will be entered. Nations not yet included in this Annex are invited to provide their unit designations. With a view to making this Annex easier to understand, each military symbol is accompanied by a group number, which is explained at the end of the Annex.

Explanatory Notes

B002. These group numbers should not be used outside the context of this STANAG. They are not intended as definitions in themselves.

- a. **Group 1.** The smallest basic unit, part of a group 2 and/or a group 3 unit. Requires administrative and logistical support.
- b. **Group 2.** A unit larger than a group 1 unit but smaller than a group 3 unit. Requires administrative and logistical support.
- c. **Group 3.** A unit designed to perform a tactical or support mission, composed of two or more group 1 and/or group 2 units and normally forming part of a group 4 unit. It is commanded by an OF-1/OF-2 or OR-7/OR-8 (see STANAG 2116) and may or may not require administrative support.
- d. **Group 4.** A unit designed to be capable of administering itself if operating independently and may be self-accounting. It is composed of two or more group 3 units and is commanded by an OF-2 or 3 (see STANAG 2116). It is normally part of a group 5 unit. It can be a composite group 4 unit of mixed arms.
- e. **Group 5.** A unit designed to be self-administering and self-accounting and capable of operating independently. It is composed of two or more group 4 units and is commanded by an OF-3 or 4 (see STANAG 2116). It can be grouped with group 1, 2, 3 or 4 units of different arms to form a composite group 5 unit of mixed arms.
- f. **Group 6.** A unit of two or more group 5 units or group 4 units usually of the same arm under a designated commander. Usually commanded by an OF-4, 5 or 6 (see STANAG 2116).
- g. **Group 7.** A formation of two more combat arm group 5 units or group 6 units with group 1, 2, 3, 4 or 5 units from supporting arms and services normally commanded by an OF-5 or 6 (see STANAG 2116); it is smaller than a group 8 formation.

- h. **Group 8.** A major tactical and administrative formation which combines in itself the necessary arms and services required for sustained combat, larger than a group 7 formation and smaller than a group 9 formation. It is normally commanded by an OF-7 (see STANAG 2116).
- i. **Group 9.** A formation larger than a group 8 formation and smaller than a group 10 formation which usually consists of two or more group 8 formations together with supporting arms and services. It is normally commanded by OF-8 (see STANAG 2116).
- j. **Group 10.** The largest tactical and administrative formation of armed forces made up of a number of group 9 and group 8 formations.
- k. **Group 11.** Several group 10 or group 9 formations under a designated joint force commander.

GROUP	SYMBOL	NATIONAL DESIGNATION	REMARK	COUNTRY
1	●			ALB
2	● ●			
3	● ● ●			
4	I			
5	II			
6	III			
7	X			
8	XX			
9	XXX			
10	XXXX			
11	XXXXX			

GROUP	SYMBOL	NATIONAL DESIGNATION		REMARK	COUNTRY
		FRANCAISE	NEERLANDAISE		
					BEL
1	●	Equipe	Ploeg	(1)	
2	● ●	Section	Sectie	(1)	
3	● ● ●	Peloton	Peloton	(1)	
4	I	Compagnie Escadron Batterie	Compagnie Eskadron Batterij	(1) armor artillery	
5	II	Bataillon Escadrille	Bataljon Escadrille	(1) army aviation	
6	III	Groupement Regiment	Groepering Regiment	<u>Applies only to home forces</u>	
7	X	Brigade	Brigade	(1)	
8	XX	Division	Divisie	(1)	
9	XXX	Corps d'armée	Legerkorps	(1)	
10	XXXX	Armée	Leger	(2)	
11	XXXXX	Group d'armée	Legergroep	(2)	

GROUP	SYMBOL	NATIONAL DESIGNATION	REMARK	COUNTRY
				BGR
1	●	Razchet (Разчет) Ekipazh (Екипаж)	(1) artillery, signals, air-defence infantry, armour, reconnaissance, engineers, signals	
2	● ●	Otdelenie (Отделение)	(1) infantry, reconnaissance, NBC, logistic, signals, engineers	
3	● ● ●	Vzvod (Взвод)	(1) infantry, armour, reconnaissance, artillery, air-defence, engineers, signals, NBC, logistic,	
4	I	Rota (Рота) Batareja (Батарея)	(1) infantry, armour reconnaissance, signals, engineers, NBC, logistic artillery, air-defence	
5	II	Bataliyon (Батальон) Diviziyon (Дивизион)	(1) infantry, armour reconnaissance, signals, engineers, NBC, logistic artillery, air-defence	
6	III	Polk (Полк)	(1) infantry, armour reconnaissance, artillery, signals, engineers, NBC, logistic	
7	X	Brigada (Бригада)	(1) infantry, armour, artillery, engineers, logistic	
8	XX	No equivalent	(2)	
9	XXX	Komandvane (Командване)	(1), (3)	
10	XXXX	Armia (Армия)	(1)	
11	XXXXX	No equivalent	(2)	

(1) basic national designation.

(2) non existent in the Bulgarian armed forces.

(3) will exist in the Bulgarian armed forces up to the end of 2006.

Note: Words in Latin letters are the transcribed pronunciation of national designations.

GROUP	SYMBOL	NATIONAL DESIGNATION	REMARK	COUNTRY
				CAN
1	●	Element smaller than a Section		
2	● ●	Section	(1)	
3	● ● ●	Platoon Troop Section	(1) infantry armour, artillery, engineers, signals aviation	
4	I	Company Squadron Battery Flight	(1) infantry armour, engineers artillery aviation	
5	II	Battalion Regiment Squadron	(1) infantry armour, artillery, engineers, signals aviation	
6	III	Regiment Wing Group	(2) aviation established as required generally in support of joint operations	
7	X	Brigade Brigade group Aviation group	(1)	
8	XX	Division	(2)	
9	XXX	Corps	(2)	
10	XXXX	Army	(2)	
11	XXXXX	Army group	(2)	

(1) basic national designation.

(2) non existent in the Canadian armed forces.

GROUP	SYMBOL	NATIONAL DESIGNATION	REMARK	COUNTRY
1	●	Osádka, obsluha, sekce	Element smaller than a section	CZE
2	● ●	Družstvo	(1)	
3	● ● ●	Četa	(1)	
4	I	Rota Baterie Roj	(1) artillery, air defense aviation	
5	II	Prapor Oddíl Letka	(1) artillery, air defense aviation	
6	III	Pluk Letecká skupina	(1) aviation	
7	X	Brigáda Zakladna	(1) aviation	
8	XX	Divize	(1)	
9	XXX	Armádní sbor	(1)	
10	XXXX		(2)	
11	XXXXX		(2)	

(1) Basic national designation.

(2) Non existent in the Czech army.

GROUP	SYMBOL	NATIONAL DESIGNATION	REMARK	COUNTRY
1	●	Trupp	(1)	DEU
2	● ●	Gruppe Rotte	(1) army aviation	
3	● ● ● ● ● ● ●	Zug Schwarm Staffel	(1) army aviation echelon of command/control or support elements	
4	I	Kompanie Batterie Staffel Boot Inspektion	(1) artillery, army air defence army aviation, air force, medical and navy navy military school	
5	II	Bataillon Abteilung Bootsgeschwader, Schiff Lehrgruppe	(1) army aviation navy military school	
6	III	Regiment Geschwader, Bereich Schiffsgeschwader	(1) artillery, signal, army aviation, engineers, army air defence, air mobile infantry, medical, NBC defence, logistics air force navy	
7	X	Brigade Einsatzflottille Sanitätskommando Einsatz	(1) logistics, armour, armoured infantry, airborne infantry, air mechanized, special forces, army combat support navy Bundeswehr Joint Medical Service Command	
8	XX	Division Wehrbereichskommando Sanitätskommando Einsatz	(1) armour, armoured infantry, special operations, air mechanized Bundeswehr Joint Medical Service Command	
9	XXX	Korps Kommando Operative Führung Eingreifkräfte Kommando Operative Führung Luftstreitkräfte Flottenkommando	(1) Response Forces Operations Command air force navy	
10	XXXX	Armee Component Command Einsatzführungskommando der Bundeswehr TSK FüKdo und Ämter	(2) (2) Bundeswehr Operations Command Single Service Commands & Departments	
11	XXXXX	Armeegruppe Joint Force Command	(2) (2)	

(101) Basic national designation.

(102) Non existent in the German Armed Forces.

GROUP	SYMBOL	NATIONAL DESIGNATION	REMARK	COUNTRY
1	●	Gruppe	(1)	DNK
2	● ●	Sektion	(1)	
3	● ● ●	Deling	(1)	
4	I	Kompagni Eskadron Batteri	infantry, engineers, signals armour artillery	
5	II	Bataljon Afdeling Bataljons kampgruppe	(1) artillery composite unit of mixed arms, mainly infantry or armour with other arms added	
6	III	Regiment	peacetime training and administrative unit	
7	X	Brigade	(1)	
8	XX	Division	(1)	
9	XXX	Korps	(1)	
10	XXXX	Arme	(2)	
11	XXXXX	Armegruppe	(2)	

(1) basic national designation.

(2) non existent in the Danish Army.

GROUP	SYMBOL	NATIONAL DESIGNATION	REMARK	COUNTRY
1	●	Escuadra/Equipo Patrulla	(1) army air	ESP
2	● ●	Peloton		
3	● ● ●	Seccion		
4	I	Compania Bateria Escuadron Subgrupo Tactico	(1) artillery armour composite unit of mixed arms	
5	II	Battallon Grupo Grupo Tactico	(1) artillery, cavalry, services composite unit of mixed arms	
6	III	Regimiento Agrupacion Tactica	(1) composite unit of mixed arms	
7	X	Brigada	(1)	
8	XX	Division	(1)	
9	XXX	Cuerpo de Ejercito	(1)	
10	XXXX	Ejercito	(2)	
11	XXXXXX	Grupo de Ejercito	(2)	

(1) basic national designation.

(2) non existent in the Spanish army.

GROUP	SYMBOL	NATIONAL DESIGNATION	REMARK	COUNTRY
				EST
1	●			
2	● ●			
3	● ● ●			
4	I			
5	II			
6	III			
7	X			
8	XX			
9	XXX			
10	XXXX			
11	XXXXX			

GROUP	SYMBOL	NATIONAL DESIGNATION	REMARK	COUNTRY
1	●	Equipe Equipage	(1) personnel responsible for the operation of equipment	FRA
2	● ●	Groupe Patrouille	(1) reconnaissance	
3	● ● ●	Section Peloton	(1) armour and transportation units	
4	I	Compagnie Batterie Escadron Flight	(1) artillery armour and transportation units army aviation	
5	II	Bataillon Groupement	(1) (1) temporary unit	
6	III	Regiment	(1)	
7	X	Brigade	(1) logistic unit	
8	XX	Division	(1)	
9	XXX	Corps d'Armée	(1)	
10	XXXX	Armée	(1)	
11	XXXXXX	Groupe d'Armées	(2)	

(1) Basic national designation.

(2) non existent in the French army.

GROUP	SYMBOL	NATIONAL DESIGNATION	REMARK	COUNTRY
1	●	Section	(1)	GBR
2	● ●		(2)	
3	● ● ●	Platoon Troop Flight	(1) marines, armour, artillery, engineers, signals, special air service, transport, army air, RAF Regiment	
4	I	Company Squadron Battery Combat group. Squadron group, Coy/Sqn group	(1) armour, engineers, signals, special air service, army air , transport, RAF Regiment	
5	II	Battalion Regiment Field Ambulance Armoured or Field workshop Wing Battle group Commando	(1) armour, artillery, engineers, signals, special air service, army air medical repair and recovery RAF Regiment composite unit of mixed arms "marines"	
6	III		(2)	
7	X	Field force/Brigade	(1)	
8	XX	Division	(1)	
9	XXX	Corps	(1)	
10	XXXX		(2)	
11	XXXXX	Army Group	(1)	

(1) basic national designation.

(2) non existent in the British army.

GROUP	SYMBOL	NATIONAL DESIGNATION	REMARK	COUNTRY
1	●	Hemi-Homas Stoecheon	Infantry Infantry, armour	GRC
2	● ●	Homas Stoecheon	Infantry, armour, engineers, signals artillery	
3	● ● ●	Themoerea Ulamos	infantry, engineers, signals artillery, armor	
4	I	Lochos Pyrovolarchia Ili	infantry, engineers, signals artillery armour	
5	II	Taghma Mora Epilarchia	infantry, engineers, signals artillery armour	
6	III	Stntagma Theoekissis machis Merarchiakon Pyrovolikon Homas Pyrovolikon Mahis	infantry armour)) artillery))	
7	X	Taxiarchia	armour	
8	XX	Merarchia	(1)	
9	XXX	Soma stratou	(1)	
10	XXXX	Stratia	(1)	
11	XXXXX		(2)	

(1) Basic national designation.

(2) Nonexistent in the Greek army.

GROUP	SYMBOL	NATIONAL DESIGNATION	REMARK	COUNTRY
1	●			HRV
2	● ●			
3	● ● ●			
4	I			
5	II			
6	III			
7	X			
8	XX			
9	XXX			
10	XXXX			
11	XXXXX			

GROUP	SYMBOL	NATIONAL DESIGNATION	REMARK	COUNTRY
1	●	Résleg Repülő géppár	(1) It does not exist as an organic unit.	HUN
2	● ●	Kezelőszemélyzet Raj	(1) armour, infantry reconnaissance	
3	● ● ●	Szakasz	(1) armour, infantry, engineers, signals	
4	I	Század Úteg	(1) armour, infantry, signals, air artillery air defence	
5	II	Zászlóalj Osztály	(1) armour, infantry, combat service support artillery air defence	
6	III	Ezred	(1) radar, air	
7	X	Dandár	(1) infantry, logistics	
8	XX	Hadosztály	(2)	
9	XXX	Hadtest	(1)	
10	XXXX	Hadsereg	(2)	
11	XXXXXX	Hadseregcsoport	(2)	

(1) Basic national designation.

(2) Nonexistent in the Hungarian Defense Forces.

GROUP	SYMBOL	NATIONAL DESIGNATION	REMARK	COUNTRY
1	●			ISL
2	● ●			
3	● ● ●			
4	I			
5	II			
6	III			
7	X			
8	XX			
9	XXX			
10	XXXX			
11	XXXXX			

GROUP	SYMBOL	NATIONAL DESIGNATION	REMARK	COUNTRY
1	●	Squadra Squadra pezzo Equipaggio	(1) artillery tank and cavalry	ITA
2	● ●	Pattuglia	This formation is not an organic unit. A comparable unit is organized on a case by case basis in accordance with the task. The unit strength may range from group 1 to 3.	
3	● ● ●	Plotone Sezione	(1) artillery, transport	
4	I	Compagnia Squadrone Batteria Autoreparto Complesso minore	(1) cavalry, army aviation artillery transport combined arms company group	
5	II	Battaglione Gruppo Gruppo squaroni Autogruppo Reparto	(1) infantry, signal, engineers, logistic, transport artillery cavalry, army aviation transport combined arms battle group (battalion level), headquarters units, medical	
6	III	Reggimento	(1) In the Italian Army the regiment is battalion sized. Grouping of combat support units Combined arms battle group	
7	X	Brigata	(1)	
8	XX	Divisione Comando Operativo Intermedio Comando dei Supporti delle Forze Operative Terrestri	(1) divisional headquarters are called "Intermediate Operational Command" CS and CCS headquarters of the Operational Land Forces Command	
9	XXX	Corpo d' Armata Comando Operativo Intermedio Comando Forze Operative Terrestri	(1) The "Intermediate Operational Command" may be elevated to corps level. Operational Land Forces Command	
10	XXXX	Armata	Applicable only time	

(1) Basic national designation.

GROUP	SYMBOL	NATIONAL DESIGNATION	REMARK	COUNTRY
				LTU
1	●	Grandis Grupė	(1) Artillery	
2	● ●	Skyrius	(1)	
3	● ● ●	Būrys Ekipa, komanda, grupė	(1) Special forces	
4	I	Kuopa Baterija Grandis	(1) Artillery, Air defence Air forces	
5	II	Batalionas Eskadrilė	(1) Air forces	
6	III	Pulkas Rinktinė	Land forces training unit only National volunteer forces unit only	
7	X	Brigada	(1)	
8	XX	Karinis regionas	Territorial (regional) organization	
9	XXX	Ginkluotosios pajėgos	Unified command organization for all armed forces services and units	
10	XXXX		(2)	
11	XXXXX		(2)	

(1) Basic national designation.

(2) Nonexistent in the Lithuanian Armed Forces.

GROUP	SYMBOL	NATIONAL DESIGNATION	REMARK	COUNTRY
1	●	Equipe	(1)	LUX
2	● ●	Groupe	(1)	
3	● ● ●	Section	(1)	
4		Compagnie	(1)	
5		Bataillon	(1)	
6		Regiment	(2)	
7	X	Brigade	(2)	
8	X X	Division	(2)	
9	X X X	Corps d'Armée	(2)	
10	X X X X	Armée	(2)	
11	X X X X X	Groupe d'Armée	(2)	

(1) Basic national designation.

(2) Nonexistent in the Luxembourgian army.

GROUP	SYMBOL	NATIONAL DESIGNATION	REMARK	COUNTRY
				LVA
1	●			
2	● ●			
3	● ● ●			
4	I			
5	II			
6	III			
7	X			
8	XX			
9	XXX			
10	XXXX			
11	XXXXX			

GROUP	SYMBOL	NATIONAL DESIGNATION	REMARK	COUNTRY
1	●	Groep Ploeg Stuk	(1) services, cavalry (reconnaissance) artillery, mortars with infantry and cavalry	NLD
2	● ●	Detachement Groep Sectie	(1) cavalry, artillery, armour	
3	● ● ●	Peloton Gevechtsbatterij Vlucht	(1) anti aircraft artillery (except quad. 5 AAMG unit, designation “peloton”) army aviation	
4	I	Compagnie Eskadron Batterij Squadron	(1) cavalry, armour, military police artillery, anti aircraft artillery army aviation	
5	II	Bataljon Afdeling Groep Colonne Commando	(1) artillery, anti aircraft artillery army aviation civil defence services, indicates a non-organic formation consisting of various group 3 and 4 units	
6	III	Regiment Geniegevechtsgroep Groep (2)	exist only as a non-organic traditional grouping of battalions of the same arm or branch engineers (1)artillery) indicates a non-organic anti aircraft) formation consisting of artillery) various group 4 and 5 units signals) services)	
7	X	Brigade Legerkorps artillerie Legerkorps logistiek commando	(1) artillery services	
8	XX	Divisie	(1)	
9	XXX	Legerkorps	(1)	
10	XXXX	Leger	(3)	
11	XXXXX	Legergroep	(3)	

(1) basic national designation.

(2) always with the prefix of an arm, branch or service, e.. “intendance groep”

(3) non existent in the Royal Netherlands army.

GROUP	SYMBOL	NATIONAL DESIGNATION	REMARK	COUNTRY
1	●	Lag	(1)	NOR
2	● ●	Gruppe	(1)	
3	● ● ●	Tropp	(1)	
4	I	Kompani Eskadron Batteri Stridsgruppe	(1) armour, cavalry artillery composite unit of mixed arms	
5	II	Bataljon Stridsgruppe	(1) composite unit of mixed arms	
6	III	Regiment	administrative unit only	
7	X	Brigade Kombinert regiment	composite formation of mixed arms (Brigade Size)	
8	XX	Division Forsvarsdistrikt Landforsvar	(1)) territorial organization) ("Land Defence")	
9	XXX	Korps	(2)	
10	XXXX	Forsvarskommando	combined organization for all three services	
11	XXXXX	Arme-gruppe	(2)	

(1) basic national designation.

(2) non existent in the Norwegian army.

GROUP	SYMBOL	NATIONAL DESIGNATION	REMARK	COUNTRY
1	●	Element mniejszy niż drużyna	It does not exist as an organic unit and is structured each time in view of a particular task.	POL
2	● ●	Drużyna Załoga Działon	(1) infantry, reconnaissance, engineers, signals, air mobile armour artillery	
3	● ● ●	Pluton	(1)	
4	I	Kompania Bateria Swadron	(1) artillery air cavalry	
5	II	Batalion Dywizjon	(1) artillery	
6	III	Pułk	(1)	
7	X	Brygada	(1)	
8	XX	Dywizja	(1)	
9	XXX	Korpus	(1)	
10	XXXX		(2)	
11	XXXXX		(2)	

(1) Basic national designation.

(2) Nonexistent in the Polish Army.

GROUP	SYMBOL	NATIONAL DESIGNATION	REMARK	COUNTRY
1	●	Esquadra	(1)	PRT
2	● ●	Seccao	(1)	
3	● ● ●	Pelotao	(1)	
4	I	Companhia Bateria Esquadrao	(1) artillery cavalry and armour	
5	II	Batalhao Grupo	(1) cavalry, armour, artillery	
6	III	Regimento	(1)	
7	X	Brigada Agrupamento	(1) special duties organization	
8	XX	Divisao	(1)	
9	XXX	Corps de exercito	(1)	
10	XXXX	Exercito de campanha	(2)	
11	XXXXX	Grupo de exercitos	(2)	

(1) basic national designation.

(2) non existent in the Portuguese army.

GROUP	SYMBOL	NATIONAL DESIGNATION	REMARK	COUNTRY
				ROU
1	●	Secție		
2	● ●	Echipă Piesă	artillery.	
3	● ● ●	Pluton Secție	artillery	
4	I	Companie Baterie	Artillery	
5	II	Batalion Divizion	artillery	
6	III	Regiment		
7	X	Brigadă		
8	XX	Divizie		
9	XXX	Corp de armată		
10	XXXX	Armată		
11	XXXXXX			

GROUP	SYMBOL	NATIONAL DESIGNATION	REMARK	COUNTRY
				SVK
1	●			
2	● ●			
3	● ● ●			
4	I			
5	II			
6	III			
7	X			
8	XX			
9	XXX			
10	XXXX			
11	XXXXX			

GROUP	SYMBOL	NATIONAL DESIGNATION	REMARK	COUNTRY
				SVN
1	●			
2	● ●			
3	● ● ●			
4	I			
5	II			
6	III			
7	X			
8	XX			
9	XXX			
10	XXXX			
11	XXXXX			

GROUP	SYMBOL	NATIONAL DESIGNATION	REMARK	COUNTRY
1	●	Manga	(1)	TUR
2	● ●	Kisim	(1)	
3	● ● ●	Takim	(1)	
4	I	Bölük Batarya	(1) artillery	
5	II	Tabur	(1)	
6	III	Alay (muharebe grubu)		
7	X	Tugay	(1)	
8	XX	Tümen	(1)	
9	XXX	Kolordu	(1)	
10	XXXX	Ordu	(1)	
11	XXXXX	Ordular grubu		

(1) basic national designation.

(2) non existent in the Turkish army.

GROUP	SYMBOL	NATIONAL DESIGNATION	REMARK	COUNTRY
1	●	Squad	(1)	USA
2	● ●	Section	(1)	
3	● ● ●	Platoon Detachment	(1) Special Forces, Military Police	
4	I	Company Battery Troop	(1) artillery armored cavalry, air cavalry	
5	II	Battalion Squadron	armored cavalry, air cavalry	
6	III	Regiment Group	(1) armored cavalry artillery, engineer, aviation, Special Forces, combat service support	
7	X	Brigade	(1)	
8	XX	Division	(1)	
9	XXX	Corps	(1)	
10	XXXX	Numbered army	may be established to control two or more corps	
11	XXXXX	Army group	(1)	

(1) basic national designation.

REFERENCE PUBLICATIONS

AAP-6	NATO Glossary of Terms and Definitions
AAP-15	NATO Glossary of Abbreviations Used in NATO Documents and Publications
AAP-19	NATO Combat Engineer Glossary
AJP-01	Allied Joint Doctrine
AJP-2	Allied Joint Intelligence, Counter-Intelligence and Security Doctrine
AJP-2.1	Doctrine for Intelligence Procedures
AJP-3	Allied Doctrine for Joint Operations
AJP-3.1	Allied Joint Maritime Operations
AJP-3.2	Allied Joint Doctrine for Land Operations
AJP-3.3	Joint Air and Space Operations Doctrine
AJP-3.3.5	Doctrine for Joint Airspace Control
AJP-3.4.1	Peace Support Operations
AJP-4	Allied Joint Logistic Doctrine
AJP-9	NATO Civil-Military Co-operation (CIMIC) Doctrine
STANAG 1059	Letter Codes for Geographical Entities
STANAG 1166	Standard Ship Designator System
STANAG 1241	NATO Standard Identity Description Structure for Tactical Use
STANAG 2511	Intelligence Reports
STANAG 2220	Information/Intelligence Exchange on Irregular Forces
STANAG 2287	Task Verbs for Use in Planning and the Dissemination of Orders
STANAG 2460	Functional (Category) Codes for the Classification of Places and Installation and Facilities
STANAG 2961	Classes of Supply of NATO Land Forces

(INTENTIONALLY BLANK)

LEXICON**PART I – ACRONYMS AND ABBREVIATIONS**

Part I contains abbreviations relevant to APP-6 and is not meant to be exhaustive. The definitive and more comprehensive list of NATO agreed abbreviations is in AAP-15. APP-6 uses upper case for all abbreviations to reflect how they are used in this document. Chapter 7 also includes two tables of acronyms and abbreviations relevant to that chapter.

AA	assembly area
AARROZ	air-to-air restricted operations zone
AAW	anti-air warfare
ACA	airspace coordination area
AEW	airborne early warning
AGI	auxiliary group intelligence
ALT	altitude
APC	armoured personnel carrier
APOD	airport of debarkation
APOE	airport of embarkation
APP	Allied procedural publication
ASP	ammunition supply point
ASR	alternate supply route
ASUW	antisurface warfare
ASW	antisubmarine warfare
AUV	autonomous underwater vehicle
BDZ	base defense zone
BL	bridgehead line
BSA	brigade support area
C2	command and control
CBRN	chemical, biological, radiological, and nuclear
CBT	combat
CIE	Commission Internationale de l'Eclairage
CSAR	combat search and rescue
DET	detainee(s)
DIFAR	directional frequency analysis and recording
DSA	division support area
DTG	date-time group

DZ	drop zone
ENY	enemy
EO	electro-optical
EPLRS	enhanced position location reporting system
EPW	enemy prisoner of war
ERP	engineer regulating point
EW	electronic warfare
EZ	extraction zone
FAADEZ	forward area air defence engagement zone
FARP	forward arming and refuelling point
FC	funnel cloud
FCL	final coordination line
FEBA	forward edge of the battle area
FEZ	fighter engagement zone
FFA	free-fire area
FPF	final protective fire
FSA	fire support area
FSCL	fire support coordination line
FSS	fire support station
FSSL	fire support safety line
GOV	government
GPS	global positioning system
HIDACZ	high-density airspace control zone
HIMEZ	high missile engagement zone
HL	holding line
IFF	identification, friend-or-foe
ISR	intelligence, surveillance, and reconnaissance
JEZ	joint engagement zone
LAB	laboratory
LC	landing craft
LD	line of departure
LLTR	low-level transit route
LOA	limit of advance
LOMEZ	low missile engagement zone
LP	launch point

LRP	logistics release point
LZ	landing zone
MAGTF	Marine air-ground task force
MCM	mine countermeasures
MCP	maintenance collection point
MEDEVAC	medical evacuation
MEZ	missile engagement zone
MP	military police
MRR	minimum-risk route
MSD	minesweeper, drone
MSR	main supply route
NAI	named area of interest
NATO	North Atlantic Treaty Organization
NFA	no-fire area
NFL	no fire line
OBJ	objective
PAA	position area for artillery
PD	point of departure
PIM	position and intended movement
PK	picket
PLD	probable line of deployment
PP	passage point
PR	personnel recovery
PS	personnel services
PUP	pop-up point
PX	passenger
PZ	pick-up zone
R3P	rearm, refuel, and resupply point
RFA	restricted fire area
RFL	restrictive fire line
RGB	red, green, blue
RL	release line
RLY	rally point
ROM	refuel on the move
ROZ	restricted operating zone

RS	rescue surface station
RSA	regimental support area
RS	rescue station
RV	re-entry vehicle
SAAFR	standard use Army aircraft flight route
SAM	surface-to-air missile
SAR	search and rescue
SEAD	suppression of enemy air defences
SHORADEZ	short range air defence engagement zone
SIF	selective identification feature
SIGINT	signals intelligence
SOF	special operations force
SPOD	seaport of debarkation
SPOE	seaport of embarkation
STANAG	NATO standardization agreement
SUB	submarine
TAI	target area of interest
TCP	traffic control post
TF	task force
TGT	target
TRP	target reference point
TS	thunderstorm
TTP	trailer transfer point
TV	television
UAV	unmanned aerial vehicle
UL	ultra light
UMCP	unit maintenance collection point
UUV	unmanned underwater vehicle
UXO	unexploded explosive ordnance
VSTOL	vertical or short take-off and landing
WEZ	weapon engagement zone
WFZ	weapons free zone
WMO	World Meteorological Organization

PART II - TERMS AND DEFINITIONS

assumed friend

A track or contact which is assumed to be a friend because of its characteristics, behaviour, or origin. (STANAG 1241)

attribute

A distinctive feature or characteristic such as line, shape, colour, texture (fill), edge, mass, and value.

Commission Internationale de l'Eclairage (CIE)

A colour space chart widely used to describe the range of colour seen by the human eye.

contact

Any discrete airborne, surface or subsurface object detected by electronic, acoustic, and/or visual sensors. (AAP-6)

faker

A friendly track acting as a hostile for exercise purposes. (STANAG 1241)

fields

A defined area in which a limited combination of alphanumeric and other characters, indicators, and/or abbreviations are grouped/situated in an established way around a symbol/icon, line, area, point, or boundary and used for the purpose of providing additional information about the associated object or operational environment geometry.

frame

The geometric border of a symbol that provides an indication of the affiliation, battle dimension, and status of an operational object.

friend

In identification, the designation given to a track, object or entity belonging to a declared, presumed or recognized friendly nation, faction or group. (AAP-6)

graphic

Any and all products of the cartographic and photogrammetric art. A graphic may be either a map, chart, or mosaic or even a film-strip that was produced using cartographic techniques. (AAP-6)

hostile

In identification, the designation given to a track, object or entity whose characteristics, behaviour or origin indicate that it is a threat to friendly forces. Designation as hostile does not necessarily imply clearance to engage. (AAP-6)

icon

The innermost part(s) of a symbol that provides a graphic representation of an operational object. Icons can be either graphic or alphanumeric.

indicator

One of several specific graphical additions to a symbol used to provide additional information pictorially vice textually. In intelligence usage, an item of information which reflects the intention or capability of a potential enemy to adopt or reject a course of action. (AAP-6)

interoperability

The ability to act together coherently, effectively and efficiently to achieve Allied tactical, operational and strategic objectives. (AAP-6)

joker

A friendly track or contact acting as a "suspect" track for exercise purposes only. (STANAG 1241)

meteorological symbology

A structured set of symbols and graphics for the display of meteorological information.

modifier

Optional text or graphics that provide additional information about a symbol or tactical graphic.

neutral

In identification, the designation given to a track, object or entity whose characteristics, behaviour, origin or nationality indicate that it is neither supporting nor opposing friendly forces. (AAP-6)

operational environment

Factors and conditions that must be understood to successfully apply combat power, protect the force and complete the mission.

operational symbology

Symbology used to plan and execute military operations in support of command, control, communications, computers, and intelligence functions.

pending

Tracks which have not been subject to the identification process but which are available for reporting. (STANAG 1241)

piracy

Piracy is an international crime consisting of illegal acts of violence, detention, or depredation committed for private ends by the crew or passengers of a private ship or aircraft in or over international waters against another ship or aircraft or persons and property on board. (Depredation is the act of plundering, robbing, or pillaging.)

present

Now existing or in progress; confirmed position.

signals intelligence

The generic term used to describe communications intelligence and electronic intelligence when there is no requirement to differentiate between these two types of intelligence, or to represent fusion of the two. (AAP-6) Also called SIGINT.

status

A determination or declaration as to whether a track's or object's location or battlefield environment is existing/present or is planned/anticipated at the time that the symbol was generated or the time associated/presented with the symbol itself.

suspect

A track or contact which is potentially hostile because of its characteristics, behaviour, origin, or nationality. (STANAG 1241)

symbol

An object that presents information.

symbol identification code

An alphanumeric code based on a database structure that provides the minimum elements required to construct the basic icon and/or a complete symbol.

text

Words, alphanumeric information, and other American Standard Code for Information Interchange characters used to define or further designate the meaning of a symbol.

track

A series of related contacts displayed on a data display console, other display devices, or a plotting board. The actual path of an aircraft above, or a ship on, the surface of the earth.

unknown

1. A code meaning information not available.
2. An unidentified target. An aircraft or ship that has not been determined to be hostile, friendly, or neutral, using identification friend or foe and other techniques but that must be tracked by air defense or naval engagement systems. An identity applied to an evaluated track or contact which has not been identified. (STANAG 1241) In identification, the designation given to an evaluated track, object or entity that has not been identified. (AAP-6)

(INTENTIONALLY BLANK)