



Road Bureau

Ministry of Land, Infrastructure, Transport and Tourism

[http://www.mlit.go.jp/road/road\\_e/index\\_e.html](http://www.mlit.go.jp/road/road_e/index_e.html)

2014



# 2014 ROADS IN JAPAN

# C O N T E N T S

## Chapter 1 Initiatives to Ensure Safety, Security and Comfort

Reducing Traffic Accidents .....	2
Creating a Comfortable Living Environment .....	4
Disaster Prevention .....	6
ITS (Intelligent Transport Systems) .....	8
Deployment of Multiple Applications via Smartway .....	10
Environmental Measures .....	12



## Chapter 2 Improving Performance and Service

Administrative Management .....	14
Road Development .....	16
Two-way Communication .....	23
Asset Management .....	24
Efficient Operation of the Road Network .....	28



## Chapter 3 Advanced Road Technologies

Tunnels .....	31
Bridges .....	32
Pavement .....	33



## Chapter 4 Road Administration in Japan

Type of Road .....	35
History of Roads in Japan .....	42
Organization Chart .....	48



Road Structure Ordinance .....

Statistics .....

# Chapter 1 Initiatives to Ensure Safety, Security and Comfort



Japan is a country with beautiful natural scenery, which changes from season to season, but also has steep land formations, weak geological features and is prone to earthquakes, storms, heavy snowfall and other natural disasters. Traffic accident fatalities and casualties are also rising with traffic-related deaths of about 5,000 and traffic-related casualties reaching 900,000, signifying

that one out of every 140 people is injured or dies in a traffic accident. Diverse measures are being implemented to prevent disasters and accidents; mitigate damages; enable quick restoration; improve the safety and security of road traffic; and create comfortable living environments.

# Reducing Traffic Accidents

The number of traffic fatalities has decreased for 12 consecutive years, fell below 4,500 in 2012, but the number of traffic fatalities and injuries still exceeds 800,000. In particular, the ratios of senior citizen and pedestrian fatalities are higher than in Europe and the United States.

Therefore, effective and efficient measures are being implemented to reduce traffic accidents on both arterial roads and community roads.

## Changes in the number of traffic accidents, fatalities and injuries

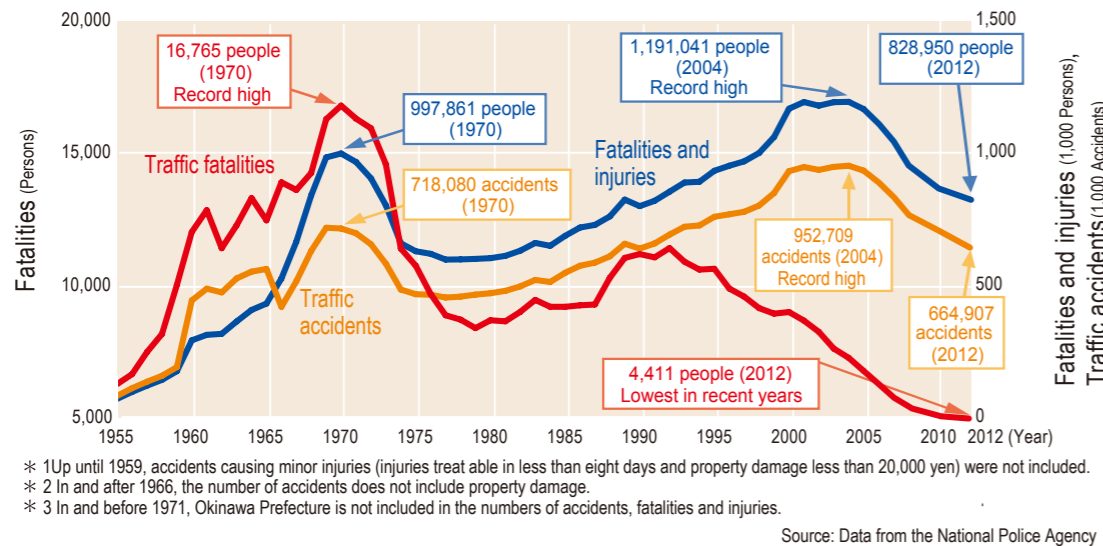

## Accident prevention measures on arterial roads

Because traffic accidents frequently occur in specific sections of arterial roads, 3,396 sections with a particularly high incidence of death or injury accidents were designated as high accident sections. Intensive measures for these sections are being conducted through the collaboration of prefectural Public Safety Commissions and road administrators.

### Example of measures in high accident section

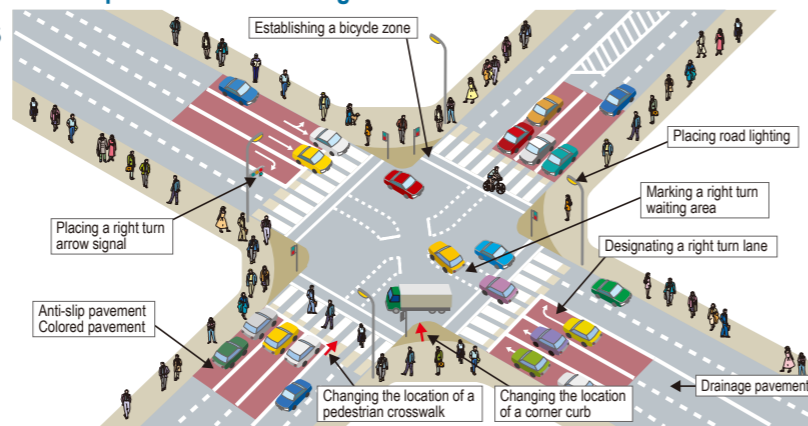

## Method for identifying road sections requiring Accident prevention measures

### Accident occurrence on arterial roads

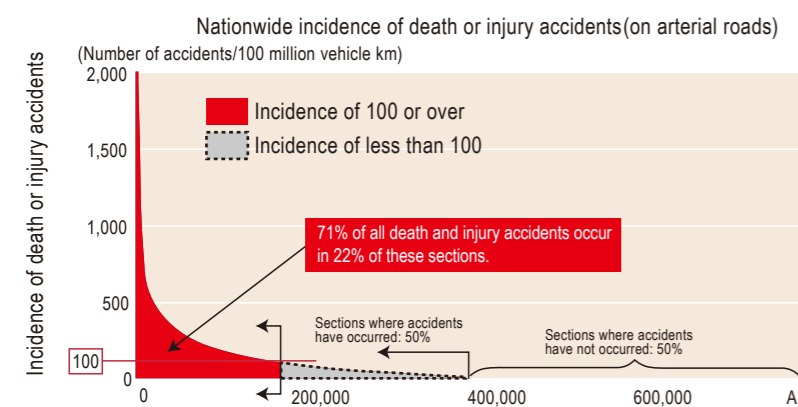

After sorting the sections in descending order according to the incidence of death or injury accidents, those which require priority implementation of measures are selected and specified as priority action sections.

\* Created from data on averages of accidents that occurred during four years (2003-2006) on approximately 180,000 km of national and prefectural roads throughout Japan.

## Accident prevention measures for community roads

Meticulous traffic accident measures are being conducted for community roads by establishing a problem solving cycle from problem identification and sorting to confirmation of

project implementation benefits through collaboration with regional residents and related organizations.

### Arterial road measures

- Intersection improvement**
  - Placement of right-turn lanes and improvement of intersections
  - Securing parking space and regulation of illegal parking (Public Safety Commissions)
- Improvement and modification of traffic signals** (Public Safety Commissions)
  - Controlling traffic signals based on traffic volume and other information
  - Installing LED traffic signals and barrier free-type traffic signals

### A schematic diagram of a safe-to-walk area



### Route measures

- Development of walking spaces**
  - Development of sidewalks, bicycle roads, wide sidewalks, and shared pedestrian-vehicle roads and underground installation of electric cables

### Zone measures

Creation of zones where pedestrians and bicycles have priority



Speed regulation within the zone (Public Safety Commissions)



Chicane



Speed bump

## Easing traffic at railroad crossings

A survey on the road traffic situation at roughly 36,000 railroad crossings all over Japan was conducted in 2006 and revealed that about 1,800 crossings urgently need measures for easing traffic congestion. Comprehensive and focused measures are being carried out on the crossings by combining immediate measures, such as widening pedestrian paths, and drastic measures, such as the implementation of grade separation.

### Continuous grade separation project

Before improvement



After improvement



The continuous grade separation project promotes integration of divided cities and smoothes urban traffic flow by eliminating many crossings through the use of elevated or underground railways at road-rail intersections.

# Creating a Comfortable Living Environment

Road construction and improvement projects are being implemented so that people can truly experience the improvements, such as safe and comfortable pedestrian spaces; high-quality living environments with roadside greening; running utility cables underground, etc.

## Promoting universal design in pedestrian spaces

By 2012, barrier-free pedestrian paths will be increased to represent about 75% of all road segments interconnecting railway stations, government facilities, hospitals and the like, which are designated by the Minister of Land, Infrastructure, Transport and Tourism as road sections where a large number of elderly and disabled people normally travel on foot.

### Example of universal design in pedestrian spaces



## Eliminating utility poles

Utility poles are being eliminated to help secure safe and comfortable pedestrian spaces; create a visually enhanced landscape and living environment; prevent disasters; improve the reliability of telecommunications networks conserve historical townscapes; promote tourism, restore local culture; and revitalize local communities.

We will continue to promote the elimination of utility poles in the future by aggressively utilizing multiple methods that suit local situations such as a combined approach of widening roads projects in conjunction with the elimination of utility poles and wiring in spaces under or behind building eaves. We will additionally look to reduce costs.

### [Multiple methods for eliminating utility poles]

Identical installation of common utility duct simultaneous with road construction project

Moving cables to the side street behind the street where poles are to be eliminated

Running cables under/along the eaves of houses along the street

### [Example of utility pole elimination]



## Creating a safe and pleasant environment for cyclists riding

While bicycles play an important role in the urban transportation system as a convenient transportation method, infrastructure for cyclists is not yet sufficient and is resulting in an increase of bicycle accidents relative to the total number of traffic accidents.

To stop this trend, MLIT and the National Police Agency (NPA) cooperated to launch the "Committee for Creating a Safe & Comfortable Bicycle-Use Environment" in 2011. The Committee submitted the following proposal to MLIT and the NPA: "A Bicycle Environment that is Friendly to Everybody: Proposal for a Safe & Comfortable Bicycle-Use Environment." In response to the proposal, in November 2012, MLIT and the NPA jointly formulated, "Guideline for Creating a Safe & Comfortable Bicycle-Use Environment."

### Changes in the number of bicycle accidents classified according to the other party (last 5 years)

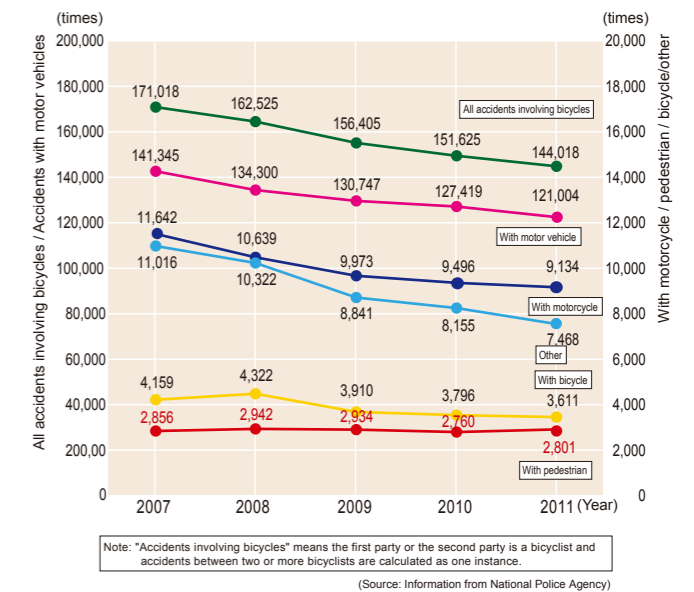

## Aiming to create advanced urban settings for bicycle usage



Development of cycling route networks



Collaboration with public transportation



Construction of bicycle parking facilities



Educating of people on bicycle riding rules and etiquette



Development and promotion of community bicycle programs

\* Conceptual images of the initiative

# Disaster Prevention

In order to secure safe and reliable road networks, high-standard arterial highways, urban ring roads and other disaster-resistant roads are being constructed. Measures against earthquakes, storms and heavy snows are also being implemented. Roads are an important infrastructure after a disaster has occurred.

## Earthquake

The land area of Japan comprises only 0.25% of the world's total, but Japan is one of the foremost countries to experience earthquakes, with the probability of a large-scale earthquake (magnitude of 6.0 or more) occurring at about 23%.



Massive earthquake and the following giant tsunami on the 11th of March 2011 caused enormous damages to the roads (National Highway 6, Hirono-machi, Fukushima Prefecture) (Photo: Tohoku Regional Development Bureau)

## Heavy rain

Japan receives twice as much precipitation as the mean precipitation in the rest of the world, especially during the rainy season and typhoon seasons. During the last decade, local heavy rains have increased sharply, therefore increasing the risk of floods. The soft soil collapses easily during storms and is prone to sediment run-off, landslides and other sediment-related disasters.



July 2009  
Mudslide caused by heavy rain in Chugoku and northern Kyushu regions (National Highway 262, Hofu City, Yamaguchi Prefecture)

## Heavy snow

Because the Sea of Japan lies between Japan and the Asian continent, Japan receives heavy snows brought by prevailing winds from the continent in winter, especially in areas facing the Sea. About 60% of the land is snowy and cold, where about one-fifth of the total population live, causing the population density to be as high as 105 people per km<sup>2</sup>, which far exceeds the values in other snowy countries.



February 2014  
Record-breaking heavy snow in Kanto-region:  
Japan Self-Defence Force clearing snow on the route 20  
(Photo: Mainichi Shimbun)

## Earthquake protection

To ensure a highly reliable road network that allows for fast and safe emergency activities during earthquakes, bridges are being retrofitted with earthquake protection.



Non-seismically reinforced bridge pier damaged by earthquake



Bridge pier seismically reinforced by concrete jacketing

## Disaster prevention for roadside slopes

A number of measures are implemented to protect road traffic from heavy rain and heavy snow. These include, among others, disaster prevention work on roadside slopes and construction of roads that circumvent disaster-prone sections.



Road with rockfall shelter

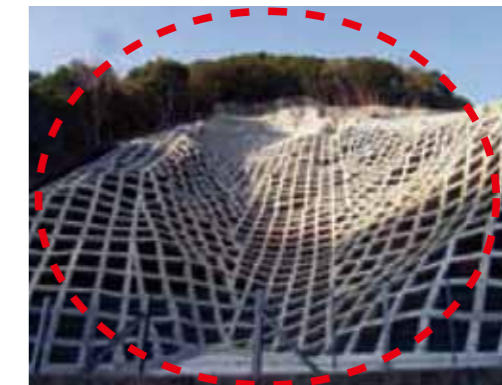

Protective concrete that prevents roadside slope collapsing

## Protection of road transport in winter

Road transport in snowy cold regions in the wintertime is protected by efficient snow removal as well as proactive installation of avalanche and other snow protection facilities.



Snow shed that provides avalanche protection



Snow removal operation

# ITS (Intelligent Transport Systems)

In Japan, ITS (Intelligent Transport Systems) are steadily expanding with the popularization of ETC (Electronic Toll Collection System) and VICS (Vehicle Information and Communication System), and have effectively opened up traffic by providing real-time information; eliminating congestion at toll gates; and mitigating environmental impacts by differential toll discounts. ITS has now entered its second stage and is being promoted in order to solve social issues. Installation of systems for collecting and providing information, which are the basis of ITS, is promoted and systems are being developed whereby drivers can enjoy diverse services via a single ITS on-board unit.

## ETC (Electronic Toll Collection System)

Since it went into service in March 2001, ETC users have been rapidly increasing in number with the quick popularization of ETC on-board units. At the end of March 2011, there were about 34.24 million ETC-equipped vehicles. ETC users now account for 86.2% of all vehicles on expressways in Japan. The system has effectively eliminated congestion at toll gates. Previously, 30% of congestion on expressways occurred at toll

gates. By allowing drivers to pass through toll gates without having to stop, ETC improves the processing capability of toll gates, eliminating congestion that would otherwise occur there. ETC communication technology is also used by private operators for non-stop passage through parking gates and ferry boarding, among others.

### Changes in number of vehicles equipped with ETC on-board unit and percentage of ETC use

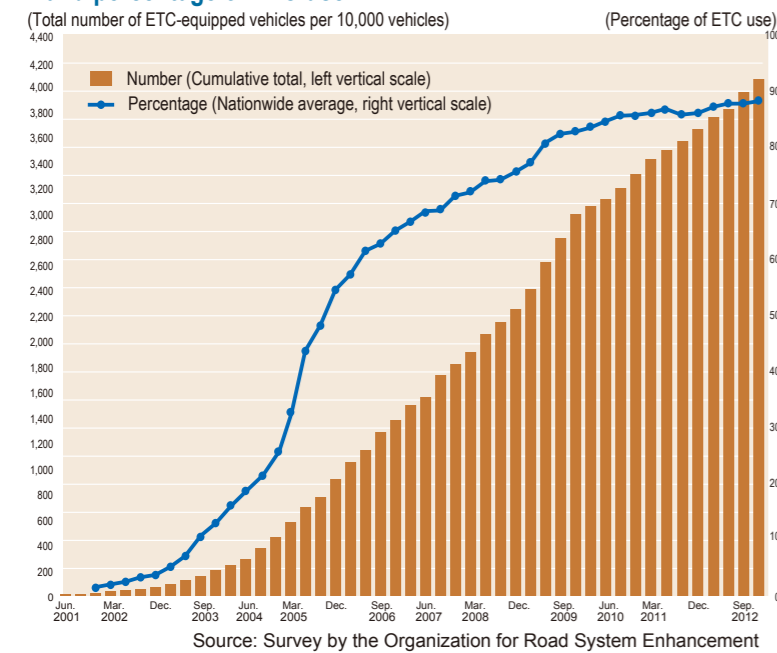

ETC for non-stop toll collection has been installed at almost all expressway toll gates in Japan, contributing toward mitigating toll-booth congestion.



Automated parking lot payment



Simplified ferry boarding procedure

### Congestion reduction effect of spreading ETC use on Metropolitan Expressway

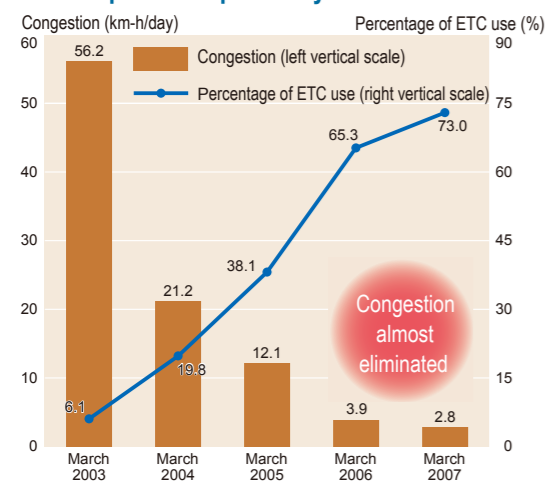

## VICS (Vehicle Information and Communication System)

VICS transmits road traffic data, such as congestion and traffic restrictions on a real-time basis, to onboard vehicle navigation units and displays data in the form of text, simple graphics and maps. The service started in Japan in April 1996, earlier than anywhere else in the world. VICS delivers information using three types of media: FM multiplex broadcasting, a radio wave beacon and an infrared beacon. At the end of March 2011, over 30.13 million vehicles were equipped with VICS compatible onboard units. VICS's best route guidance rectifies traffic flow and improves mileage, which in turn reduces CO2 emissions and environmental impacts. A target of the Kyoto Protocol Goal Achievement Plan is to reduce CO2 emissions by approximately 2.5 million tons (approximately 30% of all road related policy measures) by FY 2012, through the popularization of VICS.

### Number of VICS-compatible on-board units in use

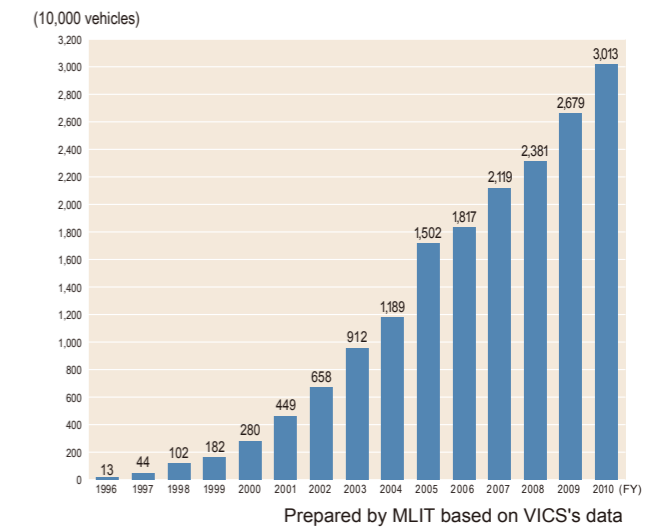

### Mechanism of VICS information

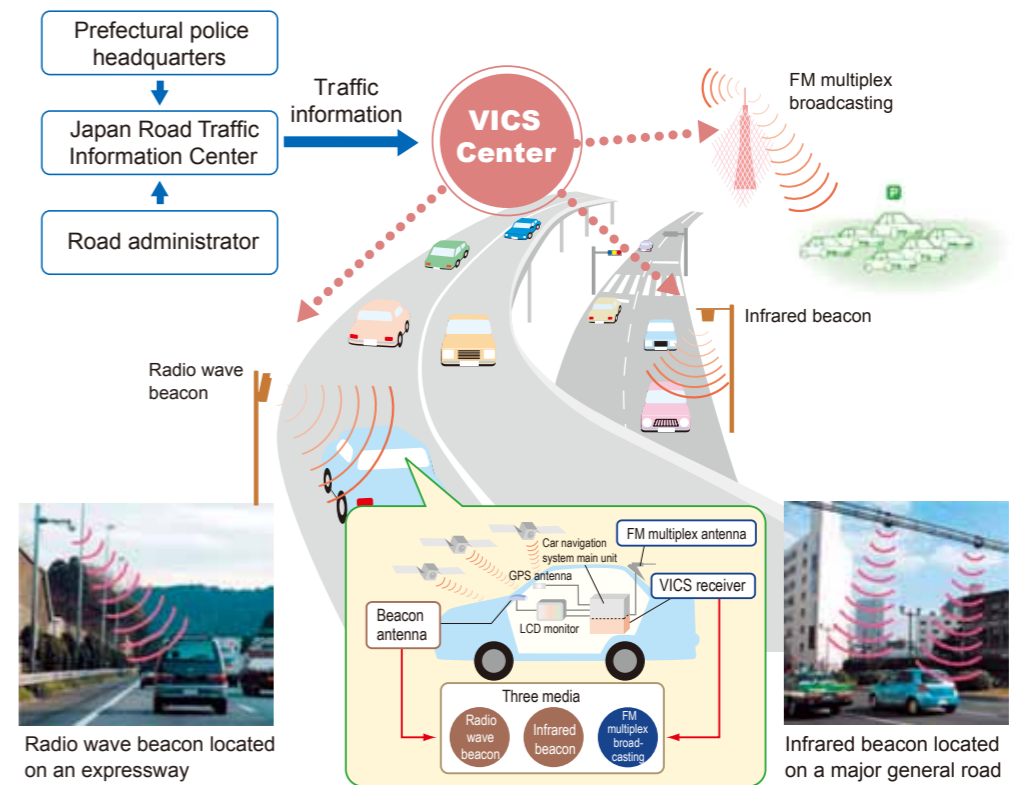

Radio wave beacon located on an expressway

Infrared beacon located on a major general road

Text (Level 1)	Simple graphics (Level 2)	Map (Level 3)
Tomei Expressway Nagoya-bound Accident Tomei Kawasaki IC →Tokyo IC Lane closure	Radio wave beacon: 25 minutes via XX street Infrared beacon: 45 minutes via National Hwy 20 FM multiplex broadcasting	Map

Source: Vehicle Information and Communication System Center

# Deployment of Multiple Applications via Smartway

“Smartway” is a next-generation road traffic system incorporating ITS technologies that provide information to connect people, vehicles and roads with the primary aim of ensuring traffic safety, reducing traffic congestion, and protecting the environment. To make it a reality, industry, government and academia have been working together in research, development and demonstration testing. Services such as VICS and ETC are now provided by separate onboard units, but these services will be available using a single (ITS) onboard unit. Furthermore, aims are to build an “Open Platform” that develops wider services including account settlement, sightseeing, logistics, etc., in addition to providing a wide-range of road traffic information, safe driving support information and so on.

## Characteristics of smartway

Central to the communication functions of Smartway is 5.8 GHz DSRC (Dedicated Short Range Communication), an international standard adopted by ISO (International Organization for Standardization) and ITU (International Telecommunication Union) that enables high speed, high volume, two-way communication. DSRC will make various services available by using the roadside “ITS spots” and a “compatible in-vehicle car navigation system.”

### Outline of ITS Spots and Compatible Car Navigation System

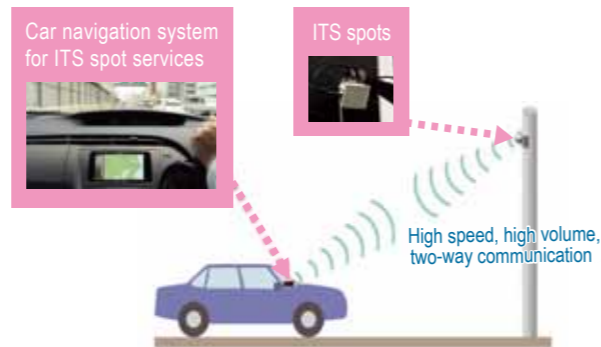

## Expanding ITS spot services throughout Japan

ITS spot services are available in about 1,600 places, centered on expressways in Japan, as of August 2011. With intercity expressways, an ITS spot is installed about every 10 to 15 km,

including about 90 locations before each junction, while with urban expressways, a spot is installed about every 4 km.

### Locations of ITS spots



## ITS spot services

### Comparison of scope of information provided by existing FM-VICS and ITS spot (Urban area)

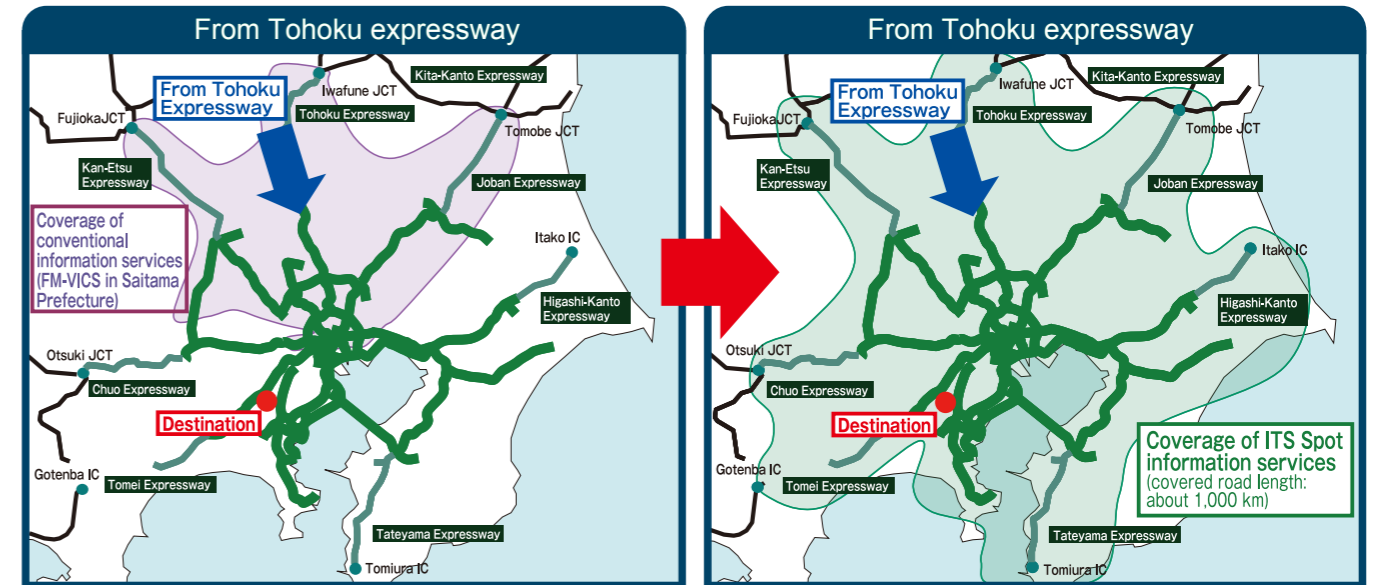

ITS spot services consist of three basic services that are made available as an all-in-one system by high speed, high volume road-to-vehicle communications.

① Wide-Range Road Traffic Information  
By transmitting road traffic information in real-time, car navigation systems can search a wide-area of expressways that cross prefectural borders, urban expressways and other roads, and select the fastest route based on the latest information.

② Safe Driving Support  
ITS spots provide a wide range of road traffic information on a regular basis, including traffic safety issues for specific roads. In emergencies, they provide information that supports safe driving.

③ ETC  
ITS spot services utilize the same technologies as ETC, therefore existing ETC services can be enjoyed with a compatible car navigation system.

④ Other services  
With some car navigation systems, information on tourist sites and updated maps are provided over the internet.

### Information provided by car navigation systems

- When sensor detects a traffic jam out of sight beyond an upcoming curve
- Normal driving

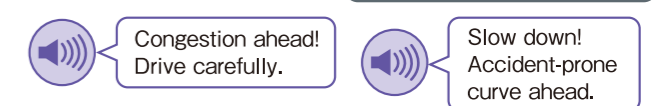
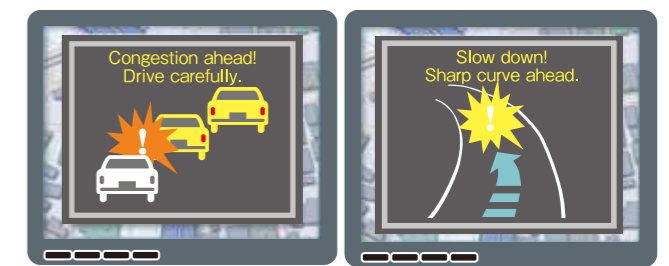

### Example of provided image information



(Travel direction is indicated by a white arrow, while a simplified graphic image appears on the right.)

## Enhanced services for ITS spots

Because ITS spots are being built as an open platform where the public and private sectors can work together to provide diverse services, plans are to develop a wide variety of services, i.e., cashless bill payment for parking areas, logistics support, and so forth.

Moreover, it is possible to acquire probe information (actual travel distance and speed of the vehicle) from ITS spots, therefore plans are to use this information for road construction, road policy planning and assessing instituted measures.

# Environmental Measures

Projects are being executed to improve roadside environments and roadside areas quickly. In order to prevent global warming, the transport industry must urgently deploy measures to reduce CO<sub>2</sub> emissions from vehicles, which account for a large percentage of total emissions.

## Protecting and creating roadside environments

### Noise barriers

Noise barriers prevent noise from reaching roadside residential and other districts.



Roadside environmental measures are being deployed to achieve environmental quality standards on noise and air pollution. Measures to control the heat-island phenomenon in cities are also being actively researched and developed.

### Sound absorbing panels installed under bridges

Sound absorbing panels installed under elevated road sections reduce noise.



### Green belts

Trees are planted between highways and residential districts to create green spaces and reduce noise and gas emissions.



### Low noise pavement

Small porous in the asphalt pavement surface absorb the noise produced by tires.

## Implementation of road measures that contribute to reduced CO<sub>2</sub> emissions

According to Japan's Kyoto Protocol Target Achievement Plan, reduction targets are decided for each sector. By FY2010 the transportation sector needs to reduce emissions by 14-17 million tons from the actual emission level of FY2005. Since the increased traveling speed resulting from smooth traffic flow improves effective mileage and thus reduces CO<sub>2</sub> emissions from vehicles, traffic flow improvement measures are under way, including improvement of ring road and arterial road networks, grade separation of intersections, as well as the development of the cycling environments and the advancement of ITS.

### Changes in CO<sub>2</sub> emissions in transportation sector

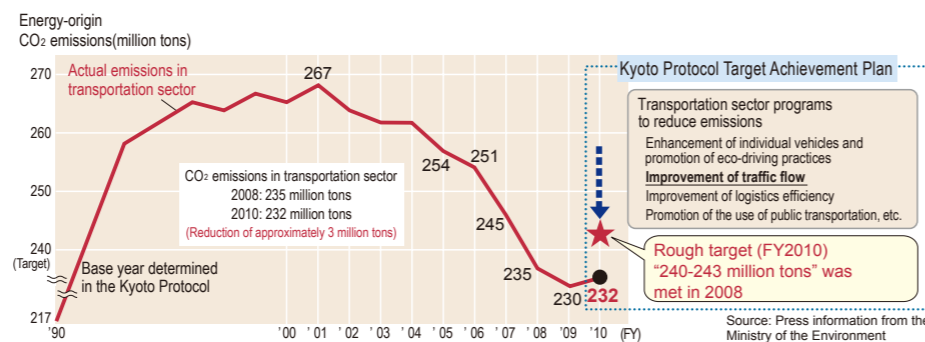

### Traveling speed and CO<sub>2</sub> emissions

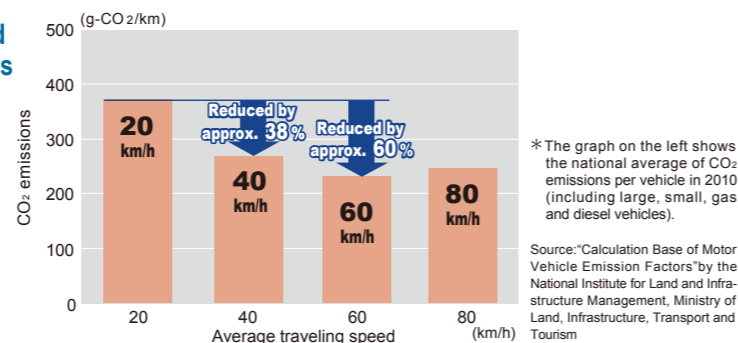

## Chapter 2

# Improving Performance and Service



Consistent road construction programs in post-World War II Japan have created a certain stock of roads. In a more mature society, it will be important to shift to road administration that focuses on the outcomes of road

services and satisfies road users. The project management approach has been used to ensure accountability to the public, as well as effective and efficient road administration.



# Administrative Management

Results-oriented road administration management has been promoted to achieve a shift toward more effective, efficient and transparent road administration from the viewpoint of citizens.

Today, efforts are under way to enhance road administrative management jointly with regional public corporations, NPOs and other citizens' groups.

## Establishing a well organized evaluation system

Road administration management is currently conducted according to the PDCA cycle, whereby policy goals are set by using citizen-oriented performance (outcome) indicators (Plan); policy measures and projects are executed (Do); results are analyzed and achievements evaluated (Check); and the results are reflected in subsequent administrative activities (Action).

### Target and past performance measured by Key Performance Indicators (KPIs) specified in the Priority Social Infrastructure Development Plan (five years from FY 2012-2016)

Objective	Measure	KPI	Actual performance		Target
			2012	2013	2017
1. Reduce disaster risk on a large scale or in wide areas	1-1 Enhance earthquake resistance in infrastructure and implement other non-infrastructure measures	Number of quake-resistant bridges on emergency routes (percentage)	77% (as of the end of FY2010)	78% (as of the end of FY2011)	82%
		Number of power lines on arterial roads in urban areas that are buried in the ground	15%	15.3%	18%
		Number of road links that provide a fast connection between major cities*1	46% (as of the end of FY2010)	47% (as of the end of FY2011)	About 50%
	1-2 Protect massive or region-wide tsunami-prone areas and improve the protection of areas below sea level, which either have a large population or a significant number of assets, from high tide water and abrasive action	Number of power lines on arterial roads in urban areas that are buried in the ground (percentage)	15%	15.3%	18%
	1-3 Enhance flood and large-scale landslide control measures to protect areas with a large population or a significant number of assets or areas that were significantly damaged in recent years	Number of improved slopes and embankments that were in need of protection (percentage)	54% (as of the end of FY2010)	56% (as of the end of FY2011)	68%
2. Enhance infrastructure across the country for industry and the economy, to boost international competitiveness	2-1 Expand and enhance capacity and accessibility of internationally competitive large cities, ports, and airports and promote overseas projects through public-private cooperation	Length of ring roads in operation in the three largest metropolitan areas (percentage)	56%	58%	About 75%
	2-2 Maintain and enhance dynamism by stressing the unique strengths and charms of each area	Number of power lines on arterial roads in urban areas that are buried in the ground (percentage)	15%	15.3%	18%
		Number of road links that provide fast connections between major cities (percentage)*1	46% (as of the end of FY2010)	47% (as of the end of FY2011)	About 50%
3. Achieve a sustainable and vibrant society and regional communities	3-1 Create a model for a sustainable and energy-efficient life style and encourage the diffusion of this life style domestically and internationally	Time lost due to railroad crossings that are closed all the time	1.28 million person-time/day	1.24 million person-time/day	1.21 million person-time/day
	3-2 Shift to a safe and secure society in this era of aging population, which correlates with a declining number of children	Percentage of specified roads with barrier-free elements	77%	81%	About 100% (as of the end of FY2020)
		Number of power lines on arterial roads in urban areas that are buried in the ground (percentage)	15%	15.3%	18%
		Number of prevented road traffic accidents at accident-prone locations (percentage)	-	-	About 30% of potential accidents were prevented
		Length of sidewalks provided for school roads (percentage)*2	51% (as of the end of FY2010)	52% (as of the end of FY2011)	About 60%
4. Maintain, manage, and reconstruct social infrastructure in a proper manner		Number of plans for extending road/bridge life across the country (percentage)	76%	89%	100%

\*1 Number of road links that provide fast connection between major cities: "fast connection" is defined as 60km/h or higher when the length of the shortest route between cities is divided by the shortest travel time.

\*2 "School road": specified in the Article 3 of the Act on Advancement of Traffic Safety Facilities Improvement Program.

Excerpt from "Chapter 3 Outline of Priority Objectives and Projects during the Target Period" in "the Priority Social Infrastructure Development Plan" (decided by the Cabinet on August 31 2013)

## Effective implementation of projects by selection and concentration

In order to effectively implement each project, data analysis is conducted for each policy issue to clearly select sites and sections especially in need of concentrated countermeasures. Road administration becomes more effective, efficient and transparent through consultation with the

general public at each stage (P, D, C, A) so that, for example, regional needs and challenges can be understood and confirmation of whether selected sites are meeting the requirements of daily life can be made.

### Road administration management that collaborates with general public

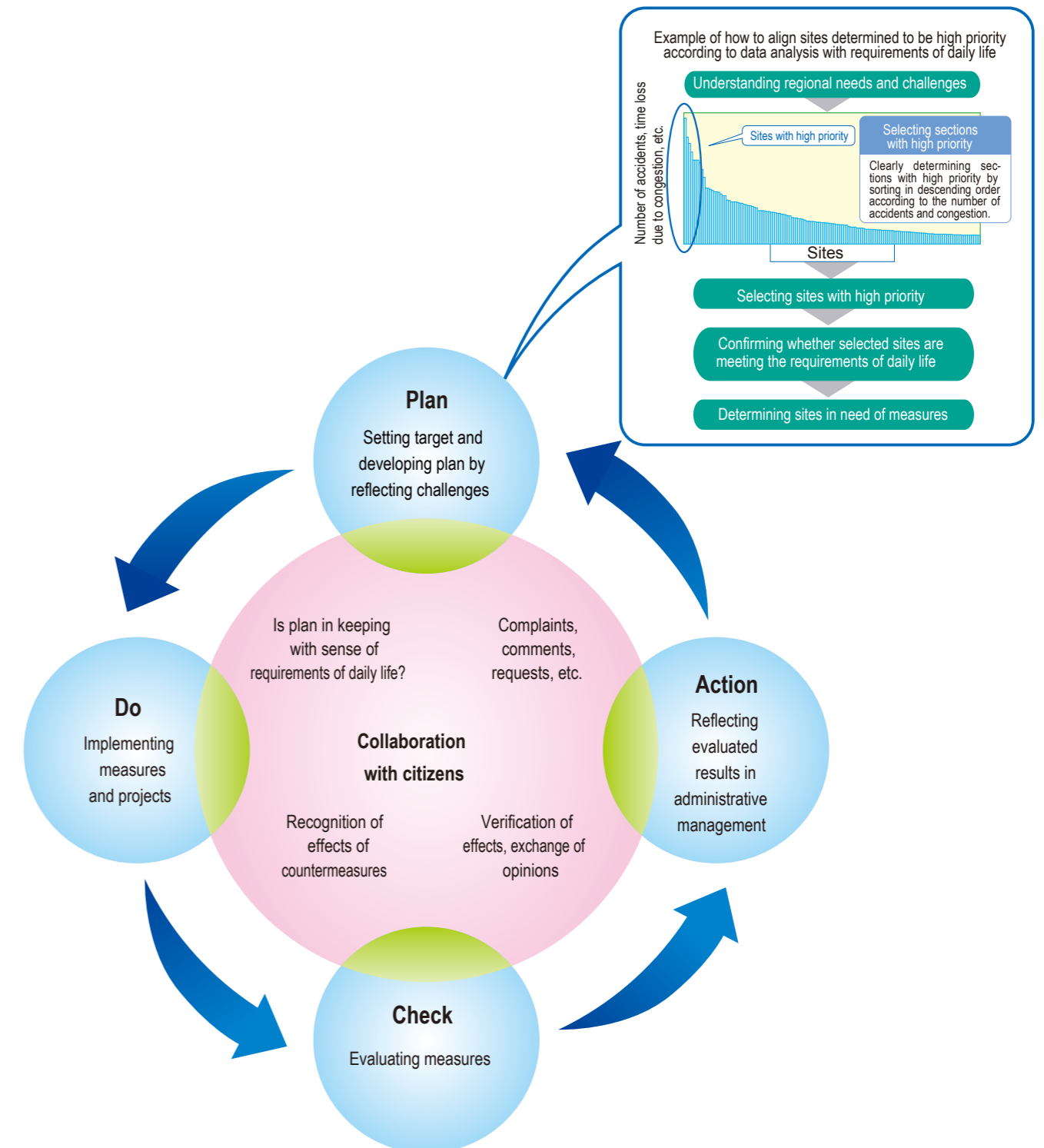

# Road Development

This section describes how our road project is evaluated in order to achieve accountability.

## Evaluation system implemented

Project evaluation is implemented for the entire process, from preparation, to execution and servicing, in order to improve efficiency and transparency. The first evaluation is conducted when planning a new project and involves cost-benefit analysis. Projects that are not completed in five years after their start are reassessed, and those that are found to be insufficiently effective are discontinued or

cancelled. Projects are also assessed when they are completed.

In order to evaluate the sustainability of a project, it should be assessed in terms of economy, environment and social effects. Economic and environmental impacts are already being assessed through cost-benefit analyses and environmental assessments, respectively.

### Procedure of road development project

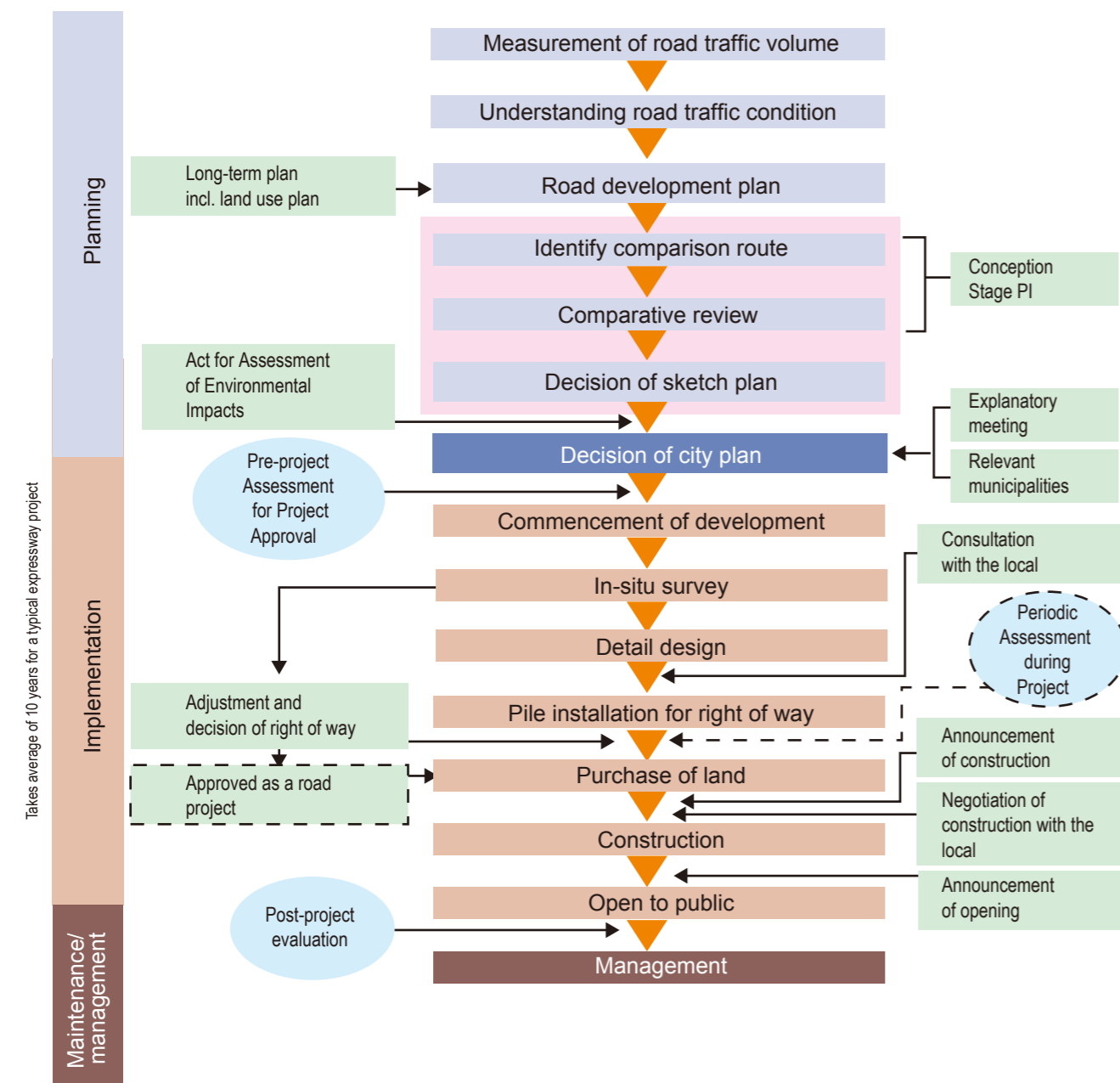

## Policy goals assessments for road projects

To enhance the transparency and efficiency of road projects, reviews have been introduced into the planning stage of bypass, road widening and other projects, and "results-oriented management" practices that are based on data have been introduced for local projects.

### Flow of planning review and results-oriented management

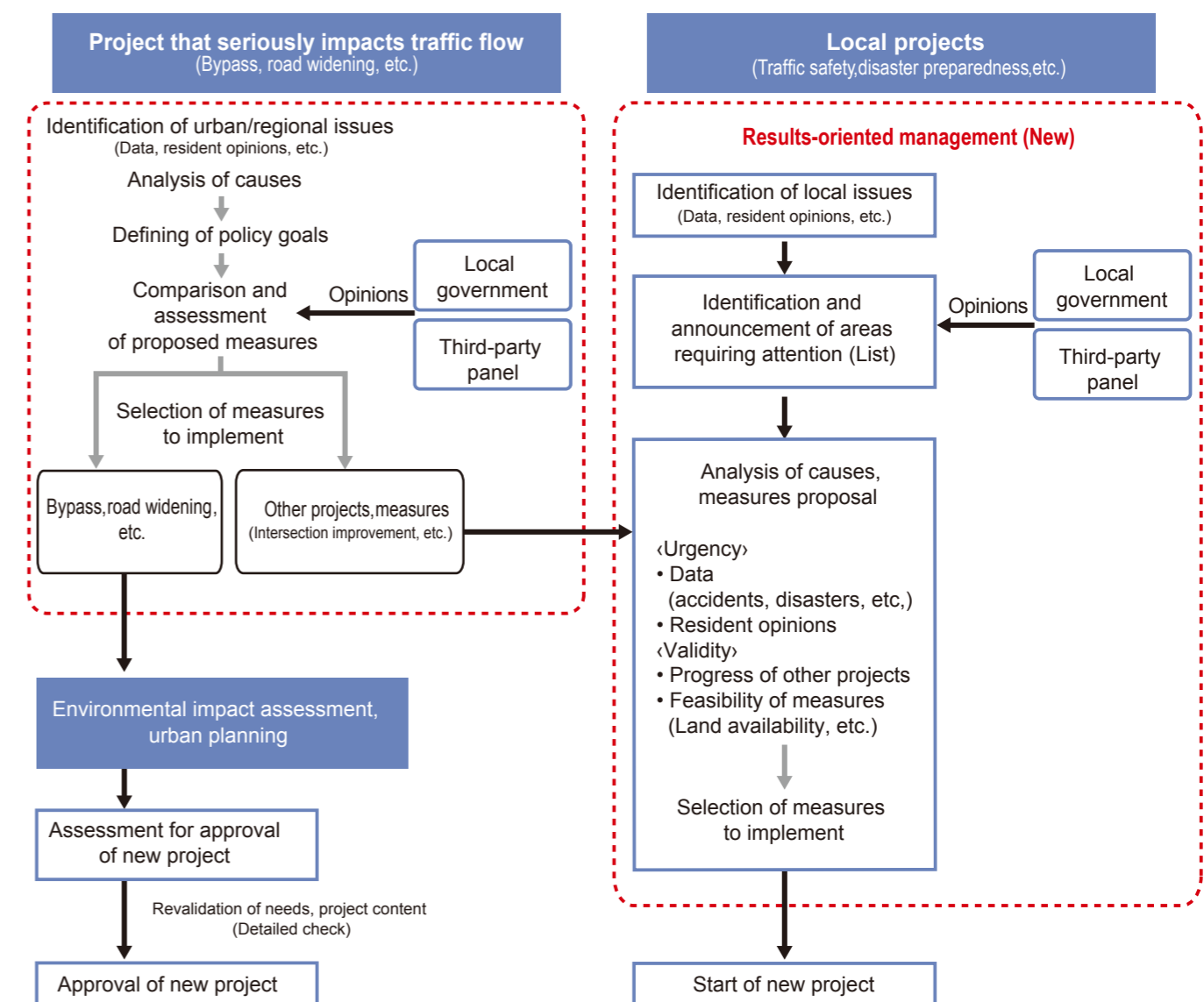

■ Planning of road development

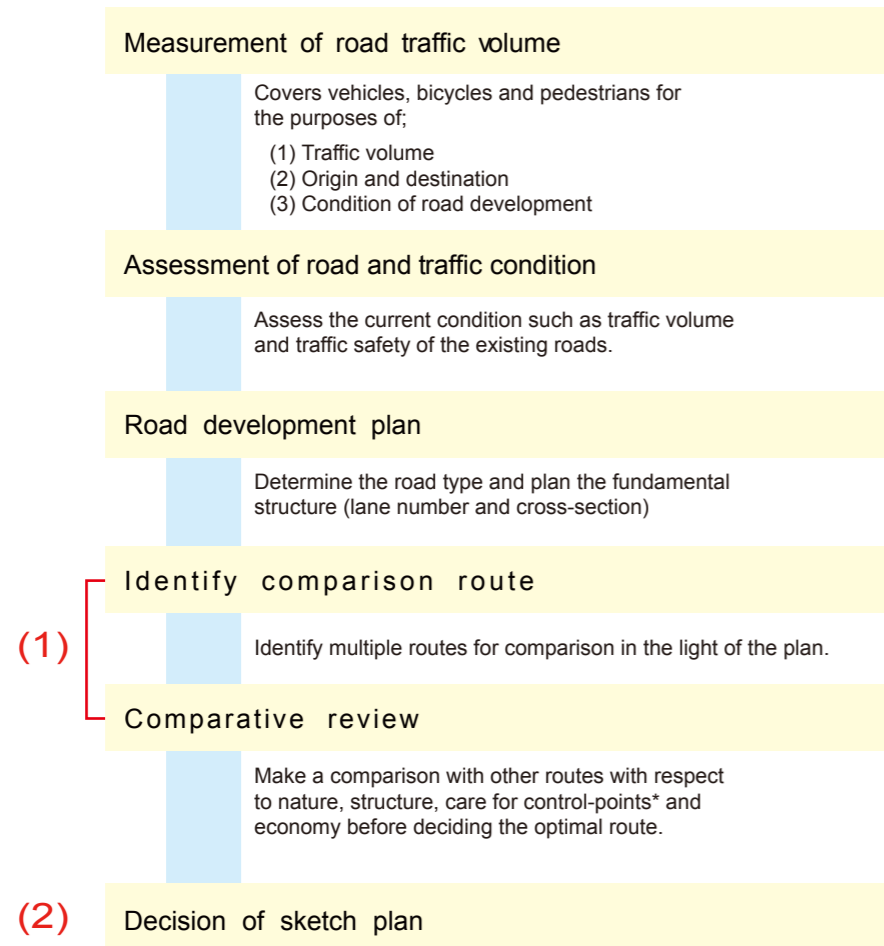

\*Control-point: a spot where a route should avoid because of its societal condition such as shrines and temples or landslide-prone areas.

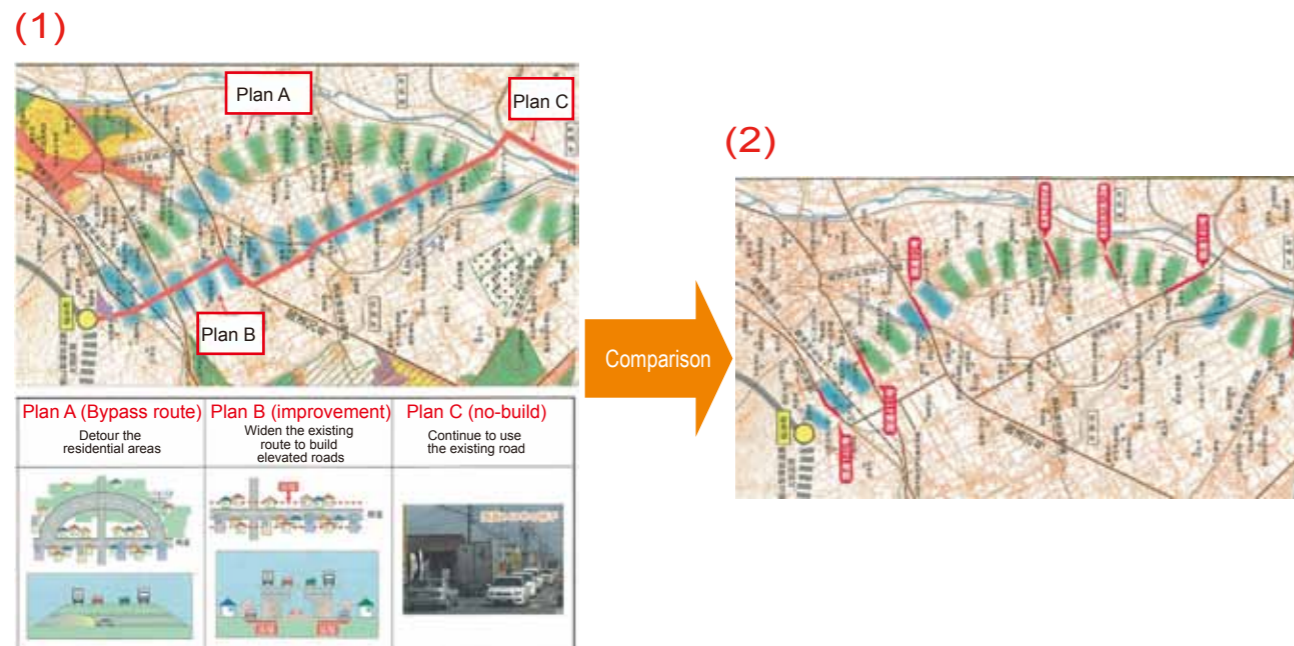

■ Implementation of road project

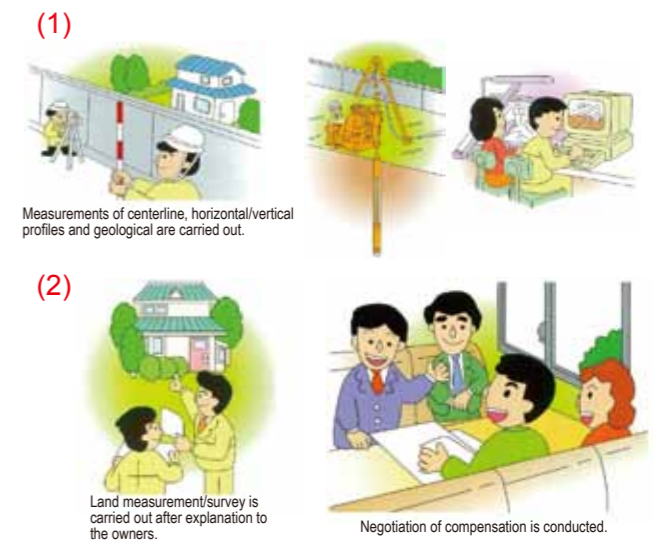
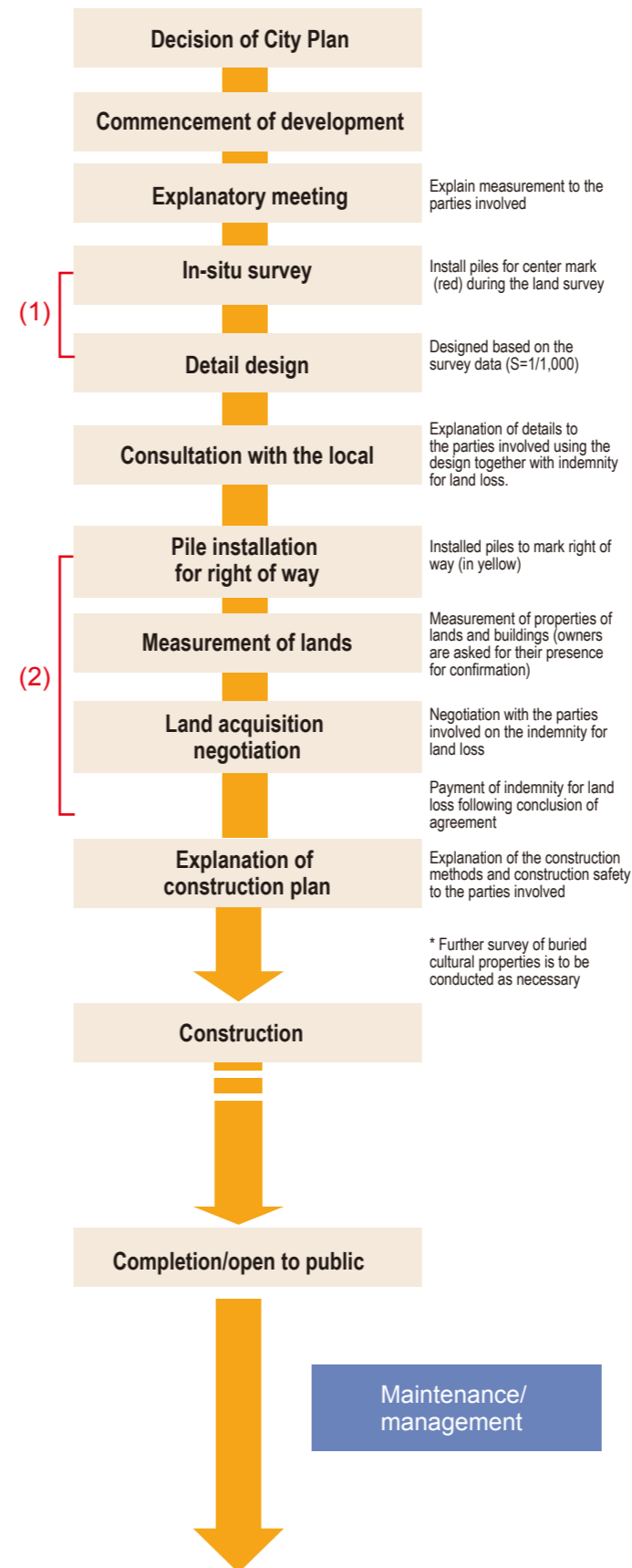

【Pile installation】

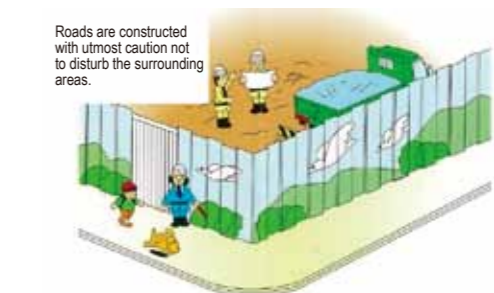
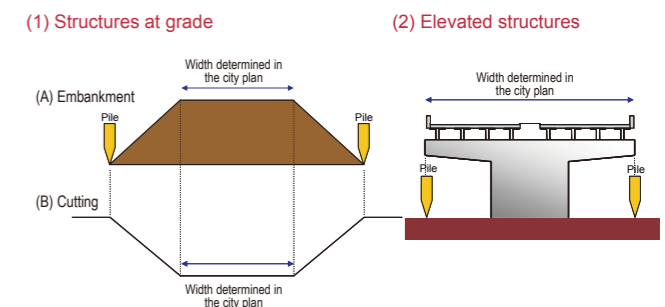

Roads are open to pedestrians and vehicles after completion of construction.



## Environmental Impact Assessment (EIA)

An assessment system in which a project proponent itself identifies/predicts/evaluates the potential impacts of the project on the environment prior to decision being made on the details. This collected information is open to the public and municipalities for their inputs to create an improved project.

### Road projects to be assessed

	Class 1	Class 2
National Expressway	All	————
Tokyo Metropolitan Expressway	4 lanes or more	————
National Highway	4 lanes or more, 10km or longer	Length between 7.5km and 10km
National Highway	2 lanes or more, 20km or longer	Length between 15km and 20km

-Class 1: A large-sized project with potentially significant environmental impacts

-Class 2: A large-sized project that requires an assessment to determine whether it has significant environmental impacts.

### Road Projects to be assessed

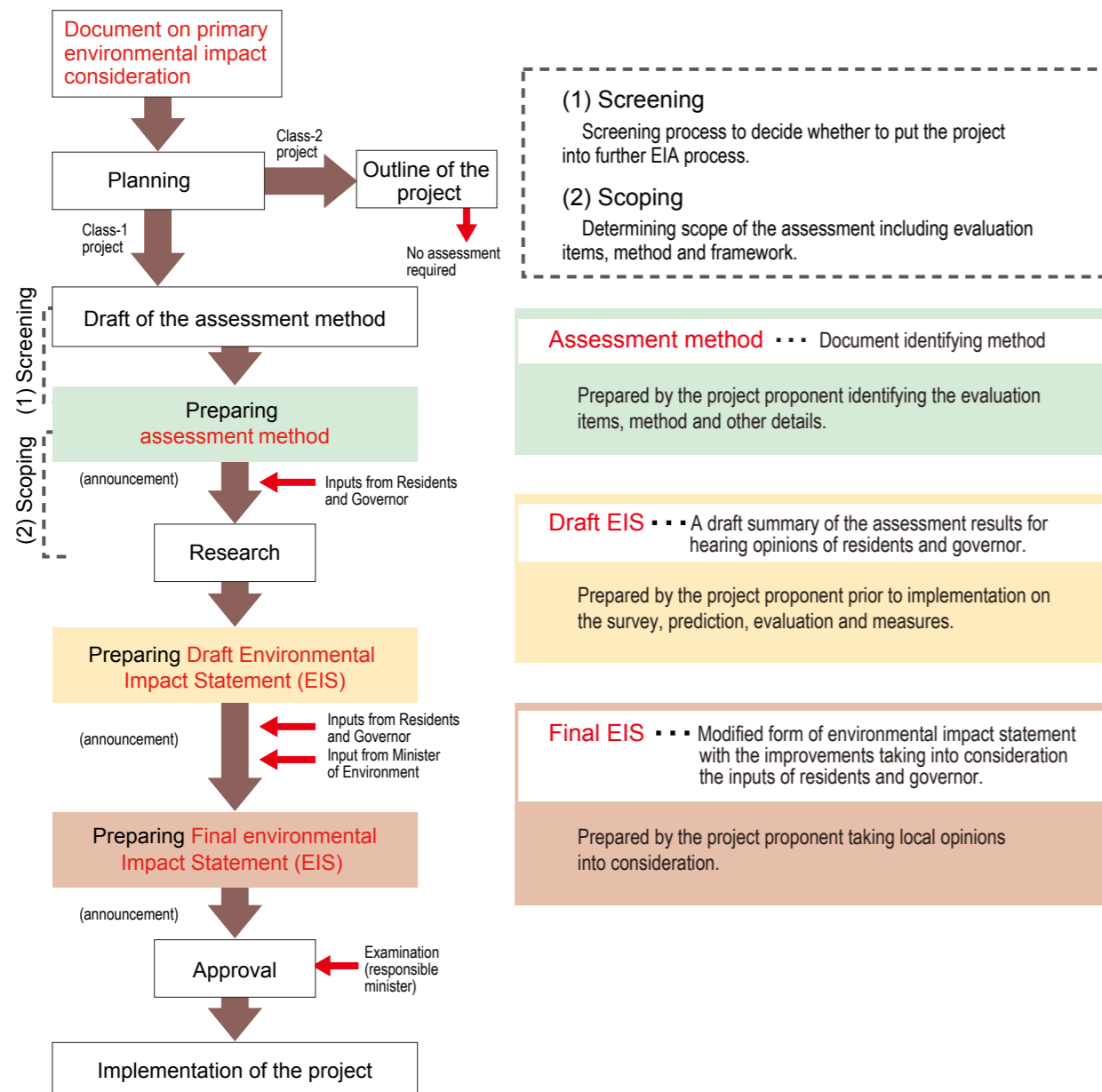

### Road project assessment

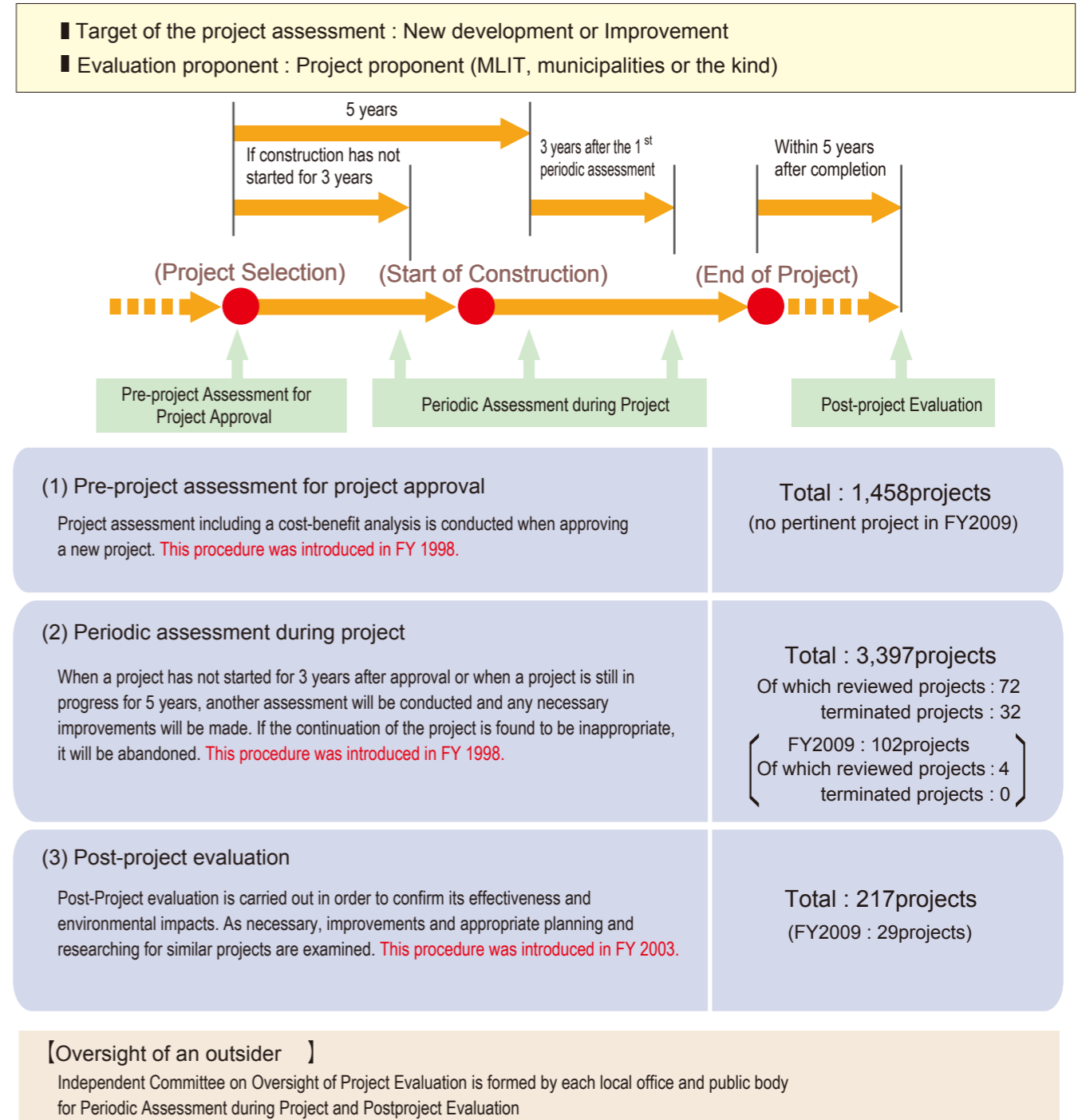

# Two-way Communication

Road users present increasingly complicated and diversified needs for the road administration. Interactive communication between users and road administrators is promoted to provide appropriate services. Strategies are being implemented to better understand the needs of users and to provide substantial services that respond to their needs.

## Cost-benefit (B/C Ratio) calculation

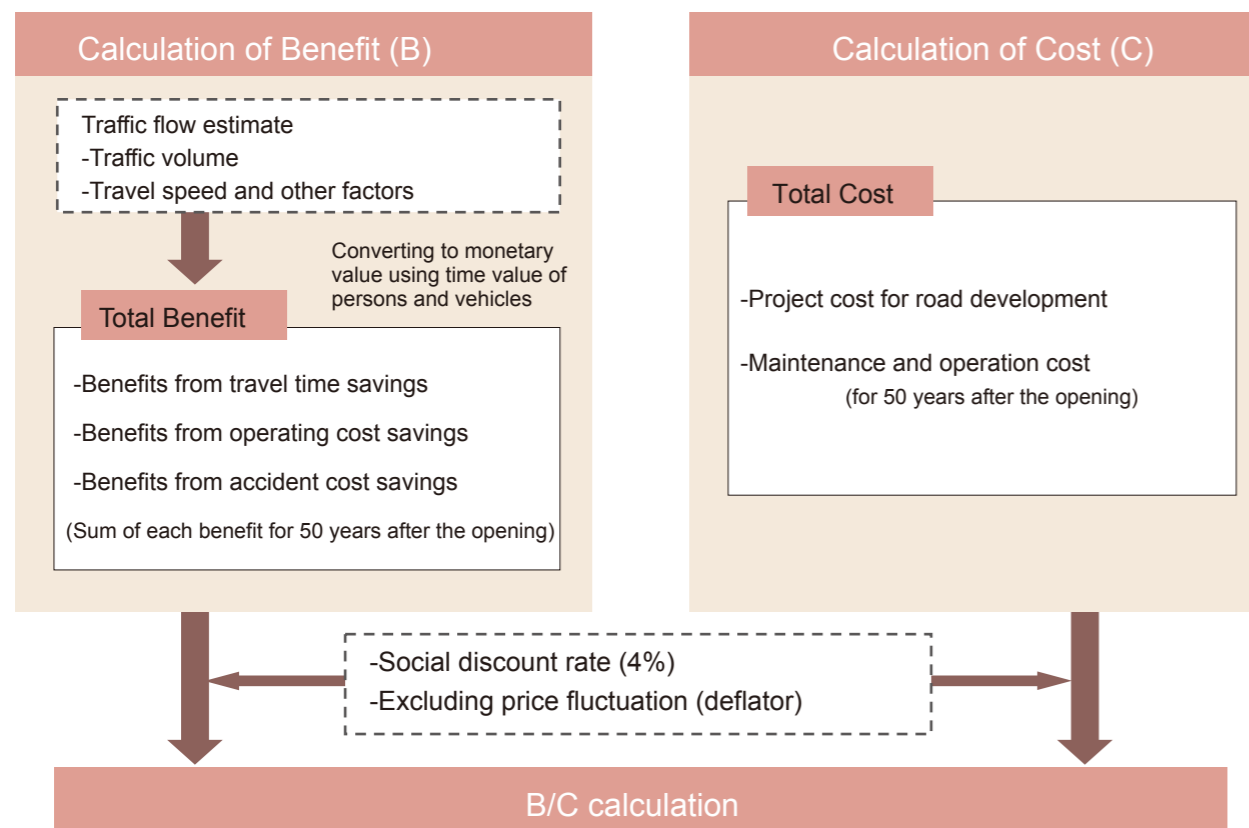

## Three benefit types of road development

Travel time saving	
◆ Travel time saving =	$\frac{\text{Time value for 1 vehicle}}{\text{Saved time}} \times \text{Traffic volume}$
Operating cost savings	
◆ Operating cost savings =	$\text{Operating cost saving rate from road development} \times \text{Distance Traveled} \times \text{Traffic volume}$
Accident cost savings	
◆ Accident cost savings =	$\text{Reduction in traffic accident from road development} \times \text{Average cost per injury accident (human loss, material loss and economical loss due to congestion)}$

## Substantial systems for responding to the diverse needs of users

Road counseling and road telephone services are used to collect information about roads from users, which then serve as a reference when revising road policies. In addition, efforts are being made to constructively introduce various monitors and incorporate opinions from users before implementing road policies.

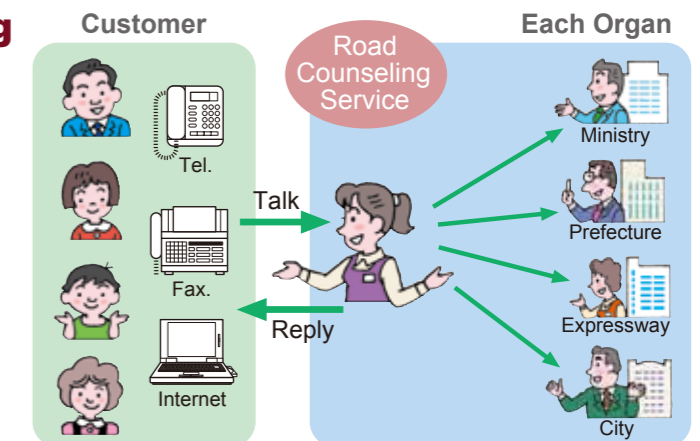

## Substantial road services by collaborating with NPOs and local communities

Groups involved in volunteer support programs, under agreements with road administrators and municipal governments, are steadily increasing and there are 2,258 groups working in many parts of Japan since the end of March 2011. Main activities include cleaning road sides; weeding, planting and growing flowers; as well as snow removal and information provision. Road administrators provide groups with cleaning tools and garbage bags to support their volunteer activities.

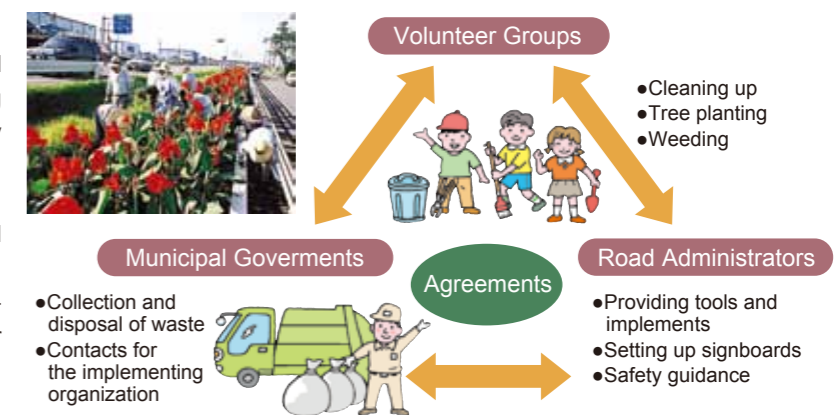

## Roadside rest areas (Michi-no-eki)

Roadside rest areas, called *Michi-no-eki*, are being constructed on national highways to provide users with three amenities, i.e., parking areas, restrooms, as well as road and regional information outlets and serve as community centers for residents. Currently, 970 rest areas have been constructed in all parts of Japan (as of March 2011). *Michi-no-eki* are being built with emergency facilities so that the rest areas can serve as a staging ground for disaster-relief activities and evacuation centers. Information provision at rest areas is being enhanced to improve and increase services. *Michi-no-eki* are also expected to revitalize regional economies by serving as a base for tourists visiting nearby natural, historic and cultural sites.



# Asset Management

A great deal of Japan's infrastructure was constructed during the postwar rehabilitation period and the subsequent period of rapid economic growth in the 1950s to 1970s. As the Japanese society and its economy have matured, today's concern is to extend the use of accumulated capital stocks in order to cope with a decreasing birthrate, aging population and to protect the global environment. Infrastructure management in Japan is in the process of switching its focus from construction to maintenance.

## Development of road asset management

The Bridge Management System (BMS) and the Pavement Management System (PMS) are being developed to predict future damage and deterioration of structures; to extend their life by extending the time until renovations are needed and reducing the total costs of maintenance and renovation.

### Overview of a Bridge Management System

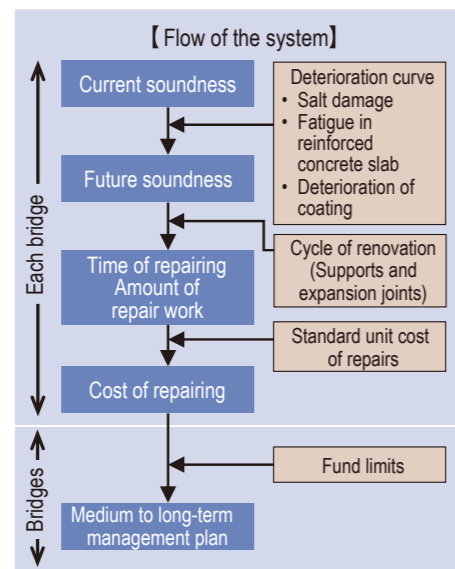

### Overview of Pavement Management System

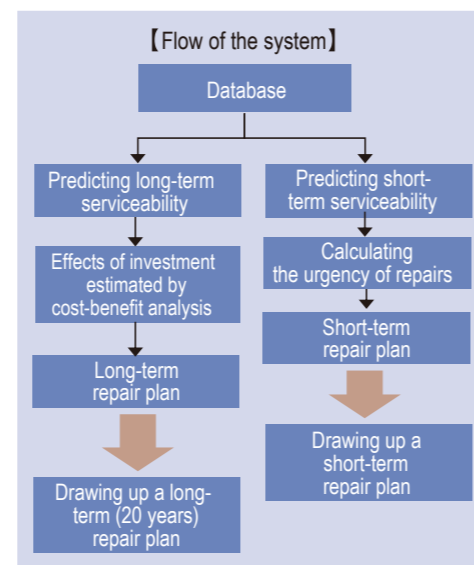

### Number of newly constructed bridges

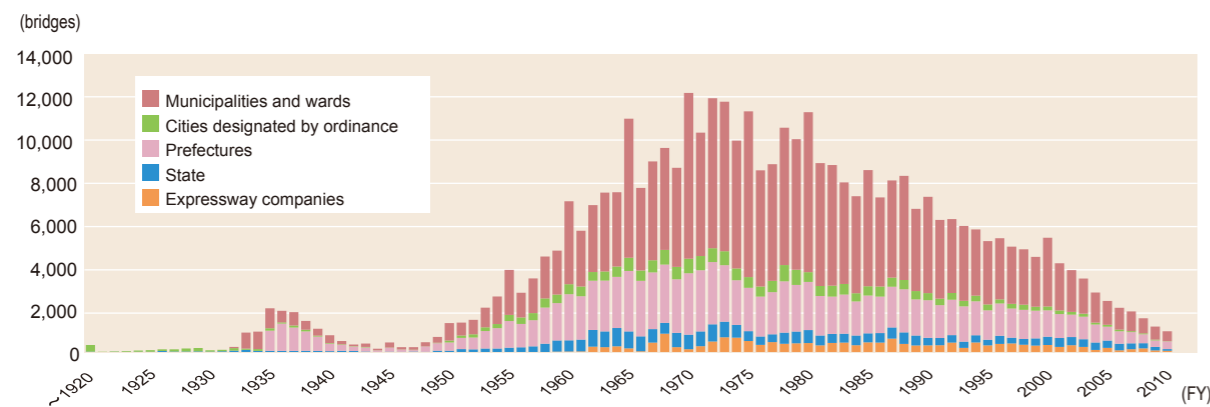

### Percentage of bridges older than 50 years

The number of bridges aged 50 years or above, which is a yardstick of aging, will account for 43% of all bridges in ten years and 67% in 20 years.

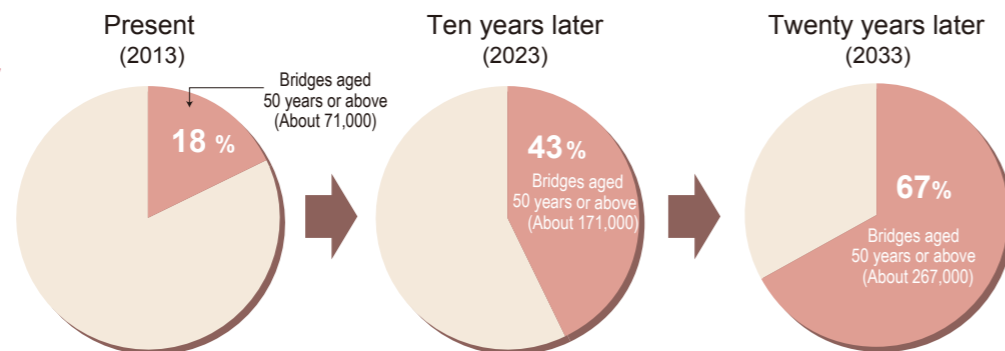

Source: Survey of current road infrastructure conditions (data as of April 2013)  
All road bridges nationwide: about 700,000 (those which are 2m or longer)

## Efficient management of road assets

Preventive maintenance, which involves taking appropriate measures before roads are seriously damaged, is important to ensuring the safety of roads and minimizing the costs of repairs and renovation.

Efforts will be made to ensure long-term safety and security of road traffic by extending the service life of road bridges that connect expressways with municipal roads through

planned implementation of "preventive maintenance, or early detection and early maintenance" based on periodic inspection of the bridges.

Cost-saving and other measures will be carried out through efficient maintenance and management based on regional characteristics.

### Schematic diagram of the effects of preventive repairing (comparison of total unit cost)

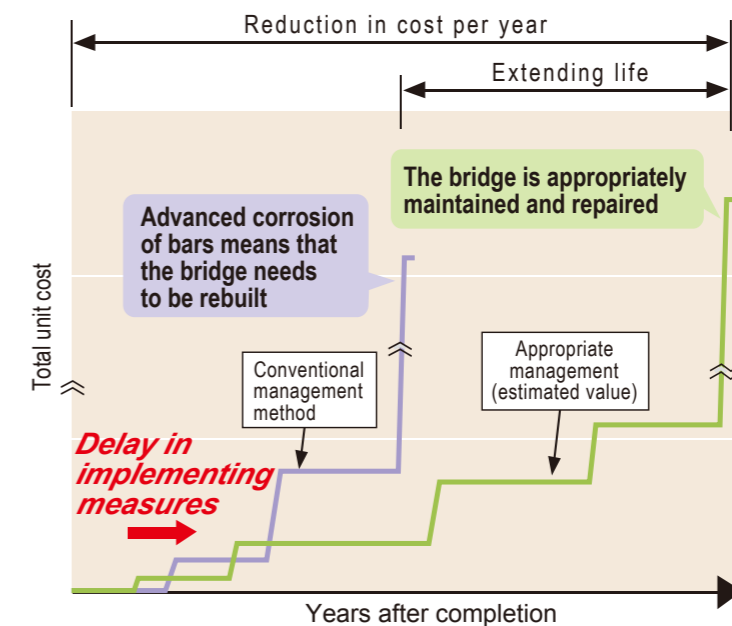

Bridge inspection example



Collapsed slab due to fatigue



Deterioration due to salt damage



Deterioration due to an alkali aggregate reaction

## Road-related systems in Japan

Roads are designed to ensure safe and smooth traffic for vehicles with certain specifications. In principle, vehicles that do not meet size and weight requirements are not allowed to be on the road, because they can potentially damage the road's structure or disrupt traffic. However, road administrators are empowered to give permis-

sion to the vehicles that exceed the size or weight regulations to use the road, but only if the road administrator acknowledges that there are no alternatives after examining the vehicle's structure and the cargo. In these cases, the road administrator will put certain conditions in place to protect the road structure and prevent potential dangers to road users.

### On general roads

General limit (upper limit) of vehicles according to Article 3.1, Vehicle Size and Weight Restriction

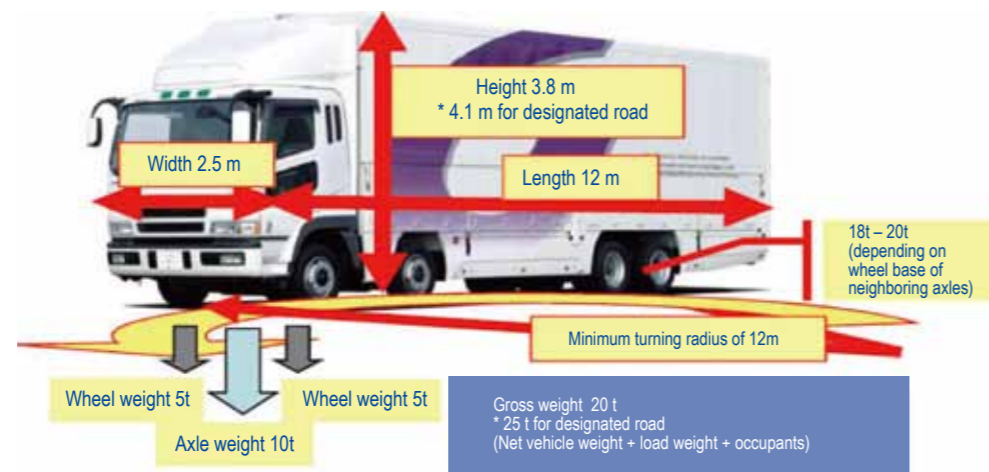

### Typical special vehicles



### On expressways

Dimension & weight limits for specified vehicles are more lenient than on general roads

	Length									
Semi-trailer	16.5m									
Full-trailer	18.0m									
Greatest axle distance	8m or more	9m or more	10m or more	11m or more	12m or more	13m or more	14m or more	15m or more	15.5m or more	
Gross weight	25t	26t	27t	29t	30t	32t	33t	35t	36t	

### Specified vehicles



## Approval system for the use of special vehicles on roads

Road administrators are authorized to permit the drivers of vehicles that exceed the size or weight regulations to use the road, but only after the road administrator examines the vehicle's structure and the cargo and determines that there are no alternatives. In these cases, the road administrator will put certain conditions in place to protect the road structure and to prevent any potential dangers to other road users. Road fatigue, which is caused by vehicle traffic that is over the weight or size regulations, has a significant effect on road structures and pavement. In order to utilize our road stock effectively in the future, it is important to ensure that road structures are properly maintained now.



Instructive enforcement

## Controlling illegal vehicles

### 1. Instructive enforcement

Drivers are told to pull over at "instruction stations", where vehicle weights and sizes are measured. If the vehicle exceeds the size or weight regulation, the drivers are ordered or warned to reduce the weight and size of the vehicle by splitting the cargo.

### 2. Weigh-in-motion (WIM)

A WIM device automatically measures a vehicle's gross weight as the vehicle drive over a measurement site. If the vehicle is over the weight regulations, it then determines if the overweight vehicle has a permit by accessing the database. Based on the results, repeated violators will be given an instructive warning.



Number plate recognition device

### Weigh-in-motion

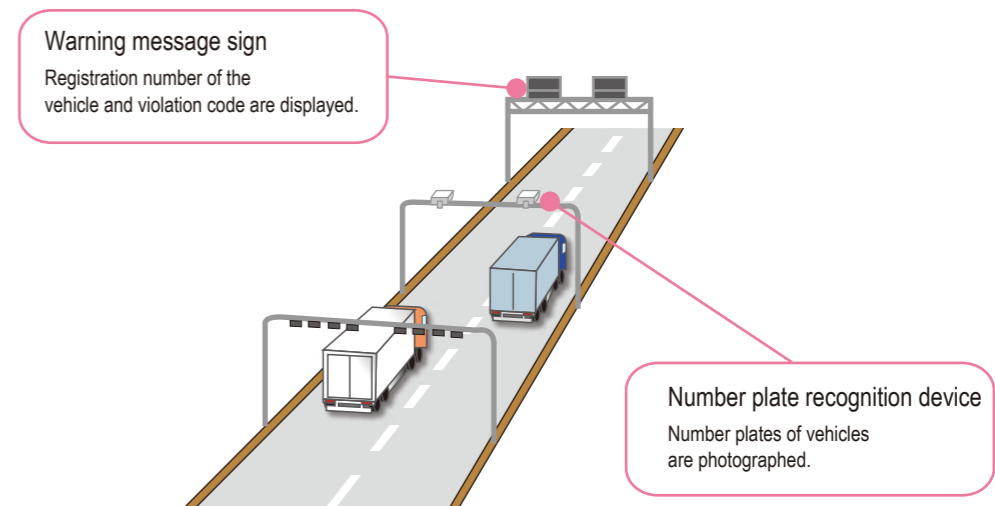

# Efficient Operation of the Road Network

Traffic is controlled 24 hours a day to ensure efficient operation and to provide safe, smooth and comfortable traffic flow. Diverse kinds of road information are collected, accumulated, analyzed and provided to road users.

## Collecting information

Vehicle detectors, TV cameras, meteorological observation apparatuses and other sensors are installed along roads to quickly collect correct information on traffic congestion, stationary vehicles, and accidents. During disaster events, patrol cars and vehicles equipped with satellite communication systems rush to the site and collect information. Today, efficient methods are used to identify congestion-prone points, such as the use of GPS equipped probe cars, VICS data and other ITS technologies, in cooperation with police departments, instead of the conventional method of conducting field surveys at major intersections.



Vehicle detector



TV camera



Meteorological observation apparatus



Vehicle equipped with satellite communication system

## Collecting data using probe cars; processing, accumulation and utilization of data collected

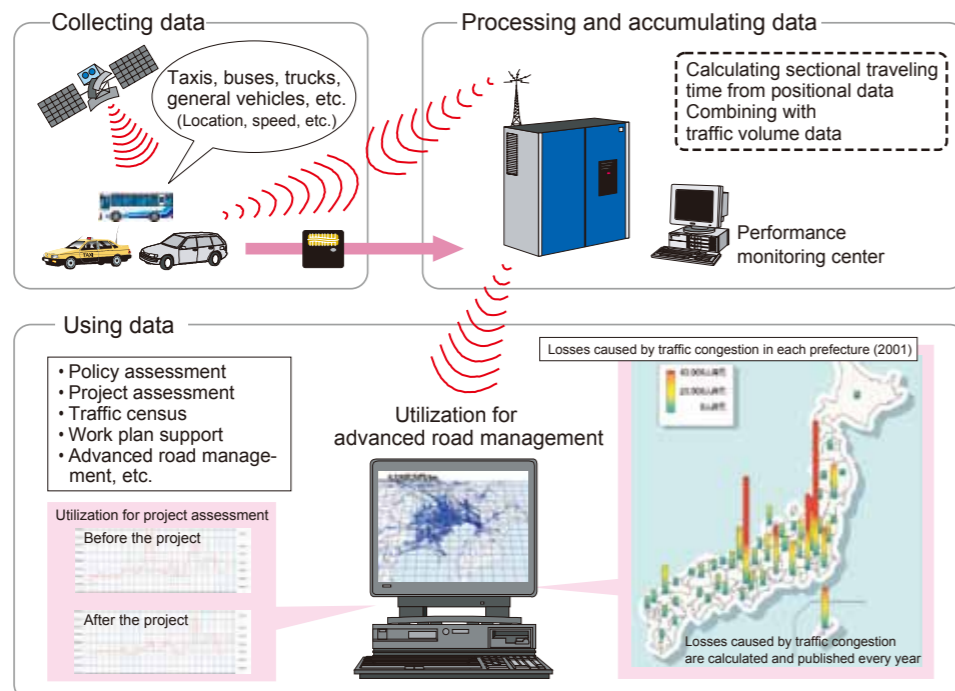

## Accumulating, analyzing and providing information

### Traffic control center

Information collected by on-road sensors is transmitted to traffic control centers and analyzed. Information on traffic congestion, accidents and traffic regulations is quickly and properly transmitted for use via roadside light information boards, VICS and the Internet.



### Providing road information



Displaying congested road sections on an information board



Warning of tunnel congestion, using an information board



Displaying congested sections and the time required to traverse these



Car radio



Providing information to VICS-compatible car navigation units



Displaying traffic congestion information on large displays at Service Areas and Parking Areas



Providing information via the Internet



## Chapter 3

# Advanced Road Technologies



Work within a shield tunneling machine for constructing Tokyo Bay Aqua-line Expressway

Of Japan's total land area of about 378,000 km<sup>2</sup>, only one-third is suitable for living. Due to its topographical, geological, meteorological and other natural conditions, Japan is prone to numerous natural

disasters such as storms, heavy snowfall, floods, landslides, earthquakes and tsunamis. Various road construction technologies have therefore been developed to overcome such severe conditions and difficulties.

## Tunnels

The islands of Japan stretch out long and thin from north to south with a backbone of steep mountains rising to elevations of 2,000 to 3,000 m. As about 70% of the land is mountainous, roads must be constructed on the narrow strips of land between steep slopes and the sea, along rivers winding between mountains, and through tunnels. Tunnels are increasingly used when constructing roads in highly populated areas of cities due to the shortage of land and to protect the environment.

### Kan-etsu Tunnel (Kan-etsu Expressway)

The Kan-etsu Tunnel passes through steep mountains with a maximum depth of 1,100 m from a mountain top. The 11km long tunnel is the longest highway tunnel in Japan and the fifth-longest in the world. Of its four lanes, the outbound lanes were opened in 1985 and the inbound lanes were completed in 1991.



### Yamate Tunnel

(Central Circular Shinjuku Route of the Metropolitan Expressway)

The Central Circular Shinjuku Route of the Metropolitan Expressway connects Shibuya, Shinjuku and Ikebukuro, which are major sub-centers of Tokyo. Two tunnels account for most of its 11 km length, one for the inbound lanes and the other for the outbound lanes. The tunnels were completed in 2010.

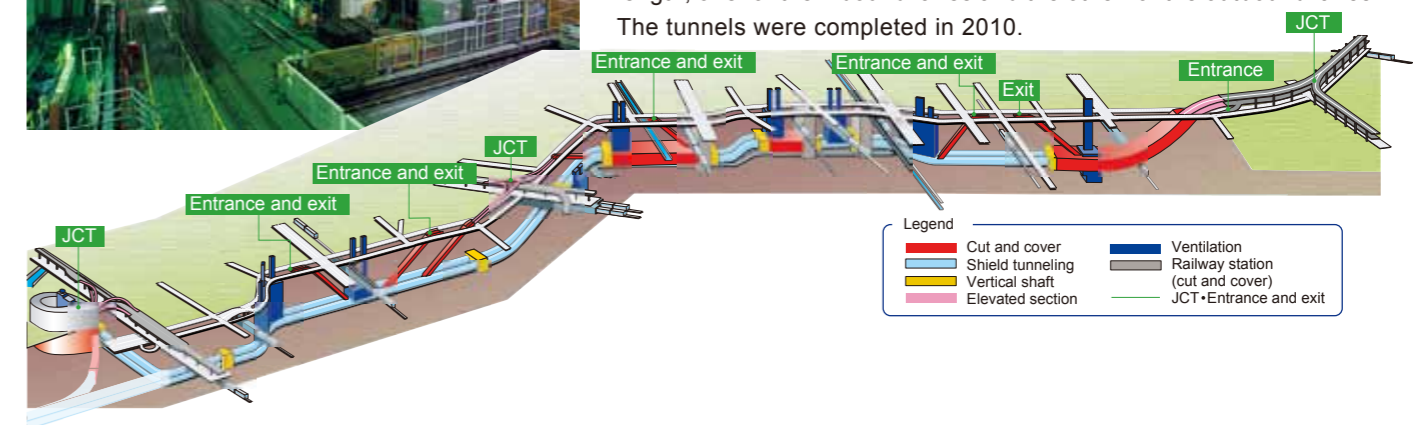

### Shield machine

The shield machine cuts the ground with the cutter face in the front, assembles segments inside the machine, and advances through the ground by constructing the tunnel behind. Advanced robotic technologies are used, with a computer controlling the series of tunneling work.

World's largest shield machine (diameter: 14.14 m) used for the Tokyo Bay Aqua-line Expressway



# Bridges

Japan consists of four major islands of Hokkaido, Honshu, Kyushu and Shikoku and a number of small islands. Straits and inland seas hinder the traffic between islands. For well-balanced development of the nation, new transportation axes are needed, and bridges connecting islands have been constructed. Japan is also highly prone to earthquakes, typhoons and strong winds, so cutting-edge technologies are used for constructing and maintaining long-span bridges that can withstand such severe natural conditions.

## Honshu-Shikoku Expressway

The Honshu-Shikoku Expressway, which was completed in 1999 and connects the main island of Honshu with the island of Shikoku, has three routes; the Kobe-Naruto route (the Kobe Naruto Expressway), the Kojima-Sakaide route (the Seto-Chuo Expressway and the JR Seto-Ohashi line), the

Onomichi-Imabari route (the Nishi-Seto Expressway). Control length of these roads is approximately 173 km. The center span of the Akashi Kaikyo Bridge is 1,991m; the longest in the world, and the height of the main tower is approximately 300m above sea level.



Akashi Kaikyo Bridge



Tatara Bridge



Seto Bridge

## Tokyo Bay Aqua-line Expressway

Of the 15.1 km of the Tokyo Bay Aqua-line Expressway across Tokyo Bay, which was completed in 1997, about 10 km is a tunnel under the ocean and the remaining 5 km is a bridge (Aqua Bridge). A ventilation tower ("Kaze-no-to") was constructed in the middle of the tunnel, and a manmade island ("Umihotaru") was constructed where the tunnel and the bridge meet.



A manmade island "Umihotaru" and the Aqua-line Bridge

### Reinforcement and management of long bridges



Non-destructive inspection of hangers

Long bridges are inspected daily using advanced technologies such as non-destructive methods of inspecting hangers of suspended bridges, and are maintained to prolong their service life.

Implementation of damage control earthquake-resistant designs for retrofitting existing long bridges has reduced the cost of constructing long bridges to 65%.



Model experiment using a 1/6-scale model of braces for restraining buckling

Use of damage control earthquake-resistant design on Minato-ohashi Bridge reduced its construction cost (Hanshin Expressway).



# Pavement

In 1955, the paved road ratio of national highways in Japan was less than 14%. The ratio increased sharply thereafter as motorization progressed rapidly, reaching 57% in 1965, 79% in 1975, and over 90% today.

Various paving technologies have been researched and developed since roads in Japan are subjected to large seasonal temperature differences and heavy rainfall. Technologies are also being developed to address an aging society and environmental issues.

## Drainage and low-noise pavement

The surface is more porous than ordinary pavement, allowing water to seep down through it. The water passes through the pavement and flows along an inclined impermeable course, and is then discharged to side gutters. The pavement drains well, remains non-slippery on the surface even on rainy days, controls spray, and ensures good visibility. The porousness also suppresses the noise generated by tires and traffic.

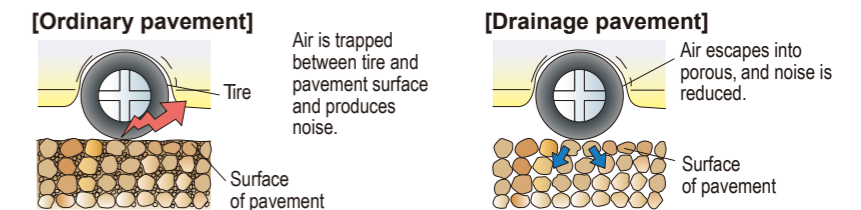

### Reducing the reflection of vehicle noise from the road surface

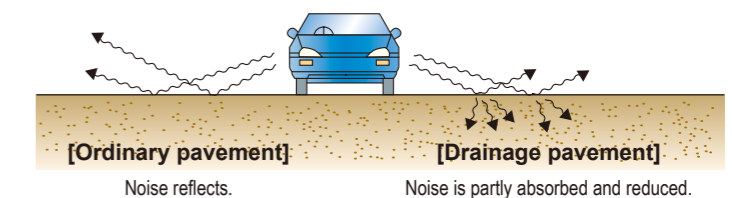

## Water-retaining pavement

Water is retained in the pavement and the road temperature is lowered by the heat of water evaporation. Diverse technologies have been proposed, such as injecting water-retaining materials like polymers into the voids of asphalt mixtures, from which rain water and underground water slowly evaporate.

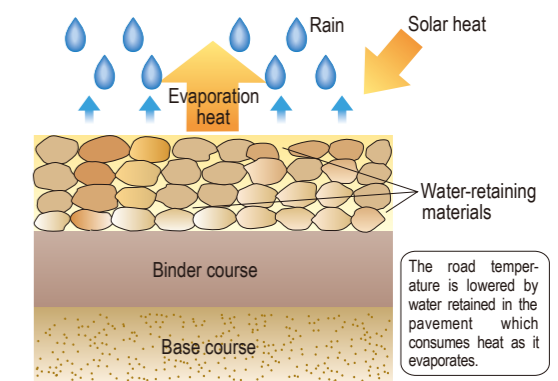

## Heat-insulating pavement

Special paint is applied on the pavement surface to reflect infrared rays from the sun and thus reduce the heat which accumulates in the pavement. The paint controls the rise in

surface temperature of pavement and improves the thermal environment for pedestrians and road-side areas, helping to mitigate the heat-island phenomenon.

### Example of application

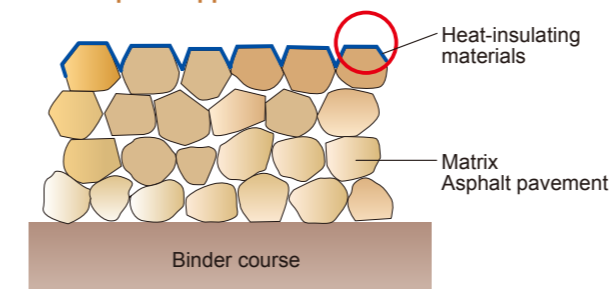

### Example of filling

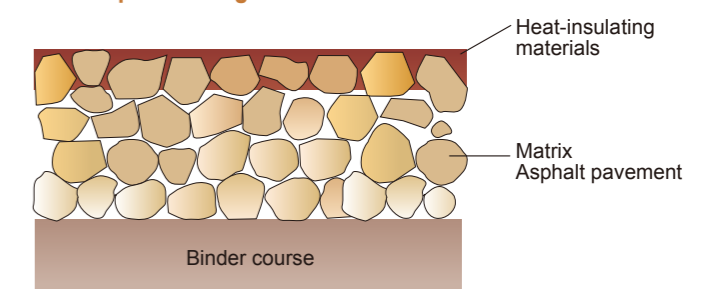

# Road Administration in Japan

## Type of Road

This chapter describes road types which are administrated differently by national government, prefectural government, municipal government and expressway companies. It also explains how their development/improvement and maintenance/repair costs are secured along with their governing acts.

### What is a “Road” from a Legal Perspective?

“Road” in Road Act

Road Act

Article 2 In this Act, “Road” is defined as a thoroughfare that is open to public use and is classified according to the following types.

Article 3 Road Types

- 1) National Expressways\*1
- 2) National Highways\*2
- 3) Prefectural Roads\*3
- 4) Municipal Roads\*4

#### ■ National Expressway



Ichinomiya Interchange  
On Meishin Expressway

#### ■ National Highway



National Highway No 20

#### ■ Expressway networks in Japan

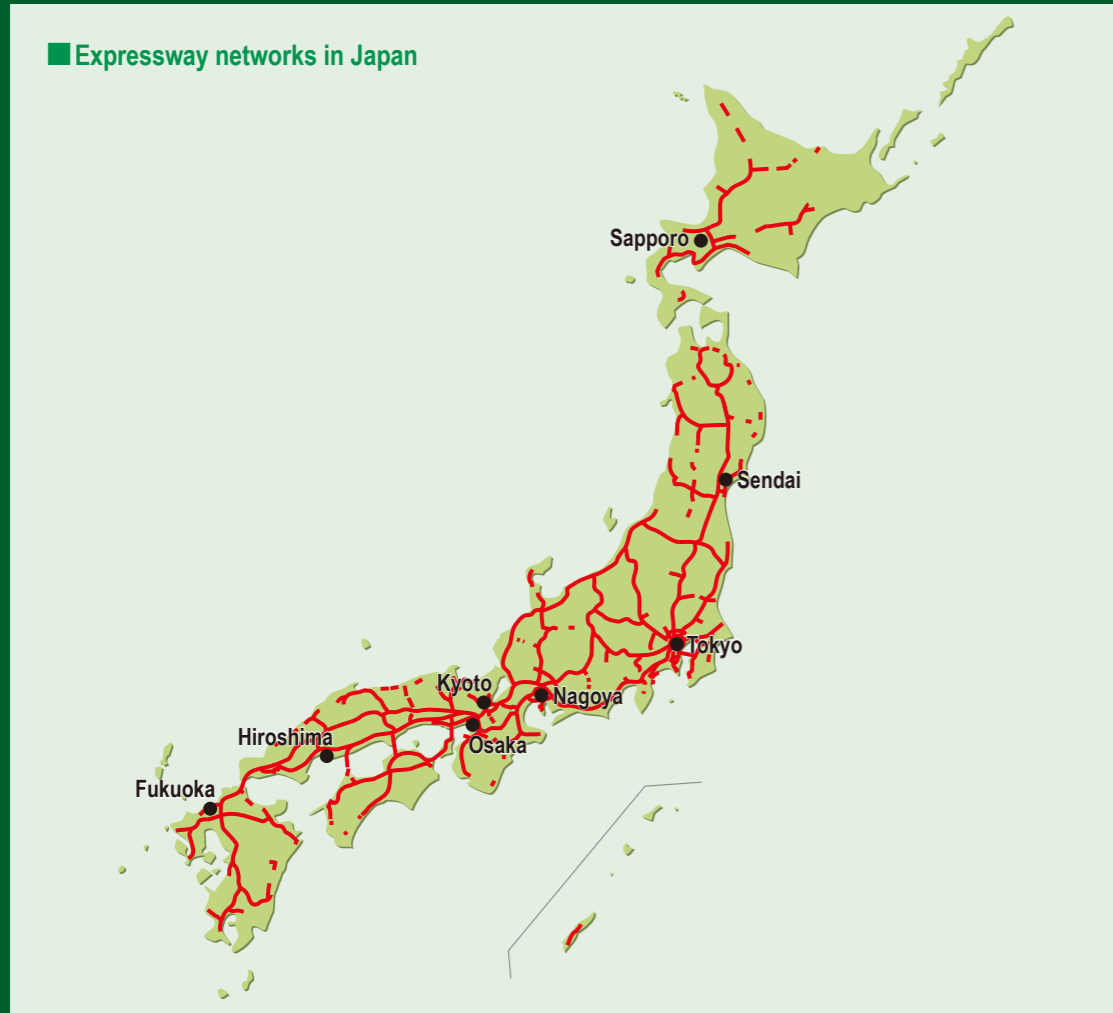

#### ■ Roads in Japan

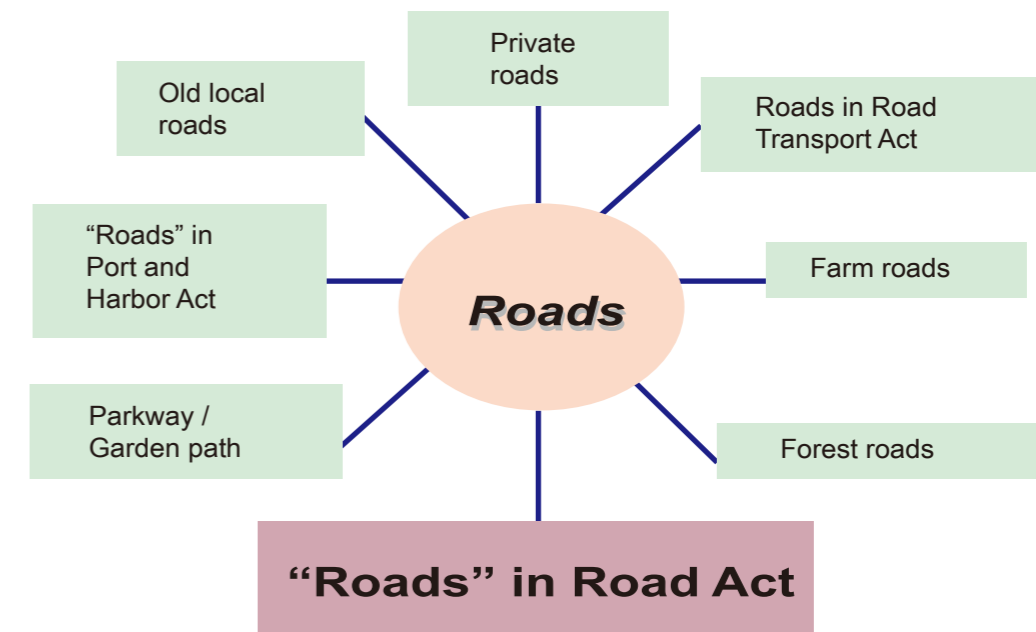

Definition:

\*1: National Expressways form the strategic traffic network for automobiles across the country and connects the areas of political/economical/cultural importance or with a critical influence on national interest. (Article 4 of the National Expressway Act)

\*2: Together with National Expressways, National Highways form the strategic road network and meet legal requirements (Article 5 of the Road Act)

\*3: Prefectural Roads form the regional arterial road network and meet legal requirements (Article 7 of the Road Act)

\*4: Municipal Roads serve within a municipal jurisdiction. (Article 8 of the Road Act)

**Burden sharing of road development projects**

Road Type		Road Administrator	Burden is carried by	Burden Sharing	
				Development/improvement	Maintenance/repair
National Expressway	Toll	Minister*1 [Article 6 of the National Expressway Act]	Expressway Companies (NEXCOs)	Development, improvement and repair are carried out with the loan. The debt and management expense are repaid with toll revenue [ Article 3 & 4 of Act on Special Measures concerning Road Construction and Improvement ]	
	Under jurisdiction of MLIT		National Gov. Prefectures*2	National Gov : 3/4 Prefectural Gov*2 : 1/4 [ Article 20 of the National Expressway Act ]	National Gov : 10/10 [Article 20 of the National Expressway Act ]
National Highway	Under jurisdiction of MLIT	<Development/improvement> Minister*1 [ Article 12 of the Road Act ]  <Maintenance, Repair and other management> Designated section : Minister*1	National Gov. Prefectures*2	National Gov : 2/3 Prefectural Gov*2 : 1/3 [ Article 50 of the Road Act ]	National Gov : 10/10 [ Article 49 of the Road Act ]
	Under jurisdiction of Pref.*		National Gov. Prefectures*2	National Gov : 1/2 Prefectural Gov*2 : 1/2 [ Article 50 of the Road Act ]	Maintenance*3 : Prefectural Gov*2 [Article 49 of the Road Act ] Repair : Can be subsidized up to 1/2 by National Gov [Article 56 of the Road Act ]
Prefectural Road	Prefecture*2 [ Article 12 and 13 of the Road Act ]	Prefectures*2	Can be subsidized up to 1/2 by National Gov [ Article 56 of the Road Act ]	Maintenance*3 : Prefectural Gov*2 [Article 49 of the Road Act ] Repair : Can be subsidized 1/2 by National Gov [Article 1 of the Road Repair Act ]	
Municipal Road	Municipality [ Article 16 of the Road Act ]	Municipalities	Can be subsidized up to 1/2 by National Gov [ Article 56 of the Road Act ]	Maintenance*3 : Municipalities [Article 49 of the Road Act ] Repair : Can be subsidized 1/2 by National Gov [Article 1 of the Road Repair Act ]	

\*1 "Minister" refers to Minister of Land, Infrastructure and Transport  
 \*2 "Prefecture" includes ordinance-designated city  
 \*3 "Maintenance" includes repair

Note: Some national highways, prefectural roads and municipal roads are maintained by Expressway Companies or Road Public Corporations.

**Classification under article 3 of the Road Act**

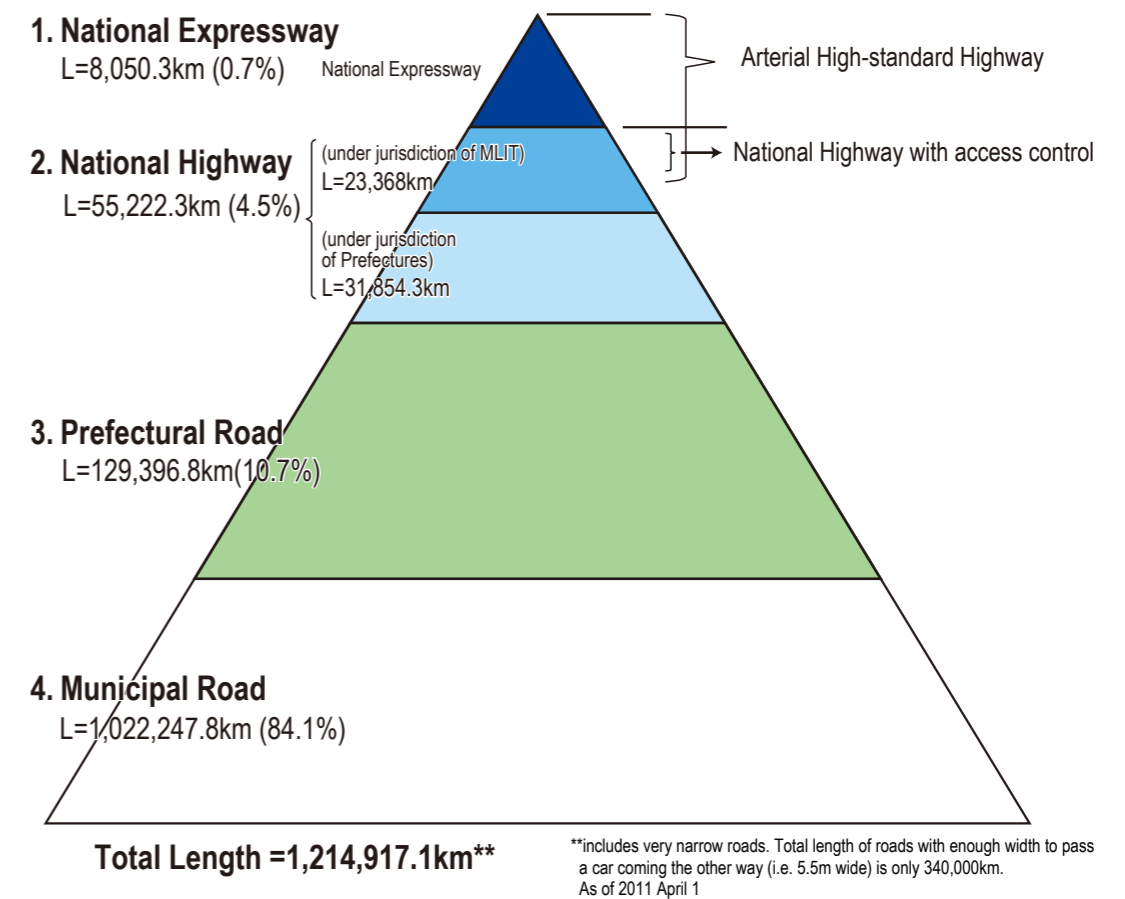

**Length and travel by road type**

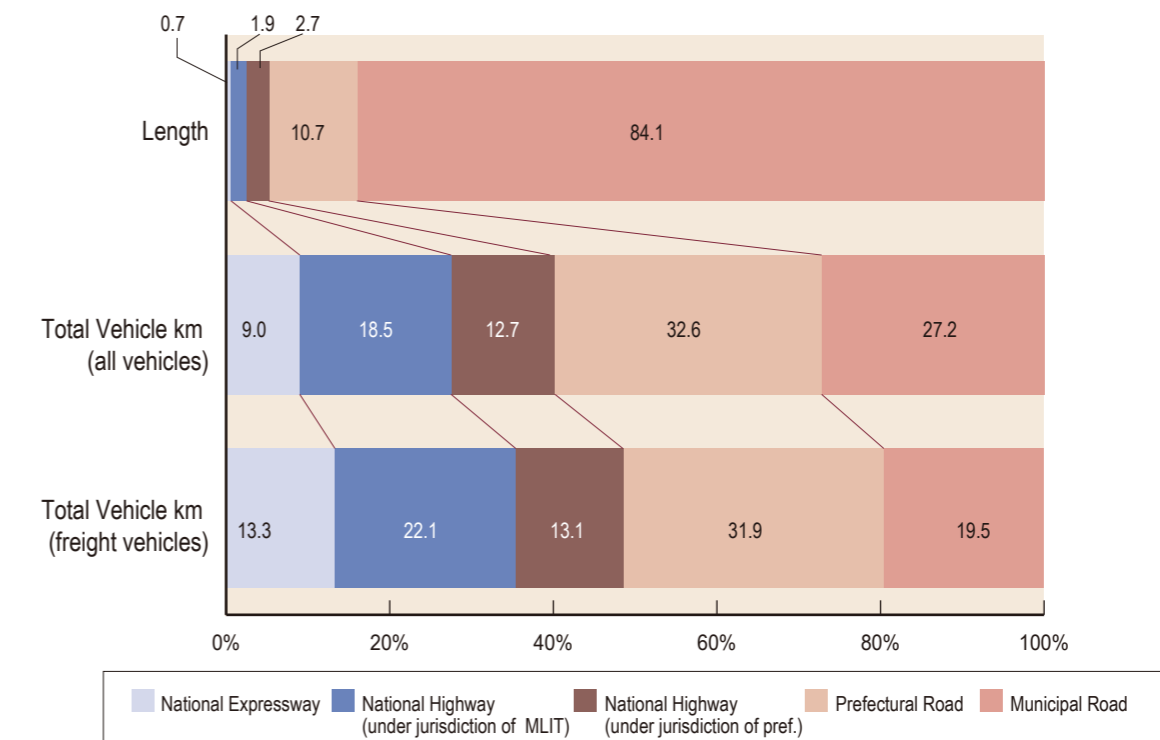

Note:  
 Data of road length is from "Annual Report of Road Statistics 2013"  
 Data of vehicle km traveled is from "Road Traffic Census 2005" and "Annual Report of Automobile Transport 2005".  
 As of Mar 2009 for National Expressways. As of April 1 2007 for other roads

■ Classification of arterial high-standard highway system

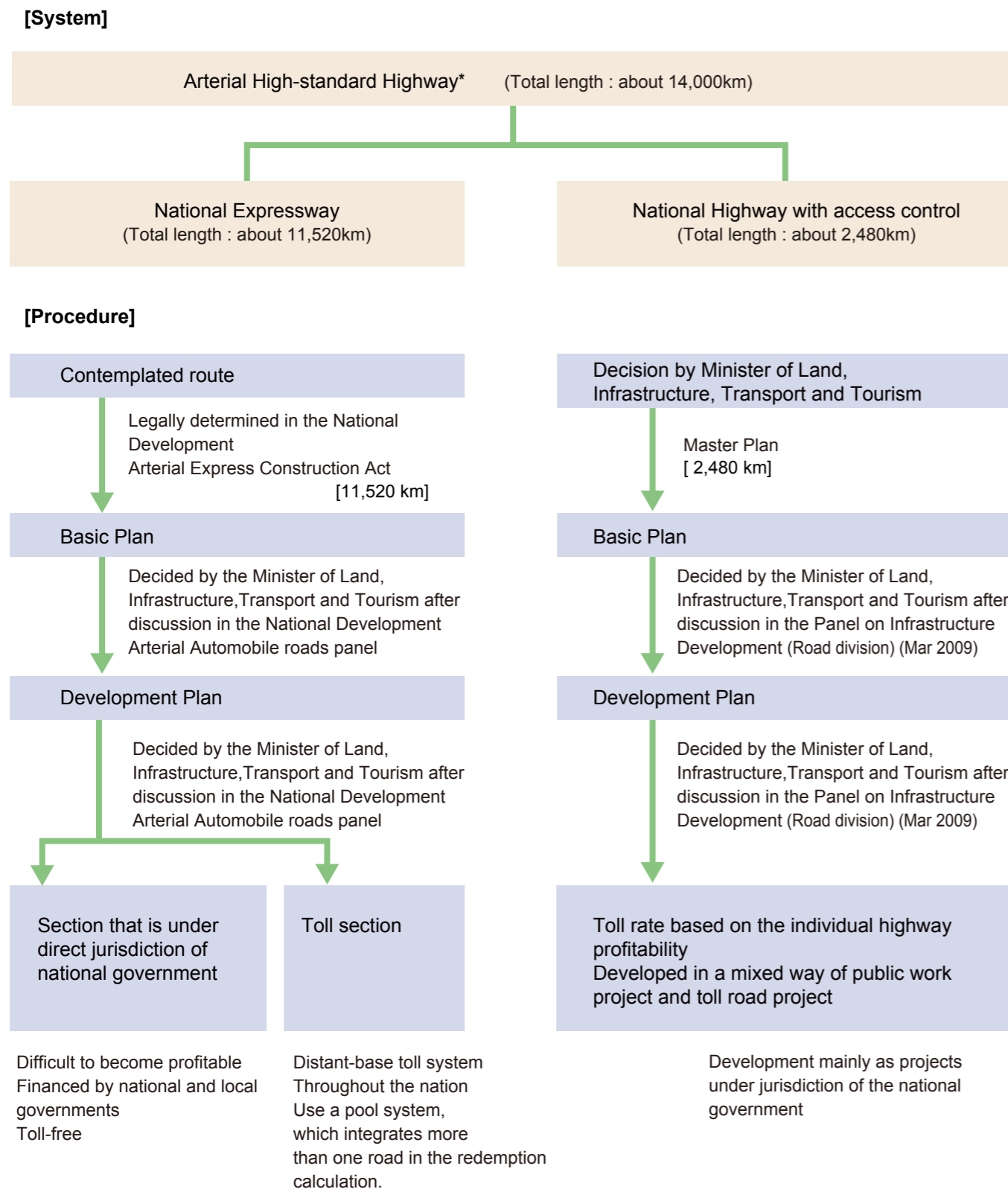

\* Planned as a strategic high-speed surface traffic network in "the Forth Comprehensive national Development Plan" (decided by the Cabinet on June 30 1987 and "Grand Design of Japan for the 21st century" (decided by the Cabinet on Mar 31 1998).

■ Arterial high-standard highway network

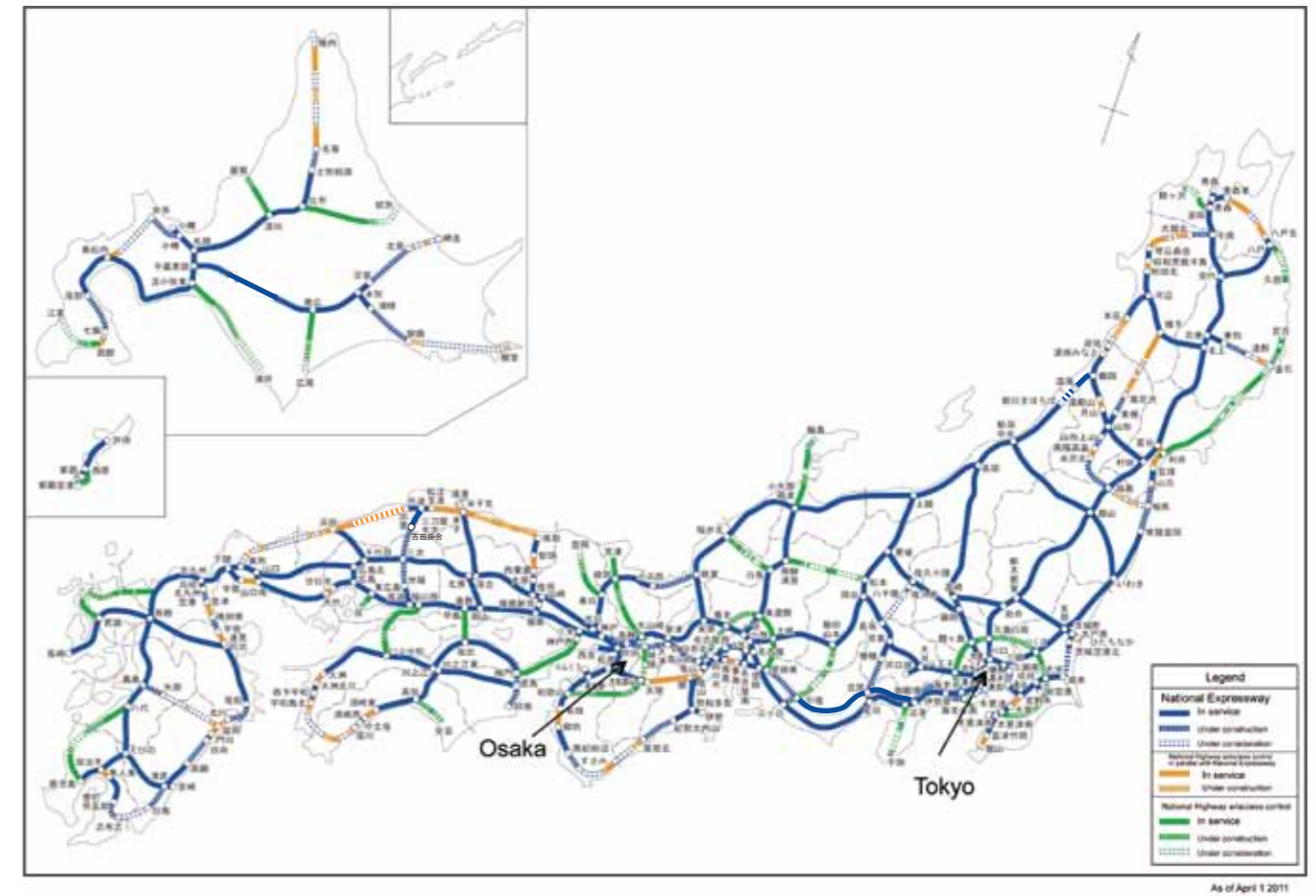

■ Burden-sharing of arterial high-standard highway network

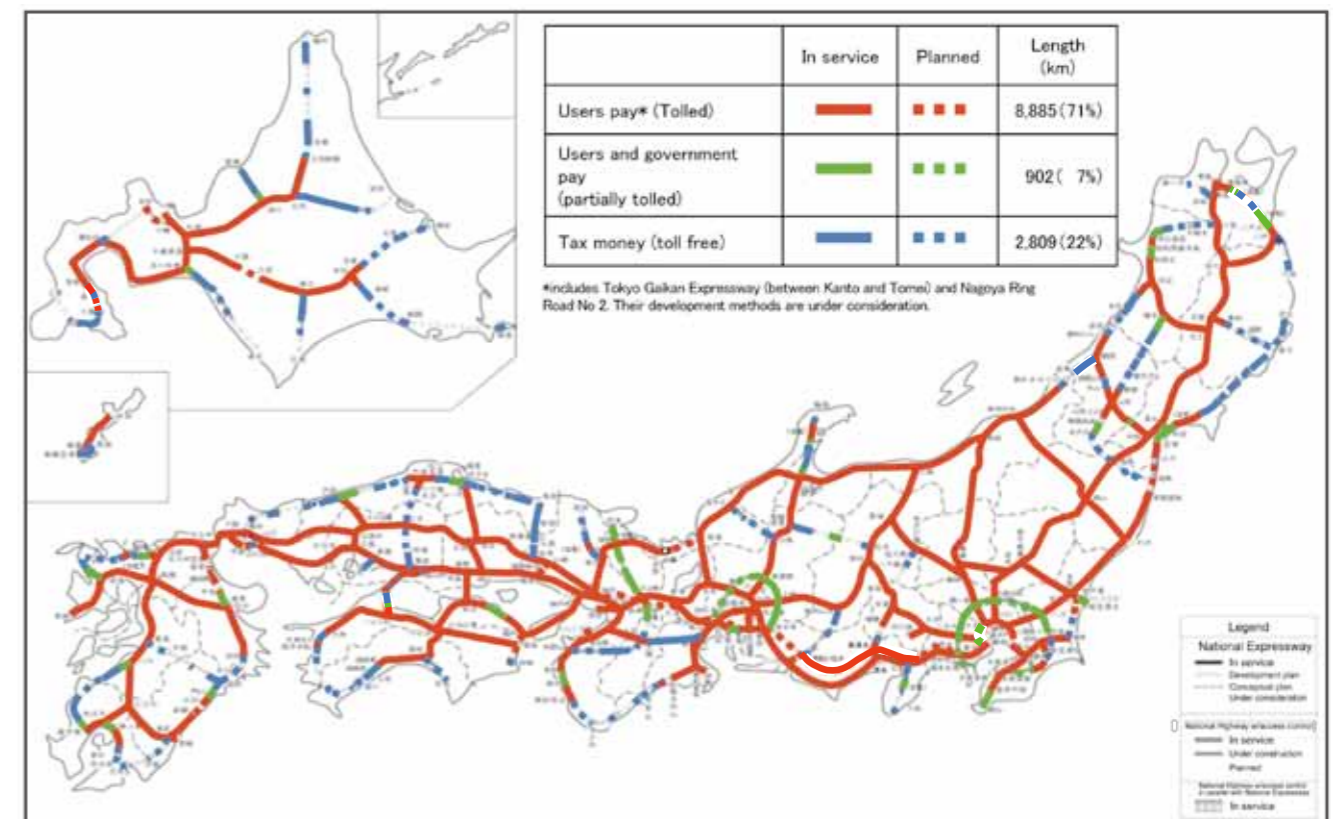

Introduction of toll road system in Japan

In response to rapidly increasing traffic demand after World War II, immediate road development required additional financial resource to supplement general revenue; namely, the following 2 systems.

① Earmarking gasoline tax for road development

② Toll Road System

1952 Act on Special Measures concerning Road Construction and Improvement was enacted.

→Toll road system was introduced to the public roads across the country.

(Project proponent : National, prefectural or municipal government as a road administrator)

To expand current toll road system as a measure of immediate development of roads across the country, an organization such as the Japan Highway Public Corporation (JHPC, provisional name) needs to be established so that private funds will be widely introduced and comprehensive and efficient operation will be carried out. (Road Council's recommendation 1955)

1956 Full-fledged revision of the Act on Special Measures concerning Road Construction and Improvement Act on Japan Highway Public Corporation was enacted.

1959 Act on the Metropolitan Expressway Public Corporation was enacted.

1962 Act on the Hanshin Expressway Public Corporation was enacted.

1970 Act on the Honsyu-Shikoku Bridge Authority was enacted.

Pool system

After the partial opening of Meishin Expressway in 1963, about total of 3,400km of development plan was formulated by Mar 1972 based on individual profitability. About 710km of 8 expressways including Tomei Expressway and Chuou Expressway was developed.

1972 Road Council Recommendation

- Expressways should be an arterial traffic network, connected to each other across the country. Each link is not necessarily considered independent, therefore, the toll rates should remain consistent and integrated.
- Under the circumstance where development costs are affected largely by changing land cost and construction costs depending on the construction period, cost differentiation due to project start timing should be avoided. In addition, debt repayment should be carried out smoothly.
  - ⇒ Shifting from individual profitability system to pool system seems effective.

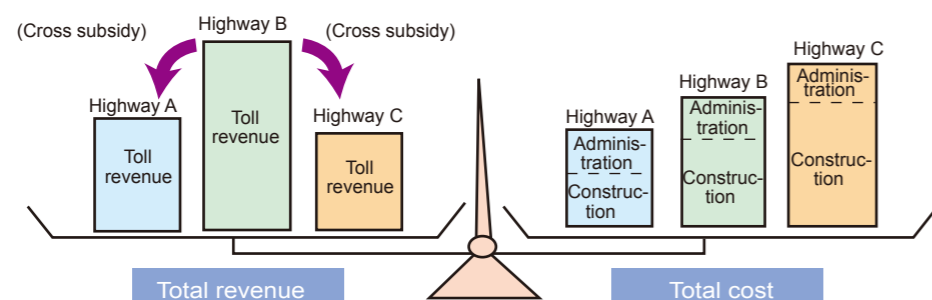

Organizational chart after privatization

Privatization objectives

- Maintain the repayment of 40 trillion JPY
- Construct essential roads promptly with the least national burden, while supporting expressway companies individual initiatives.
- Provide various and flexible toll rate settings and services while taking advantage of being a private company.

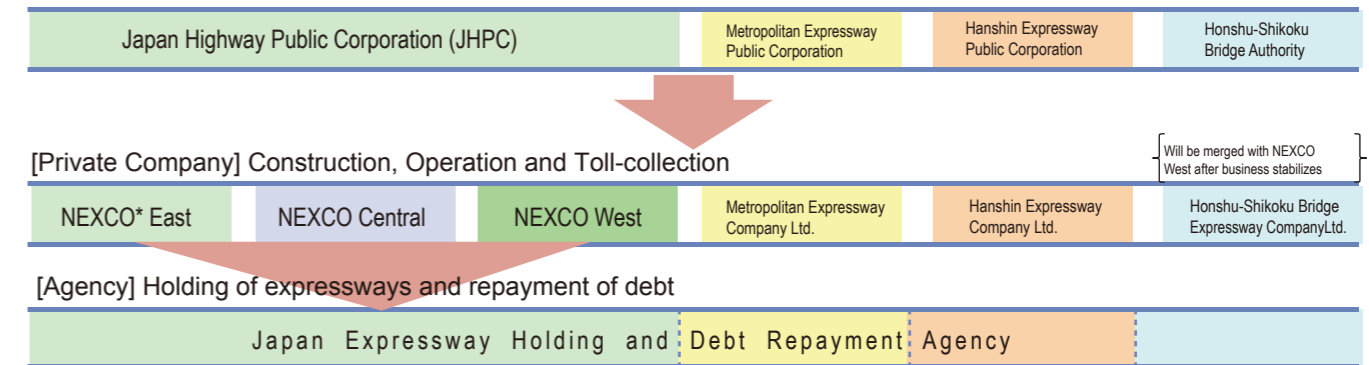

4 Laws Related to Privatization of Former Highway Public Corporations

- Expressway Company Law
- Japan Expressway Holding and Debt Repayment Agency Law
- Law regarding the Development of Highway-related Laws in connection with the Privatization of the Japan Highway Public Corporation
- Act for Enforcement of Acts Related to Privatization of the Japan Highway Public Corporation, etc.

\*NEXCO: Nippon Expressway Company

Business Scheme

- Expressway Companies are responsible for constructing new roads funded by debt and loans before transferring expressway assets and debts to the Agency.
- The Agency is responsible for completing the repayment of debts with the revenue of lease fees in 45 years.

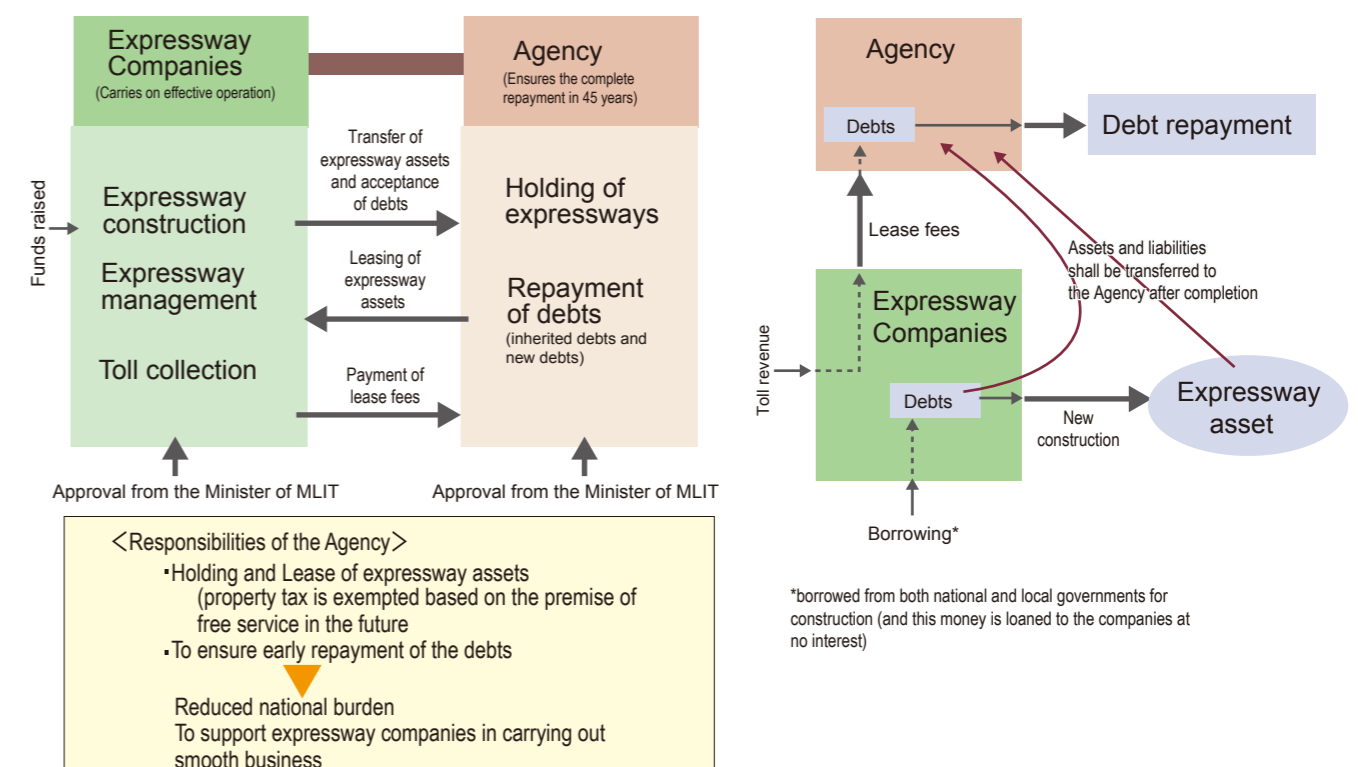

\*borrowed from both national and local governments for construction (and this money is loaned to the companies at no interest)

# History of Roads in Japan

There is a country comprised of four major islands and numerous minor islands in a crescent shape situated to the east of the Asian continent in the northwestern Pacific Ocean. Of the 378,000 square km of land, a substantial 70% is mountainous terrain. That is Japan.

It is a country with a wonderful harmony between traditional culture from ancient eras and a modern society with advanced technology. Japan's fascinating natural environment changes from season to season and is home to more than 120 million people.

The history of land transport in Japan over the last two thousand years can be roughly categorized into the following three ages: 1) Age of People and Nature (ancient times until the Meiji Restoration in 1867), 2) Age of Modernization (from the Meiji Restoration until the 1950s), 3) Age of High Efficiency Networks (from the 1950s to the present day), and 4) Age of Good Maintenance and Management for Maximum Utilization of Existing Roads.

## I. Age of People and Nature (Ancient times until the Meiji Restoration in 1867)

### 1) The Ancient Foundations of Modern Japan

The oldest written record of roads in Japan appeared in a Chinese history book in the 3rd Century called Gishi-wajinden. At that time, Japan was in the process of unifying the country under the Yamato Dynasty. People travelled on foot or horseback for hundreds of years until the Meiji Restoration when Japan opened its doors to the modern nations of the West, late in the 19th century.

Unlike in China and the European countries, horse-drawn carriages never fully evolved in this country. The lack of use of horse-drawn carriages in Japanese history may be attributed to the country's terrain, which is mostly mountainous with numerous creeks and is surrounded by the sea.

After the Reformation of the Taika Era (645), when an elaborate central government system with administrative and judicial institutions was established and a new road network was developed that connected Honshu (the main island) to Shikoku (the smallest of the four main islands) and all the way to Kyushu (the southernmost and third largest island). This nationwide public road network system was called "Seven Roads", composed of Tokaido, Tosando, Hokurikudo, San-indo, San-yodo, Nankaido, and Saikaido ('-do' in

Japanese means 'road'). Once the Seven Roads were opened, after bitter struggles with the rough terrain of the country, they became a prototype for highways and roads in much later years. Almost all routes of the Seven Roads were used for the arterial railways in the Meiji Era (1868~) and the expressways opened from 1964 onward. In short, the Seven Roads established during this age have served as the backbone of transport routes in Japan.

### 2) User-friendly Roads Can Be Traced Back to Early Times

With the establishment of the Seven Roads came another system called "Ekiba, Tenma" (Post Horse System), which eventually became the modern international word "Ekiden" (a relay road race). In this Chinese-originated system, an "Eki" (meaning station) was located at intervals of 16km and would provide necessary services for the officials and people of high rank on their journeys. About 400 "Eki" were developed across the country. In the mid-8th century, a number of fruit trees were systematically planted along the Seven Roads, which would eventually evolve into today's tree-lined roads.

In more recent years (later in the 16th century), a road signage system called "Ichirizuka" was established by referencing the practice in ancient China. This system can be interpreted as the Asian version of the Roman milestone

system.

After the Edo Shogunate was established in 1603, the Ichirizuka system was transformed into ample facilities and the 5 Major Highway System radiating from Edo (old name for the current Tokyo). The Shogunate specified that the five major highways should be about 11m wide and secondary roads 5.5m wide. The road was filled with gravel and cobbles to a depth of 3cm and finished with sand after treading them down.

Sir Rutherford Alcock, who came to Japan as the first British minister in Japan, at the end of the Shogunate era, wrote, "Their highways, the Tokaido, the imperial roads throughout the kingdom, may challenge comparison with the finest in Europe. Broad, level, carefully kept and well macadamized, with magnificent avenues of timber to give shade from the scorching heat of the sun, it is difficult to exaggerate their merit."

### 3) Road Construction with a Consideration for People and Scenery

Japanese people frequently travelled, to a degree that foreigners found incredible. They would not hesitate to travel because there were excellent road facilities and services even then.

In the middle of the Edo Era (1690), Engelbert Kaempfer, a German doctor who came to Japan to work for a Dutch trading house, wrote in his book<sup>1</sup>:

"An unbelievable number of people travel the highways of this country every day. The reason for this is the high population of this country, but another reason is that, unlike other nations, the Japanese travel extremely often."

The Hakone Road was already paved in 1680. Sir Ernest Satow, a British diplomat who came to Japan at the end of the Edo Shogunate (mid-19th century), wrote in his book, "A Diplomat in Japan", about his astonishment at the pavement: "Next morning we started at half-past six to ascend the pass which climbs the range of mountains by an excellent road paved with huge stones after the manner of the Via Appia where it leaves Rome at the Forum, and lined with huge pine trees and cryptomerias."

Unlike Via Appia, however, Japanese surface transport routes were developed primarily for people and horses, because horse-drawn carriages were not common prior to the Meiji Era (1868~). For this reason, roads in those days were usually kept in good condition: damages from traffic

were not severe and the maintenance was relatively easy. Road cleaning and other regular maintenance was not performed by the Shogunate or the government of feudal clans, but by residents alongside the roads. Back then, roads were taken care of by roadside residents on a voluntary basis, not by the governments.

This implies that there was general understanding that roads were not the exclusive property of the overlords, but were "public property".

<sup>1</sup>"Geschichte und Beschreibung von Japan"

## 2. Age of Modernization (from Meiji Restoration to the 1950's)

After ending two hundred years of national seclusion in the Edo Era, the revolutionary government of the Meiji Era (1868-1912) quickly started modernization of the surface transport system by importing new technologies from Europe. Unlike China and Europe, however, Japan did not have a history of horse-drawn carriages as transport during the Middle Ages. It was thus impossible to transform the ancient roads designed strictly for the passage of people and horses into modern roads in a single step.

The beautifully maintained pre-modern roads of the Edo Era began to deteriorate under the burdens of modern horse-drawn and human-powered vehicles (or rickshaws). Arthur Crow, who visited Japan in 1881, recorded this observation in "Highways and Byways in Japan": "The Tokaido is in a dreadfully bad state, with ruts and holes large enough almost to swallow a cart, and yet traffic is very heavy, both for horse and man-power vehicles".

The slow improvement of roads can be partially attributed to the decision by the Meiji Government to give rail and sea transport a higher priority over roads. This decision was intended to allow Japan to catch up with the advanced nations of the West as quickly as possible. The backwardness of the road system in Japan continued until 1945 when Japan was defeated in World War II and the entire national landscape was devastated by bombings and other influences of the war. During the process of reconstruction, the modernization of roads in Japan was fully accelerated along with the development of railways.

### 3. Age of High Efficiency Networks (from the 1950's ~ today)

#### 1) Arrival of the Motorization Age

Automobiles proliferated quickly as the Japanese economy recovered from defeat and the standard of living improved. Only 130,000 vehicles were registered at the end of World War II, but the number increased rapidly, reaching 500,000 vehicles by 1951, then doubling to one million in 1953, and doubling again to two million in 1957. The Age of Motorization had arrived in Japan.

However, the road system remained insufficient to support the rapid motorization. Ralph J. Watkins, an economist invited by the Japanese government to conduct research on the Meishin Expressway wrote in his 1956 report, "The roads of Japan are incredibly bad. No other industrial nation has so completely neglected its highway system".

Japan's road system in those days was indeed terrible. Only 23% of the first-class arterial national highway system was paved. Only two-thirds of the total national Highway Route 1, supposedly the major arterial highway connecting Tokyo with Osaka, was paved. The Japanese Government at that time accepted Mr. Watkins' proposals and immediately put them into practice. Thus, road improvement in Japan moved into high gear, propelling the nation into the high economic growth era of later years.

#### 2) The Five-Year Road Development Program, Toll Road System, and Tax Revenue System with Earmarks for Roads

Without a history of horse-drawn carriages, Japan had only poor roads in those days. What is worse, road development was inevitably slow, because the development of the railway system was given priority over the development of roads. Under these circumstances, the Five-Year Road Development Program was launched so that road development would be fully accelerated.

Because the public works budget under the general revenue scheme was not sufficient to meet ever-increasing road traffic demand, two financing systems were introduced so that a significant number of road projects could be under-



The state of roads in the mid 1950s was "incredibly bad" as Watkins wrote in his report.



April 1968  
Vehicles running from Okazaki IC to Komaki IC after the opening ceremony of Tomei Expressway (Photo: Mainichi Shimbun)

taken in a short period: the toll road system and the tax revenue system with earmarks for roads.

The former "Act on Special Measures concerning Road Construction and Improvement", enacted in 1952, enabled the introduction of the toll road system where the national and municipal governments could borrow sufficient money to develop roads and the borrowed money would be repaid with toll revenue from the new roads.

The toll road system was applied primarily for national expressway projects. In 1956, the Japan Highway Public Corporation (JH) was founded, so that expressways would be operated efficiently and financial resources from the private sector could be widely utilized.

With the founding of JH, toll road development was led by JH instead of by the National Government. Although the mechanism of the toll road system was similar to that of

Figure: Change in Investment in the Five-Year Road Development Program

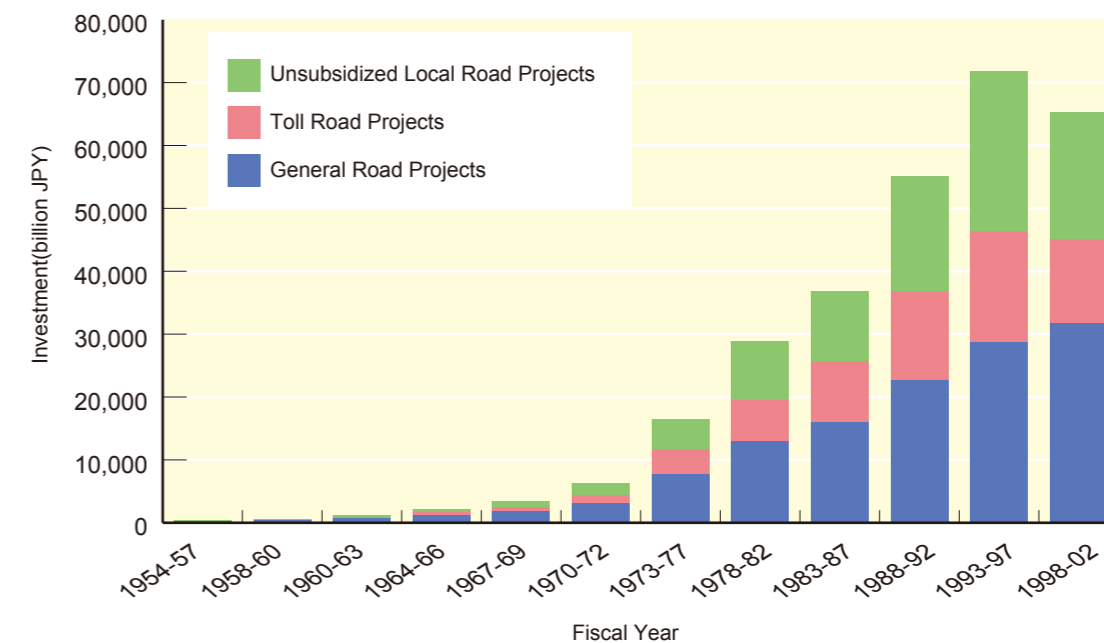

Note: 1) Reserve fund (¥150 billion) is included. 2) Reserve fund (¥100 billion) is included. 3) Reserve fund (¥500 billion) is included. 4) Reserve fund (¥700 billion) is included. 5) Adjustment cost (¥1,300 billion) is included. 6) Adjustment cost (¥1,300 billion) is included. 7) Adjustment cost (¥1,400 billion) is included. 8) Adjustment cost (¥5,000 billion) is included. 9) Reserve fund (¥11.2 billion (for Okinawa)) is included in the total of the 6th plan.

current PPP projects, the former included an ingenious system that enabled them to carry out unprofitable road projects if the road was recognized as necessary from an economic vantage point. The National Government reduced the business risk, of unprofitable road projects, by guaranteeing the loan and by paying a fixed rate of interest. In addition, the Government utilized the pool system, in which revenues and expenditures were balanced for the integral road network as opposed to a collection of individual roads. This system enabled them to develop not only profitable urban roads but also unprofitable regional roads across the country.

In 1953, the "Act on State's Tentative Financial Measures for Road Construction Projects" was enacted, which introduced a new tax revenue system with earmarks for roads. This system earmarked the revenues from gasoline tax and other automobile-related taxes for road projects based on the beneficiary payment principle. This measure secured stable financial resources for long-term development of roads, including the 1st to 12th Five-Year Road Development Programs.

The toll road system and the tax revenue system with earmarks for roads supported the development of the nationwide road network for more than 50 years.

During those years, all major roads were paved and more

than 10,000 km of expressways were developed all across the country.

However, there were increasing calls for a change in both of the financial revenue systems, since the road networks were developed to a certain level. There were various criticisms and opinions arguing that the roads were developed one after another by spending a large amount of both borrowed money and the national budget with a unilateral approach. At the same time, the repayment and management costs were not sufficiently saved due to the high-cost structure of JH's toll road system. As a result, JH was privatized and reorganized into the Japan Expressway and Debt Repayment Agency (JEDRA) and 6 other Expressway Companies. The main purpose of this change was to ensure the full repayment of the massive debt reaching 40 trillion yen, to streamline the administrative authority, and to provide various services for road users by utilizing experience in the private sector.

There was also increasing criticism of the tax revenue system with earmarks for roads. Critics argued that fixed expenditures from the abundant financial resources resulted in a number of unnecessary road developments. In 2009, the tax revenue system with earmarks for roads was abandoned and the Government decided to cover road expenditures with general revenue.



#### 4. Age of Good Maintenance and Management for Maximum Utilization of Existing Roads

Moving into the 21st century, with the total length of expressways coming to more than 10,000 km, there was a tide of public opinion claiming that Japan had sufficient road networks, especially in urban areas. At the same time, Japan entered the age of declining birthrates and aging population (the national population has been declining since it peaked in 2008).

In addition to these changes in social conditions, ever-increasing social security costs and the fragile national financial condition galvanized public opinion to a view that public investments should be economized. This brought

about the abolition of the tax system with earmarks for roads and the reorganization and privatization of JH. While road development is slowing down, utilization of existing road networks or improvement of asset management is beginning to become the focus of current programs.

The first task of asset management is to map out strategies for the aging road infrastructure that was largely developed during the high-growth period of the Japanese economy (from the later 1950s to the 1960s).

The second task is to continually provide road transport services and to support the lives and economies of the people who live in a country that is prone to natural disasters, such as earthquakes and typhoons.

The third task is to provide road services that are safe, accessible, and environmentally friendly by utilizing evolving ITS technologies and by improving the quality of roads.

##### Change in real GDP per capita

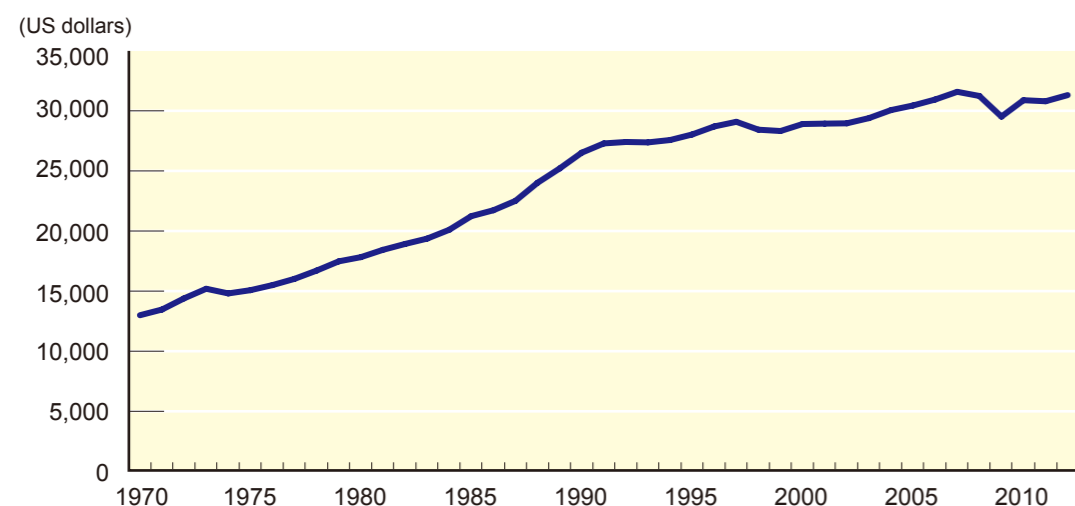

##### Change in total length of expressways

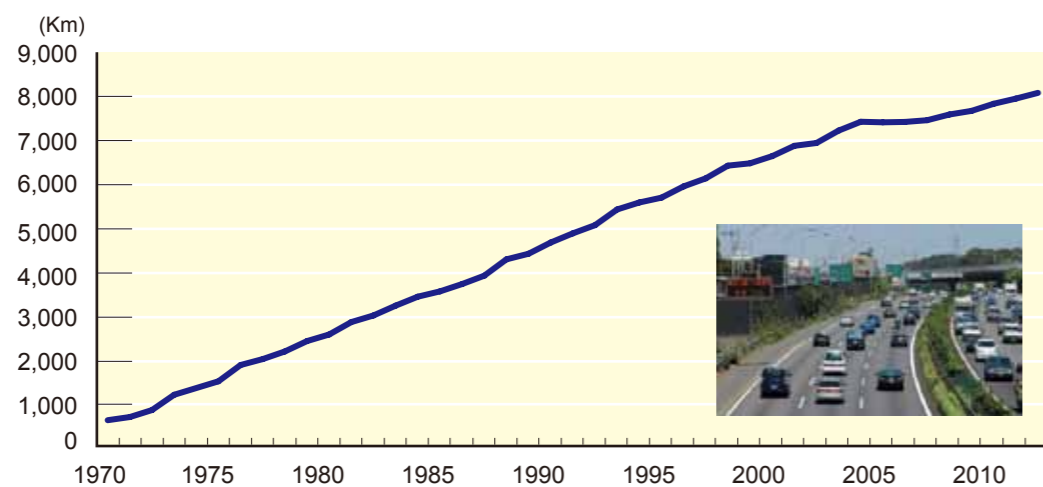

##### Change in vehicle registrations

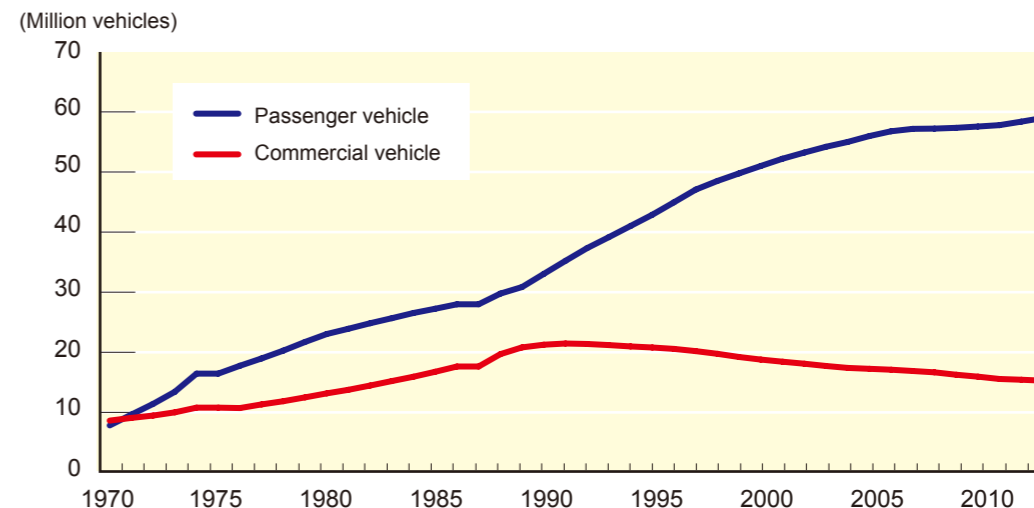

##### 1) Strategies for Aging Road Infrastructure

The majority of roads and bridges that were constructed in the high-growth period of the Japanese economy will be 50 years old in the next 10 years. To maintain the safety of this aging infrastructure, periodic investigation and database management, as well as systematic repair work, are required. It is a new technical challenge to efficiently investigate and repair 5.2 million bridges and 10,000 tunnels. At the same time, this is a significant challenge in terms of financial and human resources as well.

##### 2) Preparing for Natural Disasters

The Great East Japan Earthquake in March 2011 brought about the rediscovery of the importance of road networks in the event of a large-scale disaster. As an earthquake-prone country, in which 20% of the world-wide earthquakes having a magnitude 6 or higher occur, disaster prevention measures, including improvement of bridges' quake resistance, are carried out after the repeated experience of large earthquakes. In addition, it is necessary to enhance road networks for redundancy in the event of road closure after a large-scale disaster and in order to add disaster prevention functions to existing roadside service facilities. As climate change is increasingly occurring on a global scale, Japan has been experiencing more frequent heavy rains and snows at the local level. Landslides on slopes and snowbound traffic are always significant challenges in a country with precipitous terrain. Japanese road administra-

tion has been implementing countermeasures such as constructing slope protection, establishing a snow removal system, installing road monitoring systems, and improving operations for swift responses.

##### 3) Improvement of Road Service Provision using Intelligent Transport System (ITS)

Ring roads are being developed in the Tokyo Metropolitan Areas, where traffic congestion is a serious problem. Once completed, ring roads are expected to provide multiple route options and smoother vehicular flow.

Since they were introduced in 1990s, ITS technologies have provided various new services including car navigation systems and Electronic Toll Collection (ETC). Even now, the technologies are evolving in the road infrastructure and automobile sectors. Newly introduced automobiles with crash-avoidance systems offer a good prospect for fully automatic driving systems in the near future. In the road infrastructure sector, dynamic traffic guidance, warning messaging, and vehicular controlling technologies are under study as road-to-vehicle and/or vehicle-to-vehicle communication systems.

The advancement of technology is going to integrate road infrastructure with automobiles into a new synthetic transport system and will provide a break-through solution for "traffic congestion", "traffic accidents" and "environmental protection", issues that have been major challenges since the modernization of the road system began.

# Organization Chart

The Ministry of Land, Infrastructure, Transport, and Tourism (MLIT) is in charge of the comprehensive and systematic use of national land, development and conservation, consistent infrastructure development, implementation of traffic policies, development of meteorological service, and maritime safety and security. Below is the chart showing the organization of the MLIT.

## Organization Chart of MLT

The Organization of the Ministry of Land, Infrastructure, Transport and Tourism (As of July 1, 2011)

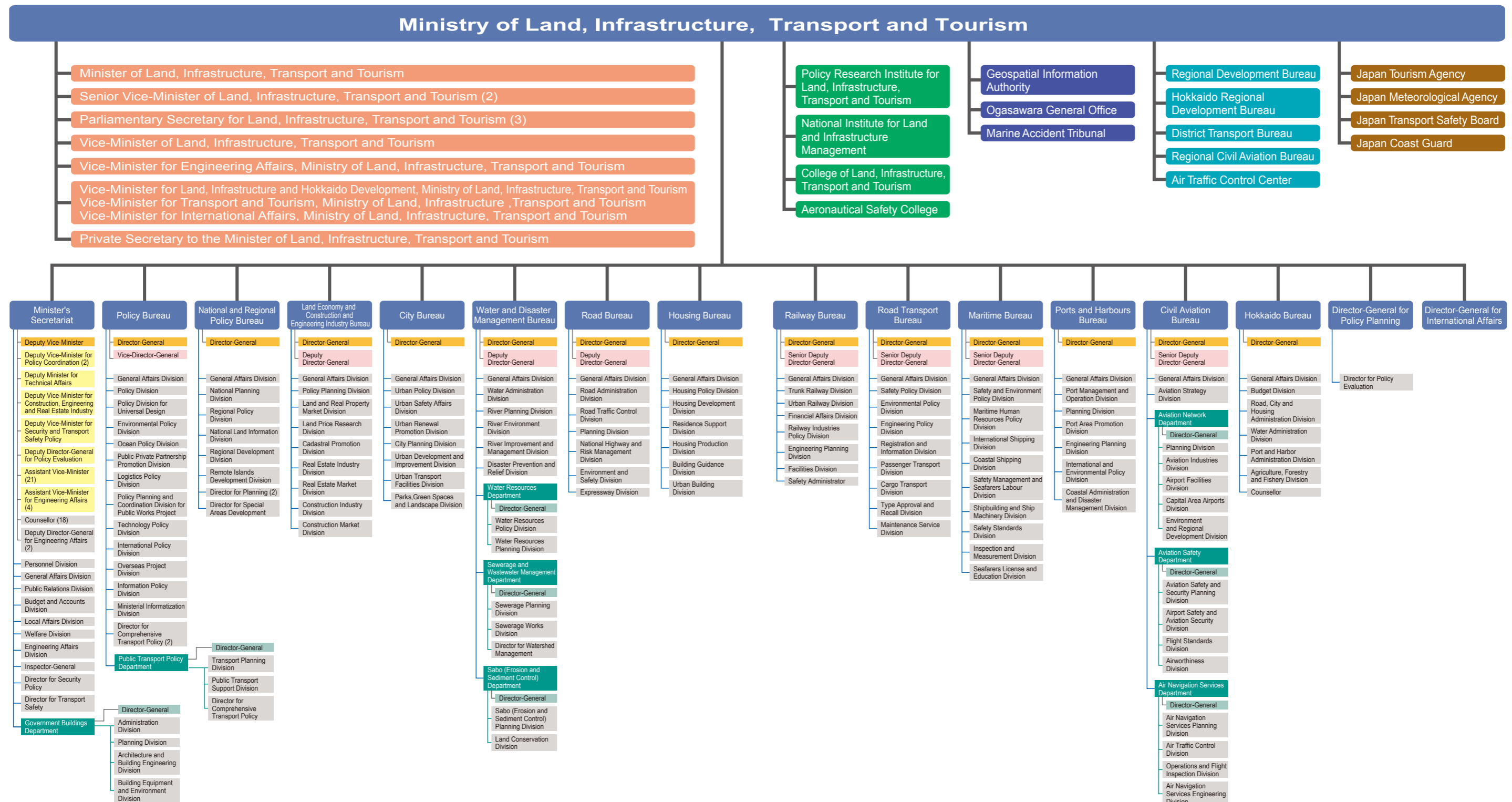

■ Organization Chart of Road Bureau

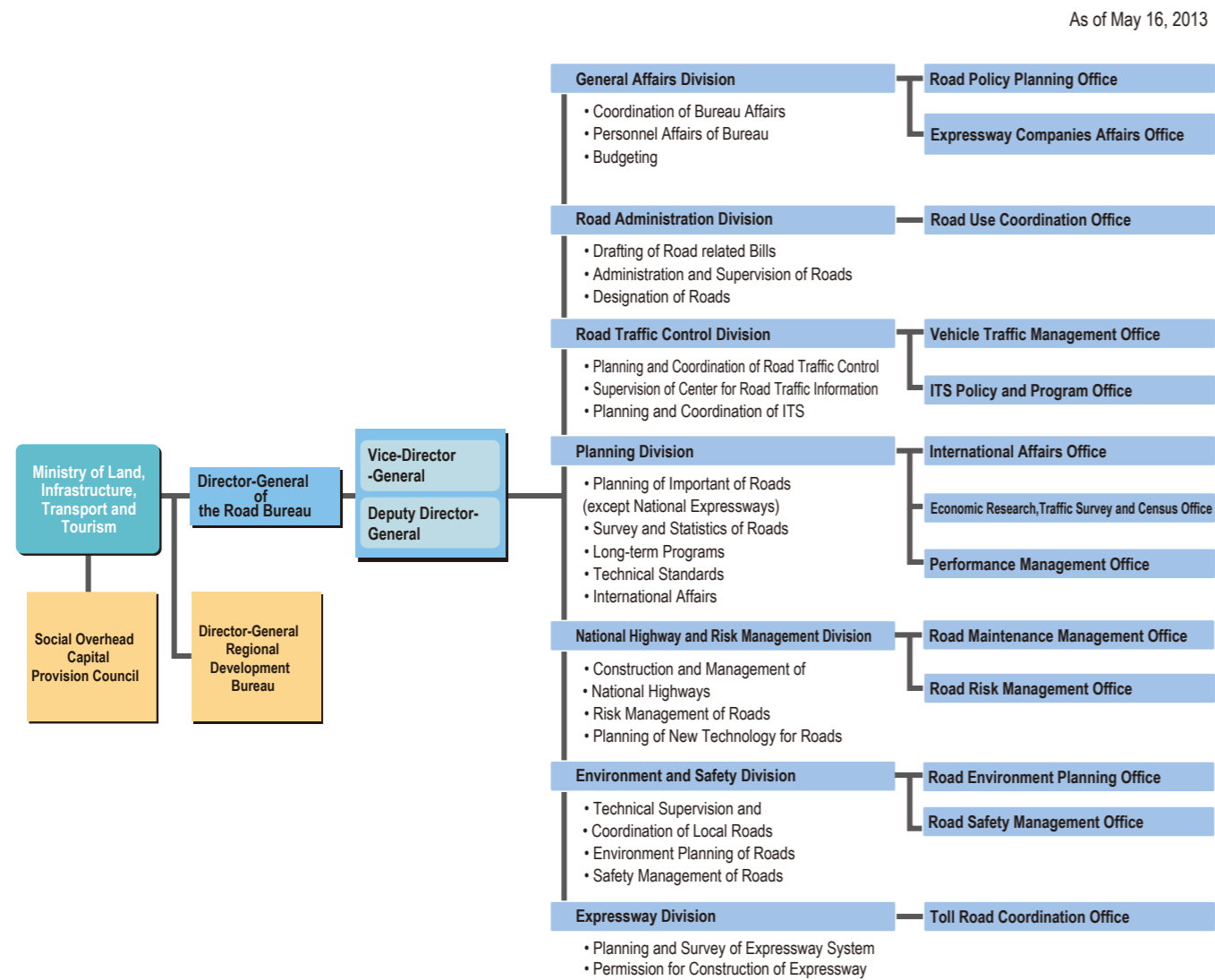

■ Organization of Road Bureau

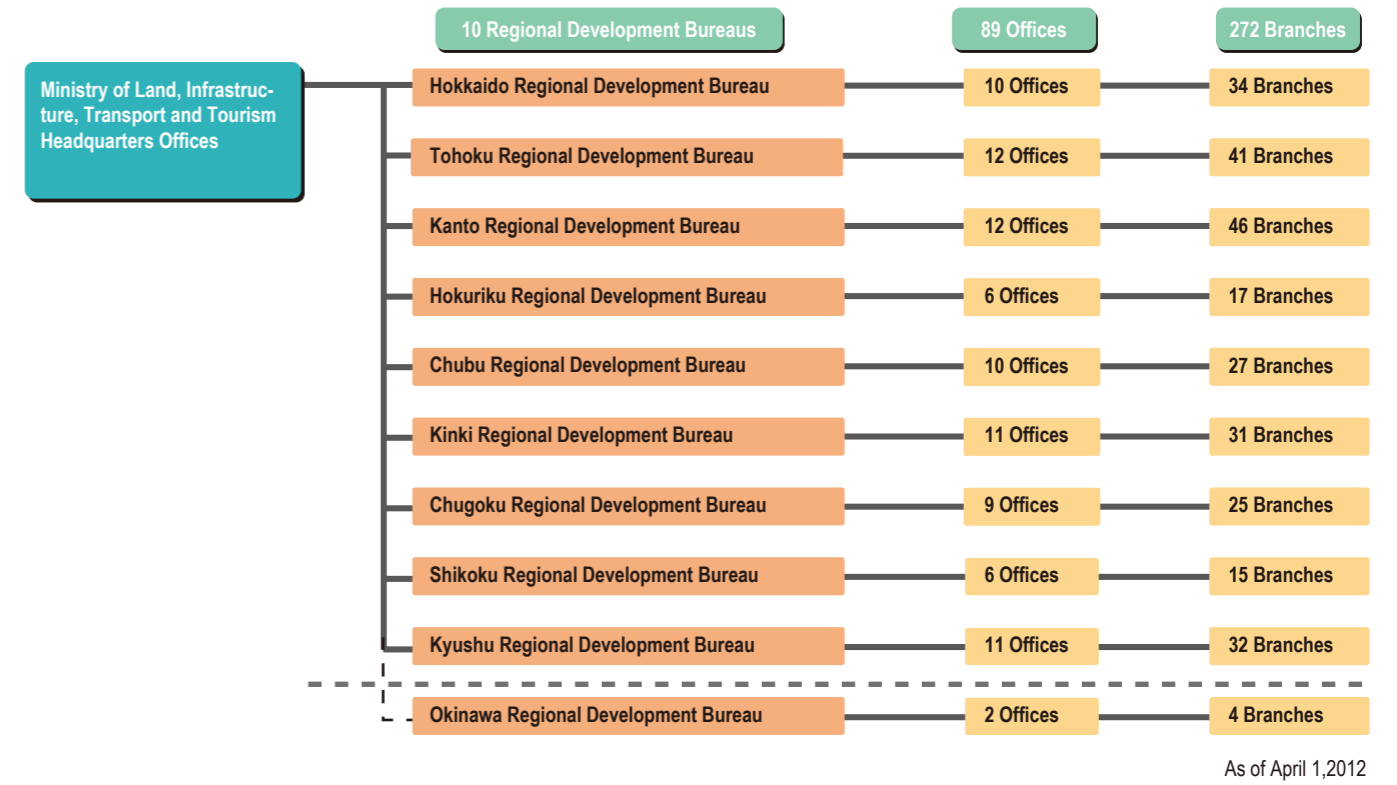

■ Organization of Regional Development Bureau

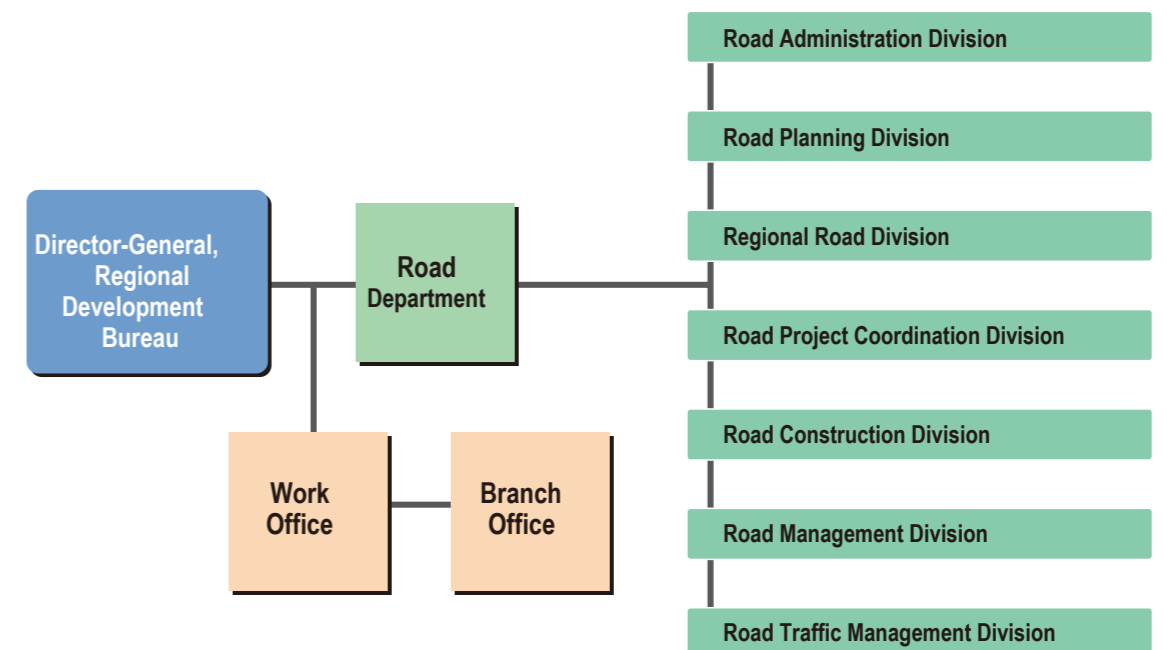

# Road Structure Ordinance

(Government Ordinance No.320 of 29th October, 1970)

[Provisional translation]

## Structure of Road Technique Standards

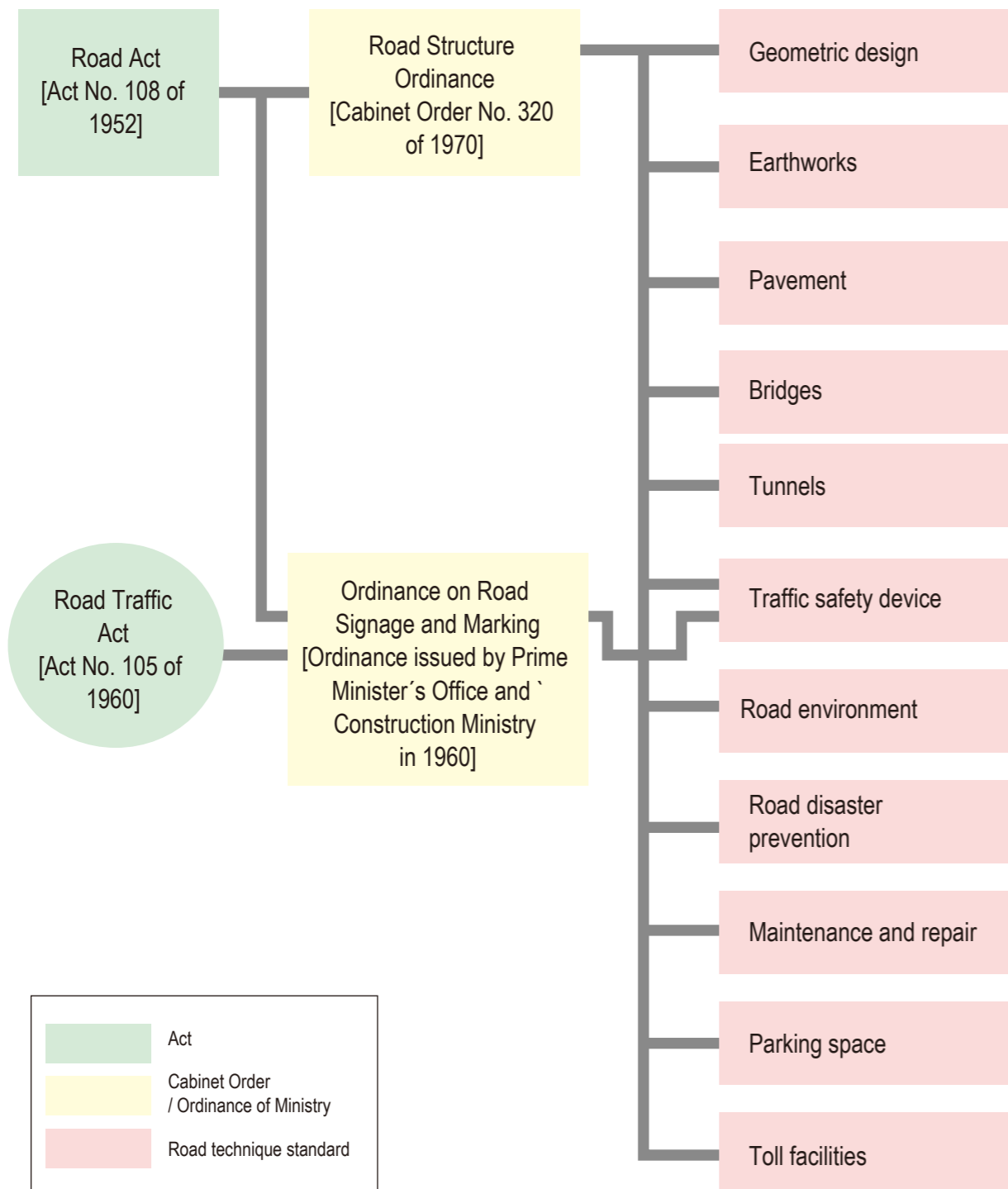

## (Purpose of This Ordinance)

### Article 1

This Ordinance specifies general technical standards (limited to the provisions of the Road Act (hereinafter "Act") Article 30.1.1, 30.1.3 and 30.1.12 for general technical standards of the structure of prefectural roads and municipal roads) for the structure of national expressways and national highways when these roads will be newly constructed or reconstructed and also specifies general technical

standards that should be taken into account when technical standards (except for the provisions in Article 30.1.1, 30.1.3 and 30.1.12) for the construction of prefectural roads and municipal roads are required under the ordinances of prefectural or municipal governments, who also serve as a road administrator.

### (Definition)

#### Article 2

The following terminology definitions shall apply to the corresponding terms in this Ordinance:

1. Sidewalk: A road section provided for dedicated pedestrian traffic, which is separated by curb lines or fences or other similar structures.
2. Bicycle track: A road section provided for dedicated bicycle traffic, which is separated by curb lines or fences or other similar structures.
3. Bicycle/pedestrian track: A road section provided for dedicated bicycle/pedestrian traffic, which is separated by curb lines or fences or other similar structures.
4. Carriageway: A road section used by dedicated vehicle traffic, except for bicycles.
5. Lane: A strip section of the carriageway (except for the service road) provided for safe and smooth traffic by directional separation of vehicles traveling in a single direction.
6. Additional overtaking lane: An additional lane (except for climbing, turning and speed change lanes) provided specifically for vehicles to overtake other vehicles.
7. Climbing lane: A lane for slower vehicles to be separated from other vehicles on uphill roads.
8. Turning lane: A lane for vehicles to turn right or left.
9. Speed change lane: A lane for vehicles to accelerate or decelerate.
10. Center strip: A strip road section provided to separate a lane from the traffic in the opposite direction and ensure lateral clearances.
11. Service road: A strip of carriageway provided to applicable sections, parallel to the carriageway, to ensure access of vehicles to roadsides where access is prevented by reason of embankment and/or cut, or other means.
12. Shoulder: A strip of road section connected with carriageway sidewalks, bicycle tracks or bicycle/pedestrian tracks to protect major road structure sections and to maintain carriageway functions.
13. Marginal strip: A strip section of the center strip or shoulder connected with the carriageway to provide optical guidance for drivers and ensure lateral clearance.
14. Stopping lane: A strip of carriageway section principally used to park vehicles.
15. Track bed: A road section dedicated for use by streetcar traffic (streetcars as specified in Article 2.1.13 of the Road Traffic Act [Act No.105 of 1960]; this definition of streetcars shall apply hereinafter).
16. Island: An area facility provided at intersections, carriageway separation points, bus bays, streetcars stops, or other areas to ensure safe and smooth vehicle traffic or the safety of pedestrians crossing streets or bus and streetcar passengers boarding or alighting.
17. Planting strip: A strip of road section provided for tree planting in order to improve road traffic environment and ensure a better living environment along roadsides, which is separated by using curb lines or fences or other similar structures.
18. On-street facility: A road accessory facility on sidewalks, bicycle tracks, bicycle/pedestrian tracks, center strips, shoulders, bicycle paths and bicycle/pedestrian paths, except for common ducts and common cable ducts.
19. Urban area: An area forming or expected to form a city or town.
20. Rural area: Other areas than urban areas.
21. Designed daily volume: Daily vehicle traffic volume determined by planners for road construction or reconstruction planners designated by the Land, Infrastructure and Transport Ministry's ordinance according to requirements in the same ordinance for the basis of road design, in consideration of trends of development in the area and vehicle traffic conditions in the future.
22. Design speed: Vehicle speed that is used as a basis for road design.
23. Sight distance: The distance measured along the lane (or carriageway in the case of a road without a lane and the same is applied hereinafter) centerline at which an apex of a 10cm high object on the lane centerline is visible from 1.2m on the lane centerline.

**(Road Classification)**

**Article 3**

1. Roads shall be classified into Types 1 through 4 as listed in the following table.

National expressways and access-controlled highways or other roads.	Area where road is located	
	Rural Area	Urban Area
National expressways and access-controlled highways	Type1	Type2
Other Roads	Type3	Type4

2. Type 1 roads shall be classified into classes 1 through 4 as listed in Table 1, Type 2 roads shall be classified into Class 1 or 2 as listed in Table 2, Type 3 roads shall be classified into classes 1 through 5 as listed in Table 3, and Type 4 roads shall be classified into classes 1 through 4 except where topographic conditions or

other circumstances do not permit such provision. Roads can be classified into one class lower than the original class unless roads are otherwise applicable to Type 1 Class 4, Type 2 Class 3, Type 3 Class 5, or Type 4 Class 4.

**Table 1 Type 1 Roads**

Road type	Topography area where road is located	Designed daily volume (vehicles/day)			
		More than 30,000	20,000~30,000	10,000~20,000	Less than 10,000
National Expressway	Level Area	Class 1	Class 2		Class 3
	Mountainous Area	Class 2	Class 3		Class 4
Roads other than National Expressway	Level Area	Class 2		Class 3	
	Mountainous Area	Class 3		Class 4	

**Table 2 Type 2 Roads**

Road type	Area where road is located	Areas other than Central Business District	Central Business District
		National Expressway	Class 1
Roads other than National Expressway		Class 1	Class 2

**Table 3 Type 3 Roads**

Road type	Area where road is located	Designed daily volume (vehicles/day)				
		More than 20,000	4,000~20,000	1,500~4,000	500~1,500	Less than 500
National Highway	Level Area	Class 1	Class 2	Class 3		
	Mountainous Area	Class 2	Class 3	Class 4		
Prefectural Roads	Level Area	Class 2		Class 3		
	Mountainous Area	Class 3		Class 4		
Municipal Roads	Level Area	Class 2		Class 3	Class 4	Class 5
	Mountainous Area	Class 3		Class 4		Class 5

**Table 4 Type 4 Roads**

Road type	Designed daily volume (vehicles/day)	More than 10,000	4,000~10,000	500~4,000	Less than 500	
		National Highway	Class 1		Class 2	
Prefectural Roads		Class 1	Class 2	Class 3		
Municipal Roads		Class 1	Class 2	Class 3	Class 4	

- Roads shall be classified as specified in the previous paragraph 2 based on traffic conditions.
- Type 1, 2 and 3 Class 1 through 4 roads or Type 4 Class 1 through 3 roads (limited to elevated roads and other structures from which vehicles cannot access roadsides for Type 3 Class 1 through 4 roads and Type 4 Class 1 through 3 roads) can be specified as the roads provided exclusively for the traffic of smaller motor vehicles (hereinafter indicating small-sized vehicles and other similar small vehicles; and pedestrians and bicycles in the case of Type 3 Class 1 through 4 and Type 4 Class 1 through 3 roads), in an unavoidable case such as for a topographical reason and due to conditions of urbanization, there shall be a neighboring detour road for other types of vehicles, other than smaller motor vehicles.
- A lane specifically for the traffic of smaller motor vehicles can be provided, by separating other lanes on Type 1, 2 and 3 Class 1

through 4 roads or Type 4 Class 1 through 3 roads, in unavoidable cases such as for a topographical reason and due to conditions of urbanization. In the case of Type 3 Class 1 through 4 roads and Type 4 Class 1 through 3 roads, the lane specifically for the traffic of smaller motor vehicles shall be limited to elevated roads or other structures from which vehicles cannot access roadsides.

6. Roads shall be classified into smaller motor vehicle roads (hereinafter indicating the roads provided specifically for the traffic of smaller motor vehicles specified in the paragraph 4 and smaller motor vehicles and pedestrians and bicycles in Type 3 Class 1 through 4 and Type 4 Class 1 through 3 roads and vehicles specified in the previous paragraph) and regular motor vehicle roads (hereinafter indicating roads and road sections other than smaller motor vehicle roads).

**(General Technical Standards for Construction of National Expressways and National Highways Structures)**

**Article 3-2**

The next Article through Article 40 specify general technical standards for the construction of national expressways and national

highways structures, when these roads will be newly constructed or reconstructed.

**(Design Vehicles)**

**Article 4**

- Roads shall be so designed for the smooth and safe passage of small-sized motor vehicles and semitrailers (hereinafter indicating combined body consisting of trailing motor vehicle and trailed vehicle without front axle, in which a part of the trailed vehicle rests on the motor vehicle and substantial weight of the trailed vehicle and its load are supported by the motor vehicle) on Type 1, Type 2, Type 3 Class 1 or Type 4 Class 1 regular motor vehicle roads,

small-sized motor vehicles and regular-sized motor vehicles on other regular motor vehicle roads and smaller motor vehicles on smaller motor vehicle roads).

2. Specifications for the vehicle that is a basis of road design (hereinafter referred to as "design vehicle") by Type shall be listed below.

	Length	Width	Height	Front-edge overhang	Wheelbase	Rear-edge overhang	Minimum turning radius
Small-sized motor vehicle	4.7	1.7	2.0	0.8	2.7	1.2	6.0
Smaller motor vehicles	6.0	2.0	2.8	1.0	3.7	1.3	7.0
Regular-sized motor vehicle	12.0	2.5	3.8	1.5	6.5	4.0	12.0
Semi-trailer	16.5	2.5	3.8	1.3	Front section wheelbase: 4.0 Rear section wheelbase: 9.0	2.2	12.0

For this table, the following terminology definitions shall apply to the corresponding terms.

- Front-edge overhang: Distance from the front face of the vehicle body to the center of the front-wheel axle of a vehicle.
- Wheelbase: Distance from the center of front-wheel axle of a vehicle to the center of the rear-wheel axle.
- Rear-edge overhang: Distance from the rear face of the vehicle body to the center of the rear-wheel axle of a vehicle.

**(Lane)**

**Article 5**

- The carriageway (except for the service road, stopping lane and other sections specified by the ordinances of Ministry of Land, Infrastructure, Transport and Tourism) shall consist of the below-specified lanes, except for those classified as Type 3 Class 5.
- The number of lanes shall be 2 (except for additional overtaking, climbing, turning and speed change lanes and the same is applied

in the following paragraph) in accordance with the road classification and on rural roads where designed daily traffic volume is no more than values of standard design volume (hereinafter indicating maximum allowable traffic volume) as listed in the following table, while taking into account topographic conditions.

Classification		Topography	Standard Design Volume (vehicles/day)
Type1	Class 2	Level Area	14,000
	Class 3	Level Area	14,000
		Mountainous Area	10,000
	Class 4	Level Area	13,000
Mountainous Area		9,000	
Type3	Class 2	Level Area	9,000
	Class 3	Level Area	8,000
		Mountainous Area	6,000
	Class 4	Level Area	8,000
Mountainous Area		6,000	
Type4	Class 1		12,000
	Class 2		10,000
	Class 3		9,000

As for Type 4 roads with many intersections, standard design traffic volume shall be calculated by multiplying standard design traffic volume herein by 0.8.

3. The number of lanes on roads, other than those specified in the provision above, (except for Type 2 one-way roads and Type 3 Class 5) shall be more than 4 (a multiple of 2 unless otherwise required depending on traffic conditions) on Type 2 roads and one-way roads shall be more than 2 on roads that meet the road

classification and are located in rural areas, and shall be determined by the rate of designed daily volume on the road according to standard design traffic volume per lane as listed in the following table, taking into consideration topographic conditions.

Classification		Topography	Standard Design Traffic Volume per Lane(vehicles/day)
Type1	Class 1	Level Area	12,000
	Class 2	Level Area	12,000
		Mountainous Area	9,000
	Class 3	Level Area	11,000
		Mountainous Area	8,000
	Class 4	Level Area	11,000
Mountainous Area		8,000	
Type2	Class 1		18,000
	Class 2		17,000
Type3	Class 1	Level Area	11,000
	Class 2	Level Area	9,000
	Class 3	Mountainous Area	7,000
		Level Area	8,000
	Class 4	Mountainous Area	6,000
		Mountainous Area	5,000
Type4	Class 1		12,000
	Class 2		10,000
	Class 3		10,000

In the case of Type 4 roads with many intersections, standard design traffic volume per lane shall be calculated by multiplying standard design traffic volume per lane herein by 0.6.

4. Lane width (except for climbing, turning, and speed change lanes,) shall be the as listed in the columns for lane width, in the following table, in accordance with road classification. However, the lane width on Type 1 Class 1 and 2 or Type 3 Class 2 or Type 4 Class 1 regular motor vehicle roads may add 0.25m to the values as

listed in the columns depending on the traffic situation. Lane width on Type 1 Class 2 or 3 smaller motor vehicle roads or Type2 Class 1 roads may be reduced 0.25m from the values as listed in the columns in unavoidable cases, such as for topographical and other reasons.

Classification			Lane Width (m)	
Type1	Class 1		3.5	
	Class 2			
	Class 3	Regular motor vehicle roads	3.5	
		Smaller motor vehicle roads	3.25	
Class 4	Regular motor vehicle roads	3.25		
	Smaller motor vehicle roads	3.0		
	Type2	Class 1	Regular motor vehicle roads	3.5
		Class 1	Smaller motor vehicle roads	3.25
Class 2	Regular motor vehicle roads	3.25		
	Smaller motor vehicle roads	3.0		
	Type3	Class 1	Regular motor vehicle roads	3.5
		Class 1	Smaller motor vehicle roads	3.0
Regular motor vehicle roads			3.25	
Smaller motor vehicle roads		2.75		
Class 2	Regular motor vehicle roads	3.0		
	Smaller motor vehicle roads	2.75		
	Class 3		2.75	
	Type4	Class 1	Regular motor vehicle roads	3.25
Smaller motor vehicle roads			2.75	
Class 2 and 3		Regular motor vehicle roads	3.0	
		Smaller motor vehicle roads	2.75	

5. Carriageway width on Type 3 Class 5 regular motor vehicle roads shall be 4m. However, the width could be reduced to 3m where designed daily traffic volume is extremely low and topographic

conditions or special reasons do not permit such provisions or where a narrow pass is created on regular motor vehicle roads pursuant to the provisions of Article 31.2.

**(Lane Division)**

**Article 6**

- The lanes (hereinafter this applies for all except one-way roads) on Type 1, Type 2 or Type 3 Class 1 roads shall be directionally divided. It is also applied to other roads with four or more lanes if necessary for safe and smooth traffic.
- Notwithstanding the provisions of the first sentence of the preceding paragraph, Type 1 roads with three or less lanes (hereinafter, this applies for all except for climbing, turning and speed change lanes) may be left directionally undivided in unavoidable cases, such as for topographical conditions or any other reasons.
- A center strip shall be provided, when required, for directional lane division.
- Center strip width shall be no less than the values indicated in the left columns in the following table. However, the center strip width can be reduced to values listed in the right columns, in the same table, where tunnels longer than 100m, bridges longer than 50m, elevated roads, topographic conditions or other special conditions do not permit.

- A marginal strip shall be provided to the center strip.
- The width of the marginal strips shall be the values listed in the left column of the following table in accordance with road classification. However, the center strip width can be reduced to the values listed in the right columns of the same table when the center strip width of the road or road section is reduced in accordance with paragraph 4.

Classification	Width of Marginal Strip Provided to Center Strip(m)	
	Left Column	Right Column
Type1	Class 1	0.25
	Class 2	
	Class 3	0.5
	Class 4	
Type2		0.5
Type3	Class 1	0.25
	Class 2	
	Class 3	
	Class 4	
Type4	Class 1	0.25
	Class 2	
	Class 3	

Classification	Center Strip Width(m)	
	Left Column	Right Column
Type1	Class 1	2.0
	Class 2	
	Class 3	1.5
	Class 4	
Type2	Class 1	1.5
	Class 2	1.25
Type3	Class 1	1.0
	Class 2	
	Class 3	
	Class 4	
Type4	Class 1	1.0
	Class 2	
	Class 3	

- Fences, or other similar structures, or curb lines connected to the marginal strip shall be provided to sections other than the marginal strip of the center strip (hereinafter referred to as the "median").
- When on-street facilities are provided on the median, the center strip width shall be determined considering clearances as specified in Article 12.
- If necessary, additional overtaking lanes shall be provided to the carriageway of Type 1 roads with single lanes in each direction.

**(Service Roads)**

**Article 7**

1. The service roads shall be provided to Type 3 or 4 roads with more than four lanes (except for climbing, turning and speed change lanes) if necessary.
2. Service road width shall be a standard 4m.

**(Shoulders)**

**Article 8**

1. Shoulders shall be provided to roads connected to carriageways, except where a center strip or stopping lane is provided.
2. Shoulder width on the left side of the carriageway shall be, in accordance with road classification, no less than the values listed in the left column of the following table. However, road width may be reduced to the values listed in the right columns in the same table where additional overtaking lanes, climbing lanes or speed change lanes are provided, or on road sections of bridges 50m or longer or elevated roads or other road sections in unavoidable cases such as for a topographical or other special reasons.

Classification		Width of Shoulder Provided on Left of Carriageway(m)		
Type1	Class 1 and 2	Regular motor vehicle roads	2.5	1.75
		Smaller motor vehicle roads	1.25	
	Class 3 and 4	Regular motor vehicle roads	1.75	1.25
		Smaller motor vehicle roads	1.0	
Type2	Regular motor vehicle roads	1.25		
	Smaller motor vehicle roads	1.0		
Type3	Class 1	Regular motor vehicle roads	1.25	0.75
		Smaller motor vehicle roads	0.75	
	Class 2 through 4	Regular motor vehicle roads	0.75	0.5
		Smaller motor vehicle roads	0.5	
	Class 5		0.5	
Type4		0.5		

3. Notwithstanding the provisions of the preceding paragraph, shoulder width on the left side of carriageways on Type 1 roads with directionally divided lanes shall be, in accordance with road classification, no less than the values listed in the left column of the following table. However, shoulder width on the left side of the carriageway may be reduced to the values listed in the right columns in the same table where the road section is in a tunnel of no shorter than 100m, on bridges of no shorter than 50m, on elevated roads with low traffic volume of larger vehicles, or in unavoidable conditions such as for topographic or other reasons.

Classification		Width of Shoulder Provided on Left of Carriageway(m)	
Class 2 and 3	Regular motor vehicle roads	2.5	1.75
	Smaller motor vehicle roads	1.25	
Class 4	Regular motor vehicle roads	2.5	2.0
	Smaller motor vehicle roads	1.25	

4. Width of the shoulders provided on the right of carriageway shall be, in accordance with road classification, no less than the values listed in the right column of the following table.

Classification		Width of Shoulder Provided on Left of Carriageway(m)	
Type 1	Class 1 and 2	Regular motor vehicle roads	1.25
		Smaller motor vehicle roads	0.75
	Class 3 and 4	Regular motor vehicle roads	0.75
		Smaller motor vehicle roads	0.5
Type 2	Regular motor vehicle roads	0.75	
	Smaller motor vehicle roads	0.5	
Type 3			0.5
Type 4			0.5

5. Shoulder widths of the regular motor vehicle roads in tunnels (except for shoulders specified in the paragraph 3) or shoulder widths on the left side of smaller motor vehicle roads (except for shoulders specified in the paragraph 3) may be reduced to 1m on Type 1 Class 1 or 2 roads, 0.75m on Type 1 Class 3 or 4 roads and 0.5m on Type 3 (except for Class 5) regular motor vehicle roads or Type 3 Class 1 smaller motor vehicle roads.
6. As for the shoulder connecting to the service road, values of "1.25" and "0.75" in the left column of Type 3 carriageway as tabulated in Section 2 shall be regarded as "0.5" and provisory requirements in Section 2 shall not be applied.
7. On roads where sidewalks, bicycle tracks or bicycle/pedestrian tracks are provided, major road structures shall be protected. If smooth carriageway traffic can be maintained, the shoulder connecting width can be omitted or the width can be reduced.
8. A marginal strip shall be provided to the shoulder connecting with the carriageway on Type 1 or 2 roads.
9. The width of the marginal strips for regular motor vehicle roads shall be the values listed in the left column of the following table in accordance with road classification. The width of the marginal strips on smaller motor vehicle roads shall be 0.25m. However,

Classification		Width of Marginal Strip Provided to Shoulder (m)	
Type1	Class 1	0.75	0.5
	Class 2		
	Class 3	0.5	0.25
	Class 4		
Type2	Class 1	0.5	
	Class 2		

10. Where it is necessary to protect major road structures, the shoulder shall be provided on road ends so as to be connected to the sidewalk, bicycle track or bicycle/pedestrian track.
11. Where on-street facilities are provided on the shoulder connected to the carriageway, shoulder width shall be the values of shoulder width provided for the left side of the carriageway listed in paragraph 2 or the values of shoulder width provided for the right side of the carriageway listed in paragraph 4, plus the values required for the on-street facilities.

**(Stopping Lane)**

**Article 9**

1. A stopping lane shall be provided on the left carriageway end on Type 4 roads to prevent stopping vehicles from impeding safe and smooth traffic.
2. The stopping lane width shall be 2.5m. However, the width may be reduced to 1.5m where the traffic volume of larger vehicles is low.

**(Track Bed)**

**Article 9.2**

The track bed width shall be, in accordance with single or double track, wider than the values listed in the bottom columns of the following table.

Single or Double Track	Track Bed Width(m)
Single Track	3
Double Track	6

**(Bicycle Track)**

**Article 10**

1. Bicycle tracks shall be provided on both sides of roads on Type 3 or 4 roads with higher vehicle and bicycle traffic volume, except where topographic conditions or other special reasons do not permit such provision.
2. Bicycle tracks shall be wider than 2m, except where topographic conditions or other special reasons do not permit such provision.
3. Bicycle tracks shall be wider than 2m, except where topographic conditions or other special reasons do not permit such provision, in such cases the width can be reduced to 1.5m.
4. Where on-street facilities are provided on the bicycle tracks, the road width shall be determined in consideration of clearances as specified in Article 12.
5. Bicycle track width shall be determined in consideration of bicycle traffic conditions on roads.

**(Bicycle/Pedestrian Track)**

**Article 10.2**

1. Bicycle/pedestrian tracks shall be provided on both sides of Type 3 or 4 roads with large traffic volume (except for roads where the bicycle tracks would already be provided) except where topographic conditions or other special reasons do not permit such provisions.
2. Bicycle/pedestrian track width shall be wider than 4m for roads with higher pedestrian traffic volume and wider than 3m for other roads.
3. Where a sidewalk is crossing a bridge or underpass (hereinafter referred to as "pedestrian crossing bridge") or on-street facilities

are provided, the bicycle/pedestrian track width shall be increased by 3m where a pedestrian crossing bridge is to be constructed, 2m where a roofed bench is to be installed, 1.5m where a row of trees is to be planted, 1m where a bench is installed or 0.5m in other cases, respectively to the values given in the preceding paragraph. The requirements as specified above shall be applied

except for Type 3 Class 5 roads where topographic conditions or other special reasons do not permit such provisions.  
 4. The bicycle/pedestrian track width shall be determined in consideration of bicycle and pedestrian traffic conditions on the road.

**(Sidewalk)**

**Article 11**

1. A sidewalk shall be provided on both sides of Type 4 roads (excluding those roads provided with bicycle/pedestrian tracks), Type 3 roads (except for Class 5 and excluding those roads provided with bicycle/pedestrian tracks) with higher pedestrian traffic volume or Type 3 roads already provided with bicycle tracks, except where topographical conditions or any other reasons prevent such provision.
2. Sidewalks shall be provided on Type 3 roads (excluding those roads already provided with bicycle/pedestrian tracks and those roads stipulated in the preceding paragraph) where it is required for safe and smooth traffic, except where topographic conditions or any other reasons do not permit such provision.
3. The sidewalk width shall be wider than 3.5m for roads with higher pedestrian traffic volume and wider than 2m for other roads.

4. Where a sidewalk is crossing a bridge or underpass (hereinafter referred to as "pedestrian crossing bridge") or on-street facilities are provided, bicycle/pedestrian track width shall be increased by 3m where a pedestrian crossing bridge is to be constructed, 2m where a roofed bench is to be installed, 1.5m where a row of trees is to be planted, 1m where a bench is installed or 0.5m in other cases, respectively to the values given in the preceding paragraph, and requirements as specified above shall be applied, except for Type 3 Class 5 roads where topographic conditions or other special reasons do not permit such provisions.
5. The sidewalk width shall be determined in consideration of pedestrian traffic conditions on the roads.

**(Waiting Area for Pedestrians)**

**Article 11.2**

Waiting space for pedestrians shall be provided on sidewalks, bicycle-and pedestrian tracks, bicycle-and pedestrian paths or exclusive pedestrian roads, in the case that it is necessary to

ensure that the safe and smooth passage of pedestrians or bicycle riders will not be impeded due to the accumulation of pedestrians at the pedestrian crossings or at bus stops.

**(Center Strip Width in Snowy Areas)**

**Article 11.3**

Center strip, shoulder, bicycle/pedestrian track and side walk width in snowy areas shall be determined in consideration of snow removal.

**(Planting Strip)**

**Article 11.4**

1. The planting strip shall be provided to Type 4 Class 1 and Class 2 roads and if necessary to other roads, except where topographic conditions or other special reasons do not permit such provisions.
2. The planting strip width standard shall be 1.5m.
3. The planting strips provided between road sections as described below shall have proper width values, exceeding values specified in the section above when required for conditions in comprehensive consideration of road structure, traffic condition, and land use of adjoining areas and other measures taken to

improve road traffic environment or to ensure a better living environments along adjoining areas irrespective of the requirements above:  
 1) Sections of arterial roads and central business districts in large cities running through scenic spots.  
 2) Sections of arterial roads running through residential areas or areas that are expected to become residential.  
 4. For planting strips, the selection of plant species and arrangement of trees shall take into account with the ecological characteristics of the area.

**(Clearances)**

**Article 12**

Clearances on roads shall be shown in Fig.1 for carriageways and in Fig.2 for sidewalks and bicycle tracks or bicycle/pedestrian tracks

(hereinafter referred to as "bicycle tracks").

**Fig.1**

(1)		(2)	(3)
Carriageway of roads where the shoulder is provided by connecting with the carriageway [except for the road sections specified in (3)]		Carriageway of roads where the shoulder is not provided by connecting with the carriageway [except for the road sections specified in (3)]	Of carriageway, sections related to Separator or Island
Carriageway of roads other than tunnels without sidewalk or bicycle track, bridge longer than 50m or viaduct	Carriageway in tunnels without sidewalk or bicycle track, on bridges longer than 50m or viaduct		

Figure (omitted)  
 In this figure, H, A, b, c, d and e indicate the following values.  
 H: 4.5m for regular motor vehicle roads and 3m for smaller motor vehicle roads except for Type 3 Class 5 regular motor vehicle roads where the value may be reduced to 4m in unavoidable cases such as for a topographical reason (or 3m when traffic volume of large-sized motor vehicles is extremely small and these may access neighboring bypass roads).  
 a: The width of the shoulder connected with the carriageway on regular motor vehicle roads (for shoulders where on-street facilities are provided, shoulder width minus value required for on-street facilities), provided that the value exceeds 1m shall be 1m. The width of the shoulder connected with the carriageway on smaller motor vehicle roads shall be 0.5m.  
 b: Value subtracting 3.8m from H (regarded as 3.8m where H is less than 3.8m) for regular motor vehicle roads and this value shall be 0.2m for smaller motor vehicle roads.  
 c and d: Concerning the separator, values listed in columns c and d in accordance with road classification and concerning the island, the value of c shall be 0.25m and the value of d shall be 0.5m.

Classification		c (Unit: m)	d (Unit: m)
Type 1	Class 1	Regular motor vehicle roads	1.0
		Smaller motor vehicle roads	0.5
	Class 2	Regular motor vehicle roads	1.0
		Smaller motor vehicle roads	0.5
Class 3 and 4	Regular motor vehicle roads	0.75	
	Smaller motor vehicle roads	0.5	
Type 2	Regular motor vehicle roads	0.75	
	Smaller motor vehicle roads	0.5	
Type 3		0.5	0.5
Type 4		0.25	0.5

e: Width of the shoulder connected with the carriageway (for shoulders where on-street facilities are provided, shoulder width minus value required for on-street facilities).

**Fig. 2 (omitted)**

**(Design Speed)**

**Article 13**

1. Design speed on roads, except for service roads, shall be the values listed in the left column of the following table, in accordance with road classification, except where topographical conditions or any other reasons do not permit such provisions. Design speed on roads may be the values listed in the right column of the same table when dealing with these exceptions, however this does not apply to Type 1 Class 4 roads that are national expressways.
2. Design speed on the service roads shall be 40km, 30km, or 20km per hour.

Classification		Design Speed (km/h)	
Type1	Class 1	120	100
	Class 2	100	80
	Class 3	80	60
	Class 4	60	50
Type2	Class 1	80	60
	Class 2	60	50 or 40
Type3	Class 1	80	60
	Class 2	60	50 or 40
	Class 3	60,50 or 40	30
	Class 4	50,40 or 30	20
	Class 5	40,30 or 20	
Type4	Class 1	60	50 or 40
	Class 2	60,50 or 40	30
	Class 3	50,40 or 30	20



**(Carriageway Bend Section)**

**Article 14**

Carriageway bend sections shall be curved in shape, except for transition sections, (hereinafter indicating certain sections, provided at the carriageway bend sections, that allow for smooth vehicle

traffic) or bend sections provided pursuant to the provision of Article 31.2.

**(Radius of Curve)**

**Article 15**

Radii of curve at the centerline of the carriageway (hereinafter referred to as "radius of curve"), except for transition sections, (hereinafter referred to as "carriageway curve section") shall not be less than the values as listed in the left column of the following table according to design speed, except when unavoidable due to, for example, topographical reasons, in which case the radii of curve may be reduced to the values as listed in the right column of the same table.

Design Speed (km/h)	Radius of Curve (m)	
	Standard	Reduced
120	710	570
100	460	380
80	280	230
60	150	120
50	100	80
40	60	50
30	30	
20	15	

**(Super-elevation at Curve Section)**

**Article 16**

Appropriate super-elevation with no more than the values as listed in the right column of the following table (6% for Type 3 roads without bicycle track) shall be provided on curves of the carriageway, the center strip (except for median), and the shoulder connected with the carriageway, according to road classification and degree of snow fall or cold climate in the areas where the roads are located, in consideration of design speed, radii of curve, and topographical conditions, unless the radius of the curve is too large, except for Type 4 roads which can be omitted in such unavoidable cases as topographical conditions or any other reasons.

Classification	Area Where Road is Located		Maximum Super-elevation (%)
	Snowy or Cold Area	Other Areas	
Type 1,2 and 3	Snowy or Cold Area	Severely Snowy or Cold Area	6
		Other Areas	8
	Other Areas		10
Type4			6

**(Widening Lane at Curve Section)**

**Article 17**

The lane width on carriageway curve sections (or carriageway width in the case of roads without lanes) shall be appropriately widened

except for Type 2 and 4 roads, where topographical conditions or any other reasons do not permit such provisions.

**(Transition Section)**

**Article 18**

1. Transition sections shall be provided on carriageway bend sections for Type 4 roads where topographical conditions or any other reasons do not permit such provisions.
2. When a curved section is widened and/or provided with super-elevation, a runoff for this widening and/or super-elevation shall be completed in the transition section.
3. The transition curve length shall not be less than the right side value as listed in the following table according to design speed (or length required for runoff when length required for runoff as specified in Section above exceeds values as listed in the same column).

Design Speed (km/h)	Transition Section Length (m)
120	100
100	85
80	70
60	50
50	40
40	35
30	25
20	20

**(Sight Distance)**

**Article 19**

1. Sight distance shall not be less than the values below, as listed in the following table according to design speed.
2. For roads with two lanes (except for one-way roads), sufficient sections of oncoming highway visible to the driver shall be provided for overtaking.

Design Speed (km/h)	Transition Section Length (m)
120	210
100	160
80	110
60	75
50	55
40	40
30	30
20	20

**(Grade)**

**Article 20**

Carriageway grades shall be no more than the values listed in the left grade column of the following table according to road classification and design speed, except where topographical

conditions or any other reasons do not permit such provisions; in such cases the values of the grade may be reduced to the values listed in the right grade column of the same table.

Classification	Design Speed (km/h)	Grade (%)		
		Standard	Reduced	
Type 1, Type 2 & Type3	Regular motor vehicle roads	120	2	5
		100	3	6
		80	4	7
		60	5	8
		50	6	9
		40	7	10
	Smaller motor vehicle roads	30	8	11
		20	9	12
		120	4	5
		100		6
		80	7	
		60	8	
50	9			
Type 4	Regular motor vehicle roads	40	10	
		30	11	
		20	12	
		60	5	7
		50	6	8
		40	7	9
	Smaller motor vehicle roads	30	8	10
		20	9	11
		60	8	
		50	9	
		40	10	
		30	11	
	20	12		

**(Climbing Lane)**

**Article 21**

1. A climbing lane, if necessary, shall be provided to the carriageway of the regular motor vehicle roads where grades exceed 5% (or 3% when the design speed is no less than 100

- km per hour on other regular motor vehicle roads than national expressways and national highways).
2. The climbing lane width shall be 3m.

**(Vertical Curve)**

**Article 22**

1. Vertical curves shall be provided where grades change on the carriageway.
2. Radii of vertical curves shall be more than the values listed in the radius of vertical curve column of the following table according to design speed and Types of vertical curves, except when the radii of crest vertical curves on Type 4 Class 1 roads, when design

- speed is 60km per hour, the radii shall be reduced to 1,000m, where topographical conditions or any other reasons do not permit such provisions.
3. Vertical curve lengths shall be more than the values listed in the below right column of the following table according to design speed.

Design Speed (km/h)	Type of Vertical Curve	Radius of Vertical Curve(m)
120	Crest	11,000
	Sag	4,000
100	Crest	65,00
	Sag	3,000
80	Crest	3,000
	Sag	2,000
60	Crest	1,400
	Sag	1,000
50	Crest	65,00
	Sag	800
40	Crest	700
	Sag	450
30	Crest	250
	Sag	250
20	Crest	100
	Sag	100

Design Speed (km/h)	Vertical Curve Length(m)
120	100
100	85
80	70
60	50
50	40
40	35
30	25
20	20

**(Pavement)**

**Article 23**

1. Carriageways, center strips (except for median), shoulders connected with carriageways, bicycle tracks and sidewalks shall be paved except in unavoidable cases, such as extremely small traffic volume.
2. The pavement of carriageways and marginal strips shall be constructed so that safe and smooth vehicle traffic can be ensured on the basis of the design wheel load of 49 kN, in consideration of designed daily volume, vehicle weight, subgrade conditions, and meteorological conditions and that shall meet the standards laid down in the Ordinance of Ministry of Land,

- Infrastructure, Transport and Tourism, except in the case of small vehicle traffic volume or any other unavoidable conditions.
3. Type 4 roads (except for tunnels) shall be constructed so that it shall be capable of causing storm water to permeate smoothly under the road surfaces and reducing the traffic noise level, in consideration of the land uses and vehicle traffic conditions in the area where the roads are located or along them, except where road structure, meteorological conditions or other special reasons do not permit such provisions.

**(Cross Slope)**

**Article 24**

1. Cross slopes shall be provided to the carriageway, center strip (except for median) and shoulder connected with the carriageway according to road surface Type and the right side values as listed in the following table unless super-elevation is provided.
2. 2% of cross slope as a standard shall be provided to sidewalks and bicycle tracks.
3. The paved road of the structure specified in paragraph 3 of the previous Article may dispense with or reduce cross slope, if proper road surface drainage can be ensured in consideration of meteorological conditions.

Road Surface Type	Cross Slope (%)
Paved Road Complying with Standards Specified in Article 23.2	1.5-2
Others	3-5

**(Compound Grade)**

**Article 25**

1. Compound Grades (hereinafter indicating combination of vertical grade and super-elevation or cross slope) shall be no more than the right side values as listed in the following table according to design speed, except for roads with design speed of 30km/h or 20km/h where compound grades may be 12.5% in unavoidable cases, such as topographical conditions or any other reasons.
2. Compound grades shall be not more than 8% on those roads located in severely snowy or cold areas.

Design Speed (km/h)	Compound Grade (%)
120	10
100	
80	
60	10.5
50	
40	11.5
30	
20	

**(Drainage Facility)**

**Article 26**

Gutter, gully, or other drainage facilities shall be provided to roads if necessary.

**(At-grade Intersection or Connection)**

**Article 27**

1. An intersection shall be designed so as to contain no more than five intersecting legs, except when it is located in a special place such as in front of a station.
2. At an intersection where two or more roads join or intersect at grade, if necessary, a turning lane, speed change lane, or island shall be provided, and corners of intersection shall be cut, and unobstructed sight shall be ensured.
3. Where the turning lane or speed change lane is provided, lane width (except for the turning lane or speed change lane) of the

- related section may be reduced to 3m for Type 4 Class 1 regular motor vehicle roads or to 2.75m for Type 4 Class 2 or 3 regular motor vehicle roads or to 2.5m for Type 4 smaller motor vehicle roads.
4. The standard width of turning and speed change lanes shall be 3m for regular motor vehicle roads and 2.5m for smaller motor vehicle roads.
5. Where a turning or speed change lane is provided, proper runoff shall be provided according to design speed.

**(Grade Separation)**

**Article 28**

1. When two regular motor vehicle roads having four or more lanes intersecting mutually, excluding climbing lanes, turning lanes and speed change lanes, the intersection shall be separated by grades as a rule, except when the grade separation is unsuitable due to traffic conditions or in an unavoidable case such as a topographical reason.
2. When a smaller motor vehicle road with four or more lanes (except for turning lanes and speed change lanes) crosses

- another smaller motor or a regular motor vehicle road, the intersection shall be separated by grades.
3. Where the grade separation is provided, a road linking intersecting roads mutually (hereinafter referred to as a "ramp" ) shall be provided if necessary.
4. Provisions of Articles 5 through 8, Article 12, Article 13, Article 15, Article 16, Articles 18 through 20, Articles 22 and 25 shall not be applied to the ramp.

**(At-grade Intersection with Railway)**

**Article 29**

When a road intersects at a grade with a railway or street railway newly constructed in accordance with the Street Railway Act (Act No.76 1921) (hereinafter referred to as a "railway" ), the road shall be so constructed as specified below.

1. Intersection angles shall be not less than 45 degrees.
2. Sections 30m from both ends of railroad crossing and the railroad crossing section shall be straight and vertical carriageways, grades for these sections shall be less than 2.5%, except where there is extremely small vehicle traffic volume or topographical

- conditions or any other reasons do not permit such provisions.
3. A visible distance, distance from the intersection point of the railway end track centerline and the carriageway centerline to the point on the track centerline visible at the height of 1.2m at point 5m on the carriageway centerline from the track, shall not be less than the values listed in the following table, except for where a crossing gate or other security facilities are provided or with smaller vehicle traffic volume and fewer passing trains.

Maximum Train Speed at Railroad Crossing (km/h)	Visible Distance (m)
Less than 50	110
50-70	160
70-80	200
80-90	230
90-100	260
100-110	300
More than 110	350

**(Turnout)**

**Article 30**

Turnout shall be provided on Type 3 Class 5 roads as specified below, except for on roads where smooth traffic can be ensured.

1. Distance between two turnouts shall be within 300m.
2. Roads between two turnouts shall be visible from one of these

- turnouts.
3. The length shall be more than 20m and the total width of the carriageway shall be more than 5m.

**(Traffic Safety Device)**

**Article 31**

When it is necessary for traffic accident prevention, the pedestrian crossing bridge, fence, lighting, safety post, emergency notification facility, and other similar facilities, as specified by the Land,

Infrastructure and Transport Ministry's Ordinances, shall be provided.

**(Protrusions, Narrow Passes, etc.)**

**Article 31.2**

When it is necessary for slowing down vehicles, to ensure safe pedestrian or bicycle traffic, protrusions shall be provided on the surface of the carriageway or on the shoulders connecting to the

carriageway, or narrow passes or bend sections shall be provided on the carriageway, on Type 3 Class 5 roads intended primarily for use by nearby residents.

**(Islands Provided at Bus Bays)**

**Article 31.3**

Islands shall be provided as necessary at bus bays or streetcar stops that do not connect to bicycle tracks, bicycle/pedestrian tracks

or sidewalks.

**(Automobile Parking Lot)**

**Article 32**

Automobile parking lots, bicycle parking lots, bus bays, emergency parking basis or other similar facilities specified by the Land, Infrastructure and Transport Ministry's Ordinances shall be

provided, if necessary, to ensure safe and smooth traffic or to contribute to public convenience.

**(Snow Protection Facility and Other Protector)**

**Article 33**

1. Where an avalanche, blizzard, snowfall or other meteorological events could prevent smooth traffic, snow shed, drain for snow removal, snow melting facilities or other facilities shall be provided as specified by the Land, Infrastructure and Transport

- Ministry's Ordinances.
2. Unless specified above, a fence, retaining wall, and other proper protectors shall be installed where falling stone, slope failure, billow, etc. could prevent traffic or damage road structure.

**(Tunnel)**

**Article 34**

1. To ensure safe and smooth traffic, proper ventilation facilities shall be provided in the tunnel when required in consideration of designed daily volume and tunnel length on the road.
2. When required for safe and smooth traffic, proper lighting shall be provided in the tunnel in consideration of design speed.

3. When a vehicle fire or other accidents in the tunnel could cause risks to traffic, the communication facilities, warning facilities, firefighting facilities and other emergency facilities shall be provided in the tunnel if necessary.

**(Bridge and Viaduct)**

**Article 35**

1. Bridges, viaducts, or other similar roads shall be steel or concrete structure or the equivalent.
2. Design vehicle load for bridges, viaducts, and other similar regular motor vehicle roads shall be 245kN. The structures of said bridges, viaducts, and other similar regular motor vehicle roads shall secure safe traffic in view of large-sized vehicle traffic conditions for these roads.
3. Design vehicle load for bridges, viaducts, and other similar smaller motor vehicle roads shall be 30kN. The structures of said

- bridges, viaducts, and other similar smaller motor vehicle roads shall secure safe traffic in view of smaller vehicle traffic conditions for these roads.
4. In addition to the requirements in the three previous paragraphs, necessary matters regarding construction standards for bridges, viaducts, or other similar roads shall be specified by the Ordinances of the Ministry of Land, Infrastructure, Transport and Tourism.

**(Exception to Accessory Work)**

**Article 36**

After a case is identified in which road work executed on others roads or work other than road work is executed and determined to be influencing roads, provisions from Articles 4 to 35 (except for

Article 8, Article 13, Article 14, Article 24, Article 26, Article 31 and Article 33) may be exempted from application after it is approved that the case is not subject to these requirements.

**(Exception to Change of Road Classification)**

**Article 37**

When classification, as specified in Article 3.2, is changed by plans as to change a part of national highways to prefectural or municipal roads, classification following the change shall result in applying requirements of Article 3.4, Article 3.5, Article 4, Article 5, Article 6.1, Article 6.4, Article 6.6, Article 8.2 through 8.6, Article 8.9, Article 8.11, Article 9.1, Article 10.2.3, Article 11.1, Article 11.2, Article 11.4, Article 11.4.1, Article 12, Article 13.1, Article 16, Article 17, Article 18.1, Article 20, Article 22.2, Article 23.3, Article 27.3, Article 30 and Article 31.2. In this case, "Type 3 Class 5 roads" in proviso of Article 5.1, Article 5.5, proviso of Article 10.2.3, proviso of Article

11.4 and Article 12 shall be read as "Type 3 Class 5 or Type 4 Class 4 roads". "Type 3 Class 5 roads" in Article 5.3 shall be read as "Type 3 Class 5 and Type 4 Class 4 roads". "Type 4 roads" in Article 9.1 and Article 11.1 shall be read as "Type 4 (except for Class 4)". "Type 3" in these paragraphs shall be read as "Type 3 or Type 4 Class 4". "Type 3" in Article 11.2 shall be read as "Type 3 or Type 4 Class 4". "Values listed in the top column" in Article 13.1 shall be read as "Values listed in the top column (for Type 4 Class 4 roads, 40km/h, 30km/h or 20km/h)". "Mainly" in Article 31.2 shall be read as "Type 4 Class 4 roads or mainly".

**(Exception to Reconstruction of Short Section)**

**Article 38**

1. When a short section on roads that severely prevents traffic is reconstructed as an emergency measure, except for reconstruction as listed in the following requirements, this section may be exempted from application of Article 5, Article 6.4 through Article 6.6, Article 7, Article 9, Article 9.2, Article 10.3, Article 10.2.2, Article 10.2.3, Article 11.3, Article 11.4, Article 11.4.2, Article 11.4.3, Article 15 through Article 22, Article 23.3, and Article 25, if it is approved that the road structure of sections adjacent to this section do not satisfy these requirements.

2. When a short section of roads that severely impact safety is reconstructed as an emergency measure, this section shall be exempt from application of Article 5, Article 6.4 through Article 6.6, Article 7, Article 8.2, Article 9, Article 9.2, Article 10.3, Article 10.2.2, Article 10.2.3, Article 11.3, Article 11.4, Article 11.4.2, Article 11.4.3, Article 19.1, Article 21.2, Article 23.3, Article 39.1, Article 39.2, and Article 40.1, if it is determined in consideration of road conditions that it is not proper to apply these requirements.

**(Bicycle Path and Bicycle/Pedestrian Path)**

**Article 39**

1. Bicycle path width shall be not less than 3m, while bicycle/pedestrian path width shall be no less than 4m. However, where topographical conditions or any other reasons do not permit such provisions, bicycle path width can be reduced to 2.5m.
2. Lateral clearances wider than 0.5m shall be provided to both sides of bicycle paths or bicycle/pedestrian paths as a part of the roads.
3. Where on-street facilities are provided on bicycle tracks or bicycle/pedestrian tracks, width of these tracks shall be determined in consideration of clearances as specified in the following provision.
4. Bicycle path and bicycle/pedestrian path clearances shall be in accordance with the following figure.
5. Alignment, grade, and other features of bicycle paths and bicycle/pedestrian paths shall be determined so as to ensure safe and smooth bicycle and pedestrian traffic.
6. Requirements of Article 3 through 37 and Section 1 of the preceding Article (excluding Article 1 1.2 for bicycle/pedestrian path) shall not be applied to bicycle paths and bicycle/pedestrian paths.

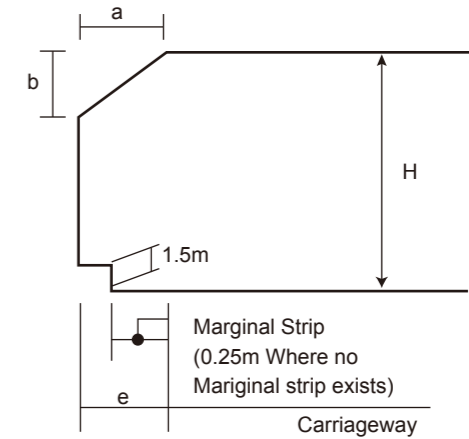
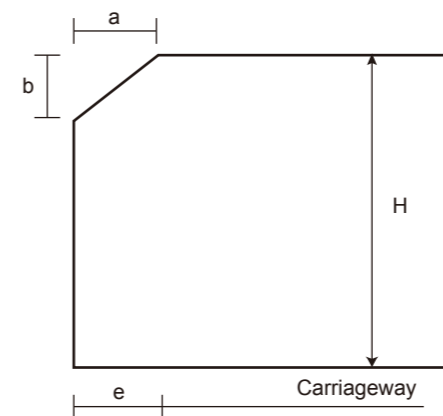
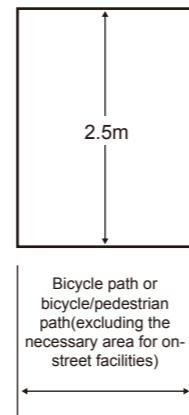

**(Pedestrian Path)**

**Article 40**

1. Pedestrian path width shall be not less than 2m in consideration of pedestrian traffic conditions and areas where the track is located, except where topographical conditions or other reasons do not permit such provisions, in which case the width can be reduced to 1m.
2. Where on-street facilities are provided on pedestrian paths, width shall be determined in consideration of clearances as specified in the following provision.
3. Pedestrian path clearances shall be in accordance with the following figure.
4. Alignment, grade and other features of pedestrian paths shall be determined so as to ensure safe and smooth pedestrian traffic.
5. Requirements of Articles 3 through 11, Article 11.3 through 37 and Section 1 of Article 38 shall not be applied to pedestrian paths.

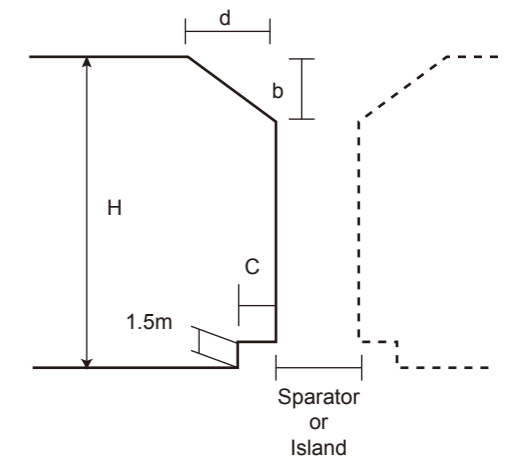
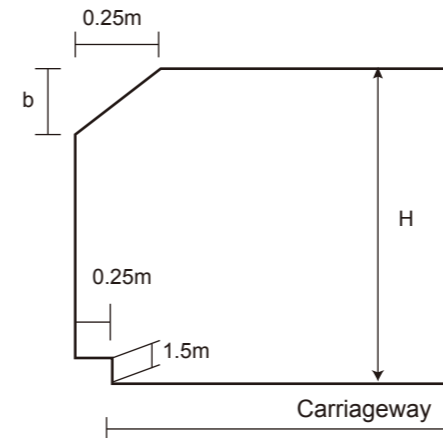
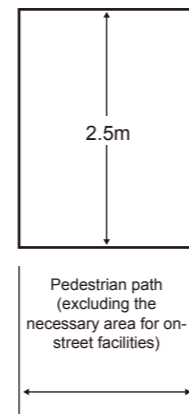

**(General technical standards for structure of prefectural and municipal roads)**

**Article 41**

1. The provisions of Article 4, 12, 35.2, 35.3, 35.4 (limited to the matters listed in Article 30.1.12), 39.4, and 40.3 shall apply mutatis mutandis to general technical standards for the structure of prefectural or municipal roads when these roads are newly constructed or reconstructed. In this case, "Type 3 Class 5" in Article 12 shall be read as "Type 3 Class 5 or Type 4 Class 4".
2. The provisions of Article 5 through Article 11.4, Article 13 through 34, Article 35.1 and 35.4 (except for the provisions listed in Article 30.1.12), Article 36 through 38, Article 39.1 through 39.3, Article 39.5 and 39.6, Article 40.1, 40.2, 40.4, and 40.5 shall apply mutatis mutandis to the standard specified in Article 30.3. In this case, "Type 3 Class 5 roads" in proviso of Article 5.1, Article 5.5, proviso of Article 10.2.3, and proviso of Article 11.4 shall be read as "Type 3 Class 5 or Type 4 Class 4 roads". "Type

3. "Class 5 roads" in Article 5.3 shall be read as "Type 3 Class 5 and Type 4 Class 4 roads". "Type 4 roads" in Article 9.1 and Article 11.1 shall be read as "Type 4 (except for Class 4)". "Type 3" in these paragraphs shall be read as "Type 3 or Type 4 Class 4". "Type 3" in Article 11.2 shall be read as "Type 3 or Type 4 Class 4". "Values listed in the left column" in Article 13.1 shall be read as "Values listed in the left column (for Type 4 Class 4 roads 40km/h, 30km/h or 20km/h)". "Primarily for use" in Article 31.2 shall be read as "Primarily for Type 4 Class 4 roads or use". In Article 37 "National highways" shall be read as "prefectural roads", "prefectural roads or municipal roads" and "other roads" shall be read as "municipal roads", "subject part" shall be read as "subject prefectural roads".

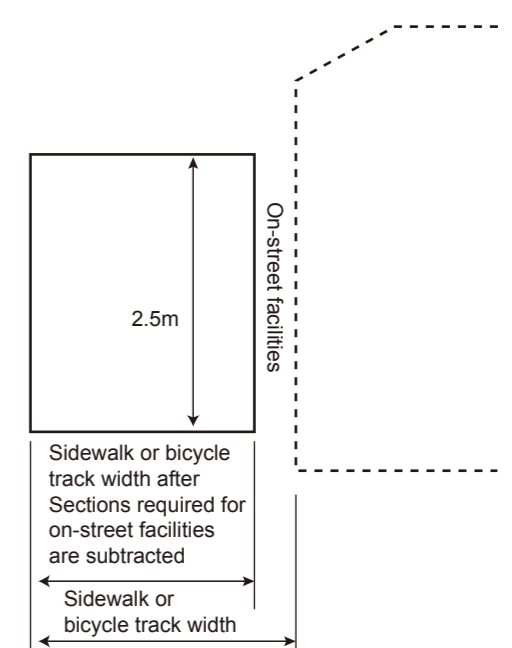
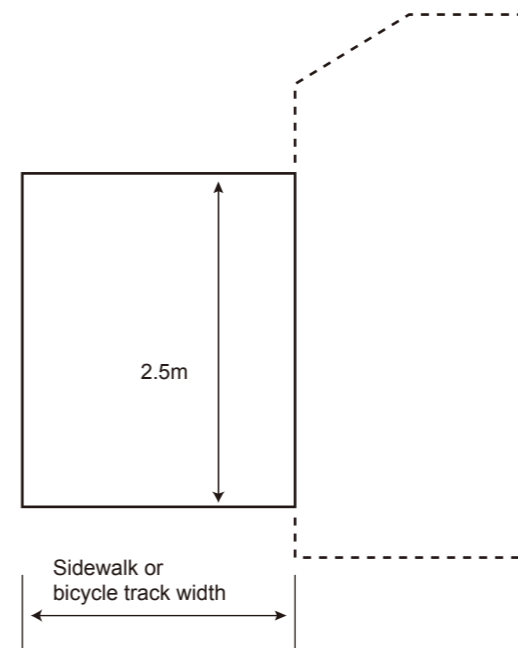

# Statistics

## Road Statistics of Japan

### Road Length by Category (April 1, 2012)

Category	Unit : km
Motorways	8,050
Highways, Main or National Roads	51,237
Secondary or Regional Roads	91,440
Other Roads	190,782
<b>Total</b>	<b>341,509</b>

• Roads less than 5.5m in width have been excluded from the statistics.  
 (Source: Road Statistics Annual Report [Douro Toukei Nenpo] 2012, Road Bureau, MLIT)

### Vehicle Traffic Volume (2011)

Vehicle type	Million vehicle km
Passenger cars	499,037
Buses & Motor coaches	6,124
Vans, pick-ups, lorries, road tractors	196,821
<b>Total</b>	<b>701,982</b>

• Since 2010, survey and calculation methods for road traffic have been changed, so the data do not match the previous data.  
 • Due to Great East Japan Earthquake, traffic for March of FY2010 (2010.4-2011.3) in Hokkaido and Tohoku Regions are not included in 2010 figures.  
 (Source: Transport-related Statistics Data [Kotsu Kanren Toukei Shiryoshu], Policy Bureau, MLIT)

### Freight Transport (2011)

Modes	Unit: million ton-km/year
Road	231,061
Rail	19,998
Inland Waterway	174,900
<b>Total</b>	<b>425,959</b>

### Passengers Transport (2009)

Modes	Unit: million passenger-km/year
Road, public transport	81,360
Road, private transport	817,361
Rail	393,765
<b>Total</b>	<b>1,292,486</b>

• Since 2010, survey and calculation methods for road traffic have been changed, so the data do not match the previous data.  
 Private passenger car and private truck were excluded from the survey.  
 • Due to Great East Japan Earthquake, traffic for March of FY2010 (2010.4-2011.3) in Hokkaido and Tohoku Regions are not included in 2010 figures.  
 (Source: Transport-related Statistics Data [Kotsu Kanren Toukei Shiryoshu], Policy Bureau, MLIT)

### Vehicles in Use (Mar. 31, 2012)

Vehicle type	Unit: vehicles
Passenger cars	59,357,223
Buses & Motor coaches	226,047
Vans, pick-ups, lorries, road tractors	16,506,405
<b>Total</b>	<b>76,089,675</b>
(Reference) Motorcycles & Mopeds	3,535,528

(Source: Automobile Inspection & Registration Information Association website)

### Road Accidents (2012)

	Unit: accidents, or persons
Number of Injury Accidents	665,138
Number of Persons Injured	825,396
Number of Persons Killed	5,237

(Source: Traffic Accidents Situation, and Number of Fatalities within 30 days from the Time of Accident, National Police Agency)

### Road Expenditure (2011)

	Unit: million yen
Gross investment	3,974,213
Maintenance expenditures	1,740,214
<b>Total</b>	<b>5,714,427</b>

• Expenditures for toll roads are excluded.  
 (Source: Road Statistics Annual Report [Douro Toukei Nenpo] 2012, Road Bureau, MLIT)

## Change in Investment in the Five-Year Road Development Program

The Five-Year Road Development Plans	General Road Projects		Toll Road Projects		Unsubsidized Local Road Projects		Total ¥ billions
	Investment ¥ billions	Ratio %	Investment ¥ billions	Ratio %	Investment ¥ billions	Ratio %	
1st Plan (A)	260.0	100.0	-	-	-	-	260.0
FY1954-57 (a)	182.1	59.0	146.0	4.7	111.9	36.3	308.6
a/A (%)	70.0	-	-	-	-	-	-
2nd Plan (B)	610.0	61.0	200.0	20.0	190.0	19.0	1,000.0
FY1958-60 (b)	322.2	61.3	51.0	9.7	152.1	29.0	525.2
b/B (%)	52.8	-	25.5	-	80.0	-	52.5
3rd Plan (C)	1,300.0	61.9	450.0	21.4	350.0	16.7	2,100.0
FY1960-63 (c)	722.2	57.7	225.5	18.0	304.5	24.3	1,252.2
c/C (%)	55.6	-	50.1	-	87.0	-	59.6
4th Plan (D)	2,200.0	53.7	1,100.0	26.8	800.0	19.5	4,100.0
FY1964-66 (d)	1,244.1	56.8	443.2	20.2	502.3	23.0	2,189.6
d/D (%)	56.6	-	40.3	-	62.8	-	53.4
5th Plan (E)	3,550.0	53.8	1,800.0	27.3	1,100.0	16.6	1) 6600
FY1967-69 (e)	1,795.6	51.9	753.5	21.7	912.7	26.4	3,461.8
e/E (%)	50.6	-	41.9	-	83.0	-	52.5
6th Plan (F)	5,200.0	50.2	2,500.0	24.2	2,550.0	24.6	2) 10300
FY1970-72 (f)	3,108.0	49.9	1,317.9	21.2	1,786.3	28.8	9) 6223.5
f/F (%)	59.8	-	52.7	-	70.1	-	60.1
7th Plan (G)	9,340.0	47.9	4,960.0	25.4	4,700.0	24.1	3) 19500
FY1973-77 (g)	7,757.8	47.3	3,960.8	24.1	4,693.9	28.6	16,412.5
g/G (%)	83.1	-	79.9	-	99.9	-	84.2
8th Plan (H)	13,500.0	47.4	6,800.0	23.9	7,500.0	26.3	4) 28500
FY1978-82 (h)	12,947.9	45.0	6,614.5	23.0	9,231.4	32.0	28,793.8
h/H (%)	95.9	-	97.3	-	123.1	-	101.0
9th Plan (I)	16,000.0	41.9	9,200.0	24.1	11,700.0	30.6	5) 38200
FY1983-87 (i)	15,926.5	43.1	9,740.3	26.4	11,252.7	30.5	36,919.4
i/I (%)	99.5	-	105.9	-	96.2	-	96.6
10th Plan (J)	23,800.0	44.9	14,000.0	26.4	13,900.0	26.2	6) 53000
FY1988-92 (j)	22,637.6	41.1	14,238.7	25.9	18,164.3	33.0	55,040.6
j/J (%)	9.1	-	101.7	-	130.7	-	103.9
11th Plan (K)	28,800.0	37.9	20,600.0	27.1	25,200.0	33.2	7) 76000
FY1993-97 (k)	28,627.4	39.9	17,703.6	24.7	25,476.2	35.5	71,807.2
k/K (%)	99.4	-	85.9	-	101.1	-	94.5
12th Plan (L)	29,200.0	37.4	17,000.0	21.8	26,800.0	34.4	8) 78000
FY1998-02 (l)	31,729.0	48.6	13,431.2	20.6	20,155.4	30.9	65,315.6
l/L (%)	108.7	-	79.0	-	75.2	-	83.7