

UNCLASSIFIED

AD NUMBER

AD394812

CLASSIFICATION CHANGES

TO: unclassified

FROM: confidential

LIMITATION CHANGES

TO:
Approved for public release, distribution unlimited

FROM:
Distribution authorized to U.S. Gov't. agencies and their contractors; Administrative/Operational Use; 18 AUG 1968. Other requests shall be referred to Army Chief of Staff for Force Development, Washington, DC 20310.

AUTHORITY

OAG D/A ltr 29 Apr 1980; OAG D/A ltr 29 Apr 1980

THIS PAGE IS UNCLASSIFIED

**GENERAL
DECLASSIFICATION
SCHEDULE**

**IN ACCORDANCE WITH
DOD 5200.1-R & EXECUTIVE ORDER 11652**

SECURITY

MARKING

The classified or limited status of this report applies to each page, unless otherwise marked.
Separate page printouts MUST be marked accordingly.

THIS DOCUMENT CONTAINS INFORMATION AFFECTING THE NATIONAL DEFENSE OF THE UNITED STATES WITHIN THE MEANING OF THE ESPIONAGE LAWS, TITLE 18, U.S.C., SECTIONS 793 AND 794. THE TRANSMISSION OR THE REVELATION OF ITS CONTENTS IN ANY MANNER TO AN UNAUTHORIZED PERSON IS PROHIBITED BY LAW.

NOTICE: When government or other drawings, specifications or other data are used for any purpose other than in connection with a definitely related government procurement operation, the U.S. Government thereby incurs no responsibility, nor any obligation whatsoever; and the fact that the Government may have formulated, furnished, or in any way supplied the said drawings, specifications, or other data is not to be regarded by implication or otherwise as in any manner licensing the holder or any other person or corporation, or conveying any rights or permission to manufacture, use or sell any patented invention that may in any way be related thereto.

CONFIDENTIAL

**DEPARTMENT OF THE ARMY
OFFICE OF THE ADJUTANT GENERAL
WASHINGTON, D.C. 20310**



IN REPLY REFER TO

AD394812

AGAM-P (M)(11 Dec 68) FOR OT UT 683153 23 December 1968

SUBJECT: Operational Report - Lessons Learned, Headquarters, 4th
Infantry Division, Period Ending 31 July 68 (U)

SEE DISTRIBUTION

1. Subject report is forwarded for review and evaluation in accordance with paragraph 5b, AR 525-15. Evaluations and corrective actions should be reported to ACSFOR OT UT, Operational Reports Branch, within 90 days of receipt of covering letter.
2. Information contained in this report is provided to insure that the Army realizes current benefits from lessons learned during recent operations.
3. To insure that the information provided through the Lessons Learned Program is readily available on a continuous basis, a cumulative Lessons Learned Index containing alphabetical listings of items appearing in the reports is compiled and distributed periodically. Recipients of the attached report are encouraged to recommend items from it for inclusion in the Index by completing and returning the self-addressed form provided at the end of this report.

BY ORDER OF THE SECRETARY OF THE ARMY:

Kenneth G. Wickham

KENNETH G. WICKHAM
Major General, USA
The Adjutant General

1 Incl
as

DISTRIBUTION:

Commanding Generals
US Continental Army Command
US Army Combat Developments Command
Commandants
US Army War College
US Army Command and General Staff College
US Army Adjutant General School
US Army Air Defense School
US Army Armor School
US Army Artillery and Missile School
US Army Aviation School

Regraded unclassified when separated
from classified inclosure.

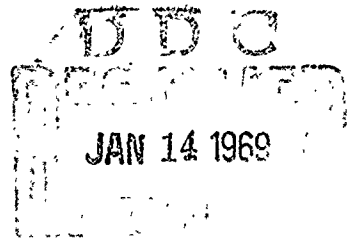

"This document contains information affecting the National Defense of the United States within the meaning of the Espionage Laws, Title 18, U.S.C., Sections 793 and 794. Its transmission or the revelation of its contents in any manner to an unauthorized person is prohibited by law."

CONFIDENTIAL

DISTRIBUTION (Cont'd)

- US Army Chemical School
- US Army Civil Affairs School
- US Army Engineer School
- US Army Infantry School
- US Army Intelligence School
- US Army Medical Field Service School
- US Army Military Police School
- US Army Missile and Munitions School
- US Army Ordnance School
- US Army Quartermaster School
- US Army Security Agency School
- US Army Signal School
- US Army Southeastern Signal School
- US Army Special Warfare School
- US Army Transportation School

Copies furnished:

- Office, Chief of Staff, US Army
- Deputy Chiefs of Staff
- Chief of Engineers
- Chief of Research and Development
- Assistant Chiefs of Staff
- The Surgeon General
- The Provost Marshal General
- Research Analysis Corporation
- OSD(SA), Assistant for Southeast Asia Forces
- Defense Documentation Center
- Security Officer, Hudson Institute
- Director Weapons Systems Evaluation Group
- USAF Air Ground Operations School
- Joint Action Control Office
- Commanding Generals
 - US Army Weapons Command
 - US Army Materiel Command
 - US Army Flight Training Center
 - US STRIKE Command
 - 4th Infantry Division
- Commanding Officers
 - US Army Limited War Laboratory
 - US Army Logistics, Doctrine Systems & Readiness Agency
 - US Army Aviation Test Activity
- Air University Library
- Army Representative, COMSEVENTHFLT

CONFIDENTIAL

DEPARTMENT OF THE ARMY
HEADQUARTERS 4TH INFANTRY DIVISION
APO San Francisco 96262

AVDDH-GC-MH

SUBJECT: Operational Report - Lessons Learned (RCS CSFOR-65) for
Quarterly Period Ending 31 July 1968 (U)

SECTION 1 (C) OPERATIONS: SIGNIFICANT ACTIVITIES

1. (C) General.

a. During the period covered by this report, the 4th Infantry Division continued its participation in Operation MAC ARTHUR. On 15 July the operation was renamed BINH TAY-MAC ARTHUR in keeping with the practice of conducting combined operations with ARVN and territorial units wherever possible.

b. Organizational Structure. Task organization for Operation BINH TAY-MAC ARTHUR for the period is contained at inclosure 1.

c. Key personnel. Commanders as of the end of the reporting period are listed at inclosure 2.

d. Mission.

(1) The general mission of the division at the end of the reporting period was to conduct surveillance and offensive operations and to provide maximum support to the Government of VIETNAM's Refugee Resettlement Program and the Revolutionary Development Program.

(2) The specific missions of the 4th Infantry Division are to:

(a) Conduct reconnaissance and surveillance of the CAMBODIAN Border and destroy enemy (NVA/VC) units within the assigned area of operations.

(b) Block enemy infiltration routes from CAMBODIA/LAOS across the highlands into the coastal provinces.

(c) Conduct spoiling attacks and ambush operations.

(d) Destroy enemy base areas and supply installations.

(e) Detect and eliminate VIET CONG infrastructure.

(f) Clear, secure and assist in the development of the Tactical Area of Responsibility.

(g) Support the Government of VIETNAM's EDAP ENANG Resettlement Program.

(h) Open, secure and maintain land lines of communication.

(i) Be prepared to deploy forces for the relief/reinforcement of Camp

FOR OT UT
683153
INCL 1

CONFIDENTIAL

DOWNGRADED AT 3 YEAR INTERVALS;
DECLASSIFIED AFTER 12 YEARS.
DOD DIR 5200.10

CONFIDENTIAL

AVDDH-GC-MH

18 August 1968

SUBJECT: Operational Report - Lessons Learned (RCS CSFOR-65) for
Quarterly Period Ending 31 July 1968 (U)

Strike Forces, Regional and Popular Forces, critical signal sites and sector/
subsector headquarters within II Corps Tactical Zone.

(j) Provide to I Field Force, VIETNAM, a battalion size reserve on order.

2. (C) Intelligence

a. General: At the beginning of the reporting period, the enemy posed a three divisional threat to friendly installations and units in KONTUM Province. The 1st NVA Division was deployed west of POLEI KLENG, where their drive toward POLEI KLENG and KONTUM City in late March had been stopped by the ring of 4th Infantry Division fire support bases established on the mountains dominating the approaches to the enemy objective. The 325C NVA Division had moved into the Tri-border (LAOS-CAMBODIA-VIETNAM) area in late April from KHE SANH, and was preparing to launch an offensive to take BEN HET and DAK TO. The 2nd NVA Division had moved from DANANG into LAOS border area north of DAK PEK in late April, and was preparing for attacks on Special Forces Camps.

During May and early June 1st NVA Division conducted heavy attacks by fire and small ground probes against the fire support bases west of POLEI KLENG with little success, while at the same time sustaining severe casualties from B-52 strikes and artillery. With casualties and supply shortages mounting, the 1st NVA Division withdrew into Base Area 702 in CAMBODIA in late June. In May and early June the 325C Division conducted several futile attacks on 4th Infantry Division fire support bases deployed around BEN HET. After suffering very heavy casualties from friendly fire power, which included numerous B-52 strikes, the 325C Division withdrew in mid-June to Base Area 609 in LAOS and CAMBODIA. In late May, the 2nd NVA Division overran two Special Forces Camps in I Corps, and moved into position to take DAK PEK. Rapid deployment of two US battalions into fire support bases between DAK PEK and the enemy forces, combined with concentrated B-52 strikes, forced the 2nd NVA Division to withdraw to the north.

After remaining in Base Area 702 until early July, the 1st NVA Division deployed south to DARLAC Province and began preparation for an attack on BAN ME THUOT to take place in early or mid-August.

Additional intelligence indicated that the 18B and 95th NVA Regiments would move from the coast across DARLAC to B-3 Front base areas in CAMBODIA during the latter part of July and remain there for three months to train and resupply. One battalion of each regiment was to remain on the coast for deception purposes. This movement was conducted, and at the end of the reporting period these units were in CAMBODIAN base areas west of DUC CO.

At the end of the reporting period, the 1st NVA Division was in position north and south of BAN ME THUOT, and constituted the major enemy threat in the Central Highlands. The 325C NVA Division remained in Base Area 609. The 2nd NVA Division which has moved away from the 4th Inf Div Area of Operations, is no longer considered an immediate threat.

INCL 1

2

CONFIDENTIAL

CONFIDENTIAL

AVDDH-GC-MH

18 August 1968

SUBJECT: Operational Report - Lessons Learned (RCS CSFOR-65) for
Quarterly Period Ending 31 July 1968 (U)

(1) KONTUM: A massive build-up of enemy forces characterized activity in KONTUM Province during early May. After the infiltration of enemy forces was completed by mid-May, friendly forces were opposed by the largest concentration of enemy units ever assembled in the Central Highlands.

After overrunning KHAM DUC Special Forces Camp, QUANG RIN Province, on 11 May, control elements of the 2nd NVA Division along with the 21st Regt moved south into the DAK PEK area of northern KONTUM. The enemy units arrived in the area west of DAK PEK SF Camp in late May and prepared positions from which they could launch offensive operations against the camp. The apparent mission of the unit was to overrun DAK PEK.

The 3250 NVA Div, with two well-equipped regiments, moved into the area west of BEN HET, and on 9 May overran a Camp Strike Force Co on Hill 990 just west of the BEN HET SF Camp. The ultimate objective of the division was to overrun the 1st Bde, 4th Infantry Division to seize DAK TO. PW's and HOI CHANHS indicated that the 3250 NVA Div would employ tanks and artillery during the forthcoming offensive.

To oppose the threat the 1st Bde, 4th Infantry Division established fire bases on the high ground surrounding the objectives and massed their fire-power against the known enemy positions. The 1st Bde was initially joined by the 3 Bde, 101st Abn on 26 May, however, because of the continued build-up in the DAK PEK area, the 3d Bde (-) was moved to the high ground west and north of DAK PEK on 28 May.

West of POLEI KLENG, the 1st NVA Div, with three regiments, the 174th 320th, and 66th, were completing preparations for their attempted breakthrough of 3d Bde, 4th Inf Div bases located on critical terrain surrounding the POLEI KLENG SF Camp. Once they had seized POLEI KLENG, the division would attempt to wrest KONTUM City from allied control.

The enemy offensive in the Highlands was in full swing by late May and continued to mid-June. In late May, the major contacts were enemy initiated.

The enemy's thrust in the DAK PEK and POLEI KLENG areas was characterized by intense attacks by fire. In late May fire base BRILLO PAD, west of POLEI KLENG, received 1100 rounds of incoming RR, mortar, and rocket fire in a 4 day period. Eighty-two recoilless guns and 140mm rockets were employed for the first time in the Highlands during the attacks by fire against installations in the DAK PEK area in late May and early June. These attacks were followed by assaults against the fire bases which resulted in moderate enemy casualties and light friendly losses.

The fiercest fighting took place west of BEN HET. On 26 May, Fire Support Base 29, just southwest of BEN HET, received an intense attack by fire and ground assault by an NVA Bn. This attack resulted in 150 confirmed enemy killed. US forces suffered light casualties. On 30 May, just northwest

CONFIDENTIAL

CONFIDENTIAL

AVDDH-CC-1H

18 August 1968

SUBJECT: Operational Report - Lessons Learned (RCS CSFOR-65) for
Quarterly Period Ending 31 July 1968 (U)

of BEN HET, a fire base on Hill 990 was hit by a battalion-sized unit resulting in 50 enemy killed and only light friendly losses. For the first time, the enemy employed 100mm guns and 105mm howitzers in the Central Highlands; however, the projected armor threat never materialized. By early June the enemy's drive had been blunted by superior allied firepower and airpower.

Two tactics, the control of the high ground and the extensive use of B-52 strikes, assured the US forces of the ultimate victory. Fire support bases were established along the key terrain surrounding the enemy's objectives. These fire bases were then covered by mutually supporting artillery. The NVA were thus forced to mass their forces in an attempt to break through the wall of fire bases. However, when they massed for the attack, an unprecedented number of B-52 strikes were unleashed on their positions. By the time the enemy's defeat was completed in mid-June, 178 B-52 strikes had been launched against them.

The withdrawal of enemy forces began in early June in the BEN HET area and ended by late June in the DAK PEK and POLEI KLENG area. The 325C Div, which had been hit the hardest, withdrew west into base area 609 in the tri-border area in early June. Since that period, enemy activity has been at low level in the BEN HET area. Small recon units from the 325C Div have conducted only minor harassing attacks, but a threat continues in the area as long as the 325C Div remains located in Base Area 609.

After failing in the DAK PEK area, the 21st Regt, 2nd NVA Div withdrew northwest into LAOS in mid-June and left behind platoon-size heavy weapons units to cover their withdrawal and conduct harassing attacks in the area. By late July indications were that the 21st Regt and 2nd NVA Div HQs had completely exfiltrated the area.

The pattern established in the DAK PEK and BEN HET areas was followed by the 1st NVA Div west of POLEI KLENG in late June. After being repulsed in their attacks on POLEI KLENG, the division began its movement southwest into base area 702 in CAMBODIA, leaving friendly forces in control of southwestern KONTUM Province. Since that time, there have been no indications of enemy movement back into the area. The major elements of the 1st NVA Div ultimately infiltrated into DARLAC Province.

The 24th NVA Regt had been operating north of KONTUM City. On 15 May almost an entire battalion of the 24th NVA Regt was annihilated during an assault on a Regional Force/Popular Force hamlet northeast of KONTUM City. In late June it withdrew to CAMBODIA, and probably then moved to DARLAC Province with the 1st NVA Div. During July, the KONTUM City area was extremely quiet with only 304 LF Bn and 406 Sapper Bn conducting mining operations and resupply missions in the area.

(2) PLEIKU: In late April, elements of the 6th Bn, 32nd, NVA Regt moved from the west, along the PLEIKU-KONTUM boundary, toward Highway 14N. The unit's

CONFIDENTIAL

CONFIDENTIAL

AVDDH-GC-MH

18 August 1968

SUBJECT: Operational Report - Lessons Learned (RCS CSFOR-65) for
Quarterly Period Ending 31 July 1968 (U)

mission was to interdict traffic, both supply convoys and security forces, moving from PLEIKU to KONTUM. During May, in attempting to accomplish this mission, the unit conducted harassment activities, mining, and two major ambushes. The 6th Bn lost 122 men killed in a 5 May attempted ambush about 28 km north of PLEIKU City, and another 15 killed on 26 May about 19 km north of the City. In both cases, north bound convoys were attacked. PW's from these contacts indicated that their unit, 6th Bn, 32nd Regt, has been guided, while moving into the province, by elements of the 95B Regt. One of the PW's stated the unit was moving to join the 95B Regt when it conducted the 5 May attack.

Documents captured in these contacts indicated that the unit's moral was very low. The commander's personal notes revealed that many of his cadre and men were new, lacking in experience, and that some of his equipment was inadequate for the mission. The 6th Bn, 32nd Regt failed in its mission of interdicting the highway. Armor and gunships proved too much of a challenge for the unit, which, no longer combat effective, dispersed into the high ground east of Highway 14. There were no identifications of any elements of the 6th Bn, 32nd Regt from late May through July.

In northwestern PLEIKU Province, an increase of river traffic and trail activity, from early to mid-May, revealed that enemy forces, probably elements of the 1st NVA Div, were moving into the area from southwestern KONTUM Province. Long Range Patrol contacts confirmed the presence of unidentified squad and company size enemy units. A subsequent decrease of activity in this region was followed in late June by an increased amount of low level reports and significant visual reconnaissance, revealing that unidentified enemy elements were entering the province from CAMBODIAN base areas west of PLEI DJERENG and northwest of DUC CO. LRP contacts with squad and company size NVA units, and concurrent minor incidents along Highway 14B, continued in the area until late July. The activity then decreased, having produced no major contacts or enemy unit identifications.

The enemy fired 122mm rockets into allied installations in the PLEIKU City area in early May and June, including 4th Infantry Division Base Camp, CAMP ENARI. In one of these attacks, which damaged two C-47's at PLEIKU Air Force Base, the enemy fired his rockets at about 1800 hours. All other attacks occurred between 2400 and 0200 hours. The enemy units involved were elements of the 31st Bn, 40th Artillery Regt. The 1st Co, 31st Bn, 40th Arty Regt was identified in a contact 18 km southwest of CAMP ENARI on 22 May. A PW stated that the 1st Co, equipped with four 122mm rocket launchers, was targeted against CAMP ENARI, while the 2nd Co had two 122mm launchers and was targeted against PLEIKU City. Documents captured on 30 May, 15 km northeast of PLEIKU City, identified the 31st Bn, 40th Arty Regt.

From May to July, harassing attacks and attacks by fire were conducted against the PLEIKU City area by elements of the 408th Sapper Bn. This unit, operating from the DE MANG area, 20 to 24 km northeast of PLEIKU

CONFIDENTIAL

CONFIDENTIAL

LDH-68-71

10 August 1968

Subject: Operational Report - Lessons Learned (RCS CSFOR-63) for
Quarterly Period Ending 31 July 1968 (U)

City, had the mission of destroying personnel and equipment at installations around the city. Throughout the period, the effectiveness of the attacks decreased since the 408th had not successfully rebuilt its ranks following the TET Offensive. Locally trained replacements led by inexperienced officers, combined with food shortages, produced low morale. The 408th Sapper Bn was last identified in an attack against bridge security elements 15 km east of PLEIKU City on 4 June. A PW captured in the attack identified himself as [redacted], 408th Sapper Bn.

Elements of a major enemy resupply route across southern PLEIKU Province were revealed by a contact with an NVA transportation company 7 km south of PLEI ME and by the discovery of three large ammunition caches 12 km north-east of PLEI ME in early June, as well as the discovery of five large rice caches, in late June, to 15 km southeast of PLEI DO LIM, along the DAK AYUNH River. Also, the discovery of a large cache of 60mm and 82mm mortar rounds 16 km east of PLEI DO LIM shows that the route was used for resupply, probably to elements of the 95B Regt in the DAK PAYAU Valley. Documents captured in a 1 June contact south of PLEI ME revealed that the transportation company was coordinating with the 95B Regt.

Elements of the 95B Regt occupied base areas in the southern DAK PAYAU Valley, south of Highway 19E. The 5th Bn, 95B Regt continued its mission of ambushing vehicular traffic along this highway. There was a total of 17 squad size ambushes during this period, from LE TRUNG District HQ to the Province boundary, in which the enemy employed small arms and RPG-2 fire.

The 5th Bn, 95B Regt was identified by a prisoner captured in a squad size ambush 38 km east of PLEIKU City in late June. The enemy also directed 75mm recoilless rifle and 60mm mortar fire against installations along the highway.

Friendly elements were deployed in the DAK PAYAU Valley in mid-June. Squad to platoon size mixed VMC and NVA units were met in sporadic contacts which continued through early July. As a result of these contacts, the 5th Bn, as well as the Engineer, Anti-Aircraft, and Medical Support Companies of the 95B Regt were identified. From mid to late July these elements remained in the lower DAK PAYAU Valley, reorganizing and reestablishing their base areas.

(3) DARLAC: At the beginning of the reporting period, the 32nd and 33rd NVA Regiments were located in Base Area 740 in CAMBODIA, where they had re-located in mid-April to conduct training and to resupply. The training consisted of hit and run tactics for use in attacking friendly outposts. The first action of the period took place on 6 May 68, when DUC LAF was attacked by the 5th Bn, 32nd Regt. The objective was to divert attention from the dispersal of the 32nd and 33rd Regiments to III Corps and probably to test the effectiveness of their recent training. The attack consisted of mortar and rocket bombardment of the DUC LAF Special Forces Camp and MACV sub-sector

CONFIDENTIAL

CONFIDENTIAL

AVDDH-GC-MH

16 August 1968

SUBJECT: Operational Report - Lessons Learned (RCS CSFOR-65) for
Quarterly Period Ending 31 July 1968 (U)

headquarters, with ground forces attacking the latter. The enemy suffered moderate casualties in the two days of battle in and around DUC IAP. The 5th Bn, 32nd Regt returned to Base Area 740 after the attack.

Enemy activity from mid-May to mid-July was at a low level in DARLAC Province. Enemy units known to be operating in the province were the E-301 and 401 Local Force Battalions with a combined strength of approximately 400 men. Activity was characterized by attacks by fire on friendly installations. The weapons employed in these attacks were 60mm and 82mm mortars, 75mm RR, and 122mm rockets. Minor contacts with VC/VMC units were also noted.

Enemy activity increased in mid-July when NVA company-size units were contacted during operations conducted by Special Forces. Elements of the 1st NVA Div were detected in mid-July moving forces into DARLAC. The 1st MA Div and the 66th NVA Regt were identified north of BAN ME THUOT by a VC agent named CHANH who returned on 21 July, by documents captured on 22 July, and by contacts during the last two weeks of July. Documents were captured on 15 and 27 July that identified the 2nd Co, K-39 Bn, which had been left behind by the 33rd Regt to provide infantry support for the rocket attacks on BAN ME THUOT. The E-301 LF Bn was again identified by documents captured on 26 July.

In late June documents captured by ROK forces on the coast revealed that the 18B and 95th NVA Regiments, 5th NVA Division, would move across DARLAC to B-3 Front base areas in CAMBODIA, where they would train and resupply for approximately three months. Each regiment was to cache their weapons before moving out, and a battalion from each regiment was to be left behind for deception purposes. In July these units moved across DARLAC, and at the end of the reporting period were training and resupplying in CAMBODIAN base areas west of DUC CO.

At the end of the reporting period, it became obvious, based on reports, sighting, and contacts with 1st NVA Div reconnaissance elements, that BAN ME THUOT was the objective of the 1st NVA Div. The first indication of the planned attack came from a VMC agent who penetrated a 4th Infantry Division IRP team and was captured on 17 July. This agent revealed that an attack on BAN ME THUOT was planned for 9 August. Further indication of this attack was provided by a PW from a local VC force, who was captured on 26 July. He stated that BAN ME THUOT would be attacked on 10 August. Units to participate in the attack are expected to be the 66th, 320th, and 24th Regiments. The attacks will reportedly come from the south, southeast and north. All indications are that the attacks will take place in early or mid-August.

CONFIDENTIAL

CONFIDENTIAL

AVDDH-GC-MH

18 August 1968

SUBJECT: Operational Report - Lessons Learned (RCS CSFOR-65) for
Quarterly Period Ending 31 July 1968 (U)

b. Estimated Enemy Composition, Disposition and strength on 31 July 1968.

<u>UNIT</u>	<u>CURRENT EST STR</u>	<u>LAST KNOWN LOCATION</u>
R-3 Front Hq	500	Tri-border area
3250 NVA Inf Div (HQ & SPT)	2200	Tri-border area
1010 NVA Inf Begt	1600	Tri-border area
950 NVA Inf Regt	1800	Tri-border area
1000 NVA Inf Div (HQ & SPT)	1415	CAMBODIA/DARLAC border
1000 NVA Inf Regt	1800	North of BAN ME THUOT
3200 NVA Inf Regt	1800	CAMBODIA/DARLAC border
2400 NVA Inf Regt	1800	South of BAN ME THUOT
950 NVA Inf Regt	900	E. PLEIKU Province
1000 NVA Arty Regt	1200	Tri-border area
180 NVA Inf Regt	1200	West of DUC CO
950 NVA Inf Regt	1000	West of DUC CO
H-15 LF VC Bn	200	E. PLEIKU Province
301st LF VC Bn	300	North of BAN ME THUOT
304th LF VC Bn	300	NW of KONTUM City
401st LF VC Bn	100	North of BAN ME THUOT
406th Sapper Bn	200	North of KONTUM City
407th Sapper Bn	250	PLEIKU/BINH DINH border
408th Sapper Bn	250	North of PLEIKU City
K-39 NVA Inf Bn	300	South of BAN ME THUOT

* VC's in tri-border area, 2 battalions in KONTUM Province, 1 battalion in PLEIKU Province, and 1 battalion in DARLAC Province.

c. Counterintelligence

During the reporting period, there was a significant increase in the identification of VIET CONG Infrastructure Personalities. Sector Teams of Special Operations Branch, Counterintelligence Section, 4th Military Intelligence Detachment, detected 201 VIET CONG Infrastructure Personalities, of whom 109 were detained. Seventy-eight of the detainees were declared Prisoners of War and 31 were declared Civil Defendants; none were declared Innocent Civilians.

This increase in figures from the last reporting period came as a result of splitting the Division Tactical area of Operations into five sectors with one Special Agent assigned to each sector, rather than having two Special Agents cover the entire area. Each Special Agent has been able to gain an intimate knowledge of his area of operations. By conducting single operations against specific VC individuals, as opposed to the larger cordon and search operations, a greater number of VC have been apprehended.

d. Interrogation of Prisoners of War

During the reporting period, there was a significant increase in the num-

CONFIDENTIAL

CONFIDENTIAL

AVDDH-GC-MH

18 August 1968

SUBJECT: Operational Report - Lessons Learned (RCS CSFOR-65) for
Quarterly Period Ending 31 July 1968 (U)

ber of detainees who were classified as PW's. The 4th Infantry Division Compound processed 319 detainees, who were interrogated by personnel of the IPW Section, 4th MI Detachment. Of these detainees, 92 were classified Prisoners of War (75 VC/VMC; 17 NVA); 30 were classified Civil Defendants; 58 were classified Innocent Civilians; and 139 were classified Returnees.

This increase in detainees classified as PW's is a direct result of the improved system used to identify and apprehend these individuals (Ref para 2c).

e. Significant Enemy Tactics, Techniques and Capabilities

(1) General: The enemy continues to show that he can employ any of several tactics in his operations. Although he made no large-scale attacks on any city during the reporting period, his re-deployment around BAN ME THUOT in late July indicated that he still plans to conduct major offensive operations when conditions are favorable. Although he has never succeeded in seizing and holding a US fire support base, and experience has proven that he normally loses the equivalent of at least one battalion when he makes an all-out ground attack on a FSB, he made several disastrous attempts around BEN HET and DAK PEK in May and June. Throughout the reporting period, local forces have attempted to strangle the economy of the provinces by mining and by conducting ambushes on the highways, encirclement and harassment of the cities, and taxation and raids on outlying villages. His success in these operations has been minimal. The enemy continues to lack the staying power to conduct sustained offensives.

(2) Significant Changes in Tactics:

(a) The enemy attempted to eliminate the obstacle posed by US FSB's by massing artillery fire on them. He attempted this in late May - early June near POLEI KLENG and BEN HET. The enemy employed 105mm howitzers against a fire support base southwest of BEN HET, the first known employment of this weapon in II CTZ. The enemy also introduced the 82mm recoilless gun, the 140mm rocket, and the 100mm gun into the Highlands during this period. Although this tactic of massing fire on US fire support bases caused minimal damage, it did demonstrate an increased enemy artillery capability, and the enemy can be expected to attempt it again in the future.

(b) During the reporting period the enemy began utilizing larger numbers of plastic mines, which, being undetectable, with metallic mine detectors presented a new threat to friendly vehicular traffic. From May to mid-June the enemy initiated an increased campaign of ambushes and minings in the AO in conjunction with the offensives at POLEI KLENG, BEN HET and DAK PEK. The 4th Infantry Division's counter-ambush program kept the enemy's campaign from succeeding, and enemy units attempting ambushes suffered heavy casualties. In mid-June ambush and mining activity decreased greatly, and at the end of the reporting period this activity was at a low level.

CONFIDENTIAL

CONFIDENTIAL

AVODH-GC-MH

18 August 1968

SUBJECT: Operational Report - Lessons Learned (RCS CSFOR-65) for
Quarterly Period Ending 31 July 1968 (U)

(3) Recapitulation of Enemy Battle Losses:

(a) Personnel:	KIA (BC)	907
	NVAC	17
	VCC/VMCC	<u>75</u>
	Total	999
(b) Weapons:	S/A	278
	C/S	<u>15</u>
	Total	293
(c) Ammunition:	S/A rds	549,560
	C/S rds	1,424
	Grenades	525
	Mines	137

(d) Miscellaneous captured item:

Explosives	968 lbs
Documents	156 inches
Rice	6.2 tons
Salt	185 lbs

(e) Enemy facilities destroyed:	Structures	136
	Fortifications	749

2. Enemy Capabilities, Vulnerabilities and Probable Courses of Action.

(1) Enemy Capabilities:

(a) The 325C NVA Div is capable of conducting attacks by fire and ground attacks on fire support bases in the BEN HET-DAK TO area.

(b) The 1st NVA Div is capable of conducting a multi-regimental attack on BAN ME THUOT.

(c) The 304 LF Bn and the 406 Sapper Bn can conduct ambush and mining operations on Highway 14 north of KONTUM City. Additionally, these units are capable of attacking friendly installations in the vicinity of KONTUM City.

(d) Elements of the 31st Bn, 40th NVA Arty Regt are capable of conducting attacks by fire on PLEIKU and CAMP ENARI.

(e) The 95th and 18B NVA Regiments are capable of entering country from the COCLA and conducting attacks on friendly installations west of PLEIKU.

(f) Conduct ambushes, particularly in the MANG YANG Pass area on Route 19E.

(g) The 301 and 401 LF Bns have the capability of conducting ambush and

CONFIDENTIAL

AVDDH-GC-MH

18 August 1968

SUBJECT: Operational Report - Lessons Learned (RCS CSFOR-65) for
Quarterly Period Ending 31 July 1968 (U)

mining operations on Highway 21 and 14S. The K-39, which was part of the 33rd NVA Regt but did not move south with the regiment, can attack friendly installations in the BAN ME THUOT area. The units are also capable of supporting the 1st NVA Div in an attack on BAN ME THUOT.

(h) The enemy is capable of introducing new forces without warning into the AO from adjacent CAMBODIA and LAOS.

(2) Enemy Vulnerabilities: The enemy is vulnerable to artillery and air strikes when he bivouacs or masses for a large attack.

(3) Enemy Probable Courses of Action:

(a) Attack in the BAN ME THUOT area in the early part of August with the 1st NVA Div, supported by the K-39 Bn and the 401 and 301 LF Bns.

(b) Maintain pressure in the BEN HET-DAK TO area by utilizing the 325C Div and elements of the 40th Arty Regt in small ground attacks and attacks by fire against friendly fire support bases.

(c) Conduct mining operations on LOC's with particular emphasis on Highways 19E and W and north of KONTUM City.

(d) Conduct attacks by fire in the KONTUM City and PLEIKU City areas.

(e) Conduct ambushes, particularly in the MANG YANG Pass area on route 19E.

3. (C) OPERATIONS AND TRAINING ACTIVITIES

a. The following OPLANS/OPORDS were published:

(1) OPLAN 10-68 (DUCKBLIND) dated 14 May 68, classified SECRET, will not be discussed in this report.

(2) OPORD 11-68 (MATHEWS) dated 24 May 68 (with 2 changes) classified SECRET, will not be discussed in this report. OPORD 11-68 terminated 12 June 1968.

(3) OPLAN 12-68 (RED BALL) dated 27 May 68 directs that rescue, security and recovery of personnel, documents, sensitive equipment, and downed aircraft will be the responsibility of the unit in whose AO the downed aircraft is located.

(4) OPORD 13-68 (SCOUT) dated 31 May 68, outlines the selection, orientation, training, and employment of HOI CHANHS as Kit Carson Scouts to augment the 4th Infantry Division's reconnaissance efforts in AO BINH TAY-MAC ARTHUR.

(5) OPORD 14-68 (ROADRUNNER) dated 23 June 68. 4th Inf Div elements will conduct ROADRUNNER operations within assigned AO. ROADRUNNER Operations will use specifically tailored forces traversing main and secondary roads throughout the AO at irregular intervals and in random patterns.

CONFIDENTIAL

//

CONFIDENTIAL

AVDDH-GC-MH

18 August 1968

SUBJECT: Operational Report - Lessons Learned (RCS CSFOR-65) for
Quarterly Period Ending 31 July 1968 (U)

Operations will be integrated, when feasible, with tactical operations.
Quick reaction forces will be employed to exploit contacts.

(6) OPLAN 15-68 (SPEEDBALL) dated 9 July 68. 4th Infantry Division elements and ARVN 24th STZ will conduct combined security operations to clear, secure and react to enemy activities along Highway ~~238~~ between PLEIKU and KONTUM City. ^{14N}

(7) OPLAN 16-68 (REMAGEN) dated 15 July 68, classified SECRET, will not be discussed in this report.

(8) OPLAN 17-68 (BASTOGNE) dated 16 Jul 68, classified SECRET, will not be discussed in this report.

(9) OPLAN 18-68 (JAY-SILVER) dated 28 Jul 68, classified SECRET, will not be discussed in this report.

b. Operations. The 4th Infantry Division continued Operation BINH TAY-MAC ARTHUR which began 12 October 1967. A chronological summary of significant activities for this quarter is at Inclosure 3. The action of TF MATHEWS in the vicinity of DAK TO covering the period 24 May - 12 June is at Inclosure 6.

c. Training:

(1) During this period, the first class in an ARVN LRP training program began on 23 April and was completed 21 June 1968. ARVN LRP training scheduled for 29 July - 19 Aug was modified into a reconnaissance operations course when the scheduled ARVN students failed to arrive and Regional Force personnel appeared in their place.

(b) A Kit Carson Scout (KCS) program was established at the 4th Division to exploit former VC personnel. Training for the first group of 25 was conducted 5-18 June on basic US weapons, tactics, physical training and miscellaneous political indoctrination subjects. Students were deployed to units in the field on 19 June to assist with their special knowledge of enemy techniques and methods of operation. A second group of 24 underwent training from 14 thru 27 July.

(c) A USARV training team visited the 4th Division from 29 June through 1 July and conducted training on the AN/PPS-5 radar for men from the 3/506 Inf, 2/1 Cav, 1/10 Cav, 1/8 Inf and the 1/14th Inf.

A USARV Team visited the 4th Division from 5 through 9 July and conducted training in KY38 Secure Voice Device operations for divisional units.

CONFIDENTIAL

CONFIDENTIAL

AVDDH-GC-MH

18 August 1968

SUBJECT: Operational Report - Lessons Learned (RCS CSFOR-65) for
Quarterly Period Ending 31 July 1968 (U)

(d) On 29 July, the Division Materiel Office conducted classes for divisional units on TAER's and dispatching procedures.

(2) 4th Infantry Division Training Detachment.

(a) The detachment trained 4,760 enlisted and 95 officer replacements.

(b) The Combat NCO Leadership School provided instruction to 235 students, all of whom successfully completed the course.

(c) The Recondo Preparatory course provided instruction to 47 students. Of these, 23 successfully completed the course. Twenty-nine personnel attended the MACV Recondo School. Twenty-four successfully completed the course.

(3) RF/PF Training.

(a) During the quarter, CMIT/CMTT activities were conducted from 1 May through 1 July. On 1 July the seven remaining teams were reassigned to MACV and converted to Mobile Advisory Teams (MATS). The MATS, which will number 96 prior to CY 69, should provide considerable assistance to RF/PF units throughout the II Corps area. The 4th Infantry Division personnel have been used to fill those MATS located in KONTUM, PLEIKU, DARLAC, QUANG ~~TR~~^{TR}, ~~TR~~^{TR} EN DAC, and LAM DANG Provinces. MACV replacements will be directed on a one-for-one basis to 4th Infantry Division. This procedure will insure that MATS located in the Highland provinces of II Corps receive experienced personnel. Fourth Division units have been directed to identify with MATS operating in the division AO and to render assistance within their capability.

(b) Problem areas. Problem areas have been identified in almost every province. Those that are of a recurring nature and must constantly be corrected include:

1. Leadership. The major problem area facing the upgrading of RF/PF units is lack of leadership. This area must be given special attention.

2. Logistical Support. Resupply and maintenance for RF/PF units is at best poor. Many improvements have been made, but extensive work in this area is necessary.

3. There is a reluctance on the part of Province and District Chief to make units available for training. The reason given is usually attributed to alleged enemy activities. Detailed planning must be accomplished at all levels to insure that training momentum is continuous.

(c) Observations.

1. The CMIT/CMTT Program conducted from 15 October 1967 to July 1968 decidedly improved RF/PF units which received training in the Highland provinces of II Corps.

CONFIDENTIAL

AVDDH-GC-11H

18 August 1968

SUBJECT: Operational Report - Lessons Learned (RCS CSFOR-65) for
Quarterly Period Ending 31 July 1968 (U)

2. Over one-third of the RF/PF units in II Corps were trained by the CMIT/CMTTs'. Sixty-one (61) RF companies and one hundred twenty-six (126) PF platoons received training.

3. It is expected that emphasis being placed on RF/PF training will result in significant improvement during the next quarter.

(4) (C) R&D: Several new items of equipment were evaluated by division during this quarter. Evaluations included:

(a) Light Weight Entrenching Tool: 120 tools were evaluated in the 1st and 2d Bdes. In general the tool was found to be too light for extensive digging, although the reduced size and weight did make it easier to carry.

(b) Patrol Seismic Intrusion Devices: 12 sets, consisting of 4 transmitters and 1 receiver, were evaluated. Although the sets were rugged, light-weight and easy to emplace, the large number of false sensings was definitely a problem. Operators have been instructed to reduce the sensitivity setting on the transmitter in order to reduce the number of false sensings.

(c) Mine Roller: An expendable bogey wheel mine roller was delivered for evaluation in March. The shipment was short six critical parts which have been reordered. The system will be evaluated by the 4th Engr Bn when all the necessary parts have been obtained.

(d) Tunnel Exploration Kits: The kits were evaluated in the Fall of 1967 and modifications were recommended and adopted. The new kits are now being received in operational quantities; 2 kits per maneuver battalion.

(e) Discreet Hamlet Signaling Device: The signaling device scheduled for delivery in April is now expected in Sep 68.

(f) Communications Balloon: 2d Ede LRP's have been selected to receive and evaluate the communications balloon. The system consists of a 17 foot dirigible type helium-filled balloon to which is attached a remoted PRC-25 radio. The balloon is then tethered at 500 feet altitude by a nylon rope and winch assembly. The increased altitude is expected to increase the LRP communications range significantly.

(g) Elevated Site Markers: 20 ESM's were received for evaluation in late April. The system consists of a standard meteorology balloon, a supply of helium and a nylon tether line. When a unit operating below a jungle canopy wants to mark its position for an airborne observer, a balloon is filled and allowed to ascend through the canopy on the tether line. The advantage of the system is that the balloon can penetrate the canopy when smoke might not, and the marker can remain in place as long as the aerial observer is in the area so the position of the unit is always identifiable. The system is designed to be used once and then discarded.

CONFIDENTIAL

AVD. 4 JC-MH

18 August 1968

SUB. T: Operational Report - Lessons Learned (RCS CSFOR-65) for
Quarterly Period Ending 31 July 1968 (U)

(h) M113 APC Belly Armor: Five modification kits are being installed on 2/1 Cav APC's for evaluation. The kits consist of 3/4 inch steel plate which is affixed to the underside of the APC. The armor is designed to increase troop protection against mines. The kit also includes an emergency quick release to the loading ramp and a safety harness for the driver.

(i) Improved Munitions: COFRAM hand grenades and 40mm grenades were released for use in late June after units had conducted specialized training on these munitions. The grenades represent a significant increase in lethality over standard munitions.

(j) XM174 Automatic Grenade Launcher: Eight 40mm launchers were received during the month of July for a one month evaluation. To date, the launchers have not been used in a contact mission. Ten weapons, which fire the same rounds as the M-79, permit the individual soldier to put a high volume of 40mm grenades on a target within a short period of time.

(k) V 100 Commando Cars: The division obtained a 180 loan of 30 V-100 Commando Cars from ARVN forces. The cars were assigned to the 4th MP Company for use in convoy escort and protection. The vehicles offer complete protection against small arms fire and mount twin M-60 machineguns as armament. The vehicles have significantly reduced the tracked vehicle mileage previously experienced within the division.

(5) Training Regulations:

(a) A regulation was published requiring a training POI for each LRP unit. LRP units are to train a minimum of 300 hours annually on the team level.

(b) A revision of the replacement training regulation was published expanding the original and adding a section on M-16 firing tables and requirements.

(c) A revision of the M-16 regulation was published which consolidated the policies of a series of command letters.

(d) A revision of the unit training regulation was published establishing mandatory and recurring training subjects required and creating a new training record form.

(e) 4th Inf Div Reg 350-12 (ARVN, RF/PF CIDG Training), 350-13 (War Dog Opns) and 350-19 (Combined Operations Training) are in the process of being revised.

e. Air Support.

CONFIDENTIAL

Inclosure 2

15

CONFIDENTIAL

AVF⁰ GC-MH

18 August 1968

SUI -T Operational Report - Lessons Learned (RCS CSFOR-65) for
Quarterly Period Ending 31 July 1968 (U)

(1) The following close air support missions were flown in support of
Operation BINH TAY-MAC ARTHUR, 1 May 1968 - 31 July 1968.

TYPE	MSNS	REQUESTED	FLOWN	SORTIES	A1	B57	F4	F100	F105	A37	A447
FAC, PP	1499		874	1826	276	9	569	782	191	0	00
FAC/IMM	0236		217	0435	143	1	088	194	012	2	00
CSS/PP	0524		341	0512	004	9	133	312	054	0	00
CSS/IMM	0021		017	0021	000	0	008	013	000	0	00
SPOOKY	0047		045	0045	000	0	000	000	000	0	45
MOONSHINE	0012		011	0011	000	0	000	000	000	0	11
Total	2339		1505	2850	423	19	797	1301	257	2	56

(2) Bomb Damage Assessment:

TYPE	EST	SEC	SEC	AA	MRTR	FOX	RKT	ROAD				
MSNS	KBS	BUNKERS	FIRES	EXP	AW	PSN	HUTS	TRUCKS	HOLES	BRIDGE	PSN	CUTS
FAC/PP	087	137	47	60	24	11	02	0	64	14	5	83
FAC/IMM	109	191	184	35	08	12	26	1	18	01	3	09
CSS/PP	000	000	00	01	00	00	00	0	00	00	0	01
CSS/IMM	000	000	00	00	00	00	00	0	00	00	0	00
SPOOKY	001	000	00	00	00	00	00	0	00	00	0	00
Total	197	598	65	96	32	23	28	1	82	15	8	93

(3) B-52 Strikes.

B-52 struck known base areas, infiltration routes, strong points and major
NVA headquarters. Both primary and secondary strikes were delivered in the 4th
Division AO in support of Operation BINH TAY-MAC ARTHUR. The following figures
show the number of B-52 strikes carried out during the period 1 May 1968 - 31 July
1968.

PRIMARY MISSIONS		TOTAL SORTIES
4th Div	174	987
II Corps	4	24
Total	178	1011
SECONDARY MISSIONS		TOTAL SORTIES
4th Div	59	194
II Corps	0	0
Total	59	194
TOTAL MISSIONS		TOTAL SORTIES
4th Div	223	1181
II Corps	4	24
Total	227	1205

Incl 2

16

CONFIDENTIAL

CONFIDENTIAL

AVDDH-GC-MH

SUBJECT: Operational Report - Lessons Learned (RCS CSFOR-65) for
Quarterly Period Ending 31 July 1968 (U)

(4) Gravel Mines:

XMA1 Gravel Mines (Air dropable, self-arming, self-sterilizing, anti-personnel mines) were employed on the following targets along the PLEI TRAP road as an obstacle to NVA infiltration and road reconstruction efforts. Because friendly ground forces did not conduct operations in the vicinity of the Gravel target boxes, conclusive data on the effectiveness of the munition as an obstacle is not available. A total of 17 AIE missions/68 AIE sorties was used to seed the target areas:

Target #1 - YL 741036 - YB 741043 - YB 751036 - YB 751043
Target #2 - YB 730054 - YB 734056 - YB 734044 - YB 739046
Target #3 - YB 746012 - YB 751012 - YB 746022 - YB 751022
Target #4 - YE 760035 - YB 764039 - YB 769029 - YB 771034
Target #7 - YB 760212 - YB 764212 - YB 764219 - YB 760219
Target #8 - YB 76219 - YB 767219 - YB 774219 - YB 772223

(5) Weather:

Frequent inclement weather throughout the reporting period caused cancellation of a significant number of pre-planned FAC-controlled airstrikes. If a fighter mission carried low-drag, general purpose bombs, it was possible to deliver the ordnance by Combat Sky Spot Direction. However, when the ordnance consisted of retarded-fall (high drag) bombs, napalm, or cluster bomb units, Combat Sky Spots could not be used, and the mission was cancelled by the Direct Air Support Center.

f. Chemical

(1) (U) The Division Chemical Section and 43d Chemical Detachment continued to support combat operations within the division during the reporting period by employing riot control agents (RCA), supervising the defoliation program, operating and maintaining the division's Airborne Personnel Detectors (APD), rendering technical advice on use of flame munitions, operating a chemical ASP, and inspecting unit CBR readiness, equipment, and supply.

(2) (C) Defoliation operations were seriously curtailed by weather, especially during the last half of the reporting period. Only three Traildust missions were flown during the months of June and July compared to an average of nine monthly for previous quarters. With the coming of the growing season the chemical section once again became engaged in crop destruction operations. Approximately 391 acres of enemy crops including rice, beans, corn and bananas were destroyed. Perimeter defoliation was also increased due to excessive growth of grass and brush around friendly installations. See Inclosure #4 for complete summary of defoliation operations.

CONFIDENTIAL

AVDDH-GC-MH

18 August 1968

SUBJECT Operational Report - Lessons Learned (RCS CSFOR-65) for
Quarterly Period Ending 31 July 1968 (U)

(3) (U) RCA Employment. The use of riot control agents generally decreased during the reporting period due to decreased enemy activity and lack of lucrative targets.

(a) Bulk Agent. The Division Chemical Section employed very little bulk CS as compared to previous quarters. On 30 July, 2080 pounds were employed from a CH-47 helicopter on the NVA road at YB772222. On 28 May the Air Force employed 20,480 pounds of CS-1 at YB905854 on the NVA road entering VIETNAM from LAOS. The 80 pound drums were dropped from C-123 aircraft. This was the first use of C-123's in this manner in VIETNAM. Another drop of 17,920 pounds was made at YB9385 on 1 June. A total of 6480 pounds of CS in eight pound plastic jugs was issued to ground units for use in contaminating enemy bunkers and tunnels.

(b) XM-15 CS Cannister Clusters. The XM-15, formerly known as the E-158, were employed on only one occasion in the division AO. On 18 May, eight XM-15's were dropped from a UH-1 helicopter at YA955859 (LZ BHILLO-PAD) in support of the 1/12th Infantry Battalion.

(c) E-8 Tactical CS Launchers. Use of E-8's increased during the quarter with 741 being issued to subordinate units as compared to 226 for the previous period. This increase was due primarily to successful use of the E-8 in defense of firebase in the DAK TO area. In early May, the 1/8th and 3/8th Infantry Battalions had occasion to fire several E-8's in defense of their firebases against estimated enemy battalion-size forces. The E-8's were credited with playing an important role in repulsing the attack, and in the case of the attack on the 3/8th, were the deciding factor in the capture of six NVA.

(d) XM651 40mm Cartridge. Availability of the XM651 round for the M-79 grenade launcher ceased on 2 June when USARV ordered the turn in of the entire division's assets for redistribution to USARV units. The round has proved its worth in combat and will be a tremendous asset when made available in operational quantities.

(e) The Division Chemical Section developed a new munition called the BFCG (Box Full of Grenades) consisting of a plywood box filled with 25 M7A3 CS grenades and rigged so as to release the grenades above the ground after dropping the 25 pound munition from a helicopter. The munition is cheap, easily constructed, reliable and extremely effective. Since 4 May when the first BFCG was constructed, 262 have been issued to subordinate units, most of which were employed by battalion commanders from their command and control ships. See Inclosure #4 for a picture of the BFCG.

(4) Airborne Personnel Detector Operations. A total of 83 APD missions were flown with the two APD's available to the division. Monthly summary follows:

CONFIDENTIAL

CONFIDENTIAL

AVDDH-GC-MH

18 August 1968

SUBJECT: Operational Report - Lessons Learned (RCS CSFOR-65) for
Quarterly Period Ending 31 July 1968 (U)

<u>MONTH</u>	<u>MISSIONS</u>	<u>HOURS</u>
MAY	26	34.0
JUNE	15	19.8
JULY	42	98.3

g. Psychological Operations:

(a) A total of 22,885,000 leaflets were dropped during the period, compared with 35 million during the preceding period. Air and ground loudspeaker time amounted to 932 hours, compared with 520 hours during the previous period. Themes used were primarily in support of the CHIEU HOI Program, with emphasis on the exploitation of HOI CHANH.

(b) The Division had a total of nine HOI CHANHs during the period. Of these, six were NVA and three were VMC. Significant observations concerning the six NVA HOI CHANHs are that two were Non-Commissioned Officers. The six rallied in groups of three, and two, and one by himself. All NVA HOI CHANHs were exploited through the use of quick reaction leaflets and taped loudspeaker appeals, and several group appeals by leaflet.

(c) The Volunteer Informant Program, stressing both the Reward for Information and the Public Safety Themes began to show positive results during the reporting period. On 12 May, 500 pounds of cal. 50, 7.62mm, and 5.56 ammunition were turned over to a Civic Action team by the villagers of KON MONAY KOTU (AR80293), KONTUM Province. On 25 May, 12 machinegun barrels, three machinegun operating rods, and a 106mm recoilless rifle sight were turned over to a Civic Action team by the villager of PLEI BONG GOLAR (AR824425), PLEIKU Province.

(d) The bi-monthly NVA newspaper, BINH MINH (First Light) continues to draw favorable comments from HOI CHANH. This paper prints news stories which are extracted from all sources on a variety of subjects. Photographs are also included. The newspaper was started since intelligence indicates, that there has been a complete news blackout among the NVA units in our area of operations.

4. (C) Logistics

a. General

(1) Extensive airdrop operations were conducted during the period 2-18 June. Airdrops were in support of 4th Division units operating north of KONTUM in the vicinity of DAK PEK and DAK SEANG. Five airdrops consisting of 505.6 short tons of Class I, III & V were made during this period.

(2) Action was completed on 122 Reports of Survey. Thirty-two Quarterly Reports of Operational Loss were approved and 336 Combat Loss Report were

CONFIDENTIAL

CONFIDENTIAL

ADDY-GC-44

18 August 1968

SUBJECT: Operational Report - Lessons Learned (RCS CSFOR-65) for
Quarterly Period Ending 31 July 1968 (U)

processed.

b. Supply and Services

The following figures represent cumulative support data for support activities of the 4th Supply and Transportation Battalion at all locations in the division area of operations.

- (1) Division Supply Office

Requisitions received	19,556
Requisitions passed	4,200
Requisitions filled	11,379
Total due out releases	7,390

- (2) Class I

Average headcount issues	9,400
Average number of units	41

- (3) Class III

JP-4	888,000 gal
MOGAS	896,000 gal
DIESEL	1,049,000 gal
AVGAS	52,900 gal

- (4) Baths

Individuals processed	25,873
-----------------------	--------

- (5) Graves Registration

Human remains processed	6
Personal Property shipments processed	270

c. Transportation Services

(1) During this period convoy operations consisted of 835 convoys with a total of 43,194 vehicles. Seventy-nine special missions by fixed wing aircraft were flown in support of the division, lifting 836.5 short tons of cargo equipment. Additionally, the C7A division courier lifted 11,669 passengers and 236.6 short tons of cargo.

(2) The hold baggage section of CAMP ENARI processed 2,613 pieces consisting of 91.7 short tons.

d. Materiel Readiness.

CONFIDENTIAL

AVDDH-GC-MH

18 August 1968

SUBJECT: Operational Report - Lessons Learned (RCS CSFOR-65) for
Quarterly Period Ending 31 July 1968 (U)

- (1) The Division Command Maintenance Management Inspection cycle was completed with five initial inspections and three re-inspections.
- (2) Assistance was rendered to the II Corp MACV advisor in the formation of a CMMI Team inspection program in support of ARVN units.
- (3) Roadside inspections continued on a daily basis.
- (4) The Project Counter instructional team from QUI NHON Support Command instructed all divisional units on the establishment and maintenance of prescribed load list (PLL) during the first two weeks of June.
- (5) Classes were conducted by the Division Materiel Section for all divisional units on the TAERS forms system.
- (6) An M16 Rifle Inspection Team, consisting of personnel from ACoFS, G3 and G4 offices, was formed on 2 Jun 68 to conduct unannounced inspections of divisional units in both the forward and rear areas. These inspections have been incorporated in the Command Maintenance support and supply of spare parts for all divisional and attached elements continued to be accomplished through three forward support companies, the maintenance support company and the aircraft maintenance company of the 704th Maintenance Battalion. Provisional emergency support was provided the 3d Bde, 101st Airborne Div and Special Forces Units within the AO. Contact teams were provided on a special mission basis.

e. Medical Service. Medical support was provided by the Division Medical Battalion.

	<u>HQ & Co A</u>	<u>Co B</u>	<u>Co C</u>	<u>Co D</u>
Patients seen	14,039	9,646	2,429	3,269
Patients admitted	1,033	2,139	412	1,263
Patients returned	468	209	412	185

f. Operation BINH TAY-MAC ARTHUR logistics.

- (1) Logistical support was provided forward elements of the division by Forward Support Activity (FSA) facilities from PLEIKU Sub-Area Command and 1st Logistical Command units located at CAM RAHN BAY.
- (2) During the period 24 May through 12 June 1968, TASK FORCE MATHEWS operating in northern KONTUM Province was supported by FSA, 1st Log Command. FSA provided Class I, III, V, barrier materiel, graves registration, bath and laundry services. FSA DAK TO is established on a permanent basis primarily providing the above supply and services to 3d Brigade operating in Northern KONTUM Province. A JP-4/Refuel point was operated by 4th Aviation Battalion in DAK PEK to reduce helicopter flying time.
- (3) FSE KONTUM is operated by the Division Support Command primarily

CONFIDENTIAL

AVDDH-GC-lmH

18 August 1968

SUBJECT: Operational Report - Lessons Learned (RCS CSFOR-65) for
Quarterly Period Ending 31 July 1968 (U)

in support of 3d Brigade units operating in that area. FSE provides Class I, III, II & IV fast moving items and barrier materiel. Class III, bulk and packaged products, is provided by PLEIKU Sub-Area Command (PKSAC). The Class III point is operated jointly by PKSAC and the 57th Aviation Company for JP-4 at the KONTUM Air Field. Additional Class III items, MOGAS and DIESEL, are provided by FSE KONTUM located at the 3d Brigade CP area near KONTUM. Class V is provided by the 1st Log Command from the 1st Log Command ASP located in KONTUM. A forward JP-4/Refuel point was operated at POLEI KLENG by the 4th Aviation Battalion, to decrease helicopter flying time.

(4) On 12 June 1968, a forward supply point was established adjacent to Special Forces Camp, DAK SEANG to reduce helicopter flying time and turn around time for resupply operations in support of units operating north of KONTUM. Forward supply point provided Class I, III & IV and was operated by the Division Support Command depending solely on paradrop for resupply. The 4th Aviation Battalion established and operated a JP-4/Refuel point to support air operations in the area.

(5) The FSE in operation at the OASIS continued to provide support for 2d Brigade operations in the western PLEIKU area. This FSE provided Class I, bulk and packaged Class III, V, barrier materiel, graves registration, bath and laundry services. The bath and laundry units were attached from the 1st Log Command. 3d Brigade assumed area responsibility on 19 July 1968 and FSE continues to support 3d Brigade units from OASIS.

(6) On 18 July 1968 the 2d Battalion, 35th Infantry was deployed to BAN ME THUOT for operations in that area. An expediting team from the 1st Log Command at CAM RAHN BAY, augmented by Class I, V, and graves registration personnel from Division Support Command, provided logistical support direct from 1st Log Command CAM RAHN BAY. This facility was increased to full FSA operated by 1st Log Command effective 19 July 1968 with deployment of 2d Brigade Task Force to BAN ME THUOT. An FSA, augmented with Division Support Command personnel, continues to support 2d Brigade Task Force with Class I, bulk and packaged III, IV, barrier materiel, V, graves registration, bath and laundry services. FSA BAN ME THUOT is supported directly from the 1st Log Command, CAM RAHN BAY, by LLOC with back up ALOC.

g. In addition to the logistical support provided by US Army elements, the US Air Force expended the following quantities of Class III and V in support of operations:

<u>Class III</u>	<u>QTY (GALLONS)</u>
Fighters	27,519,000
B-52's	334,390,000

CONFIDENTIAL

CONFIDENTIAL

AVDDH-GC-MH

18 August 1968

SUBJECT: Operational Report - Lessons Learned (RCS CSFOR-65) for
Quarterly Period Ending 31 July 1968 (U)

<u>ORDNANCE</u>	<u>QTY</u>	<u>WEIGHT (S/T)</u>
BOMBS	11,764	3,641.7
CBU	740	110.8
NAPALM	1,541	574.5
ROCKETS	650	130

Delivered by fighters and AC47 (Spooky)

<u>ORDNANCE</u>	<u>QTY</u>	<u>WEIGHT (S/T)</u>
20mm	57,400	14.3
7.62mm	840,000	21.7

Delivered by B-52

<u>ORDNANCE</u>	<u>QTY</u>	<u>WEIGHT (S/T)</u>
Bombs	Unk	21,424.2

5. (U) Military Civic Action Program.

a. TAOR: The Good Neighbor Program continued within the Division TAOR. Consolidation of hamlets resulted in further reduction in the number of separate hamlets from 66 in the past quarter to 60. The relocation of six hamlets in respect to last quarter's total of 19 shows continuing progress in the consolidation program, but is not indicative of the outstanding receptiveness of other hamlets to either join existing consolidated villages or to form new ones. There have been five instances where consolidated villages have been probed by VC during the period and in all instances the villages have given a commendable account of themselves. A further decrease in the number of kidnappings within the TAOR was noted, with a total of four chiefs and 19 villagers reported kidnapped, in comparison to the 18 chiefs and 88 villagers of last quarter. A noticeable distinction is recognized by TAOR Civic Action Teams in the manner in which friendly villages treat VC influenced villages. The complete disassociation from VC influenced villages by GVN orientation of consolidated villages is in itself encouraging and is understood as signifying a closer alignment with the VIETNAMESE Government and a commitment to the principles of democratic government. There were no significant population changes or shifts within the TAOR during the reporting period. The overall civic action effort remained constant with 26 teams visiting approximately 20,000 civilians within area.

b. PLEIKU Province:

(1) The 2d Brigade continued civic action responsibility along Route 19W and in the PLEI MRONG area until the 19th of July when this AO came under the control of the 3d Brigade.

CONFIDENTIAL

18 July 1968

SUBJECT: Operational Report - Lessons Learned (RCS CSFOR-65) for
Quarterly Period Ending 31 July 1968 (U)

(2) The 2d Squadron, 1st Cavalry, continued civic action along Highway 19W from PLEIKU City to the MANG YANG Pass.

(3) Civil Affairs Team 9, 41st Civil Affairs Company, continued civic action activities at the EDAP ENANG Refugee Center. Beginning the quarterly period with approximately 4,600 inhabitants, EDAP ENANG continued to increase in population to its present population of approximately 6,000. The program has all indications of being a success at this time. There is a distinct change in that people are now being placed on a waiting list for EDAP ENANG. Quarterly comparisons indicate that the improvements made at EDAP ENANG have changed the project from a potential failure to a potential success.

(4) Plans are now being formulated for a new refugee center on the eastern periphery of CATECKA Tea Plantation. The planning for this new village was initiated during the period with the actual construction being delayed pending the allocation of funds and final decision by the Province Chief.

c. KONTUM Province: The 1st Brigade continued civic action activities in DAK TO and DAK SUT Districts with intensified civic action programs coinciding with the increased tactical activity in the areas. Adding a combined ARVN/US Civic Action team to its established CA resources, the 1st Bde is expanding and improving an already excellent civic action program. The 3d Brigade began civic action activity in the vicinity of KONTUM City during the last reporting period and has developed a regular CA program in the area during the present period.

d. DARLAC Province: Civic action activity was curtailed in the BAN ME THUOT area during the last reporting period due to the movement of US tactical units away from the area. The return of 4th Infantry Division elements from the 2d Bde on 18 July has necessitated a new civic action program which was just beginning to operate on 31 July.

e. Nation Building Program:

(1) Psychological Development.

(a) Government:

1. The Division "Good Neighbor Council House" was utilized for a TAOR hamlet meeting during the month of May and bi-monthly sector meetings during the months of June and July. The bi-monthly meetings are intended to provide an informal assembly of the various chiefs and sub-chiefs within a specific sector in order to express opinions and develop a better working relationship between the villages. It has become standard practice to include division dignitaries, CORDS representative, and district officials at these meetings. By combining a festive atmosphere with appropriate topics of discussion, the meetings have become a popular, worthwhile accomplishment.

18 August 1968

SUBJECT: Operational Report - Lessons Learned (RCS CSFOR-65) for
Quarterly Period Ending 31 July 1968 (U)

2. A weekly council meeting is being held in the village of PLEI NHGO YUT by the 704th Maintenance Battalion Civic Action Team and an elected council of villages. This project was initiated with CORDS assistance as a self-help program to encourage a better understanding of the VIETNAMESE Government. The meeting has developed into an efficient decision-making apparatus and a ready means of providing agricultural and hygienic self-improvement information.

3. The VIETNAMESE supply/logistics system: Improved coordination with VIETNAMESE supply and logistics agencies is best exemplified by the outstanding success in requesting and receiving fish for stocking purposes in the many fish ponds constructed throughout the area. The initial benefit derived from the accelerated fish pond projects within the TAOR is the experience derived by village and hamlet leaders in dealing directly with province and district officials in order to obtain the fish for stocking. This is expected to be as valuable as the protein supplement derived from the fish.

(b) Education:

1. The construction and establishment of a village school in the predominantly VIETNAMESE village of PLEI MY has provided a significant improvement in local GVN/MONTAGNARD relations due to the excellent working relationship of the MONTAGNARD/VIETNAMESE students. It has been a common observation of unit civic action teams that villagers throughout the TAOR have an extremely intense desire to obtain an education for their children. The combining of MONTAGNARD and VIETNAMESE students within the same classroom not only satisfies their desire to learn, but is expected to develop an understanding between the people as they mature.

2. There were four women attending sewing classes at the PLEIKU City Training Center at the close of the reporting period, and it is expected they will finish the course in good standing. At the completion of the course of instruction, diplomas are given to qualified students and CORDS provides a sewing machine to each village in which there are four qualified seamstresses. Nine women graduated from the course during the reporting period. Two villages have received sewing machines at this time.

(2) Development of the Standard of Living:

(a) Water Supplies: Nine wells were completed within the TAOR during the reporting period; in addition, six spillways were constructed at various village sites. There have been ten fish ponds constructed within the TAOR since 1 May 1968. These ponds provide a potential irrigation source as well as a food producing area. In all but one of these ponds, a constant supply of water is guaranteed to provide an emergency water supply throughout the year.

18 August 1968

SUBJECT: Operational Report - Lessons Learned (RCS CSFOR-65) for
Quarterly Period Ending 31 July 1968 (U)

(b) Animal Husbandry

1. An extensive pig raising facility has been developed within the DISCOM Sector of the TAOR which shows increasing indications of success. Yorkshire hogs were procured and selective breeding has taken place. Classification, separation, and castration phases have been completed and further US assistance is planned in the development of an artificial insemination program. The initial litters resulting from the cross breeding program have impressed various villages so much that the boars are in demand by the LE TRUNG District Chief to spread the program throughout the District.

2. Early in May, Major Fergusson of the Walter Reed Medical Research Team visited several villages within the 4th Division TAOR and confirmed a previously suspected outbreak of rinderpest disease among the cattle in the vicinity of PLEI WAU (AR843447), LE TRUNG District, PLEIKU Province. As result of his findings, vaccine was procured from the Pasteur Laboratories at SANANG and a selective inoculation program was initiated. Suitable pens and holding chutes were constructed to allow diagnosis and treatment. The program became so well accepted that six villages have build corrals and holding chutes within the TAOR to facilitate veterinary assistance. The efforts of the personnel involved with the control of this rinderpest outbreak have been rewarded by a very low animal mortality rate from this disease during the period, while the usual mortality rate is 90%.

(c) Crop Production: Experimental gardens have been planted in three separate villages within the TAOR during the reporting period. Using seed obtained through the 5th Special Forces Group, the villagers were encouraged to plant gardens. Advice is given by CORDS agricultural experts. Benefiting from the weekly visits of these agricultural experts, and by the daily care given by the MONTAGNARDS, the gardens are growing better than expected and are a source of pride to the villages taking part in the program.

(d) Health Program

1. In the hamlet of PLEI DO (AR813436), the CA team has encouraged the building of new fences around the homes of the residents. Replacing the traditional bamboo branch fences normally used, the fences use either barbed wire or woven, trimmed bamboo. The motivating factor behind this suggested change to MONTAGNARD tradition was the great number of eye injuries caused by the protruding branches of the old styled fence. A significant decrease in the number of eye injuries has been noted since the new style fencing has been built.

2. During the reporting period, a new dental program was initiated for the villages assisted by the CA team of the 2/1 Cav. On Wednesday and Friday of each week, the CA team takes a large number of villagers into PLEIKU Province Hospital to receive free dental care and instruction from the

18 August 1968

SUBJECT: Operational Report - Lessons Learned (RCS CSFOR-65) for
Quarterly Period Ending 31 July 1968 (U)

clinic. The CA team will continue this program until all of the personnel having dental problems within the unit's villages are treated. The program is continuing as of the end of this reporting period, with approximately 300 people having been treated.

3. Due to the trust established between the CA team and villages of the consolidated village located at AR840377, a CA team suggestion concerning the separation of family living quarters and livestock holding areas was readily accepted. The elimination of waste and vermin, which was formerly accepted with the ownership of livestock, has done a great deal to improve the sanitation of the village.

4. The dispensary construction program has continued within the Division TAOR during the quarterly period. Five new dispensaries were built and 16 repaired. The supplies obtained for dispensary construction have been obtained through district logistics channels. The constant use of the dispensaries indicates an outstanding value for the low cost materials and labor required.

(3) Development of Security: Four PF platoons have been trained as village security forces within the TAOR, while one additional platoon began training on the 30th of July for the newly consolidated village in DIVARTY Sector. Civic action teams have been permanently assigned to the several consolidated villages throughout the TAOR in order to coordinate US assistance in case of enemy activity and to provide a communications capability to coordinate supporting weapons and relief forces.

(4) Statistical Summary of Civic Action:

(a) Construction:

Dwellings	16
Roads	9.5 km
Churches	2
Hospitals	3
Dispensaries	21
Market Places	1
Schools	11
Latrines	4
Bridges	11
Fish Ponds	6
Spillways	12
Cattle pens and chutes	9
Fences	20
Wells	9
Pig Pens	16
Bulletin Boards	6
Chicken Coops	6
Playgrounds	12
Showers	3

18 August 1968

SUBJECT: Operational Report - Lessons Learned (RCS CSFOR-65) for
Quarterly Period Ending 31 July 1968 (U)

Flagpoles 2

(b) Health:

Medcaps 67,779
Youth Health Program 144,946
Vetcap 247

(c) Services:

Food Distribution 29,927 lbs
Clothing 4,552 lbs
Lumber 102,276 bd ft
Soap 18,150 lbs

(d) Recovered goods returned to GVN control:

Rice 11,650 lbs

(e) Results-Intelligence: Villages served by division civic action teams have provided the following assistance:

1. 11 May 1968 - 500 lbs of cal. 50, 7.62mm and 5.56mm ammunition were turned in by the villagers of PLEI KON MONAY KOTU (AR802903).

2. 25 May 1968 - 12 M-60 machine gun barrels, 3 M-60 machine gun operating rods, and 1 106mm recoilless rifle sight were turned in by the residents of PLEI BONG GOLAR (AR824425).

3. 13 July 1968 - 300 rounds of 7.62 ammunition, 50 rounds of 40mm ammunition, and one 40 pound shaped charge were turned in by the village of THAN PHU (ZA234825).

4. 19 July 1968 - one 60mm mortar round was turned in by the village of THAN PHU (AR234925).

5. 20 July 1968 - Three 60mm mortar rounds and one 82mm mortar round were turned in by the village of THAN PHU (AR234825).

(5) Summary: The continuation of the 4th Infantry Division "Good Neighbor Program" has evolved into a more concentrated effort to initiate and support consolidated villages within the Division TAOR. The formation and training of PF defense forces within the consolidated villages has been encouraged and implemented with outstanding results. Civic action programs within the forward areas have progressed during the period with the main emphasis on high impact-short duration projects, and in the case of the 1st CA, the incorporation of ARVN CA teams into their S5 structure. Coordination and mutual assistance with province and district officials improved noticeably.

CONFIDENTIAL

AVDDH-GC-MH

18 August 1968

SUBJECT: Operational Report - Lessons Learned (RCS CSFOR-65) for
Quarterly Period Ending 31 July 1968 (U)

within the Division Area of Operations during the reporting period, allowing greater facility in the initiation of more advanced civic action programs.

6. (C) Personnel

a. Strength: Authorized and assigned strengths at the beginning and close of the reporting period were as follows:

(1) Beginning of Reporting Period (1 May 1968)

	<u>OFF</u>	<u>WO</u>	<u>EM</u>	<u>AGG</u>
(a) Authorized - organic units	1,076	185	16,241	17,272
Authorized - attached units	<u>44</u>	<u>3</u>	<u>1,016</u>	<u>1,063</u>
Total	1,147	188	17,257	18,335
(b) Assigned - organic units	1,147	165	16,488	17,800
Assigned - attached units	<u>41</u>	<u>3</u>	<u>984</u>	<u>1,028</u>
Total	1,188	168	17,472	18,828

(2) End of Reporting Period (31 July 1968)

(a) Authorized - organic units	1,108	185	16,373	17,656
Authorized - attached units	<u>44</u>	<u>3</u>	<u>1,016</u>	<u>1,063</u>
Total	1,152	188	17,389	18,719
(b) Assigned - organic units	994	154	16,497	17,645
Assigned - attached units	<u>39</u>	<u>3</u>	<u>1,182</u>	<u>1,224</u>
Total	1,033	157	17,679	18,869

b. Replacements: A total of 357 officer and 5988 enlisted replacements were received. During the same period, division losses were 512 officers and 5781 enlisted personnel. Emergency leaves processed during the reporting period totaled 398.

c. Promotions: A total of 5016 enlisted personnel were promoted during the reporting period.

d. Casualties:

CONFIDENTIAL

AVDDH-GC-MH

18 August 1968

SUBJECT: Operational Report - Lessons Learned (RCS CSFOR-65) for
Quarterly Period Ending 31 July 1968 (U)

UNIT	HOSTILE			NON-HOSTILE		
	DEAD	MISSING	WOUNDED	DEAD	MISSING	INJURED
1st Bde	39	0	223	9	0	25
2nd Bde	43	1	258	0	0	19
3rd Bde	22	0	152	2	0	47
DIVARTY	17	0	69	0	0	12
DISCOM	3	0	0	2	0	6
2/1 Cav	11	0	58	0	0	9
1/10 Cav	2	0	49	0	0	32
1/69 Armor	2	0	41	0	0	3
4th Engr	3	0	4	3	0	9
4th Avn	0	0	6	0	0	6
124th Sig Bn	1	0	6	0	0	1
HHC, 4th Inf Div	0	0	0	0	0	0
4th MP Co	3	0	4	0	0	0
4th Admin Co	0	0	2	0	0	3
Scout Dog	0	0	7	0	0	0
E, 20th Inf	2	0	8	0	0	0
E, 58th Inf	1	0	4	0	0	0
4th MI	0	0	2	0	0	0
Total	149	1	893	16	0	172

e. Morale and Personnel Services

(1) Decorations Awarded.

	<u>MAY</u>	<u>JUNE</u>	<u>JULY</u>
Distinguished Service Cross	1	2	3
Silver Star	29	38	23
Legion of Merit	5	14	20
Distinguished Flying Cross	1	4	0
Soldier's Medal	3	0	1
Bronze Star (Valor)	182	204	103
Air Medal (Valor)	3	11	0
Army Commendation (Valor)	73	137	136
Bronze Star (Service)	132	377	187
Army Commendation (Service)	812	1514	655
Air Medal (Service)	343	328	204
Purple Heart	600	362	127
Total	2184	2991	1459

(2) Badges

Combat Infantryman Badge	815	793	868
Combat Medical Badge	108	59	46

CONFIDENTIAL

AVDDH-GC-MH

18 August 1968

SUBJECT: Operational Report - Lessons Learned (RCS CSFOR-65) for
Quarterly Period Ending 31 July 1968 (U)

	<u>MAY</u>	<u>JUNE</u>	<u>JULY</u>
Aircraft Crewman Badge	34	0	0
Miscellaneous Badge	<u>95</u>	<u>38</u>	<u>4</u>
Total	1052	890	918

f. Reenlistments: 171 reenlistments or extension actions were completed. The enlistment/extension breakdown was as follows: first term RA reenlistments-37, AUS enlistments-21, RA extensions-13, AUS extension-3.

g. Postal

- (1) Money Order Sales: \$4,467,045.49.
- (2) Parcel Post and Postal Fees: \$84,872.95.
- (3) Incoming Mail: Sacks-14,110, Pouches-2539, Daily Average-156 Sacks and 28 Pouches.
- (4) Outgoing Mail: Sacks-5588, Pouches-1131, Daily Average-62 Sacks and 12 Pouches.
- (5) Number of mail days: 92.

h. Special Services

(1) The 4th Infantry Division was visited by five USO Shows: Joe Flynn and Bob Hastings hand-shake tour, a Country and Western Variety Show, the Claude Stroud Show, the James Brown Show, and another hand-shake tour with Pat Morrow and Joyce Jillson. Jan Moorehead from the USO office also visited and distributed cigarettes and candy to our infantrymen.

- (2) R&R quotas received were 4120 out-of-country and 995 in-country.
- (3) A total of 114 movies circulated within the division.

i. Chaplain Activities

<u>DENOMINATION</u>	<u>NO. OF SERVICES</u>	<u>ATTENDANCE</u>
Roman Catholic	1022	25,814
Protestant	1555	43,316
Jewish	17	265
Memorial Services	41	

j. Maintenance of Discipline, Law and Order.

- (a) A total of 632 incidents were reported to the Provost Marshal's

CONFIDENTIAL

AVDDH-GC-MH

18 August 1968

SUBJECT: Operational Report - Lessons Learned (RCS CSFOR-65) for
Quarterly Period Ending 31 July 1968 (U)

Office during the period.

(b) Combined police patrols continue in effect. The composition of the patrols varies:

1. One 4th Div MP, one 504th MP, one ARVN policeman (QC), one National policeman (NP), and an ARVN interpreter.

2. Two 4th Div MP, one QC, one NP, and an ARVN interpreter.

3. One 4th Div MP, one 504th MP and three NP.

These patrols operate in the vicinity of CAMP ENARI and PLEIKU City, and provide for handling of all military and civil police problems involving US Forces personnel. Additionally, the 1st Platoon, 4th Military Police Company, serving in support of the 1st Brigade, operates two similar patrols in the DAK TO area, and the 2nd Platoon, supporting the 2nd Brigade initiated two combined patrols in the BAN ME THUOT area.

(c) Checkpoint #31, located at the base of Dragon Mountain, is now operated by two 4th Div MP, one NP, and one QC. This checkpoint searches VIETNAMESE civilian, ARVN, and AMERICAN vehicles passing through on a selected basis. Its primary mission is the control of traffic on Hwys 14S and 19W, with a secondary mission of searching for enemy war materials, contraband, and false identification papers being carried by VIETNAMESE using the road.

(d) A VIETNAMESE National Policeman continues to serve as liaison between the division and LE TRUNG District for police matters. He maintains his office in the Provost Marshal's Office.

(e) A total of seven combined cordon and search operations, consisting of 4th Div MP, National Police, 4th MI Det, G-5, and infantry or cavalry troops resulted in the search of sixteen villages with many detainees captured, some of whom were eventually classified as VMC.

(2) Military Justice

(a) General Court-Martial	11
(b) Special Court-Martial	52
(c) Summary Court-Martial	28

k. Health.

(1) The general health of the division during the quarter remained at a satisfactory level.

(2) Malaria again was the most important medical problem in the division.

CONFIDENTIAL

AVDDH-CC-MH

18 August 1968

SUBJECT: Operational Report - Lessons Learned (RCS CSFOR-65) for
Quarterly Period Ending 31 July 1968 (U)

The increased command emphasis on malaria discipline caused the rates for June to fall to the lowest level since the division arrived in VIETNAM. In June, the vivax rate was 2.1 cases/1000 men/month; the falciparum rate for the same period was 3.5 cases/1000 men/month. The fact that the southwest monsoon brought less rainfall than expected during the quarter undoubtedly assisted command efforts to control malaria. As has been demonstrated in the past, strict emphasis of malaria discipline should render vivax malaria an insignificant problem and minimize the incidence of falciparum malaria.

(3) During the quarter 47 animal bites were reported, resulting in 35 persons taking the rabies immunization series. In an effort to eliminate this problem, an intensified program to vaccinate pets was initiated in June. Military police began collecting animals on post that were not vaccinated and registered. They were then euthanized by the Division Veterinarian. A number of rat bites, inflicted while men were sleeping on the bunker line, could have been prevented by the proper use of mosquito nets. With the arrival of monsoon rains, rats will be driven from their burrows. Maintenance of high standards of area sanitation and use of rat poisons and traps will reduce rodent problems in the area.

7. (C) Engineer

a. Intelligence:

(1) Aerial reconnaissance of LLOC's were conducted within the AO. Ground reconnaissance of bridge and culvert inspection was conducted from convoy bound vehicles.

(2) Mining Incidents:

<u>Anti-tank</u>		<u>Other</u>	
Plastic	33	Command detonated	1
Homemade	25	Anti-personnel	6
Unknown	88	Total	7
Total	136		

b. Operations and Training:

(1) Operations. During this quarter the 4th Engineer Battalion (Combat) directed engineer effort from the battalion CP located at CAMP ENARI. Companies A, B and C worked in direct support of the 1st, 2d and 3d Brigades respectively. Company D was committed to general support until the later part of the reporting period when it exchanged missions with Company C. Company E (Bridge) supported the division with tactical bridging, transportation, and assistance in base camp projects. Headquarters and Headquarters Company continued in a general support role.

CONFIDENTIAL

CONFIDENTIAL

AVDDH-GC-MH

18 August 1968

SUBJECT: Operational Report - Lessons Learned (RCS CSFOR-65) for
Quarterly Period Ending 31 July 1968 (U)

(2) Training:

(a) Unit leaders were required to review bridge classification, engineer reconnaissance, and techniques of safe bunker construction.

(b) The Engineering Rappelling Platoon (ERP) conducted training at periodic intervals to maintain its capability to enter an area and clear an LZ quickly.

c. Logistics:

(1) Chainsaw problems have become less acute with the receipt of 40 additional chainsaw and certain repair parts.

(2) Six 65 gpm pumps were received for the 600 pgh water purification units.

(3) Difficulty has been experienced in keeping the M60A1 AVLB operational. Few support maintenance personnel are knowledgeable in M60A1 repair. This is due to the high density of M48 model tanks in RVN.

d. Engineer:

(1) The AN/PRS-4 mine detector was tested during the reporting period. It was found to be effective in locating both metallic and non-metallic mines. Disadvantages include greater weight and less rugged construction than the Polar 153.

(2) There has been a lack of proper maintenance support for a dozer on forward firebases. Well qualified operators need to be provided to insure good operating techniques and maintenance procedures. Every two weeks the dozers should be lifted to a base area for thorough organizational maintenance.

(3) Periodic bunker inspections throughout the division indicated several areas which need to be improved:

(a) Stringers need to be braced on timber supports, not sandbags.

(b) The spans on roof beams should use a center support if the distance is over four feet.

(c) PSP should be used to supplement basic timber structure, not as a roof stringer.

(d) Timber supports should be notched to secure roof stringers.

(e) Interceptor ditches, drainage pits or sumps and waterproofing on the roof will lengthen bunker life.

34

CONFIDENTIAL

CONFIDENTIAL

AVDDH-GC-MH

18 August 1968

SUBJECT: Operational Report - Lessons Learned (RCS CSFOR-65) for
Quarterly Period Ending 31 July 1968 (U)

8. (C) Army Aviation Operations

Operational Totals for the Quarter

	<u>Co A</u>	<u>Co B</u>	<u>Bn Total</u>
a. Sorties	14,778	11,893	26,671
b. Hours Flown	4,614	2,015	6,629
c. Troops Lifted	26,985	2,261	29,246
d. Tons of Cargo	553	N/A	553
e. Aircraft Flares	447	N/A	447
f. Ammo Expended (7.62, 2.75, 40mm)	61,700	358,500	420,200

9. (U) Inspector General.

a. The FY 68 Annual General Inspection Program was completed during the period.

b. Beginning on 24 June a program of Courtesy AGI's initiated to prepare those units scheduled to be inspected by the USARV IG in September. This program will continue until 20 August.

c. No complaints were received by this office during the reporting period. Numerous personnel visited the office to request assistance.

10. (U) Signal

a. Operations.

(1) There were two major changes in the Division Area Communication System.

(a) The first major alteration occurred 24 May to 10 June on Operation TF MATHEWS. A 4th Division TOC was located with 1st Bde Hq at DAK TO and the 3rd Bde, 101st Airborne Division was attached to the 4th Infantry Division and located at the old DAK TO Air Field. To support the 4th Div forward TOC, the 124th Sig Bn furnished the following.

1. One (1) AN/MTC-3 switchboard to DAK TO. One-half of the switchboard was used to provide the TOC with common user trunking service while the remainder was used as a TOC switchboard to provide direct hot line service for the TOC.

2. one (1) AN/VRC-49 (FM Retransmission) at DAK TO, MACV for Division Command Net #1.

3. Two (2) RT-524 and two (2) RC-292 were employed in the TAC Hqs.

18 August 1968

SUBJECT: Operational Report - Lessons Learned (RCS CSFOR-65) for
Quarterly Period Ending 31 July 1968 (U)

4. One (1) AN/MSC-31 to DAK TO. The Assistant Division Signal Officer established a 4th Inf Div SYSCON (System Control) and controlled all communications for the TF.

5. Long distance trunking circuits were provided over the existing UHF systems.

6. To support the 3d Bde, 101st Abn Div the 124th Sig Bn furnished the following:

a. Two (2) AN/MRC-69 to 3/101 CP to terminate two (2) VHF systems. One to connect them with 4th Div TOC and the other to connect them with 4th Div Main via a relay located at Dragon Mountain.

b. One (1) AN/MRC-69 at DAK TO and one (1) AN/MRC-69 at CAMP ENARI to terminate the systems described above.

c. To provide the 3/101 Abn a complete Forward Area Support Center, they were provided at their CP location: One 5B-611 Patch Panel, one AN/MTC-7 switchboard, one AN/MGC-17 Message Center.

d. When the 3/101 Abn deployed a forward CP into the DAK PEK area, a UHF system was established from DAK TO to DAK PEK via a relay located at BEN HET. Upon departure of 3/101 Abn from DAK PEK area the 3/8 Inf move onto Hill 1270. A four channel VHF system was installed and operated from DAK TO to Hill 1270.

(b) The second major alteration occurred on 15 July with the relocation of 2d Bde to BAN ME THUOT and 3d Bde to OASIS. Another element equivalent to a FASC platoon was provided for the 2d Bde. The platoon which had supported the 2d Bde prior to the move remained in position to support the 3d Bde. Circuits to provide 2d Bde access to Div Main were established over a TROPO system from Dragon Mountain (D6M) to BAN ME THUOT. The circuits were extended to 2d Bde CP via a 12 channel VHF system. The circuits were extended from Dragon Mountain to Div Main and KONTUM, where the 3d Bde was previously located, one was deactivated. The FASC platoon has remained in KONTUM in anticipation of the arrival of another Bde into that area.

(2) A change occurred in the division's tactical trunking circuits when an AN/MTC-1 operated by the 124th Sig Bn was placed in operation on VHF Hill. A tactical trunk service was discontinued from the CAMP ENARI switchboard and is now routed through FAMOUS. This was accomplished in anticipation of the establishment of the Dial Central Office. Also affected under this plan is the removal of the FAVOR switchboard to be completed by mid-August.

(a) The 124th Sig Bn was relieved of the responsibility for rebroadcasting of Armed Forces Radio Service with the establishment of the 50,000 watt station at CAMP ENARI.

18 August 1968

SUBJECT: Operational Report - Lessons Learned (RCS CSFOR-65) for
Quarterly Period Ending 31 July 1968 (U)

(U) After an extensive training program the AN/GRC-142's were placed in operation and are currently being utilized for Net #3 (Div Comd Opns Net). Current locations of AN/GRC-142 as operational stations are as follows:

1. 1st and 3d Bde Hq, (provided and operated by Bde Communication Platoon Personnel).
2. 2d Bde Hq, CAMP ENARI (NCS), and 2/1 Cav Hq (Provided and operated by 124th Sig Bn).

b. Logistics

(1) The Division Distribution Authority (DISTR) has received 135 TSFC/KY-38 which is the secure voice for the AN/PRC-77. Proposals for distribution and issue are currently in progress and it is expected that operational nets will be established in late August.

(2) Eight (8) of a scheduled twelve (12) AN/GRC-142 Radio Teletype Sets, replacements for the AN/GRC-46, were received.

(3) Shortage of TOE power units is the most pressing logistical problem of the 124th Sig Battalion.

11. (U) Information Activities.

a. Because of the division's combat action in May against the 1st NVA Division west of KONTUM and the 325C Division in the DAK TO-Tri-border area there was more interest shown by the news media toward the 4th Division than had been experienced since the Battle for DAK TO. During May, 56 civilian new media representatives visited the division, the majority coming the last week in May to cover TASK FORCE MATHEWS operations. All major wire services and three TV networks were on hand. During the remainder of the quarter 34 more newsmen visited the Division. BG S.L.A. Marshal (ret) also visited the division in May where he was briefed by the Commanding General and visited forward battalion areas.

b. The world-wide quarterly report for the U.S. Army Home Town News Center for the last quarter of FY 68, revealed that the Ivy Division had more DS Forms 1526, Information for Home Town News Release, processed than any other reporting unit in the Army. The first two months of this reporting period, May and June, were included in this total. For the month of July still another new high was reached when 3989 hometowners were processed and sent to the Center.

c. The Division Chapter of the National 4th Infantry (Ivy) Division Association was very active during this period with 2321 new members added, bringing the chapter total to 5056. Two major projects were taken on during

18 August 1968

SUBJECT: Operational Report - Lessons Learned (RCS CSFOR-65) for
Quarterly Period Ending 31 July 1968 (U)

the period, the kick-off of the 4th Division Scholarship Fund drive, and the selection of a chapter representative to attend the annual reunion at Boston, Mass., the first weekend in August. The mechanics of the Scholarship Fund were established and published in Div Reg 230-4. In June the first payroll drive was held and the chapter transferred \$10,000 to the fund accounting. By the end of the period \$29,900.89 toward the goal of \$150,000 had been collected. The Board of Governors of the Chapter selected from six candidates from the major commands, SGM Guy Sullivan, 1st Battalion, 35th Infantry, to represent the Chapter at the Annual Reunion being held this year in Boston on 2-4 August. The SGM will return to the division and give a report to the CG on the reunion. He will also present a report of the division's operations during the past 12 months in the form of a slide presentation to the assembled members.

d. The Assistant Information Officer travelled to Tokyo, Japan, on 17 July in order to procure \$3,000 in photographic and sound-recording equipment from Central Post Welfare Funds. He is also supervising the printing of a historical booklet on the 4th Division. The \$2000, cost of this booklet came from Central Post Welfare Funds. The book is expected to be delivered by mid-August.

CONFIDENTIAL

AVDDH-GC

18 August 1968

SUBJECT: Operational Report - Lessons Learned (RCS CSFOR-65)
for Quarterly Period Ending 31 July 1968 (U)

Section 2 (C) Lessons Learned: Commander's Observations, Evaluations and Recommendations.

1. (U) Personnel - None.
2. (C) Operations.
 - a. Night LZ Extractions

Observation: Artificial illumination assists in final extractions conducted during the hours of darkness.

Evaluation: Even during daylight hours, final extraction from an LZ is an extremely sensitive task that requires detailed planning and coordination. This problem is even greater during periods of darkness. The employment of flare ships inhibits enemy action, minimizes unfavorable flying conditions, and allows the use of daylight techniques for final extraction.

Recommendation: That when a night extraction is planned, consideration should be given to the employment of flare ships to permit daylight extraction techniques.

- b. Use of "Natural" LZs

Observation: In extremely difficult terrain, natural LZs should be located and recorded for future use.

Evaluation: During combat operations, the preparation of LZs are recorded, units can be directed to these locations for resupply and evacuation; often with a considerable saving of time, materiel and effort.

Recommendation: That LZs requiring little or no preparation should be recorded and maintained on file to facilitate planning for future operations.

- c. LP Bunker

Observation: LP bunkers should not be connected to the perimeter by a communication trench.

Evaluation: It has been discovered that the enemy will utilize a communication trench connecting an LP bunker to the main perimeter for an approach into the perimeter. In one instance, as an LP withdrew after detecting heavy movement around his positions, the enemy followed him along the trench; an enemy ground attack was subsequently launched and succeeded in penetrating the perimeter through the same trench.

CONFIDENTIAL

CONFIDENTIAL

AVDDH-GC

18 August 1968

SUBJECT: Operational Report - Lessons Learned (RCS CSFOR-65)
for Quarterly Period Ending 31 July 1968 (U)

Recommendation: That units do not construct communication trenches leading from the main perimeter.

d. Integration of CSF Elements into US Unit

Observation: Integration of CSF elements with US units during combat operations can be beneficial to the success of the Operation.

Evaluation: Because of their knowledge of the land, native CSF elements make excellent guides, scouts and security elements when integrated with US line elements. Unit commanders report great success in integrating these elements; the CSF unit was reinforced with firepower, and the US unit became more effective in its reconnaissance operations. Finally, integration of these elements fostered a mutual respect and sense of cooperation between both elements.

Recommendation: That US units capitalize on the indigenous knowledge of CSF elements by making maximum use of integration with US units.

e. Use of Trip Flares

Observation: Because of restrictions placed on long range employment of booby-traps, another early warning device has been devised.

Evaluation: Trip flares placed in four concentric belts around a fixed installation provide satisfactory long range early warning when coupled with a hand flare. The device called a "Bauer Flare" operates when the trip flare activates the hand flare. It has been successfully observed at distances up to six kilometers and is ideally suited to trigger an artillery concentration.

Recommendation: That units operating from fixed bases establish trip-flare and Bauer Flare early warning devices to improve their defensive posture.

f. Mine Detection

Observation: Standard mine detection devices alone are not adequate to locate all mines, especially the plastic anti-tank mines.

Evaluation: A continued use of plastic mines by the NVA has resulted in an increased road hazard. Plastic mines are undetectable by the metallic mine detector. Consequently the only successful detection continues to be the eye and the bayonet. This technique coupled with the use of metallic

CONFIDENTIAL

CONFIDENTIAL

AVDDH-GC-MH

18 August 1968

SUBJECT: Operational Report - Lessons Learned (RCS CSFOR-65) for
Quarterly Period Ending 31 July 1968 (U)

detectors can decrease a likely hazard. Foot prints along the shoulders of the road, fresh piles of dirt in nearby shrubs or an overly symmetrical depression in the road are all indicators. Another technique is in the formation and composition of the sweep team as shown on the following page.

Recommendation: That the above formation be employed by units conducting road sweep operations.

g. Integration of Kit Carson Scout and Scout Dogs

Observation: The combined use of Kit Carson Scouts with Scout Dogs for small unit patrols improves the ability of the patrol to perform its mission. The advantage of the Kit Carson's knowledge of the terrain coupled with the Scout Dogs capability to provide sufficient warning of enemy approach is an effective combination.

Evaluation: It has been found that employing the Kit Carson Scouts with Scout Dogs for small unit patrols, enhances the ability of the patrol to perform its mission. The advantage of the Kit Carson's knowledge of the terrain coupled with the Scout Dogs capability to provide sufficient warning of enemy approach is an effective combination.

Recommendation: That Kit Carson Scouts and Scout Dogs be employed with small unit patrols as often as possible,

h. Use of Saturation OP's and LP's

Observation: It has frequently been found that enemy build-up for an attack cannot be detected through the use of conventional air and ground reconnaissance techniques. This is especially true when the enemy is intimately familiar with the terrain and when he chooses to confine his movements to the hours of darkness.

Evaluation: In operations in the BAN ME THUOT area involving three infantry battalions with the mission of preempting an anticipated attack on the city, extensive use is being made of four to five man groups equipped with a radio located on high ground and astride likely infiltration routes. The mission of these groups which remain stationary, is to detect and give warning of all enemy movement. This technique was also used successfully in the POLEI KLENG area, where an entire battalion was employed in this role, utilizing radios drawn from other units.

Recommendation: That where intelligence indicates an enemy build-up for an impending attack on a defensive position or area which must be protected, extensive use be made of four to five man groups equipped with a radio to cover all likely routes into the area. To provide complete saturation of an area, an entire battalion should be employed to provide the reconnaissance screen.

CONFIDENTIAL

CONFIDENTIAL

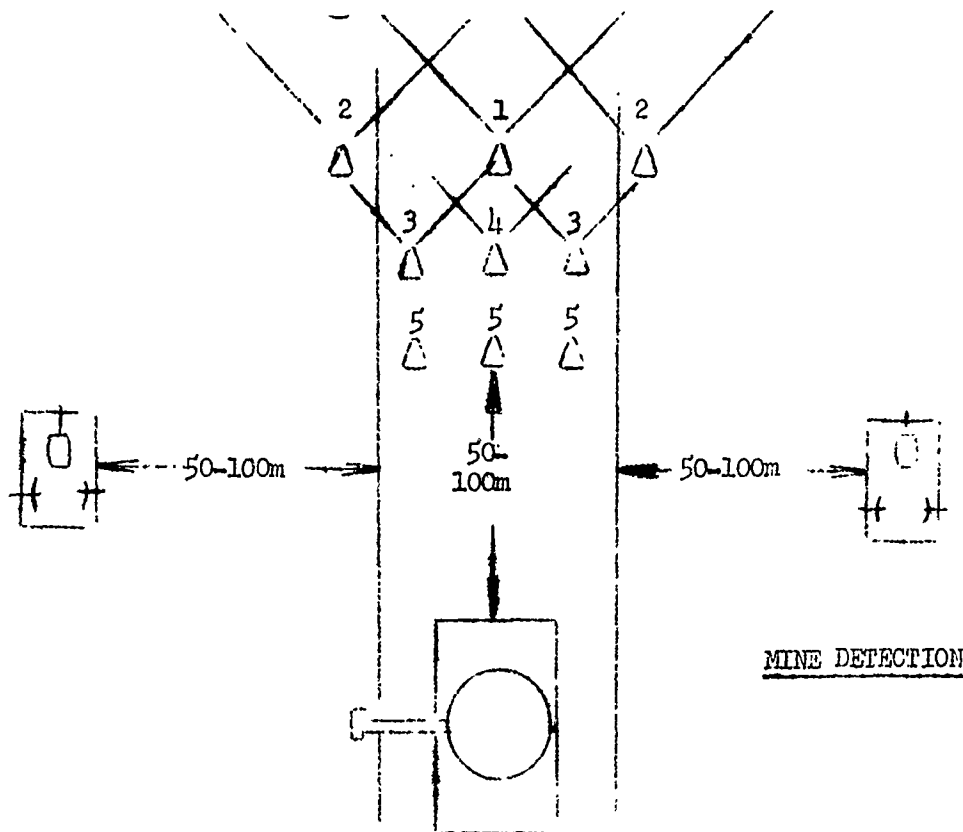

1. Pointman: Surveys road surface for signs of tampering, soil discoloration or footprints.
2. Dismounted shoulder sweepmen: Look for wires (command detonated) fresh dirt under shrubs or in grass.
3. Visual sweepmen: Visually check outside portion of road for physical indicators while operating metallic detector.
4. Center Sweepmen : Sweeps center portion of road visually and with mine detector.
5. Probers: Assist sweepmen by probing any unusual areas.
6. Security: ACAV's provide flank security while lead tank or vehicle remains sufficiently far enough to the rear to preclude injury to the sweepmen in case it hits a missed mine.

CONFIDENTIAL

CONFIDENTIAL

AVDDH-GC

18 August 1968

SUBJECT: Operational Report - Lessons Learned (RCS CSFOR-65)
for Quarterly Period Ending 31 July 1968 (U)

i. NVA Tactics

Observation: Enemy tactics during a recent engagement suggests that the NVA forces select targets by orienting on the shout of "Medic."

Evaluation: During an engagement with a large NVA force, a US platoon received four WIA. Following the initial exchange of fire, the enemy patiently waited until the WIA shouted "Medic" and then took the area under intense fire. The correlation between shouts for medic and incoming fire over a period of time suggests the validity of the observation.

Recommendation: Shouts for aid on the battle field should be no louder than necessary, and covering fire must be provided for personnel moving to the aid of wounded.

j. Fabricated Spray Bar for AGAVENCO System

Observation: An aircraft must fly at speeds in excess of 50 knots to provide enough pressure to open the valves in the AGAVENCO spray system. In the small cultivated fields encountered in the highlands, 50 knots is too fast to provide adequate and effective coverage for crop destruction.

Evaluation: A locally fabricated spray bar can be used effectively in crop destruction missions. By replacing the standard spray bar with a 20-foot piece of one inch water pipe drilled with $\frac{1}{4}$ " holes, less pressure is required to operate the system, and the aircraft can fly at 20-30 knots, an acceptable airspeed for crop destruction.

Recommendation: That the AGAVENCO system with locally fabricated spray bar be used as the primary crop destruction spray system.

k. The E-8 Tactical CS Launcher on Armored Vehicles

Observation: The E-8 Tactical CS Launcher can be mounted on armored vehicles and used effectively in convoy operations.

Evaluation: Mounts can be locally fabricated from angle iron and scrap metal on which E-8 Launcher can be easily attached on any armored vehicle. The Launchers can be employed in recon by fire and for counter ambush.

Recommendation: That armored vehicles engaged in convoy security or

CONFIDENTIAL

CONFIDENTIAL

AVDDH-GC

18 August 1968

SUBJECT: Operational Report - Lessons Learned (RCS CSFOR-65)
for Quarterly Period Ending 31 July 1968 (U)

road security have E-8 Launchers mounted and ready for use at all times.

1. Circuit Breakers for Airborne Personnel Detectors

Observation: Fuse wells in Airborne Personnel Detectors (APDs) are a source of trouble due to lack of replacement fuses.

Evaluation: N/A

Recommendation: That APDs issued to the division be modified by replacing the fuse wells with circuit breakers.

m. S-5's and Tactical Operations

Observation: Sector S-5's could be more advantageously employed to assist in the conduct of Tactical Operations within their sectors.

Evaluation: Operations conducted within the Division TAOR would cause less unnecessary property damage to friendly indigenous personnel if proper coordination were made with S-5 teams responsible for the areas concerned prior to the initiation of tactical operations. The familiarity of Sector S-5 personnel would allow for the determination of friendly agricultural projects, temporarily abandoned hamlets and population habits and customs. The participation of S-5 personnel in the conduct of tactical operations would provide a verifying element to determine the status of otherwise suspicious and questionable cultivated or occupied areas.

Recommendation: That tactical units make coordination with appropriate Section S-5 personnel prior to the initiation of tactical operations with the TAOR.

3. (C) Training

a. Determining Direction and Distance to Key Terrain Features

Observation: Because of the difficult terrain in the Central Highlands, the individual soldier requires intensive training in determining the direction and distances to key terrain features to his front while occupying a defensive position.

Evaluation: With proper training, the individual soldier can render accurate and timely reports on the location of enemy fire. This training is easily accomplished while the unit is occupying a fire base. The training involves the use of target detection techniques and a compass. An individual

CONFIDENTIAL

CONFIDENTIAL

AVDDH-GC

18 August 1968

SUBJECT: Operational Report - Lessons Learned (RCS CSFOR-65)
for Quarterly Period Ending 31 July 1968 (U)

so trained can provide information to bring rapid suppressive fires on the enemy.

Recommendation: That all units conduct training in firebases in the determination of accurate direction and distance to key terrain features.

4. (C) Intelligence

a. Use of AN/PPS-5 Radar for Convoy Security

Observation: It has been demonstrated that the AN/PPS-5 radar is an effective addition to convoy security.

Evaluation: On several occasions during the reporting period the AN/PPS-5 proved effective for increasing convoy protection. When situated on observation posts overlooking the LLOC, it can detect the enemy planting mines or his movement with a high degree of accuracy, enabling direct or indirect fire to be brought on the enemy without visual contact.

Recommendation: That AN/PPS-5 radar sets be used where feasible in a convoy protection role.

b. Patrolling

Observation: Immediately upon occupation of a new area a rifle company should conduct aggressive saturation patrols out to a distance of four kilometers.

Evaluation: Patrolling at company level is common practice; however, often these patrols are few in number and traverse distances of only 500-1000 meters. In at least one instance in the area of DAK PEK SF Camp, a unit occupied a defensive position and did not discover an enemy force located 3000 meters away until the US unit was attacked the second night. Indications subsequent to the attack revealed that the enemy force had occupied the same position the previous night; however, because of the 1500 meter limit of the US patrols, the enemy location was not discovered.

Recommendation: That aggressive patrolling to a distance of 4,000 meters be done immediately upon occupation of a new area.

c. NVA Diversionary Tactics

Observation: Enemy forces utilize small elements to draw fires of a FSB as a diversion to bypass the FSB.

CONFIDENTIAL

CONFIDENTIAL

AVDDH-GC

18 August 1968

SUBJECT: Operational Report - Lessons Learned (RCS CSFOR-65)
for Quarterly Period Ending 31 July 1968 (U)

Evaluation: Activities around LZ BRILLO PAD during the first part of July revealed that significant enemy elements infiltrated the valley system east of that location. During the same period, sporadic attacks by fire during evening hours were launched on BRILLO PAD from CU PU mountain 2 kilometers west of BRILLO PAD. Also, attacks by fire were received by LZ BUNKER HILL during this time. The intensity of the attacks indicated that a small force was involved. Concentration of artillery fires, a normal procedure, probably increased the enemy's ability to bypass both BRILLO PAD and BUNKER HILL.

Recommendation: That before massing artillery fires during a series of sporadic attacks, consideration should first be given to the possibility of an enemy attempt to create a diversion in order to bypass.

d. Searching PWs

Observation: On a recent mission, a PW was said to have been thoroughly searched by the capturing unit. On closer inspection two double edge razor blades were concealed in the PWs shirt pocket.

Evaluation: The razor blades lay flat against the individual's chest and should have been easily spotted. The insertion of the hand into the pocket while searching could have resulted in severe cuts.

Recommendation: That capturing units tear the pockets from the shirts of PWs and make a visual search for similar small weapons.

5. (C) Logistics

a. Plastic and Cloth Sandbags

Observation: Experience has proven that the cloth sandbag is more versatile than the plastic sandbag.

Evaluation: Vertical construction almost always demands the use of cloth bags since they are less prone to slip and fall. The plastic bag is satisfactory for horizontal construction. The plastic bag is more durable than the cloth bag, but is very susceptible to slipping. The plastic bag is acceptable for use in revetment walls, blast shields and in open-topped fighting positions for crew served weapons.

Recommendation: That only cloth bags be used for side-wall construction of bunkers and all vertical construction over four feet in height. Neither bag should be used as a weight bearing surface or for support.

CONFIDENTIAL

CONFIDENTIAL

AVDDH-GC

18 August 1968

SUBJECT: Operational Report - Lessons Learned (RCS CSFOR-65)
for Quarterly Period Ending 31 July 1968 (U)

b. Vitamin Supplements

Observation: The incidence of rashes and infections is related to vitamin deficiency.

Evaluation: Vitamin tablets were issued to the forward elements of one battalion for one month. With no change in operations or requirements during this period, the incidence of infectious rashes, heat rashes, and minor infections was reduced considerably.

Recommendation: That multi-vitamin tablets be made available in sufficient quantity to allow regular use.

c. UH-1H Rotational Maintenance Humps

Observation: The 4th Aviation Battalion received all of its UH-1H aircraft during a short time span. This has caused the majority of the aircraft to enter scheduled maintenance at the same time.

Evaluation: Every 100 hours each army aircraft must undergo an extensive inspection termed the Periodic Inspection. A rotational maintenance problem occurs when it is time for a Periodic Inspection since most of the helicopters reach the 100 hour mark within the same general time frame. The length of time required to perform the Periodic Inspection varies according to the number of parts that need replacement and the availability of these parts.

Recommendation: That spacing in aircraft maintenance be accomplished similar to the DEROS on individuals. Aviation units arriving in an overseas theater should infuse aircraft with other aviation units to avoid the maintenance hump.

d. Resupply by Helicopter

Observation: Turbulence in mountainous terrain causes hazardous flying conditions, often making resupply of friendly units difficult or impossible.

Evaluation: In extremely mountainous terrain where only DZs are available and unsafe flying conditions due to turbulence preclude hovering, a sling employed under a UH-1 helicopter for a "quick drop" facilitates the operation.

Recommendation: That UH-1 aircraft sling load resupply items when terrain or weather prohibits normal resupply techniques.

CONFIDENTIAL

CONFIDENTIAL

AVDDH-GC

18 August 1968

SUBJECT: Operational Report - Lessons Learned (RCS CSFOR-65)

2 for Quarterly Period Ending 31 July 1968 (U)

6. (U) Organization - None.
7. (C) Tactical Cover and Deception

Enemy Evasive Patterns

Observation: After daylight operations, US units are often required to leave their AO before nightfall to establish security of a populated area. Over a period of several days, the enemy soon recognizes this pattern and can easily evade friendly forces when they return to their area of operations the following day.

Evaluation: In one instance, friendly forces realized the enemy's evasive pattern and moved infantry forces into ambush positions along enemy withdrawal routes within the friendly AO. At first light, an armored force entered the AO in accordance with their previously established pattern. Two of the ambushes intercepted enemy withdrawing hastily from the mechanized force.

Recommendation: That ambushes be used to capitalize on a pattern of enemy reaction to friendly operations.

8. (C) Other

A. Civil Affairs

(1) Control of Rice Sales

Observation: Intelligence sources have substantiated that NV/NVA elements have forced excessive rice purchases from local villagers as a means of resupply.

Evaluation: Indigenous families often require purchased rice to supplement their regular crop production. NV/NVA forces attempt to collect a variable portion of each family's rice supply regardless of US Civic Action assistance. To discontinue making purchased rice available would create extreme hardship among the villagers. The formation of consolidated, fortified villages also requires a commitment to provide assistance in economic functions while the newly introduced civic improvements are being accomplished. Documenting rice purchases made by the villages will preclude excessive amounts of rice purchased, insure an adequate supply for the villages, and require enemy forces to alienate themselves from the civilian population when attempts are made to tax this amount. An inventory of rice available within a village, and a record of rice consumed within a given period will provide some basis for the control of rice.

CONFIDENTIAL

CONFIDENTIAL

AVDDH-GC

18 August 1968

SUBJECT: Operational Report - Lessons Learned (RCS CSFOR-65) for Quarterly Period Ending 31 July 1968 (U)

Recommendation: That a proposed rice purchase be cleared through a control authority a minimum of 24 hours prior to the desired date of purchase. After determining the minimum rice needs of a village, a comprehensive file should be kept to provide a record of all unusually large purchases.

(2) CA Teams and Local Customs

Observation: It is a mistake to assume that a civil affairs project should not be attempted because it apparently violates customs and taboos.

Evaluation: Undesirable traditions can be changed if the alternatives are properly presented. In the consolidated village of PLEI KING BRECH the MONTAGNARD practice of keeping their livestock under their homes was creating a serious sanitation problem. A CA team recommended to the village chief that all livestock be penned outside the village. The village chief decided to take the advice of the CA Team and build cattle pens outside the village.

Recommendation: That CA Teams demonstrate to the people that the change will be to the advantage of the village. Often the traditional taboos and customs of the MONTAGNARDS will be readily changed if an alternative is properly presented.

(3) MONTAGNARD Injuries on US Vehicles

Observation: Several vehicle accidents within a short period of time have involved MONTAGNARD passengers who fell from the rear of moving US Army vehicles.

Evaluation: MONTAGNARD passengers in US military vehicles require greater supervision than US personnel. The unfamiliarity with basic safety practices and the great excitement experienced by MONTAGNARDS riding in a moving vehicle necessitates a safety lecture and positive supervision during the conduct of any vehicle movement.

Recommendation: That all units involved in the transportation of indigenous civilians require a safety lecture prior to boarding the vehicle, and the presence of a responsible US individual in the same passenger compartment as the indigenous personnel. The supervisor should insure that all indigenous personnel sit, and remain seated, during the duration of the ride.

B. Engineer

(1) Over-reliance on Airmobile Engineer Equipment

CONFIDENTIAL

CONFIDENTIAL

AVDDH-GC-MH

18 August 1968

SUBJECT: Operational Report - Lessons Learned (RCS CSFOR-65) for
Quarterly Period Ending 31 July 1968 (U)

Observation: Units have tendency to over-rely on airmobile engineer equipment.

Evaluation: Airmobile engineer equipment is a "nice to have" item. However, this equipment is subject to numerous maintenance problems when located at a fire base for more than one week. The 3414 Tractor, D-5A, D-6B, and Case 450 dozers have all experienced maintenance difficulties away from good maintenance facilities.

Recommendation: That airmobile engineer equipment be committed for a limited period of one to two weeks to firebases, and then returned to brigade base areas for thorough maintenance.

(2) Shortage of Airmobile Rigging Equipment.

Observation: Difficulty has been experienced in securing airmobile rigging equipment for rapid response to operations.

Evaluation: It has been difficult at time to secure sufficient slings and cleavices to move a piece of heavy equipment. Rigging equipment rapidly becomes lost or unserviceable over a period of several sorties.

Recommendation: That direct support engineer companies have available to them a basic issue of twenty (20) feet, 20,000 pound slings, 30 cleavices, and five donut rolls.

(3) AVLB and Rough Terrain

Observation: The Armored Vehicle Launched Bridge (AVLB) is not suited for rough terrain.

Evaluation: The AVLB has proven too top heavy for operations in exceptionally rough terrain. Insufficient maintenance support add to the complications of a long distance mission. Air lifted dry gap spans (MAT6) can often be emplaced more quickly and with greater assurance, when a long distance mission is involved.

Recommendation: That AVLB's be used on a very limited basis and primarily on short distance missions on roads or good trails.

(4) Removal of MAT6 Float Bridge

Observation: Too much time is wasted removing the MAT6 float bridge.

Evaluation: Much of the time in removing a float bridge is taken up by washing the mud off the bridge, removing the end ramps, and unpinning the bridge. Since this takes only a squad of men, these details can be accomplished one day prior to the actual removal of the bridge while the rest of the unit is conveying to the site.

CONFIDENTIAL

AVDDH-GC

18 August 1968

SUBJECT: Operational Report - Lessons Learned (RCS CSFOR-65) for Quarterly
Period Ending 31 July 1968 (U)

Recommendation: That one squad equipped with a 250 cfm compressor for cleaning of the bridge be dispatched one day prior to the removal of the bridge.

(C) Signal

Use of Secure Mode

Observation: Use of the secure mode on the command net blocks traffic on that frequency between radios not on secure mode.

Evaluation: A "secure-only" radio frequency has been established apart from the Command A frequency. The operation of this net requires one additional radio at each monitoring station. This method prevents the back-log of clear, routine traffic from completely monopolizing the net following extended secure messages.

Recommendation: That units experiencing message back log on their Command A frequency consider the establishment of a secure-only net.

6 Inclosures
as
Incl 2,3,5,6 w/d Hq, DA

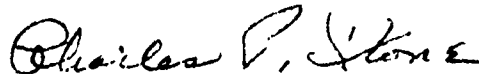

CHARLES P. STONE
Major General, USA
Commanding

CONFIDENTIAL

CONFIDENTIAL

AVFA-GC-OT (18 Aug 68) 1st Ind
SUBJECT: Operational Report of Headquarters, 4th Infantry Division
for Period Ending 31 July 1968, ACS CSFOR-65 (RI) (U)

DA, Headquarters, I Field Force Vietnam, APO 96350 14 SLP 1968

TO: Commanding General, United States Army Vietnam, ATTN: MVEHC-DJT,
APO 96375

(C) This headquarters has evaluated the subject report and makes the following comments or recommendations.

a. Reference paragraph 2f(2), Section 1, page 11, Enemy Vulnerabilities. Within the 4th Infantry Division Area of Operations (AO) additional enemy vulnerabilities are:

- (1) Shortages of medicine and proper medical facilities.
- (2) Effects of the monsoon season on enemy movement of supplies and men.
- (3) Low morale due to sickness, lack of significant victories and fear of death.

b. Reference paragraph 2j, Section 2, page 43, Fabricated Spring Bar for AGAVENCO Systems. This headquarters has recommended to the 4th Inf Div that an EIR be submitted on the spray bar.

c. Reference paragraph 2k, Section 2, page 43, the E-8 Tactical CS Launcher on Armored Vehicles. The use of the E-8 Tactical CS Launcher does not warrant an EIR as it is a field expedient and the proper place to mount the launchers can best be accomplished by using unit SOP's.

d. Reference paragraph 2l, Section 2, page 44, Circuit Breakers for Airborne Personnel Detectors. This headquarters has recommended to the 4th Inf Div that an EIR be submitted on the circuit breaker for APD's.

e. Reference paragraph 8b(1), Section 2, page 49, Over-Reliance on Airmobile Engineer Equipment. Airmobile engineer equipment (AEE) is most essential for the timely construction of fire support bases in the highlands area. Due to the low density of AEE, maintenance problems presently being experienced are due to the lack of sufficient demand data for parts to establish adequate PLL's.

f. Reference paragraph 8c, Section 2, page 50, Use of Secure Mode. Experience indicated the use of the secure mode will increase the number of radios needed for combat operations. Recommend that the appropriate agencies consider the fact that additional radios may be required in the TO&E or that radio sets of the future have increased capabilities.

52

CONFIDENTIAL

CONFIDENTIAL

AVTA-GC-CT (18 Aug 68)

SUBJECT: Operational Report of Headquarters, 4th Infantry Division
for Period Ending 31 July 1968, RCC CSFCR-65 (R1) (U)

g. Reference paragraph 15a, Inclosure 6, page 22, Control of Army Aviation. For any multi-battalion operations, the supporting aviation unit should provide necessary personnel, with communications equipment, for liaison with the supported units, and for coordination and control of airmobile assets.

h. Reference paragraph 15b, Inclosure 6, page 22, Need for Airmobile Engineer Equipment (AEE). Actions have been taken by this headquarters to increase the AEE assets in the II CTZ. Six airmobile modification kits (dollies) have been requested from COMUS by USARV. The lead time to II CTZ is four to six months. A MTOE would be unfavorably considered at this time due to the shortage of the M6B bulldozer with adapter kits.

FOR THE COMMANDER:

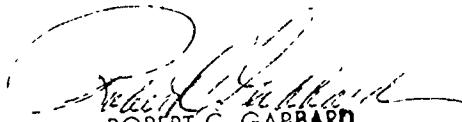
ROBERT C. GABBARD
ILT, AGC
ASST ADJUTANT GENERAL

Copies furnished:
2- CSFCR, DA
1-4th Inf Div

CONFIDENTIAL

AVHGC-DST (18 Aug 68) 2d Ind (C) MAJ Klingman/ds/LEN 4433
SUBJECT: Operational Report - Lessons Learned (RCS USFOR-65) for Quarterly
Period Ending 31 July 1968 (U)

HEADQUARTERS, UNITED STATES ARMY, VIETNAM, APO San Francisco 96375 22 OCT 1968

TO: Commander in Chief, United States Army, Pacific, ATTN: GPOP-DT,
APO 96558

1. (U) This headquarters has reviewed the Operational Report-Lessons Learned for the quarterly period ending 31 July 1968 from Headquarters, 4th Infantry Division.
2. (C) Comments follow:
 - a. Reference item concerning plastic and cloth sandbags, page 46, paragraph 5a. This headquarters has prepared a list of instructions for all Army commands concerning construction techniques to be used with plastic sandbags.
 - b. Reference item concerning vitamin supplements, page 47, paragraph 5b: Nonconcur. The empirical observation that daily multivitamins reduced the incidence of various rashes and infections of the skin does not constitute sufficient evidence to warrant the routine use of multivitamin tablets on all personnel.
 - c. Reference item concerning UH-1H rotational maintenance humps, page 47, paragraph 5c: Nonconcur. The responsibility for staggering periodic inspections rests with the owning unit, and is an important element of maintenance management.
 - d. Reference item concerning use of secure mode, page 51, paragraph 8c; and 1st Indorsement, paragraph f: Nonconcur. The basis of issue for KY-8/KY-38 for the division, when distribution is completed, will provide sufficient secure voice equipment to all organizations required to enter the command net. This matter will be discussed at the next USARV Signal Officers Conference in November 1968.

FOR THE COMMANDER:

W. C. ARNTZ
CPTAGC
Assistant Adjutant General

Cy furn:
HQ I FFV
HQ 4th Inf Div

54

CONFIDENTIAL

CONFIDENTIAL

GPOP-DT (18 Aug 68) 3d Ind (C)

SUBJECT: Operational Report of HQ, 4th Inf Div for Period Ending
31 July 1968, RCS CSFOR-65 (R1)

HQ, US Army, Pacific, APO San Francisco 96558

6 DEC 1968

TO: Assistant Chief of Staff for Force Development, Department of the
Army, Washington, D. C. 20310

1. (U) This headquarters has evaluated subject report and forwarding indorsements and concurs in the report as indorsed.

2. (C) Reference (page 54) paragraph 2, 2d Indorsement: One of the COMSEC objectives as outlined in AR 380-8 is to provide on-line encryption of selected tactical voice circuits or systems. It was not intended nor is it desirable that additional secure voice radio nets be established particularly in view of the critical shortage of radio frequencies and equipment currently existing in Vietnam. Until all radio stations in a net are equipped with on-line devices, the normal net operation must of necessity be in a non-secure mode with selective use of secure mode between stations so equipped after initial in the clear contact.

FOR THE COMMANDER IN CHIEF:

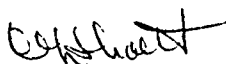

C. A. SHORT
CPT, AGC
Asst AG

Cy furn:
CG USARV

CONFIDENTIAL

CONFIDENTIAL

HENTON PROVINCE

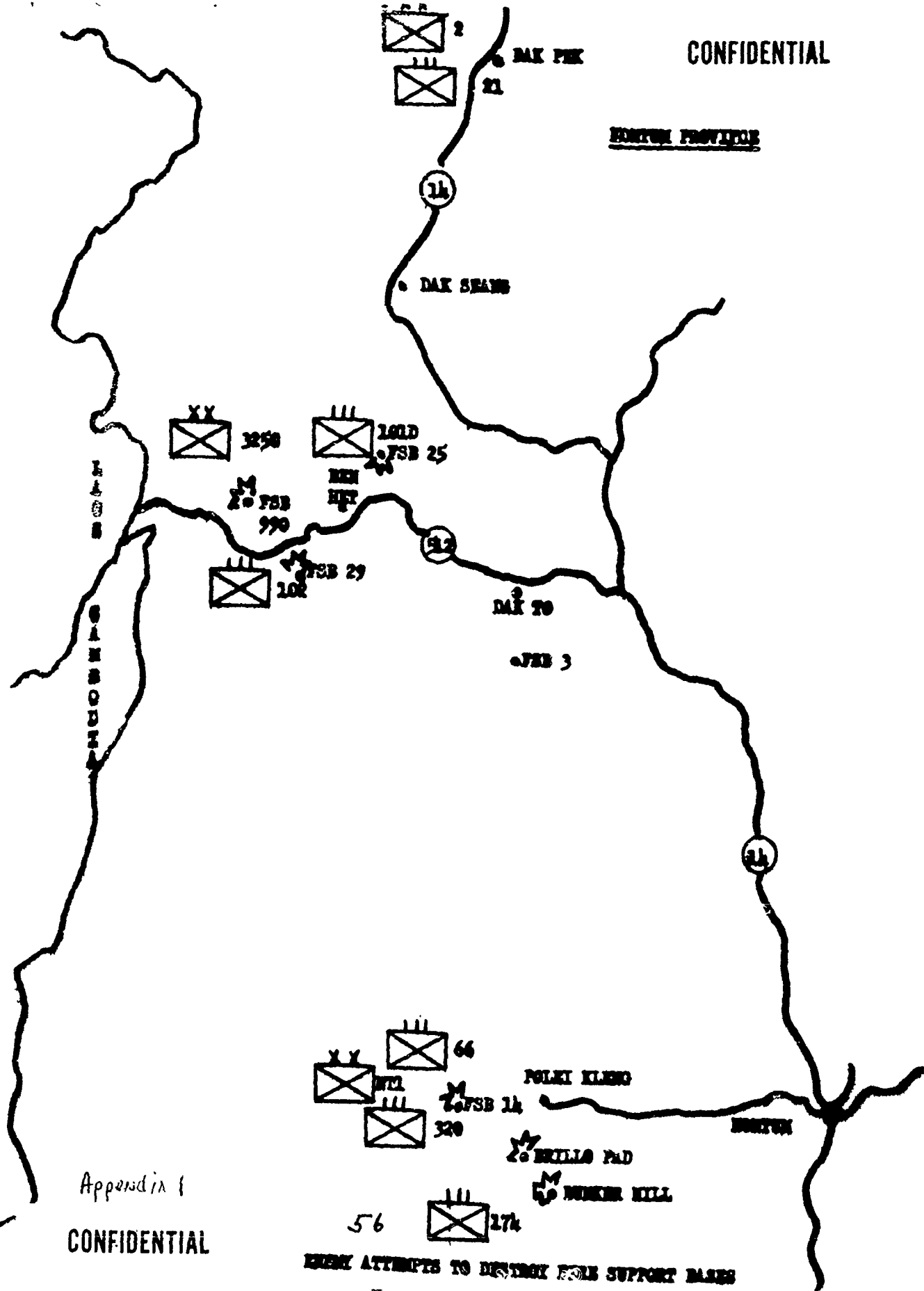

Appendix 1
CONFIDENTIAL

ENEMY ATTEMPTS TO DESTROY OUR SUPPORT BASES

CONFIDENTIAL

KONTUM PROVINCE

ENEMY WITHDRAWAL AFTER BEING DEFEATED

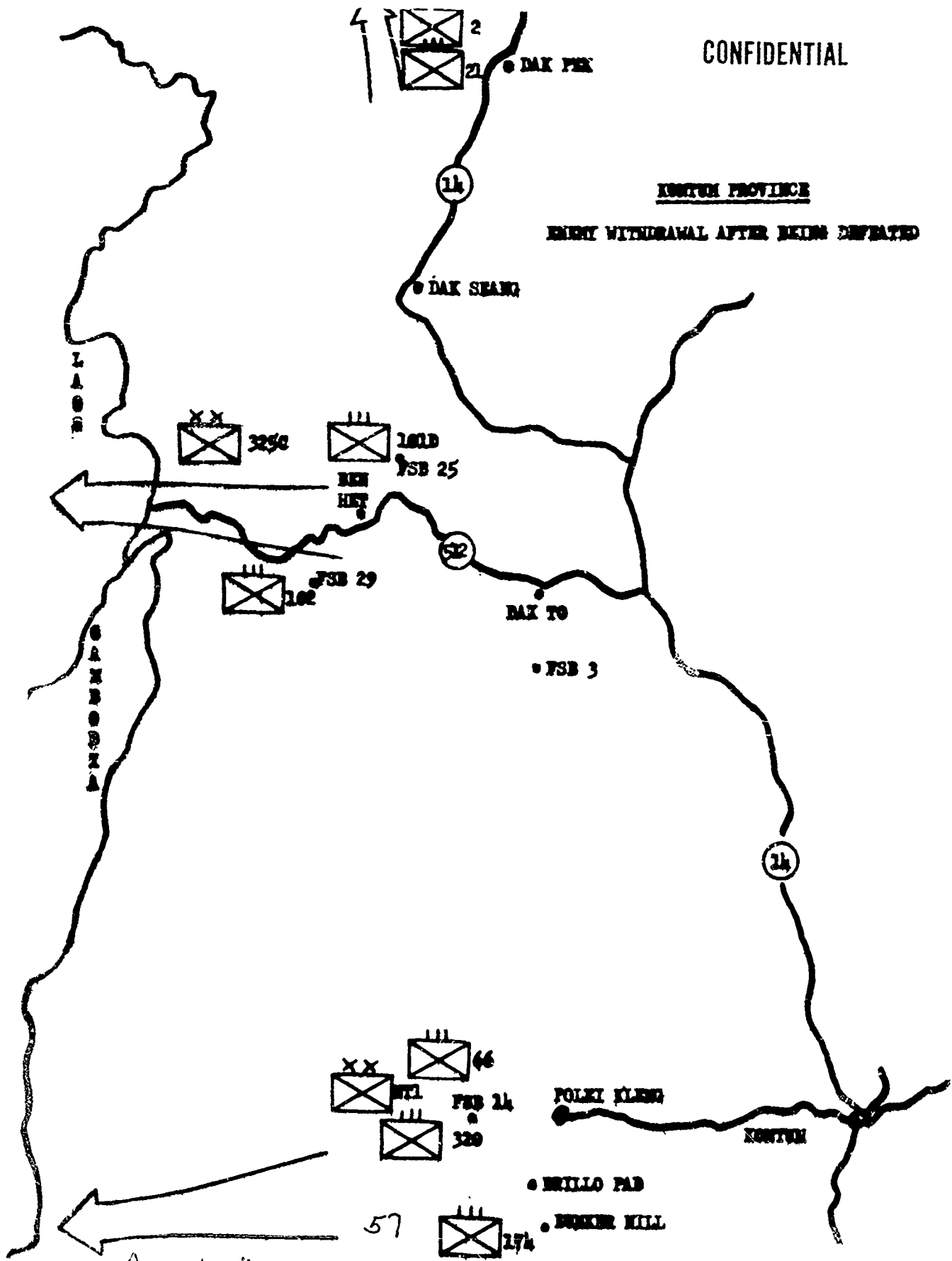

Appendix 2

CONFIDENTIAL

CONFIDENTIAL

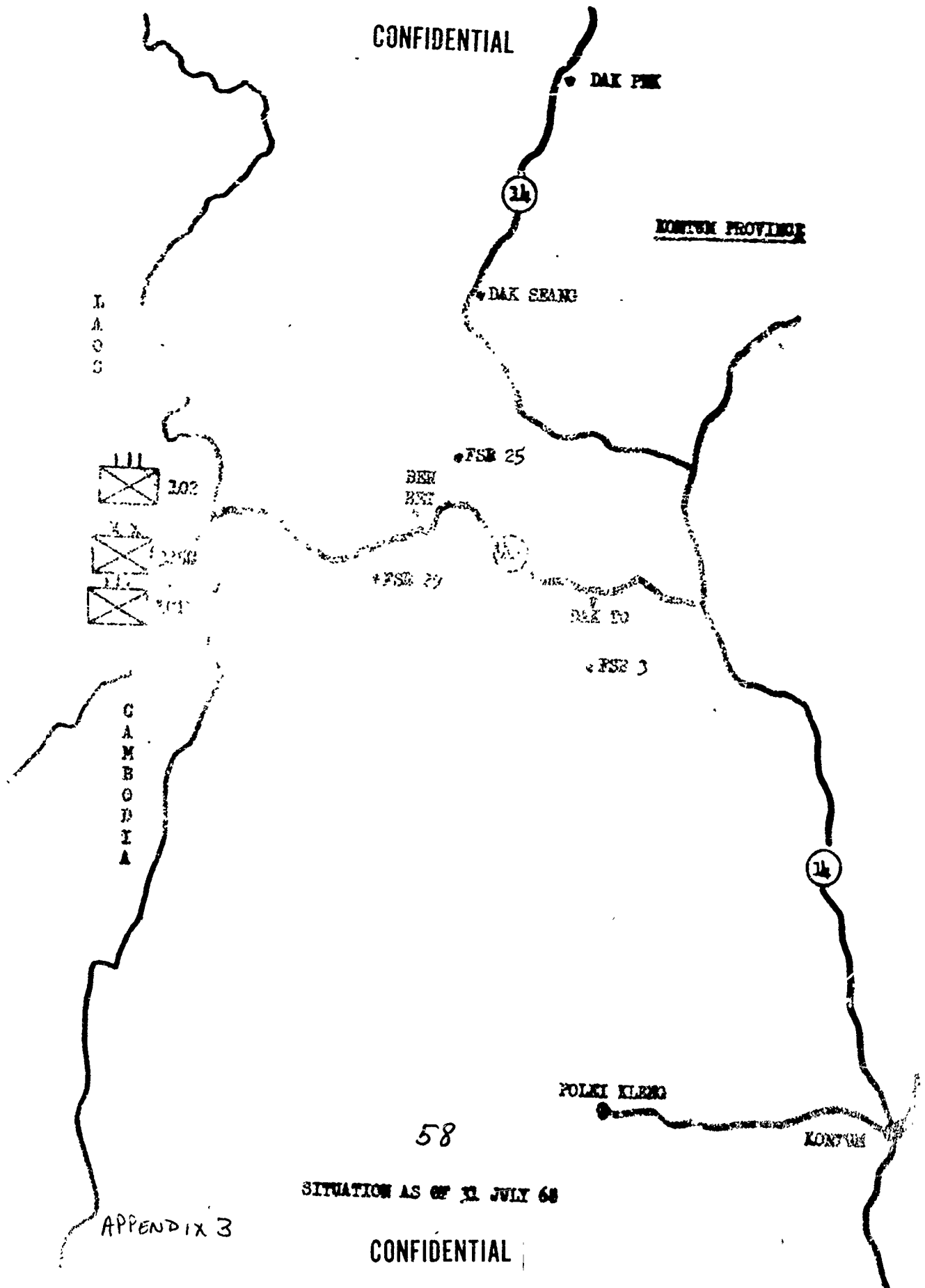

58

SITUATION AS OF 31 JULY 68

APPENDIX 3

CONFIDENTIAL

CONFIDENTIAL

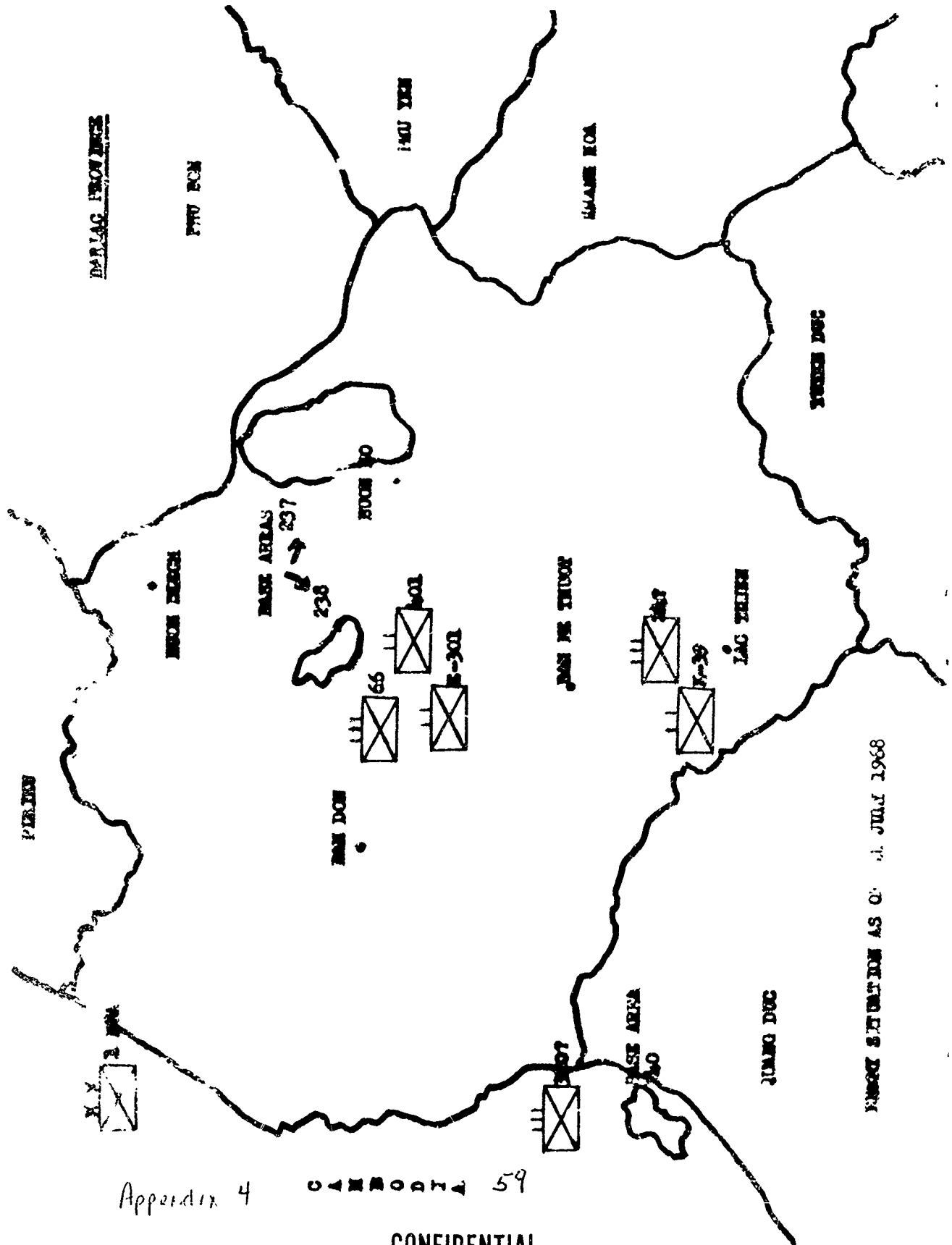

DAR LAG PROVINCE

PHU BOM

140 YEN

HUANG HOA

TUONG DUC

NAM SONH

NAM SONH 237

NAM SONH 10

NAM SONH

NAM SONH 101

NAM SONH 102

LAC TRINH

PIE LON

NAM SONH 103

NAM SONH 66

NAM SONH 301

NAM SONH 302

NAM SONH 303

NAM SONH 304

NAM SONH 305

NAM SONH 306

NAM SONH 307

NAM SONH 308

NAM SONH 309

NAM SONH 310

NAM SONH 311

NAM SONH 312

NAM SONH 313

NAM SONH 314

NAM SONH 315

NAM SONH 316

NAM SONH 317

NAM SONH 318

NAM SONH 319

NAM SONH 320

NAM SONH 321

NAM SONH 322

NAM SONH 323

NAM SONH 324

NAM SONH 325

NAM SONH 326

NAM SONH 327

NAM SONH 328

NAM SONH 329

NAM SONH 330

NAM SONH 331

NAM SONH 332

NAM SONH 333

NAM SONH 334

NAM SONH 335

NAM SONH 336

NAM SONH 337

NAM SONH 338

NAM SONH 339

NAM SONH 340

NAM SONH 341

NAM SONH 342

NAM SONH 343

NAM SONH 344

NAM SONH 345

NAM SONH 346

NAM SONH 347

NAM SONH 348

NAM SONH 349

NAM SONH 350

NAM SONH 351

NAM SONH 352

NAM SONH 353

NAM SONH 354

NAM SONH 355

NAM SONH 356

NAM SONH 357

NAM SONH 358

NAM SONH 359

NAM SONH 360

NAM SONH 361

NAM SONH 362

NAM SONH 363

NAM SONH 364

NAM SONH 365

NAM SONH 366

NAM SONH 367

NAM SONH 368

NAM SONH 369

NAM SONH 370

NAM SONH 371

NAM SONH 372

NAM SONH 373

NAM SONH 374

NAM SONH 375

NAM SONH 376

NAM SONH 377

NAM SONH 378

NAM SONH 379

NAM SONH 380

NAM SONH 381

NAM SONH 382

NAM SONH 383

NAM SONH 384

NAM SONH 385

NAM SONH 386

NAM SONH 387

NAM SONH 388

NAM SONH 389

NAM SONH 390

NAM SONH 391

NAM SONH 392

NAM SONH 393

NAM SONH 394

NAM SONH 395

NAM SONH 396

NAM SONH 397

NAM SONH 398

NAM SONH 399

NAM SONH 400

BASE SITUATION AS OF 1 JULY 1968

Appendix 4

PHU BOM 59

CONFIDENTIAL

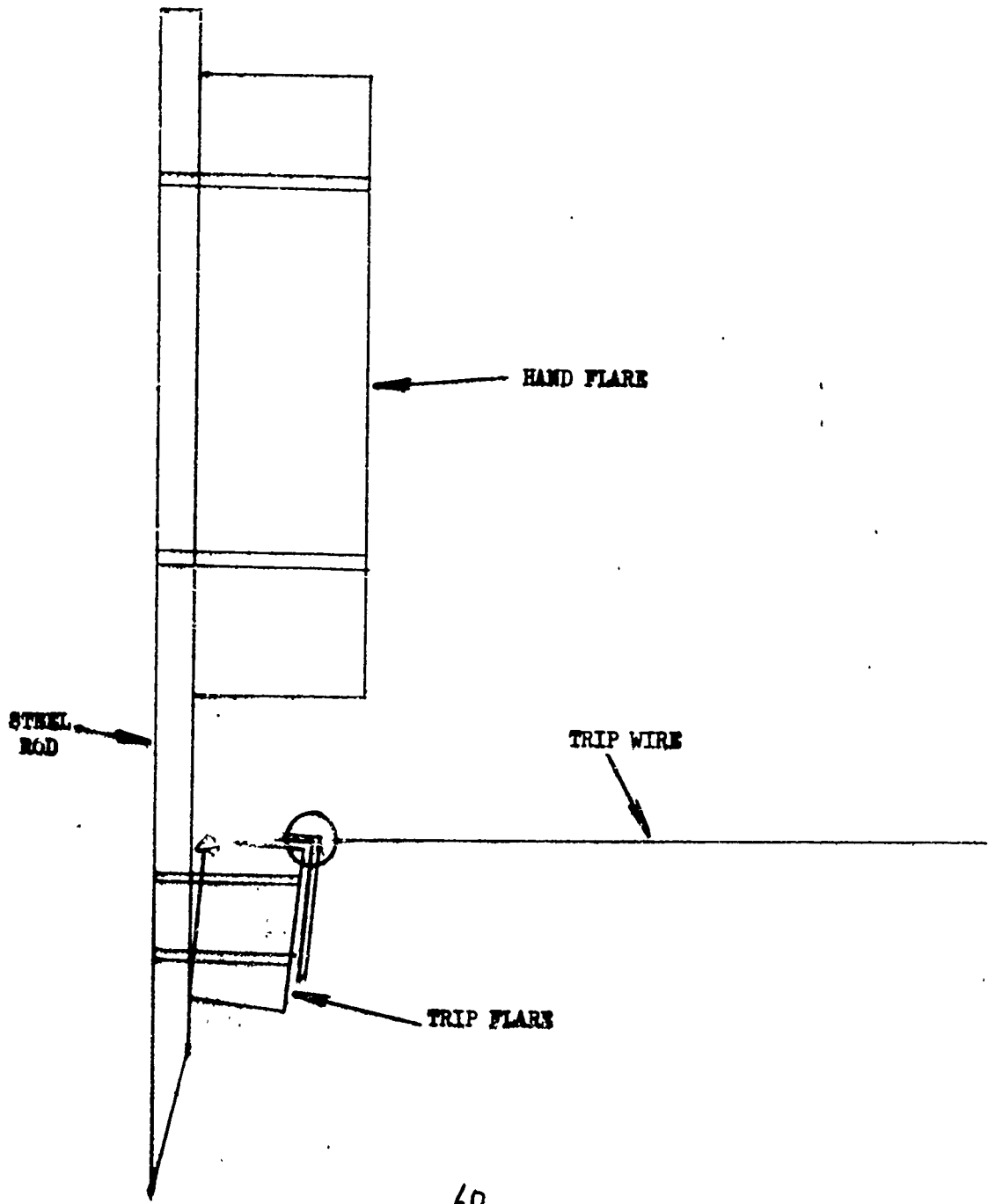

Appendix 5

BAUER FLARE

CONFIDENTIAL

ORGANIZATIONAL STRUCTURE

1. (C) Task Organization as of 30 April 1968 was:

1st Bde, 4th Inf Div

3-8 Inf
3-12 Inf
1-8 Inf
C/2-1 Cav
6-29 Arty
A/5-16 Arty
B/6-14 Arty
A/6-14 Arty
Co A(-), 4th Engr Bn
T.CP

2d Bde, 4th Inf Div

2-8 Inf (Mech) (-)
1-10 Cav (-)
4-42 Arty
A/6-14 Arty
B/3-6 Arty
C/3-6 Arty
B/5-16 Arty
Co B(-), 4th Engr Bn
T.CP

DISCOM

DIV ARTY

3d Bde, 4th Inf Div

1-14 Inf
1-35 Inf
2-35 Inf
1-12 Inf
1-22 Inf
B/1-10 Cav (-)
A/2-8 Inf (Mech) (-)
2-9 Arty
B/1-92 Arty
C/1-92 Arty
C/6-14 Arty
C/5-16 Arty
D/5-16 Arty
C/5-22 Arty
C/4-42 Arty
Co C(-), 4th Engr Bn
T.CP

Div Troops

2-1 Cav (-)
7-17 Air Cav (-) GS
A/5-22 Arty
4th Engr Bn

2. (C) Task Organization as changed by FRAGO 63-37-67

1st Bde, 4th Inf Div

ADD: 1-22 Inf (-)

2d Bde, 4th Inf Div

DELETE: B-1-10 Cav

3d Bde, 4th Inf Div

DELETE: 1-22 Inf (-)
ADD: B/1-10 Cav

3. (C) Task Organization as changed by OPORD 11-68

TASK FORCE MATHEUS

1st Bde, 4th Inf Div

3-8 Inf
3-12 Inf

3d Bde, 101st Abn Div

1-506 Inf (Abn)
2-506 Inf (Abn)

Inclosure 1

61

CONFIDENTIAL

CONFIDENTIAL

1-35 Inf
Co A, 4th Engr Bn
6-29 arty
C/4-42 arty (DS)
T. CP

3-187 Inf (Abn)
1-8 Inf
1-22 Inf
C/2-1 Cav (+)
2-319 arty (DS)

HEADQUARTERS 4TH INFANTRY DIVISION

3d Bde, 4th Inf Div

1-12 Inf
1-14 Inf
2-35 Inf
B/2-8 Inf (Mech)
C/1-10 Cav
Co C, 4th Engr Bn
2-9 arty (DS)
B/4-42 arty (DS)
T. CP

DIV. ARTY

5-16 arty

DISCOM

2d Bde, 4th Inf Div

2-8 Inf (Mech) (-)
1-10 Cav (-)
Co B, 4th Engr Bn
4-42 arty (-) (DS)
B/3-6 arty (DS)
T. CP

Dir Troops

2-1 Cav (-)
7-17 Air Cav (GS)
A/5-22 arty
4th Engr Bn

4. (C) Task Organization as changed by FRAGO 65-37-67:

TASK FORCE MATHEWS

DELETE: 1-35 Inf

3d Bde, 4th Inf Div

ADD: 1-35 Inf

5. (C) Task Organization as changed by FRAGO 65-37-67:

TASK FORCE MATHEWS

DELETE: 3d Bde, 101st (Abn) Div (-)
2-506 Inf (Abn)
3-187 Inf (Abn)

6. (C) Task Organization as changed by FRAGO 67-37-67

TASK FORCE MATHEWS dissolved effective 121500 June. The 1st Bde, 4th Infantry Division returns to division control effective 121500 June.

1st Bde, 4th Inf Div

ADD: 1-506 Inf (Abn) (eff 121500 Jun)

1st Bde, 4th Inf Div

1-8 Inf
3-8 Inf

3d Bde, 4th Inf Div

1-12 Inf
1-14 Inf

CONFIDENTIAL

3-12 Inf
1-22 Inf
1-506 Inf (.bn)
B/2-1 Cav
B/6-14 Arty
C/4-42 Arty
A/1-92 Arty
C/1-92 Arty
A/2-319 Arty
Co A, 4th Engr Bn. (-)

2d Bde, 4th Inf Div

2-8 Inf (Mech) (-)
1-10 Cav (-)
A/6-14 Arty
B/3-6 Arty
C/3-6 Arty
4-42 Arty (-)
Co B, 4th Engr (-)

DIV. ARTY

1-35 Inf
2-35 Inf
B/2-8 Inf (Mech)
A/1-10 Cav
C/1-10 Cav
2-9 Arty
B/4-42 Arty
B/1-92 Arty
B/5-16 Arty
B/7-15 Arty
6-84 Arty
C/6-14 Arty
C/5-22 Arty
Co C, 4th Engr Bn. (-)

Division Troops

2-1 Cav (-)
7-17 Air Cav (CS)
A/5-22 Arty
4th Engr Bn (-)

DISCOM

7. (C) Task Organization as changed by FR. GO 68-37-67:

The 1st Battalion, 506th Infantry (bn) depart M.C. PTHUR and 4th Infantry Division control, effective 17 June.

8. (C) Task Organization as changed by FR. GO 69-37-67:

3d Bde, 4th Inf Div

DELETE: C/1-10 Cav (-)
ADD: A/1-10 Cav

1st Bde, 4th Inf Div

DELETE: 1-22 Inf

2d Bde, 4th Inf Div

DELETE: A/1-10 Cav
ADD: 1-22 Inf
C/1-10 Cav (-)

9. (C) Task Organization as changed by FR. GO 70-37-67:

3d Bde, 4th Inf Div

DELETE: 2 Co's/2-35 Inf
2-35 Inf (-)

2d Bde, 4th Inf Div

ADD: 2 Co's/2-35 Inf

Div Troops

ADD: 2-35 Inf (-)

CONFIDENTIAL

10. (C) Task Organization as changed by FRAGO 72-37-67:

<u>Division Troops</u>	<u>2d Bde, 4th Inf Div</u>
DELETE: 2-35 Inf (-)	ADD: 2-35 Inf (-)
<u>1st Bde, 4th Inf Div</u>	<u>3d Bde, 4th Inf Div</u>
ADD: 1-35 Inf	DELETE: 1-35 Inf

11. (C) Task Organization as changed by FRAGO 73-37-67:

<u>2d Bde, 4th Inf Div</u>	<u>Division Troops</u>
DELETE: 2-35 Inf	ADD: 2-35 Inf

12. (C) Task Organization as changed by FRAGO 74-37-67:

<u>2d Bde, 4th Inf Div</u>	<u>3d Bde, 4th Inf Div</u>
DELETE: 2-8 Inf	ADD: 2-8 Inf
1-12 Inf	1-12 Inf
1-10 Cav	1-10 Cav
ADD: 2-35 Inf	
A/7-17 Air Cav	<u>Division Troops</u>
	DELETE: 2-35 Inf
	A/7-17 Air Cav

13. (C) Task Organization as changed by FRAGO 75-37-67:

<u>3d Bde, 4th Inf Div</u>	<u>2d Bde, 4th Inf Div</u>
DELETE: 1-12 Inf	ADD: 1-12 Inf
1-10 Cav	1-10 Cav

14. (C) Task Organization as changed by FRAGO 76-37-67:

<u>Division Troops</u>	<u>2d Bde, 4th Inf Div</u>
DELETE: D/7-17 Air Cav	ADD: D/7-17 Air Cav

15. (C) Task Organization as changed by FRAGO 77-37-67:

<u>1st Bde, 4th Inf Div</u>	<u>3d Bde, 4th Inf Div</u>
DELETE: 1-35 Inf	ADD: 1-35 Inf

16. (C) Task Organization as changed by FRAGO 78-37-67:

<u>3d Bde, 4th Inf Div</u>	<u>Division Troops</u>
DELETE: 1-35 Inf	ADD: 1-35 Inf

CONFIDENTIAL

17. (C) Task Organization as of 31 July with supporting artillery units:

<u>1st Bde, 4th Inf Div</u>	<u>2d Bde, 4th Inf Div</u>	<u>3d Bde, 4th Inf Div</u>
3-8 Inf	2-35 Inf	1-14 Inf
3-12 Inf	1-22 Inf	2-8 Inf
1-8 Inf	1-12 Inf	1-10 Cav (-)
B/2-1 Cav	B/1-10	1-35 Inf (-)
6-29 Arty	A/7-17 Air Cav	A/2-9 Arty
A/1-92 Arty	D/7-17 Air Cav	A/3-6 Arty
C/5-16 Arty	B/1-35 Inf	B/3-6 Arty
D/5-16 Arty	D/1-35 Inf	B/1-92 Arty
B/6-14 Arty	B/4-42 Arty	A/5-16 Arty
Co A, 4th Engr Bn	C/4-42 Arty	A/6-14 Arty
T. CP	B/2-9 Arty	C/6-14 Arty
	C/1-92 Arty	C/2-9 Arty
<u>Division Troops</u>	B/5-22 Arty	Prov Btry
2-1 Cav (-)	Co B, 4th Engr Bn	Co E, 4th Engr Bn
7-17 Air Cav (-)	T. CP	T. CP
A/5-22 Arty		
4th Engr Bn		

DISCOM

DIVARTY

65

CONFIDENTIAL

CONFIDENTIAL

CHEMICAL OPERATIONS

1. (C) Traildust Missions:

<u>DATE</u>	<u>COORDINATES</u>	<u>SORTIES</u>
2 May	YB7504-YA7588	6
3 May	YA7127-7722-8114	6
5 May	YB7504-YA7588	6
7 May	YA8901-YV8984	6
9 May	YA7284-YA6571	6
24 May	YB7504-YA7508	6
28 May	YA7144-7127	6
14 Jun	YA8802-YV8885	6
16 Jul	YB7804-YB8506-YB9506	2
18 Jul	YA9101-8605-8115	2

2. (C) Crop Destruction:

<u>DATE</u>	<u>COORDINATES</u>	<u>TYPE CROPS</u>	<u>ACRES</u>	<u>AGENT</u>	<u>GALLONS</u>
29 Jun	ZB7871-8232	Corn	34.5	White	150
2 Jul	BR1125	Corn, Rice	53	Blue	240
3 Jul	BR1325-1326	Corn, Rice	59	Blue	250
3 Jul	BR1216	Rice, Beans	74	Blue	350
4 Jul	BR1213	Rice	22	Blue	75
9 Jul	BR1323	Rice, Beans	37	Blue	110
10 Jul	BR1523	Rice	25	Blue	110
11 Jul	BR1423-0924	Rice, Bananas	25	Blue	110
13 Jul	YA8977	Rice, Corn	21	Blue	110
14 Jul	YA8977	Beans, Rice Corn	21	Blue	110

3. (U) Perimeter Defoliation:

<u>DATE</u>	<u>UNIT</u>	<u>COORDINATES</u>	<u>METHOD</u>	<u>AGENT</u>	<u>GALLONS</u>
28 May	Div	AR7833	Truck	Blue	165
31 May	Div	AR7833	Truck	Blue	550
1 Jun	Div	AR7833	Truck	Blue	495
11 Jun	Div	AR7835	Truck	Blue	605
12 Jun	Div	AR7834	Truck	Blue	660
13 Jun	Div	AR7834	Truck	Blue	550
14 Jun	Div	AR7834	Truck	Blue	495
19 Jun	Div	AR8036	Truck	Blue	550
29 Jun	Sp Forces	ZB0393	UH-1	White	225
4 Jul	Div	AR8033	UH-1	Blue	75
14 Jul	Div	AR8035	UH-1	Blue	150
18 Jul	Sp Forces	ZA2387	Truck	Blue	330

Inclosure 4

66

CONFIDENTIAL

CONFIDENTIAL 2

<u>DATE</u>	<u>UNIT</u>	<u>COORDINATES</u>	<u>METHOD</u>	<u>AGENT</u>	<u>GALLONS</u>
19 Jul	2/1 Cav	BRL453	Truck	Orange	270
31 Jul	Div	AR7833	CH-47	Blue	1500
		AR7834			
		AR7835			

67

CONFIDENTIAL

CONFIDENTIAL

Box Full Of Grenades

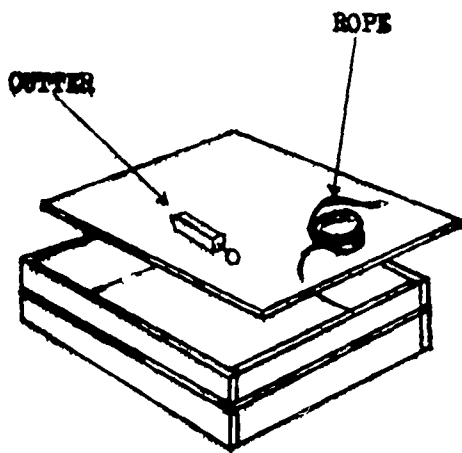

FIGURE 1

20 CS GRENADES
WITH PINS PULLED

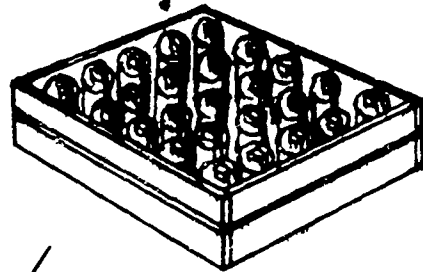

FIGURE 2

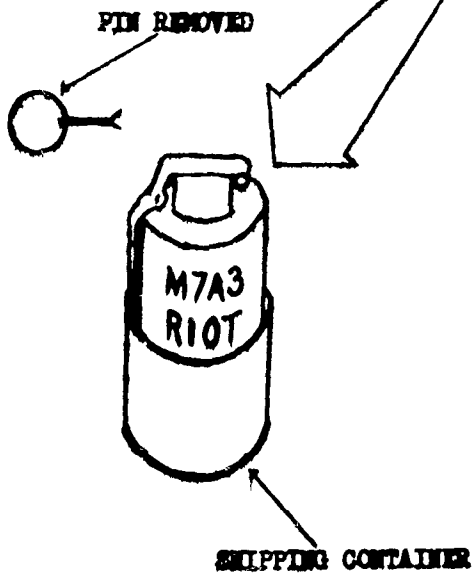

FIGURE 3

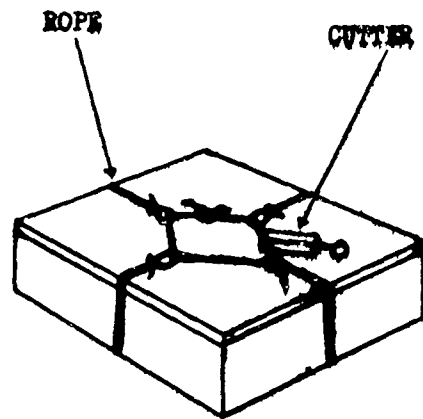

FIGURE 4

68

CONFIDENTIAL

UNCLASSIFIED

Security Classification

DOCUMENT CONTROL DATA - R & D

(Security classification of title, body of abstract and indexing annotation must be entered when the overall report is classified)

1. ORIGINATING ACTIVITY (Corporate author)		2a. REPORT SECURITY CLASSIFICATION Confidential	
		2b. GROUP 4	
3. REPORT TITLE Operational Report - Lessons Learned, Headquarters, 4th Infantry Division			
4. DESCRIPTIVE NOTES (Type of report and inclusive dates) Experiences of unit engaged in counterinsurgency operations, 1 May - 31 July 1968			
5. AUTHOR(S) (First name, middle initial, last name) CG, 4th Infantry Division			
6. REPORT DATE undated		7a. TOTAL NO. OF PAGES 69	7b. NO. OF REFS
6a. CONTRACT OR GRANT NO		9a. ORIGINATOR'S REPORT NUMBER(S) 683153	
b. PROJECT NO N/A		9b. OTHER REPORT NO(S) (Any other numbers that may be assigned this report)	
c.			
d.			
14. DISTRIBUTION STATEMENT			
11. SUPPLEMENTARY NOTES N/A		12. SPONSORING MILITARY ACTIVITY OACSFOR, DA, Washington, D.C. 20310	
13. ABSTRACT			

The following items are recommended for inclusion in the Lessons Learned Index:

ITEM 1

* SUBJECT TITLE _____
** FOR OT RD # _____
***PAGE # _____

ITEM 2

SUBJECT TITLE _____
FOR OT RD # _____
PAGE # _____

ITEM 3

SUBJECT TITLE _____
FOR OT RD # _____
PAGE # _____

ITEM 4

SUBJECT TITLE _____
FOR OT RD # _____
PAGE # _____

ITEM 5

SUBJECT TITLE _____
FOR OT RD # _____
PAGE # _____

* Subject Title: A short (one sentence or phrase) description of the item of interest.

** FOR OT RD # : Appears in the Reply Reference line of the Letter of Transmittal. This number must be accurately stated.

***Page # : That page on which the item of interest is located.

- - FOLD - - -

DEPARTMENT OF THE ARMY

POSTAGE AND FEES PAID
DEPARTMENT OF THE ARMY

OFFICIAL BUSINESS

Office of the Assistant Chief of Staff for
Force Development
ATTN: Operational Reports Branch
Headquarters, Department of the Army
Washington, D.C. 20310

STAPLE

DA Label 18, 1 APR 59 PREVIOUS EDITIONS OF THIS LABEL ARE OBSOLETE.

- - FOLD - - -

THIS REPORT HAS BEEN DELIMITED
AND CLEARED FOR PUBLIC RELEASE
UNDER DOD DIRECTIVE 5200.20 AND
NO RESTRICTIONS ARE IMPOSED UPON
ITS USE AND DISCLOSURE.

DISTRIBUTION STATEMENT A

APPROVED FOR PUBLIC RELEASE;
DISTRIBUTION UNLIMITED.