

Costs of Storing and Transporting Hydrogen

Wade A. Amos

National Renewable Energy Laboratory



National Renewable Energy Laboratory
1617 Cole Boulevard
Golden, Colorado 80401-3393
A national laboratory of the U.S. Department of Energy
Managed by Midwest Research Institute
for the U.S. Department of Energy
under contract No. DE-AC36-83CH10093

Costs of Storing and Transporting Hydrogen

Wade A. Amos
National Renewable Energy Laboratory



National Renewable Energy Laboratory
1617 Cole Boulevard
Golden, Colorado 80401-3393
A national laboratory of the U.S. Department of Energy
Managed by Midwest Research Institute
for the U.S. Department of Energy
under contract No. DE-AC36-83CH10093

Prepared under Task No. HY914041

November 1998

NOTICE

This report was prepared as an account of work sponsored by an agency of the United States government. Neither the United States government nor any agency thereof, nor any of their employees, makes any warranty, express or implied, or assumes any legal liability or responsibility for the accuracy, completeness, or usefulness of any information, apparatus, product, or process disclosed, or represents that its use would not infringe privately owned rights. Reference herein to any specific commercial product, process, or service by trade name, trademark, manufacturer, or otherwise does not necessarily constitute or imply its endorsement, recommendation, or favoring by the United States government or any agency thereof. The views and opinions of authors expressed herein do not necessarily state or reflect those of the United States government or any agency thereof.

Available to DOE and DOE contractors from:
Office of Scientific and Technical Information (OSTI)
P.O. Box 62
Oak Ridge, TN 37831
Prices available by calling 423-576-8401

Available to the public from:
National Technical Information Service (NTIS)
U.S. Department of Commerce
5285 Port Royal Road
Springfield, VA 22161
703-605-6000 or 800-553-6847
or
DOE Information Bridge
<http://www.doe.gov/bridge/home.html>



EXECUTIVE SUMMARY

An analysis was performed to estimate the costs associated with storing and transporting hydrogen. These costs can be added to a hydrogen production cost to determine the total delivered cost of hydrogen.

Storage methods analyzed included compressed gas, liquid hydrogen, metal hydride, and underground storage. Major capital and operating costs were considered over a range of production rates and storage times. In all cases, underground storage was the cheapest method; liquid hydrogen has advantages over compressed gas for longer storage times.

For the transport of hydrogen, compressed gas, liquid hydrogen, metal hydride, and pipeline delivery were considered. Modes of transportation included truck and rail transport for the compressed gas and metal hydride. For liquid hydrogen, barge delivery was investigated as an option in addition to truck and rail. Transportation costs were estimated for a range of production rates and delivery distances. For large quantities of hydrogen, pipeline delivery was the cheapest option. For smaller quantities of hydrogen, liquid hydrogen had advantages over the other methods for longer delivery distances.

All cost assumptions and sample calculations are included in the report along with some background information on each storage method. The appendix contains sensitivity analyses and graphs showing important trends associated with hydrogen storage and transportation.

TABLE OF CONTENTS

1.0 INTRODUCTION.....	1
2.0 HYDROGEN STORAGE OPTIONS.....	1
2.1 Liquid Hydrogen.....	1
2.1.1 Liquefaction Processes.....	1
2.1.2 Ortho-to-Para Conversion.....	6
2.1.3 Liquid Hydrogen Storage.....	9
2.1.4 Plant Size.....	10
2.2 Metal Hydride Storage.....	10
2.3 Compressed Gas Storage.....	13
2.4 Underground Storage.....	13
2.5 Storage in Pipelines.....	14
2.6 Compressors.....	14
2.7 Expanders.....	15
2.8 Developing Methods of Hydrogen Storage.....	15
2.8.1 Liquid Hydrides.....	15
2.8.2 Adsorption.....	15
2.8.3 Sponge Iron.....	16
2.8.4 Glass Microspheres.....	16
2.8.5 Ammonia.....	16
3.0 CAPITAL COSTS OF STORAGE EQUIPMENT.....	17
3.1 Compressor Capital Costs.....	17
3.2 Liquefaction Capital Costs.....	17
3.3 Metal Hydride Capital Costs.....	18
3.4 Compressed Gas (Above-Ground) Capital Costs.....	19
3.5 Liquid Hydrogen Vessel Capital Costs.....	20
3.6 Underground Storage Capital Costs.....	21
3.7 Pipeline Capital Costs.....	21
4.0 OPERATING COSTS FOR HYDROGEN STORAGE.....	22
4.1 Compressed Gas Operating Costs.....	22
4.2 Liquefaction Operating Costs.....	23
4.3 Metal Hydride Operating Costs.....	24
4.4 Underground Compressed Gas Operating Costs.....	24
5.0 CHOICE OF STORAGE.....	24
5.1 Application.....	25
5.2 Energy Density.....	25
5.3 Quantity.....	25
5.4 Storage Period.....	26

5.5 Energy Availability.....	27
5.6 Maintenance and Reliability	27
5.7 Safety.....	27
5.8 Summary	27
6.0 ANALYSIS OF STORAGE COSTS	28
6.1 Cost Assumptions	28
6.2 Compressed Gas Storage Methodology	29
6.3 Liquid Hydrogen Storage Methodology	30
6.4 Metal Hydride Methodology	30
6.5 Underground Storage Methodology.....	30
6.6 Storage Conclusions.....	30
7.0 TRANSPORTATION OF HYDROGEN.....	32
7.1 Compressed Gas Transport.....	32
7.2 Liquid Hydrogen Transport	33
7.3 Metal Hydride Transport.....	33
8.0 CAPITAL COSTS OF TRANSPORTATION EQUIPMENT.....	34
8.1 Compressed Gas Transport Costs.....	34
8.2 Compressed Gas Pipeline Costs.....	34
8.3 Liquid Hydrogen Transport Costs.....	35
8.4 Metal Hydride Transport Costs	36
9.0 CHOICE OF TRANSPORTATION.....	36
9.1 Quantities.....	36
9.2 Distance.....	37
9.3 Special Case--Power Supply	37
9.4 Futures in Hydrogen Transport.....	37
9.5 Summary	38
10.0 ANALYSIS OF THE COST TO TRANSPORT HYDROGEN	38
10.1 Cost Assumptions for Hydrogen Transport.....	39
10.2 Truck Transport Methodology.....	41
10.3 Rail Delivery Methodology	41
10.4 Water Transport Methodology	42
10.5 Pipeline Delivery Methodology	42
10.6 Transport Conclusions.....	43
11.0 COMBINED STORAGE AND TRANSPORTATION COSTS	44
12.0 HYDROGEN MARKET.....	45
12.1 Current Use.....	45

12.2 Projected Demand	46
12.3 Uses	47
12.4 Delivery Method	48
12.5 Current Prices.....	49
REFERENCES AND PERTINENT LITERATURE.....	50
APPENDIX A - SAMPLE CALCULATIONS OF HYDROGEN STORAGE COSTS	
APPENDIX B - SAMPLE CALCULATIONS OF HYDROGEN TRANSPORT COSTS	
APPENDIX C - SAMPLE POWER REQUIREMENT CALCULATIONS	
APPENDIX D - HYDROGEN STORAGE COSTS	
APPENDIX E - HYDROGEN TRANSPORT COSTS	
APPENDIX F - HYDROGEN STORAGE FIGURES	
APPENDIX G - HYDROGEN TRANSPORTATION FIGURES	
APPENDIX H - COMBINED STORAGE AND TRANSPORT COSTS	

LIST OF FIGURES

Figure 1 - Linde Liquefaction Process Flowsheet	2
Figure 2 - Linde Process Temperature-Entropy Diagram.....	3
Figure 3 - Pre-Cooled Liquefaction Flowsheet.....	4
Figure 4 - Pre-Cooled Liquefaction Temperature-Entropy Diagram.....	5
Figure 5 - Ideal Liquefaction Flowsheet	7
Figure 6 - Ideal Liquefaction Temperature-Entropy Diagram.....	8
Figure 7 - Metal Hydride Pressure Behavior	12

Appendix F - Hydrogen Storage Figures

Appendix G - Hydrogen Transportation Figures

Appendix H - Combined Storage and Transportation Costs

LIST OF TABLES

Table 1 - Compressor Capital Costs	17
Table 2 - Liquefier Capital Costs.....	18
Table 3 - Metal Hydride Capital Costs	19
Table 4 - Compressed Hydrogen Pressure Vessel Capital Costs.....	20
Table 5 - Liquid Hydrogen Dewar Costs	20
Table 6 - Underground Storage Capital Costs	21
Table 7 - Compressed Gas Above-Ground Storage Total Costs.....	22
Table 8 - Liquefier Operating Costs.....	23
Table 9 - Liquefier Power Requirements.....	23
Table 10 - Hydrogen Storage Capital Cost Assumptions.....	28
Table 11 - Storage Operating Cost Assumptions	29
Table 12 - Pipeline Installation Costs	35
Table 13 - Hydrogen Transport Capital Cost Assumptions.....	39
Table 14 - Transport Operating Cost Assumptions	40
Table 15 - Current Hydrogen Consumption.....	46
Table 16 - Projected Hydrogen Demand	46
Table 17 - Merchant Hydrogen Demand	47
Table 18 - Projected Merchant Hydrogen Demand.....	47
Table 19 - Merchant Hydrogen Use	48
Table 20 - Industrial Hydrogen Use (Hart 1997).....	48
Table 21 - Hydrogen Prices	49

Appendix D - Hydrogen Storage Costs

Appendix E - Hydrogen Transport Costs

ABBREVIATIONS AND ACRONYMS

ADS	Alternative depreciation system	m	Meter
atm	Atmospheres (pressure)	M	One thousand (1,000)
Btu	British thermal unit	MH ₂	Metal hydride
°C	Degrees Celsius	mi	Mile
cal	Calorie	MM Btu	One million Btu's
d	Day	mo	Month
°F	Degrees Fahrenheit	MPa	Megapascal
ft	Feet	mpg	Miles per gallon
gal	Gallon	mph	Miles per hour
GH ₂	Gaseous hydrogen	N	Newton
GJ	Gigajoule	Nm ³	Normal cubic meter
gm	Gram	Pa	Pascal
h	Hour	psia	Pounds (force) per square inch absolute pressure
H ₂	Hydrogen	psig	Pounds (force) per square inch gauge pressure
hp	Horsepower	Q	Heat
hr	Hour	s	Second
in.	Inch	scf	Standard cubic foot
K	Degrees Kelvin	sec	Second
kg	Kilogram	ton	English ton (2,000 pounds)
kJ	Kilojoule	tonne	Metric ton (1,000 kilograms)
km	Kilometer	tpd	Tons per day
kW	Kilowatt	Wc	Work (compression)
kWh	Kilowatt-hour	We	Work (expansion)
L	Liter	yr	Year
lb	Pound		
LH ₂	Liquid hydrogen		

1.0 INTRODUCTION

The purpose of this report is to analyze the capital and operating costs associated with storing and transporting hydrogen. It mentions some future trends in hydrogen storage and transportation, but concentrates on current commercial processes. The storage techniques considered are liquid hydrogen, compressed gas, metal hydride, and underground storage. The modes of transportation examined are liquid hydrogen delivery by truck, rail, and barge; gaseous hydrogen delivery by truck, rail, and pipeline; and metal hydride delivery by truck and rail.

2.0 HYDROGEN STORAGE OPTIONS

The main options for storing hydrogen are as a compressed gas, as a liquid, or combined with a metal hydride. Underground storage is also considered, although it is just a special case of compressed gas storage. Each alternative has advantages and disadvantages. For example, liquid hydrogen has the highest storage density of any method, but it also requires an insulated storage container and an energy-intensive liquefaction process.

2.1 Liquid Hydrogen

2.1.1 Liquefaction Processes

Liquefaction is done by cooling a gas to form a liquid. Liquefaction processes use a combination of compressors, heat exchangers, expansion engines, and throttle valves to achieve the desired cooling (Flynn 1992). The simplest liquefaction process is the Linde cycle or Joule-Thompson expansion cycle. In this process, the gas is compressed at ambient pressure, then cooled in a heat exchanger, before passing through a throttle valve where it undergoes an isenthalpic Joule-Thompson expansion, producing some liquid. This liquid is removed and the cool gas is returned to the compressor via the heat exchanger (Flynn 1992). A flowsheet of the Linde process is shown in Figure 1. The same process is represented on a temperature-entropy diagram in Figure 2.

The Linde cycle works for gases, such as nitrogen, that cool upon expansion at room temperature. Hydrogen, however, warms upon expansion at room temperature. In order for hydrogen gas to cool upon expansion, its temperature must be below its inversion temperature of 202 K (-95°F). To reach the inversion temperature, modern hydrogen liquefaction processes use liquid nitrogen pre-cooling to lower the temperature of the hydrogen gas to 78 K (-319°F) before the first expansion valve. The nitrogen gas is recovered and recycled in a continuous refrigeration loop (Flynn 1992; Timmerhaus and Flynn 1989). The pre-cooled Linde process is shown in Figure 3. Figure 4 is the associated temperature-entropy diagram for the process.

Figure 1 - Linde Liquefaction Process Flowsheet

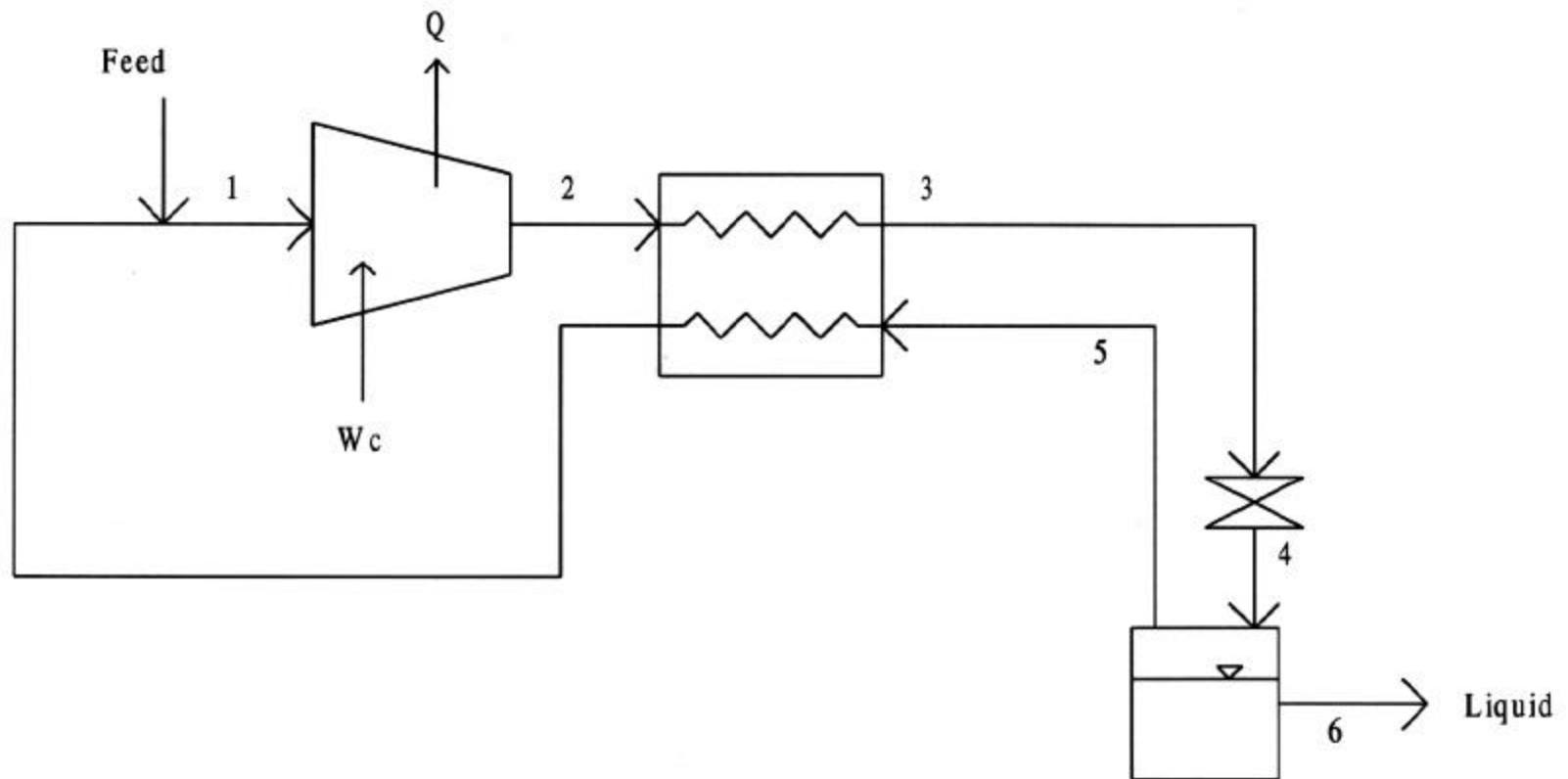

Figure 2 - Linde Process Temperature-Entropy Diagram

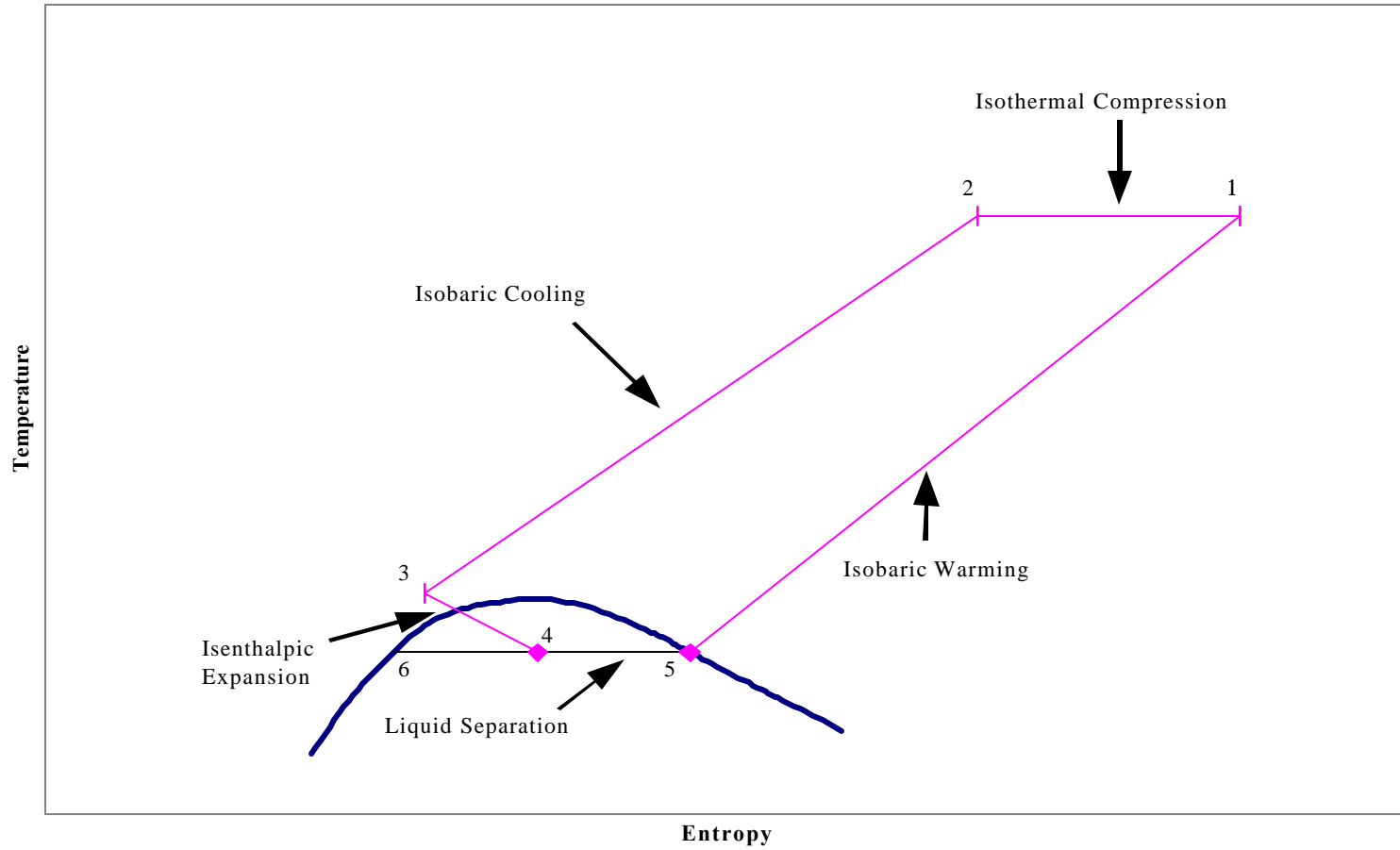

Figure 3 - Pre-Cooled Liquefaction Flowsheet

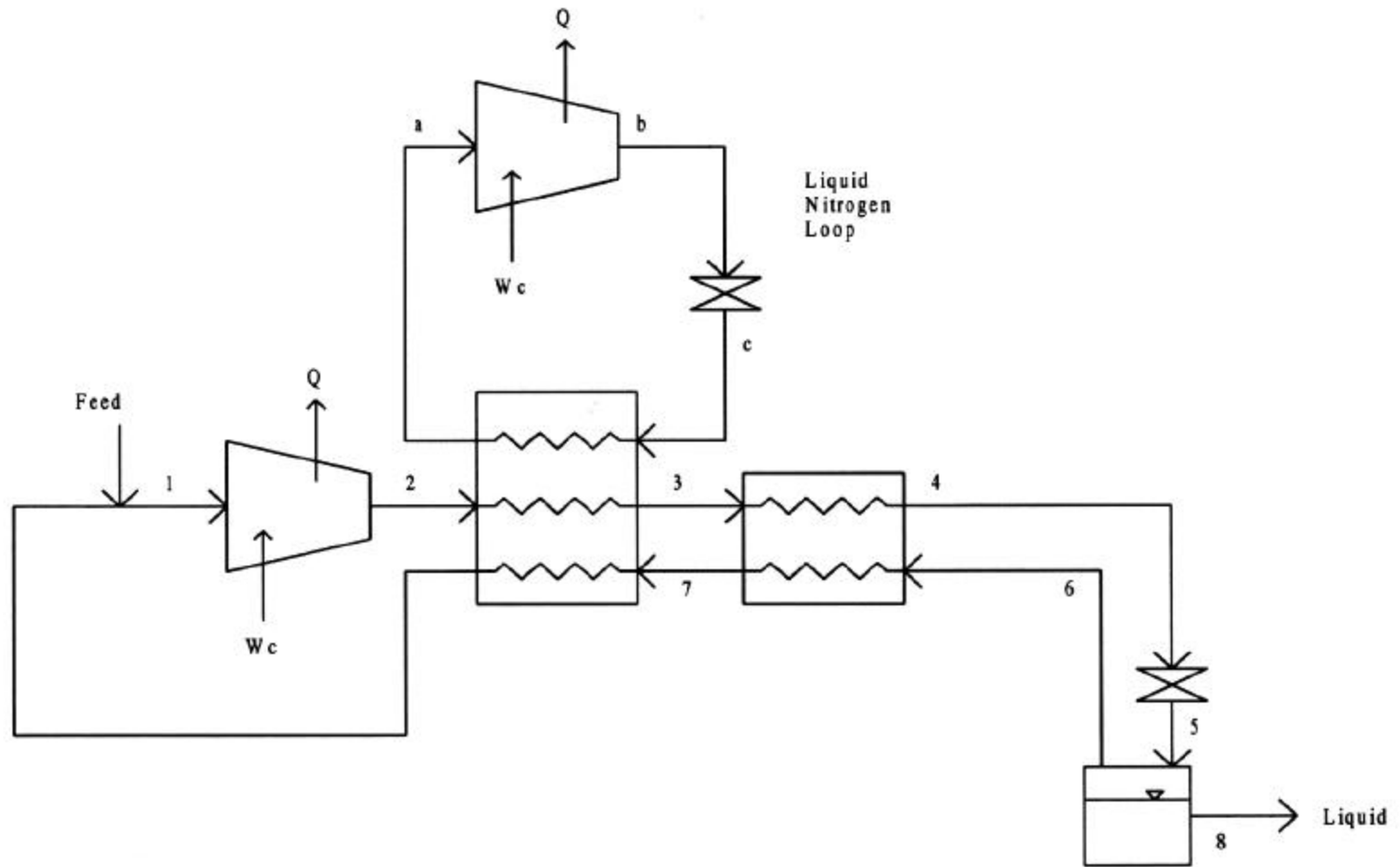
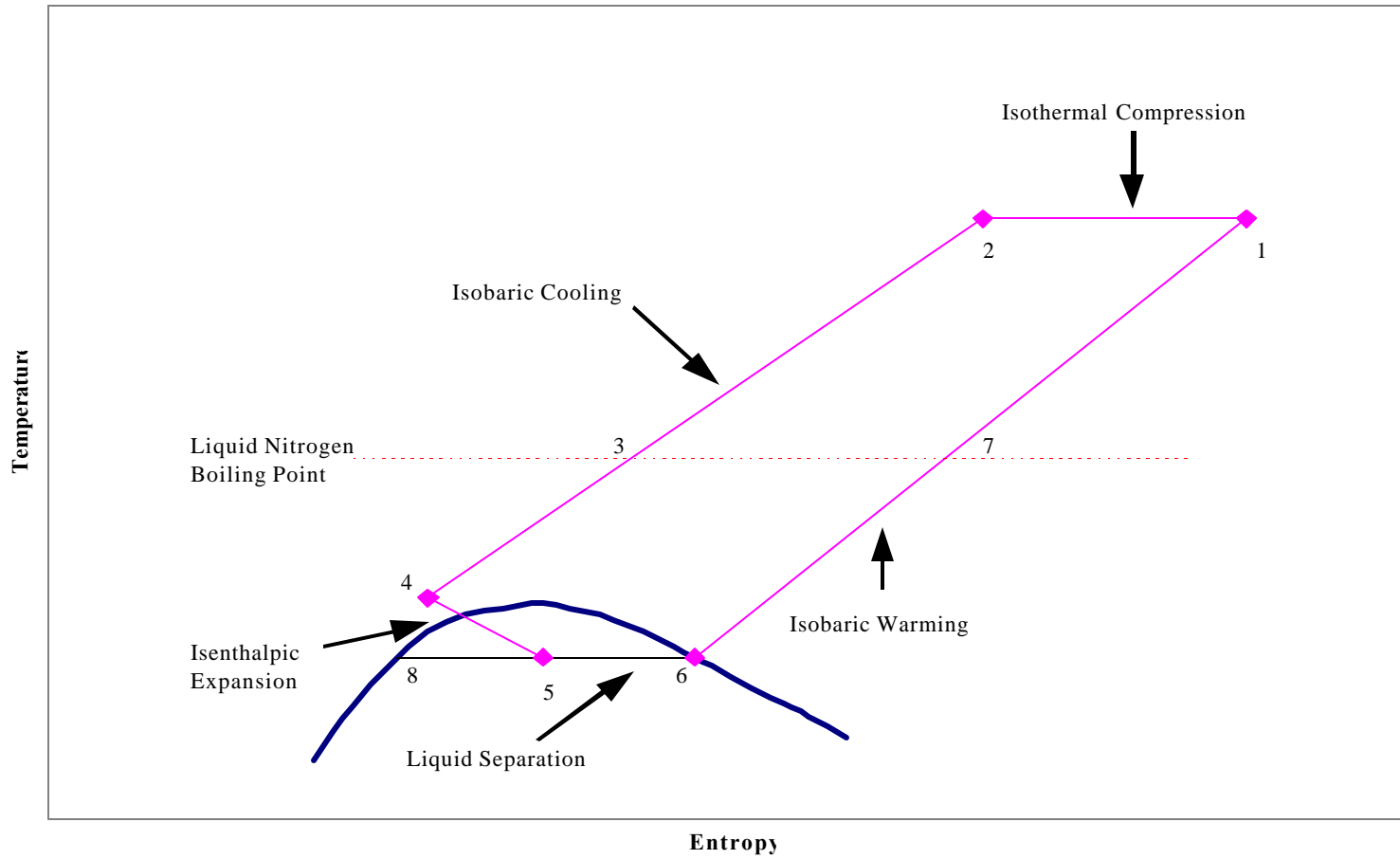

Figure 4 - Pre-Cooled Liquefaction Temperature-Entropy Diagram



An alternative to the pre-cooled Linde process is to pass the high-pressure gas through an expansion engine. An expansion engine, or turbine, will always cool a gas, regardless of its inversion temperature (Flynn 1992). The theoretical process referred to as *ideal liquefaction* uses a reversible expansion to reduce the energy required for liquefaction. It consists of an isothermal compressor, followed by an isentropic expansion to cool the gas and produce a liquid. It is used as a theoretical basis for the amount of energy required for liquefaction, or ideal work of liquefaction, and is used to compare liquefaction processes (Timmerhaus and Flynn, 1989). In practice, an expansion engine can be used only to cool the gas stream, not to condense it because excessive liquid formation in the expansion engine would damage the turbine blades (Timmerhaus and Flynn 1989). Figure 5 is a flowsheet for an ideal liquefaction process; Figure 6 shows the process using a temperature-entropy diagram.

The ideal work of liquefaction for hydrogen is 3.228 kWh/kg (1.464 kWh/lb). For comparison, the ideal work of liquefaction for nitrogen is only 0.207 kWh/kg (0.094 kWh/lb) (Timmerhaus and Flynn 1989). Appendix C contains sample work calculations for ideal liquefaction, the Linde process, and the nitrogen pre-cooled Linde process.

Other processes include the Dual-Pressure Linde Process, the Claude Cycle, the Dual-Pressure Claude Cycle, and the Haylandt Cycle. They are similar to the above processes, but use extra heat exchangers, multiple compressors, and expansion engines to reduce the energy required for liquefaction. This energy reduction is offset by higher capital costs (Timmerhaus and Flynn 1989).

2.1.2 Ortho-to-Para Conversion

Hydrogen molecules exist in two forms, para and ortho, depending on the electron configurations in the two individual hydrogen atoms (Noganow 1992). At hydrogen's boiling point of 20 K (-423°F), the equilibrium concentration is almost all para-hydrogen, but at room temperature or higher, the equilibrium concentration is 25% para-hydrogen and 75% ortho-hydrogen (Noganow 1992; Encyclopedia of Chemical Technology 1991; Timmerhaus and Flynn 1989). The uncatalyzed conversion from ortho to para-hydrogen proceeds very slowly, so without a catalyzed conversion step, the hydrogen may be liquefied, but may still contain significant quantities of ortho-hydrogen. This ortho-hydrogen will eventually be converted into the para form in an exothermic reaction (Timmerhaus and Flynn, 1989).

This poses a problem because the transition from ortho to para-hydrogen releases a significant amount of heat (527 kJ/kg [227 Btu/lb]) (Noganow 1992). If ortho-hydrogen remains after liquefaction, this heat of transformation will slowly be released as the conversion proceeds, resulting in the evaporation of as much as 50% of the liquid hydrogen over about 10 days. This means long-term storage of hydrogen requires that the hydrogen be converted from its ortho form to its para form to minimize boil-off losses (Noganow 1992; Timmerhaus and Flynn 1989).

Figure 5 - Ideal Liquefaction Flowsheet

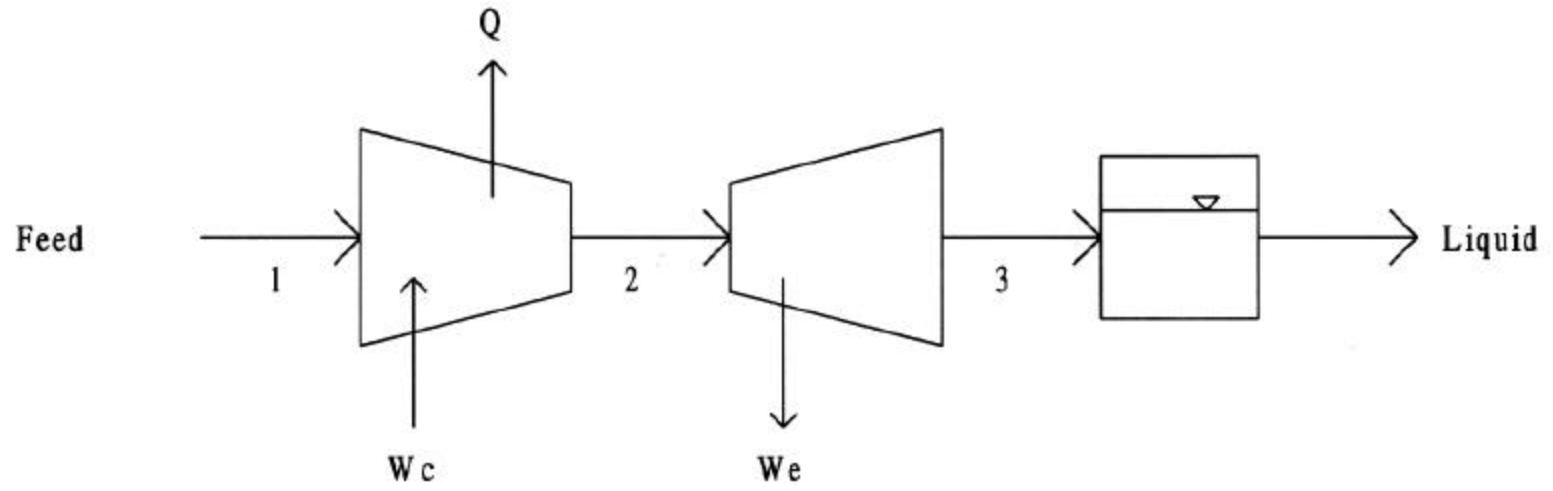
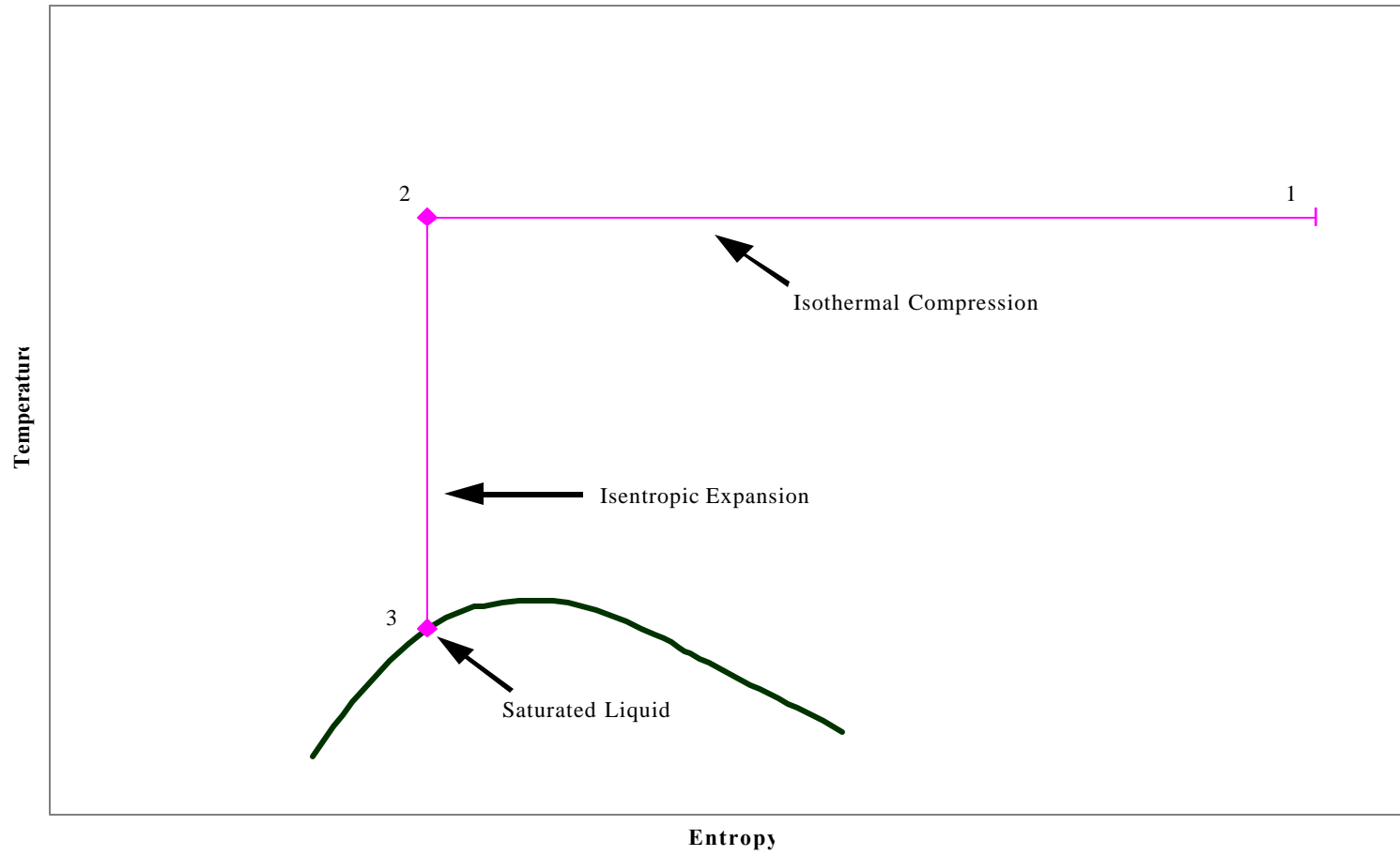

Figure 6 - Ideal Liquefaction Temperature-Entropy Diagram



This can be accomplished using a number of catalysts including activated carbon, platinized asbestos, ferric oxide, rare earth metals, uranium compounds, chromic oxide, and some nickel compounds (Encyclopedia of Chemical Technology 1991; Timmerhaus and Flynn 1989). Activated charcoal is used most commonly, but ferric oxide is also an inexpensive alternative (Noganow 1992; Timmerhaus and Flynn 1989). The heat released in the conversion is usually removed by cooling the reaction with liquid nitrogen, then liquid hydrogen. Liquid nitrogen is used first because it requires less energy to liquefy than hydrogen, but still cools the hydrogen enough to achieve an equilibrium concentration of roughly 60% para-hydrogen (Timmerhaus and Flynn, 1989).

2.1.3 Liquid Hydrogen Storage

A major concern in liquid hydrogen storage is minimizing hydrogen losses from liquid boil-off. Because liquid hydrogen is stored as a cryogenic liquid that is at its boiling point, any heat transfer to the liquid causes some hydrogen to evaporate. The source of this heat can be ortho-to-para conversion, mixing or pumping energy, radiant heating, convection heating or conduction heating. Any evaporation will result in a net loss in system efficiency, because work went into liquefying the hydrogen, but there will be an even greater loss if the hydrogen is released to the atmosphere instead of being recovered.

The first step in avoiding boil-off losses is to perform an ortho-to-para conversion of the hydrogen during the liquefaction step to prevent any conversion and subsequent evaporation from occurring during storage. Another important step in preventing boil-off is to use insulated cryogenic containers.

Cryogenic containers, or dewars, are designed to minimize conductive, convective, and radiant heat transfer from the outer container wall to the liquid (Hart 1997). All cryogenic containers have a double-wall construction and the space between the walls is evacuated to nearly eliminate heat transfer from convection and conduction. To prevent radiant heat transfer, multiple layers (30-100) of reflective, low-emittance heat shielding--usually aluminized plastic Mylar--are put between the inner and outer walls of the vessel. A cheaper alternative to Mylar film is perlite (colloidal silica) placed between the vessel walls (Timmerhaus and Flynn 1989). Some large storage vessels have an additional outer wall with the space filled with liquid nitrogen. This reduces heat transfer by lowering the temperature difference driving the heat transfer (Huston 1984).

Most liquid hydrogen tanks are spherical, because this shape has the lowest surface area for heat transfer per unit volume (Hart 1997; Timmerhaus and Flynn 1989; Report to Congress 1995). As the diameter of the tank increases, the volume increases faster than the surface area, so a large tank will have proportionally less heat transfer area than a small tank, reducing boil-off. Cylindrical tanks are sometimes used because they are easier and cheaper to construct than spherical tanks and their volume-to-surface area ratio is almost the same (Timmerhaus and Flynn 1989).

Liquid hydrogen storage vessels at customer sites typically have a capacity of 110-5,300 kg (230-11,700 lb) (International Journal of Ambient Energy 1992; Report to Congress 1995; Zittel and Wurster 1996; Huston 1984; Taylor et al. 1986). NASA has the largest spherical tank in the world with a capacity of 228,000 kg (500,000 lb) of liquid hydrogen (International Journal of Ambient Energy 1992; Zittel and Wurster 1996; Taylor et al. 1986; Report to Congress 1995). Hydrogen liquefaction plants normally have about 115,000 kg (250,000 lb) of storage onsite (Report to Congress 1995). Single tanks can be constructed to hold as much as 900,000 kg (2,000,000 lb) of hydrogen (Report to Congress 1995).

Even with careful insulation, some hydrogen will evaporate. This hydrogen gas can be vented, allowed to build up pressure in the vessel, or captured and returned to the liquefaction process. If the liquid hydrogen is stored in a pressure vessel, the gas can be left to build up gradually until it reaches the design pressure, then some of the gas must be vented (Hart 1997). The length of time it takes for the gas pressure to reach the pressure limit is called the lock-up time. For processes that use gaseous hydrogen, if the storage time is shorter than the lock-up time, no hydrogen losses will occur--any gases produced can be drawn off first and used in the process instead of being vented to the atmosphere (Hart 1997).

Another option if the hydrogen is stored on the same site where it is liquefied is to pull the hydrogen gas out of the liquid hydrogen vessel and re-liquefy it. This way no hydrogen is lost, and because the hydrogen gas is still cold, it is easier to compress. In large transportation applications such as barges, the boil-off gas is being considered as transportation fuel--as the hydrogen gas boils off the liquid, it is recaptured and fed into the ship's boiler.

If the hydrogen cannot be recovered, it can be vented. Venting the hydrogen to the atmosphere poses little safety risk because it will quickly diffuse into the air.

2.1.4 Plant Size

Medium-sized liquefaction plants have production rates of 380-2,300 kg/h (830-5,000 lb/h) (Zittel and Wurster 1996). Plants built during the past few years have been smaller (110-450 kg/h [250-1000 lb/h]) (Zittel and Wurster, 1996). One plant built in Germany during 1991 has a production rate of 170 kg/h (370 lb/h) (Zittel and Wurster 1996).

2.2 Metal Hydride Storage

Metal hydrides store hydrogen by chemically bonding the hydrogen to metal or metalloid elements and alloys (Nogonow 1992). Hydrides are unique because some can adsorb hydrogen at or below atmospheric pressure, then release the hydrogen at significantly higher pressures when heated--the higher the temperature, the higher the pressure. There is a wide operating range of temperatures and pressures for hydrides depending on the alloy chosen (Ali and Sadhu 1994; Hydrogen Components, Inc. 1997). Each alloy has different performance characteristics, such as cycle life and heat of reaction.

Figure 7 illustrates the temperature and pressure relationship for a typical hydride. When the hydrogen partial pressure is first increased, the hydrogen dissolves in the metal or alloy, then begins to bond to the metal. During the bonding period the equilibrium or plateau pressure remains constant from the time that 10% of the hydrogen has been stored until about 90% of the storage capacity is reached. After the 90% point, higher pressures are required to reach 100% of the hydride storage capacity (Worf 1992; Huston 1984). Heat released during hydride formation must be continuously removed to prevent the hydride from heating up. If the temperature is allowed to increase the equilibrium pressure will increase until no more bonding occurs. If hydrogen is being recovered from another gas, some hydrogen can be allowed to escape or blow off, taking away any contaminants that didn't bond to the hydride (Au et al. 1996).

To recover the hydrogen from the metal hydride, heat must be added to break the bonds between the hydrogen and the metal. Again, the higher the temperature, the higher the release pressure. Initially the pressure of the gas is high as any free hydrogen is released, then the pressure plateaus as the hydride bonds are broken. When only about 10% of the hydrogen remains the equilibrium pressure drops off (Worf 1992; Huston 1984). This last bit of hydrogen dissolved in the metal matrix is difficult to remove, and represents strongly bonded hydrogen that cannot be recovered in the normal charge/discharge cycle (Au et al. 1996).

Metal hydride beds can be configured similar to carbon adsorption columns. This results in a reaction front moving through the bed with a very high upstream concentration of hydrogen and a low residual concentration downstream of the reaction front. Using this configuration, it is easy to determine when the bed is completely charged because the outlet hydrogen concentration will suddenly increase. Using multiple columns allows semi-continuous charging and discharging of the hydrides (Au et al. 1996).

Hydrides store only about 2%-6% hydrogen by weight (Encyclopedia of Chemical Technology 1991; Hart 1997), but have high volumetric storage densities. The heats of reaction for hydrides can range from 9,300 to greater than 23,250 kJ/kg (4,000-10,000 Btu/lb) of hydrogen, and operating pressures can reach more than 10 MPa (1,450 psig). Some hydride release temperatures can also be quite high—greater than 500°C (932°F) (Ali and Sadhu 1994; Hydrogen Components, Inc. 1997).

With this wide range in pressures and temperatures, the construction of the storage unit becomes a challenge. The vessel containing the hydride must be pressurized and contain sufficient heat exchange area to allow rapid heat transfer for charging and discharging the hydride (Encyclopedia of Chemical Technology 1991). The metal hydride alloy must also be structurally and thermally stable to withstand numerous charge/discharge cycles. Some hydrides can also be poisoned by carbon dioxide, sulfur compounds, or water (International Journal of Ambient Energy 1992).

Figure 7 - Metal Hydride Pressure Behavior

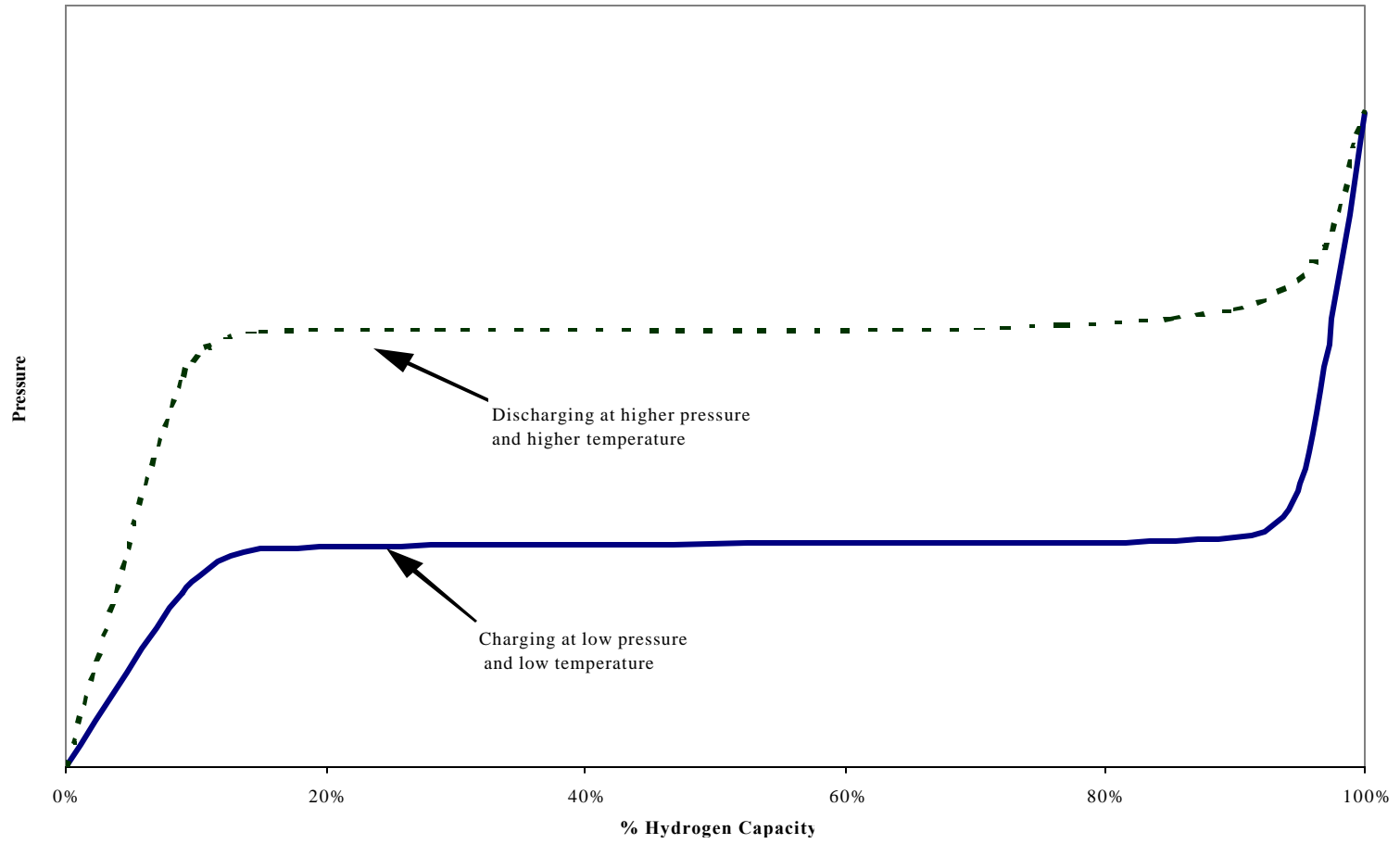

One industrial site has used a low-temperature metal hydride to successfully recover 18 kg (39 lb) of hydrogen in 4 hours from an ammonia waste stream containing 50% hydrogen. Cooling water was used for removing heat during absorption and warm water supplied the heat for desorption. One benefit of using a metal hydride in this application was the purification effect provided by the metal hydride. Even though the incoming hydrogen concentration was only 50%, a brief purging or blowdown of the hydride vessel resulted in a 99.999% hydrogen purity with 76% hydrogen recovery (Au et al. 1996).

2.3 Compressed Gas Storage

Compressed gas storage of hydrogen is the simplest storage solution--the only equipment required is a compressor and a pressure vessel (Schwarz and Amonkwah 1993). The main problem with compressed gas storage is the low storage density, which depends on the storage pressure. Higher storage pressures result in higher capital and operating costs (Garrett 1989).

Low-pressure spherical tanks can hold as much as 1,300 kg (2,900 lb) of hydrogen at 1.2-1.6 MPa (1,700-2,300 psig) (Hart 1997). High-pressure storage vessels have maximum operating pressures of 20-30 MPa (2,900-4,350 psig) (Zittel and Wurster 1996). European countries tend to use low-pressure cylindrical tanks with a maximum operating pressure of 5 MPa (725 psig) and storage capacities of 115-400 kg (255-800 lb) of hydrogen (Zittel and Wurster 1996).

One concern with large storage vessels (especially underground storage) is the cushion gas that remains in the "empty" vessel at the end of the discharge cycle. In small containers this may not be a concern, but in larger containers this may represent a large quantity of gas (Hart 1997; Taylor et al. 1986). One option is to use a liquid such as brine to fill the volume of the container and displace the remaining hydrogen gas (Taylor et al. 1986).

2.4 Underground Storage

Depending on the geology of an area, underground storage of hydrogen gas may be possible (Zittel and Wurster 1996). Underground storage of natural gas is common and underground storage of helium, which diffuses faster than hydrogen, has been practiced successfully in Texas (Hart 1997).

For underground storage of hydrogen, a large cavern or area of porous rock with an impermeable caprock above it is needed to contain the gas. A porous layer of rock saturated with water is an example of a good caprock layer. Other options include abandoned natural gas wells, solution mined salt caverns, and manmade caverns.

As mentioned with compressed gas containers, one consideration is the cushion gas that occupies the underground storage volume at the end of the discharge cycle (Hart 1997; Taylor et al. 1986). This can be as much as 50% of the working volume, or several hundred thousand kilograms

(pounds) of gas. Some storage schemes pump brine into the area to displace the hydrogen, but this increases the operating and capital costs (Taylor et al. 1986; Zittel and Wurster 1996).

2.5 Storage in Pipelines

Piping systems are usually several miles long, and in some cases may be hundreds of miles long. Because of the great length, and therefore great volume, of these piping systems, a slight change in the operating pressure of a pipeline system can result in a large change in the amount of gas contained within the piping network. By making small changes in operating pressure, the pipeline can be used to handle fluctuations in supply and demand, avoiding the cost of onsite storage (Hart 1997; Report to Congress 1995).

2.6 Compressors

Compressed gas storage, liquefaction, underground storage, and pipelines all require compressors; only metal hydride storage does not, although a compressor may also be used for hydrides depending upon the hydride plateau pressure (Schwarz and Amonkwah 1993).

Hydrogen can be compressed using standard axial, radial or reciprocating piston-type compressors by making slight modifications of the seals to take into account the higher diffusivity of the hydrogen molecules (Hart 1997). Reciprocating compressors can be as large as 11,200 kW (15,000 hp) and can handle hydrogen flows of 890 kg/h (1,950 lb/h) at up to 25 MPa (3,600 psig). They also work well with variable flows (Timmerhaus and Flynn 1989). Radial compressors are used for flows of 160-22,000 kg/h (350-49,000 lb/h) and axial compressors for 6,400-89,000 kg/h (14,000-200,000 lb/h) (Timmerhaus and Flynn 1989). One benefit of axial compressors is that several can be mounted on one common shaft, but they must be protected from surging by using a recycle and have an efficiency of only about 50% (Timmerhaus and Flynn 1989).

The first stage in most multi-stage compressors normally reaches a couple of atmospheres of compression (0.3-0.4 MPa [45-60 psig]). In higher-pressure applications, 3-4 MPa (435-580 psig) of precompression is done before compressing the gas to 25-30 MPa (3,600-4,400 psig) (Zittel and Wurster 1996).

A metal hydride can also be used for gas compression by adsorbing hydrogen at a low temperature and low pressure and then heating the hydride to a higher temperature to produce a higher pressure (Hydrogen Components, Inc. 1997). A series of hydrides that have increasing desorption temperatures can be used for compression so the adsorption heat of one hydride can be used for the desorption heat of another. Compression ratios greater than 20:1 are possible using hydrides, with final pressures of over 100 MPa (14,700 psig) (Huston, 1984, Hydrogen Components, Inc. 1997).

2.7 Expanders

Modern liquefaction processes and some compressed gas storage schemes use expansion engines to recover some of the energy in the compressed hydrogen gas. In liquefaction, expansion engines are used to cool the gas more efficiently than just throttling the gas in a Joule-Thompson expansion (Timmerhaus and Flynn 1989). In gas storage, expansion engines are sometimes used to produce work from the gas leaving a high-pressure storage container if the application requires only low pressure hydrogen.

Turboexpanders are usually used for large gas flows, but can range from 0.75 to 7,500 kW (1-10,000 hp), handling flows as high as 103,000 kg/h (230,000 lb/h) of hydrogen (Timmerhaus and Flynn 1989). Turboexpanders have efficiencies of 85% at full flow, but the efficiency can drop to 60% as the flow rate for a given turbine drops (Timmerhaus and Flynn 1989). Reciprocating expanders, which can be used for variable flows, have efficiencies of 75%-85% (Timmerhaus and Flynn 1989).

2.8 Developing Methods of Hydrogen Storage

Besides liquid, gaseous, metal hydride, and underground storage methods, several other methods of storing hydrogen are in various stages of development. Each has its own advantages and disadvantages.

2.8.1 Liquid Hydrides

Japan is looking at a scheme to produce hydrogen by electrolysis using hydropower in Canada, storing the hydrogen in the form of cyclohexane for transport to Japan, then regenerating the hydrogen to produce electricity. Because hydroelectric power is available at relatively low costs in Canada, this source of renewable energy can be used to produce hydrogen through electrolysis. The hydrogen then reacts with benzene to form cyclohexane. The hydrogen can be recovered using a catalyzed reaction with membrane separation (Chemical Engineering 1994).

This would allow the hydrogen to be transported across the ocean as a stable liquid, but the process does involve a toxic chemical (benzene) and requires complex recovery equipment. (T-Raissi and Sadhu 1994; Huston 1984). Hydrogen can also be converted into methanol, but again the toxicity of methanol is a concern (Chemical Engineering 1994; Huston 1984; Hart 1997; T-Raissi and Sadhu 1994).

2.8.2 Adsorption

Adsorption is a high density storage alternative compared to compressed gas, with a storage volume of about one-third that of compressed gas at 20 MPa (2,900 psig). The mass of the storage media, however, becomes a factor because only 1%-10% of the storage system by weight is hydrogen. The weight of the storage media may be two to four times heavier than a

comparable compressed gas system, including the vessel. Another issue with hydrogen adsorption is that under some circumstances, only 80% of the adsorbed hydrogen can be recovered from the storage media (Hart 1997).

Carbon adsorption has a relatively good storage density, but currently available systems require refrigeration and an insulated storage container to reach high storage densities. Carbon nanotube research may improve the outlook of using carbon adsorption by producing carbon with much higher surface areas per unit mass, allowing it to adsorb greater amounts of hydrogen at room temperature. Currently carbon can adsorb up to 4% hydrogen by weight, with a goal of reaching about 8% at room temperature with further research (Hart 1997; Schwarz and Amonkwah 1993; T-Raissi and Sadhu 1994; Report to Congress 1995).

2.8.3 Sponge Iron

Iron oxide reacts with hydrogen in an endothermic reaction at 1,230°C (2,240°F) to form iron and water. Later, the hydrogen can be recovered by reacting the iron with steam to again form iron oxide and hydrogen. The uncatalyzed reaction requires temperatures of 430°-630°C (800°-1,160°F), but with the appropriate catalyst, the reaction temperature can be reduced to 250°C (482°F). An added benefit of using sponge iron is that, unlike some competing storage methods, it is not poisoned by carbon monoxide, which is produced when reforming hydrocarbons to hydrogen (Hart 1997; T-Raissi and Sadhu 1994).

So far, sponge iron storage has been demonstrated on a laboratory scale only and is at least 3-5 years from commercialization, but it could have the advantages of high energy density and low storage cost (T-Raissi and Sadhu 1994; Zittel and Wurster 1996).

2.8.4 Glass Microspheres

Glass microspheres are small, hollow spheres 25-500 microns (0.001-0.020 in.) in diameter constructed of a glass that becomes permeable to hydrogen when heated to 200°-400°C (392°-752°F). Hydrogen gas enters the microspheres and becomes trapped when they are cooled to room temperature. The hydrogen can then be recovered by reheating the microspheres (Hart 1997; Report to Congress 1995).

2.8.5 Ammonia

Hydrogen can be reacted to form ammonia, which can be stored at 1.7 MPa (250 psig). It can then be dissociated back into hydrogen and nitrogen over an iron oxide catalyst at 700°C (1,292°F) and 0.1 MPa (15 psig), consuming 7.9 kWh/kg (3.6 kWh/lb) of electricity in the process. The ammonia gas provides a high storage density, but it is hazardous to handle and requires electricity to dissociate the ammonia back into hydrogen and nitrogen (Huston 1984).

3.0 CAPITAL COSTS OF STORAGE EQUIPMENT

3.1 Compressor Capital Costs

Compressor costs are based on the amount of work done by the compressor, which depends on the inlet pressure, outlet pressure, and flow rate. Reciprocating compressors are most commonly used for hydrogen applications, but centrifugal compressors are also an option. Reciprocating compressors cost about 50% more than a comparable centrifugal compressor, but have higher efficiencies (Timmerhaus and Flynn 1989). The capital costs of both types of compressors have a sizing exponent of 0.80. High operating pressures also add to the cost of a compressor (Garrett 1985).

Table 1 gives some examples of compressor costs. The prices are \$650-\$6,600/kW (\$440-\$4,900/hp); the larger compressors are several times cheaper on a unit basis than smaller ones.

Table 1 - Compressor Capital Costs

Size (kW)	Size (hp)	Cost* (\$)	Cost/kW* (\$/kW)	Cost/hp* (\$/hp)	Source
10	13	n/a	\$6,600	\$4,900	Zittel and Wurster 1996
75	100	\$180,000	\$2,400	\$1,800	Taylor et al 1986
250	335	n/a	\$660-\$990	\$490-\$735	Zittel and Wurster 1996
2,700	3,600	\$2,330,000	\$863	\$647	Taylor et al. 1986
3,700	5,000	\$2,440,000	\$650	\$480	Taylor et al. 1986
4,500	6,000	\$3,160,000	\$702	\$527	Taylor et al. 1986
28,300	38,000	\$20,000,000	\$702	\$526	TransCanada Pipeline, Ltd. 1996a

*All costs are adjusted to 1995 dollars. n/a - Specific information not provided.

3.2 Liquefaction Capital Costs

The capital cost of a liquid hydrogen plant can be estimated based upon the hydrogen production rate. Sizing exponents for liquid hydrogen plants range from 0.6-0.7 (Zittel and Wurster 1996; Garret 1985; Cuoco et al. 1995). One source gave the total capital cost breakdown as 10% planning, 60% equipment, and 30% construction (Zittel and Wurster 1996).

Table 2 lists some capital costs for liquid hydrogen facilities of various sizes. Price ranged from

\$25,600/kg/hr (\$11,600/lb/h) to \$118,000/kg/hr (\$53,300/lb/h).

Table 2 - Liquefier Capital Costs

Size (kg/h)	Size (lb/h)	Cost* (\$)	Cost* (\$/kg/h)	Cost* (\$/lb/h)	Source
170	375	\$20,000,000	\$118,000	\$53,300	Zittel and Wurster 1996
380	830	n/a	\$31,750	\$14,400	Taylor et al. 1986
1,500	3,300	\$38,800,000	\$25,600	\$11,600	Taylor et al. 1986
n/a	n/a	n/a	\$116,000	\$52,500	Cuoco et al. 1995

*All costs are adjusted to 1995 dollars. n/a - Specific information not provided.

3.3 Metal Hydride Capital Costs

For metal hydrides, capital expenses include not only the storage material, but also a pressure vessel and an integrated heat exchanger for cooling and heating during absorption and desorption, respectively (Schwarz and Amonkwah 1993). In some cases, the gas may need to be compressed, depending on the particular properties of the hydride used (Schwarz and Amonkwah 1993). Because much of the capital cost is for the hydride material itself, there is little economy of scale for metal hydride storage (Carpetis 1994).

Table 3 gives some cost estimates for metal hydride storage. Values ranged from \$820/kg (\$370/lb) of hydrogen to \$60,000/kg (\$29,000/lb) for very small hydride units. Metal hydride units have been constructed for as much as 27 kg (59 lb) of hydrogen (Hydrogen Components, Inc. 1997).

Table 3 - Metal Hydride Capital Costs

Size (kg)	Size (lb)	Cost* (\$)	Cost/kg H ₂ * (\$/kg)	Cost/lb H ₂ * (\$/lb)	Source
n/a	n/a	n/a	\$1,765	\$800	Carpetis 1994
n/a	n/a	n/a	\$2,100-\$2,600	\$940-\$1,200	Carpetis 1994
0.036	0.080	\$2,150	\$60,000	\$29,000	Hydrogen Components Inc. 1997
0.089-8.9	0.2-20	n/a	\$820-\$1,300	\$370-\$570	Oy 1992
8.9-890	20-2000	n/a	\$1,400-\$1,800	\$640-\$800	Oy 1992
2.7	5.9	\$8,500-\$33,000	\$3,150-\$12,200	\$1,440-\$5,600	Zittel and Wurster 1996
0.089	0.2	n/a	\$6,000-\$22,000	\$3,000-\$10,000	Zittel and Wurster 1996
0.89	2	n/a	\$3,000-\$11,000	\$1,350-\$5,050	Zittel and Wurster 1996
8.9	20	n/a	\$2,200-\$8,200	\$1,000-\$3,700	Zittel and Wurster 1996

*All costs are adjusted to 1995 dollars. n/a - Specific information not provided.

3.4 Compressed Gas (Above-Ground) Capital Costs

Above-ground storage of hydrogen typically employs high-pressure spherical or cylindrical tanks with pressure ratings as high as 30 MPa (4,350 psig), but low-pressure spherical tanks with large diameters are also used (Zittel and Wurster 1996; Hart 1997.) Pressure vessel sizing exponents vary from 0.62 to 0.75 based on the capacity (Garrett 1985; Carpetis 1994; Cuoco et al 1995).

Listed in Table 4 are some sample costs for hydrogen gas storage. Capital costs are \$625-\$2,080/kg (\$280-\$940/lb) of hydrogen. In many cases, small tanks are rented by the gas supplier for a couple thousand dollars per month (Zittel and Wurster 1996).

Table 4 - Compressed Hydrogen Pressure Vessel Capital Costs

Size (kg)	Size (lb)	Cost* (\$)	Cost/kg* (\$/kg)	Cost/lb* (\$/lb)	Source
n/a	n/a	n/a	\$625-\$2,080	\$280-\$940	Carpetis 1994
8.9-890	20-2,000	n/a	\$950-\$1,400	\$430-\$640	Oy 1992
0.089-8.9	0.2-20	n/a	\$715-\$840	\$325-\$380	Oy 1992
250	550	\$180,000	\$720	\$330	Taylor et al. 1986
1240	2750	\$840,000	\$680	\$305	Taylor et al. 1986

*All costs are adjusted to 1995 dollars. n/a - Specific information not provided.

3.5 Liquid Hydrogen Vessel Capital Costs

Liquid hydrogen vessels are low pressure, but have high capital costs because of the insulation required to prevent boil-off (Zittel and Wurster 1996). The cost depends mainly on volume with a sizing exponent of around 0.7 (Carpetis 1994, Garrett 1989). Small vessels can be quite expensive and the economy of scale savings are not significant except with large volumes. There is also a reduction in hydrogen losses with larger vessels because of the lower surface area per unit volume at the larger sizes (Carpetis 1994). Perlite insulated tanks cost less than Mylar wrapped tanks, but still provide good insulating properties (International Journal of Ambient Energy 1992).

Table 5 lists some costs for liquid hydrogen vessels of various sizes. Costs were \$31-\$700/kg (\$8.20-\$320/lb).

Table 5 - Liquid Hydrogen Dewar Costs

Size (kg)	Size (lb)	Cost* (\$)	Cost/kg* (\$/kg)	Cost/lb* (\$/lb)	Source
n/a	n/a	n/a	\$31-\$520	\$14-\$235	Carpetis 1994
8.9-890	20-2,000	n/a	\$21-\$36	\$9-\$16	Oy 1992
0.089-8.9	0.2-20	n/a	\$490-\$700	\$220-\$320	Oy 1992
270	590	\$120,000	\$450	\$200	Taylor et al. 1986
300,000	660,000	\$5,400,000	\$18	\$8.20	Taylor et al. 1986

*All costs are adjusted to 1995 dollars. n/a - Specific information not provided.

3.6 Underground Storage Capital Costs

Underground storage is the most inexpensive means of storage for large quantities of hydrogen. Capital costs vary depending on whether there is a suitable natural cavern or rock formation, or whether a cavern must be mined. Using abandoned natural gas wells is the cheapest alternative, followed by solution salt mining and hard rock mining. Solution mining costs were estimated at \$23/m³ (\$0.66/ft³); hard rock mining costs were estimated at \$34-\$84/m³ (\$1.00-\$2.50/ft³) depending on the depth (Taylor et al. 1986).

New York State Electric & Gas recently completed an underground natural gas storage system consisting of 89 km (55 mi) of high-pressure pipeline, a 1,930 kW (2,587 hp) compressor and a solution mined cavern with a 22.6 million Nm³ (800 million scf) working volume (roughly equivalent to 2 million kg [4.5 million lb] of H₂). The complete project cost was cost \$57.2 million (NYSEG 1996b, NYSEG 1996c). The cavern storage capacity was later expanded to 41 million Nm³ (1.45 billion scf, or about 3.6 million kg [8 million lb] of H₂) working volume by adding two more compressors and raising the operating pressure (NYSEG 1997).

One additional expense for underground storage is the value of the cushion gas that remains when the storage system is at the end of its discharge cycle. Brine can be used to displace this gas at an additional expense for pumping and storing the brine solution (Taylor et al, 1986).

Table 6 gives some underground storage capital cost estimates. Prices are \$2.50-\$18.90/kg (\$1.10-\$9.00/lb). This is an order of magnitude less than liquid hydrogen storage and two orders of magnitude less than compressed gas above-ground storage.

Table 6 - Underground Storage Capital Costs

Size (kg)	Size (lb)	Cost* (\$)	Cost/kg* (\$/kg)	Cost/lb* (\$/lb)	Source
n/a	n/a	n/a	\$10.00	\$5.00	Carpetis 1994
8.9-890	20-2000	n/a	\$2.50-\$7.00	\$1.10-\$3.20	Oy 1992
n/a	n/a	n/a	\$6.30-\$18.90	\$3.50-\$9.00	Taylor et al. 1986
2,000,000	4,500,000	n/a	\$28.60 **	\$12.70 **	NYSEG 1996b

*All costs are adjusted to 1995 dollars. n/a - Specific information not provided.

** Includes 89 km (55 mi) of pipeline.

3.7 Pipeline Capital Costs

Pipeline construction costs will be included later in the report with transportation costs. Storing hydrogen in a pipeline system by increasing the operating pressure requires no additional capital

expense as long as the pressure rating of the pipe and the capacity of the compressors are not exceeded (Hart 1997; Report to Congress 1995).

4.0 OPERATING COSTS FOR HYDROGEN STORAGE

Utility costs for hydrogen storage consist of electricity, heat for the metal hydride, and cooling for all the processes. For liquid hydrogen, boil-off losses increase costs.

4.1 Compressed Gas Operating Costs

The largest operating cost with above-ground gas storage is the energy to compress the hydrogen. The exact energy requirements would, of course, depend on the final pressure, but because compression work is an exponential function of pressure, a high final storage pressure requires minimal power compared to the initial compression of the gas. Pressurized electrolyzers that produce hydrogen at an elevated pressure have lower power requirements for compression or liquefaction than electrolyzers operating at or near atmospheric pressures (Hart 1997).

The efficiency of the compressor will also affect the economics. Small compressors may have efficiencies as low as 40%-50%; larger alternating, double-action compressors may have efficiencies in the 65%-70% range (Zittel and Wurster 1996; Cuoco et al. 1995). The energy to compress hydrogen from 0.1 to 15-20 MPa (14.5 psig to 2,100-2,800 psig) can be 8%-10% of the energy content of the hydrogen (Cuoco et al. 1995).

Total costs for compressed gas storage, including equipment-related charges are listed in Table 7. One source breaks down the contributors to above-ground storage costs as follows: \$0.46/kg (\$0.21/lb) for the storage vessel, \$0.06/kg (\$0.03/lb) for compressor-related costs, and \$0.08/kg (\$0.04/lb) for the compressor energy (Schwarz and Amonkwah 1993). In other words, the capital cost of the tank was 75% of the storage costs, explaining the much lower cost for underground storage.

Table 7 - Compressed Gas Above-Ground Storage Total Costs

Size (kg)	Size (lb)	Cost/kg* (\$/kg)	Cost/lb* (\$/lb)	Source
167,000	368,000	\$0.60	\$0.28	Schwarz and Amonkwah 1993
n/a	n/a	\$1.00-\$1.50	\$0.46-\$0.67	Cuoco et al. 1995
n/a	n/a	\$0.07 **	\$0.03 **	Carpetis 1994

*All costs are adjusted to 1995 dollars. n/a - Specific information not provided.

**Power-related costs only.

4.2 Liquefaction Operating Costs

The highest operating cost for liquefaction is electricity. Small amounts of nitrogen and cooling water are also needed. One source breaks down costs as \$0.08/kg (\$0.04/lb) for compression equipment and utilities, \$0.13/kg (\$0.06/lb) for the liquid hydrogen tank, and \$0.99/kg (\$0.45/lb) for electrical energy (Schwarz and Amonkwah, 1993). Compared to compressed gas storage, the storage vessels costs are lower, but for liquefaction the energy requirements are higher.

Table 8 - Liquefier Operating Costs

Size (kg)	Size (lb)	Cost/kg* (\$/kg)	Cost/lb* (\$/lb)	Source
167,000	368,000	\$1.20	\$0.55	Schwarz and Amonkwah 1993
n/a	n/a	\$0.40 **	\$0.19 **	Carpentis 1994

*All costs are adjusted to 1995 dollars. n/a - Specific information not provided.

** Cost for power only.

Liquefaction power requirements varied from 8.0 kWh/kg (3.6 kWh/lb) to 12.7 kWh/kg (5.8 kWh/lb). Application of magnetocaloric cooling to liquefy hydrogen may result in energy requirements as low as 4.94 kWh/kg (2.24 kWh/lb) in the future (Schwarz and Amonkwah 1993; International Journal of Ambient Energy 1992; Zittel and Wurster 1996; Johannsen 1993; Cuoco et al. 1995). For comparison, the ideal energy of liquefaction of hydrogen is 3.228 kWh/kg (1.464 kWh/lb) (Timmerhaus and Flynn 1989). Table 9 gives some liquefaction power requirements.

Table 9 - Liquefier Power Requirements

Liquefaction Energy (kWh/kg)	Liquefaction Energy (kWh/lb)	Source
10.4	4.7	Schwarz and Amonkwah 1993
12.7	5.8	Zittel and Wurster 1996
9.0-11.0	4.1-5.0	Johannsen 1993
8.0	3.6	Cuoco et al. 1995

Boil-off rates depend on the size of the storage vessel and range from 2%-3% per day for small portable containers down to 0.06% per day for large vessels (International Journal of Ambient Energy 1992; Carpentis 1994; Timmerhaus and Flynn 1989; Johannsen 1993; Cuoco et al. 1995; Taylor et al. 1986). A typical boil-off rate is 0.1% (Timmerhaus and Flynn 1989; Johannsen 1993; Taylor et al. 1986). If this hydrogen is not recaptured by the process, the lost hydrogen

represents an expense, and even if it is recaptured, energy is required to re-liquefy it. The industry target for boil-off rate is 0.03% per day (Johannsen 1993).

4.3 Metal Hydride Operating Costs

The main operating cost considerations with metal hydrides are the heating and cooling requirements for the desorption and absorption processes (Encyclopedia of Chemical Technology 1991; Carpetis 1994; Zittel and Wurster 1996). When a metal hydride is also used for purification, the 10% or so of hydrogen lost during blow-off of the contaminants results in an additional cost (Au et al 1996).

A breakdown of storage costs from one source was \$0.04/kg (\$0.02/lb) for utilities, \$0.17/kg (\$0.08/lb) for energy, and \$0.44/kg (\$0.20/lb) for the vessel, heat exchanger and metal hydride (Schwarz and Amonkwah 1993). In this case, the capital cost of the hydride is two-thirds of the total storage cost and energy costs are another 27% of the total storage cost.

Heating and cooling requirements vary from 9,300-18,600 kJ/kg H₂ (4,000-8,000 Btu/lb H₂) (T-Raissi and Sadhu 1994). In the case of low-temperature hydrides, the hydride temperature requirement is generally less than 100°C (212°F), but the heat source may need to be at a higher temperature to allow fast heat transfer with a minimum of heat transfer area (T-Raissi and Sadhu 1994).

4.4 Underground Compressed Gas Operating Costs

The operating costs for underground storage are limited to the energy and maintenance costs related to compressing the gas into underground storage and possibly boosting the pressure coming back out. One estimate of the operating costs of underground storage is \$1.00-\$3.90/kg (\$0.47-\$1.80/lb) (Oy 1992).

5.0 CHOICE OF STORAGE

The choice of which method of hydrogen storage is best depends on:

- The application (Is liquid hydrogen required? What pressure is required?)
- The required energy density (What form of hydrogen delivery will be used? Is space an issue?)
- The quantity of hydrogen to be stored (Is the storage used as a buffer, or primary storage for a large amount of hydrogen?)
- The storage period (Will the storage be used to keep hydrogen for a few hours, or is it seasonal storage?)
- What forms of energy are readily available (Is there waste heat available? Is there high-pressure steam available for a turbine?)
- What is the geology of the area (Are there abandoned natural gas wells available?)

- Any future expansion needs (Are there reasons to believe additional storage will be needed in the future?)
- Maintenance requirements (Is high reliability required? How often can the storage system be shut down for maintenance?)
- Capital costs (Are high capital costs prohibitive?)

(T-Raissi and Sadhu 1994; Oy 1992)

5.1 Application

If hydrogen is required for a cryogenic application, the only choice is liquid hydrogen. If on the other hand, hydrogen can be used as a gas, this would allow all forms of storage and delivery to be considered.

5.2 Energy Density

The energy density of the hydrogen may be an important consideration. For example, if the hydrogen must be delivered to a site far away, liquid hydrogen would probably be the best option. The higher density of liquid hydrogen means one truck can carry as much liquid hydrogen as 20 trucks carrying compressed gas.

Energy density can be expressed in terms of the volumetric energy density or the weight density. This is important in the case of metal hydrides because they have a high volumetric density, but a low weight density (Encyclopedia of Chemical Technology 1991; Hart 1997; Schwarz and Amonkwah 1993). In other words, a metal hydride storage tank may have a small footprint, but can weigh several tons. One reason metal hydrides are difficult to use in automobiles is weight limitation, but for stationary storage, size is usually of more concern than weight.

If hydrogen is being delivered continuously by pipeline, little if any hydrogen storage may be required, and it would not make sense to liquefy the hydrogen, then deliver it to a pipeline as a gas (Hart 1997; Report to Congress 1995). In pipelines with large variation in flow, hydrogen may need to be stored to meet peak demand. The method of storage in that case would depend on the quantity to be stored and the storage time.

5.3 Quantity

The quantity of hydrogen to be stored is a major consideration because the capital cost per pound of hydrogen is generally lower for larger capacity storage units. In the case of liquid hydrogen, boil-off rates are also inversely proportional to the vessel size, so larger storage units will have lower boil-off rates.

Compressed gas storage can be used for small quantities of hydrogen when cryogenic temperatures are not required (Carpentis 1994). Because of the high capital cost of a liquefaction

plant, liquid hydrogen would be cost-prohibitive for small quantities of hydrogen, and the high boil-off rates associated with the smaller vessel size would raise this cost even more. A metal hydride might be a cost-effective option if the hydrogen is produced at a low pressure and a high-pressure gas is required. A metal hydride could also be used if the hydrogen must be purified. With very small quantities of hydrogen, the cost difference between compressed gas and metal hydride storage is not great because both require a pressure vessel and the metal hydride alloy cost is small compared to the vessel cost for small units (Carpentis 1994).

As the storage requirements increase, the metal hydride alloy becomes a larger percentage of the unit cost and becomes the driving cost factor. At the same time, the cost of compressed gas storage decreases per unit volume with larger vessels, making compressed gas storage more economical. Metal hydride storage may still be economical if high pressure hydrogen is needed and a source of waste heat is available (Carpentis 1994).

For even greater quantities of hydrogen, liquid hydrogen starts to become competitive because of the lower storage unit cost per pound of hydrogen. For small quantities of hydrogen, the pressure vessel cost for the compressed gas is lower than the combined costs of the insulated dewar, liquefier, high boil-off, and high energy use. However, as the quantity of hydrogen to be stored increases, the cost of the pressure vessel increases faster than the liquefaction costs (Taylor et al. 1986).

Underground storage is a special case of compressed gas storage where the “vessel” cost is very low. In most cases, underground storage in a natural geological formation will cost less than any other storage technique (Carpentis 1994; Oy 1992). The only case it wouldn't be cheaper is with small quantities of gas in large caverns where the amount of working capital invested in the cushion gas is large compared to the amount of hydrogen stored.

Compressed gas storage is generally limited to 1,300 kg (2,800 lb) of hydrogen or less because of high capital costs (Taylor et al. 1986). Over this, liquid hydrogen storage or underground storage should be considered.

5.4 Storage Period

The longer hydrogen is to be stored, the more favorable underground or liquid hydrogen storage becomes because of lower capital costs. If hydrogen is stored for a long time, the operating cost can be a small factor compared to the capital costs of storage (Carpentis 1994; Oy 1992).

Underground storage is the cheapest for short-term storage, followed by above-ground compressed gas storage, which should be considered for storage times of several hours to several days (Carpentis 1994; Oy 1992). Liquid storage and underground storage should be considered for seasonal or long-term storage of hydrogen for periods longer than a couple of days or 5% annual turnover rates of gas (Carpentis 1994). Metal hydride storage is not economical for large quantities of gas because of the high capital cost of the metal hydride (Oy 1992).

5.5 Energy Availability

The available energy may be another consideration when choosing methods of storage. For compressed gas storage and hydrogen liquefaction, compressor power consumption can be quite high. If inexpensive electricity, gas turbine, or steam turbine power is available, the compression costs will be lower. A cheap source of thermal energy or waste heat would benefit metal hydride storage by reducing the energy costs for releasing the hydrogen from the hydride (Carpentis 1994).

5.6 Maintenance and Reliability

Maintenance and reliability will depend on how simple the storage method is to operate and maintain. A liquefaction plant will be much more complicated and more costly to maintain than a metal hydride storage unit that has no rotating assemblies. Liquefaction will have the highest maintenance requirements, followed by compressed gas storage, and then metal hydrides.

5.7 Safety

Safety is a concern with any option. When the main options for storage are examined, metal hydrides appear to be the safest storage option because the storage unit is at low pressure. If there is a leak in the container, very little hydrogen will leak out because a source of continuous heat is required to release the bond between the metal and the hydrogen (Encyclopedia of Chemical Technology 1991; Hart 1997).

For compressed gas, there are two dangers. First, a high-pressure vessel always presents some level of risk, whether it is an inert gas or a reactive gas such as hydrogen (Schwarz and Amonkwah 1993; T-Raissi and Sadhu 1994). Second, if a compressed gas tank develops a leak, it will result in the release of a large amount of hydrogen very quickly. Liquid hydrogen has the potential to release even more hydrogen than compressed gas if a storage container leaks because the liquid hydrogen will quickly vaporize. In open areas there is, however, little chance of detonation, because hydrogen diffuses into air quickly (Hart 1997).

5.8 Summary

Based on current hydrogen storage technology, the following generalizations can be made:

Underground Storage - For large quantities of gas or long-term storage.

Liquid Hydrogen - For large quantities of gas, long-term storage, low electricity costs or applications requiring liquid hydrogen.

Compressed Gas - For small quantities of gas, high cycle times or short storage times.

Metal Hydrides - For small quantities of gas.

6.0 ANALYSIS OF STORAGE COSTS

An analysis was performed to estimate storage costs based on the major operating and capital expenses. For storage, there were two main factors: production rate and storage time. Production rate is used in sizing compressors and liquefaction plants, and determining the operating costs in each case. Production rate multiplied by the number of days of storage gives the storage capacity required, which in turn determines the storage unit size and capital costs. Flow rates are used to calculate the electricity, heating, and cooling requirements. These operating costs are independent of storage capacity. Sample calculations for each storage option are in Appendix A.

6.1 Cost Assumptions

Table 10 provides the factors used to estimate the capital costs associated with hydrogen storage. These particular numbers were used because they provided the best cost estimates over the entire range of flows examined.

Table 10 - Hydrogen Storage Capital Cost Assumptions

	Base Size	Base Cost	Base Pressure	Sizing Exponent	Pressure Factor
Compressor	4,000 kW (5,400 hp)	\$1,000/kW (\$746/hp)	20 MPa (2,900 psia)	0.80	0.18
Compressed Gas Vessel	227 kg (500 lb)	\$1,323/kg (\$600/lb)	20 MPa (2,900 psia)	0.75	0.44
Liquefier	454 kg/h (1,000 lb/h)	\$44,100/kg/hr (\$20,000/lb/h)	n/a	0.65	n/a
Dewar	45 kg (100 lb)	\$441/kg (\$200/lb)	n/a	0.70	n/a
Metal Hydride	n/a	\$2,200/kg (\$1,000/lb)	n/a	1.00	n/a
Underground	n/a	\$8.80/kg (\$4.00/lb)	20 MPa (2,900 psia)	1.00	1.00

n/a - Not applicable.

Table 11 gives the operating cost assumptions used in the analysis:

Table 11 - Storage Operating Cost Assumptions

	SI Units	English Units
Compressor Power (0.1 to 20 MPa [14.7 to 2,900 psia])	2.2 kWh/kg	1.0 kWh/lb
Compressor Cooling (0.1 to 20 MPa [14.7 to 2,900 psia])	50 L/kg	6.0 gal/lb
Liquefier Power	10 kWh/kg	4.5 kWh/lb
Liquefier Cooling	626 L/kg	75 gal/lb
Boil-Off Rate	0.1%/d	0.1%/d
Hydride Cooling	209 L/kg	25 gal/lb
Hydride Heat of Reaction	23,260 kJ/kg	10,000 Btu/lb
Electricity Cost	\$0.05/kWh	\$0.05/kWh
Steam Cost	\$3.80/GJ	\$4.00/MM Btu
Cooling Water Cost	\$0.02/100 L	\$0.07/1,000 gal
Operating Days	350/yr	350/yr
Depreciation	22-year, straight-line, ADS method	22-year, straight-line, ADS method

6.2 Compressed Gas Storage Methodology

For compressed gas, the storage requirements are calculated from the production rate and storage time. Energy use is based on the flow rate and final outlet pressure. The base case for this power consumption assumes compression from 1 atmosphere to 20 MPa (2,900 psia). For other outlet pressures, a ratio of the natural logs of the pressures is used to adjust the power requirements up or down. Compressor costs are based on the power of the compressor and are adjusted for outlet pressure. Compressor tank costs are based on an estimate of the storage cost at 20 MPa (2,900 psia) and this cost is adjusted for different sizes at different pressures. Although the base cost is given on a mass basis, it is scaled based on volume by multiplying by a ratio of the pressures (See Appendix A.1 for details). Capital costs include the compressor and pressure vessel; operating costs include the electricity and cooling water costs. Depreciation is calculated using the 22-year straight-line Alternative Depreciation System (ADS).

6.3 Liquid Hydrogen Storage Methodology

The flow rate or production rate for the liquid hydrogen case is adjusted to account for hydrogen boil-off losses that occur during storage. A simple exponential rate equation is used in this calculation. The amount of hydrogen storage is based on the adjusted flow rate and storage time. Operating costs are also based on the adjusted production rate. When converting to costs per pound of hydrogen, the losses are taken into account. The electricity and cooling water requirements are based on the adjusted flow rate. The liquefier capital cost is also based on the adjusted flow rate and scaled using the factor noted earlier. The dewar capital cost is based on the total amount of hydrogen stored. The capital cost calculations include the cost of the liquefier and dewar and, as in the compressed gas case, are depreciated over 22 years. Appendix A.2 has a sample calculation for liquid hydrogen storage.

6.4 Metal Hydride Methodology

Like the other cases, the metal hydride storage requirements are calculated by multiplying the production rate times the storage time. Energy and cooling requirements are calculated based on the hydrogen flow rate. Cooling water is required to store the hydrogen in its hydride form, and heat is used to later release the hydrogen from the hydride. Hydride capital costs were based on a fixed storage cost for a given quantity of hydrogen with no scaling factor, so the resulting costs are independent of flow rate. Energy costs are calculated assuming a fixed steam cost, and a pre-existing heat source was assumed. Total costs include heating, cooling, and the depreciation cost of the metal hydride. These calculations are shown in Appendix A.3.

6.5 Underground Storage Methodology

The hydrogen flow rate is used to calculate the power and cooling requirements for compressing the hydrogen from 1 atmosphere to 20 MPa (2,900 psia), as in the compressed gas case. Again, a ratio of the natural logs of the pressures is used to calculate the power requirements for pressures other than 20 MPa (2,900 psia). The compressor cost is based on the power and outlet pressure. The underground cavern cost is calculated based on a fixed cost per unit storage volume. When a pressure other than 20 MPa (2,900 psia) is used, a ratio of the pressures is used to take the volume change of the gas into account. No increased cavern costs are assumed for higher pressures; the cost difference is associated only with the change in volume. Capital costs include the cost of the compressor and cavern. Operating costs include electricity and cooling water. A sample underground storage cost calculation is shown in Appendix A.4.

6.6 Storage Conclusions

Underground storage was found to be the cheapest method at all production rates and storage times because of the low capital cost of the cavern. Most of the cost of underground storage is associated with the electricity requirements to compress the gas, which is independent of storage

volume. This means the cost of underground storage is very insensitive to changes in production rate or storage time.

The metal hydride storage was assumed to provide no economy of scale, so its hydrogen storage costs were independent of flow rate. There were no savings at larger sizes, so it does not compete with the other storage options at long storage times or high hydrogen flows. Because the alloy capital cost is a major portion of the total hydride storage cost, hydride storage costs vary little with heating costs. Metal hydride storage, however, does compete with liquid hydrogen and compressed gas storage at low flow rates and short storage times.

Liquid hydrogen storage is not economical at low production rates because of the high capital cost of the liquefier. Even at higher production rates, compressed gas is more economical for short storage periods. However, as the storage time increases, liquid hydrogen has an advantage over compressed gas because of the low capital cost of a liquid hydrogen dewar compared to a compressed gas pressure vessel.

Because of the low cost of the dewar, liquid hydrogen storage costs are relatively insensitive to storage time. At high production rates, economy of scale factors reduce the liquid storage costs until they are eventually limited by the electricity costs associated with liquefaction. Liquid hydrogen storage cost is affected the greatest by changes in electricity price because it has the largest power requirement. The analysis found that boil-off rate did not become a major cost factor until the storage time was longer than a week or two, so for short-term storage, cheaper insulation may reduce overall costs.

Compressed gas storage competes with liquid hydrogen and metal hydride storage for small quantities of hydrogen and low production rates. At low production rates, the capital cost of the pressure vessel is large, but economy of scale reduces this cost at higher production rates, until the storage cost is eventually limited by the compressor electricity cost. As storage time increases, the capital cost of the pressure vessel drives up the storage cost.

One option for compressed gas storage is to increase the operating pressure of the system. This increases the cost of the pressure vessel and compressor, but the reduction in tank size can result in an overall savings. For short storage periods with compressed gas, an optimum occurs where the reduction in tank capital costs is balanced against the increased compressor and compressor electricity costs. At longer storage times, the capital cost reduction becomes the important factor, so the optimum occurs at the maximum operating pressure, which minimizes the tank size and cost.

A similar analysis was carried out for underground storage, and indicated that for short storage periods, the optimum occurs at the lowest possible storage pressure because this is where the compressor electricity requirements are the lowest. At longer storage times, the capital cost of the cavern becomes significant, and an optimum is formed where the electricity costs balance out the cavern costs. Note that the price of cushion gas was not taken into account. A high cushion

gas cost would favor higher operating pressures, allowing more storage or working volume for the same amount of cushion gas.

For all storage options examined, cooling water costs were negligible compared to the energy and capital expenses.

Appendix D contains detailed data for each storage option at various production rates and storage times. Graphs identifying important trends in the data, along with some sensitivity analyses are included in Appendix F.

7.0 TRANSPORTATION OF HYDROGEN

Hydrogen can be transported as a compressed gas, a cryogenic liquid, or as a solid metal hydride. The cheapest method of transportation will depend on the quantity delivered and the distance. The methods of delivering the hydrogen considered were truck, rail, ship, and pipeline.

7.1 Compressed Gas Transport

Compressed gas can be transported using high-pressure cylinders, tube trailers or pipelines. If hydrogen is to be transported as a gas, it should be compressed it to a very high pressure to maximize tank capacities. High-pressure gas cylinders for example are rated as high as 40 MPa (5,800 psig) and hold about 1.8 kg (4 lb) of hydrogen, but are very expensive to handle and transport (Encyclopedia of Chemical Technology 1991).

Tube trailers, consisting of several steel cylinders mounted to a protective framework, can be configured to hold 63-460 kg (140-1,000 lb) of hydrogen (Air Products 1997), depending on the number of tubes. Operating pressures are 20-60 MPa (2,900-8,700 psig) (Leiby 1994; Hart 1997; Zittel and Wurster 1996; Air Products 1997).

Hydrogen is delivered by pipeline in several industrial areas of the United States, Canada, and Europe. Typical operating pressures are 1-3 MPa (145-435 psig) with flows of 310-8,900 kg/h (685-20,000 lb/h) (Hart 1997; Zittel and Wurster 1996; Report to Congress 1995). Germany has a 210 km (130 mi) pipeline that has been operating since 1939, carrying 8,900 kg/h (20,000 lb/h) of hydrogen through a 0.25 m (10 in.) pipeline operating at 2 MPa (290 psig) (Hart 1997). The longest hydrogen pipeline in the world is owned by Air Liquide and runs 400 km (250 miles) from Northern France to Belgium (Hart 1997). The United States has more than 720 km (447 mi) of hydrogen pipelines concentrated along the Gulf Coast and Great Lakes (Hart 1997; Report to Congress 1995).

No information was found on the transport of compressed hydrogen by rail.

7.2 Liquid Hydrogen Transport

Liquid hydrogen is transported using special double-walled insulated tanks to prevent boil-off of the liquid hydrogen. Some tankers also use liquid nitrogen heat shields to cool the outer wall of the liquid hydrogen vessel to further minimize heat transfer (Huston 1984).

Tank trucks can carry 360-4,300 kg (800-9,500 lb) of liquid hydrogen (Leiby 1994; International Journal of Ambient Energy 1992; Huston 1984; Timmerhaus and Flynn 1989). Railcars have even greater capacities, carrying 2,300-9,100 kg (5,000-20,000 lb) of hydrogen (Encyclopedia of Chemical Technology 1991; International Journal of Ambient Energy 1992; Huston 1984; Timmerhaus and Flynn 1989). Boil-off rates for trucks and railcars are 0.3%-0.6%/day (Encyclopedia of Chemical Technology 1991; Timmerhaus and Flynn 1989).

Barges or sea-going vessels have been considered for long-distance transport of hydrogen. Canada developed several ship designs for transatlantic transport of hydrogen. One uses five small barges carried in a larger ship that can be separated once the trip is complete. Each barge would carry 21,200 kg (46,800 lb) of hydrogen, with no venting during a 50-day trip. Other designs included a single tanker holding 7 million kg (16 million lb) of hydrogen and another with four spherical tanks, each holding 3.5 million kg (8 million lb). Boil-off rates for these vessels are estimated at 0.2%-0.4%/day (Hart 1997). None of these vessels has been constructed, but liquid natural gas tankers transport as much as 125,000 m³ of natural gas (roughly equivalent to 9 million kg [20 million lb] of hydrogen) (Timmerhaus and Flynn 1989).

One other idea for the delivery of liquid hydrogen is through an insulated pipeline that would also include a super-conducting wire. The liquid hydrogen would act as a refrigerant for the superconductor and would allow long distance transportation of electricity without the high current losses of conventional power lines (Oy 1992; Timmerhaus and Flynn 1989). The main problem with liquid hydrogen transport would be the specialized insulating requirements and losses from pumping and re-cooling the liquid hydrogen along the way (Timmerhaus and Flynn 1989).

7.3 Metal Hydride Transport

Metal hydrides can be used for transport by absorbing hydrogen with a metal hydride, then loading the entire container onto a truck or railcar for transport to the customer's site where it can be exchanged for an empty hydride container, or used as a conventional tanker (Huston 1984; Au et al. 1996).

8.0 CAPITAL COSTS OF TRANSPORTATION EQUIPMENT

8.1 Compressed Gas Transport Costs

Tube trailer capital costs depend on the operating pressure of the truck, the storage capacity of each trailer, and the distance to the customer site. Higher operating pressures increase the capacity of a tube trailer, but increase the purchased price of each truck. This can result in lower overall capital costs by reducing the number of trucks required. The distance to the customer site also affects the number of trucks. For local delivery, the same truck can make several trips back and forth between the production site and the customer site, but for long distances, each truck might be able to make only one or two deliveries per day.

One capital cost of \$340,000 was found for a tube trailer containing 16 tubes with a total capacity of 460 kg (1,000 lb) of hydrogen. The cost of a truck cab to go with it was \$110,000 (Taylor et al. 1986). A recent budgetary estimate for a tube truck was \$140,000 (FIBA 1998).

Operating costs include fuel costs and driver wages or freight charges.

8.2 Compressed Gas Pipeline Costs

Hydrogen pipelines are constructed of 0.25-0.30 m (10-12 in.) commercial steel and operate at 1-3 MPa (145-435 psig). Natural gas mains for comparison are constructed of pipe as large as 2.5 m (5 ft) in diameter and have working pressures of 7.5 MPa (1,100 psig) (Hart, 1997).

Because a large fraction of the pipeline cost is for installation, natural gas construction prices were used to estimate the pipeline costs. Table 12 lists the installation costs of some recent projects.

Table 12 - Pipeline Installation Costs

Length (km)	Length (mi)	Cost* (\$)	Cost* (\$/km)	Cost* (\$/mi)	Source
78.4	48.7	\$18,000,000	\$237,000	\$370,000	TransCanada Pipeline, Ltd. 1996a
108.5	67.4	\$84,000,000	\$774,000	\$1,250,000	TransCanada Pipeline, Ltd. 1996b
46.9	29.1	\$48,000,000	\$1,000,000	\$1,650,000	TransCanada Pipeline, Ltd. 1996c
731.0	454.0	\$910,000,000	\$1,250,000	\$2,000,000	TransCanada Pipeline, Ltd. 1993
561.0	349.0	\$384,000,000	\$685,000	\$1,100,000	TransCanada Pipeline, Ltd. 1997
40.2	25.0	\$5,300,000	\$132,000	\$212,000	NYSEG 1996a

*All costs are adjusted to 1995 dollars.

The major operating cost for hydrogen pipelines is compressor power and maintenance. Some hydrogen losses may occur in the piping network, but for natural gas piping systems, these losses are less than 1% (Hart, 1997). An estimate of the cost of piping hydrogen from North Africa to Central Europe (3,300 km [2,050 mi]) was \$0.90-\$1.20/kg (\$0.41-\$0.53/lb), including compression costs. Another estimate for the United States put the cost at \$0.39/kg (\$0.18/lb) (Report to Congress 1995). Two other studies also noted that for large quantities of hydrogen, pipelines are the cheapest means of transporting hydrogen, except for transport across the ocean, when liquid hydrogen transport is the cheapest means (Oy 1992; Johannsen 1993).

8.3 Liquid Hydrogen Transport Costs

The capital costs of liquid hydrogen transport will consist mainly of the insulated tank trailer or railcar, plus the cost of the cab for truck transport. Although hydrogen is not currently transported overseas, a hydrogen barge is expected to cost 3.5-4 times as much as a liquefied natural gas barge (Carpetis 1994).

The liquid hydrogen truck transport costs include the same fuel, driver wages and maintenance charges as for gas transport, but also include boil-off losses during transport. Expected boil-off losses during transfer between tanks is 10%-20%, but can be as high as 50% (Huston 1984; Johannsen 1993; Taylor et al. 1986). As mentioned earlier, boil-off during transport is expected to be 0.3%-0.6%/day. Railcar transport of hydrogen includes boil-off losses during transport and transfer, plus rail freight charges.

One source estimated long-distance transportation of liquid hydrogen from Africa to Europe at \$1.80-\$2.10/kg (\$0.82-\$0.94/lb) (Johannsen 1993). Another source mentions that shipping liquid hydrogen across the Atlantic would triple its price (Oy 1992).

8.4 Metal Hydride Transport Costs

For transportation of hydrogen using metal hydrides, the major cost is the capital expense of buying the metal hydride and containers. Once filled, the hydride containers can be shipped like any other piece of freight, with charges depending on the distance and weight.

9.0 CHOICE OF TRANSPORTATION

The main factors affecting the choice of hydrogen transport are the application, quantity, and distance from the production site to the customer. As mentioned under storage, if liquid hydrogen is needed for the application, it should be delivered as liquid hydrogen.

9.1 Quantities

For large quantities of hydrogen, pipeline delivery is cheaper than all other methods except in the case of transport over an ocean, in which case liquid hydrogen transport would be cheapest. The next cheapest method of delivery would be liquid hydrogen. Pipeline delivery has the benefit of a very low operating cost, consisting mainly of compressor power costs, but has a high capital investment. Liquid hydrogen, on the other hand, would have a high operating cost, but possibly a lower capital cost, depending on the quantity of hydrogen and the delivery distance. The break-even point between liquid hydrogen and a pipeline will vary depending on the distance and quantity.

For smaller quantities of hydrogen, pipeline delivery is not competitive, but compressed gas delivery may be competitive. Compared to liquid hydrogen, compressed gas has lower power requirements and slightly lower capital costs for the tube trailers, but many more tube trailers are required to deliver the same quantity of hydrogen. Which delivery method is more economical will depend on the delivery distance, because it may be possible to use the same tube trailer for several trips per day if it is a short distance.

For still smaller quantities, the high capital cost of a pipeline eliminates it as an option. The deciding factor between liquid hydrogen and compressed gas becomes a matter of distance. For long distances, the higher energy costs of liquefaction will balance out against the higher capital and transportation expense of many compressed gas tube trailer trips back and forth. If the distance is relatively short, and the quantity of hydrogen transported is small, compressed gas may win out.

Metal hydride transport costs tend to fall between those for liquid hydrogen transport and compressed gas transport. While metal hydride transport has a larger capital expense per truck, the hydrogen capacity per truck is greater compared to using compressed gas transport.

9.2 Distance

As mentioned earlier, distance is an important factor. For a short distance a pipeline can be very economical because the capital expense of a short pipeline may be close to the capital cost of tube trucks or tankers, and there are no transportation or liquefaction costs. As the distance increases, the capital cost of a pipeline increases rapidly, and the economics will depend on the quantity of hydrogen--pipelines will be favored for larger quantities of hydrogen. For small quantities of hydrogen, at some point the capital cost of the pipeline will be higher than the operational costs associated with delivering and liquefying the hydrogen.

Distance is a deciding factor between liquid and gaseous hydrogen. At long distances, the number of trucks required to deliver a given quantity of compressed hydrogen will be greater than the increased energy costs associated with liquefaction and fewer trucks.

9.3 Special Case--Power Supply

One special case related to hydrogen is when energy must be transmitted a long distance. Currently, energy is transmitted by high-voltage power lines, and current losses result in a 7%-8% loss in transmitted energy. Hydrogen gas transport through a pipeline on the other hand, results in somewhat lower losses, meaning it may be cheaper to produce hydrogen and pipe it to a location requiring heat or electrical energy because the energy losses are less with a hydrogen pipeline (Hart 1997). One source indicated the cutoff where hydrogen energy transport is cheaper than overhead lines is 1,000-2,250 km (631-1,398 miles) (Report to Congress 1995).

9.4 Futures in Hydrogen Transport

Several trends in hydrogen transportation were identified. First, there is continued research in long-range transport of hydrogen using barges or ships. Canada is especially interested because it has large hydroelectric resources that could be used to produce hydrogen. It has designed several vessels for carrying hydrogen across the Atlantic. One design uses five barges contained on a single ship, designed to go for 50 days without venting hydrogen. Once overseas, the barges can be separated to go to different destinations without incurring transfer losses (Hart 1997). Two other designs include a ship with four spherical dewars, each holding 3.5 million kg (8 million lb) of hydrogen and a single-hull design capable of carrying 7 million kg (16 million lb) of hydrogen with a boil-off rate of 0.2%-0.4%/d (Hart 1997). Another option mentioned was the use of airplanes to delivery hydrogen over great distances to reduce transport times and consequently reduce boil-off losses. Work is also being done to reduce transfer losses in hydrogen transportation, with a goal of reducing losses to 8% (Johannsen 1993).

Pipeline delivery of liquid hydrogen was not analyzed, but there are pipes capable of carrying liquid hydrogen (Oy 1992; Timmerhaus and Flynn 1989). One special case of using a liquid hydrogen pipe is when it is combined with a superconducting wire. The liquid hydrogen could keep the wire cool enough to be a superconductor for very efficient transport of electricity, possibly justifying the higher capital costs of the liquid hydrogen pipeline (International Journal of Ambient Energy 1992).

Large-scale distribution networks for hydrogen must address storage issues to provide a buffer between production facilities and customers and to cover fluctuations in demand (Report to Congress 1995). Natural gas pipelines could be converted to hydrogen gas (Hart 1997), but there is some concern that hydrogen embrittlement of the fittings and piping would cause them to crack and leak (Report to Congress 1995).

Much work is being done to increase the storage density and reduce the costs of metal hydrides because of the reduced risk of catastrophic hydrogen releases. One option for metal hydrides is to use metal hydride "boxes" where a charged hydride container is exchanged for an empty one at the customer site. This would eliminate the need for separate storage units at the hydrogen plant and customer site if the price of the hydride were low enough to allow the use of several units (Huston 1984).

As mentioned in the storage section, liquid hydrides are being investigated and could be easily transported by pipeline, tanker truck, railcar, or supertanker (Hart 1997).

9.5 Summary

Below is a summary of the decision making criteria:

Pipeline - For large quantities or long-distance power transmission.

Liquid Hydrogen - For transport over long distances.

Compressed Gas - For small quantities over short distances.

Metal Hydride - For short distances.

10.0 ANALYSIS OF THE COST TO TRANSPORT HYDROGEN

The two main factors affecting the cost of transporting hydrogen are production rate and delivery distance. It is incorrect to calculate the delivered cost of hydrogen based on a per truck basis, because this does not take into account the fact that one truck can make several trips, or may sit idle much of the time. For example, if a liquid hydrogen tanker makes only one trip per day, its capital and operating costs are added to one truckload of hydrogen. If the same truck makes five trips, the capital expense for the truck is spread out over five times as much hydrogen.

Truck capacity is an important factor, especially for longer distances, because it determines the number of trips that must be made and how many trucks are required. At higher production rates or longer distances, several trucks may be in transit at any given time.

Capital costs include the cost of the transport container, the cost of the truck cab and the cost of the trailer undercarriage, or the cost of pipeline installation and construction. For flexibility, a separate cost was included for the truck undercarriage and tank container. This reflects the trend by industry toward intermodal transport units that can be used with trucks, railcars, or even ships. Operating costs include labor for drivers, fuel, compressor electricity, and freight charges for rail and ship transport. Labor and truck availability are calculated based on average speeds and the delivery distance with added time for loading and unloading.

Appendix B contains sample calculations for each hydrogen transport method.

10.1 Cost Assumptions for Hydrogen Transport

Table 13 lists the assumptions that were used for the transportation capital costs.

Table 13 - Hydrogen Transport Capital Cost Assumptions

	Cost	Hydrogen Capacity/Size
Tube Truck Intermodal Unit	\$100,000	180 kg (400 lb)
Truck Liquid Intermodal Unit	\$350,000	4,080 kg (9,000 lb)
Metal Hydride Intermodal Unit	\$2,200/kg H ₂ (\$1,000/lb)	454 kg H ₂ (1,000 lb)
Truck Undercarriage	\$60,000	
Truck Cab	\$90,000	
Rail Tube Assembly	\$200,000	454 kg (1,000 lb)
Rail Liquid Unit	\$400,000	9,090 kg (20,000 lb)
Rail Hydride Unit	\$2,200/kg H ₂ (\$1,000/kg)	910 kg (2,000 lb)
Rail Undercarriage	\$100,000	
Ship Liquid Unit	\$350,000	4,080 kg (9,000 lb)
Pipeline Cost	\$620,000/km (\$1 million/mi)	
Compressor Cost	\$1,000/kW (\$746/hp)	4,000 kW (5,400 hp)

Table 14 gives the assumptions used for calculating the operating costs.

Table 14 - Transport Operating Cost Assumptions

Truck Mileage	6 mpg (2.6 km/L)
Average Truck Speed	50 mph (80 km/h)
Truck Load/Unload Time	2 h/trip
Truck Availability	24 h/d
Driver Availability	12 h/d
Driver Wage (Fully Loaded)	\$28.75/h
Diesel Price	\$1.00/gal
Truck Boil-Off Rate	0.3%/d
Rail Average Speed	25 mph (40 km/h)
Rail Load/Unload Time	2 h/trip
Rail Car Availability	24 h/d
Rail Freight Charge	\$400/wagon
Rail Boil-Off Rate	0.3%/d
Average Ship Speed	10 mph (16 km/h)
Ship Load/Unload Time	48 h/trip
Ship Tank Availability	24 h/day
Ship Freight Charge	\$3,000/intermodal unit
Ship Boil-Off Rate	0.3%/d
Pipeline Roughness	4.6×10^5 m
Pipeline Diameter	0.25 m (10 in.)
Pipeline Gas Temperature	10 C (50 F)
Pipeline Delivery Pressure	20 MPa (2,900 psia)
Hydrogen Viscosity	8.62×10^{-6} kg/m s
Hydrogen Gas Constant	4,124 N m/kg K
Compressor Power (0.1 to 20 MPa [14.6 to 2,900 psia])	2.2 kWh/kg(1.0 kWh/lb)
Electricity Cost	\$0.05/kWh
Operating Days	350 d/yr
Trailer Depreciation	6 years, straight-line, ADS method
Truck Cab Depreciation	4 years, straight-line, ADS method
Railcar Depreciation	15 years, straight-line, ADS method
Pipeline Depreciation	22 years, straight-line, ADS method

10.2 Truck Transport Methodology

The truck transportation costs were calculated as follows:

First the production rate is multiplied by the operating days to calculate the annual production rate. This annual production rate is divided by the truck capacity to find the number of trips. (It is possible to have less than one trip per day for small production rates.) The total number of miles traveled is calculated using the two-way drive distance times the number of trips per year. The travel time per trip is calculated by dividing the two-way distance by the average truck speed and rounding up to the next whole hour. The per trip travel time is multiplied by the total number of trips per year to get the total driving time per year. The total time for loading and unloading is calculated by multiplying the load/unload time by the number of trips per year. Adding the drive time and loading/unloading time gives the total delivery time. (See Appendix B for a sample calculation.)

The total delivery time is divided by the truck availability per year to determine the number of trucks needed (One truck may be used for several trips using this method). Dividing the total delivery time by the yearly driver availability determines the number of drivers needed (One driver may make multiple trips, or multiple drivers may be needed for long trips). Fuel use is based on the distance driven divided by the mileage. Fuel cost is then calculated based on usage.

The capital costs include the price of the truck cab, undercarriage, and intermodal storage unit. Depreciation is straight-lined separately for the cab and trailer since they have different Internal Revenue Service class lives. The labor costs are based on total driving hours. (Whether the driver wages were paid for time on the road or time driving was unclear. In the case of trips longer than 12 hours, two drivers are needed, but in these calculations, the wages were paid for time driving only.) Total cost consists of capital depreciation, labor, and fuel costs.

Trip frequency is calculated by dividing the trips per year by the number of operating days. Trip length was based on the total delivery time divided by the number of trips (or drive time per trip plus the delivery time). A utilization rate is calculated by dividing the trip frequency by the number of trucks.

A fixed price was assumed for all trailers. Metal hydride costs were calculated using a metal hydride storage price, but the capacity of the metal hydride truck was kept constant. For liquid hydrogen, boil-off losses were taken into account by assuming some hydrogen was lost during transit. No transfer losses during loading and unloading were included.

10.3 Rail Delivery Methodology

For rail transport, similar procedures were used to calculate the delivery time and number of railcars required, but there are no fuel or labor costs. Instead, a flat rate freight charge is assumed. The transit times were rounded up to the next whole day, and the loading/unloading

time was changed to 24 hours, assuming one rail switch per day. The hydrogen producer was assumed to own the rail cars, so no demurrage or rental fees were included.

For the rail case, higher storage capacities were used. For the metal hydride, a higher railroad weight allowance allowed the storage capacity to be raised to 910 kg (2,000 lb). At 3% storage density, this would result in a total hydride alloy weight of 30 tonnes (33 tons). The liquid hydrogen capacity was based on values for a jumbo liquid hydrogen railcar.

Capital costs for the rail case consist of the rail car storage unit and undercarriage. The only operating cost is the railroad freight charge. Hydrogen boil-off is accounted for in the liquid hydrogen case.

10.4 Water Transport Methodology

The cost calculations for shipping hydrogen by ship or barge are very similar to the calculations for shipping by rail, except the average speed is lower and the load/unload time is extended to 48 hours, assuming a shipping container must be there the day before the ship leaves and can't be picked up until the day after the ship arrives. Again, a flat rate is assumed for calculating shipping charges and the travel time is rounded up to the next whole day.

The storage capacities used for transport by ship are the same as for truck transport, because intermodal transport units are assumed to be used. In this case, no undercarriage charge was used. The costs of getting the intermodal units from the hydrogen plant to the shipyard were not included.

10.5 Pipeline Delivery Methodology

For pipelines, the costs considered included the installed pipeline costs, the compressor cost to overcome the friction losses in the pipe, and the electricity requirements for the compressor.

The pressure loss through the pipe was calculated assuming the roughness of steel pipe and a compressible gas flow equation. The gas being pumped was assumed to be coming out of storage at pressure, and the only compression needed was to provide motive force to overcome friction losses in the pipe. The compressor size and energy requirements were based on the same ratio of logs used to calculate the incremental increase in storage pressures. In most cases the pipeline losses, and therefore compressor size, were small.

Capital costs for the pipeline include all costs associated with purchasing the pipe, installing it and obtaining any required right-of-ways. The total cost for pipeline delivery includes the compressor, pipeline, and electricity costs.

10.6 Transport Conclusions

Liquid hydrogen transport by truck is the cheapest alternative, except for large quantities of hydrogen, when pipeline delivery becomes competitive. At longer distances, the capital cost of the extra pipeline requires more hydrogen flow before it will compete with liquid hydrogen delivery. Sharing the expense of a pipeline among several suppliers and users would reduce these costs. Because the major expense is installing the pipeline, and not the pipeline cost itself, a larger pipeline can be installed to handle multiple users for about the same cost. This is currently done along the Gulf Coast and around the Great Lakes.

Very little energy is required to pump the hydrogen through the pipeline. Bringing the hydrogen up to pressure would require a great deal more energy than is shown. These power requirements were incorporated into the previous storage costs.

In all cases, except pipeline delivery, a minimum transport cost is associated with each delivery method for a given distance. This point is reached when the production rate is high enough that the truck or rail car is being fully utilized 100% of the time. As an example, a small hydrogen plant doubles its production rate and, instead of making one trip per day with a liquid hydrogen truck, it makes two trips per day. The total capital cost remains the same--the cost of one truck--but this cost is now spread out over twice as much hydrogen. If a truck is already fully utilized, however, any increase in production will require purchasing another truck and produces no reduction in transport costs. The lowest capacity methods level off first for any given distance as production rate increases.

Rail car costs vary little with production rate and distance; railcars quickly become fully utilized because of the long transit times associated with rail transport--they spend most of their time in transit or sitting in a rail yard. This results in high capital costs for many of rail cars, but the flat shipping rate makes rail transport charges insensitive to distance. Liquid transport by rail is almost as cheap as truck liquid transport and is cheaper than the other trucking options because of the large capacity per railcar.

As expected, the truck transport costs increase with distance because of the higher labor and fuel costs. Capital costs also increase with distance. For short distances, one truck can make multiple trips each day, but as the distance increases, more trucks are needed because more time is spent in transit--there is less chance to use the same truck for multiple trips. Compressed gas transport is affected the most--it requires the most trips because of the low hydrogen capacity per truck. For all methods, labor costs quickly start to dominate for distances longer than 160 km (100 mi). Compressed gas delivery costs also see the largest effect from fuel price because of the many trips.

For small production rates, liquid hydrogen transport costs are high because the truck is not fully utilized, it may only make a few trips per week. At these low flows, the truck capital cost contribution is the largest cost, but the costs are also less sensitive to distance because there are

far fewer trips compared to larger production rates. At all flow rates, as distance increases, liquid hydrogen delivery charges become dominated by the labor costs. However, with liquid hydrogen, the effect is small compared to compressed gas because the driver is carrying more hydrogen per trip. One hydrogen tanker can carry more than 20 times the amount of hydrogen as a tube trailer.

At a medium production rate of 450 kg/h (1,000 lb/h) and a 160 km (100 mi) delivery distance, liquid hydrogen trucking was the cheapest means of transport, but metal hydride also competes because of its high storage density. To illustrate the effect of truck capacity for each delivery method, at the above production rate and delivery distance, 15 tube trailers would be needed, making 60 trips per day (four trips per truck), six hydride trucks making 24 trips per day (four trips per truck) or one liquid hydrogen truck making three trips per day.

The increased weight of the metal hydride was not taken into account when analyzing the transportation costs. Also, there is a great difference in capital expenditures required among the different transport methods. For the above example, the price of one liquid hydrogen tanker with cab is \$500,000, the price of 15 tube trailers with cabs is about \$3.75 million, and the price of six metal hydride transports is \$6.9 million to transport the same amount of hydrogen the same distance.

Detailed data on transportation costs for various production rates and delivery distances can be found in Appendix E. Appendix G contains figures showing important trends in the data.

11.0 COMBINED STORAGE AND TRANSPORTATION COSTS

When considering the delivered cost of hydrogen, it is important to understand that there are three factors must be considered: production rate, delivery distance, and storage time. In some cases, these factors are dependent on each other. For example, storage time may depend on delivery distance. If a small hydrogen plant is producing one truckload of hydrogen every 4 days, it might need 3 days of storage if the truck is making a delivery far away and is on the road the whole time. On the other hand, if the delivery distance is 16 km (10 mi), the most that would be needed is 1 day, because the truck would be gone from the site only a short time. This becomes more of an issue with rail cars, which may be gone for as long as 3 days for a short delivery distance (1 day in transit to the customer, 1 day to unload and switch and 1 day to bring it back).

Transport and delivery options can also be mixed. For example, metal hydride delivery would be compatible with compressed gas, underground, or even liquid hydrogen storage. Pipeline transport without any storage may also be an option. Appendix H contains four charts showing the combined effect of transportation and storage costs for two production rates with two delivery distances for each.

The cost tables or graphs in the appendices can be used by selecting a production rate, delivery distance, and delivery method to give transport cost and delivery frequency. Based on the delivery frequency, a storage time can be chosen and used with a production rate to determine the cost of storage. Adding these two costs gives the total cost associated with hydrogen storage and delivery, including depreciation, but with no return on investment.

When the storage and delivery costs are added, the benefit of liquid hydrogen becomes apparent. For production rates of 450 kg/h (1,000 lb/h), one day of storage and a 160-km (100-mi) delivery distance, liquid hydrogen is only slightly cheaper than metal hydride transport, but at a longer distance of 1,600 km (1,000 mi) liquid hydrogen is four times cheaper than metal hydride and seven times cheaper than compressed gas.

12.0 HYDROGEN MARKET

In North America, the chief bulk hydrogen suppliers are Air Products, Airco/BOC, and Air Liquide (Leiby 1994). Almost all the hydrogen sold is consumed close to the production site (Encyclopedia of Chemical Technology 1991). More than 99% of all hydrogen produced comes from fossil fuels (Hart 1997), with 95% of it being produced by steam reforming (Report to Congress 1995). In 1980, there were six liquid hydrogen plants in the United States. The largest was in New Orleans with a hydrogen production capacity of 60 tpd (2,300 kg/h [5,000 lb/h]) (Huston 1984). Merchant hydrogen represents only 3% of all hydrogen production (Encyclopedia of Chemical Technology 1991).

12.1 Current Use

Several sources cited current hydrogen consumption, but these numbers varied widely:

Table 15 - Current Hydrogen Consumption

Quoted Value	Quantity (kg/yr)	Quantity (lb/yr)	Source
Total Consumption	9.6 billion kg/yr	21 billion lb/yr	Encyclopedia of Chemical Technology 1991
Total Production	0.6 billion kg/yr	1.3 billion lb/yr	Hairston 1996
Total World Production	35 billion kg/yr	78 billion lb/yr	Hart 1997
Captive Production	0.3 billion kg/yr	0.7 billion lb/yr	Hairston 1996
Pipeline Delivery	0.2 billion kg/yr	0.5 billion lb/yr	Hairston, 1996
Captive Production	5.8 billion kg/yr	12.7 billion lb/yr	Encyclopedia of Chemical Technology 1991
Merchant Use	0.2 billion kg/yr	0.4 billion lb/yr	Encyclopedia of Chemical Technology 1991
Total U.S. Demand	0.3 billion kg/yr	0.4 billion lb/yr	Hairston 1996
U.S. Hydrogen Production	8.5 billion kg/yr	18.7 billion lb/yr	Report to Congress 1995
Merchant Use	0.05 billion kg/yr	0.1 billion lb/yr	Hairston 1996

12.2 Projected Demand

Table 16 gives projections on hydrogen demand.

Table 16 - Projected Hydrogen Demand

Quoted Value	Quantity (kg/yr)	Quantity (lb/yr)	Source
Total Production (2000)	0.9 billion kg/yr	2.0 billion lb/yr	Report to Congress 1995
Captive Production (2000)	0.5 billion kg/yr	1.1 billion lb/yr	Hairston 1996
Pipeline Production (2000)	0.4 billion kg/yr	0.8 billion lb/yr	Hairston 1996
U.S. Demand (2000)	0.4 billion kg/yr	0.9 billion lb/yr	Hairston 1996
Merchant Demand (2000)	0.08 billion kg/yr	0.2 billion lb/yr	Hairston 1996

Demand for industrial hydrogen is expected to grow 5%/yr (Report to Congress 1995). Growth of 7.7%/yr is projected for processing and production of chemicals, 4.2%/yr for food processing in hydrogenation of fats and oils, and 3.3%/yr in metal manufacture (Hairston 1996). There will also be higher demand for hydrogen in alcohols, acetic acid, and urethane production and at refineries for producing cleaner-burning fuels (Hairston 1996). Strong hydrogen demand is anticipated in South America, along the Pacific Rim, and in Western Europe (Hairston 1996).

12.3 Uses

Table 17 contains data on hydrogen use.

Table 17 - Merchant Hydrogen Demand

Use	Quantity (kg/yr)	Quantity (lb/yr)	Source
Ammonia, Methanol, and Refineries	5.8 billion kg/yr	12.7 billion lb/yr	Encyclopedia of Chemical Technology 1991
Merchant Use	0.2 billion kg/yr	0.4 billion lb/yr	Encyclopedia of Chemical Technology 1991
Chemical Processing	0.2 billion kg/yr	0.5 billion lb/yr	Hairston 1996
Electronics	0.02 billion kg/yr	0.05 billion lb/yr	Hairston 1996
Food Processing	0.01 billion kg/yr	0.05 billion lb/yr	Hairston 1996
Metal Manufacture	0.008 billion kg/yr	0.02 billion lb/yr	Hairston 1996
Other	0.03 billion kg/yr	0.07 billion lb/yr	Hairston 1996
Merchant Use	0.05 billion kg/yr	0.11 billion lb/yr	Hairston 1996

Table 18 gives some projected merchant hydrogen demands for the year 2000.

Table 18 - Projected Merchant Hydrogen Demand

Use	Quantity (kg/yr)	Quantity (lb/yr)	Source
Chemicals	0.3 billion kg/yr	0.7 billion lb/yr	Hairston 1996
Electronics	0.04 billion kg/yr	0.08 billion lb/yr	Hairston 1996
Food	0.01 billion kg/yr	0.03 billion lb/yr	Hairston 1996
Metal Manufacture	0.01 billion kg/yr	0.02 billion lb/yr	Hairston 1996
Other	0.04 billion kg/yr	0.1 billion lb/yr	Hairston 1996

Table 19 gives a breakdown for merchant hydrogen use from two sources, and the expected breakdown for the year 2000:

Table 19 - Merchant Hydrogen Use

Use	(Merchant Use) Encyclopedia of Chemical Technology 1991	(U.S. Use) Hairston 1996	(U.S. Use in 2000) Hairston 1996
Chemicals	83%	74%	76%
Electronics	5%	8%	9%
Metals	5%	3%	2%
Government	4%	n/a	n/a
Glass	1%	n/a	n/a
Food	1%	4%	3%
Other	n/a	12%	10%

n/a - Specific information not provided.

Table 20 gives a breakdown of all industrial hydrogen use.

Table 20 - Industrial Hydrogen Use (Hart 1997)

Ammonia	50%
Refineries	37%
Methanol	8%
Space	1%
Other	4%

12.4 Delivery Method

Bulk hydrogen delivery is economical for less than 20,000-25,000 kg/mo (45,000-56,000 lb/mo) (Leiby 1994). Tube trailers are used for small-scale distribution, but liquid hydrogen is important for large consumers (Carpetis 1994). It can be delivered as a liquid, pumped to a high pressure, then vaporized and fed into a process as a high-pressure gas (Carpetis 1994). Liquid hydrogen delivery can be up to an order of magnitude cheaper than compressed gas transport for long distances due to higher mass density (Carpetis 1994). Bulk liquid hydrogen shipments in United States number more than 10,000 per year to more than 300 locations (Report to Congress 1995), and can be delivered by barge, tank trailer, and railcars in quantities of 3,500-70,000 kg (7,700-154,000 lb) (Report to Congress 1995).

12.5 Current Prices

Table 21 provides some hydrogen price estimates from different sources, adjusted to 1995 dollars using the Chemical Engineering CPI index.

Table 21 - Hydrogen Prices

Delivery Method	Cost (\$/kg)	Cost (\$/lb)	Source
Pipeline	\$0.11-\$0.70/kg	\$0.05-\$0.31/lb	Encyclopedia of Chemical Technology 1991
Pipeline (Gulf Coast)	\$10-\$18/kg	\$5-\$8/lb	Leiby 1994
Reformed Hydrogen	\$0.65/kg	\$0.30/lb	Report to Congress 1995
Recovered Hydrogen	\$0.80-\$1.20/kg	\$0.36-\$0.53/lb	Report to Congress 1995
Electrolysis	\$2.40-\$3.60/kg	\$1.10-\$1.70/lb	Report to Congress 1995
Bulk Liquid	\$3.22-\$8.48/kg	\$1.46-\$3.85/lb	Encyclopedia of Chemical Technology 1991
Bulk Liquid	\$6.60/kg	\$3.00/lb	Huston 1984
Bulk Liquid, Standard Grade	\$21/kg	\$10/lb	Encyclopedia of Chemical Technology 1991
Bulk Liquid, Electronics Grade	\$107/kg	\$48/lb	Encyclopedia of Chemical Technology 1991

REFERENCES AND PERTINENT LITERATURE

Air Products. (1997). Web Page.

Au, M.; Chen, C.; Ye Z., Fong, T.; Wu, J.; Wang, O. (1996). "The Recovery, Purification, Storage and Transport of Hydrogen Separated from Industrial Purge Gas by Means of Mobile Hydride Containers." *International Journal of Energy*. (12:1); pp. 33-37.

Carpentis, C. (1994). "Technology and Costs of Hydrogen Storage." *TERI Information Digest on Energy*. Vol. 4:1, pp. 1-13.

Chemical Engineering. (December 1994). "Cyclohexane Makes the Grade as a Carrier of Hydrogen." (101:12); p. 19.

Cuoco, A.; Sgalambro, G.; Paolucci, M.; D'Alessio, L. (1995). "Is Photovoltaic Hydrogen in Italy Competitive with Traditional Fossil Fuels?" *Energy*. (20:12); pp. 1303-1309.

Encyclopedia of Chemical Technology. (1991). "Hydrogen." 4th edition. Vol. 13. New York: Wiley, pp. 838-894.

FIBA Technologies, Inc. (1998). Price Quote.

Flynn, T.M. (1992). "Liquification of Gases." *McGraw-Hill Encyclopedia of Science & Technology*. 7th edition. Vol. 10. New York: McGraw-Hill; pp. 106-109.

Garret, D.E. (1989). *Chemical Engineering Economics*. New York: Von Nostrand Reinhold.

Hairston, D. (February 1996). "Hail Hydrogen." *Chemical Engineering* (103:2); pp. 59-62.

Hart, D. (1997). *Hydrogen Power: The Commercial Future of 'the Ultimate Fuel.'* London, UK: Financial Times Energy Publishing.

Huston, E.L. (1984). "Liquid and Solid Storage of Hydrogen." *Proceedings of the 5th World Hydrogen Energy Conference*. Vol. 3; July 15-20, 1984, Toronto, Canada.

Hydrogen Components, Inc. (1997). Web Page. Littleton, CO.

International Journal of Ambient Energy. (January 1992). "Towards a Hydrogen Economy: The Storage and Transmission of Hydrogen: Technical Note." (13:1).

Johannsen, T.B., ed. (1993) *Renewable Energy: Sources for Fuels and Electricity*.

- Leiby, S.M. (1994). *Options for Refinery Hydrogen*. Menlo Park, CA: SRI International.
- New York State Electric & Gas. (26 August 1996a). "NYSEG Brings Natural Gas to New York's North Country."
- New York State Electric & Gas. (10 October 1996b). "NYSEG Completes Seneca Lake Storage Project."
- New York State Electric & Gas. (18 December 1996c). "Seneca Lake Storage Project Completed."
- New York State Electric & Gas. (22 October 1997a). "FERC Approves Market Based Rate for NYSEG's Seneca Lake Storage Project."
- New York State Electric & Gas. (11 December 1997b). "NYSEG Community Partners Celebrate Seneca Lake Project Phase II."
- Noganow, L.S. (1992). "Hydrogen." *McGraw-Hill Encyclopedia of Science & Technology*. 7th edition. Vol. 8. New York: McGraw-Hill; pp. 581-588.
- Oy, N. (1992) *New Hydrogen Technologies Project Report: Evaluation of Techniques*.
- Report to Congress. (1995). *Hydrogen: Technology and Policy*. 95-540 SR.
- Schwarz, J.A.; Amonkwah, K.A.G. (1993). *Hydrogen Storage Systems*. Washington, DC: U.S. Geological Survey.
- Taylor, J.B.; Alderson, J.E. A.; Kalyanam, K.M.; Lyle, A.B.; Phillips, L.A. (1986). "Technical and Economic Assessment of Methods for the Storage of Large Quantities of Hydrogen." *International Journal of Hydrogen Energy*. (11:1); pp. 5-22.
- Timmerhaus, C.; Flynn, T.M. (1989) *Cryogenic Engineering*. New York: Plenum Press.
- T-Raissi, A.; Sadhu, A. (1994). "System Study of Metal Hydride Storage Requirements." *Proceedings of 1994 DOE/NREL Hydrogen Program Review; April 18-21, 1994, Livermore, CA*.
- TransCanada Pipelines, Ltd. (13 May 1993). Press Release. "TransCanada Files \$1.1 Billion Pipeline Expansion Application."

TransCanada Pipelines, Ltd. (17 July 1996a). Press Release. "Pipeline Construction Gives Saskatchewan Economy a Boost."

TransCanada Pipelines, Ltd. (17 July 1996b). Press Release. "Pipeline Construction Gives Manitoba Economy a Boost."

TransCanada Pipelines, Ltd. (17 July 1996c). Press Release. "Pipeline Construction Gives Northwestern Ontario Economy a Boost."

TransCanada Pipelines, Ltd. (3 November 1997). Press Release. "'ANG Pipeline to Build New Gas Link Across Southern B.C."

Worf, J.C. (1992). "Metal Hydrides." *McGraw-Hill Encyclopedia of Science & Technology*. 7th edition. Vol. 11. New York: McGraw-Hill; pp. 37-41.

Zittel, W.; Wurster, R. (1996). *Hydrogen in the Energy Sector*.

APPENDIX A – SAMPLE CALCULATIONS OF HYDROGEN STORAGE COSTS

A.0 Hydrogen Storage Cost Assumptions

A.1 Compressed Gas Storage

A.2 Liquid Hydrogen Storage

A.3 Metal Hydride Storage

A.4 Underground Storage

Appendix A contains sample cost calculations for each storage option. In each case, the hydrogen production rate is 450 kg/h (1,000 lb/h) with 1 day of storage. The calculations were done using MachCAD so all required unit conversions were done internal to the program. The resulting values are the same as those found in Appendix D for the above flowrate and storage time.

A.0 HYDROGEN STORAGE COST ASSUMPTIONS - English Units

$\text{CompCost} := \frac{1000}{\text{kW}}$	$\text{CompSize} := 4000 \cdot \text{kW}$	$\text{CompExp} := 0.8$	Compressor Assumptions
	$\text{CompPress} := 20 \cdot 10^6 \cdot \text{Pa}$	$\text{CPExp} := 0.18$	
$\text{TankCost} := \frac{600}{\text{lb}}$	$\text{TankSize} := 500 \cdot \text{lb}$	$\text{TankExp} := 0.75$	Compressed Gas Tank Assumptions
	$\text{TankPress} := 20 \cdot 10^6 \cdot \text{Pa}$	$\text{TPExp} := 0.44$	
$\text{LiqCost} := \frac{20000}{\left\{ \frac{\text{lb}}{\text{hr}} \right\}}$	$\text{LiqSize} := 1000 \cdot \left\{ \frac{\text{lb}}{\text{hr}} \right\}$	$\text{LiqExp} := 0.65$	Liquefier Assumptions
$\text{DewarCost} := \frac{200}{\text{lb}}$	$\text{DewarSize} := 100 \cdot \text{lb}$	$\text{DewarExp} := 0.70$	Dewar Assumptions
$\text{HydCost} := \frac{1000}{\text{lb}}$		$\text{HydExp} := 1.0$	Metal Hydride Assumptions
$\text{UnderCost} := \frac{4}{\text{lb}}$		$\text{UnderExp} := 1.0$	Underground Storage Assumptions
$\text{CompPower} := 1.0 \cdot \frac{\text{kW} \cdot \text{hr}}{\text{lb}}$	$\text{CompCool} := 6.0 \cdot \frac{\text{gal}}{\text{lb}}$		Compressor Utility Requirements
$\text{LiqPower} := 4.5 \cdot \frac{\text{kW} \cdot \text{hr}}{\text{lb}}$	$\text{LiqCool} := 75 \cdot \frac{\text{gal}}{\text{lb}}$		Liquefier Utility Requirements
$\text{BOR} := 0.1 \frac{\%}{\text{day}}$			Assumed Boil-Off Rate
$\text{HydHeat} := 10000 \cdot \frac{\text{BTU}}{\text{lb}}$	$\text{HydCool} := 25 \cdot \frac{\text{gal}}{\text{lb}}$		Metal Hydride Utility Requirements
$\text{ElecCost} := \frac{0.05}{\text{kW} \cdot \text{hr}}$			Assumed Electricity Cost
$\text{SteamCost} := \frac{4}{\left(1 \cdot 10^6 \cdot \text{BTU} \right)}$			Assumed Steam Cost
$\text{CoolWatCost} := \frac{0.07}{(1000 \cdot \text{gal})}$			Assumed Cooling Water Cost
$\text{OpDays} := \frac{350 \cdot \text{day}}{\text{yr}}$	$\text{Life} := 22 \cdot \text{yr}$		Cost Assumptions

A.0 HYDROGEN STORAGE COST ASSUMPTIONS - SI Units

$$\text{TankCost} = \frac{1}{\text{kg}}$$

$$\text{TankSize} =$$

$$\text{LiqCost} = \frac{1}{\left\{ \frac{\text{kg}}{\text{hr}} \right\}}$$

$$\text{LiqSize} = \frac{\text{kg}}{\text{hr}}$$

$$\text{DewarCost} = \frac{1}{\text{kg}}$$

$$\text{DewarSize} =$$

$$\text{HydCost} = \frac{1}{\text{kg}}$$

$$\text{UnderCost} = \frac{1}{\text{kg}}$$

$$\text{CompPower} = \frac{\text{kW} \cdot \text{hr}}{\text{kg}}$$

$$\text{CompCool} = \frac{\text{liter}}{\text{kg}}$$

$$\text{LiqPower} = \frac{\text{kW} \cdot \text{hr}}{\text{kg}}$$

$$\text{LiqCool} = \frac{\text{liter}}{\text{kg}}$$

$$\text{HydHeat} = \frac{1000 \cdot \text{joule}}{\text{kg}}$$

$$\text{HydCool} = \frac{\text{liter}}{\text{kg}}$$

$$\text{SteamCost} = \frac{1}{10^9 \cdot \text{joule}}$$

$$\text{CoolWatCost} = \frac{1}{1000 \cdot \text{liter}}$$

A.1 COMPRESSED GAS STORAGE SAMPLE CALCULATION

Flow := 1000 · $\frac{\text{lb}}{\text{hr}}$	Flow = $\frac{\text{kg}}{\text{hr}}$	Production Rate
Time := 1 · day		Days of Storage
Storage := Flow · Time	Storage = °lb	Storage Capacity
	Storage =	
Prod := Flow · OpDays	Prod = $\frac{\text{lb}}{\text{yr}}$	Annual Production
	Prod = $\frac{\text{kg}}{\text{yr}}$	
P := 20 · 10 ⁶ · Pa		Operating Pressure
Energy := Flow · CompPower · $\left[\frac{\ln\left\{\frac{P}{0.1 \cdot 10^6 \cdot \text{Pa}}\right\}}{\ln\left\{\frac{20 \cdot 10^6 \cdot \text{Pa}}{0.1 \cdot 10^6 \cdot \text{Pa}}\right\}} \right]$	Energy = °kW	Comp. Power
Cooling := Flow · CompCool · $\left[\frac{\ln\left\{\frac{P}{0.1 \cdot 10^6 \cdot \text{Pa}}\right\}}{\ln\left\{\frac{20 \cdot 10^6 \cdot \text{Pa}}{0.1 \cdot 10^6 \cdot \text{Pa}}\right\}} \right]$	Cooling = $\frac{\text{°gal}}{\text{hr}}$	Cooling Water
	Cooling = $\frac{\text{°liter}}{\text{hr}}$	
CompCap := (CompCost · CompSize) · $\left\{ \frac{\text{Energy}}{\text{CompSize}} \right\}^{\text{CompExp}} \cdot \left\{ \frac{P}{\text{CompPress}} \right\}^{\text{CPExp}}$		Comp. Cost
CompCap =		
TankCap := (TankCost · TankSize) · $\left\{ \frac{\text{Storage} \cdot \text{TankPress}}{\text{TankSize} \cdot P} \right\}^{\text{TankExp}} \cdot \left\{ \frac{P}{\text{TankPress}} \right\}^{\text{TPExp}}$		Tank Cost
TankCap =		
TotCap := CompCap + TankCap	TotCap =	Total Capital Cost

A.1 COMPRESSED GAS STORAGE SAMPLE CALCULATION (continued)

$\text{DepCost} := \frac{\text{TotCap}}{\text{Life}}$	$\text{DepCost} = \frac{1}{\text{yr}}$	Depreciation	
$\text{EnerCost} := \text{Energy} \cdot \text{ElecCost}$	$\text{EnerCost} = \frac{1}{\text{hr}}$	Annual Electricity Cost	
$\text{EnerCost} \cdot \text{OpDays} = \frac{1}{\text{yr}}$			
$\text{CoolingCost} := \text{Cooling} \cdot \text{CoolWatCost}$	$\text{CoolingCost} = \frac{1}{\text{hr}}$	Annual Cooling Water Cost	
$\text{CoolingCost} \cdot \text{OpDays} = \frac{1}{\text{yr}}$			
$\text{TotCost} := \text{EnerCost} \cdot \text{OpDays} + \text{CoolingCost} \cdot \text{OpDays} + \text{DepCost}$			
$\text{TotCost} = \frac{1}{\text{yr}}$		Total Annual Cost	
$\text{Dep} := \frac{\text{DepCost}}{\text{Prod}}$	$\text{Dep} = \frac{1}{\text{lb}}$	$\text{Dep} = \frac{1}{\text{kg}}$	Capital Cost
$\text{Ener} := \frac{\text{EnerCost}}{\text{Flow}}$	$\text{Ener} = \frac{1}{\text{lb}}$	$\text{Ener} = \frac{1}{\text{kg}}$	Energy Cost
$\text{Cool} := \frac{\text{CoolingCost}}{\text{Flow}}$	$\text{Cool} = \frac{1}{\text{lb}}$	$\text{Cool} = \frac{1}{\text{kg}}$	Cooling Cost
$\text{Tot} := \text{Ener} + \text{Cool} + \text{Dep}$	$\text{Tot} = \frac{1}{\text{lb}}$	$\text{Tot} = \frac{1}{\text{kg}}$	Total Cost
$\text{Comp} := \frac{\text{CompCap}}{(\text{Prod} \cdot \text{Life})}$	$\text{Comp} = \frac{1}{\text{lb}}$	$\text{Comp} = \frac{1}{\text{kg}}$	Comp. Cost
$\text{Tank} := \frac{\text{TankCap}}{(\text{Prod} \cdot \text{Life})}$	$\text{Tank} = \frac{1}{\text{lb}}$	$\text{Tank} = \frac{1}{\text{kg}}$	Tank Cost
$\text{Comp} := \frac{\text{CompCap}}{\text{Energy}}$	$\text{Comp} = \frac{1}{\text{kW}}$		Comp. Capital
$\text{Tank} := \frac{\text{TankCap}}{\text{Storage}}$	$\text{Tank} = \frac{1}{\text{lb}}$	$\text{Tank} = \frac{1}{\text{kg}}$	Tank Capital

A.2 LIQUID HYDROGEN STORAGE SAMPLE CALCULATION

Flow := 1000 · $\frac{\text{lb}}{\text{hr}}$	Flow = $\frac{\text{kg}}{\text{hr}}$	Production Rate
Time := 1 · day		Days of Storage
FlowBOR := Flow · $\left[1 + \left(1 - e^{-\text{BOR} \cdot \text{Time}}\right)\right]$	FlowBOR = $\frac{\text{lb}}{\text{hr}}$	Production plus Boil-Off
	FlowBOR = $\frac{\text{kg}}{\text{hr}}$	
Storage := FlowBOR · Time	Storage = lb	Storage Capacity
	Storage =	
Prod := Flow · OpDays	Prod = $\frac{\text{lb}}{\text{yr}}$	Annual Production
	Prod = $\frac{\text{kg}}{\text{yr}}$	
Energy := FlowBOR · LiqPower	Energy = kW	Liquefier Power
Cooling := FlowBOR · LiqCool	Cooling = $\frac{\text{gal}}{\text{hr}}$	Cooling Water
	Cooling = $\frac{\text{liter}}{\text{hr}}$	
LiqCap := (LiqCost · LiqSize) · $\left\{\frac{\text{FlowBOR}}{\text{LiqSize}}\right\}^{\text{LiqExp}}$		Liquefier Cost
LiqCap =		
DewarCap := (DewarCost · DewarSize) · $\left\{\frac{\text{Storage}}{\text{DewarSize}}\right\}^{\text{DewarExp}}$		Dewar Cost
DewarCap =		
TotCap := LiqCap + DewarCap	TotCap =	Total Capital Cost

A.2 LIQUID HYDROGEN STORAGE SAMPLE CALCULATION (continued)

$DepCost := \frac{TotCap}{Life}$	$DepCost = \frac{1}{yr}$		Depreciation
$EnerCost := Energy \cdot ElecCost$	$EnerCost = \frac{1}{hr}$		Annual Electricity Cost
$EnerCost \cdot OpDays = \frac{1}{yr}$			
$CoolingCost := Cooling \cdot CoolWatCost$	$CoolingCost = \frac{1}{hr}$		Annual Cooling Water Cost
$CoolingCost \cdot OpDays = \frac{1}{yr}$			
$TotCost := EnerCost \cdot OpDays + CoolingCost \cdot OpDays + DepCost$			Total Annual Cost
$TotCost = \frac{1}{yr}$			
$Dep := \frac{DepCost}{Prod}$	$Dep = \frac{1}{lb}$	$Dep = \frac{1}{kg}$	Capital Cost
$Ener := \frac{EnerCost}{Flow}$	$Ener = \frac{1}{lb}$	$Ener = \frac{1}{kg}$	Energy Cost
$Cool := \frac{CoolingCost}{Flow}$	$Cool = \frac{1}{lb}$	$Cool = \frac{1}{kg}$	Cooling Cost
$Tot := Ener + Cool + Dep$	$Tot = \frac{1}{lb}$	$Tot = \frac{1}{kg}$	Total Cost
$Liq := \frac{LiqCap}{(Prod \cdot Life)}$	$Liq = \frac{1}{lb}$	$Liq = \frac{1}{kg}$	Liquefier Cost
$Tank := \frac{DewarCap}{(Prod \cdot Life)}$	$Tank = \frac{1}{lb}$	$Tank = \frac{1}{kg}$	Tank Cost
$Liq := \frac{LiqCap}{FlowBOR}$	$Liq = \frac{1}{\left\{ \frac{lb}{,} \right\}}$	$Liq = \frac{1}{kg}$	Liquefier Cost
$Tank := \frac{DewarCap}{Storage}$	$Tank = \frac{1}{lb}$	$Tank = \frac{1}{kg}$	Tank Cost

A.3 METAL HYDRIDE STORAGE SAMPLE CALCULATION

Flow := 1000 · $\frac{\text{lb}}{\text{hr}}$	Flow = $\bullet \frac{\text{kg}}{\text{hr}}$	Production Rate
Time := 1 · day		Days of Storage
Storage := Flow · Time	Storage = $\bullet \text{lb}$	Storage Capacity
	Storage =	
Prod := Flow · OpDays	Prod = $\bullet \frac{\text{lb}}{\text{yr}}$	Annual Production
	Prod = $\bullet \frac{\text{kg}}{\text{yr}}$	
Energy := Flow · HydHeat	Energy = $\bullet \left\{ 10^6 \cdot \frac{\text{BTU}}{\text{hr}} \right\}$	Heat Requirement
	Energy = $\bullet \frac{1000 \cdot \text{joule}}{\text{hr}}$	
Cooling := Flow · HydCool	Cooling = $\bullet \frac{\text{gal}}{\text{hr}}$	Cooling Requirement
	Cooling = $\bullet \frac{\text{liter}}{\text{hr}}$	
HydCap := Storage · HydCost	HydCap =	Hydride Cost
TotCap := HydCap	TotCap =	Total Capital Cost
DepCost := $\frac{\text{TotCap}}{\text{Life}}$	DepCost = $\bullet \frac{1}{\text{yr}}$	Depreciation
EnerCost := Energy · SteamCost	EnerCost = $\bullet \frac{1}{\text{hr}}$	Annual Steam Cost
EnerCost · OpDays = $\bullet \frac{1}{\text{yr}}$		
CoolingCost := CoolWatCost · Cooling	CoolingCost = $\bullet \frac{1}{\text{hr}}$	Annual Cooling Water Cost
CoolingCost · OpDays = $\bullet \frac{1}{\text{yr}}$		

A.3 METAL HYDRIDE STORAGE SAMPLE CALCULATION (continued)

$$\text{TotCost} := \text{EnerCost} \cdot \text{OpDays} + \text{CoolingCost} \cdot \text{OpDays} + \text{DepCost}$$

$\text{TotCost} = \frac{1}{\text{yr}}$			Total Annual Cost
$\text{Dep} := \frac{\text{DepCost}}{\text{Prod}}$	$\text{Dep} = \frac{1}{\text{lb}}$	$\text{Dep} = \frac{1}{\text{kg}}$	Capital Cost
$\text{Ener} := \frac{\text{EnerCost}}{\text{Flow}}$	$\text{Ener} = \frac{1}{\text{lb}}$	$\text{Ener} = \frac{1}{\text{kg}}$	Energy Cost
$\text{Cool} := \frac{\text{CoolingCost}}{\text{Flow}}$	$\text{Cool} = \frac{1}{\text{lb}}$	$\text{Cool} = \frac{1}{\text{kg}}$	Cooling Cost
$\text{Hyd} := \frac{\text{HydCap}}{(\text{Prod} \cdot \text{Life})}$	$\text{Hyd} = \frac{1}{\text{lb}}$	$\text{Hyd} = \frac{1}{\text{kg}}$	Hydride Cost
$\text{Tot} := \text{Ener} + \text{Cool} + \text{Dep}$	$\text{Tot} = \frac{1}{\text{lb}}$	$\text{Tot} = \frac{1}{\text{kg}}$	Total Cost

A.4 UNDERGROUND STORAGE SAMPLE CALCULATION

$$\text{Flow} := 1000 \cdot \frac{\text{lb}}{\text{hr}} \qquad \text{Flow} = 453.592 \cdot \frac{\text{kg}}{\text{hr}} \qquad \text{Production Rate}$$

$$\text{Time} := 1 \cdot \text{day} \qquad \text{Days of Storage}$$

$$\text{Storage} := \text{Flow} \cdot \text{Time} \qquad \text{Storage} = \text{lb} \qquad \text{Storage Capacity}$$

$$\text{Storage} =$$

$$\text{Prod} := \text{Flow} \cdot \text{OpDays} \qquad \text{Prod} = \frac{\text{lb}}{\text{yr}} \qquad \text{Annual Production}$$

$$\text{Prod} = \frac{\text{kg}}{\text{yr}}$$

$$P := 20 \cdot 10^6 \cdot \text{Pa} \qquad \text{Operating Pressure}$$

$$\text{Energy} := \text{Flow} \cdot \text{CompPower} \cdot \frac{\left[\ln \left(\frac{P}{0.1 \cdot 10^6 \cdot \text{Pa}} \right) \right]}{\left[\ln \left(\frac{20 \cdot 10^6 \cdot \text{Pa}}{0.1 \cdot 10^6 \cdot \text{Pa}} \right) \right]} \qquad \text{Energy} = \text{kW} \qquad \text{Comp. Power}$$

$$\text{Cooling} := \text{Flow} \cdot \text{CompCool} \cdot \frac{\left[\ln \left(\frac{P}{0.1 \cdot 10^6 \cdot \text{Pa}} \right) \right]}{\left[\ln \left(\frac{20 \cdot 10^6 \cdot \text{Pa}}{0.1 \cdot 10^6 \cdot \text{Pa}} \right) \right]} \qquad \text{Cooling} = \frac{\text{gal}}{\text{hr}} \qquad \text{Cooling Water}$$

$$\text{Cooling} = \frac{\text{liter}}{\text{hr}}$$

$$\text{CompCap} := (\text{CompCost} \cdot \text{CompSize}) \cdot \left(\frac{\text{Energy}}{\text{CompSize}} \right)^{\text{CompExp}} \cdot \left(\frac{P}{\text{CompPress}} \right)^{\text{CPExp}} \qquad \text{Comp. Cost}$$

$$\text{CompCap} =$$

$$\text{CaveCap} := \left[(\text{UnderCost}) \cdot \left(\text{Storage} \cdot \frac{\text{TankPress}}{P} \right) \right] \qquad \text{Cavern Cost}$$

$$\text{CaveCap} =$$

$$\text{TotCap} := \text{CompCap} + \text{CaveCap} \qquad \text{TotCap} = \qquad \text{Total Capital}$$

A.4 UNDERGROUND STORAGE SAMPLE CALCULATION (continued)

$DepCost := \frac{TotCap}{Life}$	$DepCost = \frac{1}{yr}$		Depreciation
$EnerCost := Energy \cdot ElecCost$	$EnerCost = \frac{1}{hr}$		Annual Electricity Cost
$EnerCost \cdot OpDays = \frac{1}{yr}$			
$CoolingCost := Cooling \cdot CoolWatCost$	$CoolingCost = \frac{1}{hr}$		Annual Cooling Water Cost
$CoolingCost \cdot OpDays = \frac{1}{yr}$			
$TotCost := EnerCost \cdot OpDays + CoolingCost \cdot OpDays + DepCost$			Total Cost
$TotCost = \frac{1}{yr}$			
$Dep := \frac{DepCost}{Prod}$	$Dep = \frac{1}{lb}$	$Dep = \frac{1}{kg}$	Capital Cost
$Ener := \frac{EnerCost}{Flow}$	$Ener = \frac{1}{lb}$	$Ener = \frac{1}{kg}$	Electricity Cost
$Cool := \frac{CoolingCost}{Flow}$	$Cool = \frac{1}{lb}$	$Cool = \frac{1}{kg}$	Cooling Cost
$Tot := Ener + Cool + Dep$	$Tot = \frac{1}{lb}$	$Tot = \frac{1}{kg}$	Total Cost
$Comp := \frac{CompCap}{(Prod \cdot Life)}$	$Comp = \frac{1}{lb}$	$Comp = \frac{1}{kg}$	Comp. Cost
$Cave := \frac{CaveCap}{(Prod \cdot Life)}$	$Cave = \frac{1}{lb}$	$Cave = \frac{1}{kg}$	Cavern Cost
$Comp := \frac{CompCap}{Energy}$	$Comp = \frac{1}{kW}$		Comp. Capital
$Cave := \frac{CaveCap}{Storage}$	$Cave = \frac{1}{lb}$	$Cave = \frac{1}{kg}$	Cavern Capital

APPENDIX B – SAMPLE CALCULATIONS OF HYDROGEN TRANSPORT COSTS

- B.0 Hydrogen Transportation Cost Assumptions
- B.1 Compressed Gas Delivery by Truck
- B.2 Compressed Gas Delivery by Rail
- B.3 Liquid Hydrogen Delivery by Truck
- B.4 Liquid Hydrogen Delivery by Rail
- B.5 Liquid Hydrogen Delivery by Ship
- B.6 Metal Hydride Delivery by Truck
- B.7 Metal Hydride Delivery by Rail
- B.8 Pipeline Delivery

Appendix B contains sample cost calculations for the main transportation options. In each case, the hydrogen production rate is 450 kg/h (1,000 lb/h) and the delivery distance is 160 km (100 mi). These calculations were done using MathCAD so all required unit conversions were done internal to the program. The resulting values are the same as those found in Appendix E for the above flowrate and delivery distance.

B.0 HYDROGEN TRANSPORTATION COST ASSUMPTIONS - English Units

TruckGH2Cost := 100000	TruckGH2Size := 400·lb	Capacities & Capital Costs
TruckLH2Cost := 350000	TruckLH2Size := 9000·lb	
TruckMH2Cost := $\frac{1000}{\text{lb}}$	TruckMH2Size := 1000·lb	
TruckUnderCost := 60000	TruckCabCost := 90000	
TruckMileage := $6 \cdot \frac{\text{mi}}{\text{gal}}$	TruckSpeed := $50 \cdot \frac{\text{mi}}{\text{hr}}$	Trucking Assumptions
TruckLoadTime := 2·hr	TruckAvail := $24 \cdot \frac{\text{hr}}{\text{day}}$	
DriverWage := $\frac{28.75}{\text{hr}}$	DriverAvail := $12 \cdot \frac{\text{hr}}{\text{day}}$	
DieselPrice := $\frac{1}{\text{gal}}$	TruckBOR := $0.3 \cdot \frac{\%}{\text{day}}$	
RailGH2Cost := 200000	RailGH2Size := 1000·lb	Rail Assumptions
RailLH2Cost := 400000	RailLH2Size := 20000·lb	
RailMH2Cost := $\frac{1000}{\text{lb}}$	RailMH2Size := 2000·lb	
RailSpeed := $25 \cdot \frac{\text{mi}}{\text{hr}}$	RailUnderCost := 100000	
RailAvail := $24 \cdot \frac{\text{hr}}{\text{day}}$	RailLoadTime := 24·hr	
RailBOR := $0.3 \cdot \frac{\%}{\text{day}}$	RailFreight := 400	
ShipLH2Cost := 350000	ShipLH2Size := 9000·lb	Ship Assumptions
ShipSpeed := $10 \cdot \frac{\text{mi}}{\text{hr}}$	ShipLoadTime := 48·hr	
ShipAvail := $24 \cdot \frac{\text{hr}}{\text{day}}$	ShipFreight := 3000	
ShipBOR := $0.3 \cdot \frac{\%}{\text{day}}$		

**B.0 HYDROGEN TRANSPORTATION COST ASSUMPTIONS - English Units
(continued)**

$\text{PipeCost} := \frac{1000000}{\text{mi}}$	$\text{Roughness} := 4.6 \cdot 10^{-5} \cdot \text{m}$	$\text{PipeDia} := 0.25 \cdot \text{m}$	Pipeline Assumptions
------------------------------------------------	--------------------------------------------------------	-----------------------------------------	----------------------

$\text{DelPress} := 2 \cdot 10^6 \cdot \text{Pa}$	$\text{Temp} := 283 \cdot \text{K}$	$\text{FricFact} := 0.005$
---------------------------------------------------	-------------------------------------	----------------------------

$\text{RH2} := 4124 \cdot \frac{(\text{N} \cdot \text{m})}{\text{kg} \cdot \text{K}}$	$\text{Visc} := 8.62 \cdot 10^{-6} \cdot \frac{\text{kg}}{(\text{m} \cdot \text{sec})}$
---------------------------------------------------------------------------------------	-----------------------------------------------------------------------------------------

$\text{CompCost} := \frac{1000}{\text{kW}}$	$\text{CompSize} := 4000 \cdot \text{kW}$	$\text{CompExp} := 0.80$	Compressor Assumptions
	$\text{CompPress} := 20 \cdot 10^6 \cdot \text{Pa}$	$\text{CPExp} := 0.18$	

$$\text{CompPower} := 1.0 \cdot \frac{(\text{kW} \cdot \text{hr})}{\text{lb}}$$

$\text{ElecCost} := \frac{0.05}{(\text{kW} \cdot \text{hr})}$	Electricity Cost
---------------------------------------------------------------	------------------

$\text{OpDays} := 350 \frac{\text{day}}{\text{yr}}$	Operating Cost Assumptions
-----------------------------------------------------	----------------------------

$\text{TrailerDep} := 6 \cdot \text{yr}$

$\text{TractorDep} := 4 \cdot \text{yr}$

$\text{RailcarDep} := 15 \cdot \text{yr}$

$\text{PipelineDep} := 22 \cdot \text{yr}$

B.0 HYDROGEN TRANSPORTATION COST ASSUMPTIONS - SI Units

$$\text{TruckGH2Size} = 181.437 \cdot \text{kg}$$

$$\text{TruckLH2Size} = 4.082 \cdot 10^3 \cdot \text{kg}$$

$$\text{TruckMH2Cost} = 2.205 \cdot 10^3 \cdot \frac{1}{\text{kg}}$$

$$\text{TruckMH2Size} = 453.592 \cdot \text{kg}$$

$$\text{TruckSpeed} = 80.467 \cdot \frac{\text{km}}{\text{hr}}$$

$$\text{RailGH2Size} = 453.592 \cdot \text{kg}$$

$$\text{RailLH2Size} = 9.072 \cdot 10^3 \cdot \text{kg}$$

$$\text{RailMH2Cost} = 2.205 \cdot 10^3 \cdot \frac{1}{\text{kg}}$$

$$\text{RailMH2Size} = 907.185 \cdot \text{kg}$$

$$\text{RailSpeed} = 40.234 \cdot \frac{\text{km}}{\text{hr}}$$

$$\text{ShipLH2Size} = 4.082 \cdot 10^3 \cdot \text{kg}$$

$$\text{ShipSpeed} = 16.093 \cdot \frac{\text{km}}{\text{hr}}$$

$$\text{PipeCost} = 6.214 \cdot 10^5 \cdot \frac{1}{\text{km}}$$

$$\text{CompPower} = 2.205 \cdot \frac{\text{kW} \cdot \text{hr}}{\text{kg}}$$

B.1 COMPRESSED GAS TRUCKING SAMPLE CALCULATION

Flow := $1000 \cdot \frac{\text{lb}}{\text{hr}}$	Flow = $453.592 \cdot \frac{\text{kg}}{\text{hr}}$	Production Rate
Prod := Flow · OpDays	Prod = $8.4 \cdot 10^6 \cdot \frac{\text{lb}}{\text{yr}}$	Annual Production
	Prod = $3.81 \cdot 10^6 \cdot \frac{\text{kg}}{\text{yr}}$	
Distance := 100 · mi	Distance = 160.934 · km	Delivery Distance (One-Way)
TwoWay := Distance · 2	TwoWay = 200 · mi	Distance (Two-Way)
	TwoWay = 321.869 · km	
Trips := $\left\lceil \frac{\text{Prod} \cdot 1 \cdot \text{yr}}{\text{TruckGH2Size}} \right\rceil$	Trips = $2.1 \cdot 10^4$	Number of Trips per Year
Miles := Trips · TwoWay	Miles = $4.2 \cdot 10^6 \cdot \text{mi}$	Total Miles Driven
	Miles = $6.759 \cdot 10^6 \cdot \text{km}$	
TripTime := $\text{ceil} \left\{ \frac{\text{TwoWay}}{\text{TruckSpeed}} \right\}$	TripTime = 4 · hr	Time per Trip (rounded up)
DriveTime := Trips · TripTime	DriveTime = $8.4 \cdot 10^4 \cdot \text{hr}$	Total Drive Time
LoadTime := Trips · TruckLoadTime	LoadTime = $4.2 \cdot 10^4 \cdot \text{hr}$	Load/Unload Time
TotalTime := DriveTime + LoadTime	TotalTime = $1.26 \cdot 10^5 \cdot \text{hr}$	Total Delivery Time
TruckTime := TruckAvail · OpDays · 1 · yr	TruckTime = $8.4 \cdot 10^3 \cdot \text{hr}$	Truck Availability
Trucks := $\text{ceil} \left\{ \frac{\text{TotalTime}}{\text{TruckTime}} \right\}$	Trucks = 15	Trucks Required (rounded up)
DriverTime := DriverAvail · OpDays · 1 · yr	DriverTime = $4.2 \cdot 10^3 \cdot \text{hr}$	Driver Availability
Drivers := $\text{ceil} \left\{ \frac{\text{TotalTime}}{\text{DriverTime}} \right\}$	Drivers = 30	Drivers Required (rounded up)

B.1 COMPRESSED GAS TRUCKING SAMPLE CALCULATION (continued)

$$\text{FuelUse} := \frac{\text{Miles}}{\text{TruckMileage}} \quad \text{FuelUse} = 7 \cdot 10^5 \text{ gal} \quad \text{Annual Fuel Use}$$

$$\text{CapCost} := \text{Trucks} \cdot (\text{TruckGH2Cost} + \text{TruckUnderCost} + \text{TruckCabCost})$$

$$\text{CapCost} = 3.75 \cdot 10^6 \quad \text{Total Capital Cost}$$

$$\text{DepCost} := \frac{\text{Trucks} \cdot (\text{TruckGH2Cost} + \text{TruckUnderCost})}{\text{TrailerDep}} + \frac{\text{Trucks} \cdot (\text{TruckCabCost})}{\text{TractorDep}}$$

$$\text{DepCost} = 7.375 \cdot 10^5 \cdot \frac{1}{\text{yr}} \quad \text{Depreciation}$$

$$\text{FuelCost} := \text{FuelUse} \cdot \frac{\text{DieselPrice}}{\text{yr}} \quad \text{FuelCost} = 7 \cdot 10^5 \cdot \frac{1}{\text{yr}} \quad \text{Annual Fuel Cost}$$

$$\text{LaborCost} := \text{TotalTime} \cdot \frac{\text{DriverWage}}{\text{yr}} \quad \text{LaborCost} = 3.623 \cdot 10^6 \cdot \frac{1}{\text{yr}} \quad \text{Annual Labor Cost}$$

$$\text{TotalCost} := \text{FuelCost} + \text{DepCost} + \text{LaborCost} \quad \text{Total Annual Cost}$$

$$\text{TotalCost} = 5.06 \cdot 10^6 \cdot \frac{1}{\text{yr}}$$

$$\text{Dep} := \frac{\text{DepCost}}{\text{Prod}} \quad \text{Dep} = 0.088 \cdot \frac{1}{\text{lb}} \quad \text{Dep} = 0.194 \cdot \frac{1}{\text{kg}} \quad \text{Capital Cost}$$

$$\text{Fuel} := \frac{\text{FuelCost}}{\text{Prod}} \quad \text{Fuel} = 0.083 \cdot \frac{1}{\text{lb}} \quad \text{Fuel} = 0.184 \cdot \frac{1}{\text{kg}} \quad \text{Fuel Cost}$$

$$\text{Labor} := \frac{\text{LaborCost}}{\text{Prod}} \quad \text{Labor} = 0.431 \cdot \frac{1}{\text{lb}} \quad \text{Labor} = 0.951 \cdot \frac{1}{\text{kg}} \quad \text{Labor Cost}$$

$$\text{Tot} := \frac{\text{TotalCost}}{\text{Prod}} \quad \text{Tot} = 0.602 \cdot \frac{1}{\text{lb}} \quad \text{Tot} = 1.328 \cdot \frac{1}{\text{kg}} \quad \text{Total Cost}$$

$$\text{TripsFreq} := \frac{\frac{\text{Trips}}{\text{yr}}}{\frac{\text{OpDays}}{\text{day}}} \quad \text{TripsFreq} = 60 \quad \text{Trip Frequency}$$

$$\text{TripLength} := \text{ceil} \left\{ \frac{\text{TotalTime}}{\text{Trips}} \right\} \quad \text{TripLength} = 6 \text{ hr} \quad \text{Trip Length}$$

$$\text{UtilRate} := \frac{\text{TripsFreq}}{\text{Trucks}} \quad \text{UtilRate} = 4 \quad \text{Truck Utilization Rate}$$

B.2 COMPRESSED GAS RAIL SAMPLE CALCULATION

Flow := $1000 \cdot \frac{\text{lb}}{\text{hr}}$	Flow = $453.592 \cdot \frac{\text{kg}}{\text{hr}}$	Production Rate
Prod := Flow · OpDays	Prod = $8.4 \cdot 10^6 \cdot \frac{\text{lb}}{\text{yr}}$	Annual Production
	Prod = $3.81 \cdot 10^6 \cdot \frac{\text{kg}}{\text{yr}}$	
Distance := 100 · mi	Distance = 160.934 · km	Delivery Distance (One-Way)
TwoWay := Distance · 2	TwoWay = 200 · mi	Distance (Two-Way)
	TwoWay = 321.869 · km	
Trips := $\left\lceil \frac{\text{Prod} \cdot 1 \cdot \text{yr}}{\text{RailGH2Size}} \right\rceil$	Trips = $8.4 \cdot 10^3$	Number of Trips per Year
Miles := Trips · TwoWay	Miles = $1.68 \cdot 10^6 \cdot \text{mi}$	Total Miles
	Miles = $2.704 \cdot 10^6 \cdot \text{km}$	
TripTime := $\left\lceil \frac{\left\{ \frac{\text{Distance}}{\text{RailSpeed}} \right\}}{\text{day}} \right\rceil \cdot 2 \cdot \text{day}$	TripTime = 2 · day	Time per Trip
DriveTime := Trips · TripTime	DriveTime = $4.032 \cdot 10^5 \cdot \text{hr}$	Total Transit Time
LoadTime := Trips · RailLoadTime	LoadTime = $2.016 \cdot 10^5 \cdot \text{hr}$	Total Load/Unload Time
TotalTime := DriveTime + LoadTime	TotalTime = $6.048 \cdot 10^5 \cdot \text{hr}$	Total Delivery Time
RailTime := RailAvail · OpDays · 1 · yr	RailTime = $8.4 \cdot 10^3 \cdot \text{hr}$	Railcar Availability
Railcars := $\left\lceil \frac{\text{TotalTime}}{\text{TruckTime}} \right\rceil$	Railcars = 72	Number of Railcars (rounded up)
CapCost := Railcars · (RailGH2Cost + RailUnderCost)		Total Capital Cost
CapCost = $2.16 \cdot 10^7$		

B.2 COMPRESSED GAS RAIL SAMPLE CALCULATION (continued)

$\text{DepCost} := \frac{\text{CapCost}}{\text{RailcarDep}}$	$\text{DepCost} = 1.44 \cdot 10^6 \cdot \frac{1}{\text{yr}}$	Depreciation	
$\text{FreightCost} := \frac{\text{Trips} \cdot \text{RailFreight} \cdot 2}{\text{yr}}$	$\text{FreightCost} = 6.72 \cdot 10^6 \cdot \frac{1}{\text{yr}}$	Annual Freight Cost	
$\text{TotalCost} := \text{FreightCost} + \text{DepCost}$		Total Annual Cost	
$\text{TotalCost} = 8.16 \cdot 10^6 \cdot \frac{1}{\text{yr}}$			
$\text{Dep} := \frac{\text{DepCost}}{\text{Prod}}$	$\text{Dep} = 0.171 \cdot \frac{1}{\text{lb}}$	$\text{Dep} = 0.378 \cdot \frac{1}{\text{kg}}$	Capital Cost
$\text{Freight} := \frac{\text{FreightCost}}{\text{Prod}}$	$\text{Freight} = 0.8 \cdot \frac{1}{\text{lb}}$	$\text{Freight} = 1.764 \cdot \frac{1}{\text{kg}}$	Freight Cost
$\text{Tot} := \frac{\text{TotalCost}}{\text{Prod}}$	$\text{Tot} = 0.971 \cdot \frac{1}{\text{lb}}$	$\text{Tot} = 2.142 \cdot \frac{1}{\text{kg}}$	Total Cost
$\text{TripFreq} := \frac{\frac{\text{Trips}}{\text{yr}}}{\frac{\text{OpDays}}{\text{day}}}$	$\text{TripFreq} = 24$		Trip Frequency
$\text{TripLength} := \text{ceil}\left\{\frac{\text{TotalTime}}{\text{Trips}}\right\}$	$\text{TripLength} = 72 \cdot \text{hr}$		Trip Length
$\text{UtilRate} := \frac{\text{TripFreq}}{\text{Railcars}}$	$\text{UtilRate} = 0.333$		Railcar Utilization Rate

B.3 LIQUID HYDROGEN TRUCKING SAMPLE CALCULATION

Flow := $1000 \cdot \frac{\text{lb}}{\text{hr}}$	Flow = $453.592 \cdot \frac{\text{kg}}{\text{hr}}$	Production Rate
Prod := Flow · OpDays	Prod = $8.4 \cdot 10^6 \cdot \frac{\text{lb}}{\text{yr}}$	Annual Production
	Prod = $3.81 \cdot 10^6 \cdot \frac{\text{kg}}{\text{yr}}$	
Distance := 100 · mi	Distance = 160.934 · km	Delivery Distance (One-Way)
TwoWay := Distance · 2	TwoWay = 200 · mi	Distance (Two-Way)
	TwoWay = 321.869 · km	
Trips := $\left\{ \frac{\text{Prod} \cdot 1 \cdot \text{yr}}{\text{TruckLH2Size}} \right\}$	Trips = 933.333	Number of Trips per Year
Miles := Trips · TwoWay	Miles = $1.867 \cdot 10^5 \cdot \text{mi}$	Total Miles Driven
	Miles = $3.004 \cdot 10^5 \cdot \text{km}$	
TripTime := $\text{ceil} \left\{ \frac{\text{TwoWay}}{\text{TruckSpeed}} \right\}$	TripTime = 4 · hr	Time per Trip (rounded up)
Delivered := Prod · (e) ^{-TruckBOR · $\left\{ \frac{\text{TripTime}}{2} \right\}$}		Quantity after Boil-Off
Delivered = $8397900 \cdot \frac{\text{lb}}{\text{yr}}$	Delivered = $3.809 \cdot 10^6 \cdot \frac{\text{kg}}{\text{yr}}$	
DriveTime := Trips · TripTime	DriveTime = $3.733 \cdot 10^3 \cdot \text{hr}$	Total Drive Time
LoadTime := Trips · TruckLoadTime	LoadTime = $1.867 \cdot 10^3 \cdot \text{hr}$	Total Load/Unload Time
TotalTime := DriveTime + LoadTime	TotalTime = $5.6 \cdot 10^3 \cdot \text{hr}$	Total Delivery Time
TruckTime := TruckAvail · OpDays · 1 · yr	TruckTime = $8.4 \cdot 10^3 \cdot \text{hr}$	Truck Availability
Trucks := $\text{ceil} \left\{ \frac{\text{TotalTime}}{\text{TruckTime}} \right\}$	Trucks = 1	Trucks Required (rounded up)

B.3 LIQUID HYDROGEN TRUCKING SAMPLE CALCULATION (continued)

$$\text{DriverTime} := \text{DriverAvail} \cdot \text{OpDays} \cdot 1 \cdot \text{yr} \quad \text{DriverTime} = 4.2 \cdot 10^3 \cdot \text{hr} \quad \text{Driver Availability}$$

$$\text{Drivers} := \text{ceil} \left\{ \frac{\text{TotalTime}}{\text{DriverTime}} \right\} \quad \text{Drivers} = 2 \quad \text{Drivers Required (rounded up)}$$

$$\text{FuelUse} := \frac{\text{Miles}}{\text{TruckMileage}} \quad \text{FuelUse} = 3.111 \cdot 10^4 \cdot \text{gal} \quad \text{Annual Fuel Use}$$

$$\text{CapCost} := \text{Trucks} \cdot (\text{TruckLH2Cost} + \text{TruckUnderCost} + \text{TruckCabCost}) \quad \text{Total Capital Cost}$$

$$\text{CapCost} = 5 \cdot 10^5$$

$$\text{DepCost} := \frac{\text{Trucks} \cdot (\text{TruckLH2Cost} + \text{TruckUnderCost})}{\text{TrailerDep}} + \frac{\text{Trucks} \cdot (\text{TruckCabCost})}{\text{TractorDep}}$$

$$\text{DepCost} = 9.083 \cdot 10^4 \cdot \frac{1}{\text{yr}} \quad \text{Depreciation}$$

$$\text{FuelCost} := \text{FuelUse} \cdot \frac{\text{DieselPrice}}{\text{yr}} \quad \text{FuelCost} = 3.111 \cdot 10^4 \cdot \frac{1}{\text{yr}} \quad \text{Annual Fuel Cost}$$

$$\text{LaborCost} := \text{TotalTime} \cdot \frac{\text{DriverWage}}{\text{yr}} \quad \text{LaborCost} = 1.61 \cdot 10^5 \cdot \frac{1}{\text{yr}} \quad \text{Annual Labor Cost}$$

$$\text{TotalCost} := \text{FuelCost} + \text{DepCost} + \text{LaborCost} \quad \text{Total Annual Cost}$$

$$\text{TotalCost} = 2.829 \cdot 10^5 \cdot \frac{1}{\text{yr}}$$

$$\text{Dep} := \frac{\text{DepCost}}{\text{Delivered}} \quad \text{Dep} = 0.011 \cdot \frac{1}{\text{lb}} \quad \text{Dep} = 0.024 \cdot \frac{1}{\text{kg}} \quad \text{Capital Cost}$$

$$\text{Fuel} := \frac{\text{FuelCost}}{\text{Delivered}} \quad \text{Fuel} = 3.705 \cdot 10^{-3} \cdot \frac{1}{\text{lb}} \quad \text{Fuel} = 8.167 \cdot 10^{-3} \cdot \frac{1}{\text{kg}} \quad \text{Fuel Cost}$$

$$\text{Labor} := \frac{\text{LaborCost}}{\text{Delivered}} \quad \text{Labor} = 0.019 \cdot \frac{1}{\text{lb}} \quad \text{Labor} = 0.042 \cdot \frac{1}{\text{kg}} \quad \text{Labor Cost}$$

$$\text{Tot} := \frac{\text{TotalCost}}{\text{Delivered}} \quad \text{Tot} = 0.034 \cdot \frac{1}{\text{lb}} \quad \text{Tot} = 0.074 \cdot \frac{1}{\text{kg}} \quad \text{Total Cost}$$

B.3 LIQUID HYDROGEN TRUCKING SAMPLE CALCULATION (continued)

$\text{TripFreq} := \frac{\frac{\text{Trips}}{\text{yr}}}{\frac{\text{OpDays}}{\text{day}}}$	TripFreq = 2.667	Trip Frequency
$\text{TripLength} := \text{ceil}\left\{\frac{\text{TotalTime}}{\text{Trips}}\right\}$	TripLength = 6*hr	Trip Length
$\text{UtilRate} := \frac{\text{TripFreq}}{\text{Trucks}}$	UtilRate = 2.667	Truck Utilization Rate

B.4 LIQUID HYDROGEN RAIL SAMPLE CALCULATION

Flow := $1000 \cdot \frac{\text{lb}}{\text{hr}}$	Flow = $453.592 \cdot \frac{\text{kg}}{\text{hr}}$	Production Rate
Prod := Flow · OpDays	Prod = $8.4 \cdot 10^6 \cdot \frac{\text{lb}}{\text{yr}}$	Annual Production
	Prod = $3.81 \cdot 10^6 \cdot \frac{\text{kg}}{\text{yr}}$	
Distance := 100 · mi	Distance = 160.934 · km	Delivery Distance (One-Way)
TwoWay := Distance · 2	TwoWay = 200 · mi	Distance (Two-Way)
	TwoWay = 321.869 · km	
Trips := $\left\lceil \frac{\text{Prod} \cdot 1 \cdot \text{yr}}{\text{RailLH2Size}} \right\rceil$	Trips = 420	Number of Trips per Year
Miles := Trips · TwoWay	Miles = $8.4 \cdot 10^4 \cdot \text{mi}$	Total Miles
	Miles = $1.352 \cdot 10^5 \cdot \text{km}$	
TripTime := $\text{ceil} \left\{ \frac{\text{Distance}}{\text{RailSpeed}} \right\} \cdot 2 \cdot \text{day}$	TripTime = 2 · day	Trip Length
Delivered := Prod · (e) ^{-RailBOR · $\left\{ \frac{\text{TripTime}}{2} \right\}$}		Quantity after Boil-Off
Delivered = $8374838 \cdot \frac{\text{lb}}{\text{yr}}$	Delivered = $3.799 \cdot 10^6 \cdot \frac{\text{kg}}{\text{yr}}$	
DriveTime := Trips · TripTime	DriveTime = $2.016 \cdot 10^4 \cdot \text{hr}$	Total Transit Time
LoadTime := Trips · RailLoadTime	LoadTime = $1.008 \cdot 10^4 \cdot \text{hr}$	Total Load/Unload Time
TotalTime := DriveTime + LoadTime	TotalTime = $3.024 \cdot 10^4 \cdot \text{hr}$	Total Delivery Time
RailTime := RailAvail · OpDays · 1 · yr	RailTime = $8.4 \cdot 10^3 \cdot \text{hr}$	Railcar Availability
Railcars := $\text{ceil} \left\{ \frac{\text{TotalTime}}{\text{TruckTime}} \right\}$	Railcars = 4	Railcars Required (rounded up)

B.4 LIQUID HYDROGEN RAIL SAMPLE CALCULATION (continued)

$\text{CapCost} := \text{Railcars} \cdot (\text{RailLH2Cost} + \text{RailUnderCost})$			Total Capital Cost
$\text{CapCost} = 2 \cdot 10^6$			
$\text{DepCost} := \frac{\text{CapCost}}{\text{RailcarDep}}$	$\text{DepCost} = 1.333 \cdot 10^5 \cdot \frac{1}{\text{yr}}$		Depreciation
$\text{FreightCost} := \frac{\text{Trips} \cdot \text{RailFreight} \cdot 2}{\text{yr}}$	$\text{FreightCost} = 3.36 \cdot 10^5 \cdot \frac{1}{\text{yr}}$		Annual Freight Cost
$\text{TotalCost} := \text{FreightCost} + \text{DepCost}$			Total Annual Cost
$\text{TotalCost} = 4.693 \cdot 10^5 \cdot \frac{1}{\text{yr}}$			
$\text{Dep} := \frac{\text{DepCost}}{\text{Prod}}$	$\text{Dep} = 0.016 \cdot \frac{1}{\text{lb}}$	$\text{Dep} = 0.035 \cdot \frac{1}{\text{kg}}$	Depreciation
$\text{Freight} := \frac{\text{FreightCost}}{\text{Prod}}$	$\text{Freight} = 0.04 \cdot \frac{1}{\text{lb}}$	$\text{Freight} = 0.088 \cdot \frac{1}{\text{kg}}$	Freight Cost
$\text{Tot} := \frac{\text{TotalCost}}{\text{Prod}}$	$\text{Tot} = 0.056 \cdot \frac{1}{\text{lb}}$	$\text{Tot} = 0.123 \cdot \frac{1}{\text{kg}}$	Total Cost
$\text{TripFreq} := \frac{\frac{\text{Trips}}{\text{yr}}}{\frac{\text{OpDays}}{\text{day}}}$	$\text{TripFreq} = 1.2$		Trip Frequency
$\text{TripLength} := \text{ceil}\left\{\frac{\text{TotalTime}}{\text{Trips}}\right\}$	$\text{TripLength} = 72 \cdot \text{hr}$		Trip Length
$\text{UtilRate} := \frac{\text{TripFreq}}{\text{Railcars}}$	$\text{UtilRate} = 0.3$		Railcar Utilization Rate

B.5 LIQUID HYDROGEN SHIP SAMPLE CALCULATION

Flow := $1000 \cdot \frac{\text{lb}}{\text{hr}}$	Flow = $453.592 \cdot \frac{\text{kg}}{\text{hr}}$	Production Rate
Prod := Flow · OpDays	Prod = $8.4 \cdot 10^6 \cdot \frac{\text{lb}}{\text{yr}}$	Annual Production
	Prod = $3.81 \cdot 10^6 \cdot \frac{\text{kg}}{\text{yr}}$	
Distance := 100 · mi	Distance = 160.934 · km	Delivery Distance (One-Way)
TwoWay := Distance · 2	TwoWay = 200 · mi	Distance (Two-Way)
	TwoWay = 321.869 · km	
Trips := $\left\{ \frac{\text{Prod} \cdot 1\text{-yr}}{\text{ShipLH2Size}} \right\}$	Trips = 933.333	Number of Trips per Year
Miles := Trips · TwoWay	Miles = $1.867 \cdot 10^5 \cdot \text{mi}$	Total Miles
	Miles = $3.004 \cdot 10^5 \cdot \text{km}$	
TripTime := $\text{ceil} \left\{ \frac{\text{Distance}}{\text{ShipSpeed}} \right\} \cdot 2 \cdot \text{day}$	TripTime = 2 · day	Time per Trip
Delivered := Prod · (e) ^{-ShipBOR · $\left\{ \frac{\text{TripTime}}{2} \right\}$}		Quantity after Boil-Off
Delivered = 8374838 · $\frac{\text{lb}}{\text{yr}}$	Delivered = $3.799 \cdot 10^6 \cdot \frac{\text{kg}}{\text{yr}}$	
DriveTime := Trips · TripTime	DriveTime = $4.48 \cdot 10^4 \cdot \text{hr}$	Total Transit Time
LoadTime := Trips · ShipLoadTime	LoadTime = $4.48 \cdot 10^4 \cdot \text{hr}$	Total Load/Unload Time
TotalTime := DriveTime + LoadTime	TotalTime = $8.96 \cdot 10^4 \cdot \text{hr}$	Total Delivery Time
ShipTime := ShipAvail · OpDays · 1 · yr	ShipTime = $8.4 \cdot 10^3 \cdot \text{hr}$	Tank Availability
Tanks := $\text{ceil} \left\{ \frac{\text{TotalTime}}{\text{ShipTime}} \right\}$	Tanks = 11	Tanks Required (rounded up)

B.5 LIQUID HYDROGEN SHIP SAMPLE CALCULATION (continued)

$$\text{CapCost} := \text{Tanks} \cdot (\text{ShipLH2Cost}) \quad \text{Total Capital Cost}$$

$$\text{CapCost} = 3.85 \cdot 10^6$$

$$\text{DepCost} := \frac{\text{CapCost}}{\text{TrailerDep}} \quad \text{DepCost} = 6.417 \cdot 10^5 \cdot \frac{1}{\text{yr}} \quad \text{Depreciation}$$

$$\text{FreightCost} := \frac{\text{Trips} \cdot \text{ShipFreight} \cdot 2}{\text{yr}} \quad \text{FreightCost} = 5.6 \cdot 10^6 \cdot \frac{1}{\text{yr}} \quad \text{Annual Freight Cost}$$

$$\text{TotalCost} := \text{FreightCost} + \text{DepCost} \quad \text{Total Annual Cost}$$

$$\text{TotalCost} = 6.242 \cdot 10^6 \cdot \frac{1}{\text{yr}}$$

$$\text{Dep} := \frac{\text{DepCost}}{\text{Prod}} \quad \text{Dep} = 0.076 \cdot \frac{1}{\text{lb}} \quad \text{Dep} = 0.168 \cdot \frac{1}{\text{kg}} \quad \text{Capital Cost}$$

$$\text{Freight} := \frac{\text{FreightCost}}{\text{Prod}} \quad \text{Freight} = 0.667 \cdot \frac{1}{\text{lb}} \quad \text{Freight} = 1.47 \cdot \frac{1}{\text{kg}} \quad \text{Freight Cost}$$

$$\text{Tot} := \frac{\text{TotalCost}}{\text{Prod}} \quad \text{Tot} = 0.743 \cdot \frac{1}{\text{lb}} \quad \text{Tot} = 1.638 \cdot \frac{1}{\text{kg}} \quad \text{Total Cost}$$

$$\text{TripFreq} := \frac{\frac{\text{Trips}}{\text{yr}}}{\frac{\text{OpDays}}{\text{day}}} \quad \text{TripFreq} = 2.667 \quad \text{Trip Frequency}$$

$$\text{TripLength} := \text{ceil} \left\{ \frac{\text{TotalTime}}{\text{Trips}} \right\} \quad \text{TripLength} = 96 \cdot \text{hr} \quad \text{Trip Length}$$

$$\text{UtilRate} := \frac{\text{TripFreq}}{\text{Tanks}} \quad \text{UtilRate} = 0.242 \quad \text{Tank Utilization Rate}$$

B.6 METAL HYDRIDE TRUCKING SAMPLE CALCULATION

Flow := $1000 \cdot \frac{\text{lb}}{\text{hr}}$	Flow = $453.592 \cdot \frac{\text{kg}}{\text{hr}}$	Production Rate
Prod := Flow · OpDays	Prod = $8.4 \cdot 10^6 \cdot \frac{\text{lb}}{\text{yr}}$	Annual Production
	Prod = $3.81 \cdot 10^6 \cdot \frac{\text{kg}}{\text{yr}}$	
Distance := 100 · mi	Distance = 160.934 · km	Delivery Distance (One-Way)
TwoWay := Distance · 2	TwoWay = 200 · mi	Distance (Two-Way)
	TwoWay = 321.869 · km	
Trips := $\left\lceil \frac{\text{Prod} \cdot 1 \cdot \text{yr}}{\text{TruckMH2Size}} \right\rceil$	Trips = $8.4 \cdot 10^3$	Number of Trips per Year
Miles := Trips · TwoWay	Miles = $1.68 \cdot 10^6 \cdot \text{mi}$	Total Miles Driven
	Miles = $2.704 \cdot 10^6 \cdot \text{km}$	
TripTime := $\text{ceil} \left\{ \frac{\text{TwoWay}}{\text{TruckSpeed}} \right\}$	TripTime = 4 · hr	Time per Trip (rounded up)
DriveTime := Trips · TripTime	DriveTime = $3.36 \cdot 10^4 \cdot \text{hr}$	Total Driving Time
LoadTime := Trips · TruckLoadTime	LoadTime = $1.68 \cdot 10^4 \cdot \text{hr}$	Total Load/Unload Time
TotalTime := DriveTime + LoadTime	TotalTime = $5.04 \cdot 10^4 \cdot \text{hr}$	Total Delivery Time
TruckTime := TruckAvail · OpDays · 1 · yr	TruckTime = $8.4 \cdot 10^3 \cdot \text{hr}$	Truck Availability
Trucks := $\text{ceil} \left\{ \frac{\text{TotalTime}}{\text{TruckTime}} \right\}$	Trucks = 6	Trucks Required (rounded up)
DriverTime := DriverAvail · OpDays · 1 · yr	DriverTime = $4.2 \cdot 10^3 \cdot \text{hr}$	Driver Availability
Drivers := $\text{ceil} \left\{ \frac{\text{TotalTime}}{\text{DriverTime}} \right\}$	Drivers = 12	Drivers Required (rounded up)

B.6 METAL HYDRIDE TRUCKING SAMPLE CALCULATION (continued)

$$\text{FuelUse} := \frac{\text{Miles}}{\text{TruckMileage}} \quad \text{FuelUse} = 2.8 \cdot 10^5 \text{ gal} \quad \text{Annual Fuel Use}$$

$$\text{CapCost} := \text{Trucks} \cdot (\text{TruckMH2Cost} \cdot \text{TruckMH2Size} + \text{TruckUnderCost} + \text{TruckCabCost})$$

$$\text{CapCost} = 6.9 \cdot 10^6 \quad \text{Total Capital Cost}$$

$$\text{DepCost} := \frac{\text{Trucks} \cdot (\text{TruckMH2Cost} \cdot \text{TruckMH2Size} + \text{TruckUnderCost})}{\text{TrailerDep}} + \frac{\text{Trucks} \cdot (\text{TruckCabCost})}{\text{TractorDep}}$$

$$\text{DepCost} = 1.195 \cdot 10^6 \cdot \frac{1}{\text{yr}} \quad \text{Depreciation}$$

$$\text{FuelCost} := \text{FuelUse} \cdot \frac{\text{DieselPrice}}{\text{yr}} \quad \text{FuelCost} = 2.8 \cdot 10^5 \cdot \frac{1}{\text{yr}} \quad \text{Annual Fuel Cost}$$

$$\text{LaborCost} := \text{TotalTime} \cdot \frac{\text{DriverWage}}{\text{yr}} \quad \text{LaborCost} = 1.449 \cdot 10^6 \cdot \frac{1}{\text{yr}} \quad \text{Annual Labor Cost}$$

$$\text{TotalCost} := \text{FuelCost} + \text{DepCost} + \text{LaborCost} \quad \text{Total Annual Cost}$$

$$\text{TotalCost} = 2.924 \cdot 10^6 \cdot \frac{1}{\text{yr}}$$

$$\text{Dep} := \frac{\text{DepCost}}{\text{Prod}} \quad \text{Dep} = 0.142 \cdot \frac{1}{\text{lb}} \quad \text{Dep} = 0.314 \cdot \frac{1}{\text{kg}} \quad \text{Capital Cost}$$

$$\text{Fuel} := \frac{\text{FuelCost}}{\text{Prod}} \quad \text{Fuel} = 0.033 \cdot \frac{1}{\text{lb}} \quad \text{Fuel} = 0.073 \cdot \frac{1}{\text{kg}} \quad \text{Fuel Cost}$$

$$\text{Labor} := \frac{\text{LaborCost}}{\text{Prod}} \quad \text{Labor} = 0.173 \cdot \frac{1}{\text{lb}} \quad \text{Labor} = 0.38 \cdot \frac{1}{\text{kg}} \quad \text{Labor Cost}$$

$$\text{Tot} := \frac{\text{TotalCost}}{\text{Prod}} \quad \text{Tot} = 0.348 \cdot \frac{1}{\text{lb}} \quad \text{Tot} = 0.767 \cdot \frac{1}{\text{kg}} \quad \text{Total Cost}$$

$$\text{TripFreq} := \frac{\frac{\text{Trips}}{\text{yr}}}{\frac{\text{OpDays}}{\text{day}}} \quad \text{TripFreq} = 24 \quad \text{Trip Frequency}$$

$$\text{TripLength} := \text{ceil} \left\{ \frac{\text{TotalTime}}{\text{Trips}} \right\} \quad \text{TripLength} = 6 \cdot \text{hr} \quad \text{Trip Length}$$

$$\text{UtilRate} := \frac{\text{TripFreq}}{\text{Trucks}} \quad \text{UtilRate} = 4 \quad \text{Truck Utilization Rate}$$

B.7 METAL HYDRIDE RAIL SAMPLE CALCULATION

Flow := $1000 \cdot \frac{\text{lb}}{\text{hr}}$	Flow = $453.592 \cdot \frac{\text{kg}}{\text{hr}}$	Production Rate
Prod := Flow · OpDays	Prod = $8.4 \cdot 10^6 \cdot \frac{\text{lb}}{\text{yr}}$	Annual Production
	Prod = $3.81 \cdot 10^6 \cdot \frac{\text{kg}}{\text{yr}}$	
Distance := 100 · mi	Distance = 160.934 · km	Delivery Distance (One-Way)
TwoWay := Distance · 2	TwoWay = 200 · mi	Distance (Two-Way)
	TwoWay = 321.869 · km	
Trips := $\left\lceil \frac{\text{Prod} \cdot 1 \cdot \text{yr}}{\text{RailMH2Size}} \right\rceil$	Trips = $4.2 \cdot 10^3$	Number of Trips per Year
Miles := Trips · TwoWay	Miles = $8.4 \cdot 10^5 \cdot \text{mi}$	Total Miles Driven
	Miles = $1.352 \cdot 10^6 \cdot \text{km}$	
TripTime := $\text{ceil} \left\{ \frac{\text{Distance}}{\frac{\text{RailSpeed}}{\text{day}}} \right\} \cdot 2 \cdot \text{day}$	TripTime = 2 · day	Time per Trip (rounded up)
DriveTime := Trips · TripTime	DriveTime = $2.016 \cdot 10^5 \cdot \text{hr}$	Total Drive Time
LoadTime := Trips · RailLoadTime	LoadTime = $1.008 \cdot 10^5 \cdot \text{hr}$	Total Load/Unload Time
TotalTime := DriveTime + LoadTime	TotalTime = $3.024 \cdot 10^5 \cdot \text{hr}$	Total Delivery Time
RailTime := RailAvail · OpDays · 1 · yr	RailTime = $8.4 \cdot 10^3 \cdot \text{hr}$	Railcar Availability
Railcars := $\text{ceil} \left\{ \frac{\text{TotalTime}}{\text{TruckTime}} \right\}$	Railcars = 36	Railcars Required (rounded up)
CapCost := Railcars · (RailMH2Cost · RailMH2Size + RailUnderCost)		Total Capital Costs
CapCost = $7.56 \cdot 10^7$		

B.7 METAL HYDRIDE RAIL SAMPLE CALCULATION (continued)

$$\text{DepCost} := \frac{\text{CapCost}}{\text{RailcarDep}} \quad \text{DepCost} = 5.04 \cdot 10^6 \cdot \frac{1}{\text{yr}} \quad \text{Depreciation}$$

$$\text{FreightCost} := \frac{\text{Trips} \cdot \text{RailFreight} \cdot 2}{\text{yr}} \quad \text{FreightCost} = 3.36 \cdot 10^6 \cdot \frac{1}{\text{yr}} \quad \text{Annual Freight Cost}$$

$$\text{TotalCost} := \text{FreightCost} + \text{DepCost} \quad \text{Total Annual Cost}$$

$$\text{TotalCost} = 8.4 \cdot 10^6 \cdot \frac{1}{\text{yr}}$$

$$\text{Dep} := \frac{\text{DepCost}}{\text{Prod}} \quad \text{Dep} = 0.6 \cdot \frac{1}{\text{lb}} \quad \text{Dep} = 1.323 \cdot \frac{1}{\text{kg}} \quad \text{Capital Cost}$$

$$\text{Freight} := \frac{\text{FreightCost}}{\text{Prod}} \quad \text{Freight} = 0.4 \cdot \frac{1}{\text{lb}} \quad \text{Freight} = 0.882 \cdot \frac{1}{\text{kg}} \quad \text{Freight Cost}$$

$$\text{Tot} := \frac{\text{TotalCost}}{\text{Prod}} \quad \text{Tot} = 1 \cdot \frac{1}{\text{lb}} \quad \text{Tot} = 2.205 \cdot \frac{1}{\text{kg}} \quad \text{Total Cost}$$

$$\text{TripFreq} := \frac{\frac{\text{Trips}}{\text{yr}}}{\frac{\text{OpDays}}{\text{day}}} \quad \text{TripFreq} = 12 \quad \text{Trip Frequency}$$

$$\text{TripLength} := \text{ceil} \left\{ \frac{\text{TotalTime}}{\text{Trips}} \right\} \quad \text{TripLength} = 72 \cdot \text{hr} \quad \text{Trip Length}$$

$$\text{UtilRate} := \frac{\text{TripFreq}}{\text{Railcars}} \quad \text{UtilRate} = 0.333 \quad \text{Railcar Utilization Rate}$$

B.8 PIPELINE SAMPLE CALCULATION

$\text{Flow} := 1000 \cdot \frac{\text{lb}}{\text{hr}}$	$\text{Flow} = 0.126 \cdot \frac{\text{kg}}{\text{s}}$	Production Rate
$\text{Prod} := \text{Flow} \cdot \text{OpDays}$	$\text{Prod} = 8.4 \cdot 10^6 \cdot \frac{\text{lb}}{\text{yr}}$	Annual Production
	$\text{Prod} = 3.81 \cdot 10^6 \cdot \frac{\text{kg}}{\text{yr}}$	
$\text{Distance} := 100 \cdot \text{mi}$	$\text{Distance} = 160.934 \cdot \text{km}$	Distance (One-Way)
$\text{Area} := \frac{\pi \cdot \text{PipeDia}^2}{4}$	$\text{Area} = 0.049 \cdot \text{m}^2$	Pipe Cross-Sectional Area
$\text{Flux} := \frac{\text{Flow}}{\text{Area}}$	$\text{Flux} = 2.567 \cdot \frac{\text{kg}}{\text{m}^2 \cdot \text{s}}$	Flux Through Pipe
$\text{NRe} := \frac{\text{PipeDia} \cdot \text{Flux}}{\text{Visc}}$	$\text{NRe} = 7.444 \cdot 10^4$	Reynolds Number
$\text{RelRoughness} := \frac{\text{Roughness}}{\text{PipeDia}}$	$\text{RelRoughness} = 0.00018$	Relative Roughness
$\text{PInlet} := \sqrt{\frac{[4 \cdot \text{FricFact} \cdot \text{Distance} \cdot \text{Flux}^2 \cdot (\text{RH2} \cdot \text{Temp})]}{\text{PipeDia}} + \text{DelPress}^2}$		Inlet Pressure (Delivery Pressure plus Frictional Losses)
$\text{PInlet} = 2.025 \cdot 10^6 \cdot \text{Pa}$		
$\text{Energy} := \text{Flow} \cdot \text{CompPower} \cdot \left[\frac{\ln\left\{\frac{\text{PInlet}}{0.1 \cdot 10^6 \cdot \text{Pa}}\right\}}{\ln\left\{\frac{20 \cdot 10^6 \cdot \text{Pa}}{0.1 \cdot 10^6 \cdot \text{Pa}}\right\}} - \frac{\ln\left\{\frac{\text{DelPress}}{0.1 \cdot 10^6 \cdot \text{Pa}}\right\}}{\ln\left\{\frac{20 \cdot 10^6 \cdot \text{Pa}}{0.1 \cdot 10^6 \cdot \text{Pa}}\right\}} \right]$		Compressor Power to Overcome Frictional Losses
$\text{Energy} = 2.307 \cdot \text{kW}$		
$\text{Energy} \cdot \text{OpDays} = 1.938 \cdot 10^4 \cdot \frac{\text{kW} \cdot \text{hr}}{\text{yr}}$		
$\text{CompCap} := (\text{CompCost} \cdot \text{CompSize}) \cdot \left\{ \frac{\text{Energy}}{\text{CompSize}} \right\}^{\text{CompExp}} \cdot \left\{ \frac{\text{PInlet}}{\text{CompPress}} \right\}^{\text{CPExp}}$		Compressor Cost
$\text{CompCap} = 6.789 \cdot 10^3$		

B.8 PIPELINE SAMPLE CALCULATION (continued)

PipelineCap := PipeCost·Distance	PipelineCap = $1 \cdot 10^8$	Pipeline Cost	
CapCost := CompCap + PipelineCap		Total Capital Cost	
CapCost = $1 \cdot 10^8$			
DepCost := $\frac{\text{CapCost}}{\text{PipelineDep}}$	DepCost = $4.546 \cdot 10^6 \cdot \frac{1}{\text{yr}}$	Depreciation	
EnerCost := Energy·OpDays·ElecCost	EnerCost = $969.019 \cdot \frac{1}{\text{yr}}$	Annual Electricity Cost	
TotalCost := EnerCost + DepCost		Total Annual Cost	
TotalCost = $4.547 \cdot 10^6 \cdot \frac{1}{\text{yr}}$			
Dep := $\frac{\text{DepCost}}{\text{Prod}}$	Dep = $0.541 \cdot \frac{1}{\text{lb}}$	Dep = $1.193 \cdot \frac{1}{\text{kg}}$	Capital Cost
Ener := $\frac{\text{EnerCost}}{\text{Prod}}$	Ener = $1.154 \cdot 10^{-4} \cdot \frac{1}{\text{lb}}$	Ener = $2.543 \cdot 10^{-4} \cdot \frac{1}{\text{kg}}$	Electricity Cost
Labor := $\frac{\text{LaborCost}}{\text{Prod}}$	Labor = $0.173 \cdot \frac{1}{\text{lb}}$	Labor = $0.38 \cdot \frac{1}{\text{kg}}$	Labor Cost
Tot := $\frac{\text{TotalCost}}{\text{Prod}}$	Tot = $0.541 \cdot \frac{1}{\text{lb}}$	Tot = $1.193 \cdot \frac{1}{\text{kg}}$	Total Cost
Comp := $\frac{\text{CompCap}}{(\text{Prod} \cdot \text{PipelineDep})}$	Comp = $3.674 \cdot 10^{-5} \cdot \frac{1}{\text{lb}}$	Comp = $8.1 \cdot 10^{-5} \cdot \frac{1}{\text{kg}}$	Compressor Cost
Pipe := $\frac{\text{PipelineCap}}{(\text{Prod} \cdot \text{PipelineDep})}$	Pipe = $0.541 \cdot \frac{1}{\text{lb}}$	Pipe = $1.193 \cdot \frac{1}{\text{kg}}$	Pipeline Cost

APPENDIX C – SAMPLE POWER REQUIREMENT CALCULATIONS

- C.1 Ideal Liquefaction of Hydrogen
- C.2 Linde Process for Liquefaction of Nitrogen
- C.3 Pre-Cooled Linde Process for Liquefaction of Hydrogen
- C.4 Hydrogen Compression Power Requirement

Appendix C contains sample work calculations for the compression and liquefaction of hydrogen and nitrogen. The thermodynamic data used in the calculations came from government Bureau of Standards temperature-entropy charts. The specific pressures and temperatures were chosen to demonstrate how to do the work calculations and do not necessarily represent actual operating conditions. The calculations were done using MachCAD so all required unit conversions were done internal to the program.

C.1 IDEAL LIQUEFACTION OF HYDROGEN

$$S_1 := 16.75 \cdot \frac{\text{cal}}{\text{gm} \cdot \text{K}} \quad h_1 := 1010 \cdot \frac{\text{cal}}{\text{gm}} \quad P_1 := 1 \cdot \text{atm} \quad T_1 := 300 \cdot \text{K}$$

$$S_2 := 4.35 \cdot \frac{\text{cal}}{\text{gm} \cdot \text{K}} \quad T_2 := 300 \cdot \text{K}$$

$$S_3 := 4.35 \cdot \frac{\text{cal}}{\text{gm} \cdot \text{K}} \quad h_3 := 70 \cdot \frac{\text{cal}}{\text{gm}} \quad P_3 := 1 \cdot \text{atm} \quad T_3 := 20 \cdot \text{K}$$

$$w := T_1 \cdot (S_1 - S_2) - (h_1 - h_3) \quad \text{Calculate ideal work per pound}$$

$$w = 1.467 \cdot \frac{\text{kW} \cdot \text{hr}}{\text{lb}}$$

C.2 LINDE PROCESS FOR LIQUEFACTION OF NITROGEN

$$S_1 := 1.05 \cdot \frac{\text{cal}}{\text{gm}\cdot\text{K}} \quad h_1 := 460 \cdot \frac{\text{joule}}{\text{gm}} \quad P_1 := 1 \cdot \text{atm} \quad T_1 := 300 \cdot \text{K}$$

$$S_2 := 0.725 \cdot \frac{\text{cal}}{\text{gm}\cdot\text{K}} \quad h_2 := 445 \cdot \frac{\text{joule}}{\text{gm}} \quad P_2 := 100 \cdot \text{atm} \quad T_2 := 300 \cdot \text{K}$$

$$S_3 := 0.2 \cdot \frac{\text{cal}}{\text{gm}\cdot\text{K}} \quad h_3 := 100 \cdot \frac{\text{joule}}{\text{gm}} \quad P_3 := 100 \cdot \text{atm} \quad T_3 := 105 \cdot \text{K}$$

$$S_4 := 0.35 \cdot \frac{\text{cal}}{\text{gm}\cdot\text{K}} \quad h_4 := 100 \cdot \frac{\text{joule}}{\text{gm}} \quad P_4 := 1 \cdot \text{atm} \quad T_4 := 77 \cdot \text{K}$$

$$S_5 := 0.7 \cdot \frac{\text{cal}}{\text{gm}\cdot\text{K}} \quad h_5 := 230 \cdot \frac{\text{joule}}{\text{gm}} \quad P_5 := 1 \cdot \text{atm} \quad T_5 := 77 \cdot \text{K}$$

$$S_6 := 0.1 \cdot \frac{\text{cal}}{\text{gm}\cdot\text{K}} \quad h_6 := 30 \cdot \frac{\text{joule}}{\text{gm}} \quad P_6 := 1 \cdot \text{atm} \quad T_6 := 77 \cdot \text{K}$$

$$y := \frac{(h_1 - h_2)}{(h_1 - h_6)}$$

Calculate percentage of gas stream liquefied on each pass

$$y = 0.09$$

$$w := T_1 \cdot (S_1 - S_2) - (h_1 - h_2)$$

Calculate work per pound of gas

$$w = 0.05 \cdot \frac{\text{kW}\cdot\text{hr}}{\text{lb}}$$

$$\frac{w}{y} = 0.551 \cdot \frac{\text{kW}\cdot\text{hr}}{\text{lb}}$$

Calculate work per pound of liquid nitrogen

$$\frac{w}{y} = 1.215 \cdot \text{kW} \cdot \frac{\text{hr}}{\text{kg}}$$

Work per kg of liquid nitrogen

C.3 NITROGEN PRE-COOLED LIQUEFACTION OF HYDROGEN

$S_1 := 16.75 \cdot \frac{\text{cal}}{\text{gm}\cdot\text{K}}$	$h_1 := 1010 \cdot \frac{\text{cal}}{\text{gm}}$	$P_1 := 1 \cdot \text{atm}$	$T_1 := 300 \cdot \text{K}$
$S_2 := 12.5 \cdot \frac{\text{cal}}{\text{gm}\cdot\text{K}}$	$h_2 := 1020 \cdot \frac{\text{cal}}{\text{gm}}$	$P_2 := 100 \cdot \text{atm}$	$T_2 := 300 \cdot \text{K}$
$S_3 := 7.75 \cdot \frac{\text{cal}}{\text{gm}\cdot\text{K}}$	$h_3 := 280 \cdot \frac{\text{cal}}{\text{gm}}$	$P_3 := 100 \cdot \text{atm}$	$T_3 := 77 \cdot \text{K}$
$S_4 := 5 \cdot \frac{\text{cal}}{\text{gm}\cdot\text{K}}$	$h_4 := 120 \cdot \frac{\text{cal}}{\text{gm}}$	$P_4 := 100 \cdot \text{atm}$	$T_4 := 35 \cdot \text{K}$
$S_5 := 6.5 \cdot \frac{\text{cal}}{\text{gm}\cdot\text{K}}$	$h_5 := 120 \cdot \frac{\text{cal}}{\text{gm}}$	$P_5 := 1 \cdot \text{atm}$	$T_5 := 20 \cdot \text{K}$
$S_6 := 9.5 \cdot \frac{\text{cal}}{\text{gm}\cdot\text{K}}$	$h_6 := 170 \cdot \frac{\text{cal}}{\text{gm}}$	$P_6 := 1 \cdot \text{atm}$	$T_6 := 20 \cdot \text{K}$
$S_7 := 12.75 \cdot \frac{\text{cal}}{\text{gm}\cdot\text{K}}$	$h_7 := 320 \cdot \frac{\text{cal}}{\text{gm}}$	$P_7 := 1 \cdot \text{atm}$	$T_7 := 77 \cdot \text{K}$
$S_8 := 4.25 \cdot \frac{\text{cal}}{\text{gm}\cdot\text{K}}$	$h_8 := 70 \cdot \frac{\text{cal}}{\text{gm}}$	$P_8 := 1 \cdot \text{atm}$	$T_8 := 20 \cdot \text{K}$
$S_a := 1.05 \cdot \frac{\text{cal}}{\text{gm}\cdot\text{K}}$	$h_a := 460 \cdot \frac{\text{joule}}{\text{gm}}$	$P_a := 1 \cdot \text{atm}$	$T_a := 300 \cdot \text{K}$
$S_b := 0.725 \cdot \frac{\text{cal}}{\text{gm}\cdot\text{K}}$	$h_b := 445 \cdot \frac{\text{joule}}{\text{gm}}$	$P_b := 100 \cdot \text{atm}$	$T_b := 300 \cdot \text{K}$
$S_d := 0.35 \cdot \frac{\text{cal}}{\text{gm}\cdot\text{K}}$	$h_d := 100 \cdot \frac{\text{joule}}{\text{gm}}$	$P_d := 1 \cdot \text{atm}$	$T_d := 77 \cdot \text{K}$

C.3 NITROGEN PRE-COOLED LIQUEFACTION OF HYDROGEN (continued)

$$r := 1$$

Pounds of nitrogen refrigeration per pound of hydrogen

$$y := \frac{(h_1 - h_2)}{(h_1 - h_8)} + r \cdot \left[\frac{(h_a - h_d)}{(h_1 - h_8)} \right]$$

Calculate percentage of gas liquefied compared to total gas flow

$$y = 0.081$$

$$w := \left[T_1 \cdot (S_1 - S_2) - (h_1 - h_2) \right] + r \cdot (T_a \cdot (S_a - S_b) - (h_a - h_b))$$

$$w = 0.727 \cdot \frac{\text{kW} \cdot \text{hr}}{\text{lb}}$$

Calculate work per pound of gas

$$\frac{w}{y} = 8.999 \cdot \frac{\text{kW} \cdot \text{hr}}{\text{lb}}$$

Calculate work per pound of liquid hydrogen

$$\frac{w}{y} = 19.839 \cdot \frac{\text{kW} \cdot \text{hr}}{\text{kg}}$$

Work per kg of liquid hydrogen

C.4 COMPRESSION OF HYDROGEN TO 20 MPa

$$S_1 := 16.75 \cdot \frac{\text{cal}}{\text{gm} \cdot \text{K}} \quad h_1 := 1010 \cdot \frac{\text{cal}}{\text{gm}} \quad P_1 := 1 \cdot \text{atm} \quad T_1 := 300 \cdot \text{K}$$

$$S_2 := 11.5 \cdot \frac{\text{cal}}{\text{gm} \cdot \text{K}} \quad h_2 := 1040 \cdot \frac{\text{cal}}{\text{gm}} \quad P_2 := 200 \cdot \text{atm} \quad T_2 := 300 \cdot \text{K}$$

$$W_c := T_1 \cdot (S_1 - S_2) - (h_1 - h_2)$$

Calculate compressor work per pound of hydrogen

$$W_c = 0.847 \cdot \frac{\text{kW} \cdot \text{hr}}{\text{lb}}$$

$$W_c = 1.867 \cdot \frac{\text{kW} \cdot \text{hr}}{\text{kg}}$$

Work per kg of hydrogen

APPENDIX D - HYDROGEN STORAGE COSTS

D.0 Hydrogen Storage Assumptions

D.1 Compressed Gas Storage

D.2 Liquid Hydrogen Storage

D.3 Metal Hydride Storage

D.4 Underground Gas Storage

Appendix D contains some of the cost data from the analysis of storage costs for the different hydrogen storage options. Costs are given in both SI and traditional English units for each storage method. Costs are arranged in the tables by production rate and the number of days of hydrogen storage.

D.0 HYDROGEN STORAGE ASSUMPTIONS			
Compressor Capital Cost=	\$1,000	per kW	
Comp. Gas Capital Cost=	\$1,323	per kg	\$600 per lb
Liquefaction Capital Cost=	\$44,093	per kg/hr	\$20,000 per lb/hr
Liquid Dewar Capital Cost=	\$441	per kg	\$200 per lb
Hydride Capital Cost=	\$2,205	per kg	\$1,000 per lb
Underground Capital Cost=	\$9	per kg	\$4 per lb
Compressor Size=	4,000	kW	
Comp. Gas Tank Size=	227	kg	500 lb
Liquefaction Size=	454	kg/hr	1,000 lb/hr
Liquid Dewar Size=	45	kg	100 lb
Compressor Pressure=	20	MPa	
Comp. Pressure Scale-Up=	0.18		
Comp. Gas Tank Pressure=	20	MPa	
Tank Pressure Scale-Up=	0.44		
Comp. Cost Scale-Up=	0.80		
Comp. Gas Tank Scale-Up=	0.75		
Liquefaction Scale-Up=	0.65		
Dewar Scale-Up=	0.70		
Hydride Scale-Up=	1.00		
Underground Scale-Up=	1.00		
Compressor Power=	2.2	kWh/kg (20 MPa)	1.0 kWh/lb (20 MPa)
Compressor Cooling=	50	liter/kg (20 MPa)	6.0 gal/lb (20 MPa)
Liquefaction Power=	9.9	kWh/kg	4.5 kWh/lb
Liquefaction Cooling=	626	liter/kg	75 gal/lb
Boil-off Rate=	0.1%	per day	
Hydride Cooling=	209	liter/kg	25 gal/lb
Hydride Heating=	23,260	kJ/kg	10,000 Btu/lb
Electric Cost=	\$0.05	per kWh	
Steam Cost=	\$3.79	per GJ	\$4.00 per MM Btu
Cooling Cost=	\$0.02	per M liters	\$0.07 per M gal
Operating Days/Year=	350	days/yr	
Depreciation=	22	years	

D.1 COMPRESSED GAS STORAGE - SI Units										
Compressor Capital Cost=	\$1,000	per kW								
Comp. Gas Capital Cost=	\$1,323	per kg								
Compressor Size=	4,000	kW								
Comp. Gas Tank Size=	227	kg								
Compressor Pressure=	20	MPa								
Comp. Pressure Scale-Up=	0.18									
Comp. Gas Tank Pressure=	20	MPa								
Tank Pressure Scale-Up=	0.44									
Comp. Cost Scale-Up=	0.80									
Comp. Gas Tank Scale-Up=	0.75									
Compressor Power=	2.20	kWh/kg (20 MPa)								
Compressor Cooling=	50	gal/kg (20 MPa)								
Electric Cost=	\$0.05	per kWh								
Cooling Cost=	\$0.02	per M liters								
Operating Days/Year=	350	days/yr								
Depreciation=	22	years								
Production Rate (kg/hr)	Days of Storage (days)	Operating Pressure (MPa)	Storage Capacity (kg)	Annual Production (kg/yr)	Compressor Power (kWh/hr)	Cooling Water (liter/hr)	Compressor Size (kW)	Compressor Cost (\$)	Tank Cost (\$)	Total Capital Cost (\$)
5	1	20	109	38,102	10	227	10	\$33,145	\$173,002	\$206,147
45	1	20	1,089	381,016	100	2,271	100	\$209,128	\$972,864	\$1,181,992
454	1	20	10,886	3,810,156	1,000	22,712	1,000	\$1,319,508	\$5,470,817	\$6,790,325
4,536	1	20	108,862	38,101,560	10,000	227,124	10,000	\$8,325,532	\$30,764,664	\$39,090,197
45,359	1	20	1,088,616	381,015,600	100,000	2,271,240	100,000	\$52,530,556	\$173,002,422	\$225,532,978
5	2	20	218	38,102	10	227	10	\$33,145	\$290,954	\$324,099
45	2	20	2,177	381,016	100	2,271	100	\$209,128	\$1,636,156	\$1,845,284
454	2	20	21,772	3,810,156	1,000	22,712	1,000	\$1,319,508	\$9,200,781	\$10,520,289
4,536	2	20	217,723	38,101,560	10,000	227,124	10,000	\$8,325,532	\$51,739,792	\$60,065,324
45,359	2	20	2,177,232	381,015,600	100,000	2,271,240	100,000	\$52,530,556	\$290,954,233	\$343,484,789
5	4	20	435	38,102	10	227	10	\$33,145	\$489,325	\$522,469
45	4	20	4,354	381,016	100	2,271	100	\$209,128	\$2,751,675	\$2,960,803
454	4	20	43,545	3,810,156	1,000	22,712	1,000	\$1,319,508	\$15,473,807	\$16,793,315
4,536	4	20	435,446	38,101,560	10,000	227,124	10,000	\$8,325,532	\$87,015,611	\$95,341,144
45,359	4	20	4,354,464	381,015,600	100,000	2,271,240	100,000	\$52,530,556	\$489,324,743	\$541,855,299
5	7	20	762	38,102	10	227	10	\$33,145	\$744,519	\$777,663
45	7	20	7,620	381,016	100	2,271	100	\$209,128	\$4,186,737	\$4,395,865
454	7	20	76,203	3,810,156	1,000	22,712	1,000	\$1,319,508	\$23,543,754	\$24,863,262
4,536	7	20	762,031	38,101,560	10,000	227,124	10,000	\$8,325,532	\$132,396,259	\$140,721,791
45,359	7	20	7,620,312	381,015,600	100,000	2,271,240	100,000	\$52,530,556	\$744,518,876	\$797,049,432
5	14	20	1,524	38,102	10	227	10	\$33,145	\$1,252,127	\$1,285,271
45	14	20	15,241	381,016	100	2,271	100	\$209,128	\$7,041,225	\$7,250,353
454	14	20	152,406	3,810,156	1,000	22,712	1,000	\$1,319,508	\$39,595,717	\$40,915,225
4,536	14	20	1,524,062	38,101,560	10,000	227,124	10,000	\$8,325,532	\$222,663,079	\$230,988,611
45,359	14	20	15,240,624	381,015,600	100,000	2,271,240	100,000	\$52,530,556	\$1,252,126,507	\$1,304,657,063
5	30	20	3,266	38,102	10	227	10	\$33,145	\$2,217,651	\$2,250,796
45	30	20	32,658	381,016	100	2,271	100	\$209,128	\$12,470,766	\$12,679,894
454	30	20	326,585	3,810,156	1,000	22,712	1,000	\$1,319,508	\$70,128,270	\$71,447,778
4,536	30	20	3,265,848	38,101,560	10,000	227,124	10,000	\$8,325,532	\$394,360,241	\$402,685,773
45,359	30	20	32,658,480	381,015,600	100,000	2,271,240	100,000	\$52,530,556	\$2,217,650,608	\$2,270,181,164

D.1 COMPRESSED GAS STORAGE - SI Units (Continued)														
Production Rate (kg/hr)	Days of Storage (days)	Depreciation (\$/yr)	Annual Electricity Cost (\$/yr)	Annual Cooling Water Cost (\$/yr)	Total Annual Cost (\$/yr)	Capital Cost (\$/kg)	Energy Cost (\$/kg)	Cooling Cost (\$/kg)	Total Cost (\$/kg)		Comp. Cost (\$/kg)	Tank Cost (\$/kg)	Comp. Capital (\$/kW)	Tank Capital (\$/kg)
5	1	\$9,370	\$4,200	\$35	\$13,606	\$0.25	\$0.11	\$0.00	\$0.36		\$0.04	\$0.21	\$3,314	\$1,589
45	1	\$53,727	\$42,000	\$353	\$96,080	\$0.14	\$0.11	\$0.00	\$0.25		\$0.02	\$0.12	\$2,091	\$894
454	1	\$308,651	\$420,000	\$3,528	\$732,179	\$0.08	\$0.11	\$0.00	\$0.19		\$0.02	\$0.07	\$1,320	\$503
4,536	1	\$1,776,827	\$4,200,000	\$35,280	\$6,012,107	\$0.05	\$0.11	\$0.00	\$0.16		\$0.01	\$0.04	\$833	\$283
45,359	1	\$10,251,499	\$42,000,000	\$352,800	\$52,604,299	\$0.03	\$0.11	\$0.00	\$0.14		\$0.01	\$0.02	\$525	\$159
5	2	\$14,732	\$4,200	\$35	\$18,967	\$0.39	\$0.11	\$0.00	\$0.50		\$0.04	\$0.35	\$3,314	\$1,336
45	2	\$83,877	\$42,000	\$353	\$126,229	\$0.22	\$0.11	\$0.00	\$0.33		\$0.02	\$0.20	\$2,091	\$751
454	2	\$478,195	\$420,000	\$3,528	\$901,723	\$0.13	\$0.11	\$0.00	\$0.24		\$0.02	\$0.11	\$1,320	\$423
4,536	2	\$2,730,242	\$4,200,000	\$35,280	\$6,965,522	\$0.07	\$0.11	\$0.00	\$0.18		\$0.01	\$0.06	\$833	\$238
45,359	2	\$15,612,945	\$42,000,000	\$352,800	\$57,965,745	\$0.04	\$0.11	\$0.00	\$0.15		\$0.01	\$0.03	\$525	\$134
5	4	\$23,749	\$4,200	\$35	\$27,984	\$0.62	\$0.11	\$0.00	\$0.73		\$0.04	\$0.58	\$3,314	\$1,124
45	4	\$134,582	\$42,000	\$353	\$176,935	\$0.35	\$0.11	\$0.00	\$0.46		\$0.02	\$0.33	\$2,091	\$632
454	4	\$763,332	\$420,000	\$3,528	\$1,186,860	\$0.20	\$0.11	\$0.00	\$0.31		\$0.02	\$0.18	\$1,320	\$355
4,536	4	\$4,333,688	\$4,200,000	\$35,280	\$8,568,968	\$0.11	\$0.11	\$0.00	\$0.22		\$0.01	\$0.10	\$833	\$200
45,359	4	\$24,629,786	\$42,000,000	\$352,800	\$66,982,586	\$0.06	\$0.11	\$0.00	\$0.18		\$0.01	\$0.06	\$525	\$112
5	7	\$35,348	\$4,200	\$35	\$39,584	\$0.93	\$0.11	\$0.00	\$1.04		\$0.04	\$0.89	\$3,314	\$977
45	7	\$199,812	\$42,000	\$353	\$242,165	\$0.52	\$0.11	\$0.00	\$0.64		\$0.02	\$0.50	\$2,091	\$549
454	7	\$1,130,148	\$420,000	\$3,528	\$1,553,676	\$0.30	\$0.11	\$0.00	\$0.41		\$0.02	\$0.28	\$1,320	\$309
4,536	7	\$6,396,445	\$4,200,000	\$35,280	\$10,631,725	\$0.17	\$0.11	\$0.00	\$0.28		\$0.01	\$0.16	\$833	\$174
45,359	7	\$36,229,520	\$42,000,000	\$352,800	\$78,582,320	\$0.10	\$0.11	\$0.00	\$0.21		\$0.01	\$0.09	\$525	\$98
5	14	\$58,421	\$4,200	\$35	\$62,657	\$1.53	\$0.11	\$0.00	\$1.64		\$0.04	\$1.49	\$3,314	\$822
45	14	\$329,561	\$42,000	\$353	\$371,914	\$0.86	\$0.11	\$0.00	\$0.98		\$0.02	\$0.84	\$2,091	\$462
454	14	\$1,859,783	\$420,000	\$3,528	\$2,283,311	\$0.49	\$0.11	\$0.00	\$0.60		\$0.02	\$0.47	\$1,320	\$260
4,536	14	\$10,499,482	\$4,200,000	\$35,280	\$14,734,762	\$0.28	\$0.11	\$0.00	\$0.39		\$0.01	\$0.27	\$833	\$146
45,359	14	\$59,302,594	\$42,000,000	\$352,800	\$101,655,394	\$0.16	\$0.11	\$0.00	\$0.27		\$0.01	\$0.15	\$525	\$82
5	30	\$102,309	\$4,200	\$35	\$106,544	\$2.69	\$0.11	\$0.00	\$2.80		\$0.04	\$2.65	\$3,314	\$679
45	30	\$576,359	\$42,000	\$353	\$618,712	\$1.51	\$0.11	\$0.00	\$1.62		\$0.02	\$1.49	\$2,091	\$382
454	30	\$3,247,626	\$420,000	\$3,528	\$3,671,154	\$0.85	\$0.11	\$0.00	\$0.96		\$0.02	\$0.84	\$1,320	\$215
4,536	30	\$18,303,899	\$4,200,000	\$35,280	\$22,539,179	\$0.48	\$0.11	\$0.00	\$0.59		\$0.01	\$0.47	\$833	\$121
45,359	30	\$103,190,053	\$42,000,000	\$352,800	\$145,542,853	\$0.27	\$0.11	\$0.00	\$0.38		\$0.01	\$0.26	\$525	\$68

D.1 COMPRESSED GAS STORAGE - English Units										
Compressor Capital Cost=	\$1,000	per kW								
Comp. Gas Capital Cost=	\$600	per lb								
Compressor Size=	4,000	kW								
Comp. Gas Tank Size=	500	lb								
Compressor Pressure=	20	MPa								
Comp. Pressure Scale-Up=	0.18									
Comp. Gas Tank Pressure=	20	MPa								
Tank Pressure Scale-Up=	0.44									
Comp. Cost Scale-Up=	0.80									
Comp. Gas Tank Scale-Up=	0.75									
Compressor Power=	1.00	kWh/lb (20 MPa)								
Compressor Cooling=	6.0	gal/lb (20 MPa)								
Electric Cost=	\$0.05	per kWh								
Cooling Cost=	\$0.07	per M gal								
Operating Days/Year=	350	days/yr								
Depreciation=	22	years								
Production Rate (lb/hr)	Days of Storage (days)	Operating Pressure (MPa)	Storage Capacity (lb)	Annual Production (lb/yr)	Compressor Power (kWh/hr)	Cooling Water (gal/hr)	Compressor Size (kW)	Compressor Cost (\$)	Tank Cost (\$)	Total Capital Cost (\$)
10	1	20	240	84,000	10	60	10	\$33,145	\$173,002	\$206,147
100	1	20	2,400	840,000	100	600	100	\$209,128	\$972,864	\$1,181,992
1,000	1	20	24,000	8,400,000	1,000	6,000	1,000	\$1,319,508	\$5,470,817	\$6,790,325
10,000	1	20	240,000	84,000,000	10,000	60,000	10,000	\$8,325,532	\$30,764,664	\$39,090,197
100,000	1	20	2,400,000	840,000,000	100,000	600,000	100,000	\$52,530,556	\$173,002,422	\$225,532,978
10	2	20	480	84,000	10	60	10	\$33,145	\$290,954	\$324,099
100	2	20	4,800	840,000	100	600	100	\$209,128	\$1,636,156	\$1,845,284
1,000	2	20	48,000	8,400,000	1,000	6,000	1,000	\$1,319,508	\$9,200,781	\$10,520,289
10,000	2	20	480,000	84,000,000	10,000	60,000	10,000	\$8,325,532	\$51,739,792	\$60,065,324
100,000	2	20	4,800,000	840,000,000	100,000	600,000	100,000	\$52,530,556	\$290,954,233	\$343,484,789
10	4	20	960	84,000	10	60	10	\$33,145	\$489,325	\$522,469
100	4	20	9,600	840,000	100	600	100	\$209,128	\$2,751,675	\$2,960,803
1,000	4	20	96,000	8,400,000	1,000	6,000	1,000	\$1,319,508	\$15,473,807	\$16,793,315
10,000	4	20	960,000	84,000,000	10,000	60,000	10,000	\$8,325,532	\$87,015,611	\$95,341,144
100,000	4	20	9,600,000	840,000,000	100,000	600,000	100,000	\$52,530,556	\$489,324,743	\$541,855,299
10	7	20	1,680	84,000	10	60	10	\$33,145	\$744,519	\$777,663
100	7	20	16,800	840,000	100	600	100	\$209,128	\$4,186,737	\$4,395,865
1,000	7	20	168,000	8,400,000	1,000	6,000	1,000	\$1,319,508	\$23,543,754	\$24,863,262
10,000	7	20	1,680,000	84,000,000	10,000	60,000	10,000	\$8,325,532	\$132,396,259	\$140,721,791
100,000	7	20	16,800,000	840,000,000	100,000	600,000	100,000	\$52,530,556	\$744,518,876	\$797,049,432
10	14	20	3,360	84,000	10	60	10	\$33,145	\$1,252,127	\$1,285,271
100	14	20	33,600	840,000	100	600	100	\$209,128	\$7,041,225	\$7,250,353
1,000	14	20	336,000	8,400,000	1,000	6,000	1,000	\$1,319,508	\$39,595,717	\$40,915,225
10,000	14	20	3,360,000	84,000,000	10,000	60,000	10,000	\$8,325,532	\$222,663,079	\$230,988,611
100,000	14	20	33,600,000	840,000,000	100,000	600,000	100,000	\$52,530,556	\$1,252,126,507	\$1,304,657,063
10	30	20	7,200	84,000	10	60	10	\$33,145	\$2,217,651	\$2,250,795
100	30	20	72,000	840,000	100	600	100	\$209,128	\$12,470,766	\$12,679,894
1,000	30	20	720,000	8,400,000	1,000	6,000	1,000	\$1,319,508	\$70,128,270	\$71,447,778
10,000	30	20	7,200,000	84,000,000	10,000	60,000	10,000	\$8,325,532	\$394,360,241	\$402,685,773
100,000	30	20	72,000,000	840,000,000	100,000	600,000	100,000	\$52,530,556	\$2,217,650,608	\$2,270,181,164

D.1 COMPRESSED GAS STORAGE - English Units (Continued)													
Production Rate (lb/hr)	Days of Storage (days)	Depreciation (\$/yr)	Annual Electricity Cost (\$/yr)	Annual Cooling Water Cost (\$/yr)	Total Annual Cost (\$/yr)	Capital Cost (\$/lb)	Energy Cost (\$/lb)	Cooling Cost (\$/lb)	Total Cost (\$/lb)	Comp. Cost (\$/lb)	Tank Cost (\$/lb)	Comp. Capital (\$/kW)	Tank Capital (\$/lb)
10	1	\$9,370.32	\$4,200	\$35	\$13,606	\$0.11	\$0.05	\$0.000	\$0.16	\$0.02	\$0.09	\$3,314	\$721
100	1	\$53,726.91	\$42,000	\$353	\$96,080	\$0.06	\$0.05	\$0.000	\$0.11	\$0.01	\$0.05	\$2,091	\$405
1,000	1	\$308,651.13	\$420,000	\$3,528	\$732,179	\$0.04	\$0.05	\$0.000	\$0.09	\$0.01	\$0.03	\$1,320	\$228
10,000	1	\$1,776,827.12	\$4,200,000	\$35,280	\$6,012,107	\$0.02	\$0.05	\$0.000	\$0.07	\$0.00	\$0.02	\$833	\$128
100,000	1	\$10,251,499.00	\$42,000,000	\$352,800	\$52,604,299	\$0.01	\$0.05	\$0.000	\$0.06	\$0.00	\$0.01	\$525	\$72
10	2	\$14,731.76	\$4,200	\$35	\$18,967	\$0.18	\$0.05	\$0.000	\$0.23	\$0.02	\$0.16	\$3,314	\$606
100	2	\$83,876.54	\$42,000	\$353	\$126,229	\$0.10	\$0.05	\$0.000	\$0.15	\$0.01	\$0.09	\$2,091	\$341
1,000	2	\$478,194.94	\$420,000	\$3,528	\$901,723	\$0.06	\$0.05	\$0.000	\$0.11	\$0.01	\$0.05	\$1,320	\$192
10,000	2	\$2,730,242.01	\$4,200,000	\$35,280	\$6,965,522	\$0.03	\$0.05	\$0.000	\$0.08	\$0.00	\$0.03	\$833	\$108
100,000	2	\$15,612,944.94	\$42,000,000	\$352,800	\$57,965,745	\$0.02	\$0.05	\$0.000	\$0.07	\$0.00	\$0.02	\$525	\$61
10	4	\$23,748.60	\$4,200	\$35	\$27,984	\$0.28	\$0.05	\$0.000	\$0.33	\$0.02	\$0.26	\$3,314	\$510
100	4	\$134,581.96	\$42,000	\$353	\$176,935	\$0.16	\$0.05	\$0.000	\$0.21	\$0.01	\$0.15	\$2,091	\$287
1,000	4	\$763,332.50	\$420,000	\$3,528	\$1,186,860	\$0.09	\$0.05	\$0.000	\$0.14	\$0.01	\$0.08	\$1,320	\$161
10,000	4	\$4,333,688.34	\$4,200,000	\$35,280	\$8,568,968	\$0.05	\$0.05	\$0.000	\$0.10	\$0.00	\$0.05	\$833	\$91
100,000	4	\$24,629,786.30	\$42,000,000	\$352,800	\$66,982,586	\$0.03	\$0.05	\$0.000	\$0.08	\$0.00	\$0.03	\$525	\$51
10	7	\$35,348.34	\$4,200	\$35	\$39,584	\$0.42	\$0.05	\$0.000	\$0.47	\$0.02	\$0.40	\$3,314	\$443
100	7	\$199,812.06	\$42,000	\$353	\$242,165	\$0.24	\$0.05	\$0.000	\$0.29	\$0.01	\$0.23	\$2,091	\$249
1,000	7	\$1,130,148.27	\$420,000	\$3,528	\$1,553,676	\$0.13	\$0.05	\$0.000	\$0.18	\$0.01	\$0.13	\$1,320	\$140
10,000	7	\$6,396,445.03	\$4,200,000	\$35,280	\$10,631,725	\$0.08	\$0.05	\$0.000	\$0.13	\$0.00	\$0.07	\$833	\$79
100,000	7	\$36,229,519.62	\$42,000,000	\$352,800	\$78,582,320	\$0.04	\$0.05	\$0.000	\$0.09	\$0.00	\$0.04	\$525	\$44
10	14	\$58,421.41	\$4,200	\$35	\$62,657	\$0.70	\$0.05	\$0.000	\$0.75	\$0.02	\$0.68	\$3,314	\$373
100	14	\$329,561.49	\$42,000	\$353	\$371,914	\$0.39	\$0.05	\$0.000	\$0.44	\$0.01	\$0.38	\$2,091	\$210
1,000	14	\$1,859,782.94	\$420,000	\$3,528	\$2,283,311	\$0.22	\$0.05	\$0.000	\$0.27	\$0.01	\$0.21	\$1,320	\$118
10,000	14	\$10,499,482.30	\$4,200,000	\$35,280	\$14,734,762	\$0.12	\$0.05	\$0.000	\$0.18	\$0.00	\$0.12	\$833	\$66
100,000	14	\$59,302,593.78	\$42,000,000	\$352,800	\$101,655,394	\$0.07	\$0.05	\$0.000	\$0.12	\$0.00	\$0.07	\$525	\$37
10	30	\$102,308.87	\$4,200	\$35	\$106,544	\$1.22	\$0.05	\$0.000	\$1.27	\$0.02	\$1.20	\$3,314	\$308
100	30	\$576,358.81	\$42,000	\$353	\$618,712	\$0.69	\$0.05	\$0.000	\$0.74	\$0.01	\$0.67	\$2,091	\$173
1,000	30	\$3,247,626.26	\$420,000	\$3,528	\$3,671,154	\$0.39	\$0.05	\$0.000	\$0.44	\$0.01	\$0.38	\$1,320	\$97
10,000	30	\$18,303,898.79	\$4,200,000	\$35,280	\$22,539,179	\$0.22	\$0.05	\$0.000	\$0.27	\$0.00	\$0.21	\$833	\$55
100,000	30	\$103,190,052.89	\$42,000,000	\$352,800	\$145,542,853	\$0.12	\$0.05	\$0.000	\$0.17	\$0.00	\$0.12	\$525	\$31

D.2 LIQUID HYDROGEN STORAGE - SI Units									
Liquefaction Capital Cost=		\$44,093	per kg/hr						
Liquid Dewar Capital Cost=		\$441	per kg/hr						
Liquefaction Size=		2,205	kg/hr						
Liquid Dewar Size=		220	kg/hr						
Liquefaction Scale-Up=		0.65							
Dewar Scale-Up=		0.70							
Liquefaction Power=		9.9	kWh/kg						
Liquefaction Cooling=		626	gal/lb						
Boil-off Rate=		0.1%	per day						
Electric Cost=		\$0.05	per kWh						
Cooling Cost=		\$0.02	per M liters						
Operating Days/Year=		350	days/yr						
Depreciation=		22	years						
Production Rate (kg/hr)	Days of Storage (days)	Production plus Boil-Off (kg/hr)	Storage Capacity (kg)	Annual Production (kg/yr)	Liquefier Power (kWh/hr)	Cooling Water (liters/hr)	Liquefier Cost (\$)	Dewar Cost (\$)	Total Capital Cost (\$)
5	1	5	109	38,102	45	2,842	\$1,003,026	\$36,939	\$1,039,964
45	1	45	1,090	381,016	450	28,419	\$4,480,351	\$185,132	\$4,665,483
454	1	454	10,897	3,810,156	4,504	284,189	\$20,012,991	\$927,858	\$20,940,849
4,536	1	4,540	108,970	38,101,560	45,045	2,841,888	\$89,394,748	\$4,650,306	\$94,045,055
45,359	1	45,404	1,089,704	381,015,600	450,450	28,418,876	\$399,311,672	\$23,306,742	\$422,618,414
5	2	5	218	38,102	45	2,845	\$1,003,676	\$60,049	\$1,063,725
45	2	45	2,182	381,016	451	28,447	\$4,483,255	\$300,958	\$4,784,213
454	2	454	21,816	3,810,156	4,509	284,472	\$20,025,965	\$1,508,362	\$21,534,327
4,536	2	4,545	218,158	38,101,560	45,090	2,844,722	\$89,452,700	\$7,559,719	\$97,012,419
45,359	2	45,450	2,181,582	381,015,600	450,899	28,447,224	\$399,570,532	\$37,888,347	\$437,458,879
5	4	5	437	38,102	45	2,850	\$1,004,974	\$97,686	\$1,102,659
45	4	46	4,372	381,016	452	28,504	\$4,489,052	\$489,588	\$4,978,641
454	4	455	43,718	3,810,156	4,518	285,038	\$20,051,860	\$2,453,754	\$22,505,614
4,536	4	4,554	437,185	38,101,560	45,180	2,850,384	\$89,568,368	\$12,297,902	\$101,866,271
45,359	4	45,540	4,371,847	381,015,600	451,796	28,503,835	\$400,087,205	\$61,635,516	\$461,722,721
5	7	5	767	38,102	45	2,859	\$1,006,914	\$144,830	\$1,151,744
45	7	46	7,673	381,016	453	28,589	\$4,497,719	\$725,871	\$5,223,590
454	7	457	76,735	3,810,156	4,531	285,885	\$20,090,572	\$3,637,975	\$23,728,547
4,536	7	4,568	767,347	38,101,560	45,314	2,858,854	\$89,741,288	\$18,233,068	\$107,974,356
45,359	7	45,675	7,673,468	381,015,600	453,139	28,588,540	\$400,859,610	\$91,381,807	\$492,241,417
5	14	5	1,545	38,102	46	2,879	\$1,011,411	\$236,409	\$1,247,820
45	14	46	15,453	381,016	456	28,785	\$4,517,805	\$1,184,854	\$5,702,659
454	14	460	154,525	3,810,156	4,563	287,852	\$20,180,295	\$5,938,337	\$26,118,632
4,536	14	4,599	1,545,251	38,101,560	45,626	2,878,520	\$90,142,066	\$29,762,185	\$119,904,251
45,359	14	45,990	15,452,506	381,015,600	456,256	28,785,198	\$402,649,820	\$149,164,272	\$551,814,092
5	30	5	3,362	38,102	46	2,923	\$1,021,532	\$407,396	\$1,428,929
45	30	47	33,624	381,016	463	29,230	\$4,563,017	\$2,041,819	\$6,604,836
454	30	467	336,237	3,810,156	4,633	292,296	\$20,382,247	\$10,233,337	\$30,615,584
4,536	30	4,670	3,362,368	38,101,560	46,330	2,922,957	\$91,044,153	\$51,288,178	\$142,332,331
45,359	30	46,700	33,623,684	381,015,600	463,300	29,229,566	\$406,679,291	\$257,049,801	\$663,729,093

D.2 LIQUID HYDROGEN STORAGE - SI Units (Continued)													
Production Rate	Days of Storage	Depreciation	Annual Electric Cost	Annual Cooling Water Cost	Total Annual Cost	Capital Cost	Energy Cost	Cooling Cost	Total Cost	Liquefier Cost	Dewar Cost	Liquefier Capital	Dewar Capital
(kg/hr)	(days)	(\$/yr)	(\$/yr)	(\$/yr)	(\$/yr)	(\$/kg)	(\$/kg)	(\$/kg)	(\$/kg)	(\$/kg)	(\$/kg)	(\$/kg)	(\$/kg)
5	1	\$47,271	\$18,919	\$441	\$66,631	\$1.24	\$0.50	\$0.01	\$1.75	\$1.20	\$0.04	\$221,130	\$339
45	1	\$212,067	\$189,189	\$4,414	\$405,671	\$0.56	\$0.50	\$0.01	\$1.06	\$0.53	\$0.02	\$98,775	\$170
454	1	\$951,857	\$1,891,889	\$44,144	\$2,887,890	\$0.25	\$0.50	\$0.01	\$0.76	\$0.24	\$0.01	\$44,121	\$85
4,536	1	\$4,274,775	\$18,918,891	\$441,441	\$23,635,107	\$0.11	\$0.50	\$0.01	\$0.62	\$0.11	\$0.01	\$19,708	\$43
45,359	1	\$19,209,928	\$189,188,906	\$4,414,408	\$212,813,241	\$0.05	\$0.50	\$0.01	\$0.56	\$0.05	\$0.00	\$8,803	\$21
5	2	\$48,351	\$18,938	\$442	\$67,731	\$1.27	\$0.50	\$0.01	\$1.78	\$1.20	\$0.07	\$221,274	\$275
45	2	\$217,464	\$189,378	\$4,419	\$411,261	\$0.57	\$0.50	\$0.01	\$1.08	\$0.53	\$0.04	\$98,839	\$138
454	2	\$978,833	\$1,893,776	\$44,188	\$2,916,797	\$0.26	\$0.50	\$0.01	\$0.77	\$0.24	\$0.02	\$44,150	\$69
4,536	2	\$4,409,655	\$18,937,762	\$441,881	\$23,789,299	\$0.12	\$0.50	\$0.01	\$0.62	\$0.11	\$0.01	\$19,721	\$35
45,359	2	\$19,884,494	\$189,377,622	\$4,418,811	\$213,680,928	\$0.05	\$0.50	\$0.01	\$0.56	\$0.05	\$0.00	\$8,809	\$17
5	4	\$50,121	\$18,975	\$443	\$69,539	\$1.32	\$0.50	\$0.01	\$1.83	\$1.20	\$0.12	\$221,560	\$223
45	4	\$226,302	\$189,754	\$4,428	\$420,484	\$0.59	\$0.50	\$0.01	\$1.10	\$0.54	\$0.06	\$98,967	\$112
454	4	\$1,022,982	\$1,897,545	\$44,276	\$2,964,803	\$0.27	\$0.50	\$0.01	\$0.78	\$0.24	\$0.03	\$44,207	\$56
4,536	4	\$4,630,285	\$18,975,449	\$442,760	\$24,048,495	\$0.12	\$0.50	\$0.01	\$0.63	\$0.11	\$0.01	\$19,747	\$28
45,359	4	\$20,987,396	\$189,754,490	\$4,427,605	\$215,169,491	\$0.06	\$0.50	\$0.01	\$0.56	\$0.05	\$0.01	\$8,820	\$14
5	7	\$52,352	\$19,032	\$444	\$71,828	\$1.37	\$0.50	\$0.01	\$1.89	\$1.20	\$0.17	\$221,988	\$189
45	7	\$237,436	\$190,318	\$4,441	\$432,195	\$0.62	\$0.50	\$0.01	\$1.13	\$0.54	\$0.09	\$99,158	\$95
454	7	\$1,078,570	\$1,903,184	\$44,408	\$3,026,162	\$0.28	\$0.50	\$0.01	\$0.79	\$0.24	\$0.04	\$44,292	\$47
4,536	7	\$4,907,925	\$19,031,838	\$444,076	\$24,383,840	\$0.13	\$0.50	\$0.01	\$0.64	\$0.11	\$0.02	\$19,785	\$24
45,359	7	\$22,374,610	\$190,318,380	\$4,440,762	\$217,133,752	\$0.06	\$0.50	\$0.01	\$0.57	\$0.05	\$0.01	\$8,837	\$12
5	14	\$56,719	\$19,163	\$447	\$76,329	\$1.49	\$0.50	\$0.01	\$2.00	\$1.21	\$0.28	\$222,979	\$153
45	14	\$259,212	\$191,628	\$4,471	\$455,311	\$0.68	\$0.50	\$0.01	\$1.19	\$0.54	\$0.14	\$99,601	\$77
454	14	\$1,187,211	\$1,916,276	\$44,713	\$3,148,199	\$0.31	\$0.50	\$0.01	\$0.83	\$0.24	\$0.07	\$44,490	\$38
4,536	14	\$5,450,193	\$19,162,756	\$447,131	\$25,060,081	\$0.14	\$0.50	\$0.01	\$0.66	\$0.11	\$0.04	\$19,873	\$19
45,359	14	\$25,082,459	\$191,627,564	\$4,471,310	\$221,181,333	\$0.07	\$0.50	\$0.01	\$0.58	\$0.05	\$0.02	\$8,877	\$10
5	30	\$64,951	\$19,459	\$454	\$84,864	\$1.70	\$0.51	\$0.01	\$2.23	\$1.22	\$0.49	\$225,210	\$121
45	30	\$300,220	\$194,586	\$4,540	\$499,346	\$0.79	\$0.51	\$0.01	\$1.31	\$0.54	\$0.24	\$100,598	\$61
454	30	\$1,391,617	\$1,945,858	\$45,403	\$3,382,879	\$0.37	\$0.51	\$0.01	\$0.89	\$0.24	\$0.12	\$44,935	\$30
4,536	30	\$6,469,651	\$19,458,579	\$454,034	\$26,382,264	\$0.17	\$0.51	\$0.01	\$0.69	\$0.11	\$0.06	\$20,072	\$15
45,359	30	\$30,169,504	\$194,585,794	\$4,540,335	\$229,295,634	\$0.08	\$0.51	\$0.01	\$0.60	\$0.05	\$0.03	\$8,966	\$8

D.2 LIQUID HYDROGEN STORAGE - English Units									
Liquefaction Capital Cost=		\$20,000	per lb/hr						
Liquid Dewar Capital Cost=		\$200	per lb						
Liquefaction Size=		1,000	lb/hr						
Liquid Dewar Size=		100	lb						
Liquefaction Scale-Up=		0.65							
Dewar Scale-Up=		0.70							
Liquefaction Power=		4.5	kWh/lb						
Liquefaction Cooling=		75	gal/lb						
Boil-off Rate=		0.1%	per day						
Electric Cost=		\$0.05	per kWh						
Cooling Cost=		\$0.07	per M gal						
Operating Days/Year=		350	days/yr						
Depreciation=		22	years						
Production Rate (lb/hr)	Days of Storage (days)	Production plus Boil-Off (lb/hr)	Storage Capacity (lb)	Annual Production (lb/yr)	Liquefier Power (kWh/hr)	Cooling Water (gal/hr)	Liquefier Cost (\$)	Dewar Cost (\$)	Total Capital Cost (\$)
10	1	10	240	84,000	45	751	\$1,003,026	\$36,939	\$1,039,964
100	1	100	2,402	840,000	450	7,507	\$4,480,351	\$185,132	\$4,665,483
1,000	1	1,001	24,024	8,400,000	4,504	75,075	\$20,012,991	\$927,858	\$20,940,849
10,000	1	10,010	240,240	84,000,000	45,045	750,750	\$89,394,748	\$4,650,306	\$94,045,055
100,000	1	100,100	2,402,399	840,000,000	450,450	7,507,496	\$399,311,672	\$23,306,742	\$422,618,414
10	2	10	481	84,000	45	751	\$1,003,676	\$60,049	\$1,063,725
100	2	100	4,810	840,000	451	7,515	\$4,483,255	\$300,958	\$4,784,213
1,000	2	1,002	48,096	8,400,000	4,509	75,150	\$20,025,965	\$1,508,362	\$21,534,327
10,000	2	10,020	480,959	84,000,000	45,090	751,499	\$89,452,700	\$7,559,719	\$97,012,419
100,000	2	100,200	4,809,590	840,000,000	450,899	7,514,985	\$399,570,532	\$37,888,347	\$437,458,879
10	4	10	964	84,000	45	753	\$1,004,974	\$97,686	\$1,102,659
100	4	100	9,638	840,000	452	7,530	\$4,489,052	\$489,588	\$4,978,641
1,000	4	1,004	96,383	8,400,000	4,518	75,299	\$20,051,860	\$2,453,754	\$22,505,614
10,000	4	10,040	963,832	84,000,000	45,180	752,994	\$89,568,368	\$12,297,902	\$101,866,271
100,000	4	100,399	9,638,323	840,000,000	451,796	7,529,940	\$400,087,205	\$61,635,516	\$461,722,721
10	7	10	1,692	84,000	45	755	\$1,006,914	\$144,830	\$1,151,744
100	7	101	16,917	840,000	453	7,552	\$4,497,719	\$725,871	\$5,223,590
1,000	7	1,007	169,172	8,400,000	4,531	75,523	\$20,090,572	\$3,637,975	\$23,728,547
10,000	7	10,070	1,691,719	84,000,000	45,314	755,232	\$89,741,288	\$18,233,068	\$107,974,356
100,000	7	100,698	16,917,189	840,000,000	453,139	7,552,317	\$400,859,610	\$91,381,807	\$492,241,417
10	14	10	3,407	84,000	46	760	\$1,011,411	\$236,409	\$1,247,820
100	14	101	34,067	840,000	456	7,604	\$4,517,805	\$1,184,854	\$5,702,659
1,000	14	1,014	340,671	8,400,000	4,563	76,043	\$20,180,295	\$5,938,337	\$26,118,632
10,000	14	10,139	3,406,712	84,000,000	45,626	760,427	\$90,142,066	\$29,762,185	\$119,904,251
100,000	14	101,390	34,067,123	840,000,000	456,256	7,604,268	\$402,649,820	\$149,164,272	\$551,814,092
10	30	10	7,413	84,000	46	772	\$1,021,532	\$407,396	\$1,428,929
100	30	103	74,128	840,000	463	7,722	\$4,563,017	\$2,041,819	\$6,604,836
1,000	30	1,030	741,279	8,400,000	4,633	77,217	\$20,382,247	\$10,233,337	\$30,615,584
10,000	30	10,296	7,412,792	84,000,000	46,330	772,166	\$91,044,153	\$51,288,178	\$142,332,331
100,000	30	102,955	74,127,922	840,000,000	463,300	7,721,658	\$406,679,291	\$257,049,801	\$663,729,093

D.2 LIQUID HYDROGEN STORAGE - English Units (Continued)													
Production Rate (lb/hr)	Days of Storage (days)	Depreciation (\$/yr)	Annual Electric Cost (\$/yr)	Annual Cooling Water Cost (\$/yr)	Total Annual Cost (\$/yr)	Capital Cost (\$/lb)	Energy Cost (\$/lb)	Cooling Cost (\$/lb)	Total Cost (\$/lb)	Liquefier Cost (\$/lb)	Dewar Cost Cost/lb	Liquefier Capital (\$/lb)	Dewar Capital (\$/lb)
10	1	\$47,271	\$18,919	\$441	\$66,631	\$0.56	\$0.23	\$0.01	\$0.79	\$0.54	\$0.02	\$100,303	\$154
100	1	\$212,067	\$189,189	\$4,414	\$405,671	\$0.25	\$0.23	\$0.01	\$0.48	\$0.24	\$0.01	\$44,804	\$77
1,000	1	\$951,857	\$1,891,889	\$44,144	\$2,887,890	\$0.11	\$0.23	\$0.01	\$0.34	\$0.11	\$0.01	\$20,013	\$39
10,000	1	\$4,274,775	\$18,918,891	\$441,441	\$23,635,107	\$0.05	\$0.23	\$0.01	\$0.28	\$0.05	\$0.00	\$8,939	\$19
100,000	1	\$19,209,928	\$189,188,906	\$4,414,408	\$212,813,241	\$0.02	\$0.23	\$0.01	\$0.25	\$0.02	\$0.00	\$3,993	\$10
10	2	\$48,351	\$18,938	\$442	\$67,731	\$0.58	\$0.23	\$0.01	\$0.81	\$0.54	\$0.03	\$100,368	\$125
100	2	\$217,464	\$189,378	\$4,419	\$411,261	\$0.26	\$0.23	\$0.01	\$0.49	\$0.24	\$0.02	\$44,833	\$63
1,000	2	\$978,833	\$1,893,776	\$44,188	\$2,916,797	\$0.12	\$0.23	\$0.01	\$0.35	\$0.11	\$0.01	\$20,026	\$31
10,000	2	\$4,409,655	\$18,937,762	\$441,881	\$23,789,299	\$0.05	\$0.23	\$0.01	\$0.28	\$0.05	\$0.00	\$8,945	\$16
100,000	2	\$19,884,494	\$189,377,622	\$4,418,811	\$213,680,928	\$0.02	\$0.23	\$0.01	\$0.25	\$0.02	\$0.00	\$3,996	\$8
10	4	\$50,121	\$18,975	\$443	\$69,539	\$0.60	\$0.23	\$0.01	\$0.83	\$0.54	\$0.05	\$100,497	\$101
100	4	\$226,302	\$189,754	\$4,428	\$420,484	\$0.27	\$0.23	\$0.01	\$0.50	\$0.24	\$0.03	\$44,891	\$51
1,000	4	\$1,022,982	\$1,897,545	\$44,276	\$2,964,803	\$0.12	\$0.23	\$0.01	\$0.35	\$0.11	\$0.01	\$20,052	\$25
10,000	4	\$4,630,285	\$18,975,449	\$442,760	\$24,048,495	\$0.06	\$0.23	\$0.01	\$0.29	\$0.05	\$0.01	\$8,957	\$13
100,000	4	\$20,987,396	\$189,754,490	\$4,427,605	\$215,169,491	\$0.02	\$0.23	\$0.01	\$0.26	\$0.02	\$0.00	\$4,001	\$6
10	7	\$52,352	\$19,032	\$444	\$71,828	\$0.62	\$0.23	\$0.01	\$0.86	\$0.54	\$0.08	\$100,691	\$86
100	7	\$237,436	\$190,318	\$4,441	\$432,195	\$0.28	\$0.23	\$0.01	\$0.51	\$0.24	\$0.04	\$44,977	\$43
1,000	7	\$1,078,570	\$1,903,184	\$44,408	\$3,026,162	\$0.13	\$0.23	\$0.01	\$0.36	\$0.11	\$0.02	\$20,091	\$22
10,000	7	\$4,907,925	\$19,031,838	\$444,076	\$24,383,840	\$0.06	\$0.23	\$0.01	\$0.29	\$0.05	\$0.01	\$8,974	\$11
100,000	7	\$22,374,610	\$190,318,380	\$4,440,762	\$217,133,752	\$0.03	\$0.23	\$0.01	\$0.26	\$0.02	\$0.00	\$4,009	\$5
10	14	\$56,719	\$19,163	\$447	\$76,329	\$0.68	\$0.23	\$0.01	\$0.91	\$0.55	\$0.13	\$101,141	\$69
100	14	\$259,212	\$191,628	\$4,471	\$455,311	\$0.31	\$0.23	\$0.01	\$0.54	\$0.24	\$0.06	\$45,178	\$35
1,000	14	\$1,187,211	\$1,916,276	\$44,713	\$3,148,199	\$0.14	\$0.23	\$0.01	\$0.37	\$0.11	\$0.03	\$20,180	\$17
10,000	14	\$5,450,193	\$19,162,756	\$447,131	\$25,060,081	\$0.06	\$0.23	\$0.01	\$0.30	\$0.05	\$0.02	\$9,014	\$9
100,000	14	\$25,082,459	\$191,627,564	\$4,471,310	\$221,181,333	\$0.03	\$0.23	\$0.01	\$0.26	\$0.02	\$0.01	\$4,026	\$4
10	30	\$64,951	\$19,459	\$454	\$84,864	\$0.77	\$0.23	\$0.01	\$1.01	\$0.55	\$0.22	\$102,153	\$55
100	30	\$300,220	\$194,586	\$4,540	\$499,346	\$0.36	\$0.23	\$0.01	\$0.59	\$0.25	\$0.11	\$45,630	\$28
1,000	30	\$1,391,617	\$1,945,858	\$45,403	\$3,382,879	\$0.17	\$0.23	\$0.01	\$0.40	\$0.11	\$0.06	\$20,382	\$14
10,000	30	\$6,469,651	\$19,458,579	\$454,034	\$26,382,264	\$0.08	\$0.23	\$0.01	\$0.31	\$0.05	\$0.03	\$9,104	\$7
100,000	30	\$30,169,504	\$194,585,794	\$4,540,335	\$229,295,634	\$0.04	\$0.23	\$0.01	\$0.27	\$0.02	\$0.01	\$4,067	\$3

D.3 METAL HYDRIDE STORAGE - SI Units							
Hydride Capital Cost=		\$2,205	per kg				
Hydride Scale-Up=		1.00					
Hydride Cooling=		209	liters/kg				
Hydride Heating=		23,260	kJ/kg				
Steam Cost=		\$3.79	per kJ				
Cooling Cost=		\$0.02	per M liters				
Operating Days/Year=		350	days/yr				
Depreciation=		22	years				
Production Rate (kg/hr)	Days of Storage (days)	Storage Capacity (kg)	Annual Production (kg/yr)	Heat Requirement (kJ/hr)	Cooling Requirement (liters/hr)	Hydride Cost (\$)	Total Capital Cost (\$)
5	1	109	38,102	105,506	946	\$240,000	\$240,000
45	1	1,089	381,016	1,055,060	9,464	\$2,400,000	\$2,400,000
454	1	10,886	3,810,156	10,550,600	94,635	\$24,000,000	\$24,000,000
4,536	1	108,862	38,101,560	105,506,000	946,350	\$240,000,000	\$240,000,000
45,359	1	1,088,616	381,015,600	1,055,060,000	9,463,500	\$2,400,000,000	\$2,400,000,000
5	2	218	38,102	105,506	946	\$480,000	\$480,000
45	2	2,177	381,016	1,055,060	9,464	\$4,800,000	\$4,800,000
454	2	21,772	3,810,156	10,550,600	94,635	\$48,000,000	\$48,000,000
4,536	2	217,723	38,101,560	105,506,000	946,350	\$480,000,000	\$480,000,000
45,359	2	2,177,232	381,015,600	1,055,060,000	9,463,500	\$4,800,000,000	\$4,800,000,000
5	4	435	38,102	105,506	946	\$960,000	\$960,000
45	4	4,354	381,016	1,055,060	9,464	\$9,600,000	\$9,600,000
454	4	43,545	3,810,156	10,550,600	94,635	\$96,000,000	\$96,000,000
4,536	4	435,446	38,101,560	105,506,000	946,350	\$960,000,000	\$960,000,000
45,359	4	4,354,464	381,015,600	1,055,060,000	9,463,500	\$9,600,000,000	\$9,600,000,000
5	7	762	38,102	105,506	946	\$1,680,000	\$1,680,000
45	7	7,620	381,016	1,055,060	9,464	\$16,800,000	\$16,800,000
454	7	76,203	3,810,156	10,550,600	94,635	\$168,000,000	\$168,000,000
4,536	7	762,031	38,101,560	105,506,000	946,350	\$1,680,000,000	\$1,680,000,000
45,359	7	7,620,312	381,015,600	1,055,060,000	9,463,500	\$16,800,000,000	\$16,800,000,000
5	14	1,524	38,102	105,506	946	\$3,360,000	\$3,360,000
45	14	15,241	381,016	1,055,060	9,464	\$33,600,000	\$33,600,000
454	14	152,406	3,810,156	10,550,600	94,635	\$336,000,000	\$336,000,000
4,536	14	1,524,062	38,101,560	105,506,000	946,350	\$3,360,000,000	\$3,360,000,000
45,359	14	15,240,624	381,015,600	1,055,060,000	9,463,500	\$33,600,000,000	\$33,600,000,000
5	30	3,266	38,102	105,506	946	\$7,200,000	\$7,200,000
45	30	32,658	381,016	1,055,060	9,464	\$72,000,000	\$72,000,000
454	30	326,585	3,810,156	10,550,600	94,635	\$720,000,000	\$720,000,000
4,536	30	3,265,848	38,101,560	105,506,000	946,350	\$7,200,000,000	\$7,200,000,000
45,359	30	32,658,480	381,015,600	1,055,060,000	9,463,500	\$72,000,000,000	\$72,000,000,000

D.3 METAL HYDRIDE STORAGE - SI Units (Continued)									
Production	Days of	Depreciation	Annual Electric	Annual Cooling	Total Annual	Capital	Energy	Cooling	Total
Rate	Storage		Cost	Water Cost	Cost	Cost	Cost	Cost	Cost
(kg/hr)	(days)	(\$/yr)	(\$/yr)	(\$/yr)	(\$/yr)	(\$/kg)	(\$/kg)	(\$/kg)	(\$/kg)
5	1	\$10,909	\$3,360	\$147	\$14,416	\$0.29	\$0.09	\$0.00	\$0.38
45	1	\$109,091	\$33,600	\$1,470	\$144,161	\$0.29	\$0.09	\$0.00	\$0.38
454	1	\$1,090,909	\$336,000	\$14,700	\$1,441,609	\$0.29	\$0.09	\$0.00	\$0.38
4,536	1	\$10,909,091	\$3,360,000	\$147,000	\$14,416,091	\$0.29	\$0.09	\$0.00	\$0.38
45,359	1	\$109,090,909	\$33,600,000	\$1,470,000	\$144,160,909	\$0.29	\$0.09	\$0.00	\$0.38
5	2	\$21,818	\$3,360	\$147	\$25,325	\$0.57	\$0.09	\$0.00	\$0.66
45	2	\$218,182	\$33,600	\$1,470	\$253,252	\$0.57	\$0.09	\$0.00	\$0.66
454	2	\$2,181,818	\$336,000	\$14,700	\$2,532,518	\$0.57	\$0.09	\$0.00	\$0.66
4,536	2	\$21,818,182	\$3,360,000	\$147,000	\$25,325,182	\$0.57	\$0.09	\$0.00	\$0.66
45,359	2	\$218,181,818	\$33,600,000	\$1,470,000	\$253,251,818	\$0.57	\$0.09	\$0.00	\$0.66
5	4	\$43,636	\$3,360	\$147	\$47,143	\$1.15	\$0.09	\$0.00	\$1.24
45	4	\$436,364	\$33,600	\$1,470	\$471,434	\$1.15	\$0.09	\$0.00	\$1.24
454	4	\$4,363,636	\$336,000	\$14,700	\$4,714,336	\$1.15	\$0.09	\$0.00	\$1.24
4,536	4	\$43,636,364	\$3,360,000	\$147,000	\$47,143,364	\$1.15	\$0.09	\$0.00	\$1.24
45,359	4	\$436,363,636	\$33,600,000	\$1,470,000	\$471,433,636	\$1.15	\$0.09	\$0.00	\$1.24
5	7	\$76,364	\$3,360	\$147	\$79,871	\$2.00	\$0.09	\$0.00	\$2.10
45	7	\$763,636	\$33,600	\$1,470	\$798,706	\$2.00	\$0.09	\$0.00	\$2.10
454	7	\$7,636,364	\$336,000	\$14,700	\$7,987,064	\$2.00	\$0.09	\$0.00	\$2.10
4,536	7	\$76,363,636	\$3,360,000	\$147,000	\$79,870,636	\$2.00	\$0.09	\$0.00	\$2.10
45,359	7	\$763,636,364	\$33,600,000	\$1,470,000	\$798,706,364	\$2.00	\$0.09	\$0.00	\$2.10
5	14	\$152,727	\$3,360	\$147	\$156,234	\$4.01	\$0.09	\$0.00	\$4.10
45	14	\$1,527,273	\$33,600	\$1,470	\$1,562,343	\$4.01	\$0.09	\$0.00	\$4.10
454	14	\$15,272,727	\$336,000	\$14,700	\$15,623,427	\$4.01	\$0.09	\$0.00	\$4.10
4,536	14	\$152,727,273	\$3,360,000	\$147,000	\$156,234,273	\$4.01	\$0.09	\$0.00	\$4.10
45,359	14	\$1,527,272,727	\$33,600,000	\$1,470,000	\$1,562,342,727	\$4.01	\$0.09	\$0.00	\$4.10
5	30	\$327,273	\$3,360	\$147	\$330,780	\$8.59	\$0.09	\$0.00	\$8.68
45	30	\$3,272,727	\$33,600	\$1,470	\$3,307,797	\$8.59	\$0.09	\$0.00	\$8.68
454	30	\$32,727,273	\$336,000	\$14,700	\$33,077,973	\$8.59	\$0.09	\$0.00	\$8.68
4,536	30	\$327,272,727	\$3,360,000	\$147,000	\$330,779,727	\$8.59	\$0.09	\$0.00	\$8.68
45,359	30	\$3,272,727,273	\$33,600,000	\$1,470,000	\$3,307,797,273	\$8.59	\$0.09	\$0.00	\$8.68

D.3 METAL HYDRIDE STORAGE - English Units							
Hydride Capital Cost=		\$1,000	per lb				
Hydride Scale-Up=		1.00					
Hydride Cooling=		25	gal/lb				
Hydride Heating=		10,000	Btu/lb				
Steam Cost=		\$4.00	per MM Btu				
Cooling Cost=		\$0.07	per M gal				
Operating Days/Year=		350	days/yr				
Depreciation=		22	years				
Production Rate (lb/hr)	Days of Storage (days)	Storage Capacity (lb)	Annual Production (lb/yr)	Heat Requirement (Btu/hr)	Cooling Requirement (gal/hr)	Hydride Cost (\$)	Total Capital Cost (\$)
10	1	240	84,000	100,000	250	\$240,000	\$240,000
100	1	2,400	840,000	1,000,000	2,500	\$2,400,000	\$2,400,000
1,000	1	24,000	8,400,000	10,000,000	25,000	\$24,000,000	\$24,000,000
10,000	1	240,000	84,000,000	100,000,000	250,000	\$240,000,000	\$240,000,000
100,000	1	2,400,000	840,000,000	1,000,000,000	2,500,000	\$2,400,000,000	\$2,400,000,000
10	2	480	84,000	100,000	250	\$480,000	\$480,000
100	2	4,800	840,000	1,000,000	2,500	\$4,800,000	\$4,800,000
1,000	2	48,000	8,400,000	10,000,000	25,000	\$48,000,000	\$48,000,000
10,000	2	480,000	84,000,000	100,000,000	250,000	\$480,000,000	\$480,000,000
100,000	2	4,800,000	840,000,000	1,000,000,000	2,500,000	\$4,800,000,000	\$4,800,000,000
10	4	960	84,000	100,000	250	\$960,000	\$960,000
100	4	9,600	840,000	1,000,000	2,500	\$9,600,000	\$9,600,000
1,000	4	96,000	8,400,000	10,000,000	25,000	\$96,000,000	\$96,000,000
10,000	4	960,000	84,000,000	100,000,000	250,000	\$960,000,000	\$960,000,000
100,000	4	9,600,000	840,000,000	1,000,000,000	2,500,000	\$9,600,000,000	\$9,600,000,000
10	7	1,680	84,000	100,000	250	\$1,680,000	\$1,680,000
100	7	16,800	840,000	1,000,000	2,500	\$16,800,000	\$16,800,000
1,000	7	168,000	8,400,000	10,000,000	25,000	\$168,000,000	\$168,000,000
10,000	7	1,680,000	84,000,000	100,000,000	250,000	\$1,680,000,000	\$1,680,000,000
100,000	7	16,800,000	840,000,000	1,000,000,000	2,500,000	\$16,800,000,000	\$16,800,000,000
10	14	3,360	84,000	100,000	250	\$3,360,000	\$3,360,000
100	14	33,600	840,000	1,000,000	2,500	\$33,600,000	\$33,600,000
1,000	14	336,000	8,400,000	10,000,000	25,000	\$336,000,000	\$336,000,000
10,000	14	3,360,000	84,000,000	100,000,000	250,000	\$3,360,000,000	\$3,360,000,000
100,000	14	33,600,000	840,000,000	1,000,000,000	2,500,000	\$33,600,000,000	\$33,600,000,000
10	30	7,200	84,000	100,000	250	\$7,200,000	\$7,200,000
100	30	72,000	840,000	1,000,000	2,500	\$72,000,000	\$72,000,000
1,000	30	720,000	8,400,000	10,000,000	25,000	\$720,000,000	\$720,000,000
10,000	30	7,200,000	84,000,000	100,000,000	250,000	\$7,200,000,000	\$7,200,000,000
100,000	30	72,000,000	840,000,000	1,000,000,000	2,500,000	\$72,000,000,000	\$72,000,000,000

D.3 METAL HYDRIDE STORAGE - English Units (Continued)									
Production	Days of	Depreciation	Annual Electric	Annual Cooling	Total Annual	Capital	Energy	Cooling	Total
Rate	Storage		Cost	Water Cost	Cost	Cost	Cost	Cost	Cost
(lb/hr)	(days)	(\$/yr)	(\$/yr)	(\$/yr)	(\$/yr)	(\$/lb)	(\$/lb)	(\$/lb)	(\$/lb)
10	1	\$10,909	\$3,360	\$147	\$14,416	\$0.13	\$0.04	\$0.00	\$0.17
100	1	\$109,091	\$33,600	\$1,470	\$144,161	\$0.13	\$0.04	\$0.00	\$0.17
1,000	1	\$1,090,909	\$336,000	\$14,700	\$1,441,609	\$0.13	\$0.04	\$0.00	\$0.17
10,000	1	\$10,909,091	\$3,360,000	\$147,000	\$14,416,091	\$0.13	\$0.04	\$0.00	\$0.17
100,000	1	\$109,090,909	\$33,600,000	\$1,470,000	\$144,160,909	\$0.13	\$0.04	\$0.00	\$0.17
10	2	\$21,818	\$3,360	\$147	\$25,325	\$0.26	\$0.04	\$0.00	\$0.30
100	2	\$218,182	\$33,600	\$1,470	\$253,252	\$0.26	\$0.04	\$0.00	\$0.30
1,000	2	\$2,181,818	\$336,000	\$14,700	\$2,532,518	\$0.26	\$0.04	\$0.00	\$0.30
10,000	2	\$21,818,182	\$3,360,000	\$147,000	\$25,325,182	\$0.26	\$0.04	\$0.00	\$0.30
100,000	2	\$218,181,818	\$33,600,000	\$1,470,000	\$253,251,818	\$0.26	\$0.04	\$0.00	\$0.30
10	4	\$43,636	\$3,360	\$147	\$47,143	\$0.52	\$0.04	\$0.00	\$0.56
100	4	\$436,364	\$33,600	\$1,470	\$471,434	\$0.52	\$0.04	\$0.00	\$0.56
1,000	4	\$4,363,636	\$336,000	\$14,700	\$4,714,336	\$0.52	\$0.04	\$0.00	\$0.56
10,000	4	\$43,636,364	\$3,360,000	\$147,000	\$47,143,364	\$0.52	\$0.04	\$0.00	\$0.56
100,000	4	\$436,363,636	\$33,600,000	\$1,470,000	\$471,433,636	\$0.52	\$0.04	\$0.00	\$0.56
10	7	\$76,364	\$3,360	\$147	\$79,871	\$0.91	\$0.04	\$0.00	\$0.95
100	7	\$763,636	\$33,600	\$1,470	\$798,706	\$0.91	\$0.04	\$0.00	\$0.95
1,000	7	\$7,636,364	\$336,000	\$14,700	\$7,987,064	\$0.91	\$0.04	\$0.00	\$0.95
10,000	7	\$76,363,636	\$3,360,000	\$147,000	\$79,870,636	\$0.91	\$0.04	\$0.00	\$0.95
100,000	7	\$763,636,364	\$33,600,000	\$1,470,000	\$798,706,364	\$0.91	\$0.04	\$0.00	\$0.95
10	14	\$152,727	\$3,360	\$147	\$156,234	\$1.82	\$0.04	\$0.00	\$1.86
100	14	\$1,527,273	\$33,600	\$1,470	\$1,562,343	\$1.82	\$0.04	\$0.00	\$1.86
1,000	14	\$15,272,727	\$336,000	\$14,700	\$15,623,427	\$1.82	\$0.04	\$0.00	\$1.86
10,000	14	\$152,727,273	\$3,360,000	\$147,000	\$156,234,273	\$1.82	\$0.04	\$0.00	\$1.86
100,000	14	\$1,527,272,727	\$33,600,000	\$1,470,000	\$1,562,342,727	\$1.82	\$0.04	\$0.00	\$1.86
10	30	\$327,273	\$3,360	\$147	\$330,780	\$3.90	\$0.04	\$0.00	\$3.94
100	30	\$3,272,727	\$33,600	\$1,470	\$3,307,797	\$3.90	\$0.04	\$0.00	\$3.94
1,000	30	\$32,727,273	\$336,000	\$14,700	\$33,077,973	\$3.90	\$0.04	\$0.00	\$3.94
10,000	30	\$327,272,727	\$3,360,000	\$147,000	\$330,779,727	\$3.90	\$0.04	\$0.00	\$3.94
100,000	30	\$3,272,727,273	\$33,600,000	\$1,470,000	\$3,307,797,273	\$3.90	\$0.04	\$0.00	\$3.94

D4. UNDERGROUND STORAGE - SI Units										
Compressor Capital Cost=		\$1,000		per kW						
Underground Capital Cost=		\$9		per kg						
Compressor Size=		4,000		kW						
Compressor Pressure=		20		MPa						
Comp. Pressure Scale-Up=		0.18								
Comp. Cost Scale-Up=		0.80								
Underground Scale-Up=		1.00								
Compressor Power=		2.20		kWh/kg (20 MPa)						
Compressor Cooling=		50		liters/kg (20 MPa)						
Electric Cost=		\$0.05		per kWh						
Cooling Cost=		\$0.02		per M liters						
Operating Days/Year=		350		days/yr						
Depreciation=		22		years						
Production	Days of	Operating	Storage	Annual	Comp.	Cooling	Compressor	Compressor	Cavern	Total Capital
Rate	Storage	Pressure	Capacity	Production	Power	Requirement	Size	Cost	Cost	Cost
(kg/hr)	(days)	(MPa)	(kg)	(kg/yr)	(kWh/hr)	(liters/hr)	(kW)	(\$)	(\$)	(\$)
5	1	20	109	38,102	10	227	10	\$33,145	\$960	\$34,105
45	1	20	1,089	381,016	100	2,271	100	\$209,128	\$9,600	\$218,728
454	1	20	10,886	3,810,156	1,000	22,712	1,000	\$1,319,508	\$96,000	\$1,415,508
4,536	1	20	108,862	38,101,560	10,000	227,124	10,000	\$8,325,532	\$960,000	\$9,285,532
45,359	1	20	1,088,616	381,015,600	100,000	2,271,240	100,000	\$52,530,556	\$9,600,000	\$62,130,556
5	2	20	218	38,102	10	227	10	\$33,145	\$1,920	\$35,065
45	2	20	2,177	381,016	100	2,271	100	\$209,128	\$19,200	\$228,328
454	2	20	21,772	3,810,156	1,000	22,712	1,000	\$1,319,508	\$192,000	\$1,511,508
4,536	2	20	217,723	38,101,560	10,000	227,124	10,000	\$8,325,532	\$1,920,000	\$10,245,532
45,359	2	20	2,177,232	381,015,600	100,000	2,271,240	100,000	\$52,530,556	\$19,200,000	\$71,730,556
5	4	20	435	38,102	10	227	10	\$33,145	\$3,840	\$36,985
45	4	20	4,354	381,016	100	2,271	100	\$209,128	\$38,400	\$247,528
454	4	20	43,545	3,810,156	1,000	22,712	1,000	\$1,319,508	\$384,000	\$1,703,508
4,536	4	20	435,446	38,101,560	10,000	227,124	10,000	\$8,325,532	\$3,840,000	\$12,165,532
45,359	4	20	4,354,464	381,015,600	100,000	2,271,240	100,000	\$52,530,556	\$38,400,000	\$90,930,556
5	7	20	762	38,102	10	227	10	\$33,145	\$6,720	\$39,865
45	7	20	7,620	381,016	100	2,271	100	\$209,128	\$67,200	\$276,328
454	7	20	76,203	3,810,156	1,000	22,712	1,000	\$1,319,508	\$672,000	\$1,991,508
4,536	7	20	762,031	38,101,560	10,000	227,124	10,000	\$8,325,532	\$6,720,000	\$15,045,532
45,359	7	20	7,620,312	381,015,600	100,000	2,271,240	100,000	\$52,530,556	\$67,200,000	\$119,730,556
5	14	20	1,524	38,102	10	227	10	\$33,145	\$13,440	\$46,585
45	14	20	15,241	381,016	100	2,271	100	\$209,128	\$134,400	\$343,528
454	14	20	152,406	3,810,156	1,000	22,712	1,000	\$1,319,508	\$1,344,000	\$2,663,508
4,536	14	20	1,524,062	38,101,560	10,000	227,124	10,000	\$8,325,532	\$13,440,000	\$21,765,532
45,359	14	20	15,240,624	381,015,600	100,000	2,271,240	100,000	\$52,530,556	\$134,400,000	\$186,930,556
5	30	20	3,266	38,102	10	227	10	\$33,145	\$28,800	\$61,945
45	30	20	32,658	381,016	100	2,271	100	\$209,128	\$288,000	\$497,128
454	30	20	326,585	3,810,156	1,000	22,712	1,000	\$1,319,508	\$2,880,000	\$4,199,508
4,536	30	20	3,265,848	38,101,560	10,000	227,124	10,000	\$8,325,532	\$28,800,000	\$37,125,532
45,359	30	20	32,658,480	381,015,600	100,000	2,271,240	100,000	\$52,530,556	\$288,000,000	\$340,530,556

D4. UNDERGROUND STORAGE - SI Units (Continued)														
Production Rate (kg/hr)	Days of Storage (days)	Depreciation (\$/yr)	Annual Electric Cost (\$/yr)	Annual Cooling Water Costs (\$/yr)	Total Annual Cost (\$/yr)	Capital Cost (\$/kg)	Electricity Cost (\$/kg)	Cooling Cost (\$/kg)	Total Cost (\$/kg)	Comp. Cost (\$/kg)	Cavern Cost/lb (\$/kg)	Comp. Capital (\$/kW)	Cavern Capital (\$/kg)	
5	1	\$1,550	\$4,200	\$35	\$5,785	\$0.04	\$0.11	\$0.00	\$0.15	\$0.04	\$0.00	\$3,314	\$8.82	
45	1	\$9,942	\$42,000	\$353	\$52,295	\$0.03	\$0.11	\$0.00	\$0.14	\$0.02	\$0.00	\$2,091	\$8.82	
454	1	\$64,341	\$420,000	\$3,528	\$487,869	\$0.02	\$0.11	\$0.00	\$0.13	\$0.02	\$0.00	\$1,320	\$8.82	
4,536	1	\$422,070	\$4,200,000	\$35,280	\$4,657,350	\$0.01	\$0.11	\$0.00	\$0.12	\$0.01	\$0.00	\$833	\$8.82	
45,359	1	\$2,824,116	\$42,000,000	\$352,800	\$45,176,916	\$0.01	\$0.11	\$0.00	\$0.12	\$0.01	\$0.00	\$525	\$8.82	
5	2	\$1,594	\$4,200	\$35	\$5,829	\$0.04	\$0.11	\$0.00	\$0.15	\$0.04	\$0.00	\$3,314	\$8.82	
45	2	\$10,379	\$42,000	\$353	\$52,731	\$0.03	\$0.11	\$0.00	\$0.14	\$0.02	\$0.00	\$2,091	\$8.82	
454	2	\$68,705	\$420,000	\$3,528	\$492,233	\$0.02	\$0.11	\$0.00	\$0.13	\$0.02	\$0.00	\$1,320	\$8.82	
4,536	2	\$465,706	\$4,200,000	\$35,280	\$4,700,986	\$0.01	\$0.11	\$0.00	\$0.12	\$0.01	\$0.00	\$833	\$8.82	
45,359	2	\$3,260,480	\$42,000,000	\$352,800	\$45,613,280	\$0.01	\$0.11	\$0.00	\$0.12	\$0.01	\$0.00	\$525	\$8.82	
5	4	\$1,681	\$4,200	\$35	\$5,916	\$0.04	\$0.11	\$0.00	\$0.16	\$0.04	\$0.00	\$3,314	\$8.82	
45	4	\$11,251	\$42,000	\$353	\$53,604	\$0.03	\$0.11	\$0.00	\$0.14	\$0.02	\$0.00	\$2,091	\$8.82	
454	4	\$77,432	\$420,000	\$3,528	\$500,960	\$0.02	\$0.11	\$0.00	\$0.13	\$0.02	\$0.00	\$1,320	\$8.82	
4,536	4	\$552,979	\$4,200,000	\$35,280	\$4,788,259	\$0.01	\$0.11	\$0.00	\$0.13	\$0.01	\$0.00	\$833	\$8.82	
45,359	4	\$4,133,207	\$42,000,000	\$352,800	\$46,486,007	\$0.01	\$0.11	\$0.00	\$0.12	\$0.01	\$0.00	\$525	\$8.82	
5	7	\$1,812	\$4,200	\$35	\$6,047	\$0.05	\$0.11	\$0.00	\$0.16	\$0.04	\$0.01	\$3,314	\$8.82	
45	7	\$12,560	\$42,000	\$353	\$54,913	\$0.03	\$0.11	\$0.00	\$0.14	\$0.02	\$0.01	\$2,091	\$8.82	
454	7	\$90,523	\$420,000	\$3,528	\$514,051	\$0.02	\$0.11	\$0.00	\$0.13	\$0.02	\$0.01	\$1,320	\$8.82	
4,536	7	\$683,888	\$4,200,000	\$35,280	\$4,919,168	\$0.02	\$0.11	\$0.00	\$0.13	\$0.01	\$0.01	\$833	\$8.82	
45,359	7	\$5,442,298	\$42,000,000	\$352,800	\$47,795,098	\$0.01	\$0.11	\$0.00	\$0.13	\$0.01	\$0.01	\$525	\$8.82	
5	14	\$2,117	\$4,200	\$35	\$6,353	\$0.06	\$0.11	\$0.00	\$0.17	\$0.04	\$0.02	\$3,314	\$8.82	
45	14	\$15,615	\$42,000	\$353	\$57,968	\$0.04	\$0.11	\$0.00	\$0.15	\$0.02	\$0.02	\$2,091	\$8.82	
454	14	\$121,069	\$420,000	\$3,528	\$544,597	\$0.03	\$0.11	\$0.00	\$0.14	\$0.02	\$0.02	\$1,320	\$8.82	
4,536	14	\$989,342	\$4,200,000	\$35,280	\$5,224,622	\$0.03	\$0.11	\$0.00	\$0.14	\$0.01	\$0.02	\$833	\$8.82	
45,359	14	\$8,496,843	\$42,000,000	\$352,800	\$50,849,643	\$0.02	\$0.11	\$0.00	\$0.13	\$0.01	\$0.02	\$525	\$8.82	
5	30	\$2,816	\$4,200	\$35	\$7,051	\$0.07	\$0.11	\$0.00	\$0.19	\$0.04	\$0.03	\$3,314	\$8.82	
45	30	\$22,597	\$42,000	\$353	\$64,950	\$0.06	\$0.11	\$0.00	\$0.17	\$0.02	\$0.03	\$2,091	\$8.82	
454	30	\$190,887	\$420,000	\$3,528	\$614,415	\$0.05	\$0.11	\$0.00	\$0.16	\$0.02	\$0.03	\$1,320	\$8.82	
4,536	30	\$1,687,524	\$4,200,000	\$35,280	\$5,922,804	\$0.04	\$0.11	\$0.00	\$0.16	\$0.01	\$0.03	\$833	\$8.82	
45,359	30	\$15,478,662	\$42,000,000	\$352,800	\$57,831,462	\$0.04	\$0.11	\$0.00	\$0.15	\$0.01	\$0.03	\$525	\$8.82	

D4. UNDERGROUND STORAGE - English Units										
Compressor Capital Cost=	\$1,000	per kW								
Underground Capital Cost=	\$4	per lb								
Compressor Size=	4,000	kW								
Compressor Pressure=	20	MPa								
Comp. Pressure Scale-Up=	0.18									
Comp. Cost Scale-Up=	0.80									
Underground Scale-Up=	1.00									
Compressor Power=	1.00	kWh/lb (20 MPa)								
Compressor Cooling=	6.0	gal/lb (20 MPa)								
Electric Cost=	\$0.05	per kWh								
Cooling Cost=	\$0.07	per M gal								
Operating Days/Year=	350	days/yr								
Depreciation=	22	years								
Production	Days of	Operating	Storage	Annual	Comp.	Cooling	Compressor	Compressor	Cavern	Total Capital
Rate	Storage	Pressure	Capacity	Production	Power	Requirement	Size	Cost	Cost	Cost
(lb/hr)	(days)	(MPa)	(lb)	(lb/yr)	(kWh/hr)	(gal/hr)	(kW)	(\$)	(\$)	(\$)
10	1	20	240	84,000	10	60	10	\$33,145	\$960	\$34,105
100	1	20	2,400	840,000	100	600	100	\$209,128	\$9,600	\$218,728
1,000	1	20	24,000	8,400,000	1,000	6,000	1,000	\$1,319,508	\$96,000	\$1,415,508
10,000	1	20	240,000	84,000,000	10,000	60,000	10,000	\$8,325,532	\$960,000	\$9,285,532
100,000	1	20	2,400,000	840,000,000	100,000	600,000	100,000	\$52,530,556	\$9,600,000	\$62,130,556
10	2	20	480	84,000	10	60	10	\$33,145	\$1,920	\$35,065
100	2	20	4,800	840,000	100	600	100	\$209,128	\$19,200	\$228,328
1,000	2	20	48,000	8,400,000	1,000	6,000	1,000	\$1,319,508	\$192,000	\$1,511,508
10,000	2	20	480,000	84,000,000	10,000	60,000	10,000	\$8,325,532	\$1,920,000	\$10,245,532
100,000	2	20	4,800,000	840,000,000	100,000	600,000	100,000	\$52,530,556	\$19,200,000	\$71,730,556
10	4	20	960	84,000	10	60	10	\$33,145	\$3,840	\$36,985
100	4	20	9,600	840,000	100	600	100	\$209,128	\$38,400	\$247,528
1,000	4	20	96,000	8,400,000	1,000	6,000	1,000	\$1,319,508	\$384,000	\$1,703,508
10,000	4	20	960,000	84,000,000	10,000	60,000	10,000	\$8,325,532	\$3,840,000	\$12,165,532
100,000	4	20	9,600,000	840,000,000	100,000	600,000	100,000	\$52,530,556	\$38,400,000	\$90,930,556
10	7	20	1,680	84,000	10	60	10	\$33,145	\$6,720	\$39,865
100	7	20	16,800	840,000	100	600	100	\$209,128	\$67,200	\$276,328
1,000	7	20	168,000	8,400,000	1,000	6,000	1,000	\$1,319,508	\$672,000	\$1,991,508
10,000	7	20	1,680,000	84,000,000	10,000	60,000	10,000	\$8,325,532	\$6,720,000	\$15,045,532
100,000	7	20	16,800,000	840,000,000	100,000	600,000	100,000	\$52,530,556	\$67,200,000	\$119,730,556
10	14	20	3,360	84,000	10	60	10	\$33,145	\$13,440	\$46,585
100	14	20	33,600	840,000	100	600	100	\$209,128	\$134,400	\$343,528
1,000	14	20	336,000	8,400,000	1,000	6,000	1,000	\$1,319,508	\$1,344,000	\$2,663,508
10,000	14	20	3,360,000	84,000,000	10,000	60,000	10,000	\$8,325,532	\$13,440,000	\$21,765,532
100,000	14	20	33,600,000	840,000,000	100,000	600,000	100,000	\$52,530,556	\$134,400,000	\$186,930,556
10	30	20	7,200	84,000	10	60	10	\$33,145	\$28,800	\$61,945
100	30	20	72,000	840,000	100	600	100	\$209,128	\$288,000	\$497,128
1,000	30	20	720,000	8,400,000	1,000	6,000	1,000	\$1,319,508	\$2,880,000	\$4,199,508
10,000	30	20	7,200,000	84,000,000	10,000	60,000	10,000	\$8,325,532	\$28,800,000	\$37,125,532
100,000	30	20	72,000,000	840,000,000	100,000	600,000	100,000	\$52,530,556	\$288,000,000	\$340,530,556

D4. UNDERGROUND STORAGE - English Units (Continued)													
Production Rate (lb/hr)	Days of Storage (days)	Depreciation (\$/yr)	Annual Electric Cost (\$/yr)	Annual Cooling Water Costs (\$/yr)	Total Annual Cost (\$/yr)	Capital Cost (\$/lb)	Electricity Cost (\$/lb)	Cooling Cost (\$/lb)	Total Cost (\$/lb)	Comp. Cost (\$/lb)	Cavern Cost/lb	Comp. Capital (\$/kW)	Cavern Capital (\$/lb)
10	1	\$1,550	\$4,200	\$35	\$5,785	\$0.02	\$0.05	\$0.00	\$0.07	\$0.02	\$0.00	\$3,314	\$4.00
100	1	\$9,942	\$42,000	\$353	\$52,295	\$0.01	\$0.05	\$0.00	\$0.06	\$0.01	\$0.00	\$2,091	\$4.00
1,000	1	\$64,341	\$420,000	\$3,528	\$487,869	\$0.01	\$0.05	\$0.00	\$0.06	\$0.01	\$0.00	\$1,320	\$4.00
10,000	1	\$422,070	\$4,200,000	\$35,280	\$4,657,350	\$0.01	\$0.05	\$0.00	\$0.06	\$0.00	\$0.00	\$833	\$4.00
100,000	1	\$2,824,116	\$42,000,000	\$352,800	\$45,176,916	\$0.00	\$0.05	\$0.00	\$0.05	\$0.00	\$0.00	\$525	\$4.00
10	2	\$1,594	\$4,200	\$35	\$5,829	\$0.02	\$0.05	\$0.00	\$0.07	\$0.02	\$0.00	\$3,314	\$4.00
100	2	\$10,379	\$42,000	\$353	\$52,731	\$0.01	\$0.05	\$0.00	\$0.06	\$0.01	\$0.00	\$2,091	\$4.00
1,000	2	\$68,705	\$420,000	\$3,528	\$492,233	\$0.01	\$0.05	\$0.00	\$0.06	\$0.01	\$0.00	\$1,320	\$4.00
10,000	2	\$465,706	\$4,200,000	\$35,280	\$4,700,986	\$0.01	\$0.05	\$0.00	\$0.06	\$0.00	\$0.00	\$833	\$4.00
100,000	2	\$3,260,480	\$42,000,000	\$352,800	\$45,613,280	\$0.00	\$0.05	\$0.00	\$0.05	\$0.00	\$0.00	\$525	\$4.00
10	4	\$1,681	\$4,200	\$35	\$5,916	\$0.02	\$0.05	\$0.00	\$0.07	\$0.02	\$0.00	\$3,314	\$4.00
100	4	\$11,251	\$42,000	\$353	\$53,604	\$0.01	\$0.05	\$0.00	\$0.06	\$0.01	\$0.00	\$2,091	\$4.00
1,000	4	\$77,432	\$420,000	\$3,528	\$500,960	\$0.01	\$0.05	\$0.00	\$0.06	\$0.01	\$0.00	\$1,320	\$4.00
10,000	4	\$552,979	\$4,200,000	\$35,280	\$4,788,259	\$0.01	\$0.05	\$0.00	\$0.06	\$0.00	\$0.00	\$833	\$4.00
100,000	4	\$4,133,207	\$42,000,000	\$352,800	\$46,486,007	\$0.00	\$0.05	\$0.00	\$0.06	\$0.00	\$0.00	\$525	\$4.00
10	7	\$1,812	\$4,200	\$35	\$6,047	\$0.02	\$0.05	\$0.00	\$0.07	\$0.02	\$0.00	\$3,314	\$4.00
100	7	\$12,560	\$42,000	\$353	\$54,913	\$0.01	\$0.05	\$0.00	\$0.07	\$0.01	\$0.00	\$2,091	\$4.00
1,000	7	\$90,523	\$420,000	\$3,528	\$514,051	\$0.01	\$0.05	\$0.00	\$0.06	\$0.01	\$0.00	\$1,320	\$4.00
10,000	7	\$683,888	\$4,200,000	\$35,280	\$4,919,168	\$0.01	\$0.05	\$0.00	\$0.06	\$0.00	\$0.00	\$833	\$4.00
100,000	7	\$5,442,298	\$42,000,000	\$352,800	\$47,795,098	\$0.01	\$0.05	\$0.00	\$0.06	\$0.00	\$0.00	\$525	\$4.00
10	14	\$2,117	\$4,200	\$35	\$6,353	\$0.03	\$0.05	\$0.00	\$0.08	\$0.02	\$0.01	\$3,314	\$4.00
100	14	\$15,615	\$42,000	\$353	\$57,968	\$0.02	\$0.05	\$0.00	\$0.07	\$0.01	\$0.01	\$2,091	\$4.00
1,000	14	\$121,069	\$420,000	\$3,528	\$544,597	\$0.01	\$0.05	\$0.00	\$0.06	\$0.01	\$0.01	\$1,320	\$4.00
10,000	14	\$989,342	\$4,200,000	\$35,280	\$5,224,622	\$0.01	\$0.05	\$0.00	\$0.06	\$0.00	\$0.01	\$833	\$4.00
100,000	14	\$8,496,843	\$42,000,000	\$352,800	\$50,849,643	\$0.01	\$0.05	\$0.00	\$0.06	\$0.00	\$0.01	\$525	\$4.00
10	30	\$2,816	\$4,200	\$35	\$7,051	\$0.03	\$0.05	\$0.00	\$0.08	\$0.02	\$0.02	\$3,314	\$4.00
100	30	\$22,597	\$42,000	\$353	\$64,950	\$0.03	\$0.05	\$0.00	\$0.08	\$0.01	\$0.02	\$2,091	\$4.00
1,000	30	\$190,887	\$420,000	\$3,528	\$614,415	\$0.02	\$0.05	\$0.00	\$0.07	\$0.01	\$0.02	\$1,320	\$4.00
10,000	30	\$1,687,524	\$4,200,000	\$35,280	\$5,922,804	\$0.02	\$0.05	\$0.00	\$0.07	\$0.00	\$0.02	\$833	\$4.00
100,000	30	\$15,478,662	\$42,000,000	\$352,800	\$57,831,462	\$0.02	\$0.05	\$0.00	\$0.07	\$0.00	\$0.02	\$525	\$4.00

APPENDIX E - HYDROGEN TRANSPORT COSTS

- E.0 Hydrogen Transportation Assumptions
- E.1 Compressed Gas Delivery by Truck
- E.2 Compressed Gas Delivery by Rail
- E.3 Liquid Hydrogen Delivery by Truck
- E.4 Liquid Hydrogen Delivery by Rail
- E.5 Liquid Hydrogen Delivery by Ship
- E.6 Metal Hydride Delivery by Truck
- E.7 Metal Hydride Delivery by Rail
- E.8 Pipeline Delivery

Appendix E contains some of the cost data from the analysis of transport costs for the different hydrogen delivery options. Costs are given in both SI and traditional English units for each storage method. Costs are arranged in the tables by production rate and delivery distance.

E.0 HYDROGEN TRANSPORTATION ASSUMPTIONS				
Truck Tube Unit=	\$100,000	per module		
Truck Tube Capacity=	181	kg/truck	400	lb/truck
Truck Liquid Tank=	\$350,000	per module		
Truck Liquid Capacity=	4,082	kg/truck	9,000	lb/truck
Truck Hydride Container=	\$2,205	per kg hydrogen	\$1,000	per lb hydrogen
Truck Hydride Capacity=	454	kg/truck	1,000	lb/truck
Truck Undercarriage=	\$60,000	per trailer		
Truck Cab=	\$90,000	per cab		
Truck Mileage=	6	mpg		
Truck Average Speed=	80	km/hr	50	mph
Truck Load/Unload Time=	2	hr/trip		
Truck Availability=	24	hr/day		
Hours/Driver=	12	hr/driver		
Driver Wage w/ Benefits=	\$28.75	per hour		
Diesel Price=	\$1.00	per gal		
Truck Boil-Off Rate=	0.30%	/day		
Rail Tube Unit=	\$200,000	per module		
Rail Tube Capacity=	454	kg/railcar	1,000	lb/railcar
Rail Liquid Tank=	\$400,000	per tank		
Rail Tank Capacity=	9,072	kg/railcar	20,000	lb/railcar
Rail Hydride Container=	\$1,000	per lb hydrogen		
Rail Hydride Capacity=	907	kg/railcar	2,000	lb/railcar
Rail Undercarriage=	\$100,000	per railcar		
Rail Average Speed=	40	km/hr	25	mph
Rail Load/Unload Time=	24	hr/trip		
Rail Car Availability=	24	hr/day		
Rail Freight=	\$400	per rail car		
Rail Boil-Off Rate=	0.30%	per day		
Ship Liquid Tank=	\$350,000	per container		
Ship Liquid Capacity=	4,082	lb/tank	9,000	lb/tank
Ship Average Speed=	16	km/hr	10	mph
Ship Load/Unload Time=	48	hr/trip		
Ship Tank Availability=	24	hr/day		
Shipping Charge=	\$3,000	per container		
Ship Boil-Off Rate=	0.30%	per day		
Pipeline Cost=	\$621,504	per km	\$1,000,000	per mile
Steel Roughness=	4.6E-05	m		
Pipe Diameter=	0.25	m		
Temperaure=	283	K		
Delivery Pressure=	2	MPa		
Viscosity=	8.62E-06	kg/m*s		
R (hydrogen)=	4124	N*m/kg K		
Compressor Capital Cost=	\$1,000	per kW		
Compressor Size=	4,000	kW		
Compressor Pressure=	20	MPa		
Comp. Pressure Scale-Up=	0.18			
Comp. Cost Scale-Up=	0.80			
Compressor Power=	2.2	kWh/kg (20 MPa)	1.00	kWh/lb (20 MPa)
Electric Cost=	\$0.05	per kWh		
Operating Days/Year=	350	days/year		
Trailer/Tank Depreciation=	6	years		
Tractor Depreciation=	4	years		
Railcar Depreciation=	15	years		
Pipeline Depreciation=	22	years		

E.1 COMPRESSED GAS DELIVERY BY TRUCK - SI Units															
Truck Tube Unit=	\$100,000	per module													
Truck Undercarriage=	\$60,000	per trailer													
Truck Cab=	\$90,000	per cab													
Truck Tube Capacity=	181	kg/truck													
Truck Mileage=	6	mpg													
Truck Average Speed=	80	km/hr													
Hours/Driver=	12	hr/driver													
Truck Load/Unload Time=	2	hr/trip													
Truck Availability=	24	hr/day													
Driver Wage w/ Benefits=	\$28.75	per hour													
Diesel Price=	\$1.00	per gal													
Operating Days/Year=	350	days/yr													
Trailer/Tank Depreciation=	6	years													
Tractor Depreciation=	4	years													
Production Rate (kg/hr)	Delivery Distance One-Way (km)	Distance Two-Way (km/trip)	Annual Production (kg/yr)	Truck Capacity (kg/truck)	Number of Trips (trips/yr)	Total Miles Driven (km/yr)	Time per Trip (hr/trip)	Total Drive Time (hr/yr)	Total Load/Unload Time (hr/yr)	Total Delivery Time (hr/yr)	Truck Availability (hr/yr)	Trucks Required	Driver Availability (hr/yr)	Drivers Required	Annual Fuel Use (gal/yr)
5	16	32	38,102	181	210	6,758	1	210	420	630	8,400	1	4,200	1	700
5	32	64	38,102	181	210	13,516	1	210	420	630	8,400	1	4,200	1	1,400
5	80	161	38,102	181	210	33,789	2	420	420	840	8,400	1	4,200	1	3,500
5	161	322	38,102	181	210	67,578	4	840	420	1,260	8,400	1	4,200	1	7,000
5	322	644	38,102	181	210	135,156	8	1,680	420	2,100	8,400	1	4,200	1	14,000
5	805	1,609	38,102	181	210	337,890	20	4,200	420	4,620	8,400	1	4,200	2	35,000
5	1,609	3,218	38,102	181	210	675,780	40	8,400	420	8,820	8,400	2	4,200	3	70,000
45	16	32	381,016	181	2,100	67,578	1	2,100	4,200	6,300	8,400	1	4,200	2	7,000
45	32	64	381,016	181	2,100	135,156	1	2,100	4,200	6,300	8,400	1	4,200	2	14,000
45	80	161	381,016	181	2,100	337,890	2	4,200	4,200	8,400	8,400	1	4,200	2	35,000
45	161	322	381,016	181	2,100	675,780	4	8,400	4,200	12,600	8,400	2	4,200	3	70,000
45	322	644	381,016	181	2,100	1,351,560	8	16,800	4,200	21,000	8,400	3	4,200	5	140,000
45	805	1,609	381,016	181	2,100	3,378,900	20	42,000	4,200	46,200	8,400	6	4,200	11	350,000
45	1,609	3,218	381,016	181	2,100	6,757,800	40	84,000	4,200	88,200	8,400	11	4,200	21	700,000
45.4	16	32	3,810,156	181	21,000	675,780	1	21,000	42,000	63,000	8,400	8	4,200	15	70,000
45.4	32	64	3,810,156	181	21,000	1,351,560	1	21,000	42,000	63,000	8,400	8	4,200	15	140,000
45.4	80	161	3,810,156	181	21,000	3,378,900	2	42,000	42,000	84,000	8,400	10	4,200	20	350,000
45.4	161	322	3,810,156	181	21,000	6,757,800	4	84,000	42,000	126,000	8,400	15	4,200	30	700,000
45.4	322	644	3,810,156	181	21,000	13,515,600	8	168,000	42,000	210,000	8,400	25	4,200	50	1,400,000
45.4	805	1,609	3,810,156	181	21,000	33,789,000	20	420,000	42,000	462,000	8,400	55	4,200	110	3,500,000
45.4	1,609	3,218	3,810,156	181	21,000	67,578,000	40	840,000	42,000	882,000	8,400	105	4,200	210	7,000,000
45.36	16	32	38,101,560	181	210,000	6,757,800	1	210,000	420,000	630,000	8,400	75	4,200	150	700,000
45.36	32	64	38,101,560	181	210,000	13,515,600	1	210,000	420,000	630,000	8,400	75	4,200	150	1,400,000
45.36	80	161	38,101,560	181	210,000	33,789,000	2	420,000	420,000	840,000	8,400	100	4,200	200	3,500,000
45.36	161	322	38,101,560	181	210,000	67,578,000	4	840,000	420,000	1,260,000	8,400	150	4,200	300	7,000,000
45.36	322	644	38,101,560	181	210,000	135,156,000	8	1,680,000	420,000	2,100,000	8,400	250	4,200	500	14,000,000
45.36	805	1,609	38,101,560	181	210,000	337,890,000	20	4,200,000	420,000	4,620,000	8,400	550	4,200	1,100	35,000,000
45.36	1,609	3,218	38,101,560	181	210,000	675,780,000	40	8,400,000	420,000	8,820,000	8,400	1,050	4,200	2,100	70,000,000
45,359	16	32	381,015,600	181	2,100,000	67,578,000	1	2,100,000	4,200,000	6,300,000	8,400	750	4,200	1,500	7,000,000
45,359	32	64	381,015,600	181	2,100,000	135,156,000	1	2,100,000	4,200,000	6,300,000	8,400	750	4,200	1,500	14,000,000
45,359	80	161	381,015,600	181	2,100,000	337,890,000	2	4,200,000	4,200,000	8,400,000	8,400	1,000	4,200	2,000	35,000,000
45,359	161	322	381,015,600	181	2,100,000	675,780,000	4	8,400,000	4,200,000	12,600,000	8,400	1,500	4,200	3,000	70,000,000
45,359	322	644	381,015,600	181	2,100,000	1,351,560,000	8	16,800,000	4,200,000	21,000,000	8,400	2,500	4,200	5,000	140,000,000
45,359	805	1,609	381,015,600	181	2,100,000	3,378,900,000	20	42,000,000	4,200,000	46,200,000	8,400	5,500	4,200	11,000	350,000,000
45,359	1,609	3,218	381,015,600	181	2,100,000	6,757,800,000	40	84,000,000	4,200,000	88,200,000	8,400	10,500	4,200	21,000	700,000,000

E.1 COMPRESSED GAS DELIVERY BY TRUCK - SI Units (Continued)													
Production Rate (kg/hr)	Delivery Distance (km)	Total Capital Cost (\$)	Depreciation (\$/yr)	Annual Fuel Cost (\$/yr)	Annual Labor Cost (\$/yr)	Total Annual Cost (\$/yr)	Capital Cost (\$/kg)	Fuel Cost (\$/kg)	Labor Cost (\$/kg)	Total Cost (\$/kg)	Trip Frequency (trips/day)	Trip Length (hours)	Truck Utilization (Trips/truck/d)
5	16	\$250,000	\$49,167	\$700	\$18,113	\$268,813	\$1.29	\$0.02	\$0.48	\$7.06	0.6	3	0.60
5	32	\$250,000	\$49,167	\$1,400	\$18,113	\$68,679	\$1.29	\$0.04	\$0.48	\$1.80	0.6	3	0.60
5	80	\$250,000	\$49,167	\$3,500	\$24,150	\$76,817	\$1.29	\$0.09	\$0.63	\$2.02	0.6	4	0.60
5	161	\$250,000	\$49,167	\$7,000	\$36,225	\$92,392	\$1.29	\$0.18	\$0.95	\$2.42	0.6	6	0.60
5	322	\$250,000	\$49,167	\$14,000	\$60,375	\$123,542	\$1.29	\$0.37	\$1.58	\$3.24	0.6	10	0.60
5	805	\$250,000	\$49,167	\$35,000	\$132,825	\$216,992	\$1.29	\$0.92	\$3.49	\$5.70	0.6	22	0.60
5	1,609	\$500,000	\$98,333	\$70,000	\$253,575	\$421,908	\$2.58	\$1.84	\$6.66	\$11.07	0.6	42	0.30
45	16	\$250,000	\$49,167	\$7,000	\$181,125	\$237,292	\$0.13	\$0.02	\$0.48	\$0.62	6	3	6.00
45	32	\$250,000	\$49,167	\$14,000	\$181,125	\$244,292	\$0.13	\$0.04	\$0.48	\$0.64	6	3	6.00
45	80	\$250,000	\$49,167	\$35,000	\$241,500	\$325,667	\$0.13	\$0.09	\$0.63	\$0.85	6	4	6.00
45	161	\$500,000	\$98,333	\$70,000	\$362,250	\$530,583	\$0.26	\$0.18	\$0.95	\$1.39	6	6	3.00
45	322	\$750,000	\$147,500	\$140,000	\$603,750	\$891,250	\$0.39	\$0.37	\$1.58	\$2.34	6	10	2.00
45	805	\$1,500,000	\$295,000	\$350,000	\$1,328,250	\$1,973,250	\$0.77	\$0.92	\$3.49	\$5.18	6	22	1.00
45	1,609	\$2,750,000	\$540,833	\$700,000	\$2,535,750	\$3,776,583	\$1.42	\$1.84	\$6.66	\$9.91	6	42	0.55
454	16	\$2,000,000	\$393,333	\$70,000	\$1,811,250	\$2,274,583	\$0.10	\$0.02	\$0.48	\$0.60	60	3	7.50
454	32	\$2,000,000	\$393,333	\$140,000	\$1,811,250	\$2,344,583	\$0.10	\$0.04	\$0.48	\$0.62	60	3	7.50
454	80	\$2,500,000	\$491,667	\$350,000	\$2,415,000	\$3,256,667	\$0.13	\$0.09	\$0.63	\$0.85	60	4	6.00
454	161	\$3,750,000	\$737,500	\$700,000	\$3,622,500	\$5,060,000	\$0.19	\$0.18	\$0.95	\$1.33	60	6	4.00
454	322	\$6,250,000	\$1,229,167	\$1,400,000	\$6,037,500	\$8,666,667	\$0.32	\$0.37	\$1.58	\$2.27	60	10	2.40
454	805	\$13,750,000	\$2,704,167	\$3,500,000	\$13,282,500	\$19,486,667	\$0.71	\$0.92	\$3.49	\$5.11	60	22	1.09
454	1,609	\$26,250,000	\$5,162,500	\$7,000,000	\$25,357,500	\$37,520,000	\$1.35	\$1.84	\$6.66	\$9.85	60	42	0.57
4,536	16	\$18,750,000	\$3,687,500	\$700,000	\$18,112,500	\$22,500,000	\$0.10	\$0.02	\$0.48	\$0.59	600	3	8.00
4,536	32	\$18,750,000	\$3,687,500	\$1,400,000	\$18,112,500	\$23,200,000	\$0.10	\$0.04	\$0.48	\$0.61	600	3	8.00
4,536	80	\$25,000,000	\$4,916,667	\$3,500,000	\$24,150,000	\$32,566,667	\$0.13	\$0.09	\$0.63	\$0.85	600	4	6.00
4,536	161	\$37,500,000	\$7,375,000	\$7,000,000	\$36,225,000	\$50,600,000	\$0.19	\$0.18	\$0.95	\$1.33	600	6	4.00
4,536	322	\$62,500,000	\$12,291,667	\$14,000,000	\$60,375,000	\$86,666,667	\$0.32	\$0.37	\$1.58	\$2.27	600	10	2.40
4,536	805	\$137,500,000	\$27,041,667	\$35,000,000	\$132,825,000	\$194,866,667	\$0.71	\$0.92	\$3.49	\$5.11	600	22	1.09
4,536	1,609	\$262,500,000	\$51,625,000	\$70,000,000	\$253,575,000	\$375,200,000	\$1.35	\$1.84	\$6.66	\$9.85	600	42	0.57
45,359	16	\$187,500,000	\$36,875,000	\$7,000,000	\$181,125,000	\$225,000,000	\$0.10	\$0.02	\$0.48	\$0.59	6000	3	8.00
45,359	32	\$187,500,000	\$36,875,000	\$14,000,000	\$181,125,000	\$232,000,000	\$0.10	\$0.04	\$0.48	\$0.61	6000	3	8.00
45,359	80	\$250,000,000	\$49,166,667	\$35,000,000	\$241,500,000	\$325,666,667	\$0.13	\$0.09	\$0.63	\$0.85	6000	4	6.00
45,359	161	\$375,000,000	\$73,750,000	\$70,000,000	\$362,250,000	\$506,000,000	\$0.19	\$0.18	\$0.95	\$1.33	6000	6	4.00
45,359	322	\$625,000,000	\$122,916,667	\$140,000,000	\$603,750,000	\$866,666,667	\$0.32	\$0.37	\$1.58	\$2.27	6000	10	2.40
45,359	805	\$1,375,000,000	\$270,416,667	\$350,000,000	\$1,328,250,000	\$1,948,666,667	\$0.71	\$0.92	\$3.49	\$5.11	6000	22	1.09
45,359	1,609	\$2,625,000,000	\$516,250,000	\$700,000,000	\$2,535,750,000	\$3,752,000,000	\$1.35	\$1.84	\$6.66	\$9.85	6000	42	0.57

E.1 COMPRESSED GAS DELIVERY BY TRUCK - English Units															
Truck Tube Unit=		\$100,000	per module												
Truck Undercarriage=		\$60,000	per trailer												
Truck Cab=		\$90,000	per cab												
Truck Tube Capacity=		400	lb/truck												
Truck Mileage=		6	mpg												
Truck Average Speed=		50	mph												
Hours/Driver=		12	hr/driver												
Truck Load/Unload Time=		2	hr/trip												
Truck Availability=		24	hr/day												
Driver Wage w/ Benefits=		\$28.75	per hour												
Diesel Price=		\$1.00	per gal												
Operating Days/Year=		350	days/yr												
Trailer/Tank Depreciation=		6	years												
Tractor Depreciation=		4	years												
Production Rate (lb/hr)	Delivery Distance (miles)	Distance (miles/trip)	Annual Production (lb/yr)	Truck Capacity (lb/truck)	Number of Trips (trips/yr)	Total Miles Driven (miles/yr)	Time per Trip (hr/trip)	Total Drive Time (hr/yr)	Total Load/Unload Time (hr/yr)	Total Delivery Time (hr/yr)	Truck Availability (hr/yr)	Trucks Required	Drivers Availability (hr/yr)	Drivers Required	Annual Fuel Use (gal/yr)
10	10	20	84,000	400	210	4,200	1	210	420	630	8,400	1	4,200	1	700
10	20	40	84,000	400	210	8,400	1	210	420	630	8,400	1	4,200	1	1,400
10	50	100	84,000	400	210	21,000	2	420	420	840	8,400	1	4,200	1	3,500
10	100	200	84,000	400	210	42,000	4	840	420	1,260	8,400	1	4,200	1	7,000
10	200	400	84,000	400	210	84,000	8	1,680	420	2,100	8,400	1	4,200	1	14,000
10	500	1,000	84,000	400	210	210,000	20	4,200	420	4,620	8,400	1	4,200	2	35,000
10	1,000	2,000	84,000	400	210	420,000	40	8,400	420	8,820	8,400	2	4,200	3	70,000
100	10	20	840,000	400	2,100	42,000	1	2,100	4,200	6,300	8,400	1	4,200	2	7,000
100	20	40	840,000	400	2,100	84,000	1	2,100	4,200	6,300	8,400	1	4,200	2	14,000
100	50	100	840,000	400	2,100	210,000	2	4,200	4,200	8,400	8,400	1	4,200	2	35,000
100	100	200	840,000	400	2,100	420,000	4	8,400	4,200	12,600	8,400	2	4,200	3	70,000
100	200	400	840,000	400	2,100	840,000	8	16,800	4,200	21,000	8,400	3	4,200	5	140,000
100	500	1,000	840,000	400	2,100	2,100,000	20	42,000	4,200	46,200	8,400	6	4,200	11	350,000
100	1,000	2,000	840,000	400	2,100	4,200,000	40	84,000	4,200	88,200	8,400	11	4,200	21	700,000
1,000	10	20	8,400,000	400	21,000	420,000	1	21,000	42,000	63,000	8,400	8	4,200	15	70,000
1,000	20	40	8,400,000	400	21,000	840,000	1	21,000	42,000	63,000	8,400	8	4,200	15	140,000
1,000	50	100	8,400,000	400	21,000	2,100,000	2	42,000	42,000	84,000	8,400	10	4,200	20	350,000
1,000	100	200	8,400,000	400	21,000	4,200,000	4	84,000	42,000	126,000	8,400	15	4,200	30	700,000
1,000	200	400	8,400,000	400	21,000	8,400,000	8	168,000	42,000	210,000	8,400	25	4,200	50	1,400,000
1,000	500	1,000	8,400,000	400	21,000	21,000,000	20	420,000	42,000	462,000	8,400	55	4,200	110	3,500,000
1,000	1,000	2,000	8,400,000	400	21,000	42,000,000	40	840,000	42,000	882,000	8,400	105	4,200	210	7,000,000
10,000	10	20	84,000,000	400	210,000	4,200,000	1	210,000	420,000	630,000	8,400	75	4,200	150	700,000
10,000	20	40	84,000,000	400	210,000	8,400,000	1	210,000	420,000	630,000	8,400	75	4,200	150	1,400,000
10,000	50	100	84,000,000	400	210,000	21,000,000	2	420,000	420,000	840,000	8,400	100	4,200	200	3,500,000
10,000	100	200	84,000,000	400	210,000	42,000,000	4	840,000	420,000	1,260,000	8,400	150	4,200	300	7,000,000
10,000	200	400	84,000,000	400	210,000	84,000,000	8	1,680,000	420,000	2,100,000	8,400	250	4,200	500	14,000,000
10,000	500	1,000	84,000,000	400	210,000	210,000,000	20	4,200,000	420,000	4,620,000	8,400	550	4,200	1,100	35,000,000
10,000	1,000	2,000	84,000,000	400	210,000	420,000,000	40	8,400,000	420,000	8,820,000	8,400	1,050	4,200	2,100	70,000,000
100,000	10	20	840,000,000	400	2,100,000	42,000,000	1	2,100,000	4,200,000	6,300,000	8,400	750	4,200	1,500	7,000,000
100,000	20	40	840,000,000	400	2,100,000	84,000,000	1	2,100,000	4,200,000	6,300,000	8,400	750	4,200	1,500	14,000,000
100,000	50	100	840,000,000	400	2,100,000	210,000,000	2	4,200,000	4,200,000	8,400,000	8,400	1,000	4,200	2,000	35,000,000
100,000	100	200	840,000,000	400	2,100,000	420,000,000	4	8,400,000	4,200,000	12,600,000	8,400	1,500	4,200	3,000	70,000,000
100,000	200	400	840,000,000	400	2,100,000	840,000,000	8	16,800,000	4,200,000	21,000,000	8,400	2,500	4,200	5,000	140,000,000
100,000	500	1,000	840,000,000	400	2,100,000	2,100,000,000	20	42,000,000	4,200,000	46,200,000	8,400	5,500	4,200	11,000	350,000,000
100,000	1,000	2,000	840,000,000	400	2,100,000	4,200,000,000	40	84,000,000	4,200,000	88,200,000	8,400	10,500	4,200	21,000	700,000,000

E.1 COMPRESSED GAS DELIVERY BY TRUCK - English Units (Continued)													
Production Rate (lb/hr)	Delivery Distance (miles)	Total Capital Cost (\$)	Depreciation (\$/yr)	Annual Fuel Cost (\$/yr)	Annual Labor Cost (\$/yr)	Total Annual Cost (\$/yr)	Capital Cost (\$/lb)	Fuel Cost (\$/lb)	Labor Cost (\$/lb)	Total Cost (\$/lb)	Trip Frequency (trips/day)	Trip Length (hours)	Truck Utilization (Trips/truck/d)
10	10	\$250,000	\$49,167	\$700	\$18,113	\$268,813	\$0.59	\$0.01	\$0.22	\$3.20	0.6	3	0.60
10	20	\$250,000	\$49,167	\$1,400	\$18,113	\$68,679	\$0.59	\$0.02	\$0.22	\$0.82	0.6	3	0.60
10	50	\$250,000	\$49,167	\$3,500	\$24,150	\$76,817	\$0.59	\$0.04	\$0.29	\$0.91	0.6	4	0.60
10	100	\$250,000	\$49,167	\$7,000	\$36,225	\$92,392	\$0.59	\$0.08	\$0.43	\$1.10	0.6	6	0.60
10	200	\$250,000	\$49,167	\$14,000	\$60,375	\$123,542	\$0.59	\$0.17	\$0.72	\$1.47	0.6	10	0.60
10	500	\$250,000	\$49,167	\$35,000	\$132,825	\$216,992	\$0.59	\$0.42	\$1.58	\$2.58	0.6	22	0.60
10	1,000	\$500,000	\$98,333	\$70,000	\$253,575	\$421,908	\$1.17	\$0.83	\$3.02	\$5.02	0.6	42	0.30
100	10	\$250,000	\$49,167	\$7,000	\$181,125	\$237,292	\$0.06	\$0.01	\$0.22	\$0.28	6	3	6.00
100	20	\$250,000	\$49,167	\$14,000	\$181,125	\$244,292	\$0.06	\$0.02	\$0.22	\$0.29	6	3	6.00
100	50	\$250,000	\$49,167	\$35,000	\$241,500	\$325,667	\$0.06	\$0.04	\$0.29	\$0.39	6	4	6.00
100	100	\$500,000	\$98,333	\$70,000	\$362,250	\$530,583	\$0.12	\$0.08	\$0.43	\$0.63	6	6	3.00
100	200	\$750,000	\$147,500	\$140,000	\$603,750	\$891,250	\$0.18	\$0.17	\$0.72	\$1.06	6	10	2.00
100	500	\$1,500,000	\$295,000	\$350,000	\$1,328,250	\$1,973,250	\$0.35	\$0.42	\$1.58	\$2.35	6	22	1.00
100	1,000	\$2,750,000	\$540,833	\$700,000	\$2,535,750	\$3,776,583	\$0.64	\$0.83	\$3.02	\$4.50	6	42	0.55
1,000	10	\$2,000,000	\$393,333	\$70,000	\$1,811,250	\$2,274,583	\$0.05	\$0.01	\$0.22	\$0.27	60	3	7.50
1,000	20	\$2,000,000	\$393,333	\$140,000	\$1,811,250	\$2,344,583	\$0.05	\$0.02	\$0.22	\$0.28	60	3	7.50
1,000	50	\$2,500,000	\$491,667	\$350,000	\$2,415,000	\$3,256,667	\$0.06	\$0.04	\$0.29	\$0.39	60	4	6.00
1,000	100	\$3,750,000	\$737,500	\$700,000	\$3,622,500	\$5,060,000	\$0.09	\$0.08	\$0.43	\$0.60	60	6	4.00
1,000	200	\$6,250,000	\$1,229,167	\$1,400,000	\$6,037,500	\$8,666,667	\$0.15	\$0.17	\$0.72	\$1.03	60	10	2.40
1,000	500	\$13,750,000	\$2,704,167	\$3,500,000	\$13,282,500	\$19,486,667	\$0.32	\$0.42	\$1.58	\$2.32	60	22	1.09
1,000	1,000	\$26,250,000	\$5,162,500	\$7,000,000	\$25,357,500	\$37,520,000	\$0.61	\$0.83	\$3.02	\$4.47	60	42	0.57
10,000	10	\$18,750,000	\$3,687,500	\$700,000	\$18,112,500	\$22,500,000	\$0.04	\$0.01	\$0.22	\$0.27	600	3	8.00
10,000	20	\$18,750,000	\$3,687,500	\$1,400,000	\$18,112,500	\$23,200,000	\$0.04	\$0.02	\$0.22	\$0.28	600	3	8.00
10,000	50	\$25,000,000	\$4,916,667	\$3,500,000	\$24,150,000	\$32,566,667	\$0.06	\$0.04	\$0.29	\$0.39	600	4	6.00
10,000	100	\$37,500,000	\$7,375,000	\$7,000,000	\$36,225,000	\$50,600,000	\$0.09	\$0.08	\$0.43	\$0.60	600	6	4.00
10,000	200	\$62,500,000	\$12,291,667	\$14,000,000	\$60,375,000	\$86,666,667	\$0.15	\$0.17	\$0.72	\$1.03	600	10	2.40
10,000	500	\$137,500,000	\$27,041,667	\$35,000,000	\$132,825,000	\$194,866,667	\$0.32	\$0.42	\$1.58	\$2.32	600	22	1.09
10,000	1,000	\$262,500,000	\$51,625,000	\$70,000,000	\$253,575,000	\$375,200,000	\$0.61	\$0.83	\$3.02	\$4.47	600	42	0.57
100,000	10	\$187,500,000	\$36,875,000	\$7,000,000	\$181,125,000	\$225,000,000	\$0.04	\$0.01	\$0.22	\$0.27	6000	3	8.00
100,000	20	\$187,500,000	\$36,875,000	\$14,000,000	\$181,125,000	\$232,000,000	\$0.04	\$0.02	\$0.22	\$0.28	6000	3	8.00
100,000	50	\$250,000,000	\$49,166,667	\$35,000,000	\$241,500,000	\$325,666,667	\$0.06	\$0.04	\$0.29	\$0.39	6000	4	6.00
100,000	100	\$375,000,000	\$73,750,000	\$70,000,000	\$362,250,000	\$506,000,000	\$0.09	\$0.08	\$0.43	\$0.60	6000	6	4.00
100,000	200	\$625,000,000	\$122,916,667	\$140,000,000	\$603,750,000	\$866,666,667	\$0.15	\$0.17	\$0.72	\$1.03	6000	10	2.40
100,000	500	\$1,375,000,000	\$270,416,667	\$350,000,000	\$1,328,250,000	\$1,948,666,667	\$0.32	\$0.42	\$1.58	\$2.32	6000	22	1.09
100,000	1,000	\$2,625,000,000	\$516,250,000	\$700,000,000	\$2,535,750,000	\$3,752,000,000	\$0.61	\$0.83	\$3.02	\$4.47	6000	42	0.57

E.2 COMPRESSED GAS DELIVERY BY RAIL - SI Units												
Rail Tube Unit=		\$200,000	per module									
Rail Undercarriage=		\$100,000	per rail car									
Rail Tube Capacity=		454	kg/rail car									
Rail Average Speed=		40	km/hr									
Rail Load/Unload Time=		24	hr/trip									
Rail Car Availability=		24	hr/day									
Rail Freight=		\$400	per rail car									
Operating Days/Year=		350	days/yr									
Railcar Depreciation=		15	years									
Hydrogen	Delivery Distance	Distance	Annual	Railcar	Number	Total Miles	Transit	Total Transit	Total Load/	Total Delivery	Railcar	Railcars
Production	One-Way	Two-Way	Production	Capacity	of Trips		Time	Time	Unload Time	Time	Availability	Required
(kg/hr)	(km)	(km/trip)	(kg/yr)	(kg/truck)	(trips/yr)	(km/yr)	(days/trip)	(hr/yr)	(hr/yr)	(hr/yr)	(hr/yr)	
5	16	32	38,102	454	84	2,703	2	4,032	2,016	6,048	8,400	1
5	32	64	38,102	454	84	5,406	2	4,032	2,016	6,048	8,400	1
5	80	161	38,102	454	84	13,516	2	4,032	2,016	6,048	8,400	1
5	161	322	38,102	454	84	27,031	2	4,032	2,016	6,048	8,400	1
5	322	644	38,102	454	84	54,062	2	4,032	2,016	6,048	8,400	1
5	805	1,609	38,102	454	84	135,156	2	4,032	2,016	6,048	8,400	1
5	1,609	3,218	38,102	454	84	270,312	4	8,064	2,016	10,080	8,400	2
45	16	32	381,016	454	840	27,031	2	40,320	20,160	60,480	8,400	8
45	32	64	381,016	454	840	54,062	2	40,320	20,160	60,480	8,400	8
45	80	161	381,016	454	840	135,156	2	40,320	20,160	60,480	8,400	8
45	161	322	381,016	454	840	270,312	2	40,320	20,160	60,480	8,400	8
45	322	644	381,016	454	840	540,624	2	40,320	20,160	60,480	8,400	8
45	805	1,609	381,016	454	840	1,351,560	2	40,320	20,160	60,480	8,400	8
45	1,609	3,218	381,016	454	840	2,703,120	4	80,640	20,160	100,800	8,400	12
454	16	32	3,810,156	454	8,400	270,312	2	403,200	201,600	604,800	8,400	72
454	32	64	3,810,156	454	8,400	540,624	2	403,200	201,600	604,800	8,400	72
454	80	161	3,810,156	454	8,400	1,351,560	2	403,200	201,600	604,800	8,400	72
454	161	322	3,810,156	454	8,400	2,703,120	2	403,200	201,600	604,800	8,400	72
454	322	644	3,810,156	454	8,400	5,406,240	2	403,200	201,600	604,800	8,400	72
454	805	1,609	3,810,156	454	8,400	13,515,600	2	403,200	201,600	604,800	8,400	72
454	1,609	3,218	3,810,156	454	8,400	27,031,200	4	806,400	201,600	1,008,000	8,400	120
4,536	16	32	38,101,560	454	84,000	2,703,120	2	4,032,000	2,016,000	6,048,000	8,400	720
4,536	32	64	38,101,560	454	84,000	5,406,240	2	4,032,000	2,016,000	6,048,000	8,400	720
4,536	80	161	38,101,560	454	84,000	13,515,600	2	4,032,000	2,016,000	6,048,000	8,400	720
4,536	161	322	38,101,560	454	84,000	27,031,200	2	4,032,000	2,016,000	6,048,000	8,400	720
4,536	322	644	38,101,560	454	84,000	54,062,400	2	4,032,000	2,016,000	6,048,000	8,400	720
4,536	805	1,609	38,101,560	454	84,000	135,156,000	2	4,032,000	2,016,000	6,048,000	8,400	720
4,536	1,609	3,218	38,101,560	454	84,000	270,312,000	4	8,064,000	2,016,000	10,080,000	8,400	1,200
45,359	16	32	381,015,600	454	840,000	27,031,200	2	40,320,000	20,160,000	60,480,000	8,400	7,200
45,359	32	64	381,015,600	454	840,000	54,062,400	2	40,320,000	20,160,000	60,480,000	8,400	7,200
45,359	80	161	381,015,600	454	840,000	135,156,000	2	40,320,000	20,160,000	60,480,000	8,400	7,200
45,359	161	322	381,015,600	454	840,000	270,312,000	2	40,320,000	20,160,000	60,480,000	8,400	7,200
45,359	322	644	381,015,600	454	840,000	540,624,000	2	40,320,000	20,160,000	60,480,000	8,400	7,200
45,359	805	1,609	381,015,600	454	840,000	1,351,560,000	2	40,320,000	20,160,000	60,480,000	8,400	7,200
45,359	1,609	3,218	381,015,600	454	840,000	2,703,120,000	4	80,640,000	20,160,000	100,800,000	8,400	12,000

E.2 COMPRESSED GAS DELIVERY BY RAIL - SI Units (Continued)											
Hydrogen Production (kg/hr)	Delivery Distance One-Way (km)	Total Capital Cost (\$)	Depreciation (\$/yr)	Annual Freight Cost (\$/yr)	Total Annual Cost (\$/yr)	Capital Cost (\$/kg)	Freight Cost (\$/kg)	Total Cost (\$/kg)	Trip Frequency (trips/day)	Trip Length (hours)	Railcar Utilization (trips/railcar/d)
5	16	\$300,000	\$20,000	\$67,200	\$87,200	\$0.52	\$1.76	\$2.29	0.24	72	0.24
5	32	\$300,000	\$20,000	\$67,200	\$87,200	\$0.52	\$1.76	\$2.29	0.24	72	0.24
5	80	\$300,000	\$20,000	\$67,200	\$87,200	\$0.52	\$1.76	\$2.29	0.24	72	0.24
5	161	\$300,000	\$20,000	\$67,200	\$87,200	\$0.52	\$1.76	\$2.29	0.24	72	0.24
5	322	\$300,000	\$20,000	\$67,200	\$87,200	\$0.52	\$1.76	\$2.29	0.24	72	0.24
5	805	\$300,000	\$20,000	\$67,200	\$87,200	\$0.52	\$1.76	\$2.29	0.24	72	0.24
5	1,609	\$600,000	\$40,000	\$67,200	\$107,200	\$1.05	\$1.76	\$2.81	0.24	120	0.12
45	16	\$2,400,000	\$160,000	\$672,000	\$832,000	\$0.42	\$1.76	\$2.18	2.4	72	0.30
45	32	\$2,400,000	\$160,000	\$672,000	\$832,000	\$0.42	\$1.76	\$2.18	2.4	72	0.30
45	80	\$2,400,000	\$160,000	\$672,000	\$832,000	\$0.42	\$1.76	\$2.18	2.4	72	0.30
45	161	\$2,400,000	\$160,000	\$672,000	\$832,000	\$0.42	\$1.76	\$2.18	2.4	72	0.30
45	322	\$2,400,000	\$160,000	\$672,000	\$832,000	\$0.42	\$1.76	\$2.18	2.4	72	0.30
45	805	\$2,400,000	\$160,000	\$672,000	\$832,000	\$0.42	\$1.76	\$2.18	2.4	72	0.30
45	1,609	\$3,600,000	\$240,000	\$672,000	\$912,000	\$0.63	\$1.76	\$2.39	2.4	120	0.20
454	16	\$21,600,000	\$1,440,000	\$6,720,000	\$8,160,000	\$0.38	\$1.76	\$2.14	24	72	0.33
454	32	\$21,600,000	\$1,440,000	\$6,720,000	\$8,160,000	\$0.38	\$1.76	\$2.14	24	72	0.33
454	80	\$21,600,000	\$1,440,000	\$6,720,000	\$8,160,000	\$0.38	\$1.76	\$2.14	24	72	0.33
454	161	\$21,600,000	\$1,440,000	\$6,720,000	\$8,160,000	\$0.38	\$1.76	\$2.14	24	72	0.33
454	322	\$21,600,000	\$1,440,000	\$6,720,000	\$8,160,000	\$0.38	\$1.76	\$2.14	24	72	0.33
454	805	\$21,600,000	\$1,440,000	\$6,720,000	\$8,160,000	\$0.38	\$1.76	\$2.14	24	72	0.33
454	1,609	\$36,000,000	\$2,400,000	\$6,720,000	\$9,120,000	\$0.63	\$1.76	\$2.39	24	120	0.20
4,536	16	\$216,000,000	\$14,400,000	\$67,200,000	\$81,600,000	\$0.38	\$1.76	\$2.14	240	72	0.33
4,536	32	\$216,000,000	\$14,400,000	\$67,200,000	\$81,600,000	\$0.38	\$1.76	\$2.14	240	72	0.33
4,536	80	\$216,000,000	\$14,400,000	\$67,200,000	\$81,600,000	\$0.38	\$1.76	\$2.14	240	72	0.33
4,536	161	\$216,000,000	\$14,400,000	\$67,200,000	\$81,600,000	\$0.38	\$1.76	\$2.14	240	72	0.33
4,536	322	\$216,000,000	\$14,400,000	\$67,200,000	\$81,600,000	\$0.38	\$1.76	\$2.14	240	72	0.33
4,536	805	\$216,000,000	\$14,400,000	\$67,200,000	\$81,600,000	\$0.38	\$1.76	\$2.14	240	72	0.33
45,359	1,609	\$360,000,000	\$24,000,000	\$67,200,000	\$91,200,000	\$0.63	\$1.76	\$2.39	240	120	0.20
45,359	16	\$2,160,000,000	\$144,000,000	\$672,000,000	\$816,000,000	\$0.38	\$1.76	\$2.14	2400	72	0.33
45,359	32	\$2,160,000,000	\$144,000,000	\$672,000,000	\$816,000,000	\$0.38	\$1.76	\$2.14	2400	72	0.33
45,359	80	\$2,160,000,000	\$144,000,000	\$672,000,000	\$816,000,000	\$0.38	\$1.76	\$2.14	2400	72	0.33
45,359	161	\$2,160,000,000	\$144,000,000	\$672,000,000	\$816,000,000	\$0.38	\$1.76	\$2.14	2400	72	0.33
45,359	322	\$2,160,000,000	\$144,000,000	\$672,000,000	\$816,000,000	\$0.38	\$1.76	\$2.14	2400	72	0.33
45,359	805	\$2,160,000,000	\$144,000,000	\$672,000,000	\$816,000,000	\$0.38	\$1.76	\$2.14	2400	72	0.33
45,359	1,609	\$3,600,000,000	\$240,000,000	\$672,000,000	\$912,000,000	\$0.63	\$1.76	\$2.39	2400	120	0.20

E.2 COMPRESSED GAS DELIVERY BY RAIL - English Units												
Rail Tube Unit=		\$200,000	per module									
Rail Undercarriage=		\$100,000	per rail car									
Rail Tube Capacity=		1,000	lb/rail car									
Rail Average Speed=		25	mph									
Rail Load/Unload Time=		24	hr/trip									
Rail Car Availability=		24	hr/day									
Rail Freight=		\$400	per rail car									
Operating Days/Year=		350	days/yr									
Railcar Depreciation=		15	years									
Hydrogen	Delivery Distance	Distance	Annual	Railcar	Number	Total Miles	Transit	Total Transit	Total Load/	Total Delivery	Railcar	Railcars
Production	One-Way	Two-Way	Production	Capacity	of Trips		Time	Time	Unload Time	Time	Availability	Required
(lb/hr)	(miles)	(miles/trip)	(lb/yr)	(lb/truck)	(trips/yr)	(miles/yr)	(days/trip)	(hr/yr)	(hr/yr)	(hr/yr)	(hr/yr)	
10	10	20	84,000	1,000	84	1,680	2	4,032	2,016	6,048	8,400	1
10	20	40	84,000	1,000	84	3,360	2	4,032	2,016	6,048	8,400	1
10	50	100	84,000	1,000	84	8,400	2	4,032	2,016	6,048	8,400	1
10	100	200	84,000	1,000	84	16,800	2	4,032	2,016	6,048	8,400	1
10	200	400	84,000	1,000	84	33,600	2	4,032	2,016	6,048	8,400	1
10	500	1,000	84,000	1,000	84	84,000	2	4,032	2,016	6,048	8,400	1
10	1,000	2,000	84,000	1,000	84	168,000	4	8,064	2,016	10,080	8,400	2
100	10	20	840,000	1,000	840	16,800	2	40,320	20,160	60,480	8,400	8
100	20	40	840,000	1,000	840	33,600	2	40,320	20,160	60,480	8,400	8
100	50	100	840,000	1,000	840	84,000	2	40,320	20,160	60,480	8,400	8
100	100	200	840,000	1,000	840	168,000	2	40,320	20,160	60,480	8,400	8
100	200	400	840,000	1,000	840	336,000	2	40,320	20,160	60,480	8,400	8
100	500	1,000	840,000	1,000	840	840,000	2	40,320	20,160	60,480	8,400	8
100	1,000	2,000	840,000	1,000	840	1,680,000	4	80,640	20,160	100,800	8,400	12
1,000	10	20	8,400,000	1,000	8,400	168,000	2	403,200	201,600	604,800	8,400	72
1,000	20	40	8,400,000	1,000	8,400	336,000	2	403,200	201,600	604,800	8,400	72
1,000	50	100	8,400,000	1,000	8,400	840,000	2	403,200	201,600	604,800	8,400	72
1,000	100	200	8,400,000	1,000	8,400	1,680,000	2	403,200	201,600	604,800	8,400	72
1,000	200	400	8,400,000	1,000	8,400	3,360,000	2	403,200	201,600	604,800	8,400	72
1,000	500	1,000	8,400,000	1,000	8,400	8,400,000	2	403,200	201,600	604,800	8,400	72
1,000	1,000	2,000	8,400,000	1,000	8,400	16,800,000	4	806,400	201,600	1,008,000	8,400	120
10,000	10	20	84,000,000	1,000	84,000	1,680,000	2	4,032,000	2,016,000	6,048,000	8,400	720
10,000	20	40	84,000,000	1,000	84,000	3,360,000	2	4,032,000	2,016,000	6,048,000	8,400	720
10,000	50	100	84,000,000	1,000	84,000	8,400,000	2	4,032,000	2,016,000	6,048,000	8,400	720
10,000	100	200	84,000,000	1,000	84,000	16,800,000	2	4,032,000	2,016,000	6,048,000	8,400	720
10,000	200	400	84,000,000	1,000	84,000	33,600,000	2	4,032,000	2,016,000	6,048,000	8,400	720
10,000	500	1,000	84,000,000	1,000	84,000	84,000,000	2	4,032,000	2,016,000	6,048,000	8,400	720
10,000	1,000	2,000	84,000,000	1,000	84,000	168,000,000	4	8,064,000	2,016,000	10,080,000	8,400	1,200
100,000	10	20	840,000,000	1,000	840,000	16,800,000	2	40,320,000	20,160,000	60,480,000	8,400	7,200
100,000	20	40	840,000,000	1,000	840,000	33,600,000	2	40,320,000	20,160,000	60,480,000	8,400	7,200
100,000	50	100	840,000,000	1,000	840,000	84,000,000	2	40,320,000	20,160,000	60,480,000	8,400	7,200
100,000	100	200	840,000,000	1,000	840,000	168,000,000	2	40,320,000	20,160,000	60,480,000	8,400	7,200
100,000	200	400	840,000,000	1,000	840,000	336,000,000	2	40,320,000	20,160,000	60,480,000	8,400	7,200
100,000	500	1,000	840,000,000	1,000	840,000	840,000,000	2	40,320,000	20,160,000	60,480,000	8,400	7,200
100,000	1,000	2,000	840,000,000	1,000	840,000	1,680,000,000	4	80,640,000	20,160,000	100,800,000	8,400	12,000

E.2 COMPRESSED GAS DELIVERY BY RAIL - English Units (Continued)											
Hydrogen Production (lb/hr)	Delivery Distance One-Way (miles)	Total Capital Cost (\$)	Depreciation (\$/yr)	Annual Freight Cost (\$/yr)	Total Annual Cost (\$/yr)	Capital Cost (\$/lb)	Freight Cost (\$/lb)	Total Cost (\$/lb)	Trip Frequency (trips/day)	Trip Length (hours)	Railcar Utilization (trips/railcar/d)
10	10	\$300,000	\$20,000	\$67,200	\$87,200	\$0.24	\$0.80	\$1.04	0.24	72	0.24
10	20	\$300,000	\$20,000	\$67,200	\$87,200	\$0.24	\$0.80	\$1.04	0.24	72	0.24
10	50	\$300,000	\$20,000	\$67,200	\$87,200	\$0.24	\$0.80	\$1.04	0.24	72	0.24
10	100	\$300,000	\$20,000	\$67,200	\$87,200	\$0.24	\$0.80	\$1.04	0.24	72	0.24
10	200	\$300,000	\$20,000	\$67,200	\$87,200	\$0.24	\$0.80	\$1.04	0.24	72	0.24
10	500	\$300,000	\$20,000	\$67,200	\$87,200	\$0.24	\$0.80	\$1.04	0.24	72	0.24
10	1,000	\$600,000	\$40,000	\$67,200	\$107,200	\$0.48	\$0.80	\$1.28	0.24	120	0.12
100	10	\$2,400,000	\$160,000	\$672,000	\$832,000	\$0.19	\$0.80	\$0.99	2.4	72	0.30
100	20	\$2,400,000	\$160,000	\$672,000	\$832,000	\$0.19	\$0.80	\$0.99	2.4	72	0.30
100	50	\$2,400,000	\$160,000	\$672,000	\$832,000	\$0.19	\$0.80	\$0.99	2.4	72	0.30
100	100	\$2,400,000	\$160,000	\$672,000	\$832,000	\$0.19	\$0.80	\$0.99	2.4	72	0.30
100	200	\$2,400,000	\$160,000	\$672,000	\$832,000	\$0.19	\$0.80	\$0.99	2.4	72	0.30
100	500	\$2,400,000	\$160,000	\$672,000	\$832,000	\$0.19	\$0.80	\$0.99	2.4	72	0.30
100	1,000	\$3,600,000	\$240,000	\$672,000	\$912,000	\$0.29	\$0.80	\$1.09	2.4	120	0.20
1,000	10	\$21,600,000	\$1,440,000	\$6,720,000	\$8,160,000	\$0.17	\$0.80	\$0.97	24	72	0.33
1,000	20	\$21,600,000	\$1,440,000	\$6,720,000	\$8,160,000	\$0.17	\$0.80	\$0.97	24	72	0.33
1,000	50	\$21,600,000	\$1,440,000	\$6,720,000	\$8,160,000	\$0.17	\$0.80	\$0.97	24	72	0.33
1,000	100	\$21,600,000	\$1,440,000	\$6,720,000	\$8,160,000	\$0.17	\$0.80	\$0.97	24	72	0.33
1,000	200	\$21,600,000	\$1,440,000	\$6,720,000	\$8,160,000	\$0.17	\$0.80	\$0.97	24	72	0.33
1,000	500	\$21,600,000	\$1,440,000	\$6,720,000	\$8,160,000	\$0.17	\$0.80	\$0.97	24	72	0.33
1,000	1,000	\$36,000,000	\$2,400,000	\$6,720,000	\$9,120,000	\$0.29	\$0.80	\$1.09	24	120	0.20
10,000	10	\$216,000,000	\$14,400,000	\$67,200,000	\$81,600,000	\$0.17	\$0.80	\$0.97	240	72	0.33
10,000	20	\$216,000,000	\$14,400,000	\$67,200,000	\$81,600,000	\$0.17	\$0.80	\$0.97	240	72	0.33
10,000	50	\$216,000,000	\$14,400,000	\$67,200,000	\$81,600,000	\$0.17	\$0.80	\$0.97	240	72	0.33
10,000	100	\$216,000,000	\$14,400,000	\$67,200,000	\$81,600,000	\$0.17	\$0.80	\$0.97	240	72	0.33
10,000	200	\$216,000,000	\$14,400,000	\$67,200,000	\$81,600,000	\$0.17	\$0.80	\$0.97	240	72	0.33
10,000	500	\$216,000,000	\$14,400,000	\$67,200,000	\$81,600,000	\$0.17	\$0.80	\$0.97	240	72	0.33
100,000	1,000	\$360,000,000	\$24,000,000	\$67,200,000	\$91,200,000	\$0.29	\$0.80	\$1.09	240	120	0.20
100,000	10	\$2,160,000,000	\$144,000,000	\$672,000,000	\$816,000,000	\$0.17	\$0.80	\$0.97	2400	72	0.33
100,000	20	\$2,160,000,000	\$144,000,000	\$672,000,000	\$816,000,000	\$0.17	\$0.80	\$0.97	2400	72	0.33
100,000	50	\$2,160,000,000	\$144,000,000	\$672,000,000	\$816,000,000	\$0.17	\$0.80	\$0.97	2400	72	0.33
100,000	100	\$2,160,000,000	\$144,000,000	\$672,000,000	\$816,000,000	\$0.17	\$0.80	\$0.97	2400	72	0.33
100,000	200	\$2,160,000,000	\$144,000,000	\$672,000,000	\$816,000,000	\$0.17	\$0.80	\$0.97	2400	72	0.33
100,000	500	\$2,160,000,000	\$144,000,000	\$672,000,000	\$816,000,000	\$0.17	\$0.80	\$0.97	2400	72	0.33
100,000	1,000	\$3,600,000,000	\$240,000,000	\$672,000,000	\$912,000,000	\$0.29	\$0.80	\$1.09	2400	120	0.20

E.3 LIQUID HYDROGEN DELIVERY BY TRUCK - SI Units																
Truck Liquid Tank=	\$350,000	per module														
Truck Undercarriage=	\$60,000	per trailer														
Truck Cab=	\$90,000	per cab														
Truck Liquid Capacity=	4,082	lb/truck														
Truck Boil-Off Rate=	0.30%	/day														
Truck Mileage=	6	mpg														
Truck Average Speed=	80	km/hr														
Hours/Driver=	12	hr/driver														
Truck Load/Unload Time=	2	hr/trip														
Truck Availability=	24	hr/day														
Driver Wage w/ Benefits=	\$28.75	per hour														
Diesel Price=	\$1.00	per gal														
Operating Days/Year=	350	days/yr														
Trailer/Tank Depreciation=	6	years														
Tractor Depreciation=	4	years														
Production Rate (kg/hr)	Delivery Distance (km)	Distance (km/trip)	Annual Production (kg/yr)	Truck Capacity (kg/truck)	Boil-Off Rate (%/d)	Number of Trips (trips/yr)	Total Miles Driven (km/yr)	Time per Trip (hr/trip)	Quantity after Boil-Off (kg/yr)	Total Drive Time (hr/yr)	Total Load/Unload Time (hr/yr)	Total Delivery Time (hr/yr)	Trucks Required	Driver Availability (hr/yr)	Drivers Required	Annual Fuel Use (gal/yr)
5	16	32	38,102	4,082	0.30%	9	187	1	38,099	9	19	28	1	4,200	1	31
5	32	64	38,102	4,082	0.30%	9	373	1	38,099	9	19	28	1	4,200	1	62
5	80	161	38,102	4,082	0.30%	9	933	2	38,097	19	19	37	1	4,200	1	156
5	161	322	38,102	4,082	0.30%	9	1,867	4	38,092	37	19	56	1	4,200	1	311
5	322	644	38,102	4,082	0.30%	9	3,733	8	38,083	75	19	93	1	4,200	1	622
5	805	1,609	38,102	4,082	0.30%	9	9,333	20	38,054	187	19	205	1	4,200	1	1,556
5	1,609	3,218	38,102	4,082	0.30%	9	18,667	40	38,006	373	19	392	1	4,200	1	3,111
45	16	32	381,016	4,082	0.30%	93	1,867	1	380,992	93	187	280	1	4,200	1	311
45	32	64	381,016	4,082	0.30%	93	3,733	1	380,992	93	187	280	1	4,200	1	622
45	80	161	381,016	4,082	0.30%	93	9,333	2	380,968	187	187	373	1	4,200	1	1,556
45	161	322	381,016	4,082	0.30%	93	18,667	4	380,920	373	187	560	1	4,200	1	3,111
45	322	644	381,016	4,082	0.30%	93	37,333	8	380,825	747	187	933	1	4,200	1	6,222
45	805	1,609	381,016	4,082	0.30%	93	93,333	20	380,540	1,867	187	2,053	1	4,200	1	15,556
45	1,609	3,218	381,016	4,082	0.30%	93	186,667	40	380,064	3,733	187	3,920	1	4,200	1	31,111
454	16	32	3,810,156	4,082	0.30%	933	18,667	1	3,809,918	933	1,867	2,800	1	4,200	1	3,111
454	32	64	3,810,156	4,082	0.30%	933	37,333	1	3,809,918	933	1,867	2,800	1	4,200	1	6,222
454	80	161	3,810,156	4,082	0.30%	933	93,333	2	3,809,680	1,867	1,867	3,733	1	4,200	1	15,556
454	161	322	3,810,156	4,082	0.30%	933	186,667	4	3,809,204	3,733	1,867	5,600	1	4,200	2	31,111
454	322	644	3,810,156	4,082	0.30%	933	373,333	8	3,808,251	7,467	1,867	9,333	2	4,200	3	62,222
454	805	1,609	3,810,156	4,082	0.30%	933	933,333	20	3,805,396	18,667	1,867	20,533	3	4,200	5	155,556
454	1,609	3,218	3,810,156	4,082	0.30%	933	1,866,667	40	3,800,643	37,333	1,867	39,200	5	4,200	10	311,111
4,536	16	32	38,101,560	4,082	0.30%	9,333	186,667	1	38,099,179	9,333	18,667	28,000	4	4,200	7	31,111
4,536	32	64	38,101,560	4,082	0.30%	9,333	373,333	1	38,099,179	9,333	18,667	28,000	4	4,200	7	62,222
4,536	80	161	38,101,560	4,082	0.30%	9,333	933,333	2	38,096,798	18,667	18,667	37,333	5	4,200	9	155,556
4,536	161	322	38,101,560	4,082	0.30%	9,333	1,866,667	4	38,092,036	37,333	18,667	56,000	7	4,200	14	311,111
4,536	322	644	38,101,560	4,082	0.30%	9,333	3,733,333	8	38,082,514	74,667	18,667	93,333	12	4,200	23	622,222
4,536	805	1,609	38,101,560	4,082	0.30%	9,333	9,333,333	20	38,053,963	186,667	18,667	205,333	25	4,200	49	1,555,556
4,536	1,609	3,218	38,101,560	4,082	0.30%	9,333	18,666,667	40	38,006,425	373,333	18,667	392,000	47	4,200	94	3,111,111
45,359	16	32	381,015,600	4,082	0.30%	93,333	1,866,667	1	380,991,787	93,333	186,667	280,000	34	4,200	67	311,111
45,359	32	64	381,015,600	4,082	0.30%	93,333	3,733,333	1	380,991,787	93,333	186,667	280,000	34	4,200	67	622,222
45,359	80	161	381,015,600	4,082	0.30%	93,333	9,333,333	2	380,967,976	186,667	186,667	373,333	45	4,200	89	1,555,556
45,359	161	322	381,015,600	4,082	0.30%	93,333	18,666,667	4	380,920,358	373,333	186,667	560,000	67	4,200	134	3,111,111
45,359	322	644	381,015,600	4,082	0.30%	93,333	37,333,333	8	380,825,140	746,667	186,667	933,333	112	4,200	223	6,222,222
45,359	805	1,609	381,015,600	4,082	0.30%	93,333	93,333,333	20	380,539,628	1,866,667	186,667	2,053,333	245	4,200	489	15,555,556
45,359	1,609	3,218	381,015,600	4,082	0.30%	93,333	186,666,667	40	380,064,251	3,733,333	186,667	3,920,000	467	4,200	934	31,111,111

E.3 LIQUID HYDROGEN DELIVERY BY TRUCK - SI Units (Continued)																								
Production Rate	Delivery Distance (km)	Total Capital Cost (\$)	Depreciation (\$/yr)	Annual Fuel Cost (\$/yr)	Annual Labor Cost (\$/yr)	Total Annual Cost (\$/yr)	Capital Cost (\$/kg)	Fuel Cost (\$/kg)	Labor Cost (\$/kg)	Total Cost (\$/kg)	Trip Frequency (trips/day)	Trip Length (hours)	Truck Utilization (trips/truck/d)											
5	16	\$500,000	\$90,833	\$31	\$805	\$91,669	\$2.38	\$0.00	\$0.02	\$2.41	0.03	3	0.03											
5	32	\$500,000	\$90,833	\$62	\$805	\$91,701	\$2.38	\$0.00	\$0.02	\$2.41	0.03	3	0.03											
5	80	\$500,000	\$90,833	\$156	\$1,073	\$92,062	\$2.38	\$0.00	\$0.03	\$2.42	0.03	4	0.03											
5	161	\$500,000	\$90,833	\$311	\$1,610	\$92,754	\$2.38	\$0.01	\$0.04	\$2.44	0.03	6	0.03											
5	322	\$500,000	\$90,833	\$622	\$2,683	\$94,139	\$2.39	\$0.02	\$0.07	\$2.47	0.03	10	0.03											
5	805	\$500,000	\$90,833	\$1,556	\$5,903	\$98,292	\$2.39	\$0.04	\$0.16	\$2.58	0.03	22	0.03											
5	1,609	\$500,000	\$90,833	\$3,111	\$11,270	\$105,214	\$2.39	\$0.08	\$0.30	\$2.77	0.03	42	0.03											
45	16	\$500,000	\$90,833	\$311	\$8,050	\$99,194	\$0.24	\$0.00	\$0.02	\$0.26	0.27	3	0.27											
45	32	\$500,000	\$90,833	\$622	\$8,050	\$99,506	\$0.24	\$0.00	\$0.02	\$0.26	0.27	3	0.27											
45	80	\$500,000	\$90,833	\$1,556	\$10,733	\$103,122	\$0.24	\$0.00	\$0.03	\$0.27	0.27	4	0.27											
45	161	\$500,000	\$90,833	\$3,111	\$16,100	\$110,044	\$0.24	\$0.01	\$0.04	\$0.29	0.27	6	0.27											
45	322	\$500,000	\$90,833	\$6,222	\$26,833	\$123,889	\$0.24	\$0.02	\$0.07	\$0.33	0.27	10	0.27											
45	805	\$500,000	\$90,833	\$15,556	\$59,033	\$165,422	\$0.24	\$0.04	\$0.16	\$0.43	0.27	22	0.27											
45	1,609	\$500,000	\$90,833	\$31,111	\$112,700	\$234,644	\$0.24	\$0.08	\$0.30	\$0.62	0.27	42	0.27											
454	16	\$500,000	\$90,833	\$3,111	\$80,500	\$174,444	\$0.02	\$0.00	\$0.02	\$0.05	2.67	3	2.67											
454	32	\$500,000	\$90,833	\$6,222	\$80,500	\$177,556	\$0.02	\$0.00	\$0.02	\$0.05	2.67	3	2.67											
454	80	\$500,000	\$90,833	\$15,556	\$107,333	\$213,722	\$0.02	\$0.00	\$0.03	\$0.06	2.67	4	2.67											
454	161	\$500,000	\$90,833	\$31,111	\$161,000	\$282,944	\$0.02	\$0.01	\$0.04	\$0.07	2.67	6	2.67											
454	322	\$1,000,000	\$181,667	\$62,222	\$268,333	\$512,222	\$0.05	\$0.02	\$0.07	\$0.13	2.67	10	1.33											
454	805	\$1,500,000	\$272,500	\$155,556	\$590,333	\$1,018,389	\$0.07	\$0.04	\$0.16	\$0.27	2.67	22	0.89											
454	1,609	\$2,500,000	\$454,167	\$311,111	\$1,127,000	\$1,892,278	\$0.12	\$0.08	\$0.30	\$0.50	2.67	42	0.53											
4,536	16	\$2,000,000	\$363,333	\$31,111	\$805,000	\$1,199,444	\$0.01	\$0.00	\$0.02	\$0.03	26.67	3	6.67											
4,536	32	\$2,000,000	\$363,333	\$62,222	\$805,000	\$1,230,556	\$0.01	\$0.00	\$0.02	\$0.03	26.67	3	6.67											
4,536	80	\$2,500,000	\$454,167	\$155,556	\$1,073,333	\$1,683,056	\$0.01	\$0.00	\$0.03	\$0.04	26.67	4	5.33											
4,536	161	\$3,500,000	\$635,833	\$311,111	\$1,610,000	\$2,556,944	\$0.02	\$0.01	\$0.04	\$0.07	26.67	6	3.81											
4,536	322	\$6,000,000	\$1,090,000	\$622,222	\$2,683,333	\$4,395,556	\$0.03	\$0.02	\$0.07	\$0.12	26.67	10	2.22											
4,536	805	\$12,500,000	\$2,270,833	\$1,555,556	\$5,903,333	\$9,729,722	\$0.06	\$0.04	\$0.16	\$0.26	26.67	22	1.07											
45,359	1,609	\$23,500,000	\$4,269,167	\$3,111,111	\$11,270,000	\$18,650,278	\$0.11	\$0.08	\$0.30	\$0.49	26.67	42	0.57											
45,359	16	\$17,000,000	\$3,088,333	\$311,111	\$8,050,000	\$11,449,444	\$0.01	\$0.00	\$0.02	\$0.03	266.67	3	7.84											
45,359	32	\$17,000,000	\$3,088,333	\$622,222	\$8,050,000	\$11,760,556	\$0.01	\$0.00	\$0.02	\$0.03	266.67	3	7.84											
45,359	80	\$22,500,000	\$4,087,500	\$1,555,556	\$10,733,333	\$16,376,389	\$0.01	\$0.00	\$0.03	\$0.04	266.67	4	5.93											
45,359	161	\$33,500,000	\$6,085,833	\$3,111,111	\$16,100,000	\$25,296,944	\$0.02	\$0.01	\$0.04	\$0.07	266.67	6	3.98											
45,359	322	\$56,000,000	\$10,173,333	\$6,222,222	\$26,833,333	\$43,228,889	\$0.03	\$0.02	\$0.07	\$0.11	266.67	10	2.38											
45,359	805	\$122,500,000	\$22,254,167	\$15,555,556	\$59,033,333	\$96,843,056	\$0.06	\$0.04	\$0.16	\$0.25	266.67	22	1.09											
45,359	1,609	\$233,500,000	\$42,419,167	\$31,111,111	\$112,700,000	\$186,230,278	\$0.11	\$0.08	\$0.30	\$0.49	266.67	42	0.57											

E.3 LIQUID HYDROGEN DELIVERY BY TRUCK - English Units																	
Truck Liquid Tank=	\$350,000	per module															
Truck Undercarriage=	\$60,000	per trailer															
Truck Cab=	\$90,000	per cab															
Truck Liquid Capacity=	9,000	lb/truck															
Truck Boil-Off Rate=	0.30%	/day															
Truck Mileage=	6	mpg															
Truck Average Speed=	50	mph															
Hours/Driver=	12	hr/driver															
Truck Load/Unload Time=	2	hr/trip															
Truck Availability=	24	hr/day															
Driver Wage w/ Benefits=	\$28.75	per hour															
Diesel Price=	\$1.00	per gal															
Operating Days/Year=	350	days/yr															
Trailer/Tank Depreciation=	6	years															
Tractor Depreciation=	4	years															
Production Rate (lb/hr)	Delivery Distance One-Way (miles)	Distance Two-Way (miles/trip)	Annual Production (lb/yr)	Truck Capacity (lb/truck)	Boil-Off Rate (%/d)	Number of Trips (trips/yr)	Total Miles Driven (miles/yr)	Time per Trip (hr/trip)	Quantity after Boil-Off (lb/yr)	Total Drive Time (hr/yr)	Total Load/Unload Time (hr/yr)	Total Delivery Time (hr/yr)	Truck Availability (hr/yr)	Trucks Required	Driver Availability (hr/yr)	Drivers Required	Annual Fuel Use (gal/yr)
10	10	20	84,000	9,000	0.30%	9	187	1	83,995	9	19	28	8,400	1	4,200	1	31
10	20	40	84,000	9,000	0.30%	9	373	1	83,995	9	19	28	8,400	1	4,200	1	62
10	50	100	84,000	9,000	0.30%	9	933	2	83,990	19	19	37	8,400	1	4,200	1	156
10	100	200	84,000	9,000	0.30%	9	1,867	4	83,979	37	19	56	8,400	1	4,200	1	311
10	200	400	84,000	9,000	0.30%	9	3,733	8	83,958	75	19	93	8,400	1	4,200	1	622
10	500	1,000	84,000	9,000	0.30%	9	9,333	20	83,895	187	19	205	8,400	1	4,200	1	1,556
10	1,000	2,000	84,000	9,000	0.30%	9	18,667	40	83,790	373	19	392	8,400	1	4,200	1	3,111
100	10	20	840,000	9,000	0.30%	93	1,867	1	839,948	93	187	280	8,400	1	4,200	1	311
100	20	40	840,000	9,000	0.30%	93	3,733	1	839,948	93	187	280	8,400	1	4,200	1	622
100	50	100	840,000	9,000	0.30%	93	9,333	2	839,895	187	187	373	8,400	1	4,200	1	1,556
100	100	200	840,000	9,000	0.30%	93	18,667	4	839,790	373	187	560	8,400	1	4,200	1	3,111
100	200	400	840,000	9,000	0.30%	93	37,333	8	839,580	747	187	933	8,400	1	4,200	1	6,222
100	500	1,000	840,000	9,000	0.30%	93	93,333	20	838,951	1,867	187	2,053	8,400	1	4,200	1	15,556
100	1,000	2,000	840,000	9,000	0.30%	93	186,667	40	837,903	3,733	187	3,920	8,400	1	4,200	1	31,111
1,000	10	20	8,400,000	9,000	0.30%	933	18,667	1	8,399,475	933	1,867	2,800	8,400	1	4,200	1	3,111
1,000	20	40	8,400,000	9,000	0.30%	933	37,333	1	8,399,475	933	1,867	2,800	8,400	1	4,200	1	6,222
1,000	50	100	8,400,000	9,000	0.30%	933	93,333	2	8,398,950	1,867	1,867	3,733	8,400	1	4,200	1	15,556
1,000	100	200	8,400,000	9,000	0.30%	933	186,667	4	8,397,900	3,733	1,867	5,600	8,400	1	4,200	2	31,111
1,000	200	400	8,400,000	9,000	0.30%	933	373,333	8	8,395,801	7,467	1,867	9,333	8,400	2	4,200	3	62,222
1,000	500	1,000	8,400,000	9,000	0.30%	933	933,333	20	8,389,507	18,667	1,867	20,533	8,400	3	4,200	5	155,556
1,000	1,000	2,000	8,400,000	9,000	0.30%	933	1,866,667	40	8,379,026	37,333	1,867	39,200	8,400	5	4,200	10	311,111
10,000	10	20	84,000,000	9,000	0.30%	9,333	186,667	1	83,994,750	9,333	18,667	28,000	8,400	4	4,200	7	31,111
10,000	20	40	84,000,000	9,000	0.30%	9,333	373,333	1	83,994,750	9,333	18,667	28,000	8,400	4	4,200	7	62,222
10,000	50	100	84,000,000	9,000	0.30%	9,333	933,333	2	83,989,501	18,667	18,667	37,333	8,400	5	4,200	9	155,556
10,000	100	200	84,000,000	9,000	0.30%	9,333	1,866,667	4	83,979,003	37,333	18,667	56,000	8,400	7	4,200	14	311,111
10,000	200	400	84,000,000	9,000	0.30%	9,333	3,733,333	8	83,958,010	74,667	18,667	93,333	8,400	12	4,200	23	622,222
10,000	500	1,000	84,000,000	9,000	0.30%	9,333	9,333,333	20	83,895,066	186,667	18,667	205,333	8,400	25	4,200	49	1,555,556
10,000	1,000	2,000	84,000,000	9,000	0.30%	9,333	18,666,667	40	83,790,262	373,333	18,667	392,000	8,400	47	4,200	94	3,111,111
100,000	10	20	840,000,000	9,000	0.30%	93,333	1,866,667	1	839,947,502	93,333	186,667	280,000	8,400	34	4,200	67	311,111
100,000	20	40	840,000,000	9,000	0.30%	93,333	3,733,333	1	839,947,502	93,333	186,667	280,000	8,400	34	4,200	67	622,222
100,000	50	100	840,000,000	9,000	0.30%	93,333	9,333,333	2	839,895,007	186,667	186,667	373,333	8,400	45	4,200	89	1,555,556
100,000	100	200	840,000,000	9,000	0.30%	93,333	18,666,667	4	839,790,026	373,333	186,667	560,000	8,400	67	4,200	134	3,111,111
100,000	200	400	840,000,000	9,000	0.30%	93,333	37,333,333	8	839,580,105	746,667	186,667	933,333	8,400	112	4,200	223	6,222,222
100,000	500	1,000	840,000,000	9,000	0.30%	93,333	93,333,333	20	838,950,656	1,866,667	186,667	2,053,333	8,400	245	4,200	489	15,555,556
100,000	1,000	2,000	840,000,000	9,000	0.30%	93,333	186,666,667	40	837,902,623	3,733,333	186,667	3,920,000	8,400	467	4,200	934	31,111,111

E.3 LIQUID HYDROGEN DELIVERY BY TRUCK - English Units (Continued)													
Production Rate (lb/hr)	Delivery Distance (miles)	Total Capital Cost (\$)	Depreciation (\$/yr)	Annual Fuel Cost (\$/yr)	Annual Labor Cost (\$/yr)	Total Annual Cost (\$/yr)	Capital Cost (\$/lb)	Fuel Cost (\$/lb)	Labor Cost (\$/lb)	Total Cost (\$/lb)	Trip Frequency (trips/day)	Trip Length (hours)	Truck Utilization (trips/truck/d)
10	10	\$500,000	\$90,833	\$31	\$805	\$91,669	\$1.08	\$0.00	\$0.01	\$1.09	0.03	3	0.03
10	20	\$500,000	\$90,833	\$62	\$805	\$91,701	\$1.08	\$0.00	\$0.01	\$1.09	0.03	3	0.03
10	50	\$500,000	\$90,833	\$156	\$1,073	\$92,062	\$1.08	\$0.00	\$0.01	\$1.10	0.03	4	0.03
10	100	\$500,000	\$90,833	\$311	\$1,610	\$92,754	\$1.08	\$0.00	\$0.02	\$1.10	0.03	6	0.03
10	200	\$500,000	\$90,833	\$622	\$2,683	\$94,139	\$1.08	\$0.01	\$0.03	\$1.12	0.03	10	0.03
10	500	\$500,000	\$90,833	\$1,556	\$5,903	\$98,292	\$1.08	\$0.02	\$0.07	\$1.17	0.03	22	0.03
10	1,000	\$500,000	\$90,833	\$3,111	\$11,270	\$105,214	\$1.08	\$0.04	\$0.13	\$1.26	0.03	42	0.03
100	10	\$500,000	\$90,833	\$311	\$8,050	\$99,194	\$0.11	\$0.00	\$0.01	\$0.12	0.27	3	0.27
100	20	\$500,000	\$90,833	\$622	\$8,050	\$99,506	\$0.11	\$0.00	\$0.01	\$0.12	0.27	3	0.27
100	50	\$500,000	\$90,833	\$1,556	\$10,733	\$103,122	\$0.11	\$0.00	\$0.01	\$0.12	0.27	4	0.27
100	100	\$500,000	\$90,833	\$3,111	\$16,100	\$110,044	\$0.11	\$0.00	\$0.02	\$0.13	0.27	6	0.27
100	200	\$500,000	\$90,833	\$6,222	\$26,833	\$123,889	\$0.11	\$0.01	\$0.03	\$0.15	0.27	10	0.27
100	500	\$500,000	\$90,833	\$15,556	\$59,033	\$165,422	\$0.11	\$0.02	\$0.07	\$0.20	0.27	22	0.27
100	1,000	\$500,000	\$90,833	\$31,111	\$112,700	\$234,644	\$0.11	\$0.04	\$0.13	\$0.28	0.27	42	0.27
1,000	10	\$500,000	\$90,833	\$3,111	\$80,500	\$174,444	\$0.01	\$0.00	\$0.01	\$0.02	2.67	3	2.67
1,000	20	\$500,000	\$90,833	\$6,222	\$80,500	\$177,556	\$0.01	\$0.00	\$0.01	\$0.02	2.67	3	2.67
1,000	50	\$500,000	\$90,833	\$15,556	\$107,333	\$213,722	\$0.01	\$0.00	\$0.01	\$0.03	2.67	4	2.67
1,000	100	\$500,000	\$90,833	\$31,111	\$161,000	\$282,944	\$0.01	\$0.00	\$0.02	\$0.03	2.67	6	2.67
1,000	200	\$1,000,000	\$181,667	\$62,222	\$268,333	\$512,222	\$0.02	\$0.01	\$0.03	\$0.06	2.67	10	1.33
1,000	500	\$1,500,000	\$272,500	\$155,556	\$590,333	\$1,018,389	\$0.03	\$0.02	\$0.07	\$0.12	2.67	22	0.89
1,000	1,000	\$2,500,000	\$454,167	\$311,111	\$1,127,000	\$1,892,278	\$0.05	\$0.04	\$0.13	\$0.23	2.67	42	0.53
10,000	10	\$2,000,000	\$363,333	\$31,111	\$805,000	\$1,199,444	\$0.00	\$0.00	\$0.01	\$0.01	26.67	3	6.67
10,000	20	\$2,000,000	\$363,333	\$62,222	\$805,000	\$1,230,556	\$0.00	\$0.00	\$0.01	\$0.01	26.67	3	6.67
10,000	50	\$2,500,000	\$454,167	\$155,556	\$1,073,333	\$1,683,056	\$0.01	\$0.00	\$0.01	\$0.02	26.67	4	5.33
10,000	100	\$3,500,000	\$635,833	\$311,111	\$1,610,000	\$2,556,944	\$0.01	\$0.00	\$0.02	\$0.03	26.67	6	3.81
10,000	200	\$6,000,000	\$1,090,000	\$622,222	\$2,683,333	\$4,395,556	\$0.01	\$0.01	\$0.03	\$0.05	26.67	10	2.22
10,000	500	\$12,500,000	\$2,270,833	\$1,555,556	\$5,903,333	\$9,729,722	\$0.03	\$0.02	\$0.07	\$0.12	26.67	22	1.07
100,000	1,000	\$23,500,000	\$4,269,167	\$3,111,111	\$11,270,000	\$18,650,278	\$0.05	\$0.04	\$0.13	\$0.22	26.67	42	0.57
100,000	10	\$17,000,000	\$3,088,333	\$311,111	\$8,050,000	\$11,449,444	\$0.00	\$0.00	\$0.01	\$0.01	266.67	3	7.84
100,000	20	\$17,000,000	\$3,088,333	\$622,222	\$8,050,000	\$11,760,556	\$0.00	\$0.00	\$0.01	\$0.01	266.67	3	7.84
100,000	50	\$22,500,000	\$4,087,500	\$1,555,556	\$10,733,333	\$16,376,389	\$0.00	\$0.00	\$0.01	\$0.02	266.67	4	5.93
100,000	100	\$33,500,000	\$6,085,833	\$3,111,111	\$16,100,000	\$25,296,944	\$0.01	\$0.00	\$0.02	\$0.03	266.67	6	3.98
100,000	200	\$56,000,000	\$10,173,333	\$6,222,222	\$26,833,333	\$43,228,889	\$0.01	\$0.01	\$0.03	\$0.05	266.67	10	2.38
100,000	500	\$122,500,000	\$22,254,167	\$15,555,556	\$59,033,333	\$96,843,056	\$0.03	\$0.02	\$0.07	\$0.12	266.67	22	1.09
100,000	1,000	\$233,500,000	\$42,419,167	\$31,111,111	\$112,700,000	\$186,230,278	\$0.05	\$0.04	\$0.13	\$0.22	266.67	42	0.57

E.4 LIQUID HYDROGEN DELIVERY BY RAIL - SI Units														
Rail Liquid Tank=	\$400,000	per tank												
Rail Undercarriage=	\$100,000	per trailer												
Rail Tank Capacity=	9,072	kg/truck												
Rail Boil-Off Rate=	0.30%	per day												
Rail Average Speed=	25	mph												
Rail Load/Unload Time=	24	hr/trip												
Rail Car Availability=	24	hr/day												
Rail Freight=	\$400.00	per rail car												
Operating Days/Year=	350	days/yr												
Railcar Depreciation=	15	years												
Production Rate	Delivery Distance One-Way	Distance Two-Way	Annual Production	Railcar Capacity	Boil-Off Rate	Number of Trips	Total Miles	Transit Time	Quantity after Boil-Off	Total Transit Time	Total Load/Unload Time	Total Delivery Time	Railcar Availability	Railcars Required
(kg/hr)	(km)	(km/trip)	(kg/yr)	(kg/truck)	(%/d)	(trips/yr)	(km/yr)	(d/trip)	(kg/yr)	(hr/yr)	(hr/yr)	(hr/yr)	(hr/yr)	
5	16	32	38,102	9,072	0.30%	4	135	2	37,987	202	101	302	8,400	1
5	32	64	38,102	9,072	0.30%	4	270	2	37,987	202	101	302	8,400	1
5	80	161	38,102	9,072	0.30%	4	676	2	37,987	202	101	302	8,400	1
5	161	322	38,102	9,072	0.30%	4	1,352	2	37,987	202	101	302	8,400	1
5	322	644	38,102	9,072	0.30%	4	2,703	2	37,987	202	101	302	8,400	1
5	805	1,609	38,102	9,072	0.30%	4	6,758	2	37,987	202	101	302	8,400	1
5	1,609	3,218	38,102	9,072	0.30%	4	13,516	4	37,874	403	101	504	8,400	1
45	16	32	381,016	9,072	0.30%	42	1,352	2	379,874	2,016	1,008	3,024	8,400	1
45	32	64	381,016	9,072	0.30%	42	2,703	2	379,874	2,016	1,008	3,024	8,400	1
45	80	161	381,016	9,072	0.30%	42	6,758	2	379,874	2,016	1,008	3,024	8,400	1
45	161	322	381,016	9,072	0.30%	42	13,516	2	379,874	2,016	1,008	3,024	8,400	1
45	322	644	381,016	9,072	0.30%	42	27,031	2	379,874	2,016	1,008	3,024	8,400	1
45	805	1,609	381,016	9,072	0.30%	42	67,578	2	379,874	2,016	1,008	3,024	8,400	1
45	1,609	3,218	381,016	9,072	0.30%	42	135,156	4	378,736	4,032	1,008	5,040	8,400	1
454	16	32	3,810,156	9,072	0.30%	420	13,516	2	3,798,743	20,160	10,080	30,240	8,400	4
454	32	64	3,810,156	9,072	0.30%	420	27,031	2	3,798,743	20,160	10,080	30,240	8,400	4
454	80	161	3,810,156	9,072	0.30%	420	67,578	2	3,798,743	20,160	10,080	30,240	8,400	4
454	161	322	3,810,156	9,072	0.30%	420	135,156	2	3,798,743	20,160	10,080	30,240	8,400	4
454	322	644	3,810,156	9,072	0.30%	420	270,312	2	3,798,743	20,160	10,080	30,240	8,400	4
454	805	1,609	3,810,156	9,072	0.30%	420	675,780	2	3,798,743	20,160	10,080	30,240	8,400	4
454	1,609	3,218	3,810,156	9,072	0.30%	420	1,351,560	4	3,787,364	40,320	10,080	50,400	8,400	6
4,536	16	32	38,101,560	9,072	0.30%	4,200	135,156	2	37,987,427	201,600	100,800	302,400	8,400	36
4,536	32	64	38,101,560	9,072	0.30%	4,200	270,312	2	37,987,427	201,600	100,800	302,400	8,400	36
4,536	80	161	38,101,560	9,072	0.30%	4,200	675,780	2	37,987,427	201,600	100,800	302,400	8,400	36
4,536	161	322	38,101,560	9,072	0.30%	4,200	1,351,560	2	37,987,427	201,600	100,800	302,400	8,400	36
4,536	322	644	38,101,560	9,072	0.30%	4,200	2,703,120	2	37,987,427	201,600	100,800	302,400	8,400	36
4,536	805	1,609	38,101,560	9,072	0.30%	4,200	6,757,800	2	37,987,427	201,600	100,800	302,400	8,400	36
4,536	1,609	3,218	38,101,560	9,072	0.30%	4,200	13,515,600	4	37,873,635	403,200	100,800	504,000	8,400	60
45,359	16	32	381,015,600	9,072	0.30%	42,000	1,351,560	2	379,874,266	2,016,000	1,008,000	3,024,000	8,400	360
45,359	32	64	381,015,600	9,072	0.30%	42,000	2,703,120	2	379,874,266	2,016,000	1,008,000	3,024,000	8,400	360
45,359	80	161	381,015,600	9,072	0.30%	42,000	6,757,800	2	379,874,266	2,016,000	1,008,000	3,024,000	8,400	360
45,359	161	322	381,015,600	9,072	0.30%	42,000	13,515,600	2	379,874,266	2,016,000	1,008,000	3,024,000	8,400	360
45,359	322	644	381,015,600	9,072	0.30%	42,000	27,031,200	2	379,874,266	2,016,000	1,008,000	3,024,000	8,400	360
45,359	805	1,609	381,015,600	9,072	0.30%	42,000	67,578,000	2	379,874,266	2,016,000	1,008,000	3,024,000	8,400	360
45,359	1,609	3,218	381,015,600	9,072	0.30%	42,000	135,156,000	4	378,736,351	4,032,000	1,008,000	5,040,000	8,400	600

E.4 LIQUID HYDROGEN DELIVERY BY RAIL - SI Units (Continued)											
Production Rate (kg/hr)	Delivery Distance (km)	Total Capital Cost (\$)	Depreciation (\$/yr)	Annual Freight Cost (\$/yr)	Total Annual Cost (\$/yr)	Capital Cost (\$/kg)	Freight Cost (\$/kg)	Total Cost (\$/kg)	Trip Frequency (trips/day)	Trip Length (hr)	Railcar Utilization (trips/railcar/d)
5	16	\$500,000	\$33,333	\$3,360	\$36,693	\$0.88	\$0.09	\$0.97	0.012	72	0.01
5	32	\$500,000	\$33,333	\$3,360	\$36,693	\$0.88	\$0.09	\$0.97	0.012	72	0.01
5	80	\$500,000	\$33,333	\$3,360	\$36,693	\$0.88	\$0.09	\$0.97	0.012	72	0.01
5	161	\$500,000	\$33,333	\$3,360	\$36,693	\$0.88	\$0.09	\$0.97	0.012	72	0.01
5	322	\$500,000	\$33,333	\$3,360	\$36,693	\$0.88	\$0.09	\$0.97	0.012	72	0.01
5	805	\$500,000	\$33,333	\$3,360	\$36,693	\$0.88	\$0.09	\$0.97	0.012	72	0.01
5	1,609	\$500,000	\$33,333	\$3,360	\$36,693	\$0.88	\$0.09	\$0.97	0.012	120	0.01
45	16	\$500,000	\$33,333	\$33,600	\$66,933	\$0.09	\$0.09	\$0.18	0.12	72	0.12
45	32	\$500,000	\$33,333	\$33,600	\$66,933	\$0.09	\$0.09	\$0.18	0.12	72	0.12
45	80	\$500,000	\$33,333	\$33,600	\$66,933	\$0.09	\$0.09	\$0.18	0.12	72	0.12
45	161	\$500,000	\$33,333	\$33,600	\$66,933	\$0.09	\$0.09	\$0.18	0.12	72	0.12
45	322	\$500,000	\$33,333	\$33,600	\$66,933	\$0.09	\$0.09	\$0.18	0.12	72	0.12
45	805	\$500,000	\$33,333	\$33,600	\$66,933	\$0.09	\$0.09	\$0.18	0.12	72	0.12
45	1,609	\$500,000	\$33,333	\$33,600	\$66,933	\$0.09	\$0.09	\$0.18	0.12	120	0.12
454	16	\$2,000,000	\$133,333	\$336,000	\$469,333	\$0.04	\$0.09	\$0.12	1.2	72	0.30
454	32	\$2,000,000	\$133,333	\$336,000	\$469,333	\$0.04	\$0.09	\$0.12	1.2	72	0.30
454	80	\$2,000,000	\$133,333	\$336,000	\$469,333	\$0.04	\$0.09	\$0.12	1.2	72	0.30
454	161	\$2,000,000	\$133,333	\$336,000	\$469,333	\$0.04	\$0.09	\$0.12	1.2	72	0.30
454	322	\$2,000,000	\$133,333	\$336,000	\$469,333	\$0.04	\$0.09	\$0.12	1.2	72	0.30
454	805	\$2,000,000	\$133,333	\$336,000	\$469,333	\$0.04	\$0.09	\$0.12	1.2	72	0.30
454	1,609	\$3,000,000	\$200,000	\$336,000	\$536,000	\$0.05	\$0.09	\$0.14	1.2	120	0.20
4,536	16	\$18,000,000	\$1,200,000	\$3,360,000	\$4,560,000	\$0.03	\$0.09	\$0.12	12	72	0.33
4,536	32	\$18,000,000	\$1,200,000	\$3,360,000	\$4,560,000	\$0.03	\$0.09	\$0.12	12	72	0.33
4,536	80	\$18,000,000	\$1,200,000	\$3,360,000	\$4,560,000	\$0.03	\$0.09	\$0.12	12	72	0.33
4,536	161	\$18,000,000	\$1,200,000	\$3,360,000	\$4,560,000	\$0.03	\$0.09	\$0.12	12	72	0.33
4,536	322	\$18,000,000	\$1,200,000	\$3,360,000	\$4,560,000	\$0.03	\$0.09	\$0.12	12	72	0.33
4,536	805	\$18,000,000	\$1,200,000	\$3,360,000	\$4,560,000	\$0.03	\$0.09	\$0.12	12	72	0.33
4,536	1,609	\$30,000,000	\$2,000,000	\$3,360,000	\$5,360,000	\$0.05	\$0.09	\$0.14	12	120	0.20
45,359	16	\$180,000,000	\$12,000,000	\$33,600,000	\$45,600,000	\$0.03	\$0.09	\$0.12	120	72	0.33
45,359	32	\$180,000,000	\$12,000,000	\$33,600,000	\$45,600,000	\$0.03	\$0.09	\$0.12	120	72	0.33
45,359	80	\$180,000,000	\$12,000,000	\$33,600,000	\$45,600,000	\$0.03	\$0.09	\$0.12	120	72	0.33
45,359	161	\$180,000,000	\$12,000,000	\$33,600,000	\$45,600,000	\$0.03	\$0.09	\$0.12	120	72	0.33
45,359	322	\$180,000,000	\$12,000,000	\$33,600,000	\$45,600,000	\$0.03	\$0.09	\$0.12	120	72	0.33
45,359	805	\$180,000,000	\$12,000,000	\$33,600,000	\$45,600,000	\$0.03	\$0.09	\$0.12	120	72	0.33
45,359	1,609	\$300,000,000	\$20,000,000	\$33,600,000	\$53,600,000	\$0.05	\$0.09	\$0.14	120	120	0.20

E.4 LIQUID HYDROGEN DELIVERY BY RAIL - English Units														
Rail Liquid Tank=	\$400,000	per tank												
Rail Undercarriage=	\$100,000	per trailer												
Rail Tank Capacity=	20,000	lb/truck												
Rail Boil-Off Rate=	0.30%	per day												
Rail Average Speed=	25	mph												
Rail Load/Unload Time=	24	hr/trip												
Rail Car Availability=	24	hr/day												
Rail Freight=	\$400.00	per rail car												
Operating Days/Year=	350	days/yr												
Railcar Depreciation=	15	years												
Production Rate (lb/hr)	Delivery Distance (miles)	Distance (miles/trip)	Annual Production (lb/yr)	Railcar Capacity (lb/truck)	Boil-Off Rate (%/d)	Number of Trips (trips/yr)	Total Miles (miles/yr)	Transit Time (d/trip)	Quantity after Boil-Off (lb/yr)	Total Transit Time (hr/yr)	Total Load/Unload Time (hr/yr)	Total Delivery Time (hr/yr)	Railcar Availability (hr/yr)	Railcars Required
10	10	20	84,000	20,000	0.30%	4	84	2	83,748	202	101	302	8,400	1
10	20	40	84,000	20,000	0.30%	4	168	2	83,748	202	101	302	8,400	1
10	50	100	84,000	20,000	0.30%	4	420	2	83,748	202	101	302	8,400	1
10	100	200	84,000	20,000	0.30%	4	840	2	83,748	202	101	302	8,400	1
10	200	400	84,000	20,000	0.30%	4	1,680	2	83,748	202	101	302	8,400	1
10	500	1,000	84,000	20,000	0.30%	4	4,200	2	83,748	202	101	302	8,400	1
10	1,000	2,000	84,000	20,000	0.30%	4	8,400	4	83,498	403	101	504	8,400	1
100	10	20	840,000	20,000	0.30%	42	840	2	837,484	2,016	1,008	3,024	8,400	1
100	20	40	840,000	20,000	0.30%	42	1,680	2	837,484	2,016	1,008	3,024	8,400	1
100	50	100	840,000	20,000	0.30%	42	4,200	2	837,484	2,016	1,008	3,024	8,400	1
100	100	200	840,000	20,000	0.30%	42	8,400	2	837,484	2,016	1,008	3,024	8,400	1
100	200	400	840,000	20,000	0.30%	42	16,800	2	837,484	2,016	1,008	3,024	8,400	1
100	500	1,000	840,000	20,000	0.30%	42	42,000	2	837,484	2,016	1,008	3,024	8,400	1
100	1,000	2,000	840,000	20,000	0.30%	42	84,000	4	834,975	4,032	1,008	5,040	8,400	1
1,000	10	20	8,400,000	20,000	0.30%	420	8,400	2	8,374,838	20,160	10,080	30,240	8,400	4
1,000	20	40	8,400,000	20,000	0.30%	420	16,800	2	8,374,838	20,160	10,080	30,240	8,400	4
1,000	50	100	8,400,000	20,000	0.30%	420	42,000	2	8,374,838	20,160	10,080	30,240	8,400	4
1,000	100	200	8,400,000	20,000	0.30%	420	84,000	2	8,374,838	20,160	10,080	30,240	8,400	4
1,000	200	400	8,400,000	20,000	0.30%	420	168,000	2	8,374,838	20,160	10,080	30,240	8,400	4
1,000	500	1,000	8,400,000	20,000	0.30%	420	420,000	2	8,374,838	20,160	10,080	30,240	8,400	4
1,000	1,000	2,000	8,400,000	20,000	0.30%	420	840,000	4	8,349,751	40,320	10,080	50,400	8,400	6
10,000	10	20	84,000,000	20,000	0.30%	4,200	84,000	2	83,748,378	201,600	100,800	302,400	8,400	36
10,000	20	40	84,000,000	20,000	0.30%	4,200	168,000	2	83,748,378	201,600	100,800	302,400	8,400	36
10,000	50	100	84,000,000	20,000	0.30%	4,200	420,000	2	83,748,378	201,600	100,800	302,400	8,400	36
10,000	100	200	84,000,000	20,000	0.30%	4,200	840,000	2	83,748,378	201,600	100,800	302,400	8,400	36
10,000	200	400	84,000,000	20,000	0.30%	4,200	1,680,000	2	83,748,378	201,600	100,800	302,400	8,400	36
10,000	500	1,000	84,000,000	20,000	0.30%	4,200	4,200,000	2	83,748,378	201,600	100,800	302,400	8,400	36
10,000	1,000	2,000	84,000,000	20,000	0.30%	4,200	8,400,000	4	83,497,509	403,200	100,800	504,000	8,400	60
100,000	10	20	840,000,000	20,000	0.30%	42,000	840,000	2	837,483,776	2,016,000	1,008,000	3,024,000	8,400	360
100,000	20	40	840,000,000	20,000	0.30%	42,000	1,680,000	2	837,483,776	2,016,000	1,008,000	3,024,000	8,400	360
100,000	50	100	840,000,000	20,000	0.30%	42,000	4,200,000	2	837,483,776	2,016,000	1,008,000	3,024,000	8,400	360
100,000	100	200	840,000,000	20,000	0.30%	42,000	8,400,000	2	837,483,776	2,016,000	1,008,000	3,024,000	8,400	360
100,000	200	400	840,000,000	20,000	0.30%	42,000	16,800,000	2	837,483,776	2,016,000	1,008,000	3,024,000	8,400	360
100,000	500	1,000	840,000,000	20,000	0.30%	42,000	42,000,000	2	837,483,776	2,016,000	1,008,000	3,024,000	8,400	360
100,000	1,000	2,000	840,000,000	20,000	0.30%	42,000	84,000,000	4	834,975,090	4,032,000	1,008,000	5,040,000	8,400	600

E.4 LIQUID HYDROGEN DELIVERY BY RAIL - English Units (Continued)											
Production	Delivery Distance	Total Capital	Depreciation	Annual Freight	Total Annual	Capital	Freight	Total	Trip	Trip	Railcar
Rate	One-Way	Cost		Cost	Cost	Cost	Cost	Cost	Frequency	Length	Utilization
(lb/hr)	(miles)	(\$)	(\$/yr)	(\$/yr)	(\$/yr)	(\$/lb)	(\$/lb)	(\$/lb)	(trips/day)	(hr)	(trips/railcar/d)
10	10	\$500,000	\$33,333	\$3,360	\$36,693	\$0.40	\$0.04	\$0.44	0.012	72	0.01
10	20	\$500,000	\$33,333	\$3,360	\$36,693	\$0.40	\$0.04	\$0.44	0.012	72	0.01
10	50	\$500,000	\$33,333	\$3,360	\$36,693	\$0.40	\$0.04	\$0.44	0.012	72	0.01
10	100	\$500,000	\$33,333	\$3,360	\$36,693	\$0.40	\$0.04	\$0.44	0.012	72	0.01
10	200	\$500,000	\$33,333	\$3,360	\$36,693	\$0.40	\$0.04	\$0.44	0.012	72	0.01
10	500	\$500,000	\$33,333	\$3,360	\$36,693	\$0.40	\$0.04	\$0.44	0.012	72	0.01
10	1,000	\$500,000	\$33,333	\$3,360	\$36,693	\$0.40	\$0.04	\$0.44	0.012	120	0.01
100	10	\$500,000	\$33,333	\$33,600	\$66,933	\$0.04	\$0.04	\$0.08	0.12	72	0.12
100	20	\$500,000	\$33,333	\$33,600	\$66,933	\$0.04	\$0.04	\$0.08	0.12	72	0.12
100	50	\$500,000	\$33,333	\$33,600	\$66,933	\$0.04	\$0.04	\$0.08	0.12	72	0.12
100	100	\$500,000	\$33,333	\$33,600	\$66,933	\$0.04	\$0.04	\$0.08	0.12	72	0.12
100	200	\$500,000	\$33,333	\$33,600	\$66,933	\$0.04	\$0.04	\$0.08	0.12	72	0.12
100	500	\$500,000	\$33,333	\$33,600	\$66,933	\$0.04	\$0.04	\$0.08	0.12	72	0.12
100	1,000	\$500,000	\$33,333	\$33,600	\$66,933	\$0.04	\$0.04	\$0.08	0.12	120	0.12
1,000	10	\$2,000,000	\$133,333	\$336,000	\$469,333	\$0.02	\$0.04	\$0.06	1.2	72	0.30
1,000	20	\$2,000,000	\$133,333	\$336,000	\$469,333	\$0.02	\$0.04	\$0.06	1.2	72	0.30
1,000	50	\$2,000,000	\$133,333	\$336,000	\$469,333	\$0.02	\$0.04	\$0.06	1.2	72	0.30
1,000	100	\$2,000,000	\$133,333	\$336,000	\$469,333	\$0.02	\$0.04	\$0.06	1.2	72	0.30
1,000	200	\$2,000,000	\$133,333	\$336,000	\$469,333	\$0.02	\$0.04	\$0.06	1.2	72	0.30
1,000	500	\$2,000,000	\$133,333	\$336,000	\$469,333	\$0.02	\$0.04	\$0.06	1.2	72	0.30
1,000	1,000	\$3,000,000	\$200,000	\$336,000	\$536,000	\$0.02	\$0.04	\$0.06	1.2	120	0.20
10,000	10	\$18,000,000	\$1,200,000	\$3,360,000	\$4,560,000	\$0.01	\$0.04	\$0.05	12	72	0.33
10,000	20	\$18,000,000	\$1,200,000	\$3,360,000	\$4,560,000	\$0.01	\$0.04	\$0.05	12	72	0.33
10,000	50	\$18,000,000	\$1,200,000	\$3,360,000	\$4,560,000	\$0.01	\$0.04	\$0.05	12	72	0.33
10,000	100	\$18,000,000	\$1,200,000	\$3,360,000	\$4,560,000	\$0.01	\$0.04	\$0.05	12	72	0.33
10,000	200	\$18,000,000	\$1,200,000	\$3,360,000	\$4,560,000	\$0.01	\$0.04	\$0.05	12	72	0.33
10,000	500	\$18,000,000	\$1,200,000	\$3,360,000	\$4,560,000	\$0.01	\$0.04	\$0.05	12	72	0.33
10,000	1,000	\$30,000,000	\$2,000,000	\$3,360,000	\$5,360,000	\$0.02	\$0.04	\$0.06	12	120	0.20
100,000	10	\$180,000,000	\$12,000,000	\$33,600,000	\$45,600,000	\$0.01	\$0.04	\$0.05	120	72	0.33
100,000	20	\$180,000,000	\$12,000,000	\$33,600,000	\$45,600,000	\$0.01	\$0.04	\$0.05	120	72	0.33
100,000	50	\$180,000,000	\$12,000,000	\$33,600,000	\$45,600,000	\$0.01	\$0.04	\$0.05	120	72	0.33
100,000	100	\$180,000,000	\$12,000,000	\$33,600,000	\$45,600,000	\$0.01	\$0.04	\$0.05	120	72	0.33
100,000	200	\$180,000,000	\$12,000,000	\$33,600,000	\$45,600,000	\$0.01	\$0.04	\$0.05	120	72	0.33
100,000	500	\$180,000,000	\$12,000,000	\$33,600,000	\$45,600,000	\$0.01	\$0.04	\$0.05	120	72	0.33
100,000	1,000	\$300,000,000	\$20,000,000	\$33,600,000	\$53,600,000	\$0.02	\$0.04	\$0.06	120	120	0.20

E.5 LIQUID HYDROGEN DELIVERY BY SHIP - SI Units														
Ship Liquid Tank=	\$350,000	per container												
Ship Liquid Capacity=	4,082	kg/tank												
Ship Boil-Off Rate=	0.30%	per day												
Ship Average Speed=	16	km/hr												
Ship Load/Unload Time=	48	hr/trip												
Ship Tank Availability=	24	hr/day												
Shipping Charge=	\$3,000	per container												
Operating Days/Year=	350	days/yr												
Trailer/Tank Depreciation=	6	years												
Production Rate (kg/hr)	Delivery Distance (km)	Distance (km/trip)	Annual Production (kg/yr)	Tank Capacity (kg/tank)	Boil-Off Rate (%/d)	Number of Trips (trips/yr)	Total Miles (km/yr)	Time per Trip (days/trip)	Quantity after Boil-Off (kg/yr)	Total Transit Time (hr/yr)	Total Load/Unload Time (hr/yr)	Total Delivery Time (hr/yr)	Tank Availability (hr/yr)	Tanks Required
5	16	32	38,102	4,082	0.30%	9	300	2	37,987	448	448	896	8,400	1
5	32	64	38,102	4,082	0.30%	9	601	2	37,987	448	448	896	8,400	1
5	80	161	38,102	4,082	0.30%	9	1,502	2	37,987	448	448	896	8,400	1
5	161	322	38,102	4,082	0.30%	9	3,003	2	37,987	448	448	896	8,400	1
5	322	644	38,102	4,082	0.30%	9	6,007	2	37,987	448	448	896	8,400	1
5	805	1,609	38,102	4,082	0.30%	9	15,017	6	37,760	1,344	448	1,792	8,400	1
5	1,609	3,218	38,102	4,082	0.30%	9	30,035	10	37,534	2,240	448	2,688	8,400	1
45	16	32	381,016	4,082	0.30%	93	3,003	2	379,874	4,480	4,480	8,960	8,400	2
45	32	64	381,016	4,082	0.30%	93	6,007	2	379,874	4,480	4,480	8,960	8,400	2
45	80	161	381,016	4,082	0.30%	93	15,017	2	379,874	4,480	4,480	8,960	8,400	2
45	161	322	381,016	4,082	0.30%	93	30,035	2	379,874	4,480	4,480	8,960	8,400	2
45	322	644	381,016	4,082	0.30%	93	60,069	2	379,874	4,480	4,480	8,960	8,400	2
45	805	1,609	381,016	4,082	0.30%	93	150,173	6	377,602	13,440	4,480	17,920	8,400	3
45	1,609	3,218	381,016	4,082	0.30%	93	300,347	10	375,343	22,400	4,480	26,880	8,400	4
454	16	32	3,810,156	4,082	0.30%	933	30,035	2	3,798,743	44,800	44,800	89,600	8,400	11
454	32	64	3,810,156	4,082	0.30%	933	60,069	2	3,798,743	44,800	44,800	89,600	8,400	11
454	80	161	3,810,156	4,082	0.30%	933	150,173	2	3,798,743	44,800	44,800	89,600	8,400	11
454	161	322	3,810,156	4,082	0.30%	933	300,347	2	3,798,743	44,800	44,800	89,600	8,400	11
454	322	644	3,810,156	4,082	0.30%	933	600,693	2	3,798,743	44,800	44,800	89,600	8,400	11
454	805	1,609	3,810,156	4,082	0.30%	933	1,501,733	6	3,776,018	134,400	44,800	179,200	8,400	22
454	1,609	3,218	3,810,156	4,082	0.30%	933	3,003,467	10	3,753,430	224,000	44,800	268,800	8,400	32
4,536	16	32	38,101,560	4,082	0.30%	9,333	300,347	2	37,987,427	448,000	448,000	896,000	8,400	107
4,536	32	64	38,101,560	4,082	0.30%	9,333	600,693	2	37,987,427	448,000	448,000	896,000	8,400	107
4,536	80	161	38,101,560	4,082	0.30%	9,333	1,501,733	2	37,987,427	448,000	448,000	896,000	8,400	107
4,536	161	322	38,101,560	4,082	0.30%	9,333	3,003,467	2	37,987,427	448,000	448,000	896,000	8,400	107
4,536	322	644	38,101,560	4,082	0.30%	9,333	6,006,933	2	37,987,427	448,000	448,000	896,000	8,400	107
4,536	805	1,609	38,101,560	4,082	0.30%	9,333	15,017,333	6	37,760,184	1,344,000	448,000	1,792,000	8,400	214
4,536	1,609	3,218	38,101,560	4,082	0.30%	9,333	30,034,667	10	37,534,302	2,240,000	448,000	2,688,000	8,400	320
45,359	16	32	381,015,600	4,082	0.30%	93,333	3,003,467	2	379,874,266	4,480,000	4,480,000	8,960,000	8,400	1,067
45,359	32	64	381,015,600	4,082	0.30%	93,333	6,006,933	2	379,874,266	4,480,000	4,480,000	8,960,000	8,400	1,067
45,359	80	161	381,015,600	4,082	0.30%	93,333	15,017,333	2	379,874,266	4,480,000	4,480,000	8,960,000	8,400	1,067
45,359	161	322	381,015,600	4,082	0.30%	93,333	30,034,667	2	379,874,266	4,480,000	4,480,000	8,960,000	8,400	1,067
45,359	322	644	381,015,600	4,082	0.30%	93,333	60,069,333	2	379,874,266	4,480,000	4,480,000	8,960,000	8,400	1,067
45,359	805	1,609	381,015,600	4,082	0.30%	93,333	150,173,333	6	377,601,845	13,440,000	4,480,000	17,920,000	8,400	2,134
45,359	1,609	3,218	381,015,600	4,082	0.30%	93,333	300,346,667	10	375,343,017	22,400,000	4,480,000	26,880,000	8,400	3,200

E.5 LIQUID HYDROGEN DELIVERY BY SHIP - SI Units (Continued)											
Production Rate (kg/hr)	Delivery Distance (km)	Total Capital Cost (\$)	Depreciation (\$/yr)	Annual Freight Cost (\$/yr)	Total Annual Cost (\$/yr)	Capital Cost (\$/kg)	Freight Cost (\$/kg)	Total Cost (\$/kg)	Trip Frequency (trips/day)	Trip Length (hours)	Tank Utilization (trips/tank/d)
5	16	\$350,000	\$58,333	\$56,000	\$114,333	\$1.54	\$1.47	\$3.01	0.03	96	0.03
5	32	\$350,000	\$58,333	\$56,000	\$114,333	\$1.54	\$1.47	\$3.01	0.03	96	0.03
5	80	\$350,000	\$58,333	\$56,000	\$114,333	\$1.54	\$1.47	\$3.01	0.03	96	0.03
5	161	\$350,000	\$58,333	\$56,000	\$114,333	\$1.54	\$1.47	\$3.01	0.03	96	0.03
5	322	\$350,000	\$58,333	\$56,000	\$114,333	\$1.54	\$1.47	\$3.01	0.03	96	0.03
5	805	\$350,000	\$58,333	\$56,000	\$114,333	\$1.54	\$1.48	\$3.03	0.03	192	0.03
5	1,609	\$350,000	\$58,333	\$56,000	\$114,333	\$1.55	\$1.49	\$3.05	0.03	288	0.03
45	16	\$700,000	\$116,667	\$560,000	\$676,667	\$0.31	\$1.47	\$1.78	0.27	96	0.13
45	32	\$700,000	\$116,667	\$560,000	\$676,667	\$0.31	\$1.47	\$1.78	0.27	96	0.13
45	80	\$700,000	\$116,667	\$560,000	\$676,667	\$0.31	\$1.47	\$1.78	0.27	96	0.13
45	161	\$700,000	\$116,667	\$560,000	\$676,667	\$0.31	\$1.47	\$1.78	0.27	96	0.13
45	322	\$700,000	\$116,667	\$560,000	\$676,667	\$0.31	\$1.47	\$1.78	0.27	96	0.13
45	805	\$1,050,000	\$175,000	\$560,000	\$735,000	\$0.46	\$1.48	\$1.95	0.27	192	0.09
45	1,609	\$1,400,000	\$233,333	\$560,000	\$793,333	\$0.62	\$1.49	\$2.11	0.27	288	0.07
454	16	\$3,850,000	\$641,667	\$5,600,000	\$6,241,667	\$0.17	\$1.47	\$1.64	2.67	96	0.24
454	32	\$3,850,000	\$641,667	\$5,600,000	\$6,241,667	\$0.17	\$1.47	\$1.64	2.67	96	0.24
454	80	\$3,850,000	\$641,667	\$5,600,000	\$6,241,667	\$0.17	\$1.47	\$1.64	2.67	96	0.24
454	161	\$3,850,000	\$641,667	\$5,600,000	\$6,241,667	\$0.17	\$1.47	\$1.64	2.67	96	0.24
454	322	\$3,850,000	\$641,667	\$5,600,000	\$6,241,667	\$0.17	\$1.47	\$1.64	2.67	96	0.24
454	805	\$7,700,000	\$1,283,333	\$5,600,000	\$6,883,333	\$0.34	\$1.48	\$1.82	2.67	192	0.12
454	1,609	\$11,200,000	\$1,866,667	\$5,600,000	\$7,466,667	\$0.50	\$1.49	\$1.99	2.67	288	0.08
4,536	16	\$37,450,000	\$6,241,667	\$56,000,000	\$62,241,667	\$0.16	\$1.47	\$1.64	26.67	96	0.25
4,536	32	\$37,450,000	\$6,241,667	\$56,000,000	\$62,241,667	\$0.16	\$1.47	\$1.64	26.67	96	0.25
4,536	80	\$37,450,000	\$6,241,667	\$56,000,000	\$62,241,667	\$0.16	\$1.47	\$1.64	26.67	96	0.25
4,536	161	\$37,450,000	\$6,241,667	\$56,000,000	\$62,241,667	\$0.16	\$1.47	\$1.64	26.67	96	0.25
4,536	322	\$37,450,000	\$6,241,667	\$56,000,000	\$62,241,667	\$0.16	\$1.47	\$1.64	26.67	96	0.25
4,536	805	\$74,900,000	\$12,483,333	\$56,000,000	\$68,483,333	\$0.33	\$1.48	\$1.81	26.67	192	0.12
45,359	1,609	\$112,000,000	\$18,666,667	\$56,000,000	\$74,666,667	\$0.50	\$1.49	\$1.99	26.67	288	0.08
45,359	16	\$373,450,000	\$62,241,667	\$560,000,000	\$622,241,667	\$0.16	\$1.47	\$1.64	266.67	96	0.25
45,359	32	\$373,450,000	\$62,241,667	\$560,000,000	\$622,241,667	\$0.16	\$1.47	\$1.64	266.67	96	0.25
45,359	80	\$373,450,000	\$62,241,667	\$560,000,000	\$622,241,667	\$0.16	\$1.47	\$1.64	266.67	96	0.25
45,359	161	\$373,450,000	\$62,241,667	\$560,000,000	\$622,241,667	\$0.16	\$1.47	\$1.64	266.67	96	0.25
45,359	322	\$373,450,000	\$62,241,667	\$560,000,000	\$622,241,667	\$0.16	\$1.47	\$1.64	266.67	96	0.25
45,359	805	\$746,900,000	\$124,483,333	\$560,000,000	\$684,483,333	\$0.33	\$1.48	\$1.81	266.67	192	0.12
45,359	1,609	\$1,120,000,000	\$186,666,667	\$560,000,000	\$746,666,667	\$0.50	\$1.49	\$1.99	266.67	288	0.08

E.5 LIQUID HYDROGEN DELIVERY BY SHIP - English Units														
Ship Liquid Tank=	\$350,000	per container												
Ship Liquid Capacity=	9,000	lb/tank												
Ship Boil-Off Rate=	0.30%	per day												
Ship Average Speed=	10	mph												
Ship Load/Unload Time=	48	hr/trip												
Ship Tank Availability=	24	hr/day												
Shipping Charge=	\$3,000	per container												
Operating Days/Year=	350	days/yr												
Trailer/Tank Depreciation=	6	years												
Production Rate (lb/hr)	Delivery Distance (miles)	Distance (miles/trip)	Annual Production (lb/yr)	Tank Capacity (lb/tank)	Boil-Off Rate (%/d)	Number of Trips (trips/yr)	Total Miles (miles/yr)	Time per Trip (days/trip)	Quantity after Boil-Off (lb/yr)	Total Transit Time (hr/yr)	Total Load/Unload Time (hr/yr)	Total Delivery Time (hr/yr)	Tank Availability (hr/yr)	Tanks Required
10	10	20	84,000	9,000	0.30%	9	187	2	83,748	448	448	896	8,400	1
10	20	40	84,000	9,000	0.30%	9	373	2	83,748	448	448	896	8,400	1
10	50	100	84,000	9,000	0.30%	9	933	2	83,748	448	448	896	8,400	1
10	100	200	84,000	9,000	0.30%	9	1,867	2	83,748	448	448	896	8,400	1
10	200	400	84,000	9,000	0.30%	9	3,733	2	83,748	448	448	896	8,400	1
10	500	1,000	84,000	9,000	0.30%	9	9,333	6	83,247	1,344	448	1,792	8,400	1
10	1,000	2,000	84,000	9,000	0.30%	9	18,667	10	82,749	2,240	448	2,688	8,400	1
100	10	20	840,000	9,000	0.30%	93	1,867	2	837,484	4,480	4,480	8,960	8,400	2
100	20	40	840,000	9,000	0.30%	93	3,733	2	837,484	4,480	4,480	8,960	8,400	2
100	50	100	840,000	9,000	0.30%	93	9,333	2	837,484	4,480	4,480	8,960	8,400	2
100	100	200	840,000	9,000	0.30%	93	18,667	2	837,484	4,480	4,480	8,960	8,400	2
100	200	400	840,000	9,000	0.30%	93	37,333	2	837,484	4,480	4,480	8,960	8,400	2
100	500	1,000	840,000	9,000	0.30%	93	93,333	6	832,474	13,440	4,480	17,920	8,400	3
100	1,000	2,000	840,000	9,000	0.30%	93	186,667	10	827,494	22,400	4,480	26,880	8,400	4
1,000	10	20	8,400,000	9,000	0.30%	933	18,667	2	8,374,838	44,800	44,800	89,600	8,400	11
1,000	20	40	8,400,000	9,000	0.30%	933	37,333	2	8,374,838	44,800	44,800	89,600	8,400	11
1,000	50	100	8,400,000	9,000	0.30%	933	93,333	2	8,374,838	44,800	44,800	89,600	8,400	11
1,000	100	200	8,400,000	9,000	0.30%	933	186,667	2	8,374,838	44,800	44,800	89,600	8,400	11
1,000	200	400	8,400,000	9,000	0.30%	933	373,333	2	8,374,838	44,800	44,800	89,600	8,400	11
1,000	500	1,000	8,400,000	9,000	0.30%	933	933,333	6	8,324,739	134,400	44,800	179,200	8,400	22
1,000	1,000	2,000	8,400,000	9,000	0.30%	933	1,866,667	10	8,274,940	224,000	44,800	268,800	8,400	32
10,000	10	20	84,000,000	9,000	0.30%	9,333	186,667	2	83,748,378	448,000	448,000	896,000	8,400	107
10,000	20	40	84,000,000	9,000	0.30%	9,333	373,333	2	83,748,378	448,000	448,000	896,000	8,400	107
10,000	50	100	84,000,000	9,000	0.30%	9,333	933,333	2	83,748,378	448,000	448,000	896,000	8,400	107
10,000	100	200	84,000,000	9,000	0.30%	9,333	1,866,667	2	83,748,378	448,000	448,000	896,000	8,400	107
10,000	200	400	84,000,000	9,000	0.30%	9,333	3,733,333	2	83,748,378	448,000	448,000	896,000	8,400	107
10,000	500	1,000	84,000,000	9,000	0.30%	9,333	9,333,333	6	83,247,392	1,344,000	448,000	1,792,000	8,400	214
10,000	1,000	2,000	84,000,000	9,000	0.30%	9,333	18,666,667	10	82,749,403	2,240,000	448,000	2,688,000	8,400	320
100,000	10	20	840,000,000	9,000	0.30%	93,333	1,866,667	2	837,483,776	4,480,000	4,480,000	8,960,000	8,400	1,067
100,000	20	40	840,000,000	9,000	0.30%	93,333	3,733,333	2	837,483,776	4,480,000	4,480,000	8,960,000	8,400	1,067
100,000	50	100	840,000,000	9,000	0.30%	93,333	9,333,333	2	837,483,776	4,480,000	4,480,000	8,960,000	8,400	1,067
100,000	100	200	840,000,000	9,000	0.30%	93,333	18,666,667	2	837,483,776	4,480,000	4,480,000	8,960,000	8,400	1,067
100,000	200	400	840,000,000	9,000	0.30%	93,333	37,333,333	2	837,483,776	4,480,000	4,480,000	8,960,000	8,400	1,067
100,000	500	1,000	840,000,000	9,000	0.30%	93,333	93,333,333	6	832,473,919	13,440,000	4,480,000	17,920,000	8,400	2,134
100,000	1,000	2,000	840,000,000	9,000	0.30%	93,333	186,666,667	10	827,494,029	22,400,000	4,480,000	26,880,000	8,400	3,200

E.5 LIQUID HYDROGEN DELIVERY BY SHIP - English Units (Continued)											
Production Rate	Delivery Distance	Total Capital	Depreciation	Annual Freight	Total Annual	Capital	Freight	Total	Trip	Trip	Tank
(lb/hr)	(miles)	Cost	(\$/yr)	Cost	Cost	Cost	Cost	Cost	Frequency	Length	Utilization
		(\$)		(\$/yr)	(\$/yr)	(\$/lb)	(\$/lb)	(\$/lb)	(trips/day)	(hours)	(trips/tank/d)
10	10	\$350,000	\$58,333	\$56,000	\$114,333	\$0.70	\$0.67	\$1.37	0.03	96	0.03
10	20	\$350,000	\$58,333	\$56,000	\$114,333	\$0.70	\$0.67	\$1.37	0.03	96	0.03
10	50	\$350,000	\$58,333	\$56,000	\$114,333	\$0.70	\$0.67	\$1.37	0.03	96	0.03
10	100	\$350,000	\$58,333	\$56,000	\$114,333	\$0.70	\$0.67	\$1.37	0.03	96	0.03
10	200	\$350,000	\$58,333	\$56,000	\$114,333	\$0.70	\$0.67	\$1.37	0.03	96	0.03
10	500	\$350,000	\$58,333	\$56,000	\$114,333	\$0.70	\$0.67	\$1.37	0.03	192	0.03
10	1,000	\$350,000	\$58,333	\$56,000	\$114,333	\$0.70	\$0.68	\$1.38	0.03	288	0.03
100	10	\$700,000	\$116,667	\$560,000	\$676,667	\$0.14	\$0.67	\$0.81	0.27	96	0.13
100	20	\$700,000	\$116,667	\$560,000	\$676,667	\$0.14	\$0.67	\$0.81	0.27	96	0.13
100	50	\$700,000	\$116,667	\$560,000	\$676,667	\$0.14	\$0.67	\$0.81	0.27	96	0.13
100	100	\$700,000	\$116,667	\$560,000	\$676,667	\$0.14	\$0.67	\$0.81	0.27	96	0.13
100	200	\$700,000	\$116,667	\$560,000	\$676,667	\$0.14	\$0.67	\$0.81	0.27	96	0.13
100	500	\$1,050,000	\$175,000	\$560,000	\$735,000	\$0.21	\$0.67	\$0.88	0.27	192	0.09
100	1,000	\$1,400,000	\$233,333	\$560,000	\$793,333	\$0.28	\$0.68	\$0.96	0.27	288	0.07
1,000	10	\$3,850,000	\$641,667	\$5,600,000	\$6,241,667	\$0.08	\$0.67	\$0.75	2.67	96	0.24
1,000	20	\$3,850,000	\$641,667	\$5,600,000	\$6,241,667	\$0.08	\$0.67	\$0.75	2.67	96	0.24
1,000	50	\$3,850,000	\$641,667	\$5,600,000	\$6,241,667	\$0.08	\$0.67	\$0.75	2.67	96	0.24
1,000	100	\$3,850,000	\$641,667	\$5,600,000	\$6,241,667	\$0.08	\$0.67	\$0.75	2.67	96	0.24
1,000	200	\$3,850,000	\$641,667	\$5,600,000	\$6,241,667	\$0.08	\$0.67	\$0.75	2.67	96	0.24
1,000	500	\$7,700,000	\$1,283,333	\$5,600,000	\$6,883,333	\$0.15	\$0.67	\$0.83	2.67	192	0.12
1,000	1,000	\$11,200,000	\$1,866,667	\$5,600,000	\$7,466,667	\$0.23	\$0.68	\$0.90	2.67	288	0.08
10,000	10	\$37,450,000	\$6,241,667	\$56,000,000	\$62,241,667	\$0.07	\$0.67	\$0.74	26.67	96	0.25
10,000	20	\$37,450,000	\$6,241,667	\$56,000,000	\$62,241,667	\$0.07	\$0.67	\$0.74	26.67	96	0.25
10,000	50	\$37,450,000	\$6,241,667	\$56,000,000	\$62,241,667	\$0.07	\$0.67	\$0.74	26.67	96	0.25
10,000	100	\$37,450,000	\$6,241,667	\$56,000,000	\$62,241,667	\$0.07	\$0.67	\$0.74	26.67	96	0.25
10,000	200	\$37,450,000	\$6,241,667	\$56,000,000	\$62,241,667	\$0.07	\$0.67	\$0.74	26.67	96	0.25
10,000	500	\$74,900,000	\$12,483,333	\$56,000,000	\$68,483,333	\$0.15	\$0.67	\$0.82	26.67	192	0.12
100,000	1,000	\$112,000,000	\$18,666,667	\$56,000,000	\$74,666,667	\$0.23	\$0.68	\$0.90	26.67	288	0.08
100,000	10	\$373,450,000	\$62,241,667	\$560,000,000	\$622,241,667	\$0.07	\$0.67	\$0.74	266.67	96	0.25
100,000	20	\$373,450,000	\$62,241,667	\$560,000,000	\$622,241,667	\$0.07	\$0.67	\$0.74	266.67	96	0.25
100,000	50	\$373,450,000	\$62,241,667	\$560,000,000	\$622,241,667	\$0.07	\$0.67	\$0.74	266.67	96	0.25
100,000	100	\$373,450,000	\$62,241,667	\$560,000,000	\$622,241,667	\$0.07	\$0.67	\$0.74	266.67	96	0.25
100,000	200	\$373,450,000	\$62,241,667	\$560,000,000	\$622,241,667	\$0.07	\$0.67	\$0.74	266.67	96	0.25
100,000	500	\$746,900,000	\$124,483,333	\$560,000,000	\$684,483,333	\$0.15	\$0.67	\$0.82	266.67	192	0.12
100,000	1,000	\$1,120,000,000	\$186,666,667	\$560,000,000	\$746,666,667	\$0.23	\$0.68	\$0.90	266.67	288	0.08

E.6 METAL HYDRIDE TRANSPORT BY TRUCK - SI Units															
Truck Hydride Container=	\$2,205	per kg hydrogen													
Truck Undercarriage=	\$60,000	per trailer													
Truck Cab=	\$90,000	per cab													
Truck Hydride Capacity=	454	kg/truck													
Truck Mileage=	6	mpg													
Truck Average Speed=	80	km/hr													
Hours/Driver=	12	hr/driver													
Truck Load/Unload Time=	2	hr/trip													
Truck Availability=	24	hr/day													
Driver Wage w/ Benefits=	\$28.75	per hour													
Diesel Price=	\$1.00	per gal													
Operating Days/Year=	350	days/yr													
Trailer/Tank Depreciation=	6	years													
Tractor Depreciation=	4	years													
Production Rate (kg/hr)	Delivery Distance One-Way (km)	Delivery Distance Two-Way (km/trip)	Annual Production (kg/yr)	Truck Capacity (kg/truck)	Number of Trips (trips/yr)	Total Miles Driven (km/yr)	Time per Trip (hr/trip)	Total Drive Time (hr/yr)	Total Load/Unload Time (hr/yr)	Total Delivery Time (hr/yr)	Truck Availability (hr/yr)	Trucks Required	Driver Availability (hr/yr)	Drivers Required	Annual Fuel Use (gal/yr)
5	16	32	38,102	454	84	2,703	1	84	168	252	8,400	1	4,200	1	280
5	32	64	38,102	454	84	5,406	1	84	168	252	8,400	1	4,200	1	560
5	80	161	38,102	454	84	13,516	2	168	168	336	8,400	1	4,200	1	1,400
5	161	322	38,102	454	84	27,031	4	336	168	504	8,400	1	4,200	1	2,800
5	322	644	38,102	454	84	54,062	8	672	168	840	8,400	1	4,200	1	5,600
5	805	1,609	38,102	454	84	135,156	20	1,680	168	1,848	8,400	1	4,200	1	14,000
5	1,609	3,218	38,102	454	84	270,312	40	3,360	168	3,528	8,400	1	4,200	1	28,000
45	16	32	381,016	454	840	27,031	1	840	1,680	2,520	8,400	1	4,200	1	2,800
45	32	64	381,016	454	840	54,062	1	840	1,680	2,520	8,400	1	4,200	1	5,600
45	80	161	381,016	454	840	135,156	2	1,680	1,680	3,360	8,400	1	4,200	1	14,000
45	161	322	381,016	454	840	270,312	4	3,360	1,680	5,040	8,400	1	4,200	2	28,000
45	322	644	381,016	454	840	540,624	8	6,720	1,680	8,400	8,400	1	4,200	2	56,000
45	805	1,609	381,016	454	840	1,351,560	20	16,800	1,680	18,480	8,400	3	4,200	5	140,000
45	1,609	3,218	381,016	454	840	2,703,120	40	33,600	1,680	35,280	8,400	5	4,200	9	280,000
454	16	32	3,810,156	454	8,400	270,312	1	8,400	16,800	25,200	8,400	3	4,200	6	28,000
454	32	64	3,810,156	454	8,400	540,624	1	8,400	16,800	25,200	8,400	3	4,200	6	56,000
454	80	161	3,810,156	454	8,400	1,351,560	2	16,800	16,800	33,600	8,400	4	4,200	8	140,000
454	161	322	3,810,156	454	8,400	2,703,120	4	33,600	16,800	50,400	8,400	6	4,200	12	280,000
454	322	644	3,810,156	454	8,400	5,406,240	8	67,200	16,800	84,000	8,400	10	4,200	20	560,000
454	805	1,609	3,810,156	454	8,400	13,515,600	20	168,000	16,800	184,800	8,400	22	4,200	44	1,400,000
454	1,609	3,218	3,810,156	454	8,400	27,031,200	40	336,000	16,800	352,800	8,400	42	4,200	84	2,800,000
4,536	16	32	38,101,560	454	84,000	2,703,120	1	84,000	168,000	252,000	8,400	30	4,200	60	280,000
4,536	32	64	38,101,560	454	84,000	5,406,240	1	84,000	168,000	252,000	8,400	30	4,200	60	560,000
4,536	80	161	38,101,560	454	84,000	13,515,600	2	168,000	168,000	336,000	8,400	40	4,200	80	1,400,000
4,536	161	322	38,101,560	454	84,000	27,031,200	4	336,000	168,000	504,000	8,400	60	4,200	120	2,800,000
4,536	322	644	38,101,560	454	84,000	54,062,400	8	672,000	168,000	840,000	8,400	100	4,200	200	5,600,000
4,536	805	1,609	38,101,560	454	84,000	135,156,000	20	1,680,000	168,000	1,848,000	8,400	220	4,200	440	14,000,000
4,536	1,609	3,218	38,101,560	454	84,000	270,312,000	40	3,360,000	168,000	3,528,000	8,400	420	4,200	840	28,000,000
45,359	16	32	381,015,600	454	840,000	27,031,200	1	840,000	1,680,000	2,520,000	8,400	300	4,200	600	2,800,000
45,359	32	64	381,015,600	454	840,000	54,062,400	1	840,000	1,680,000	2,520,000	8,400	300	4,200	600	5,600,000
45,359	80	161	381,015,600	454	840,000	135,156,000	2	1,680,000	1,680,000	3,360,000	8,400	400	4,200	800	14,000,000
45,359	161	322	381,015,600	454	840,000	270,312,000	4	3,360,000	1,680,000	5,040,000	8,400	600	4,200	1,200	28,000,000
45,359	322	644	381,015,600	454	840,000	540,624,000	8	6,720,000	1,680,000	8,400,000	8,400	1,000	4,200	2,000	56,000,000
45,359	805	1,609	381,015,600	454	840,000	1,351,560,000	20	16,800,000	1,680,000	18,480,000	8,400	2,200	4,200	4,400	140,000,000
45,359	1,609	3,218	381,015,600	454	840,000	2,703,120,000	40	33,600,000	1,680,000	35,280,000	8,400	4,200	4,200	8,400	280,000,000

E.6 METAL HYDRIDE TRANSPORT BY TRUCK - SI Units (Continued)													
Production Rate (kg/hr)	Delivery Distance (km)	Total Capital Cost (\$)	Depreciation (\$/yr)	Annual Fuel Cost (\$/yr)	Annual Labor Cost (\$/yr)	Total Annual Cost (\$/yr)	Capital Cost (\$/kg)	Fuel Cost (\$/kg)	Labor Cost (\$/kg)	Total Cost (\$/kg)	Trip Frequency (trips/day)	Trip Length (Hours)	Truck Utilization (Trips/truck/day)
5	16	\$1,150,000	\$199,167	\$280	\$7,245	\$1,157,525	\$5.23	\$0.01	\$0.19	\$30.38	0.24	3	0.24
5	32	\$1,150,000	\$199,167	\$560	\$7,245	\$206,972	\$5.23	\$0.01	\$0.19	\$5.43	0.24	3	0.24
5	80	\$1,150,000	\$199,167	\$1,400	\$9,660	\$210,227	\$5.23	\$0.04	\$0.25	\$5.52	0.24	4	0.24
5	161	\$1,150,000	\$199,167	\$2,800	\$14,490	\$216,457	\$5.23	\$0.07	\$0.38	\$5.68	0.24	6	0.24
5	322	\$1,150,000	\$199,167	\$5,600	\$24,150	\$228,917	\$5.23	\$0.15	\$0.63	\$6.01	0.24	10	0.24
5	805	\$1,150,000	\$199,167	\$14,000	\$53,130	\$266,297	\$5.23	\$0.37	\$1.39	\$6.99	0.24	22	0.24
5	1,609	\$1,150,000	\$199,167	\$28,000	\$101,430	\$328,597	\$5.23	\$0.73	\$2.66	\$8.62	0.24	42	0.24
45	16	\$1,150,000	\$199,167	\$2,800	\$72,450	\$274,417	\$0.52	\$0.01	\$0.19	\$0.72	2.4	3	2.40
45	32	\$1,150,000	\$199,167	\$5,600	\$72,450	\$277,217	\$0.52	\$0.01	\$0.19	\$0.73	2.4	3	2.40
45	80	\$1,150,000	\$199,167	\$14,000	\$96,600	\$309,767	\$0.52	\$0.04	\$0.25	\$0.81	2.4	4	2.40
45	161	\$1,150,000	\$199,167	\$28,000	\$144,900	\$372,067	\$0.52	\$0.07	\$0.38	\$0.98	2.4	6	2.40
45	322	\$1,150,000	\$199,167	\$56,000	\$241,500	\$496,667	\$0.52	\$0.15	\$0.63	\$1.30	2.4	10	2.40
45	805	\$3,450,000	\$597,500	\$140,000	\$531,300	\$1,268,800	\$1.57	\$0.37	\$1.39	\$3.33	2.4	22	0.80
45	1,609	\$5,750,000	\$995,833	\$280,000	\$1,014,300	\$2,290,133	\$2.61	\$0.73	\$2.66	\$6.01	2.4	42	0.48
454	16	\$3,450,000	\$597,500	\$28,000	\$724,500	\$1,350,000	\$0.16	\$0.01	\$0.19	\$0.35	24	3	8.00
454	32	\$3,450,000	\$597,500	\$56,000	\$724,500	\$1,378,000	\$0.16	\$0.01	\$0.19	\$0.36	24	3	8.00
454	80	\$4,600,000	\$796,667	\$140,000	\$966,000	\$1,902,667	\$0.21	\$0.04	\$0.25	\$0.50	24	4	6.00
454	161	\$6,900,000	\$1,195,000	\$280,000	\$1,449,000	\$2,924,000	\$0.31	\$0.07	\$0.38	\$0.77	24	6	4.00
454	322	\$11,500,000	\$1,991,667	\$560,000	\$2,415,000	\$4,966,667	\$0.52	\$0.15	\$0.63	\$1.30	24	10	2.40
454	805	\$25,300,000	\$4,381,667	\$1,400,000	\$5,313,000	\$11,094,667	\$1.15	\$0.37	\$1.39	\$2.91	24	22	1.09
454	1,609	\$48,300,000	\$8,365,000	\$2,800,000	\$10,143,000	\$21,308,000	\$2.20	\$0.73	\$2.66	\$5.59	24	42	0.57
4,536	16	\$34,500,000	\$5,975,000	\$280,000	\$7,245,000	\$13,500,000	\$0.16	\$0.01	\$0.19	\$0.35	240	3	8.00
4,536	32	\$34,500,000	\$5,975,000	\$560,000	\$7,245,000	\$13,780,000	\$0.16	\$0.01	\$0.19	\$0.36	240	3	8.00
4,536	80	\$46,000,000	\$7,966,667	\$1,400,000	\$9,660,000	\$19,026,667	\$0.21	\$0.04	\$0.25	\$0.50	240	4	6.00
4,536	161	\$69,000,000	\$11,950,000	\$2,800,000	\$14,490,000	\$29,240,000	\$0.31	\$0.07	\$0.38	\$0.77	240	6	4.00
4,536	322	\$115,000,000	\$19,916,667	\$5,600,000	\$24,150,000	\$49,666,667	\$0.52	\$0.15	\$0.63	\$1.30	240	10	2.40
4,536	805	\$253,000,000	\$43,816,667	\$14,000,000	\$53,130,000	\$110,946,667	\$1.15	\$0.37	\$1.39	\$2.91	240	22	1.09
4,536	1,609	\$483,000,000	\$83,650,000	\$28,000,000	\$101,430,000	\$213,080,000	\$2.20	\$0.73	\$2.66	\$5.59	240	42	0.57
45,359	16	\$345,000,000	\$59,750,000	\$2,800,000	\$72,450,000	\$135,000,000	\$0.16	\$0.01	\$0.19	\$0.35	2400	3	8.00
45,359	32	\$345,000,000	\$59,750,000	\$5,600,000	\$72,450,000	\$137,800,000	\$0.16	\$0.01	\$0.19	\$0.36	2400	3	8.00
45,359	80	\$460,000,000	\$79,666,667	\$14,000,000	\$96,600,000	\$190,266,667	\$0.21	\$0.04	\$0.25	\$0.50	2400	4	6.00
45,359	161	\$690,000,000	\$119,500,000	\$28,000,000	\$144,900,000	\$292,400,000	\$0.31	\$0.07	\$0.38	\$0.77	2400	6	4.00
45,359	322	\$1,150,000,000	\$199,166,667	\$56,000,000	\$241,500,000	\$496,666,667	\$0.52	\$0.15	\$0.63	\$1.30	2400	10	2.40
45,359	805	\$2,530,000,000	\$438,166,667	\$140,000,000	\$531,300,000	\$1,109,466,667	\$1.15	\$0.37	\$1.39	\$2.91	2400	22	1.09
45,359	1,609	\$4,830,000,000	\$836,500,000	\$280,000,000	\$1,014,300,000	\$2,130,800,000	\$2.20	\$0.73	\$2.66	\$5.59	2400	42	0.57

E.6 METAL HYDRIDE TRANSPORT BY TRUCK - English Units															
Truck Hydride Container=	\$1,000	per lb hydrogen													
Truck Undercarriage=	\$60,000	per trailer													
Truck Cab=	\$90,000	per cab													
Truck Hydride Capacity=	1,000	lb/truck													
Truck Mileage=	6	mpg													
Truck Average Speed=	50	mph													
Hours/Driver=	12	hr/driver													
Truck Load/Unload Time=	2	hr/trip													
Truck Availability=	24	hr/day													
Driver Wage w/ Benefits=	\$28.75	per hour													
Diesel Price=	\$1.00	per gal													
Operating Days/Year=	350	days/yr													
Trailer/Tank Depreciation=	6	years													
Tractor Depreciation=	4	years													
Production Rate	Delivery Distance One-Way	Delivery Distance Two-Way	Annual Production	Truck Capacity	Number of Trips	Total Miles Driven	Time per Trip	Total Drive Time	Total Load/Unload Time	Total Delivery Time	Truck Availability	Trucks Required	Driver Availability	Drivers Required	Annual Fuel Use
(lb/hr)	(miles)	(miles/trip)	(lb/yr)	(lb/truck)	(trips/yr)	(miles/yr)	(hr/trip)	(hr/yr)	(hr/yr)	(hr/yr)	(hr/yr)		(hr/yr)		(gal/yr)
10	10	20	84,000	1,000	84	1,680	1	84	168	252	8,400	1	4,200	1	280
10	20	40	84,000	1,000	84	3,360	1	84	168	252	8,400	1	4,200	1	560
10	50	100	84,000	1,000	84	8,400	2	168	168	336	8,400	1	4,200	1	1,400
10	100	200	84,000	1,000	84	16,800	4	336	168	504	8,400	1	4,200	1	2,800
10	200	400	84,000	1,000	84	33,600	8	672	168	840	8,400	1	4,200	1	5,600
10	500	1,000	84,000	1,000	84	84,000	20	1,680	168	1,848	8,400	1	4,200	1	14,000
10	1,000	2,000	84,000	1,000	84	168,000	40	3,360	168	3,528	8,400	1	4,200	1	28,000
100	10	20	840,000	1,000	840	16,800	1	840	1,680	2,520	8,400	1	4,200	1	2,800
100	20	40	840,000	1,000	840	33,600	1	840	1,680	2,520	8,400	1	4,200	1	5,600
100	50	100	840,000	1,000	840	84,000	2	1,680	1,680	3,360	8,400	1	4,200	1	14,000
100	100	200	840,000	1,000	840	168,000	4	3,360	1,680	5,040	8,400	1	4,200	2	28,000
100	200	400	840,000	1,000	840	336,000	8	6,720	1,680	8,400	8,400	1	4,200	2	56,000
100	500	1,000	840,000	1,000	840	840,000	20	16,800	1,680	18,480	8,400	3	4,200	5	140,000
100	1,000	2,000	840,000	1,000	840	1,680,000	40	33,600	1,680	35,280	8,400	5	4,200	9	280,000
1,000	10	20	8,400,000	1,000	8,400	168,000	1	8,400	16,800	25,200	8,400	3	4,200	6	28,000
1,000	20	40	8,400,000	1,000	8,400	336,000	1	8,400	16,800	25,200	8,400	3	4,200	6	56,000
1,000	50	100	8,400,000	1,000	8,400	840,000	2	16,800	16,800	33,600	8,400	4	4,200	8	140,000
1,000	100	200	8,400,000	1,000	8,400	1,680,000	4	33,600	16,800	50,400	8,400	6	4,200	12	280,000
1,000	200	400	8,400,000	1,000	8,400	3,360,000	8	67,200	16,800	84,000	8,400	10	4,200	20	560,000
1,000	500	1,000	8,400,000	1,000	8,400	8,400,000	20	168,000	16,800	184,800	8,400	22	4,200	44	1,400,000
1,000	1,000	2,000	8,400,000	1,000	8,400	16,800,000	40	336,000	16,800	352,800	8,400	42	4,200	84	2,800,000
10,000	10	20	84,000,000	1,000	84,000	1,680,000	1	84,000	168,000	252,000	8,400	30	4,200	60	280,000
10,000	20	40	84,000,000	1,000	84,000	3,360,000	1	84,000	168,000	252,000	8,400	30	4,200	60	560,000
10,000	50	100	84,000,000	1,000	84,000	8,400,000	2	168,000	168,000	336,000	8,400	40	4,200	80	1,400,000
10,000	100	200	84,000,000	1,000	84,000	16,800,000	4	336,000	168,000	504,000	8,400	60	4,200	120	2,800,000
10,000	200	400	84,000,000	1,000	84,000	33,600,000	8	672,000	168,000	840,000	8,400	100	4,200	200	5,600,000
10,000	500	1,000	84,000,000	1,000	84,000	84,000,000	20	1,680,000	168,000	1,848,000	8,400	220	4,200	440	14,000,000
10,000	1,000	2,000	84,000,000	1,000	84,000	168,000,000	40	3,360,000	168,000	3,528,000	8,400	420	4,200	840	28,000,000
100,000	10	20	840,000,000	1,000	840,000	16,800,000	1	840,000	1,680,000	2,520,000	8,400	300	4,200	600	2,800,000
100,000	20	40	840,000,000	1,000	840,000	33,600,000	1	840,000	1,680,000	2,520,000	8,400	300	4,200	600	5,600,000
100,000	50	100	840,000,000	1,000	840,000	84,000,000	2	1,680,000	1,680,000	3,360,000	8,400	400	4,200	800	14,000,000
100,000	100	200	840,000,000	1,000	840,000	168,000,000	4	3,360,000	1,680,000	5,040,000	8,400	600	4,200	1,200	28,000,000
100,000	200	400	840,000,000	1,000	840,000	336,000,000	8	6,720,000	1,680,000	8,400,000	8,400	1,000	4,200	2,000	56,000,000
100,000	500	1,000	840,000,000	1,000	840,000	840,000,000	20	16,800,000	1,680,000	18,480,000	8,400	2,200	4,200	4,400	140,000,000
100,000	1,000	2,000	840,000,000	1,000	840,000	1,680,000,000	40	33,600,000	1,680,000	35,280,000	8,400	4,200	4,200	8,400	280,000,000

E.6 METAL HYDRIDE TRANSPORT BY TRUCK -English Units (Continued)													
Production Rate (lb/hr)	Delivery Distance (miles)	Total Capital Cost (\$)	Depreciation (\$/yr)	Annual Fuel Cost (\$/yr)	Annual Labor Cost (\$/yr)	Total Annual Cost (\$/yr)	Capital Cost (\$/lb)	Fuel Cost (\$/lb)	Labor Cost (\$/lb)	Total Cost (\$/lb)	Trip Frequency (trips/day)	Trip Length (Hours)	Truck Utilization (Trips/truck/day)
10	10	\$1,150,000	\$199,167	\$280	\$7,245	\$1,157,525	\$2.37	\$0.00	\$0.09	\$13.78	0.24	3	0.24
10	20	\$1,150,000	\$199,167	\$560	\$7,245	\$206,972	\$2.37	\$0.01	\$0.09	\$2.46	0.24	3	0.24
10	50	\$1,150,000	\$199,167	\$1,400	\$9,660	\$210,227	\$2.37	\$0.02	\$0.12	\$2.50	0.24	4	0.24
10	100	\$1,150,000	\$199,167	\$2,800	\$14,490	\$216,457	\$2.37	\$0.03	\$0.17	\$2.58	0.24	6	0.24
10	200	\$1,150,000	\$199,167	\$5,600	\$24,150	\$228,917	\$2.37	\$0.07	\$0.29	\$2.73	0.24	10	0.24
10	500	\$1,150,000	\$199,167	\$14,000	\$53,130	\$266,297	\$2.37	\$0.17	\$0.63	\$3.17	0.24	22	0.24
10	1,000	\$1,150,000	\$199,167	\$28,000	\$101,430	\$328,597	\$2.37	\$0.33	\$1.21	\$3.91	0.24	42	0.24
100	10	\$1,150,000	\$199,167	\$2,800	\$72,450	\$274,417	\$0.24	\$0.00	\$0.09	\$0.33	2.4	3	2.40
100	20	\$1,150,000	\$199,167	\$5,600	\$72,450	\$277,217	\$0.24	\$0.01	\$0.09	\$0.33	2.4	3	2.40
100	50	\$1,150,000	\$199,167	\$14,000	\$96,600	\$309,767	\$0.24	\$0.02	\$0.12	\$0.37	2.4	4	2.40
100	100	\$1,150,000	\$199,167	\$28,000	\$144,900	\$372,067	\$0.24	\$0.03	\$0.17	\$0.44	2.4	6	2.40
100	200	\$1,150,000	\$199,167	\$56,000	\$241,500	\$496,667	\$0.24	\$0.07	\$0.29	\$0.59	2.4	10	2.40
100	500	\$3,450,000	\$597,500	\$140,000	\$531,300	\$1,268,800	\$0.71	\$0.17	\$0.63	\$1.51	2.4	22	0.80
100	1,000	\$5,750,000	\$995,833	\$280,000	\$1,014,300	\$2,290,133	\$1.19	\$0.33	\$1.21	\$2.73	2.4	42	0.48
1,000	10	\$3,450,000	\$597,500	\$28,000	\$724,500	\$1,350,000	\$0.07	\$0.00	\$0.09	\$0.16	24	3	8.00
1,000	20	\$3,450,000	\$597,500	\$56,000	\$724,500	\$1,378,000	\$0.07	\$0.01	\$0.09	\$0.16	24	3	8.00
1,000	50	\$4,600,000	\$796,667	\$140,000	\$966,000	\$1,902,667	\$0.09	\$0.02	\$0.12	\$0.23	24	4	6.00
1,000	100	\$6,900,000	\$1,195,000	\$280,000	\$1,449,000	\$2,924,000	\$0.14	\$0.03	\$0.17	\$0.35	24	6	4.00
1,000	200	\$11,500,000	\$1,991,667	\$560,000	\$2,415,000	\$4,966,667	\$0.24	\$0.07	\$0.29	\$0.59	24	10	2.40
1,000	500	\$25,300,000	\$4,381,667	\$1,400,000	\$5,313,000	\$11,094,667	\$0.52	\$0.17	\$0.63	\$1.32	24	22	1.09
1,000	1,000	\$48,300,000	\$8,365,000	\$2,800,000	\$10,143,000	\$21,308,000	\$1.00	\$0.33	\$1.21	\$2.54	24	42	0.57
10,000	10	\$34,500,000	\$5,975,000	\$280,000	\$7,245,000	\$13,500,000	\$0.07	\$0.00	\$0.09	\$0.16	240	3	8.00
10,000	20	\$34,500,000	\$5,975,000	\$560,000	\$7,245,000	\$13,780,000	\$0.07	\$0.01	\$0.09	\$0.16	240	3	8.00
10,000	50	\$46,000,000	\$7,966,667	\$1,400,000	\$9,660,000	\$19,026,667	\$0.09	\$0.02	\$0.12	\$0.23	240	4	6.00
10,000	100	\$69,000,000	\$11,950,000	\$2,800,000	\$14,490,000	\$29,240,000	\$0.14	\$0.03	\$0.17	\$0.35	240	6	4.00
10,000	200	\$115,000,000	\$19,916,667	\$5,600,000	\$24,150,000	\$49,666,667	\$0.24	\$0.07	\$0.29	\$0.59	240	10	2.40
10,000	500	\$253,000,000	\$43,816,667	\$14,000,000	\$53,130,000	\$110,946,667	\$0.52	\$0.17	\$0.63	\$1.32	240	22	1.09
10,000	1,000	\$483,000,000	\$83,650,000	\$28,000,000	\$101,430,000	\$213,080,000	\$1.00	\$0.33	\$1.21	\$2.54	240	42	0.57
100,000	10	\$345,000,000	\$59,750,000	\$2,800,000	\$72,450,000	\$135,000,000	\$0.07	\$0.00	\$0.09	\$0.16	2400	3	8.00
100,000	20	\$345,000,000	\$59,750,000	\$5,600,000	\$72,450,000	\$137,800,000	\$0.07	\$0.01	\$0.09	\$0.16	2400	3	8.00
100,000	50	\$460,000,000	\$79,666,667	\$14,000,000	\$96,600,000	\$190,266,667	\$0.09	\$0.02	\$0.12	\$0.23	2400	4	6.00
100,000	100	\$690,000,000	\$119,500,000	\$28,000,000	\$144,900,000	\$292,400,000	\$0.14	\$0.03	\$0.17	\$0.35	2400	6	4.00
100,000	200	\$1,150,000,000	\$199,166,667	\$56,000,000	\$241,500,000	\$496,666,667	\$0.24	\$0.07	\$0.29	\$0.59	2400	10	2.40
100,000	500	\$2,530,000,000	\$438,166,667	\$140,000,000	\$531,300,000	\$1,109,466,667	\$0.52	\$0.17	\$0.63	\$1.32	2400	22	1.09
100,000	1,000	\$4,830,000,000	\$836,500,000	\$280,000,000	\$1,014,300,000	\$2,130,800,000	\$1.00	\$0.33	\$1.21	\$2.54	2400	42	0.57

E.7 METAL HYDRIDE TRANSPORT BY RAIL - SI Units												
Rail Hydride Container=	\$2,205	per kg hydrogen										
Rail Undercarriage=	\$100,000	per rail car										
Rail Hydride Capacity=	907	kg/truck										
Rail Average Speed=	40	km/hr										
Rail Load/Unload Time=	24	hr/trip										
Rail Car Availability=	24	hr/day										
Rail Freight=	\$400.00	per rail car										
Operating Days/Year=	350	days/yr										
Railcar Depreciation=	15	years										
Production Rate (kg/hr)	Delivery Distance (km)	Distance (km/trip)	Annual Production (kg/yr)	Railcar Capacity (kg/truck)	Number of Trips (trips/yr)	Total Miles (km/yr)	Time per Trip (d/trip)	Total Transit Time (hr/yr)	Total Load/Unload Time (hr/yr)	Total Delivery Time (hr/yr)	Railcar Availability (hr/yr)	Railcars Required
5	16	32	38,102	907	42	1,352	2	2,016	1,008	3,024	8,400	1
5	32	64	38,102	907	42	2,703	2	2,016	1,008	3,024	8,400	1
5	80	161	38,102	907	42	6,758	2	2,016	1,008	3,024	8,400	1
5	161	322	38,102	907	42	13,516	2	2,016	1,008	3,024	8,400	1
5	322	644	38,102	907	42	27,031	2	2,016	1,008	3,024	8,400	1
5	805	1,609	38,102	907	42	67,578	2	2,016	1,008	3,024	8,400	1
5	1,609	3,218	38,102	907	42	135,156	4	4,032	1,008	5,040	8,400	1
45	16	32	381,016	907	420	13,516	2	20,160	10,080	30,240	8,400	4
45	32	64	381,016	907	420	27,031	2	20,160	10,080	30,240	8,400	4
45	80	161	381,016	907	420	67,578	2	20,160	10,080	30,240	8,400	4
45	161	322	381,016	907	420	135,156	2	20,160	10,080	30,240	8,400	4
45	322	644	381,016	907	420	270,312	2	20,160	10,080	30,240	8,400	4
45	805	1,609	381,016	907	420	675,780	2	20,160	10,080	30,240	8,400	4
45	1,609	3,218	381,016	907	420	1,351,560	4	40,320	10,080	50,400	8,400	6
454	16	32	3,810,156	907	4,200	135,156	2	201,600	100,800	302,400	8,400	36
454	32	64	3,810,156	907	4,200	270,312	2	201,600	100,800	302,400	8,400	36
454	80	161	3,810,156	907	4,200	675,780	2	201,600	100,800	302,400	8,400	36
454	161	322	3,810,156	907	4,200	1,351,560	2	201,600	100,800	302,400	8,400	36
454	322	644	3,810,156	907	4,200	2,703,120	2	201,600	100,800	302,400	8,400	36
454	805	1,609	3,810,156	907	4,200	6,757,800	2	201,600	100,800	302,400	8,400	36
454	1,609	3,218	3,810,156	907	4,200	13,515,600	4	403,200	100,800	504,000	8,400	60
4,536	16	32	38,101,560	907	42,000	1,351,560	2	2,016,000	1,008,000	3,024,000	8,400	360
4,536	32	64	38,101,560	907	42,000	2,703,120	2	2,016,000	1,008,000	3,024,000	8,400	360
4,536	80	161	38,101,560	907	42,000	6,757,800	2	2,016,000	1,008,000	3,024,000	8,400	360
4,536	161	322	38,101,560	907	42,000	13,515,600	2	2,016,000	1,008,000	3,024,000	8,400	360
4,536	322	644	38,101,560	907	42,000	27,031,200	2	2,016,000	1,008,000	3,024,000	8,400	360
4,536	805	1,609	38,101,560	907	42,000	67,578,000	2	2,016,000	1,008,000	3,024,000	8,400	360
45,359	1,609	3,218	381,015,600	907	420,000	1,351,560,000	4	40,320,000	10,080,000	50,400,000	8,400	6,000
45,359	16	32	381,015,600	907	420,000	13,515,600	2	20,160,000	10,080,000	30,240,000	8,400	3,600
45,359	32	64	381,015,600	907	420,000	27,031,200	2	20,160,000	10,080,000	30,240,000	8,400	3,600
45,359	80	161	381,015,600	907	420,000	67,578,000	2	20,160,000	10,080,000	30,240,000	8,400	3,600
45,359	161	322	381,015,600	907	420,000	135,156,000	2	20,160,000	10,080,000	30,240,000	8,400	3,600
45,359	322	644	381,015,600	907	420,000	270,312,000	2	20,160,000	10,080,000	30,240,000	8,400	3,600
45,359	805	1,609	381,015,600	907	420,000	675,780,000	2	20,160,000	10,080,000	30,240,000	8,400	3,600
45,359	1,609	3,218	381,015,600	907	420,000	1,351,560,000	4	40,320,000	10,080,000	50,400,000	8,400	6,000

E.7 METAL HYDRIDE TRANSPORT BY RAIL - SI Units (Continued)											
Production	Delivery Distan	Total Capital	Depreciation	Annual Freight	Total Annual	Freight	Capital	Total	Trip	Trip	Railcar
Rate	One-Way	Cost		Cost	Cost	Cost	Cost	Cost	Frequency	Length	Utilization
(kg/hr)	(km)	(\$)	(\$/yr)	(\$/yr)	(\$/yr)	(\$/kg)	(\$/kg)	(\$/kg)	(trips/day)	(hours)	(trips/railcar/d)
5	16	\$2,100,000	\$140,000	\$33,600	\$173,600	\$0.88	\$3.67	\$4.56	0.12	72	0.12
5	32	\$2,100,000	\$140,000	\$33,600	\$173,600	\$0.88	\$3.67	\$4.56	0.12	72	0.12
5	80	\$2,100,000	\$140,000	\$33,600	\$173,600	\$0.88	\$3.67	\$4.56	0.12	72	0.12
5	161	\$2,100,000	\$140,000	\$33,600	\$173,600	\$0.88	\$3.67	\$4.56	0.12	72	0.12
5	322	\$2,100,000	\$140,000	\$33,600	\$173,600	\$0.88	\$3.67	\$4.56	0.12	72	0.12
5	805	\$2,100,000	\$140,000	\$33,600	\$173,600	\$0.88	\$3.67	\$4.56	0.12	72	0.12
5	1,609	\$2,100,000	\$140,000	\$33,600	\$173,600	\$0.88	\$3.67	\$4.56	0.12	120	0.12
45	16	\$8,400,000	\$560,000	\$336,000	\$896,000	\$0.88	\$1.47	\$2.35	1.2	72	0.30
45	32	\$8,400,000	\$560,000	\$336,000	\$896,000	\$0.88	\$1.47	\$2.35	1.2	72	0.30
45	80	\$8,400,000	\$560,000	\$336,000	\$896,000	\$0.88	\$1.47	\$2.35	1.2	72	0.30
45	161	\$8,400,000	\$560,000	\$336,000	\$896,000	\$0.88	\$1.47	\$2.35	1.2	72	0.30
45	322	\$8,400,000	\$560,000	\$336,000	\$896,000	\$0.88	\$1.47	\$2.35	1.2	72	0.30
45	805	\$8,400,000	\$560,000	\$336,000	\$896,000	\$0.88	\$1.47	\$2.35	1.2	72	0.30
45	1,609	\$12,600,000	\$840,000	\$336,000	\$1,176,000	\$0.88	\$2.20	\$3.09	1.2	120	0.20
454	16	\$75,600,000	\$5,040,000	\$3,360,000	\$8,400,000	\$0.88	\$1.32	\$2.20	12	72	0.33
454	32	\$75,600,000	\$5,040,000	\$3,360,000	\$8,400,000	\$0.88	\$1.32	\$2.20	12	72	0.33
454	80	\$75,600,000	\$5,040,000	\$3,360,000	\$8,400,000	\$0.88	\$1.32	\$2.20	12	72	0.33
454	161	\$75,600,000	\$5,040,000	\$3,360,000	\$8,400,000	\$0.88	\$1.32	\$2.20	12	72	0.33
454	322	\$75,600,000	\$5,040,000	\$3,360,000	\$8,400,000	\$0.88	\$1.32	\$2.20	12	72	0.33
454	805	\$75,600,000	\$5,040,000	\$3,360,000	\$8,400,000	\$0.88	\$1.32	\$2.20	12	72	0.33
454	1,609	\$126,000,000	\$8,400,000	\$3,360,000	\$11,760,000	\$0.88	\$2.20	\$3.09	12	120	0.20
4,536	16	\$756,000,000	\$50,400,000	\$33,600,000	\$84,000,000	\$0.88	\$1.32	\$2.20	120	72	0.33
4,536	32	\$756,000,000	\$50,400,000	\$33,600,000	\$84,000,000	\$0.88	\$1.32	\$2.20	120	72	0.33
4,536	80	\$756,000,000	\$50,400,000	\$33,600,000	\$84,000,000	\$0.88	\$1.32	\$2.20	120	72	0.33
4,536	161	\$756,000,000	\$50,400,000	\$33,600,000	\$84,000,000	\$0.88	\$1.32	\$2.20	120	72	0.33
4,536	322	\$756,000,000	\$50,400,000	\$33,600,000	\$84,000,000	\$0.88	\$1.32	\$2.20	120	72	0.33
4,536	805	\$756,000,000	\$50,400,000	\$33,600,000	\$84,000,000	\$0.88	\$1.32	\$2.20	120	72	0.33
45,359	1,609	\$12,600,000,000	\$840,000,000	\$336,000,000	\$1,176,000,000	\$0.88	\$2.20	\$3.09	1200	120	0.20
45,359	16	\$7,560,000,000	\$504,000,000	\$336,000,000	\$840,000,000	\$0.88	\$1.32	\$2.20	1200	72	0.33
45,359	32	\$7,560,000,000	\$504,000,000	\$336,000,000	\$840,000,000	\$0.88	\$1.32	\$2.20	1200	72	0.33
45,359	80	\$7,560,000,000	\$504,000,000	\$336,000,000	\$840,000,000	\$0.88	\$1.32	\$2.20	1200	72	0.33
45,359	161	\$7,560,000,000	\$504,000,000	\$336,000,000	\$840,000,000	\$0.88	\$1.32	\$2.20	1200	72	0.33
45,359	322	\$7,560,000,000	\$504,000,000	\$336,000,000	\$840,000,000	\$0.88	\$1.32	\$2.20	1200	72	0.33
45,359	805	\$7,560,000,000	\$504,000,000	\$336,000,000	\$840,000,000	\$0.88	\$1.32	\$2.20	1200	72	0.33
45,359	1,609	\$12,600,000,000	\$840,000,000	\$336,000,000	\$1,176,000,000	\$0.88	\$2.20	\$3.09	1200	120	0.20

E.7 METAL HYDRIDE TRANSPORT BY RAIL - English Units												
Rail Hydride Container=		\$1,000	per lb hydrogen									
Rail Undercarriage=		\$100,000	per rail car									
Rail Hydride Capacity=		2,000	lb/truck									
Rail Average Speed=		25	mph									
Rail Load/Unload Time=		24	hr/trip									
Rail Car Availability=		24	hr/day									
Rail Freight=		\$400.00	per rail car									
Operating Days/Year=		350	days/yr									
Railcar Depreciation=		15	years									
Production Rate (lb/hr)	Delivery Distance (miles)	Distance (miles/trip)	Annual Production (lb/yr)	Railcar Capacity (lb/truck)	Number of Trips (trips/yr)	Total Miles (miles/yr)	Time per Trip (d/trip)	Total Transit Time (hr/yr)	Total Load/Unload Time (hr/yr)	Total Delivery Time (hr/yr)	Railcar Availability (hr/yr)	Railcars Required
10	10	20	84,000	2,000	42	840	2	2,016	1,008	3,024	8,400	1
10	20	40	84,000	2,000	42	1,680	2	2,016	1,008	3,024	8,400	1
10	50	100	84,000	2,000	42	4,200	2	2,016	1,008	3,024	8,400	1
10	100	200	84,000	2,000	42	8,400	2	2,016	1,008	3,024	8,400	1
10	200	400	84,000	2,000	42	16,800	2	2,016	1,008	3,024	8,400	1
10	500	1,000	84,000	2,000	42	42,000	2	2,016	1,008	3,024	8,400	1
10	1,000	2,000	84,000	2,000	42	84,000	4	4,032	1,008	5,040	8,400	1
100	10	20	840,000	2,000	420	8,400	2	20,160	10,080	30,240	8,400	4
100	20	40	840,000	2,000	420	16,800	2	20,160	10,080	30,240	8,400	4
100	50	100	840,000	2,000	420	42,000	2	20,160	10,080	30,240	8,400	4
100	100	200	840,000	2,000	420	84,000	2	20,160	10,080	30,240	8,400	4
100	200	400	840,000	2,000	420	168,000	2	20,160	10,080	30,240	8,400	4
100	500	1,000	840,000	2,000	420	420,000	2	20,160	10,080	30,240	8,400	4
100	1,000	2,000	840,000	2,000	420	840,000	4	40,320	10,080	50,400	8,400	6
1,000	10	20	8,400,000	2,000	4,200	84,000	2	201,600	100,800	302,400	8,400	36
1,000	20	40	8,400,000	2,000	4,200	168,000	2	201,600	100,800	302,400	8,400	36
1,000	50	100	8,400,000	2,000	4,200	420,000	2	201,600	100,800	302,400	8,400	36
1,000	100	200	8,400,000	2,000	4,200	840,000	2	201,600	100,800	302,400	8,400	36
1,000	200	400	8,400,000	2,000	4,200	1,680,000	2	201,600	100,800	302,400	8,400	36
1,000	500	1,000	8,400,000	2,000	4,200	4,200,000	2	201,600	100,800	302,400	8,400	36
1,000	1,000	2,000	8,400,000	2,000	4,200	8,400,000	4	403,200	100,800	504,000	8,400	60
10,000	10	20	84,000,000	2,000	42,000	840,000	2	2,016,000	1,008,000	3,024,000	8,400	360
10,000	20	40	84,000,000	2,000	42,000	1,680,000	2	2,016,000	1,008,000	3,024,000	8,400	360
10,000	50	100	84,000,000	2,000	42,000	4,200,000	2	2,016,000	1,008,000	3,024,000	8,400	360
10,000	100	200	84,000,000	2,000	42,000	8,400,000	2	2,016,000	1,008,000	3,024,000	8,400	360
10,000	200	400	84,000,000	2,000	42,000	16,800,000	2	2,016,000	1,008,000	3,024,000	8,400	360
10,000	500	1,000	84,000,000	2,000	42,000	42,000,000	2	2,016,000	1,008,000	3,024,000	8,400	360
100,000	1,000	2,000	840,000,000	2,000	420,000	840,000,000	4	40,320,000	10,080,000	50,400,000	8,400	6,000
100,000	10	20	840,000,000	2,000	420,000	8,400,000	2	20,160,000	10,080,000	30,240,000	8,400	3,600
100,000	20	40	840,000,000	2,000	420,000	16,800,000	2	20,160,000	10,080,000	30,240,000	8,400	3,600
100,000	50	100	840,000,000	2,000	420,000	42,000,000	2	20,160,000	10,080,000	30,240,000	8,400	3,600
100,000	100	200	840,000,000	2,000	420,000	84,000,000	2	20,160,000	10,080,000	30,240,000	8,400	3,600
100,000	200	400	840,000,000	2,000	420,000	168,000,000	2	20,160,000	10,080,000	30,240,000	8,400	3,600
100,000	500	1,000	840,000,000	2,000	420,000	420,000,000	2	20,160,000	10,080,000	30,240,000	8,400	3,600
100,000	1,000	2,000	840,000,000	2,000	420,000	840,000,000	4	40,320,000	10,080,000	50,400,000	8,400	6,000

E.7 METAL HYDRIDE TRANSPORT BY RAIL - English Units (Continued)											
Production	Delivery Distanc	Total Capital	Depreciation	Annual Freight	Total Annual	Freight	Capital	Total	Trip	Trip	Railcar
Rate	One-Way	Cost		Cost	Cost	Cost	Cost	Cost	Frequency	Length	Utilization
(lb/hr)	(miles)	(\$)	(\$/yr)	(\$/yr)	(\$/yr)	(\$/lb)	(\$/lb)	(\$/lb)	(trips/day)	(hours)	(trips/railcar/d)
10	10	\$2,100,000	\$140,000	\$33,600	\$173,600	\$0.40	\$1.67	\$2.07	0.12	72	0.12
10	20	\$2,100,000	\$140,000	\$33,600	\$173,600	\$0.40	\$1.67	\$2.07	0.12	72	0.12
10	50	\$2,100,000	\$140,000	\$33,600	\$173,600	\$0.40	\$1.67	\$2.07	0.12	72	0.12
10	100	\$2,100,000	\$140,000	\$33,600	\$173,600	\$0.40	\$1.67	\$2.07	0.12	72	0.12
10	200	\$2,100,000	\$140,000	\$33,600	\$173,600	\$0.40	\$1.67	\$2.07	0.12	72	0.12
10	500	\$2,100,000	\$140,000	\$33,600	\$173,600	\$0.40	\$1.67	\$2.07	0.12	72	0.12
10	1,000	\$2,100,000	\$140,000	\$33,600	\$173,600	\$0.40	\$1.67	\$2.07	0.12	120	0.12
100	10	\$8,400,000	\$560,000	\$336,000	\$896,000	\$0.40	\$0.67	\$1.07	1.2	72	0.30
100	20	\$8,400,000	\$560,000	\$336,000	\$896,000	\$0.40	\$0.67	\$1.07	1.2	72	0.30
100	50	\$8,400,000	\$560,000	\$336,000	\$896,000	\$0.40	\$0.67	\$1.07	1.2	72	0.30
100	100	\$8,400,000	\$560,000	\$336,000	\$896,000	\$0.40	\$0.67	\$1.07	1.2	72	0.30
100	200	\$8,400,000	\$560,000	\$336,000	\$896,000	\$0.40	\$0.67	\$1.07	1.2	72	0.30
100	500	\$8,400,000	\$560,000	\$336,000	\$896,000	\$0.40	\$0.67	\$1.07	1.2	72	0.30
100	1,000	\$12,600,000	\$840,000	\$336,000	\$1,176,000	\$0.40	\$1.00	\$1.40	1.2	120	0.20
1,000	10	\$75,600,000	\$5,040,000	\$3,360,000	\$8,400,000	\$0.40	\$0.60	\$1.00	12	72	0.33
1,000	20	\$75,600,000	\$5,040,000	\$3,360,000	\$8,400,000	\$0.40	\$0.60	\$1.00	12	72	0.33
1,000	50	\$75,600,000	\$5,040,000	\$3,360,000	\$8,400,000	\$0.40	\$0.60	\$1.00	12	72	0.33
1,000	100	\$75,600,000	\$5,040,000	\$3,360,000	\$8,400,000	\$0.40	\$0.60	\$1.00	12	72	0.33
1,000	200	\$75,600,000	\$5,040,000	\$3,360,000	\$8,400,000	\$0.40	\$0.60	\$1.00	12	72	0.33
1,000	500	\$75,600,000	\$5,040,000	\$3,360,000	\$8,400,000	\$0.40	\$0.60	\$1.00	12	72	0.33
1,000	1,000	\$126,000,000	\$8,400,000	\$3,360,000	\$11,760,000	\$0.40	\$1.00	\$1.40	12	120	0.20
10,000	10	\$756,000,000	\$50,400,000	\$33,600,000	\$84,000,000	\$0.40	\$0.60	\$1.00	120	72	0.33
10,000	20	\$756,000,000	\$50,400,000	\$33,600,000	\$84,000,000	\$0.40	\$0.60	\$1.00	120	72	0.33
10,000	50	\$756,000,000	\$50,400,000	\$33,600,000	\$84,000,000	\$0.40	\$0.60	\$1.00	120	72	0.33
10,000	100	\$756,000,000	\$50,400,000	\$33,600,000	\$84,000,000	\$0.40	\$0.60	\$1.00	120	72	0.33
10,000	200	\$756,000,000	\$50,400,000	\$33,600,000	\$84,000,000	\$0.40	\$0.60	\$1.00	120	72	0.33
10,000	500	\$756,000,000	\$50,400,000	\$33,600,000	\$84,000,000	\$0.40	\$0.60	\$1.00	120	72	0.33
100,000	1,000	\$12,600,000,000	\$840,000,000	\$336,000,000	\$1,176,000,000	\$0.40	\$1.00	\$1.40	1200	120	0.20
100,000	10	\$7,560,000,000	\$504,000,000	\$336,000,000	\$840,000,000	\$0.40	\$0.60	\$1.00	1200	72	0.33
100,000	20	\$7,560,000,000	\$504,000,000	\$336,000,000	\$840,000,000	\$0.40	\$0.60	\$1.00	1200	72	0.33
100,000	50	\$7,560,000,000	\$504,000,000	\$336,000,000	\$840,000,000	\$0.40	\$0.60	\$1.00	1200	72	0.33
100,000	100	\$7,560,000,000	\$504,000,000	\$336,000,000	\$840,000,000	\$0.40	\$0.60	\$1.00	1200	72	0.33
100,000	200	\$7,560,000,000	\$504,000,000	\$336,000,000	\$840,000,000	\$0.40	\$0.60	\$1.00	1200	72	0.33
100,000	500	\$7,560,000,000	\$504,000,000	\$336,000,000	\$840,000,000	\$0.40	\$0.60	\$1.00	1200	72	0.33
100,000	1,000	\$12,600,000,000	\$840,000,000	\$336,000,000	\$1,176,000,000	\$0.40	\$1.00	\$1.40	1200	120	0.20

E.8 PIPELINE DELIVERY OF HYDROGEN - SI Units									
Compressor Capital Cost=		\$1,000	per kW						
Compressor Size=		4,000	kW						
Compressor Pressure=		20	MPa						
Comp. Cost Scale-Up=		0.80							
Comp. Pressure Scale-Up=		0.18							
Pipeline Cost=		\$621,504	per km						
Electric Cost=		\$0.05	per kWh						
Compressor Power=		2.20	kWh/kg (20 MPa)						
Steel Roughness=		4.6E-05	m						
Pipe Diameter=		0.25	m						
Temperature=		283	K						
Delivery Pressure=		2	Mpa						
Viscosity=		8.62E-06	kg/m*s						
R (hydrogen)=		4124	N*m/kg K						
Operating Days/Year=		350	days/yr						
Pipeline Depreciation=		22	years						
Roughness/Diameter=		0.000184							
Fanning friction factor, f=		0.005							
Pipe Area=		0.049	sq. m						
Production Rate	Delivery Distance	Annual Production	Flowrate	Distance	Gas Flux	Reynolds Number	Inlet Pressure	Compressor Size	Annual Electric Use
(lb/hr)	(miles)	(lb/yr)	(kg/s)	(m)	(kg/s*m^2)		(MPa)	(kW)	(kWh/yr)
5	16	38,102	0.001	16,094	0.026	744	2,000	0	0
5	32	38,102	0.001	32,187	0.026	744	2,000	0	0
5	80	38,102	0.001	80,468	0.026	744	2,000	0	0
5	161	38,102	0.001	160,936	0.026	744	2,000	0	0
5	322	38,102	0.001	321,873	0.026	744	2,000	0	0
5	805	38,102	0.001	804,682	0.026	744	2,000	0	0
5	1,609	38,102	0.001	1,609,364	0.026	744	2,000	0	0
45	16	381,016	0.013	16,094	0.257	7,444	2,000	0	2
45	32	381,016	0.013	32,187	0.257	7,444	2,000	0	4
45	80	381,016	0.013	80,468	0.257	7,444	2,000	0	10
45	161	381,016	0.013	160,936	0.257	7,444	2,000	0	20
45	322	381,016	0.013	321,873	0.257	7,444	2,000	0	39
45	805	381,016	0.013	804,682	0.257	7,444	2,001	0	98
45	1,609	381,016	0.013	1,609,364	0.257	7,444	2,002	0	196
454	16	3,810,156	0.126	16,094	2.567	74,443	2,002	0	1,960
454	32	3,810,156	0.126	32,187	2.567	74,443	2,005	0	3,914
454	80	3,810,156	0.126	80,468	2.567	74,443	2,012	1	9,749
454	161	3,810,156	0.126	160,936	2.567	74,443	2,025	2	19,380
454	322	3,810,156	0.126	321,873	2.567	74,443	2,049	5	38,298
454	805	3,810,156	0.126	804,682	2.567	74,443	2,120	11	92,485
454	1,609	3,810,156	0.126	1,609,364	2.567	74,443	2,234	21	175,299
4,536	16	38,101,560	1.260	16,094	25.668	744,430	2,234	209	1,752,985
4,536	32	38,101,560	1.260	32,187	25.668	744,430	2,445	379	3,187,650
4,536	80	38,101,560	1.260	80,468	25.668	744,430	2,992	760	6,384,080
4,536	161	38,101,560	1.260	160,936	25.668	744,430	3,728	1,175	9,873,834
4,536	322	38,101,560	1.260	321,873	25.668	744,430	4,879	1,683	14,136,965
4,536	805	38,101,560	1.260	804,682	25.668	744,430	7,314	2,447	20,557,833
4,536	1,609	38,101,560	1.260	1,609,364	25.668	744,430	10,149	3,066	25,750,421
45,359	16	381,015,600	12.600	16,094	256.679	7,444,299	10,149	30,655	257,504,206
45,359	32	381,015,600	12.600	32,187	256.679	7,444,299	14,213	37,011	310,895,909
45,359	80	381,015,600	12.600	80,468	256.679	7,444,299	22,338	45,546	382,583,212
45,359	161	381,015,600	12.600	160,936	256.679	7,444,299	31,528	52,049	437,210,943
45,359	322	381,015,600	12.600	321,873	256.679	7,444,299	44,542	58,571	491,997,371
45,359	805	381,015,600	12.600	804,682	256.679	7,444,299	70,384	67,207	564,536,199
45,359	1,609	381,015,600	12.600	1,609,364	256.679	7,444,299	99,518	73,744	619,450,278

E.8 PIPELINE DELIVERY OF HYDROGEN - SI Units (continued)													
Production Rate (lb/hr)	Delivery Distance (miles)	Compressor Cost (\$)	Pipeline Cost (\$)	Total Capital Cost (\$)	Annual Electric Cost (\$/yr)	Depreciation (\$/yr)	Total Annual Cost (\$/yr)	Capital Cost (\$/lb)	Electric Cost (\$/lb)	Total Cost (\$/lb)	Compressor Cost (\$/lb)	Pipeline Cost (\$/lb)	
5	16	0	10,000,000	10,000,000	\$0	\$454,545	\$454,545	\$11.93	\$0.00	\$11.93	\$0.00	\$11.93	
5	32	0	20,000,000	20,000,000	\$0	\$909,091	\$909,091	\$23.86	\$0.00	\$23.86	\$0.00	\$23.86	
5	80	0	50,000,000	50,000,000	\$0	\$2,272,727	\$2,272,727	\$59.65	\$0.00	\$59.65	\$0.00	\$59.65	
5	161	0	100,000,000	100,000,000	\$0	\$4,545,455	\$4,545,455	\$119.30	\$0.00	\$119.30	\$0.00	\$119.30	
5	322	0	200,000,000	200,000,000	\$0	\$9,090,909	\$9,090,909	\$238.60	\$0.00	\$238.60	\$0.00	\$238.60	
5	805	0	500,000,000	500,000,000	\$0	\$22,727,273	\$22,727,273	\$596.49	\$0.00	\$596.49	\$0.00	\$596.49	
5	1,609	1	1,000,000,000	1,000,000,001	\$0	\$45,454,545	\$45,454,545	\$1,192.98	\$0.00	\$1,192.98	\$0.00	\$1,192.98	
45	16	4	10,000,000	10,000,004	\$0	\$454,546	\$454,546	\$1.19	\$0.00	\$1.19	\$0.00	\$1.19	
45	32	8	20,000,000	20,000,008	\$0	\$909,091	\$909,091	\$2.39	\$0.00	\$2.39	\$0.00	\$2.39	
45	80	16	50,000,000	50,000,016	\$0	\$2,272,728	\$2,272,728	\$5.96	\$0.00	\$5.96	\$0.00	\$5.96	
45	161	27	100,000,000	100,000,027	\$1	\$4,545,456	\$4,545,457	\$11.93	\$0.00	\$11.93	\$0.00	\$11.93	
45	322	47	200,000,000	200,000,047	\$2	\$9,090,911	\$9,090,913	\$23.86	\$0.00	\$23.86	\$0.00	\$23.86	
45	805	99	500,000,000	500,000,099	\$5	\$22,727,277	\$22,727,282	\$59.65	\$0.00	\$59.65	\$0.00	\$59.65	
45	1,609	172	1,000,000,000	1,000,000,172	\$10	\$45,454,553	\$45,454,563	\$119.30	\$0.00	\$119.30	\$0.00	\$119.30	
454	16	1,083	10,000,000	10,001,083	\$98	\$454,595	\$454,693	\$0.12	\$0.00	\$0.12	\$0.00	\$0.12	
454	32	1,885	20,000,000	20,001,885	\$196	\$909,177	\$909,372	\$0.24	\$0.00	\$0.24	\$0.00	\$0.24	
454	80	3,914	50,000,000	50,003,914	\$487	\$2,272,905	\$2,273,393	\$0.60	\$0.00	\$0.60	\$0.00	\$0.60	
454	161	6,789	100,000,000	100,006,789	\$969	\$4,545,763	\$4,546,732	\$1.19	\$0.00	\$1.19	\$0.00	\$1.19	
454	322	11,733	200,000,000	200,011,733	\$1,915	\$9,091,442	\$9,093,357	\$2.39	\$0.00	\$2.39	\$0.00	\$2.39	
454	805	23,900	500,000,000	500,023,900	\$4,624	\$22,728,359	\$22,732,983	\$5.97	\$0.00	\$5.97	\$0.00	\$5.97	
454	1,609	40,240	1,000,000,000	1,000,040,240	\$8,765	\$45,456,375	\$45,465,139	\$11.93	\$0.00	\$11.93	\$0.00	\$11.93	
4,536	16	253,895	10,000,000	10,253,895	\$87,649	\$466,086	\$553,735	\$0.01	\$0.00	\$0.01	\$0.00	\$0.01	
4,536	32	416,373	20,000,000	20,416,373	\$159,382	\$928,017	\$1,087,399	\$0.02	\$0.00	\$0.03	\$0.00	\$0.02	
4,536	80	752,568	50,000,000	50,752,568	\$319,204	\$2,306,935	\$2,626,139	\$0.06	\$0.01	\$0.07	\$0.00	\$0.06	
4,536	161	1,109,846	100,000,000	101,109,846	\$493,692	\$4,595,902	\$5,089,594	\$0.12	\$0.01	\$0.13	\$0.00	\$0.12	
4,536	322	1,552,315	200,000,000	201,552,315	\$706,848	\$9,161,469	\$9,868,317	\$0.24	\$0.02	\$0.26	\$0.00	\$0.24	
4,536	805	2,252,872	500,000,000	502,252,872	\$1,027,892	\$22,829,676	\$23,857,568	\$0.60	\$0.03	\$0.63	\$0.00	\$0.60	
4,536	1,609	2,861,447	1,000,000,000	1,002,861,447	\$1,287,521	\$45,584,611	\$46,872,132	\$1.20	\$0.03	\$1.23	\$0.00	\$1.19	
45,359	16	18,054,508	10,000,000	28,054,508	\$12,875,210	\$1,275,205	\$14,150,415	\$0.00	\$0.03	\$0.04	\$0.00	\$0.00	
45,359	32	22,303,677	20,000,000	42,303,677	\$15,544,795	\$1,922,894	\$17,467,690	\$0.01	\$0.04	\$0.05	\$0.00	\$0.00	
45,359	80	28,563,578	50,000,000	78,563,578	\$19,129,161	\$3,571,072	\$22,700,232	\$0.01	\$0.05	\$0.06	\$0.00	\$0.01	
45,359	161	33,815,859	100,000,000	133,815,859	\$21,860,547	\$6,082,539	\$27,943,086	\$0.02	\$0.06	\$0.07	\$0.00	\$0.01	
45,359	322	39,550,484	200,000,000	239,550,484	\$24,599,869	\$10,888,658	\$35,488,527	\$0.03	\$0.06	\$0.09	\$0.00	\$0.02	
45,359	805	47,940,472	500,000,000	547,940,472	\$28,226,810	\$24,906,385	\$53,133,195	\$0.07	\$0.07	\$0.14	\$0.01	\$0.06	
45,359	1,609	54,958,003	1,000,000,000	1,054,958,003	\$30,972,514	\$47,952,637	\$78,925,150	\$0.13	\$0.08	\$0.21	\$0.01	\$0.12	

E.8 PIPELINE DELIVERY OF HYDROGEN - English Units									
Compressor Capital Cost=		\$1,000	per kW						
Compressor Size=		4,000	kW						
Compressor Pressure=		20	MPa						
Comp. Cost Scale-Up=		0.80							
Comp. Pressure Scale-Up=		0.18							
Pipeline Cost=		\$1,000,000	per mile						
Electric Cost=		\$0.05	per kWh						
Compressor Power=		1.00	kWh/lb (20 MPa)						
Steel Roughness=		4.6E-05	m						
Pipe Diameter=		0.25	m						
Temperature=		283	K						
Delivery Pressure=		2	Mpa						
Viscosity=		8.62E-06	kg/m*s						
R (hydrogen)=		4124	N*m/kg K						
Operating Days/Year=		350	days/yr						
Pipeline Depreciation=		22	years						
Roughness/Diameter=		0.000184							
Fanning friction factor, f=		0.005							
Pipe Area=		0.049	sq. m						
Production Rate	Delivery Distance	Annual Production	Flowrate	Distance	Gas Flux	Reynolds Number	Inlet Pressure	Compressor Size	Annual Electric Use
(lb/hr)	(miles)	(lb/yr)	(kg/s)	(m)	(kg/s*m ²)	Number	(MPa)	(kW)	(kWh/yr)
10	10	84,000	0.001	16,094	0.026	744	2,000	0	0
10	20	84,000	0.001	32,187	0.026	744	2,000	0	0
10	50	84,000	0.001	80,468	0.026	744	2,000	0	0
10	100	84,000	0.001	160,936	0.026	744	2,000	0	0
10	200	84,000	0.001	321,873	0.026	744	2,000	0	0
10	500	84,000	0.001	804,682	0.026	744	2,000	0	0
10	1,000	84,000	0.001	1,609,364	0.026	744	2,000	0	0
100	10	840,000	0.013	16,094	0.257	7,444	2,000	0	2
100	20	840,000	0.013	32,187	0.257	7,444	2,000	0	4
100	50	840,000	0.013	80,468	0.257	7,444	2,000	0	10
100	100	840,000	0.013	160,936	0.257	7,444	2,000	0	20
100	200	840,000	0.013	321,873	0.257	7,444	2,000	0	39
100	500	840,000	0.013	804,682	0.257	7,444	2,001	0	98
100	1,000	840,000	0.013	1,609,364	0.257	7,444	2,002	0	196
1,000	10	8,400,000	0.126	16,094	2.567	74,443	2,002	0	1,960
1,000	20	8,400,000	0.126	32,187	2.567	74,443	2,005	0	3,914
1,000	50	8,400,000	0.126	80,468	2.567	74,443	2,012	1	9,749
1,000	100	8,400,000	0.126	160,936	2.567	74,443	2,025	2	19,380
1,000	200	8,400,000	0.126	321,873	2.567	74,443	2,049	5	38,298
1,000	500	8,400,000	0.126	804,682	2.567	74,443	2,120	11	92,485
1,000	1,000	8,400,000	0.126	1,609,364	2.567	74,443	2,234	21	175,299
10,000	10	84,000,000	1.260	16,094	25.668	744,430	2,234	209	1,752,985
10,000	20	84,000,000	1.260	32,187	25.668	744,430	2,445	379	3,187,650
10,000	50	84,000,000	1.260	80,468	25.668	744,430	2,992	760	6,384,080
10,000	100	84,000,000	1.260	160,936	25.668	744,430	3,728	1,175	9,873,834
10,000	200	84,000,000	1.260	321,873	25.668	744,430	4,879	1,683	14,136,965
10,000	500	84,000,000	1.260	804,682	25.668	744,430	7,314	2,447	20,557,833
10,000	1,000	84,000,000	1.260	1,609,364	25.668	744,430	10,149	3,066	25,750,421
100,000	10	840,000,000	12.600	16,094	256.679	7,444,299	10,149	30,655	257,504,206
100,000	20	840,000,000	12.600	32,187	256.679	7,444,299	14,213	37,011	310,895,909
100,000	50	840,000,000	12.600	80,468	256.679	7,444,299	22,338	45,546	382,583,212
100,000	100	840,000,000	12.600	160,936	256.679	7,444,299	31,528	52,049	437,210,943
100,000	200	840,000,000	12.600	321,873	256.679	7,444,299	44,542	58,571	491,997,371
100,000	500	840,000,000	12.600	804,682	256.679	7,444,299	70,384	67,207	564,536,199
100,000	1,000	840,000,000	12.600	1,609,364	256.679	7,444,299	99,518	73,744	619,450,278

E.8 PIPELINE DELIVERY OF HYDROGEN - English Units (continued)													
Production Rate	Delivery Distance	Compressor	Pipeline	Total Capital	Annual Electric	Depreciation	Total Annual	Capital	Electric	Total		Compressor	Pipeline
(lb/hr)	One-Way (miles)	Cost (\$)	Cost (\$)	Cost (\$)	Cost (\$/yr)	(\$/yr)	Cost (\$/yr)	Cost (\$/lb)	Cost (\$/lb)	Cost (\$/lb)		Cost (\$/lb)	Cost (\$/lb)
10	10	0	10,000,000	10,000,000	\$0	\$454,545	\$454,545	\$5.41	\$0.00	\$5.41		\$0.00	\$5.41
10	20	0	20,000,000	20,000,000	\$0	\$909,091	\$909,091	\$10.82	\$0.00	\$10.82		\$0.00	\$10.82
10	50	0	50,000,000	50,000,000	\$0	\$2,272,727	\$2,272,727	\$27.06	\$0.00	\$27.06		\$0.00	\$27.06
10	100	0	100,000,000	100,000,000	\$0	\$4,545,455	\$4,545,455	\$54.11	\$0.00	\$54.11		\$0.00	\$54.11
10	200	0	200,000,000	200,000,000	\$0	\$9,090,909	\$9,090,909	\$108.23	\$0.00	\$108.23		\$0.00	\$108.23
10	500	0	500,000,000	500,000,000	\$0	\$22,727,273	\$22,727,273	\$270.56	\$0.00	\$270.56		\$0.00	\$270.56
10	1,000	1	1,000,000,000	1,000,000,001	\$0	\$45,454,545	\$45,454,545	\$541.13	\$0.00	\$541.13		\$0.00	\$541.13
100	10	4	10,000,000	10,000,004	\$0	\$454,546	\$454,546	\$0.54	\$0.00	\$0.54		\$0.00	\$0.54
100	20	8	20,000,000	20,000,008	\$0	\$909,091	\$909,091	\$1.08	\$0.00	\$1.08		\$0.00	\$1.08
100	50	16	50,000,000	50,000,016	\$0	\$2,272,728	\$2,272,728	\$2.71	\$0.00	\$2.71		\$0.00	\$2.71
100	100	27	100,000,000	100,000,027	\$1	\$4,545,456	\$4,545,457	\$5.41	\$0.00	\$5.41		\$0.00	\$5.41
100	200	47	200,000,000	200,000,047	\$2	\$9,090,911	\$9,090,913	\$10.82	\$0.00	\$10.82		\$0.00	\$10.82
100	500	99	500,000,000	500,000,099	\$5	\$22,727,277	\$22,727,282	\$27.06	\$0.00	\$27.06		\$0.00	\$27.06
100	1,000	172	1,000,000,000	1,000,000,172	\$10	\$45,454,553	\$45,454,563	\$54.11	\$0.00	\$54.11		\$0.00	\$54.11
1,000	10	1,083	10,000,000	10,001,083	\$98	\$454,595	\$454,693	\$0.05	\$0.00	\$0.05		\$0.00	\$0.05
1,000	20	1,885	20,000,000	20,001,885	\$196	\$909,177	\$909,372	\$0.11	\$0.00	\$0.11		\$0.00	\$0.11
1,000	50	3,914	50,000,000	50,003,914	\$487	\$2,272,905	\$2,273,393	\$0.27	\$0.00	\$0.27		\$0.00	\$0.27
1,000	100	6,789	100,000,000	100,006,789	\$969	\$4,545,763	\$4,546,732	\$0.54	\$0.00	\$0.54		\$0.00	\$0.54
1,000	200	11,733	200,000,000	200,011,733	\$1,915	\$9,091,442	\$9,093,357	\$1.08	\$0.00	\$1.08		\$0.00	\$1.08
1,000	500	23,900	500,000,000	500,023,900	\$4,624	\$22,728,359	\$22,732,983	\$2.71	\$0.00	\$2.71		\$0.00	\$2.71
1,000	1,000	40,240	1,000,000,000	1,000,040,240	\$8,765	\$45,456,375	\$45,465,139	\$5.41	\$0.00	\$5.41		\$0.00	\$5.41
10,000	10	253,895	10,000,000	10,253,895	\$87,649	\$466,086	\$553,735	\$0.01	\$0.00	\$0.01		\$0.00	\$0.01
10,000	20	416,373	20,000,000	20,416,373	\$159,382	\$928,017	\$1,087,399	\$0.01	\$0.00	\$0.01		\$0.00	\$0.01
10,000	50	752,568	50,000,000	50,752,568	\$319,204	\$2,306,935	\$2,626,139	\$0.03	\$0.00	\$0.03		\$0.00	\$0.03
10,000	100	1,109,846	100,000,000	101,109,846	\$493,692	\$4,595,902	\$5,089,594	\$0.05	\$0.01	\$0.06		\$0.00	\$0.05
10,000	200	1,552,315	200,000,000	201,552,315	\$706,848	\$9,161,469	\$9,868,317	\$0.11	\$0.01	\$0.12		\$0.00	\$0.11
10,000	500	2,252,872	500,000,000	502,252,872	\$1,027,892	\$22,829,676	\$23,857,568	\$0.27	\$0.01	\$0.28		\$0.00	\$0.27
10,000	1,000	2,861,447	1,000,000,000	1,002,861,447	\$1,287,521	\$45,584,611	\$46,872,132	\$0.54	\$0.02	\$0.56		\$0.00	\$0.54
100,000	10	18,054,508	10,000,000	28,054,508	\$12,875,210	\$1,275,205	\$14,150,415	\$0.00	\$0.02	\$0.02		\$0.00	\$0.00
100,000	20	22,303,677	20,000,000	42,303,677	\$15,544,795	\$1,922,894	\$17,467,690	\$0.00	\$0.02	\$0.02		\$0.00	\$0.00
100,000	50	28,563,578	50,000,000	78,563,578	\$19,129,161	\$3,571,072	\$22,700,232	\$0.00	\$0.02	\$0.03		\$0.00	\$0.00
100,000	100	33,815,859	100,000,000	133,815,859	\$21,860,547	\$6,082,539	\$27,943,086	\$0.01	\$0.03	\$0.03		\$0.00	\$0.01
100,000	200	39,550,484	200,000,000	239,550,484	\$24,599,869	\$10,888,658	\$35,488,527	\$0.01	\$0.03	\$0.04		\$0.00	\$0.01
100,000	500	47,940,472	500,000,000	547,940,472	\$28,226,810	\$24,906,385	\$53,133,195	\$0.03	\$0.03	\$0.06		\$0.00	\$0.03
100,000	1,000	54,958,003	1,000,000,000	1,054,958,003	\$30,972,514	\$47,952,637	\$78,925,150	\$0.06	\$0.04	\$0.09		\$0.00	\$0.05

APPENDIX F - HYDROGEN STORAGE FIGURES

Appendix F contains figures showing important trends and sensitivity analyses for the storage of hydrogen. An index for the figures is included to help find specific information quickly. Most of the graphs either compare the different storage methods, or show a cost breakdown of the capital and operating cost contributions for one storage option.

F.0 INDEX TO HYDROGEN STORAGE FIGURES								
Figure	Method	y-axis	x-axis	Dep. Var. (y)	Ind. Var. (x)	Flow (kg/hr)	Time (days)	Lines
1	All	Norm	Log	Cost (\$/kg)	Flow (kg/hr)			1 Comp
2	All	Norm	Log	Cost (\$/kg)	Flow (kg/hr)			2 Comp
3	All	Norm	Log	Cost (\$/kg)	Flow (kg/hr)			7 Comp.
4	All	Log	Norm	Cost (\$/kg)	Time (d)	5		Comp.
5	All	Log	Norm	Cost (\$/kg)	Time (d)	450		Comp.
6	All	Norm	Norm	Cost (\$/kg)	Elec. Cost (\$/kWh)	450		1 Comp.
7	GH2	Norm	Log	Cost (\$/kg)	Pressure (MPa)			1 Flow (kg/hr)
8	GH2	Norm	Log	Cost (\$/kg)	Pressure (MPa)			7 Flow (kg/hr)
9	GH2	Norm	Log	Cost (\$/kg)	Flow (kg/hr)			1 Costs
10	GH2	Norm	Norm	Cost (\$/kg)	Time (d)	450		Costs
11	GH2	Norm	Log	Cost (\$/kg)	Pressure (MPa)	450		1 Costs
12	GH2	Norm	Norm	Cost (\$/kg)	Pressure (MPa)	450		1 Costs
13	GH2	Norm	Log	Tank Cost (\$/kg)	Capacity (kg)			Pressure (MPa)
14	GH2	Norm	Norm	Tank Cost (\$/kg)	Pressure (MPa)			Capacity (kg)
15	GH2, Under	Norm	Log	Comp. Cost (\$/kW)	Flow (kg/hr)			Pressure (MPa)
16	GH2, Under	Norm	Norm	Comp. Cost (\$/kW)	Pressure (MPa)			Flow (kg/hr)
17	LH2	Norm	Log	Cost (\$/kg)	Flow (kg/hr)			1 Costs
18	LH2	Norm	Norm	Cost (\$/kg)	Time (d)	450		Costs
19	LH2	Norm	Norm	Cost (\$/kg)	BOR (%/d)	450		Time (d)
20	MH2	Norm	Norm	Cost (\$/kg)	Time (d)	450		Costs
21	MH2	Norm	Norm	Cost (\$/kg)	Steam Cost (\$/GJ)	450		Time (d)
22	Under	Norm	Log	Cost (\$/kg)	Flow (kg/hr)			1 Costs
23	Under	Norm	Norm	Cost (\$/kg)	Time (d)	450		Costs
24	Under	Norm	Log	Cost (\$/kg)	Pressure (MPa)			1 Flow (lb/hr)
25	Under	Norm	Log	Cost (\$/kg)	Pressure (MPa)			7 Flow (kg/hr)
26	Under	Norm	Log	Cost (\$/kg)	Pressure (MPa)	450		1 Costs
27	Under	Norm	Norm	Cost (\$/kg)	Pressure (MPa)	450		1 Costs
28	Under	Norm	Log	Cost (\$/kg)	Pressure (MPa)	450		7 Costs
29	Under	Norm	Norm	Cost (\$/kg)	Pressure (MPa)	450		7 Costs

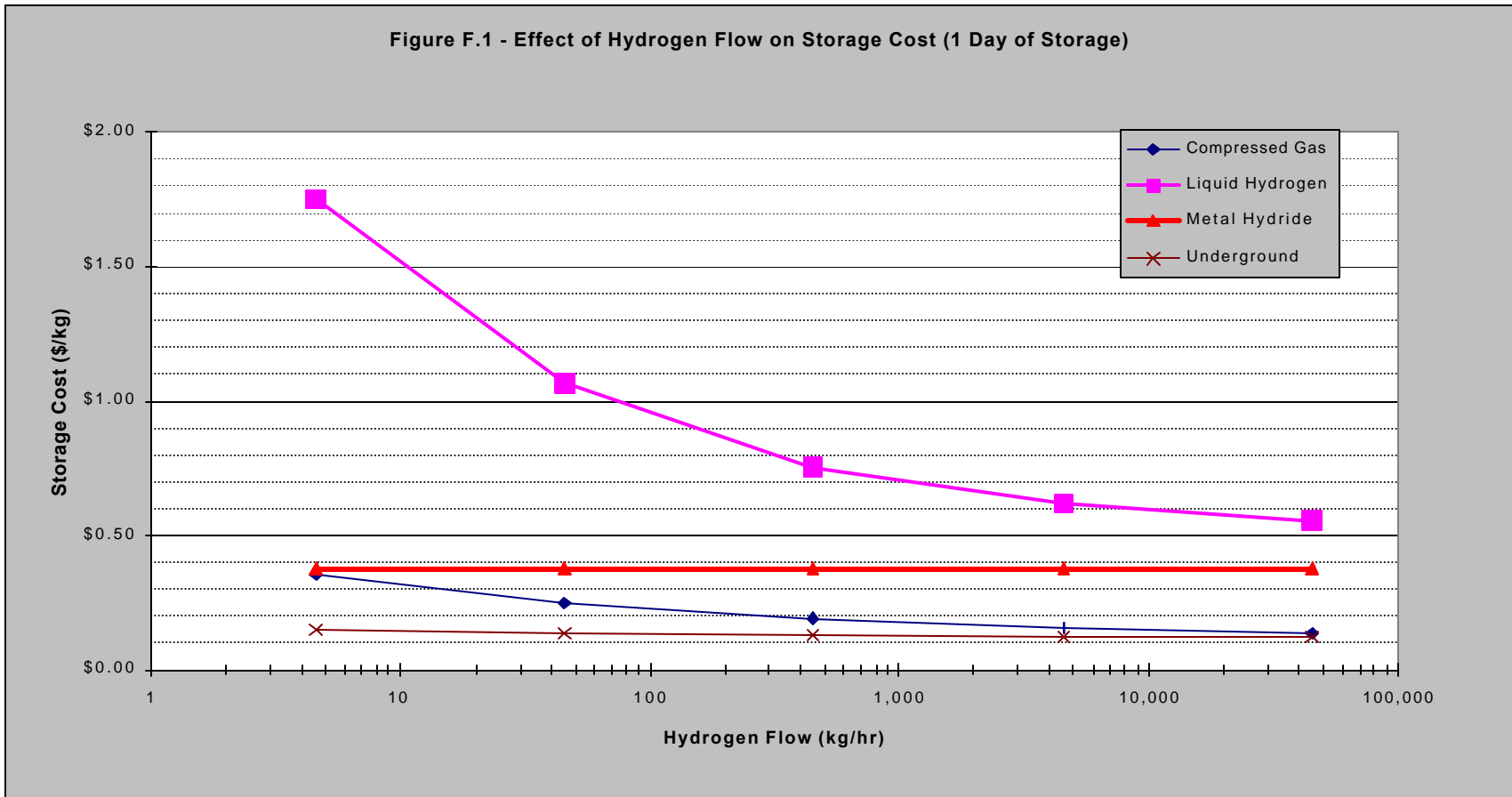

Figure F.1 – Economy of scale drops the liquid hydrogen storage cost as the production rate increases.

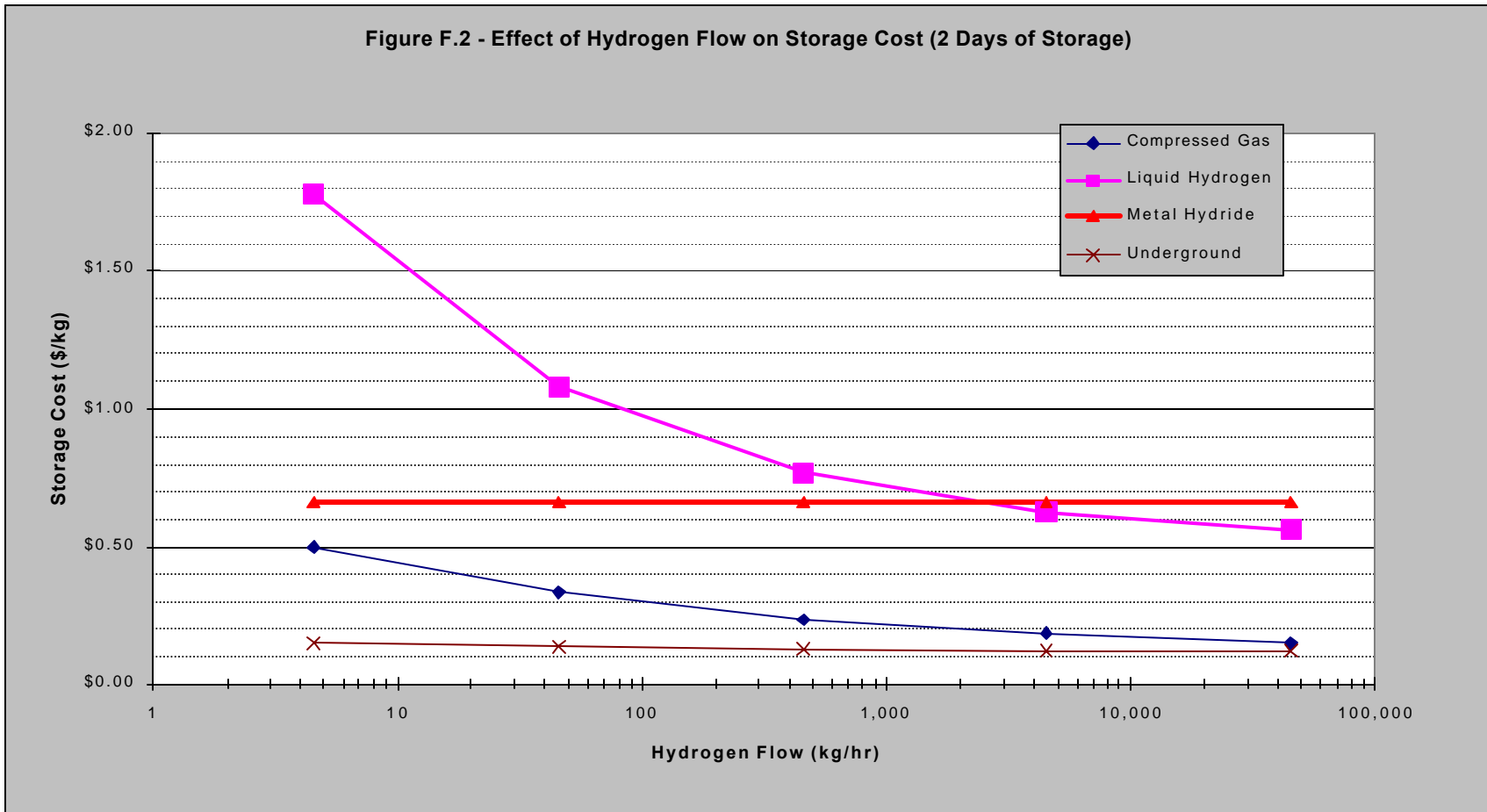

Figure F.2 – At longer storage times, liquid hydrogen storage starts to compete with other methods.

Figure F.3 - Effect of Hydrogen Flow on Storage Cost (7 Days of Storage)

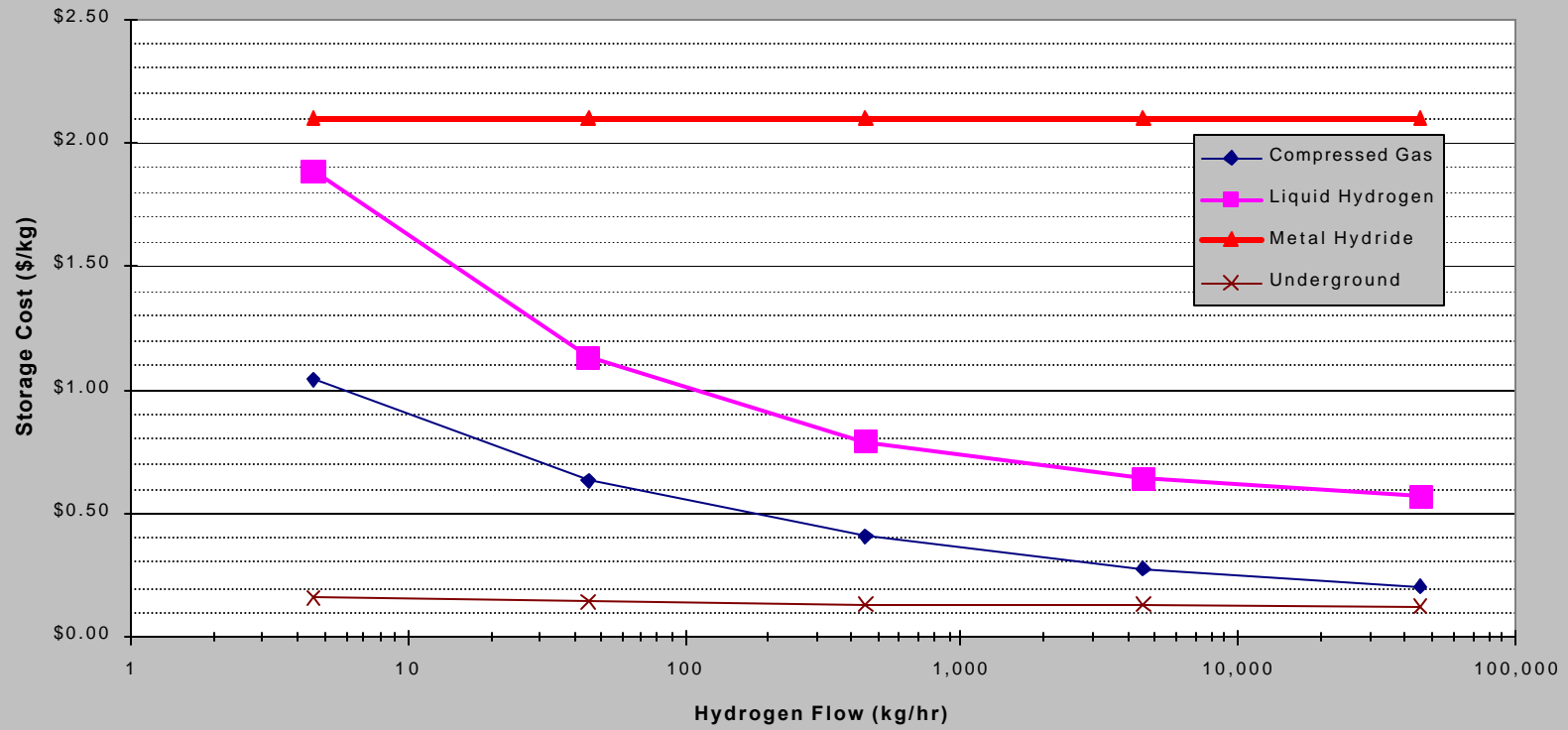

Figure F.3 – Metal hydride storage is not competitive for long storage times due to the high capital cost.

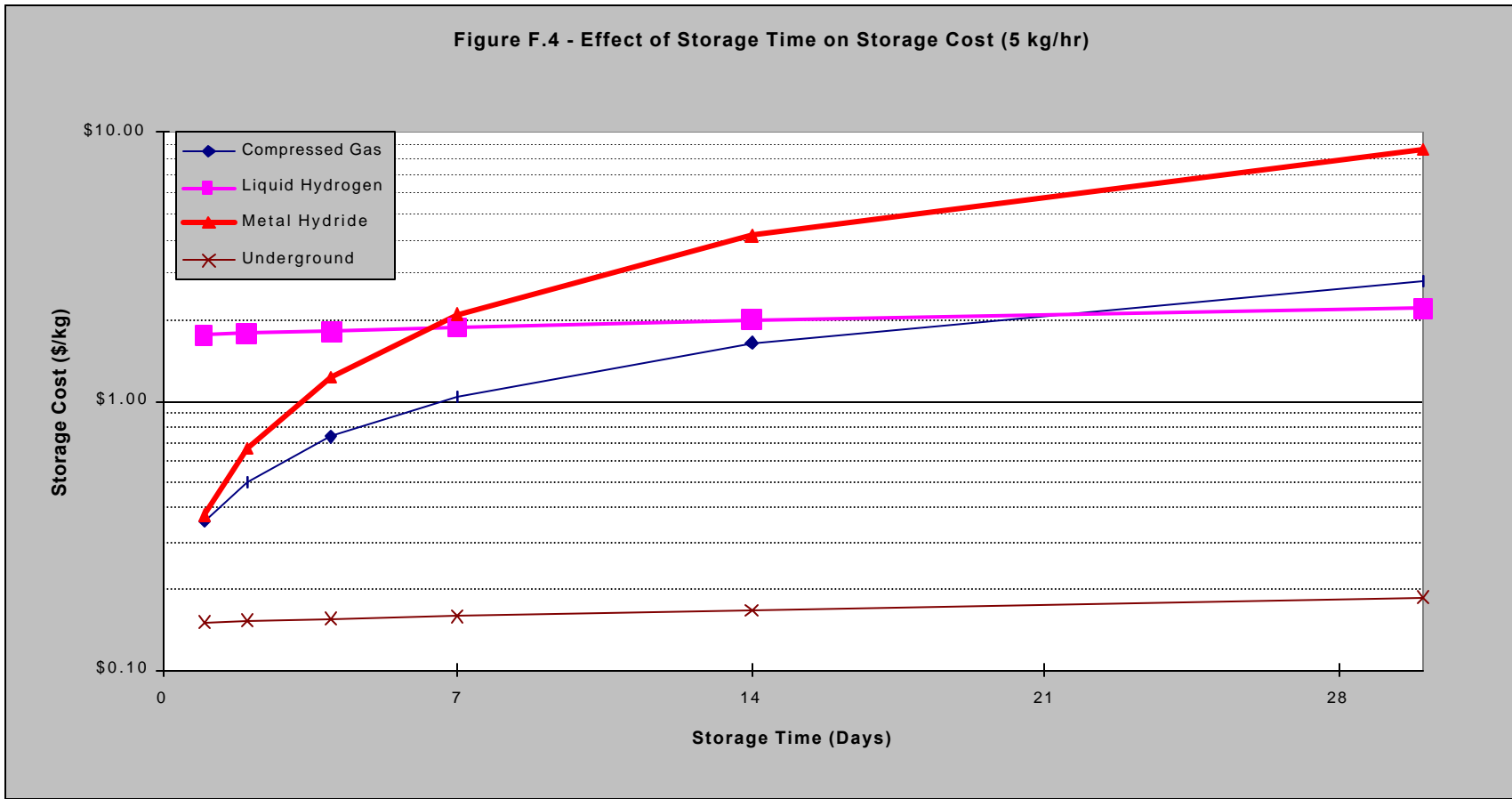

Figure F.4 – Metal hydride and compressed gas storage have comparable costs at low production rates and short storage times.

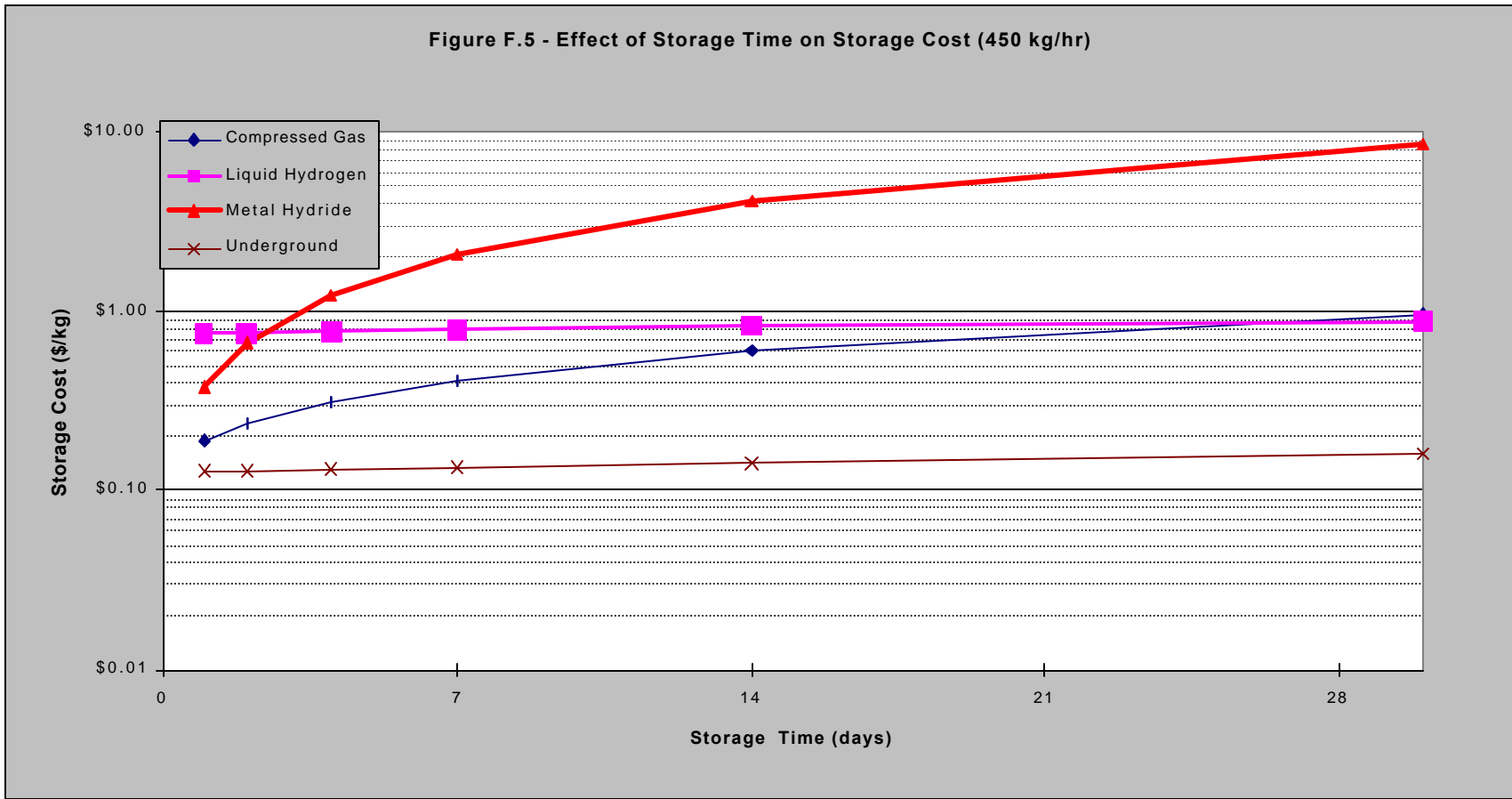

Figure F.5 – Liquid hydrogen and underground storage show relatively little increase in cost with longer storage times due to low capital costs of storage.

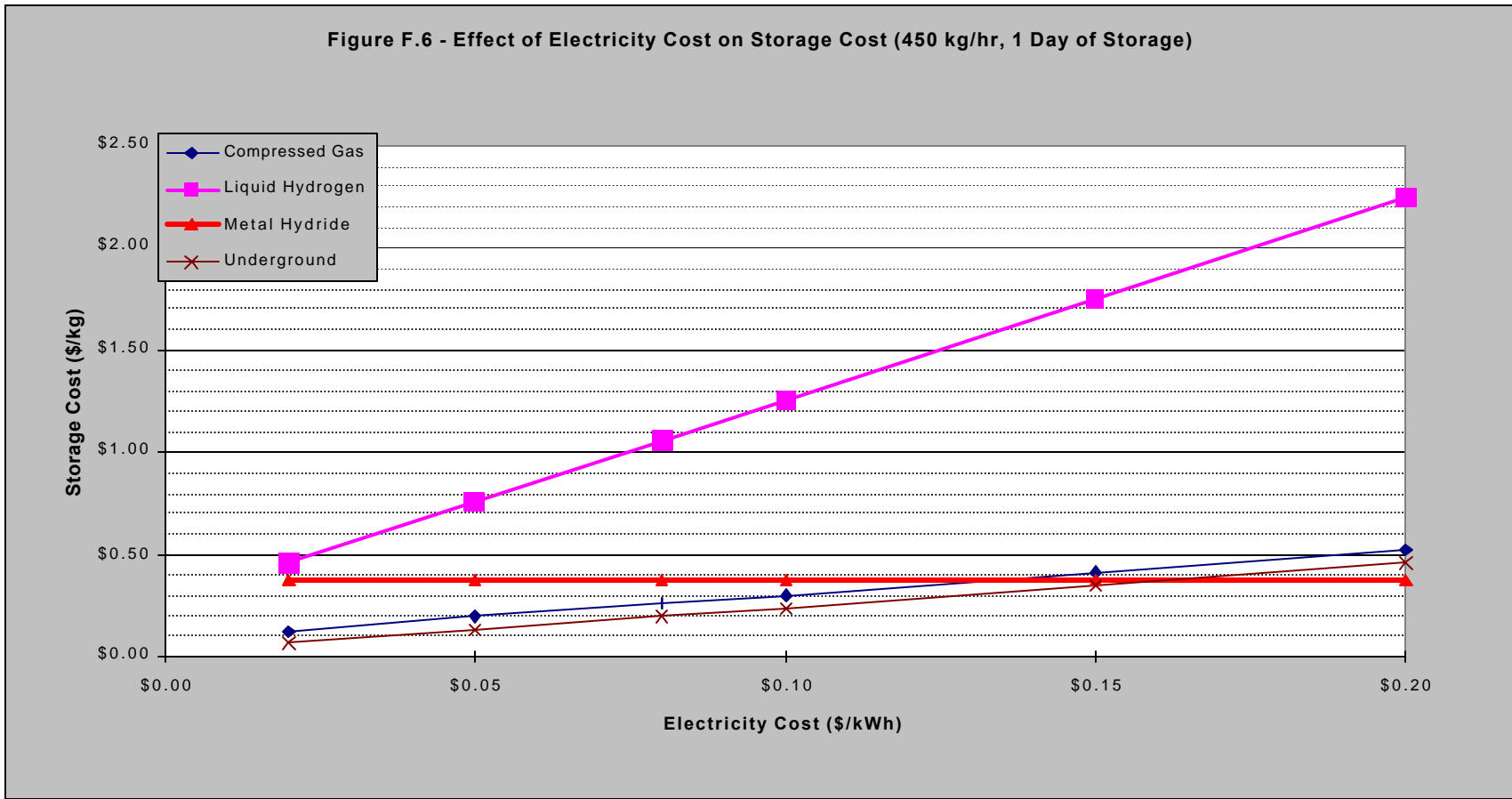

Figure F.6 – Electricity cost has the largest effect on liquid hydrogen storage since it has the highest electricity requirement.

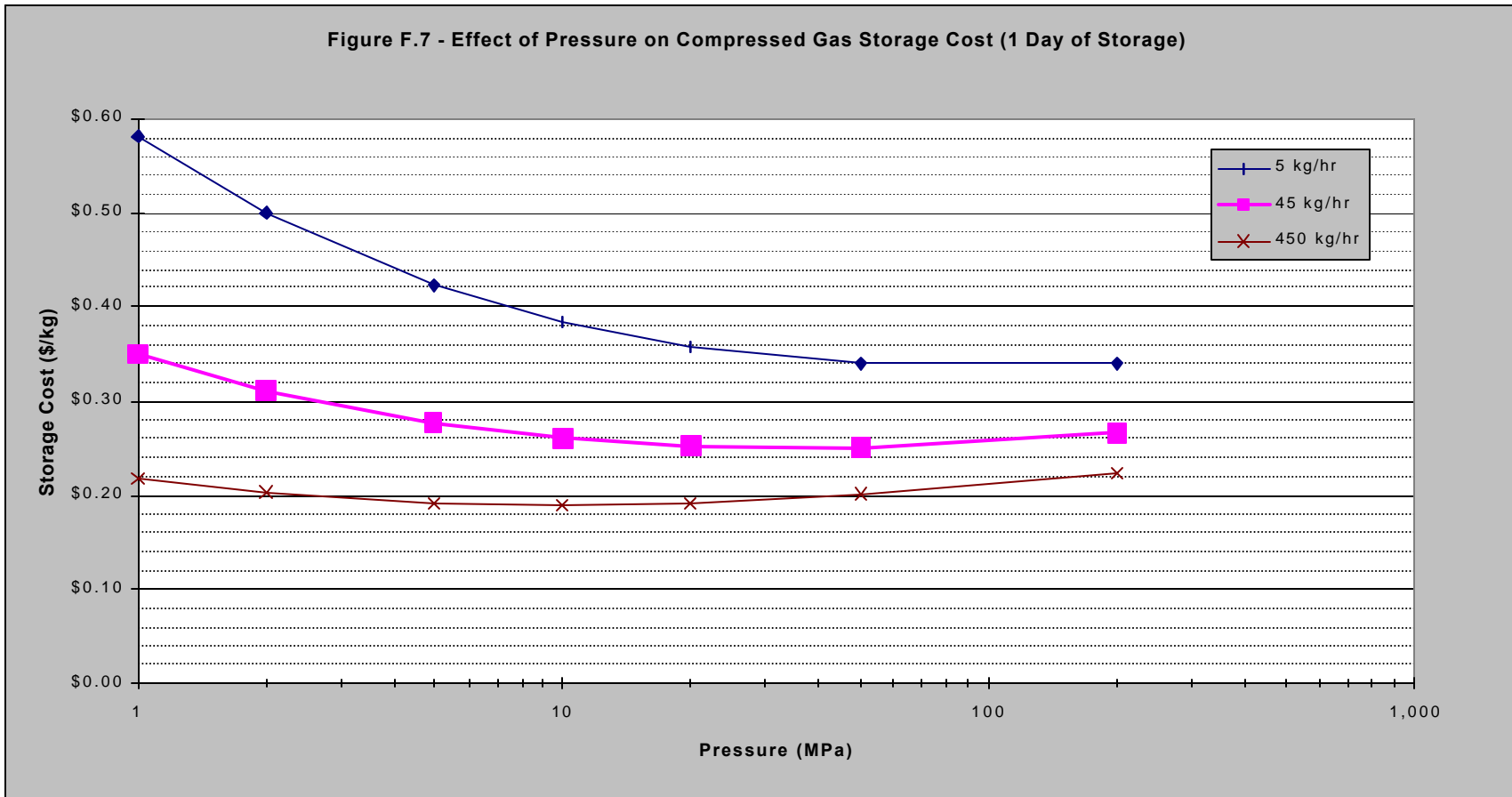

Figure F.7 - For short storage times, an optimum pressure exists for compressed gas storage.

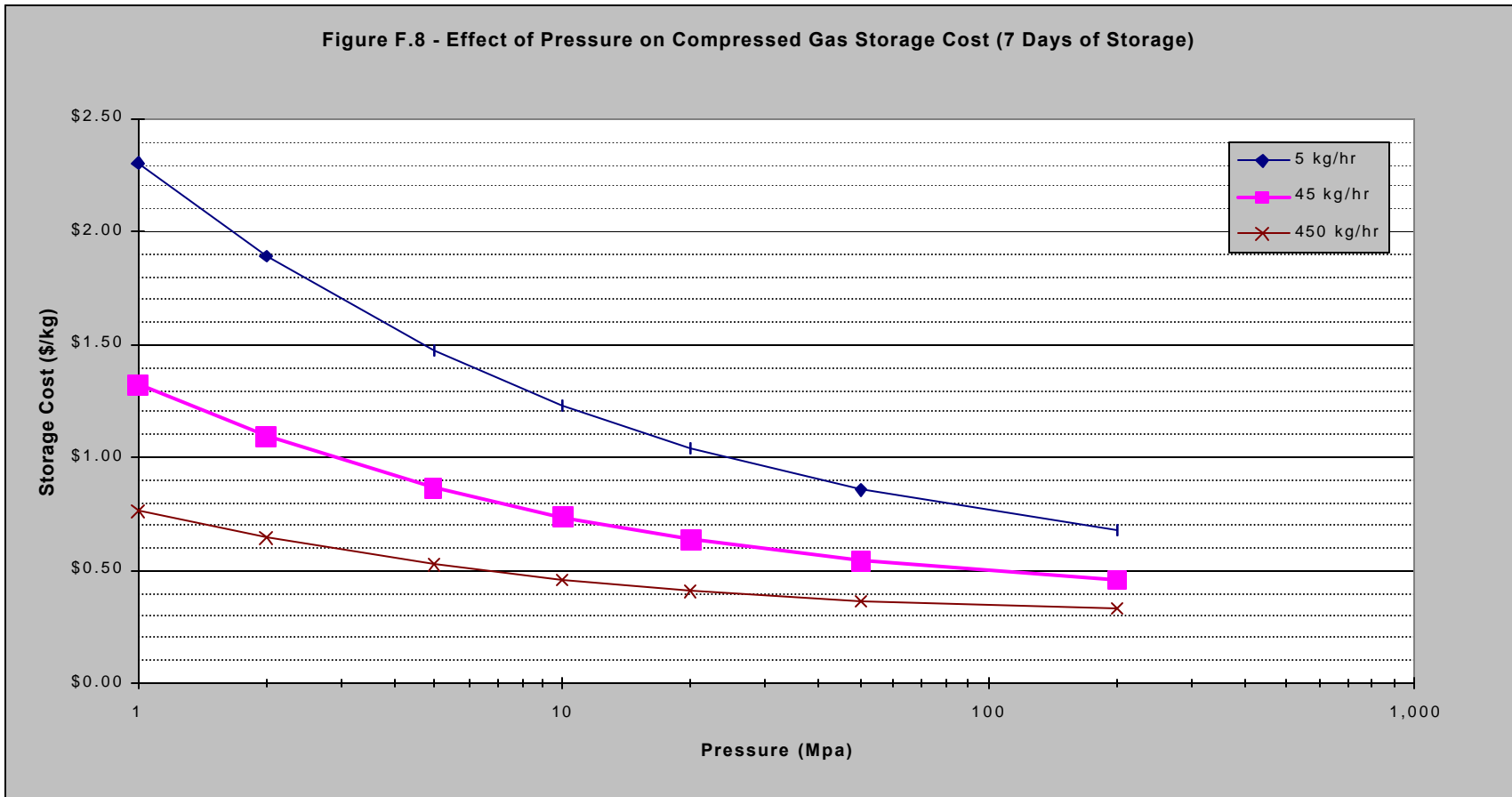

Figure F.8 - For longer storage times, increased capital costs cause high pressures to give the lowest compressed gas storage costs.

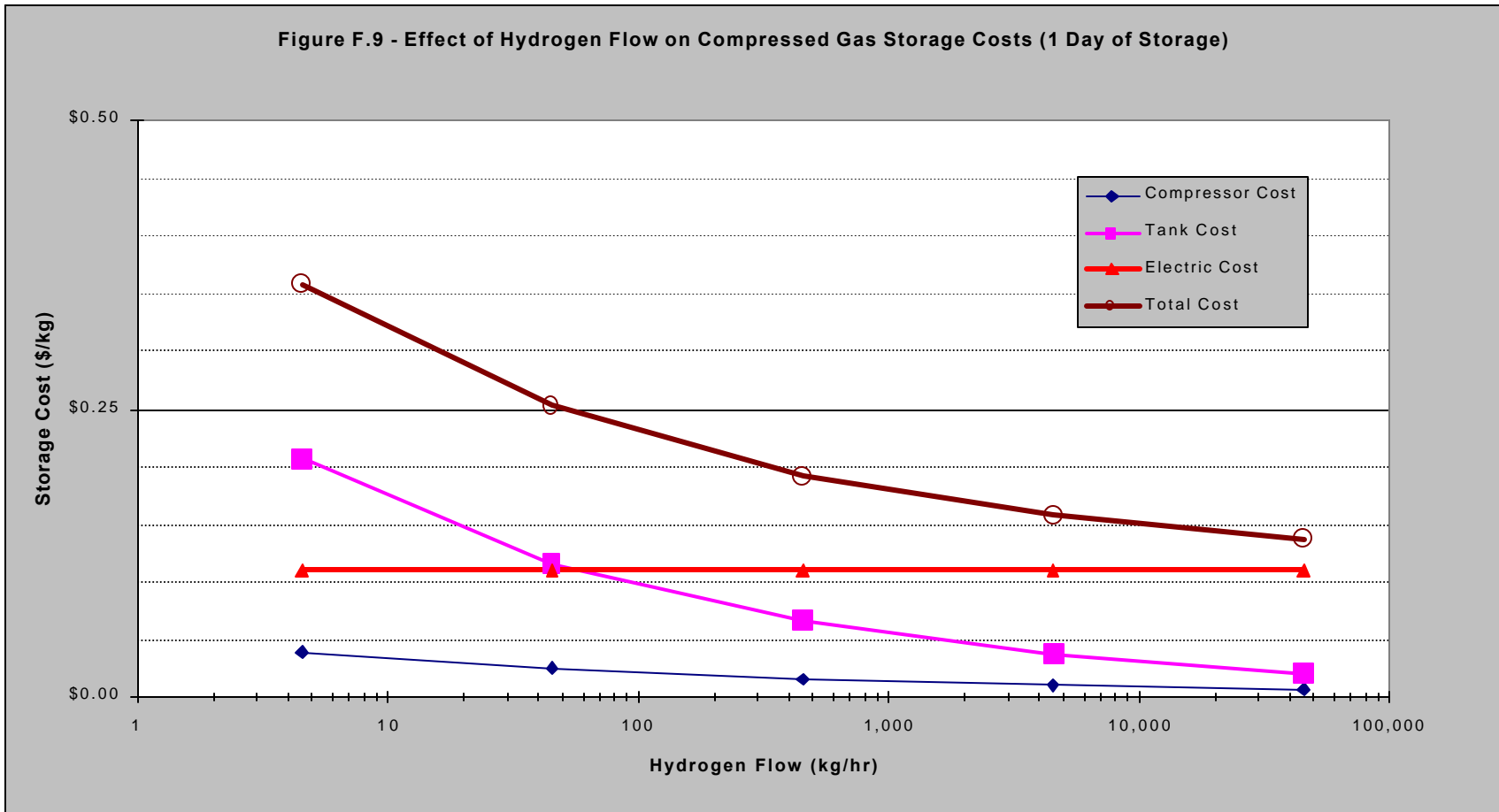

Figure F.9 - The tank cost dominates at low flows, then the compressed gas storage costs are eventually limited by electricity costs.

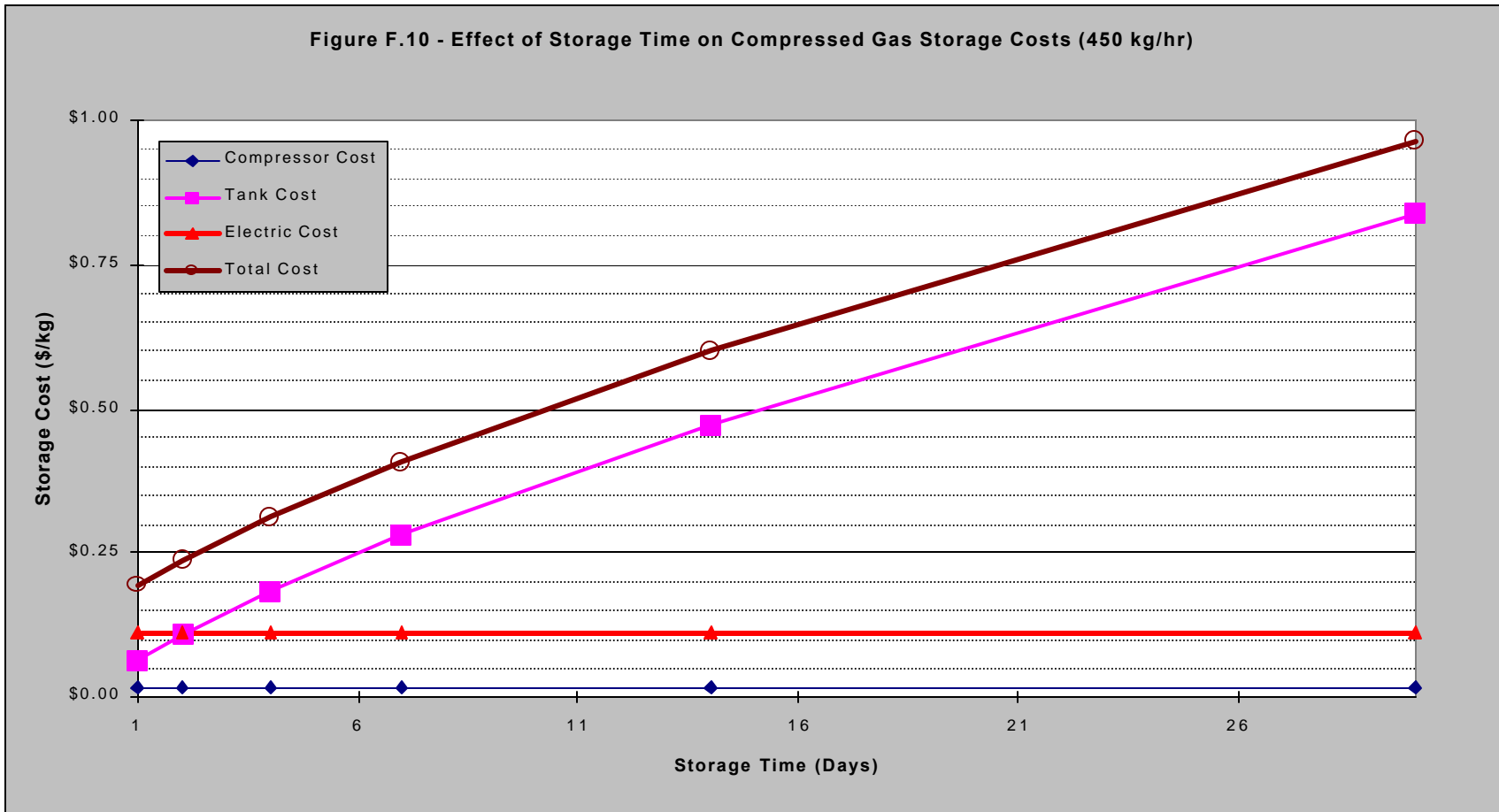

Figure F.10 - The tank cost skyrockets as the storage time increases.

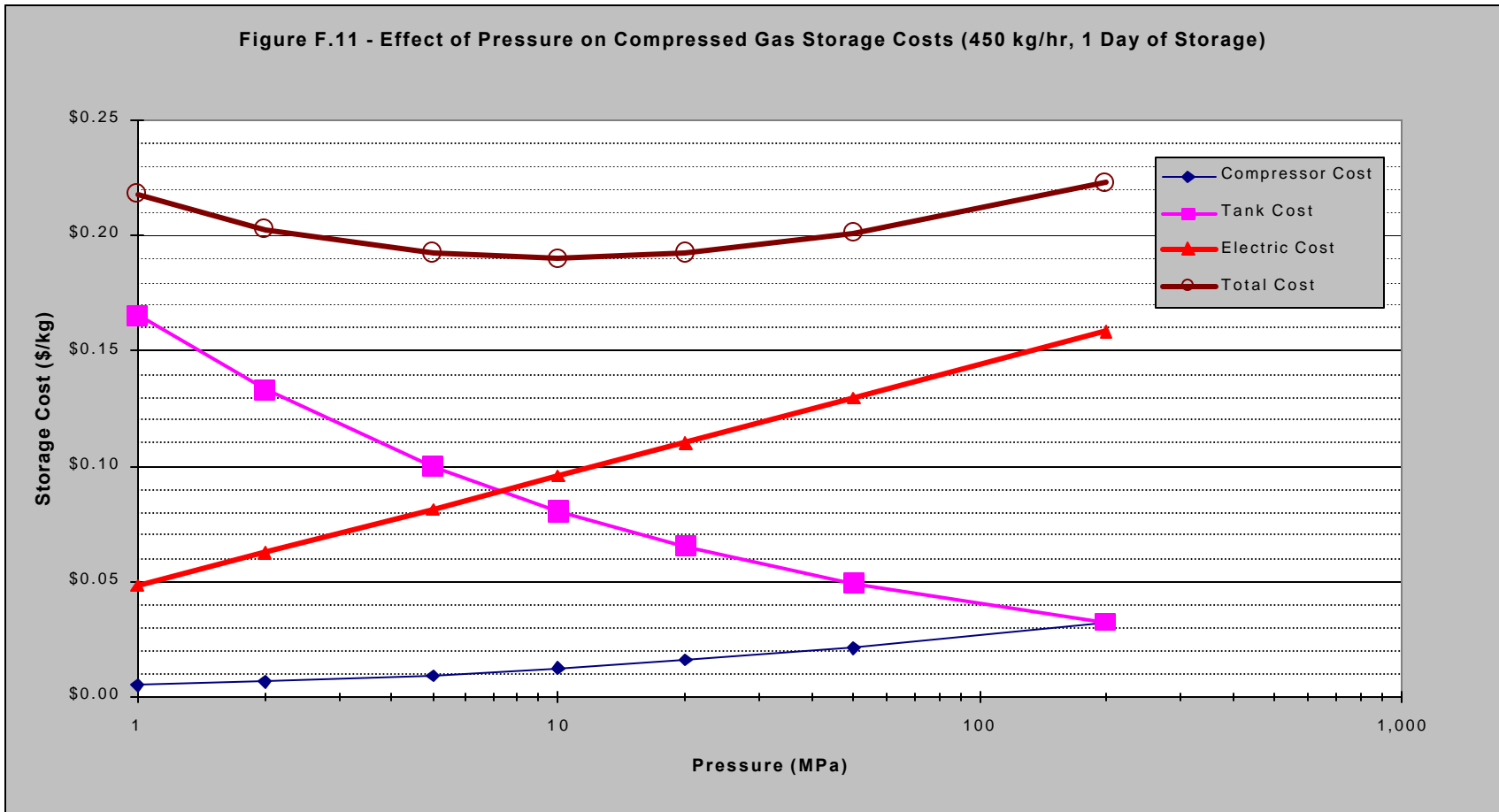

Figure F.11 - The optimum pressure for compressed gas storage occurs due to increasing the electricity cost compared to the reduced tank cost.

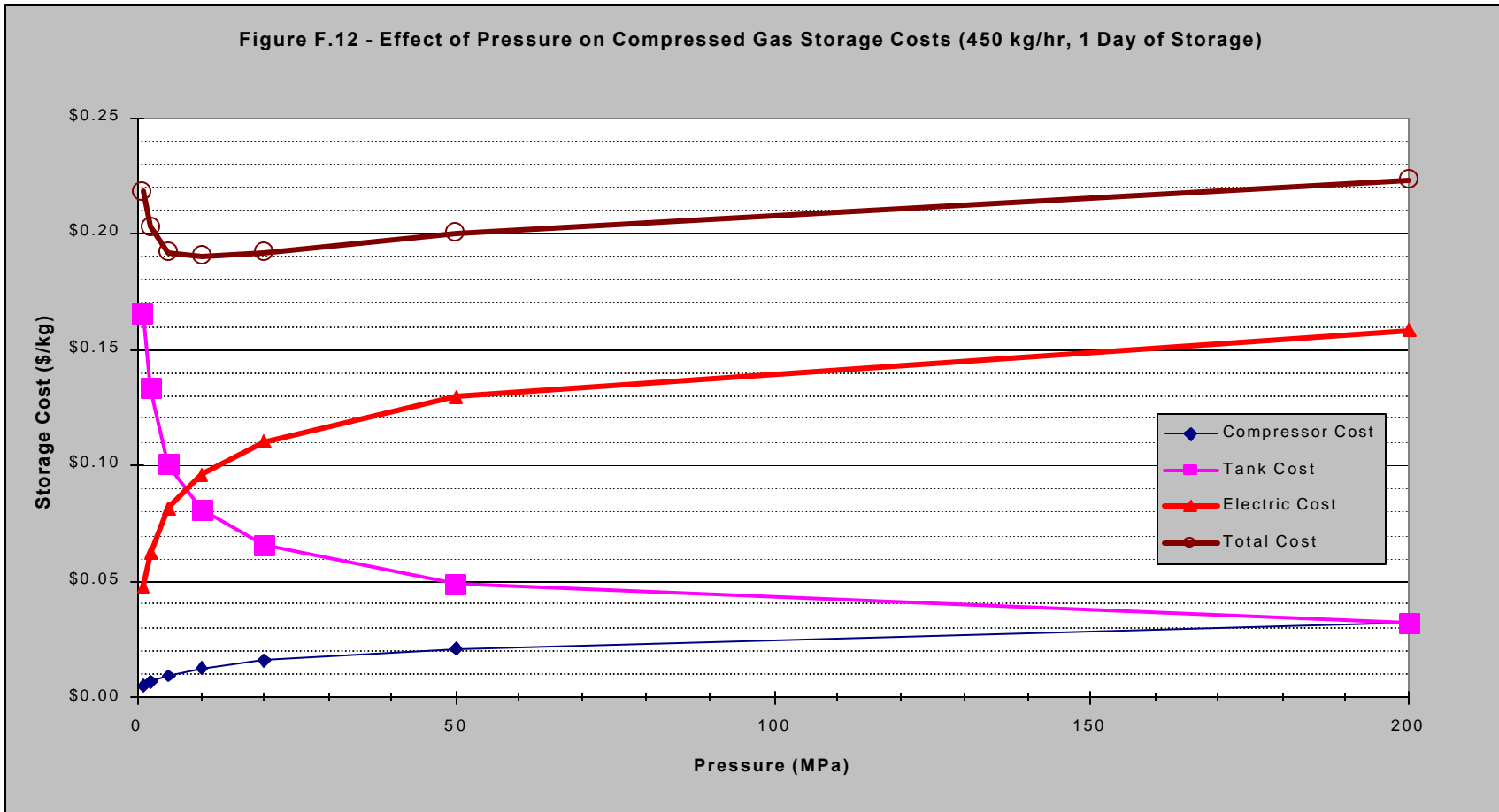

Figure F.12 - Compressor electricity costs initially increase quickly with pressure.

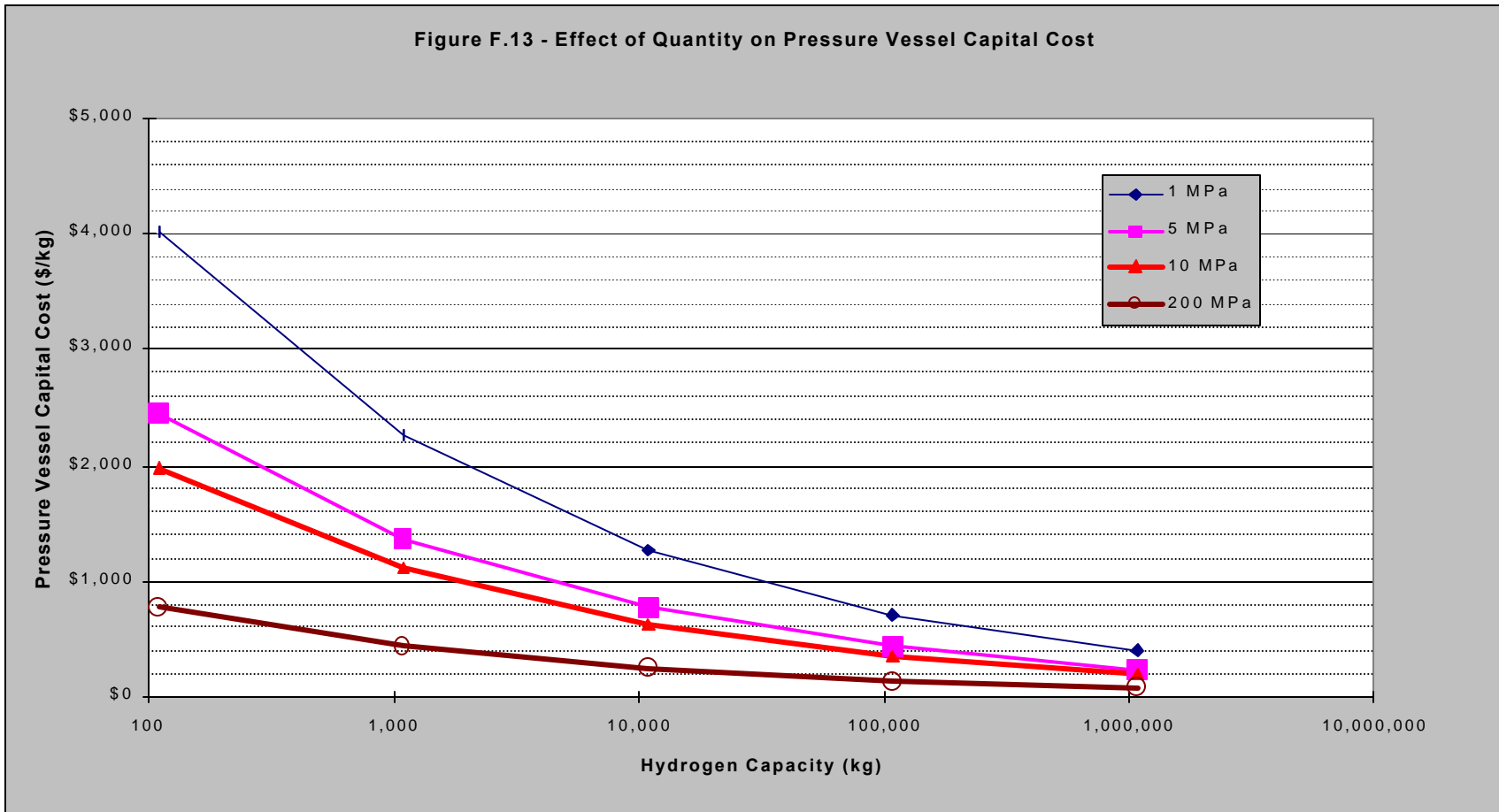

Figure F.13 - Economy of scale reduces compressed gas tank costs and lessens the effect of pressure on the tank capital cost.

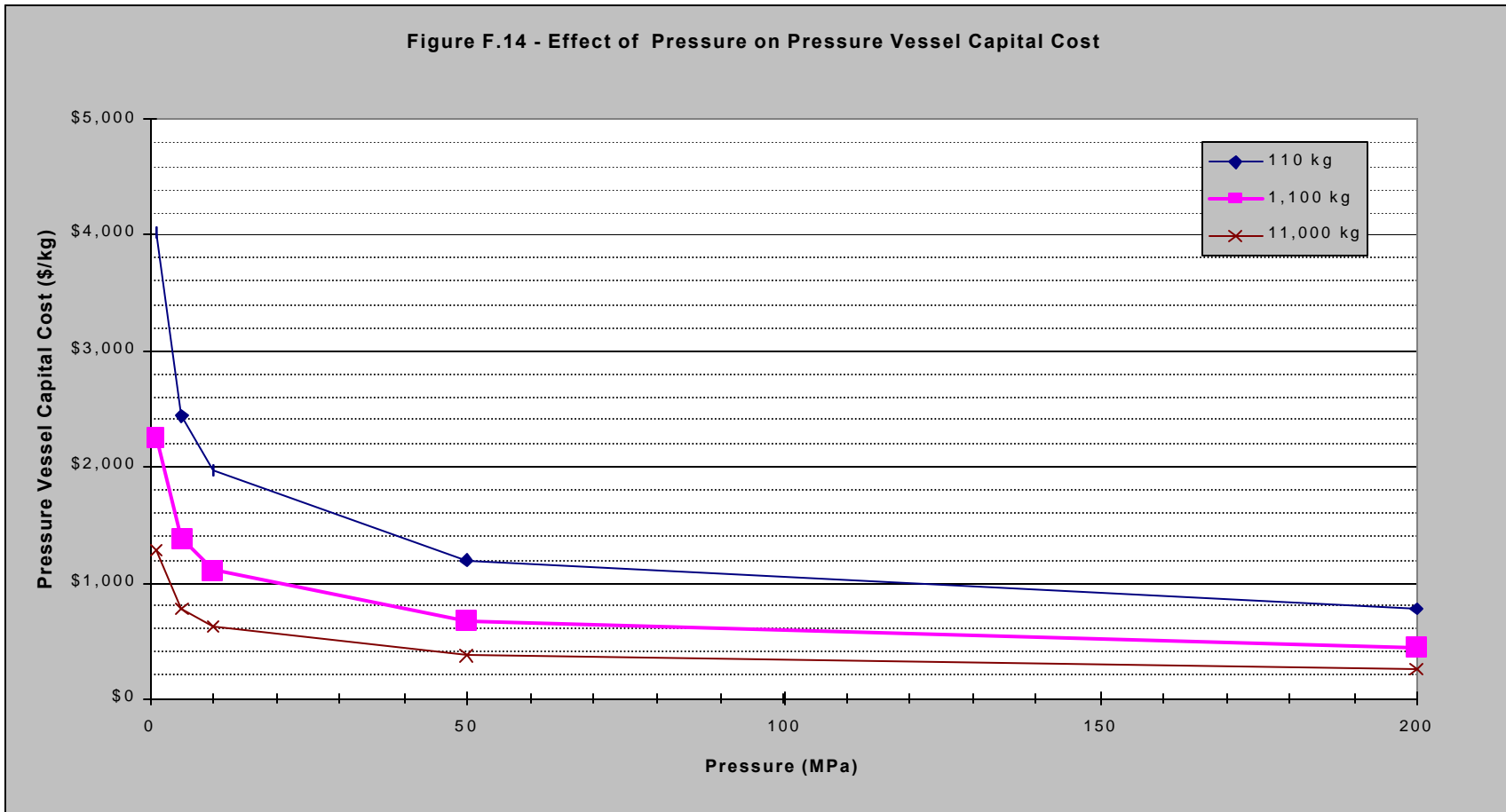

Figure F.14 - Tank costs drop with increased pressures due to smaller vessel size.

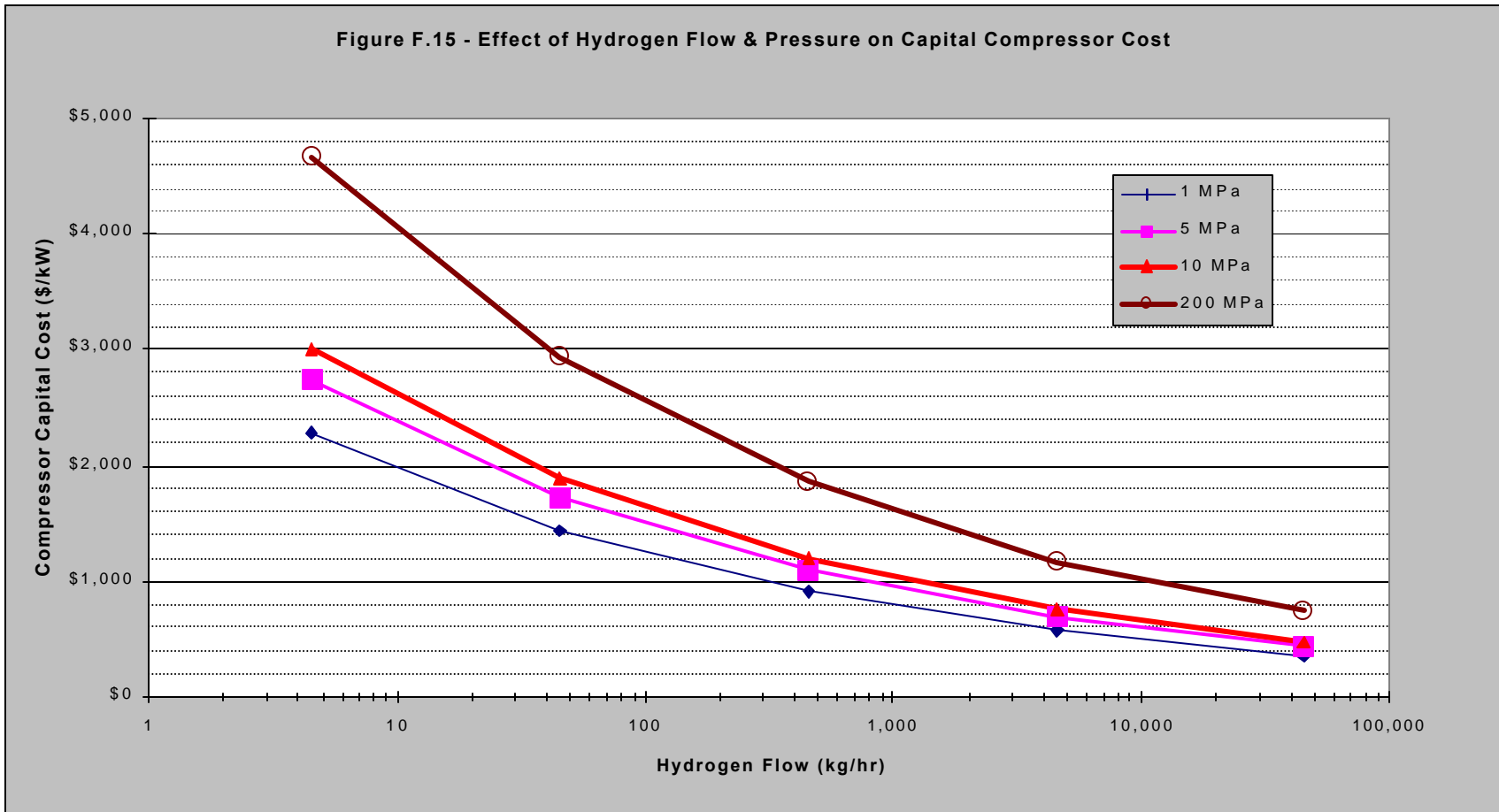

Figure F.15 - Economy of scale reduces compressor capital costs at high flowrates.

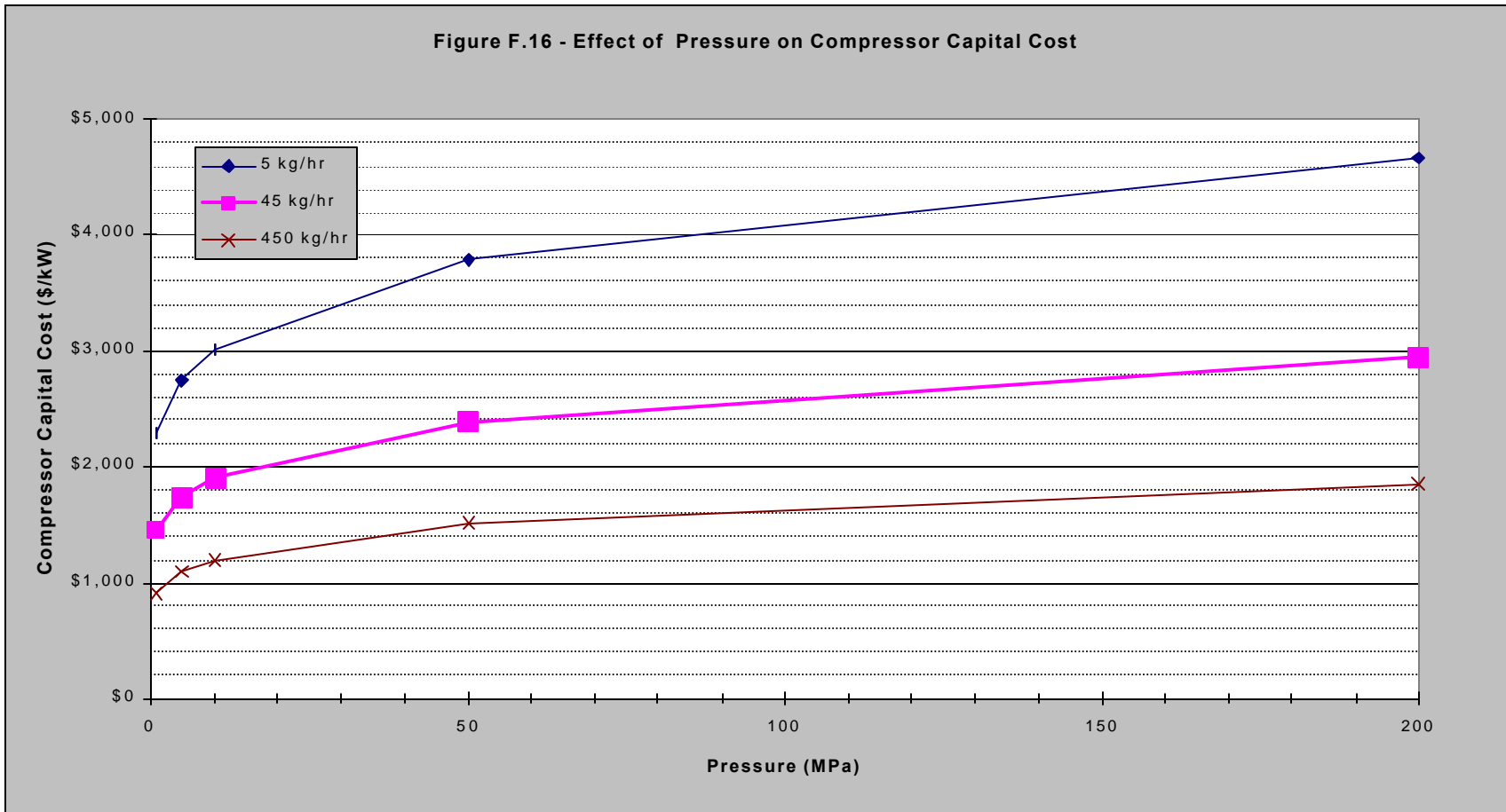

Figure F.16 - Compressor capital costs increase with increased operating pressures.

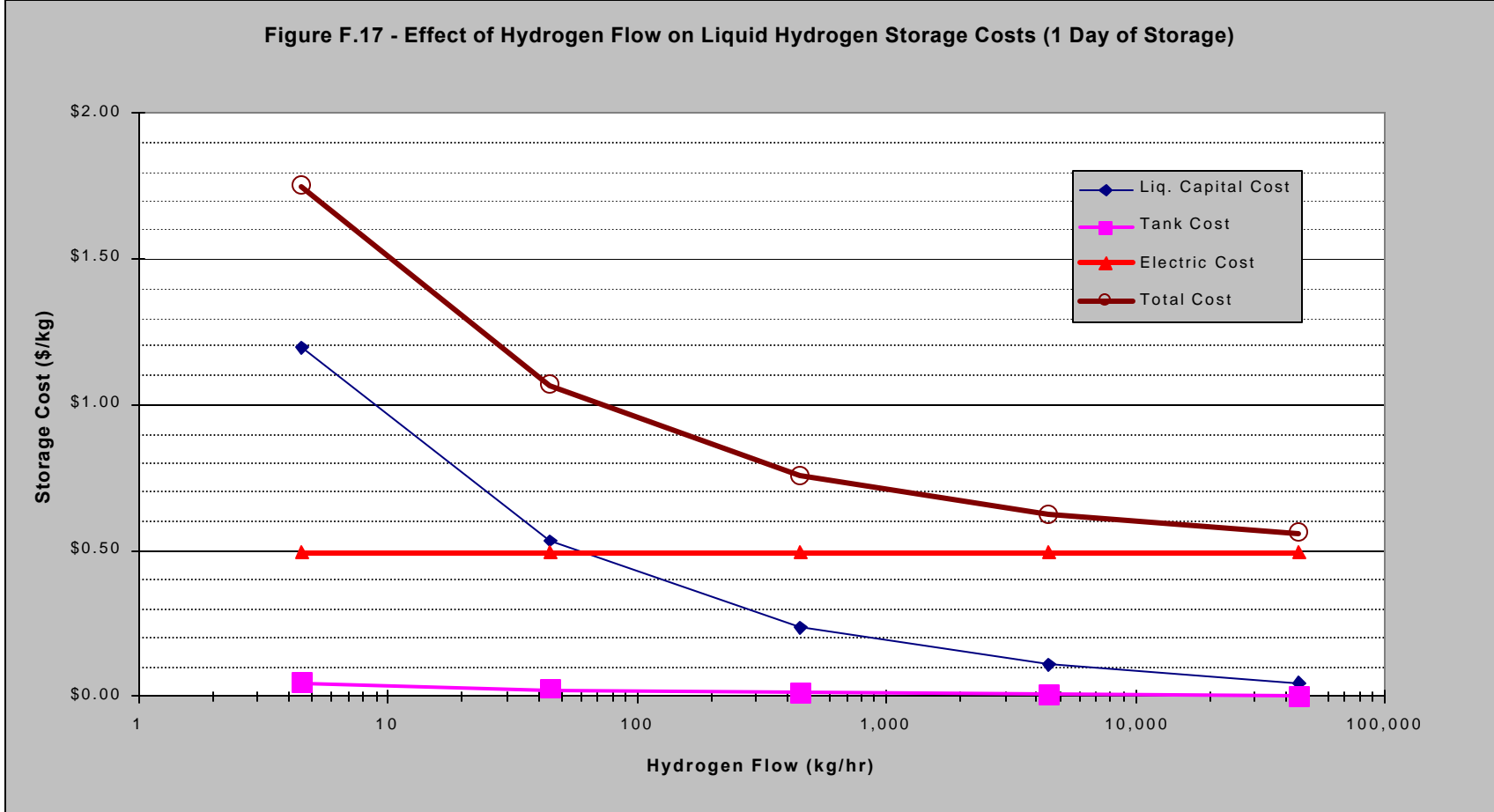

Figure F.17 - Economy of scale reduces liquid hydrogen storage costs until limited by electricity cost.

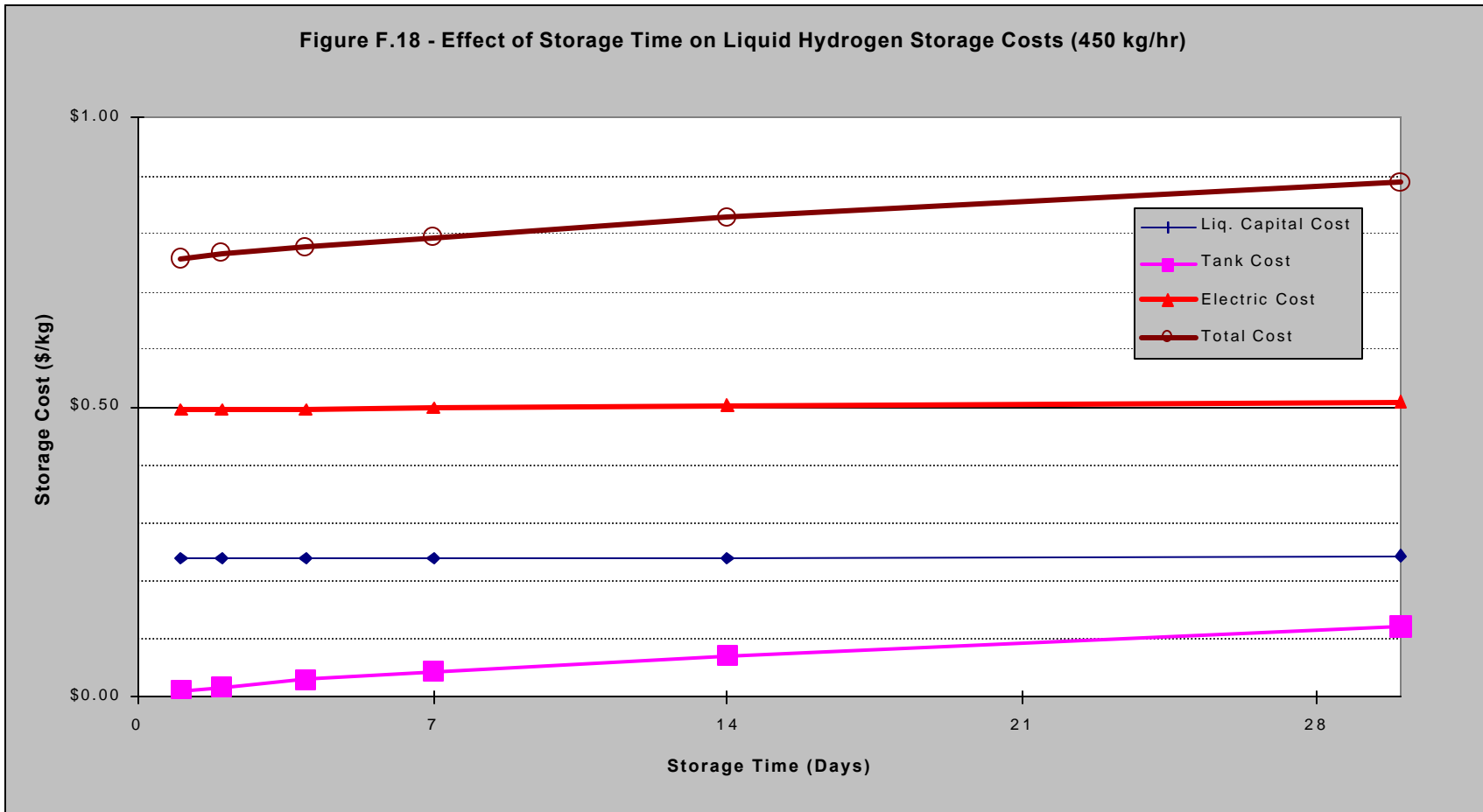

Figure F.18 - Storage time has little effect on liquid hydrogen storage costs since the dewar storage costs are relatively small.

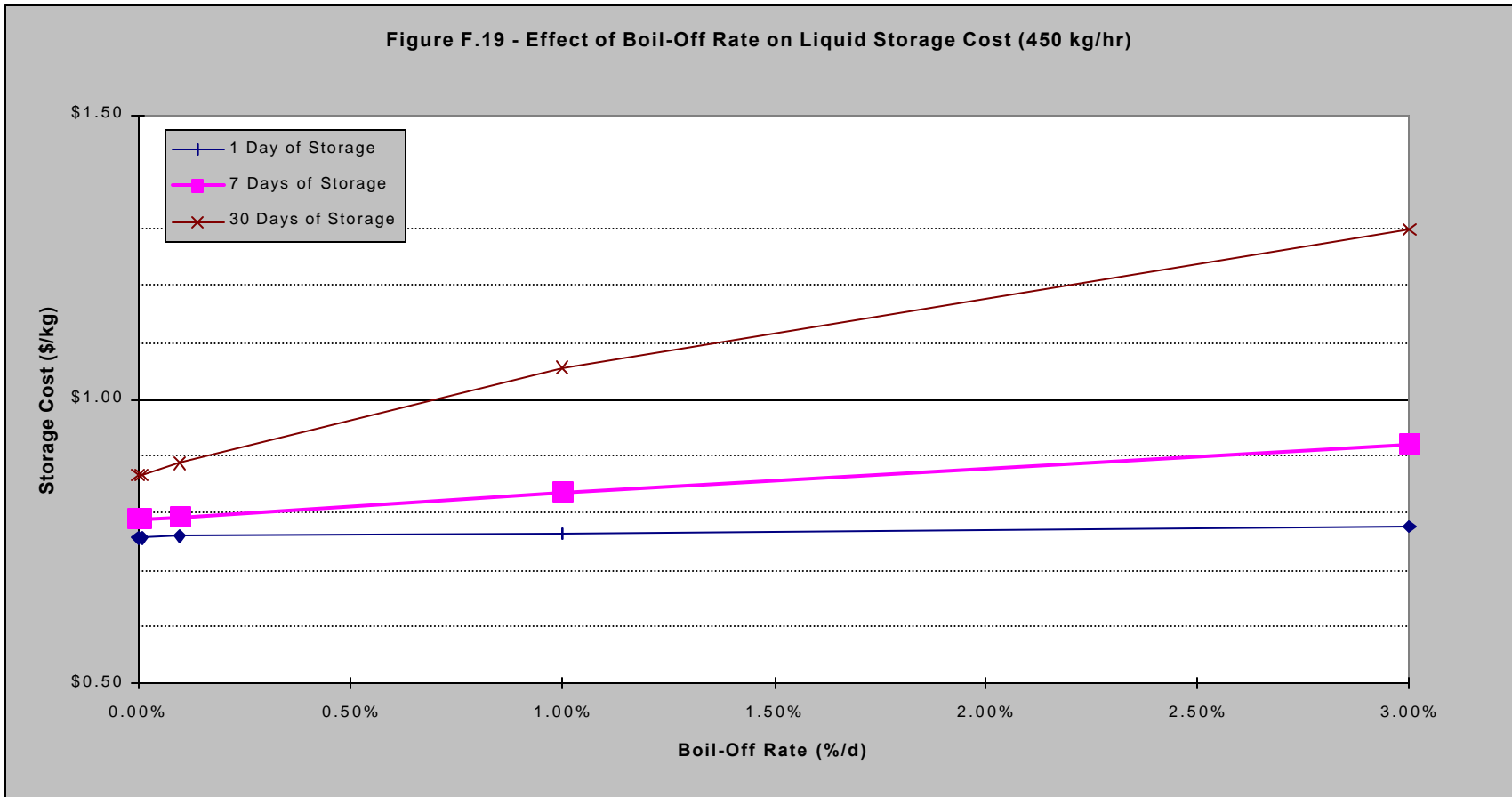

Figure F.19 - Boil-off rate has only a minor effect on costs for short storage times.

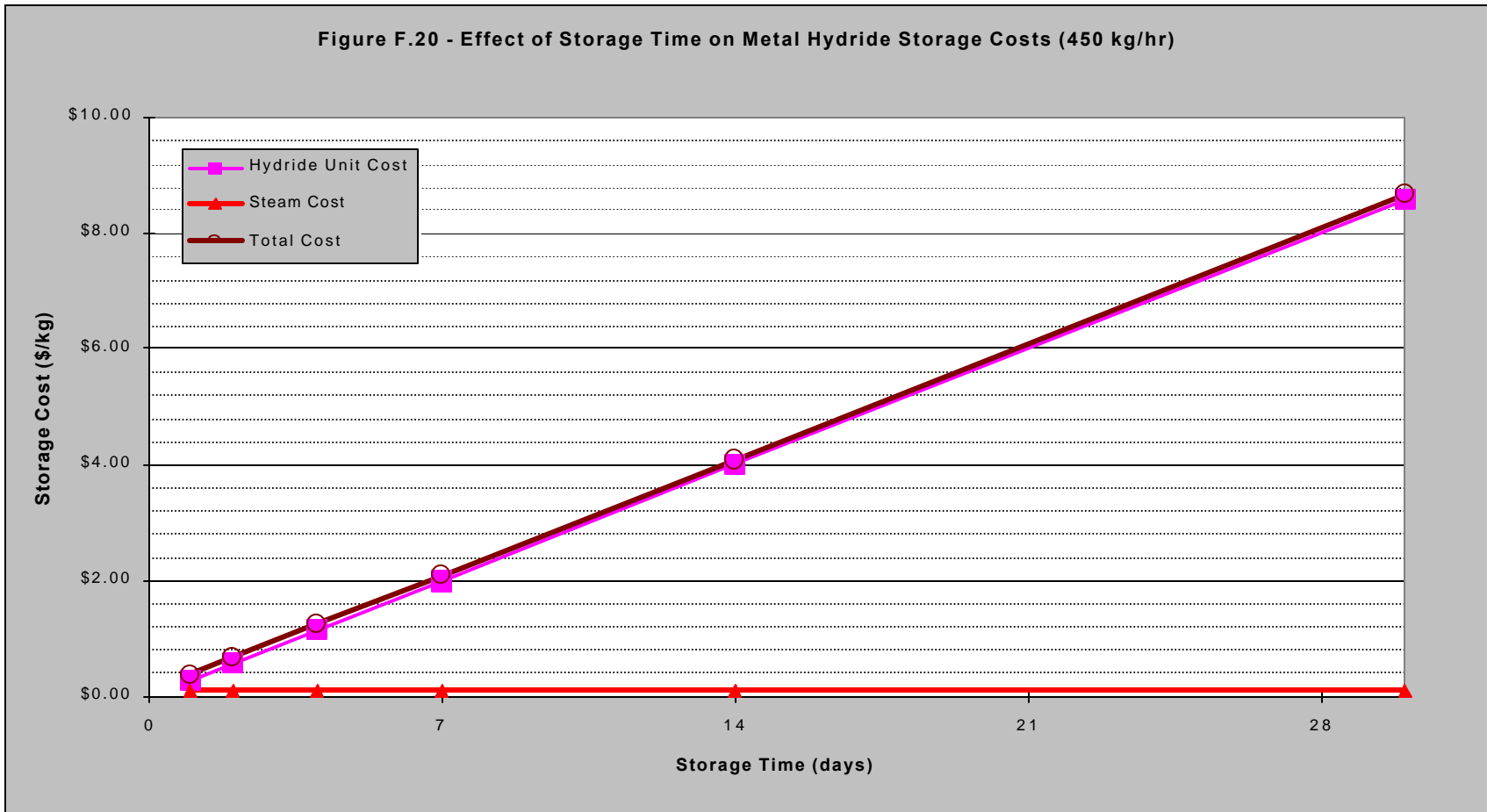

Figure F.20 - Most of the metal hydride storage cost is associated with the alloy capital cost, which provides no economy of scale savings.

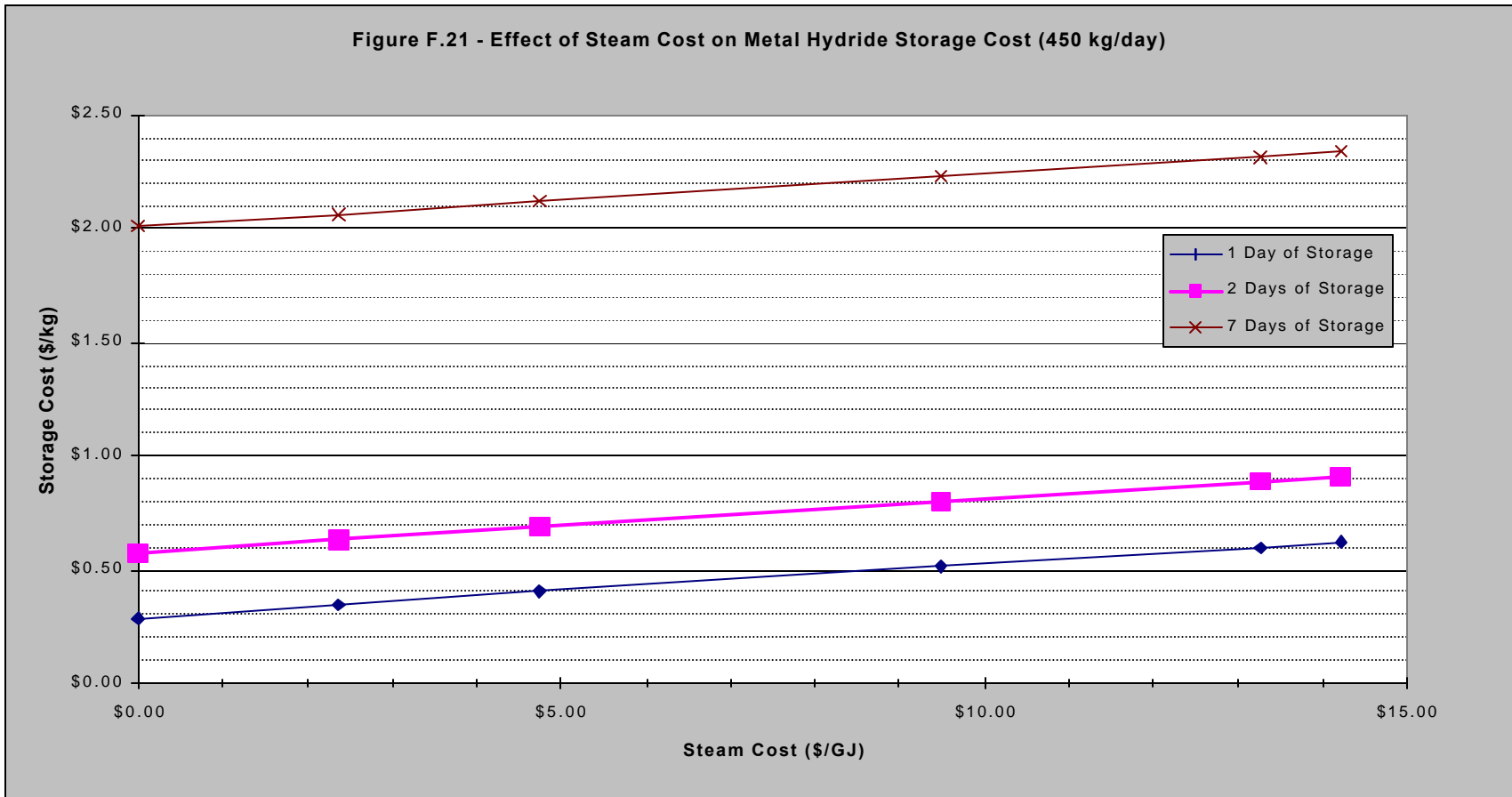

Figure F.21 - Steam cost will affect metal hydride storage costs.

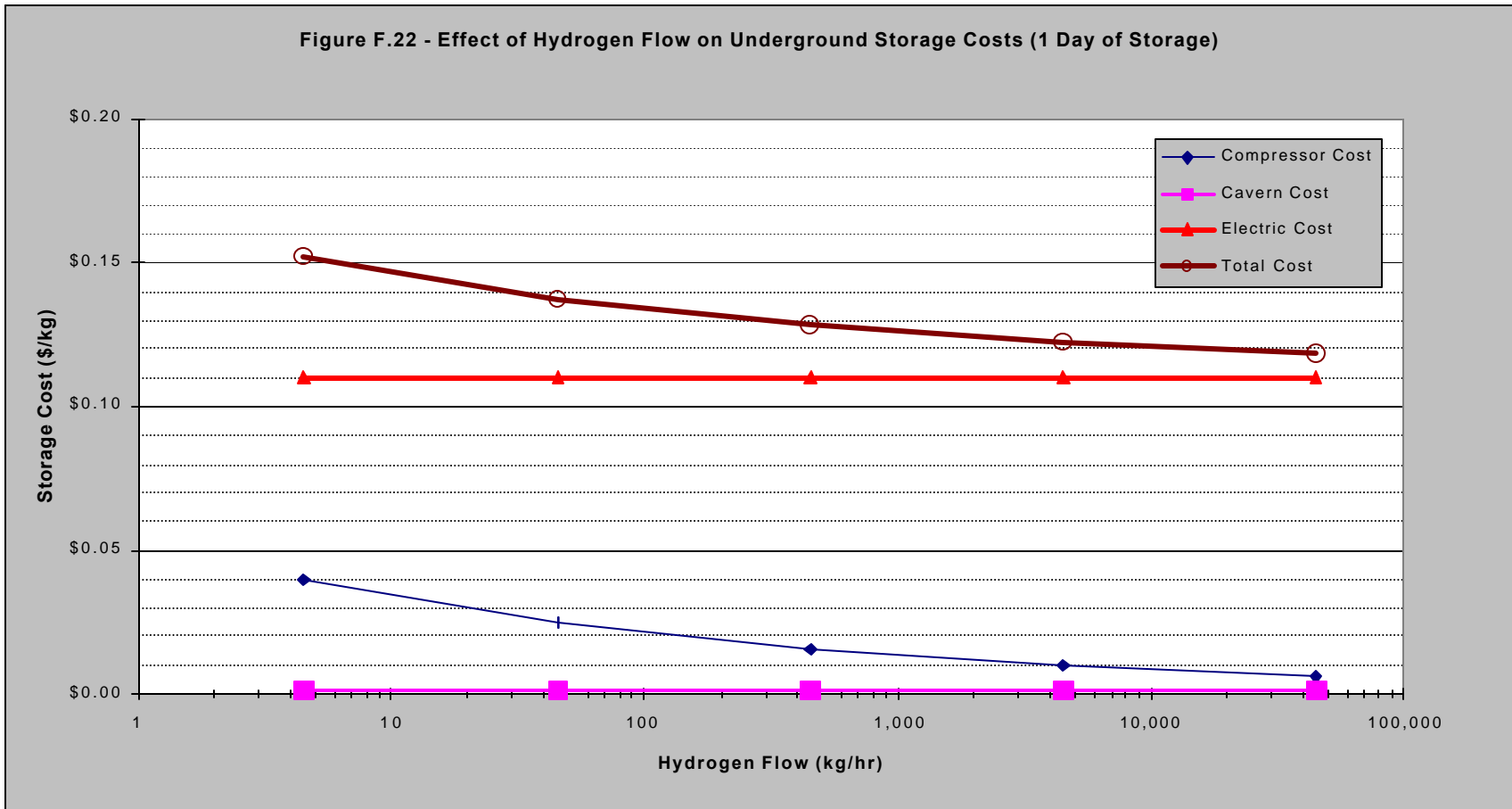

Figure F.22 - Underground storage is the cheapest option with the main cost being compressor electricity.

Figure F.23 - Effect of Storage Time on Underground Storage Costs (450 kg/hr)

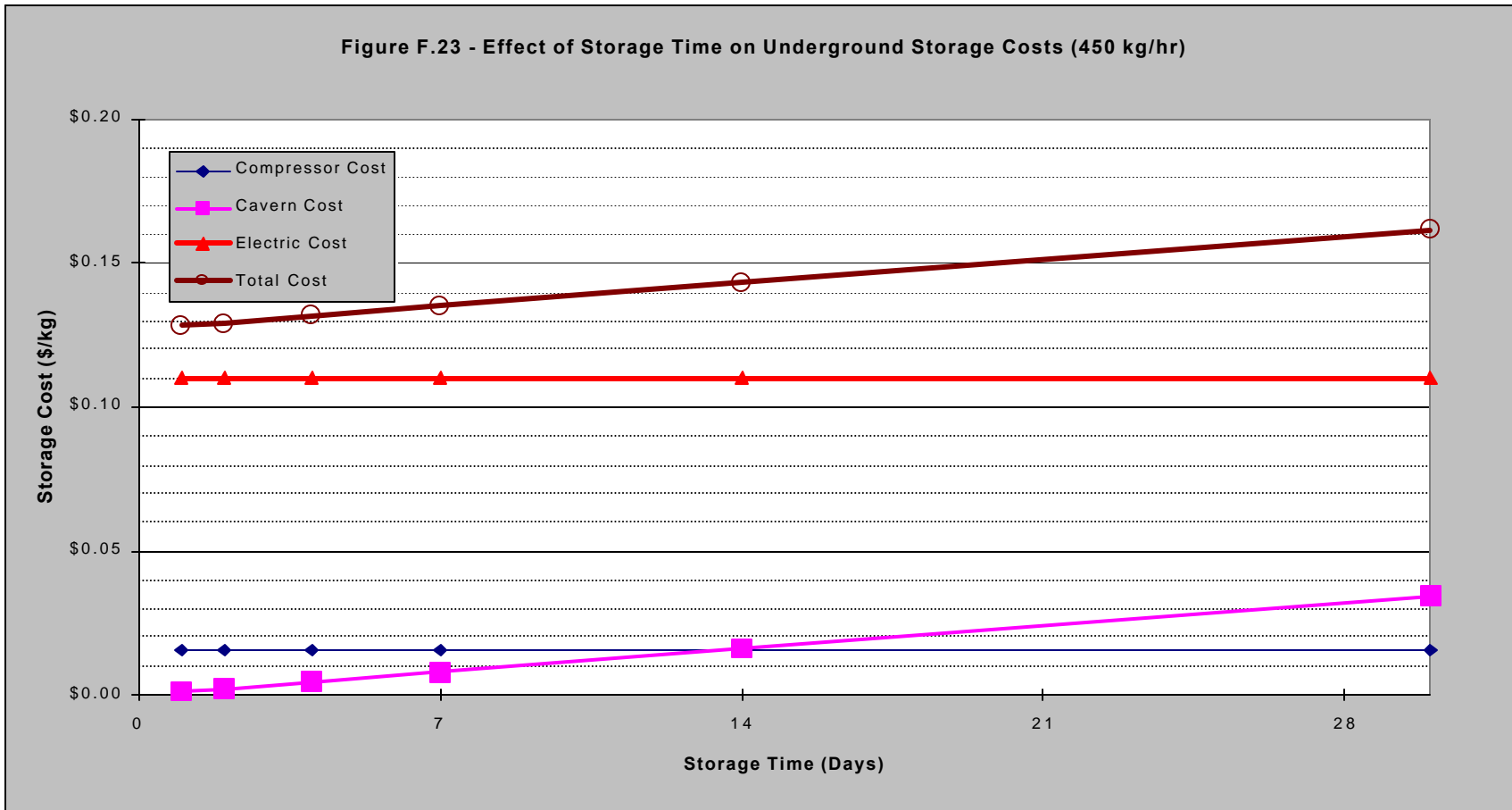

Figure F.23 - There is only a minor increase in storage costs with longer storage times because of low cavern cost.

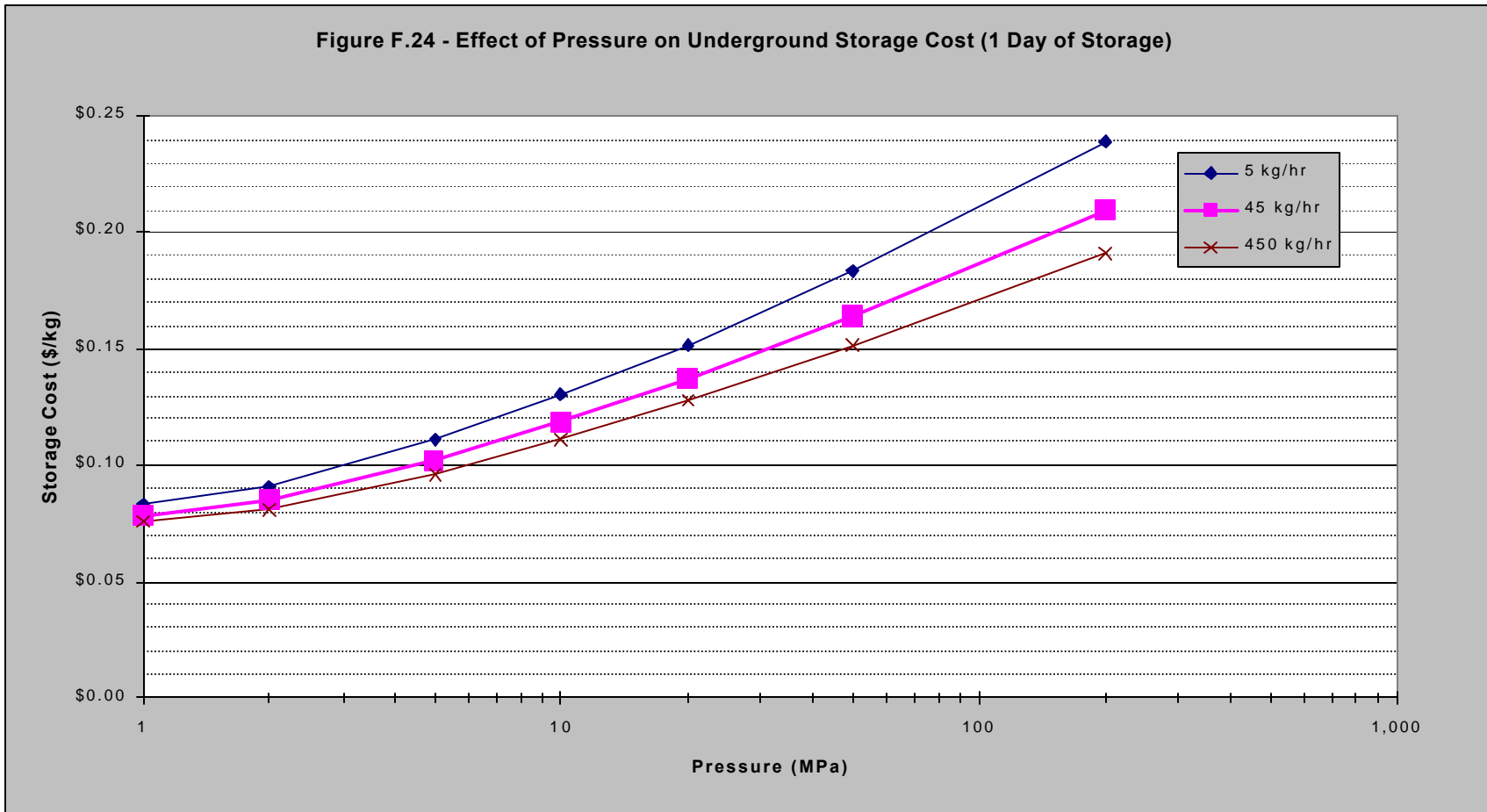

Figure F.24 - For short storage times, the lowest cost is at low pressures where electricity costs are the lowest.

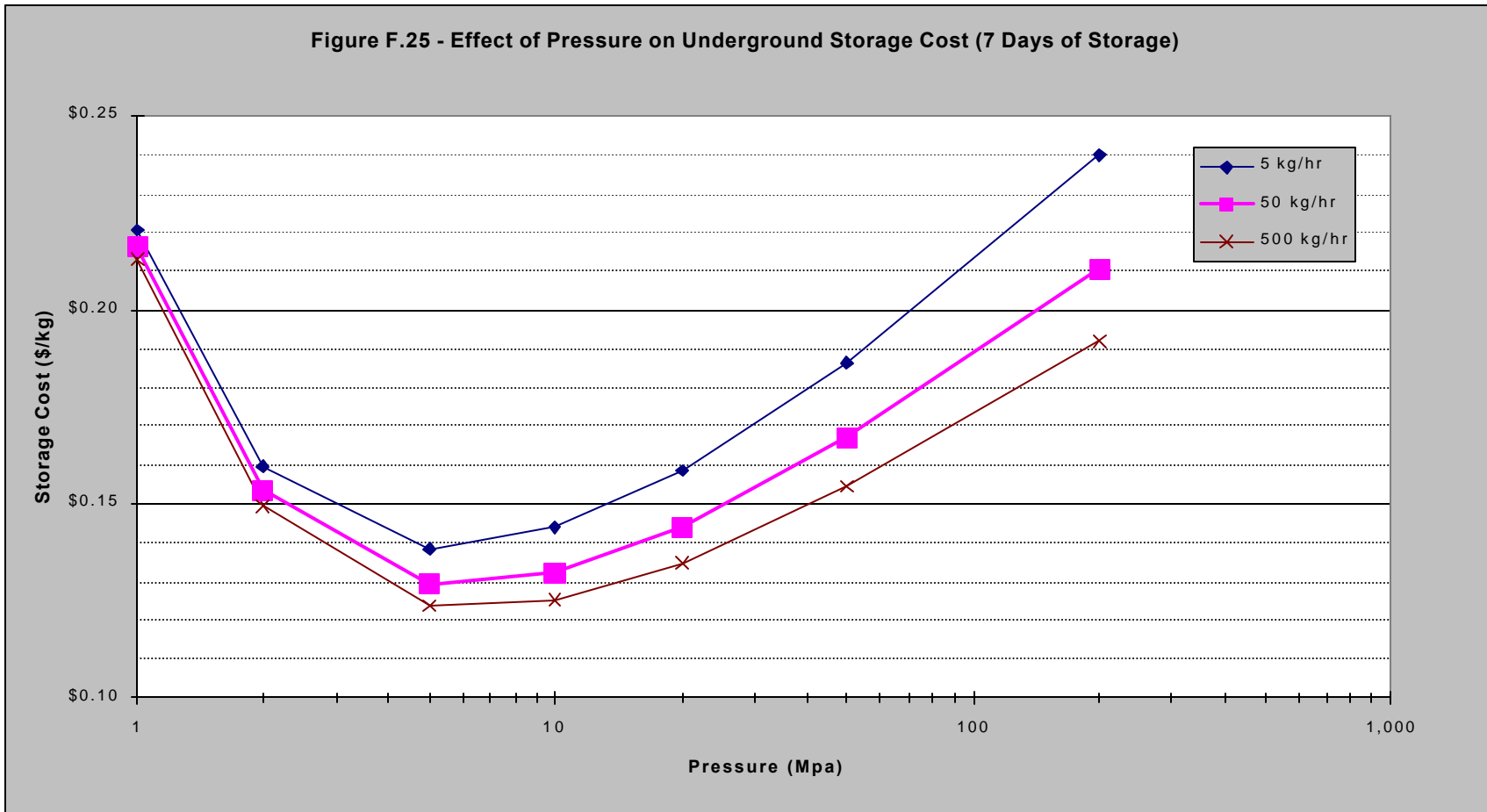

Figure F.25 - For longer storage times, an optimum forms as cavern capital costs increase.

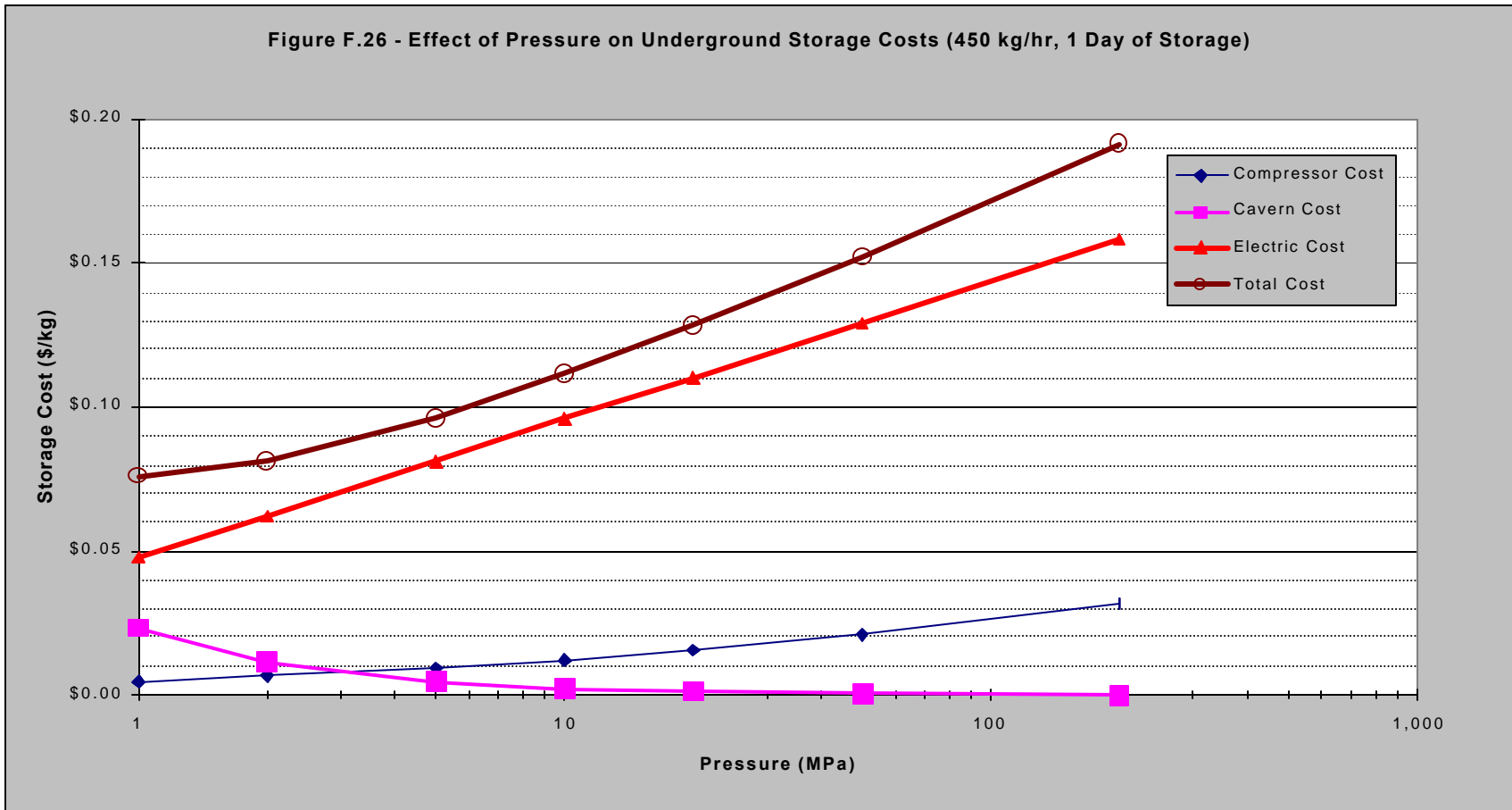

Figure F.26 - For short storage times, the optimum is at low pressures where compressor electricity is minimized.

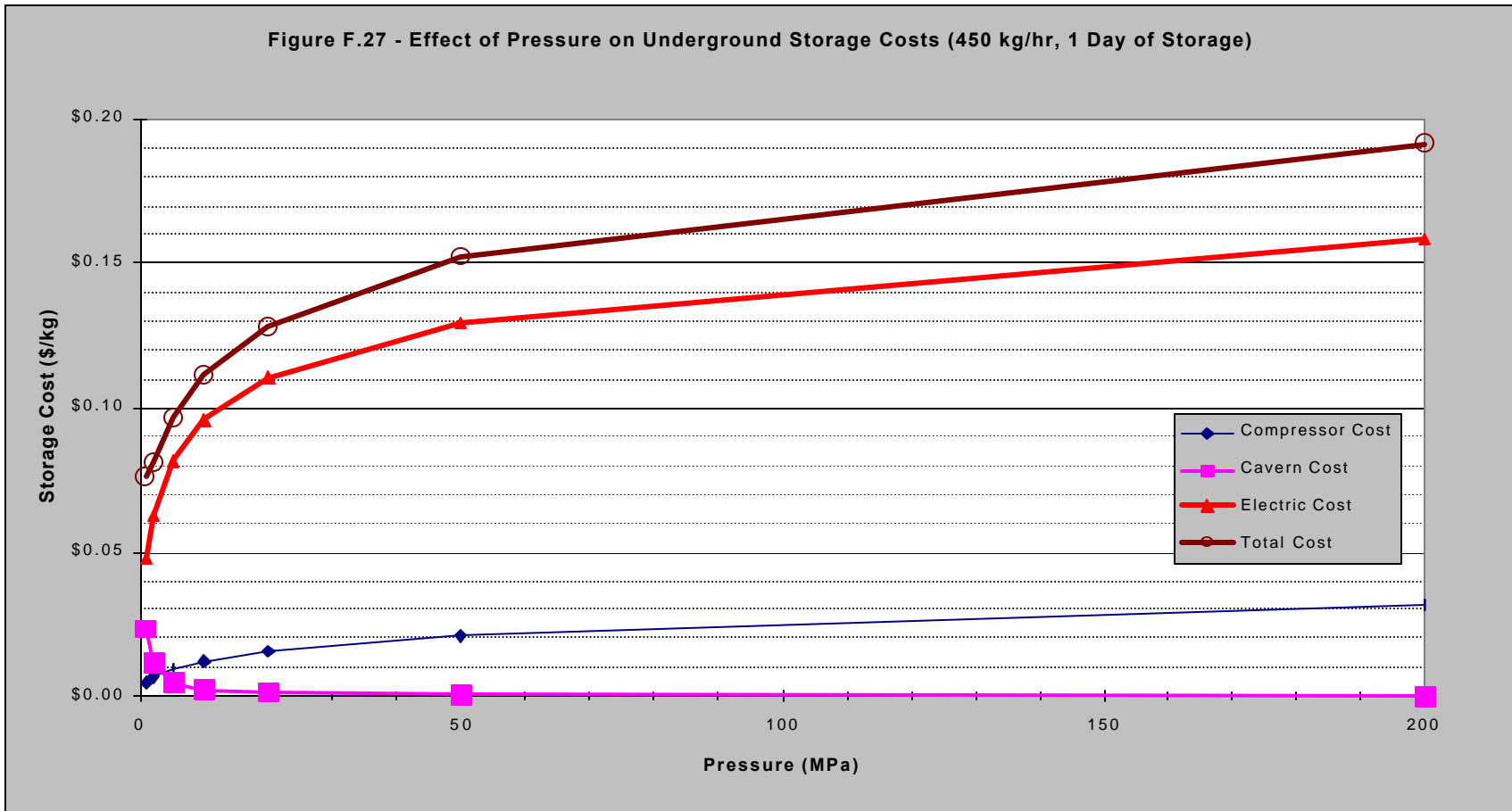

Figure F.27 - On a linear scale, it can be seen the highest energy requirement is for the initial compression at low pressures.

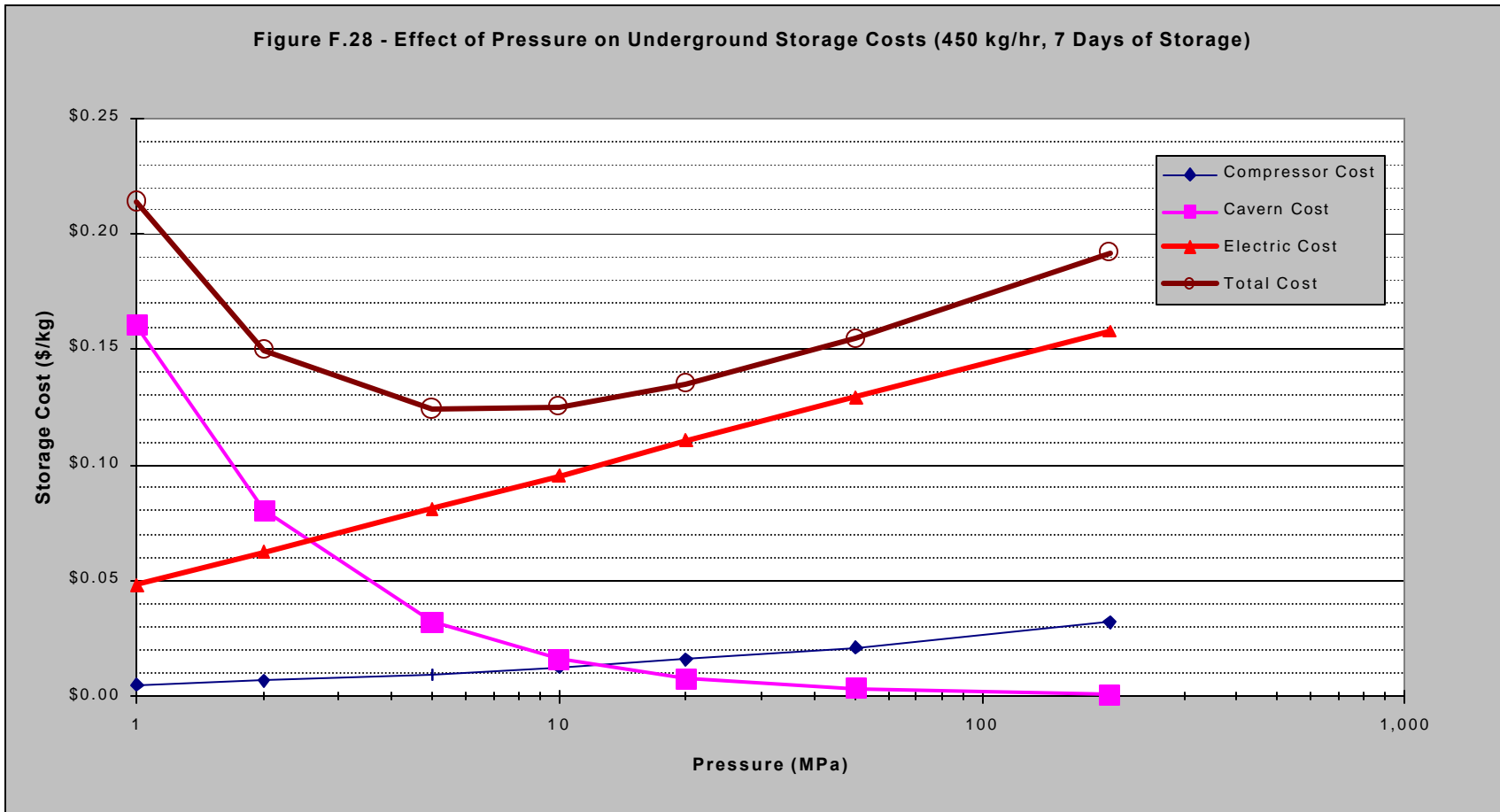

Figure F.28 - For longer storage times, an optimum occurs where lower capital costs offset higher electricity costs.

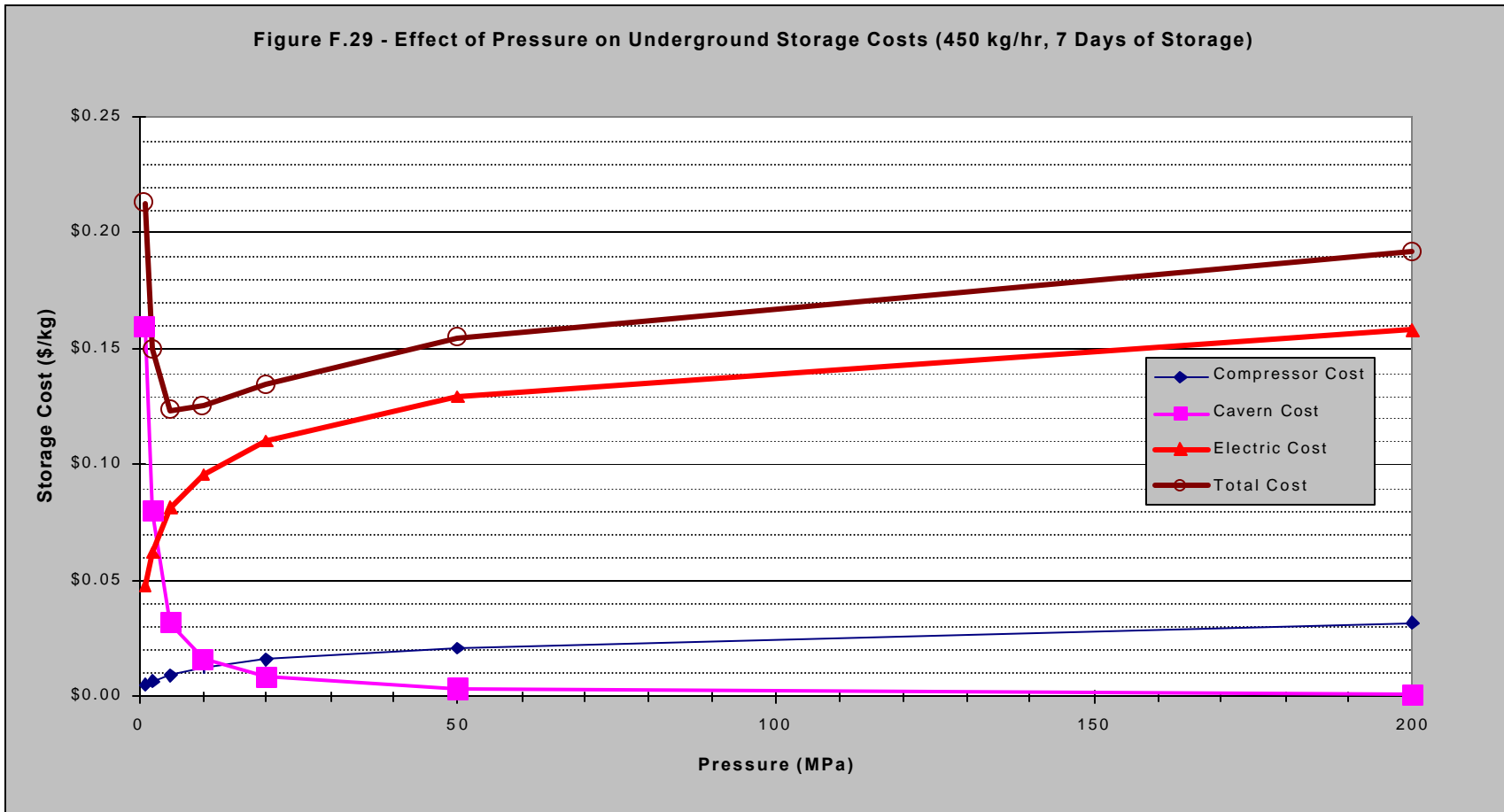

Figure F.29 - On a linear graph, the pressure effects are more pronounced at low pressures.

APPENDIX G - HYDROGEN TRANSPORTATION FIGURES

Appendix G contains figures showing important trends and sensitivity analyses for the transport of hydrogen. An index for the figures is included to help find specific information quickly. Most of the graphs either compare the different transport methods, or show a cost breakdown of the cost contributions for one method of delivery.

G.0 INDEX TO HYDROGEN TRANSPORT FIGURES									
Figure	Method	y-axis	x-axis	Dep. Var. (y)	Ind. Var. (x)	Flow (lb/hr)	Time (days)	Distance (miles)	Lines
1	All	Log	Log	Cost (\$/kg)	Flow (kg/hr)			16	Comp
2	All	Log	Log	Cost (\$/kg)	Flow (kg/hr)			160	Comp
3	All	Log	Log	Cost (\$/kg)	Flow (kg/hr)			800	Comp
4	All	Log	Log	Cost (\$/kg)	Distance (km)	450			Comp
5	All	Norm	Norm	Cost (\$/kg)	Fuel Cost (\$/gal)	450		160	Comp
6	All + Rail	Log	Log	Cost (\$/kg)	Flow (kg/hr)			16	Comp
7	All + Rail	Log	Log	Cost (\$/kg)	Flow (kg/hr)			160	Comp
8	All + Rail	Log	Log	Cost (\$/kg)	Distance (km)	450			Comp
9	All + Rail	Norm	Log	Cost (\$/kg)	Distance (km)	450			Comp
10	GH2	Norm	Norm	Cost (\$/kg)	Capacity (kg/truck)			160	Flow (kg/hr)
11	GH2	Norm	Log	Cost (\$/kg)	Flow (kg/hr)			160	Costs
12	GH2	Norm	Log	Cost (\$/kg)	Distance (km)	450			Costs
13	LH2	Norm	Norm	Cost (\$/kg)	Capacity (kg/truck)			160	Flow (kg/hr)
14	LH2	Norm	Log	Cost (\$/kg)	Flow (kg/hr)			160	Costs
15	LH2	Norm	Norm	Cost (\$/kg)	Distance (km)	5			Costs
16	LH2	Norm	Norm	Cost (\$/kg)	Distance (km)	450			Costs
17	LH2	Log	Log	Cost (\$/kg)	Capacity (kg/truck)	5		160	Costs
18	LH2	Norm	Norm	Cost (\$/kg)	Capacity (kg/truck)	5		160	Costs
19	LH2	Log	Log	Cost (\$/kg)	Capacity (kg/truck)	450		160	Costs
20	LH2	Norm	Norm	Cost (\$/kg)	Capacity (kg/truck)	450		160	Costs
21	MH2	Norm	Log	Cost (\$/kg)	Flow (kg/hr)			160	Costs
22	MH2	Norm	Norm	Cost (\$/kg)	Distance (km)	450			Costs
23	Pipeline	Norm	Log	Cost (\$/kg)	Flow (kg/hr)			16	Costs
24	Pipeline	Norm	Norm	Cost (\$/kg)	Distance (km)	450			Costs
25	All + Rail	Norm	Bar	Cost (\$/kg)		450		160	Costs

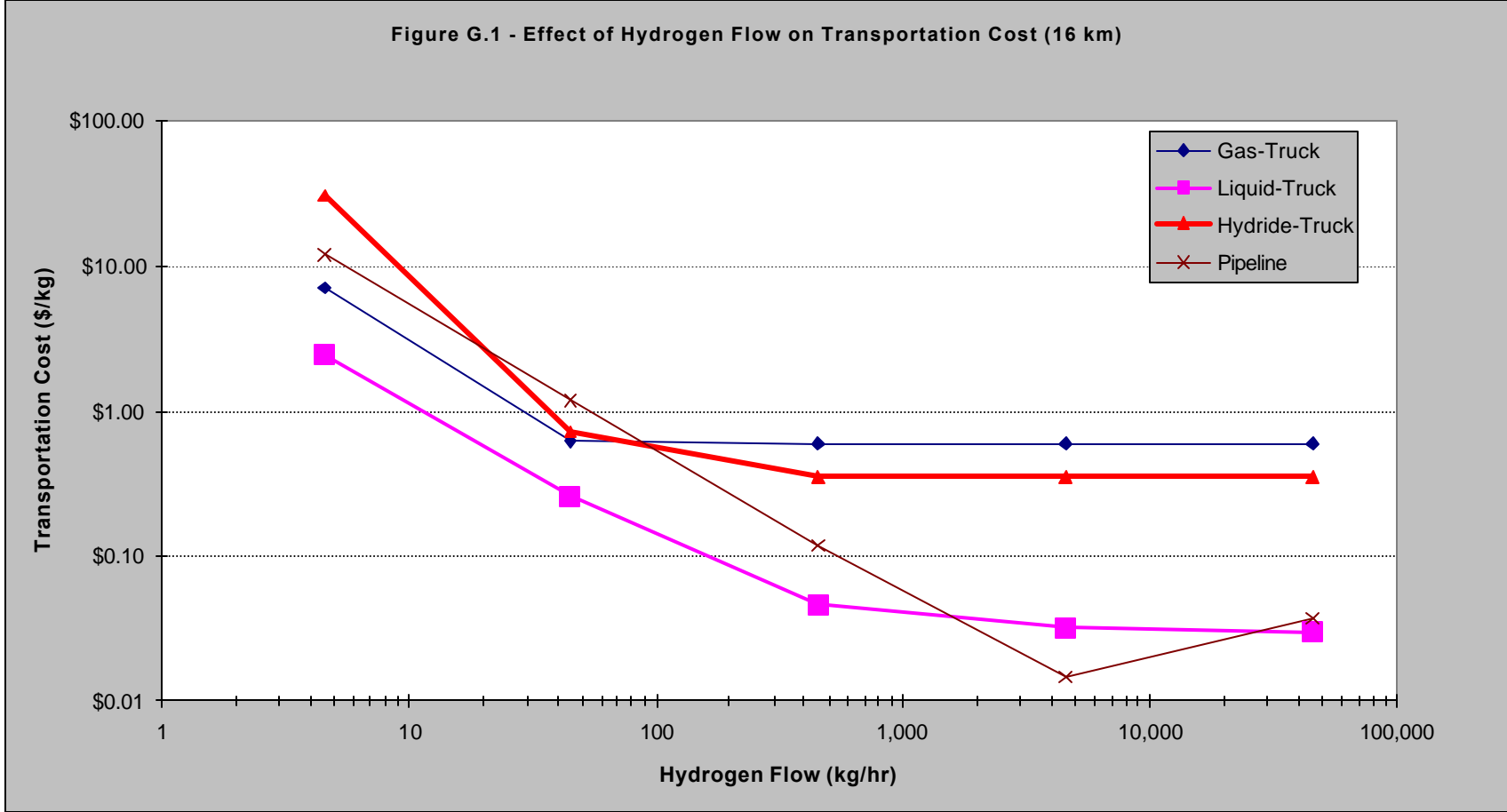

Figure G.1 - At high production rates, the cost of truck transportation bottoms out and levels off.

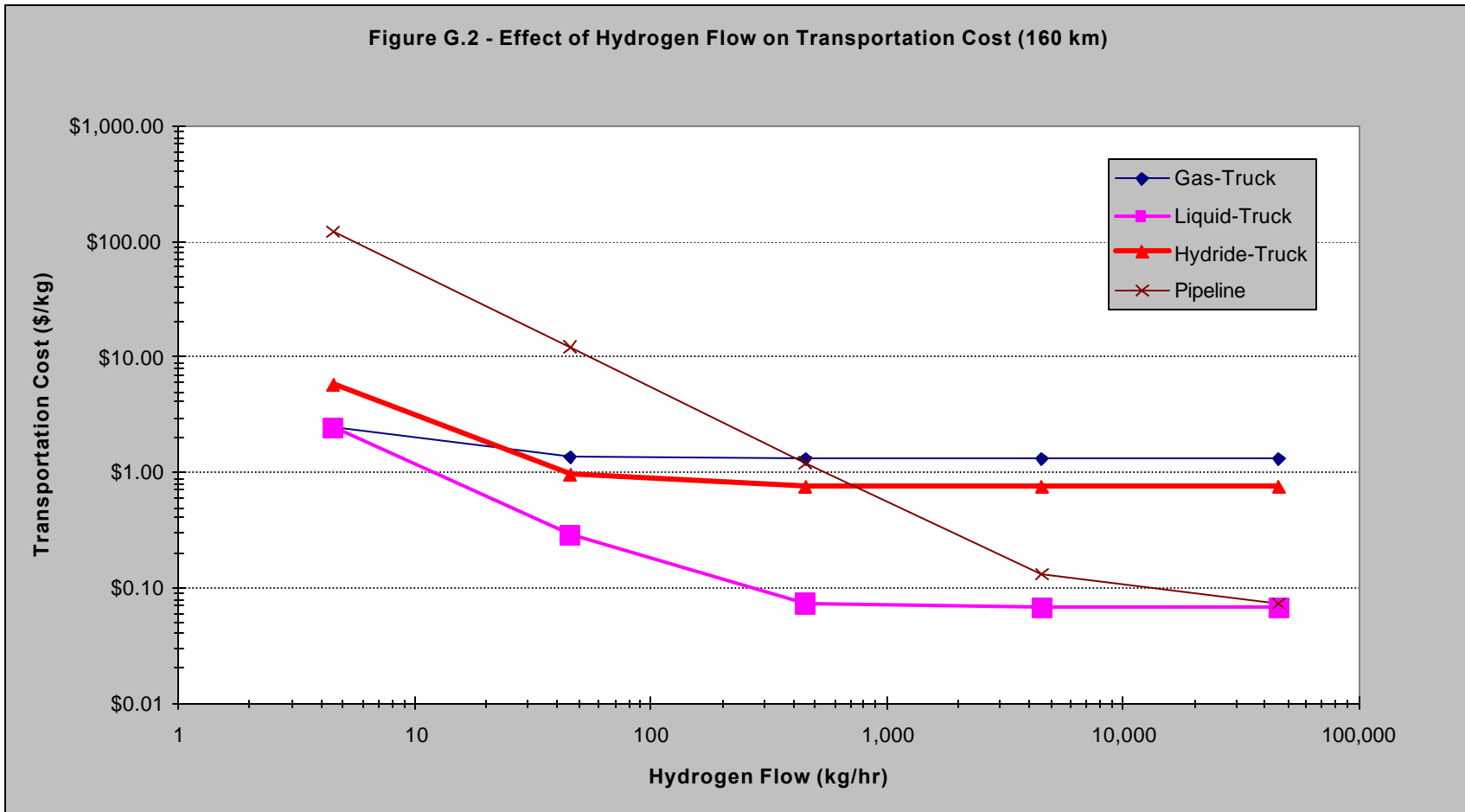

Figure G.2 - At high flows, pipeline costs start leveling off as compressor electricity costs increase.

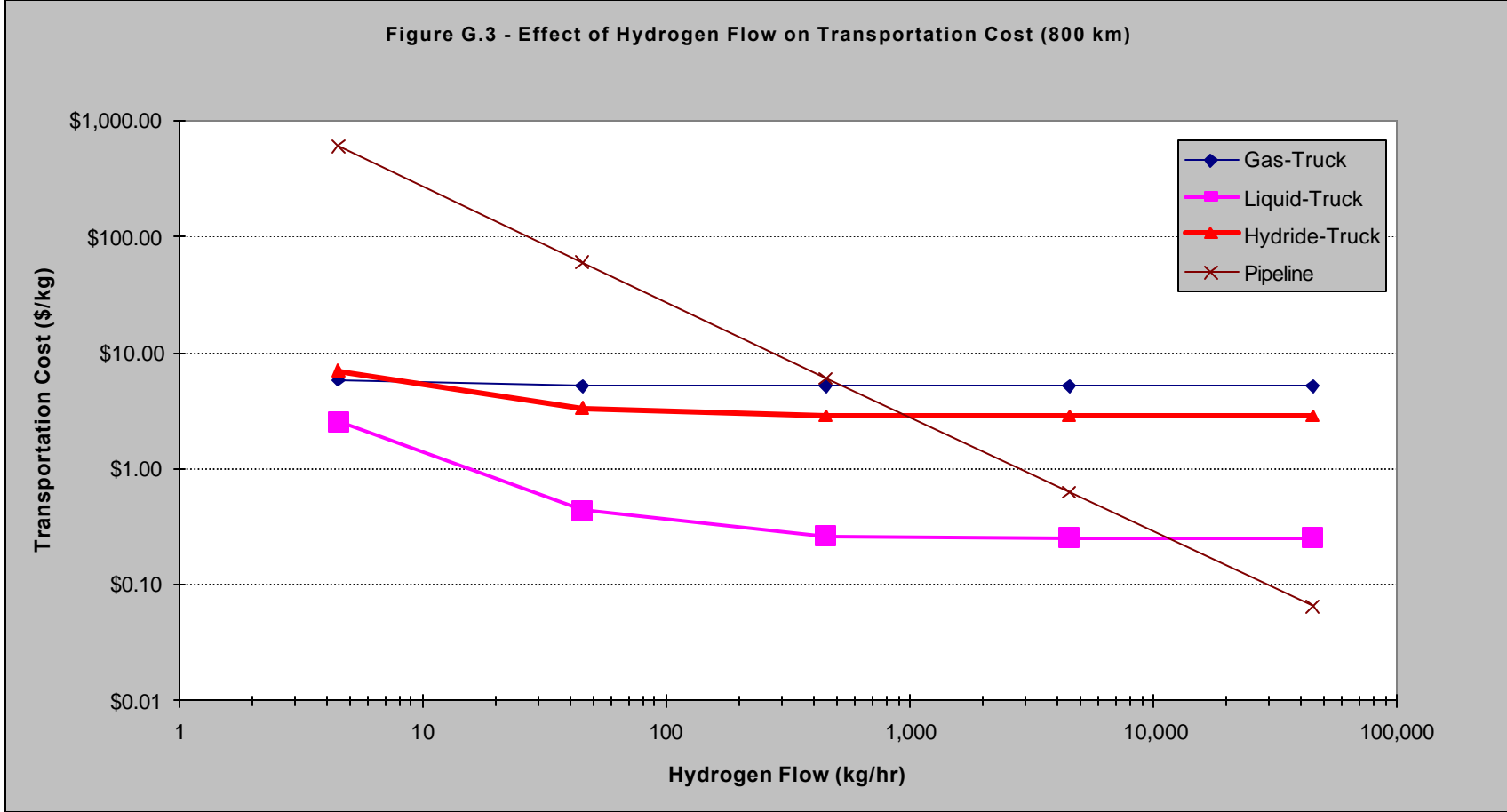

Figure G.3 - Trucking costs level out sooner at longer delivery distances.

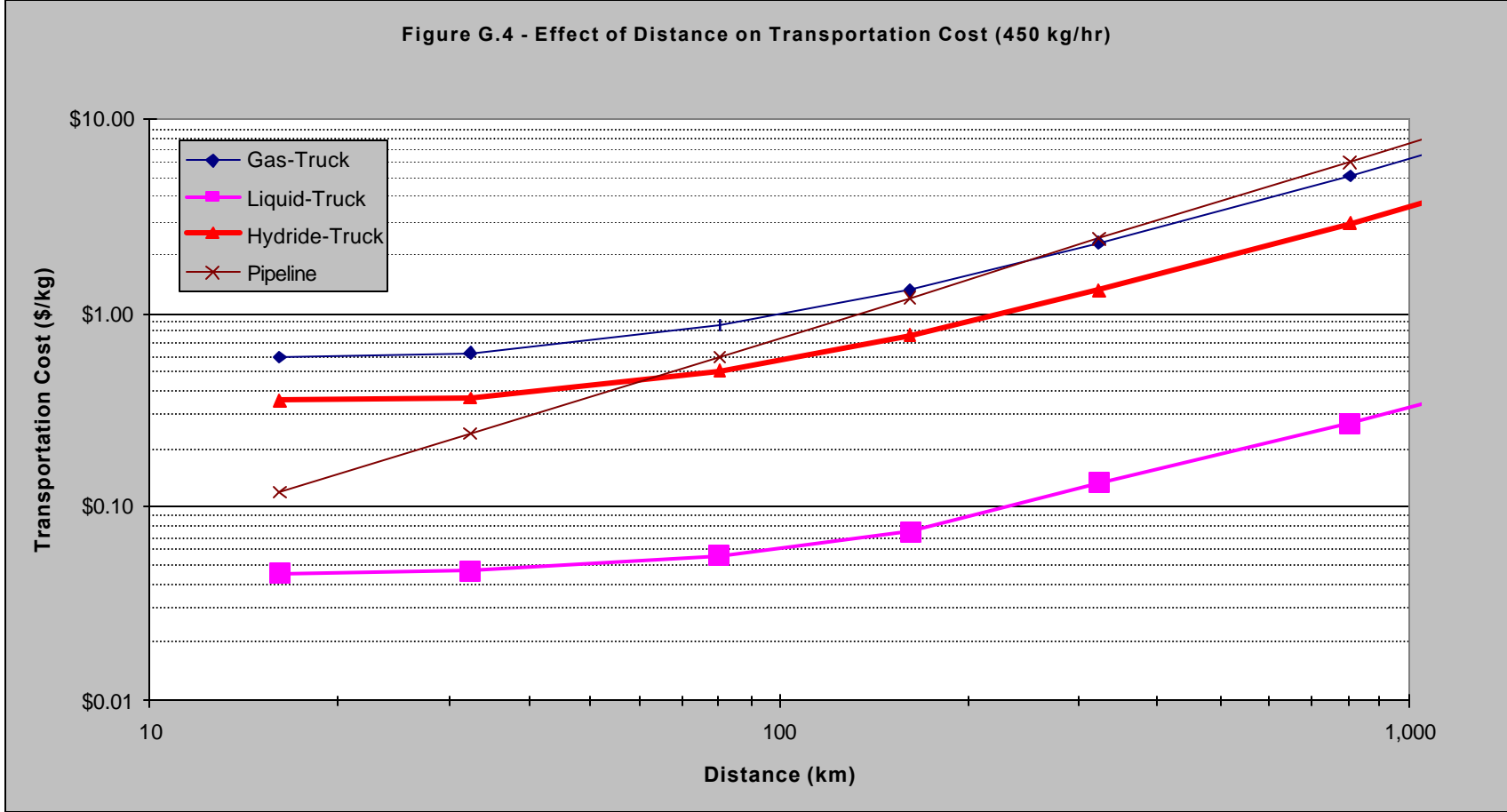

Figure G.4 - Trucking costs quickly increase for delivery distances over 100 km.

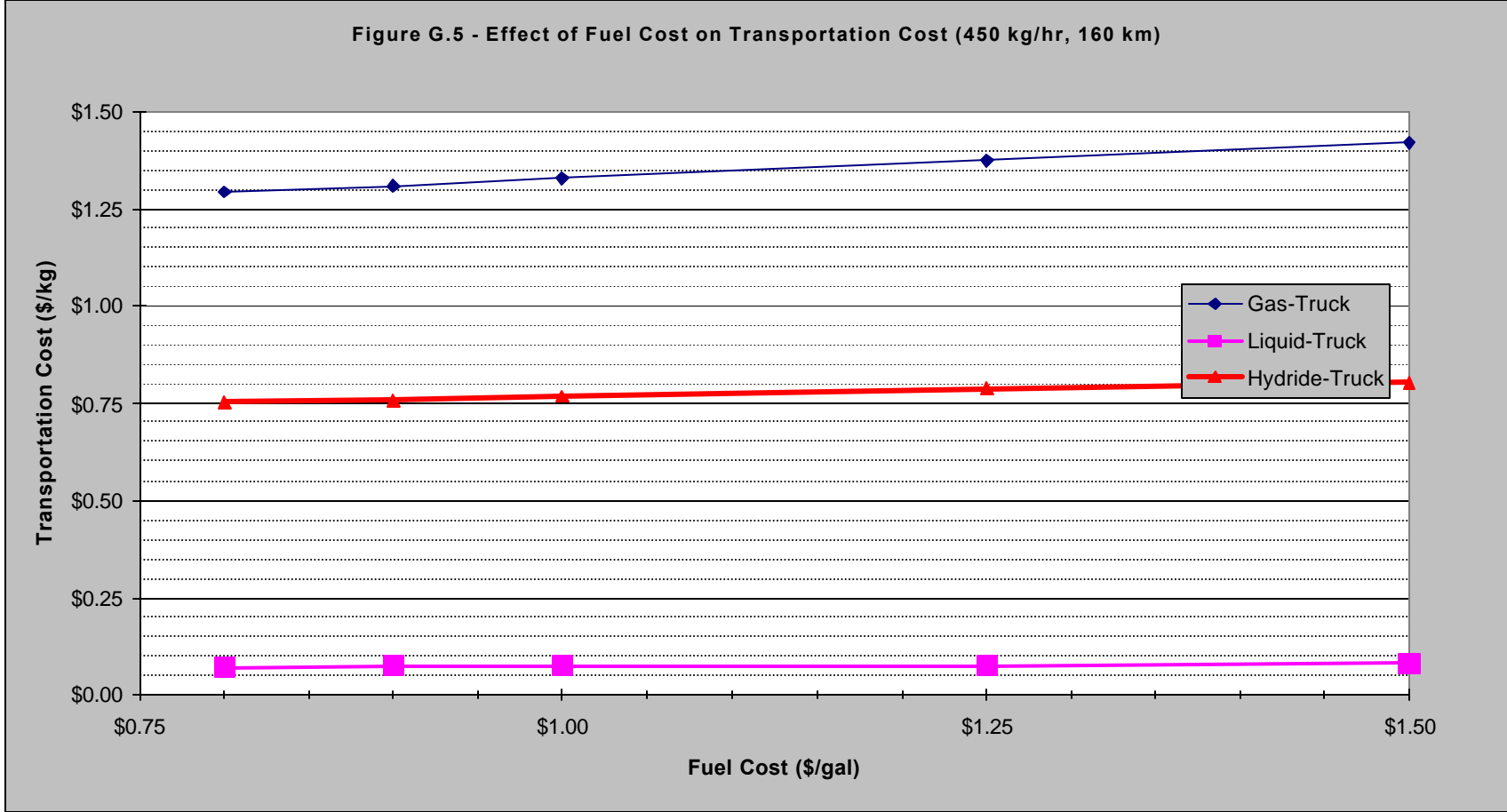

Figure G.5 - Compressed gas delivery is affected the most by fuel cost since the low truck capacity requires more trips.

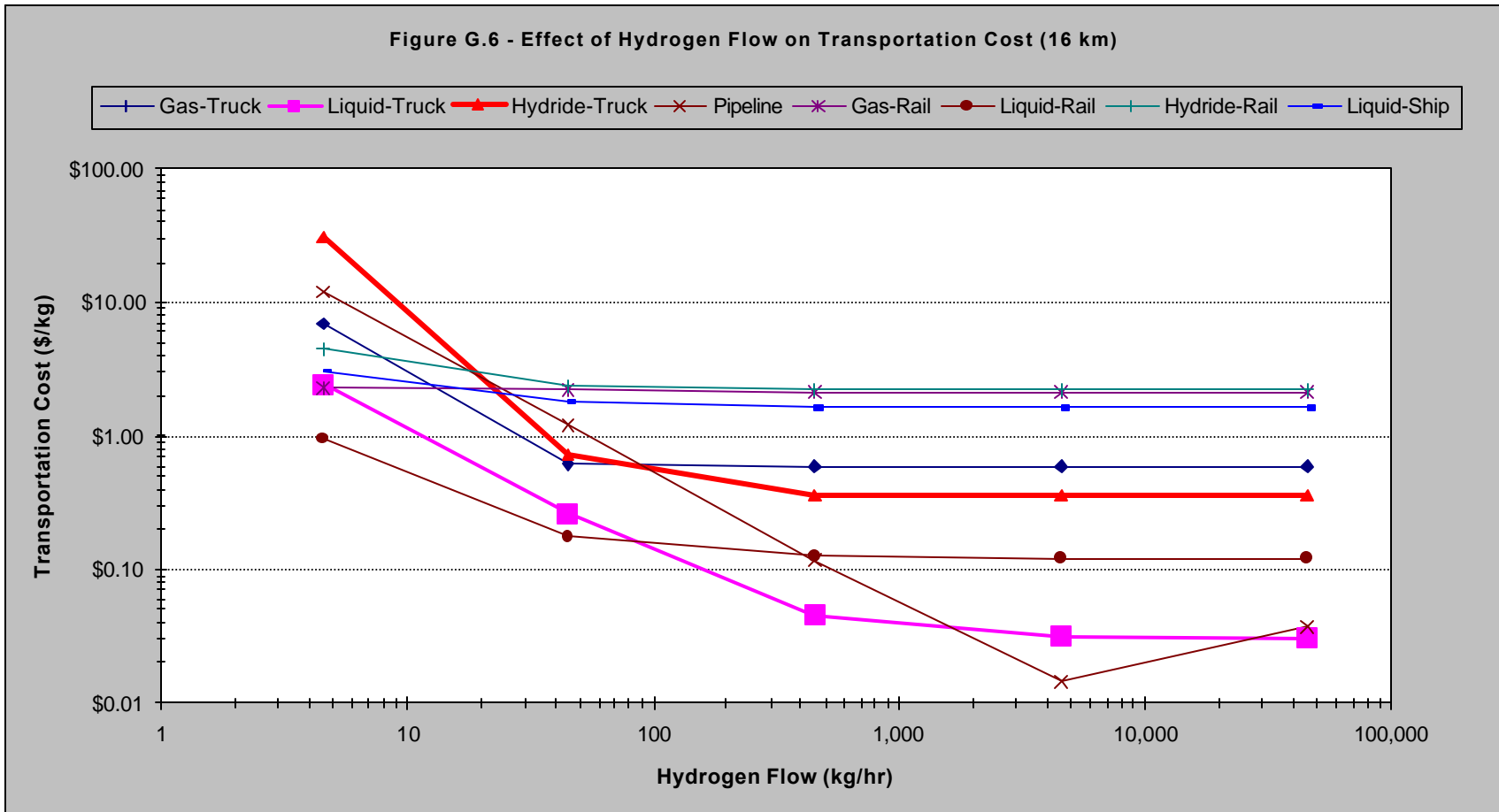

Figure G.6 - Liquid hydrogen delivery by rail has the potential to compete with truck delivery.

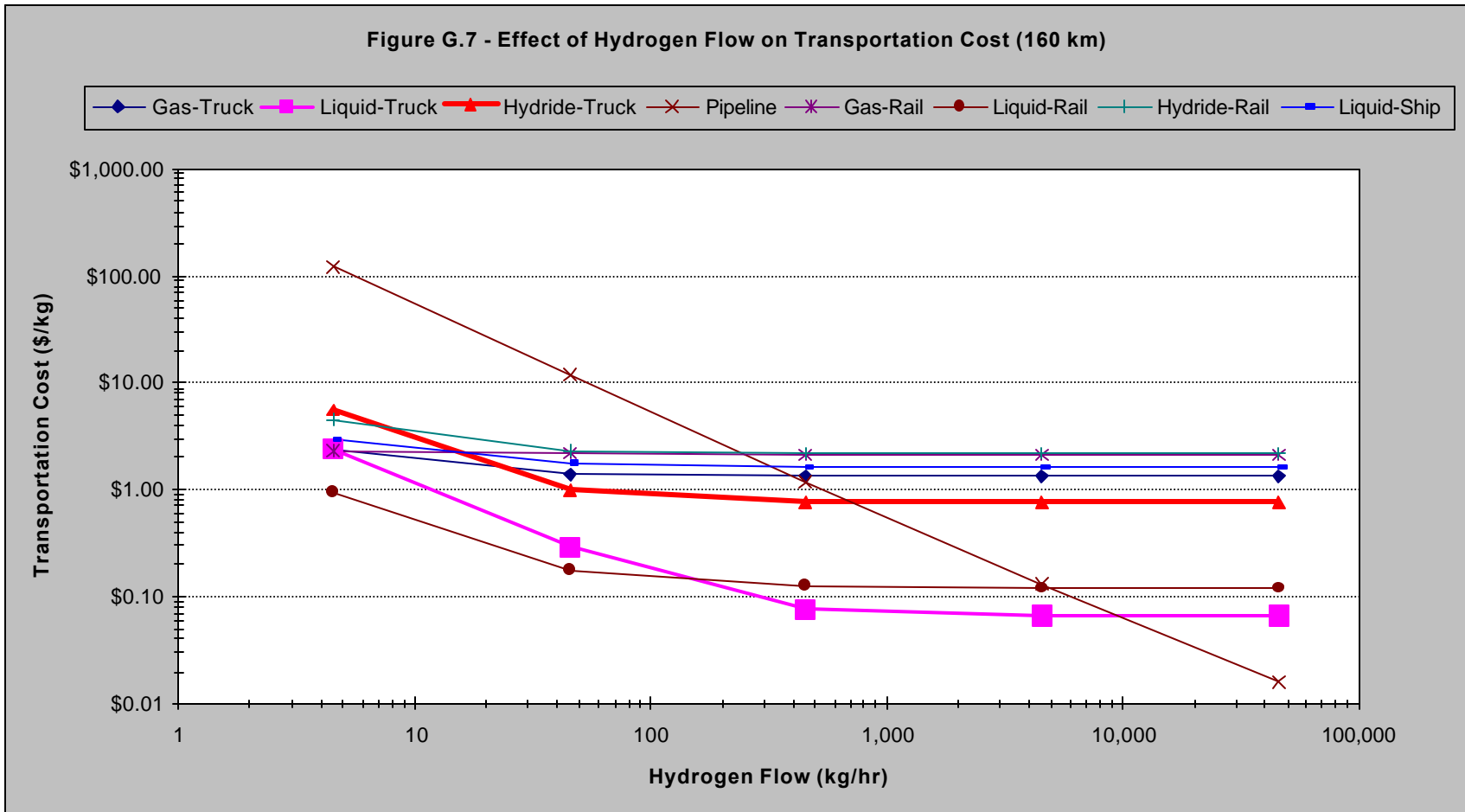

Figure G.7 - At high flows, pipeline delivery becomes the cheapest option.

Figure G.8 - Effect of Distance on Transportation Cost (450 kg/hr)

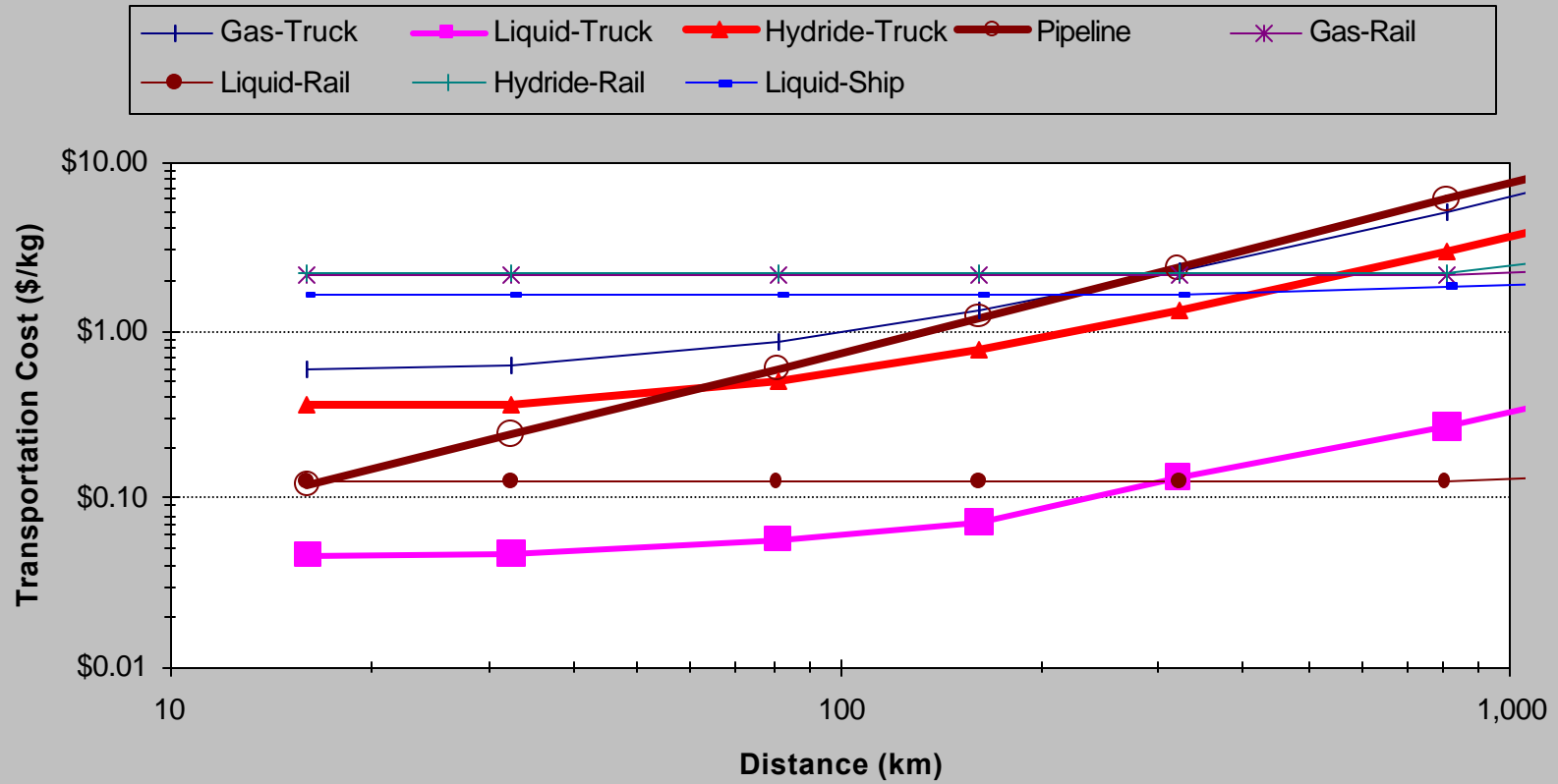

Figure G.8 - Rail transport has an advantage over trucking at long delivery distances because of flat-rate freight charges.

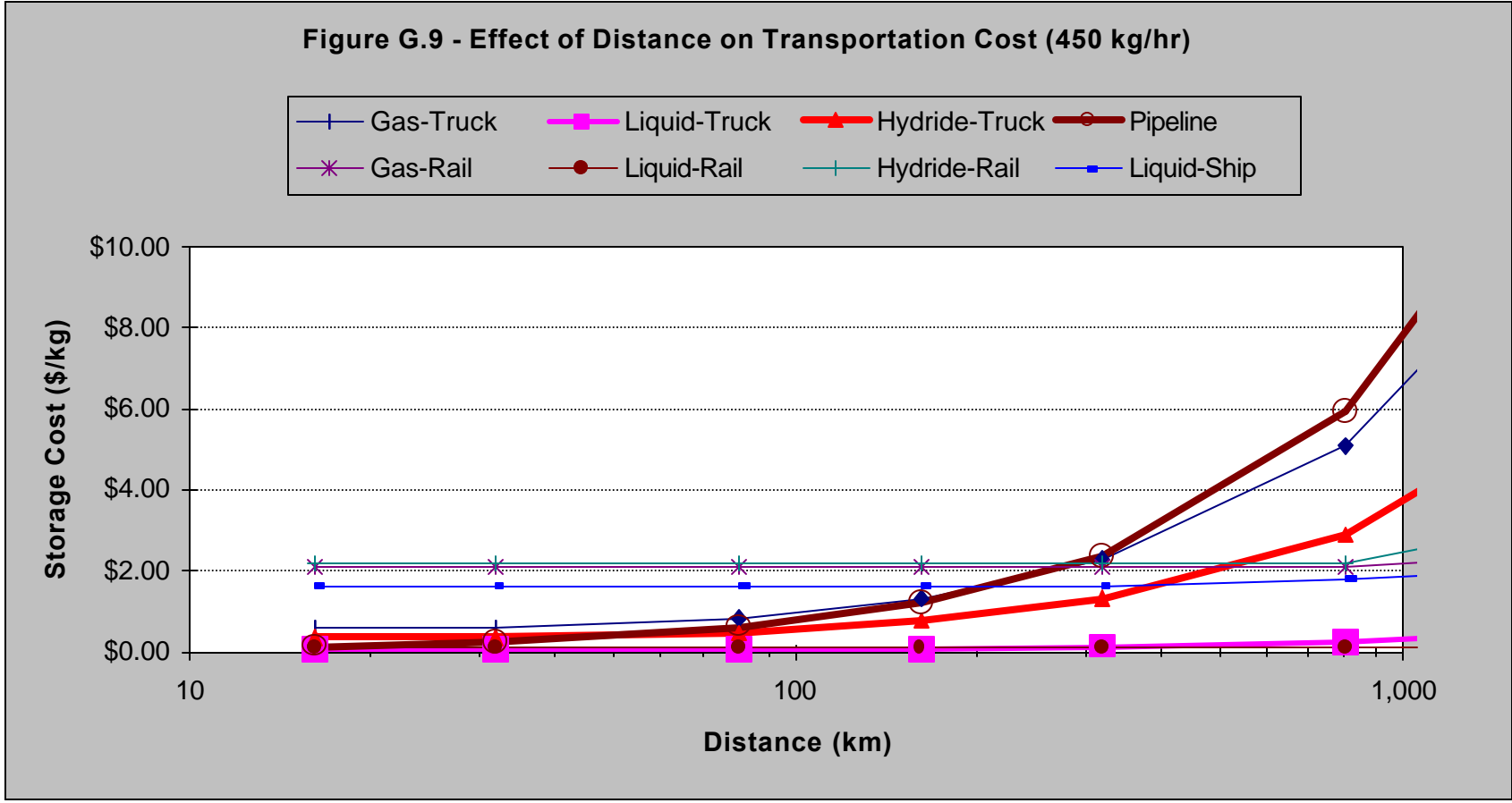

Figure G.9 - Pipeline costs quickly increase with distance compared to liquid hydrogen delivery.

Figure G.10 - Effect of Capacity on Compressed Gas Transportation Cost (160 km)

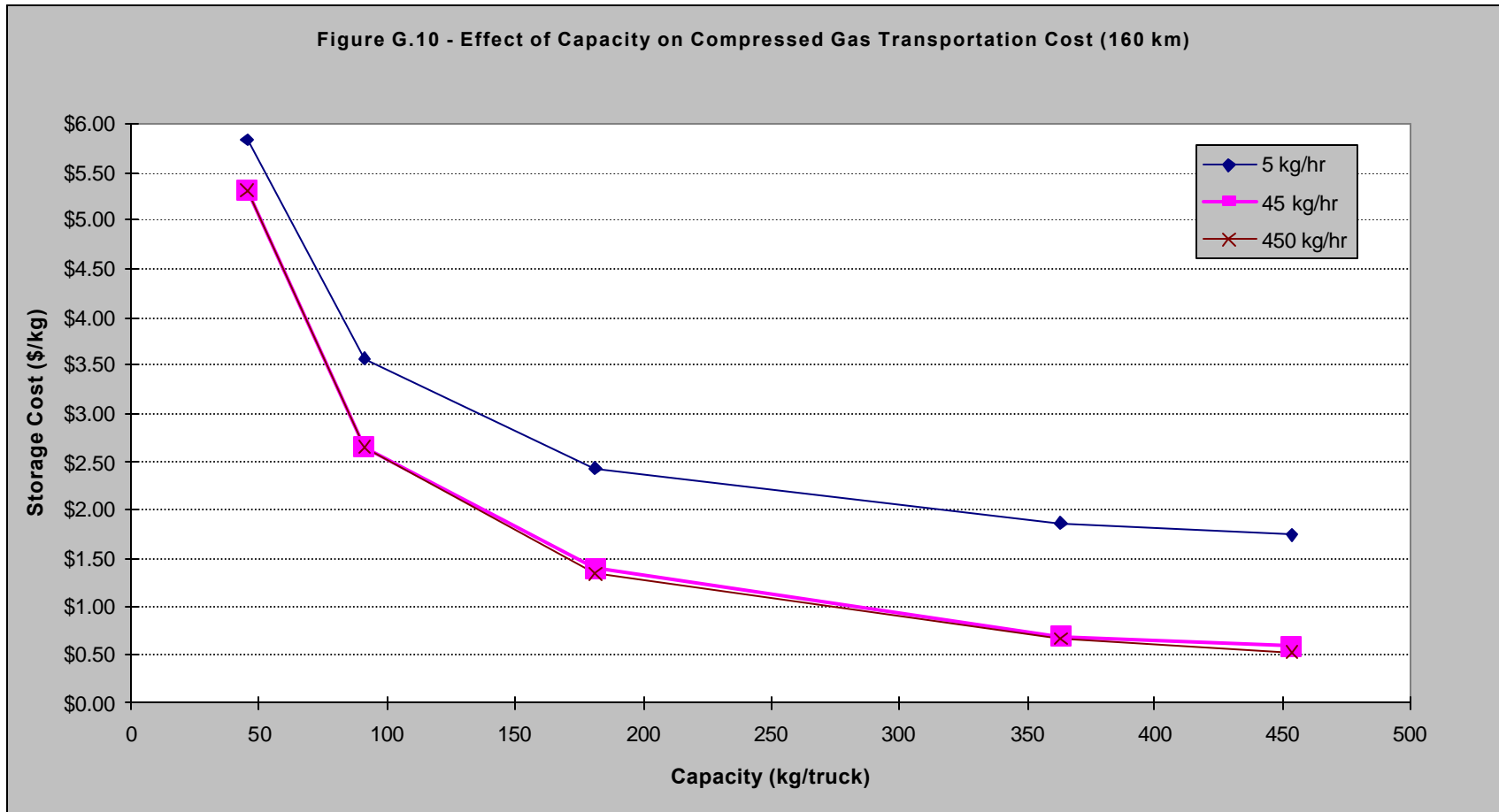

Figure G.10 - Compressed gas transport is very expensive for low capacity (i. e., low pressure) trucks.

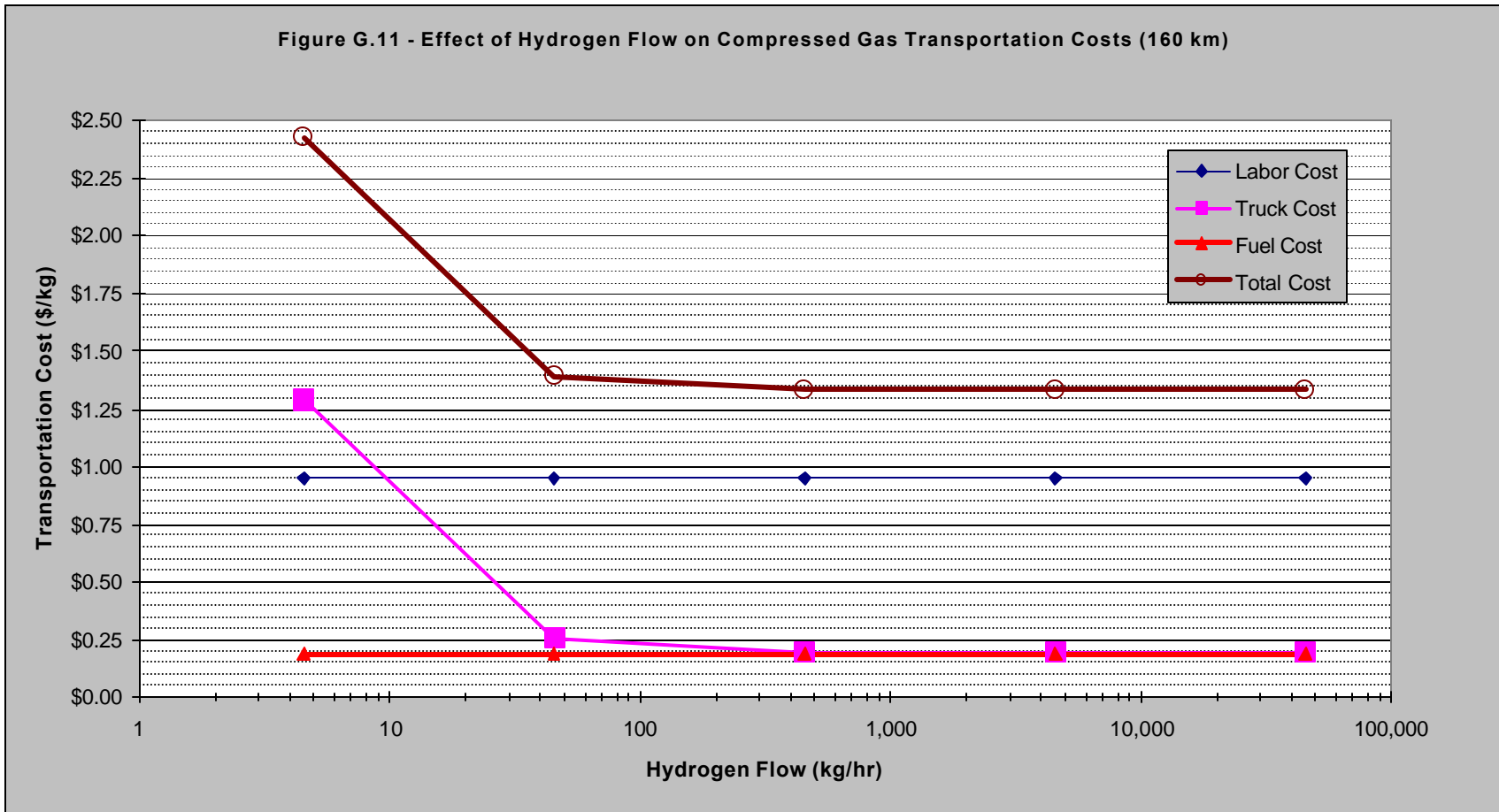

Figure G.11 - At low production rates, the truck is underutilized and represents a large expense.

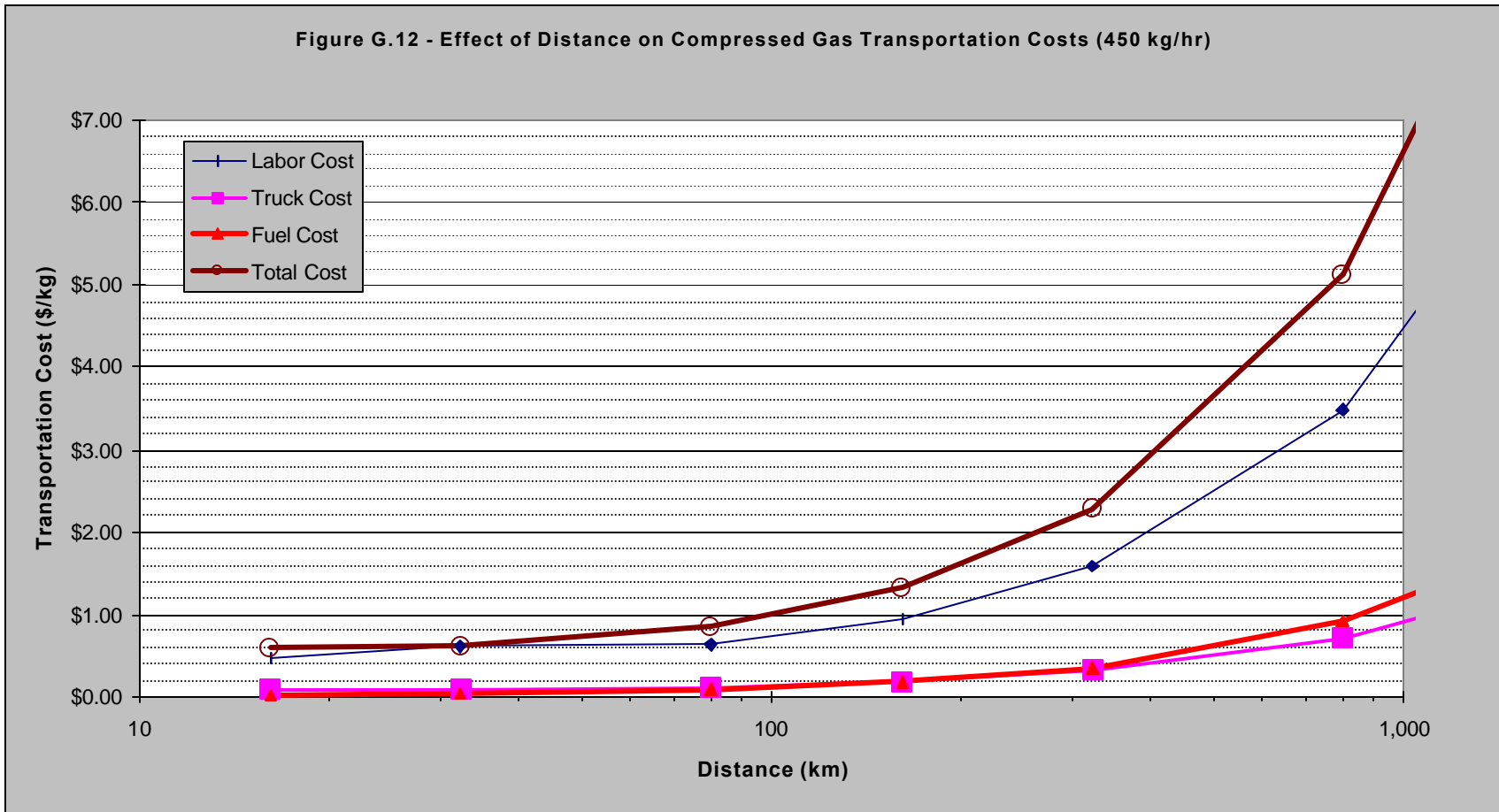

Figure G.12 - Labor costs quickly increase with distance.

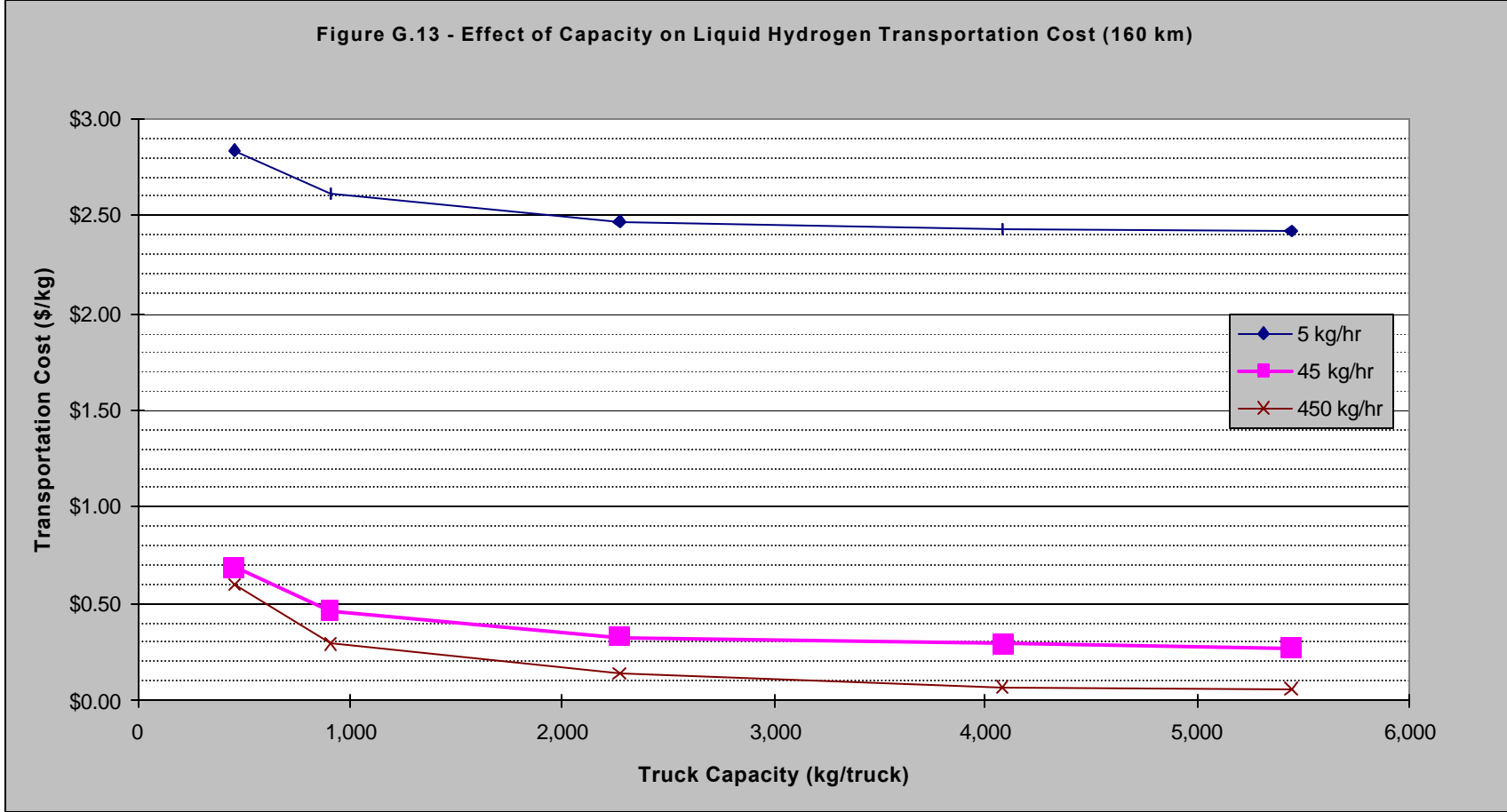

Figure G.13 - Truck capacity is less important with liquid hydrogen transport since a large amount of hydrogen is carried, even at low capacities.

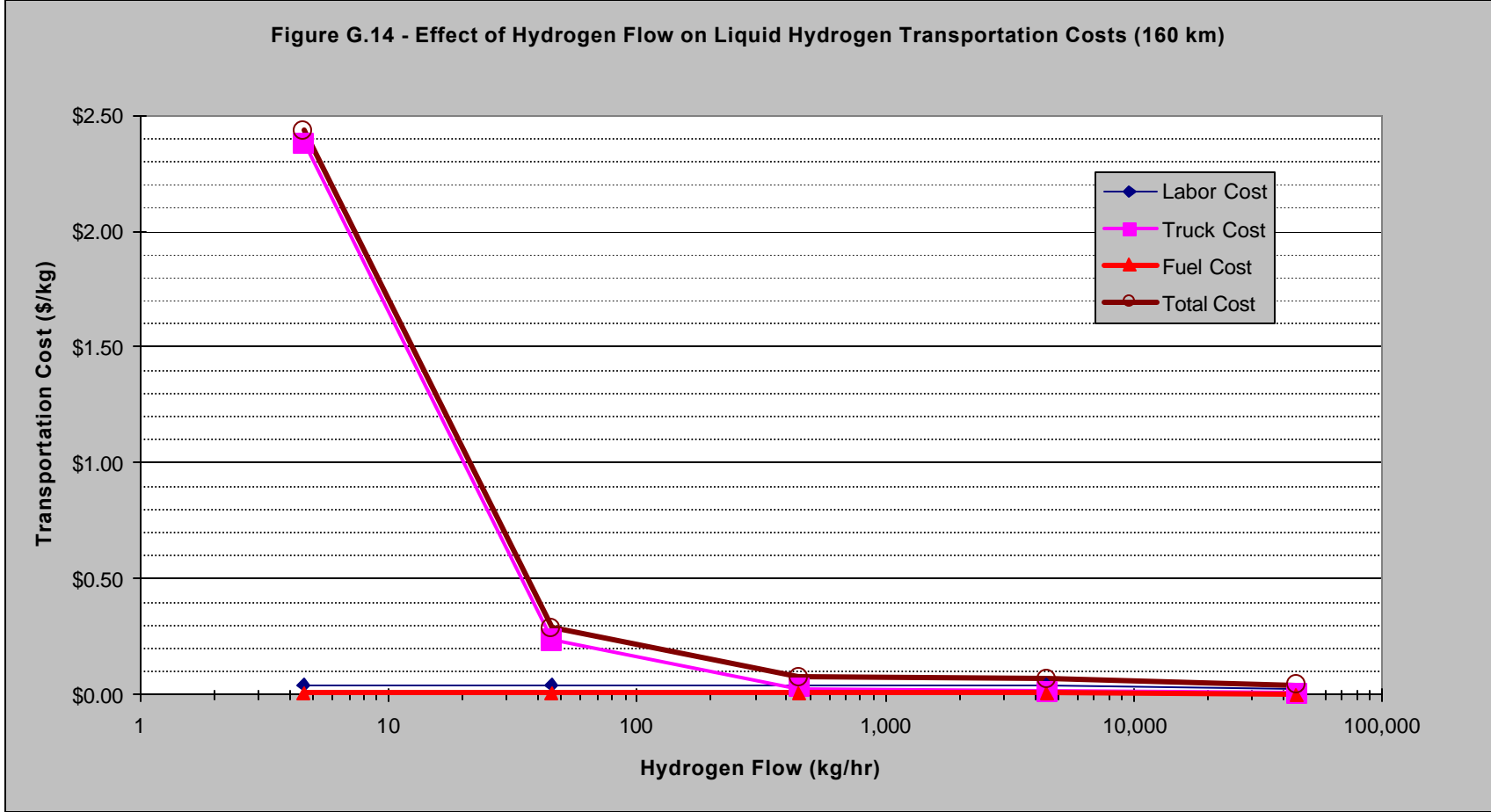

Figure G.14 - At low production rates, truck capital costs are high, but drop as more hydrogen is transported.

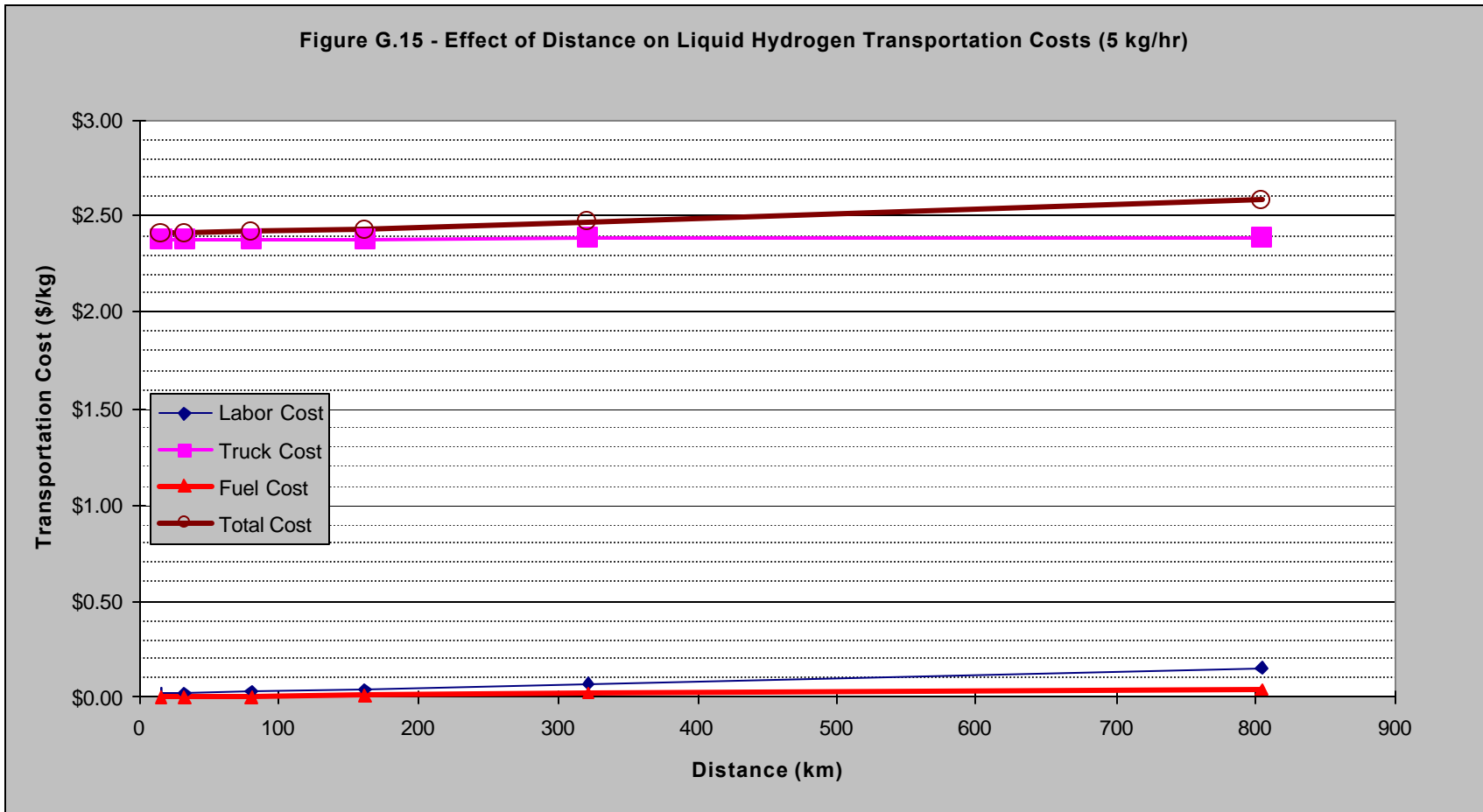

Figure G.15 - At low flows, distance has little effect since trips are infrequent.

Figure G.16 - Effect of Distance on Liquid Hydrogen Transportation Costs (450 kg/hr)

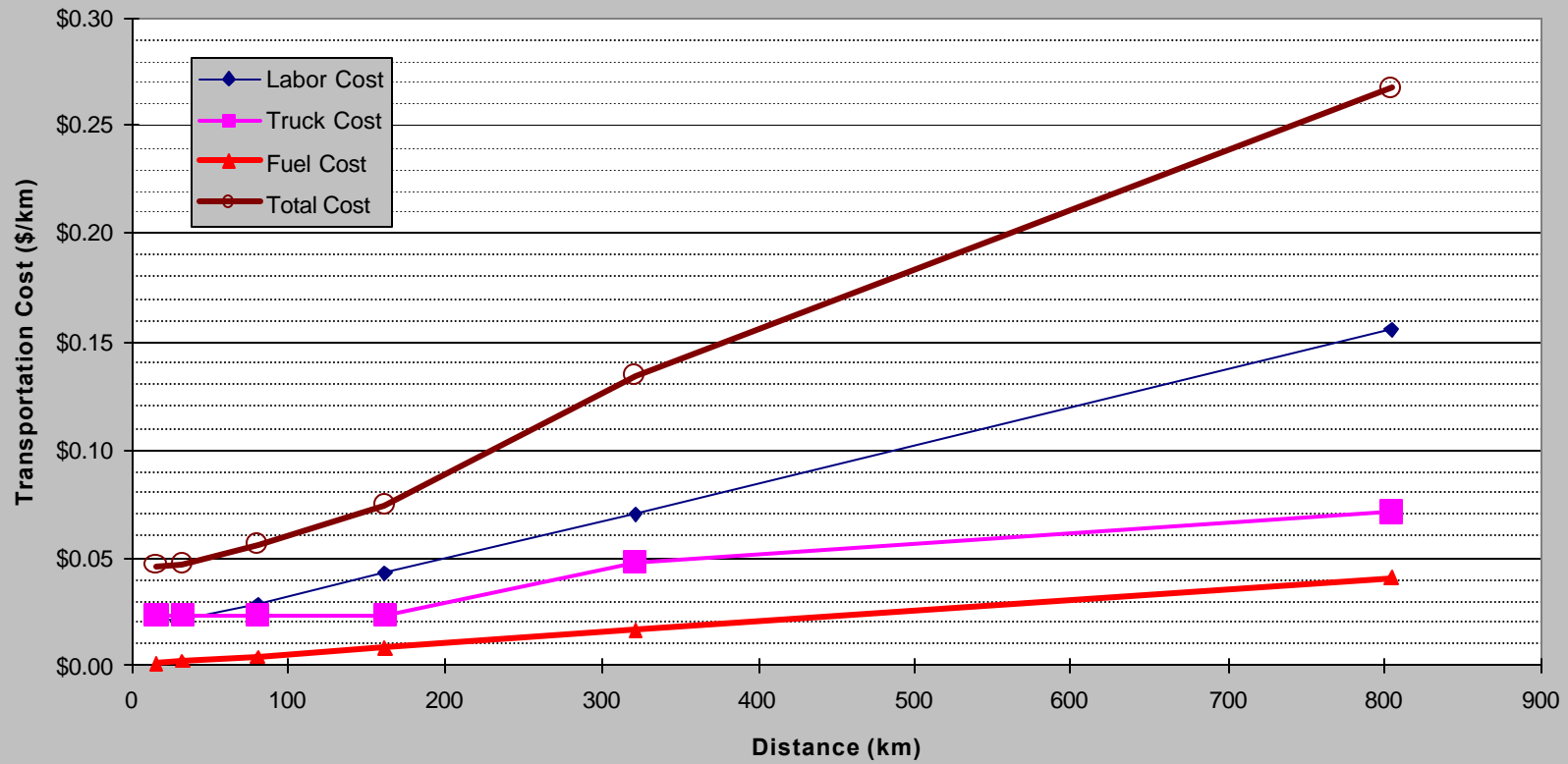

Figure G.16 - At higher flows, labor costs dominate transport costs.

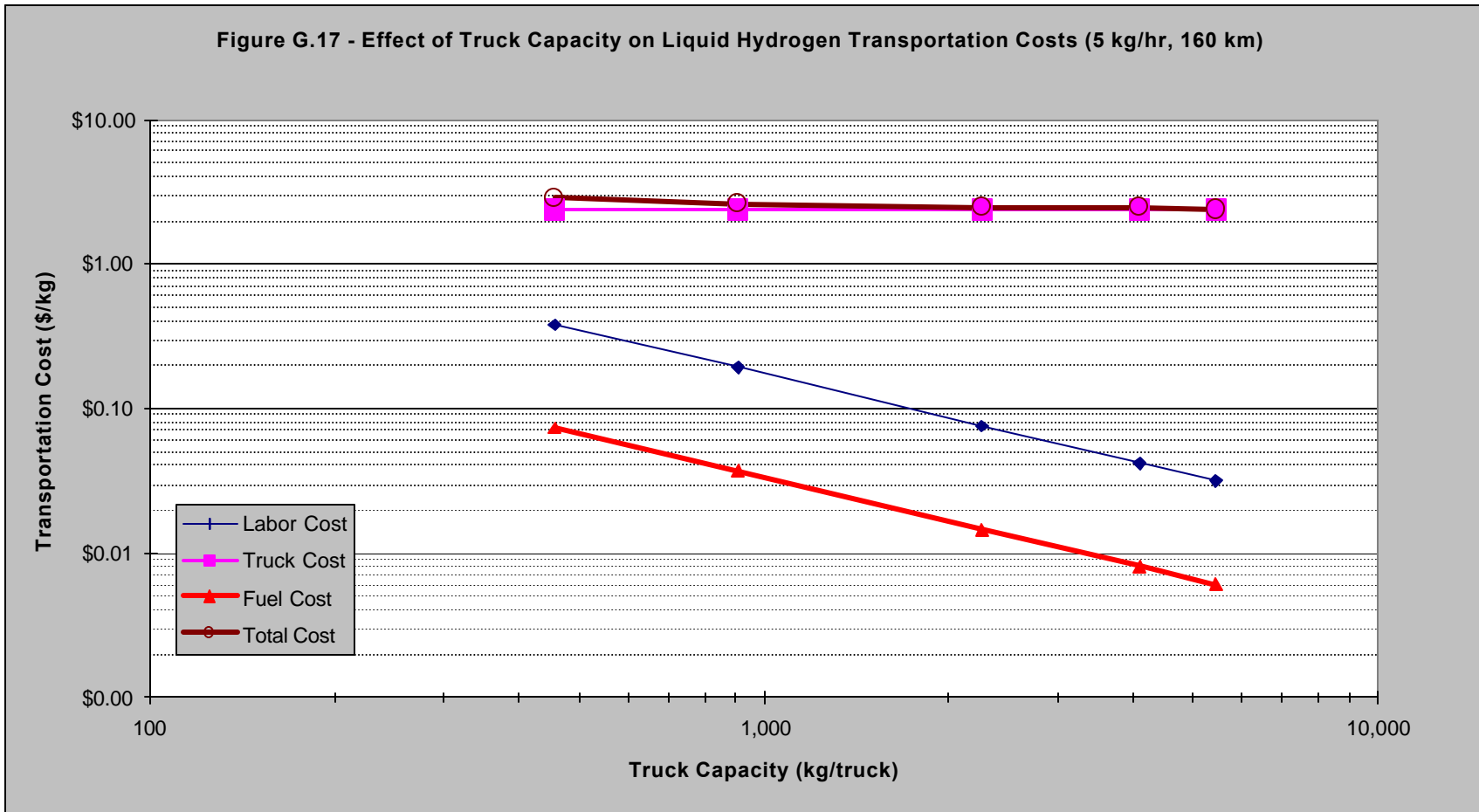

Figure G.17 - Liquid hydrogen truck capital costs dominate at low production rates.

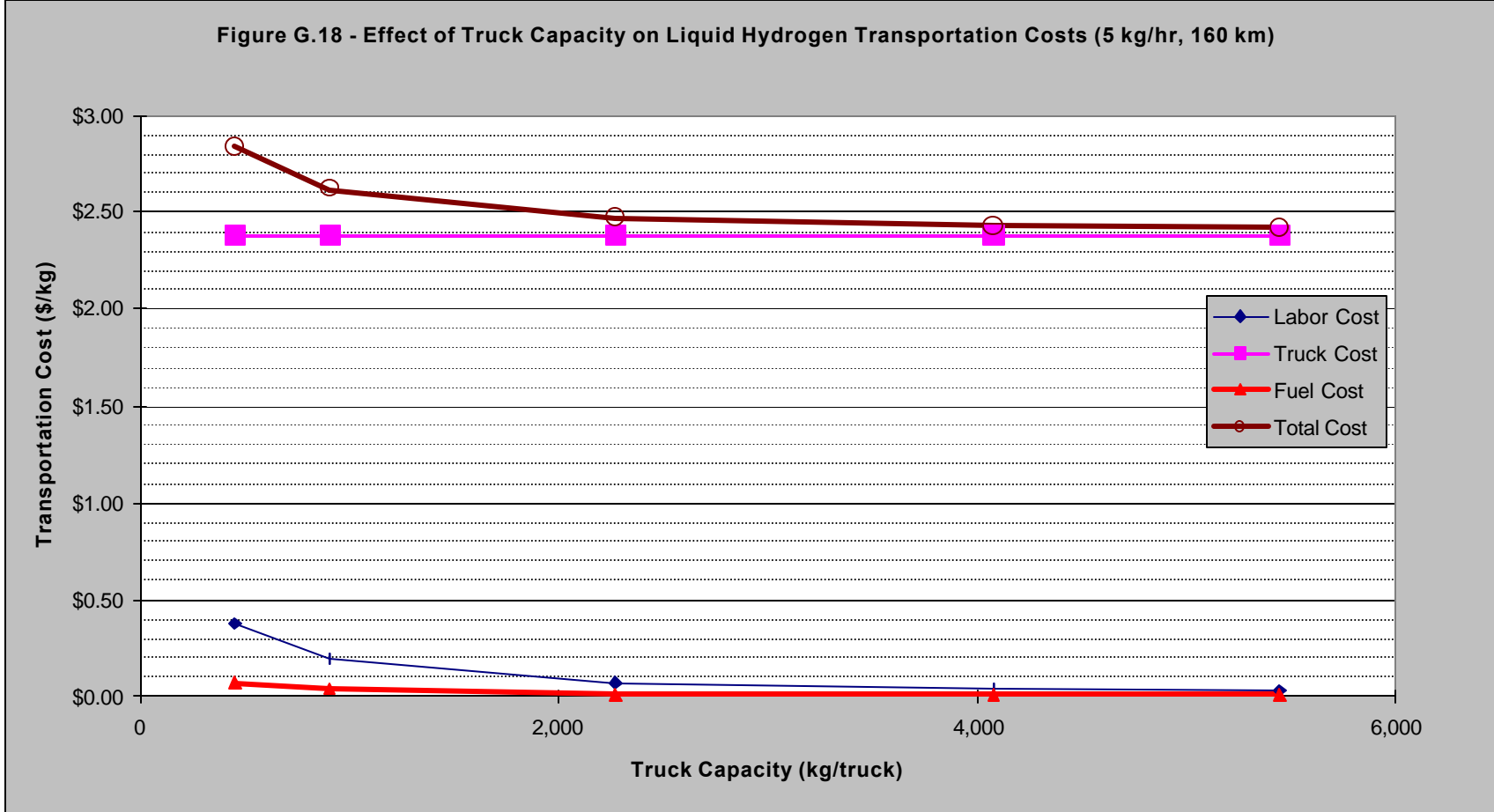

Figure G.18 - Truck capacity has little effect at low production rates.

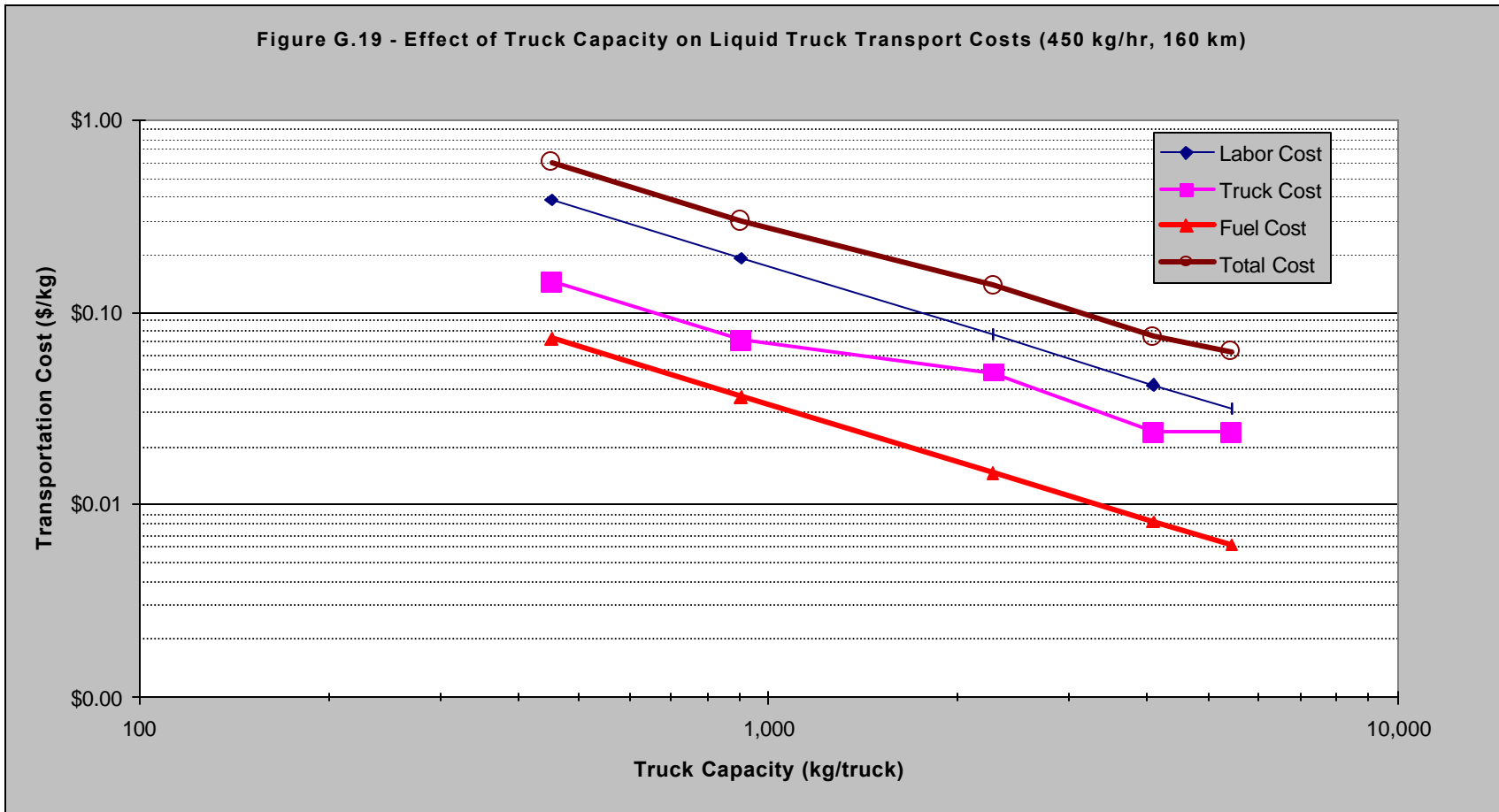

Figure G.19 - Truck capital costs are not linear--discontinuities occur when the number of trucks increases.

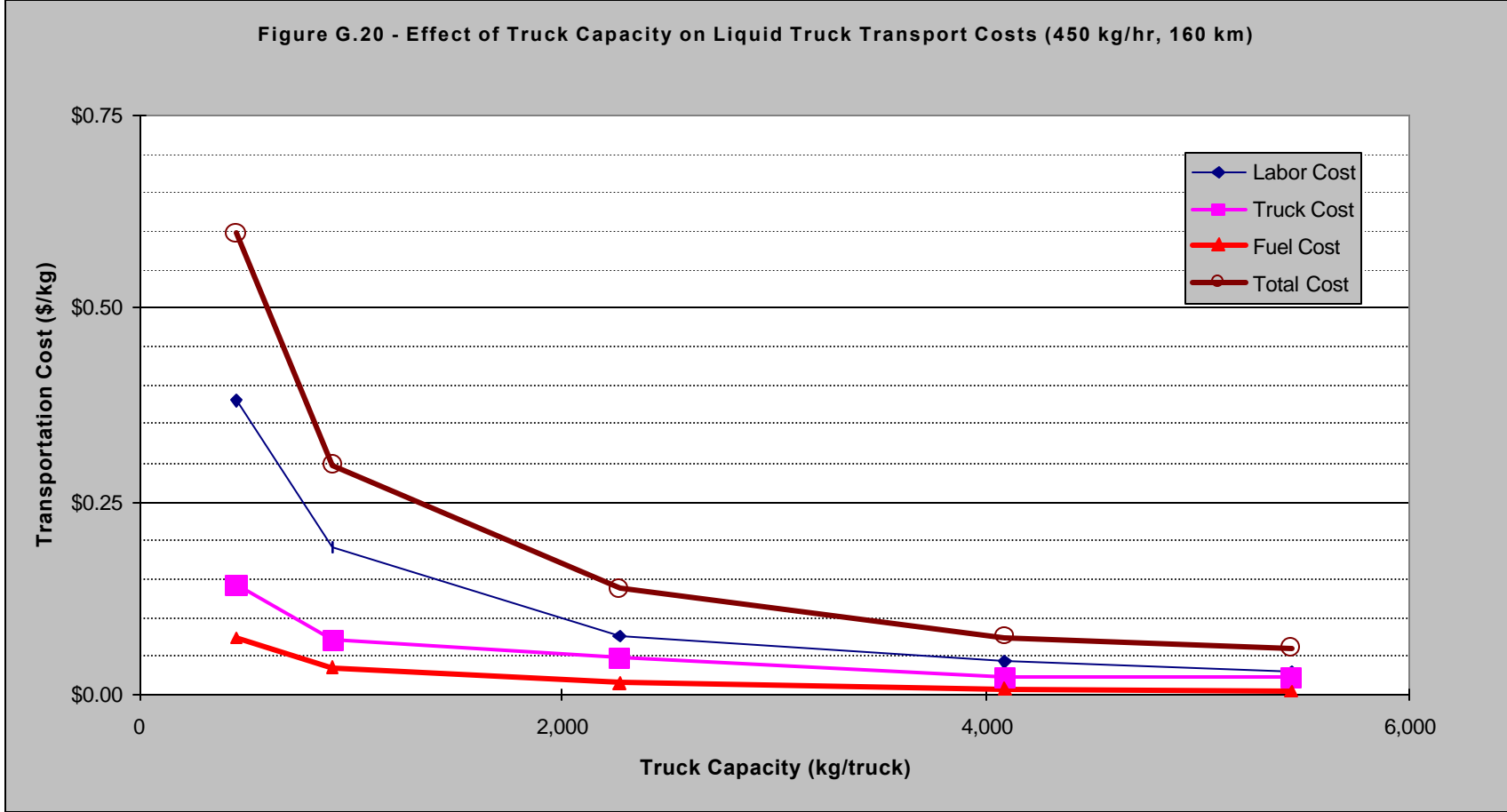

Figure G.20 - Increased truck capacities produce savings in all cost areas.

Figure G.21 - Effect of Hydrogen Flow on Metal Hydride Transportation Costs (160 km)

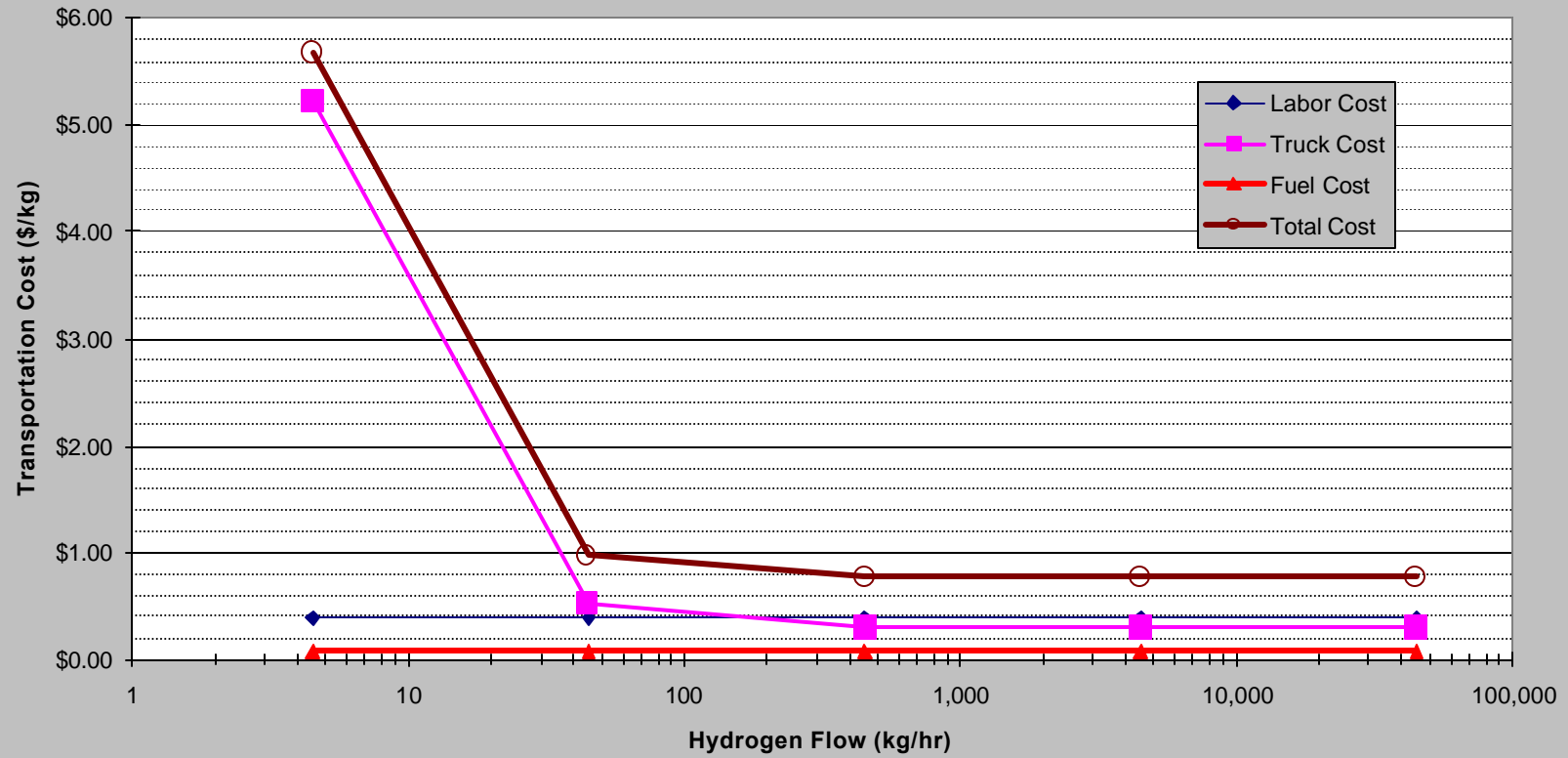

Figure G.21 - Hydride truck capital costs dominate at low production rates.

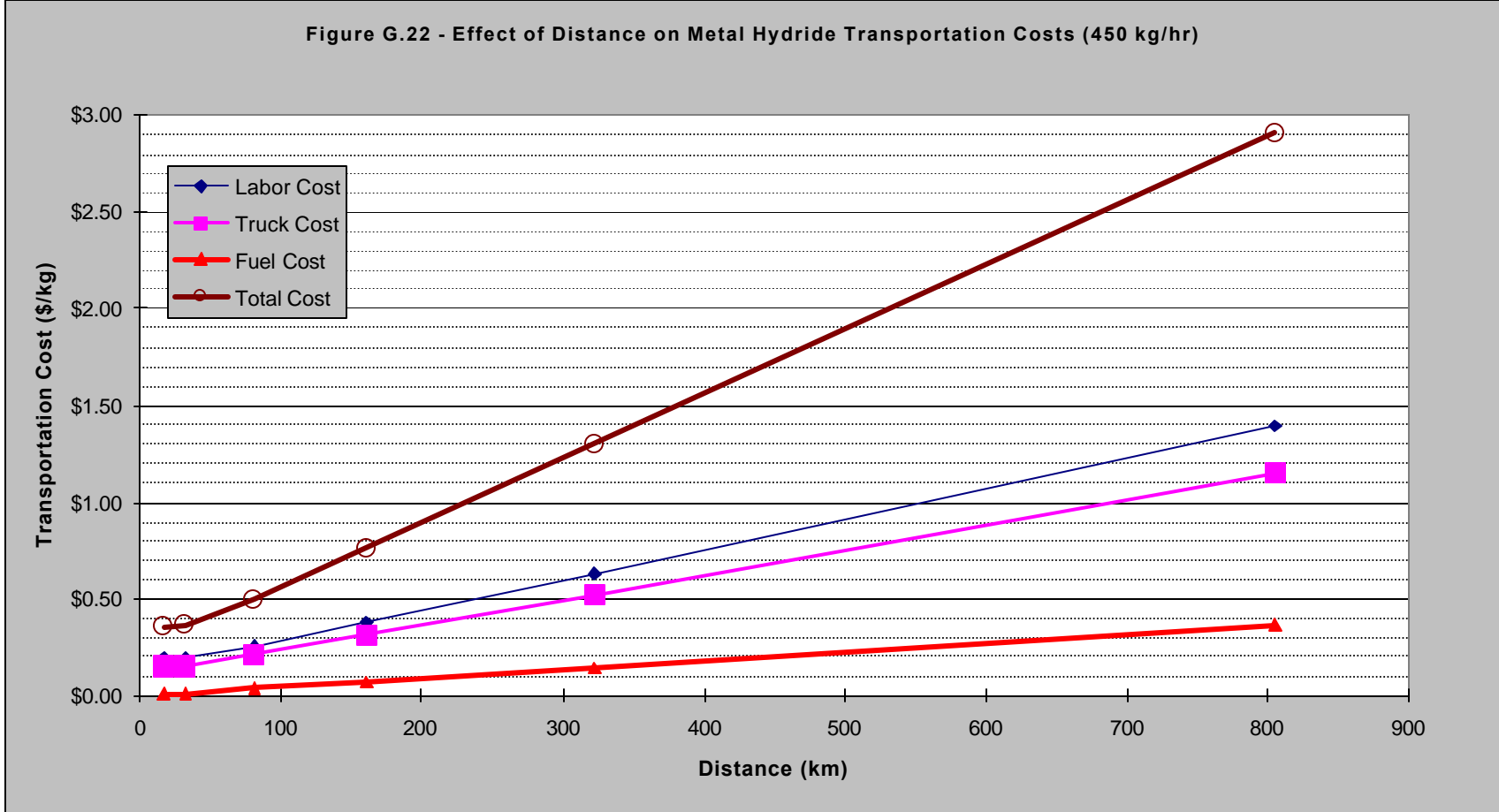

Figure G.22 - At medium production rates, labor is the highest cost of delivery.

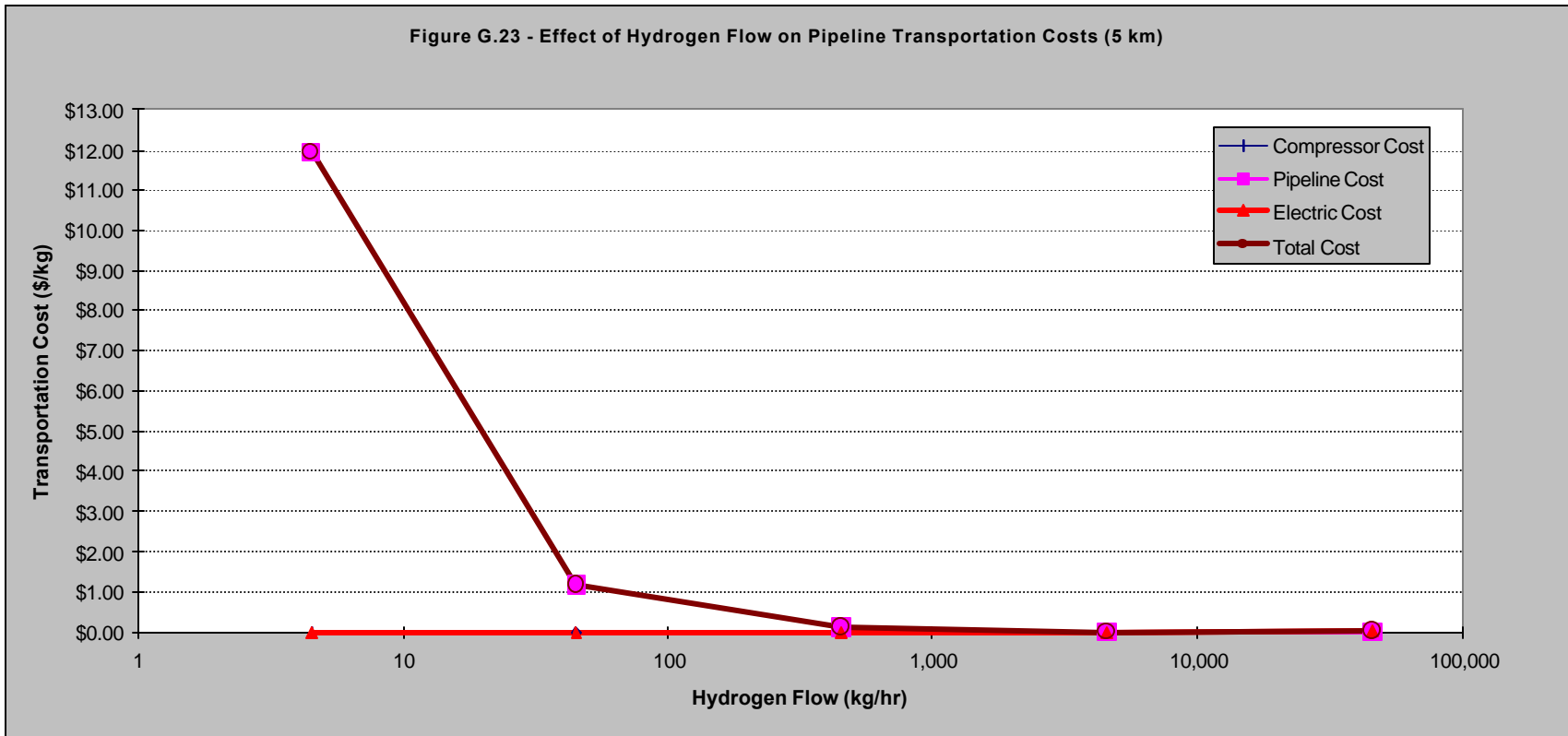

Figure G.23 - At low flows, pipeline costs are high, even for short distances, but drop with increased flows.

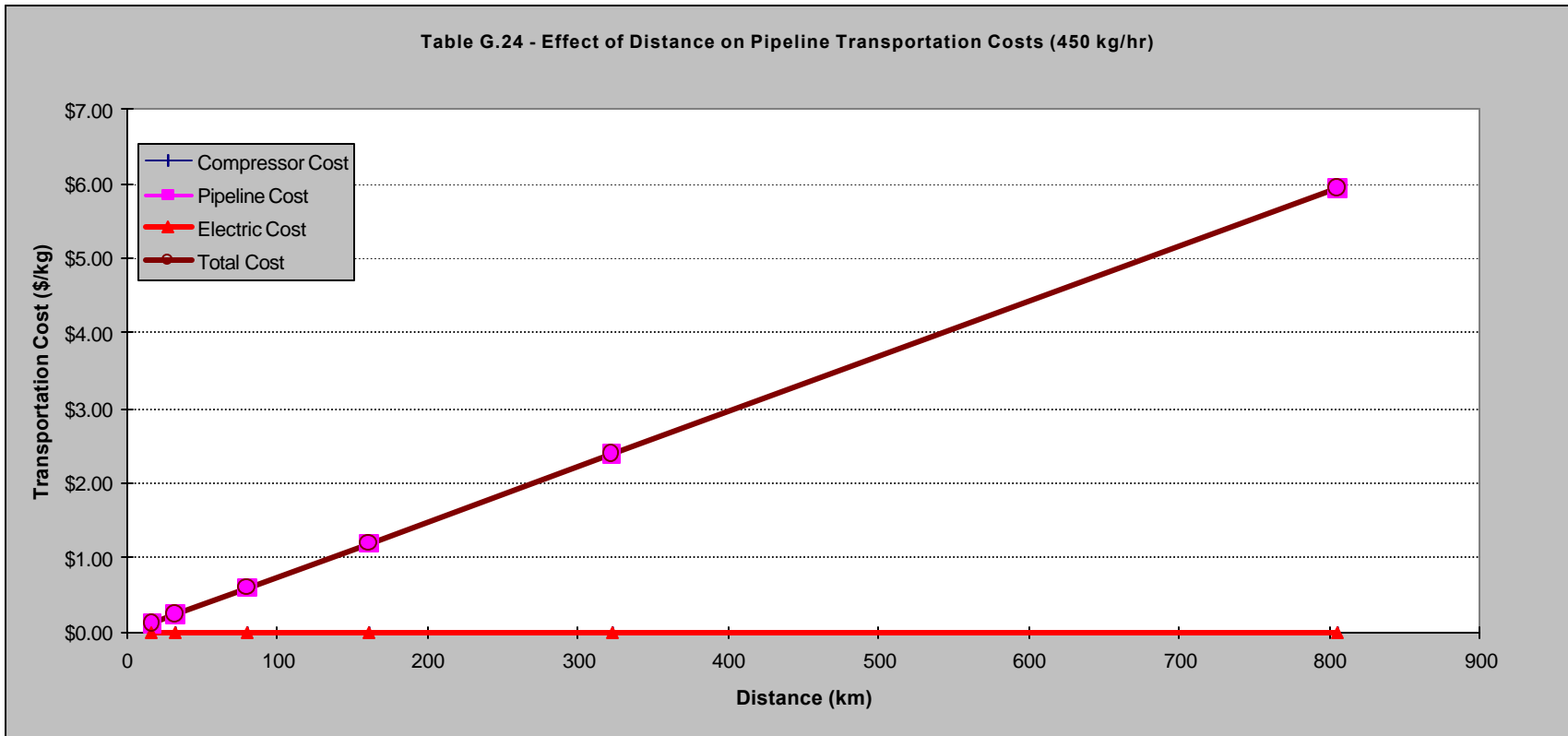

Figure G.24 - Pipeline delivery costs are directly related to the pipeline installation and construction costs.

Figure G.25 - Transportation Cost Breakdown (450 kg/hr, 160 km)

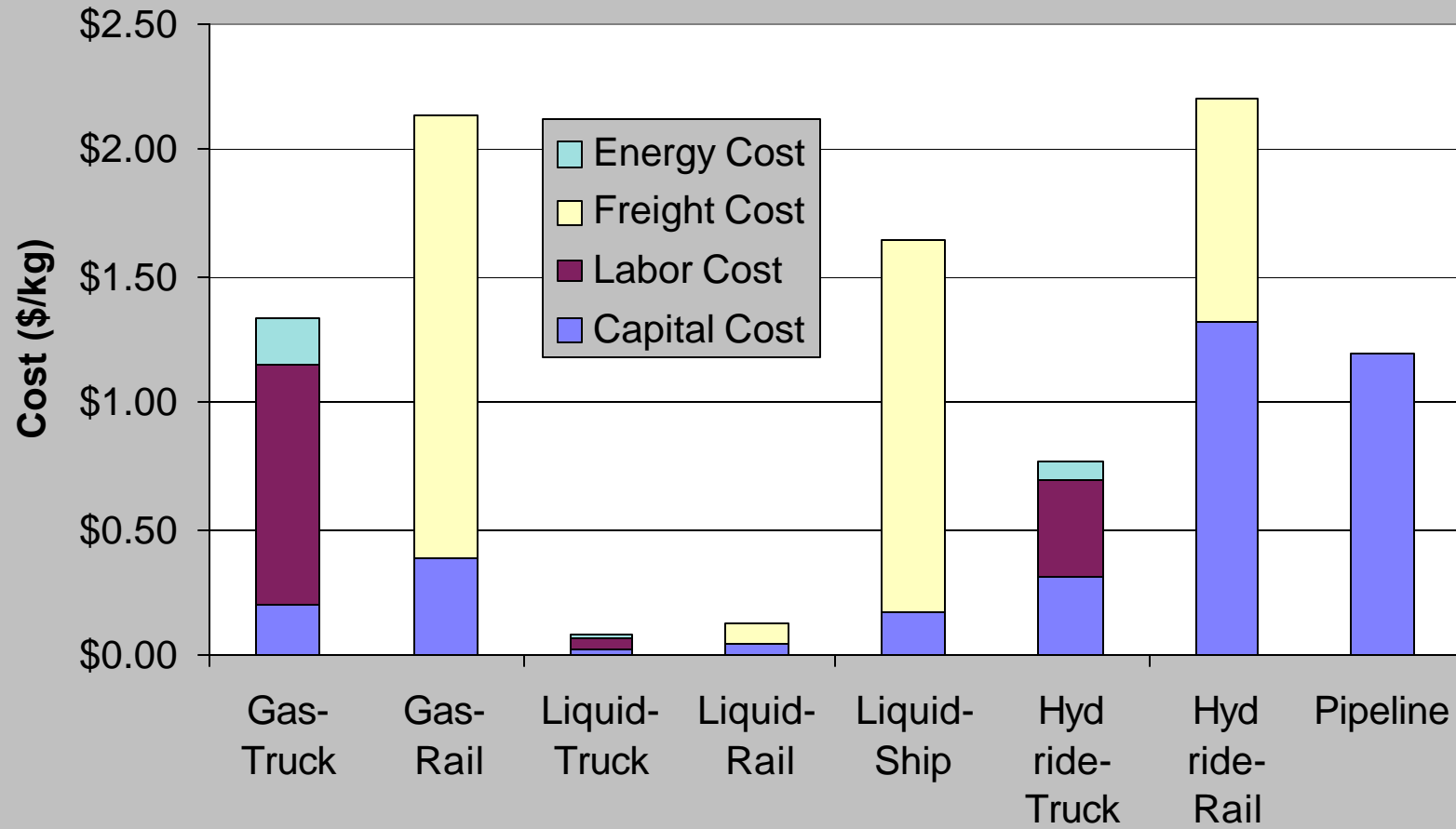

Figure G.25 - Liquid hydrogen delivery by truck or rail is the cheapest delivery option for a medium sized hydrogen facility.

APPENDIX H - COMBINED STORAGE AND TRANSPORT COSTS

- H.1 Low production rate & short delivery distance.
- H.2 Low production rate & long delivery distance.
- H.3 High production rate & short delivery distance.
- H.4 High production rate & long delivery distance.

Appendix H contains figures showing the contributions of both the hydrogen storage and the hydrogen transportation costs for the four cases shown above. Costs for eleven combinations of storage and transport options were examined, plus the option of using a pipeline without any storage. For the low production rate, 45 kg/h (100 lb/h) was used. The high production rate was 4,500 kg/h (10,000 lb/h). The two delivery distances used were 16 km (10 mi) and 800 km (500 mi).

Figure H.1 - Combined Storage & Transportation Costs (45 kg/hr, 16 km)

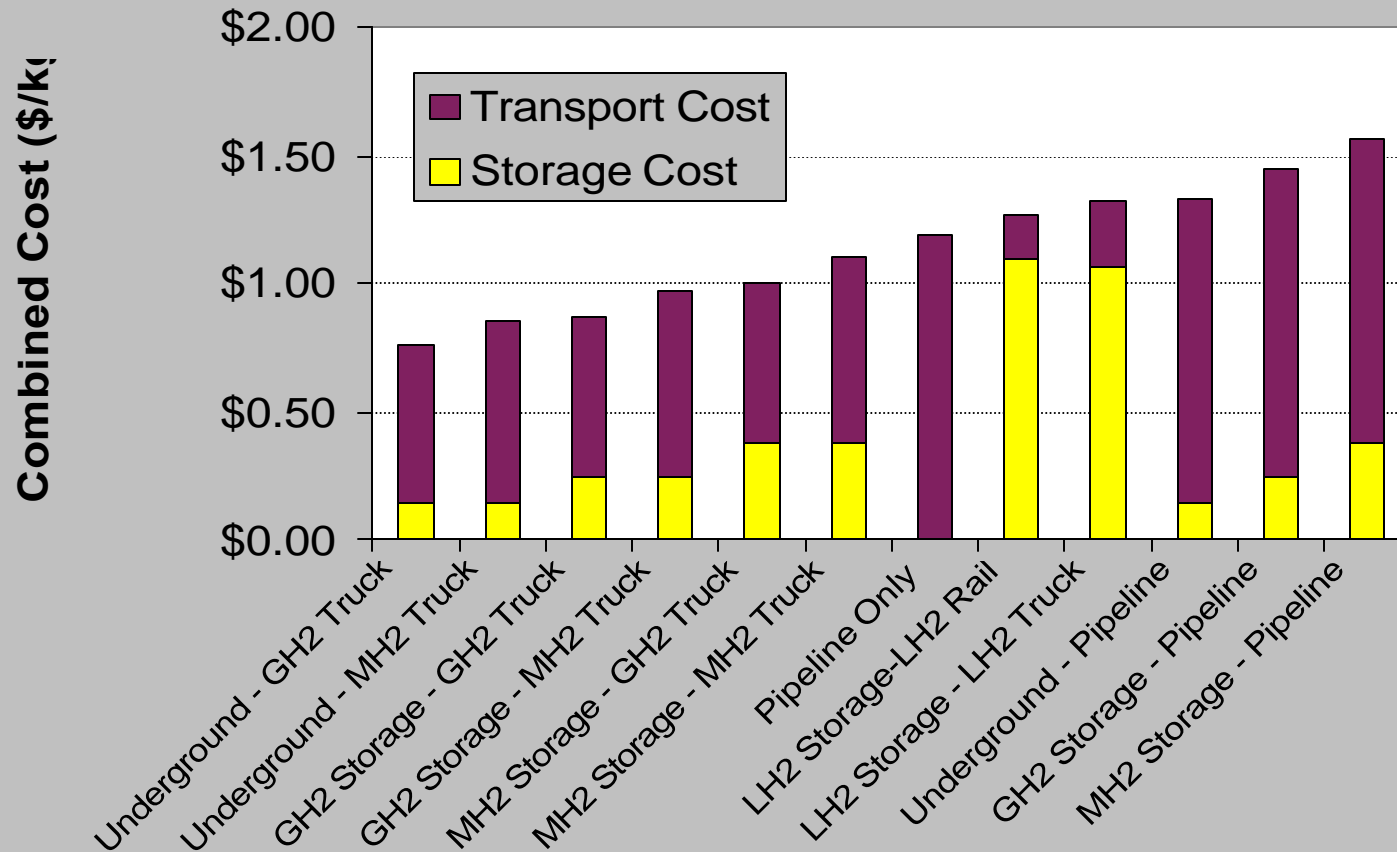

Figure H.1 - For low hydrogen production rates and short delivery distances, compressed gas is the cheapest, but there are several options.

Figure H.2 - Combined Storage & Transportation Costs (45 kg/hr, 800 km)

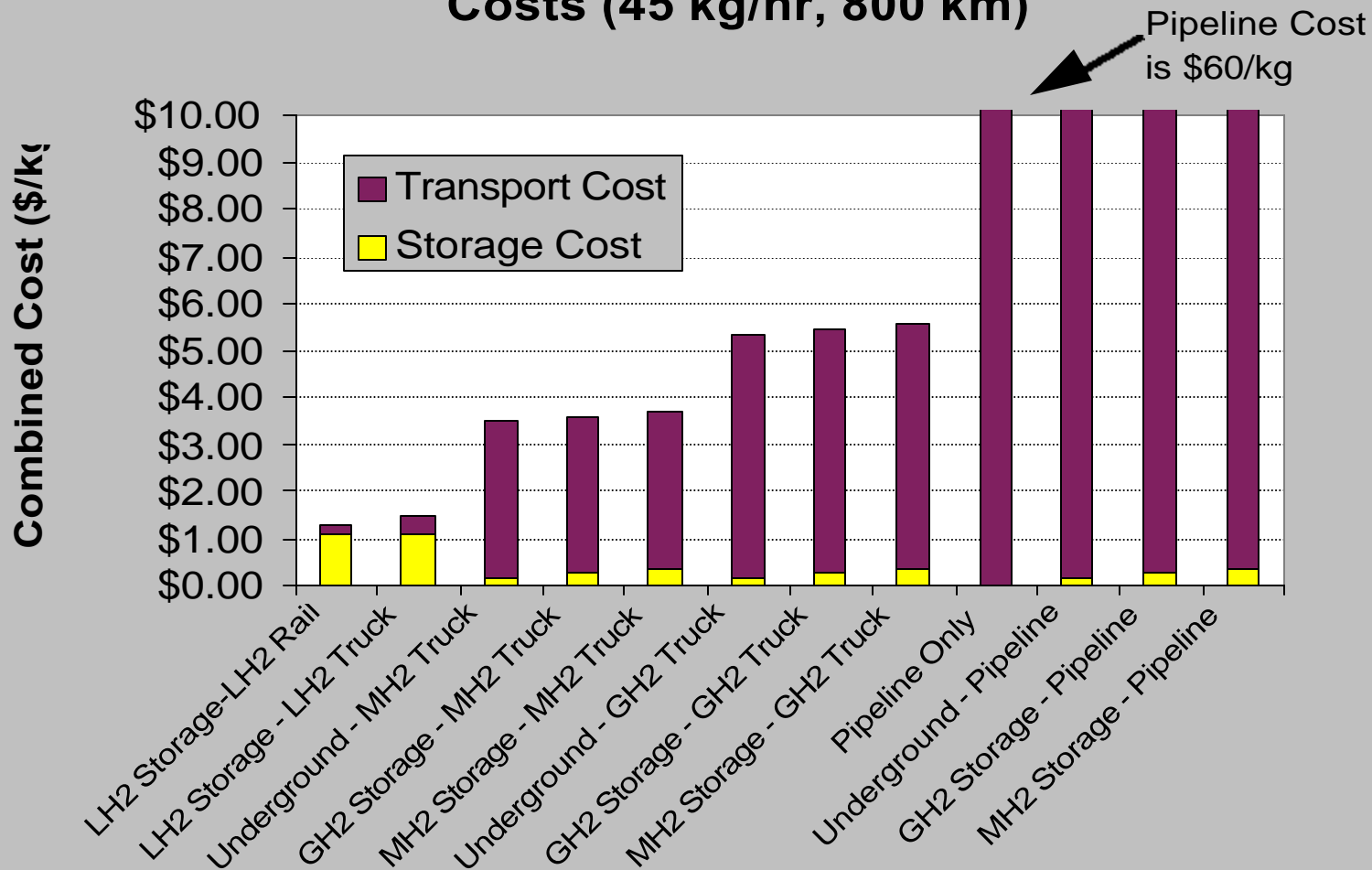

Figure H.2 - For low production rates and long distances, liquid hydrogen is the clear winner.

Figure H.3 - Combined Storage & Transportation Costs (4,500 kg/hr, 16 km)

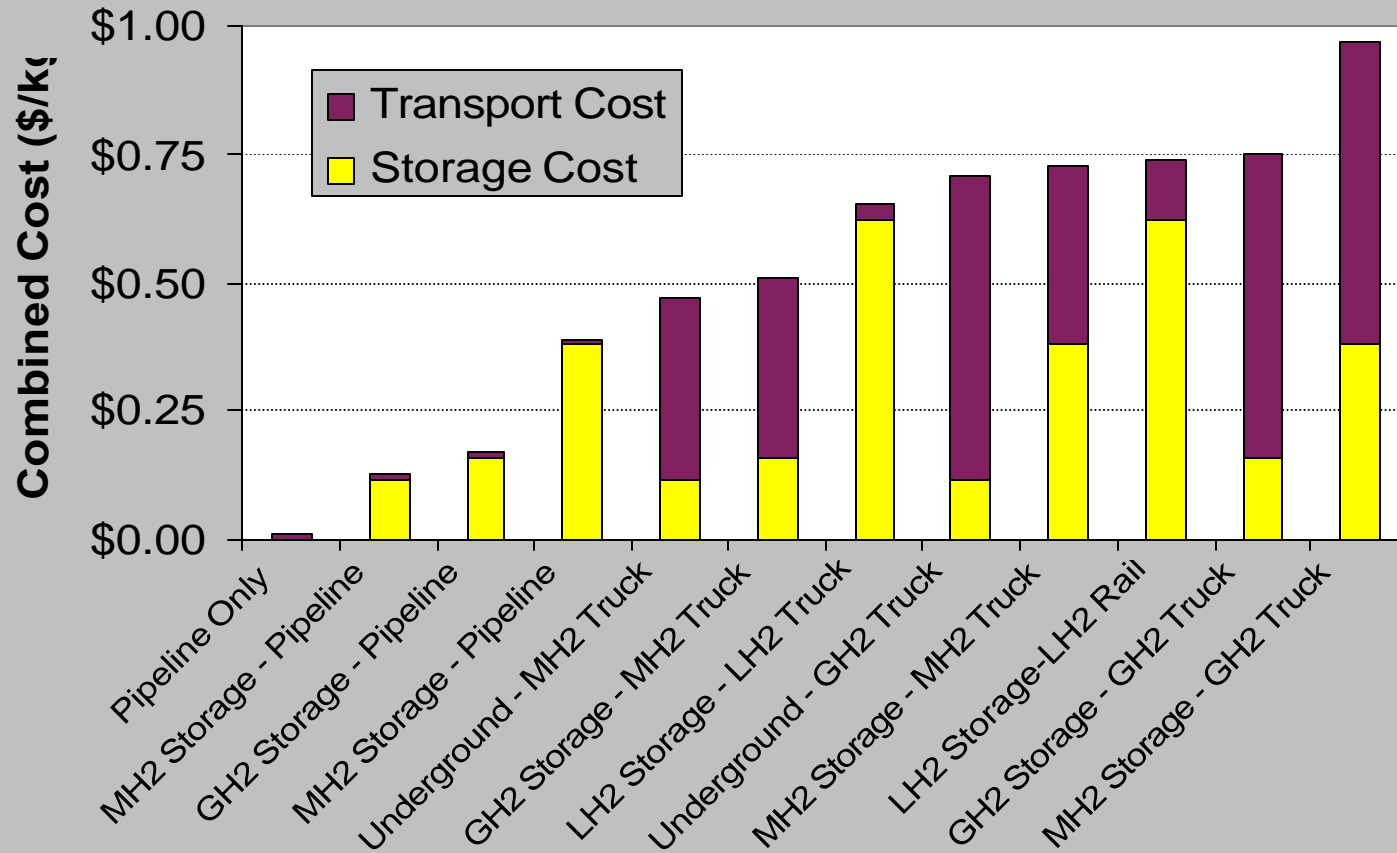

Figure H.3 - For high production rates and short distances, pipeline delivery is very inexpensive.

Figure H.4 - Combined Storage & Transportation Costs (4,500 kg/hr, 800 km)

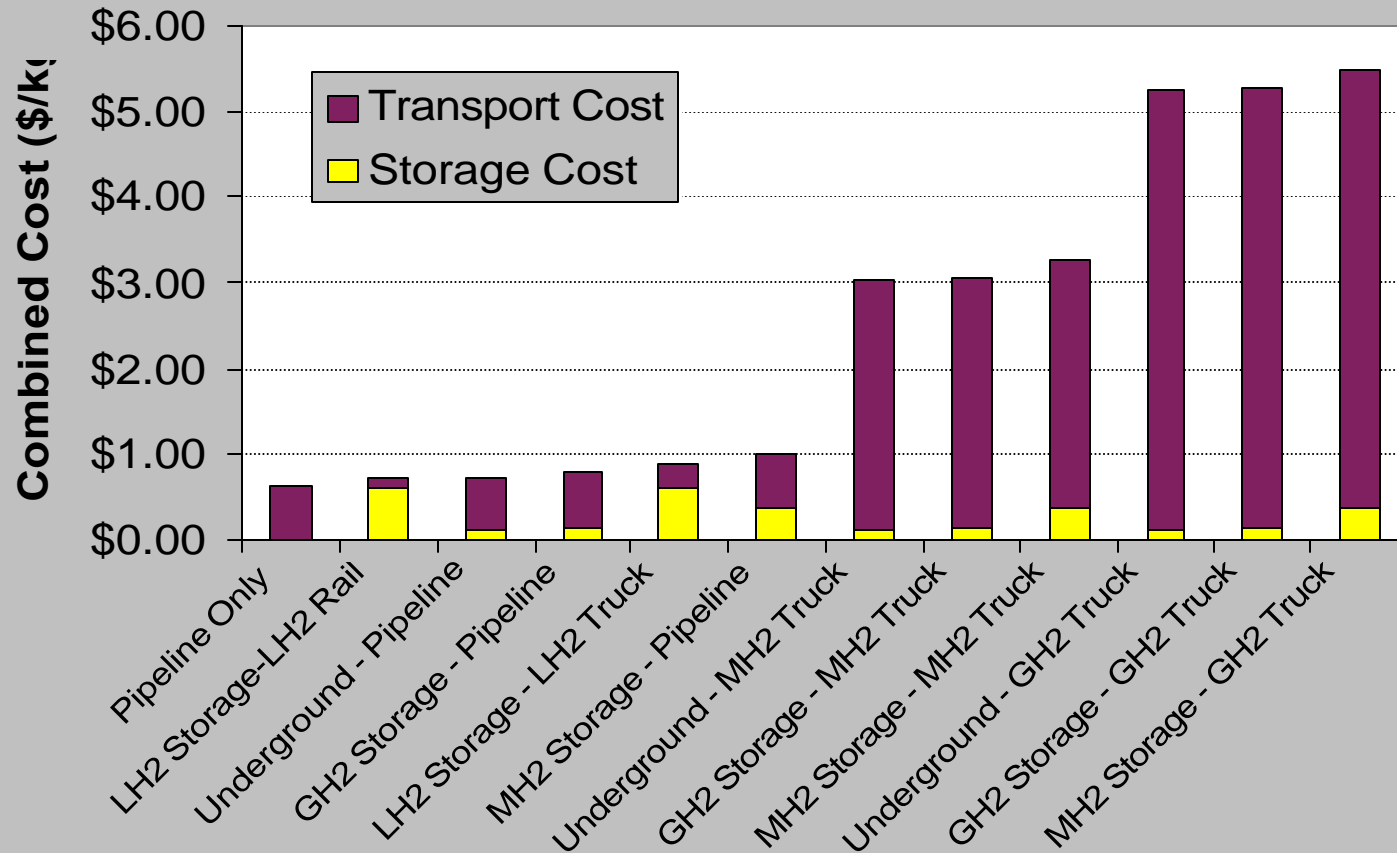

Figure H.4 - For large production rates and long distances, pipeline delivery and liquid hydrogen are the main options.

REPORT DOCUMENTATION PAGE

Form Approved
OMB NO. 0704-0188

Public reporting burden for this collection of information is estimated to average 1 hour per response, including the time for reviewing instructions, searching existing data sources, gathering and maintaining the data needed, and completing and reviewing the collection of information. Send comments regarding this burden estimate or any other aspect of this collection of information, including suggestions for reducing this burden, to Washington Headquarters Services, Directorate for Information Operations and Reports, 1215 Jefferson Davis Highway, Suite 1204, Arlington, VA 22202-4302, and to the Office of Management and Budget, Paperwork Reduction Project (0704-0188), Washington, DC 20503.

1. AGENCY USE ONLY (Leave blank)	2. REPORT DATE November 1998	3. REPORT TYPE AND DATES COVERED Technical Report	
4. TITLE AND SUBTITLE Costs of Storing and Transporting Hydrogen		5. FUNDING NUMBERS HY914041	
6. AUTHOR(S) W.A. Amos			
7. PERFORMING ORGANIZATION NAME(S) AND ADDRESS(ES) National Renewable Energy Laboratory 1617 Cole Boulevard Golden, CO 80401-3393		8. PERFORMING ORGANIZATION REPORT NUMBER	
9. SPONSORING/MONITORING AGENCY NAME(S) AND ADDRESS(ES) National Renewable Energy Laboratory 1617 Cole Boulevard Golden, CO 80401-3393		10. SPONSORING/MONITORING AGENCY REPORT NUMBER NREL/TP-570-25106	
11. SUPPLEMENTARY NOTES			
12a. DISTRIBUTION/AVAILABILITY STATEMENT National Technical Information Service U.S. Department of Commerce 5285 Port Royal Road Springfield, VA 22161		12b. DISTRIBUTION CODE	
13. ABSTRACT (<i>Maximum 200 words</i>) An analysis was performed to estimate the costs associated with storing and transporting hydrogen. These costs can be added to a hydrogen production cost to determine the total delivered cost of hydrogen. Storage methods analyzed included compressed gas, liquid hydrogen, metal hydride, and underground storage. Major capital and operating costs were considered over a range of production rates and storage times.			
14. SUBJECT TERMS hydrogen, compressed gas, liquid hydrogen, metal hydride, underground storage		15. NUMBER OF PAGES 219	16. PRICE CODE
17. SECURITY CLASSIFICATION OF REPORT	18. SECURITY CLASSIFICATION OF THIS PAGE	19. SECURITY CLASSIFICATION OF ABSTRACT	20. LIMITATION OF ABSTRACT