

MANNED VENUS FLYBY

February 1, 1967

M. S. Feldman
L. A. Ferrara
P. L. Havenstein
J. E. Volonte
P. H. Whipple

Work performed for Manned Space Flight, National Aeronautics and
Space Administration under Contract NASw-417.

BELLCOMM, INC.

ABSTRACT

This study is one of several being conducted at Bellcomm and in Manned Space Flight whose purpose is to give guidance to the Apollo Applications Program's technical objectives by focusing on a longer range goal. The assumed mission in this case is a three-man flyby of Venus launched in November, 1973 on a single standard Saturn V. The selected flight configuration includes a Command and Service Module similar in some respects to Apollo, an Environmental Support Module which occupies the adapter area and a spent S-IVB stage which is utilized for habitable volume and structural support of a solar cell electrical power system. The total injected weight, 106,775 lbs., is within the capability of a single Saturn V of the early 1970's. The study is focused on the selection of subsystem technologies appropriate to long duration flight. The conclusions are reported in terms of the technical characteristics to be achieved as part of the Apollo Applications Program's long duration objectives.

BELLCOMM, INC.

MANNED VENUS FLYBY

Table of Contents

<u>Section</u>	<u>Title</u>	<u>Page</u>
1.0	Introduction	1-1
2.0	Mission Analysis	2-1
2.1	Mission Selection	2-1
2.2	Trajectory	2-4
2.3	System Requirements	2-6
3.0	Systems Analysis	3-1
3.1	Structures	3-2
3.2	Navigation, Guidance and Control	3-10
3.3	Propulsion	3-14
3.4	Environmental Control	3-17
3.5	Crew Systems	3-25
3.6	Experiments	3-28
3.7	Communications	3-33
3.8	Electrical Power	3-38
3.9	Systems Integration	3-42
3.10	System Development	3-49
4.0	Conclusions	4-1
<u>Appendix</u>		
I	Saturn V Payload Capability	I-1
II	Venus Flyby Mission Trajectory	II-1
III	Unmanned Probe Lander Analysis	III-1

BELLCOMM, INC.

List of Tables

<u>Number</u>	<u>Title</u>	<u>Page</u>
3-1	Radiation Guidelines for Manned Space Vehicle	3-7a
3-2	Navigation, Guidance and Control Summary	3-13a
3-3	Propellant Requirements Summary	3-16a
3-4	Propulsion System Summary	3-16b
3-5	Metabolic Loads as a Function of Activity	3-18a
3-6	Environmental Control System Options	3-20a
3-7	Environmental Control System Summary	3-24a
3-8	Crew Systems Summary	3-27a
3-9	Experiments Summary	3-32a
3-10	Data Processing Requirements	3-33a
3-11	Spacecraft to Earth Microwave Transmission Analysis	3-35a
3-12	Earth-Spacecraft Communications Link Analysis	3-35b
3-13	Probe-to-Spacecraft Link Analysis	3-36a
3-14	Communications Summary	3-37a
3-15	Electrical Power Summary	3-38a
3-16	Electrical Power System Comparison	3-39a
3-17	Electrical Weight Summary	3-41a
3-18	Functional Assignments of System Modules	3-42a
3-19	Command Module Weight Summary	3-43b
3-20	Service Module Weight Summary	3-43c
3-21	ESM Weight Summary	3-43d
3-22	S-IVB/IU Weight Summary	3-43e
3-23	Injected Weight Summary	3-43f
3-24	CSM Propellant Requirements	3-53a

BELLCOMM, INC.

List of Illustrations

<u>Number</u>	<u>Title</u>	<u>Page</u>
2-1	Mission Parameters - 1973 Venus Lightside Flyby	2-1a
2-2	Saturn V Injection Capability - Launch Date 1973	2-1b
2-3	Trajectory for Venus Flyby Mission	2-6a
2-4	Celestial Positions of Spacecraft, Venus and Earth	2-6b
2-5	Required Abort Propulsion from Departure Hyperbola	2-7a
2-6	Venus Flyby Trajectory	2-8a
2-7	Ground Track of Flyby Trajectory	2-8b
2-8	Spacecraft Distances and Sun-Spacecraft-Earth Angle	2-9a
3-1	Spacecraft Equilibrium Temperature vs. Distance from Sun	3-17a
3-2	Environmental Control System Functional Block Diagram	3-21a
3-3	Cruise Configuration	3-43a
3-4	Development Steps	3-54a
I-1	Saturn V Payload Capability	I-1a
II-1	Earth Departure Trajectory	II-4a
II-2	Earth Departure Trajectories	II-5a
II-3	Earth Departure Trajectory Elements	II-5b
II-4	Launch and Parking Orbit Trajectory Elements	II-6a
II-5	Earth-Sun Geometry	II-8a
II-6	Spacecraft Distances to Earth During Departure Hyperbola	II-10a
II-7	Earth Departure Hyperbola Geometry	II-11a
II-8	Post-Injection Ground Tracks and Tracking Coverage for Launch Window 1 Trajectories	II-11b
II-9	Post-Injection Ground Tracks and Trajectory Coverage for Launch Window 2 Trajectories	II-11c
II-10	Abort Geometry	II-11d
II-11	Required Abort Propulsion from Departure Hyperbola	II-12a
II-12	Celestial Sphere - Outbound Leg Trajectory	II-13a
II-13	Celestial Sphere - Outbound Leg Trajectory	II-14a
II-14	Trajectory for Venus Flyby Mission	II-15a
II-15	Celestial Positions of Spacecraft, Venus and Earth	II-15b

BELLCOMM, INC.

List of Illustrations (cont'd)

II-16	Spacecraft Distances and Sun-Spacecraft-Earth Angle	II-15c
II-17	Venus Flyby Trajectory Elements	II-16a
II-18	Venus Flyby Trajectory Elements	II-17a
II-19	Ground Track of Flyby Trajectory	II-17b
II-20	Venus Flyby Trajectory	II-17c
II-21	Venus-Earth-Sun Geometry at Flyby	II-19a
II-22	Venus Flyby Trajectory Elements	II-19b
II-23	Venus Flyby Trajectory Elements	II-22a
III-1	Shape of Venus Probe Lander	III-1a

BELLCOMM, INC.

1.0 Introduction

This study is one of several being conducted at Bellcomm to define and evaluate an Apollo Applications (AAP) objective of extended duration manned space flight. The other studies range from longer duration Mars flyby and landing missions to shorter duration extensions of available Apollo systems. The Venus Flyby Study is focused on mission and configuration near the midpoint of this spectrum involving men and systems for about one year in space.

Concurrent with this study, the Joint Action Group of Manned Space Flight is conducting a thorough analysis of the requirements for manned Mars/Venus flyby. This study chose to focus on Venus flyby because, as a future mission, it appeared closer in both time and scope to the Apollo program; and, therefore, it was judged that a more direct impact could be felt by the AAP.

This study is evolved from a previous and much briefer analysis of effects of a future planetary flyby mission on AAP objectives (Reference 1). It covered a wide range of uses to which the Saturn-Apollo systems could be put in order to prepare for future planetary exploration. A key use, and one within the purview of AAP, was to develop the technology for sustaining men in space for up to two years. In translating that requirement to suitable flight missions, a rough cut was taken at a possible configuration. The flight vehicle had three major units: a CSM (Command and Service Module), an ESM (Environmental Support Module) and an S-IVB/IU spent stage. A preliminary estimate was that they would weigh 35,000 lbs., 30,000 lbs. and 40,000 lbs., respectively.

The CSM retained the functions of guidance and control, communications, reaction control, earth landing, propulsion, electrical power for launch and landing only and environmental control to support these CSM functions. The ESM had the functions of long duration life support, major environmental control and major experiments. The S-IVB/IU had the large volume living space, minor experiment support and the long duration electrical power through solar cells mounted on the SLA panels.

With this previous study as background and with additional objectives of limiting the scope of the current

work and of avoiding unnecessary duplication, the following guidelines were adopted:

1. The mission and system are constrained by the performance of a standard Saturn V and the external configuration of Apollo.
2. A new module (ESM), to be carried in or to replace the LEM adapter, will be required to support the extended duration mission function.
3. A modified CSM will be required to support early aborts, final entry and landing and other functions to be determined.
4. The spent S-IVB stage will be considered for its contribution to the mission.
5. The mission and system analysis is focused on a three-man flyby of Venus launched in 1973.

It is clearly not the intent of this study to recommend that NASA undertake a Venus flyby mission in 1973 or at any time; but it is the intent to show that such a mission is feasible under the above ground rules and, therefore, provides a reasonable basis for choosing long duration system characteristics.

The sections which follow cover the analyses in the order in which they were accomplished. Section 2.0 derives the system requirements for long duration flight from a detailed analysis of a three-man Venus flyby mission. On the basis of these requirements, Section 3.0 examines the technology available or forecast in the several subsystem areas, chooses the better subsystem configurations and synthesizes from them a one-year space vehicle. This is the central portion of the study and the part that is most applicable to AAP technical evaluations. Section 4.0 summarizes the results and conclusions in terms of AAP long duration technical recommendations.

In this brief survey it was necessary to draw heavily on the previous in-house and contracted studies of planetary and earth orbital systems which have been conducted over the past five years. Although this was done as critically as time allowed, it should be recognized that the accuracy of weight and performance data rests upon a rather uneven base of a variety of studies. The references are listed at the end of the report.

BELLCOMM, INC.

2.0 Mission Analysis

2.1 Mission Selection

For purposes of conducting the study, the objectives adopted for the manned Venus flyby mission in 1973-74 are: to demonstrate an early capability for manned interplanetary space flight; and to obtain scientific data on the solar and galactic systems with primary emphasis on Venus.

In order to select a mission on which to base the analysis, it is necessary to consider the effect of earth launch date on the required injection velocity, earth entry velocity and mission duration. These relationships from References 2, 3 and 4 are shown in Figure 2-1 for a launch occurring late in 1973 and a light side passage in 1974 with a periapsis altitude of one Venus radius. The mission parameters are relatively insensitive to the planetary miss distance for altitudes up to the order of several planetary radii; and the choice here, while an arbitrary one to get the study started, is based on an anticipated tradeoff between the need for approaching Venus as closely as possible to obtain scientific data and the possible guidance penalties associated with uncertainties in the knowledge of the gravitational field of Venus.

Figure 2-1 shows that injection velocity goes through a minimum of 12,350 fps about November 15, 1973. Figure 2-2 shows the corresponding variation in Saturn V capability in terms of total injected weight (including flight performance reserve and residuals). These data, based on Appendix I, are for both a 90° and a 72° launch azimuth from Complex 39, carrying the launch escape system through first stage flight and injection from the fourth 100 n.m. parking orbit. It is apparent that the total injected weight will determine the length of the available launch period. At 105,000 lbs., the duration of the launch period is 45 days; at 115,000 lbs., 20 days.

The selection of a realistic launch period requirement is vital to mission analysis and involves a number of factors. The principal one is the program impact of failing to achieve a successful launch in a period which occurs only every other year. In one view, and a fairly realistic one, the impact can be measured in terms of a two-year program

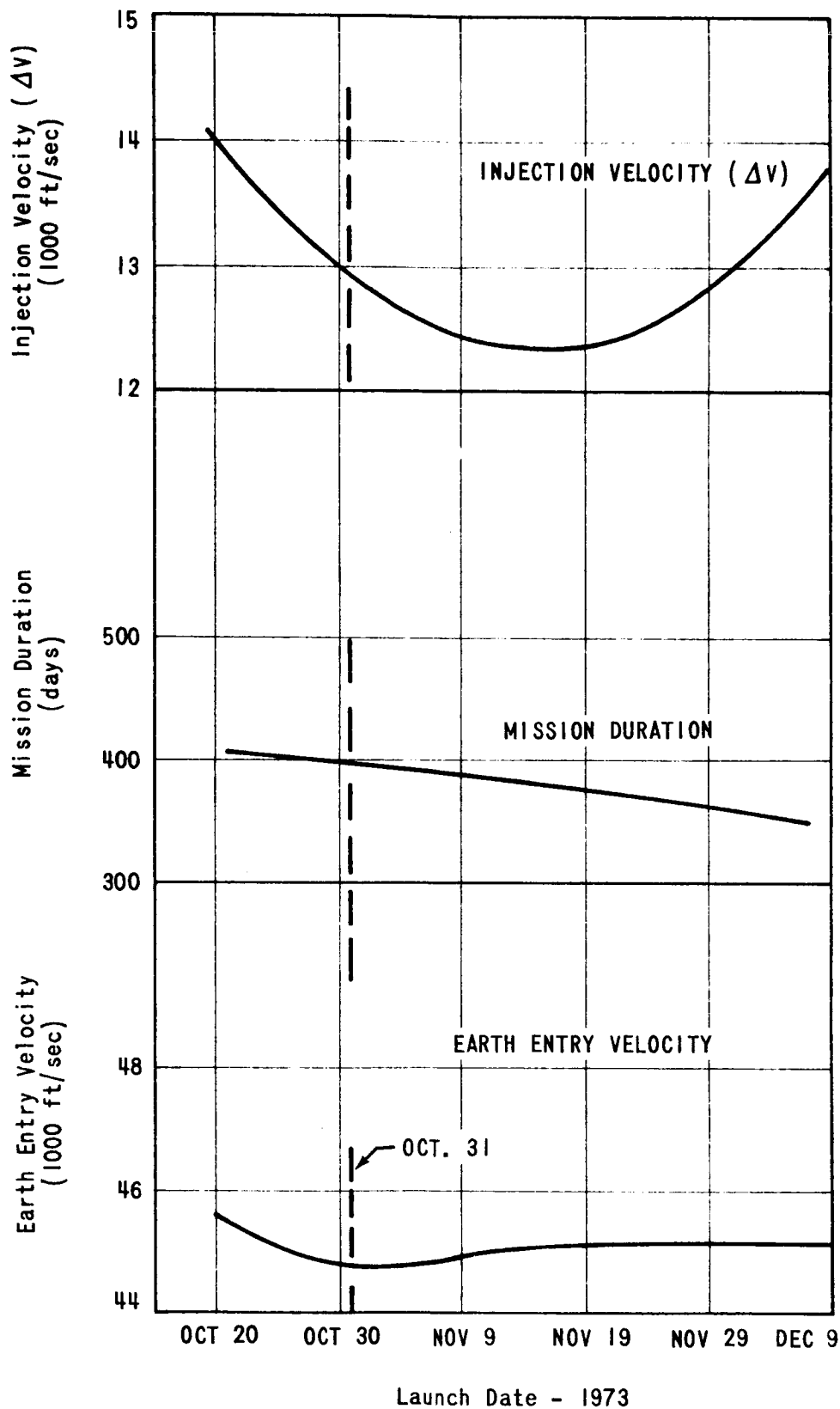

FIGURE 2-1 - MISSION PARAMETERS 1973 VENUS LIGHTSIDE FLYBY
PERIAPSIS ALTITUDE - 1 PLANETARY RADIUS

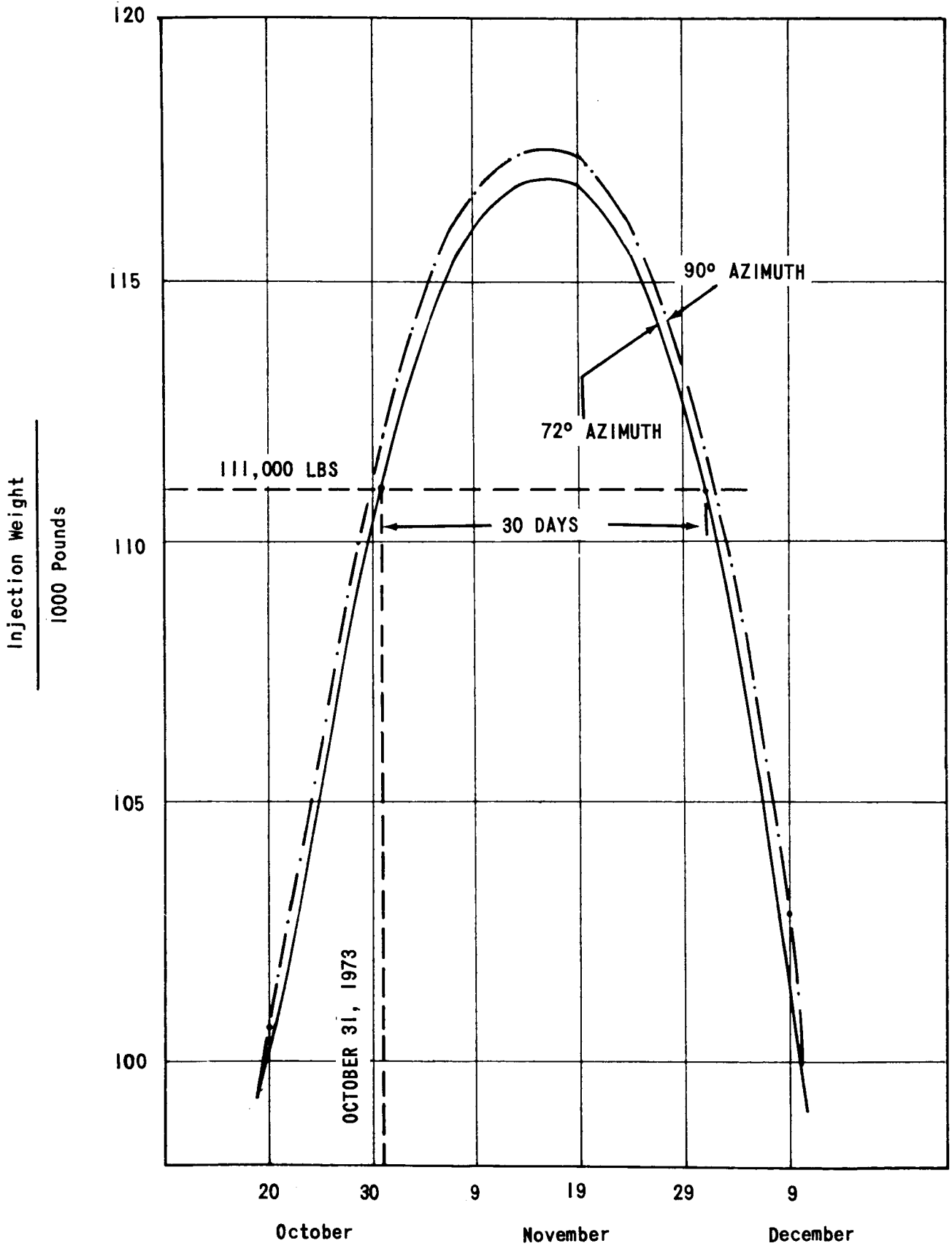

FIGURE 2-2 - SATURN V INJECTION CAPABILITY LAUNCH DATE - 1973

continuation at almost peak rates of expenditure. This factor leads to the desire for long launch periods and to the consideration of dual launches within the period.

The Mariner program (with the exception of Mariner '67) has always planned dual launches. Mariner '62 and '65 were each successful only on the second launch of the launch period. With the Complex 39 capability a dual launch can be considered for the Venus flyby; and, assuming a limitation only on terminal launch crews, a second vehicle could be in terminal count and launched three to four days after the first. Therefore, a dual launch would of itself not require a long launch period.

Another factor is vehicle availability or the ability to meet a given launch date with high confidence. If the launch were the first of a kind, as was the case with Mariner, the availability factor would be low and the launch period requirements high. With manned space flight, crew safety and crew training requirements dictate the need for previous manned test and simulation missions in the same vehicle configuration, and this essentially leads to a high availability factor for the mission. A poor hold or recycle capability can also affect availability by reducing the number of launch windows in a launch period, and this is a factor which should not be overlooked in design.

Operational readiness is a broad factor which includes such things as crew readiness, ground system status, recovery status and weather. The weather, for instance, in the month of November at Cape Kennedy is still hurricane season and is a period of general increase in the average velocity of high altitude winds. Weather changes occur with a not too sharply defined mean period of five to seven days; and, therefore, the scheduling of a launch period as short as a week would incur a very significant probability of encountering weather problems. Fortunately, this probability drops off sharply with increasing launch period. The other operational elements have a more rapid time of recovery from a no-go status and are individually less of a factor.

The thirty day period from October 31 to November 30, 1973, was selected for this study. This puts an upper bound on injected weight of 111,000 lbs., and the 6,500 lbs. between this and the maximum capability on November 15, 1966, at a launch azimuth of 90°, constitutes the flight geometry reserve of the launch vehicle. From Figure 2-1 it can be seen that the total mission duration varies from about 400 days at the

beginning of the period to about 360 days at the end. The earth entry velocity varies slightly from 44,800 to 45,200 fps during the period.

Based on the above considerations, a reference mission has been chosen at the opening of the launch period having the following characteristics:

Earth departure	-	October 31, 1973
Injection velocity (from 100 n.m. orbit)	-	12,900 fps
Outbound leg	-	123 days
Venus encounter	-	March 3, 1974
Periapsis altitude	-	3,340 n.m.
Inbound leg	-	273 days
Earth return date	-	December 1, 1974
Entry velocity	-	44,800 fps
Launch azimuth	-	72° - 108°
First launch window	-	1305 - 1738 EST
Second launch window	-	1855 - 2327 EST

2.2 Trajectory

The complete trajectory for a free-return, round-trip Venus flyby mission consists of the following components: (1) powered ascent from the earth's surface, (2) approximately circular low earth orbit, (3) five conic segments which are described in greater detail below, and (4) descent to the earth's surface.

The five conic segments which comprise the major portion of the trajectory are planet-centered hyperbolas that describe the spacecraft trajectory in the near planet regions and sun-centered elliptical trajectories that describe the spacecraft trajectory during the greatest part of the mission when the spacecraft is well outside the planetary spheres of influence. While this is an approximate technique, it is sufficient for planning purposes.

The basic element of the outbound trajectory is a heliocentric elliptical segment that extends from the position of earth on the departure date to the position of Venus on the arrival date. The earth departure hyperbolic trajectory is designed to connect the earth parking orbit to the interplanetary trajectory. Injection from the earth parking orbit into the perigee of this hyperbolic trajectory is the only major propulsive event of the mission after launch.

The heliocentric elliptical path for the return trip from Venus is not part of the heliocentric ellipse that contains the outbound leg. A Venus-centered hyperbolic trajectory, which represents the flyby portion of the trajectory, is used to patch these two segments together. For specified Venus approach and departure trajectories, the periapsis altitude would be varied to shape the hyperbolic trajectory to provide the required change in direction to the spacecraft. In this analysis, however, where the periapsis altitude is specified, the heliocentric segments are in large part defined. Near the completion of the round trip trajectory, an earth-centered hyperbolic trajectory is patched onto the return heliocentric leg, providing a perigee altitude low enough to bring the spacecraft within the atmosphere.

Based on the above the following flight phases are identified and used in the remainder of the study:

- Launch
- Parking Orbit
- Injection

Interplanetary Flight
Outbound Leg
Venus Encounter
Inbound Leg
Earth Return

Using principally the data of References 2 and 3, the trajectory for the selected mission has been determined as described in detail in Appendix II. Results necessary to completion of the mission analysis and to development of system requirements are set forth in Figures 2-3 through 2-8, which are in the following section on System Requirements.

2.3 System Requirements

The system requirements for carrying out the Venus flyby mission are set forth in functional terms in the following paragraphs. While the spacecraft system cannot be fully defined until the systems analysis is carried out, the study is based on maximum use of Saturn/Apollo hardware. As a result, the system requirements are to a degree tailored to the Saturn/Apollo system capability and, where possible, are expressed in terms of that capability. The system breakdown is similar to Apollo and includes structure, navigation, guidance and control, propulsion, environmental control, crew systems, experiments, communication and electrical power.

For the most part the flight vehicle and ground systems are functionally similar to the Apollo system through the injection phase and during the earth return phase. The requirements which follow are focused primarily on the interplanetary flight phase.

2.3.1 Structures

The function of the structural system is to support and protect the other systems and the crew from both the induced and the natural environment. Referring to Figures 2-3 and 2-4 it should be noted that during the interplanetary flight phase the spacecraft will approach to within 0.7 AU of the sun; and, even though the mission will occur during a period of minimum solar radiation activity, provision must be made for protection of personnel against a solar event occurring at this relatively close range. With regard to the meteoroid hazard, the spacecraft will remain well inside the asteroid belt, and only cometary meteoroids need be considered. While it is desirable as a goal to provide meteoroid protection for the entire spacecraft, it may be necessary to limit the shielding to the critical system elements. The space vehicle and its systems, including crew, are to be protected against natural environment hazards with a reliability of at least 0.99, the value used in the Apollo program (Reference 5).

As indicated in Section 2.1, the atmospheric entry velocity in the earth return phase is approximately 45,000 fps. This must be analyzed as either a structural or a retro-propulsion requirement.

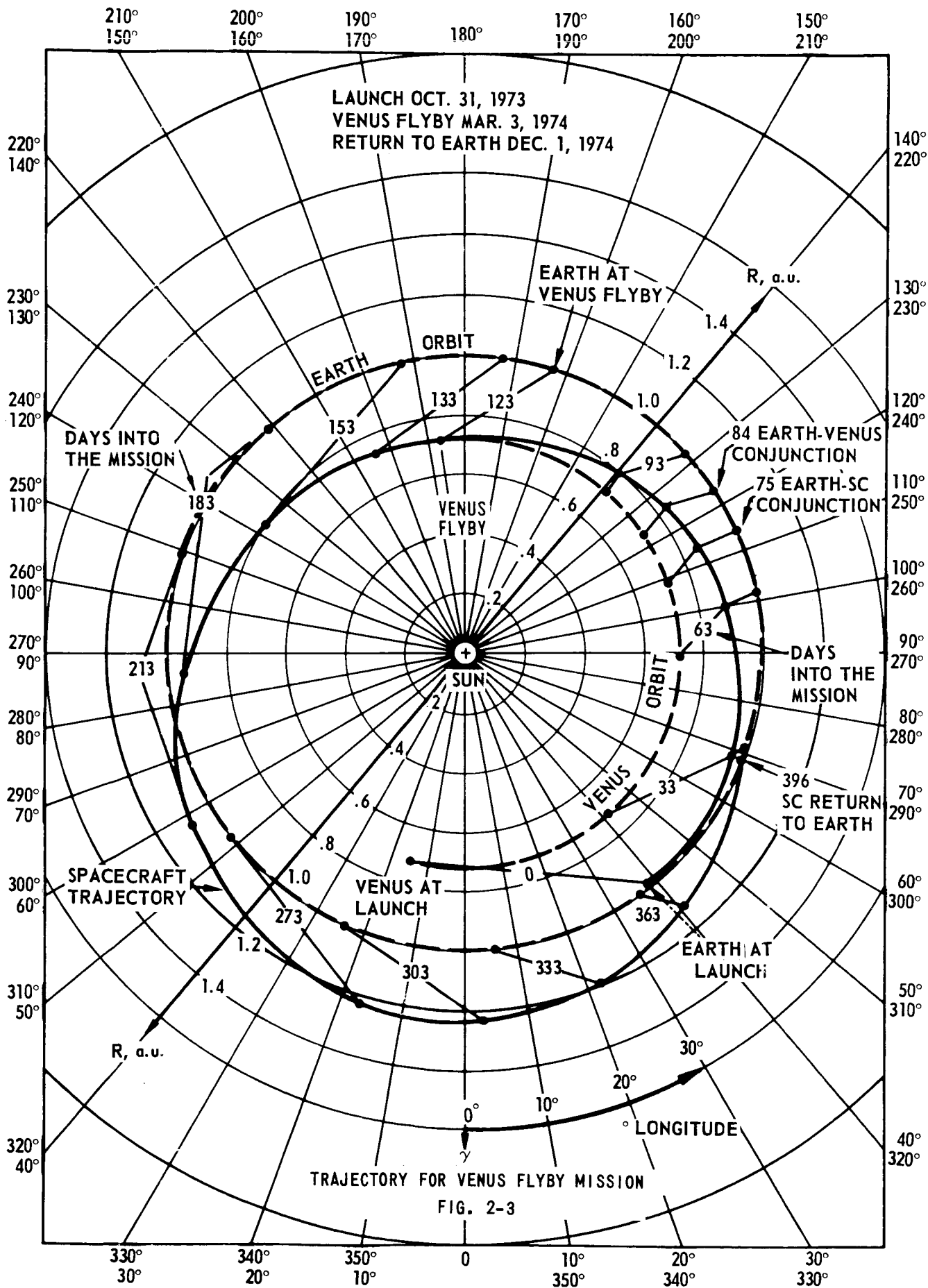

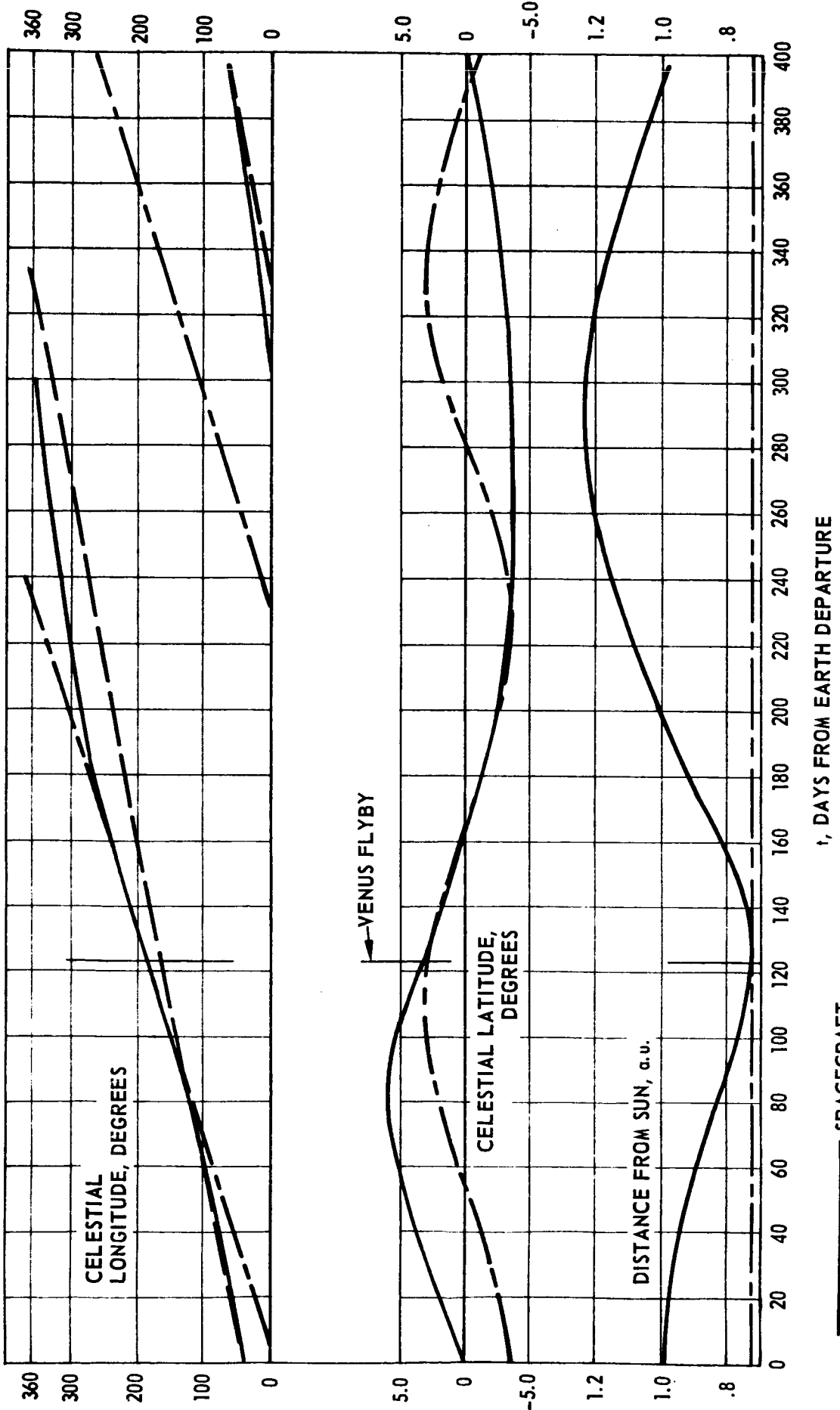

FIG. 2-4 CELESTIAL POSITIONS OF SPACECRAFT, VENUS AND EARTH

2.3.2 Navigation, Guidance and Control

The requirements of this system are:

- a. Guidance and control of the spacecraft during a post-injection abort to the earth's surface.
- b. Navigation, guidance and control capable of correcting for injection errors and errors due to uncertainties in data on the solar system.
- c. Stabilization and control of the attitude of the space vehicle as necessary to permit conducting experiments during the interplanetary flight phase.
- d. Guidance and control of the CM during earth entry to the preselected point of parachute deployment.

2.3.3 Propulsion

Figure 2-5 shows the propulsion requirements for a post-injection abort as a function of time after injection. Based on the analysis and assumption in Appendix II, it is seen that, for an abort initiated about 45 minutes after injection, a ΔV of 5,800-6,600 fps is required to achieve an abort orbit with a period of 36-60 hours. Because of the short time between injection and the initiation of an abort, it was decided to do the transposition and docking maneuver in the parking orbit phase rather than post-injection. This decision results in an "eye-balls out" acceleration to the crew of no more than two g's and a requirement for structural loads at the docking interface. Additional propulsion requirements are anticipated for midcourse correction, for attitude control and maneuver during interplanetary flight and control of entry during the earth return phase.

2.3.4 Environmental Control

The environmental control system, including life support system functions, should provide atmosphere control, thermal control, food and water management and waste management generally in accordance with Apollo criteria. Following are special requirements:

- a. While EVA will not be required for routine accomplishment of the mission, provision should be made for a limited number of emergency EVA's.

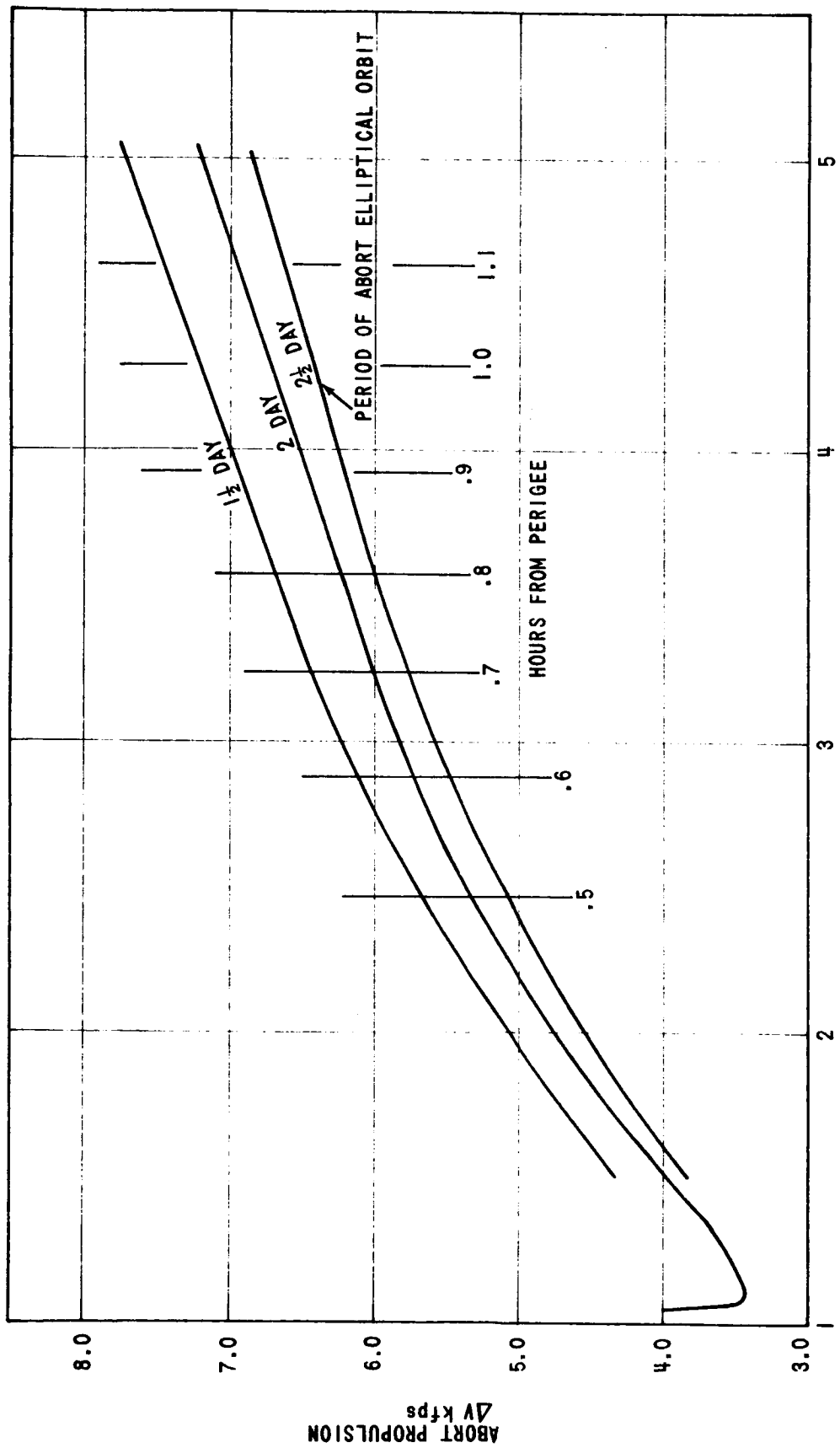

SPACECRAFT RADIUS FROM EARTH CENTER AT ABORT INITIATION IN EARTH RADII
 REQUIRED ABORT PROPULSION FROM DEPARTURE HYPERBOLA
 FIG. 2-5

- b. Thermal control measures should not compromise the operational flexibility of the space vehicle during the mission.
- c. As a goal, waste matter should not be dumped into space. If such dumping is necessary, the waste matter should first be sterilized.

2.3.5 Crew Systems

Crew systems are to be provided as necessary to meet the following requirements: berthing accommodations, food and food preparation, clothing, tools and equipment, personal hygiene, medical equipment and supplies, recreation and physical fitness and survival after landing.

The individual requirements are to be based on the following planning factors:

- a. No artificial-g environment will be provided.
- b. Routine accomplishment of the mission will not require EVA; there should be a capability for a limited number of emergency EVA's.
- c. A command station will be manned by at least one crew member at all times.
- d. An experiments control station will be manned intermittently as required.
- e. At least one of the crew members will be capable of performing minor, emergency surgery.
- f. All crew members will be capable of performing routine checkout and minor maintenance and repair.

2.3.6 Experiments

The experiment system is required to support the scientific investigation of Venus and the solar system. Figures 2-6 and 2-7 show the dominant characteristics of the brief Venus encounter. It is anticipated that both direct observation and probes will be required to gain the maximum information from the mission. The following are the Venus data requirements:

- a. Atmospheric density, temperature and pressure as functions of altitude, latitude and time.

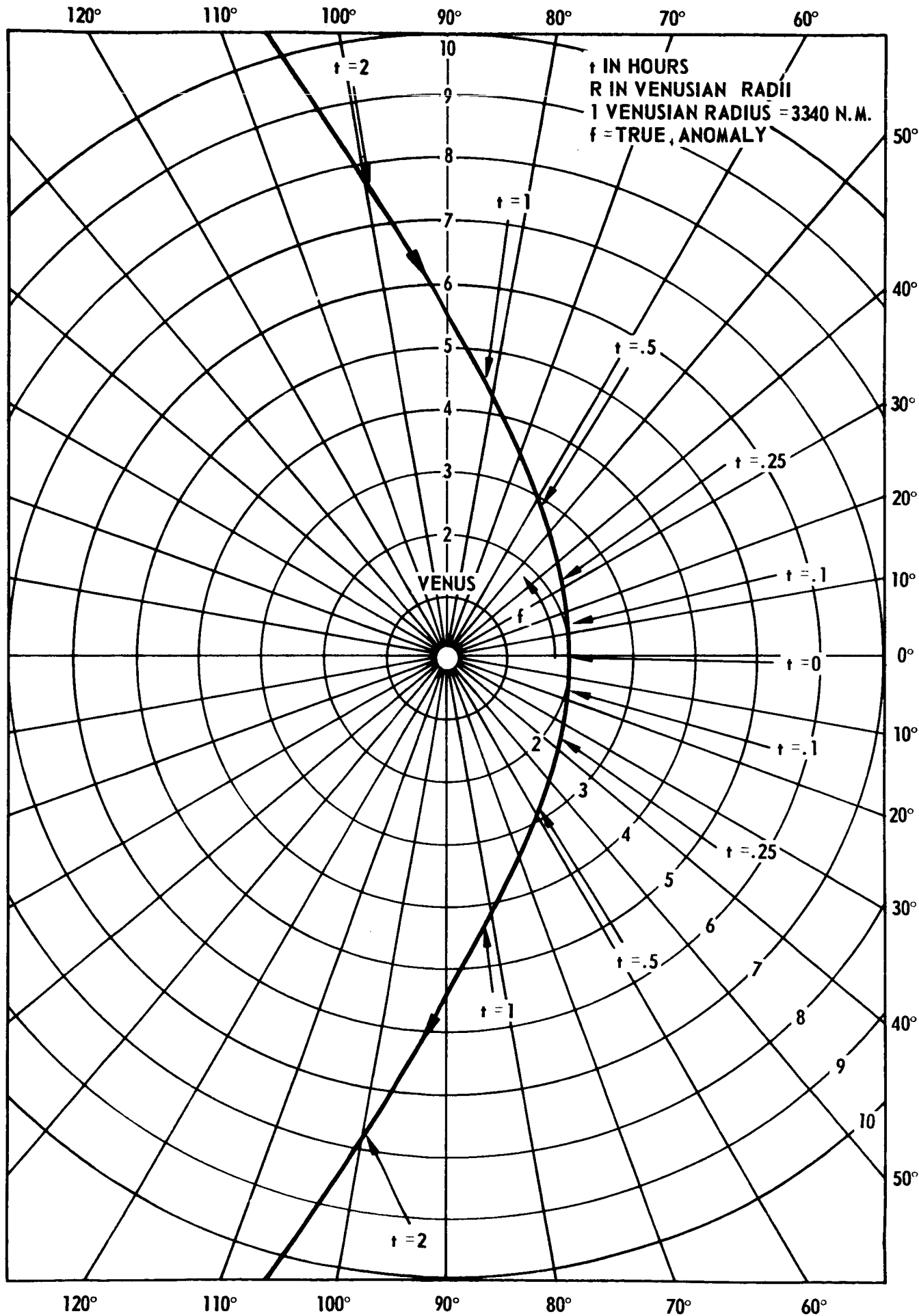

FIG. 2-6 VENUS FLYBY TRAJECTORY

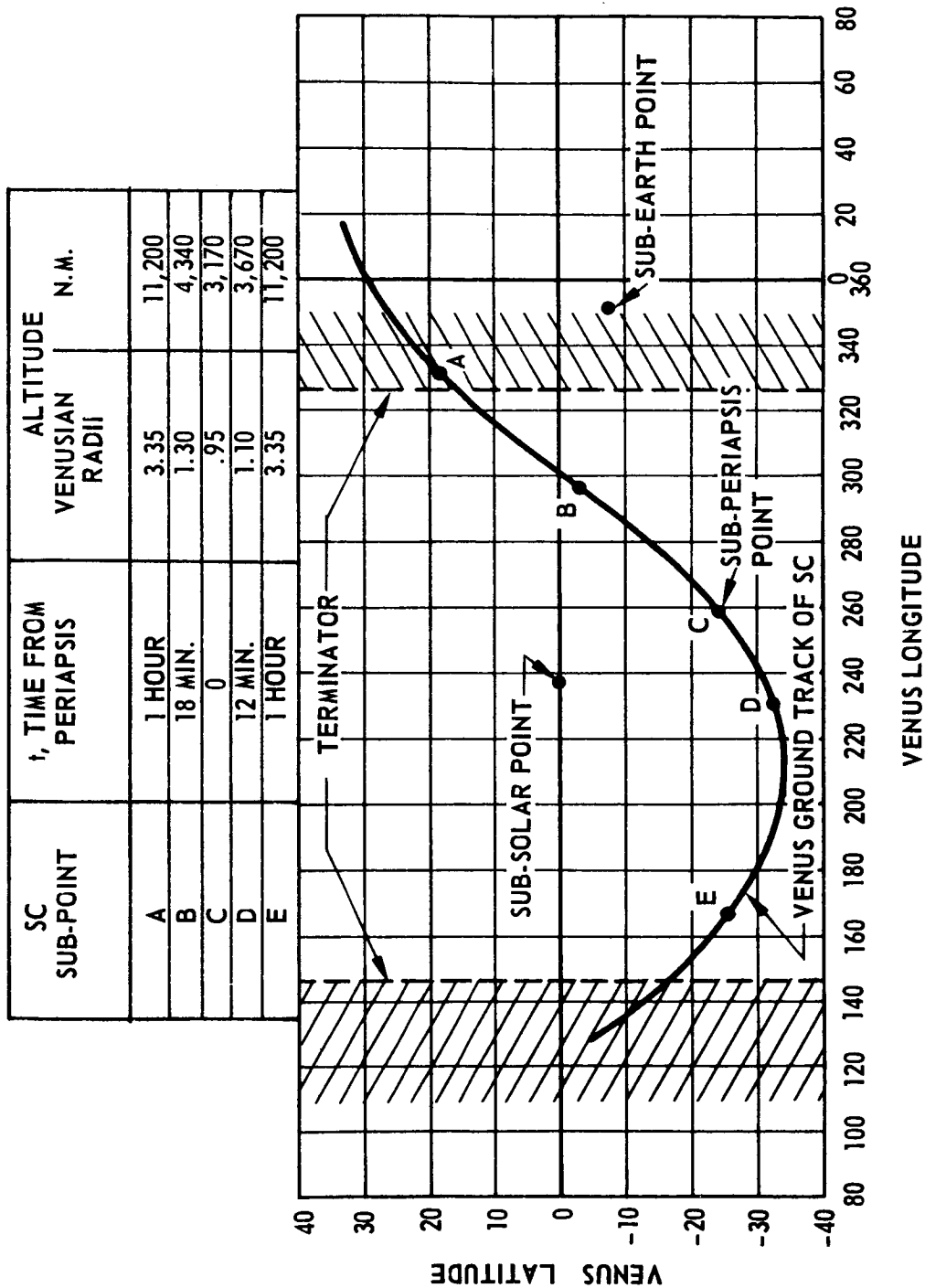

FIG. 2-7 GROUND TRACK OF FLYBY TRAJECTORY

- b. Definition of the planetary surface and its properties.
- c. Chemical composition of the low atmosphere and the planetary surface.
- d. Planetary figure, gravitational field anomalies and rotation period.
- e. Ionospheric data such as radio reflectivity and electron density and properties of cloud layers.

During the inbound and outbound legs as much of the following data as possible should be obtained:

- a. Optical astronomy - UV and IR measurements above the earth's atmosphere to aid in the determination of the spatial distribution of hydrogen.
- b. Solar astronomy - UV, X-ray and possible infrared measurements of the solar spectrum and space monitoring of solar events.
- c. Radio and radar astronomy - radio observations to map the brightness of the radio sky and to investigate solar, stellar and planetary radio emissions; radar measurements of the surface of Venus and Mercury.
- d. X-ray astronomy - measurements to identify new X-ray sources in the galactic system and to obtain additional information on sources previously identified.
- e. Data on the earth-Venus interplanetary environment, including particulate radiation, magnetic fields and meteoroids.
- f. Data on the planet Mercury, which will be in mutual planetary alignment with Venus approximately two weeks after the Venus flyby. At this time the spacecraft will be at a range of about 0.3 AU from Mercury.

2.3.7 Communications

The requirements are somewhat similar to those for Apollo, but it should be noted from Figure 2-8 that the maximum earth-spacecraft distance will be about 0.9 AU. Further, in this mission the sun never occupies a position between the

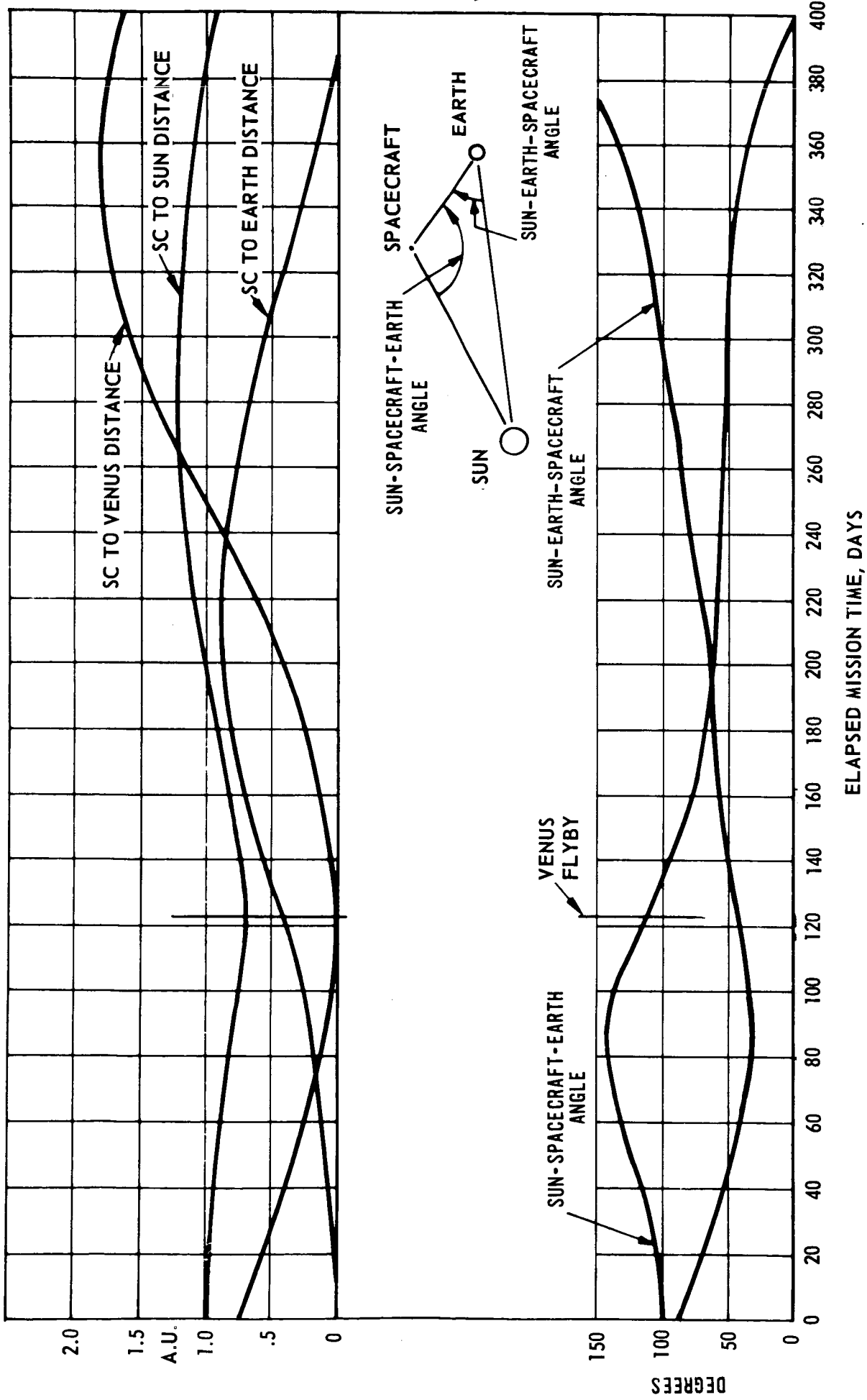

SPACECRAFT DISTANCES AND SUN-SPACECRAFT-EARTH ANGLE

FIG. 2-8

spacecraft and the earth, and the maximum sun-spacecraft-earth angle is about 150° . It is concluded that the sun will not interfere with earth-spacecraft communications in either direction.

While the CM is expected to have some capability for return to earth of data in the form of tapes, films, etc., it is desired that the spacecraft have the capability of transmitting all data to earth.

Voice communications requirements from lift-off through injection and from entry to recovery are similar to those for Apollo. For the remainder of the mission, two-way communications are required between:

- a. The spacecraft command station and crew members in any of the spacecraft modules.
- b. Crew members in any of the spacecraft modules.
- c. The command station and the earth.
- d. The command station and crew members on EVA.

From lift-off through injection and from entry to recovery telemetry requirements are similar to those for Apollo. For the remainder of the mission transmission and reception of operational, biomedical and scientific data between earth and spacecraft at low bit, data rates are acceptable. The specific requirements for the system used to acquire data on Venus will be covered under the Experiments System.

Transmission of television pictures from the spacecraft to the MSFN and closed-loop television system operating among the spacecraft modules are desirable.

Continuous tracking capability by the DSN is required to be compatible with and similar to the Apollo Unified S-band System.

2.3.8 Electrical Power

Electrical power requirements are functionally similar to those for Apollo. Power for operation of the following systems is required during all phases of the mission: communications, environmental control, navigation, guidance and control, propulsion, illumination and biomedical instrumentation.

Power for experiments is required only during the interplanetary flight phase. As the earth entry module, the CM requires a self-contained power source for use during the entry, descent and post-landing subphases. In addition, the CSM must be furnished power for a period up to 60 hours following post-injection abort.

BELLCOMM, INC.

3.0 Systems Analysis

The purpose of this section is to select the specific space vehicle configuration to be used for the mission.

In Sections 3.1 through 3.8 the individual system requirements stated functionally under Section 2.0 are analyzed to provide the basis for (1) determining the capability of Saturn/Apollo systems to meet the requirements, (2) determining the need for augmenting the Saturn/Apollo systems, and (3) selecting suitable hardware systems within the expected state-of-the-art as necessary to fulfill the functional requirements or to provide the modular or functional redundancy required for a 400-day mission. Section 3.9 (Systems Integration) is devoted to integrating the results of the individual systems analyses to yield a space vehicle configuration capable of carrying out the mission. Functions are assigned to the space vehicle modules and the overall system capability is evaluated. Section 3.10 discusses some of the technical aspects of a development and test program.

Since the study evolves from the analysis of Reference 1, the general configuration assumed for purposes of the systems analyses includes a modified Apollo Block II CSM, a standard Saturn V launch vehicle, and a new mission module which is called the Environmental Support Module (ESM) and which is to be carried in or replace the LM adapter. Preliminary analysis indicated the desirability of including the S-IVB spent stage in the interplanetary flight configuration, primarily to improve habitability in the zero-g environment.

Where possible, the results of the individual analyses are presented parametrically, but in some cases analysis of the requirements within the system constraints outlined in Section 1.0 leads directly to selection and sizing of hardware systems.

3.1 Structures

The structures system provides for the support and protection of other systems and the crew in the natural and induced environment of flight. This sub-section will treat only the special requirements for meteoroid, radiation and heat shielding and leave to a system integration sub-section the more conventional requirements for supporting the other systems after they have been defined.

3.1.1 Meteoroids

The environment encountered by a spacecraft on a Venus flyby mission may include cometary meteoroids ranging in mass from several hundred tons down to 10^{-6} gm and smaller. On such a flight the spacecraft will be subjected to three kinds of possible meteoroid damage, protection against which should be provided: erosion, puncture and spalling. A fourth type of damage would be the result of collision between the spacecraft and a large meteoroid, but the probability of such occurrence is vanishingly small.

Erosion

The majority of impacting particles will be small meteoroids, regarded as dust, which are expected to cause vehicle erosion to the extent of 1 to 200 A° per year (Reference 6). (This is in agreement with Apollo usage which is based on an erosion rate of 10^{-14} cm/sec over long periods [Reference 7].) The amount of erosion is small enough that its effects will probably be limited to degradation of the optical properties of exposed lenses, mirrors and windows. Hence, there is no need for special protection through structural shielding.

Puncture and Spalling

The principal threat to the spacecraft will be posed by meteoroids of intermediate mass, roughly 1 gm to 10^{-5} gm, which are large enough to damage space vehicle structures and frequent enough to have a significant probability of impact. The hazard here results from puncture or spalling of the protective shielding of the space vehicle, and it is necessary to provide a shielding thickness sufficient to prevent such casualties as:

- a. Leakage of atmosphere through holes resulting from puncture.
- b. Fire and personnel flash burns caused by rapid oxidization of a penetrating particle along with some of the space vehicle skin material.
- c. Personnel injury and equipment damage caused by impacting high energy particles and material.
- d. Explosion of propellant tanks under high internal pressure.

Meteoroid Shielding

The determination of the shielding requirements is based on the data derived by J. S. Dohnanyi (Reference 8). The principal features of the approach used are:

- a. It is assumed that meteoroid flux in space is uniform and isotropic, that the vulnerable surface of the space vehicle is in random motion, and hence that the probability of a damaging impact by a particle can be described by a Poisson's distribution.
- b. The relationship between cumulative meteoroid flux (in meters⁻² sec⁻¹) of particles penetrating an aluminum sheet and the thickness of the sheet (in meters) is given by:

$$\phi = 6.02 \times 10^{-19} T^{-3}$$

This is based on soft aluminum with a density of 2.7×10^3 kg/m³, a meteoroid density of 10^3 kg/m³ and a thickness (T) which is 1.8 times the penetration depth into a semi-infinite target (to cover penetration and spalling).

- c. The probability that no damaging impact will occur is 0.99.

The foregoing yields the following relationship between equivalent thickness of aluminum shielding required and vulnerable vehicle surface area for a mission of 400 days' duration:

$$T = 1.27 \times 10^{-3} A^{1/3} \text{ (with T in meters and A in square meters)}$$

The analysis above is based on using single sheet aluminum as the meteoroid shield, but it has been demonstrated that use of a bumper shield significantly improves the effectiveness of an equivalent weight of shield (Reference 9). Although effectiveness factors up to 20 have been suggested for cometary particles, a factor of 5 is selected as a figure for this study.

The assumed space vehicle configuration, including the spent S-IVB stage, would have an exposed surface area of about 5,800 ft² and would require 10.4 mm (5.6 lb/ft²) of single aluminum sheet or 2.1 mm (1.1 lb/ft²) for a bumper shield. [It should be noted that, eliminating the S-IVB would reduce the exposed area of the vehicle and would result in shielding requirements of 8.0 mm (4.3 lb/ft²) of single aluminum sheet or 1.6 mm (0.9 lb/ft²) for a bumper.]

The status of each of the space vehicle modules with regard to meeting the requirement is:

- a. CM The Block II CM, with a minimum structural shell weight of 6.0 lb/ft² (Reference 4), meets the requirement without structural change.
- b. SM The propellant tanks of the SM are protected by the outer SM skin which has a 1.2 mm equivalent thickness of aluminum, and there are provisions for installing bumper sheets between the structural shell and the tanks. Suitable shielding can be provided by installation of a 1.2 mm bumper; this entails additional weight at 0.6 lb/ft², or an estimated 52 lbs. per tank to be shielded.
- c. ESM Since the ESM will be new, it will have to be designed with the required shielding. For a surface area in the 1300-1500 ft² range, the bumper shield weight would be 1400-1650 lbs.
- d. S-IVB The skin of the S-IVB, in the area between the forward and aft skirts, is being fabricated from 3/4" aluminum which is milled to 0.134" thickness (3.4 mm) in a 9-inch square waffle pattern to reduce weight. Hence, the S-IVB does not meet the single sheet criterion of 10.4 mm, and the addition of a bumper shield is necessary. Failure to provide

additional shielding would result in a probability of no meteoroid penetration of the S-IVB no higher than 0.94. Such a probability may be acceptable if suitable self-sealing or on-board repair techniques are developed. If necessary, the S-IVB could be abandoned after damaging particle penetration, and the crew could continue the mission under somewhat emergency conditions in the CM and mission module. The design of the mission module would, of course, have to be based on such a contingency.

It should be noted that this analysis does not consider the possibility of micrometeoroid penetration of the linear shaped charge of the propellant dispersion system, which remains attached to the exteriors of the hydrogen and oxygen tanks. Because the surface area of the charge is small, the probability of impact is low; and, as pointed out by Douglas (Reference 10) in its Orbital S-IVB Spent Stage Study, there is a question as to the magnitude of penetration necessary to initiate burning or explosion of the charge.

3.1.2 Radiation

The radiation environment through which the spacecraft will travel on a Venus flyby mission is made up of the following principal components: (a) galactic cosmic, (b) solar cosmic, (c) solar wind, (d) geomagnetically trapped, and (e) long-wavelength electromagnetic, i.e., radiowave emission, from the sun and stars. The possibility of an additional component in a radiation belt around Venus has been generally rejected as a result of the Mariner II flight (Reference 11). Of the five components listed, only the first two are considered in determining the requirements for radiation shielding because of the following reasons:

- a. Solar wind radiation, i.e., the outward flow of ionized hydrogen gas from the solar corona, presents no biological problem since the energy of the plasma particles is very low.
- b. The radiation dose arising from a fast transit of the trapped radiation belt around the earth is acceptably small compared to that arising from the other components.
- c. The long-wave electromagnetic radiation presents no biological problem.

Galactic Cosmic Radiation

Galactic cosmic radiation originates outside the solar system and consists mainly of very energetic nuclei stripped of their electrons, although electrons and gamma rays are also present as minor constituents. Galactic cosmic ray doses range from 0.1 to 0.3 rad/week for maximum and minimum solar activity, respectively (Reference 7); but since the energy range is very high (from tens of millions of electron volts up to at least 10^{14} mev, with an average of about 4,000 mev), adequate shielding can be provided only by very thick materials. In addition, since the radiation occurs at a relatively constant level, protection can be afforded only by shielding the entire volume to be occupied by the spacecraft crew. The shielding problem is further complicated by the fact that an insufficiently thick shield may be worse than no shield at all because the secondary radiation produced may result in greater doses than those from unshielded primary radiation.

The consensus appears to be that, for long duration missions, it is preferable to use only the basic spacecraft shell as shielding against galactic cosmic radiation and to accept the doses stated above. It should be noted that those doses are independent of shielding.

Solar Cosmic Radiation

Solar cosmic radiation, which consists of energetic charged particles, principally protons and alpha particles, emitted by the sun during solar flare activity, presents the major radiation problems for a Venus flyby mission. The number of solar cosmic ray events follows the 11-year sun spot cycle which attained a peak in 1958 and should reach the next peak in 1968-69. Accordingly, the Venus mission in 1973-74 should take place at a time when solar flare activity is approaching a minimum. However, during the mission the spacecraft will approach to within 0.7 AU of the sun, and the crew should be protected against a solar flare which may occur at this relatively close distance. The radiation flux is estimated to vary inversely with the distance from the sun.

To protect the crew against solar cosmic radiation, it may be necessary to provide an emergency shelter which will house the entire crew. The maximum time required for shelter in a single event is estimated at several days, but the critical need in such a scheme is for an adequate alerting system. On a flight to Venus it is possible that the solar cosmic radiation which will be experienced by the spacecraft will not be detectable on earth; accordingly, on-board radiation detection equipment to be monitored by the crew will have to be provided. For this

purpose, the nuclear portable detectors and dosimeters planned for use on Apollo missions should be adequate for the Venus mission.

Human Tolerance Criteria

For a variety of reasons it is difficult to establish precise criteria for human radiobiological tolerance. A number of radiation guidelines have been proposed for short-duration as well as long-duration manned flights; but since none has been adopted as the NASA standard, it seems appropriate for the purposes of this analysis to utilize the guidelines currently under consideration by NASA for use in planning interplanetary missions (Reference 12). The guidelines pertinent to this analysis have been extracted and are set forth in Table 3-1.

It can be shown that, depending on the shielding thickness and radiation levels, either the blood-forming organs or the whole-body skin will represent the critical organ for purposes of designing radiation shielding. The eye is clearly sensitive to radiation, but radiation damage to the eye does not occur immediately and generally takes the form of cataracts occurring after a period of time expected to be longer than the duration of the Venus mission (Reference 13). Since special eye guards can be provided for use during high radiation events and since the expected eye damage is neither as permanent nor as temporarily incapacitating as damage to the other organs, the other organs are used in this analysis as the criteria for shielding requirements.

Although it has been suggested that radiation protection should be designed by giving consideration to the recovery capability of the human body between exposures on a long mission, this approach seems sufficiently uncertain at this time to dictate that it not be used in this analysis. Further, it is likely that most of the dosage will be received over a period of a few days or a week. Hence, it appears preferable to design for the no-recovery condition and to allow whatever recovery is available to provide a margin of safety.

Shielding

While there is a reasonable amount of data on solar radiation during the period 1956-65, there is insufficient data on other solar cycles to afford a sound basis for predicting with any calculable reliability the solar cosmic radiation environment of 1973-74. The mission is being

TABLE 3-1

Radiation Guidelines for Manned Space Vehicle
(Suggested for Interplanetary Missions)

<u>Risk-Limiting Critical Organ</u>	<u>Maximum Permissible Dose (REM)</u>		
	<u>Protracted or Fractionated (1 year)</u>	<u>Single Acute</u>	<u>Emergency Acute</u>
Whole-body and blood-forming organs	100*	50	150
Lens of eye	270	100	200
Skin of whole body	400	100	400
Skin of extremities	900	250	600

*Maximum exposure during any 20-day period not to exceed 25 REM.

planned for a solar minimum, and although there is a temptation to design the shield to withstand the radiation encountered during the recent solar minimum, this approach appears undesirable. A preferred approach, and the one to be used here, is the selection of shielding which would have provided adequate protection during the solar maximum activity of 1959. The intent is to determine the required shielding thickness and to shield a volume which is as small as necessary to remain within the space vehicle weight constraints, but which is large enough to serve as a storm shelter during periods of solar activity.

Reference 12 indicates that the solar cosmic radiation doses observed in 1959 at a distance of 1 AU were:

<u>Shielding</u> (gm/cm ²)	<u>Skin Dose</u> (rem/year)	<u>Blood-Forming Organ Dose</u> (rem/year)
1	1900	128
5	224	51
10	92	46
100	.5	.4

To obtain the doses at 0.7 AU, each of the above figures is divided by 0.7; and, to determine the total dosage experienced by a crew on an interplanetary mission, the galactic radiation of about 10 rem/year must be added. (This is based on a dose of 5 rad/year for a solar maximum period and a conservative RBE of 2.0 rem/rad.) The total dosages on which to base the vehicle design are then:

<u>Aluminum Shielding</u> (gm/cm ²)	<u>Skin Dose</u> (rem/year)	<u>Blood-Forming Organ Dose</u> (rem/year)
1	2710	193
5	330	83
10	141	76
100	11	11

It can be seen from the foregoing that a shielding of 5 gm/cm² (10 lb/ft²) will keep the radiation within the tolerances specified in Table 3-1 for a yearly protracted or fractionated dosage.

The status of each of the assumed space vehicle modules with regard to meeting the requirement is:

- a. CM Approximately 11% of the Apollo Block II CM has a shielding equivalent of less than 5 gm/cm^2 (Reference 14); and, accordingly, the CM without modification is not suitable as a radiation shelter for the mission.
- b. ESM Since the ESM will be new, it will have to be designed to provide a shelter of suitable size with shielding of 10 lb/ft^2 .
- c. S-IVB The milled portion of the skin of the S-IVB provides an aluminum wall of less than 2 lb/ft^2 ; and, hence, the S-IVB without modification cannot be used as a radiation shelter.

3.1.3 Entry Heat Shield

The trajectory selected for the Venus flyby will result in an earth entry velocity of about 45,000 fps. The results of a NASA study (Reference 15) show that the Apollo CM configuration is capable of providing the necessary heat protection if the weight of the shield is increased. For the overshoot trajectory case, i.e., the worst case, entry at parabolic velocity (36,000 fps) requires a heat shield weight which is 12.6% of the CM weight. At 45,000 fps that percentage for the overshoot case would increase to 16.5. Hence, assuming a 11,000 lb. CM, the increase in heat shield weight required for the Venus mission would be approximately 430 lbs. Since the charring ablator used has a density of 40 lb/ft^3 (Reference 16), a volume of about 11 ft^3 will have to be sacrificed for the additional shielding.

Based on the foregoing, it is concluded without further analysis that, based on heating considerations, retro-propulsion is not required for earth entry.

3.2 Navigation, Guidance and Control

Venus flyby navigation, guidance and control requirements are functionally similar to Apollo through injection or an injection abort and from entry to landing. For this reason the launch vehicle and CM systems have been selected for the first cut to be standard configurations with appropriate software changes. This section then focuses on the remainder of the mission phases to determine additional requirements and to modify or select new system characteristics.

3.2.1 Navigation

The navigation function is the determination of the space vehicle position and velocity vectors and the uncertainty in these quantities during flight. Apollo uses two independent and functionally redundant systems, and these will be retained for the Venus flyby. The primary system employs ground based radar tracking and data reduction. The secondary system employs on-board optical sighting combined with IMU measurements and data reduction. The ground system is primary because for most phases of the Venus mission it is about two orders of magnitude more accurate, and this accuracy can be used to minimize propellant consumption. The ground system can also, because of its large data processing capability, make effective use of combined on-board and ground measurements.

The ground tracking system is unified S-band. There will be about a half dozen deep space antennas both 210 feet and 85 feet in diameter and three 85-foot Manned Space Flight Network antennas which can be used for this mission. Tracking is achieved primarily by single station or multistation doppler range rate measurement, although range and angle measurements can be used in the near earth portions of the mission. Velocity uncertainties of a few centimeters per second and position uncertainties of a few kilometers can be achieved. Mariner II (Reference 17) reported a range rate accuracy on the order of 1/2 cm/sec. The ground elements of the tracking system are highly redundant and reliable, but the system relies on the on-board communications system for both the tracking itself and the transmission to the spacecraft of navigation or guidance information. As a consequence, the space vehicle communications system has an extremely high reliability requirement.

The on-board navigation system utilizes sextant observations of celestial bodies and planetary landmarks which

are then processed in the Apollo Guidance Computer to provide space vehicle position and velocity. Even with frequent observations the on-board system accuracy does not approach that of ground based tracking. As a backup system, however, it has the advantage of being self-contained in the spacecraft and not reliant on communications. Even if used intermittently or as backup, its reliability for a year-long mission needs a thorough evaluation. Design changes to make the system more mission specific, to simplify functions and to increase redundancy seem indicated.

3.2.2 Guidance

The guidance function includes the calculation of required velocity changes for midcourse correction, the maintenance and display of an inertial attitude reference and the generation of thrust vector steering and thrust termination signals. Only the first of these can be accomplished on the ground in the primary mode.

There are three types of errors which need to be considered in the midcourse guidance system: navigation errors, maneuver execution errors and mathematical model errors. Reference 4 calculated 283 fps for a representative but not necessarily optimum total midcourse requirement. This was based on four midcourses on the outbound leg, four on the inbound, on-board navigation accuracy, maneuver accuracy of 1 foot per second and a fixed-time-of-arrival guidance law. All the assumptions seem extremely conservative with the possible exception of the mathematical model errors (planetary ephemerides, solar pressure effects and mass of Venus, for instance). A total midcourse requirement of 650 fps has been estimated and used in this study.

In Apollo the attitude reference for attitude control and antenna pointing are provided by the IMU. For reasons given in the following section on control, this system is used primarily in the launch, abort and entry phases and relegated to a backup role for the remainder of the mission. Attitude control will be maintained by an independent gyro system as part of the control system.

Thrust vector control through injection into the inter-planetary orbit is retained as a primary function of the Saturn V launch vehicle guidance and control system with the CSM G&N system serving as a functional backup. Thrust vector control for abort and entry phases is retained as a primary function of the CSM G&N system with the Stabilization and Control System (SCS) and manual overrides serving as functional backups. For the planetary phases the G&N control will be retained as backup to the control system which follows.

3.2.3 Control

The control function includes attitude stabilization and control, thrust vector control, manual control capabilities and antenna pointing.

In Apollo the control system works directly with the Reaction Control System (RCS) in maintaining or changing the attitude of the spacecraft. The lunar mission requires about 1,000 lbs. of RCS propellant, and the intermediate missions studied by the AAP require considerably more. It appears desirable for one year of controlled flight to look at different system technologies and concepts. The gyroscopic stabilization principle, for instance, has been used in spacecraft for years with spinning of the entire space vehicle or portions of it.

Spinning the entire space vehicle would appear to impose difficult mechanization problems on pointing systems such as antennas and optical experiments; problems which would tend to increase complexity and reduce reliability. There are, in addition, the possibilities of physiological and psychological effects on the crew. Momentum exchange systems such as reaction wheels or control moment gyros appear to be a better choice, particularly in view of the fact that it appears that solar power to meet electric requirements should be available and economical on this mission.

Reaction wheels and control moment gyros will both require an RCS system to "unload" them and electrical power to spin them and control them. Generally, the reaction wheel should be a simpler device, but, at the same time, considerably less flexible in operation. The control moment gyros were chosen principally because they afford a greater potential for such applications. While the data on the current development program (Reference 18) is limited, studies of their use have been conducted in the AAP.

The control moment gyro (CMG) being evaluated by the AAP consists of a fly-wheel spinning at a constant speed ($\sim 12,000$ rpm) mounted on double gimbals which are aligned with a spacecraft axis in their reference position. Control torques about two axes are developed by driving the gimbal angles at rates proportional to the spacecraft's apparent attitude and rate errors. The total momentum storage of this CMG is estimated at 2,000 ft-lb-sec. An integrated gyro system, which consists of three such CMG's plus suitable control electronics, can provide for both rapid angular maneuvers (0.5 deg/sec or more) and for fine attitude control (0.1 arc sec or less) of the spacecraft.

In the continued presence of external torques, the gyro will precess with a resulting possibility of maneuver restriction or gimbal lock. It will be necessary periodically to "unload" this condition by driving the gimbals while imposing control torques on the vehicle with the reaction control system. This makes the total system time dependent, as will be discussed in the propulsion section to follow.

Having established that computer electronics are required for the derivation of signals to be applied to the CMG gimbals, these same electronics can be used for other functions and interfaces with other systems. For instance, the control of RCS "unloading", the provision for manual control, the control of antenna pointing, the control of experiment optics and the maintenance and measurement of a celestial reference are considered feasible and desirable functions. It may, in fact, be possible to control the larger thrusts required for mid-course operations with the addition of an acceleration measuring system, but this needs further study. In effect the CMG system can be functionally an almost complete replacement for the CM Stabilization and Control System (SCS) and should be considered primary with SCS backup in order to achieve overall redundancy during the interplanetary flight phase. Considerable attention will have to be devoted to the basic reliability of this new system.

3.2.4 Summary

Table 3-2 is a summary of estimated weights of the navigation, guidance and control system. For the CSM the characteristics are those of the Block II configuration on the assumption that weight savings due to deleted functions, such as the deletion of rendezvous modes, are counteracted by weight increases for extended duration reliability. The ESM characteristics are based on CMG data of Reference 18 with electronics tripled for additional functions and reliability. Controls and displays are estimated equivalent to those of the Command Module although there is a functional change.

TABLE 3-2
Navigation, Guidance & Control Summary

	<u>Weight (pounds)</u>	<u>Peak Power (watts)</u>	<u>Avg. Power (watts)</u>
<u>Command Module</u>	(850)	(895)	(70)
Guidance & Navigation	350	570	50
Stabilization & Control	200	300	-
Controls & Displays	300	25	20
<u>ESM</u>	(1160)	(710)	(310)
Control Moment Gyro	860	660	270
Controls & Displays	300	50	40

3.3 Propulsion

The functions of the propulsion system are to provide velocity changes for launch and injection aborts, for transition and docking and for midcourse maneuvers and to provide attitude control during those velocity changes as well as during interplanetary cruise and final entry. The dominant new requirements are the result of the need for long term reliability in the interplanetary environment and for post-injection abort.

3.3.1 Post-Injection Abort

From Section 2 the post injection abort requires a maximum velocity increment to the CSM of 6,600 fps in order to provide a 1 1/2 day abort trajectory up to 45 minutes after injection. This plus midcourses, attitude control and reserve require about 19,000 lbs. of Apollo storable propellant for a CSM estimated full weight of 37,500 lbs. Large thrust is required in order to accomplish the abort with reasonable burning times.

In order to economize on injected weight, the same propulsion system should be used for the flyby when abort is not required; and, consequently, the propulsion function is allocated to the CSM. This leads to additional long duration reliability requirements which can be approached here by system redundancy. Two LM descent engines and accessories weigh about the same as the service propulsion engine and, when substituted, will together provide 21,000 lbs. of thrust at a specific impulse of 305 seconds. The throttling provisions are not required. The abort requires about 300 seconds of burning of both engines or 600 seconds if only one functions; these are both well below the 730 second capability of current LM design. The LM engines have an additional advantage in that they do not intrude as far into the usable volume of the adapter.

3.3.2 Midcourses

In the previous section on navigation, guidance and control, it was decided to allocate 650 fps for midcourse maneuvers in the interplanetary flight phase. This requirement with the LM engines translates to 6,500 lbs. of propellant for the 100,000 lb. cruise vehicle and to total burn times well within LM engine limits. Because the individual midcourses will vary from a few fps up to about 200 fps, consideration can be given to utilizing the smaller thrust RCS engines for the smaller maneuvers and perhaps all the maneuvers, thus providing additional functional redundancy for this

all-important requirement. If four 100 lb.-thrust radiation cooled engines similar to those on the Apollo SM were to burn the entire 6,500 lbs. of fuel, the burn time on each would be about 5,000 seconds. The current Apollo requirement is for 1,000 seconds duration; but, because with radiation cooling there is no fundamental failure mechanism which limits the duration, it is felt that 5,000 seconds or more are completely feasible and this additional midcourse redundancy should be implemented. This will require a common propellant system for both the main propulsion and RCS as well as suitable isolation and crossover systems.

3.3.3 Attitude Control

As indicated in the navigation, guidance and control section the primary attitude control during cruise is to be exercised by the CMG's with the RCS required for periodic "unloading". Two factors affect the "unloading" requirements: long-term unbalanced external torques and space vehicle maneuvers.

External torques can come from aerodynamic forces, gravity gradients and solar winds. In contrast to low earth orbital missions, aerodynamic forces and gravity gradients can be neglected for the cruise portion of this mission and for the brief planetary encounter. According to Reference 17, the solar wind consists of protons and some alpha particles moving outward from the sun with velocities varying from 320 to 770 kilometers per second and with flux varying with a period equal to the sun's rotation (27 days). The flux of the particles also varies inversely with the square of the distance from the sun. The estimated force broadside to the cruise configuration in the worst case is .001 lbs., and the distance between the center of gravity and the center of pressure is about 15 feet. To overcome this torque periodically during the year will require approximately 250 lbs. of RCS propellant.

Space vehicle maneuvers will affect the RCS requirements in two ways. First, it may be necessary to "pre-load" the CMG's prior to an attitude change in order to prevent passing through or coming close to gimbal alignment positions; this adjustment may have to be removed in returning to the cruise position. Second, there may be residual unbalanced torques resulting from the tail-off of midcourse maneuvers. At the present time, there is no reasonable way to estimate either of these requirements.

CMG internal torques, space vehicle structural and fluid damping and crew movements may all cause energy losses and resulting electrical power requirements but should not result in net momentum unbalance requiring RCS propellant. The attitude control function has been quite arbitrarily allocated 3,000 lbs. of propellant. Extrapolation of the data in Reference 18 would indicate 6,000 lbs. for a year in low earth orbit, so that allocation would appear to be extremely conservative. It includes the minor requirements for transposition and docking in earth parking orbit.

The entry control of the CM requires an independent reaction control system. Reference 19 indicates that a maximum roll rate of at least $20^\circ/\text{sec}$ is satisfactory for entry velocities up to 70,000 ft/sec. Since the Apollo CM will have a capability of $50^\circ/\text{sec}$ (Reference 20), it should meet the 18.5 n.m. corridor requirement determined in Appendix II.

3.3.4 Summary

Table 3-3 summarizes the propellant requirements. For the abort case, 600 lbs. corresponds to a midcourse and navigation requirement of 290 fps and 200 lbs. is allocated to attitude control. As shown in the table, the propellant requirement for attitude control and midcourse corrections in the nominal Venus flyby mission is one-half of the total propellant required for the abort maneuver. As a result, if placed in two sets of tankage with suitable interconnection, a completely redundant propulsion system is achieved.

Table 3-4 summarizes the system weight and power requirements. The CM system is assumed equal to the Block II configuration. The SM installation has two LM descent engines, 16 SM RCS engines in four quads, two separate but interconnected tankage and plumbing installations and 19,000 lbs. of usable propellant.

TABLE 3-3
Propellant Requirements Summary
(pounds)

	Venus Flyby	Abort
Attitude Control	3,000	200
Midcourse Corrections	6,500	600
Abort	--	18,200
Margin	9,500	
Total	19,000	19,000

TABLE 3-4
Propulsion System Summary

<u>Equipment</u>	<u>Weight (pounds)</u>	<u>Peak Power (watts)</u>	<u>Avg. Power (watts)</u>
<u>Command Module</u>	(300)	(30)	
RCS Engines	140	30	-
RCS Tankage	160	-	-
<u>Service Module</u>	(1530)	(4830)	(30)
Main Engines	1250	4800	-
RCS Engines	280	30	30
<u>Useful Load</u>			
<u>Command Module</u>	(270)		
RCS Propellant	270		
<u>Service Module</u>	(19,500)		
Usable Propellant	19,000		
Unusable Propellant	500		

3.4 Environmental Control

The environmental control system (ECS) is required to perform the functions of thermal control, atmosphere control, water management and waste management for three men and equipment for 400 days. The CSM must perform all functions until the ESM can be activated and during earth return; in addition, it must provide thermal control for the navigation, guidance, control, propulsion and perhaps other systems as indicated, or to be indicated, in other sections of this study. It appears appropriate that the ESM take care of all other ECS functions from the time of its activation until the earth return phase.

3.4.1 Thermal Requirements

The thermal load is made up of external and internal sources and sinks which will be treated separately.

External Thermal Environment

From the time of injection until entry into the earth's atmosphere, some 400 days later, the spacecraft will be subjected to direct radiation from the sun at solar distances which will vary between 0.7 and 1.2 AU. Since only .1% of the mission time is spent within 3 radii of any planetary body, the effects of solar reflectivity or energy emission from these sources upon the spacecraft are neglected. The thermal model postulated for the spacecraft is a cylinder-conical frustrum - cylinder configuration representing the S-IVB spent stage, ESM (truncated SLA) and CSM, respectively. The spacecraft longitudinal axis is assumed to be normal to the plane of the trajectory and approximately perpendicular to the solar radiation vector.

The absorptivity/emissivity ratios $\left(\frac{\alpha}{\epsilon}\right)$ for the different spacecraft elements vary according to the material and finish exposed to the external environment. The ratios for the spacecraft are spread between 0.84 for the solar cells and 0.4 for the radiator panels (Reference 21).

Figure 3-1 shows the average equilibrium temperature of the spacecraft as a function of solar distance for different absorptivity/emissivity ratios. It can be seen that with no internal heat generated, the average temperatures of the spacecraft sections will vary about 130°F during the mission.

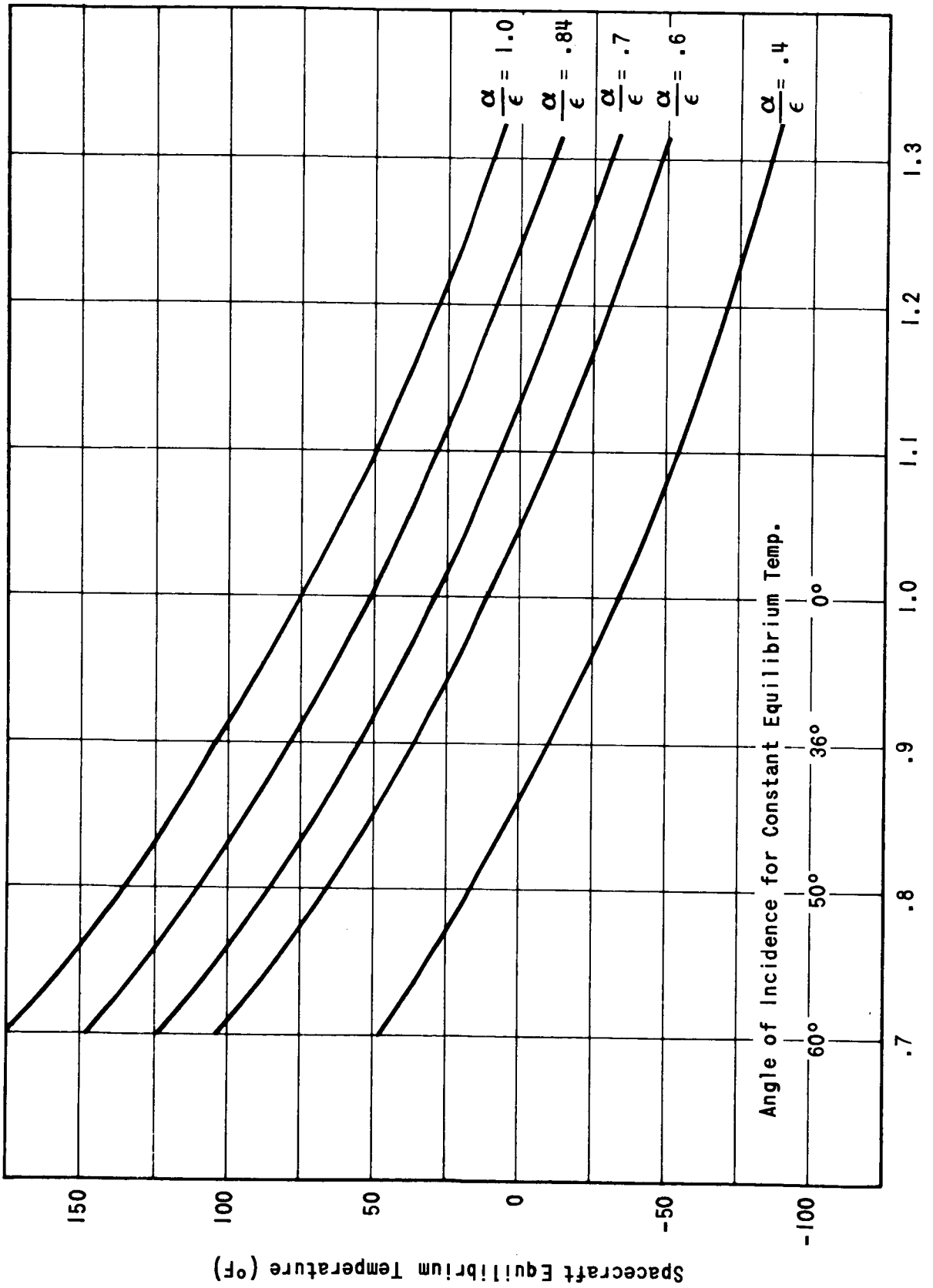

Distance from Sun ~ (AU)

Figure 3-1

Internal Thermal Loads

Internal thermal loads are generated by the crew and their equipment. Table 3-5, adapted from Reference 4, indicates an average heat load from the three crew members to be 1500 BTU/hr. For equipment, if an average power dissipation of 3 kw is assumed, the heat load is about 10,000 BTU/hr. For each element of the space vehicle this represents a temperature increase of from 1° to 3°F, so it is apparent that the solar radiation environment and the surface characteristics of the vehicle play a predominant part in establishing the equilibrium temperature.

Inclining the spacecraft's longitudinal axis towards the solar vector will decrease the amount of absorbed energy; and, if the inclination is programmed as a function of solar distance, the temperature spread will be reduced. While the environmental control system can manage the effects of these temperature ranges, electrical power demands can be reduced by following a programmed inclination to the solar vector except when performing experiments or mission operations demanding particular spacecraft attitudes.

3.4.2 Atmosphere Requirements

Following are the consumption rates which determine atmospheric gas requirements:

Metabolic oxygen @ 2.0 lbs/man-day	2,400 lbs.
Spacecraft leakage @ 5 lbs/day	2,000
Pressurization (3 each of S-IVB and ESM plus 5 EVA's)	<u>1,400</u>
	5,800 lbs.

The cabin atmospheric leakage rate is estimated at 5 lbs/day for the total spacecraft. Current studies estimate this leakage rate as high as 25 lbs/day (5 for each of CM and ESM and 15 for S-IVB), which would require an additional 8,000 lbs. of atmospheric gases. According to Reference 22, proven state-of-the-art in seals and seal seats should bring the leakage rate down to less than 1 lb/day for this configuration. This assumes improved seals on all hatches, even and adequate seal stress (which may require modifications to existing hardware for more rigid hatches and hatch mountings), care in handling cargo to avoid scraping the seals or seal faces, and the ability to replace damaged seals in flight. Consequently, a maximum total leakage rate of 5 lbs/day is considered achievable.

TABLE 3-5

Metabolic Loads as a Function of Activity
(based on 1 man-day of activity)

Activity	Duration (hours)	Heat Rate BTU/hr	Total Heat BTU
Sleep	7.5	300.0	2,250
Relaxation	2.0	350.0	700
Exercise	2.0	2000.0	4,000
Biomedical Monitoring	1.5	500.0	750
Eating	1.5	400.0	600
Personal Hygiene	1.0	400.0	400
Scientific Experiments	2.0	475.0	950
Systems Management	3.0	500.0	1,500
Systems Monitoring	2.0	350.0	700
Maintenance	1.5	550.0	825
TOTALS	24.0		12,675

This should provide some margin for emergency repressurizations in case of meteoroid puncture and additional use of airlocks and EVA's over the initial estimates.

A two-gas (70% oxygen, 30% nitrogen at 5 psia) atmosphere is proposed for the mission because of the physiological uncertainties involved in man's prolonged exposure to a pure oxygen environment. The atmosphere supply and conditioning system must provide temperature control ($75^{\circ}\text{F} \pm 5$), humidity control (50% RH), CO_2 removal, and contaminant control to the ESM and to the S-IVB after it has been activated.

The two-gas system controls are somewhat more complicated (and slightly less reliable) than the single gas control system in the Apollo Block II vehicle. The changes are primarily the addition of oxygen partial pressure regulators, flow control valves and nitrogen pressure regulators. These controls must automatically adjust the cabin atmosphere to the correct composition by admitting additional O_2 and N_2 to the cabin to make up for leakage and metabolic usage. The control system must permit emergency use of pure oxygen; and, as in Apollo, provide a full flow of atmosphere gases to keep up cabin pressure in case of puncture. Pressure suit operation will be the same as in Apollo, with pure oxygen at 3.5 psia circulated in the suit and cooled in the suit heat exchanger.

3.4.3 Water Requirements

The water required for the mission is one of the heaviest launch weight items if none is reclaimed. This is based on a drinking and food preparation requirement of 5.0 lbs/man-day and personal hygiene of 3.6 lbs/man-day, resulting in a total weight of 10,300 lbs. and volume of 245 ft^3 for a 1,200 man-day mission.

3.4.4 Waste Requirements

The solid waste from a crew on a dried food diet of 1.5 lbs/man-day is estimated at 0.5 lbs/man-day. There does not appear for the foreseeable future any reliable method of growing food on board during the space voyage nor, psychological drawbacks notwithstanding, utilizing solid wastes in a regenerative scheme. Most schemes examined for food growth, such as algae beds or reclamation of water and nutrients from fecal matter, generally require more equipment, space and/or power than their use would justify. For sanitary reasons, however, fecal matter will be germicidally processed, dried and stored; and the effluent gases will be vented to space. Such processing will not only inhibit bacterial growth but also considerably reduce the volume to be stored.

3.4.5 System Selection

The consumables were analyzed to determine the launch weight saved by closing or partly closing the ecological loops through regenerative schemes and the attendant penalties in equipment space, weight, power and systems reliability. Table 3-6 shows the options which are available to satisfy the total consumable requirements for environmental control functions.

If the consumables are used and exhausted in an open loop environmental control system, they total 21,400 lbs., about half of which is water. While this is clearly the simplest and most reliable approach, the weight when combined with other system requirements would exceed the Saturn V capability indicated in Section 2.1. The partial closing of the ecological loop was considered in three steps: water reclamation, cyclic CO₂ removal and oxygen regeneration. For reasons mentioned in the preceding subsection, a completely closed loop system was not considered.

Most of the wash water is fairly easy to reclaim through filtering and germicidal treatment. Moisture in the cabin atmosphere from crew respiration and perspiration is also recoverable through condensation over cold plates, then adsorption in thermally cycled silica gel beds and final transfer to a storage and treatment tank.

Several promising schemes for water recovery through urine purification were considered. One of the more straightforward is an evaporative scheme where warm dry atmosphere is passed over wicks from the urine collection tank. The wicks will have to be replaced as they become contaminated. The moisture laden atmosphere is subsequently passed over a condensate removal coil and the purified water collected and treated in a manner similar to metabolic moisture recovery. This system is selected here because of its relative simplicity and comparative economy of power.

Assuming a highly efficient, leak-free water management system, 600 lbs. more water than the crew requires could be reclaimed mainly because metabolic water output contains some moisture from the combination of hydrogen in the ingested food with the inhaled oxygen. Five hundred pounds of fresh water is provided in the spacecraft at launch to get the water cycle started and provide for contingencies such as less efficient system operation, loss of moisture through cabin atmosphere leakage and shutdowns for maintenance. Of this water 400 lbs. is stored in the CM as emergency supply and heat sink for the entry loads; the remaining 100 lbs. is stored in a tank in the ESM.

TABLE 3-6
Environmental Control System Options
 (400-day, 3-man mission)

Option Class	Component Weights(lb)	Net Launch Wts.(lb)	Power Req'd (watts)
I. Open Loop Consumables:		21,400	
Water	10,300		
Atmosphere Gases	5,800		
CO ₂ Removal Canisters	5,300		
II. Reclaim Water:		11,600	
Wash Water	-4,320		
Metabolic H ₂ O	-2,640*		
Urine	-3,960		
Add: Processing Equipment Wt.	+1,120		
III. CO ₂ Removal:		6,600	~300W
Omit LiOH Canisters	-5,300		
Add: Molecular Sieve and Drier	+300		
IV. Oxygen Regeneration from CO ₂ :		5,100	~100W
Oxygen	-1,920**		
Add: Bosch Reactor Electrolysis Cell	+420		

*More water recovered than ingested due to hydrolyzing of food.

**Will require some make-up water to produce enough oxygen.

The next step would be to change the CO₂ removal system. Carbon dioxide levels can be controlled by utilizing a 4-bed thermal swing molecular sieve instead of the conventional Apollo LiOH canisters. A weight savings of 5,000 lbs. of expendable LiOH cartridges is realized by going to this regenerative system. The 4-bed sieve is selected over the 2-bed system because the adsorbed atmospheric water which is removed in the silica gel bed is not vacuum-vented with the removed CO₂, but can be kept in the system and ultimately collected as it condenses in the heat exchanger.

The LiOH CO₂ removal system with a few days' supply of cartridges is retained, however, as a backup to permit maintenance of the sieve if required. These canisters are the same ones used in the CSM for the launch, abort and entry phases. Atmospheric trace contaminants are removed by charcoal beds and filters, and the cabin atmosphere is given a final germicidal treatment with ultra-violet light.

The third step involves oxygen regeneration from CO₂. There are a number of such processes, the least complex of which is the Bosch, involving CO₂ reduction with hydrogen in the water-gas reaction. The water produced by this reaction is then electrolyzed to recover the desired oxygen and to recycle the hydrogen. Because of the complexity, the state of development, the power requirements and the marginal reduction of consumables, this last step was rejected in the selection of the system.

3.4.6 System Configuration

A functional block diagram of the proposed ECS for the spacecraft is shown in Figure 3-2. The system consists fundamentally of a two-gas atmosphere loop which controls the temperature, humidity and contaminant levels of the pressurized compartments through the interchange and processing of atmosphere and a coolant loop which distributes hot or cold fluid to the system elements as required. Excess heat is rejected through an integral radiator system which completely surrounds the ESM, and auxiliary electric heaters provide energy to the system as required to maintain temperature limits of the atmosphere and coolant loops. Carbon dioxide levels are controlled by a molecular sieve, which is backed up by an emergency LiOH system intended for use during periods of sieve maintenance. Water is reclaimed by filtering and treating wash water, by condensing atmospheric moisture over cold plates, by adsorbing moisture in the silica gel beds of the molecular sieve and by evaporating urine.

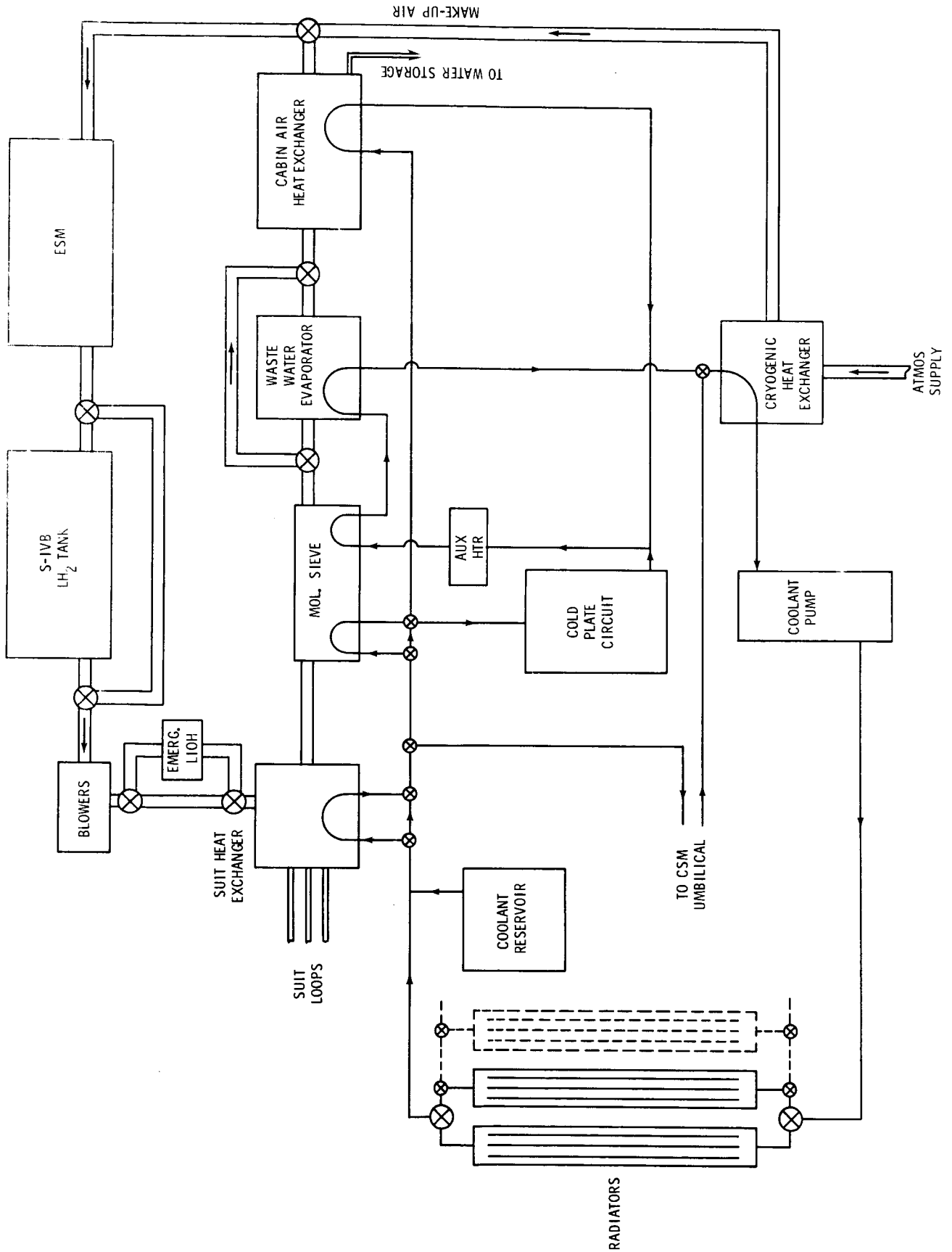

Figure 3-2

The purpose of the water-glycol coolant loop of the environmental control system is to transport heat to and from the elements of the ECS. As seen in Figure 3-2, it distributes cold fluid from the radiator to the suit and cabin air heat exchangers, the electronic equipment cold plate circuit, a section of the molecular sieve and the potable water chiller. As the coolant picks up heat from these elements, its temperature is increased from about 40°F to 115°F under average system heat loads.

For proper operation of the molecular sieve desorbing beds, a minimum inlet temperature of 125° is recommended (Reference 23). A thermostatically operated auxiliary heater is used to increase the temperature of the coolant, which then gives up a portion of heat to the molecular sieve and serves to increase the circulating air temperature in the waste water evaporator. This permits the atmosphere to carry moisture from the wet wicks to the chiller section where it condenses and is returned to the fresh water tank for treatment. The warm fluid then passes to the cryogenic heat exchanger where additional heat is released in maintaining the proper pressure in the cryogenic service tanks.

The hot glycol fluid then is pumped to the radiator sections for cooling and recycling in the system at a 250 lb/hr rate. Temperature actuated proportional flow valves are set to distribute or bypass the glycol on demand throughout the coolant loop, resulting in a more efficient heat transfer and minimizing the electrical demand on the auxiliary heaters and excess heat dumping from the radiators. The coolant loop also provides for heat transfer through the umbilical to the CSM. Coolant can thereby be transferred to the cold plate network in the CSM when the CSM-electronics systems are being used, or the transfer loop can be used to provide the radiator heat sink if the CM ECS must be activated.

The radiators, contained in eight multipass sections completely surrounding the ESM, have an effective area of 450 ft² and can reject up to 45,000 BTU/hr. The radiators are integral with the conical structure surrounding the SLA and with coolant are dense enough to contribute to protection against solar radiation.

In addition to the heat rejection function, the radiators serve as a thermal jacket for the ESM, distributing the warm glycol through the temperature controlled proportional flow valves to the shadowed side of the spacecraft thereby minimizing the temperature differential between the sunlit

and shaded sides. The solar heat flux is expected to nearly double at the closest point to the sun (.7 AU); and, in addition, the absorptivity (α), while initially designed at about 0.4, could increase on long interplanetary flights through erosion of surface coatings. Under these conditions, the net absorbed energy could increase.

Passive thermal control of the spacecraft is inherent in the design and selection of materials and thermal coatings. Reasonable spacecraft temperatures can be maintained in spite of environment and surface changes for most of the interplanetary flight phase of the mission by selectively inclining the spacecraft to the sun's radiation vector as a function of solar distance. This scheme, a primary mode of thermal control, provides functional back-up to the ECS.

The large radiator provides a comfortable margin for rejecting the additional heat loads. A low heat rejection rate, such as will be desirable at maximum solar distance or under minimum electric power consumption and operational activity, can also be accommodated by utilizing the Apollo selective stagnation concept of flow through the radiator passes, which automatically varies the effective radiator area as a function of the required heat rejection rate.

Portable inlet and exhaust ducts are rigged in the S-IVB tank and connected to the main cabin atmosphere heat exchanger and blowers in the ESM to provide adequate atmosphere circulation. In addition, small fans are available at the astronauts' sleeping quarters and work stations in the S-IVB to provide local comfort control.

Because of the possibility of varying heat load requirements in one compartment or both, the atmosphere control for each compartment (S-IVB and ESM) is essentially divided into separate zones with individual atmosphere flow and coolant rates, but discharging their heat loads into a common heat exchanger. Proportional flow valves actuated by temperature settings divert coolant as needed to the appropriate section of the heat exchanger.

Gaseous and liquid storage methods for the atmosphere gas supply have been investigated for this mission, and weight optimization is considered a more significant parameter

than volume optimization. High pressure gas storage has the following optimum design characteristics (Reference 24).

	<u>O₂</u>	<u>N₂</u>
Optimum pressure (psia)	10,500	9,500
Weight penalty (lb/lb of useful fluid)	3.46	3.66

The gaseous storage tank weight for this mission would be 20,245 lbs. For the same 5,800 lbs. of gases, if cryogenically stored in the subcritical phase in spherical vessels at the penalties are:

	<u>O₂</u>	<u>N₂</u>
Storage pressure (psia)	150	150
Weight penalty (lb/lb of useful fluid)	1.1	1.05

Therefore, a composite weight penalty of 1.1 lb/lb of usable fluid has been selected. This weight parameter includes the bottles, tanks, super-insulation and supports but not the delivery system or heater penalties associated with keeping the cryogenics in a homogeneous single phase and at a proper delivery pressure. The weight of the subcritical cryogenic storage is then 2,380 lbs.

In the proposed system the Apollo Block II ECS, with the exception of the space radiators (which have been removed from the SM), is left intact. The CM ECS can be reactivated in case of failure by utilizing the ESM radiators or the ESM ECS can provide coolant to the CM if partial activation of the CM equipment is desired. The CM ECS functions during launch and entry, and a water boiler with uprated capacity and an additional 400 lbs. of water is used to cool the spacecraft during the high speed entry on the return to earth.

3.4.7 Summary

The weight and power requirements of the ECS are summarized in Table 3-7.

TABLE 3-7
Environmental Control System Summary

<u>Equipment</u>	<u>Weight (pounds)</u>	<u>Peak Power (watts)</u>	<u>Avg. Power (watts)</u>
<u>Command Module</u>	(400)	(350)	(50)
<u>ESM</u>	(6100)	(1100)	(1050)
Atmosphere Control	530	300	300
Temperature Control	680	450	450
Water Control	160	300	300
Waste Control	50	-	-
Cryo Tanks	2380	50	-
Radiators and Coolant	2300	-	-
<u>Useful Load</u>			
<u>Command Module</u>	(490)		
Water	400		
LiOH	35		
Oxygen	55		
<u>ESM</u>	(5900)		
Oxygen	4780		
Nitrogen	1020		
Water	100		

3.5 Crew Systems

The estimated requirements of individual crew subsystems are outlined in the following sections. The data on crew systems provisions planned for the Apollo Block II CM are derived from Reference 25.

3.5.1 Berthing

The Apollo CM is equipped with three sets of crew couch pads and restraints which will be required during the mission phases through injection and during earth entry. Additional requirements for berthing accommodations are generally dependent on the detailed spacecraft configuration and the plans for occupancy of the available living space. Since, however, the CM is not suitable as a radiation shelter, it is necessary to provide at least three sleeping bag-type accommodations for use elsewhere in the spacecraft. These bunks should also be usable for protracted periods of the flight to provide some flexibility in sleeping arrangements. Estimated additional weight is 5 lbs.

3.5.2 Food Equipment

The current Apollo CM allowance of 60 lbs. for food associated equipment should be adequate for the mission.

3.5.3 Crew Equipment and Clothing

The Apollo CM will contain approximately 350 lbs. of equipment, clothing, accessories and items not covered in other sections. It is estimated that, for the 1,200 man-day mission, the following augmentation will be required:

<u>Item</u>	<u>Number</u>	<u>Augmentation Weight(lbs)</u>
Pressure garment assembly	3	102.0
Portable life support system	4	212.0
Emergency oxygen system	6	19.5
Constant wear garments	36	186.0
External thermal garments	5	67.0
Tool sets	2	7.0
Thermal garment storage bags	5	7.5
Pressure garment assembly storage bags	3	4.0
Belt assembly	2	2.0
Crew Optics		8.0
Personal hygiene & showers, shaving wash pads		160.0
	<u>Total</u>	<u>775.0</u>

3.5.4 Personal Hygiene

The Apollo CM useful load already includes 10.5 lbs. of waste management supplies such as fecal bags, wiper pads and germicide pouches. For a 400 day mission it is estimated that these supplies will have to be multiplied by a factor of 30; hence, an additional 290 lbs. is entailed.

Also, there is a need to provide in other modules to be occupied the canisters and receptacle assemblies, weighing 3.3 lbs., provided in the Apollo CM.

3.5.5 Medical Equipment and Supplies

The medical equipment in the Apollo CM includes 8.6 lbs. of medication, clinical instruments and bio-instrumentation. To provide for carrying out surgical therapy, an estimated total of 30 lbs. is required to cover also surgical instruments, radiographic equipment, instruction package and intravenous therapy equipment (Reference 4).

3.5.6 Recreation and Physical Fitness

In its study of the Venus mission (Reference 4), NAA recommends the following recreation and physical fitness items, which are considered reasonable and necessary for such a mission:

<u>Item</u>	<u>Weight(lbs)</u>
Exercise device	3.0
Recorded music	3.0
Movies	5.0
Reading materials	20.0
Games	<u>2.0</u>
Total	33.0

In addition, a 60-lb exercycle is regarded as a physical fitness requirement.

3.5.7 Survival Equipment

The survival equipment being provided for Apollo to sustain the crew for seven days after landing, is considered adequate and necessary for the Venus mission.

3.5.8 Food

Dried food will be stored and prepared in the same manner as Apollo missions. The food requirement is estimated at 1.5 lbs/man-day, resulting in a total weight of 1,800 lbs.

3.5.9 Summary

The weight and power requirements of the crew systems are summarized in Table 3-8.

TABLE 3-8
Crew Systems Summary

<u>Equipment</u>	<u>Weight (pounds)</u>	<u>Peak Power (watts)</u>	<u>Avg. Power (watts)</u>
<u>Command Module</u>	(75)	(10)	-
Accessories	75	10	-
<u>ESM</u>	(1650)	(300)	(270)
S-IVB Equipment	390	250	250
Crew Equipment	775		
Other	485	50	20
<u>S-IVB/IU</u>	(400)		
Coatings	300		
Fittings	100		
<u>Useful Load</u>			
<u>Command Module</u>	(900)		
Crew	560		
Equipment	340		
<u>ESM</u>	(1800)		
Food	1800		

3.6 Experiments

It is estimated that some 3,000 to 4,000 lbs. of the spacecraft weight should be available for experiments. In the following sections possible experiments aimed at achieving the objectives listed in Section 2.3.6 are described, the final selection of experiments for the system being deferred to the discussion under Section 3.9 (Systems Integration).

3.6.1 Venus Data

The desired Venus data can generally be obtained by: (1) unmanned probes equipped with suitable sensing devices entering the Venusian atmosphere, descending through the atmosphere and impacting the surface; (2) unmanned probes landing on the planetary surface, retrieving surface samples and returning to the spacecraft; and (3) telescopes and cameras capable of making and recording observations over a relatively wide frequency spectrum. Other studies have shown that the weight required for the sample return probe is in excess of the expected experiments payload availability in the mission; and, hence, such an experiment is rejected without further consideration. The other approaches, however, appear feasible and are discussed below.

Unmanned Probe Lander

It has been estimated (Reference 26) that an instrument package weighing about 50 lbs. and installed in a probe lander would provide the following planetary atmosphere data: density/pressure, temperature and chemical composition vs. altitude; ion and electron density in ionosphere; and ionic composition of ionosphere. The total injected weight of such a package, including its supporting systems, is estimated at about 500 lbs., and, hence, appears suitable for consideration in the mission.

To obtain the desired data on Venus, it is envisioned that the probe lander would be deployed as follows:

- a. At a point on the approach to Venus the spacecraft would be properly oriented and its attitude stabilized.

- b. The probe would be ejected mechanically, probably using a spring system, from its sterilized container.
- c. The probe's guidance would correctly align the thrust axis and the probe would be stabilized by spin jets.
- d. Following a coast period, the probe's propulsion unit (solid propellant) would provide the ΔV necessary for ballistic entry into the Venusian atmosphere and impact on the planetary surface. Ballistic entry has been selected because of the basic simplicity of such configuration and because of the relatively dense Venusian atmosphere.
- e. Except for a period of communications blackout, the spacecraft would track the probe to impact and would receive/record telemetered data from the probe after entry. Special provisions would be required to accommodate tracking/telemetry for more than one probe. A multiple launch, however, is a desirable goal since it would permit obtaining Venus data at various geographic positions.

In Appendix III the feasibility of providing a 500 lb. probe which could obtain useful data on the Venus atmosphere is examined. Based on that analysis, it is concluded that such a probe is feasible; and, for purposes of determining the spacecraft configuration, a probe configuration is selected. The probe chosen is one which has a $W/C_D A$ of 100 lb/ft² and which could be carried in a cylindrical container with a diameter of about 3 feet and a length of 7 feet.

Telescope System

Obtaining data on Venus by telescopic means will be difficult because of the cloud layer which appears to completely obscure the planetary surface. However, frequent observations at ranges considerably closer than that of the earth may permit a determination of patterns of motion of the cloud cover. Observation at various portions of the frequency spectrum will assist in determining the composition of the Venusian atmosphere, and it is conceivable that penetration to the surface can be achieved.

Without attempting to optimize the selection of a telescope system for the mission, it appears that a 40 cm aperture telescope would be a suitable basic unit. The surface resolution at periapsis would be about 11 m. From Reference 27 it can be seen that with a minimum focal length of about 2 m, the 40 cm telescope would be usable with a

camera system having a film format of 10 cm x 10 cm with 300 lines/mm. Based on the planning for the Orbiting Astronomical Observatory program, the estimated weight of basic optics and structure of the 40 cm telescope would be about 220 lbs.

In addition to the telescope designed for visible spectrum data, units similar to those being proposed for the ATM experiments should be provided to cover infrared, ultraviolet and X-ray data. The estimated total additional weight requirements would be about 600 lbs.

The support requirements for the telescope installation outlined above as derived from other studies are:

- a. Weight The weight of the camera system, structure, control unit and other auxiliary systems is estimated to be in the order of several hundred pounds. An allowance of 1,200 lbs. for the total telescope experiments system appears appropriate.
- b. Power The average power requirement for operation of the system is estimated at 10 watts. Assuming infrequent, intermittent operation for most of the flight and virtually continuous operation from 24 hours before periapsis to 24 hours after, the total energy requirements would be about 0.5 kWh.
- c. Pointing Control The pointing accuracy of 5 arc seconds specified for the ATM experiments appears suitable for the Venus flyby mission. At periapsis this would be translated to a horizontal distance on Venus of about 500 feet and at a distance of 50 Venusian radii, approximately 4 n.m.
- d. Thermal Control Based on the requirements for other similar experiments, it is estimated that the telescope system should be maintained in an environment with a temperature range of -20 to +50°C.
- e. Data It is estimated that approximately 10,000 photographs will be taken with the bulk occurring during the 48-hour period centered at periapsis. This amounts to a film weight of about 50 lbs. and is the equivalent of about 4×10^{12} bits of data.

3.6.2 Interplanetary Data

The routine monitoring of the interplanetary environment could be accomplished by the Interplanetary Environments Monitor (IEM) suggested by NAA in Reference 4. The IEM consists

of a number of sensors: magnetometer; spectrometers for high and moderate energy particles, proton plasma and electron plasma; X-ray and UV photometers; micrometeoroid detectors; and ion chamber. It weights 54 lbs. and has a total volume of 1.5 ft³. To prevent data interference by the spacecraft during flight, the IEM is mounted on a boom which, for optimum data collection, should be oriented perpendicular to the solar equatorial plane.

The support requirements for the IEM installation are:

- a. Weight The weight of the required boom and deployment mechanism is estimated at an additional 50 lbs.
- b. Power It is expected that the IEM will be in operation throughout the entire mission, and based on the NAA estimate of an average power requirement of 54 watts, the total energy requirement is 520 kWh.
- c. Pointing Control For routine monitoring the IEM orientation should be maintained with an accuracy of $\pm 5^\circ$. For measurements requiring up to a minute of time, the pointing direction should be known to within $\pm 0.5^\circ$.
- d. Thermal Control Reference 4 indicates no thermal control requirements. However, other similar experiments generally require operating temperatures within the range of -50 to $+50^\circ\text{C}$. Since the IEM is mounted on an external boom, an integrally mounted thermal control unit appears necessary.
- e. Data The only real-time data requirement associated with IEM acquisition is expected to be solar flare data; all other data are susceptible to handling through non-real-time transmission to earth. Based on the NAA report, the IEM would acquire 2×10^6 bits of data per day, or about 8×10^8 bits for a 400 day mission. During a solar flare period lasting three days, it is estimated that 5.7×10^6 bits requiring real-time transmission would be recorded.

3.6.3 Mercury Data

The telescope system proposed for acquisition of Venus data will be capable of obtaining similar data on Mercury after the Venus encounter. It should be noted, though, that at the closest point of approach to Mercury, the surface

resolution of the telescope will be about 44 n.m. The proposed pointing accuracy is adequate since at periapsis the Mercury diameter will subtend an angle of 22 arc seconds.

3.6.4 Astronomical Data

Of the other solar and galactic systems astronomical data mentioned in Section 2.3.6, much could be obtained by the telescope system described in Section 3.6.1. In particular, IR, UV and X-ray measurements of targets of opportunity or pre-selected targets would be feasible with no appreciable increase in the spacecraft energy and data handling requirements.

Radar measurements of the surface of Venus would be particularly desirable since observations at the other frequencies may not penetrate the planetary atmosphere to the surface. While there are under consideration for the manned space flight programs experiments based on radar investigation of earth and the moon, the equipment is generally sized for orbits at altitudes up to 200 n.m. Scaling the hardware to the periapsis altitude of the mission would generally result in prohibitive weight and power requirements to obtain useful surface resolution capabilities. However, if the periapsis altitude had been selected at about 500 n.m., then the hardware requirements would have more closely matched the system capability.

3.6.5 Summary

The weight and power requirements of the Experiments System are summarized in Table 3-9.

TABLE 3-9
Experiments Summary

<u>Equipment</u>	<u>Weight (pounds)</u>	<u>Peak Power (watts)</u>	<u>Avg. Power (watts)</u>
<u>ESM</u>	(1300)	(50)	(50)
Telescope	1200	10	-
Magnetometer	100	50	50
 <u>Useful Load</u>			
<u>ESM</u>	(2600)		
Probes	2200		
Film	100		
Tape	300		

3.7 Communications

The communications requirements of the mission include voice, telemetry and picture transmission to the MSFN; internal communications; tracking and telemetry reception from the scientific probes; ranging by the MSFN; and voice and updata reception.

Because of the limited capability to return "hard copy" data to earth in the command module, it is desirable that the spacecraft communication system have the capability in addition to the above functions to transmit all experiments data back to earth.

3.7.1 Data Processing Requirements

The data generated by the spacecraft housekeeping functions and experiments are summarized in Table 3-10.

It can be seen that the largest data load comes from the processing of the 10,000 frames of film from the telescope experiments. If all this data (4×10^{12} bits) were to be transmitted, the average bit rate would be 116 kbps spread over the entire mission time. Further, the majority of the film exposures will take place at Venus encounter, with only 280 days left to transmit the data. The average data load would then increase to 166 kbps for the latter portion of the mission. Twenty kbps is assumed as the average data rate for the biomedical and housekeeping telemetry, 2.5 kbps for digital voice requirements and a small increment (250 bps) for data from the probes and IEM experiments. The capability should be provided to collect data on at least one solar flare of 72 hours duration, resulting in an estimated load of 5.7×10^6 bits. Transmission of solar flare data along with biomedical monitoring, selected spacecraft parameters and voice represent the only real time requirements, the remainder of the data acquired during the mission being susceptible to storage and transmission on a scheduled basis. Two sets of data storage equipment (magnetic tape with monitoring and editing facilities) must be provided to record and play back data on a scheduled basis.

In the sizing of the spacecraft communication transmission system, margin must be allowed for the fact that continuous transmission to earth at the highest data rate may not be possible or desirable due to operational or environmental consideration; therefore, to be conservative and to allow for growth

TABLE 3-10
Data Processing Requirements

	<u>Total Bits</u>	<u>Avg. Bit Rate</u>
Probes (4)	3.2×10^5	250 bps
Telescope Film (10,000 frames)	4×10^{12}	116 kbps
Interplanetary Environment Monitor Package	8×10^8	23 bps 230 bps real time
Digital Voice Channel		7.5 kbps
Biomedical & Spacecraft Parameters		20 kbps

a 280 kbps data requirement has been used in the following sections.

3.7.2 Spacecraft-Earth Communications Link

With the desired transmission rate established the spacecraft-earth communications link is examined to determine the system parameters necessary to support this data rate. The system characteristics used in calculating this link are as follows (Reference 28):

1. S-band frequencies in the 2.3 GHz spectrum will be used.
2. The bit error rate (BER) for data received at the earth terminal will not exceed 10^{-3}
3. The signal-to-noise ratio required in a bit rate bandwidth assuming coherent PSK modulation for 10^{-3} BER is 7.0 dB.
4. The MSFN is assumed to be upgraded to include 210-foot diameter antennas, and low noise temperature receiving systems ($T_{\text{eff}} = 50^{\circ}\text{K}$, noise spectral density - 211.8 dBW).
5. Tracking will be performed at these stations providing continuous range-rate data while receiving the modulated signal from the spacecraft. Range data will be established periodically using the existing PRN capability of the MSFN.
6. Uplink and voice communications will be transmitted from these stations employing a 100 kW power amplifier.
7. Total communications systems losses (ground and spacecraft) will not exceed 12 dB.
8. The maximum spacecraft-earth distance is .9 AU (73×10^6 n.m.).
9. Maximum use of Apollo spacecraft communications systems will be made with modifications as necessary to support the communications requirements.

Based on the above and the one-way transmission equation, Table 3-11 calculates the power gain product ($P_t G_t$) required to transmit the 280 kbps data signal from the maximum range of .9 AU to be 63.5 dBW.

3.7.3 Earth-Spacecraft Link Analysis

The spacecraft receiving system is analyzed assuming a spacecraft receiver system noise spectral density of -203.8 dBW/Hz and a ground transmitter power output of 100 kW. As indicated in Table 3-12, the bit rate that can be received at maximum range with the Apollo Block II antenna is 490 kbps. If increased data rates are desirable, the antenna size can be increased as follows:

<u>Antenna</u>	<u>Gain(dB)</u>	<u>Data Rate(bps)</u>
Baseline Apollo Block II	27.4	$.490 \times 10^6$
10-foot diameter	34	2.27×10^6
13-foot diameter	36.5	4×10^6
15-foot diameter	38.0	5.6×10^6

3.7.4 System Selection

With the required $P_t G_t$ of 63.5 dBW from the spacecraft, the following characteristics are implicit for a parabolic reflector operating at 2.3 GHz and power amplifier efficiency of 30%.

<u>Antenna</u>	<u>Antenna Gain (dB)</u>	<u>Transmitter RF Power Req'd(kW)</u>	<u>Primary Power Req'd(kW)</u>
Apollo Block II	27	4.3	14.3
10-foot diameter	34	.93	3.1
13-foot diameter	36.5	.52	1.75
15-foot diameter	38.0	.370	1.24
20-foot diameter	40	.23	.770
25-foot diameter	42	.15	.50

3.7.5 Probe Tracking

The four Venus experiment probes are to be released sequentially from the spacecraft approximately 24 hours before closest approach. Each probe contains an S-band transmitter at a discrete frequency, and its carrier will be programmed "on" shortly after departure from the spacecraft. The probe ejection system and programmed trajectory are designed to

TABLE 3-11

Spacecraft to Earth Microwave Transmission Analysis

Ground Receiver Noise Spectral Density		-211.8 dBW/Hz
Information Bandwidth Required (280 kHz)		54.5 dB/Hz
Total Noise Power		-157.3 dBW
S/N Required (10^{-3} BER)		7.0 dB
Required Receiver Power		-150.3 dBW
. Free Space Loss	-262.8 dB	
. System Losses	-12.0 dB	
. Ground Receiver Antenna Gain	<u>+61.0 dB</u>	
Net losses subtotal		-213.8 dB
Power Gain Product Required in Spacecraft Transmitter ($P_t G_t$)		63.5 dBW

TABLE 3-12

Earth-Spacecraft Communications Link Analysis

Transmitter Power	50 dBW
Transmitter Antenna Gain	60.5 dB
Path Loss (.9 AU)	-262.8 dB
System Losses	-12.0 dB
Spacecraft Receiver Antenna Gain(Apollo Blk II)	+27.4 dB
Received Signal Power	-136.9 dBW
S/N Required ¹	10.0 dB
Allowable Noise Power	-146.9 dBW
Spacecraft Receiver Noise Spectral Density @ $T_{\text{eff}} = 300^{\circ}\text{K}$	-203.8 dBW/Hz
Information Bandwidth	56.9 dB/Hz
Maximum Data Rate Available	490 kbps

¹BER 10^{-5} is used for greater updata link reliability.

cluster the probes, and they will slowly separate from the craft reaching a maximum distance of about 5000 miles as they impact the Venusian surface while the module passes over.

The probe-to-spacecraft link calculations (Table 3-13) indicate a bit rate capacity of 415 bps, an ample margin over the estimated 230 bps which each probe will sequentially transmit during its final six minutes before impact. The Apollo Block II S-band communications system modified to accept the four S-band links simultaneously and to auto track on one probe carrier will be the spacecraft receiving system. This S-band system in its conventional mode will be used for near earth communications and as a planetary phase backup (with reduced bit rate capability - low rate telemetry and emergency voice).

The antenna beam width is switchable from the tracking beam to a broader angle, with corresponding reduction in gain, to keep the probes in the main lobe as they spread on impact. Auto track will probably be lost during "blackout" as the probes transit the Venus atmosphere and most probably when the beam is switched to a wider angle. Sufficient trajectory history, however, should be available to keep the antenna pointed at the probes. It should further be noted that, although current probe design does not require commands over the RF link, the capability is inherent in the S-band system, with some modifications to the digital processor, and could be added at a later time.

Furthermore, should refinement of the probe design incorporate on-board tape recorders, the total data sensed by the probe could be simultaneously recorded for "burst" transmission playback after blackout. Perhaps two of the four probes could be so equipped and the design refinement could incorporate a more sophisticated digital system which by allowing a lower signal to noise ratio would accommodate the higher bit rate "burst" transmission. The primary S-band system could also be configured to optionally receive the probe data and could be used as a backup for the tracking, reception and recording of the probe data.

3.7.6 Systems Configuration

The requirement for a continuous communications link to the earth based DSN, the desirability of enhanced reliability through a redundant communications system and the requirement for a higher power gain product than currently exists with the Apollo Block II S-band system led to the selection of a new, high power communications system located in the ESM. In addition, the CSM S-band system is remoted from the ESM so that it may be

TABLE 3-13
Probe-to-Spacecraft Link Analysis

Probe Transmitter Power	7	dBW
Probe Antenna Gain	0	dB
System Losses	-16	dB
Fade Margin	-6	dB
Path Loss	-177	dB
Spacecraft Antenna Gain (Apollo Block II)	27.4	dB
Received Power	-164.6	dBW
S/N Required (FM Analog)	10.0	dB
Allowable Noise Power	-174.6	dB
Receiver Noise Spectral Density	-203.8	dBW/Hz
Receiver IF Bandwidth	830	Hz
Maximum Information Bandwidth	415	bps

operated as a backup for spacecraft-earth communications (with reduced capability) as well as for probe communications. Just before and after Venus encounter, when the heaviest spacecraft to earth communication load would be expected, the CSM system serves as an independent link to track and receive data from the probes.

Analysis of the systems to be integrated in the spacecraft, reliability considerations and the desire to protect the antenna during the boost phase led to the decision for packaging the largest antenna possible internal to the launch configuration and deployable after launch. In addition, the circular parabolic reflectors parametrically selected in Section 3.7.4 have a characteristic focal point diameter ratio (F/D) of .4 which further constrains the choice of locations to stow the antenna. A selection was made, therefore, to locate the antenna in the interspace between the SM and the ESM and to deploy it when the CSM separates in earth orbit during the transposition and docking phase. A 13-foot diameter reflector with a 36.5 dB gain was chosen from the table in Section 3.7.4, and it is apparent that .52kW of RF power will have to be provided to accommodate the desired bit rate.

Allowing 20% for degradation of output, four 150 W amplifron power amplifiers were selected to be placed in parallel at the output of the present 20 W transmitter, which will act as the driver. Amplifiers of this size or larger should be available as flight rated hardware by the early 1970's. These amplifiers can be activated one at a time as the distance and data rate dictate, thereby providing flexibility, reliability through redundancy and efficient use of primary power.

The 13-foot diameter antenna on the ESM communication system will now permit a maximum updata link bit rate of 4 megabits (refer to Section 3.7.3) giving increased flexibility to the programming of earth-to-spacecraft information. It should be noted also that the communications system redundancy allows a backup throughout the entire mission in case of failure of the higher power ESM system or the requirement for a simultaneous emergency transmission. It is calculated that at maximum communication range a 1300 bps transmission capability still exists in the CSM S-band system which could be used for an emergency keying channel as well as ranging capability from the earth.

3.7.7 Summary

Table 3-14 summarizes the weight and power requirements of the Communications System.

TABLE 3-14
Communications Summary

	<u>Weight (pounds)</u>	<u>Peak Power (watts)</u>	<u>Avg. Power (watts)</u>
<u>Command Module</u>	(320)	(470)	(150)
USB	280	390	70
Instrumentation	40	80	80
<u>Service Module</u>	(160)	(100)	(100)
Antenna	110	-	-
Instrumentation	50	100	100
<u>ESM</u>	(1100)	(3480)	(1280)
Antenna	175	30	30
Power Amplifiers	160	3000	1000
Data Reduction	305	400	200
Installation	350	-	-
Instrumentation	110	50	50

3.8 Electrical Power System

Table 3-15 contains a summary of the power requirements for the Command Module, the Service Module and the ESM systems. The average power during the planetary phases totals slightly over 3 kW and the peak power about 12 kW. This peak of course, is the peak of all the systems simultaneously which operationally would not be required. The two largest requirements are the SPS, approaching 5 kW, and the communications at 3.5 kW.

3.8.1 Command and Service Module

The CSM must function similarly to Apollo from launch through injection and from entry through landing. For the mission, however, there is also a requirement for a CSM capability during an injection abort maneuver with a duration up to 60 hours. In addition, the entry capability is required some 400 days after launch. The preferred solution appears to be the use of CSM batteries which can be kept at full charge by the ESM electrical power system and which are sized for the most critical independent operation, the abort maneuver. The estimated abort energy requirement, 35 kWh, can be accomplished with 850 lbs. of silver-zinc secondary batteries mounted in the Service Module. These batteries have a capability of up to a hundred discharge-charge cycles and can be considered for peak loads during the interplanetary flight phase. If the ESM electrical system has a peak capacity of 5 kW, then the CSM batteries will be needed only during the 5 kW SPS midcourse operations, a maximum of eight times.

3.8.2 ESM Electrical System Comparisons

As a basis for selecting a suitable electric power system for the space vehicle, the average power requirements were initially sized at 3.0 kW with peak powers as high as 5 kW. The energy requirements for the 400-day mission were calculated at 29,000 kWh.

State-of-the-art power systems were considered along with systems which may be available in the early 1970's, and the preliminary investigation covered the following energy sources: chemical, solar and nuclear. The chemical energy sources analyzed include batteries and extensions of current fuel cell technologies. Solar energy investigations covered thermo-electric, thermo-dynamic and photovoltaic methods of conversion. Nuclear reactor sources were briefly reviewed within the bounds of available unclassified data, as were radio-isotope systems. Combinations of sources were also considered to meet the specific requirement of each mission phase.

TABLE 3-15
Electrical Power Summary

	<u>Peak Power</u> (watts)	<u>Avg. Power</u> (watts)
<u>Command Module</u>	(1755)	(270)
Navigation, Guidance & Control	895	70
Propulsion	30	-
ECS	350	50
Crew Systems	10	-
Communications	470	150
<u>Service Module</u>	(4930)	(130)
Propulsion	4830	30
Communications	100	100
<u>ESM</u>	(5650)	(2960)
Navigation, Guidance & Control	710	310
ECS	1100	1050
Crew Systems	300	270
Experiments	60	50
Communications	3480	1280
<u>Total</u>	12,335	3360

Systems reliability and launch weight were established as the governing parameters for systems selection, with specific volume a secondary consideration. Table 3-16 compares the launch weights of the candidate electrical systems. Other characteristics of the more promising systems are discussed in the following paragraphs.

Fuel Cell Systems

Hydrogen-oxygen fuel cell power plants such as the improved Pratt & Whitney or Allis-Chalmers 1200-hour life cells, analyzed by North American Aviation in their recent AES study (Reference 29), were investigated as the primary electrical generation system for the Venus flyby mission. They are attractive from aspects such as reliability through redundancy (eight sets of two each are required for the 400-day mission), ability to meet peak electrical demands and capacity to produce high purity product water. The reactant supply and storage weight penalties, however, dictate rejection of this scheme. Reactant consumption is calculated at 1.0 lb. of cryogenes for each kWh of required energy. The weight penalty for cryogenes, tankage and interconnecting plumbing and insulation averages 1.3 lb/lb of usable oxygen and 6.0 lb/lb of usable hydrogen. As indicated in Table 3-16, for a 29,000-kWh energy requirement a gross power plant and reactant storage system would weigh 56,100 lbs. Granted that 7,000 lbs. of product water could be utilized for crew consumption and some of the excess water used in water boilers to assist in thermal control, the rest would have to be stored or dumped.

Clearly then, even with the expected improvement in fuel cell life, which would cut the fuel cell hardware requirements in half, the net reactant supply weight is prohibitive for this mission.

Radio-isotope Systems

Existing systems such as the SNAP-3, 9A, 11, 17 have power outputs (less than 100 Watts steady state) which are too low on a unit basis for consideration even if used in combinations. The primary weight penalty is, of course, in the shielding required. Advanced systems are being considered in the 10 kW_e range at a specific power up to 500 lbs/kW_e for high temperature Brayton cycle systems which are competitive with solar cell systems, but these are not sufficiently developed to permit planning their use in the early 1970's. There is, furthermore, a strong possibility that the availability of large isotope systems will be limited by isotope production.

TABLE 3-16
Electrical Power System Comparison

	<u>Subsystem Weights (pounds)</u>	<u>Total Launch Wt. (pounds)</u>
Fuel Cell		56,100
Fuel Cells	3,200	
Reactant Supply	29,000	
Tankage	23,900	
Radio-isotope-Thermoelectric		2,000
Radio-isotope-Brayton		1,000
Reactor Power		6,000
Solar Cell		1,850
Photovoltaic cells	1,000	
Silver-zinc batteries	850	

Reactor Power Systems

Reactor power systems are similarly considered in too early a development stage for this mission. Systems such as the SNAP-10, when shielding requirements are considered, have specific powers [about 1800 lbs/kW_e (net)] that are not competitive; and all large systems using nuclear fuels pose a fuel disposal problem at the end of the mission. As in the case of fuel cells, up to 25% of the energy, normally rejected as waste heat, could be partially utilized by integrating the EPS coolant systems with the environmental control systems. The data in Table 3-16 is based on six-500 W. SNAP-10 reactors.

Solar Cell System

The solar cell system with a secondary battery bank appears attractive for the mission. Solar cells which can be sun-oriented are conservatively rated at 100 lb/kW with advanced techniques of manufacture expected to double this specific power in the next few years (Reference 21). Design figures selected for this system analysis are based on an output of 10 Watts/ft² for a sun-oriented system at a distance of 1 AU from the sun. The specific weight of large systems is estimated at 0.5 lb/ft², including 4-mil N-P photovoltaic junctions, 3-mil red glass covers, aluminum box frame for petals, electroformed substrate, and deployment mechanism (Reference 21).

3.8.3 System Selection

Based on the foregoing, the isotope Brayton cycle and the solar cells become the leading contenders for the EPS. Reliability and availability of energy sources coupled with state-of-the-art experience, however, favor the solar cells. Furthermore, a review of the trajectory for this mission indicates no shadowing of the solar vector after departure from earth orbit at solar distances ranging from .7 AU to 1.2 AU with corresponding solar energy levels varying by the inverse square law from 265 W/ft² to 90 W/ft².

The delay in deployment of solar paddles following the launch phase and shadowing of the solar radiation during part of the earth orbital phase do not pose a serious problem for the solar cell systems since inflight rechargeable peaking batteries to accommodate peak overloads, as well as temporary interruptions in the primary source, are part of an integrated power system.

3.8.4 Solar Cell System Configuration

The solar cell system configuration must be such as to permit meeting the average power requirement of 3 kW at distances of 1.2 AU from the sun. The spacecraft will reach aphelion approximately 300 days after launch, at which point the power will have to be on the increase to maintain the thermal balance in the spacecraft. This augmentation, however, is offset by reduced need for power for communications since the spacecraft will be closing the earth and will be at a distance of about 0.5 AU from earth.

In determining the required solar panel area, due allowance must be made for degradation at a rate of up to 50% per year in the solar cell performance due to high temperature effects, meteoroid erosion and solar radiation damage.

For the system selected, with a cell packing factor of 85%, the foregoing factors result in a need for a minimum solar panel area of approximately 850 ft² deployed and exposed normal to the sun's radiation. In configuring and locating the panels, consideration must be given to their protection during the launch phase. In addition, the long-term reliability of the system should be increased by arranging the panels so that only the minimum required area can be exposed to fulfill the power needs. The individual cells are already interconnected in series-parallel networks which are intended to minimize the effects of local damage on overall performance and reliability.

The factors outlined above, as well as the need for providing flexibility in orientation of the panels, indicate the need for at least doubling the minimum required solar panel area in the space vehicle configuration. This would result in a weight requirement of the order of 850-900 lbs.

3.8.5 Summary

The electrical power system weights are summarized in Table 3-17.

TABLE 3-17
Electrical Weight Summary

	<u>Weight (pounds)</u>
<u>Command Module</u>	(1200)
Batteries	90
Control	390
Distribution	720
<u>Service Module</u>	(1410)
Batteries	850
Control	260
Distribution	300
<u>ESM</u>	(1100)
Control	200
Distribution	900
<u>S-IVB/IU</u>	(1060)
Solar Panels	910
Fittings & Installation	150

3.9 Systems Integration

The purpose of this section is to integrate the requirements of the individual systems, as determined from the preceding systems analyses, into a space vehicle configuration capable of carrying out the mission. The technical decisions and selections indicated in this section are generally the result of a number of iterations carried out during the study, only the more significant ones being documented.

3.9.1 Assignment of Functions

The assignment of functions to individual system modules is shown in Table 3-18 for the following mission periods: (1) parking orbit phase after transposition and docking, (2) injection and (3) interplanetary flight. The functional assignments from prelaunch to insertion into earth orbit and from entry to termination of the mission are similar to those of Apollo.

Those assignments are based on the following partial mission sequence:

- a. Transposition and docking to the interplanetary flight configuration in earth orbit.
- b. Activation and checkout of the ESM.
- c. Injection using the S-IVB/IU.
- d. If necessary because of unacceptable injection, abort to the earth's surface after separation of the CSM, using the SM main propulsion system.
- e. If abort unnecessary, activation of the spent S-IVB stage as living and recreation quarters.
- f. Transfer of crew to ESM for flight and experiments operations with ESM serving as command station, S-IVB serving as living quarters, and CM remaining unoccupied except for emergency purposes until the earth return phase.

TABLE 3-18

Functional Assignments of System Modules

	<u>Parking Orbit Phase</u>	<u>Injection</u>	<u>Interplanetary Flight</u>
Structures			
Meteoroid Shield	CM, SM, ESM	CM, SM, ESM	CM, ESM, S-IVB
Radiation Shield	SM, ESM	SM, ESM	ESM
Navigation Guidance and Control			
Navigation	CM-back-up to ground	CM-back-up to ground	ESM-back-up to ground CM-back-up to ESM
Guidance			
Midcourse ΔV calculation	-	-	ESM-back-up to ground CM-back-up to ESM
Inertial attitude reference	IU	IU-nominal flight CM-abort	ESM-back-up to ground CM-back-up to ESM
Thrust vector steering signals	IU	IU-nominal flight CM-abort	ESM-back-up to ground CM-back-up to ESM
Control			
Stabilization and control	IU	IU-nominal flight CSM-abort	ESM-back-up to ground CM-back-up to ESM
Thrust vector control	IU	IU-nominal flight CSM-abort	ESM-back-up to ground CM-back-up to ESM
Manual control	CM	CM	ESM-back-up to ground CM-back-up to ESM
Antenna pointing	CM	CM	ESM-back-up to ground CM-back-up to ESM
Communications			
Earth-spacecraft			
Voice	CM	CM	ESM-back-up to ground CM-back-up to ESM
Telemetry	CM	CM	ESM-back-up to ground CM-back-up to ESM
Television	-	-	ESM-back-up to ground CM-back-up to ESM

3-142a

TABLE 3-18 (cont'd)

Spacecraft-probe	-	-	-	CSM
Telemetry	-	-	-	CSM
Tracking	-	-	-	
Electrical power				
Energy source	S-IVB (solar panels)- primary CM-back-up	S-IVB (solar panels)- nominal flight CM-abort	S-IVB (solar panels)	S-IVB (solar panels)
Propulsion				
Injection		S-IVB-nominal flight SM-abort	-	
Midcourse correction		-	SM	
Attitude Control	S-IVB	S-IVB	SM	
Environmental Control				
Life support	CM		ESM	
Atmosphere control	CM and ESM	CM and ESM-nominal flight	ESM	
Thermal control	CM and ESM	CM-abort CM and ESM-nominal flight	ESM	
Food management	CM	CM-abort	ESM	
Water management	CM	CM	ESM	
Waste management	CM	CM	S-IVB	
Crew Systems				
Berthing	CM	CM	S-IVB-primary ESM-back-up	
Food preparation	CM	CM	ESM	
Personal hygiene	CM	CM	ESM and S-IVB	
Medical	CM	CM	ESM	
Recreation	-	-	S-IVB	
Experiments	ESM	ESM	ESM	

3.9.2 Specific Configuration

Using the foregoing functional assignments and the results of the earlier systems analysis, the specific configuration to be used for the mission was selected and is shown in Figure 3-3. The injected weight of the proposed vehicle is set forth in detail in Tables 3-19 through 3-23. Significant features of the selected configuration are described in the following paragraphs.

Command Module

The principal changes from the Apollo Block II CM are the increase of heat shield ablative material by 430 lbs. and the addition of 400 lbs. of water to the environmental control system primarily for abort cooling. Although not included in the total weight, it is estimated that 100 lbs. of film data can be returned to earth by the CM.

Service Module

Replacing the SPS by two LM descent engines and using the same propellant for the main engines and the RCS system not only provides increased reliability through redundancy, but also increases the available space in the adapter and affords an estimated weight saving of 1860 lbs. Limiting the ECS function to the near earth phases results in a weight reduction of approximately 300 lbs. through elimination of space radiators, associated system hardware and cryogenics. The plan is to provide coolants to the CM via an ESM umbilical connected in the earth parking orbit phase.

In order to provide the energy necessary for a 60-hr injection abort maneuver, the fuel cells and associated consumables and accessories are replaced by 850 lbs. of silver-zinc secondary batteries with a 35 kWh capability. This will cover the spacecraft needs prior to activation of the solar panels and will also augment the spacecraft power supply during SPS midcourse operations. It should be noted that the CM will continue to have its own power supply for the phases commencing with entry.

Approximately 230 lbs. of bumper shielding is installed to protect the propellant tanks against meteoroid penetration.

ESM

The ESM configuration evolves from an effort to optimize the use of the space enclosed in the Apollo SLA. With a volume

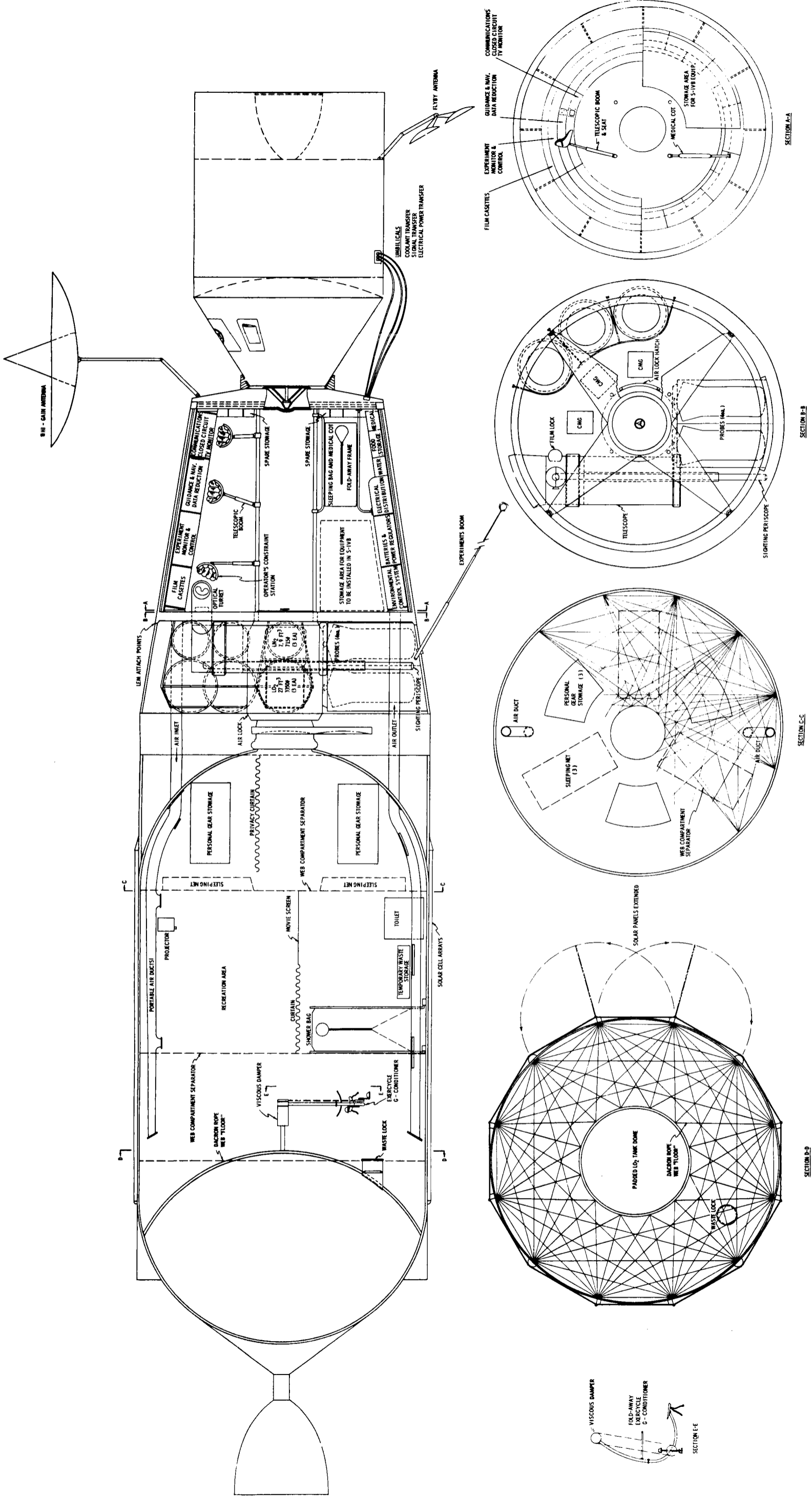

CRUISE CONFIGURATION
FIGURE 3 - 3

TABLE 3-19
Command Module Weight Summary
(pounds)

<u>Weight Empty</u>		9565
Structure	5800	
Navigation, Guidance & Control	850	
Propulsion	300	
Environmental Control	400	
Crew Systems	75	
Communications	320	
Electrical Power	1200	
Earth Landing System	620	
<u>Useful Load</u>		1660
Propulsion	270	
Environmental Control	490	
Crew Systems	900	
<u>Total</u>		11,225

TABLE 3-20
Service Module Weight Summary
(pounds)

<u>Weight Empty</u>		6740
Structure	3640	
Propulsion	1530	
Communications	160	
Electrical Power	1410	
<u>Useful Load</u>		19,500
Propulsion	19,500	
<u>Total</u>		26,240

TABLE 3-21
ESM Weight Summary
(pounds)

<u>Weight Empty</u>		24,410
Structure	12000	
Navigation, Guidance & Control	1160	
Environmental Control	6100	
Crew Systems	1650	
Experiments	1300	
Communications	1100	
Electrical Power	1100	
<u>Useful Load</u>		10,300
Environmental Control	5900	
Crew Systems	1800	
Experiments	2600	
<u>Total</u>		34,710

TABLE 3-22
S-IVB/IU Weight Summary
 (pounds)

<u>Weight Empty</u>		29201
<u>S-IVB</u>		23994
Structure	13171	
Propulsion	6226	
Equipment	4597	
<u>IU</u>		3747
Structure	531	
Equipment	3216	
<u>Modifications</u>		1460
Crew Systems	400	
Electrical Power	1060	
<u>Trapped Fluids</u>		773
<u>Interplanetary Cruise Weight</u>		29974
<u>Vented Residuals and Reserves</u>		4626
<u>Injected Weight</u>		34600

TABLE 3-23
Injected Weight Summary
(pounds)

Command Module	11,225
Service Module	26,240
ESM	34,710
S-IVB/IU	<u>34,600</u>
Injected Weight	106,775
Design Margin	<u>4,225</u>
Allowable Weight	111,000

of some 6,600 ft³ and a lateral surface area of about 1500 ft², the SLA offers a generous space for accommodation of the spacecraft systems. Assignment of principal crew systems functions to the S-IVB enhances the habitability of the overall space vehicle for a long duration mission and also permits the ESM to be devoted almost exclusively to flight operations and experiments.

In conducting the study, a number of ESM configuration problems were identified, the more significant of which, along with their solution, are described below in terms of the spacecraft systems involved.

a. Structures

The structures problem stems from a need for providing a radiation shield with a specific weight of at least 10 lb/ft² and a meteoroid shield with a specific weight of either 5.6 lb/ft² for single sheet or 1.1 lb/ft² for a bumper shield. The meteoroid shield must protect the entire pressurized space of the ESM and the radiation shield, only that part to be used as a radiation shelter. Ideally, these spaces would be identical since this would permit conducting routine flight operations and experiments during solar flare periods when it will be highly desirable to record solar and environmental data.

For protection it was decided to retain the SLA as an integral structure rather than deploy the panels as was indicated in Reference 1. This honeycomb structure with an average of 2.5 lb/ft² can provide adequate meteoroid shielding for the entire volume, but additional steps must be taken to increase the radiation protection to 10.0 lb/ft².

The first step was to limit the pressurized crew compartment to that volume above the LEM attach points and to mount cryo tanks, experiment systems and other elements in the unpressurized volume between it and the S-IVB. This reduces the exposed area of the crew compartment to about 900 ft². About 7,100 lbs. of equipment including ECS radiators, food, and electronic systems are to be located in the crew compartment and, if fairly uniformly distributed on the outer surface, can contribute about 4 lb/ft² of radiation protection. The addition of an inner honeycomb pressure bulkhead and insulation at 3.5 lb/ft² will bring the total radiation shield over the crew compartment to the required 10 lb/ft².

The crew compartment structure, then, consists of the outer honeycomb which bears the major loads and to the inner

surface of which is attached the ECS radiator loops, a layer of insulation and an inner honeycomb pressure compartment to which is mounted the equipment. The total structure including airlocks and equipment mounting provisions is estimated at 12000 lbs.

b. Environmental Control

The configuration selected for the ESM environmental control system is described in detail in Section 3.4. The system provides environmental control for the ESM from injection to entry and for the S-IVB from the time of activation of the spent stage until entry. In addition, it supports the CM ECS system during the interplanetary flight phase.

As noted above, installation of the radiators integral with the conical structure surrounding the SLA contributes to protection against solar cosmic radiation.

c. Crew Systems

Having made the S-IVB available for living and recreation space, the ESM crew systems requirements are reduced essentially to providing suitable "furniture" for the use of the crew in the operation of experiments and spacecraft equipment and for accommodations necessary during periods when the ESM is used as a storm shelter. Under the most severe conditions, it is expected that the entire crew will be in the ESM with one man at the command station, another conducting experiments, and the third sleeping, eating or engaged in personal hygiene. As can be seen in Figure 3-3, the decision was made to group the equipment of the experiments and operations stations and to provide "seats" with six degrees of freedom. Using these "seats" the crew can more effectively operate equipment and monitor consoles since their individual positions relative to the hardware can be maintained.

A single sleeping bag is provided in the ESM to accommodate the crew member who is not required for operational tasks. The bag is separated from the operating stations and can be used as a medical cot which can be kept under observation and tended by crewmen at the operating stations. Fecal canisters and receptacle assemblies are provided for routine use in the ESM and are available during solar flare periods. Similarly, the ESM contains the food preparation equipment and houses the food stores.

d. Experiments

In selecting the experiments to be conducted, it was decided to include the telescope system and Interplanetary

Environments Monitor package and to carry as many probes as weight and space considerations would permit. With some 1300 lbs. required for the first two experiments, the spacecraft can accommodate four probes, resulting in a total experiments hardware payload of about 3500 lbs. In addition, approximately 400 lbs. of film and tape can be carried.

The probes and telescope are installed in the unpressurized space between the aft bulkhead of the ESM cabin space and the S-IVB. The telescope system is mounted integral with the ESM on the bulkhead, with the eye pieces and camera on the cabin side of the bulkhead where they are readily accessible to the crew. Except for minor adjustments the telescope axis is fixed with respect to the ESM, and hence, the spacecraft must be pointed for telescope operations. The disadvantages of such a requirement, however, are offset by (1) the rigidity of the mounting, (2) the absence of an independent, remotely controlled telescope pointing system, (3) the simplicity of the thermal control technique, and (4) the protection afforded against meteoroid penetration and erosion.

Each of the probes is stored in a sterilized container which remains sealed until launch. Probe maintenance during the mission is not planned although checkout equipment is provided with the display board mounted in the airlock. After each probe is launched, its performance through injection burnout can be monitored visually using a periscope mounted parallel to the telescope system.

The Interplanetary Environments Monitor package is deployed from the unpressurized portion of the ESM on a telescopic boom which is gimbal-mounted to permit orientation of the boom axis.

e. Communications

As can be seen in Figure 3-3 and as described in Section 3.7.6, the antenna problem is solved by carrying the 13-foot antenna inside the narrow end of the ESM, just outside the docking structure. This affords protection during the launch phase, and the plan is to jettison 4.9 feet of the ESM during the transposition maneuver in earth orbit. This exposes the antenna which can be erected in the cruise position prior to docking; it also reduces the injected weight by 530 lbs.

S-IVB

Prompted by the analysis conducted in Reference 1, initial consideration was given to installation of the solar panels on the underside of the SLA panels and of erecting them

on the S-IVB/IU. As noted earlier, the structural analysis revealed that the SLA panel would be useful as shielding in the ESM structure. The decision to keep the SLA panels integral with the ESM structure was based on that consideration and on the desirability of augmenting the meteoroid protection afforded by the S-IVB skin by attaching the solar panels to the S-IVB. In addition, installation of the panels on the S-IVB tends to minimize their interference with experiments and on-board navigation and sightings.

Weighing about 900 lbs. and being approximately 0.6 mm in thickness, the solar panels provide the bumper shield necessary to protect the spent stage against meteoroids. As a result, the S-IVB hydrogen tank can be used as a living and recreation space throughout the interplanetary flight except during periods of solar flare activity.

The S-IVB internal configuration shown in Figure 3-3 represents a suggested approach to taking advantage of the large volume available. The equipment and fittings used to activate the S-IVB and to make it habitable weigh approximately 1,500 lbs. and are stored in the ESM until after injection. The use of curtains and cord webbing afford compartmentation which should enhance the individual habitability of the spent stage.

3.9.3 System Evaluation

As noted earlier, the selected configuration results from a number of iterations conducted during the study. While it is considered to represent a generally suitable and feasible system for a Venus flyby mission in 1973, additional iterations are necessary to arrive at a configuration which more closely approaches the optimum. In particular, since much of the system sizing is based on the post-injection abort requirements, the first iteration should be directed at a closer examination of this phase of the mission.

By selecting a 30-day launch period, the injected weight of the spacecraft is limited to 111,000 lbs. (Section 2.1). Since the selected configuration entails an injected weight of 106,775 lbs., a margin of little more than 4,000 lbs. is available for possible increases in weight necessary (1) to provide the reliability required for a 400-day mission, (2) to incorporate changes in requirements brought about by new solar system data and by the results of longer duration flights in the AAP, and (3) to reflect more precise knowledge of the requirements of systems which must undergo development. On the other hand, the weight margin could be increased somewhat by a different selection of experiments hardware. As an example, elimination of two of the Venus lander probes, while reducing the scientific value of the mission, would make another thousand pounds available.

The factors which may generate weight penalties are discussed in the following paragraphs.

Reliability

Since the 400-day system is based on maximum utilization of Apollo system hardware, which has been designed for much shorter missions, it cannot be readily concluded that it has the inherent reliability required for crew safety and mission success on the longer mission. In configuring the system the approach taken has been to enhance overall reliability by providing system and subsystem redundancy wherever possible. The provision of spare parts was considered and generally rejected on the basis that appreciable operating time of the system is necessary to arrive at a statistically meaningful selection of spares. It is considered preferable to increase the effort being applied to the design of components which will have the reliability required for the long mission. While such an approach will entail additional time and dollar costs and may result in increased weight penalties, it is considered to represent a favorable trade-off against the weight allowance necessary to carry spare parts and the cost of an effort to determine spares requirements. It is obvious that a flight test program may uncover system flaws, the solutions to which are more economically and effectively achieved by maintenance rather than redesign. However, the maintenance technique should be reserved for those contingencies rather than established as an initial ground rule.

Environmental and Manned Space Flight Data

In the time period leading to the mission, it can be expected that additional data on the natural environments will be obtained. In particular, other space programs should provide a clearer definition of the meteoroid and radiation hazards to which manned spacecraft will be subjected on an interplanetary flight. Hopefully, the data will show that the structural design is conservative in this regard, but it is possible that some portion of the weight margin will have to be applied to increase the shielding.

Similarly, additional experience with increasingly longer manned space flights will yield important information on man's capabilities and requirements. If it should be shown that an artificial-g environment is necessary for missions of the order of a year in duration, then the configuration would have to undergo significant change. On the other hand, if zero-g conditions turn out to be acceptable, the spacecraft with its generous allowance of personnel space represents a good baseline configuration for long duration missions.

3.10 System Development

While the configuration is based on maximum utilization of Apollo system hardware, some subsystems will require further development before the final configuration is selected. The study incorporates current best estimates of the capabilities and requirements of such systems, using conservative values where appropriate; but the performance margin of the system cannot be determined until more precise knowledge is obtained through continued development effort.

Among the principal subsystems and components in the foregoing category are:

- Control moment gyro system
- Two-gas atmosphere control system
- Molecular sieve system
- Long-life thermal coatings
- Spacecraft/module sealing systems
- Long-life, leak-proof fluid plumbing systems
- Long-life cryogenic storage systems
- Long-life engine nozzles
- Long-life, high-power RF power amplifiers
- High-power, lightweight solar panels
- Long-life, zero-g lubricants
- Self-sealing structures and sealing techniques

In addition, there is a need for investigating the ability of the systems of a module like the CM to remain essentially shutdown for a period of a year and then to be reactivated in space. The results of such investigation may dictate requirements for further development effort.

The purpose of this section is to look briefly at a possible development program with emphasis on flight test requirements, first, to evaluate whether such requirements have an effect on the design and, second, to evaluate the relationships between such a program and the precursor AAP.

3.10.1 Flight Test Profiles

An objective of the flight test program is to simulate as closely as possible the planetary mission environment. The system and environment characteristics which should be considered in selecting test profiles include: meteoroids, radiation, aerodynamics, gravity gradients, communications, thermal radiation and experiments.

The Venus flyby trajectory which goes as close as 0.7 AU and as far as 1.2 AU from the sun experiences largely cometary meteoroid impacts. Our present knowledge of these meteoroids does not discriminate any difference due to solar distances of this order so testing in the vicinity of the earth is a reasonable simulation. Near the earth, shielding by the earth and focusing by the earth tend to balance so that there is little preference for a low or high earth orbital test.

In this connection it should be pointed out that a year's test of a space vehicle protected against meteoroid damage, but not equipped with special sensors, would not give high confidence in the protection provided. It is important, therefore, to fly a Pegasus-like satellite along the approximate interplanetary trajectory to confirm our knowledge of the meteoroid environment, to discriminate the mass or energy of the particles and to accumulate enough impacts and penetrations to be statistically useful in evaluating space vehicle design. Such a test would be far more significant to the program than an actual vehicle flight as far as the meteoroid environment is concerned.

As indicated in Section 3.1.2, solar cosmic radiation presents the major radiation problems for a Venus flyby mission. Recognizing that uncertainties associated with the effect of distance on solar radiation flux are generally less than the uncertainties in the size of a large flare and in the long duration biological effects, it appears that earth orbital flights which avoid the radiation belts are a reasonable simulation of this environment. The belts can be avoided at low altitude (under 400 miles) or at high altitude (above 20,000 miles), and either is then a suitable simulation. As with meteoroids, a more fundamental interplanetary radiation experiment would be of more value than a vehicle test in reducing the uncertainties and increasing the confidence in space vehicle design.

The only aerodynamic effect in the Venus flyby is brought about by the plasma of solar protons emanating from the sun -- the solar wind. Depending on vehicle orientation and the location of the Newtonian center-of-pressure with respect to the vehicle center-of-gravity, this will produce small torques and slow precessions of the control moment gyro system. The precession must be unloaded periodically by use of the vehicle's reaction control system, and it is one of the factors influencing the RCS fuel requirements. If the vehicle were to be tested at low altitudes around the earth, the earth's atmosphere, tenuous as it is, would create aerodynamic forces and torques far exceeding those of the solar wind; and control system requirements would not be realistically simulated. For this reason an altitude above 20,000 miles (to avoid trapped radiation) appears to be the best for aerodynamic simulation.

Gravity gradients near the planets will also place significant torques on a 108 foot long vehicle. For the brief Venus encounter the control system requirements would be negligible; but, for a long duration test at low earth altitudes, this effect (like the aerodynamic effect) would completely outweigh other control system requirements. Because this effect decreases with the cube of the distance from the center of the planet, the high earth orbit would again be the preferred test environment.

In the Venus flyby, except for brief periods in parking orbit and at entry, the space vehicle is in continuous line-of-sight (and communications) with the deep-space facilities. Because the sun-earth-spacecraft angle never gets less than 27° , interruption by solar noise at the ground-based antennas is highly improbable. In spite of the delay times involved, this continuous communication capability can be of considerable value to the mission by aiding the crew in system monitoring and by permitting near real time participation of the ground in the experiment routines. The high earth orbit provides a similar continuous capability of communication; and, with the exception of the distances and angular antenna motions which cannot be simulated short of the flight itself, provides a good test of the system operational procedures. In order to avoid conflicting requirements of concurrent space operations, the 30' and 85' stations of the manned space flight network could be used to augment the deep space network and should be capable of similar performance at these altitudes.

The vehicle depends for temperature control primarily on a passive thermal balance between the sun's incident thermal radiation and that re-radiated to space. The sun's radiation near the Venus encounter is about double that at the earth and falls to about 70% at the aphelion of the return trajectory. This variation is countered by varying the inclination of the vehicle axis to the sun line and by varying the absorptivity and emissivity characteristics of the vehicle surface around its circumference. A near earth orbit will not be able to simulate the extremes of the planetary flyby environment, but it will be able to calibrate the system near the midpoint and determine the effectiveness of the passive control and active augmentation systems. In low earth orbit an apparent diameter of about 160° or nearly half the sky will be occupied by the earth and the basic thermal balance disturbed by its radiation. In addition, unless a sun synchronous orbit is achieved at high inclination angle, the vehicle will be in darkness almost half of each orbit. In a 20,000 mile orbit the earth's apparent diameter is about 17° and its radiation should not have an overriding effect on the thermal balance. If flown in the plane of the ecliptic, a 20,000 mile orbit will be in darkness about one hour a day; if inclined to the ecliptic, the daily period of darkness can be limited to 17-day periods twice a year. Higher altitudes will result in shorter occultations. The simulation of thermal environment definitely favors a high altitude orbit for earth testing.

The Venus flyby experiments include: probes of the planet's atmosphere and surface, multispectral mapping of the surface and clouds, solar and galactic system observations during transit and monitoring of the interplanetary environment. The probe trajectories are established approaching the planet by a retromaneuver of a few hundred fps. They enter the atmosphere at about 36,000 fps, and data is collected by a communication link to the space vehicle during the flyby. A good near-earth simulation would require a highly elliptic trajectory having a perigee altitude of about 3,000 miles. Probes separated shortly after apogee would enter the earth's atmosphere at about 34,000 fps and the Venus flyby communication and tracking problem could be closely simulated. Multispectral mapping of the earth could take place in the same trajectory. This trajectory would have to be flown as a special test because the vehicle propulsion requirements are somewhat different from those of a high earth orbit. The in-transit galactic and solar system observations can be directly simulated in high earth orbit with long continuous periods of observation and data taking possible. The interplanetary environment monitoring equipment could also be exercised in such a mission, the data acquired having significant scientific value.

The high earth orbit appears on all counts to have the near ideal environment for testing the Venus flyby vehicle. The only disadvantage over a low earth orbit is the dependence on a greater retro-velocity and a longer time for emergency entry and recovery. Fortunately, the propulsion requirements for high altitude orbits are almost identical in summation, though different in function, to the Venus flyby requirements.

3.10.2 High Altitude Test Mission

The test mission selected as an example has a circular orbit with an altitude of about 25,000 miles, an inclination to the equator of $28\ 1/2^\circ$, an inclination to the ecliptic of 10° and an orbital period of about $1\ 1/2$ days. The space vehicle's latitude shifts from north to south, and its longitude moves westward around the earth. The vehicle is occulted from the sun by the earth for a half-hour or less every day and a half during a twenty day period occurring twice a year. Twenty-five thousand miles was the selected altitude in order to be clear of trapped electrons at synchronous altitudes.

Launch occurs any day of the year into a low altitude parking orbit during which transposition and docking are achieved and the ESM prepared for the mission. Injection into a nine hour transfer ellipse requires about 8,500 fps; circularization requires another 4,800 fps. The total of 13,300 fps required of the S-IVB is greater than the 12,900 fps design criteria for the Venus flyby mission. The probes, however, cannot be used on the high altitude test mission, and the 2,200 lbs. made available by their removal will permit this velocity to be achieved when using a 90° launch azimuth.

Once in orbit the spent stage is activated for the mission and the cruise configuration and attitude, normal to the ecliptic plane, established. The optical line-of-sight can be directed at the sun or the vehicle tilted 10° and rolled with a one day period to point at the earth.

After a year's flight, or earlier, if required, the CSM separates and retrofires about 5,000 fps for entry. Table 3-24 compares the high altitude CSM functional propellant requirements to those previously estimated for Venus flyby and abort. If the basic attitude control requirements are the same as for Venus flyby, there is a 4,000 lb. propellant margin available for the high altitude test profile. This is less than the 100% propellant redundancy provided for the Venus mission; and, in the event of loss of one-half of the propellant capability, the vehicle would be without retrofire capability and would require a rescue operation. Unless compounded by multiple failures, this rescue need not be time

TABLE 3-24
CSM Propellant Requirements
(in pounds)

	Venus Flyby	Venus Abort	High Orbit Test
Attitude Control	3,000	200	3,000
Midcourse Corrections	6,500	600	--
Abort	--	18,200	--
Retrofire	--	--	12,000
Margin	9,500	--	4,000
Total	19,000	19,000	19,000

critical, and one could consider that by scheduling enough overlapping test missions a self-rescue capability could be provided. This rescue capability is a factor in the layout of the test program.

As previously noted, the solar and galactic system observations can be carried out in the high altitude test mission as well as the Venus flyby; and multispectral mapping of the earth can replace the mapping of Venus. With the high data rate available during the test mission, one could consider almost continuous periods of high resolution video coverage of the illuminated portions of the earth. Resolution sufficient for real time weather monitoring should clearly be possible. In high altitude orbit the spacecraft should be able to fulfill many future space station objectives, and a continuous operation uninterrupted by the start of the Venus flyby is probably indicated.

3.10.3 Development Steps

Three steps or phases in the development and flight test of the system have been chosen for reasons which will become apparent in the following discussion. These are shown by schematic drawings of the flight configuration in Figure 3-4.

The Saturn/Apollo launch configuration is maintained throughout the program. Phase A has as its objective the flight evaluation of the spent S-IVB stage as a habitable volume for long duration space flight. There is an Airlock which connects the S-IVB tank to the CSM in the docked configuration and which also permits extra-vehicular activity. This is essentially an early version of the AAP-209 mission configuration, although the current 209 has additional experiment objectives and a flight duration extension of up to 28 days.

Phase B has as its primary objective the evaluation of the systems and subsystems of the S-IVB and ESM and also the crew for a flight duration of one year. The systems have technology for planetary space flight as described in this section and, except for those changes which result from the flight evaluation, are in the final configuration. Flyby mission equipment (probes and communications) are not included. The CSM for the 1970-71 time frame is called here "Block III". It is the "general purpose" XCSM of extended capabilities which will probably be available to the AAP for extended duration flight in both lunar and earth orbital missions. For Phase B application it needs a long duration passive storage capability, restartable power supply and enough propellants to return from high altitude orbit. Its use here is in anticipation of some economy in the broader view of Apollo Applications. Although the weights of both the "Block III" CSM and ESM will

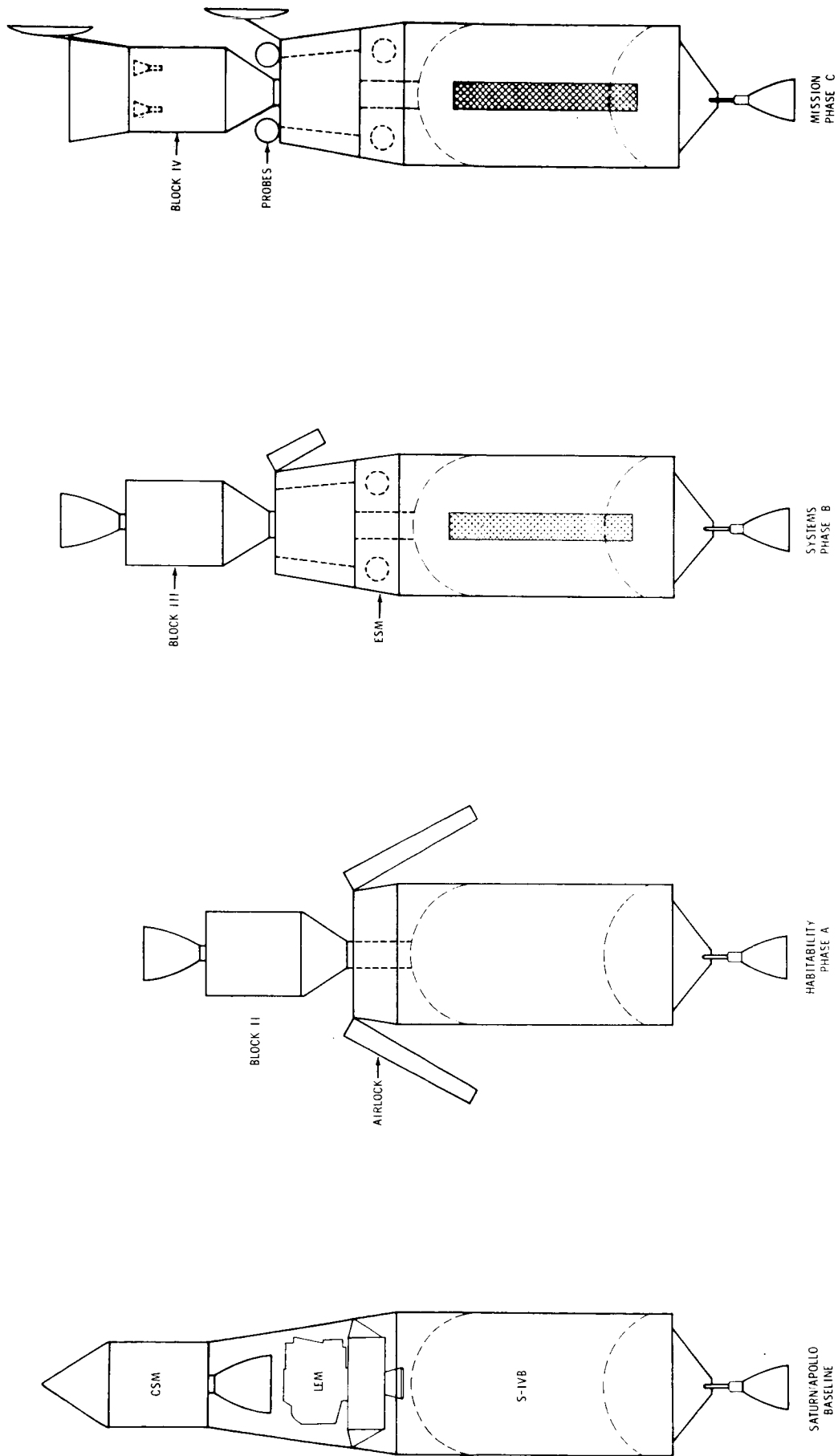

Figure 3-4 - Development Steps

be such that the operation could be conducted at low altitude on a dual Saturn IB mission, the high altitude flight test is greatly preferred in Phase B for all the reasons cited in Section 3.10.1.

The configuration for Phase C includes a "Block IV" CSM and the flyby mission probes and communications. The "Block IV" has the high speed entry capability, the propulsion, the environmental control and the communications optimized for the Venus flyby mission. The planetary antenna and flyby probes are added to the ESM in adapter volume made available by the removal of the SPS engine.

It should be noted that the use of a "general purpose Block III" CSM in Phase B dictates a change in the ESM configuration in order to accommodate the intrusion of the SPS engine into the SLA volume. A way to solve this is to locate the probes and large communications antenna in this volume and decrease the volume of the ESM. This will result in reduced structural weight for both equipment support and radiation protection while still providing more than ample crew operating space. This change was not reiterated to the weight and configurations of Section 3.9 because it has relatively little impact on the feasibility of the mission when used as guidance for AAP system technology.

4.0 Summary and Conclusions

The objective of this analysis of a manned Venus flyby system has been to assemble technical data for the possible guidance of the Apollo Applications Program. The AAP with no single clear cut goal of its own must continually make estimates of the characteristics and needs of the various programs which might follow it in order to choose the most effective development paths. For instance, Apollo subsystem technologies, such as fuel cell electrical power, can be extended to permit achievement of a year's orbital flight with six to eight resupply missions; but a look at future space flight requirements, such as Venus missions, shows that a more foresighted technology would be to use solar cell power.

The principal study results are contained in Section 3.0 which estimates the various subsystem technologies and characteristics which are applicable to long duration space flight, but there are a few from the mission analysis which are worth mentioning.

From Mission Analysis:

1. A mission duration of 400 days is required to give a thirty day launch window to Venus in 1973. The standard Saturn V injection capability for the same launch window is 111,000 lbs.
2. A module like the CSM, assumed at the start of the study, has been confirmed as a requirement for the following reasons:
 - a. An earth return velocity of 45,000 fps is not too high to use atmospheric braking.
 - b. The launch escape problem is similar to Apollo.
 - c. An assumed post injection abort capability requires a rapid (45 min.) decision and permits a return within the envelope of Apollo propulsion, duration and entry capabilities. Transposition, docking and checkout in earth orbit is a reasonable solution to the limited post injection abort time available.

3. Launch azimuths, altitudes, parking orbits and other near earth parameters are within the envelope of Apollo capabilities.
4. Other parameters such as communication distances, experiment sight lines and flyby geometry are peculiar to the Venus mission and have little impact on the AAP long duration objective.

From System Analysis

1. Structures - Venus flyby and long duration flight both require micrometeoroid protection. About 6 lb/ft² of structure are required for a vehicle with the large area suggested here.
2. Structures - Venus flyby and long duration flight both will require radiation protection of the crew. To protect against the worst year which has been measured to date (1959) will require shielding of about 10 lb/ft². In order to provide this within reasonable weight limits, the crew volume so protected must be reduced, non-sensitive equipment must be located so that its mass can contribute to crew protection, and structural elements provided for other functions must be placed so as to serve as shielding also.
3. Navigation, Guidance and Control - Attitude control through the use of reaction control alone places large requirements for consumables on long duration flight. The combination of momentum exchange and reaction control, such as is used in unmanned spacecraft, is a better solution. Control moment gyros were selected for flexibility over other momentum exchange devices.
4. Propulsion - Under the umbrella of an overriding requirement for Venus flyby post-injection abort, a redundant, cross connected, storable liquid fuel propulsion and reaction control system was selected in this study. This is not felt to be conclusive with respect to long duration flight and more study is warranted.
5. Environmental Control - Passive thermal control, or the control of crew and equipment temperatures with net active heating or cooling near zero is a long duration requirement. The approach of varying the inclination of the vehicle to the solar vector is suggested to account for the degradation of surface coatings and the increase in absorptivity with time.

6. Environmental Control - The three-man, zero-g environment was an assumption of this study and no conclusion should be drawn regarding its physiological or psychological adequacy.
7. Environmental Control - A semi-closed ecological system recycling water but not carbon dioxide was selected. Even with modest leakage rates and cryogenic storage of oxygen, the system is heavier than might be desired. Additional recycling will tend to further complicate an already complex and difficult technology. Reducing the leakage rate by reducing the number and use of airlocks and hatches is an apparent necessity for long duration flight.
8. Environmental Control - A two-gas atmosphere was an assumed rather than concluded characteristic of the environmental control system.
9. Crew Systems - Use of the S-IVB as a living and recreation space not only enhances habitability of the space vehicle for the long mission, but also permits optimization of the ESM space for experiments and flight operations.
10. Experiments - The probes and flyby experiments are peculiar to the Venus mission, but the telescope and interplanetary data systems are probably applicable to long duration flight also. Location within the vehicle's outer envelope permits better environmental protection and provides better data access.
11. Communications - The system described is peculiar to the Venus flyby mission. For long duration, it should only be noted that the bit content (10^{10} to 10^{12}) of filmed experiments is the largest communication requirement. It should also be noted that AAP might reasonably experiment with larger antenna configurations.
12. Electrical Power - Solar cell electrical power is a clear choice for both flyby and long duration systems. Non-articulating, fixed arrays can be had at weights which permit attitude flexibility and considerable redundancy.

13. System Integration - Solar cell arrays on the outside of the S-IVB cylindrical section make an effective use of the large area while at the same time providing a needed micrometeoroid bumper for the habitable volume.
14. System Development - The high altitude earth orbit (>20,000 miles) is on almost all counts the best place to test planetary or long duration manned systems. The reasons can be summarized as follows:
 - a. High altitude most closely simulates the radiation, meteoroid, thermal, aerodynamic, gravity gradient and communications environment.
 - b. The launch vehicle high altitude injection velocity requirements are almost identical to those of the Venus flyby. If a parking orbit simulation is included, a "third burn" launch vehicle will be required.
 - c. The high altitude CSM retrofire velocity requirements are slightly less than the Venus flyby CSM abort velocity requirements.
15. System Development - The investigation and development of spent stage habitability is a logical and economical "Phase A" for both planetary and long duration programs.

The systems integration and the reiteration and balancing of systems for Venus flyby was stopped at a point where the feasibility of such a manned Venus flyby was considered to be demonstrated to the degree necessary to reasonably apply its technical conclusions to the guidance of the AAP subsystem selections.

M. S. Feldman

L. A. Ferrara

P. L. Havenstein

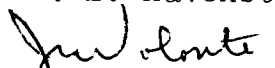
J. E. Volonte

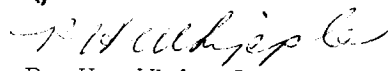
P. H. Whipple

1021-MSF
1022-LAF
1021-PLH-bap
1014-JEV
1021-PHW

APPENDIX I

Saturn V Payload Capability

A current Saturn V payload curve for the earlier Apollo missions, taken from Reference 30, is shown in Figure I-1. To obtain an estimate of this capability in the time period of the Venus mission, use is made of expected Saturn V performance for the later Apollo missions to arrive at an estimated payload curve that would be expected to apply in the early 1970's. No uprating was considered in arriving at this estimate.

Data from Reference 31 indicate that a payload capability of 103,586 lbs. can be expected for lunar mission AS-506. This corresponds to a total injected weight of about 139,400 lbs. and a total weight in earth parking orbit of about 296,600 lbs. This payload for a lunar mission defines a point on the estimated curve for later Apollo missions, also shown in Figure I-1. By using these AS-506 payload data as a base, other points on this payload curve can be determined. Data obtained in this manner are consistent with the Saturn V performance data used for Voyager planning purposes for a 1973 Mars mission.

In applying this estimated payload curve to the Venus mission, corrections must be made for weight added to the S-IVB stage or jettisoned in earth orbit.

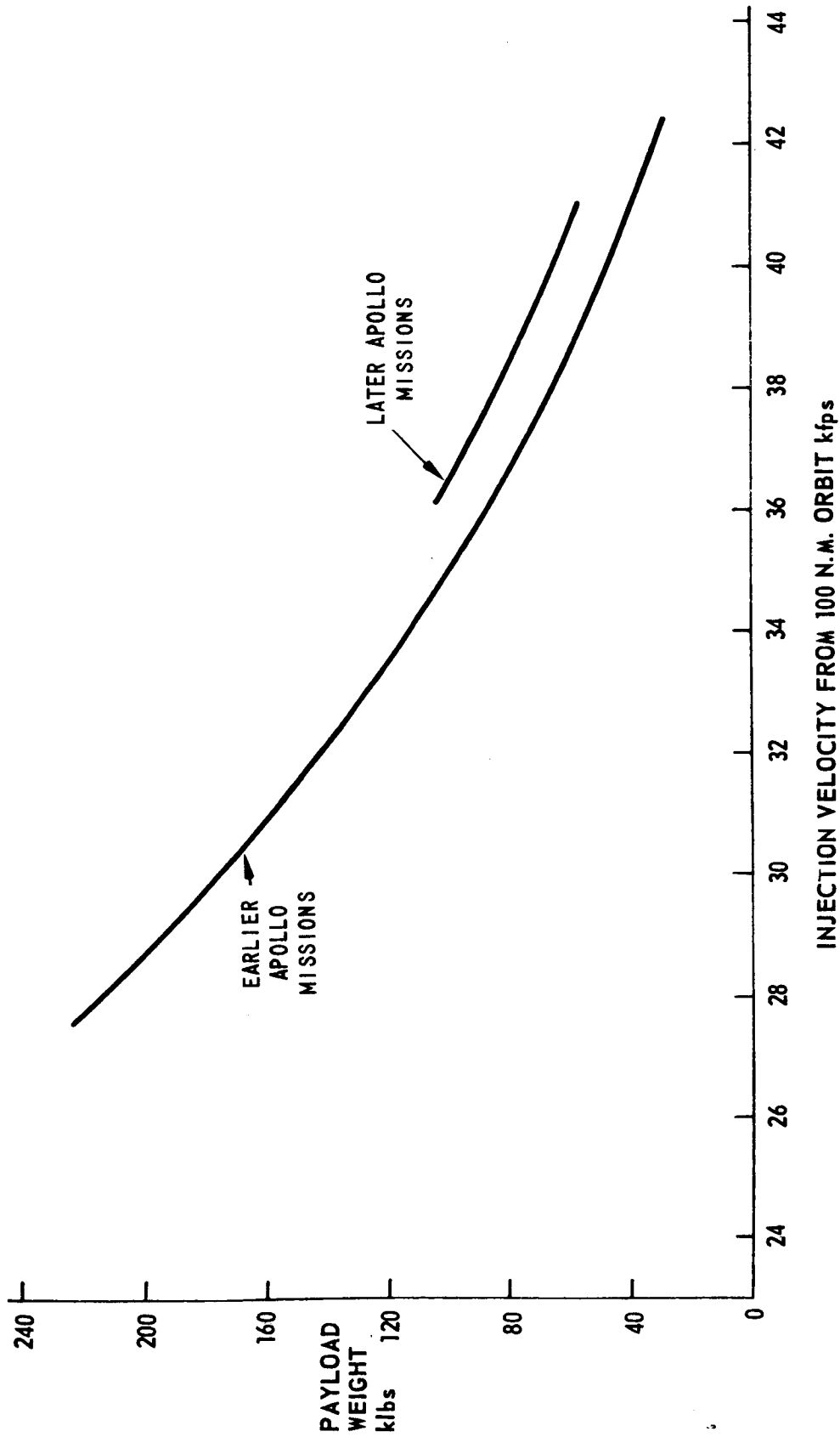

FIG. I-1 SATURN V PAYLOAD CAPABILITY

APPENDIX II

Venus Flyby Mission Trajectory

- 1.0 General
- 1.1 Mission Trajectory Selection
- 2.0 Earth Departure Trajectory
 - 2.1 Launch and Parking Orbit
 - 2.2 Earth Departure Hyperbola
 - 2.3 Abort
- 3.0 Outbound Leg
- 4.0 Venus Encounter
- 5.0 Inbound Leg
- 6.0 Earth Arrival

BELLCOMM, INC.

1.0 General

Favorable launch opportunities for Venus missions occur once every synodic period, corresponding to earth-Venus inferior conjunctions that occur every 19.2 months. For the Jan. 23, 1974 inferior conjunction, launch from earth occurs in late 1973, Venus flyby occurs early in 1974 after the conjunction, and return to earth is in late 1974. For each day in the 1973 launch opportunity, several launch trajectories may be possible. These correspond to missions having different combinations of mission duration, injection velocity, Venus approach distance and other factors. By assigning approximate values to some of the characteristics, such as Venus approach distance, and placing bounds on others, such as injection velocity and mission duration, the number of possible missions is markedly decreased and a mission definition can be made.

The complete trajectory for a free return, round trip Venus flyby mission can be analyzed by considering five conic segments patched together. These segments are planet-centered hyperbolas that describe the spacecraft trajectory in the near planet regions and sun-centered elliptical trajectories that describe the spacecraft trajectory during the greatest part of the mission when the spacecraft is well outside the planets' spheres of influence. While this is an approximate technique, it is sufficient for planning purposes.

The basic element of the outbound trajectory is a heliocentric elliptical segment that extends from the position of earth on the departure date to the position of Venus on the arrival date. The earth departure hyperbolic trajectory is designed to connect the earth parking orbit to the interplanetary trajectory. Injection from the earth parking orbit into the perigee of this hyperbolic trajectory is the only major propulsive event of the mission.

The heliocentric elliptical path for the return trip from Venus is not part of the heliocentric ellipse that contains the outbound leg. A Venus-centered hyperbolic trajectory is used to patch these two segments together. This is the flyby portion of the trajectory and is on the sunlight side of Venus. For specified Venus approach and departure trajectories, the periapsis altitude is varied to shape the hyperbolic trajectory to provide the required change in direction to the spacecraft. Conversely, for a specified periapsis altitude, the heliocentric segments are in large part defined. Near the completion

of the round trip trajectory, an earth-centered hyperbolic trajectory is patched onto the return heliocentric leg. The perigee altitude of this final segment is low enough to bring the spacecraft within the atmosphere to achieve entry with aerodynamic braking.

1.1 Mission Trajectory Selection

For the missions within the launch period chosen in Section 2.0, Mission Analysis, the dates of Venus flyby vary from February 28 to March 6, 1974. A mission with a Venus flyby date of March 3, 1974, was selected for further study for two reasons. This mission selection is compatible with the mission objectives as stated in Section 2.0, and this particular Venus flyby date is the only one in the above range of flyby dates for which computed data were available in Reference 2. Further investigation of this selected trajectory yields the following characteristics.

Launch Date	October 31, 1973
Venus Flyby Date	March 3, 1974
Earth Return Date	December 1, 1974
Mission Duration	396 days
Outbound Leg Duration	123 days
Inbound Leg Duration	273 days
Venus Periapsis Altitude	1 Venusian radius (about 3,340 n.m.)
Injection Velocity from Earth Parking Orbit	12,900 fps
Earth Entry Velocity	44,800 fps

All but the last two parameters can be obtained from Reference 2, and the injection and entry velocities are obtained from trajectory calculations such as those explained in the following sections of this Appendix.

2.0 Earth Departure Trajectory

The discussion of the earth departure trajectory can be conveniently separated into two parts -- a launch and parking orbit section and a departure hyperbola section. The launch and parking orbit section will discuss the trajectory elements of the launch, injection, and parking orbit and the launch window determination. The characteristics of the departure hyperbola will be discussed in that section. In addition, a brief section on abort possibilities is included.

2.1 Launch and Parking Orbit

2.1.1 Determination of Basic Trajectory Elements

The near-earth portion of the trajectory is shown in Figure II-1. It is helpful to visualize a non-rotating sphere about the earth at parking orbit altitude with the earth rotating within the sphere. When the launch site passes through the plane of the parking orbit, point A, during its daily rotation about the earth's axis, launch occurs with the subsequent insertion into the earth parking orbit at point B. After an interval of coasting in the parking orbit, injection occurs at the perigee of the earth departure hyperbola, point C. As the spacecraft distance from earth becomes large, the trajectory approaches its asymptote which is parallel to the V_{∞} vector shown directed from the earth's center. Also, the spacecraft velocity will approach the magnitude of the V_{∞} vector.

The V_{∞} vector is the basic element in the design of the earth departure trajectory and is obtained in the following manner. By specifying the earth departure date and the Venus arrival date, the interplanetary trajectory can be defined. This is an elliptical trajectory segment that would extend from the earth position at departure to the Venus position at flyby if the earth and Venus were massless, i.e., if the sun's gravitational field were the only one to consider. By computing the heliocentric velocity vector at the earth departure position and translating it to an earth-centered non-rotating coordinate system, the V_{∞} vector is obtained. The V_{∞} vector defines the direction of the asymptote to the earth departure hyperbolic trajectory and the spacecraft's asymptotic velocity.

With the V_{∞} vector defined and a parking orbit altitude specified, the angle $C_{I_{\infty}}$, the locus of the injection points C on the non-rotating sphere, the perigee velocity, and the ΔV added by the injection burn can be determined. The angle $C_{I_{\infty}}$ is the angle swept out by the spacecraft during its transit of the earth departure hyperbola. The orientation of the parking orbit determines the launch azimuth and time of launch.

As illustrated in Reference 3, the displacement of the actual trajectory asymptote from the V_{∞} vector is unimportant

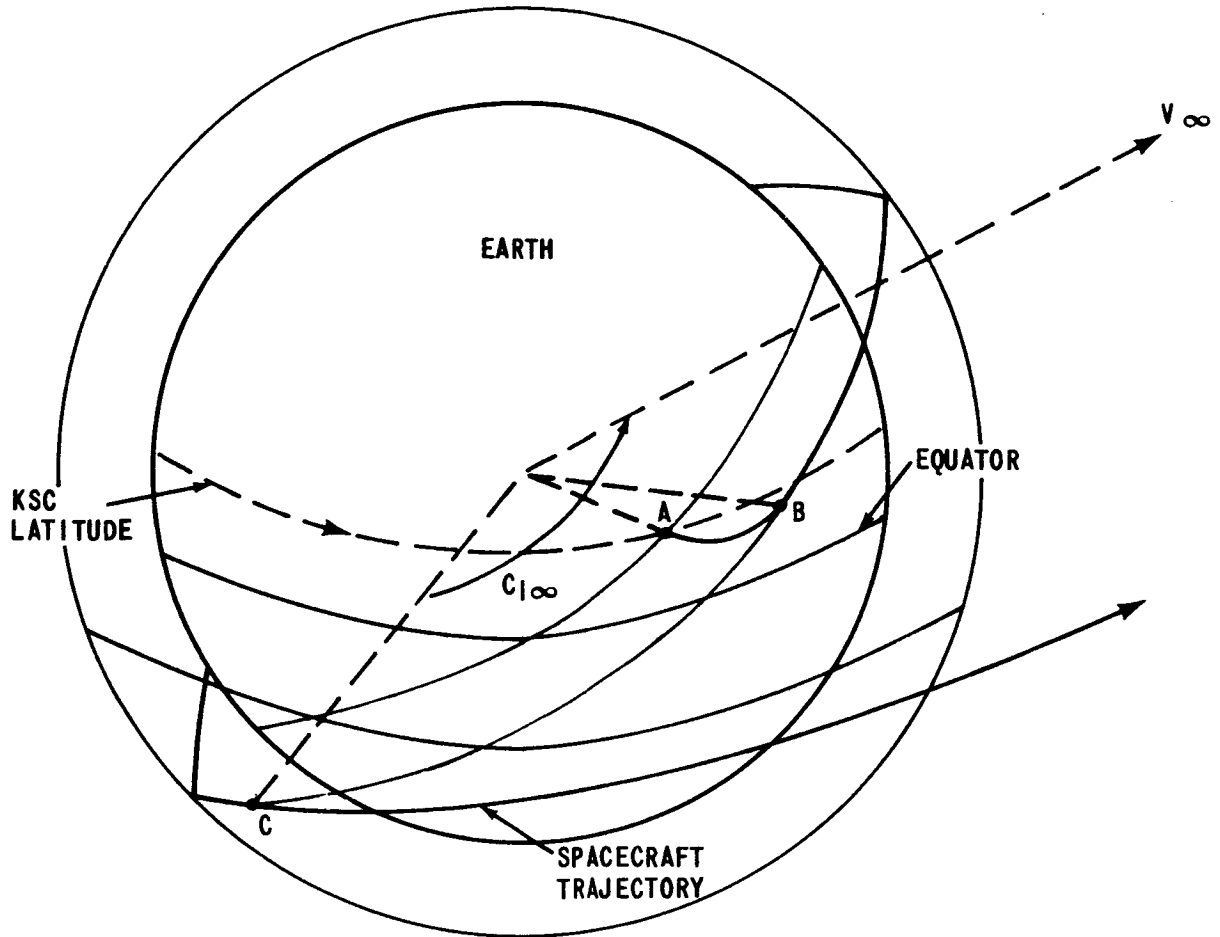

EARTH DEPARTURE TRAJECTORY
FIG. 11 - 1

since at large distances from the earth they are indistinguishable. Either of the earth departure trajectories shown in Figure II-2 is satisfactory as are all others that have the specified asymptotic velocity direction and magnitude, regardless of the actual position near earth. This results in a locus of many injection points C, corresponding to variable parking orbit inclinations, launch azimuths and launch times, permitting the definition of a launch window.

The basic trajectory elements of the departure geometry are shown in Figure II-3. For the mission with earth departure date on October 31, 1973, and Venus flyby on March 3, 1974, the V_{∞} vector can be found in Reference 2 to be the following:

$$\begin{aligned} \underline{V_{\infty}} \quad \text{declination } \delta_{\infty} &= 25.5^{\circ} \\ \text{right ascension } \alpha_{\infty} &= 302.4^{\circ} \\ |V_{\infty}| &= 13.2 \text{ kfps} \end{aligned}$$

The declination is taken positive northward from the equator, and the right ascension is taken positive eastward from a line directed from the earth's center to the sun's equatorial crossing on the vernal equinox, shown here by γ .

The angle $C_{I\infty}$ can be obtained from an expression taken from Reference 4.

$$C_{I\infty} = \tan^{-1} \left[\frac{V_{\infty}}{V_C} \sqrt{\left(\frac{V_{\infty}}{V_C}\right)^2 + 2} \right] \quad \text{where}$$

V_C is the circular velocity of the parking orbit. For the 100 n.m. parking orbit used in this study, $C_{I\infty} = 142.2^{\circ}$ for the reference trajectory. The angle C_1 can be obtained from the following expression:

$$C_1 = \sin^{-1} \left[\frac{\sin \delta_{\infty}}{\sin i} \right]$$

It is important to realize here that for the same orbit inclination, two values of C_1 are possible. For the reference

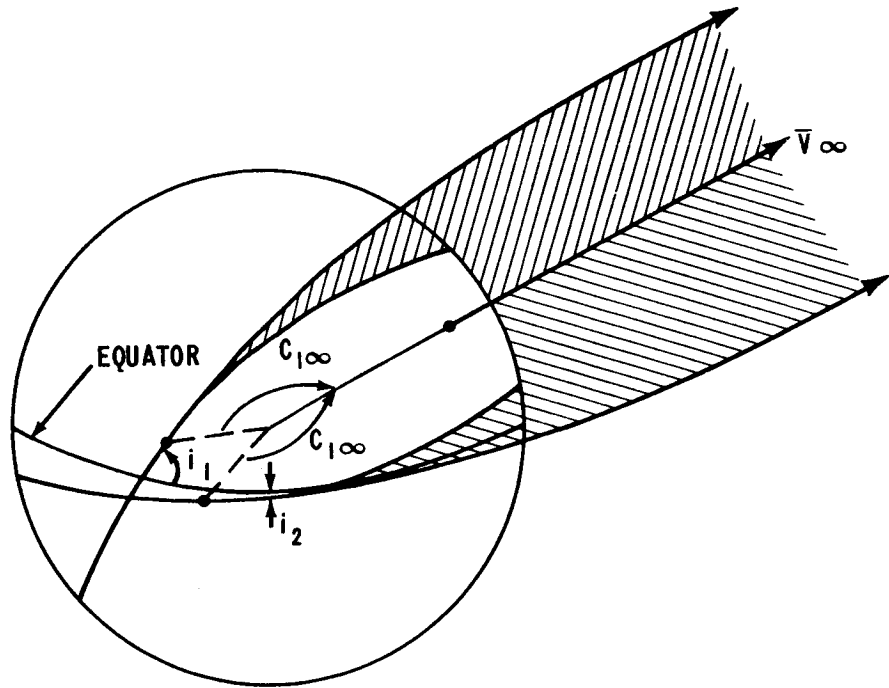

EARTH DEPARTURE TRAJECTORIES

FIG. 11 -2

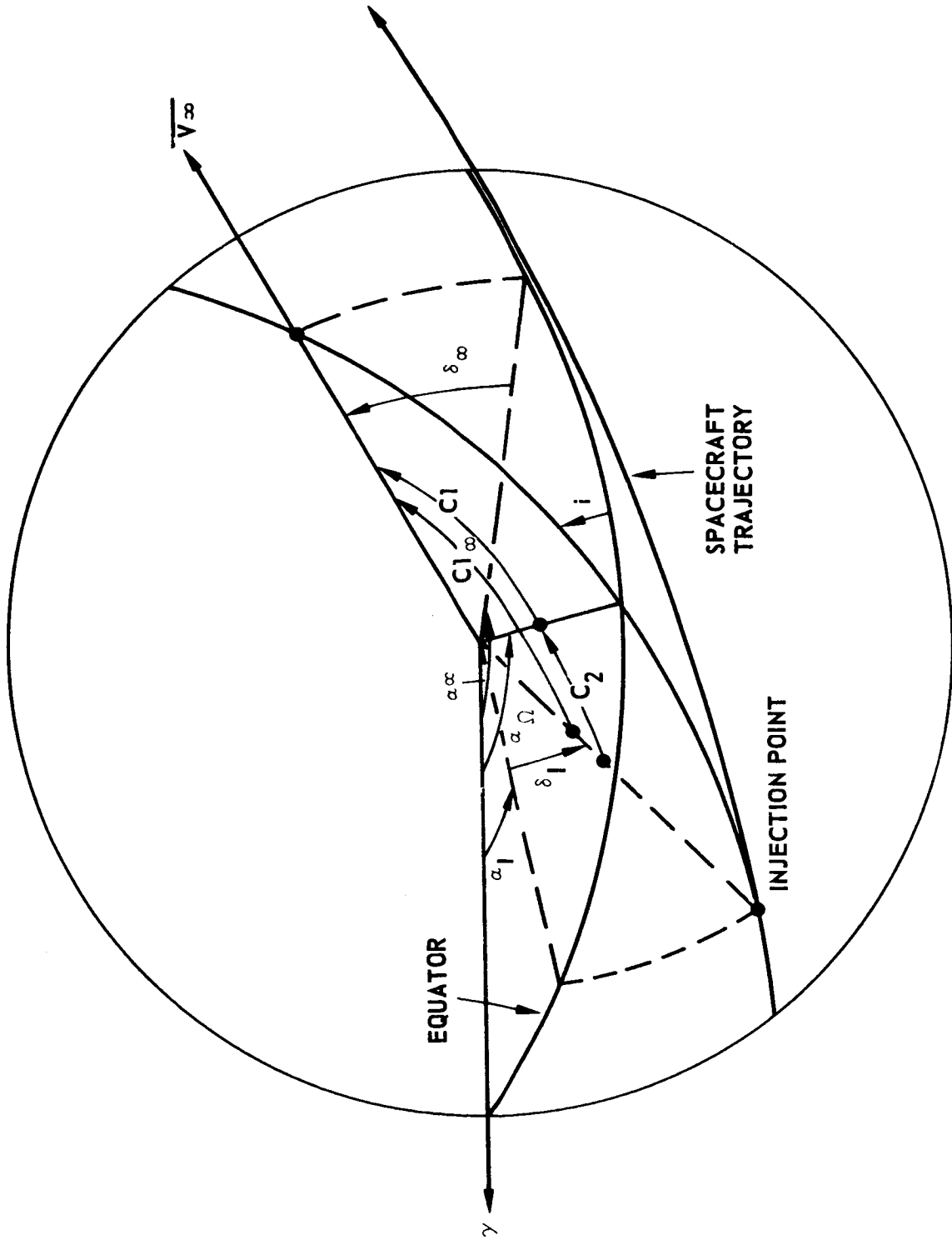

FIG. II-3 EARTH DEPARTURE TRAJECTORY ELEMENTS

trajectory of this study, $0 < C_1 < 90^\circ$ and $90^\circ < C_1 < 180^\circ$ for a given orbit inclination. It will subsequently be shown that it is this feature that results in two launch windows in the same day.

To define the injection point location, the declination δ_I , and right ascension α_I , of the injection point are solved from the following equations which are algebraic and trigonometric in nature.

$$C_2 = C_{I\infty} - C_1$$

$$\delta_I = \sin^{-1} [\sin(360^\circ - C_2) \sin i]$$

$$\begin{aligned} \alpha_\Omega &= \alpha_\infty - (\alpha_\infty - \alpha_\Omega) \\ &= \alpha_\infty - \tan^{-1} [\cos i \tan C_1] \end{aligned}$$

$$\begin{aligned} \alpha_I &= (\alpha_I - \alpha_\Omega) + \alpha_\Omega \\ &= \tan^{-1} [\cos i \tan(360^\circ - C_2)] + \alpha_\Omega \end{aligned}$$

The following values follow for the specific mission investigated for launch azimuths of 90° ($i = 28.6^\circ$), 72° ($i = 33.4^\circ$), and 108° ($i = 33.4^\circ$).

	$i = 33.4^\circ$		$i = 28.6^\circ$	
	$C_1 = 51.4^\circ$	$C_1 = 128.6^\circ$	$C_1 = 63.9^\circ$	$C_1 = 116.1^\circ$
C_2	90.8°	13.6°	78.3°	26.1°
δ_I	-33.4°	-7.4°	-28.0°	-12.2°
α_Ω	256.1°	168.7°	241.6°	183.2°
α_I	165.1°	157.3°	164.9°	159.9°

2.1.2 Launch Window Determination

It remains to determine, from the position of the launch site, the launch azimuths and launch times. A range of launch azimuths of $72^\circ - 108^\circ$ is considered here for launch window determination. In Figure II-4, it is helpful to locate the point on the non-rotating sphere that will be directly

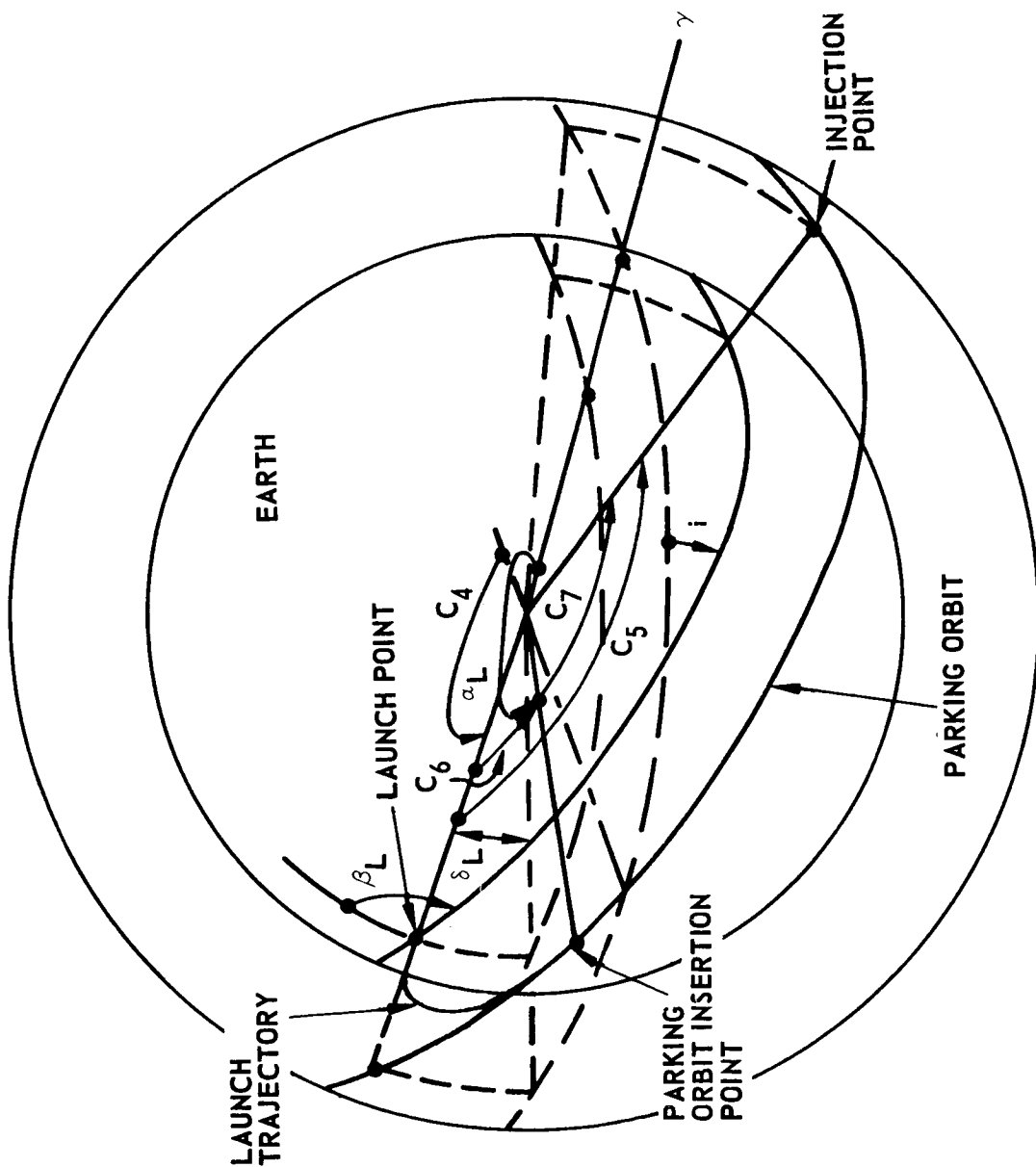

LAUNCH AND PARKING ORBIT TRAJECTORY ELEMENTS

FIG. II-4

over the launch site and then compute the time that the launch site will pass beneath it and launch can occur. Although the parking orbit duration is indicated in Figure II-4 as less than one orbit for simplicity, the parking orbit phase may have several revolutions before injection.

The declination of the launch site, δ_L , is fixed and given by the KSC latitude of 28.65° . The launch azimuth for a given inclination is computed from the following equation.

$$\beta_L = \sin^{-1} \left[\frac{\cos i}{\cos \delta_L} \right]$$

Other trajectory elements are computed as follows:

$$C_4 = \sin^{-1} \left[\frac{\sin \delta_L}{\sin i} \right]$$

$$C_5 = (360^\circ - C_2) - C_4$$

$$C_7 = C_5 - C_6 + n(360^\circ)$$

where n is the number of complete revolutions in the parking orbit phase

The angle C_7 is the central angle swept out by the spacecraft during the parking orbit coast and C_6 is the central angle swept out by the spacecraft during the launch trajectory from liftoff to parking orbit insertion. C_6 is taken here to be 23.3° , based on the 1,400 n.m. ground track during launch, taken from Reference 32. Also,

$$\alpha'_\Omega = \alpha_\Omega + \dot{\alpha}_\Omega t_{po}$$

where $\dot{\alpha}_\Omega$ is the regression rate of the ascending node due to the earth's oblateness

$$\dot{\alpha}_\Omega = .3793 \cos i \text{ degrees/hour after simplification of an expression in Reference 33.}$$

t_{po} is the time spent in parking orbit coast

$$t_{po} = \left(\frac{C_7}{360} \right) \frac{1}{T}$$

T = period of the 100 n.m. parking orbit = 1.470 hrs.

$$\begin{aligned}\alpha_L &= (\alpha_L - \alpha'_\Omega) + \alpha'_\Omega \\ &= \tan^{-1}[\tan \beta_L \sin \delta_L] + \alpha'_\Omega\end{aligned}$$

For the case of a 72° launch azimuth, injection on the fourth parking orbit, and $C_1 = 51.4^\circ$ in the reference trajectory, $C_7 = 1265.4^\circ$, $\alpha_L = 313.7^\circ$, and the parking orbit coast time is about 5.3 hours.

The determination of the launch time will be explained by computing the launch time of the trajectory selection of the preceding paragraph. From Reference 2, it is seen that the earth's celestial longitude, L , on Julian date 244 1987.5 is 38.1° . In more familiar terms, this is the position of the earth at 0:0 hours Greenwich time on November 1, 1973, and at 19:00 EST, October 31, 1973, at KSC. As shown in Figure II-5, the terrestrial right ascension of the sun can be obtained as follows. The longitude reference directions of the earth and sun coordinate systems are identical.

$$C_{\text{sun}} = 180^\circ - L$$

$$\alpha_{\text{sun}} = \tan^{-1}[\tan(360^\circ - C_{\text{sun}}) \cos i]$$

where $i = 23.5^\circ$, the inclination of the earth's equatorial plane to the ecliptic.

Assuming that at local midnight, Greenwich is directly opposite the sun, α_{GR} , the right ascension of Greenwich at 0:0, November 1, 1973, is equal to $180^\circ + \alpha_{\text{sun}}$. For the example,

$$C_{\text{sun}} = 180^\circ - L = 141.9^\circ$$

$$\alpha_{\text{sun}} = -144.3^\circ$$

$$\alpha_{\text{GR}} = 35.7^\circ$$

The right ascension of KSC at 19:00, October 31, 1973, is equal to $\alpha_{\text{GR}} - (\text{KSC longitude west of Greenwich}) = \alpha_{\text{GR}} - 80.6^\circ$.

$$\alpha_{\text{KSC}} \text{ at 19:00, October 31, 1973} = -44.9^\circ$$

The right ascension of the launch site at launch, α_L , must be 313.7° or -46.3° . Therefore, launch must occur prior to

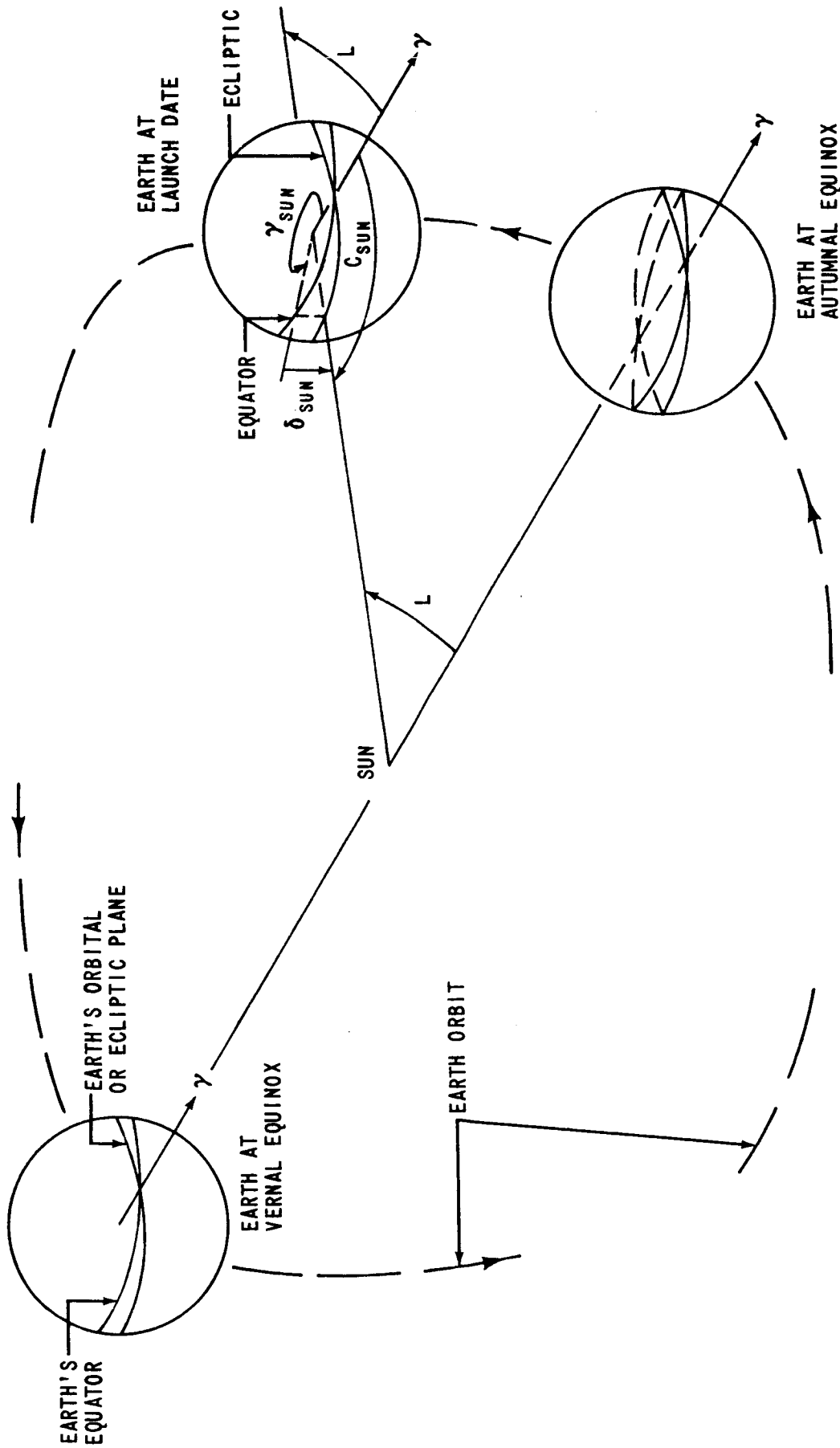

EARTH-SUN GEOMETRY
FIG. 11-5

19:00 by an amount of time that KSC will take to rotate through an angle equal to $\alpha_L - (\alpha_{KSC} \text{ at } 19:00)$. Launch must occur at about 18:55.4, October 31, 1973, to achieve the trajectory conditions of the example.

Some results of this analysis are given here for launch azimuths of 72° , 90° , 108° .

Launch Window 1

Launch Azimuth	72°	90°	108°
Launch Time (Oct. 31, 1973)	13:05	16:20	17:38 EST
Parking Orbit Duration, Hours	5.48	5.31	5.24
Injection Right Ascension	157.3°	159.9°	157.3°
Injection Declination	-7.4°	-12.2°	-7.4°

Launch Window 2

Launch Azimuth	72°	90°	108°
Launch Time (Oct. 31, 1973)	18:55	20:13	23:27 EST
Parking Orbit Duration, Hours	5.29	5.10	4.93
Injection Right Ascension	165.1°	164.9°	165.1°
Injection Declination	-33.4°	-28.0°	-33.4°

Two launch windows are available on the launch day, each approximately 4.5 hours in duration. One provides for a daylight afternoon launch and the other will probably result in a night launch.

2.2 Earth Departure Hyperbola

The characteristics of interest of the earth departure hyperbola are the perigee velocity, change in velocity at the injection burn, rate of ascent from earth, and the ground track and communications coverage of the spacecraft.

The perigee velocity is solved from the following expression:

$$v_p = \sqrt{\frac{2\mu}{R_p} + v_\infty^2}$$

For the reference mission with $V_\infty = 13.2$ kfps and the injection burn assumed to be instantaneous and tangential to the parking orbit, $V_p = 38.5$ kfps. The parking orbit circular velocity is found to be 25.6 kfps, giving a ΔV at injection of about 12.9 kfps.

The semi-major axis, a , and ellipticity, e , can be solved from the following expressions to have the indicated values for the reference mission.

$$a = \frac{\mu}{V_\infty^2} = 8.08 (10^7) \text{ feet}$$

$$e = \frac{V_p^2 R_p}{\mu} - 1 = 1.267$$

The time-distance relationship of the spacecraft after injection can be determined with the following expressions from Reference 2.

$$t = \frac{R_p}{V_\infty} (2.7770)(10^{-5}) \left[\frac{1}{e-1} (e \sinh E - E) \right]$$

where t is hours from perigee and
 E is given by

$$\cosh E = \frac{R/R_p (e-1) + 1}{e}$$

For the reference mission, these expressions reduce to the following:

$$\begin{aligned} t &= \text{hours from perigee} \\ &= 2.1530 \sinh E - 1.6999E \end{aligned}$$

$$\cosh E = (.2045) R + .78955$$

where R is measured in earth radii.

A plot of spacecraft distance from Earth vs. time from injection is shown in Figure II-6.

The ground track of the spacecraft during the departure hyperbola phase is obtained by locating the sub-spacecraft point on a non-rotating earth and correcting for the earth's rotation.

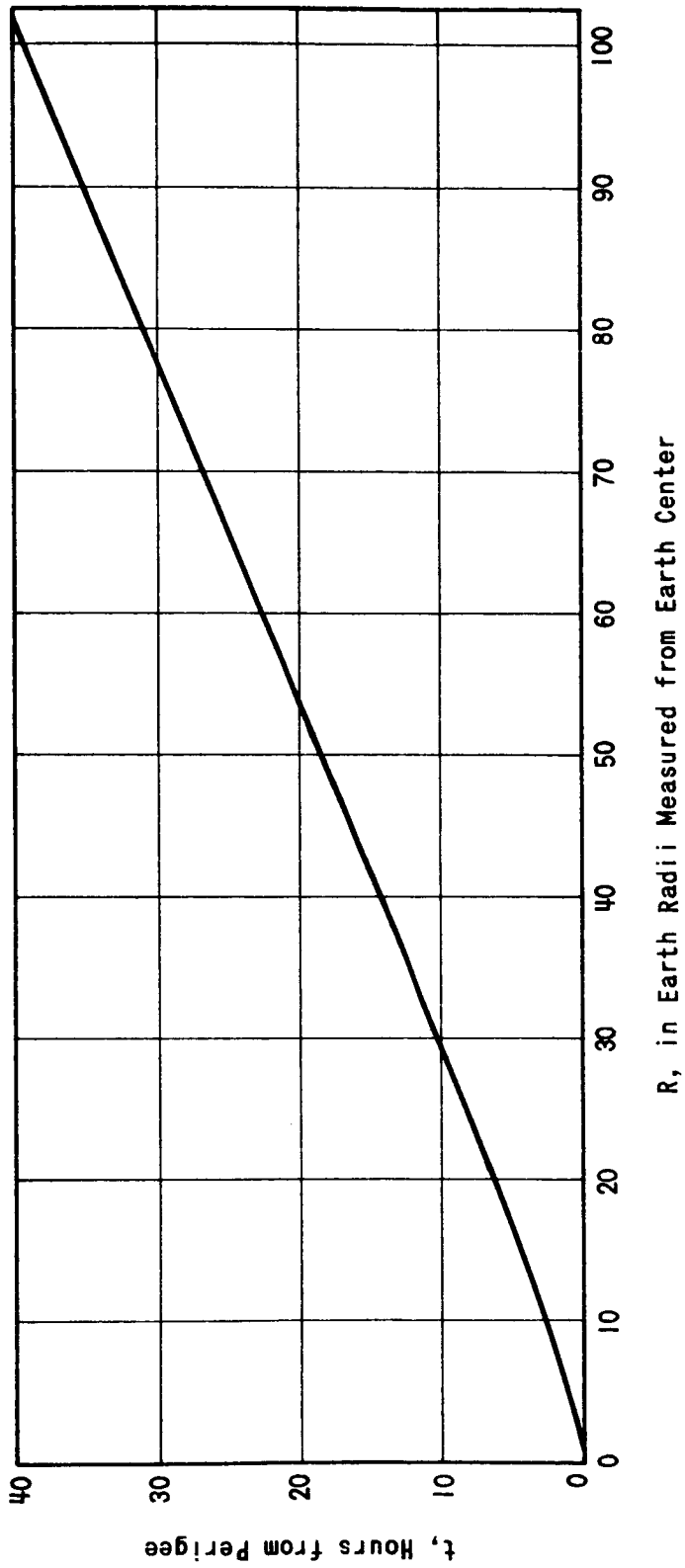

FIGURE 11-6 - SPACECRAFT DISTANCES TO EARTH DURING DEPARTURE HYPERBOLA

Referring to Figure II-7, the sub-spacecraft point on the non-rotating earth is found from the following:

$$\begin{aligned}\alpha &= (\alpha - \alpha_{\Omega}) + \alpha_{\Omega} \\ &= \tan^{-1}[\cos i \tan (f-C_2)] + \alpha_{\Omega} \\ \delta &= \sin^{-1}[\sin (f-C_2) \sin i]\end{aligned}$$

where f is the spacecraft true anomaly from injection

The declination, δ , is the same as the latitude and the right ascension, α , is converted to longitude in the following manner:

$$\begin{aligned}\text{Longitude} &= (\alpha - \alpha_L) + \text{Longitude of KSC} \\ &\quad - (15^\circ/\text{hour}) (t_{1po})\end{aligned}$$

where t_{1po} = time from liftoff

The ground tracks of the departure hyperbola for three launch azimuths of each launch window are shown in Figure II-8 and Figure II-9 for the reference mission. Also shown on these figures is the ground station coverage after injection for the principal ground stations.

2.3 Abort

Abort operations initiated prior to injection will be similar to those of the analogous periods of the Apollo mission. Aborts initiated after injection into the departure hyperbolic trajectory will require CSM separation from the remainder of the space vehicle and an SM engine burn to deflect the CSM from the hyperbolic trajectory onto an elliptical abort trajectory for return to earth. The abort initiation must be done relatively soon after injection or a commitment for a long duration mission must be accepted. It is expected that practically all equipment checkout will be completed in earth orbit prior to the injection burn. The criteria for abort after injection are based on the accuracy of the achieved departure trajectory and verification that passivation of the S-IVB stage is successfully initiated and the stage is not otherwise hazardous.

The abort geometry is shown in Figure II-10. A propulsion burn, ΔV , is applied to change the CSM velocity from that

II-11a

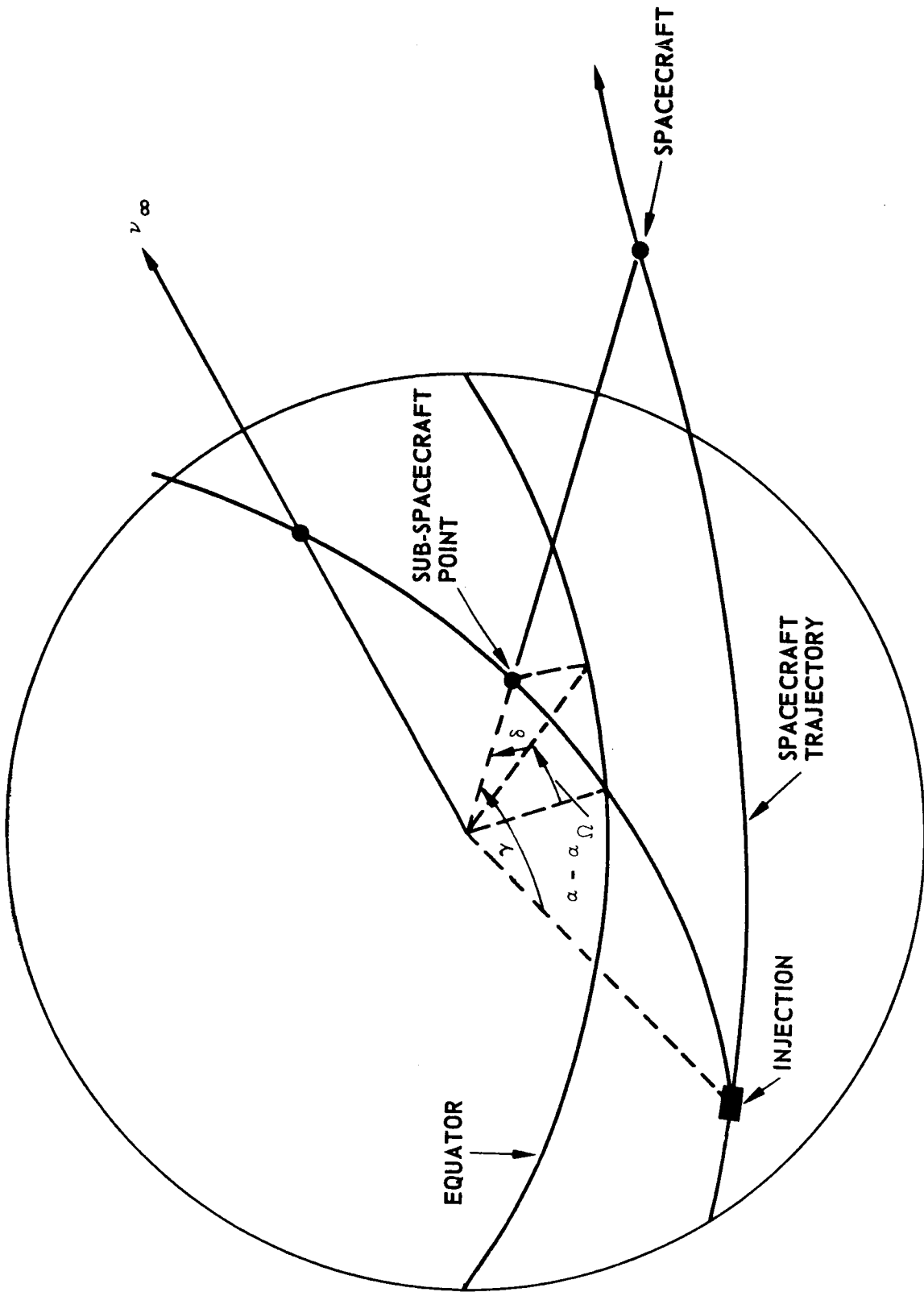

EARTH DEPARTURE HYPERBOLA GEOMETRY

FIG. 11-7

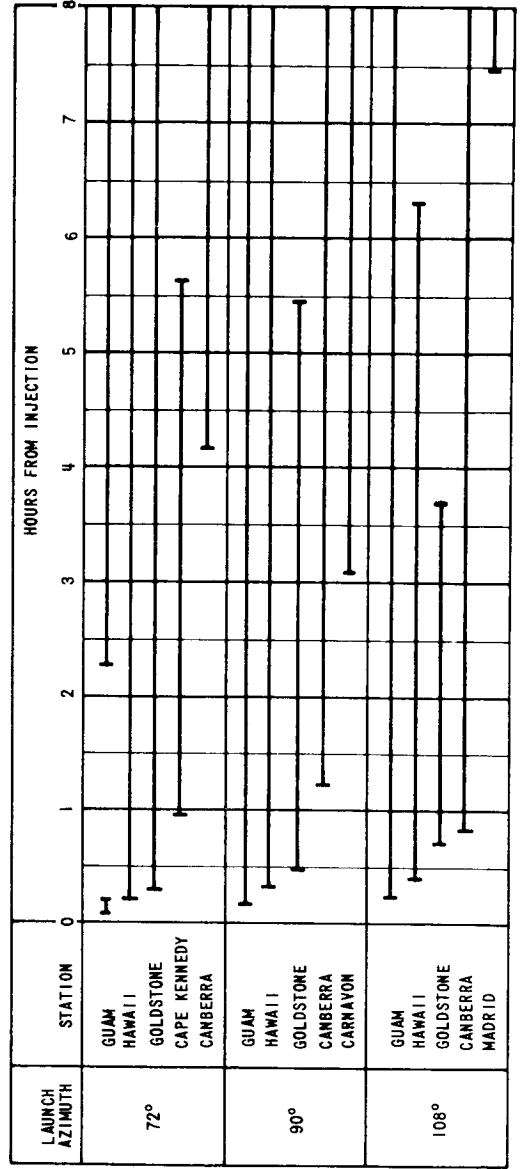
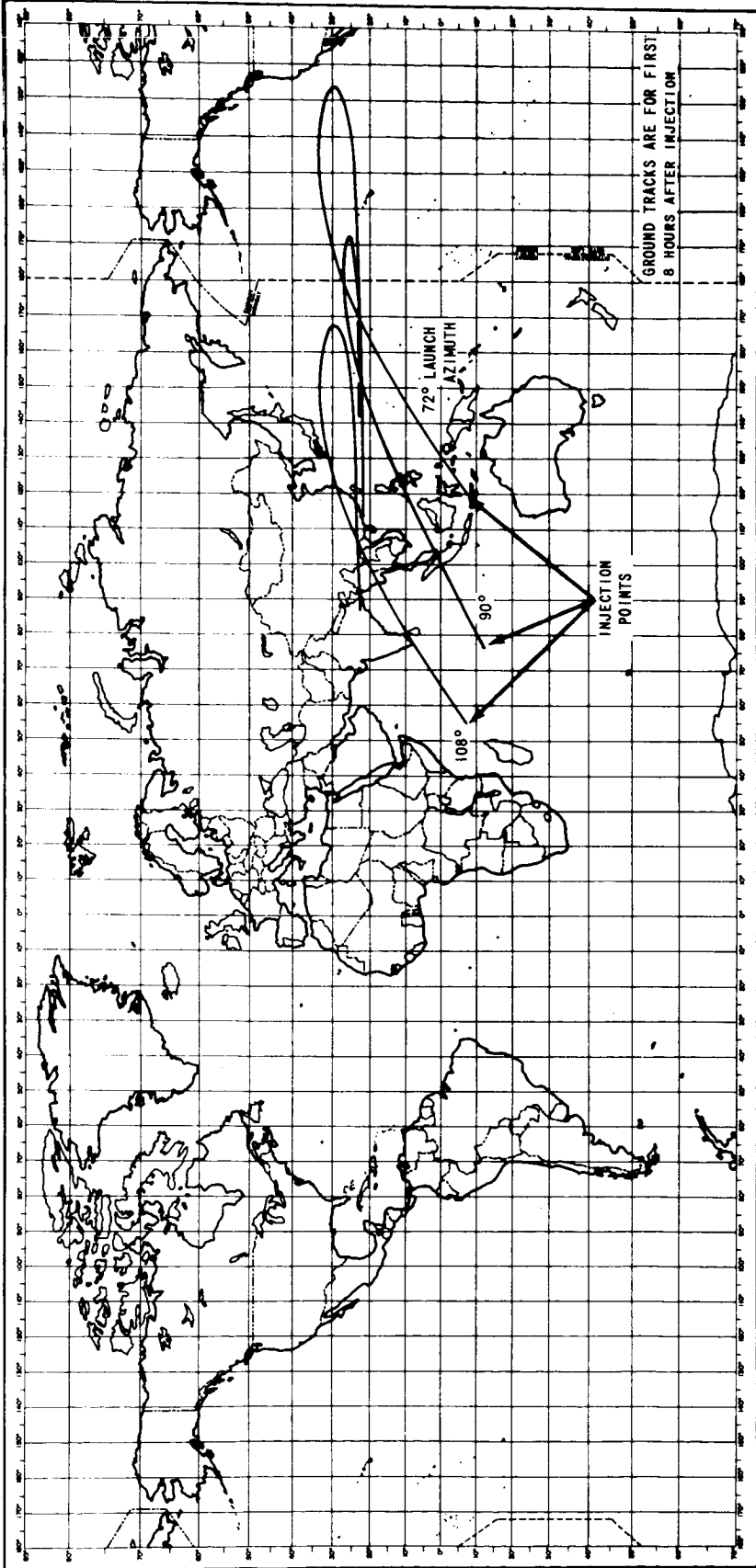

POST-INJECTION GROUND TRACKS AND TRACKING COVERAGE FOR LAUNCH WINDOW 1 TRAJECTORIES

FIGURE II-8

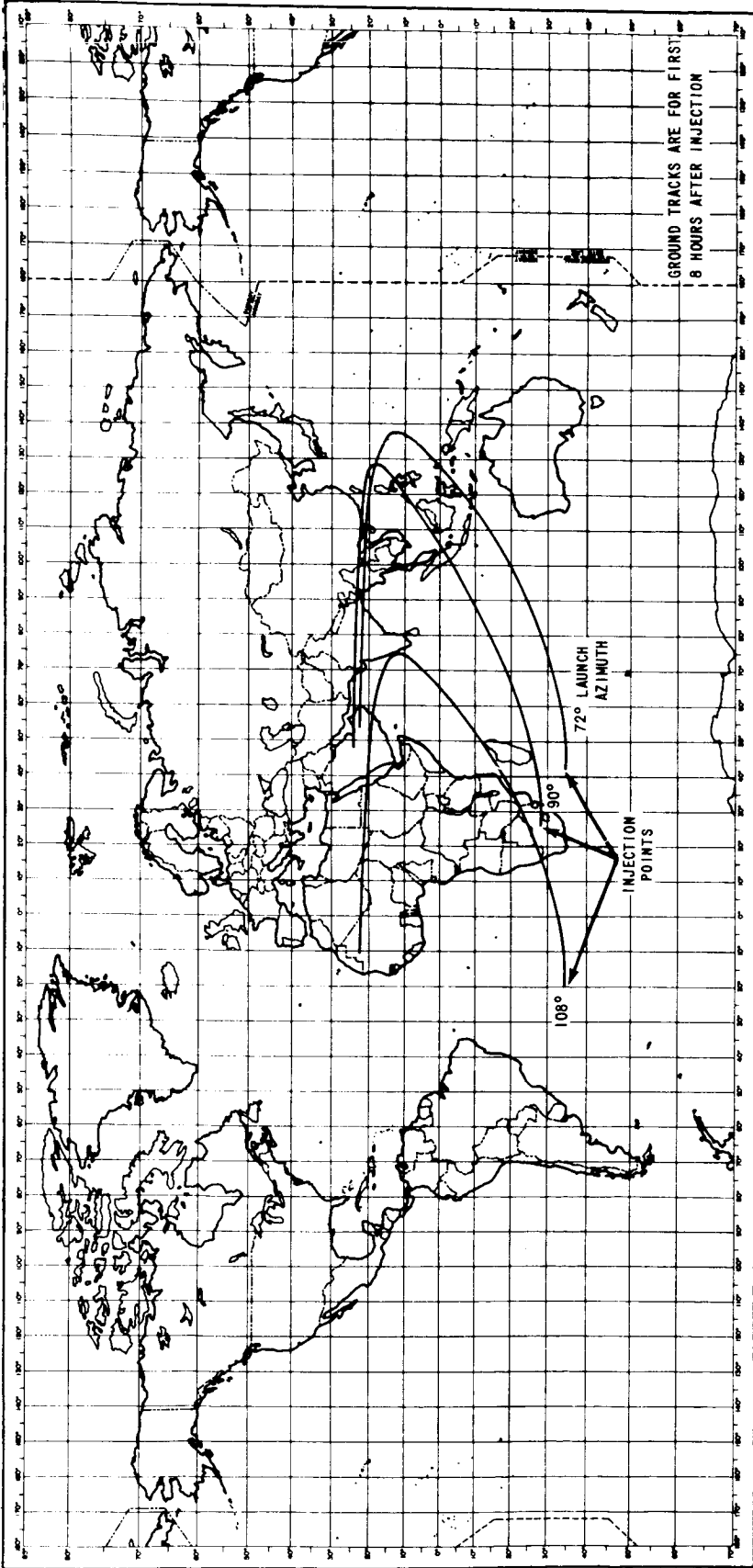

LAUNCH AZIMUTH	STATION	HOURS FROM INJECTION
72°	CARNAYON	0 - 1.5
	CAMBERRA	0 - 5.5
	GUAM	0 - 7.5
	HAWAII	0 - 3.5
90°	CARNAYON	0 - 1.5
	CAMBERRA	0 - 4.5
	GUAM	0 - 7.0
	HAWAII	0 - 3.0
108°	CARNAYON	0 - 1.5
	GUAM	0 - 2.5
	MADRID	0 - 1.0
	BERMUDA	0 - 1.0
	CAPE KENNEDY	0 - 1.0

POST-INJECTION GROUND TRACKS AND TRACKING COVERAGE FOR LAUNCH WINDOW 2 TRAJECTORIES

FIGURE II-9

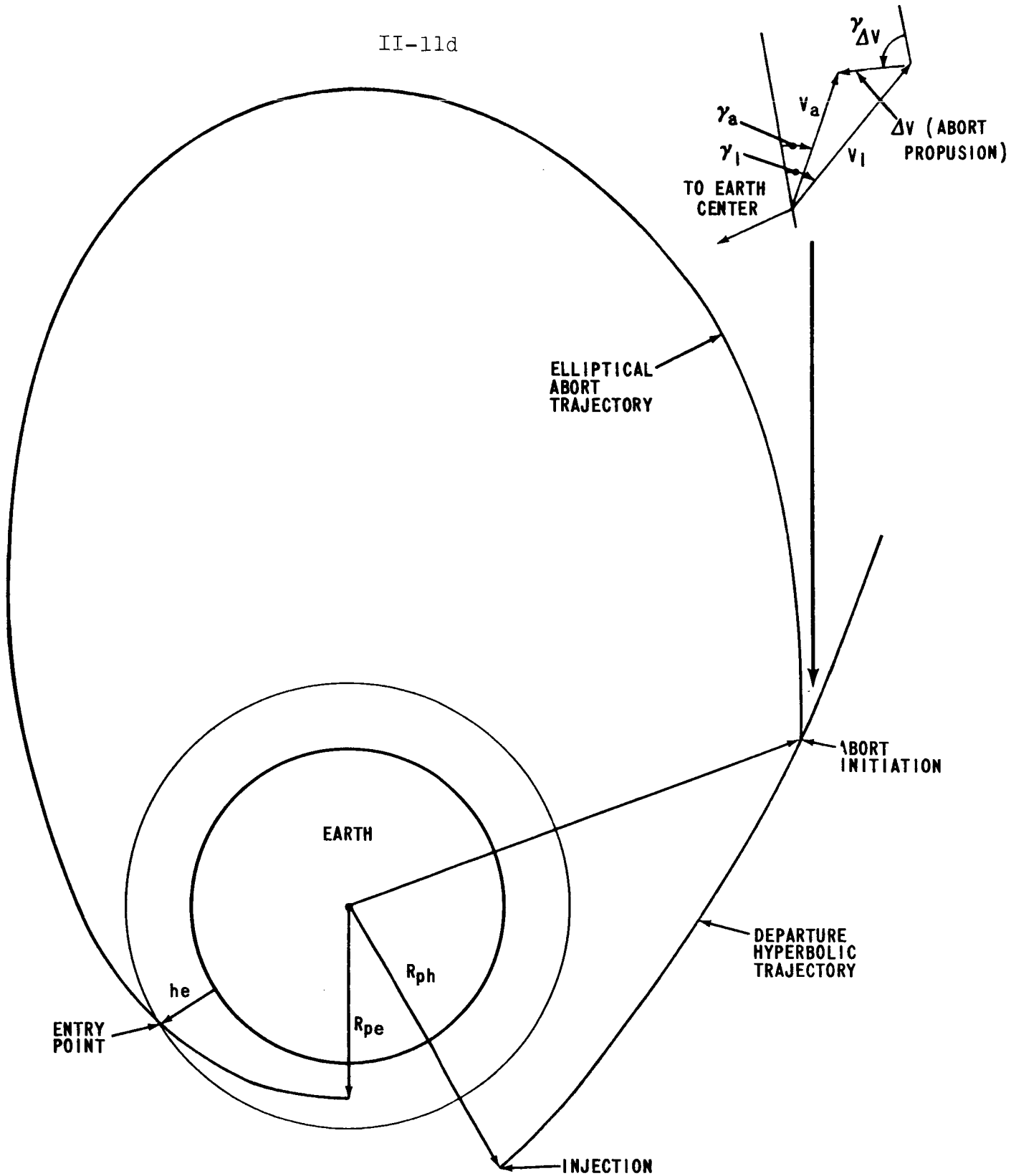

h_e = ENTRY ALTITUDE = 400,000 FEET
 R_{pe} = PERIGEE OF ABORT TRAJECTORY
 R_{ph} = PERIGEE OF DEPARTURE HYPERBOLA

ABORT GEOMETRY
 FIG. 11-10

of the departure hyperbola, V_1 , to that of the abort ellipse, V_a . The limited crew supplies and CSM operational lifetime limit the period of the abort elliptical trajectory to a nominal two days with a $\pm 1/2$ day variation for landing point selection.

The magnitude of the abort burn is given in Figure II-11 as a function of distance from earth and time from injection. For simplicity, a constant entry angle of -7.0° was assumed. It is seen that for an abort initiated about 45 minutes after injection, a ΔV of about 6,600 fps is required to achieve a 1.5 day period abort orbit. Allowing an additional 140 fps for perigee adjustment at apogee and 150 fps for navigation, the total abort requirement is 6,890 fps for this case. It is to be noted from Figures II-8 and II-9 that approximately 30 minutes of tracking time is available within 45 minutes after injection. This should be sufficient for trajectory evaluation purposes. Abort operations can be initiated up to about 1.1 hours after injection with severe restrictions on landing point selection. After 1.1 hours from injection, the available CSM propulsion is insufficient to return the CSM to earth within the CSM lifetime, and the crew must remain with the ESM and accept a long duration mission.

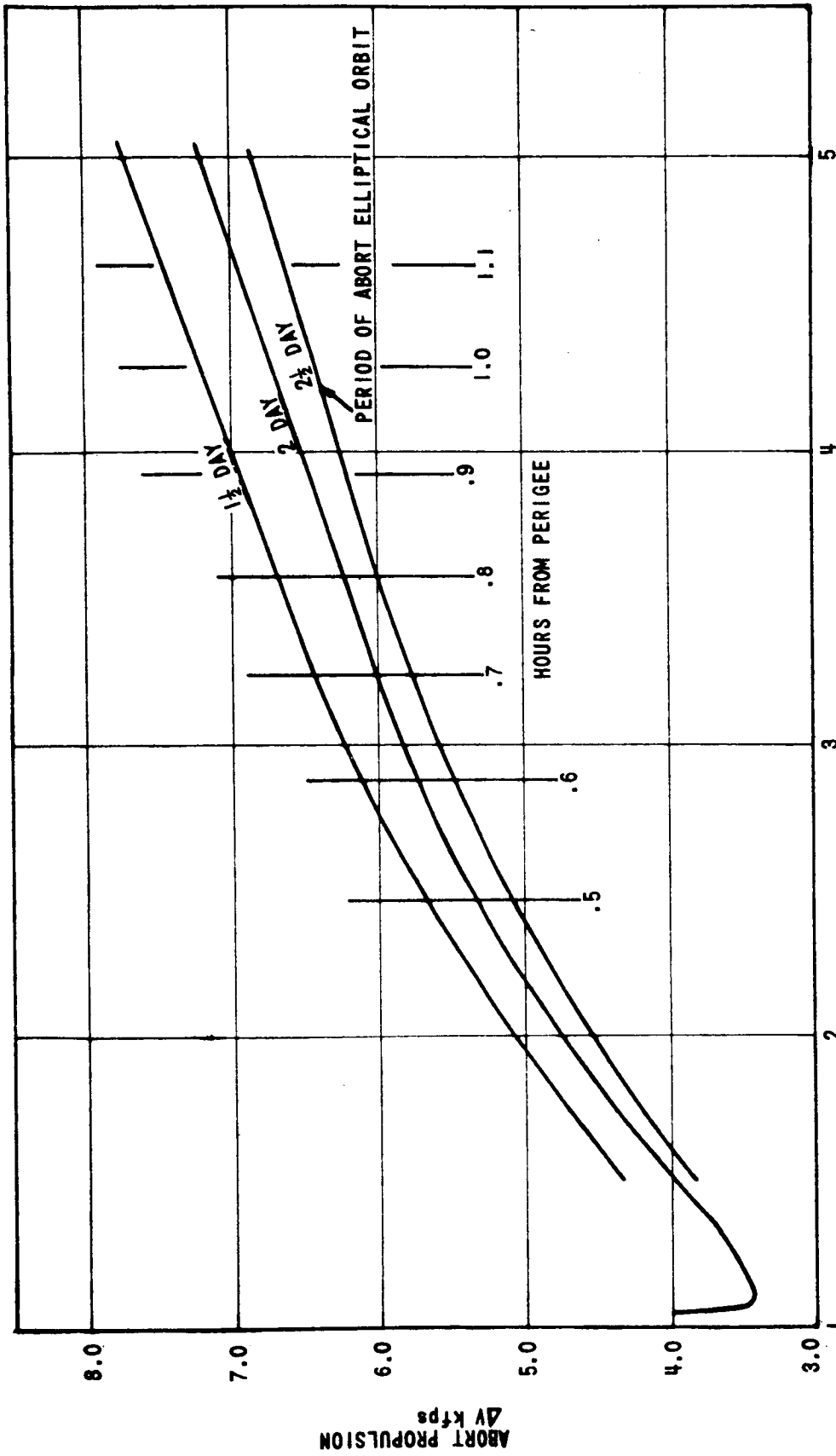

SPACECRAFT RADIUS FROM EARTH CENTER AT ABORT INITIATION IN EARTH RADII

REQUIRED ABORT PROPULSION FROM DEPARTURE HYPERBOLA

FIG. 11-11

3.0 Outbound Leg

The outbound leg of the Venus flyby trajectory consists of a segment of a sun-centered elliptical trajectory that extends from earth at departure to Venus at flyby. The spacecraft traverses the outbound leg to Venus in substantially less than half the mission duration.

For a specific mission defined by the earth departure and Venus flyby dates, the major trajectory characteristics can be obtained from Reference 2. These include the ellipticity and the semi-major axis. In addition, the aphelion, perihelion and period can be easily determined. For our reference mission, these elements have the following values.

e, ellipticity	= .169
a, semi-major axis	= .850 AU
R_p , perihelion	= .707 AU
R_a , aphelion	= .994 AU
T, period	= 286 days

During the outbound leg, the spacecraft sweeps out a central angle of 148 degrees in 123 days.

In determining the spacecraft position at any time during the outbound leg, the celestial longitude and latitude and distance from the sun must be solved. These are shown in Figure II-12 where L_{SC} is the celestial longitude, δ_{SC} is the celestial latitude and R is the spacecraft distance from the sun. Celestial longitude is measured positive eastward from the first star of Aries and latitude is measured positive northward from the ecliptic. The following expressions may be used to determine the spacecraft distance from the sun at any specific time during the outbound leg.

$$R = \frac{a(1 - e^2)}{1 + e \cos f}$$

$$t = \frac{T}{2\pi} (E - e \sin E) - t_0$$

$$\text{where } \tan \frac{E}{2} = \sqrt{\frac{1 - e}{1 + e}} \tan \frac{f}{2} \text{ and}$$

f is the true anomaly of the spacecraft in the outbound leg trajectory

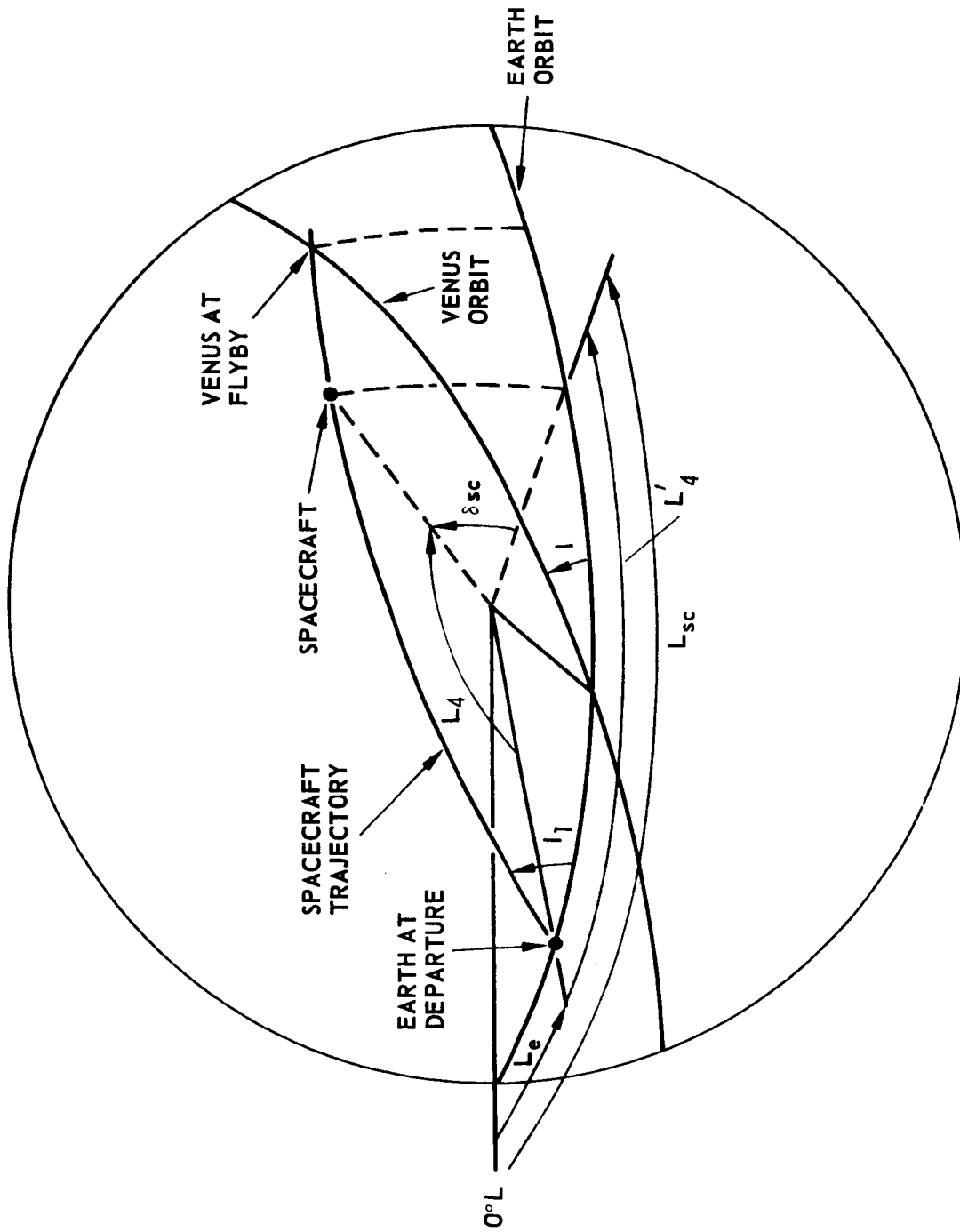

FIG. 11-12 CELESTIAL SPHERE-OUTBOUND LEG TRAJECTORY

The term t_0 may be determined from either of two boundary conditions. These boundary conditions are: 1) $t = 0$ when $R = R_e$, the earth's distance from the sun at departure, and 2) $t =$ the outbound leg transit time when $R = R_v$, the Venus distance from the sun at flyby. For our reference mission, the expressions reduce to the following.

$$R = \frac{.826}{1 + .169 \cos f} \text{ AU}$$

$$t = 45.5(E - .169 \sin E) - 146 \text{ days}$$

$$\tan \frac{E}{2} = .843 \tan \frac{f}{2}$$

In determining the longitude and latitude, the inclination of the trajectory plane to the ecliptic is required and is found with the following expressions and reference to Figure II-13. The longitude of the earth at departure is designated by L_E , the longitude of Venus at flyby by L_V , and the longitude of the Venus ascending node in the ecliptic by L_N .

$$L_1 = L_N - L_E$$

$$L_2' = L_V - L_N$$

$$L_2 = \tan^{-1} \left[\frac{\tan L_2'}{\cos I} \right]$$

where I is the mutual inclination between the earth and Venus orbit planes

$$L_3 = \cos^{-1} [\cos L_1 \cos L_2 + \sin L_1 \sin L_2 \cos I]$$

$$I_1 = \sin^{-1} \left[\sin I \left(\frac{\sin L_2}{\sin L_3} \right) \right]$$

For the reference mission, $L_E = 38.10^\circ$ and $L_V = 186.65^\circ$ are obtained from Reference 2, giving the following:

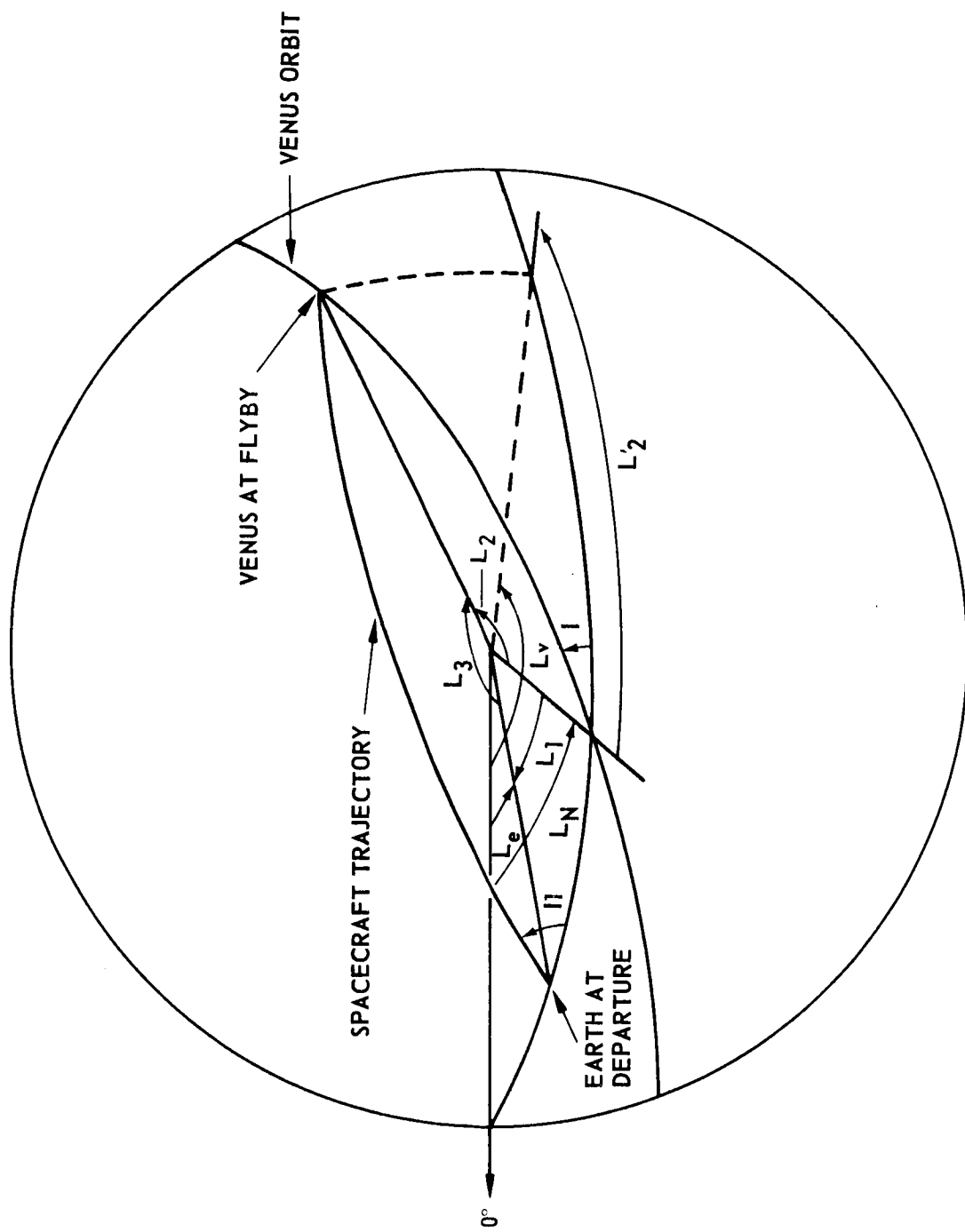

FIG. 11-13 CELESTIAL SPHERE -- OUTBOUND LEG TRAJECTORY

$$L_1 = -38.22^\circ$$

$$L_2' = 110.33^\circ$$

$$L_2 = 110.3^\circ$$

$$L_3 = 148.3^\circ$$

$$I_1 = 6.06^\circ$$

The longitude and latitude are computed as follows:

$$\delta_{sc} = \sin^{-1}[\sin L_4 \sin I_1]$$

$$L_4' = \tan^{-1}[\tan L_4 \cos I_1]$$

$$L_{sc} = L_4' + L_E$$

The angle L_4 is equal to the difference between f , the true anomaly of the spacecraft and f_o , the true anomaly at departure from earth.

The positions of the spacecraft, earth, and Venus at various times throughout the mission are given in Figure II-14. Continuous plots of the longitude, latitude, and distance from the sun are given in Figure II-15 for the spacecraft, Venus and earth.

As can be noticed from Figures II-14 and II-15, an earth-spacecraft conjunction occurs at about 75 days into the mission and an interruption in spacecraft-to-earth communications due to background interference from the sun is conceivable. This interruption would occur if the sun-spacecraft-earth angle were to closely approach 180° . However, as shown in Figure II-16, this angle does not exceed about 145 degrees due to the inclination of the spacecraft trajectory, and no communications interruption occurs.

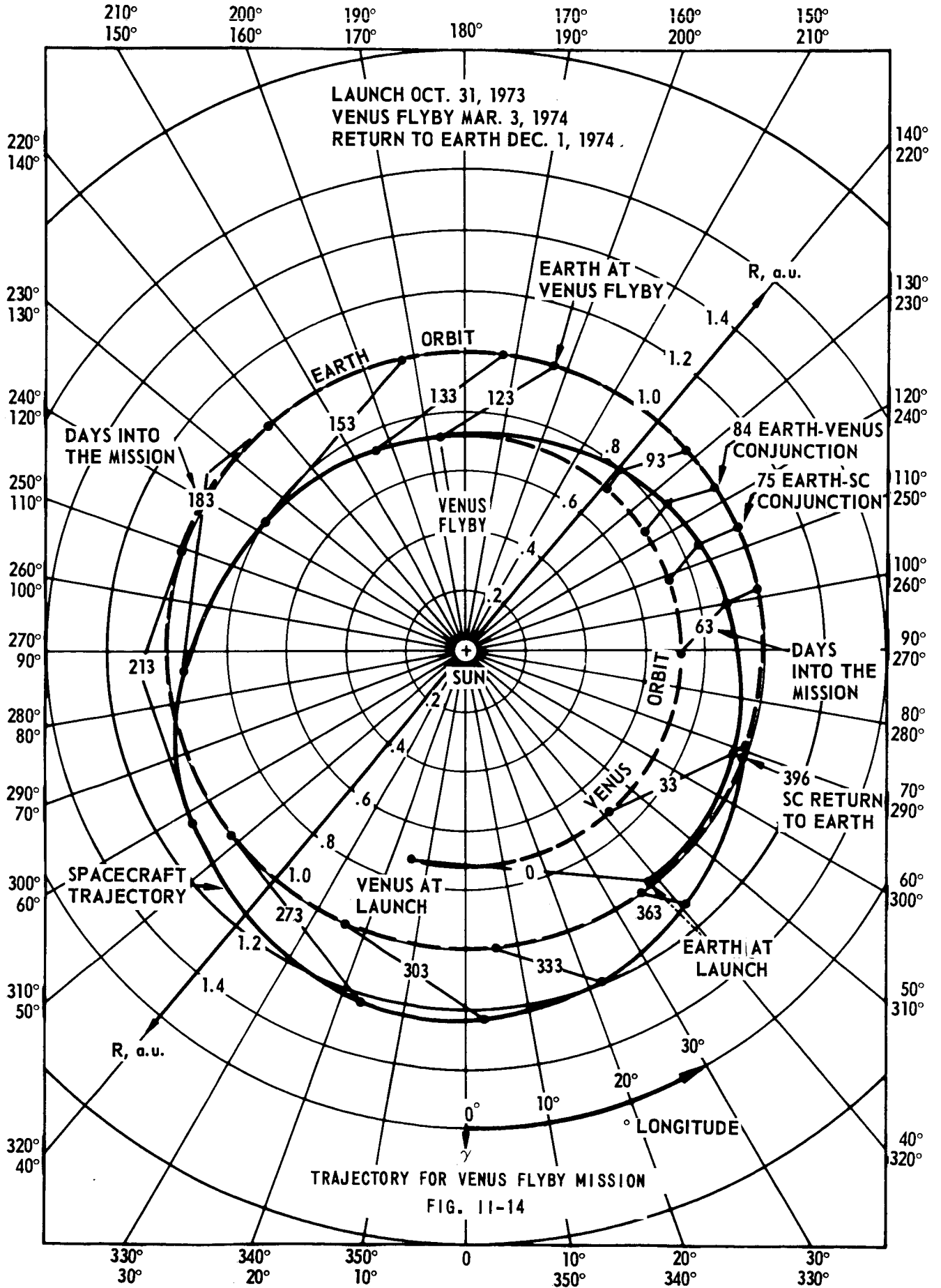

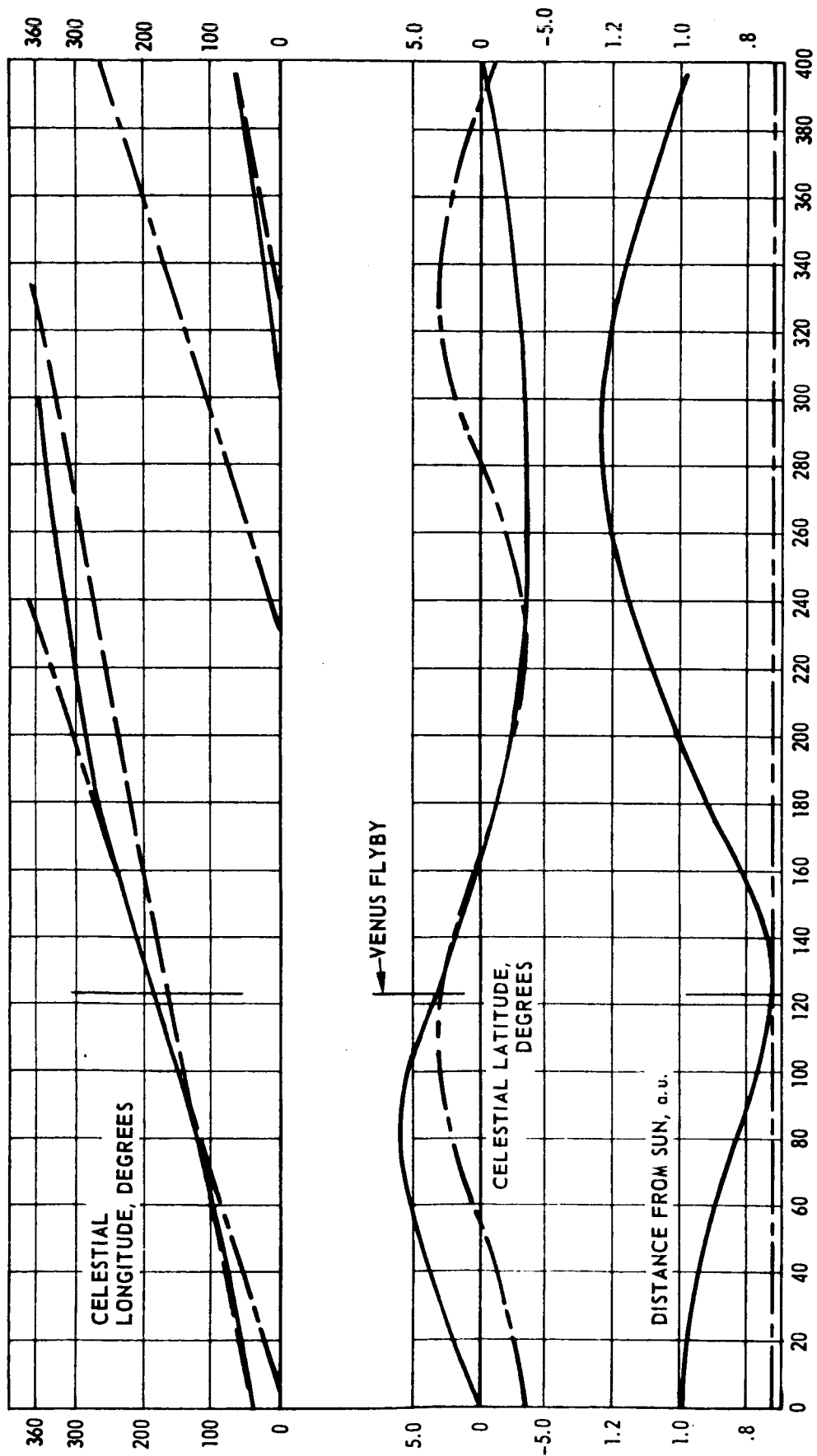

t, DAYS FROM EARTH DEPARTURE

- SPACECRAFT
- - - EARTH
- · - · - VENUS

FIG. II-15 CELESTIAL POSITIONS OF SPACECRAFT, VENUS AND EARTH

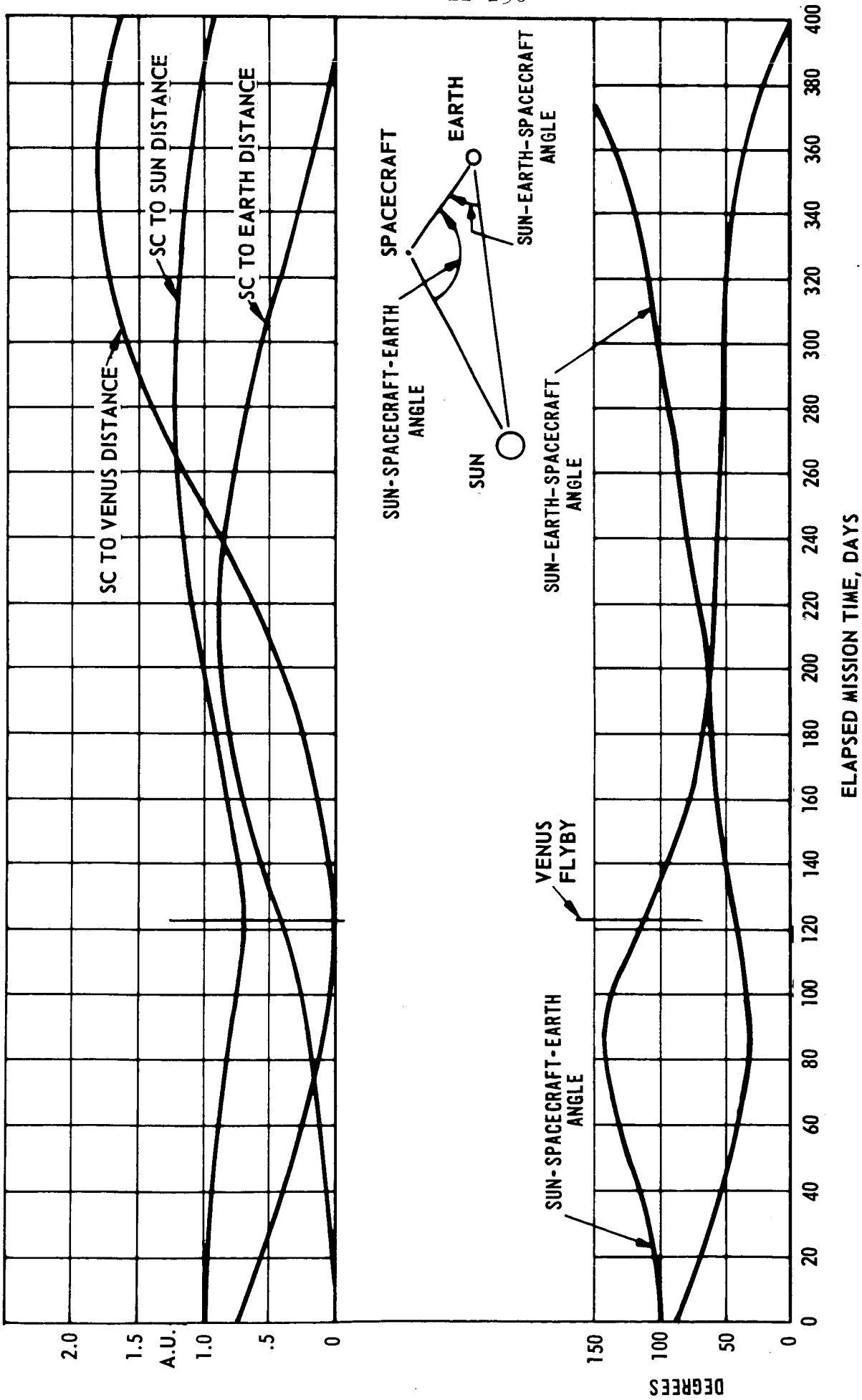

SPACECRAFT DISTANCES AND SUN-SPACECRAFT-EARTH ANGLE
FIG. 11-16

4.0 Venus Encounter

As the spacecraft approaches Venus, the Venusian gravitational field will cause the spacecraft to follow a hyperbolic orbit past the sunlit side of Venus. This will cause the spacecraft to change its direction or be deflected from its approach direction. This deflection is called the turn angle and is measured between the asymptotes of the Venus-centered hyperbola as indicated in Figure II-17. The magnitude of the turn angle is dependent upon the closest approach distance and magnitude of the V_{∞} vectors. In initially selecting the mission, outbound and inbound heliocentric legs must be found that have equal magnitudes of the V_{∞} vectors at Venus and that have a turn angle required to patch them together that is compatible with the magnitude of the V_{∞} vectors and closest approach distance desired for observation and scientific reasons.

For the reference mission of this study, the approach V_{∞} vector, $V_{\infty 1}$, and departure V_{∞} vector, $V_{\infty 2}$, can be found from Reference 2 to be the following:

	$V_{\infty 1}$	$V_{\infty 2}$
Magnitude	$ V_{\infty 1} = 14.7 \text{ kfps}$	$ V_{\infty 2} = 14.7 \text{ kfps}$
Right Ascension	$\alpha_{\infty 1} = 197.1^{\circ}$	$\alpha_{\infty 2} = 128.2^{\circ}$
Declination	$\delta_{\infty 1} = -33.2^{\circ}$	$\delta_{\infty 2} = -4.5^{\circ}$

Following the convention used in Reference 2 for the local Venus coordinate system, the Venusian equator is taken in the Venus orbit plane and the reference longitude direction, γ_V , is taken in the direction of the orbital perihelion of Venus.

The turn angle, θ , can be obtained from a simplified form of an expression in Reference 4.

$$\theta = \cos^{-1} \left\{ \frac{\cos(\delta_{\infty 1} - \delta_{\infty 2})[\cos(\alpha_{\infty 1} - \alpha_{\infty 2}) + 1]}{2} + \frac{\cos(\delta_{\infty 1} + \delta_{\infty 2})[\cos(\alpha_{\infty 1} - \alpha_{\infty 2}) - 1]}{2} \right\}$$

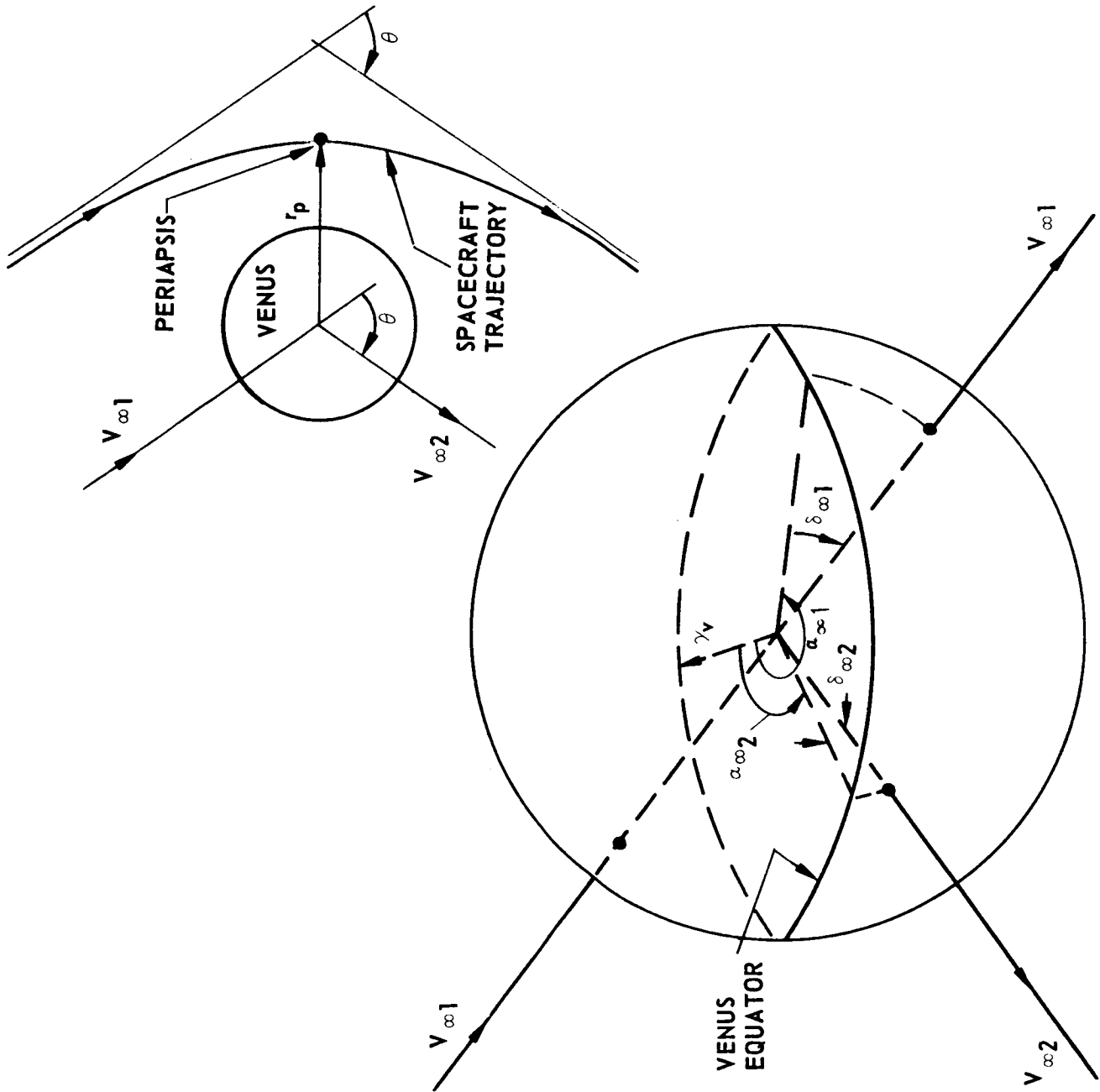

FIG. II-17 VENUS FLYBY TRAJECTORY ELEMENTS

The periplanet distance, r_p , defined as the distance from the Venus center to the periapsis point, can be found from the following expression taken from Reference 34.

$$r_p = \frac{\mu_V}{|V_\infty|^2} \left[\csc \frac{\theta}{2} - 1 \right]$$

where μ_V is the gravitational constant for Venus.

For the reference trajectory of this study, $\theta = 70^\circ$ and $r_p = 1.95$ Venusian radii. The periapsis altitude is, therefore, .95 Venusian radii or 3,170 n.m.

The trajectory aspects of interest during the Venus flyby are the spacecraft ground track on the Venusian surface, the terminator at the time of passage, the sub-solar point on the Venusian surface, the sub-periapsis point, the sub-earth point, and the time and Venus altitude relationship during the flyby. The Venus flyby geometry is illustrated in Figure II-18. Figure II-19 gives the ground track of the spacecraft during its transit of the Venus-centered hyperbola. The end points of the ground track correspond to the intersection of the asymptotes with the Venus surface. The ground track would be extended beyond these end points if the spacecraft positions during the approach and departure interplanetary trajectories were considered. However, the ground track as presented should be sufficiently accurate for distances out to about the Venus sphere of influence. This extends approximately 100 Venusian radii from the Venus center and accounts for about 3 1/4 days flight time. Figure II-20 shows a profile of the flyby trajectory in the trajectory plane.

To determine the information presented in these figures, several trajectory elements shown in Figure II-18 must be calculated. The V_∞ vectors may be expressed in rectangular coordinates by the following relationships.

$$\frac{V_{\infty 1}}{|V_{\infty 1}|} = i_x X_{\infty 1} + i_y Y_{\infty 1} + i_z Z_{\infty 1}$$

$$\text{where } X_{\infty 1} = \cos \delta_{\infty 1} \cos \alpha_{\infty 1}$$

$$Y_{\infty 1} = \cos \delta_{\infty 1} \sin \alpha_{\infty 1}$$

$$Z_{\infty 1} = \sin \delta_{\infty 1}$$

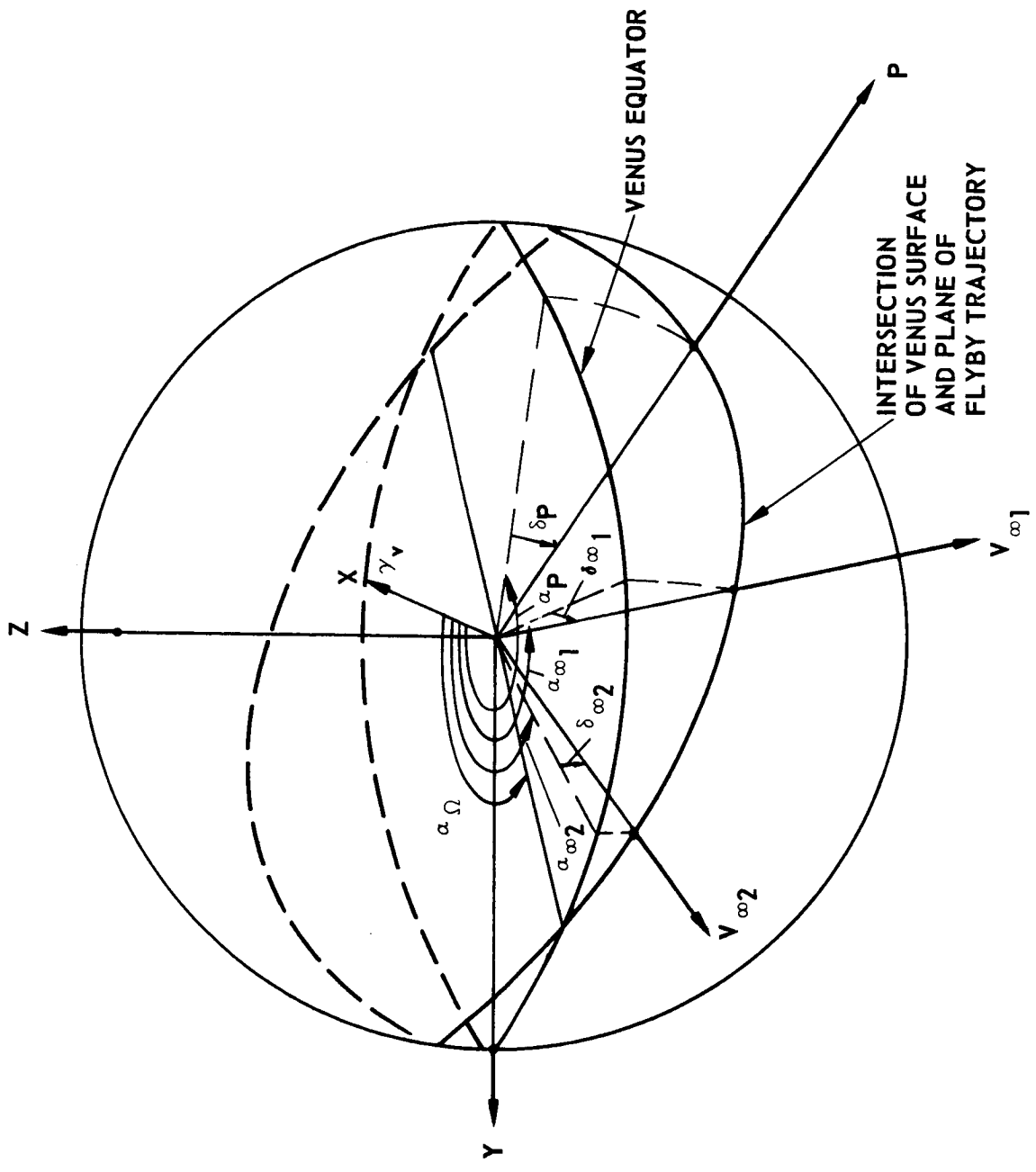

FIG. II-18 VENUS FLYBY TRAJECTORY ELEMENTS

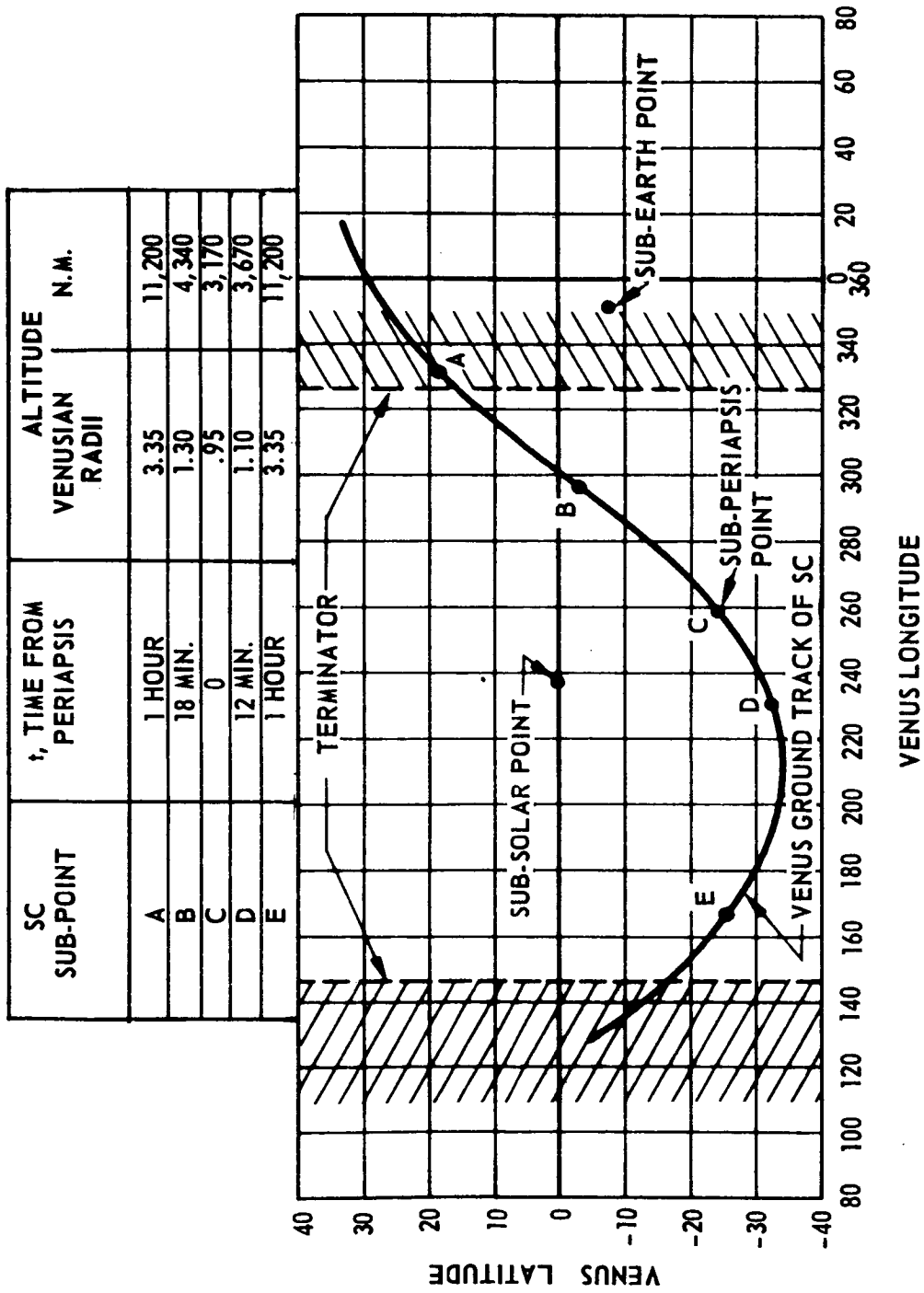

FIG. II-19 GROUND TRACK OF FLYBY TRAJECTORY

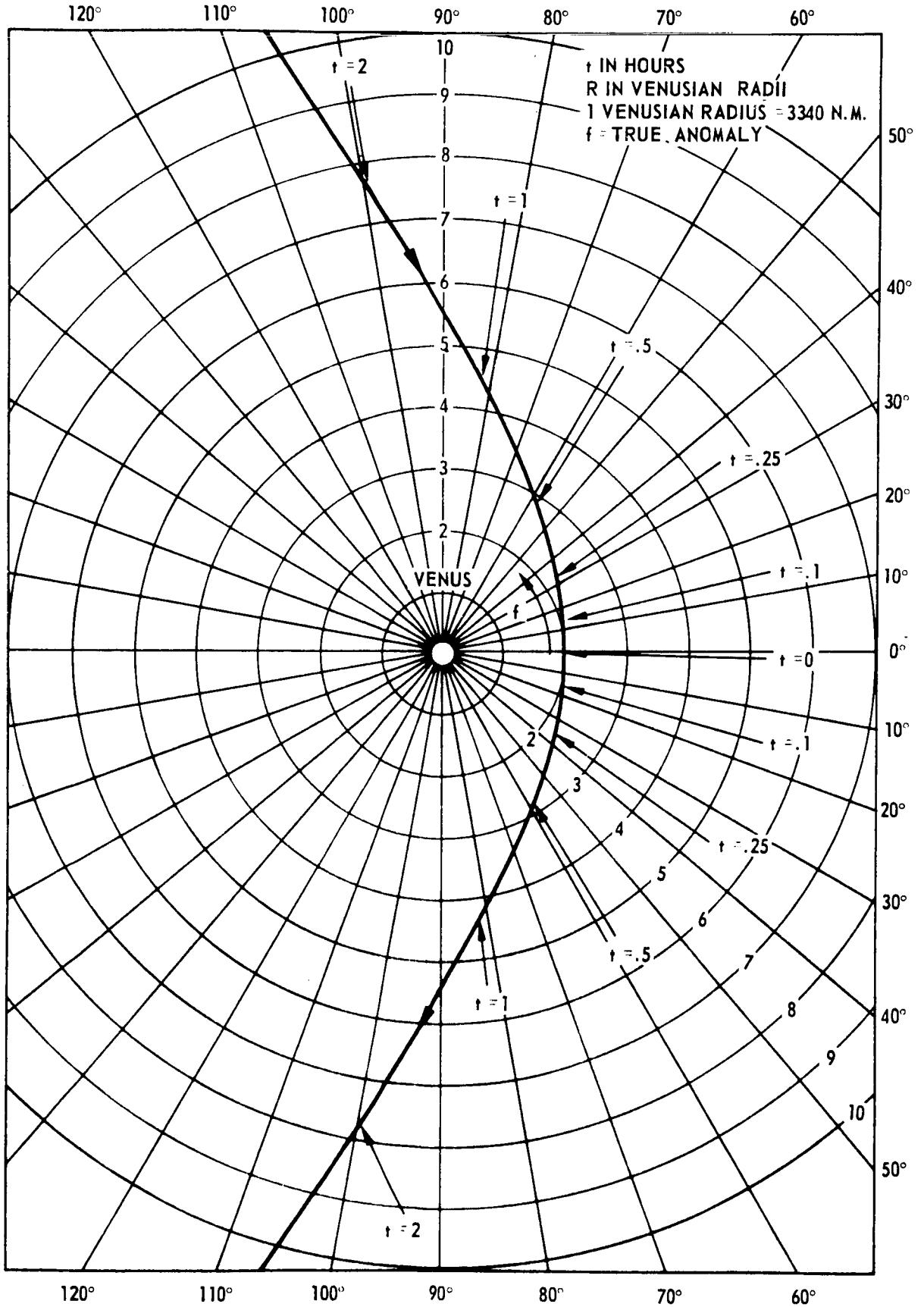

FIG. II-20 VENUS FLYBY TRAJECTORY

and similarly for $V_{\infty 2}$, where the X direction is taken in the reference longitude direction, Y is taken 90° eastward from X in the equatorial plane and Z is taken positive northward.

The normal, N, to the trajectory plane can be obtained from $N = V_{\infty 1} \times V_{\infty 2}$ which results in $N = i_x N_x + i_y N_y + i_z N_z$ where N_x , N_y , N_z are functions of $\delta_{\infty 1}$, $\delta_{\infty 2}$, $\alpha_{\infty 1}$ and $\alpha_{\infty 2}$ and can be solved numerically, and i_x , i_y and i_z are unit vectors along the X, Y and Z axes, respectively. The actual expressions are rather complex, both in derivation and form, and are not given here. These expressions and others to follow can be obtained from Reference 4.

The inclination of the orbit, i , can be obtained from

$$i = \cos^{-1} \left[\frac{i_z \cdot N}{|N|} \right]$$

In addition,

$$\alpha_{\Omega} = 90^\circ + \tan^{-1} \frac{N_y}{N_x}$$

For the example trajectory, $i = 145.9^\circ$ and $\alpha_{\Omega} = 121.5^\circ$.

The altitude of the periapsis has been determined but its position relative to the Venusian surface has not. In solving for the sub-periapsis point on the Venusian surface, consider the vector P from the Venus center to the periapsis point. Inspection of the near-Venus trajectory shows that the following equations must hold:

$$P \cdot N = 0 \quad (1)$$

$$P \cdot V_{\infty 1} = P \cdot -V_{\infty 2} \quad (2)$$

$$|P| = r_p \quad (3)$$

Equation (1) follows from N, the normal to the trajectory plane, being perpendicular to P which is contained in the trajectory

plane. Equation (2) follows from the fact that the periapsis vector, P , bisects the angle between the asymptotes, $V_{\infty 1}$ and $V_{\infty 2}$. Equation (3) is true by definition.

After manipulation of these expressions, P_x , P_y and P_z can be solved as functions of r_p , the N components, and the V_{∞} components, all of which can be determined. The right ascension of P , α_p , and the declination, δ_p , can be solved in the following manner:

$$\alpha_p = \tan^{-1} \frac{P_y}{P_x}$$

$$\delta_p = \tan^{-1} \frac{P_z}{\sqrt{P_x^2 + P_y^2}}$$

For the reference trajectory of this study, the sub-periapsis point has a right ascension, α_p , of 259.9° and a declination, δ_p , of -24.2° .

To determine the sub-earth point, defined as the intersection of the line from earth to Venus and the Venus surface, refer to Figure II-21 and Figure II-22. In Figure II-21a a sketch of portions of the earth and Venus rotations about the sun is shown. The angle, α_n , is the angle between the intersection of the Venus and earth orbit planes and the reference longitude as measured from the sun. The point A represents the Venus perihelion position at an angle ω_v from the intersection of the earth and Venus orbit planes. Angle ω_v is measured in the Venus plane. In the Venus local coordinate system, the direction from the Venus center parallel to the Venus perihelion radius at point A is used as the reference longitude. This direction is represented by γ_v in Figure II-21. Points B and C in Figure II-21a represent the Venus and earth positions at Venus flyby.

Referring to Figure II-21, the elements ϕ , Y , and ξ are solved in the following manner:

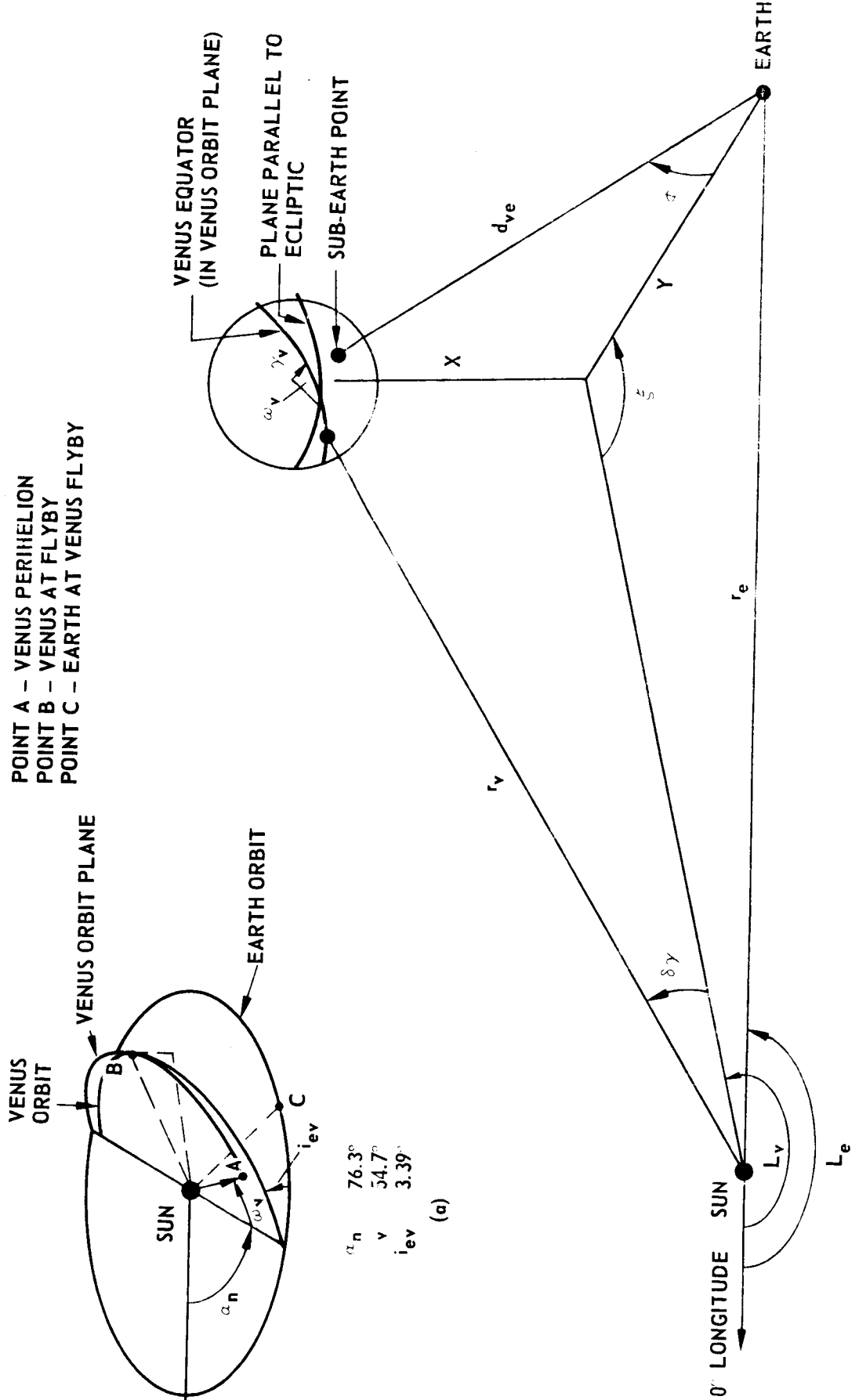
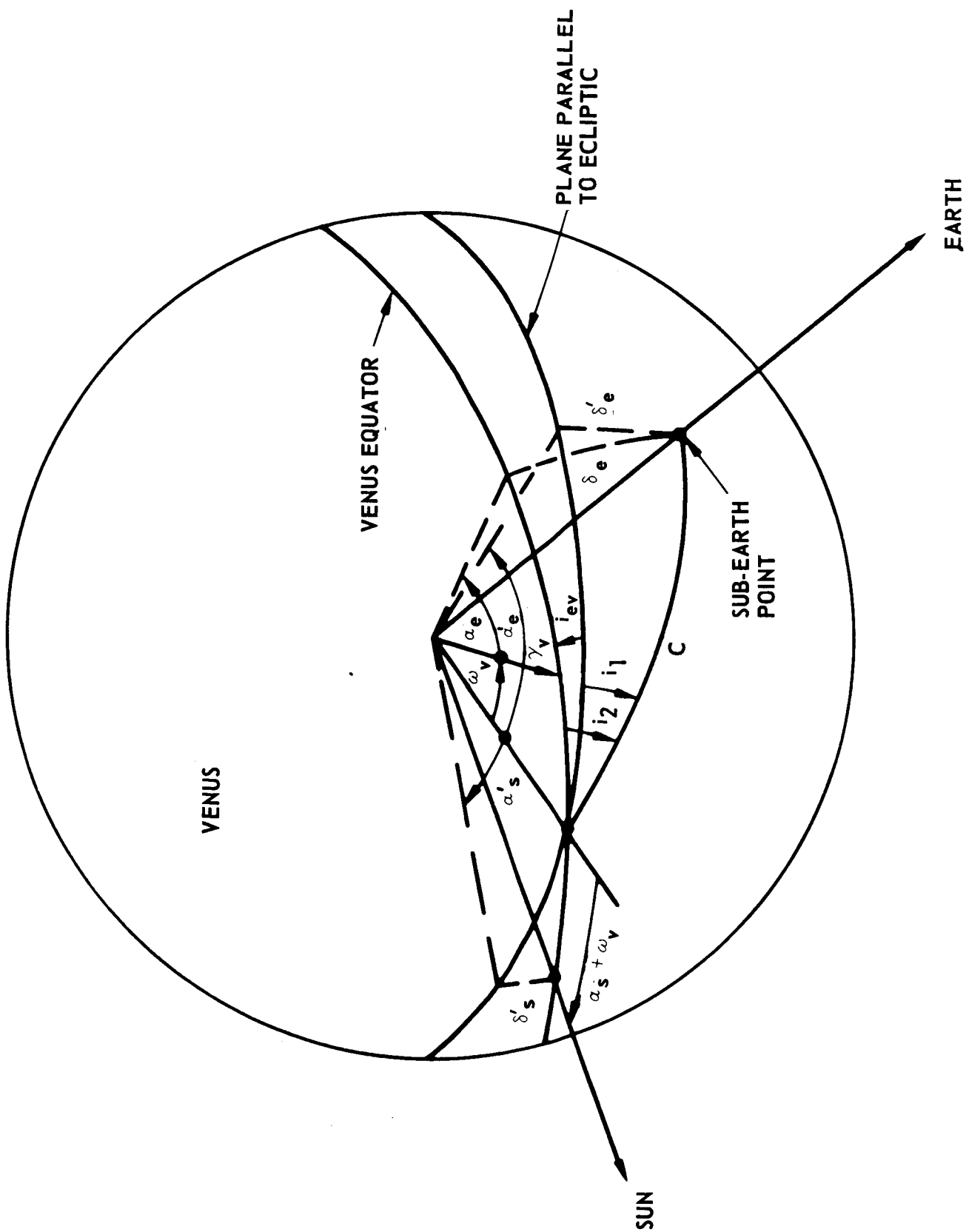

FIG. II-21 VENUS-EARTH-SUN GEOMETRY AT FLYBY



VENUS FLYBY TRAJECTORY ELEMENTS

FIG. II-22

$$\phi = \sin^{-1} \left[\frac{x}{d_{ve}} \right] = \sin^{-1} \left[\frac{r_v \sin \delta_v}{d_{ve}} \right]$$

$$y = d_{ve} \cos \phi$$

$$\xi = \sin^{-1} \left[r_e \frac{\sin (L_v - L_e)}{y} \right]$$

For the Venus flyby date of the reference mission,

$$r_v = .7205 \text{ AU}$$

$$r_e = .9916 \text{ AU}$$

$$d_{ve} = .446 \text{ AU}$$

$$\delta_v = 3.18^\circ$$

$$L_v = 186.65^\circ$$

$$L_e = 162.70^\circ$$

as taken from Reference 2. After solving the equations just given, $\phi = 5.15^\circ$ and $\xi = 115^\circ$ for the reference mission. Referring to Figure II-22, the position of the sub-earth point is determined by solving the following expressions.

$$\alpha'_s = \alpha_n - (L_v - 180^\circ)$$

$$\alpha'_e = \xi - \alpha'_s$$

$$i_1 + 180^\circ = \tan^{-1} \left[\frac{\tan \delta'_e}{\sin \alpha'_e} \right]$$

$$C = \sin^{-1} \left[\frac{\sin \delta'_e}{\sin (i_1 + 180^\circ)} \right]$$

$$i_z = i_1 - i_{ev}$$

$$\delta_e = \sin^{-1} [\sin C \sin (i_2 + 180^\circ)]$$

$$\begin{aligned}\alpha_e &= (\alpha_e + \omega_V) - \omega_V \\ &= \sin^{-1} \left[\frac{\tan \delta_e}{\tan (i_2 + 180^\circ)} \right] - \omega_V\end{aligned}$$

where α_e and δ_e are the right ascension and declination of the sub-earth point, respectively.

The declination of the sub-solar point, δ_s , is zero since the Venus equator is taken in the Venus orbital plane which must, of course, contain the sun. The right ascension of the sub-solar point, α_s , can be obtained with the aid of Figure II-22.

$$\alpha_s = (\alpha_s + \omega_V) - \omega_V = \sin^{-1} \left[\frac{\sin \delta'_s}{\sin i_{ev}} \right] - \omega_V$$

Also, since $\delta_s = 0$, the right ascension of any terminator point, α_t , will be equal to $\alpha_s \pm 90^\circ$, and the terminator declination will have values from -90° to $+90^\circ$.

In determining the time and position relationship during the flyby trajectory as shown in Figure II-20, the following relationships, taken from References 2, 4 and 34 are used.

$$R = \frac{r_p (1 + e)}{1 + e \cos f}$$

e = eccentricity of flyby hyperbolic trajectory = $\sqrt{1 + \tan^2 (90^\circ - \theta/2)}$

where θ is the turn angle computed previously

f = true anomaly

R = radial distance from spacecraft to Venus center.

t (hours from periapsis) =

$$(.7463) \left[\frac{1}{e-1} (e \sinh E - E) \right]$$

$$\text{where } E = \cosh^{-1} \frac{\frac{R}{r_p} (e - 1) + 1}{e}$$

By choosing a value for the true anomaly, f , values are computed successively for R , E and t . For the specific mission considered in this paper,

$$e = 1.743$$

$$R = \frac{5.35}{1 + 1.743 \cos f}, \text{ R in Venusian radii}$$

$$E = \cosh^{-1} [.219R + .573]$$

$$t = 1.742 \sinh E - 1.007E$$

In arriving at values for right ascension and declination to determine the spacecraft ground track on the Venus surface, the following expressions are used, based on the geometry of Figure II-23:

$$\delta = \sin^{-1} [\sin (f - f_D) \sin i]$$

$$\alpha = (\alpha - \alpha_{\Omega D}) + \alpha_{\Omega D}$$

$$= \tan^{-1} [\cos i \tan (f - f_D)]$$

$$\text{where } f_D = \tan^{-1} \left[\frac{\tan (\alpha_p - \alpha_{\Omega D})}{\cos i} \right]$$

$$\alpha_{\Omega D} = \alpha_n + 180^\circ$$

and i is taken here to be the supplement of the inclination solved previously.

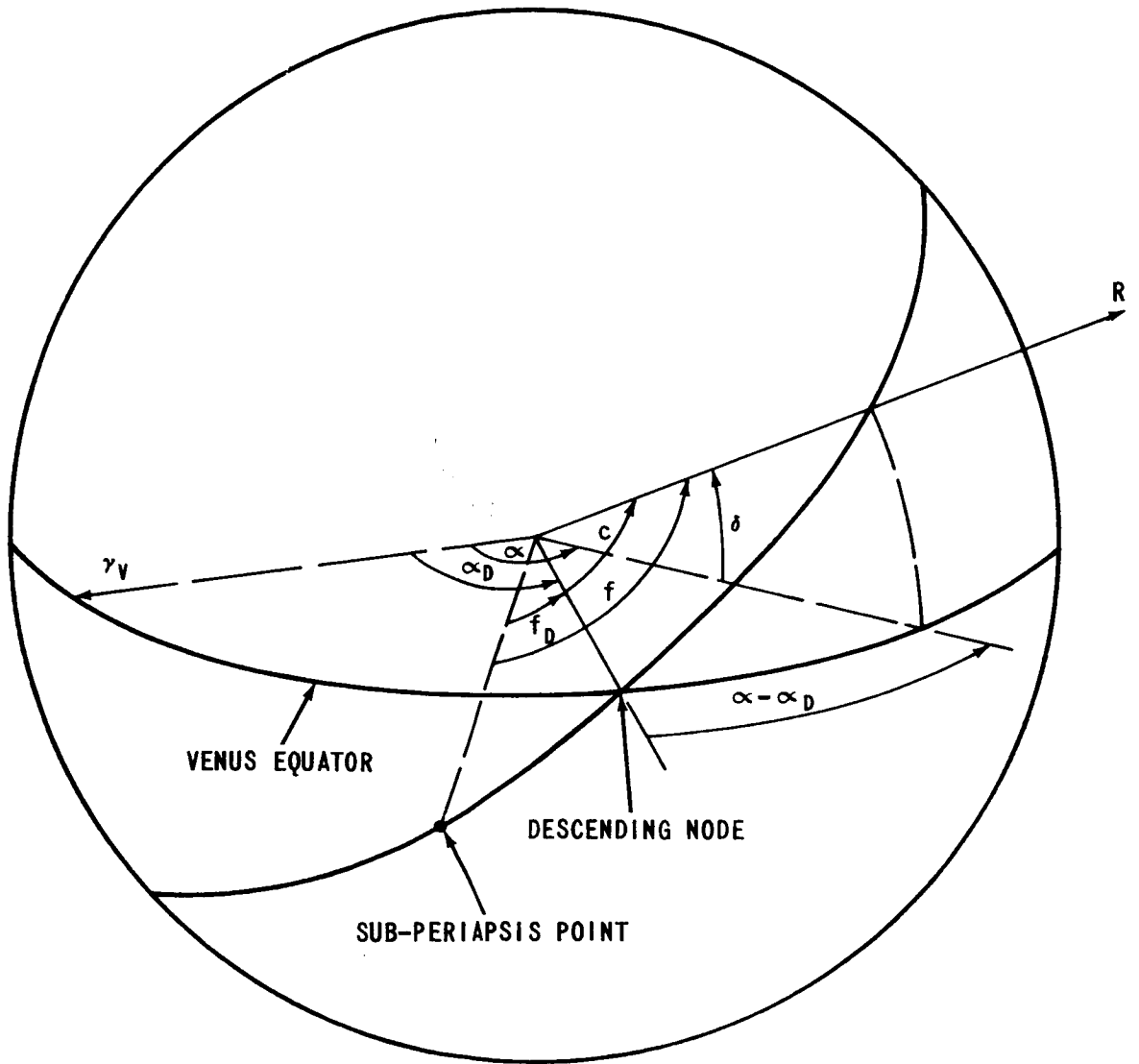

FIGURE 11-23 - VENUS FLYBY TRAJECTORY ELEMENTS

5.0 Inbound Leg

The inbound leg consists of a segment of an elliptical trajectory that extends from Venus at flyby to earth at return. The spacecraft leaves Venus near its perihelion and passes through its aphelion before reaching earth. The inbound leg is much longer in duration than the outbound leg and constitutes the major part of the mission. For the reference mission, the spacecraft sweeps out a sun-centered central angle of 243 degrees in 273 days. The major elements of the inbound leg trajectory can be obtained from Reference 2, and others can be solved in the same manner as indicated in Section 3.0 of this Appendix for the outbound leg. Values for some of the inbound leg elements are the following.

e, ellipticity	= .266
a, semi-major axis	= .979 AU
R_p , perihelion	= .719 AU
R_a , aphelion	= 1.240 AU
T, period	= 353 days

In solving for the spacecraft position at any specific time in the inbound leg trajectory, the same general relationship relating time and spacecraft distance from the sun, R, apply here.

$$R = \frac{a(1 - e^2)}{1 + e \cos f}$$

$$t = \frac{T}{2\pi} (E - e \sin E) - t_0$$

$$\text{where } \tan \frac{E}{2} = \sqrt{\frac{1 - e}{1 + e}} \tan \frac{f}{2} \quad \text{and}$$

f is the true anomaly of the spacecraft in the inbound leg trajectory.

Here, t is measured in days from Venus departure and must be added to the outbound leg transit time to arrive at elapsed mission time. The term t_0 can be solved from either of two end conditions. These are: 1) $t = 0$ when $R = R_v$, the Venus

distance from the sun at Venus departure, and 2) t = the inbound leg transit time when $R = R_E$, the earth's distance from the sun at earth arrival. For the reference mission, these expressions simplify to the following:

$$R = \frac{.909}{1 + .266 \cos f} \text{ AU}$$

$$t = 56.2 (E - .266 \sin E) - 5, \text{ days from Venus departure}$$

$$\tan \frac{E}{2} = .761 \tan \frac{f}{2}$$

In arriving at spacecraft longitude and latitude, a method similar to that illustrated in Section 3.0 is used to give the following results.

$$L_v = 186.65^\circ, \text{ Venus longitude at Venus departure}$$

$$L_e = 69.10^\circ, \text{ earth longitude at earth return}$$

$$I_1 = 3.58^\circ, \text{ inclination of the inbound leg trajectory to the ecliptic}$$

$$\delta_{sc} = \sin^{-1} [\sin (L_o + L) \sin I_1], \text{ spacecraft declination}$$

$$L_{sc} = \tan^{-1} [\tan (L_o + L) \cos I_1], \text{ spacecraft longitude}$$

$$\text{where } L_o = \sin^{-1} \left[\frac{\sin \delta_v}{\sin I_1} \right] = 117.4^\circ$$

and L is the central angle swept out by the spacecraft from Venus departure

The position data for the spacecraft, earth, sun and Venus for the inbound leg are shown on Figures II-14 and II-15. The maximum spacecraft distances to the sun and to earth occur during the inbound leg and are approximately 1.24 AU and .9 AU, respectively.

6.0 Earth Return

The spacecraft will return to earth on a hyperbolic trajectory with a perigee altitude low enough to bring the spacecraft into the atmosphere for an aerodynamic entry. As shown in Section 3.1.3 of the main body of this report, the CM heat shield can be modified to achieve an aerodynamic entry without the use of retro-propulsion.

The major elements of the earth return hyperbola can be investigated in the same manner as the earth departure and Venus encounter hyperbolic trajectories. The V_{∞} vector can be obtained from Reference 2 and has the following value for the reference mission.

Magnitude	$ V_{\infty} = 26.3$ kfps
Right Ascension	$\alpha_{\infty} = 260.0^{\circ}$
Declination	$\delta_{\infty} = -10.1^{\circ}$

It is to be noted here that the direction from the center of the earth to the spacecraft when the spacecraft is at very large distances from earth has a right ascension 180° from α_{∞} and a declination that is the negative of δ_{∞} . This follows from the V_{∞} vector and the vector directed from the center of the earth to the spacecraft being defined as opposite in direction to each other. The entry velocity, defined at an entry altitude of 400,000 feet, can be solved from the following expression to have the indicated value for the reference mission.

$$V_e = \sqrt{\frac{2\mu}{R_e} + V_{\infty}^2} = 44,850 \text{ fps}$$

where R_e is the perigee radius at an entry altitude of 400,000 feet.

The allowable entry angle range is determined by the capabilities of the CM during entry at the entry velocity. The last mid-course correction will adjust the spacecraft trajectory to achieve an acceptable entry angle in this range as well as a desired landing location.

An investigation of the CM capability during entry within the atmosphere is beyond the scope of this study. However, the following set of entry conditions for an Apollo type spacecraft from Reference 4 are given here for consideration.

$$\text{Entry Velocity} = 45,000 \text{ fps}$$

$$L/D = .4$$

$$W/C_D A = 100 \text{ psf}$$

$$\gamma_e, \text{ entry angle for undershoot limit} = -7.61^\circ$$

$$\gamma_e, \text{ entry angle for overshoot limit} = -5.92^\circ$$

The undershoot limit is for a maximum deceleration of 10 g's and full positive lift and the overshoot limit is for full negative lift. For the reference mission of this study, an L/D of .34 for the CM can be expected as can a $W/C_D A$ of about 100 psf. Therefore, the above data from Reference 4 are used here to approximate the performance of the CM during the entry phase of the Venus flyby mission. From the following expressions vacuum perigee radii can be obtained for the undershoot and overshoot cases.

$$R_e V_e \cos \gamma_e = R_p V_p$$

$$V_p^2 = \frac{2\mu}{R_p} + V_\infty^2$$

For the reference mission, the entry corridor or difference in perigee radii for the overshoot and undershoot trajectories is found to be 18.5 n.m.

BELLCOMM, INC.

APPENDIX III

Unmanned Probe Lander Analysis

1.0 Introduction

This Appendix summarizes the analysis conducted to determine the design characteristics of the Unmanned Probe Lander discussed in Section 3.6 of the basic report.

2.0 Venus Entry Velocity

From Appendix II it is determined that, during the period when the spacecraft is outside the spheres of influence of the earth and Venus, the spacecraft will be moving at a velocity of approximately 15,000 fps. Launch of the probe on a trajectory to impact Venus must be carried out at a time when the ΔV requirement will be relatively small since the propulsion unit capability is limited by the overall weight limitation on the probe. Hence, for an initial probe velocity of about 15,000 fps, it is calculated from the constant energy relationship that the probe would enter the Venus atmosphere at an altitude of 400,000 feet with a velocity of approximately 36,500 fps.

3.0 Entry, Descent and Impact

The discussion in the following sections is based on ballistic entry of the probe and descent through an atmosphere which is described as the mean density model in NASA SP-3016, "Venus and Mars Nominal Natural Environment for Advanced Manned Planetary Mission Programs" (Reference 37). The parameters of significance for the following sections are:

Surface density (ρ_0)	-	0.348 lb/ft ³
Scale height (β^{-1})	-	22,000 ft

3.1 Aerodynamic Load

The maximum deceleration achieved during descent is independent of the ballistic parameter of the probe and is given by:

III-1a

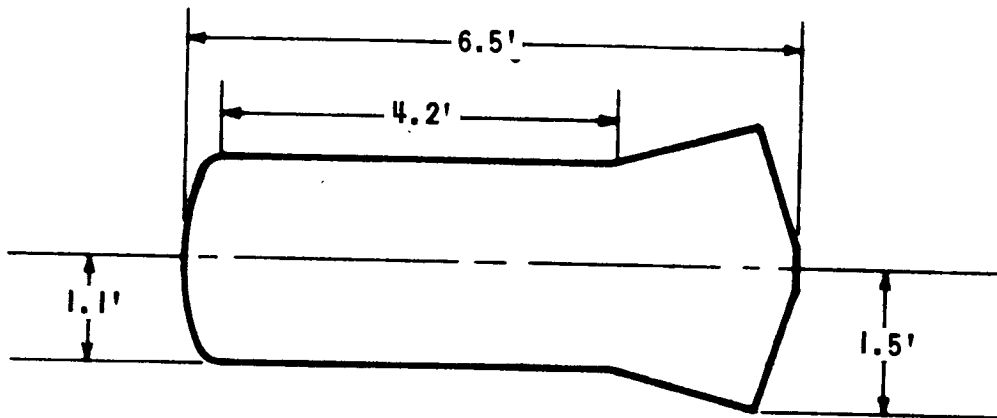

FIGURE III - 1 SHAPE OF VENUS PROBE LANDER

$$\left(\frac{dV}{dt}\right)_{\max} = \frac{\beta V_E^2 \sin \gamma_E}{2\epsilon}$$

where V_E = entry velocity

γ_E = entry flight path angle

ϵ = natural logarithm base

For vertical entry the load reaches a peak of 346 earth g's; and to provide for acquisition of data in the event the entry should be made at such an angle, the probe should be designed for such maximum decelerations. This is considered within the state-of-the-art.

The probe velocity at the point of maximum deceleration is independent of entry angle and is approximately $0.61 V_E$, or 22,300 fps.

The altitude at which maximum deceleration occurs is:

$$H = \frac{1}{\beta} \ln \left(\frac{\rho_o g}{\beta \cdot \frac{W}{C_D A} \sin \gamma_E} \right)$$

where g = gravitational constant (32.174 ft/sec²)

$\frac{W}{C_D A}$ = ballistic parameter

For vertical entry the peak load altitude would vary from 162,000 ft for a ballistic parameter of 5 lb/ft² to 96,000 ft for a 100 lb/ft².

3.2 Aerodynamic Heating

Using the data and approach of Reference 38, it can be shown that the percentage of probe weight which must be devoted to the heat shield for the entry conditions described above is of the order of 10-20% for entry angles greater than 30°. This is based on a probe with a ballistic parameter of 50 lb/ft², drag coefficient of 0.5, diameter of 1 ft, and typical heat shield material with an effective heat absorption of 5,000 BTU/lb. To size the probe it should be noted that the heat shield requirement expressed in percentage of probe weight varies as:

$$C_D \sqrt{\frac{1}{(d) \frac{W}{C_D A} \sin \gamma}} \quad \text{or} \quad \sqrt{\frac{d}{WC_D \sin \gamma}}$$

3.3 Terminal Velocity

The terminal velocity achieved by the probe during its descent to the Venusian surface is determined from the following relationship which describes the probe motion when the drag force equals the probe weight:

$$v^2 = \frac{2g}{\rho_o} \cdot \frac{W}{C_D A}$$

The foregoing yields velocities ranging from 29 ft/sec for a ballistic parameter of 5 lb/ft² to 128 ft/sec for 100 lb/ft², with approximately 90 ft/sec for 50 lb/ft².

In order to obtain data after impact at the higher terminal velocities, it will be necessary to protect the instrumentation payload with impact limiting material. Based on Reference 39, it is estimated that 50 lbs. of balsa-wood at 6.5 lb/ft³, will keep the peak deceleration on impact at a velocity of about 100 ft/sec well within acceptable limits (below 1,000 g's). However, since a high density probe may be required, the low density balsa may be unacceptable.

4.0 Probe Propulsion

The propulsion system requirements of the probe are based on providing a ΔV after launch sufficient to cause an impact on Venus. Assuming that, for the purpose of facilitating the analysis of probe data, it may be desirable to achieve a flight path entry angle of 90°, it has been estimated that a ΔV of about 350 ft/sec would be required for a launch from a distance of 50 Venusian radii. This is a conservative estimate and is based on applying the ΔV only to change the direction of the velocity vector of the probe immediately after launch. While the ΔV requirement could be decreased by launching at a greater distance from Venus, it appears desirable to provide the flexibility of a closer launch.

To size the propulsion system, it is assumed that a ΔV capability of 400 ft/sec will be provided. For a 500 lb. probe, approximately 27 lbs. of solid propellant with a vacuum

specific impulse of about 250 seconds would be sufficient, and it is estimated that the overall weight of the unit would be about 30 lbs.

5.0 Data Acquisition

The data sensed by the probes from entry into the Venusian atmosphere to impact will be telemetered by the probes to the spacecraft which will receive, record and retransmit the data to earth. While the tapes may be returned to earth via the CM, it is desirable that the data be made available for analysis as soon as possible. Based on other analyses, it is estimated that each probe would obtain about 80,000 bits of data over a period of about 6 minutes, including communications blackout, during the descent to the Venusian surface. In addition, data on impact and, if the probe instrumentation survives the landing, on surface conditions would be acquired and transmitted to the limit of the spacecraft-probe range capability.

In order to make the probe data useful, it will be necessary for the spacecraft to track each probe to obtain its position and velocity from entry to impact. Tracking prior to entry is required to establish and maintain probe identity. In this connection, the propulsion unit can be separated on completion of the ΔV burn to expose a probe antenna.

6.0 Power Supply

It is planned that, when each probe is launched from the spacecraft, its power supply will be energized and that power will be supplied to the instrumentation system and to the RF transmission system. The power requirements for those two systems are estimated at 50 and 5 watts, respectively. The former figure is derived from other studies of instrumentation systems, and the latter on a rough calculation for a low data rate, 2200 MHz system at a maximum range of about 3,400 miles.

Launching from a distance of 50 Venusian radii would entail a flight time of about 18 hours to impact. To afford some flexibility the power supply should be sized for a 24-hour flight (about 70 Venusian radii). This amounts to a requirement of 1.3 kw-hrs, which can be supplied by approximately 50 lbs. of silver-zinc batteries.

7.0 Configuration Selection

From the foregoing sections, it is concluded that a useful 500 lb. Venus probe to be launched from a flyby

spacecraft is generally feasible. The weight commitments for a 50 lb. instrumentation payload includes: heat shield - 100 lbs.; propulsion - 30 lbs.; and power supply - 50 lbs. The remaining 270 lbs. should be adequate for the structure, communication, guidance, spin-up propulsion and payload support systems as well as impact limiting material if density considerations permit.

In order to provide a specific configuration to permit completion of the spacecraft analysis, one has been selected from the Venus capsule configurations being studied by AVCO Corporation under contract to JPL (Reference 40). With no attempt at optimization, the shape shown in Figure III-1 has been chosen. This configuration has a $\frac{W}{C^D A}$ of approximately 100 lb/ft² (actually 3.0 slugs/ft²). For^Da 500 lb. probe the packing density is about 17 lb/ft³.

BELLCOMM, INC.

REFERENCES

1. P. L. Havenstein, Bellcomm Memorandum for File, "The Saturn Apollo Applications Program Structured by Planetary Objectives," May 2, 1966 (Confidential)
2. Planetary Flight Handbook, Vol. 3, Parts 1, 2 and 3 (NASA SP-35)
3. V. A. Lee and S. W. Wilson, Jr., "A Survey of Mars Mission Trajectory Characteristics," Report of AIAA/AAS Stepping Stones to Mars Meeting, Baltimore, March 28-30, 1966
4. North American Aviation Report, "Manned Mars and/or Venus Flyby Vehicle Systems Study," SID-65-761, June 1965
5. Apollo Program Specification, (SE-005-001-1), March 1, 1966
6. J. L. Mason, "Man in Space," Chap. 7 of Space Exploration, edited by D. P. LeGalley, p. 197
7. "Natural Environment and Physical Standards for the Apollo Program," (M-DE 8020-008B), April 1965, p. 30
8. J. S. Dohnanyi, Bellcomm Technical Report "Model Distribution of Photographic Meteors," TR 66-340-1, March 29, 1966
9. J. S. Dohnanyi, Bellcomm Memorandum for File, "Meteoroid Hazard for Planetary Missions," July 25, 1966
10. Douglas Missile and Space Systems Division, "Orbital S-IVB Spent Stage Study - Saturn S-IVB Stage Applications," Part II, Vol. I, SM-53176, May 17, 1966
11. S. Glasstone, Sourcebook on the Space Sciences, Princeton, 1965, p. 694
12. R. H. Hilberg, Bellcomm Memorandum for File, "Radiation Shielding Needed for Extended Interplanetary Missions," August 11, 1966
13. "Radiation Biology and Space Environmental Parameters in Manned Spacecraft Design and Operation," Aerospace Medicine, Vol. 36, No. 2, Feb. 1965
14. Boeing Co., "Computer Codes for the Evaluation of Space Radiation Hazards," Vol. 3, D2-90418-3

BELLCOMM, INC.

15. "Study of Heat Shielding Requirements for Manned Mars Landing and Return Missions," NASA CR-308, Oct. 1965
16. Dale D. Myers, "Apollo Spacecraft - On the Mark," Astronautics and Aeronautics, April 1965
17. "Mariner-Venus 1962, Final Project Report," NASA SP-59, 1965
18. "Control Moment Gyro Stabilization Systems for Manned Spacecraft," Langley Research Center, Subprogram 125-19
19. R. C. Wingrove, "Trajectory Control Problems in the Planetary Entry of Manned Vehicles," contained in AIAA Publication CP-9 (Report of AIAA Entry Technology Conference), Oct. 12-14, 1964
20. North American Aviation "Final Report of Preliminary Definition Phase - Apollo Extension System - Guidance and Control System," (SID 65-1520), Dec. 29, 1965
21. Electro-Optical Systems, Inc., "Development of Lightweight Rigid Solar Panel - Interim Design Report," (7027-IDR), May 18, 1966
22. O. F. Trout, "Sealing Manned Aircraft," Astronautics and Aerospace Engineering, Aug. 1963
23. North American Aviation, "Final Report of Preliminary Definition Phase - Apollo Extension System - Environmental Control and Life Support Systems," (SID 65-1523), Dec. 17, 1965
24. E. M. Roth, "Space Cabin Atmospheres - Engineering Trade-Offs of One Versus Two-Gas Systems," Part IV, (Contract NASr-115), March 15, 1966
25. North American Aviation, "Final Report of Preliminary Definition Phase - Apollo Extension System - Mass Properties," SID 65-1532, Dec. 18, 1965
26. F. G. Allen, P. L. Chandeysson and A. E. Hedin, Bellcomm Memorandum for File, "Martian Atmosphere Experiments for Early Missions," August 10, 1966
27. W. L. Piotrowski, Bellcomm Memorandum for File, "Mars Flyby Photography," July 25, 1966
28. R. K. Chen and R. L. Selden, Bellcomm Technical Memorandum "Communication Systems Design for Manned Mars Flyby Mission," TM-66-2021-8, July 29, 1966

BELLCOMM, INC.

29. North American Aviation, Inc., "Allis-Chalmers Fuel Cell Study - Technical Report," SID 65-1543-1, January 1966.
30. "Saturn V Launch Vehicle Data," MSFC Document No. I-V-E-PD2, April 1, 1966
31. "Saturn V July 1966 Performance Report," MSFC, R-AER-DAP-63-66, July 15, 1966
32. Apollo Mission Sequence Plan, Bellcomm TR-65-214-1, Sept. 30, 1965
33. D. van Z. Wadsworth, "Lecture Notes on Aerospace Mechanics (Revised)," BTL MF4-4253-7, May 15, 1964
34. R. H. Battin, "The Determination of Round-trip Planetary Reconnaissance Trajectories," Journal of the Aero/Space Sciences, Vol. 26, No. 9, Sept. 1959
35. F. T. Geyling and H. R. Westerman, Several BTL Technical Memoranda on Celestial Mechanics
36. V. C. Clarke, Jr., "Design of Lunar and Interplanetary Ascent Trajectories," JPL TR 32-30 (Revision No. 1), March 15, 1962
37. "Venus and Mars Nominal Natural Environment for Advanced Planetary Mission Programs," NASA SP-3016, 1965
38. C. Gazley, Jr., "Atmospheric Entry," Handbook of Astronautical Engineering, edited by H. H. Koelle, 1961
39. D. R. Cundall, "Balsa-Wood Impact Limiters for Hard Landing on the Surface of Mars," Report of AIAA/AAS Stepping Stones to Mars Meeting, Baltimore, March 28-30, 1966
40. Avco Corporation, "Mars-Venus Capsule Parameter Study," Vol. 1, RAD-TR-64-1, March 21, 1964

BELLCOMM, INC.

DISTRIBUTION LIST

OMSF

H. Cohen/MLR
J. H. Disher/MLD
F. P. Dixon/MTY
J. A. Edwards/MLO
L. K. Fero/MLV
J. P. Field/MLP
E. Z. Gray/MT
T. A. Keegan/MA-2
D. R. Lord/MTD
C. W. Mathews/ML
G. E. Mueller/M
S. C. Phillips/MA
M. Savage/MLT ← COPY TO ,
W. B. Taylor/MLA
NASA Headquarters Library (2)

MSC

J. A. Chamberlin/EA2
R. R. Gilruth/AA
G. M. Low/AB
R. O. Piland/EX
W. E. Stoney/ET
R. F. Thompson/KA
J. M. West/AD

KSC

K. H. Debus/AA
R. C. Hock/DF
J. G. Shinkle/DA
J. C. Wootton/DB

MSFC

L. K. Belew/I-S/AA
C. H. Chambers/I-V/MGR
W. A. Ferguson/I-S/AA
G. B. Hardy/I-S/AA
R. Ise/I-S/AA
S. R. Reinartz/I-S/AA-MGR
W. von Braun/DIR

Bellcomm, Inc.

R. E. Gradle
D. R. Hagner
J. J. Hibbert
W. C. Hittinger
B. T. Howard
J. Z. Menard
I. D. Nehama
I. M. Ross
C. M. Thomas
C. C. Tiffany
T. H. Thompson
R. L. Wagner
Division 101 Supervision
Division 102 Supervision
All Members Depts. 1021 & 1022
Department 1023
Central File
Library