

# Mars Science Laboratory Sample Acquisition, Sample Processing and Handling: Subsystem Design and Test Challenges

Louise Jandura \*

## Abstract

The Sample Acquisition/Sample Processing and Handling subsystem for the Mars Science Laboratory is a highly-mechanized, Rover-based sampling system that acquires powdered rock and regolith samples from the Martian surface, sorts the samples into fine particles through sieving, and delivers small portions of the powder into two science instruments inside the Rover. SA/SPaH utilizes 17 actuated degrees-of-freedom to perform the functions needed to produce 5 sample pathways in support of the scientific investigation on Mars. Both hardware redundancy and functional redundancy are employed in configuring this sampling system so some functionality is retained even with the loss of a degree-of-freedom. Intentional dynamic environments are created to move sample while vibration isolators attenuate this environment at the sensitive instruments located near the dynamic sources. In addition to the typical flight hardware qualification test program, two additional types of testing are essential for this kind of sampling system: characterization of the intentionally-created dynamic environment and testing of the sample acquisition and processing hardware functions using Mars analog materials in a low pressure environment. The overall subsystem design and configuration are discussed along with some of the challenges, tradeoffs, and lessons learned in the areas of fault tolerance, intentional dynamic environments, and special testing.

## Introduction

The Sample Acquisition/Sample Processing and Handling (SA/SPaH) subsystem for the Mars Science Laboratory (MSL) is a Rover-based sampling system capable of operating in the cold temperature, low pressure, reduced gravity environment of Mars (Figure 1). Scheduled to launch in 2011, the Rover carries a suite of ten scientific instruments capable of making remote and *in situ* measurements of the environment and of the rocks and regolith acquired by SA/SPaH. The SA/SPaH acquires rock and regolith samples from the Martian surface, processes them into fine particles through sieving, and delivers small portions of the powder into the two analytical instruments, SAM and Chemin, inside the Rover. SAM analyzes the chemistry relevant for life, including carbon chemistry, and Chemin determines the mineralogy of the delivered powder. The SA/SPaH can acquire powder from rocks at depths of 20 to 50 mm and can also pick up loose regolith with its scoop. The overall scientific goal of the mission is to assess the habitability, both past and present, of the sites visited by the Rover. The duration of the primary mission is one Martian year (approximately two Earth years.)

In order to perform its main functions of examining, acquiring, processing, and delivering samples for scientific investigation on Mars, SA/SPaH consists of a 5 degree-of-freedom, 2-meter-long Robotic Arm which can manipulate the Turret-mounted tools and instruments. The Turret (Figure 2) is approximately 600 millimeters in diameter and contains 5 devices: a powder acquisition Drill, a scooping, sieving, and portioning device called CHIMRA, a Dust Removal Tool (DRT) for clearing the surface of scientific targets, and two contact instruments, APXS and MAHLI, mounted on vibration isolators. APXS, an Alpha Particle X-ray Spectrometer, and MAHLI, an imager, are two of the ten scientific instruments on MSL.

---

\* Jet Propulsion Laboratory, California Institute of Technology, Pasadena, CA

SA/SPaH also contains other hardware that supports the overall sampling investigation (Figures 3 and 4). These include two spare bits for the Drill in individual Bit Boxes, an Organic Check Material (OCM), an Observation Tray, and Inlet Cover mechanisms that are placed over the SAM and Chemin solid sample

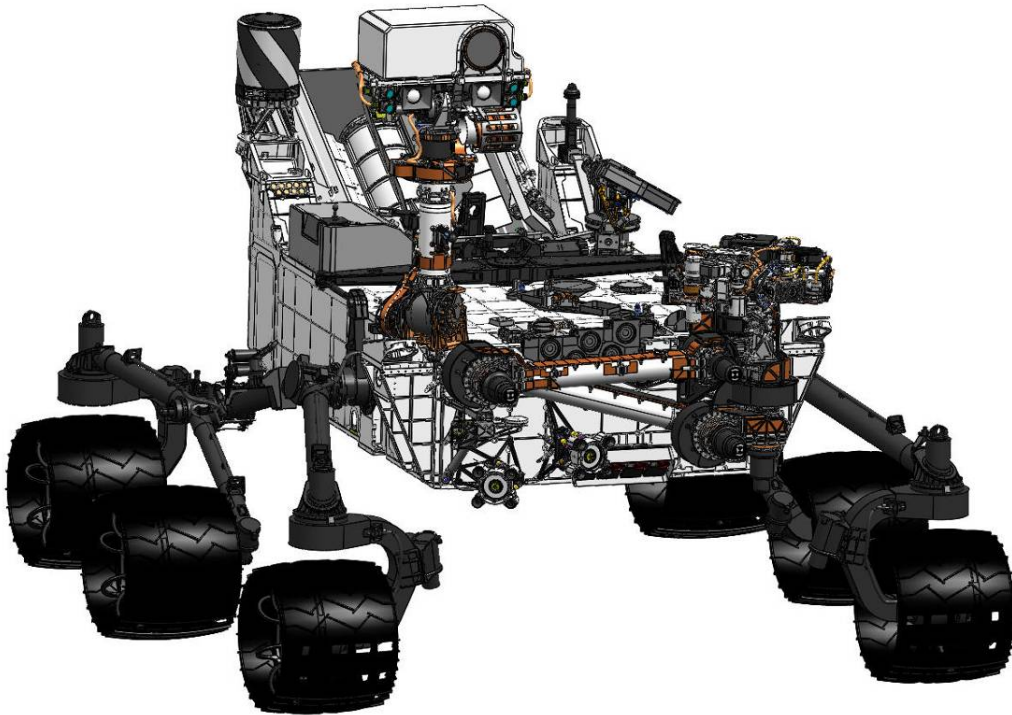

Figure 1. SA/SPaH is mounted on the front of the Rover and is shown in a configuration suitable for driving.

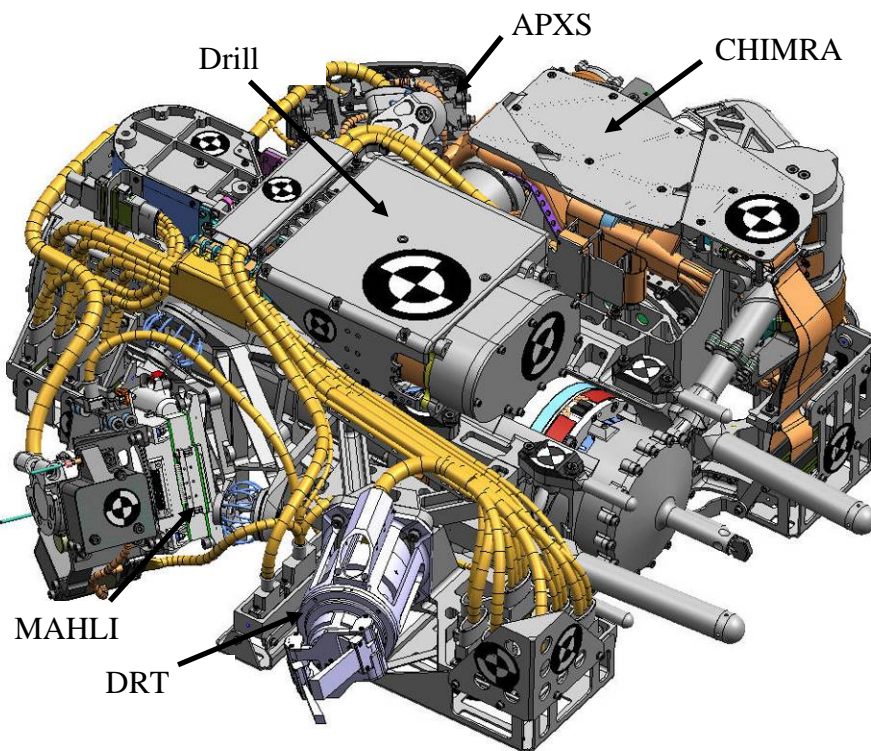
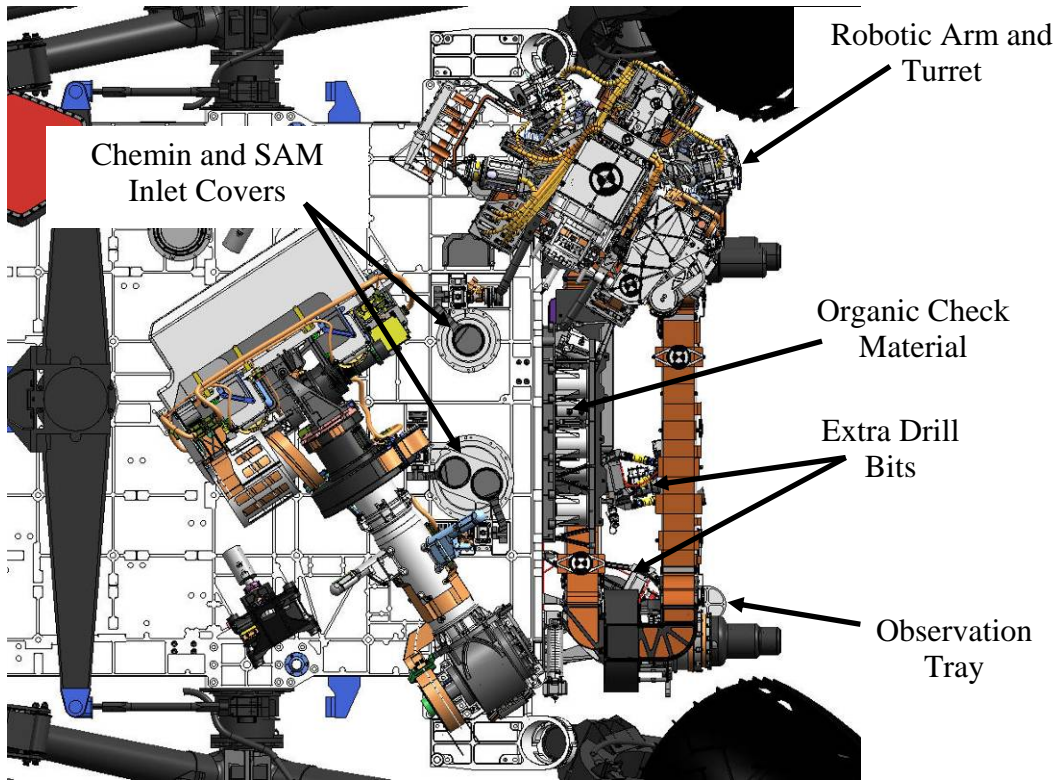
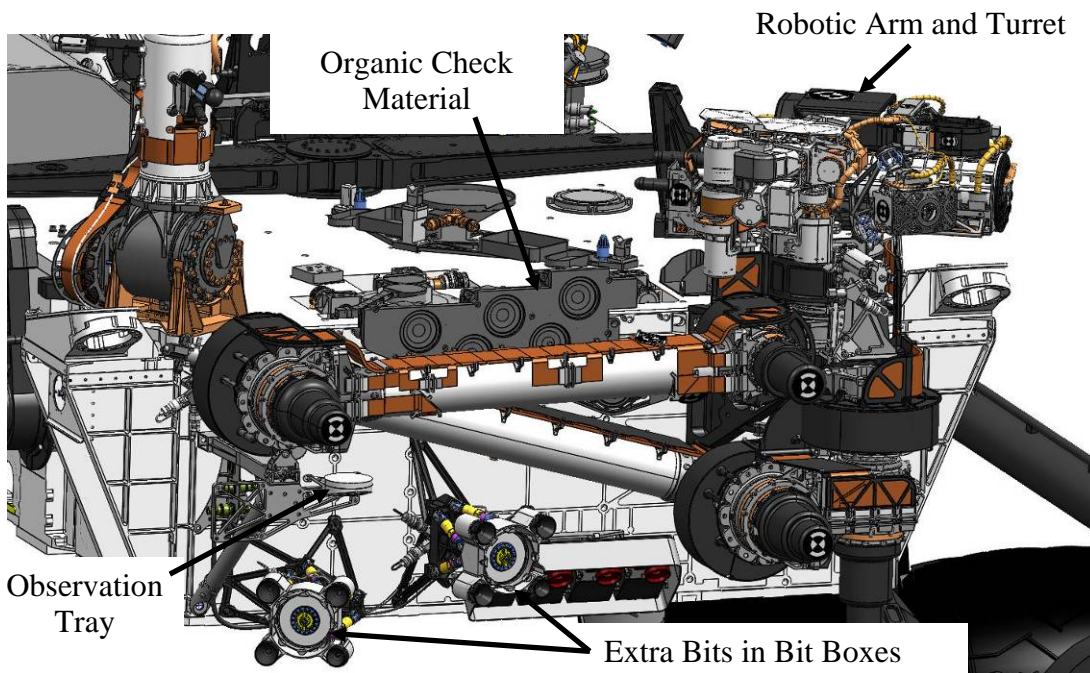

Figure 2. The approximately 600-mm-diameter Turret consists of 5 devices.



**Figure 3. Top View of the stowed SA/SPaH on the Rover**



**Figure 4. Front View of the stowed SA/SPaH on the Rover**

inlet funnels on the Rover deck. The OCM is an inorganic matrix material spiked with a known fluorocarbon calibrant. It is sampled using the Drill and processed with CHIMRA before being deposited in SAM. It is used to assist in the validation of the SAM science results with respect to the detection of organics or the lack thereof. The Observation Tray is a place where sample can be placed for viewing with the APXS or MAHLI. The Inlet Covers are dust covers for the SAM and Chemin funnels.

### **Subsystem Design and Configuration**

The SA/SPaH subsystem is a highly mechanized system with 17 actuated degrees-of-freedom (4 on the Drill, 4 on CHIMRA, 1 on the DRT, 5 on the Robotic Arm, and 3 on the Inlet Covers). Sixteen of the mechanisms are driven by rotary actuators consisting of brushless motors with planetary gearboxes, and encoders as commutation and motor position feedback devices. Drill percussion uses a linear voice coil actuator. Many devices include power-off brakes. The actuators on the Robotic Arm also have output resolvers.

#### Functionality

These 17 degrees-of-freedom are used in a coordinated fashion to perform the operations used to prepare, acquire, process, and deliver samples, and to support other activities necessary for conducting the scientific investigation on Mars. The required operations are:

- Remove dust from the surface of rocks with the DRT
- Place MAHLI and APXS on rock and regolith targets for *in situ* analysis
- Acquire powdered sample from rock interiors, 20 to 50 mm deep
- Acquire regolith sample from the Martian surface
- Process the sample by sorting into fines less than 150  $\mu\text{m}$  and creating up to 6 portions of volume 45 to 65  $\text{mm}^3$  each
- Process the sample by sorting into fines less than 1 mm and creating a single portion of volume 45 to 130  $\text{mm}^3$
- Deliver the portions of sub-150  $\mu\text{m}$  sample to SAM and Chemin
- Deliver the portion of sub-1 mm sample to SAM
- Deliver the remaining sub-150  $\mu\text{m}$  sample to the Observation Tray
- Use the DRT to clean the Observation Tray
- Place APXS and MAHLI on their respective calibration targets
- Acquire powdered sample from the OCM on the Rover using the Drill
- Acquire a bit from a bit box
- Open and close the Inlet Covers over the SAM and Chemin funnels

The 2-meter-long Robotic Arm places and holds the turret-mounted tools and instruments on both rock and regolith targets in its primary workspace and on Rover-mounted hardware such as the Observation Tray, OCM, and Bit Boxes. The Arm also repositions the Drill and CHIMRA with respect to gravity during their sample processing and sample flow activities. Finally the Arm brings CHIMRA into close proximity with the SAM and Chemin solid sample inlet funnels so that CHIMRA can drop its sample portions into the instruments. Figure 5 illustrates the Arm in representative poses for each of these types of activities. Figure 5a shows operation in the primary workspace. Figure 5b indicates a sample processing activity. In Figure 5c, the Arm positions the Turret near an inlet funnel.

The Turret is formed by attaching the 4 other Turret devices to the Drill. The CHIMRA is connected with a parallel blade flexure, the DRT is connected with a bracket, and both instruments (APXS and MAHLI) have a vibration isolator between it and its mounting bracket connected to the Drill. The Drill is attached to the Arm output plate which is rotated using the Turret actuator of the Arm. It is likely obvious by looking at the Turret in Figure 2 that the task of configuring and packaging the Turret was a very challenging endeavor. The challenge is caused both by the large amount of functionality placed on the Turret and by the number and complexity of the interactions with the Martian surface and the Rover-mounted hardware. Choosing this mounting scheme means that the Drill cannot be removed from the Turret without

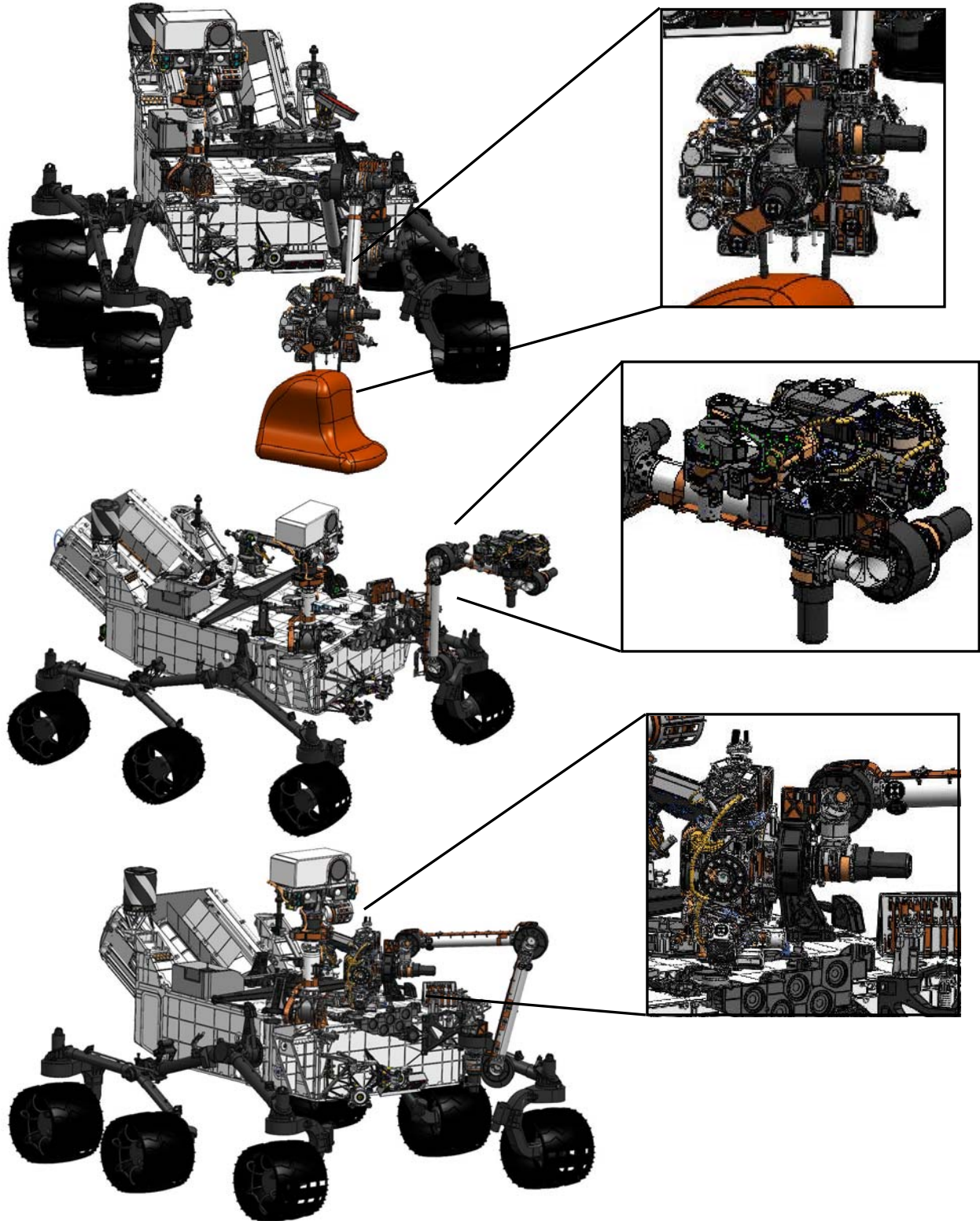
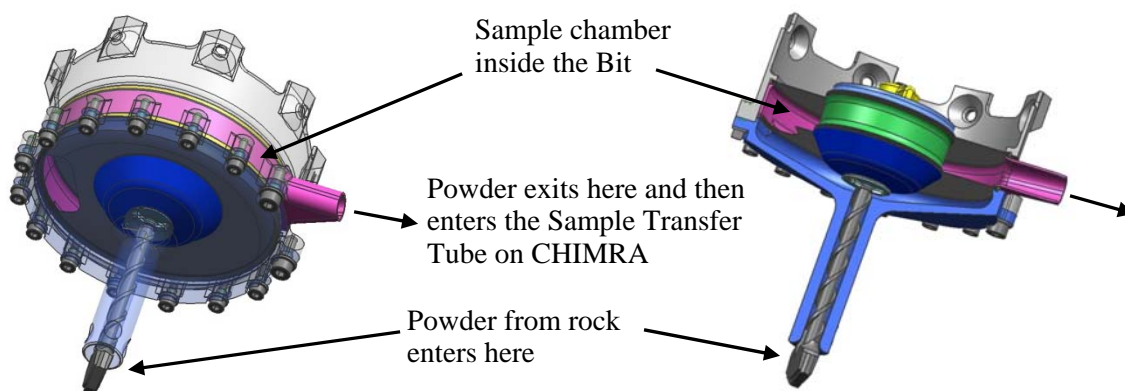

Figure 5. Representative Robotic Arm poses used in sample pathway 1, Drill to sub-150  $\mu\text{m}$  portion: a) Acquiring sample with the Drill, b) Sieving with CHIMRA, c) Depositing a sub-150  $\mu\text{m}$  portion into a SAM Inlet funnel.

disassembly of the entire Turret. Modularity was abandoned in favor of saving the mass and volume of an intermediate mounting structure. Turret mass and volume are both highly constrained resources that had to be committed to early in the design process. Turret mass drives the Arm loads and sizing while Turret volume affects the overall configuration of the subsystem since clearances between the Turret and other hardware had to be considered in both the stowed condition and during operations which put the Turret in close proximity to the Rover.

The Arm exerts large forces between the Drill contact sensor/stabilizer mechanism and the rock surface, stabilizing the Drill against the rock. This keeps the Drill from walking across the rock surface when the cutting bit engages the rock surface. The Arm creates this preload force by placing the Drill against the rock surface using the Drill contact sensor/stabilizer (Figure 5a) and then overdriving the Arm actuators so that the entire system winds up against the overall stiffness of the Arm. The Arm produces >240 N of preload force at its tip in many drilling configurations. The Arm uses the contact sensors on each instrument for placements of APXS and MAHLI. Instrument placements occur with much smaller tip forces (<3.5 N) since neither instrument requires preloading to perform its function.

In SA/SPaH, sample is acquired through either rotary percussive drilling with the Drill on rock targets or by scooping loose regolith with the CHIMRA. The Drill acquires powdered rock samples from up to 50 mm below the rock surface using 3 of its 4 actuated degrees-of-freedom. While the Drill bit is translated into the rock surface, percussion and rotation of the Drill bit also occur to cut and powder the rock material and convey it into the sample collection chamber of the bit assembly. The collected powder travels through the bit using the pathway shown in Figure 6. The fourth degree-of-freedom is used to release the Drill bit assembly from the Drill and to acquire a replacement bit from the front of the Rover. For scooping, the Arm positions the CHIMRA scoop above the loose regolith in an open position. Once positioned, the scoop is closed using its single actuated degree-of-freedom, acquiring material.



**Figure 6. The Drill sample pathway is contained in the Drill Bit. [Reference 1]**

Powdered sample from the Drill moves into the CHIMRA for processing using Arm motions to bias the sample flow and Drill percussion to create material motion. All processing of the powdered or scooped samples, which includes sieving and portioning, takes place in the CHIMRA. Various chambers, labyrinths, and sieves within CHIMRA are used to sieve and portion the material. These functions are carried out by rotating the Arm Turret Actuator to align CHIMRA with respect to the gravity vector to bias the sample flow into the desired chamber while producing material motion with a vibration mechanism. Figure 7 depicts the sample pathways used in the CHIMRA to perform its processing functions. The CHIMRA sieves are mounted to mechanisms that impart shock into the sieves to clear and clean them, preventing cross-contamination and clogging throughout the mission life. This is termed thwacking. The intentional dynamic environments created to move sample around are a key feature of the subsystem and device designs. These are percussion in the Drill and vibration in the CHIMRA. Orientation with

respect to gravity is used only to bias the direction of sample movement but nowhere within the subsystem is gravity relied upon as the sole prime mover.

### Sample Paths

The functionality described in the previous section supports the following five minimum sample pathways required for the scientific investigation on Mars.

1. Acquire rock sample with the Drill and deliver up to six 45-65 mm<sup>3</sup> portions of particles less than 150 μm to SAM and Chemin.
2. Acquire regolith sample with the CHIMRA Scoop and deliver up to six 45-65 mm<sup>3</sup> portions of particles less than 150 μm to SAM and Chemin.
3. Deliver the remaining bulk processed sub-150 μm sample (rock or regolith), after portioning to SAM and Chemin, to the Observation Tray.
4. Acquire regolith sample with the CHIMRA Scoop and deliver one 45-130 mm<sup>3</sup> portion of particles less than 1 mm to SAM.
5. Acquire OCM sample with the Drill and deliver up to six 45-65 mm<sup>3</sup> portions of particles less than 150 μm to SAM and Chemin.

Figure 5 illustrates three representative Robotic Arm poses used during sample pathway 1. In Figure 5a, the Arm has positioned and preloaded the Drill on the target rock. The Drill then uses its translation, percussion, and rotation degrees-of-freedom to powder the rock and auger the powder into a collection chamber in its Drill bit assembly. Sample moves from the Drill bit assembly into CHIMRA through a Sample Transfer Tube connecting the two devices. Particle motion is accomplished by using the Arm to bias the particle flow with respect to gravity and alternately turning on Drill percussion and CHIMRA

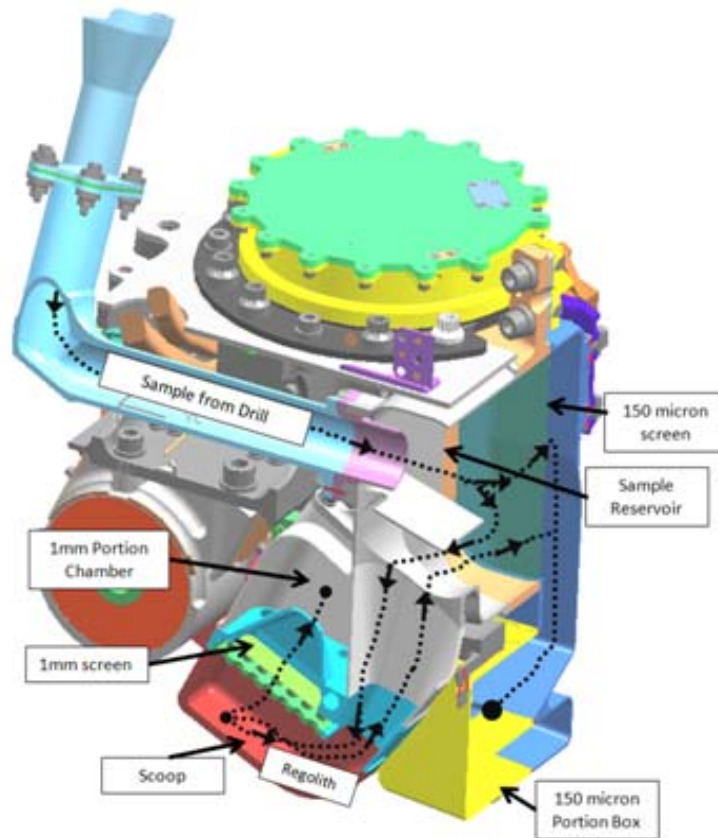

**Figure 7. CHIMRA has three required sample pathways: Drill to sub-150 μm portion, Scoop to sub-150 μm portion, and Scoop to sub-1 mm portion. The Drill to sub-1 mm portion pathway is also physically possible. [Reference 2]**

vibration until the powder has moved from the Drill to CHIMRA. Once inside CHIMRA, powder moves using Arm repositioning and CHIMRA vibration until the pose in Figure 5b is achieved. In this pose, the powder is above the 150- $\mu\text{m}$  sieve. CHIMRA vibration operates until all particles smaller than 150  $\mu\text{m}$  have passed through the sieve. Arm repositioning and CHIMRA vibration is again used to move the sieved particles into the portioning chamber and to create the 45-65  $\text{mm}^3$  portion. The Arm moves CHIMRA to the position in Figure 5c above one of the SAM inlets. The Inlet Cover door opens, the CHIMRA portion door opens, and vibration moves the portion into the funnel. CHIMRA can create and deliver additional portions to either SAM or Chemin. If none are desired by either instrument, the Arm moves CHIMRA away and the Inlet Cover door closes. At this point a number of different choices are available. The Arm can move CHIMRA into a position where it can be opened up and viewed by the Rover cameras. The remaining sub-150  $\mu\text{m}$  particles can be placed on the Observation Tray for viewing by the APXS or MAHLI or all the remaining material can be discarded onto the ground. After CHIMRA uses vibration and thwacking to clean itself, it is ready to process a different sample.

### **Fault Tolerance**

As described in the previous sections, the 17 actuated degrees-of-freedom in the SA/SPaH subsystem are arranged to provide the required functionality and create the 5 minimum sample paths needed to support the scientific investigation targeted at the acquisition and analysis of rocks and regolith. A mix of hardware redundancy and functional redundancy is used with the components of the sample paths to ensure that in the event of a failure, some of the sample paths remain intact. In addition to the hardware components of the SA/SPaH subsystem (Arm, Drill, CHIMRA, Inlet Covers), consideration must be given to the science instruments the SA/SPaH feeds with sample (SAM, Chemin), and the motor drivers.

The Arm is critical to all aspects of the sampling functionality and all 5 sample paths because it positions and manipulates all the Turret-mounted tools. The failure of any Arm joint severely degrades the subsystem functionality and leaves none of the 5 sample paths viable. Therefore the approach here is to provide hardware redundancy, particularly in the electrical circuits required for Arm use. The Avionics subsystem provides the capability to operate 8 actuators simultaneously across all the Rover functionality (32 actuators total, 17 in the SA/SPaH). Multiplexing of the motor drivers provides the needed operations. Due to the importance of the Arm functionality, the multiplex table has a backup driver available if a primary driver for an Arm joints fails. These redundant drivers for each Arm joint are carried in separate cable paths in both the round wire and the flex cable out to each Arm actuator. Moreover these are carried through multiple lines in the flex cable so in the event of a problem in one of the lines, a degraded torque capability would be available. The windings of the motor are not fully redundant but again these elements are created by multiple physical wires terminated at multiple pins so a degraded torque capability would be available in the event of a problem. Each Arm actuator has a power-off brake that is mechanically engaged when non-powered to lock the motor rotor, preventing rotation. A brake solenoid is energized to release the motor. The brakes have redundant coils, each capable of releasing the brake, energized by separate brake drivers and separately cabled. All actuators with brakes on the Rover are configured with redundant solenoids. The mechanical components of each Arm actuator such as bearings, gears, and shafts are not redundant. The life requirement for the Arm joints is not very large: 6000 output cycles or less, depending on the joint. Ensuring a reliable design is done through life testing of a qualification unit.

Instead of using a hardware redundancy approach, the Drill and CHIMRA taken together are designed to have functional redundancy in the overall ability to acquire, process, and deliver samples to the SAM and Chemin instruments. Multiple sample paths from acquisition to depositing into Instrument Inlets exist and while all paths are not equally important to the science investigation, all provide useful science. Figure 8 illustrates the Drill, CHIMRA, and Inlet Cover functions comprising each of the 5 sample paths and the required degrees-of-freedom to perform each function. Except for CHIMRA Vibe, the failure of a single actuated degree-of-freedom can cause the loss of a function and the loss of one or more sample paths but other sample paths remain viable. Due to its importance in all the CHIMRA functionality, CHIMRA



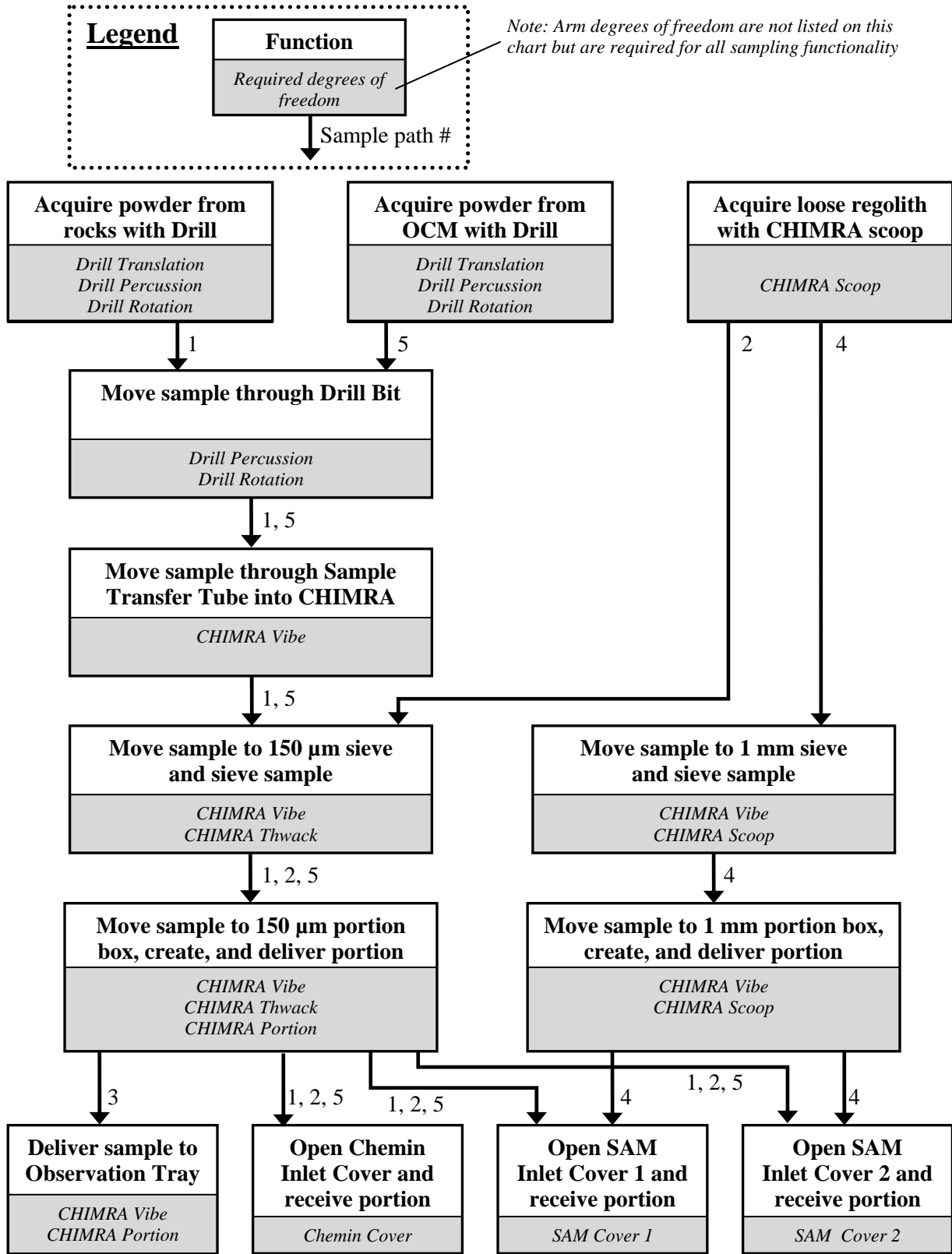

Figure 8. Flowchart of the Drill, CHIMRA, and Inlet Cover functions comprising the 5 sample pathways and the individual degrees of freedom required to perform the function.

Vibe was a likely candidate for hardware redundancy, however there was no place to package a redundant mechanism. Unlike the Arm joints, Vibe requires a high-speed, high-life mechanism so electrical circuit redundancy without mechanical redundancy is not as strong a solution and was not pursued. Instead, Drill percussion may be a viable backup for CHIMRA vibration during these activities. Initial indications from dynamic characterization testing show promise for this possibility but the result will not be definitive until it is demonstrated with sample.

Another failure scenario considered along the sample paths is clogging. This is prevented most effectively through good design practices: large physical paths where particles flow and large margin in the vibration and percussion used to move the particles. The redundant sample paths in CHIMRA allow for some functionality if one path is clogged. CHIMRA can also be opened up and viewed by the Rover cameras which may assist in diagnosing the clog and using dynamic inputs to clear it. However, if the failure to acquire sample with the Drill or to move sample through the Drill is due to clogging of the bit with sample, the bit can be exchanged for a spare bit. Bit release can also be used if the bit is stuck in the ground and cannot be extracted using the large retraction force capability of the Drill translation mechanism.

To enable the effective use of the functional redundancy approach for the Drill and CHIMRA, both the Turret configuration and the subsystem hardware configuration must ensure that the failure of one tool does not preclude the use of the others. More specifically, a CHIMRA scoop or thwack actuator failed in any position cannot prevent the use of the Drill and a Drill feed actuator failed in any position cannot prevent the use of the CHIMRA. In addition these failures cannot prevent the Arm and Turret from returning to its restraint for driving.

#### Lessons

In a sampling system of this complexity, there is an inherent tradeoff between redundancy of capability (function) and breadth of function when choosing the required sample pathways. The specific choices have consequences for both the kind of scientific investigation that can be conducted and for the engineering implementation so the appropriate balance needs to be achieved through iterative conversations between engineering and science. Moreover, the fault tolerance approach is intimately connected to these choices and needs to be considered at this point in time.

The required sample paths must be determined early in the design phase and specified completely by defining the volume of sample, particle size, processing steps, and sequence of processing. The processing of sample and movement of material are volume intensive activities. Sample paths need to be configured and volume and mass resources allocated to the functions so the detailed mechanical design can begin. Once sample paths are selected, the system rigidizes around them and significant changes are no longer possible. The process here is analogous to configuring a spacecraft.

### **Dynamic Environments**

Both the Drill and the CHIMRA create intentional operational dynamic environments to perform their functions on the rocks and regolith they operate on. Although this approach is a robust way to move sample, there are difficulties and challenges with creating an intentional dynamic environment on the coupled dynamic system of the Arm and Turret. One of the main challenges is to create the dynamic environment in the areas where it is needed (the sample processing and flow areas) while keeping it away from the places it is unwanted (the sensitive Turret-mounted instruments, APXS and MAHLI).

The basic design concept for the Turret regarding operational dynamic environments is to separate the operational frequencies of the Turret-mounted tools, CHIMRA and the Drill, and to provide isolation for the Turret-mounted instruments, APXS and MAHLI. Drill percussion operates at about 32 Hz. The translating components inside the Drill are mounted on springs that act to reduce the kickback force disturbance to the rest of the Turret devices from percussion. CHIMRA vibration is created by rotating an eccentric mass at a constant speed where the speed is chosen to be at the frequency of a CHIMRA mode of vibration. Some adjustment of the CHIMRA frequency can be made by changing the thickness of

the parallel blade flexure. The vibration level is adjusted by changing the amount of the eccentric mass and the mass is chosen to produce between 4 and 10 G at the 150- $\mu\text{m}$  sieve. Development testing showed that 150- $\mu\text{m}$  sieving required the highest level of vibration among all the CHIMRA sample functions. 4 G at the 150- $\mu\text{m}$  sieve provided performance with margin for sieving the most difficult material that was tested. 10 G was used as the design limit. An initial prediction of the CHIMRA vibration mode was about 85 Hz but the range of 70-100 Hz was reserved to account for uncertainties. The Turret design keeps the non-CHIMRA Turret modes out of the 70-100 Hz range to minimize the coupling between CHIMRA modes and other Turret modes through frequency separation. The Instrument Isolators are required to limit the Instrument response at the Instrument mounting interface to: 1) 4 G during steady state operation of the CHIMRA and the Drill, and 2) 6 G during transient operation of the CHIMRA and the Drill (such as startup).

The initial Isolator design concept was composed of six linear compression spring struts in a hexapod arrangement (Figure 9). The isolation performance of this concept can be accurately modeled so the spring stiffness can be chosen analytically and then confirmed by test without numerous iterations, a clear advantage over the final wire rope design. However, this design did not fit within the severe volume constraints on the Turret. Also the part count and mechanical complexity of the spring struts was higher than the wire rope Isolator design.

Our wire rope Isolator design (Figure 9) is based on a commercial product used for disturbance attenuation for equipment mounted on aircraft and in shipping containers. It is a mechanically simple component but it is highly nonlinear and not easily modeled. Testing showed that as the disturbance amplitude increases, the Isolator frequency decreases. Sizing our Isolator design required numerous development test iterations. After the desired loop length was chosen by testing the commercial versions, an Isolator suitable for flight was created using aluminum caps with stainless steel wire rope bonded into holes tailored to provide a good bonded joint. Further development testing determined the appropriate number of wires needed for each Instrument Isolator to meet its performance requirements while minimizing the instances of the Isolator bottoming out during random vibrate testing. Response limiting during random vibrate testing is also being used to prevent this issue.

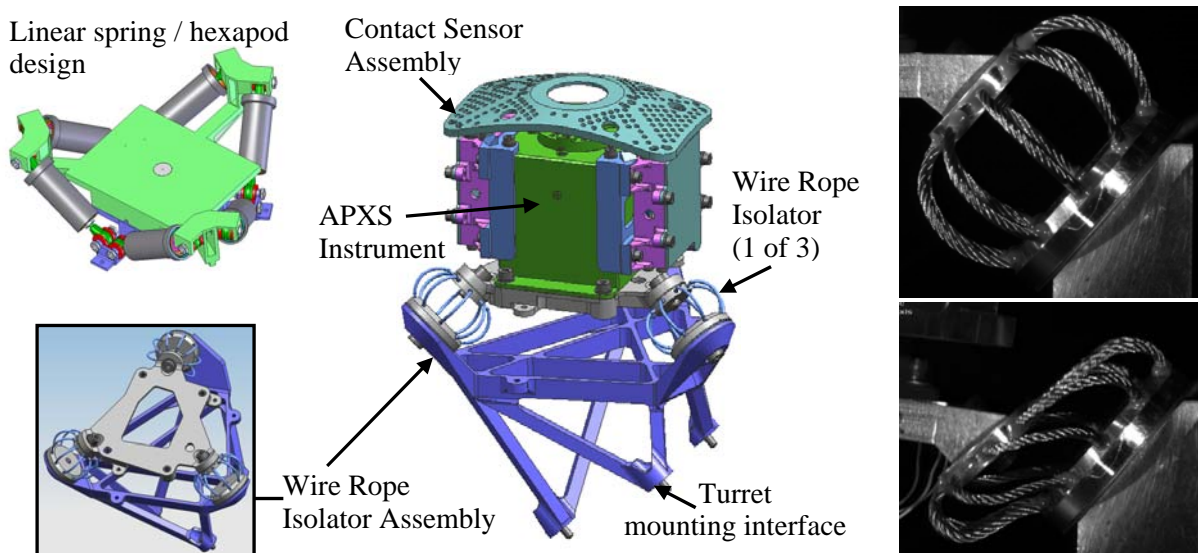

**Figure 9. Two Isolator designs were considered before the wire rope design was chosen. The APXS instrument is shown on its wire rope Isolator. One of the wire rope Isolators is shown deforming under the PF level launch environment during an Instrument Isolator development test.**

## Lessons

When using large intentional operational dynamic environments in a sampling system, anticipate the need for isolation to protect sensitive instruments located near the dynamic sources. Address the need early on in the subsystem configuration studies by either using discrete isolator assemblies (as in SA/SPaH) or by physically separating these instruments from the dynamic sources in the overall configuration.

The wire rope isolator proved to be an effective solution for our space-constrained Turret but at the expense of lots of development test time.

## **Testing**

For many elements of the SA/SPaH design, testing began with development testing on specific functions of sampling to determine and appropriately size the basic elements of the subsystem and the devices within the subsystem. These tests informed our hardware design choices and were used extensively in the areas where new designs were developed such as the Drill, CHIMRA, DRT, Instrument Isolators, and Bit Box. Development testing was the start of our process of risk reduction and subsystem characterization.

All SA/SPaH hardware elements have both an Engineering Model (EM) and a Flight Model (FM). EM units are flight-like but generally see a reduced test program (no random vibrate and limited or no thermal testing) prior to delivery to a system testbed. EM tests for the Drill, CHIMRA, and Arm are targeted at understanding the mechanism performance. In the testbed, this hardware is eventually assembled into a Rover-based SA/SPaH subsystem and operated with flight-like electronics and flight software in an Earth ambient environment, including operations on rocks and regolith. In a few instances (DRT, Instrument Inlet Covers, and Instrument Contact Sensors), EM units see a full test program and serve as Life Test Units prior to testbed delivery. FM units see a full test program designed to prove acceptance for flight.

In addition to the EM and FM units, the Drill, CHIMRA, and Instrument Isolators also have a Qualification Model (QM). QM units are used for mechanism life tests, structural verification, sampling verification and validation (operating on Mars analog rocks and regolith in a low-pressure Mars environment over the temperature range), validation of the contamination control processes, and thermal characterization.

The Drill and CHIMRA in the integrated Turret configuration form a critical portion of the MSL sample chain from acquisition of material until deposition into the analytical instruments. In addition to the typical flight hardware qualification test program, two additional types of testing form an essential part of the test program. The first is the dynamic characterization of the Turret hardware to its self-induced operational dynamic environments of CHIMRA vibration and Drill percussion. The second is the testing of the sample acquisition and processing hardware functions using Mars analog materials in a low-pressure Mars environment over the required temperature range.

The flight-like EM Turret, consisting of the EM Drill, CHIMRA, Instrument Isolators, mounting brackets, and mass models in place of the DRT, APXS, and MAHLI, was assembled on the EM Arm (Figure 10). The Turret and Arm were heavily instrumented with accelerometers to measure the response to CHIMRA vibration and Drill percussion in various Arm poses relevant to the SA/SPaH functions. Locations include the soft side of the MAHLI and APXS Isolators, near each CHIMRA sieve, the Sample Transfer Tube, the Drill aft housing, and some of the Arm joints (a total of 10 3-axis accelerometers).

The purpose of Turret dynamic characterization testing is to determine the response to CHIMRA vibration and Drill percussion at critical locations on the Turret, to find the frequency of the CHIMRA mode, therefore determining the operating speed of CHIMRA vibrate, to select the value of the eccentric mass that produces 4-10 G on the primary sieve, and to confirm that the Isolator requirements are met in the presence of the Drill and CHIMRA operational dynamic environments. Figure 11 shows two of the many poses characterized in the testing. The primary sieve pose is a particularly important one since it sizes

the eccentric mass. Data were taken with the Arm in the sieve pose with the Turret at different angles and the Drill in the surface stow position. The Drill surface stow position aligns the sample exit on the Drill bit with the Sample Transfer Tube. In the nominal operating position (Turret at 180 degrees), the results show the Instrument response meets the 4 G requirement during steady state CHIMRA operation with the steady state response at CHIMRA set near 8 G in the X direction. The CHIMRA response in the Y and Z directions is less than 4 G. No higher response was observed during startup. It is interesting to note that by changing the Turret position, the CHIMRA response can be increased or decreased (over the range of 7 to 10.5 G in the X direction) while still meeting the Instrument requirements. This may prove to be a useful feature if difficulties are encountered during testing or on Mars.

The EM Turret is about to begin testing with Mars analog materials in a low-pressure environment which is called EM Dirty Testing to highlight the fact that rocks and regolith are being processed. Although extensive development testing was done, this is the first testing with Mars analog materials on flight-like hardware in an assembled flight-like configuration.



**Figure 10. The assembled EM Turret with the Drill, CHIMRA, and Instrument Isolators installed. Mass models are used for the DRT, APXS, and MAHLI.**

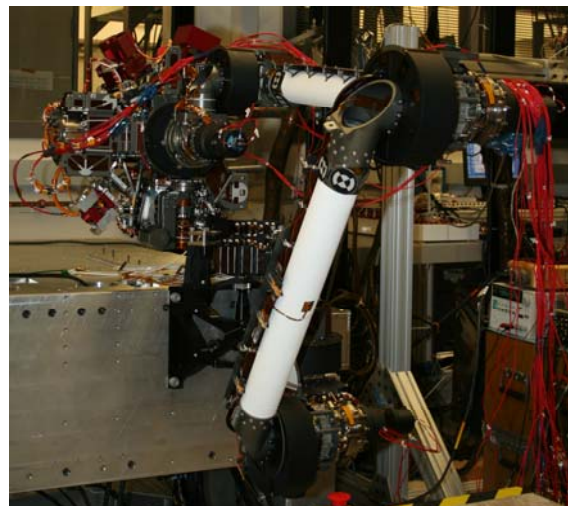
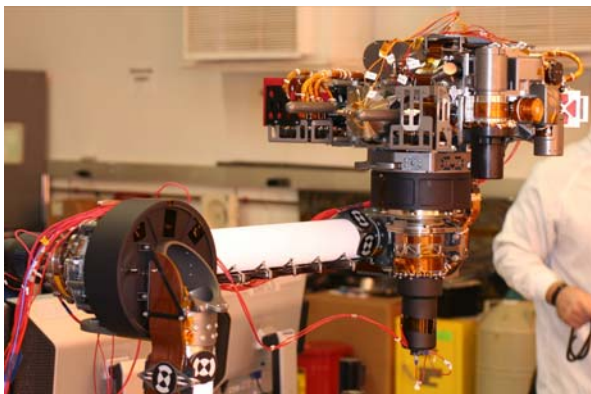

**Figure 11. The EM Turret / Robotic Arm during dynamic characterization testing: primary sieve pose with the Turret at 180 degrees (left) and depositing a 150-µm portion (right).**

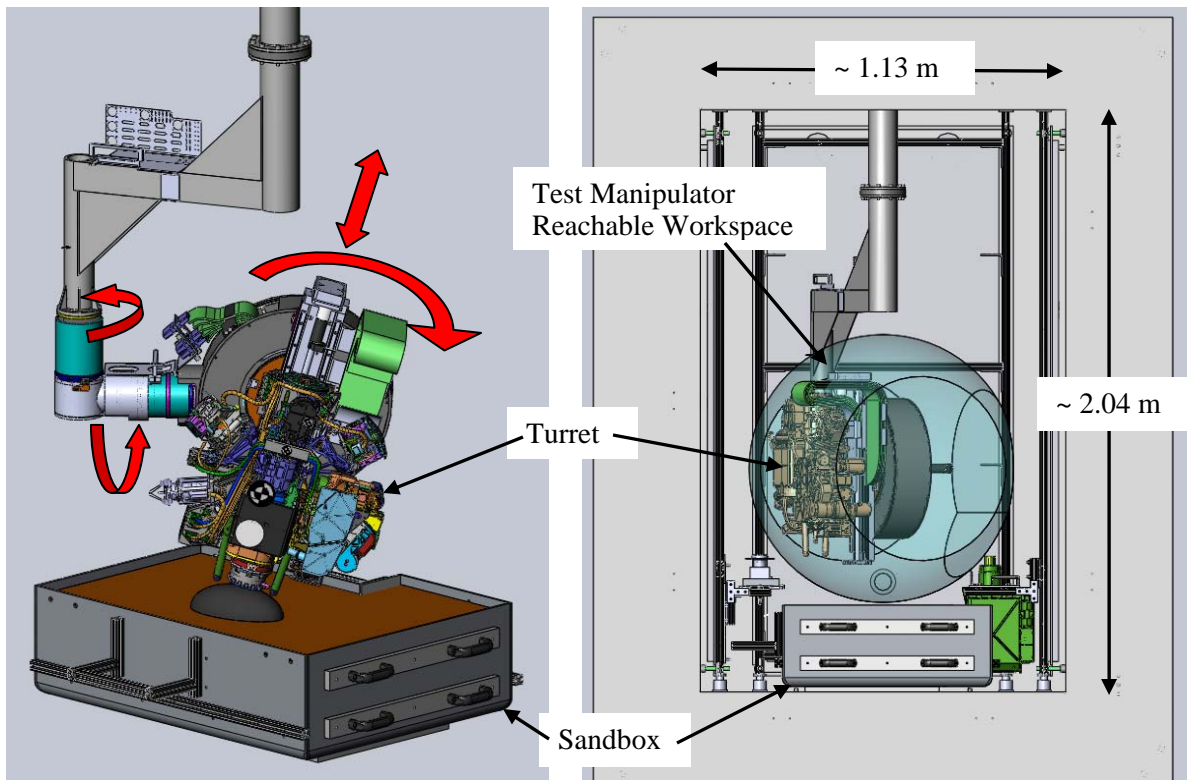

**Figure 12. The Turret is shown installed on the test manipulator and drilling a rock in the sandbox (left) and inside the chamber (right).**

Figure 12 illustrates the Turret installed on the test manipulator and in the test chamber. The 4 degree-of-freedom test manipulator was developed as a substitute for the Arm during both the EM and QM Dirty Test programs for two reasons. One is that no Arm is available to support these tests since the EM Arm is fully subscribed in the testbed and there is no QM Arm. Two is the test manipulator enables the testing to occur in a chamber that is more manageable in size than the one that would accommodate the Arm. The more manageable size comes at the cost of another dynamic characterization program. Dynamic characterization of the EM Turret instrumented with accelerometers on the test manipulator will be done in the same manner as when it was installed on the Arm. For the sampling functional performance results on the test manipulator to be valid, the Turret response needs to reproduce or be bounded by the Turret response on the Arm so the functional performance can be linked to the operational dynamic environment that the flight configuration produces. Adjustments in the test manipulator after characterization may be required to accomplish this.

#### Lessons

Characterize the operational dynamic response in hardware configurations other than the nominal ones. Although this time will be difficult to find in the typically oversubscribed test schedule, it can result in ways to alter the behavior of the system that may prove useful when difficulties are encountered both in the Earth-based sampling testing and in service on Mars.

The additional complexity added to the test program when using intentional dynamic environments to process sample cannot be overstated. Care must be taken to ensure that the relevant environment is produced when the hardware test configuration changes.

## Conclusions

The MSL SA/SPaH has been designed and implemented, with flight-like EM hardware about to start Dirty Testing and the remaining hardware (QM, FM) soon to follow. Along the way some lessons were learned in subsystem configuration, fault tolerance, intentional dynamic environments, and special testing. Additional lessons are still to come as the EM, QM, and FM test programs are completed.

## Acknowledgements

The work described in this paper was performed by the Jet Propulsion Laboratory, California Institute of Technology, under contract with the National Aeronautics and Space Administration.

Creating something like the SA/SPaH and producing it for flight is an enormous undertaking that relies on substantial contributions from far too many people to name effectively. So I will acknowledge a set of JPL people while recognizing that they like me are just the most visible representatives of the group. The hardware cognizant engineers and their teams have worked tirelessly for years to reach this point: Kyle Brown (Bit Box), Brett Kennedy (Robotic Arm), Dave Levine (Turret Configuration, Isolators), Avi Okon (Drill), and Dan Sunshine (CHIMRA). Mark Balzer, Richard Barela, Kevin Burke, Joe Melko, Suparna Mukherjee, Matt Orzewalla, Don Sevilla, Lori Shiraishi, Jeff Umland, and Chris Voorhees have made substantial contributions, also for years. Special thanks go to Dave Putnam of Lockheed Martin, Sunnyvale, who spent a great deal of time with the team when the Drill and CHIMRA mechanisms were in their infancy.

## References

1. Okon, Avi B. "Mars Science Laboratory Drill." *Proceedings of the 40<sup>th</sup> Aerospace Mechanisms Symposium*, (May 2010).
2. Sunshine, Daniel. "Mars Science Laboratory CHIMRA: A Device for Processing Powdered Martian Samples." *Proceedings of the 40<sup>th</sup> Aerospace Mechanisms Symposium*, (May 2010).

