

U.S. DEPARTMENT OF THE INTERIOR  
GEOLOGICAL SURVEY

**OPEN FILE REPORT 01-312**

# **The Containment of Soviet Underground Nuclear Explosions**

Vitaly V. Adushkin  
Institute of Dynamics of Geospheres  
Of the Russian Academy of Sciences  
Moscow, Russia

William Leith  
U.S. Geological Survey  
Reston, Virginia 20192



This report is preliminary and has not been reviewed for conformity with U.S. Geological Survey editorial standards or stratigraphic nomenclature. Any use of trade, product, or firm names is for descriptive purposes only and does not imply endorsement by the U.S. Government.

**SEPTEMBER 2001**

**TABLE OF CONTENTS**

PREFACE ..... 3

Chapter 1. THE NUCLEAR TESTING PROGRAM ..... 5

    1.1 Introduction ..... 5

    1.2 Definitions of Containment ..... 5

    1.3 Brief History of Nuclear Testing in the USSR..... 6

    1.4 Limits on Nuclear Testing ..... 9

    1.5 Types of Underground Nuclear Tests ..... 9

    1.6 Locations Where Nuclear Tests were Conducted..... 12

    1.7 Underground Testing at the Semipalatinsk Test Site..... 14

    1.8 Announcement of Nuclear Tests ..... 16

    1.9 Detonation Authority and Procedures ..... 16

Chapter 2. CONTAINMENT OF UNDERGROUND NUCLEAR TESTS..... 19

    2.1 What Happens During an Underground Nuclear Explosion..... 19

    2.3 How Nuclear Explosions Remain Contained ..... 22

    2.4 Selecting Location Depth and Spacing ..... 23

    2.6 The Containment Evaluation Panel..... 26

    2.7 Containing Vertical Shaft Tests ..... 27

    2.8 Containing Horizontal Tunnel Tests ..... 28

    2.9 Types of Radiation Releases ..... 32

    2.10 Record of Containment..... 34

    2.11 “Tired Mountain” Syndrome..... 35

    2.12 Statistics on the Containment History of Soviet Tests ..... 38

    2.13 A Few Examples..... 43

Chapter 3. MONITORING ACCIDENTAL RADIATION RELEASES..... 46

    3.1 Criteria for Conducting a Test ..... 46

    3.2 Examples of Containment Failures ..... 47

    3.3 Groundwater Contamination ..... 47

    3.4 How Safe is Safe Enough? ..... 50

Acknowledgements ..... 50

Bibliography ..... 51

*On the Cover:* Section of a “line of sight” pipe, extending from one of the three tunnels at Degelen mountain test site no. 169/2. This pipe, which is about 2 meters in diameter, was evacuated during the nuclear test at this site, on the 4<sup>th</sup> of October, 1989.

## PREFACE

This report was prepared in 2000-2001 under a contract between the U.S. Geological Survey and the Institute of Dynamics of Geospheres of the Russian Academy of Sciences (Contract no. OOHQSA0727). This goal of the project was to produce, for Soviet underground nuclear testing, a report mirroring Dr. Gregory van der Vink's report, "*Containment of Underground Nuclear Explosions*", published in 1989 by the U.S. Congress' Office of Technology Assessment. That report reviewed in detail the containment of U.S. nuclear tests at the Nevada Test site, with special attention devoted to safety and environmental aspects of underground nuclear testing. The current report uses as its outline the structure of the OTA report, modified to accommodate the differences between Soviet and U.S. nuclear testing practices and containment experiences. The basic contract reports that were provided by the Russian authors of this study have been supplemented by other published information and some unpublished works, improved citations of the literature, and a number of illustrations. Most of this report is, therefore, based on a translation from Russian to American English that was subsequently edited. The original Russian reports are available upon request to W. Leith (*email: wleith@usgs.gov*).

Basic data on Soviet underground nuclear tests are published in the six volumes of "*Nuclear Testing in the USSR*." Volume 1 of this series (published by RFYaTs-VNIIEF, 1997, as an update to MINATOM, 1996; a nearly-identical version was also published by IzdAT, 1997) contains summary data for all Soviet nuclear tests, excluding hydronuclear tests. Volume 2 presents information on the technology of nuclear testing; Volume 3, on military and political aspects of nuclear testing; Volume 4, summary information for 115 of the so-called "Peaceful Nuclear Explosions," (PNEs); Volume 5, nuclear testing and the environment. Note that, the numbers of underground nuclear tests of various types reported in these publications are inconsistent and may, in places, differ from that presented herein: For example, for the Peaceful Nuclear Explosions (PNEs), Volume 2 (*op cit*) lists 115 PNEs; while Volume 1 lists 124, and both *Sultanov et al* (1993) and *Laushkin et al* (1995) list 122 PNEs. The inconsistencies are apparently due to how tests were categorized. The categorization of underground nuclear tests used herein is that of *Adushkin and Laushkin (Experience monitoring UNTs with the seismic network of the former USSR, FSSN, v.3, 1996)*; this is shown graphically on the next page, as well as in Tables 1 and 2.

For the Semipalatinsk test site, a book reviewing nuclear testing there was published by *MEDVIO-EKSTREM* in 1997. Additional data are available in several publications, including, for underground tests: *Bocharov et al* (1989), *Adushkin et al* (1995), and *Leith* (1998). A summary of the record of containment of underground nuclear tests at the Semipalatinsk test site is available in *Gorin et al* (1993). Summary data for Soviet nuclear tests in the atmosphere is available in *Dubasov et al* (1993), and height-of-burst and other data for atmospheric nuclear explosions are available in *Andryushin et al* (1998). The latter reference also includes a listing of hydronuclear experiments conducted at the Semipalatinsk test site. A number of these hydronuclear tests (which resulted in plutonium contamination of the local environment) were conducted in tunnels at the Degelen Mountain test site, and may therefore be of interest for containment studies.

For the Novaya Zemlya test site, books reviewing nuclear testing there were published by the Khlopin Radium Institute (1999) and *IzdAT* (2000). Additional information on nuclear test containment is available in *Mikhaylov and Chernyshev* (1991), *Mikhaylov et al* (1991), *Chelyukanov and Savel'ev* (1992) and in *Andrianov and Bazhenov* (1992). The latter includes detailed descriptions for a number of containment failures at Novaya Zemlya that (summarized in this report). In general, the containment record at Novaya Zemlya has been poor (and is described some in detail, herein); this is of concern since it is now the only declared Russian nuclear test site.

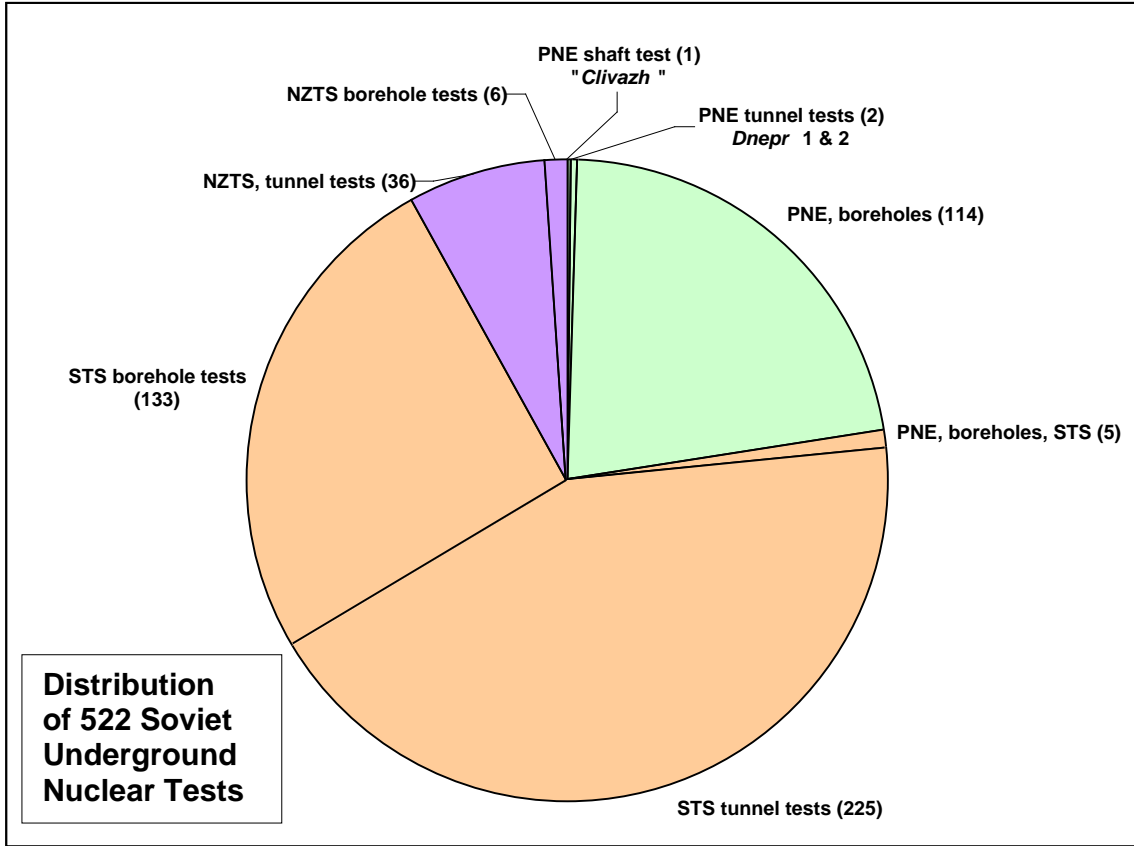

Number of Soviet Underground Nuclear Tests, categorized in terms of test emplacement mode (tunnel, borehole, shaft), and color coded by location (STS = Semipalatinsk Test Site, 363 tests; NZTS = Novaya Zemlya test sites, 42 tests; PNE = Peaceful Nuclear Explosions, 122 tests, including 5 PNEs on the STS). Hydronuclear tests are not included.

## CHAPTER 1. The Nuclear Testing Program

### 1.1 Introduction

Conducting nuclear tests is one of the most important elements in the technology of creating and improving nuclear weapons. In 1963, due to the serious environmental consequences of nuclear testing in the atmosphere, hydrosphere and in near space, the USSR, USA and Great Britain signed *the Treaty on Prohibiting Nuclear Weapons Testing in Three Media* (in the atmosphere, in space and under water), also known as the *Limited Test Ban Treaty*. Currently, this Treaty is signed by 117 nations.

The 1963 Treaty ushered in a new stage in nuclear testing, in which nuclear tests were conducted only underground. Nevertheless, this did not obviate the question of the environmental consequences of nuclear tests. The results from early underground nuclear tests indicated that releases of radioactive materials into the atmosphere were possible. As a result, during the entire period of underground testing, serious research was conducted to guarantee the ecological safety of underground nuclear explosions. One of the primary directions of this research was to guarantee the so-called "camouflagic" (contained) nature of nuclear explosions, that is, to conduct underground explosions under conditions which guarantee keeping the primary radioactive by-products that are most dangerous to man, within the area immediately surrounding the explosion location.

The basis for providing containment of nuclear tests was the concept of creating a relatively impermeable barrier to the migration of the non-condensed radioactive gasses found in the explosion cavity under high temperatures and pressures. For this barrier, it was suggested to use the layer of rock above the underground explosion. As data were obtained on the level of rock damage in the close-in zone of the nuclear explosion, concepts improved about zones of irreversible behavior of the rock massif and of the rock composing it (the so-called "zonal" approach to describing the mechanical effects of an underground nuclear explosion, see below). It was established that, in addition to buckling/crushing zones of the rock and massif damage directly abutting the explosion containment cavity, there exists an area of damaged medium near the free surface (the spall damage zone) and in the vicinity of large, tectonic faults, which significantly reduces the insulating properties of the rock massif.

It is also asserted by Russian scientists that underground nuclear tests conducted in the USSR from 1985 to 1990 support the conclusion that the task of guaranteeing containment of underground nuclear explosions has been successfully solved at the former Soviet nuclear test sites.

### 1.2 Definitions of Containment

The Limited Test Ban Treaty (LTBT) established an international requirement for adequate containment of the radioactive products of underground nuclear explosions. Article 1.1(b) of this treaty prohibits an explosion that "...causes radioactive fallout [in Russian, "*posadkha*"] to be present outside of the territorial limits of the State under whose jurisdiction or control such explosion is conducted." Using this simple criterion, one might judge that the majority of U.S., Soviet, Chinese and French underground nuclear tests were "contained," but only to the extent that they were compliance with the LTBT. However, the U.S., the Soviets/Russians and the French have since developed more rigorous requirements for containment.

The U.S. defines successful containment as "such that a test results in no radioactivity detectable off-site as measured by normal monitoring equipment, and no unanticipated release of radioactivity on site within a 24-hour period following execution". The U.S. further characterizes prompt (seconds to hours), high-release containment failures as "venting", and late-time, small, slow radiation releases as "seeps" (associated with changes in atmospheric pressure; see OTA, 1989). Also defined are "controlled tunnel purgings," which are mostly small, intentional releases of gasses trapped in sealed tunnels, and "operational releases," which are also small releases upon post-test sampling (tunnel reentry or drill-back). Ventings from early U.S. underground nuclear tests (e.g., *DesMoines*, 1962, and *Baneberry*, 1970)

account for the major radioactivity release (more than 25 million curies). Following Baneberry, the U.S. halted testing for some months to review its testing procedures and record of containment. After implementing changes in U.S. testing procedures following Baneberry, there have been only two ventings that released more than 1000 curies (*Diagonal Line*, 1971 and *Riola*, 1980), and only one seep releasing more than 100 curies (*Tierra*, 1984). Also since Baneberry, all but one U.S. underground nuclear test (Cannikin) were emplaced in relatively porous volcanic rocks or alluvium at the Nevada Test Site; i.e., in geologic environments quite different from those of the main Soviet nuclear test sites. These differences in test environments are reflected in contrasting containment practices between the two countries.

While the above definitions of containment are useful and can be used to review the available information on the containment of underground nuclear tests, under the Comprehensive Nuclear Test Ban Treaty (CTBT), the *de facto* criterion for "containment" will be undetectability by the radionuclide monitoring network of the International Monitoring System (IMS). Although there is no specific capability established for the IMS, it has been evaluated with respect to its ability to detect the venting of 10% of the radioactive gasses from a 1 kt underground nuclear explosion within 12 hours of the explosion (specifically, about  $10^{14}$  Bq of  $^{133}\text{Xe}$ ; see the Working Papers of the Conference on Disarmament CD/NTB/WP-224 and CD/NTB/WP-283, 1995). In terms of the historically-used terms for describing nuclear test containment, this criterion would be categorized as a "prompt vent".

### 1.3 A Brief History of Nuclear Testing in the USSR

Nuclear testing in the USSR began with the test of the *RDS-1* nuclear bomb<sup>1</sup>, detonated on 29 August 1949. The 22 kt charge was an implosion design with plutonium as the working substance. It was placed on a metal tower, 37.5 m high, at Training Test Site No. 2 of the USSR Ministry of Defense, a specially equipped field located 170 km from Semipalatinsk, Kazakhstan (at that time the Kazakh Soviet Socialist Republic). This test site later became known as the Semipalatinsk Polygon. In addition to testing the nuclear charge itself, approaches were developed in this experiment for recording the primary effects of a nuclear explosion in the atmosphere. Specially developed equipment was used to record the optical and electromagnetic effects, the parameters of the atmospheric shock wave and the yield of the explosion.

The organization responsible for instrumental observations of the physical and mechanical parameters of a nuclear explosion, including the development and creation of special recording devices, was headed by M.A. Sadovskiy, who later became an academician of the Russian Academy of Sciences and Director of the Institute of Physics of the Earth (IPE). The latter institution included the Special Sector (*Spetssektor*) with the independent rights of a structural subdivision. This *Spetssektor* was the leading scientific organization for studying the physics of nuclear explosions. The preparations for and the actual conduct of the first test determined the primary issues that had to be solved in the process of nuclear testing; it also determined the circle of organizations needed to participate in nuclear testing.

The term "underground nuclear test" can be defined as the near-simultaneous detonation of one or more nuclear charges inside one underground excavation (a tunnel, shaft or borehole). With this definition, of the 742 nuclear tests were conducted during the entire period of nuclear testing in the USSR, from 1949 to 1990, 522 tests (70%) were conducted underground. This includes 122 underground nuclear tests that were conducted "in the interests of the national economy" (the so-called *Peaceful Nuclear Explosions*, or PNEs). Note that, because many Soviet tests included multiple nuclear devices, detonated within a few milliseconds to seconds, the number of nuclear charges detonated (approximately 969) was significantly greater than the number of underground nuclear tests. The composite energy yield (TNT-equivalent) of all Soviet nuclear tests is estimated at 285.4 megatons (Mt).

After the first atomic bomb test, it became clear that nuclear weapons would be constantly improved, and that it was necessary to organize a systematic nuclear testing program. Academician M.A. Sadovskiy led preparations for the technical task of designing the test site. In 1950, Training Test Site No. 2 (UP-2) became the Semipalatinsk Test Site. The test site territory had a specialized military unit assigned to it, as well as command and research services. The scientific director of the test site was M.A. Sadovskiy, who was previously the scientific director of UP-2.

<sup>1</sup> The abbreviation "RDS" stands approximately for *Made in Russia* ["*Russko Delano Sama*"]

Between 1949 and 1989, a total of 483 tests were conducted at the Semipalatinsk Test Site. This comprises nearly 65% of the overall number of nuclear explosions conducted by the USSR. For its entire existence, the Semipalatinsk Test Site was the primary location for conducting nuclear testing. The last nuclear test at the Semipalatinsk Test Site was conducted at the Balapan site on 19 October 1989. The data from this explosion are as follows:

<b>Time of detonation:</b>	<b>12:49:59.98 seconds</b>
<b>Coordinates:</b>	<b>49°55'15"N ; 78°54'24"E</b>
<b># of nuclear charges:</b>	<b>three</b>
<b>Total charge yield:</b>	<b>~85 kt</b>
<b>Charge emplacement depths:</b>	<b>628, 592 and 556 m</b>
<b>Rock at the hypocenters:</b>	<b>siliceous sandstone</b>
<b>Gas content of rock:</b>	<b>12% (by weight at 1000 degrees Celsius)</b>

By the mid-1950s, it became necessary to establish a new test site for nuclear tests were being planned for water environments and for high-yield (megaton) nuclear charges. A test site was created on the territory of the Novaya Zemlya archipelago with the 31 July 1954 Decree of the Central Committee of the USSR Communist Party and the Council of Ministers of the USSR. Since its establishment, a total of 133 nuclear tests were conducted on the Novaya Zemlya Test Site, including 88 explosions in the atmosphere, 3 explosions under water, and 42 underground nuclear explosions, of which 36 were conducted in tunnels and 6 in deep boreholes.

The first nuclear explosion at the Novaya Zemlya test site was conducted underwater at *Chornaya Guba* on 21 September 1955. It was at this test site that the USSR conducted on 30 October 1961 the highest yield nuclear test of any nation—a ~50 Megaton charge exploded in the air at a height of 4000 m. The last test at Novaya Zemlya was conducted on 24 October, 1990, in tunnel A-13N. This was the last Soviet nuclear test (since then, no nuclear tests have been conducted by Russia). It is asserted by Russian scientists that, by the end of nuclear testing, the methodology for guaranteeing containment was so well developed that the last tests at Semipalatinsk and Novaya Zemlya, were conducted with practically total containment (i.e., with only an insignificant migration to the surface of light, non-condensable radioactive components in the form of inert gasses).

The number of nuclear tests conducted per year in the USSR is not equally distributed (see Figure 1).

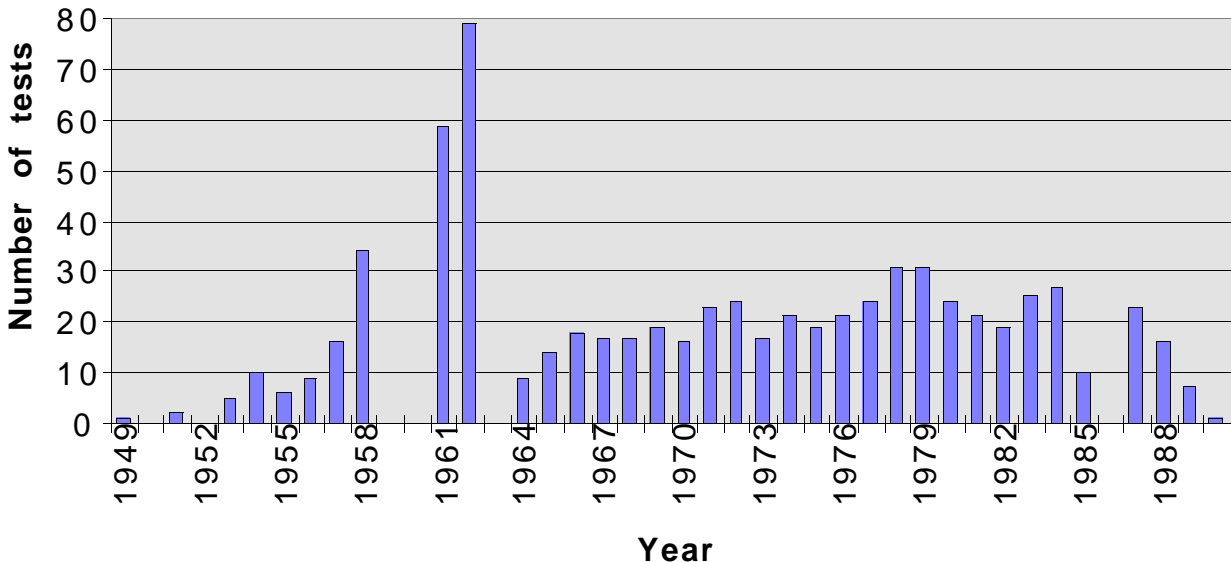

Figure 1: Annual Number of nuclear tests in the USSR.



**Figure 1: Annual Number of nuclear tests in the USSR.**

The Soviets did not conduct nuclear tests in 1950 and 1952. This was related to the specifics of the initial stage of work in creating nuclear weapons. From 1959 until August 1961, the USSR did not conduct nuclear tests due to a moratorium on nuclear testing together with the USA and Great Britain. From 1963 until March 1964, nuclear tests were not conducted because of preparations for concluding the Limited Test Ban Treaty and the transition to a program of underground nuclear testing. From August 1985 to February 1987, and from November 1989 to October 1990, nuclear testing and nuclear explosions were not conducted due to USSR participation in testing moratoria.

Table 1 presents a distribution of the quantity of nuclear tests and explosions according to the conditions in which they were conducted. It is clear that the greatest number of nuclear explosions were conducted in underground conditions (70%). Of these, 122 nuclear tests were conducted in the interests of the national economy, five of which were at the Semipalatinsk Test Site and three at Mangyshlak.

**Table 1. Distribution of the number of nuclear tests and explosions according to the environmental conditions in which they were conducted.**

Emplacement Conditions	Surface	Atmospheric	High-Altitude and Space	Underwater + water surface	Underground		Total
					Tunnel and shaft	Borehole	
Number of Explosions	32	175	8	3+2	263 + 1	258	742

The transition to conducting underground nuclear tests occurred later in the USSR than in the United States. The first underground nuclear test at the Nevada Test Site, code named *Uncle*, was a 1.2 kt cratering explosion conducted on 29 November 1951, within the framework of the *Jangle* program (this explosion was also known as *Jangle-4*). Four years later, on 23 March 1955, a second cratering nuclear explosion, *Ess* (1 kt, part of *Operation Teapot*), was conducted at the Nevada test site. While the tests were not contained, since the charges were detonated at a shallow depth (5.2 and 20.4 m for *Uncle* *Teapot* explosions, respectively), these experiments were significant in terms of developing a methodology for conducting nuclear tests in underground conditions. The first U.S. contained nuclear explosion, *Rainier*, was conducted on 19 September 1957, using a proven device with a known yield of 1.7 kt.

In the USSR, preparations for conducting underground nuclear explosions began in 1957 (by the end of 1957, the USA had already conducted 5 underground nuclear explosions: 3 in boreholes and 2 in tunnels, including *Rainier*). A large series of underground explosions of chemical (TNT) explosives weighing 1, 10 and 1000 tons was conducted in the clays and sandy loams in the steppes close to the settlement of Kabulsai, in the Kazakh SSR. The main task of these explosions was to study the "scale" effect for buried explosions, through which an increase in charge energy (and, correspondingly, the depth of the explosion) the law of geometric similarity of the excavation effect is broken, as a result of the increase in the role of the gravity force. It is necessary to account for this effect in order to guarantee the conditions of containment when conducting underground nuclear tests (see Section 2.4). These preparations continued into 1959, when in the rock massif of Tuya-Muyun (Kirghiz SSR), two *trotyl* (TNT) charges weighing 190 and 600 tons were exploded underground, in order to determine the conditions for containing large-scale nuclear explosions.

At the same time, in the rock massif of Degelen Mountain at the Semipalatinsk Test Site, Tunnel V-1 was being prepared for the first underground nuclear explosion in hard rock. In order to ascertain the technical tasking, an experimental detonation of a 600-ton *trotyl* (TNT) charge was conducted in a nearby tunnel, V-2, on 5 June 1961 —i.e., just before the nuclear explosion in tunnel V-1. The mechanical effects of this chemical explosion test, including the seismic signal, were studied in detail.

Four months later, after analyzing the results of the chemical explosion in tunnel V-2, the first fully-contained, underground nuclear explosion in the USSR was conducted on 11 October 1961, in tunnel V-1



(four years after *Rainier*). In this experiment, a nuclear charge with a yield of 1.2 kt was detonated at a depth of 118 m. Because the mechanical effects of this explosion turned out to be somewhat weaker than expected, the requirements for containment were fully achieved.

Note that, at about the same time, France (which had already conducted nuclear tests in the atmosphere) conducted its first underground nuclear explosion, code-named *Agate*, at the Reggane test site in the Sahara on 7 November 1961, with a yield of less than 20 kt. Thus, the USA, USSR and France had begun systematically conducting underground nuclear tests, in preparation for the LTBT. By 1962, the USA had conducted 58 underground nuclear explosions; the USSR, one test in underground conditions, and France, one underground explosion.

#### 1.4 Limits on Nuclear Testing

The early nuclear testing in the atmosphere created globally-detectable quantities of radioactive by-products in the atmosphere and, as a consequence led to the radioactive contamination of the Earth's surface well beyond the boundaries of the test sites.

In 1963, the Limited Nuclear Test Ban Treaty was concluded, requiring strict limitations on the release of radioactive by-products into the atmosphere during underground nuclear explosions (although no monitoring system was provided for in the Treaty). It was declared, that the concentration of radioactive by-products in air masses that pass beyond the territorial boundaries of a state conducting tests must not exceed the global background values of corresponding isotopes in the atmosphere. In addition to this, it was necessary to adhere to standards of radiation safety for the population. This, in turn, added practical limitations on the time of the onset of release of radioactive by-products from the explosion cavity into the atmosphere, even in those cases when this release was insignificant. These containment requirements could be achieved by: 1) the fundamental selection of the depth of emplacement of the nuclear charge, and 2) the development and implementation of special measures for sealing-off (stemming) the emplacement tunnels and boreholes.

By the early 1970s, it was clear that the limitations on underground nuclear explosions imposed by the LTBT did not guarantee the full measure of integrated radiation safety of the country that was testing the nuclear weapons, or of neighboring States, and in 1974, the USA and USSR reached agreement on limiting the yield of underground tests to 150 kt (Threshold Test Ban Treaty). Later, in 1976, the USA and the USSR signed the Treaty on Threshold Limitations for Underground Nuclear Explosions Conducted in the Interests of the National Economy (a.k.a. the Peaceful Nuclear Explosions Treaty). In accordance with this Treaty, the yield of a nuclear charge used for conducting peaceful nuclear explosions was limited also to 150 kt (in the case of a multiple-device explosion, the total yield of the charges could not exceed 1.5 Mt). Although the last two treaties were not ratified until 1990, both countries governed their nuclear activities according to the treaty conditions. Thus, the agreements reached in 1974 dictated that nuclear tests should be conducted only on designated test sites (although peaceful nuclear explosions were permitted at other locations), and the yield of the nuclear charge must not exceed 150 kt.

#### 1.5 Types of Underground Nuclear Tests

The Soviet underground nuclear explosions can be divided into two groups, based on the geometry of the underground emplacement: 1) explosions conducted in near-horizontal excavations (adits or tunnels), and 2) explosions conducted in deep near-vertical boreholes. In total (excluding hydronuclear explosions), 258 Soviet nuclear explosions were conducted in boreholes, and 263 in tunnels. Table 2 summarizes the numbers of nuclear explosions in tunnels and boreholes for the Semipalatinsk, Novaya Zemlya and the Peaceful Nuclear Explosion sites. From Table 2, it is clear that at Semipalatinsk, the portion of tunnel explosions comprised 62%, and at Novaya Zemlya, practically 85%. Underground Peaceful Nuclear Explosions, conducted in the interests of the national economy, were almost exclusively done in boreholes, with the exception of the *Dnepr-1* and *Dnepr-2* projects (tunnel-type emplacements) and the *Klivazh* project (a shaft-type emplacement).

**Table 2. Comparison of the numbers of Soviet underground nuclear explosions conducted in deep boreholes, tunnels and mines** (note that the numbers for Semipalatinsk include five PNEs conducted in boreholes).

Semipalatinsk		Novaya Zemlya		PNEs (beyond test sites)		
Tunnel	Borehole	Tunnel	Borehole	Tunnel	Borehole	Mineshaft
225	138	36	6	2	114	1

At the Semipalatinsk test site (STS), explosions in tunnels were conducted in Degelen Mountain. At the northern Novaya Zemlya test site (NZTS or NZ), explosions in tunnels were conducted in rock massifs along the Matochkin Shar Strait. The excavated tunnel works ranged from 200 m to 2 km long, usually made with a diameter of about 3 m. In accordance with the engineering requirements of a specific test, the system of underground works could be highly simple (one straight tunnel) or it could have a branching system of works. For example, in the test in Tunnel 704 at Degelen, one straight tunnel was used, with the charge placed at the end of the tunnel. In the complex test at Tunnel 169/2 (Degelen, 4 October 1989), two diverging tunnels were used, with the goal of observing the effects of a simultaneous release of radiation along two beams out to the surface. A third example is the complex system of underground works used for the multiple-device test in Tunnel A-37 (11 October, 1982) at the northern Novaya Zemlya test site (see *Spungin et al*, 1998). Figure 2 shows a plan view of the tunnel complex for this 80-kt test, in which four charges of differing yields were detonated in separate drifts.

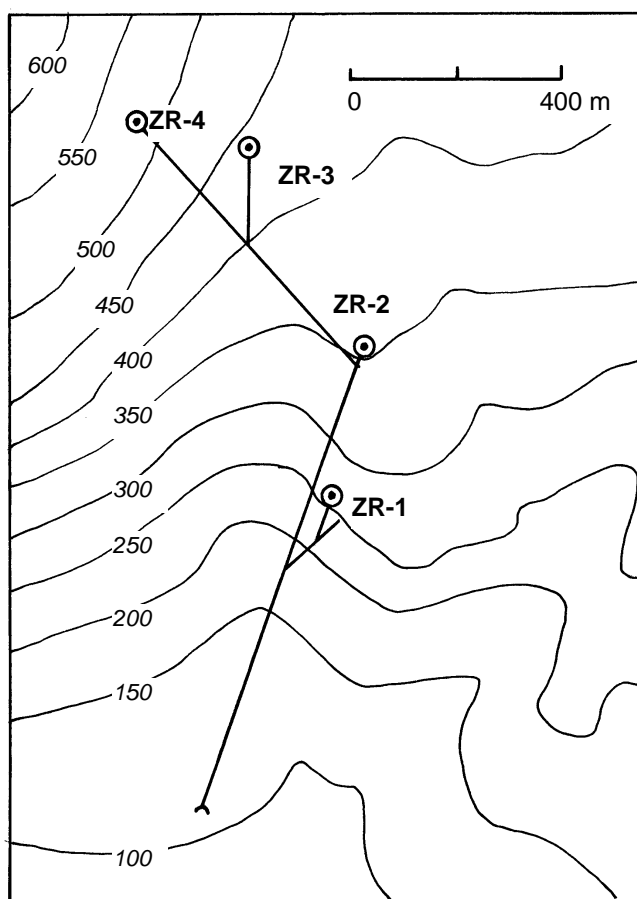

**Figure 2. Plan of Tunnel A-37, northern Novaya Zemlya test site (Matochkin Shar). The sites marked ZR-1, ZR-2, etc. (for “zero room”), are the locations of the nuclear charges within the tunnel complex. Elevation contours are in meters.**

In several cases after a test in a single, linear tunnel, a system of access drifts was excavated for research into the properties of rock at various distances and azimuths from the explosion source. For example, Figure 3 presents the plan for the underground works excavated in the rock massif, which was destroyed by the explosion in the "Tunnel V-1" experiment in 1961 at the Degelen test site (STS).

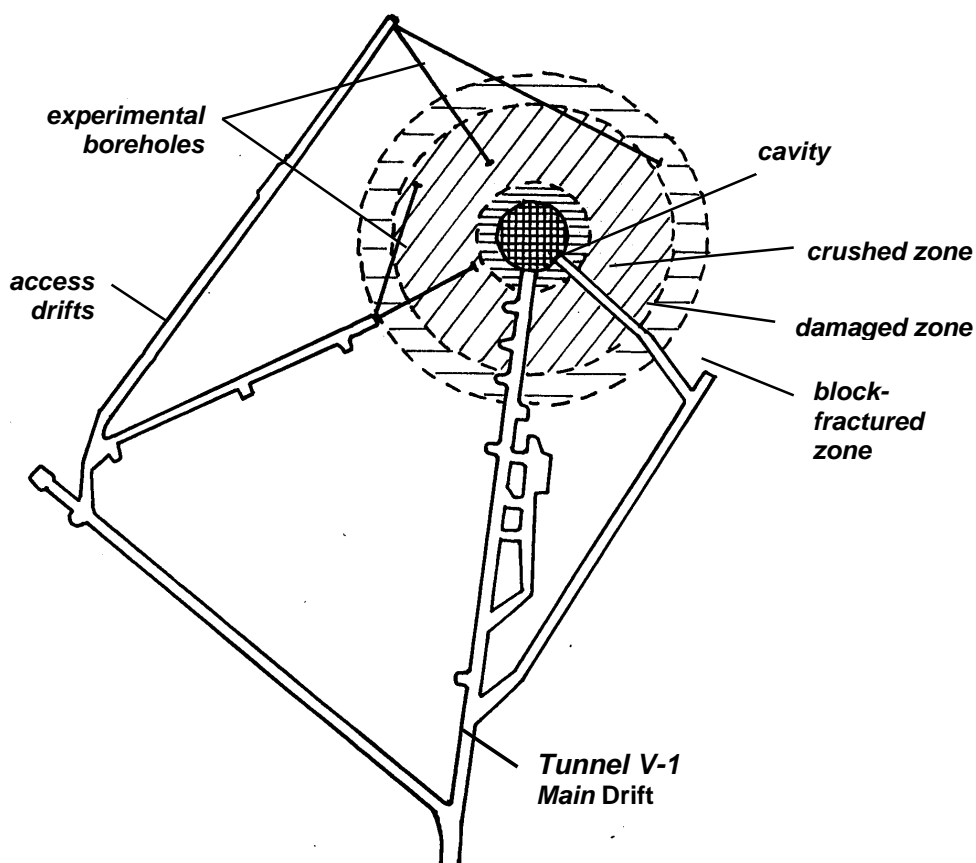

**Figure 3. Plan view of the nuclear test-experiment, "V-1", of 11 October 1961 (Degelen test site). Note that the side access drifts were constructed after the test.**

The nuclear charge was placed, as a rule, at the end of the tunnel in a specially equipped room, known as the "end box" (in U.S. usage, "zero room"). In some cases (for example, in tunnels 148 and *Dnepr-1*, when the underground works were used to direct the ejection of radioactive explosion products), the charge was placed at some distance from the end of the tunnel. Recording sensors were placed along the tunnel in specially made pits or recesses in the walls of the tunnel. All the recording equipment was placed either inside, near or close to the portal of the tunnel, or at distances of less than 1 km from it (i.e., close-in and remote measuring points). In the case of irradiation experiments (in which a radiation beam was directed to the surface), the tunnel was specially equipped so that, immediately after the radiation beam exited to the portal area where the test objects were placed, the tunnel was closed off, so as to protect the test objects from debris, as well as to contain the radioactive by-products of the explosion.

After conducting a nuclear explosion, the tunnels were generally studied from the portal to the innermost stemming, which was not equipped with a hermetically sealed pass-through. Such studies made it possible to obtain information on the level of damage of the rock at various distances from the explosion, and of the underground works. In several experiments, the working tunnels were completely opened up in order to gain access into the containment cavity.

To conduct nuclear explosions in flat terrain, vertical boreholes about 1 meter in diameter were drilled (the actual diameter of the hole varied with depth). Depths ranged from 200 m to 2 km for different tests. In several experiments, after the nuclear explosion, several investigation boreholes were excavated in order to study the properties of the damaged rock. For illustration, Figure 4 below presents the plan of the borehole in the "Borehole 102" experiment at the Balapan test site (Semipalatinsk). The boreholes made after the explosion, including one, which had a very complex shape, intersected the rock located in the various zones of the underground nuclear explosion. By analyzing the core material of these boreholes, it was possible to ascertain the characteristics of the rock and of the massif in zones of rock buckling/crushing, the damaged rock zone, and also in fracture zones (for induced and block fracturing).

### 1.6 Locations Where Nuclear Tests Were Conducted

Nuclear tests were conducted in specially equipped areas of the Semipalatinsk and Novaya Zemlya Test Sites (Figures 5 and 6). In addition, 122 underground nuclear explosions were conducted outside of these main test sites (Peaceful Nuclear Explosions, or PNE's, conducted "in the interests of the national economy"). PNE test locations span a vast region of the former Soviet Union (in Siberia, Central Asia and in the European part of Russia, see Figure 7) and a wide range of geological environments.

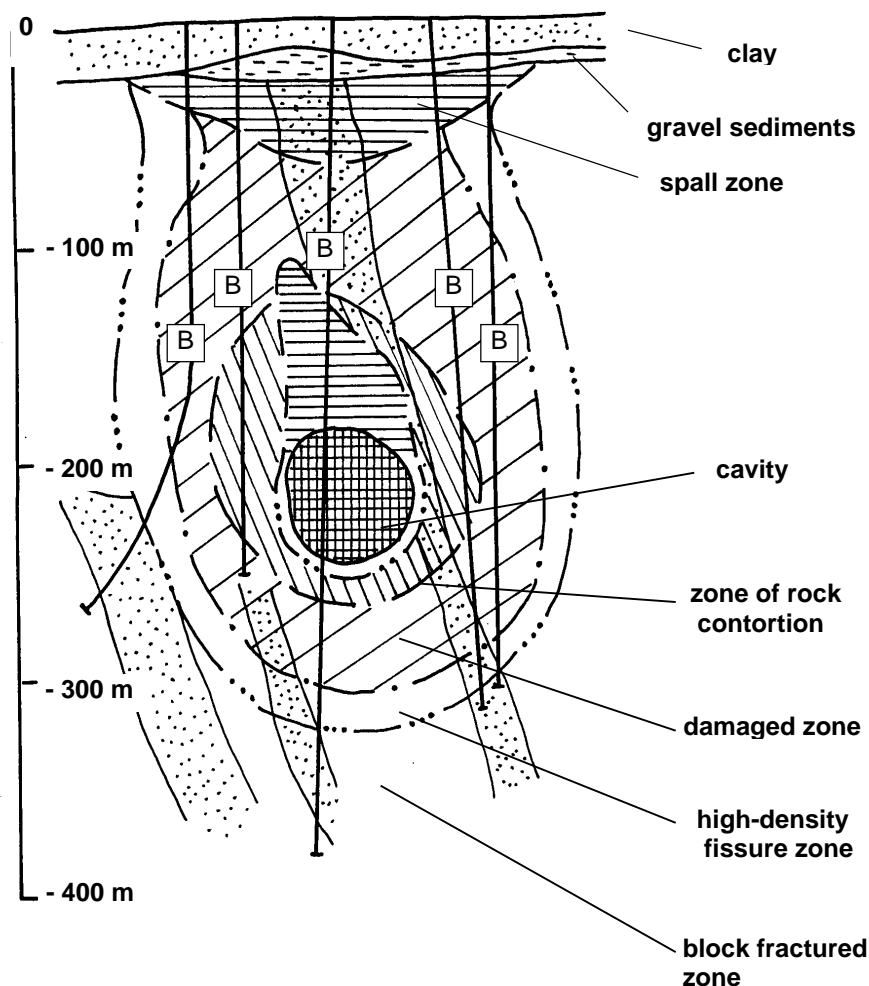

Figure 4. Structure of the central zone of the explosion in borehole 102. The vertical lines labeled "B" are the post-test exploratory boreholes.

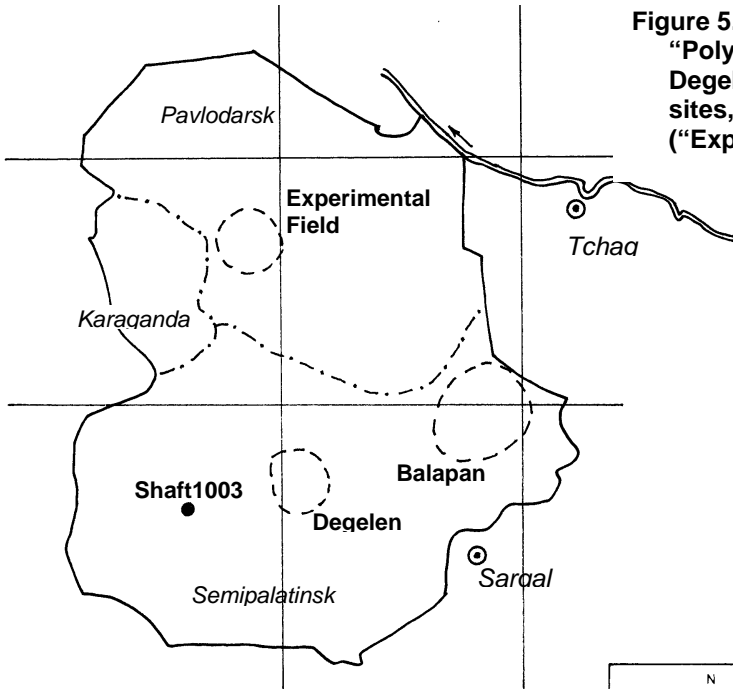

Figure 5. Semipalatinsk nuclear testing "Polygon", showing the location of the Degelen and Balapan underground test sites, and the atmospheric test site ("Experimental Field").

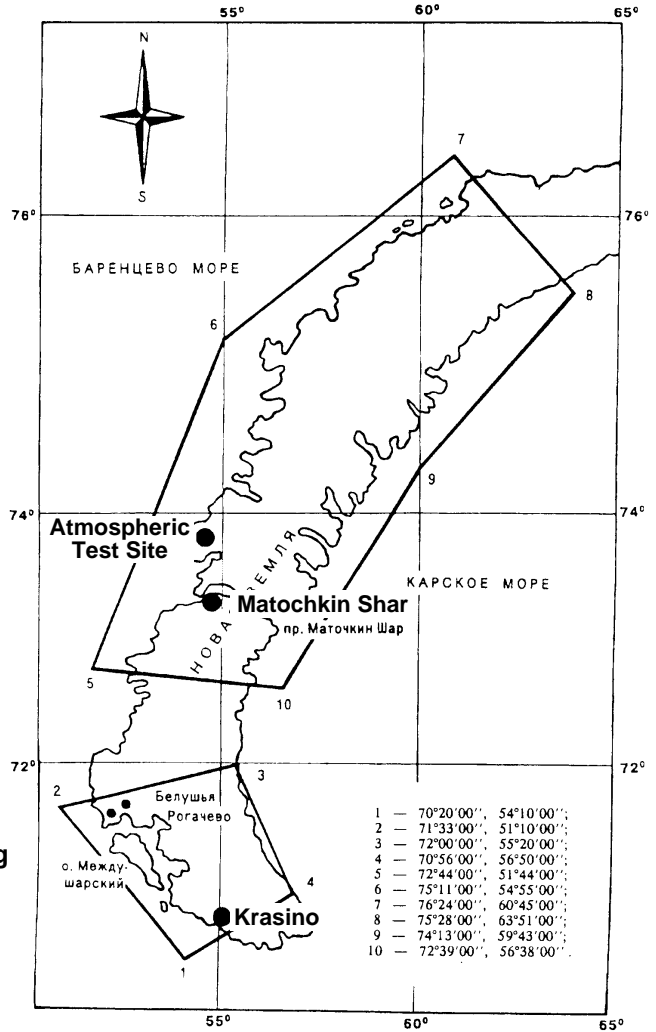
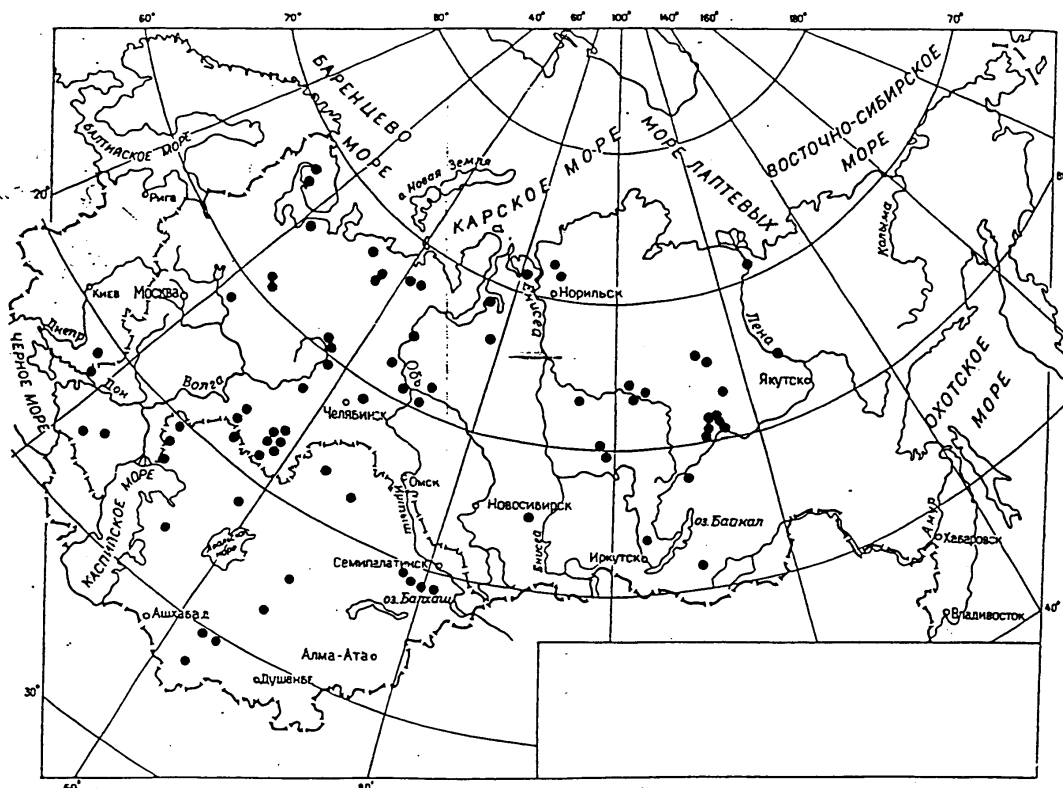

Figure 6. Novaya Zemlya nuclear testing Polygon, including the underground test sites at Matochkin Shar and Krasino, and the atmospheric test site at Chernaya Guba.



**Figure 7. Map of the former USSR, showing where “Peaceful Nuclear Explosions” were conducted outside of the main nuclear test sites (black dots). Five PNEs were also conducted on the Semipalatinsk Test Site.**

Distribution of underground nuclear explosions by location:

<u>Location</u>	<u>Number of tests</u>
Semipalatinsk Test Sites	363*
Novaya Zemlya Test Sites	42
outside of declared test sites	117**

\* including 5 PNEs conducted on the STS

\*\* at sites in the Russian Federation; European Russia; Asiatic Russia; Ukrainian SSR, Kazakh SSR; Uzbek SSR; and Turkmeneskaya SSR

### 1.7 Underground Testing at the Semipalatinsk Test Site

The Semipalatinsk Test Site was the primary location for conducting nuclear tests in the USSR. Of a total of 742 Soviet nuclear tests, 483 were conducted at STS. The existence of a good infrastructure at STS, and sufficiently mild climatic conditions (compared to the Novaya Zemlya Test Site), permitted conducting nuclear tests there at any time of year. These factors also permitted “non-standard” configurations for underground tests, including nuclear detonations with an intentional release of radiation to the surface.

During the early period of nuclear testing (from 29 August 1949 to 25 December 1962), mainly aerial nuclear explosions were conducted at STS (this also includes surface nuclear explosions which, in many respects, can be considered “atmospheric” explosions). Aerial explosions were conducted within the boundaries of the *Experimental Field* (Figure 8; see location on Figure 5).

During this early testing period of activity at the STS, it should be noted that it was also here that the Soviets first dropped a nuclear bomb from an airplane (18 October 1951), and also first conducted a thermonuclear explosion, with a yield of 450 kt (12 August 1953). In this same period at STS, the first underground test of a nuclear charge (tunnel V-1) was conducted, as was the first underground test for the purposes of studying the effects of radiation on military equipment with the release of radiation to the surface (tunnel A-1).

After the 1963-1964 moratorium on nuclear explosions, the nuclear testing program was conducted under the conditions stipulated by the Limited Test Ban Treaty. Since the 15<sup>th</sup> of March, 1964, underground nuclear explosions were conducted only in tunnels or deep boreholes.



**Figure 8. View of towers constructed for recording the effects of atmospheric nuclear tests at the “Experimental Field” at the Semipalatinsk Test Site.**



**Figure 9. The Soviet nuclear explosion, “Shagan,” of 15 January 1965, designed to create a crater and dam a water reservoir.**

On 15 January 1965, on STS but away from the active sites, the first underground nuclear explosion in a borehole was conducted beneath the Shagan riverbed. This explosion was designed to create an ejection crater (Figure 9), and is considered to be the first nuclear explosion for peaceful purposes in the USSR. In this experiment, the technology was developed for using the excavation action of nuclear explosions in the interests of the national economy. In particular, as a result of the explosion (conducted in borehole 1004 at 178 m depth), a crater was formed, 415 m in diameter, 100 m deep, with a volume of 6.4 million cubic meters. After it filled with water, this was used as a water reservoir for the dry Kazakh steppe. (Actually, the volume of the reservoir was significantly greater than the volume of the crater, since the raised lip of the crater that was formed during the explosion served well as a dam, and a second reservoir was formed adjacent to the crater).

The most powerful nuclear explosion conducted in a tunnel at the STS was the “Tunnel E-1” experiment (13 February 1966), in which the charge yield was 125 kt. The most powerful test in a borehole at the Balapan test field was the “Borehole 1061” experiment (2 November 1972) in which a 165 kt charge was tested. It was also at the STS where the methodology for conducting a salvo (multiple-device) explosion in a single tunnel was tested (at Tunnel 14, on 3rd December 1966), and where the USSR first conducted a multiple (salvo) explosion in two tunnels (Tunnels Z-2 and 140, on 10 December 1972).



The geological structure of the two main underground test areas at STS differ from one another, in terms of the amount of tectonic (natural) fracturing present in the rock massifs. The Degelen rock massif, where nuclear tests were conducted in tunnels, is highly fractured and characterized by the presence of a noticeable layer of weathered rock, whose physical and mechanical properties differ significantly from the properties of the bedrock. The Degelen area is also characterized by the presence of a large number of tectonic faults and extensive fractures. Each of the excavated tunnels in the Degelen rock massif intersects, as a rule, several level IV-VI tectonic faults.

This makes the task of containing the by-products from an underground nuclear explosion in a rock massif of special current interest. It should be noted that the primary containment conditions for underground nuclear explosions were obtained from the results of the Semipalatinsk experiments. It was here that the primary correlations were established; these determine the effect of tectonic damage on the laws governing the release into the atmosphere of by-products from an underground nuclear explosion.

## 1.8 Announcement of Nuclear Tests

The organizational system for nuclear testing in the USSR stipulated informing the administrative organizations and the nation's population of the conduct of underground nuclear explosions. Informing the administrative organizations was dictated by the necessity of appropriating the corresponding financial funding, as well as the means for engineering the tests (communications, utilities, ensuring safety, messages, and so forth). Since the system for setting up and organizing nuclear explosions was located in two USSR ministries (Ministry of Defense (MOD) of the USSR and USSR Minatom), the Office of the Council of Ministers of the USSR developed the measures for ensuring nuclear testing. The Council of Ministers developed a list of necessary documentation of oral and written reports on completing all work related to the nuclear test.

A special Decree of the Council of Ministers regulated the sequence of announcing the nuclear explosions within USSR territory. Thus, in the first quarter of each year, a Joint Decree of the USSR MINATOM and the USSR MOD determined the plan for nuclear testing in the current year. This same Decree had an appendix, which laid out the plan for specific measures to ensure safe testing. All changes in the operational plan of measurements or the schedule of testing were reported without delay to the USSR Council of Ministers by MINATOM and MOD.

After completing all preliminary measures and completing preparations for each test, a Representative of the State Commission on Testing prepared a special report to the USSR Council of Ministers and to the CPSU Central Committee on the readiness to conduct the test. This report contained a description of the nature and purpose of the test, as well as a request for approval to conduct the test. After the decision is made to conduct the test, the Council of Ministers and the USSR Defense Council inform the leadership of the appropriate test site. At the same time, no later than two days before the planned test, the administrative leadership, and before that, the party leadership of the region abutting the test site were also informed of the test. The fact that information on conducting the nuclear test was transferred and accepted was documented for all stages in the announcement process.

A planned test was announced to the population living in population centers close to the test site only one day prior to the test. Information on conducting nuclear tests and peaceful nuclear explosions was not accessible to the general population. After the nuclear tests were conducted, the USSR population was periodically informed by way of informational messages in official periodicals (e.g., the "Pravda" and "Izvestiya" newspapers). Regular publications on conducted tests began to appear only in 1987.

During the time of atmospheric testing, while there were generally no messages published, there were several exceptions. For example, on 8 August 1953, TASS announced in the "Izvestiya" newspaper the planned, 12 August 1953 test of the first hydrogen bomb at STS. In October, 1961, the General Secretary of the CPSU, N.S. Khrushchev, made an announcement at the 22<sup>nd</sup> Congress of the CPSU regarding the planned, 30 October 1961 test of the most powerful hydrogen bomb in the world (the number 100 megatons was stated). Indeed, such a test was conducted at Novaya Zemlya, but with an actual yield of 58 Mt (apparently, at the last moment, it was decided to conduct the test with a less-than-full yield). When the nation's population was informed of the test, the actual charge yield was not noted.

Often, a yield range was stated (for example, “charge yield of up to 20 kt”). However, as a rule, the purposes of the test were announced.

### 1.9 Detonation Authority and Procedures

The task of carrying out nuclear tests was entrusted to specially-created subdivisions of the Ministry of Atomic Energy (specifically, the Ministry of Medium Machine Building, MMMB, of the USSR, later *MINATOM*), and the Ministry of Defense (MOD). A specialized Directorate of the MOD was created in 1949. The Chief Directorate of the MMMB, made up of military specialists, was created in 1957. The tasking of this Directorate included the special acceptance of nuclear charges, populating military units with specialists on using nuclear charges, and conducting nuclear tests.

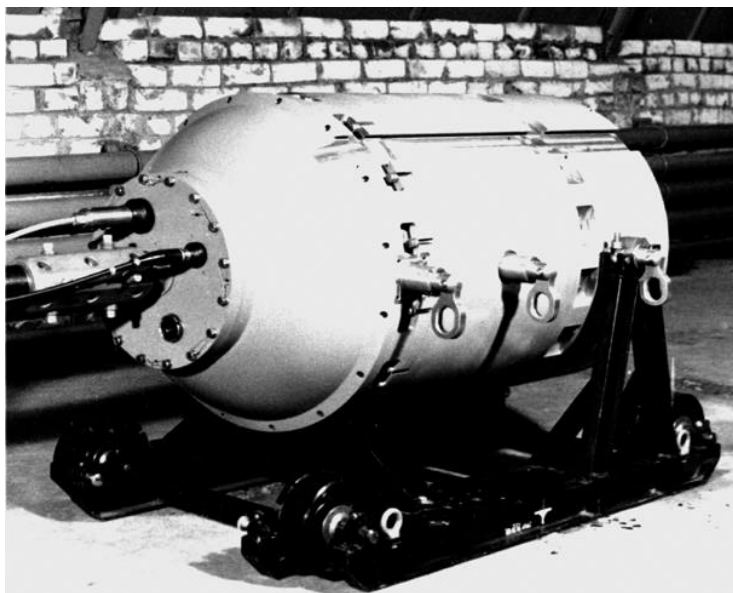

**Figure 10. The ~118 kiloton nuclear device that was detonated by the Soviets on 14 September, 1988, as part of the “Joint US-USSR Verification Experiment, in bore-hole 1350 at Balapan (Semipalatinsk test site).**

In addition to MINATOM and MOD, a wide range of organizations belonging to various agencies also participated in the fielding and evaluation of nuclear tests (Figure 11). These organizations, first and foremost, the Academy of Sciences of the USSR, researched the physical effects of the nuclear explosion, as well as its damaging effects. The *State Commission on Nuclear Testing* and the *Interagency Commission on Seismic and Radiation Safety of Nuclear Explosions* played an important role in organizing and conducting the tests (these commissions had different names at different times).

The main task of the State Commission was to provide quality and timely nuclear tests and to obtain the physical characteristics of the tested nuclear charge, as well as other information stipulated by the test program. The State Commission was also responsible for maintaining secrecy of the testing. The Commission was staffed by representatives from MINATOM and MOD, and included a scientific director who developed the charge, and representatives of associated institutes from MINATOM and other agencies. It also included representatives of the organizations who produced the charge and of the customer.

The Interagency Commission was responsible for ensuring nuclear test safety. At special meetings of this commission, the conditions for conducting the explosion were examined (when conducting underground explosions, special attention was given to the issue of containment of radioactive explosion by-products under the ground). According to the results of their examination of a specific test design, either the selected explosion parameters were deemed permissible, or corrections were added to the construction of the underground works and stemming components. At the same time, these Commission meetings also developed the requirements for the meteorological situation at the time of the nuclear test.

The Interagency Commission included specialists from various agencies: MOD, MINATOM, USSR Academy of Sciences and the Hydrometeorological Service of the USSR. After preparing the appropriate conclusions, the possibility of conducting the test was examined at a high government level in the USSR Council of Ministers and the CPSU Central Committee. Both commissions began their work two or three months before the specific nuclear test. A special role befell the State Commission on the eve of the test. Several days before the nuclear test, this commission examined the preparedness of all participating services and the state of completion of the special measures for ensuring the test.

The primary members of the Interagency Commission on Ensuring Test Safety participated in all meetings of the State Commission, which occurred in the initial test preparatory period. The last meeting of the commission occurred on the eve of the nuclear test. This was after the "Dry Run" test, in which the preparedness of all services and the operation of all equipment was verified in a mode that was as close as possible to conducting the actual test (e.g., the operation of all services and equipment was verified minute by minute). At this final meeting of the State Commission, information concerning the meteorological situation was heard, and the final decision was taken on the possibility of conducting the nuclear test in the given specific situation.

Immediately after a test was conducted, the State Commission collected the operational data, which characterized the test results. A commission meeting was convened to look over issues related to the achieved charge yield as compared to the planned yield; the results of studying the action of the explosion, and the radiation situation in the test location and in the region. At this meeting, a short report was made to the government on the results of the test (a more complete report was prepared after detailed processing of the obtained data).

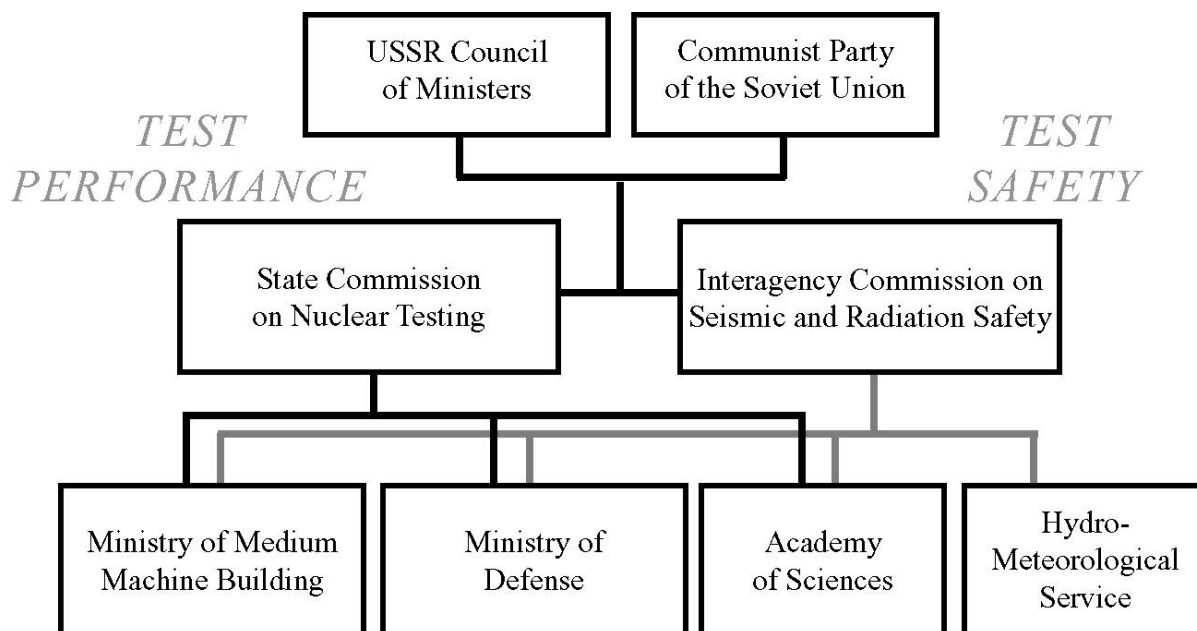

**Figure 11. Diagram summarizing the authority and interactions of the various Soviet organizations participating in the conduct of nuclear tests, as described in the text. Note that the Chair of the State Commission on nuclear testing would change, depending on the purpose of the test. For example, if the experiment was a radiation effects test, the Chair would come from the military, while if it was a device performance test, the Chair would be from one of the weapons laboratories. Also, occasional participating organizations include (depending on the test purpose): Ministry of Electronics; Ministry of General Machine Building; Ministry of Heavy Machine Building; or Ministry of Aviation.**

## Chapter 2 CONTAINMENT OF UNDERGROUND NUCLEAR TESTS

### 2.1 What Happens During an Underground Nuclear Explosion

From the point of view of ensuring underground nuclear test containment, it is interesting to examine the two main processes which accompany a nuclear explosion in a rock massif: 1) the formation of a zone of irreversible deformation of the solid medium (the containment cavity, the zones of buckling/crushing, crushing and fracture formation); and 2) the formation of highly compressed radioactive gasses in the containment cavity. It should be noted that both these processes occur essentially simultaneously.

#### *Formation of highly compressed gasses in the containment cavity*

The process of forming an explosive source during the detonation of a nuclear device is comprised of the formation of a cavity, which fills with gaseous by-products at high pressure. Estimates show that at the moment when the cavity reaches its maximum size (after roughly  $0.1 \text{ sec/kt}^{1/3}$ ), the pressure within is equal to roughly 150-200 atm, and the temperature is 4000-5000 degrees Celsius. The processes of condensation of a portion of the gasses and the mass transfer of substances lead to a situation where  $1-10 \text{ sec/kt}^{1/3}$  after the explosion, a dynamic equilibrium of the gaseous mixture is established. At this time, the temperature of the gaseous by-products is 1500-2100 degrees Celsius, and the pressure settles to the pressure level of the non-condensable gasses.

The overall quantity of non-condensable gasses,  $M$ , is determined by the relation:

$$M = \eta G q$$

where  $\eta$  is a coefficient characterizing the gas-forming properties of the rock,  $G$  is the specific mass of the rock participating in the gas formation, and  $q$  is the yield of the explosion. The formation of gas is determined by the physical-chemical composition of the rock and is related to the vaporization of rock on the wall of the cavity, the melting of the rock with subsequent vaporization of the water contained in it, and the thermal decomposition of the minerals. It also results from the strong compression of the rock (beyond the cavity) by the shock wave.

Of the gaseous by-products that arise in the process of cavity formation, only the non-condensable portion filter through the permeable space of the rock massif. The formation of non-condensable gas during the explosion occurs in the zones of vaporization, melting and thermal decomposition of the rock. Table 3 presents the numbers characterizing the quantity of vaporized and melted material during a nuclear explosion in several rock types. The experiment results indicate the fact that the zone of gas release in dense, hard rock has a mass of close to  $(2-4) \times 10^5 \text{ kg/kt}$ , and in alluvium,  $7 \times 10^5 \text{ kg/kt}$ .

**Table 3**

Rock Type	Specific mass of vaporized material (in tons per kt yield)	Specific mass of the melted material (in tons per kt yield)
Dry granite	69	300 $\pm$ 100
Moist tuff (18-20% H <sub>2</sub> O)	72	500 $\pm$ 150
Dry tuff	73	200 -300
Alluvium	107	650 $\pm$ 50
Rock salt	150	800

The nature of the gas release depends on the type of rock. In silicate rocks (quartzites, granites, tuffs and alluvium), that contain water in the pore spaces, non-condensable gas is represented by water vapor. In carbonate rocks (limestones, dolomites, and some types of quartzites), the principal mass of the non-condensable gas is comprised of carbon dioxide, which is released as a result of the thermal decomposition of the rock.

The gas temperature in the cavity should be considered to be equal to the melting temperature of the rock in silicate type rock (Table 4) and equal to the temperature of the thermal decomposition of the rock in a carbonate type rock. (Actually in the case of carbonate rock, a competition occurs between the processes of vaporization, melting, and thermal decomposition; nevertheless, the non-condensable gasses are represented, mainly by carbon dioxide).

**Table 4**

Rock Type	Shale, Porphyrite	Granite	Quartzite, Sandstone	Aleurolite, Argillite
Melting Temp., °C	1220-1450	1340-1380	1400-1750	1120-1170

The thermal decomposition of dolomites and limestones occurs at temperatures of 825 to 900 degrees Celsius. Calculations confirm the fact that the mass of dolomite, which undergoes thermal decomposition during an underground nuclear explosion, is close to 180 tons per kiloton of nuclear charge. The temperature of the gasses in the cavity reaches close to 2200 degrees Celsius. As we see, the temperature of the non-condensable gasses in the cavity in the case of a carbonate type rock is higher in comparison with silicate type rock. This can be explained by the difference between the molecular weights of carbon dioxide ( $\mu=44$ ) and of water ( $\mu=18$ ). In practice, gas formation may occur simultaneously as a result of water vaporization, and as a result of the thermal decomposition of the minerals. It is namely by this method that it occurs at the Novaya Zemlya and Semipalatinsk test sites.

At NZ, the rock massifs are represented by shales, sandstones and quartzitic sandstones with some limestone content. The shales, which are most widespread, have the following mineral composition:

<b>KAL<sub>3</sub>Si<sub>3</sub>O<sub>10</sub>(OH)<sub>2</sub></b>	<b>15-35%</b>
<b>Fe<sub>3</sub>Al<sub>2</sub>Si<sub>3</sub>O<sub>10</sub>(OH)<sub>2</sub></b>	<b>15-25%</b>
<b>SiO<sub>2</sub></b>	<b>10-30%</b>
<b>Mg<sub>3</sub>Si<sub>4</sub>O<sub>10</sub>(OH)<sub>2</sub></b>	<b>3-30%</b>
<b>FeS<sub>2</sub></b>	<b>0.1-3%</b>
<b>Dolomite</b>	<b>2-25%</b>
<b>free water</b>	<b>0.05-0.8%.</b>

At the Balapan test area on STS, the rocks are represented by siltstones, sandy tuffs, argillites, porphyries and carboniferous shales. As a whole, these rocks contain the following minerals:

<b>Quartzites</b>	<b>20-50%</b>
<b>Dolomites</b>	<b>5-15%</b>
<b>Mg<sub>3</sub>Si<sub>2</sub>O<sub>5</sub>(OH)<sub>4</sub></b>	<b>1-45%</b>
<b>CaAl<sub>2</sub>Si<sub>2</sub>O<sub>8</sub></b>	<b>10-30%</b>
<b>Mg<sub>3</sub>Si<sub>4</sub>O<sub>10</sub>(OH)<sub>2</sub></b>	<b>1-20%</b>
<b>free water</b>	<b>0.8-1.2%</b>

The variation in mineralogical compositions is the main feature of the rock at STS and NZ. Practically all minerals contain hydroxyl and carbonate groups. As a result of the thermal decomposition of these minerals, gasses form: CO<sub>2</sub>, H<sub>2</sub>O, S<sub>2</sub>, H<sub>2</sub>S and others (along with infusible oxides: SiO<sub>2</sub>, MgO, Al<sub>2</sub>O<sub>3</sub> and others).

As a result of comparative evaluations, it was found that the gas release at the NZ sites as a result of thermal decomposition of the shales occurs in a volume of rock massif, which is characterized by a mass of roughly 300 tons per kt of nuclear explosion. The equilibrium state of the gas and the cavity is upheld in this case due to the water vapor formed as a result of the decomposition of sericite, which appears during the moment of highest pressure of the saturated vapors of all the minerals comprising the shale.

To simplify the calculations, it is permissible to consider only carbon dioxide and water as the principal components. The molecular weight of the non-condensable gas will be equal, in this case, to:

$$\mu = \frac{1}{\left( \frac{CO_2}{\mu_{CO_2}} + \frac{H_2O}{\mu_{H_2O}} \right)}$$

In general, it is necessary to consider also the presence of the free water in the rock. In this case:

$$= w + H_2O + CO_2$$

where  $w$  is the specific content (weight) of free water.

*Formation of the zone of irreversible behavior of the rock*

The migration of gaseous by-products from an underground nuclear explosion, which, in the final count, determines the containment of the underground explosion, occurs along a permeable channel, which either existed initially in the rock massif, or was formed as a result of the explosion. As a result of the vaporization and melting of the rock at the focus of the explosion, and the subsequent displacement of the medium at great distances as a result of the shock and compressional waves, a containment cavity forms at the focus of the explosion. It is free from the rock volume, and filled with gaseous materials.

In the area located beyond the cavity, the medium remains solid. However, as a result of the intense compression in the explosive wave, the rocks undergo intense changes. Their physical-mechanical properties and structure change noticeably. At greater distances, the rock is damaged due to the formation of rather fine pieces (crushing zone). Then, with increased distance from the focus of the underground explosion, the size of the pieces are such that one can speak of the formation of new fractures in the rock massif.

Thus, the main zones of irreversible behavior of the medium, from the point of view of containment of the underground explosion are: the containment cavity, and the zones of rock buckling/crushing, crushing and fracture formation (Figures 3 and 4). It is specifically these zones that directly affect the migration of gaseous explosion by-products. The possibility of ensuring containment of an underground nuclear explosion is determined by the initial parameters of the gaseous explosion by-products in the containment cavity and the permeability of the rock massif in the area directly abutting the containment cavity.

Similar investigations into the mechanical state of the rock and rock massif in the vicinity of the underground explosion, which were conducted using special excavations in the rock after the explosion (adits and deep boreholes) showed that the parameters of the zone of irreversible behavior of the medium is defined by the initial physical-mechanical properties of the rock and of the massif; these are as follows:

**Degelen Site**

Zone relative size, m/kt <sup>1/3</sup>	Cavity	Rock buckling/crushing	Rock crushing	Fracture formation
	7-10	10-16	20-25	35-40

**Balapan Site**

Zone relative size, m/kt <sup>1/3</sup>	Cavity	Rock buckling/crushing	Rock crushing	Fracture formation
Increase in Massif Permeability <sup>1</sup>	10-14	14-18	25-30	50
	3-8 x	1.8-4 x	1.3-3.8 x	1.27-3 x

Note here that ensuring containment of underground nuclear explosions is based on a prediction of the dimensions of the main zones of irreversible deformation of the rock massif during the explosion.

<sup>1</sup> For the cavity, the estimated permeability increase is for that of the rock fill resulting from cavity collapse.

## 2.3 How Nuclear Explosions Remain Contained

Radioactive materials that are produced in a nuclear explosion consist of a rock melt with materials of the nuclear device and gaseous products. As the containment (*camouflet*) cavity expands, a considerable fraction of the nuclear material is converted to the solid state as a result of cooling of the melt and condensation of some of the gaseous components.

A certain amount of the radioactive products, mostly inert gases, as well as some products of dissociation of rocks and water vapor, remains in gaseous form. The nature of gas release depends on the type of rock: in rocks of silicate type (quartzites, granites, tuffs, alluvia) that contain water in the free state, the uncondensed gas is represented by water vapor, in rocks of carbonate type (limestones, dolomite, some types of quartzites), most of the uncondensed gas is carbon dioxide that is released as a result of thermal dissociation of rock.

Uncondensed gaseous radioactive products of an underground nuclear explosion that have accumulated in the underground cavity following the first instant of the explosion begin to filter through the geological medium. There are several factors that contribute to this:

- 1 – elevated permeability of rocks in the near zone of the explosion;
- 2 – the presence of tectonic disturbances (faults and fractures) whose permeability is also increased by explosive action;
- 3 – inadequate isolation of the underground excavation (tunnel, borehole).

At the same time, it should be noted that a certain fraction of the uncondensed radioactive gas remains underground due to the following factors:

- 1 – relatively low pressure of explosion products in the containment cavity (while the initial pressure is a few hundred MPa, the pressure of uncondensed gases at the instant that they begin filtering out of the cavity is on the order of 1-10 atm depending on the gas-forming properties of the rocks).
- 2 – rather high porosity of the rock mass broken by the explosion (volume of voids formed is comparable to the volume to which uncondensed radioactive gases expand when pressure falls from the initial level to atmospheric);
- 3 – with appropriate selection of the depth of burial of the device, the layer of ground situated above the charge chamber (especially the layer of unbroken rock) is good insulating material that prevents propagation of gaseous explosion products toward the free surface.
- 4 – well executed stemming systems (and other measures to isolate underground excavations) likewise serve as a good insulator to stop propagation of uncondensed gases toward the surface of the ground.

In contrast to soft rocks like tuff, no high-density layer is formed in hard rocks in the vicinity of the containment cavity. The region of crushing of hard rocks is in direct contact to the wall of the containment cavity. This somewhat decreases the isolating properties of rocks (the absence of an extra barrier in the form of a compacted rock layer allows uncondensed gases to filter out into the broken medium in the early instants following the explosion).

However, as the filtration front expands, the gas pressure in the permeable space drops rapidly due to geometric expansion of the flow, as well as to partial cooling as a result of contact with considerably less heated rock. Simple estimates show that if there are no channels for preferred filtration of uncondensed radioactive products of the nuclear explosion (for example in spherically symmetric filtration), the entire mass of these products fills the pore space of the medium broken up by the blast (Figure 12). Thus, the pore space of the broken medium is a reliable reservoir that accumulates radioactive gases.



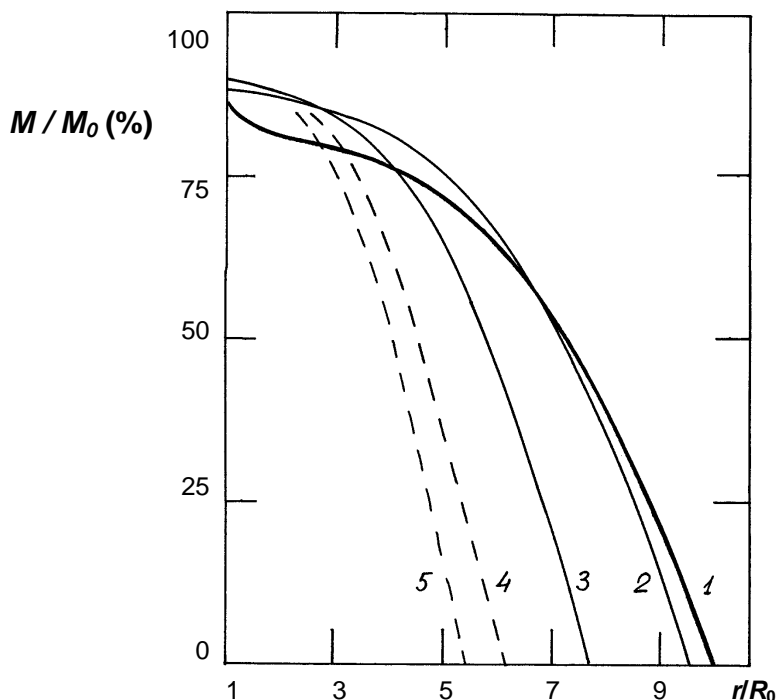

**Figure 12. Relative mass of gaseous products of underground explosion filtered to distances exceeding  $r/R_0$  ( $M_0$  is the mass of gases in the containment cavity at the initial instant;  $r$  and  $R_0$  are respectively the distance from the explosion and the radius of the containment cavity); 1 — calculation for a 2 kt explosion using results of measurement of permeability of the rock mass (experiment Dnepr-1); 2-5 calculation for medium with constant porosity  $m$ , %: 2 — 1, 3 — 2, 4 — 4, 5 — 6.**

Of course, everything is a lot more complicated in practice. Actual filtration of explosion products is typified by pronounced directionality (uncondensed gases generally filter preferentially toward the free surface). Tectonic breaks (tectonic faults and cracks of various scales) make a major contribution to delivery of gaseous products to the free surface of the earth. Nevertheless, in properly selecting the location of the charge chamber and depth of the device, the insulating properties of overlying rocks may be used to advantage.

## 2.4 Selecting Location Depth and Spacing

### *Reviewing a Test Site Location*

To ensure containment of underground nuclear tests, the location of the device is chosen from results of a careful study of the geological features of sites. This is supported by continual work of geological field parties in the investigation of all sites of proving grounds that are potentially suitable for conducting underground nuclear tests. The rock and geological conditions of specific sites are investigated by studying experimental boreholes and geophysical measurements made on the surface of rock masses.

From results of studying rock specimens taken from the surface of rock masses and coring of experimental boreholes, rock composition and the physical and mechanical properties of rocks are determined, including the gas content. The tectonic characteristics of a section are determined from results of investigation of outcroppings of rocks and underground excavations that are cut through on adjacent sections. The number, rank and extent of tectonic fractures in the rock mass, natural fracturing of rocks and thickness of the weathered layer are determined.

Tectonic faults are studied especially carefully. The width of the fault, size of the fault-affected zone, rank of the fault and probable mechanical properties of the filler are determined (all of these characteristics are more precisely determined after cutting an underground excavation). An estimate is made of the filtration properties of tectonic faults, and their possible shifts as a result of blasting effects of various scales.

Based on results of the geological study of a specific section, recommendations are made on location of the charge chamber. Following this, options for the planned test are considered with allowance for the thickness of the layer of overlying rocks and the specific properties of the rock mass. The yield of the device and conditions of setting off the explosion are selected. This is done by planning organizations, after consultations with research institutes that work on problems involved in organizing safe underground tests.

Results of hydrogeological studies of sites are a very important factor in test safety. Experimental boreholes are used to determine the level of subsurface water, intensity of subsurface water flows and their direction. Added to these are data from years of hydrogeological observations. The degree of water encroachment of the rock mass has a considerable impact, both on the initial parameters of gas formation during an underground nuclear explosion, and on the rate of transport of radioactive products of explosion with subsurface waters. Data from geophysical studies of the rock mass can reveal anomalous inhomogeneities of the structure of rocks and the extent of fracturing of the rock mass as a whole.

In special cases, seismic profiling of surface sections of rocks is done to determine the thickness of the weathered layer of rocks and the specific seismic properties of the rock mass at different depths, characterizing the degree of fracturing of the medium. With allowance for all data of geological study by the design organization, a decision is made on a subterranean excavation (tunnel) for conducting a specific test. In the course of cutting the tunnel, a set of measures is carried out to determine the properties of rocks on different sections of the tunnel, and especially in the vicinity of location of the charge chamber. Rock samples are taken for this purpose and studied under laboratory conditions.

After the tunnel has been cut, careful studies are done on subsurface tectonic faults and fractures, as well as on the jointing of the rock mass. Systems of cracks and their parameters are determined. More detailed investigations are made of the seismic properties of the rock mass by seismic shooting of the mass situated above the tunnel. This is done by recording seismic waves elicited by a series of detonations of chemical explosives at several points on the surface of the rock mass. The seismic waves are recorded by a group of sensors placed in the tunnel itself. The seismic cross section of the tunnel is plotted from the results of seismic shooting.

Results of detailed geological studies, done after excavating the tunnel with allowance for the recommended yield of the device and depth of burial, are examined at an interdepartmental commission on safety of underground nuclear tests (see section 1.9). Before convening the commission, experts make estimates of the dimensions of zones of irreversible behavior of the rock mass, considering possible variations in the yield and device.

### *Selecting Location and Depth*

In selecting the depth of burial of nuclear devices for underground testing, two basic conditions are considered: 1) guarantee of standards of radiation safety for test participants and citizens of centers of population adjacent to the proving grounds, and 2) observance of the requirements of the Moscow Treaty of 1963 (Limited Test Ban Treaty) prohibiting radioactive fallout beyond the limits of state borders, or more precisely, that the concentration of corresponding radioactive isotopes not exceed global background levels in air currents going beyond the limits of the state territory.

It is these conditions that determine the concept of the degree of containment of underground nuclear explosions. The aforesaid conditions are met by suitable selection of the depth of burial of nuclear devices and appropriate sealing of tunnels and boreholes.

When determining the depth of burial of devices, attention has been given to considerations of possible mechanisms of emission of radioactive explosion products into the atmosphere. As has already been

noted previously, the mechanisms of escape of radioactive explosion products into the atmosphere are determined by the geological structure of a specific rock mass and the physical and mechanical properties of both rocks and rock masses. Thus, the depth of burial of devices are selected with allowance for geological conditions at the location where the test is being planned.

The first underground tests of nuclear devices in the USSR were done at the Degelen Mountain Complex of Semipalatinsk Test Site (STS). In preparing and conducting these tests (specifically, the first underground explosion, in tunnel V-1 (11 October 1961), and the second explosion, in tunnel A-1 (2 February 1962)), the depth of burial of the device was established from experience studying the mechanical action of the large chemical explosions that were detonated in Tuya Muyun Mountain (with masses of 190 and 660 metric tons) and the chemical explosion detonated on 5 June 1961 directly in Degelen Mountain (with a mass of 600 metric tons of TNT).

In determining the depth of burial of nuclear devices, the usual law of energy scaling was used, in accordance with which the depth of the explosion is:

$$H \sim q^{1/3} \quad (1)$$

Where  $H$  is the depth and  $q$  is the energy of the explosion. As a result, the first Soviet nuclear explosion was placed in tunnel V-1 at a *scaled depth*,  $H/q^{1/3}$ , of 100 m/kt<sup>1/3</sup>, and the explosion in tunnel A-1 at 110 m/kt<sup>1/3</sup>. The required conditions of containment were met under these conditions: specifically, the slow discharge of radioactive gases (Xe and Cs) into the atmosphere occurred several hours after the explosion and no transport of the primary radioactive products (Kr and Sr) beyond the test site boundaries.

There were no underground tests in 1963. Tests were renewed in March 1964 under Degelen Mountain conditions. Five underground nuclear tests were conducted in 1964. Experience conducting underground tests at Degelen Mountain in 1964-1965 showed that use of scaling law (1) to determine the depth of burial of charges was not always successful from the standpoint of ensuring containment of tests. For example, analysis of experimental data for these two years showed that for some relatively high-yield explosions (yields from 10-100 kt) at 60-67 m/kt<sup>1/3</sup> there was no emission of radioactive explosion products into the atmosphere (slow discharge of radioactive gases was observed several hours or days after the explosion), whereas for lower-yield explosions ( $q \sim 1$  kt), emission of radioactive products through ground zero and corresponding fallout of radioactivity along the trail of the cloud was observed even for greater values of scaled depth, 67-70 m/kt<sup>1/3</sup>.

For this reason, the rules of selecting the depth of the explosion were changed with allowance for intensification of the role of gravity of the ground when the scale of the explosion is increased, and the law

$$H = 70 q^{1/3.4}$$

was taken as basic for Degelen Mountain, where  $H$  was in meters and  $q$  in kt. This relation was recommended for devices with yield of less than 200 kt placed in end-boxes of dimensions corresponding to an energy density greater than  $10^{-2}$  kt/m<sup>3</sup> and a moisture content in the rock of less than 1%.

In the case of moisture content in rocks of more than 1%, the relation

$$H = 70 [(1 + 0.36\eta)/1.36]q^{1/3.4}$$

was used, where  $\eta$  is the moisture content of rocks in percent.

All subsequent experience in underground nuclear testing at Degelen Mountain has shown that selection of depths of burial of devices with yield on the order of 1 kt in accordance with the aforesaid relations has enforced conditions of containment and accordingly has met the requirements of the Limited Test Ban Treaty. For devices smaller than 1 kt, depth was set individually for each specific experiment.



**Figure 13. Plan view of tunnel 108k, Degelen test site. It was at this site that a nuclear device was left sealed underground, when the Russians abandoned the test site in the early 1990s. In 1995, the device was destroyed in place by a 30 kg high-explosive charge.**

Underground tests of nuclear devices in boreholes was started in the USSR in 1966. The first test was done on 18 December 1966 on Murzhik site (STS) in hole 101. At the Balapan test site, the first test was done on 19 June 1968 in hole 1053. By this time, considerable experience had been accumulated in underground nuclear explosions. It was known from this experience that the depth of burial of the nuclear device has to be selected with allowance for geological conditions.

The geological conditions of the Murzhik and Balapan test sites were very complicated, characterized by a variety of rocks types, ranging from relatively weak siltstones, shales and argillites to rather strong porphyrites, tuff-sandstones and quartzites. Rocks occurred as steeply dipping layers and were intersected by numerous tectonic faults of various ranks up to regional. Rocks also typically had a considerable moisture content and a high content of gas-forming minerals (from 4% to 18%). The rocks are covered on top by Quaternary deposits in the form of loams and sand clay from a few meters to 50-100 m thick. Therefore, rather deep placement of devices was settled on from the very beginning of nuclear tests at these sites. The relation:

$$H = 110 q^{1/3.4}$$

was used for estimates of the depth of burial of devices.

In accordance with this relation, the minimum permissible depth of an explosion was determined for which radioactive products of the explosion were not discharged into the atmosphere. As experimental data were accumulated, it was proposed that this relation be used for large explosions with yield on the order of 100 kt, and for rocks with gas content of less than 6%. In other cases, for devices with yield on the order of 10 kt or less, and also when devices were placed in rocks with gas content of more than 6%, the depth of the explosion was determined from the relation:

$$H = 110 [(1 + 0.36\eta)/3.16] q^{1/3.4}$$

On the whole, the relations given for determining depth of underground nuclear explosions in boreholes at Semipalatinsk have ensured containment and enforcement of requirements of the Moscow Treaty of 1963.

## 2.6 The Containment Evaluation Panel

One of the main stages in determining the level of containment of a planned underground nuclear explosion in the USSR was the examination of the explosion design at the Interagency Commission on Radiation and Seismic Safety of Nuclear Explosions, which was specially created by the Government of

the USSR. The Commission included representatives from scientific-research organizations of the USSR Ministry of Defense, USSR Minatom, and the USSR Academy of Sciences. The main staff of the Commission (roughly 25 experts) was named every 3 years and comprised the permanent members of the Commission. In particular, from the USSR Academy of Sciences, M.A. Sadovskiy, V.N. Rodionov, V.V. Adushkin and A.A. Spivak all served, at various times, as permanent members over a long period. When necessary, or when special questions were being examined, the commission also named temporarily enlisted experts.

The Chairman of the Commission was the representative from either the USSR MOD or *Goskomgidromet* [the State Committee on Hydrometeorology). At various times the commission was headed by Izrael', Iu.A.;, Fillipovskiy, V.I.; and Petrov. V.N. The main purpose of the commission was to make a detailed examination of the issues related to ensuring safety of personnel and populace when conducting an underground test. The commission first heard the report from the chief engineer for test design. Most attention was given to the issue of selecting the location for the charge, the depth of the explosion and the geological structure of the portion of the rock massif in which the test was planned.

As a rule, the Commission met for a specific test after the underground works were excavated (tunnels or boreholes). This was a time when the Commission would have at their disposal the technical characteristics of the rock massif at the explosion location (i.e., the properties of the massif and its rock components as determined by studying samples taken during the excavation of the underground works). When evaluating the possibility of conducting a test, the following factors were taken into consideration:

- the gas-forming properties of the rock at the proposed charge location;
- the presence or absence of tectonic disturbances both near the charge emplacement location and along the underground works;
- the reaction of the tectonic disturbances to explosive action;
- the conformity of the location of the first and second stemming to the predicted dimensions of the zones of irreversible deformation of the rock and the massif, given the planned charge yield and for the case of incomplete actuation;
- the conformity of the charge emplacement depth which was suggested by the designers according to the specific conditions of conducting the explosion.

The design of the test had to correspond completely to the requirements of the method for determining the containment of the underground nuclear explosion. The conclusion to conduct the nuclear test was made as a result of discussions concerning the design of the explosion and as a result of examining the past experience in conducting underground explosions with similar conditions. When discussing a specific design, changes were made if necessary (for example, recommendations to move the charge placement location). In this case, the design was examined again after it was redone and after the appropriate mining work was completed, which gave additional data on the rock and massif properties.

After the final approval of the design at the Interagency Commission on the Safety of Underground Nuclear Testing, the conclusion was presented to the State Commission on Nuclear Testing, which then made the decision on the readiness for conducting the test based on the conclusion of the Interagency Commission.

## 2.7 Containing Vertical Shaft Tests

The containment of nuclear explosions conducted in deep boreholes was ensured by employing special borehole stemming methods. A plan for a typical borehole prepared for conducting underground nuclear tests is shown in Figure 14.

In order to hermetically seal off the nuclear charge, the first section of the borehole, which falls in the rock-crushing zone, is filled with rubble. In this section, it is not necessary to fully pack the charge with grout, since the rock massif will be similar to rubble after the explosion. At the same time, when filling-in

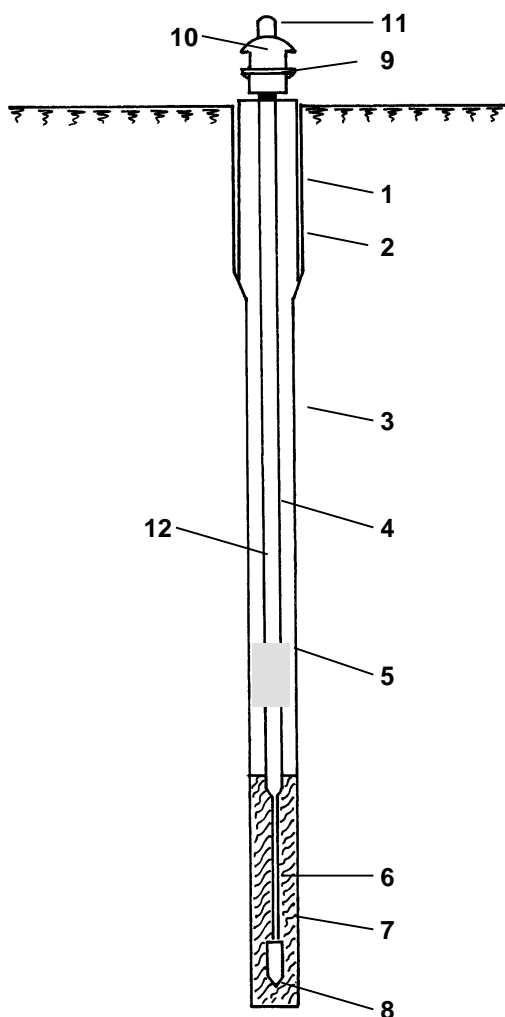

**Figure 14. Typical borehole plan for conducting an underground nuclear test: 1- 1420 mm borehole; 2- 1120 mm steel pipe; 3- 1000 mm borehole; 4- 168 mm casing; 5- cement grout; 6- 89 mm casing; 7- rubble; 8- charge; 9- unloading device; 10- elevator; 11- dynamic device; 12- additional plug of rubble.**

from the cavity along the permeable channel of the rock-crushing zone and of the zone of induced massif fracturing. The second stemming section is designed for strength relative to the compression wave from the explosion and relative to the pressure from the explosion by-products, which penetrate into this tunnel section from the cavity. The specific construction of the second stemming section is shown in Figure 16. This section is made of concrete "keys" (concrete walls that are not only partitioning but are also embedded ("keyed") into the rock massif). A cement grout is pumped in between the concrete keys. The method of pouring concrete most often used is wherein the space is filled with different grades of concrete.

with rubble, it is possible to cause mechanical damage to the charge itself (or the devices leading to it). This may also occur when cement grouts solidify (if such grouts are used). The remaining section of the borehole is cemented fully along its entire depth.

When the borehole is severely flooded, which was sometimes the case at the STS Balapan site, often the upper section of the borehole for 30-100 m was left as it was, full of groundwater. This type of construction, with the correctly selected depth for charge emplacement, ensured good explosion containment in the majority of cases.

## 2.8 Containing Horizontal Tunnel Tests

When conducting nuclear tests in horizontal underground works, the stemming complex consists of several sections of stemming, located at various distances from the explosion location, and several devices, which ensured additional isolation of the explosion (Figures 15).

### *Equipping Tunnels for Standard Nuclear Tests*

In standard nuclear tests (for the purposes of device improvement, for studying the physical processes occurring during an explosion or for studying the action of the explosion), the stemming complex consisted of a first section, located directly at the charge chamber (Fig. 15). This stemming section functions to prevent the initial pressurized release of explosion by-products into the tunnel. The length of this section is determined by a calculation wherein the device yield and rock massif properties are accounted for, as is the presence of tectonic disturbances (faults) of varying scales. As a rule, the length of this section is equal-to or greater than the radius of the rock-crushing zone for a specific explosion yield. The structure of the first stemming section is shown in Figure 16. This stemming is composed of concrete elements with rubble backfill between them.

The second stemming section is an actuating element, that can withstand the excess pressure that is formed in the section of the tunnel outside the first stemming section as a result of the partial migration of explosion by-products

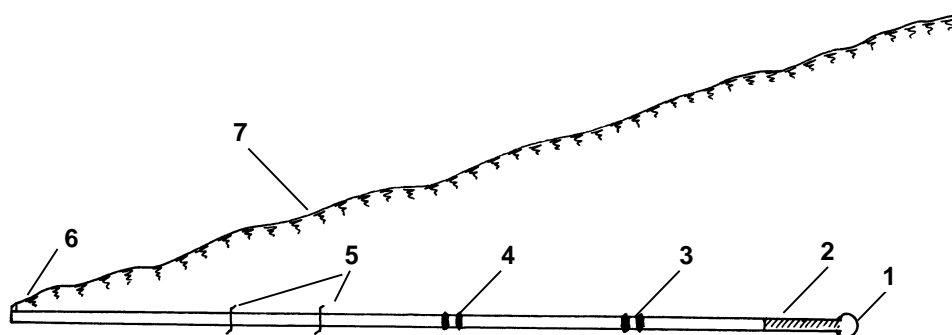

**Figure 15. Typical plan of a tunnel for conducting a nuclear charge test: 1- chamber for emplacing the charge; 2- first section of the stemming complex; 3- second stemming section; 4- second, additional stemming section; 5- hermetically sealing walls; 6- tunnel portal; 7- rock massif surface.**

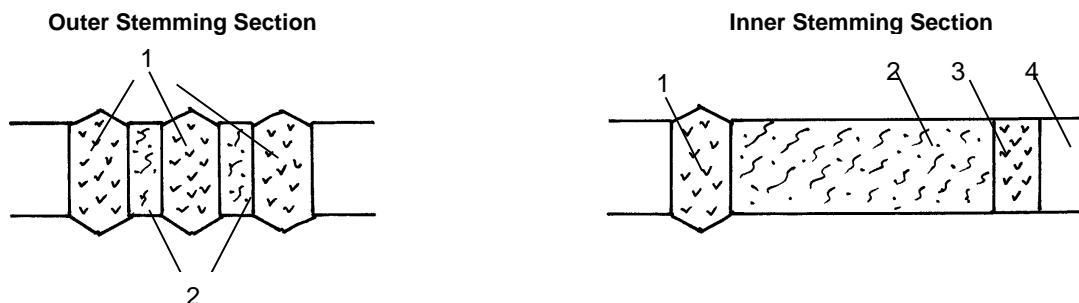

**Figure 16. Stemming Sections. Stemming complex plan: 1- concrete keys; 2- crushed rock stemming ; 3- individually-concreted sections; 4- explosion chamber. The length of concrete keys along the tunnel is nominally 3 meters, and the length of the individually concreted sections is nominally 1- to 2.5 meters, but these vary with the yield and rock mass conditions.**

The cable lines between the explosion chamber and the tunnel portal are placed in special metal boxes and are filled in with cement grout in places where the boxes pass through the stemming complexes. When this occurs, each cable is fitted with a gas-blocking device, which inhibits the release of gasses along the cable.

In order to prevent the venting of gasses from the tunnel in cases where the gas penetrates beyond the second stemming section, two hermetic elements are installed in the tunnel section after the first stemming. The hermetic elements are partitions, which are made of metal and have special so-called hermetic man-ways, specially structured doors, which ensure that the partitions are sealed during the explosion, and that personnel have access to the tunnel section located beyond the second stemming for dismantling recording equipment and for studying the action of the explosion. When necessary (in non-standard test conditions), additional elements are installed in the tunnels; these are like an additional, second stemming section (see Figure 16), made of concrete buffers and actuating sections, which reinforce the tunnel walls.

When the stemming location and the charge depth are correctly selected according to the geological conditions, all these measures for hermetically sealing the tunnel prevent the possibility of a dynamic release of radioactive explosion by-products out to the ground surface. In such cases, some leakage of short-lived inert gasses is permissible in quantities wherein the exposure dose of gamma radiation



beyond the test site boundaries does not exceed the fluctuation range values of the natural radiation background.

#### *Equipping tunnels for conducting irradiating experiments*

A highly important avenue of research was the study of the damaging factors of irradiation, which accompanies a nuclear explosion. Of great interest was the effect of irradiation (neutron, gamma quanta, x-ray) on the operability of various-purpose technical equipment, of military technical objects, including a nuclear warhead, and biological subjects. The physical irradiation experiments are the most complex and potentially dangerous type of nuclear test.

In order to obtain the maximum possible irradiation area, the USSR used the following plan for an irradiation experiment. The detonation of the nuclear charge was done so as to create a short-lived release of radiation out of the explosive chamber to the ground surface. The equipment and objects under study were placed in front of the portal. The irradiation cross-section reached 100 m<sup>2</sup>. The plan for equipping the tunnel for irradiation experiments hardly differed from the tunnels in which the usual tests were conducted. However, the necessity of releasing the radiation out of the explosive chamber to the ground surface defined several features of the stemming complex.

When conducting irradiation experiments, it is necessary to cut off the radioactive explosion by-products after the radiation passes along specially-made *Line of Sight* (LOS) pipes. Radiation releases occurred along small cross-section pipes, with a diameter of 0.4 to 1 m, which represented a special, metal duct. This duct passed through the first stemming. The same ducts passed through all the elements of the other stemming complexes. That portion of the LOS that was located directly at the explosive chamber was constructed so that the aerial shock wave would not collapse it. To some degree, this held back (for roughly 0.05 to 0.1 msec) the distribution of the explosion by-products into the remaining LOS section.

To prevent the release of explosion by-products out to the ground surface, so-called explosive doors and fast-acting closures were installed where the main stemming was and in additional locations. The explosive door was used in the tunnel space located directly after the first level stemming. Its principal role was to close down the LOS pipe. The explosive door was a cylindrical charge of chemical explosive which encircled the LOS pipe. The explosive door closed down the LOS pipe in 0.8 to 1.4 msec. It should be noted that despite the fact that in the majority of cases absolute LOS pipe closure was not achieved, the use of the explosive door permitted a significant reduction in the flow of explosion by-products into the space between the first and second stemming.

The fast-acting closures (as a rule, one or two) were installed in the tunnel at a seismically safe distance, where the compression wave amplitude did not exceed the amplitude of damage of the rock or the structures. The operating time of the closures had to be less than the arrival time of the compression wave to the closure location. This ensured the stable operation of the fast-acting closure before the arrival of the compression wave (seismic signal). The fast-acting closure cut off the radioactive gasses in both situations where the gasses were dynamically released into the tunnel in a containment failure, and during filtered seepage of the gasses along the tunnel. The fast-acting closures were thick-walled metal structures, which partially partitioned the tunnel and fully closed off the tunnel at defined moments of time. The tunnel was closed off by firing powder boosters at specifically calculated moments of time.



**Figure 16. Tunnel entrance at Degelen mountain, with supports visible for a large-diameter line-of-sight pipe. Such structures, evacuated, were used to direct a beam of radiation to test objects located outside of the tunnel complex.**



**Figure 17. Structures supporting a test object (a rocket motor) outside of tunnel 169/2 at Degelen Mountain. In this experiment (4 Oct. 1989), radiation was channeled through a flexible bag filled with a special gas, and its cross-section was modified by the crescent-shaped device.**

The principal technical characteristics of the fast-acting closures are as follows:

<b>dimensions of closed-off pipe:</b>	<b>2.55 x 2.55 m</b>
<b>time from firing to complete closure of the pipe:</b>	<b>43 msec;</b>
<b>time to close off the pipe:</b>	<b>29 msec;</b>
<b>dimensions of the casing:</b>	<b>9.2 x 3.3 x 2 m;</b>
<b>maximum speed of closure shield:</b>	<b>100m/sec.</b>

Falling closures were also used additionally in a number of experiments to close off the tunnel within 1 sec after the explosion (in order to cut off the radioactive by-products). The falling closure was a thick-walled metal-concrete structure, which closed off the tunnel by falling under the force of gravity.

*Additional measures to contain radioactive explosion by-products in the tunnel*

In complex nuclear test in tunnels, additional structures were used to close the tunnel in order to localize the radioactive explosion by-products in the tunnel. In a series of experiments, a gas release blocking system was used. This system was installed at the exit out of the tunnel and was made up of several flexible casings, which filled up with high-pressure air immediately after the explosion and provided a relatively hermetic seal to the entire tunnel cross-section. This permitted the explosion by-products to be held in the tunnel at a low pressure, such that the by-products could filter into this tunnel section through migration channels (damaged massif, or tectonic faults). In the case of an accidental release of explosion by-products through the tunnel, several experiments used a foaming material, which filled in a section of tunnel volume.

## 2.9 Types of Radiation Releases

The release of radioactive by-products from an underground nuclear explosion to the ground surface can occur in several ways. In the most favorable case, when the emplacement depth was correctly selected in accordance with the specifics of the geological structure of the rock massif, and when the stemming and hermetically-sealing complexes operated successfully, the release of explosion by-products to the ground surface may only occur simply as a result of filtration through the rock massif (Figure 18).

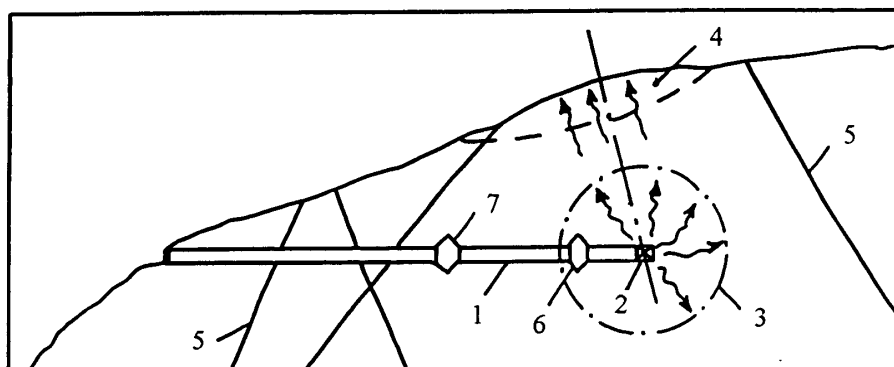

**Figure 18. Schematic illustration of gas migration through the damaged rock massif: 1- underground works; 2- zero room; 3- damage zone radius; 4- spall zone; 5- tectonic faults; 6 and 7- first and second stemming.**

Indeed, any rock massif has a finite (non-zero) permeability. Thus, if the porosity of the massif is such that it is unable to contain the expanding explosion by-products in the space between the containment cavity and the free surface, a portion of the by-products (generally very small) can reach the ground surface. In this case (Figure 18), the migration path for the by-products out of the cavity lies through the damaged-rock zone, which is characterized by an increased permeability, then through the rock massif itself and on through the spall damage zone. With correct selection of the depth of emplacement of the nuclear charge, the case in which explosion by-products are released through the massif into the atmosphere occurs in the absence of conditions that tend to “weight down” the explosion—for example, when the stemming fails or the actual yield is much smaller than predicted.

In this case, if the rock massif in the vicinity of the explosion is damaged by a tectonic fault (Figure 19), the primary migration of explosion by-products toward the ground surface can occur faster as compared to the case of filtration through the massif. This is possible when the characteristics of the fault are such that its permeability increases as a result of the explosive action, thereby exceeding the permeability of the rock massif in the area between the damage zone within the medium and the free surface.

Another case is possible wherein the radioactive explosion by-products end up in the tunnel space located between the first and second stemming. In individual cases, this can lead to a primary migration of by-products along the tectonic fault intersecting the tunnel in this section (Figure 20). As a rule, the pressure of the gaseous explosion by-products in the space between the first and second stemming is not great (does not exceed 0.2 to 2 atm). However, considering that the filtration path of the gasses toward the free surface in this tunnel section is shorter and the permeability of the tectonic faults as a result of the explosion can increase, this case must be considered undesirable. Similar cases of release of explosion by-products into the atmosphere can be observed as well in deep borehole explosions.

The last variant of release of explosion by-products into the atmosphere is related to an accidental venting through the tunnel portal (Figure 21) or along the borehole.

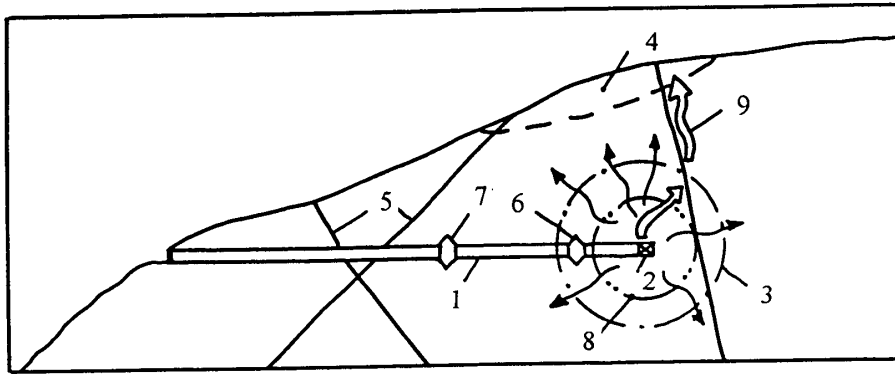

Figure 19. Illustration of gas release through a tectonic fault: 1- tunnel works; 2- zero room; 3- damage zone radius; 4- spall zone; 5- faults; 6 and 7- first and second stemming; 8- outer boundary of area in which the gas is moving through the damaged rock mass; 9- gas flow through the tectonic fault.

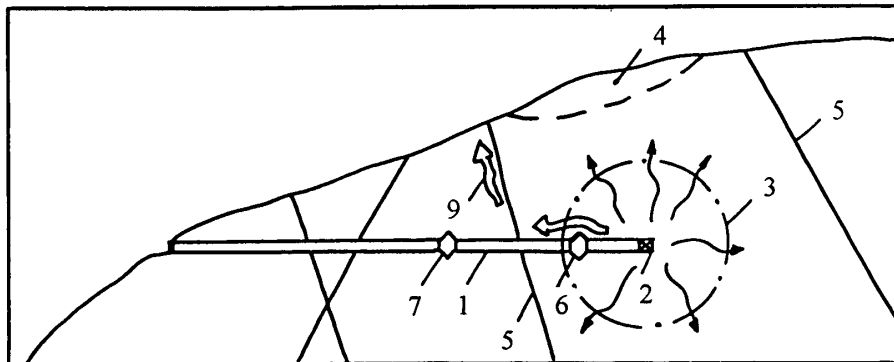

Figure 20. Illustration of gas release through a tectonic fault that intersects the tunnel between the first and second stemming sections: 1- tunnel works; 2- zero room; 3- damage zone radius; 4- spall zone; 5- tectonic faults; 6 and 7- first and second stemming; 9- gas flow through the tectonic fault.

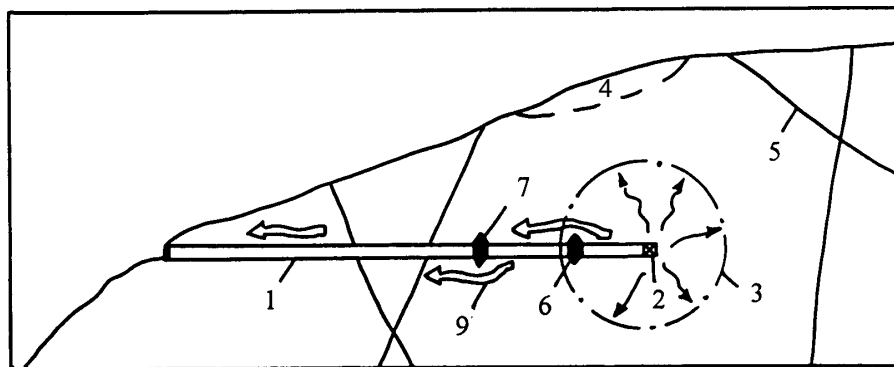

Figure 21. Illustration of gas release through the tunnel by migration around the stemming plugs: 1- tunnel works; 2- zero room; 3- damage zone radius; 4- spall zone; 5- tectonic faults; 6 and 7- first and second stemming; 9- gas flow through the tunnel and surrounding rock.

## 2.10 Record of Containment

The degree of containment of a specific underground test is determined from results of instrumental observations of the radiation environment at the test site. For this purpose, the intensity of radioactive emission is recorded at the time of the explosion, and for several hours thereafter, by sensors placed on the surface of the rock over the tunnel or bore hole. Radiation observations are also made from the air by using a helicopter and specially equipped flying laboratory.

On the day following the explosion, a radiation survey is done at the mouth of the tunnel and on the section of the emplacement tunnel situated after the second stemming. At the same time, the radiation environment on the surface of the rock mass is studied in detail, and points of emission of radioactive gases into the atmosphere are determined. Channels of preferential migration of gases through the broken rock mass or through tectonic faults are established from the intensity of gamma radiation.

Statistics show that predictions by the interdepartmental commission of the level of containment of tests are generally confirmed. Given below are basic statistics of emission of products into the atmosphere when conducting tests at Semipalatinsk and Novaya Zemlya Test Sites.



**Figure 22. Radioactive gas sampling equipment used at a tunnel in Degelen mountain by the Russian Institute for Radiation Safety. The person in the photograph is Dr. Yuri Dubasov of the Khlopin Radium Institute, St. Petersburg.**

	<u>STS</u>	<u>NZTS</u>
<b>Total number of explosions studied in detail</b>	<b>123</b>	<b>42</b>
<b>Discharge into the atmosphere through ground zero</b>	<b>73</b>	<b>24</b>
<b>Discharge of products through the excavation</b>	<b>36</b>	<b>1</b>
<b>Discharge of products through tectonic faults</b>	<b>14</b>	<b>3</b>
<b>Very faint signs of radiation ("full containment")</b>	<b>—</b>	<b>14</b>

It should be noted here that radioactive gases do get into the atmosphere in small amounts. Most of the products of explosion settle out in the containment cavity and in the section of the excavation before the first stemming.

## 2.11 “Tired Mountain” Syndrome

The underground detonation of nuclear explosions considerably alters the properties of the rock mass. Fracturing and rock breakage are extensive and markedly increased, and permeability is appreciably increased both in the rock mass itself and along isolated tectonic faults. For example, in the Dnepr-1 blast, the permeability of the rock mass was increased several times (near the containment cavity, permeability was increased by a factor of 40). The permeability of tectonic faults was increased by a factor of 2-12 on sections situated at a relative distance of up to  $150 \text{ m/kt}^{1/3}$  from the site of the explosion.

From results of engineering geology and geophysical research done to study the effect of tunnel explosions on the rock mass, the following zones have been distinguished (illustrated in Figures 3, 4; quantitative characteristics are given in Figures 24-27).

- The *cavity* usually has an ellipsoidal shape that is asymmetric relative to the center with average relative size of **7-14  $\text{m/kt}^{1/3}$**  depending on the strength properties of rocks.
- The *collapse column* is formed above the cavity, as a result of caving of broken rock situated above the confined underground explosion. The medium is characterized by a loosened rock mass with cleavage dimension close to that observed in the main zones of irreversible deformation of the medium. The height of the collapse column is 40-110 m. The dimension of fragmental material ranges from clay particles in the lower part to 10-15 cm or more on the outer boundary. The hydraulic conductivity of the rock mass in the collapse column may go as high as 200 Darcy. The porosity of fragmental material in the collapse column reaches 25%. Formation velocities are 2270 m/s.
- The *dome of stable equilibrium* (or “chimney”) is formed in contained underground explosions, and is characterized by the fundamental layering of rocks above the void over the collapse column. Its existence is determined mainly from the falling of the drill bit during reentry.
- The *zone of crushing* is in direct contact with the cavity and stretches to distances of **12-14  $\text{m/kt}^{1/3}$**  from the center of the explosion (relative thickness of up to  $3.7 \text{ m/kt}^{1/3}$ ). Rocks in this zone are pulverized, and readily break down to a sandy material under slight mechanical action. The strength and elastic properties of the rock are drastically reduced. The total porosity is 2-6 times the initial level, and the permeability of the rock is dramatically increased, to 0.4-1.13 Darcy.
- The *zone of elastic deformation* can be traced to distances as far as **14-70  $\text{m/kt}^{1/3}$** . In this zone, in addition to displacements of blocks of rock, a relatively intense crushing of the rock proper is observed, along with the formation of new fractures (Figure 27). Within the confines of this zone we can distinguish sub-zones of fracturing (out to distances of  $20\text{-}25 \text{ m/kt}^{1/3}$ ) and new cracks.

In the *sub-zone of fracturing*, the rock mass is fractured by new and reactivated natural cracks, and composed of blocks with individual dimensions from 2-3 to 5-7 cm. The total porosity of the rock mass reaches 10.5 %. The porosity of the rock mass is increased by a factor of 2-3 as compared with the initial level. The coefficient of filtration of the rock mass averages from 0.25 to 0.2 m/day, based on experimental pumping data.

--In the *sub-zone of new cracks* (to distances of **35-40  $\text{m/kt}^{1/3}$** ), the total number of cracks increases by a factor of 2-4. The rock mass acquires a pronounced block structure. The strength of the rock gradually increases from the center of the explosion toward the periphery, and elastic properties also become near natural.

--Observed farther out is a *zone of intense cracking* that extends to relative distances of **50-55  $\text{m/kt}^{1/3}$** . This zone is characterized by occurrence of new cracks along natural microcracks, structural elements of rocks and zones of mechanical weakening. Strength properties of the rock are reduced by 20-30%, acoustic properties — by 10-25%. The hydraulic conductivity of the medium is increased by a factor of as much as 1000, the greatest increase being noted along the

strike of the rocks. Formation of secondary cracks in this zone is observed in the direction of weakened tectonic zones. The number of cracks estimated from coring ranges from 4-6 per running meter to innumerable. The water permeability of the rocks is considerable, ranging from 0.001 to 10 m/day. The total porosity of the rock mass according to geological data is 10-25%.

--The *zone of block cracking* (zone of renewed cracks) is symmetric in shape, copying the zone of intense cracking in general outline. The radius of the zone in the plan view reaches **65-70  $m/kt^{1/3}$** . The strength properties of rocks in the zone are reduced by 10-15%, and acoustic properties — by 5-15%. The hydraulic conductivity of the medium ranges from 0.05 to 10 D.

2. Farther out, we can distinguish a *zone of inelastic deformations of rock mass* (situated at distances to **120-130  $m/kt^{1/3}$** , and in isolated directions may reach **150  $m/kt^{1/3}$** ). In this distance range, only occasional new cracks are encountered. Fissure opening is greatest for gently sloping cracks, while individual cessations, chips and displacements of blocks are observed along steep cracks. The width of fissure opening is more often 2-10 mm, and in the most weakened zones — 10-50 mm. The velocity of longitudinal waves in the rock mass is 5-10% less than the initial level. Permeability is near natural. In the region continuous with the outer boundary of the zone of irreversible behavior of rocks there is a ubiquitous sub-zone of reactivated cracks (at 50-60  $m/kt^{1/3}$ ).
3. *Zone of local inelastic deformations* (to distances of **200-220  $m/kt^{1/3}$** ). In this zone, inelastic deformations are instrumentally observed on structural fractures.
3. *Zones of spalling fracture* are formed in numerous underground explosions on the interface of media with differing acoustic impedance. On the free surface, spalling fractures are observed to occur at epicentral distances of 100-200  $m/kt^{1/3}$  (and, in isolated cases, out to 1000  $m/kt^{1/3}$ ). The depth of spalling fractures is determined by the specific structure of the rock mass at the location of the explosion (presence of tectonic fractures and other boundaries between rocks of different material composition) and is 10-32  $m/kt^{1/3}$ .

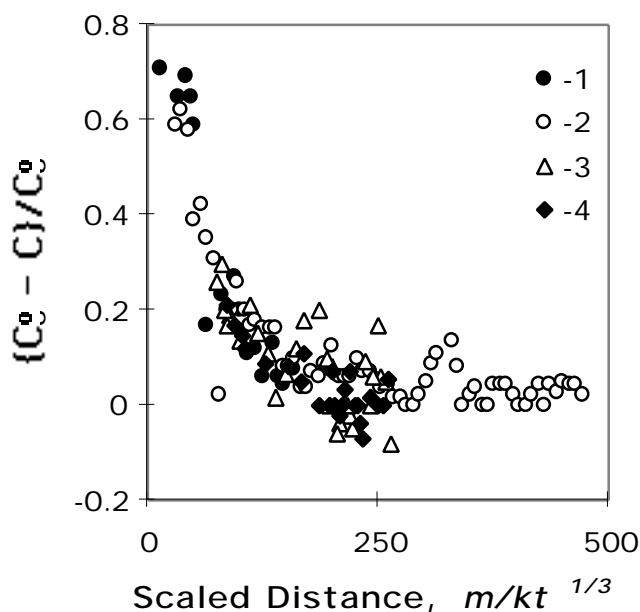

**Figure 24. Relative strength, C, of rock samples taken at different scaled distances  $r/q^{1/3}$  ( $q$  – yield) from the explosion, for tunnel-type emplacements: 1 — 8 Dec 67; 2 — 23 May 68; 3 — 30 Dec 71; 4 — Dnepr-1; 5 — 16 Dec 74; 6 — 15 Apr 84; 7 — 22 Apr 88.**

4. The zone of deformation of the free surface is generally represented by formation of residual cracks in the rock mass. In some experiments, this zone is characterized by upheaval of the rock mass, often with formation of a subsidence crater in the central part. The relative radius of the zone of rock upheaval is  $60\text{-}140 \text{ m/kt}^{1/3}$ . The height of the upheaval mound is  $0.7\text{-}2 \text{ m/kt}^{1/3}$ .

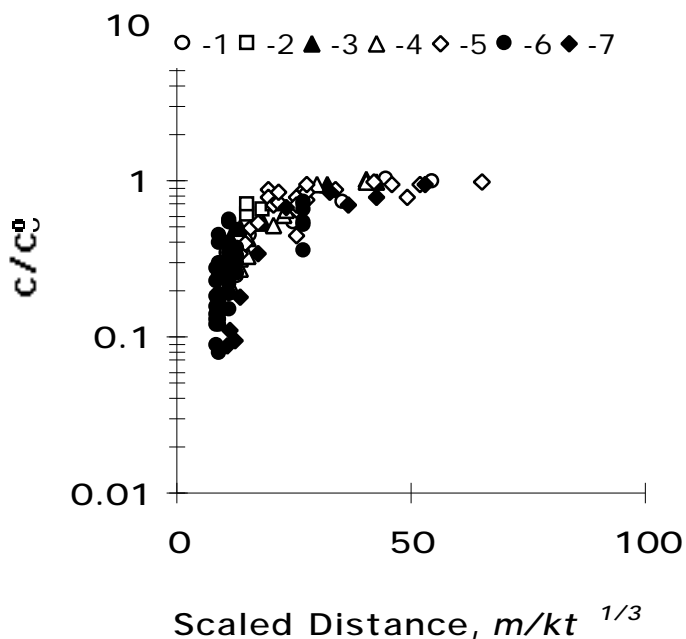

Fig. 25. Ratio of longitudinal velocity of wave propagation,  $C$ , to its initial value,  $C_0$ . Data from experiments: 1—8 Dec 67; 2—23 May 68; 3—30 Dec 71; 4—Dnepr-1; 5—16 Dec 74; 6—15 Apr 84; 7—22 Apr 88.

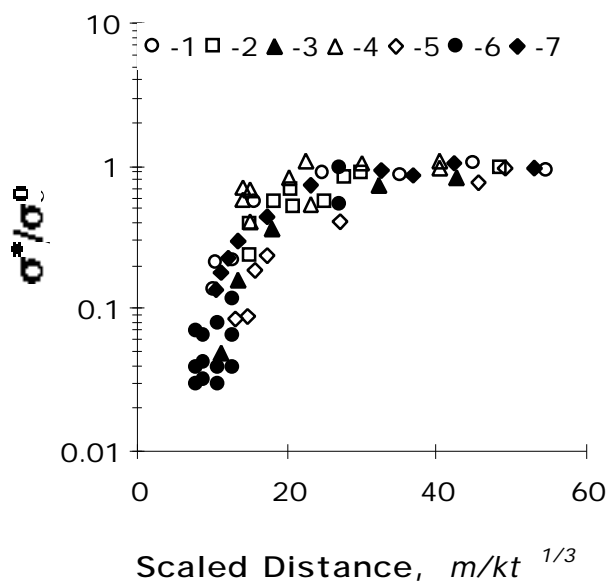
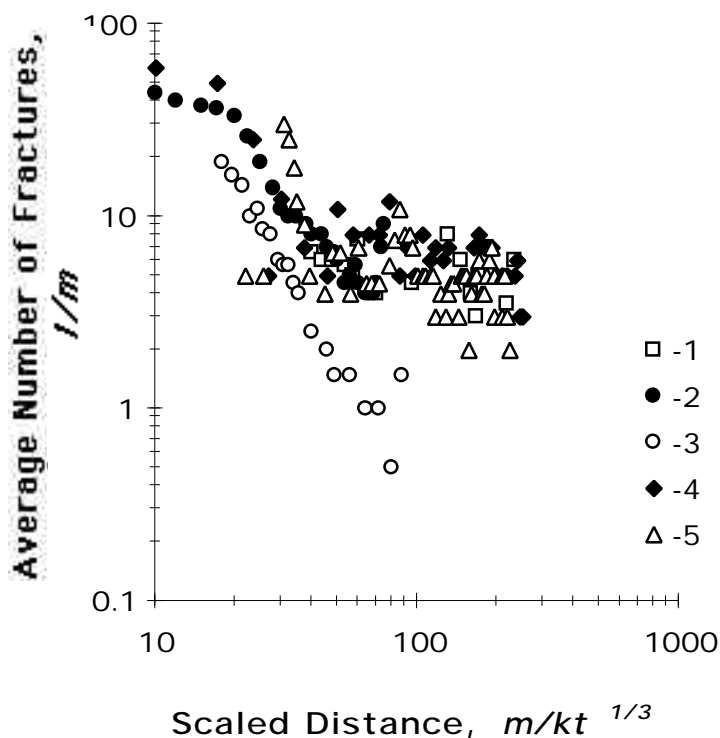

Fig. 26. Relative change in velocity of propagation of longitudinal (p-) waves in rock mass after explosion; experiments: 1—8 Dec 67; 2—15 Apr 84; 3—17 Jul 87; 4—23 Nov 88.





**Fig. 27. Average fracturing of the rock mass following the explosion: 1 — 8 Dec 67; 2 — 23 May 68; 3 — Dnepr-1; 4 — 15 Apr 84; 5 — 22 Apr 88**

These changes in properties of rocks and rock masses in the vicinity of previously conducted underground explosions impose certain requirements on selection of a location for conducting underground tests. The location of a new test must be chosen such that zones of increased fracturing of the rock mass from previously conducted explosions do not intersect with the planned explosion. However, even with such a site selection, the new test is not always fully contained. For example, in the case of emplacement in Degelen tunnel 113 (16 Feb 73), leakage of gaseous products was observed through ground zero of tunnel 510, where a test had been conducted previously (28 Jun 70). A similar phenomenon was observed at the Novaya Zemlya test site, where the gaseous products of an explosion in tunnel A-3 (7 Nov. 68) escaped into the atmosphere through an adjacent tunnel (A-8) in the same rock mass. In the subsequent test in tunnel A-8, on 27 Sep 71, allowances were made for the nearby location of tunnel A-3.

## 2.12 Statistics of the Containment History of Soviet Tests

As detailed in Chapter 1, a total of 363 underground nuclear explosions were conducted at the Semipalatinsk test site --more than 70% of the total number of underground tests conducted by the USSR. The first underground nuclear tests at Semipalatinsk were conducted in tunnels within Degelen mountain, where a total of 225 underground nuclear explosions were conducted between 1961 and 1989.

A summary of the record of containment of underground nuclear tests at the Semipalatinsk test site is available in *Gorin et al* (1993), who characterized containment using the following terminology:

**VVG** - Explosion with ejection of soil; accompanied by the destruction and movement of rock in the epicentral zone and the escape of radioactive by-products into the atmosphere in aerosol and gaseous phases; an ejection crater forms at the surface.

**VKP** - Fully contained explosion; accompanied by the formation of an underground cavity with corresponding compaction, crushing and fracturing of the rock around it, but the rock chimney prevents the escape or leakage of gaseous by-products into the atmosphere.

**VNK (RIG)** - Incompletely contained explosion; accompanied by the joining of the fracture zone and spalling damage to the earth's surface within the epicentral zone of the explosion, with insignificant ventilation into the atmosphere, as a rule, of short-lived radionuclides – inert gases (RIG):  $^{85}\text{Kr}$  ( $T^{1/2} = 4.5$  hrs, where  $T^{1/2}$  is the half life of the radionuclide);  $^{87}\text{Kr}$  ( $T^{1/2} = 76.3$  min),  $^{88}\text{Kr}$  ( $T^{1/2} = 2.84$  hrs),  $^{131}\text{Xe}$  ( $T^{1/2} = 11.9$  days),  $^{133}\text{Xe}$  ( $T^{1/2} = 5.2$  days),  $^{133\text{m}}\text{Xe}$  ( $T^{1/2} = 2.2$  days),  $^{135}\text{Xe}$  ( $T^{1/2} = 9.09$  hrs),  $^{135\text{m}}\text{Xe}$  ( $T^{1/2} = 15.3$  min),  $^{138}\text{Xe}$  ( $T^{1/2} = 14.17$  min);

**VNK (NRS)** - Incompletely contained explosion, with an irregular radiation situation (NRS), accompanied by early and pressurized dynamic release into the atmosphere of explosion by-products in the gas- and pressure-forming phase, caused by a random failure of the normal process of conducting a test or by unforeseen consequences of its design.

Statistically, *Gorin et al (op cit)* presented the containment record for Semipalatinsk underground explosions as follows:

50%	VKP
49%	VNK (RIG), including 4% VNK (NRS)
1%	VVG

emphasizing that only one test resulted in identifiable amounts of radioactive fallout beyond the boundaries of the former USSR. This was the test "Shagan" (January 15, 1965, characterized as VVG), which was conducted to develop nuclear-explosion technologies for creating artificial reservoirs by rock mass excavation. The remaining explosions therefore fulfilled the requirements of the Limited Test Ban Treaty for the criterion of "radioactive fallout".

Experience from the observation of the radiation consequences of these explosions has shown that the time of emergence of radioactive gases for most of the explosions in Degelen tunnels ranged from tens of minutes to several hours or days. Such a situation is owing to the extremely low gas-forming properties of the granites and quartzite porphyries comprising the main rock mass at Degelen. These are silicate rocks, with a mineral composition is dominated by quartz (20-40%), feldspar (60-70%) and plagioclase (15-25%). The gas-forming properties of these rocks are due solely to the content of moisture that is in pores and cracks of the rock mass in its natural state, and is generally low, ranging from 0.03 to 1.7%. In most experiments, the moisture content was 0.1-1%, and the excess pressure from water vapor in the shot cavity after condensation of rock vaporized by the nuclear explosion reached 1.2 to 3 atmospheres.

Sometimes when the moisture content in the rock increased to 1.5-2% in the spring, the water vapor pressure increased to 5-10 atm. Under such conditions, despite the small size of the shot cavity, the elevated permeability of fracture zones and the opening of tectonic fractures, there was no pressurized discharge of radioactive gases into the atmosphere. In many cases, the excess water vapor pressure was easily accommodated and condensed in cracks and pores formed by the explosion. Pressurized discharge of gases was also blocked by a melt with considerable mass of 300-400 metric tons per kt formed on the walls of the cavity and filling cracks near it.

Nevertheless, the time of emergence of radioactivity was considerably influenced by the ratio of depth of charge,  $W$ , to the cube root of yield of the device  $W/q^{1/3}$  (i.e., the normalized or "scaled" depth). The fact is that, in the range of  $W/q^{1/3} = 55-80$  m/kt $^{1/3}$ , in the region of an epicenter on the slope of a hill, a spalling crater was formed, reducing the thickness of the rock mass over the device. For example, at a scaled depth ( $W/q^{1/3}$ ) of 55-70 m/kt $^{1/3}$  the dimensions of the spalling crater were appreciable: radius  $R = (0.3-$

0.4)  $W$  and depth  $H = (0.15-0.2)W$ . The table below gives examples of explosions under such conditions, and shows the time  $t_0$  of emergence of radioactive gases into the atmosphere.

Tunnel	E-1	13	A-5	V-2	17	1	A-p	11
Rock	Granite	Quartz Porphyrites	Granite	Granite	Granite	Quartz Porphyrites	Granite	Granite
$W/q^{1/3}$ $m/kt^{1/3}$	59	61	62	65	67	68	68.5	68
, %	0	0.6	1.4	1.0	0.3	0.8	0.1	0.5
$t_0$	24 h	12 min	1.5 h	9 min	3.5 h	4.1 h	1 h	8 h

When the normalized depth of explosions was in a range of  $70-80 m/kt^{1/3}$ , the size of the spalling crater was reduced: radius —  $(0.15-0.3)W$ , depth  $(0.07-0.15)W$ . The table below gives examples of explosions under such conditions, and shows times of emergence of radioactive gases into the atmosphere.

Tunnel	Z-5	14	Zh-3	Zh-1	19	Z-1
Rock	Quartzite porphyries	Granite	Granite	Granite	Granite	Quartzite porphyries
$W/q^{1/3}$ $m/kt^{1/3}$	70	70.5	72	72	72	74
, %	0.12	0.6	0.8	0.2	0.6	0.1
$t_0$	14 h	2.5 h	3.3 h	3.5 h	5 h	18 h

And finally, in explosions with depth of charge placement greater than  $80 m/kt^{1/3}$ , no spalling crater was formed. Times  $t_0$  of emergence of radioactive gases under these conditions are given below for some explosions at the Degelen test site.

Tunnel	A-4	A	Zh-2	A-3	V-1	Z-3
Rock	Quartzite porphyries	Granite	Granite	Granite	Granite	Quartzite porphyries
$W/q^{1/3}$ , $m/kt^{1/3}$	87	91	92	93.5	97	133
, %	1.2	1.7	0.8	1.2	1.0	1.6
$t_0$	130 h	30 h	Several days	14 h	3.5 h	18 h

The data presented show that as the normalized depth of explosion increased, so did the time of emergence of radioactive gases as a whole, and with the exception of a few explosions conducted during the early years of testing at depths of  $55-65 m/kt^{1/3}$ , it was hours or days.

Consequently, the excess pressure of water vapor in the shot cavity was insufficient for pressurized flow, and radioactive gases escaped by the mechanism of thermal diffusion. In such a situation, slow displacement of warm gases upward through cracks in the rock mass was also aided by a "furnace effect" due to the difference in atmospheric pressure on the level of the tunnel and the upper section of the slope. In many cases, emergence of radioactive gases into the atmosphere was due to a change of atmospheric pressure. Let us also note that for times of emergence of gases of less than 1-3 hours, radioactivity in most explosions first appeared at the epicenter of the explosion on the slope. For later times of emergence, the first occurrence of radioactivity was noted at the mouth of the tunnel, and later in the region of the epicenter as well.

To make the picture complete, we note that for some nuclear explosions in tunnels of Degelen site, earlier emergence of radioactive gases into the atmosphere was recorded ( $t_0 = 3.5$  min). Such a situation occurred in 5 to 7 explosions (e.g., A-8sh, A-6sh, 11-p, 608-p and others). These were mainly low-yield

explosions, and were “repeat” shots; i.e., conducted within previously used tunnels of short length. The absolute depth of burial of the device was therefore also relatively shallow.

Beginning in 1965, underground nuclear explosions at STS started being conducted at Murzhik and Balapan sites. In all, 138 underground nuclear tests were conducted in the period of 1965-1989 in STS holes. Of these, 5 were under a program of peaceful explosions, including with formation of ejecta craters, 21 tests in holes at the Murzhik site, and 112 at Balapan.

The Balapan test site is situated in the eastern portion of the STS, and occupies an area of roughly 1000 km<sup>2</sup>. It is a flat plain with absolute elevations ranging from 240 to 350 m. Geologically, the structure of Balapan site is fairly complicated: the stratigraphic cross section is represented by faulted and metamorphosed volcanic-sedimentary layers in the form of alternating banks intersected by sub-vertical tectonic fractures of various orders. These folded structures are covered by sand-clay sediments, ranging in thickness from 3-10 m to 80-100 m.

The table below gives data of investigation of the mineralogical composition (in percent by weight) of sandstone and siltstone rocks taken from holes 101 and 1003 at the depth of charge placement.

Test Location	Rock		CO <sub>2</sub>	H <sub>2</sub> O	SiO <sub>2</sub>	MgO	Al <sub>2</sub> O <sub>3</sub>	CaO
Hole 101	Sandstone	12.8	6.0	6.8	48.6	23.2	7.0	8.4
Hole 1003	Siltstone	5.4	3.6	1.8	70.7	8.4	8.5	6.7

In this table, the quantity  $\gamma$  denotes the total gas content of the rock,  $\gamma_{CO_2}$  is the fraction of carbon dioxide that is formed, and  $\gamma_{H_2O}$  is the fraction of water vapor formed from minerals of the rock.

With respect to the time of the beginning of emergence of radioactive products of the explosion into the atmosphere and corresponding radiation effects, all explosions in holes can be divided into three groups.

- Early escape of radioactive gases into the atmosphere ranging from 10 s to 20 min was recorded in 30 borehole explosions. The normalized depth of burial of the device in this group ranged very widely, from 70 to 960 m/kt<sup>1/3</sup>. The total gas content of the rocks where the nuclear devices were placed ranged from 4.5% to 18%.

This group included 4 containment failure “accidents” with very early time of emergence: an explosion in hole 1204 (at  $W/q^{1/3} = 72$  m/kt<sup>1/3</sup> there was a gas breakthrough of the dome at the 12<sup>th</sup> second) and an explosion in hole 1007 (at  $W/q^{1/3} = 118$  m/kt<sup>1/3</sup> there was a gas breakthrough of the dome at the 20<sup>th</sup> second and ignition of gases in the atmosphere), and also explosions in holes 1301 and 1069 where the stemming and casing were blown out at  $W/q^{1/3} = 364$  m/kt<sup>1/3</sup> and  $W/q^{1/3} = 450$  m/kt<sup>1/3</sup> respectively. Also included in this group are two dislodging explosions: in hole 101 at  $W/q^{1/3} = 50.7$  m/kt<sup>1/3</sup> and in hole 125 at  $W/q^{1/3} = 56.2$  m/kt<sup>1/3</sup>.

In the other 24 shots of this group, radioactive gases escaped through man-made breaks produced during preparation of the explosions: through sampling ways, through the tubing-casing annulus and intercable space, through the emplacement and core holes.

- Later escape of radioactive gases ranging from 25 to 60 minutes was observed in 40 explosions, from 1 hour to 5 hours — in 30 explosions, and from 5 hours to 25 hours — in 10 explosions. The normalized depth of explosions of this group also ranged over wide limits (from 88 to 236 m/kt<sup>1/3</sup>), and the gas content of the rock was 2.6-14.4%.

With respect to these indices, the conditions of conducting explosions were practically the same as for the preceding group. In this most numerous group of 80 hole shots, radioactive gases propagated for a rather long time inside the rock mass through cracks and gaps between blocks without encountering direct channels of exit to the atmosphere.

As a result, the radiation consequences of these explosions could be minimized, and conditions of radiation containment could be observed (absence of propagation of radioactive products beyond national territorial limits).

Clearly, in explosions of this group the movement of gases in the rock mass was of filtration type, and occurred under the action of excess pressure in the shot cavity. The said later escape of gases was usually observed over a rather wide region of the epicentral zone, sometimes after formation of the cave-in column, and sometimes through the bottom of the subsidence crater (for example, hole 1066). In some explosions, on the concluding stage of the filtration process, gas escaped into the atmosphere through sites of location of core holes or research wells.

- In the third group of 23 explosions, there was no emission of radioactivity into the atmosphere. The normalized depth of explosions of this group ranged widely: from 96 to  $225 \text{ m/kt}^{1/3}$ , and the gas content of host rock reached 4-12%. With respect to these indices, the explosions of this group were practically the same as for the first and second groups, and are of little help in explaining the absence of gas escape into the atmosphere.

In our opinion, the reason that gases do not escape into the atmosphere in this group of explosion is the sealing action of the upper sand-clay layer, along with a high-quality stemming system and the sealing of other components in the epicentral zone. Indeed, the conditions of conducting these explosions differ only in terms of the thickness of a considerable layer of drift sediments, ranging from 25 to 90 m. For the explosions with escape of radioactive products into the atmosphere, the thickness of the drift was 3-30 m, and in only 10 shots was this layer 40-70 m thick. It is probable that the stemming was not of high quality in these detonations.

Thus, analysis of the specifics of propagation of radioactive gases in borehole shots at Balapan site has shown that *geological factors play an significant role in the evolution of radiation effects following an explosion*. For example, even at a considerable scaled depth of burial (more than  $100\text{-}150 \text{ m/kt}^{1/3}$ ), under conditions of rocks with high gas-forming properties and complex geological structure of the rock mass, escape of radioactive gases into the atmosphere may not be avoided.

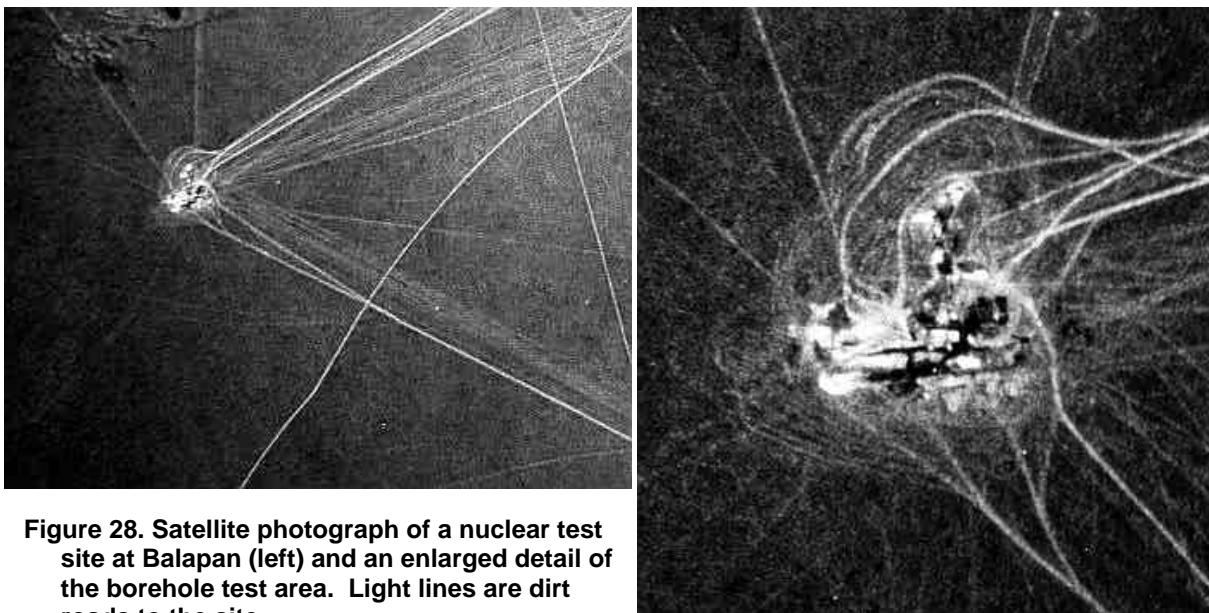

**Figure 28. Satellite photograph of a nuclear test site at Balapan (left) and an enlarged detail of the borehole test area. Light lines are dirt roads to the site.**

Containment of underground nuclear explosions at the Novaya Zemlya test sites was especially problematic. This was due initially due to the presence of carbonate rocks in the stratigraphic section (resulting in large volumes of non-condensable gasses. However, even when carbonate rocks were avoided (for tests at Matochkin Shar), the rock still included a significant amount of water, including intragranular water. The following table summarizes the major releases (over 1000 Ci) for underground nuclear tests on Novaya Zemlya (data taken from *Andrianov and Bazhenov*, 1992).

<u>Test No.</u>	<u>Date</u>	<u>release (Ci)</u>	<u>dose rate note</u>
A7, A9	14-Oct-69	large	>> 200 R/h <b>significant vent</b>
A1, A2	27-Oct-66	10,000,000	7 R/h megaton class,
A6	14-Oct-70	2,000,000	250 R/h megaton class
A26	25-Oct-84	1,081,081	500 R/h
A16	28-Aug-72	1,000,000	100 R/h megaton class
B	25-Oct-64	1,000,000	1.5 R/h low yield
A12	21-Oct-75	297,297	250 R/h megaton class
A3	07-Nov-68	10,000	5 R/h
A11	29-Aug-74	4,865	< 3 R/h megaton class
G	18-Sep-64	3,784	2 R/h low yield
A7P	09-Oct-77	2,973	1000 R/h at adit
A24	08-May-88	1,081	< 1 R/h
A37A	02-Sep-87	1,000	> 500 R/h <b>significant vent</b>
A37	11-Oct-82	1,000	0.25 R/h

### 2.13 A Few Examples

Presented below are a few examples typical of the majority of underground nuclear explosions in which radiation consequences have met safety standards.

#### Tunnel 215, Degelen Test Site (Semipalatinsk)

The explosion was conducted on 30 May 1983. The tunnel is cut in a quartz porphyry rock mass. Length of the tunnel is 780 m. Two nuclear devices with total yield of about 20 kt were detonated in the tunnel. The depth of emplacement of the devices was at 245 m and 180 m, with slant depths (line of least resistance, or *LLR*) of 221 m and 136 m respectively. Inside the tunnel, numerous tectonic cracks and faults opened along its entire length. Angles of dip of these fractures ranged from 40 to 80°. Several faults were rather large, having a width of 10-50 cm, and were filled with small-block material. Smaller faults 1-3 cm thick were cemented with frictionally produced kaolinite.

External manifestations of mechanical action of the underground explosion were characterized by an initial rate of elevation of the surface at ground zero of 11.5 m/s and height of elevation of the dome of 7-8 m. At isolated spots the height of ejecta was 15-20 m. Movement of individual large blocks could be clearly seen. The relative displacement of these blocks in the tunnel was 0.2-0.3 mm, and on the surface of the rock mass, displacements at points of emergence of large faults measured from 2-3 cm to 6-10 cm.

In an explosion in tunnel 215, instrumental observations were made of the movement of radioactive products through the tunnel and their emergence into the atmosphere. The dynamics of movement of radioactive products through the tunnel was as follows: radioactive products penetrated through the first section of the stemming system within 10 s after detonation, and were

recorded at a level of 10,000 roentgens per hour. Within 30 s, radioactive products were recorded beyond the second section of the stemming with level reaching approximately 10 roentgens per hour. Radioactivity showed up within 50 s beyond the first pressure wall at a level of less than 0.1 R/h. Radioactive products did not reach the mouth of the tunnel.

Thus, levels of radioactivity were reduced by 3-4 orders of magnitude after filtering through each component of the stemming system. In the region of the epicenter, radioactive gases were recorded within 2 hours after the explosion with maximum levels reaching 0.1-1 mR/h.

#### Tunnel K-85, Degelen Test Site (Semipalatinsk)

The explosion was conducted on 16 October 1987. The tunnel is cut in heavily fractured quartz porphyry. Length of the tunnel is 210 m. There are 10 tectonic faults lengthwise of the tunnel, of which the two closest to the mouth of the tunnel are 10 cm and 1.5 m thick, the other 8 ranging in thickness from 0.5 to 1-2 cm. The filler is frictionally produced kaolinite. Yield of the explosion was roughly 1 kt, LLR — 82 m.

Light-spot fiducial points were placed in the region of ground zero to record the initial rate of elevation of the free surface. The initial rate of elevation of the dome at the epicenter was 25 m/s. The maximum height of elevation of the dome at the epicenter was about 30 m. The dimension of the dome along the slope was roughly 150 m.

The epicentral zone of the blast was heavily fractured. A subsidence crater was formed. A mainline crack was formed in the lower part of the slope from 0.5 to 1 m wide and as long as 200 m. Inside the tunnel at a distance of roughly 70 m from the mouth there was a bend in the rails and cable duct, and it was above this location that the said mainline crack appeared on the slope.

Radioactivity sensors were placed along the tunnel. Radioactivity levels of about 1000 R/h were recorded near the first section of the stemming. Near the pressure wall — tens of R/h, and at the mouth of the tunnel — units. A radiation service helicopter flying at an altitude of 300-400 m around a circle with radius of 1.5-2 km recorded radioactivity of approximately 500  $\mu$ R/h at 72 s in the direction of wind blowing at 3.5 m/s.

This level of radioactivity persisted with slight fluctuations for about 10 minutes. At the tenth minute, the radioactive level began to rise in the area near the mouth of the tunnel. A considerable increase in the level of radioactivity (up to 100 mR/h) was recorded by the helicopter at the 15<sup>th</sup> minute.

#### Hole 1087, Balapan Test Site (Semipalatinsk)

The shot was conducted on 12 October 1980. Hole 1087 is situated 3.5 km to the north of man-made Lake Shagan produced by a cratering detonation in hole 1004. Two devices with total yield of 100 kt were detonated in the hole. The devices were placed at depths of 440 and 510 m. Emplacement of the upper device was in tuffaceous-sandstones, and the lower device in flinty siltstones. The density of rocks around the devices was 2650-2700 kg/m<sup>3</sup>, and the velocity of longitudinal waves was 4.6-5.1 km/s. Capping the rock mass was a clay layer about 50 m thick.

Under the action of the explosion, the initial rate of rise of the surface was 10 m/s. The outlines of the raised dome were uneven, and there was an abundance of vertical jets. The maximum height of the main mass of the dome was 10-15 m. Isolated jets rose above the dome as high as 20 m. After the dome had settled, rock upheaval was formed over an extensive area with radius of roughly 1 km. A mound about 1 m high and 400 m in radius appeared in the epicentral area.

A subsidence crater 0.6 m deep and 150 m in radius was formed in turn in the center of the mound. Escape of radioactive gases into the atmosphere was recorded within 66 minutes. The gas escaped through cracks in the upheaval mound and inside the subsidence crater. The measured level of radioactivity reached about 10 mR/h. The duration of active discharge of

radioactive gases was 1 hour and 15 minutes. Within 24 hours, radioactivity in the epicentral zone was roughly 100  $\mu\text{R/h}$ .

Hole 1066, Balapan Test Site (Semipalatinsk)

The shot was conducted on 23 July 1973. A nuclear device with yield of 150 kt was detonated at a depth of 465 m. The charge emplacement was in granites with inclusions of biotite. Density of the rock was  $2630 \text{ kg/m}^3$ , porosity 2.3%, velocity of longitudinal waves 5.14 km/s. Gas-forming properties of the rock with respect to weight were 3.66%, including moisture content on a level of 0.3-0.5%. The rock mass was covered over by a layer of loam drifts 13 m thick at the epicenter.

From results of high-speed cinematography the initial rate of rise of the free surface was measured at 21.2 m/s. The maximum height of rise of the dome at ground zero was 19 m. Isolated peak-like ejecta 5-10 m high could be seen in the epicentral part of the dome. A dust cloud was formed over the dome under the action of a stream of displaced air, persisting due to the complete absence of wind, and rising to a height of 50 m.

After the dome had settled, a subsidence crater was formed in the epicentral zone with radius of 110 m and maximum depth of 14 m, the radius of the crater with respect to the crest of the upheaval region reached 150 m, the maximum height of upheaval averaged 9 m, and the radius of the upheaval region reached 500-600 m.

Radioactive gases escaped into the atmosphere 25 hours after the shot. In the first hours after radioactivity was noted in the atmosphere, slow free-flow discharge of radioactive gases was observed, mainly through annular cracks formed on the periphery of the subsidence crater. Filtration of gases ended after about a day. During filtration of radioactive gases, levels of radiation were 200-300 mR/h. After filtration had ended, the radiation background within the confines of the subsidence crater and on the crest of the upheaval mound was 10-50 mR/h for the first few days.



**Figure 29. Drill rig, of the type used for drilling the nuclear test emplacement borehole. Normally, the emplacement borehole has a diameter of ~900 millimeters, and was drilled to depths ranging from 200 to about 1000 meters. The rig shown was that used to drill the hole for the Soviet nuclear test of the US-USSR Joint Verification Experiment, conducted at the Balapan test site in 1988.**



## Chapter 3. MONITORING ACCIDENTAL RADIATION RELEASES

### 3.1 Criteria for Conducting a Test

As has already been noted, the decision regarding the feasibility of conducting an underground nuclear test was made with allowance for the probable level of safeguards, both for keeping gaseous products of explosion under the ground, and for the specific weather situation at the proposed time of the shot. The latter is a very important factor for ensuring safety of underground nuclear tests, as the movement of air masses determines the nature and quantitative characteristics of transport of gaseous explosion products when they escape into the atmosphere. Specifically, the propagation of explosion products over the territory adjacent to the nuclear test site determines, in case of an accident, the doses received by individuals and the general populace.

The usual technology of conducting an underground test calls for ensuring full containment of the explosion, confining the radioactive products of the explosion underground. In doing so, an allowance has been made for the probability of escape of a small amount of radioactive materials in gaseous form at some time after the explosion. To develop requirements for radiation safety, a *State Radiation Safety Service* was set up in the USSR on 21 August 1947, even prior to the first nuclear tests (1947). This Service was transferred to the system of the Ministry of Public Health of the USSR, in the entity of the *Third Medical Administration*. This Administration was responsible for ensuring radiation safety for the entire period of nuclear testing.

The legal basis regulating the irradiation of personnel and the populace as a result of nuclear testing has been "*Sanitary Rules of Working With Radioactive Substances and Sources of Ionizing Radiation.*" These rules were first introduced legislatively in 1961. In accordance with these rules, exposure of the population was permitted up to 0.5 rem per year. Over the years, these rules were revised and expanded; yet, the basic figures remained the same. For example, "*Interim Sanitary Requirements on Ensuring Safety of Workers and the Populace When Using Underground Nuclear Explosions for Needs of the National Economy*" were developed and approved in 1967. These sanitary requirements, as well as the subsequently developed, "*Standards of Radiation Safety*" of 1969, 1976 and 1987, established the same "permissible exposure dose" of the populace at 0.5 rem per year. It was under these standards that underground nuclear tests were done in the USSR. Guidance for test site personnel were taken from "*Rules for Working with Radioactive Substances and Sources of Ionizing Radiation,*" effected in 1963 by order of the USSR Defense Ministry and renewed in 1976. The permissible "emergency levels of exposure" for personnel were, in practice, allowed to be used only in exceptional cases and by a special written decision of the Director of Tests.

In some cases, provisions had not been made for eliminating the probability of escape of radioactive gases to the atmosphere, creating the possibility of a radiation environment beyond the confines of the proving grounds with emission doses exceeding permissible levels. In these cases, the USSR Ministry of Defense, in cooperation with the Ministries of Nuclear Power and the Public Health, would be obligated to issue to the proving grounds a special permit for conducting the test with indication of the permissible external and internal exposure doses. It was mandatory that this information, as well as a list of additional measures to ensure safety, be included in a coordinated and approved "*List of Measures on Ensuring Safety When Conducting Tests of Classified Items at Proving Grounds.*"

There were also other important requirements that had to be met before underground nuclear tests could be conducted. For example, a test was prohibited if the wind was blowing toward sites where instrument structures were located and personnel would be working, or toward residential sectors of proving grounds (so-called "classified areas"). Favorable weather was defined as an anticyclone (high pressure) environment, with transport of air masses toward unpopulated areas, temperature conditions ensuring rapid rise of gases to considerable altitudes, and their dilution by atmospheric masses. The USSR *State Committee for Hydrometeorology* was responsible for the selection of adequate weather conditions.

During the conduct of a test, radiation monitoring was done both on the test site (by equipment installed in helicopters and vans), and in the surrounding territory. In the sector of possible propagation of air

masses from the region of ground zero, radiation observations were made by air reconnaissance patrols at distances out to 500 km and (if required) to the borders of the USSR.

### 3.2 Examples of Containment Failures

In some underground nuclear tests, the normal testing process was not followed, and unforeseen radiation situations occurred. Such situations usually occurred during the early and free-flow discharge of radioactive explosion products into the atmosphere. On the whole, these explosions were very few; less than 5% of the total number of tests. A few such explosions with unplanned radiation releases occurred when conducting borehole shots. Described below are two borehole shots where the emission of radioactive gases occurred as a result of breakthrough of the dome and rapid formation of a cave-in column. In tunnel emplacements, accidents rarely occurred, and only when conducting low-yield detonations (1 or 2 orders of magnitude less than a kiloton). Two experiments are described that exemplify such explosions.

#### Hole 1204, Balapan Test Site (Semipalatinsk)

The explosion was conducted on 10 December 1972. A 150 kt nuclear device was placed at a depth of 378 m in tuffaceous sandstones with interbedded porphyrite. The rocks were characterized by moderately heavy fracturing, and had a bulk density of 2680 kg/m<sup>3</sup>, a porosity of 2.4% and a longitudinal p-wave velocity of 4.63 km/s. The gas production of the rocks was 1-1.3% at 100°C and 10.8% at 1000°C. Thickness of surface deposits at ground zero was 40 m, of which 20 m was clay, covered with 20 m of sand, clay and gravel. Light-spot fiducial points were used to measure the initial rate of movement and height of rise of the dome at ground zero, which were 25.8 m/s and 32 m respectively. Within 12 seconds of the explosion, at a distance of 40 m from the epicenter, there was intense venting of cavity gases into the atmosphere with velocity of about 70 m/s. At 40-50 seconds, the gas column had risen to an altitude of 300-350 m. Within the next 18.4 s, there was another, weaker breakthrough of gases. Ultimately, an upheaval mound was formed in the epicentral region, with volume of about a million cubic meters, a radius of 560 m at the base, and an average height of 9.8 m. A subsidence crater 110 m in diameter and 36 m deep was formed in the central part of the upheaval region. Thus, in this explosion there was an early (12 s) and pressurized breakthrough of radioactive gases into the atmosphere. After 1.8 minutes, a radioactive cloud had formed above ground zero at altitude of about 350 m, moving in the direction of the wind at about 5-7 m/s. The cloud included short-lived radionuclides of inert gases: krypton with half-lives ranging from 76.3 minutes to 4.5 hours, and xenon with half-lives ranging from 14-15 minutes to 2-5 days. A radioactive trail with strontium and cesium fallout was formed on the surface of the ground in the direction of motion of the cloud. This explosion resulted in an unplanned radiation situation that led to irradiation of direct participants in the test beyond the established safety standards.

#### Hole 1207, Balapan Test Site (Semipalatinsk)

The explosion was conducted on 31 May 1974. A nuclear device with yield of about 40 kt was placed at a depth of 316 m. The host rocks of the emplacement were carbonaceous shales with density of 2710 kg/m<sup>3</sup>, porosity of 1.2% and velocity of longitudinal waves of 4.4 km/s. The carbonaceous shales were typified by high gas-forming properties, having total gas content of 10.8%, of which 10% by weight was water vapor, and 0.8% — carbon dioxide. Under the action of the explosion, the free surface started to move with initial velocity of 13.5 m/s. A dome was formed with height at the epicenter of 10 m and diameter of about 600 m. Within a few seconds, the dome had fallen to a height of 4-5 m. After roughly 10 minutes, the central part of the dome began to settle, forming a subsidence crater 200 m in diameter and 40 m deep 15 minutes after the explosion. Within 26 minutes after the explosion, escape of radioactive gases through cracks in the bottom of the subsidence crater was recorded. Suddenly at the 30<sup>th</sup> minute after the explosion, cavity gases broke through the bottom of the crater, mixed with oxygen in the air and began to burn. A fireball was formed that began growing rapidly in height and toward the sides, reaching an altitude of several hundred meters. Flame jets began springing up around the periphery of the upheaval region, and then through cracks on the free surface. The area on

which flame jets were springing up gradually increased. Radioactivity levels began to rise. Within 35 minutes after the explosion, test participants left the observation post. By that time, levels of radioactivity had reached 0.5 R/h. The occurrence of flame jets in the region of the epicenter on an area with radius of roughly 1-1.5 km lasted for 2 hours. The cause of occurrence of flame jets was that at the source of the explosion, as a result of strong heating of carbonaceous shales interbedded with coal, and occurrence of water vapor, chemical reactions of the type

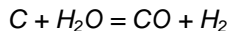

began taking place, i.e. carbon monoxide and hydrogen were produced. Gaseous hydrogen and carbon monoxide began to emerge into the atmosphere under the action of excess pressure, where they were ignited, mixing with oxygen of the air.

Tunnel 204-2, Test II, Degelen Test Site (Semipalatinsk)

The explosion was conducted on 5 December 1980. The tunnel was constructed in quartz porphyries. A low-yield device of roughly 0.1 kt was placed at a depth of 36 meters, with LLR of 33 meters. Immediately after the explosion (within approximately 1-2 s), there was an early breakthrough of gaseous products into the atmosphere through a tectonic fracture on the surface of the slope. This fracture cut through the tunnel between the first and second stemming plugs. Hence, products of explosion were thrown by the force of the blast through the first section of the stemming system and leaked out through the tectonic fracture. As the gases escaped, they were ignited in a ravine cutting across the slope in the region of emergence of the tectonic crack onto the surface.

Tunnel 609, Test II, Degelen Test Site (Semipalatinsk)

The explosion was conducted on 10 April 1976. The tunnel was constructed in granites. A low-yield device of about 0.1 kt was placed at a depth of 130 m with LLR of 100 m. Early escape of radioactive explosion products through the tunnel occurred within 12 s after detonation of the device. Levels of radioactive contamination near the mouth of the tunnel were 2.5 R/h.



**Figure 30. View of a structure at tunnel 169/2 constructed to hold a gas-filled bag used in a radiation effects experiment. In this test, radiation was directed out two diverging tunnels from a centrally-located device.**

Hole Yu-4, Krasino Test Site (Novaya Zemlya)

The shot was conducted in borehole "Yu-4" at the Krasino (southern Novaya Zemlya) testing area, on 27 Sep. 1973. The yield is estimated at 100 kt; and the, about  $190 \text{ m/kt}^{1/3}$ . The test was of an unexpectedly small device at great depth. Apparently, the venting occurred as a result of tectonic motion on an unidentified fault, which opened a passageway for the gasses to reach the surface [4]. Fault displacement was about 1 meter. The area contaminated was about  $1.5 \times 7 \text{ km}$ ; radiation readings made in 1990 were 25 microrem/hr of Cs-137 and Sr-90; fallout was  $0.1 \text{ Ci/km}^2$ .

Tunnel A-9, Matochkin Shar Test Site (Novaya Zemlya)

The nuclear test at tunnel site A-9 (Matochkin Shar testing area) was part of a double event at the northern testing area, on 14 Oct. 1969. The yield estimate of both events is 140 kt; the scaled depth of burial of A-9 was about  $100 \text{ m/kt}^{1/3}$ . Venting occurred by the explosive escape of gasses along a fault (apparently, without fault motion) that cut the tunnel between the two main stemming blocks and the blast door (see Figure 20). The failure mechanism apparently involved a moisture lens in the permafrost layer. About 10% of the radioactive gas escaped and personnel were evacuated. Containment practices were apparently changed because of this event.

Tunnel A-37, Matochkin Shar Test Site (Novaya Zemlya)

The nuclear test at tunnel site A-37A (Matochkin Shar testing area) took place on 2 Aug. 1987. The yield estimated at 70 kt; the SDOB about  $95 \text{ m/kt}^{1/3}$ . Like the 1969 test, venting occurred by escape of gasses along a fault (apparently, without fault motion) that cut the tunnel between the two main stemming blocks and the blast door (see Figure 20). About 10% of the radioactive gas escaped. An extensive description of the radiological conditions caused by this event given by *Andrianov and Bazhenov* (1992).

### 3.3 Groundwater Contamination

The territory of the Semipalatinsk Proving Grounds is characterized by complicated hydrogeological conditions. Hydrogeology here is represented by several aquifers (this is especially typical of Balapan site), as well as fissure water (Degelen Mountain) and seasonal precipitation. Degelen Mountain has several streams that flow through ravines and valleys, and also several springs.

In order to develop approaches and recommendations on preventing the transport of radioactive explosion products in the groundwater, the Institute of Dynamics of Geospheres of the Russian Academy of Sciences, in cooperation with the geological service of the proving grounds, carried out a special research program. This program was focused on determining the principles governing the influence that underground explosions have on the hydrogeological environment, both regionally and for individual test sites. Studies were done in more than 800 test holes drilled both on the territory of the proving grounds and outside its boundaries. Water samples were taken periodically in most holes. In some of the holes closest to epicenters of explosions, more detailed studies were done. These involved determinations of changes in the ground water regime as a result of an explosion, and changes in the chemical composition of water, including the presence and quantitative characteristics of any radioactive materials detected.

Efforts to study ground water began after the first underground explosions were conducted at the Semipalatinsk test site. A very thorough study was done on the radiation situation with ground water for the first shots in boreholes 1003 and 1004. Test holes were investigated, and also the water from wells in populated areas, such as Sarapan, Musa, Karabas and Chagan. Water samples taken from holes and wells contained isotopes of strontium, ruthenium, barium, zirconium, cerium, iron and cesium. The amount of these isotopes was below the permissible level defined by "Standards of Radiation Safety."

### 3.4 How Safe is Safe Enough?

Radiation monitoring, as has been noted above, includes several measures:

- detailed study of the radiation environment on test sites with recording of the time of emergence of gaseous explosion products into the atmosphere and their amount;
- detailed radiation monitoring of proving ground territory and ground water in each test,
- aircraft monitoring of nearby and remote territories.

Experience shows that with such an arrangement of radiation monitoring systems, it is almost impossible to miss a leak of radioactive gases into the atmosphere or transport of radionuclides with ground water.

However, variability in the properties of actual rock masses and in the conduct of a specific underground nuclear tests preclude any *guarantee* of achieving complete containment of an underground explosion. Experience shows that, no matter how careful the analysis of conditions of conducting the test, or how rigorous the approach to selecting the site and depth of emplacement of the device, there still may be cases of escape of gaseous products of explosion into the atmosphere, albeit small in volumes. Actually, methods used for diagnosing the rock mass (e.g., seismic surveying) give a generalized picture of fracturing of the medium, but are not capable of distinguishing important details such as the opening (“penetrability”) of an individual tectonic fault or large crack. This information may not be fully obtained, even by detailed studies of tectonic fractures in a tunnel.

The situation becomes much more complicated when tests are done in a rock mass where underground explosions have been done previously. In this case, precise estimates must be made of the dimensions of zones of fracture due to the previous and planned shots. Despite considerable experience and a great deal of experimental results, it is difficult to determine the exact boundaries of the zone of fracture of an underground explosion, since individual features of the structure of each specific rock mass may appreciably affect both the dimensions of the fracture zone and the zone affected by the explosion.

Ensuring the containment of an explosion requires considerable expenditures (e.g., for drilling a very deep hole and implementing special, high-cost measures to seal it). For example, when organizing tests in tunnels, cost considerations resulted in grouping the tunnel portals to the extent possible. This made it difficult to space the epicenters of neighboring shots far apart. A similar tradeoff happens when selecting the depth of an explosion. In order to achieve large depths, very long tunnels would have to be driven, which was economically inadvisable. Further, when the boundaries of the proving ground are limited, care had to be exercised in using up the sites that were suitable for underground tests.

All this brings up the question, “Where are the reasonable limits to ensuring full containment (or radiation safety) of nuclear tests?” Some scientists assert that, given appropriate selection of geological conditions and a high-quality stemming system, the short-term escape of radioactive gases into the atmosphere can be almost entirely eliminated. Success depends not only on results of analysis of geological and engineering characteristics of a specific planned test, but also on experience and, in part, on the intuition of the decision-making experts. When selecting the conditions for conducting a nuclear test, the primary consideration is the possible negative impact of radiation on the health of people living near the proving grounds, and the personnel working thereon. During Soviet underground nuclear testing, the conditions for conducting a test were considered acceptable if the dose of the exposure to personnel and the population of nearby settlements did not exceed permissible levels, even in case of an accidental release.

#### **Acknowledgements**

We are grateful for reviews of the manuscript that were provided by Randy Beaty, Al Bezek, Rod Matzko, Paul Orkild, Gregory van der Vink, and two anonymous reviewers, and for the substantial technical assistance and review provided by Alexander Spivak.

## Bibliography and References

- Adushkin, V.V., and others, 1993, *Description of the Environmental State on the Russian Nuclear Test Site (Novaya Zemlya)*, report to the Defense Nuclear Agency, P.O. DNA001-92-M-0714
- Adushkin, V.V., and A.A. Spivak, 1994, *Geologic Characterization and Mechanics of Underground Nuclear Explosions*, report to the Defense Nuclear Agency. Alexandria, VA, 796 p.
- Adushkin, V.V., and A.A. Spivak, 2001, *Characterization of the Release of Radioactive Underground Explosion Products into the Atmosphere*, preprint, RAS/IDG, xxx pp.
- Agreements and Protocols Between the Union of Soviet Socialist Republics and the United States of America "On Limiting Underground Nuclear Weapons Tests", 1974, and "On Underground Nuclear Explosions for Peaceful Purposes", 1976, *Catalogues of the Council of Peoples' Deputies, USSR and the USSR Supreme Soviet*, 1991. No. 21.
- Andrianov, K. N. and Bazhenov, 1992, *Nuclear Explosions in the USSR. Vol. 1: Northern Test Site*, V. N. Mikhaylov, ed., International Commission on ... Underground Nuclear Explosions, V. G. Khlopin Raduim Institute (Moscow).
- Bocharov, V.S., S.A. Zelentsov and V.I. Mikhaylov, 1989, Characteristics of 96 underground nuclear explosions at the Semipalatinsk nuclear polygon, *Atomnaya Energiya*, v. 67, n. 3, p. 210-214
- Chernyshev, A., 1991, *On the preparation for conducting nuclear explosions at the northern test site (Novaya Zemlya)*, unpublished, Canadian Centre for Arms Control, 56 pp. (transl. L. Bykowski, DNA Springfield Res. Fac., 1991).
- Chukhin, S.G., 1992, The Truth of Chagan, *Energiya*, No. 12.
- Department of Energy, 1994, *United States Nuclear Tests*, Rept. DOE/NV-209 (Rev. 11), Dec. 1994.
- Dubasov, Iu.V.; Matushchenko, A.M.; Filonov, N.P. et al., 1993, Semipalatinsk Test Site: Evaluating the Radioecological Consequences, *Bulletin of the Center of Public Information on Atomic Energy*, Special Issue, 20 January 1993.
- Dubasov, Yu.V., and others, 1998, Chronology of nuclear tests conducted in the USSR in the atmosphere, space and underwater (1949-1962), *Atomnaya Energiya I Oborona*, pp. 36-43.
- Gorin, V.V., Semipalatinsk Test Site: Chronology of Underground Nuclear Explosions and their Initial Radiation Effects (1961-1989), *Atomnaya Energiya*, v. xxx, n. xxx, p. xxx.
- Higgins G.H. Nuclear explosions data for underground engineering applications," in *Peaceful Nuclear Explosions*, IAEA Vienna, 1970, p. 111-122.
- Izrael', Iu.A., 1974, *Peaceful Nuclear Explosions and the Environment*, Gidrometeoizdat, Leningrad.
- Laushkin, V.A., S.I. Oreshin and V.M. Ovtchinnikov, 1995, *Regional analysis of former Soviet Union peaceful nuclear explosions recorded in the former Soviet Union*, contract report EOARD SPC-94-4065, RAS/IDG, 53 pp.
- Leith, W., 1988, *Degelen nuclear test and tunnel data*, Technical Memorandum to the Defense Special Weapons Agency, dated June 26, 1998, 10 pp. (revised 7/1/2001).
- Matushchenko, A.M.; Bazhenov, V.N.; Dumik, V.P.; et al. *Underground Nuclear Tests: Conditions for Conducting them per the Criteria of the Moscow Treaty 1963*, Information Bulletin. 1992. No. 9. (Center of Public Information on Atomic Energy.)
- Mikhaylov, V.N., 1991, Untitled report, *General Region Characteristics (Novaya Zemlya)*, unpublished, Canadian Centre for Arms Control, 10 pp.
- Mikhaylov, V.N., and others, 1992, Chronicle and phenomenology of nuclear tests on the Novaya Zemlya test range, pp. 1-14 in *Proc. Conf., The Radiological and Radiation Protection Problems in Nordic Regions*, Nordic Soc. For Radiation Protection, Oslo.

- Nuclear Testing in the USSR: General Characteristics Concerning the Organization of Nuclear Tests in the USSR*, V.N. Mikhaylov, dir., Izdat, 1997, 304 pp.
- Nuclear Testing in the USSR*, Vol. 1, I.A. Andryushin and others, eds., RFYaTs-VNIIEF, 1997, 95 pp.
- Nuclear Testing in the USSR*, Vol. 2, Technology of Nuclear Testing, I.A. Andryushin and others, eds., RFYaTs-VNIIEF, 1997, 320 pp.
- Nuclear Testing in the USSR*, Vol. 4, Peaceful applications of underground nuclear explosions V.I. Mikhaylov, ed., RFYaTs-VNIIEF, 1997, 155 pp.
- Nuclear Testing in the USSR*, Vol. 3: Nuclear Weapons, Military and Political Aspects, I.A. Andryushin and others, eds., RFYaTs-VNIIEF, 2000, xxx pp.
- Nuclear Testing in the USSR*, Vol. 5: Nuclear Tests and Ecology, I.A. Andryushin and others, eds., RFYaTs-VNIIEF, 2000, xxx pp.
- Nuclear Testing in the USSR*, Vol. 6, Legacy of the Atomic Era, I.A. Andryushin and others, eds., RFYaTs-VNIIEF, 2000, xxx pp.
- Nuclear Explosions in the USSR: Northern Test Site: Nuclear Explosions, Radiology, Radiation Safety. Vol 1. (Information Handbook)*; Edited by V.N. Mikhailov, G.E. Zolotukhin, A.M. Matushchenko. St. Petersburg, NPO "V.G. Khlopin Radium Institute," 1992, 195 pp. [transl. JPRS-UEQ-93-009-L]
- Nuclear Testing in the USSR: Semipalatinsk Polygon*, N.P. Voloshin and others, eds., MEDBIOEKSTREM, 1997, 320 pp.
- Olsen E.W. Time history of the cavity pressure and temperature following a nuclear detonation in alluvium.- *J. Geophys. Res.*, 1967, No.20, p. 5037-5041.
- Schoengold C.R., DeMarre M.E., Kirkwood E.M., *Radiological effluence released from U.S. continental tests, 1961 through 1992*, U.S.Department of Energy. Nevada Operation Office. Las Vegas, Nevada. 1996, 276 pp.
- Spungin, V.G., and L.S. Panteleev, 1998, Effect of the block-fault structure of a rock mass on its destruction due to underground nuclear explosions: A case study of the Novaya Zemlya test site, *Environmental Geosci.*, v. 1, n. 2, pp. 118-126.
- Sultanov, D.D., 1993, *Investigation of seismic efficiency of Soviet peaceful nuclear explosions conducted in various geological conditions*, RAS IDG, 220 pp.
- Sultanov, D.D., Murphy, J.R.; Rubinstein, K.D., 1999, A seismic source summary for Soviet peaceful nuclear explosions, *Bull. Seismol. Soc. Am.*, v. 89, n. 3, pp. 640-647
- Terminology Dictionary for Issues Concerning the Use of Underground Nuclear Explosions for Peaceful Purposes: Glossary*, O.L. Kedrovskiy, M.P. Grechushkina, L.B. Prozorov, eds., Moscow, 1981.
- Treaty on Prohibiting Nuclear Weapons Tests in the Atmosphere, in Space and Under Water*, in Catalogues of the USSR Supreme Soviet, No. 42,16 Oct. 1963.
- USSR Nuclear Tests. Hydronuclear Experiments. Plutonium Inventory*, I.A. Andryushin and others, eds., RFYaTs-VNIIEF, 1997-98, 22 pp.
- USSR Nuclear Weapons Tests and Peaceful Nuclear Explosions 1949 through 1990*, I.A. Andryushin and others, eds., RFYaTs-VNIIEF, 1996, 63 pp.
- van der Vink, G. E., 1989, *Containment of Underground Nuclear Explosions*, US Office of Technology Assessment, Washington, 83 pp. (NTIS no. PB90-156183INZ).